

ETSI TS 129 163 V12.10.0 (2016-01)



**Digital cellular telecommunications system (Phase 2+);
Universal Mobile Telecommunications System (UMTS);
LTE;
Interworking between the IP Multimedia (IM) Core Network (CN)
subsystem and Circuit Switched (CS) networks
(3GPP TS 29.163 version 12.10.0 Release 12)**



Reference

RTS/TSGC-0329163vca0

Keywords

GSM,LTE,UMTS

ETSI

650 Route des Lucioles
F-06921 Sophia Antipolis Cedex - FRANCE

Tel.: +33 4 92 94 42 00 Fax: +33 4 93 65 47 16

Siret N° 348 623 562 00017 - NAF 742 C
Association à but non lucratif enregistrée à la
Sous-Préfecture de Grasse (06) N° 7803/88

Important notice

The present document can be downloaded from:
<http://www.etsi.org/standards-search>

The present document may be made available in electronic versions and/or in print. The content of any electronic and/or print versions of the present document shall not be modified without the prior written authorization of ETSI. In case of any existing or perceived difference in contents between such versions and/or in print, the only prevailing document is the print of the Portable Document Format (PDF) version kept on a specific network drive within ETSI Secretariat.

Users of the present document should be aware that the document may be subject to revision or change of status. Information on the current status of this and other ETSI documents is available at
<http://portal.etsi.org/tb/status/status.asp>

If you find errors in the present document, please send your comment to one of the following services:
<https://portal.etsi.org/People/CommitteeSupportStaff.aspx>

Copyright Notification

No part may be reproduced or utilized in any form or by any means, electronic or mechanical, including photocopying and microfilm except as authorized by written permission of ETSI.

The content of the PDF version shall not be modified without the written authorization of ETSI.
The copyright and the foregoing restriction extend to reproduction in all media.

© European Telecommunications Standards Institute 2016.
All rights reserved.

DECT™, **PLUGTESTS™**, **UMTS™** and the ETSI logo are Trade Marks of ETSI registered for the benefit of its Members.
3GPP™ and **LTE™** are Trade Marks of ETSI registered for the benefit of its Members and of the 3GPP Organizational Partners.
GSM® and the GSM logo are Trade Marks registered and owned by the GSM Association.

Intellectual Property Rights

IPRs essential or potentially essential to the present document may have been declared to ETSI. The information pertaining to these essential IPRs, if any, is publicly available for **ETSI members and non-members**, and can be found in ETSI SR 000 314: *"Intellectual Property Rights (IPRs); Essential, or potentially Essential, IPRs notified to ETSI in respect of ETSI standards"*, which is available from the ETSI Secretariat. Latest updates are available on the ETSI Web server (<https://ipr.etsi.org>).

Pursuant to the ETSI IPR Policy, no investigation, including IPR searches, has been carried out by ETSI. No guarantee can be given as to the existence of other IPRs not referenced in ETSI SR 000 314 (or the updates on the ETSI Web server) which are, or may be, or may become, essential to the present document.

Foreword

This Technical Specification (TS) has been produced by ETSI 3rd Generation Partnership Project (3GPP).

The present document may refer to technical specifications or reports using their 3GPP identities, UMTS identities or GSM identities. These should be interpreted as being references to the corresponding ETSI deliverables.

The cross reference between GSM, UMTS, 3GPP and ETSI identities can be found under <http://webapp.etsi.org/key/queryform.asp>.

Modal verbs terminology

In the present document "**shall**", "**shall not**", "**should**", "**should not**", "**may**", "**need not**", "**will**", "**will not**", "**can**" and "**cannot**" are to be interpreted as described in clause 3.2 of the [ETSI Drafting Rules](#) (Verbal forms for the expression of provisions).

"**must**" and "**must not**" are **NOT** allowed in ETSI deliverables except when used in direct citation.

Contents

Intellectual Property Rights	2
Foreword.....	2
Modal verbs terminology.....	2
Foreword.....	15
1 Scope	16
2 References	16
3 Definitions and abbreviations.....	22
3.1 Definitions	22
3.2 Abbreviations	22
4 General	24
4.1 General interworking overview	24
5 Network characteristics	25
5.1 Key characteristics of ISUP/BICC based CS networks	25
5.2 Key characteristics of IM CN subsystem	25
6 Interworking with CS networks	26
6.1 Interworking reference model	26
6.1.1 Interworking reference points and interfaces	26
6.1.2 Interworking functional entities	26
6.1.2.1 Signalling Gateway Function (SGW)	26
6.1.2.2 Media Gateway Control Function (MGCF)	27
6.1.2.3 IP Multimedia – Media Gateway Function (IM-MGW)	27
6.2 Control plane interworking model.....	27
6.3 User plane interworking model	27
7 Control plane interworking	27
7.1 General	27
7.2 Interworking between CS networks supporting ISUP and the IM CN subsystem	28
7.2.1 Services performed by network entities in the control plane	29
7.2.1.1 Services performed by the SS7 signalling function	29
7.2.1.2 Services of the SGW	29
7.2.1.3 Services of the MGCF.....	29
7.2.1.4 Services of the SIP signalling function	29
7.2.2 Signalling interactions between network entities in the control plane.....	29
7.2.2.1 Signalling between the SS7 signalling function and MGCF.....	29
7.2.2.1.1 Signalling from MGCF to SS7 signalling function	29
7.2.2.1.2 Signalling from SS7 signalling function to MGCF	29
7.2.2.1.3 Services offered by SCTP and M3UA.....	29
7.2.2.2 Signalling between the MGCF and SIP signalling function.....	30
7.2.3 SIP-ISUP protocol interworking.....	30
7.2.3.1 Incoming call interworking from SIP to ISUP at I-MGCF	30
7.2.3.1.1 Sending of IAM.....	30
7.2.3.1.2 Coding of the IAM	31
7.2.3.1.2A Coding of the IAM when Number Portability is supported.....	45
7.2.3.1.2B Coding of the IAM for Carrier Routeing.....	48
7.2.3.1.3 Sending of COT.....	48
7.2.3.1.3A Sending of SAM.....	49
7.2.3.1.4 Sending of 180 ringing	50
7.2.3.1.4A Sending of 183 Session Progress for early media scenarios.....	53
7.2.3.1.4B Sending of 181Call is being forwarded	56
7.2.3.1.4C Sending of 183 Session Progress for overlap signalling using the in-dialog method	57
7.2.3.1.4D Sending of 183 Session Progress to carry ISUP Cause	57
7.2.3.1.4E Sending of 183 Session Progress for ICS call	57

7.2.3.1.5	Sending of the 200 OK (INVITE)	58
7.2.3.1.6	Sending of the Release message (REL).....	60
7.2.3.1.7	Coding of the REL.....	60
7.2.3.1.8	Receipt of the Release Message	61
7.2.3.1.9	Receipt of RSC, GRS or CGB (H/W oriented)	63
7.2.3.1.9a	Receipt of REFER	64
7.2.3.1.10	Autonomous Release at I-MGCF	64
7.2.3.1.11	Internal through connection of the bearer path.....	65
7.2.3.2	Outgoing Call Interworking from ISUP to SIP at O-MGCF.....	65
7.2.3.2.1	Sending of INVITE	65
7.2.3.2.1a	Sending of INVITE without determining the end of address signalling.....	68
7.2.3.2.2	Coding of the INVITE.....	70
7.2.3.2.2A	Coding of the INVITE when Number Portability is supported	81
7.2.3.2.2B	Coding of the INVITE for Carrier Routeing	83
7.2.3.2.2C	Coding of INVITE with instance-id in form of IMEI URN	83
7.2.3.2.3	Receipt of CONTINUITY	84
7.2.3.2.4	Sending of ACM and awaiting answer indication	85
7.2.3.2.5	Coding of the ACM	87
7.2.3.2.6	Sending of the Call Progress message (CPG).....	90
7.2.3.2.7	Coding of the CPG	92
7.2.3.2.7a	Receipt of 200 OK(INVITE).....	94
7.2.3.2.7b	Internal through connection of the bearer path.....	94
7.2.3.2.8	Sending of the Answer Message (ANM).....	94
7.2.3.2.9	Coding of the ANM.....	94
7.2.3.2.10	Sending of the Connect message (CON)	96
7.2.3.2.11	Coding of the CON.....	96
7.2.3.2.11A	Receipt of a reINVITE request.....	96
7.2.3.2.12	Receipt of Status Codes 4xx, 5xx or 6xx.....	96
7.2.3.2.13	Receipt of a BYE.....	99
7.2.3.2.14	Receipt of the Release Message	99
7.2.3.2.15	Receipt of RSC, GRS or CGB (H/W oriented)	99
7.2.3.2.16	Autonomous Release at O-MGCF.....	99
7.2.3.2.17	Special handling of 580 precondition failure received in response to either an INVITE or UPDATE	100
7.2.3.2.18	Sending of CANCEL.....	100
7.2.3.2.19	Receipt of SIP redirect (3xx) response	101
7.2.3.2.20	Sending of INFO for overlap signalling using the in-dialog method	101
7.2.3.3	Timers	102
7.3	Interworking between CS networks supporting BICC and the IM CN subsystem.....	102
7.3.1	Services performed by network entities in the control plane	103
7.3.2	Signalling interactions between network entities in the control plane.....	103
7.3.2.1	Signalling between the SS7 signalling function and MGCF.....	103
7.3.2.1.1	Signalling from MGCF to SS7 signalling function	103
7.3.2.1.2	Signalling from SS7 signalling function to MGCF	103
7.3.2.1.3	Services offered by STC, SCTP and M3UA	104
7.3.2.2	Signalling between the MGCF and SIP signalling function.....	104
7.3.3	SIP-BICC protocol interworking	104
7.3.3.1	Incoming call interworking from SIP to BICC at I-MGCF.....	104
7.3.3.1.1	Sending of IAM.....	104
7.3.3.1.2	Coding of IAM	104
7.3.3.1.2A	Coding of the IAM when Number Portability is supported.....	105
7.3.3.1.2B	Coding of the IAM for Carrier Routeing	105
7.3.3.1.3	Sending of COT.....	106
7.3.3.1.3A	Sending of SAM	106
7.3.3.1.4	Sending of 180 Ringing.....	106
7.3.3.1.4A	Sending of 183 Session Progress for early media scenarios.....	106
7.3.3.1.4B	Sending of 181 Call is being forwarded	106
7.3.3.1.4C	Sending of 183 Session Progress for overlap signalling using the in-dialog method	106
7.3.3.1.4D	Sending of 183 Session Progress for carry ISUP Cause	106
7.3.3.1.4E	Sending of 183 Session Progress for ICS call	106
7.3.3.1.5	Sending of the 200 OK (INVITE)	107
7.3.3.1.6	Sending of the Release message (REL).....	107

7.3.3.1.7	Coding of the REL.....	107
7.3.3.1.8	Receipt of the Release Message	107
7.3.3.1.9	Receipt of RSC, GRS or CGB (H/W oriented)	107
7.3.3.1.9a	Receipt of REFER	107
7.3.3.1.9b	Autonomous Release at I-MGCF	107
7.3.3.1.10	Internal through connection of the bearer path.....	107
7.3.3.1.11	Out of Band DTMF	107
7.3.3.2	Outgoing Call Interworking from BICC to SIP at O-MGCF	107
7.3.3.2.1	Sending of INVITE	107
7.3.3.2.1a	Sending of INVITE without determining the end of address signalling.....	108
7.3.3.2.2	Coding of the INVITE.....	108
7.3.3.2.2A	Coding of the INVITE when number portability is supported	109
7.3.3.2.2B	Coding of the INVITE for Carrier Routeing	109
7.3.3.2.2C	Coding of INVITE with instance-id in form of IMEI URN	109
7.3.3.2.3	Sending of UPDATE.....	109
7.3.3.2.4	Sending of ACM and Awaiting Answer indication.....	110
7.3.3.2.5	Coding of the ACM	110
7.3.3.2.6	Sending of the Call Progress message (CPG).....	110
7.3.3.2.7	Coding of the CPG	110
7.3.3.2.7a	Receipt of 200 OK (INVITE).....	110
7.3.3.2.7b	Internal through connection of the bearer path.....	110
7.3.3.2.8	Sending of the Answer Message (ANM).....	110
7.3.3.2.9	Coding of the ANM.....	110
7.3.3.2.10	Sending of the Connect message (CON)	110
7.3.3.2.11	Coding of the CON.....	110
7.3.3.2.11A	Receipt of re-INVITE requests.....	111
7.3.3.2.12	Receipt of Status Codes 4xx, 5xx or 6xx.....	111
7.3.3.2.13	Receipt of a BYE.....	111
7.3.3.2.14	Receipt of the Release Message	111
7.3.3.2.15	Receipt of RSC, GRS or CGB (H/W oriented)	111
7.3.3.2.16	Out of Band DTMF	111
7.3.3.2.17	Sending of CANCEL.....	111
7.3.3.2.18	Autonomous Release at O-MGCF.....	111
7.3.3.2.19	Special handling of 580 precondition failure received in response to either an INVITE or UPDATE	111
7.3.3.2.20	Receipt of SIP redirect (3xx) response	111
7.3.3.2.21	Sending of INFO for overlap signalling using the in-dialog method	111
7.3.3.3	Timers	112
7.4	Supplementary Services	112
7.4.1	Calling line identification presentation/restriction (CLIP/CLIR)	112
7.4.2	Connected line presentation and restriction (COLP/COLR).....	112
7.4.2.0	General	112
7.4.2.1	Incoming Call Interworking from SIP to BICC/ISUP at the I-MGCF.....	112
7.4.2.1.1	INVITE to IAM interworking (SIP to ISUP/BICC calls).....	112
7.4.2.1.2	ANM/CON to 200 OK (INVITE)	112
7.4.2.2	Outgoing Call Interworking from BICC/ISUP to SIP at O-MGCF	113
7.4.2.2.1	IAM to INVITE interworking (ISUP to SIP calls)	113
7.4.2.2.2	1XX to ANM or CON interworking.....	114
7.4.2.2.3	200 OK (INVITE) to ANM/CON interworking	114
7.4.3	Direct Dialling In (DDI)	115
7.4.4	Malicious call identification	115
7.4.5	Subaddressing (SUB).....	115
7.4.5.1	General.....	115
7.4.5.2	Interworking at I-MGCF.....	116
7.4.5.3	Interworking at O-MGCF	117
7.4.6	Call Forwarding Busy (CFB)/ Call Forwarding No Reply (CFNR) / Call Forwarding Unconditional (CFU) / Call Deflection (CD)	118
7.4.6.1	General	118
7.4.6.2	Interworking at the O-MGCF.....	118
7.4.6.2.1	General	118
7.4.6.2.2	Interworking SIP to ISUP.....	118
7.4.6.2.3	Interworking ISUP to SIP.....	122

7.4.6.3	Interworking at the I-MGCF	124
7.4.6.3.1	General	124
7.4.6.3.2	Interworking from SIP to ISUP	124
7.4.6.3.3	Interworking from ISUP to SIP	127
7.4.7	Void	131
7.4.8	Explicit Call Transfer (ECT)	131
7.4.9	Call Waiting	131
7.4.10	Call Hold	131
7.4.10.1	Session hold initiated from the IM CN subsystem side	131
7.4.10.2	Session hold initiated from the CS network side	132
7.4.11	Call Completion on busy subscriber	134
7.4.12	Completion of Calls on No Reply (CCNR)	134
7.4.13	Terminal Portability (TP)	134
7.4.14	Conference calling (CONF) / Three-Party Service (3PTY)	134
7.4.15	Void	135
7.4.16	Closed User Group (CUG)	135
7.4.17	Multi-Level Precedence and Pre-emption (MLPP)	135
7.4.18	Global Virtual Network Service (GVNS)	135
7.4.19	International telecommunication charge card (ITCC)	135
7.4.20	Reverse charging (REV)	135
7.4.21	User-to-User Signalling (UUS)	135
7.4.21.0	General	135
7.4.21.1	User-to-User Signalling (UUS) service 1 (implicit)	135
7.4.21.1.0	General	135
7.4.21.1.1	Void	136
7.4.21.1.2	User-to-user information Interworking from SIP to ISUP	136
7.4.21.1.3	User-to-user information Interworking from ISUP to SIP	136
7.4.21.2	User-to-User Signalling (UUS) service 1 (explicit)	136
7.4.21.3	User-to-User Signalling (UUS) service 2 (explicit)	136
7.4.21.4	User-to-User Signalling (UUS) service 3 (explicit)	136
7.4.22	Multiple Subscriber Number (MSN)	137
7.4.23	Anonymous Call rejection	137
7.4.23.0	General	137
7.4.23.1	ISUP-SIP protocol interworking at the I-MGCF	137
7.4.23.2	SIP-ISUP protocol interworking at the O-MGCF	137
7.4.24	Customized Alerting Tones (CAT) in the 3GPP CS domain	137
7.5	IMS Supplementary Services	137
7.5.1	Originating Identification Presentation (OIP) and Originating Identification Restriction (OIR)	137
7.5.2	Terminating Identification Presentation (TIP) and Terminating Identification Restriction (TIR)	137
7.5.2.1	General	137
7.5.2.2	Interworking at the O-MGCF	137
7.5.2.3	Interworking at the I-MGCF	139
7.5.2.4	Timer	140
7.5.3	void	140
7.5.4	Communication Diversion (CDIV)	140
7.5.4.1	General	140
7.5.4.2	Interworking at the O-MGCF	141
7.5.4.2.1	General	141
7.5.4.2.2	Call forwarding within the ISUP Network appeared	146
7.5.4.3	Interworking at the I-MGCF	148
7.5.5	Communication Hold (HOLD)	156
7.5.6	Conference call (CONF)	156
7.5.6.1	General	156
7.5.6.2	Subscribing for the conference event package	156
7.5.6.3	Interworking the notification	157
7.5.7	Anonymous Communication Rejection (ACR) and Communication Barring (CB)	157
7.5.8	Message Waiting Indication (MWI)	158
7.5.9	Malicious Communication Identification (MCID)	158
7.5.9.0	General	158
7.5.9.1	Interworking at the O-MGCF	158
7.5.9.1.0	General	158
7.5.9.1.1	Interworking of the MCID XML Request schema with the ISUP MCID request indicators	158

7.5.9.1.2	Interworking of the ISUP MCID response indicators with the MCID XML Response schema ...	159
7.5.9.1.3	Interworking of the ISUP Calling Party Number in an Identification Response with the OrigPartyIdentity within the MCID XML Response schema.....	159
7.5.9.1.4	Interworking of the ISUP Generic Number in an Identification Response with the GenericNumber within the MCID XML Response schema	159
7.5.9.2	Interworking at the I-MGCF	159
7.5.9.2.1	General	159
7.5.9.2.2	Interworking of identification Request	159
7.5.9.2.3	Interworking of identification Response.....	160
7.5.10	Closed User Group (CUG)	160
7.5.10.0	General	160
7.5.10.1	Interworking at the I-MGCF	160
7.5.10.2	Interworking at the O-MGCF.....	161
7.5.11	CCBS/CCNR	162
7.5.11.0	General	162
7.5.11.1	Interworking at the I-MGCF	162
7.5.11.2	Interworking at the O-MGCF.....	164
7.5.12	Communication Waiting (CW).....	166
7.5.12.0	General	166
7.5.12.1	Interworking at the I-MGCF	166
7.5.12.2	Interworking at the O-MGCF.....	166
7.5.13	Customized Alerting Tones (CAT).....	166
7.5.13.1	General	166
7.5.13.2	Early session model.....	166
7.5.13.2.1	Interworking at the O-MGCF	166
7.5.13.2.2	MGCF – IM-MGW Interaction for CAT service	167
7.5.13.3	Forking model.....	171
7.5.13.4	Gateway model	171
8	User plane interworking	171
8.1	Interworking between IM CN subsystem and bearer independent CS network	171
8.1.1	Transcoder-less Mb to Nb Interworking	172
8.1.1.1	Initialisation	172
8.1.1.2	Time alignment	172
8.1.1.3	Rate control	172
8.1.1.4	Frame quality indication	173
8.1.1.5	Framing	173
8.1.1.6	Transcoding.....	173
8.1.1.7	Discontinuous transmission	173
8.1.1.8	Timing and sequence information.....	173
8.2	Interworking between IM CN subsystem and TDM-based CS network	174
8.3	Transcoding requirements	174
8.4	Diffserv code point requirements	174
8.5	DTMF handling.....	174
9	MGCF – IM-MGW Interaction.....	175
9.1	Overview	175
9.2	Mn signalling interactions	175
9.2.1	Network model	175
9.2.2	Basic IM CN subsystem originated session.....	176
9.2.2.1	BICC forward bearer establishment	176
9.2.2.1.1	IM-MGW selection	176
9.2.2.1.2	CS network side bearer establishment.....	176
9.2.2.1.3	IM CN subsystem side termination reservation.....	176
9.2.2.1.4	IM CN subsystem side session establishment	176
9.2.2.1.5	Through-connection	177
9.2.2.1.6	Codec handling.....	177
9.2.2.1.7	Failure handling in MGCF	177
9.2.2.1.8	Message sequence chart.....	177
9.2.2.2	BICC backward bearer establishment	178
9.2.2.2.1	IM-MGW selection	178
9.2.2.2.2	IM CN subsystem side termination reservation.....	179

9.2.2.2.3	IM CN subsystem side session establishment	179
9.2.2.2.4	CS network side bearer establishment	179
9.2.2.2.5	Through-connection	180
9.2.2.2.6	Codec handling	180
9.2.2.2.7	Failure handling in MGCF	180
9.2.2.2.8	Message sequence chart	180
9.2.2.3	ISUP	181
9.2.2.3.1	IM-MGW selection	181
9.2.2.3.2	IM CN subsystem side termination reservation	181
9.2.2.3.3	IM CN subsystem side session establishment	182
9.2.2.3.4	CS network side circuit reservation	182
9.2.2.3.5	Through-connection	182
9.2.2.3.6	Continuity check	183
9.2.2.3.7	Codec handling	183
9.2.2.3.8	Voice processing function	183
9.2.2.3.9	Failure handling in MGCF	183
9.2.2.3.10	Message sequence chart	183
9.2.3	Basic CS network originated session	185
9.2.3.1	BICC forward bearer establishment	185
9.2.3.1.1	IM-MGW selection	185
9.2.3.1.2	IM CN subsystem side termination reservation	185
9.2.3.1.3	IM CN subsystem side session establishment	185
9.2.3.1.4	CS network side bearer establishment	185
9.2.3.1.5	Called party alerting	186
9.2.3.1.6	Called party answer	186
9.2.3.1.7	Through-Connection	186
9.2.3.1.8	Codec handling	186
9.2.3.1.9	Failure handling in MGCF	186
9.2.3.1.10	Message sequence chart	186
9.2.3.2	BICC Backward bearer establishment	188
9.2.3.2.1	IM-MGW selection	188
9.2.3.2.2	CS network side bearer establishment	188
9.2.3.2.3	IM CN subsystem side termination reservation	188
9.2.3.2.4	IM CN subsystem side session establishment	189
9.2.3.2.5	Called party alerting	189
9.2.3.2.6	Called party answer	189
9.2.3.2.7	Through-Connection	189
9.2.3.2.8	Codec handling	189
9.2.3.2.9	Failure handling in MGCF	190
9.2.3.2.10	Message sequence chart	190
9.2.3.3	ISUP	192
9.2.3.3.1	IM-MGW selection	192
9.2.3.3.2	CS network side circuit reservation	192
9.2.3.3.3	IM CN subsystem side termination reservation	192
9.2.3.3.4	IM CN subsystem side session establishment	192
9.2.3.3.5	Called party alerting	193
9.2.3.3.6	Called party answer	193
9.2.3.3.7	Through-Connection	193
9.2.3.3.8	Continuity Check	193
9.2.3.3.9	Codec handling	193
9.2.3.3.10	Voice Processing function	194
9.2.3.3.11	Failure handling in MGCF	194
9.2.3.3.12	Message sequence chart	194
9.2.3.4	Handling of Forking	196
9.2.3.4.1	Detection of Forking	196
9.2.3.4.2	IM CN subsystem side session establishment	196
9.2.3.4.3	IM CN subsystem side session establishment completion	197
9.2.3.4.4	Message sequence chart	197
9.2.4	Session release initiated from IM CN subsystem side	200
9.2.4.1	BICC	200
9.2.4.1.1	Session release in the IM CN subsystem side	200
9.2.4.1.2	Session release in the CS network side	200

9.2.4.1.3	Message sequence chart.....	200
9.2.4.2	ISUP	201
9.2.4.2.1	Session release in the IM CN subsystem side.....	201
9.2.4.2.2	Session release in the CS network side.....	201
9.2.4.2.3	Message sequence chart.....	201
9.2.5	Session release initiated from CS network side	201
9.2.5.1	BICC	201
9.2.5.1.1	Session release in the CS network side.....	201
9.2.5.1.2	Session release in the IM CN subsystem side.....	202
9.2.5.1.3	Message sequence chart.....	202
9.2.5.2	ISUP	202
9.2.5.2.1	Session release in the CS network side.....	202
9.2.5.2.2	Session release in the IM CN subsystem side.....	202
9.2.5.2.3	Message sequence chart.....	203
9.2.6	Session release initiated by MGCF.....	203
9.2.6.1	BICC	203
9.2.6.1.1	Session release in the CS network side.....	203
9.2.6.1.2	Session release in the IM CN subsystem side.....	203
9.2.6.1.3	Message sequence chart.....	203
9.2.6.2	ISUP	204
9.2.6.2.1	Session release in the CS network side.....	204
9.2.6.2.2	Session release in the IM CN subsystem side.....	204
9.2.6.2.3	Message sequence chart.....	204
9.2.7	Session release initiated by IM-MGW.....	205
9.2.7.1	BICC	205
9.2.7.1.1	Session release in the CS network side.....	205
9.2.7.1.2	Session release in the IM CN subsystem side.....	205
9.2.7.1.3	Message sequence chart.....	205
9.2.7.2	ISUP	206
9.2.7.2.1	Session release in the CS network side.....	206
9.2.7.2.2	Session release in the IM CN subsystem side.....	206
9.2.7.2.3	Message sequence chart.....	207
9.2.8	Handling of RTP telephone events	207
9.2.8.1	Sending DTMF digits out-of-band to CS CN (BICC).....	208
9.2.8.2	Sending and receiving DTMF digits inband to/from CS CN (ISUP or BICC)	210
9.2.8.3	Receiving DTMF digits out-of-band from CS CN (BICC).....	211
9.2.9	Session hold initiated from IM CN subsystem	212
9.2.10	Session hold initiated from CS network	214
9.2.11	Explicit Congestion Notification Support.....	216
9.2.11.1	General	216
9.2.11.1a	Incoming Call Interworking from SIP to ISUP/BICC at I-MGCF.....	216
9.2.11.1b	Outgoing Call Interworking from ISUP/BICC to SIP at O-MGCF	217
9.2.11.1c	Detection of ECN failures by IM-MGW	217
9.2.11.2	Message sequence chart	217
9.2.12	Interactive Connectivity Establishment Support.....	218
9.2.12.1	General	218
9.2.12.2	ICE lite	218
9.2.12.3	Full ICE.....	219
9.2.12.4	Procedures for Interactive Connectivity Establishment (ICE)	221
9.2.12.4.1	ICE lite	221
9.2.12.4.2	Full ICE	222
9.2.12.4.3	Connectivity check result notification (full ICE)	223
9.2.12.4.4	New peer reflexive candidate notification (full ICE)	223
9.2.13	Codec Parameters Handling.....	224
9.2.13.1	Handling of common codec parameters.....	224
9.2.13.2	EVS speech codec	225
9.3	Mn Signalling procedures	234
9.3.1	Procedures related to terminations towards the IM CN Subsystem.....	234
9.3.1.1	Reserve IMS connection point	235
9.3.1.2	Configure IMS resources	236
9.3.1.3	Reserve IMS Connection point and configure remote resources	237
9.3.1.4	Release IMS termination.....	239

9.3.1.5	Detect IMS RTP Tel event	240
9.3.1.6	Notify IMS RTP Tel event	240
9.3.1.7	Void	240
9.3.1.8	Send IMS RTP Tel event	240
9.3.1.9	Stop IMS RTP Tel event	240
9.3.1.10	Termination heartbeat indication	241
9.3.1.11	IMS Bearer Released	241
9.3.1.12	End IMS RTP Tel event	241
9.3.1.13	IMS Send Tone	241
9.3.1.14	IMS Stop Tone	241
9.3.1.15	IMS Tone Completed	241
9.3.1.16	ECN Failure Indication	242
9.3.1.17	ICE Connectivity Check Result Notification	242
9.3.1.18	ICE New Peer Reflexive Candidate Notification	243
9.3.2	Procedures related to a termination towards an ISUP network	243
9.3.2.1	Reserve TDM circuit	243
9.3.2.2	Change TDM through-connection	244
9.3.2.3	Activate TDM voice-processing function	244
9.3.2.4	Send TDM tone	244
9.3.2.5	Stop TDM tone	244
9.3.2.6	Play TDM announcement	244
9.3.2.7	TDM announcement completed	244
9.3.2.8	Stop TDM announcement	244
9.3.2.9	Continuity check	244
9.3.2.10	Continuity check verify	245
9.3.2.11	Continuity check response	245
9.3.2.12	Release TDM termination	245
9.3.2.13	Termination Out-of-Service	246
9.3.2.14	Termination heartbeat indication	246
9.3.2.15	Bearer Released	246
9.3.2.16	TDM tone completed	246
9.3.3	Procedures related to a termination towards a BICC network	246
9.3.4	Non-call related procedures	247
9.3.5	Multiple IP Realms	248
9.4	Multimedia Priority Service (MPS) Support	249
9.4.1	General	249
9.4.2	IM-MGW Resource Congestion in ADD response, request is queued	249
9.4.3	IM-MGW Resource Congestion in ADD response, MGCF seizes new IM-MGW	250
9.4.4	IM-MGW Priority Resource Allocation	250
9.4.5	IM-MGW Priority User Data marking	251
Annex A (informative):	Void	252
Annex B (normative):	Codec Negotiation between a BICC CS network and the IM CN subsystem	253
B.1	Introduction	253
B.2	Control plane interworking	253
B.2.1	Incoming call interworking from SIP to BICC at I-MGCF	253
B.2.1.1	Sending of IAM	253
B.2.1.2	Sending of SDP answer	253
B.2.2	Outgoing call interworking from BICC to SIP at O-MGCF	253
B.2.2.1	Sending of INVITE	253
B.2.2.2	Responding to serving node initiating codec negotiation	254
B.2.3	Mid-call interworking from SIP to BICC at I-MGCF or O-MGCF	254
B.2.3.1	Receipt of SDP offer	254
B.2.3.2	Generating SDP answer	255
B.2.4	Mid-call interworking from BICC to SIP at I-MGCF or O-MGCF	255
B.2.4.1	Receipt of mid-call codec negotiation request	255
B.2.4.2	Responding to serving node initiating mid-call codec negotiation	255
B.2.4.3	Receipt of codec modification request	256
B.2.5	Codec parameter translation between BICC CS network and the IM CN subsystem	256

B.2.5.1	Codec parameters for 3GPP AMR-NB codecs	257
B.2.5.2	Codec parameters for 3GPP AMR-WB codecs	258
B.2.5.3	Codec parameters for 3GPP non-AMR codecs	260
B.2.5.4	Codec parameters for ITU-T codecs	260
B.3	MGCF – IM-MGW interaction during interworking of codec negotiation.....	261
B.3.1	Basic IM CN subsystem originated session	261
B.3.1.1	BICC forward bearer establishment	262
B.3.1.1.1	IM-MGW selection	262
B.3.1.1.2	CS network side bearer establishment.....	262
B.3.1.1.3	IM CN subsystem side session establishment	262
B.3.1.1.4	Through-connection	262
B.3.1.1.5	Codec handling	263
B.3.1.1.6	Failure handling in MGCF	263
B.3.1.1.7	Message sequence chart	263
B.3.2	Basic CS network originated session.....	265
B.3.2.1	BICC forward bearer establishment.....	265
B.3.2.1.1	IM-MGW selection	265
B.3.2.1.2	IM CN subsystem side termination reservation	265
B.3.2.1.3	IM CN subsystem side session establishment	265
B.3.2.1.4	CS network side bearer establishment.....	265
B.3.2.1.5	Called party alerting	266
B.3.2.1.6	Called party answer.....	266
B.3.2.1.7	Through-Connection	266
B.3.2.1.8	Codec handling	266
B.3.2.1.9	Failure handling in MGCF	266
B.3.2.1.10	Message sequence chart	266
B.3.3	CS network initiated mid-call codec negotiation.....	269
B.3.4	IM CN subsystem initiated mid-call codec negotiation.....	270
Annex C (normative):	Interworking of CPC parameter	271
C.1	Interworking SIP to ISUP.....	271
C.2	Interworking ISUP to SIP.....	272
Annex D:	Void	273
Annex E (normative):	Multimedia interworking between the IP Multimedia Core Network (CN) Subsystem (IMS) and Circuit Switched (CS) networks	274
E.1	Basic Multimedia calls interworking between the IMS and CS Networks scenarios	274
E.2	Control plane interworking	274
E.2.1	General	274
E.2.2	Functionalities required in the MGCF for multimedia calls support.....	275
E.2.3	IM CN subsystem originated session	275
E.2.3.1	Preconditions used at IMS side.....	275
E.2.3.1.1	Interactions between H.245 or MONA and SIP/SDP	275
E.2.3.2	Preconditions not used at IMS side.....	277
E.2.3.2.1	Interactions between H.245 or MONA and SIP/SDP	277
E.2.3.3	Fallback to speech at session establishment	279
E.2.4	CS network originated session	279
E.2.4.1	Interactions between SIP/SDP and H.245 or MONA	279
E.2.4.1.1	Normal Call setup	279
E.2.4.1.2	Call setup if multimedia call can not be recognized in an unambiguous manner.....	281
E.2.4.1.3	Fallback to speech during call setup	281
E.2.4.2	CS originated – IM CN transit – CS terminated	282
E.2.5	Service change.....	283
E.2.5.2.1	SCUDIF	283
E.2.5.2.1.0	General	283
E.2.5.2.1.1	IM CN subsystem originated change.....	283
E.2.5.2.1.2	CS network originated change.....	285
E.2.5.2.2	Non-SCUDIF case (ISUP or BICC without SCUDIF)	286

E.2.5.2.2.1	Change from multimedia to audio	286
E.2.5.2.2.2	Change from speech to multimedia	287
E.2.6	Call release	287
E.2.6.1	Call release initiated from the IM CN subsystem side	287
E.2.6.2	Call release initiated from the CS network side	288
E.2.6.3	Call release initiated from the interworking node	289
E.3	User plane interworking	290
E.3.1	Functionalities required in the IM-MGW for multimedia calls support	290
E.4	MGCF and IM-MGW interactions	290
E.4.1	Introduction	290
E.4.2	Mn signalling interactions	291
E.4.2.1	Introduction	291
E.4.2.2	H.248 Context Model	291
E.4.2.3	Transport of H.245 messages between the MGCF and IM-MGW	291
E.4.2.3.1	General	291
E.4.2.3.2	Transport from MGCF to IM-MGW	292
E.4.2.3.3	Transport from IM-MGW to MGCF	292
E.4.2.4	Call establishment procedure	292
E.4.2.5	Handling of H.245 indication message	295
E.4.2.5.1	Overview	295
E.4.2.5.2	Function Not Understood / Function Not Supported message	295
E.4.2.5.3	User Input Indication message	296
E.4.2.6	Handling of H.245 Command message	296
E.4.2.6.1	Overview	296
E.4.2.6.2	Flow control command	296
E.4.2.6.3	End Session Command	297
E.4.2.6.4	videoFastUpdatePicture	297
E.4.2.7	Mn Signalling Interactions to support the Media Oriented Negotiation Acceleration (MONA)	298
E.4.2.7.1	Overview	298
E.4.2.7.2	Mn Interactions for MONA preference messages	300
E.4.2.7.3	Mn Interactions for MONA MPCs	302
E.4.2.7.4	Mn Interactions for MONA SPCs	304
E.4.2.7.4.1	General	304
E.4.2.7.4.2	Transport from MGCF to IM-MGW	304
E.4.2.7.4.3	Transport from IM-MGW to MGCF	305
E.4.2.7.4.4	Termination of SPC procedure	305
E.4.2.7.5	Mn Interactions for fallback from MONA procedures to standard H.324 setup	306
E.4.2.8	Interworking between RTCP messages and H.245 messages	307
E.4.2.8.1	Overview	307
E.4.2.8.2	IM CN subsystem originated RTCP messages	307
E.4.2.8.3	CS network originated H.245 messages	308
E.4.3	Mn Signalling procedures	309
E.4.3.1	Overview	309
E.4.3.2	Add Multiplex Termination	310
E.4.3.3	Configure Multiplex Termination	311
E.4.3.4	Signal H245 Message	312
E.4.3.5	Notify H245 Message	312
E.4.3.6	Notify MONA Preference Reception	313
E.4.3.7	Notify MONA Preference Completed	313
E.4.3.8	Signal SPC	314
E.4.3.9	Notify SPC	314
E.4.3.10	Notify MPC	315
E.4.3.11	Notify Detection of Legacy Interworking	315
E.4.3.12	Request RTCP-Interworking	316
E.4.3.13	Notify RTCP-Interworking	316
E.4.3.14	Signal-H.245-Interworking	317
E.4.3.15	Stop MPC	317
E.4.3.16	Stop SPC	317
E.4.3.17	Stop MONA Negotiation	318

Annex F (normative):	PSTN XML Scheme	320
-----------------------------	------------------------------	------------

F.1	Scope	320
F.2	MIME type	320
F.3	XML Schema definition	320
F.4	IANA registration template	325
Annex G (informative):	Void	328
Annex H (normative):	Interworking of Originating Line Information (OLI) parameter (network option).....	329
H.1	Interworking SIP to ISUP.....	329
H.2	Interworking ISUP to SIP.....	329
Annex I (normative):	GTT interworking between the IP Multimedia Core Network (CN) Subsystem (IMS) and Circuit Switched (CS) networks	330
I.1	Overview of GTT interworking between the IMS and Circuit Switched (CS) networks	330
I.2	Control plane interworking	331
I.2.1	General	331
I.2.2	Functionalities required in the MGCF for GTT calls support	331
I.2.3	IM CN subsystem originated session	331
I.2.3.1	Initial INVITE with an SDP offer including a text media line	331
I.2.4	CS network originated session	332
I.2.4.1	General.....	332
I.2.4.2	Initial INVITE with an SDP offer including audio only	332
I.2.5	Subsequent SDP offer/answer exchange adding text to an audio session	333
I.3	User plane interworking	333
I.3.1	Functionalities required in the IM-MGW for GTT support	333
I.3.2	Monitoring of text/modem signals on the CS side	333
I.3.3	Multiplexing between the CS and IMS streams	334
I.3.4	Conversion between text/modem and Real-Time Text over RTP	334
I.4	MGCF and IM-MGW interactions.....	334
I.4.1	Introduction	334
I.4.2	Mn signalling interactions	334
I.4.2.1	Introduction.....	334
I.4.2.2	H.248 Context Model	335
I.4.2.3	Specific Mn signalling for GTT.....	335
I.4.2.4	IM CN subsystem originated session between the MGCF and IM-MGW	336
I.4.2.4.1	Initial INVITE with an SDP offer including Real-Time Text.....	336
I.4.2.5	CS network originated session.....	338
I.4.2.5.1	Initial INVITE with an SDP offer only including audio	338
I.4.3	Mn Signalling procedures	339
I.4.3.1	Overview	339
Annex J (informative):	Call Flow for Customized Alerting Tone (CAT) interworking between CS network and IMS	340
J.1	Introduction	340
J.2	IMS CAT provided by the terminating IMS user using gateway model towards user served in CS networks	340
J.2.1	Callflow without using precondition mechanism	340
Annex K (normative):	T.38 interworking between the IP Multimedia Core Network (CN) Subsystem (IMS) and Circuit Switched (CS) networks	342
K.1	General	342
K.2	Recommend T.38 configuration.....	342

K.3 Handling T.38 SDP attributes at the I-MGCF343

K.4 Handling T.38 SDP attributes at the O-MGCF344

K.5 Applicable T.38 SDP attributes at the Mn Interface345

Annex L (informative): Change history346

History347

Foreword

This Technical Specification has been produced by the 3rd Generation Partnership Project (3GPP).

The contents of the present document are subject to continuing work within the TSG and may change following formal TSG approval. Should the TSG modify the contents of the present document, it will be re-released by the TSG with an identifying change of release date and an increase in version number as follows:

Version x.y.z

where:

- x the first digit:
 - 1 presented to TSG for information;
 - 2 presented to TSG for approval;
 - 3 or greater indicates TSG approved document under change control.
- Y the second digit is incremented for all changes of substance, i.e. technical enhancements, corrections, updates, etc.
- z the third digit is incremented when editorial only changes have been incorporated in the document.

1 Scope

The present document specifies the principles of interworking between the 3GPP IM CN subsystem and BICC/ISUP based legacy CS networks, in order to support IM basic voice, data and multimedia calls.

The present document addresses the areas of control and user plane interworking between the IM CN subsystem and CS networks through the network functions, which include the MGCF and IM-MGW. For the specification of control plane interworking, areas such as the interworking between SIP and BICC or ISUP are detailed in terms of the processes and protocol mappings required for the support of both IM originated and terminated voice and multimedia calls.

Other areas addressed encompass the transport protocol and signalling issues for negotiation and mapping of bearer capabilities and QoS information.

The present document specifies the interworking between 3GPP profile of SIP (as detailed according to 3GPP TS 24.229 [9]) and BICC or ISUP, as specified in ITU-T Recommendations Q.1902.1 to Q.1902.6 [30] and ITU-T Q761 to Q764 [4] respectively.

The present document also specifies the interworking between circuit switched multimedia telephony service, as described in 3GPP TS 26.110 [78] 3GPP TS 26.111 [79], and ITU-T Recommendation H.324 [81] and packet switched multimedia services, as described in 3GPP TS 26.235 [80] and 3GPP TS 26.236 [32], in particular and the interworking between the 3GPP profile of SIP and the inband control protocols for multimedia communication as specified in ITU-T Recommendations H.245 [82] and H.324 Annex K [81].

The present document addresses two interworking scenarios with respect to the properties of the CS network:

- The CS network does not use any 3GPP specific additions.
- The CS network uses 3GPP specific additions.

2 References

The following documents contain provisions which, through reference in this text, constitute provisions of the present document.

- References are either specific (identified by date of publication, edition number, version number, etc.) or non-specific.
- For a specific reference, subsequent revisions do not apply.
- For a non-specific reference, the latest version applies. In the case of a reference to a 3GPP document (including a GSM document), a non-specific reference implicitly refers to the latest version of that document *in the same Release as the present document*.

- [1] ITU-T Recommendation G.711 (11/88): "Pulse Code Modulation (PCM) of voice frequencies".
- [2] ITU-T Recommendation H.248.1 (05/02): "Gateway control protocol: Version 2".
- [3] ITU-T Recommendation Q.701 (03/93), Q.702 (11/88), Q.703 (07/96), Q.704 (07/96), Q.705 (03/93), Q.706 (03/93), Q.707 (11/88), Q.708 (03/99), Q.709 (03/93): "Functional description of the message transfer part (MTP) of Signalling System No. 7".
- [4] ITU-T Recommendations Q.761 to Q.764 (12/99): "Specifications of Signalling System No.7 ISDN User Part (ISUP)".
- [5] Void.
- [6] 3GPP TR 21.905: "Vocabulary for 3GPP Specifications".
- [7] Void.
- [8] 3GPP TS 24.228: "Signalling flows for the IP multimedia call control based on SIP and SDP".

- [9] 3GPP TS 24.229: "IP Multimedia Call Control Protocol based on SIP and SDP".
- [10] 3GPP TS 23.002: "Network Architecture".
- [11] 3GPP TS 22.228: "Service requirements for the IP Multimedia Core Network Subsystem".
- [12] 3GPP TS 23.228: "IP Multimedia subsystem (IMS)".
- [13] Void.
- [14] 3GPP TS 29.205: "Application of Q.1900 series to Bearer Independent CS Network architecture; Stage 3".
- [15] 3GPP TS 29.332: "Media Gateway Control Function (MGCF) – IM-Media Gateway (IM-MGW) interface, Stage 3".
- [16] IETF RFC 791: "Internet Protocol".
- [17] IETF RFC 768: "User Datagram Protocol".
- [18] IETF RFC 2960: "Stream Control Transmission Protocol".
- [19] IETF RFC 3261: "SIP: Session Initiation Protocol".
- [20] 3GPP TS 29.202: "Signalling System No. 7 (SS7) signalling transport in core network; Stage 3".
- [21] IETF RFC 2474: "Definition of the Differentiated Services Field (DS Field) in the Ipv4 and Ipv6 Headers".
- [22] IETF RFC 2475: "An Architecture for Differentiated Services".
- [23] IETF RFC 4867 : "RTP Payload Format and File Storage Format for the Adaptive Multi-Rate (AMR) and Adaptive Multi-Rate Wideband (AMR-WB) Audio Codecs".
- [24] IETF RFC 793: "Transmission Control Protocol".
- [25] 3GPP TS 29.414: "Core network Nb data transport and transport signalling".
- [26] 3GPP TS 29.415: "Core network Nb interface user plane protocols".
- [27] 3GPP TS 23.205: "Bearer-independent circuit-switched core network; Stage 2".
- [28] Void.
- [29] ITU-T Recommendation Q.2150.1: "Signalling transport converter on MTP3 and MTP3b".
- [30] ITU-T Recommendations Q.1902.1 to Q.1902.6 (07/01): "Bearer Independent Call Control".
- [31] Void.
- [32] 3GPP TS 26.236: "Packet switched conversational multimedia applications; Transport protocols".
- [33] Void.
- [34] Void.
- [35] ITU-T Recommendation Q.765.5: "Signalling system No. 7 – Application transport mechanism: Bearer Independent Call Control (BICC)".
- [36] IETF RFC 3264: "An Offer/Answer Model with the Session Description Protocol (SDP)".
- [37] IETF RFC 3312: "Integration of Resource Management and Session Initiation Protocol (SIP)".
- [38] ITU-T Recommendation Q.850 (05/1998) including Amendment 1 (07/2001): "Usage of cause and location in the Digital Subscriber Signalling System No. 1 and the Signalling System No. 7 ISDN User Part".
- [39] IETF RFC 2460: "Internet Protocol, Version 6 (Ipv6) Specification".

- [40] IETF RFC 3323: "A Privacy Mechanism for the Session Initiation Protocol (SIP)".
- [41] IETF RFC 3325: "Private Extensions to the Session Initiation Protocol (SIP) for Asserted Identity within Trusted Networks".
- [42] ITU-T Recommendation Q.730 (12/99), Q.731.1 (07/96), Q.731.3 (03/93), Q.731.4 (03/93), Q.731.5 (03/93), Q.731.6 (03/93), Q.731.7 (06/97), Q.731.8 (02/92), Q.732.2-5 (12/99), Q.732.7 (07/96), Q.733.1 (02/92), Q.733.2 (03/93), Q.733.3 (06/97), Q.733.4 (03/93), Q.733.5 (12/99), Q.734.1 (03/93), Q.734.2 (07/96), Q.735.1 (03/93), Q.735.3 (03/93), Q.735.6 (07/93), Q.736.1 (10/95), Q.736.3 (10/95), Q.737.1 (06/97): "ISDN user part supplementary services".
- [43] ITU-T Recommendation I.363.5 (1996): "B-ISDN ATM Adaptation Layer specification: Type 5 AAL".
- [44] ITU-T Recommendation Q.2110 (1994): "B-ISDN ATM adaptation layer – Service Specific Connection Oriented Protocol (SSCOP)".
- [45] ITU-T Recommendation Q.2140 (1995): "B-ISDN ATM adaptation layer – Service specific coordination function for signalling at the network node interface (SSCF AT NNI)".
- [46] ITU-T Recommendation Q.2210 (1996): "Message transfer part level 3 functions and messages using the services of ITU-T Recommendation Q.2140".
- [47] 3GPP TS 23.221: "Architectural requirements".
- [48] ITU-T Recommendation E.164 (05/1997): "The international public telecommunication numbering plan".
- [49] ITU-T Recommendation Q.1912.5 (03/04): "Interworking between Session Initiation Protocol (SIP) and Bearer Independent Call Control Protocol or ISDN User Part".
- [50] 3GPP TS 26.102: "Adaptive Multi-Rate (AMR) speech codec; Interface to Iu and Uu".
- [51] IETF RFC 3550: "RTP: A Transport Protocol for Real-Time Applications".
- [52] IETF RFC 3551: "RTP Profile for Audio and Video Conferences with Minimal Control".
- [53] IETF RFC 3555: "MIME Type Registration of RTP Payload Formats".
- [54] IETF RFC 3262: "Reliability of provisional responses".
- [55] IETF RFC 3311: "SIP UPDATE method".
- [56] IETF RFC 4566: "SDP: Session Description Protocol".
- [57] 3GPP TS 26.103: "Speech Codec List for GSM and UMTS".
- [58] 3GPP TS 28.062: "Inband Tandem Free Operation (TFO) of speech codecs".
- [59] IETF RFC 3556: "Session Description Protocol (SDP) Bandwidth Modifiers for RTP Control Protocol (RTCP) bandwidth".
- [60] 3GPP TS 24.604: "Communication Diversion (CDIV) using IP Multimedia (IM) Core Network (CN) subsystem; Protocol specification".
- [61] 3GPP TS 24.605: "Conference (CONF) using IP Multimedia (IM) Core Network (CN) subsystem; Protocol specification".
- [62] 3GPP TS 24.606: "Message Waiting Indication (MWI) using IP Multimedia (IM) Core Network (CN) subsystem; Protocol specification".
- [63] 3GPP TS 24.607: "Originating Identification Presentation (OIP) and Originating Identification Restriction (OIR) using IP Multimedia (IM) Core Network (CN) subsystem; Protocol specification".

- [64] 3GPP TS 24.608: "Terminating Identification Presentation (TIP) and Terminating Identification Restriction (TIR) using IP Multimedia (IM) Core Network (CN) subsystem; Protocol specification".
- [65] 3GPP TS 24.610: "Communication HOLD (HOLD) using IP Multimedia (IM) Core Network (CN) subsystem; Protocol specification".
- [66] Void.
- [67] 3GPP TS 24.611: "Anonymous Communication Rejection (ACR) and Communication Barring (CB) using IP Multimedia (IM) Core Network (CN) subsystem; Protocol specification".
- [68] Void.
- [69] IETF RFC 4040: "RTP Payload Format for a 64 kbit/s Transparent Call".
- [70] ETSI EN 300 356-1 (V4.2.1): "Integrated Services Digital Network (ISDN); Signalling System No.7 (SS7); ISDN User Part (ISUP) version 4 for the international interface; Part 1: Basic services [ITU-T Recommendations Q.761 to Q.764 (1999) modified]".
- [71] ETSI EN 300 356-21 (V4.2.1): "Integrated Services Digital Network (ISDN); Signalling System No.7 (SS7); ISDN User Part (ISUP) version 4 for the international interface; Part 21: Anonymous Call Rejection (ACR) supplementary service".
- [72] ITU-T Recommendation T.38 (09/2010): "Procedures for real-time Group 3 facsimile communication over IP networks".
- [73] IETF RFC 3362: "Real-time Facsimile (T.38) – image/t38 MIME Sub-type Registration".
- [74] 3GPP TS 23.003: "Numbering, addressing and identification".
- [75] IETF RFC 3515: "The Session Initiation Protocol (SIP) REFER method".
- [76] Void.
- [77] IETF RFC 5079: "Rejecting Anonymous Requests in the Session Initiation Protocol (SIP)".
- [78] 3GPP TS 26.110: "Codec for circuit switched multimedia telephony service; General description".
- [79] 3GPP TS 26.111: "Codec for Circuit switched Multimedia Telephony Service; Modifications to H.324".
- [80] 3GPP TS 26.235: "Packet switched conversational multimedia applications; Default codecs".
- [81] ITU-T Recommendation H.324 (04/09): "Terminal for low bitrate multimedia communication".
- [82] ITU-T Recommendation H.245: "Control protocol for multimedia communication".
- [83] ITU-T Recommendation H.261 (03/93): "Video codec for audiovisual services at p x 64 kbit/s".
- [84] ITU-T Recommendation H.263 (01/05): "Video coding for low bitrate communication".
- [85] Void.
- [86] Void.
- [87] Void.
- [88] 3GPP TS 24.173: "IMS Multimedia Telephony Communication Service and Supplementary Services, stage 3".
- [89] IETF RFC 5009: "Private Header (P-Header) Extension to the Session Initiation Protocol (SIP) for Authorization of Early Media".
- [90] IETF RFC 2663: "IP Network Address Translator (NAT) Terminology and Considerations".

- [91] IETF RFC 7044: "An extension to the Session Initiation Protocol (SIP) for Request History Information".
- [92] ITU-T Recommendation Q.769.1 (12/99): "Signalling system No. 7 – ISDN user part enhancements for the support of number portability".
- [93] IETF RFC 4694: "Number portability parameters for the "tel" URI".
- [94] Void.
- [95] Void.
- [96] ETSI EN 300 403-1 (V1.3.2): "Integrated Services Digital Network (ISDN); Digital Subscriber Signalling System No. one (DSS1) protocol; Signalling network layer for circuit-mode basic call control; Part 1: Protocol specification [ITU-T Recommendation Q.931 (1993), modified]".
- [97] IETF RFC 3966: "The tel URI for Telephone Numbers".
- [98] Void.
- [99] IETF RFC 7433: "A Mechanism for Transporting User-to-User Call Control Information in SIP".
- [99A] IETF RFC 7434: "Interworking ISDN Call Control User Information with SIP".
- [100] IETF RFC 4575: "A Session Initiation Protocol (SIP) Event Package for Conference State".
- [101] 3GPP TS 24.654: "Closed User Group (CUG) using IP Multimedia (IM) Core Network (CN) subsystem, Protocol Specification".
- [102] 3GPP TS 24.616: "Malicious Communication Identification (MCID) using IP Multimedia (IM) Core Network (CN) subsystem; Protocol specification".
- [103] 3GPP TS 23.014: "Technical Specification Group Core Network; Support of Dual Tone Multi-Frequency (DTMF) signalling".
- [104] 3GPP TS 26.114: "IP Multimedia Subsystem (IMS); Multimedia Telephony; Media handling and interaction".
- [105] IETF RFC 4733: "RTP Payload for DTMF Digits, Telephony Tones and Telephony Signals".
- [106] IETF RFC 6910: "Completion of Calls for the Session Initiation Protocol (SIP)".
- [107] IETF RFC 7462: "URNs for the Alert-Info Header Field of the Session Initiation Protocol (SIP)".
- [108] IETF RFC 4715: "The Integrated Services Digital Network (ISDN) Subaddress Encoding Type for tel URI".
- [109] IETF RFC 4585: "Extended RTP Profile for Real-time Transport Control Protocol (RTCP)-Based Feedback (RTP/AVPF)".
- [110] IETF RFC 5104: "Codec Control Messages in the RTP Audio-Visual Profile with Feedback (AVPF)".
- [111] 3GPP TS 24.615: "Communication Waiting (CW) using IP Multimedia (IM) Core Network (CN) subsystem, Protocol Specification".
- [112] 3GPP TS 24.642: "Completion of Communications to Busy Subscriber (CCBS) Completion of Communications by No Reply (CCNR) using IP Multimedia (IM) Core Network (CN) subsystem; Protocol specification".
- [113] IETF RFC 4458: "Session Initiation Protocol (SIP) URIs for Applications such as Voicemail and Interactive Voice Response (IVR)".
- [114] IETF RFC 5993: "RTP Payload format for Global System for Mobile Communications Half Rate (GSM-HR)".

- [115] IETF RFC 6432: "Carrying Q.850 Codes in Reason Header Fields in SIP (Session Initiation Protocol) Responses".
- [116] IETF RFC 3326: "The Reason Header Field for the Session Initiation Protocol (SIP)".
- [117] ANSI Standard ATIS-100013.2005(R2010) (07/2005): "Signalling System No. 7 (SS7) – Integrated Services Digital Network (ISDN) User Part".
- [118] 3GPP TS 23.237: "IP Multimedia subsystem (IMS) Service Continuity; Stage 2".
- [119] IETF RFC 5626: "Managing Client Initiated Connections in the Session Initiation Protocol (SIP)".
- [120] IETF RFC 7254: "A Uniform Resource Name Namespace for the Global System for Mobile Communications Association (GSMA) and the International Mobile station Equipment Identity (IMEI)".
- [121] 3GPP TS 23.172: "Technical realization of Circuit Switched (CS) multimedia service UDI/RDI fallback and service modification; Stage 2".
- [122] 3GPP TS 23.226: "Global Text Telephony (GTT); stage 2".
- [123] ITU-T Recommendation T.140 (02/98): "Text conversation presentation protocol".
- [124] IETF RFC 4103: "RTP Payload for Text Conversation".
- [125] ITU-T Recommendation V.18 (11/00): "Operational and interworking requirements for DCEs operating in the text telephone mode" including V.18 (2000) Amendment 1 (11/02): "Harmonization with ANSI TIA/EIA-825 (2000) text phones".
- [126] 3GPP TS 26.226: "Cellular text telephone modem; General description".
- [127] Void.
- [128] Void.
- [129] IETF RFC 3168: "The Addition of Explicit Congestion Notification (ECN) to IP".
- [130] IETF RFC 6679: "Explicit Congestion Notification (ECN) for RTP over UDP".
- [131] IETF RFC 3959: "The Early Session Disposition Type for the Session Initiation Protocol (SIP)".
- [132] 3GPP TS 24.182: "IP Multimedia Subsystem (IMS) Customized Alerting Tones (CAT); Protocol specification".
- [133] IETF RFC 6086: "Session Initiation Protocol (SIP) INFO Method and Package Framework".
- [134] 3GPP TS 23.088: "Call Barring (CB) Supplementary Services; Stage 2".
- [135] IETF RFC 3840: "Indicating User Agent Capabilities in the Session Initiation Protocol (SIP)".
- [136] 3GPP TS 22.153: "Multimedia Priority Service".
- [137] IETF RFC 3023: "XML Media Types".
- [138] IETF RFC 6665: "SIP-Specific Event Notification".
- [139] IETF RFC 7090: "Public Safety Answering Point (PSAP) Callback".
- [141] 3GPP TS 24.292: "IP Multimedia (IM) Core Network (CN) subsystem Centralized Services (ICS); Stage 3".
- [142] IETF RFC 6809: "Mechanism to Indicate Support of Features and Capabilities in the Session Initiation Protocol (SIP)".
- [143] IETF RFC 5245: "Interactive Connectivity Establishment (ICE): A Protocol for Network Address Translator (NAT) Traversal for Offer/Answer Protocols".
- [144] IETF RFC 5389: "Session Traversal Utilities for NAT (STUN)".

- [145] 3GPP TS 23.334: "IMS Application Level Gateway (IMS-ALG) – IMS Access Gateway (IMS-AGW) interface: Procedures Descriptions".
- [146] 3GPP TS 26.441: "Codec for Enhanced Voice Services (EVS); General Overview".
- [147] 3GPP TS 26.445: "Codec for Enhanced Voice Services (EVS); Detailed Algorithmic Description".
- [148] ITU-T Recommendation Q.931 (05/98): "ISDN user-network interface layer 3 specification for basic call control".

3 Definitions and abbreviations

3.1 Definitions

For the purposes of the present document, the terms and definitions given in 3GPP TR 21.905 [6], ITU-T Recommendation E.164 [48] and the following apply:

Carrier telephone mode: a mode for text communication, where continuous signals (i.e. a carrier tone) are present on the connection irrespective of whether text is being exchanged or not.

Carrierless telephone mode: a mode for text communication, where signals are only present on the connection when text is being exchanged. E.g.: Baudot

SS7 signalling function: function in the CS network, which has the capabilities to transport the SS7 MTP-User parts ISUP and BICC+STC_{mtp}

SIP signalling function: function in the IM CN subsystem, which has the capabilities to transport SIP

Incoming or Outgoing: used in the present document to indicate the direction of a call (not signalling information) with respect to a reference point.

Incoming MGCF (I-MGCF): entity that terminates incoming SIP calls from the IMS side and originates outgoing calls towards the CS side using the BICC or ISUP protocols.

Outgoing Interworking Unit (O-MGCF): entity that terminates incoming BICC or ISUP calls from the CS side and originates outgoing calls towards the IMS using SIP.

Root Termination: refers to Media Gateway as an entity in itself, rather than a Termination within it. A special TerminationID, "Root" is reserved for this purpose. See ITU-T Recommendation H.248.1 [2].

Signalling Transport Converter (STC): function that converts the services provided by a particular Signalling Transport to the services required by the Generic Signalling Transport Service.

STC_{mtp}: Signalling Transport Converter on MTP. See ITU-T Recommendation Q.2150.1 [29].

BICC+STC_{mtp}: this terminology means that BICC signalling always needs to be used on top of STC_{mtp} sublayer.

diverting URI: the URI of the node by which the existing communication was last diverted/forwarded.

diverted-to URI: the URI to which the existing communication is diverted/forwarded to.

ICE lite: The lite implementation of the Interactive Connectivity Establishment (ICE) specified in IETF RFC 5245 [143].

Full ICE: The full implementation of the Interactive Connectivity Establishment (ICE) specified in IETF RFC 5245 [143].

3.2 Abbreviations

For the purposes of the present document, the abbreviations as defined in 3GPP TR 21.905 [6] and the following apply:

3PTY Three Party

AAL1	ATM Adaptation Layer type 1
ACR	Anonymous Call Rejection
AMR	Adaptive Multi-Rate
AMR-WB	Adaptive Multi-Rate - WideBand
AMR-WB IO	Adaptive Multi-Rate - WideBand Inter-operable Mode, included in the EVS codec
ANM	Answer Message
APM	Application Transport Message
APP	APPLICATION-defined RTCP packet
APRI	Address Presentation Restriction Indicator
ATP	Access Transport Parameter
BC	Bearer Capability
BCI	Backward Call Indicators
BGCF	Breakout Gateway Control Function
BICC	Bearer Independent Call Control
CAT	Customized Alerting Tones
CB	Communication Barring
CCNR	Call Completion on No Reply
CCSS	Call Completion Service Set-up
Cda	Call Deflection Alerting
Cdi	Call Deflection Immediate
CDIV	Communication Diversion
CdPN	Called Party Number
CFB	Call Forwarding Busy
CFNR	Call Forwarding No Reply
CGB	Circuit Group Blocking
CgPN	Calling Party Number
CIC	Carrier Identification Code
CMR	Codec Mode Request
CON	Connect
CONF	Conference
COT	Continuity
CPC	Calling Party's Category
CPG	Call ProGress message
CSI	Carrier Selection Information
DSCP	DiffServ Code Point
DTX	Discontinuous Transmission
ECN	Explicit Congestion Notification
ECN-CE	ECN Congestion Experienced
EVS	Enhanced Voice Services
FAC	Facility
FQC	Frame Quality Classification
GN	Generic Number
GRS	Group Reset
GVNS	Global Virtual Network Service
H/W	Hardware
ICE	Interactive Connectivity Establishment
ICS	IMS Centralized Services
IDR	Identification Request
IEPS	International Emergency Preference Scheme
I-MGCF	Incoming MGCF
IM-MGW	IP Multimedia Media Gateway Function
INF	Information
INR	Information Request
IRS	Identification Response
ITCC	International Telecommunication Charge Card
ITU-T	International Telecommunication Union – Telecommunication Standardization Sector
MCID	Malicious Communication Identification
M3UA	MTP-L3 User Adaptation layer
MLPP	Multi-Level Precedence and Pre-emption
MONA	Media Orientation Negotiation Acceleration
MPC	Media Preconfigured Channel
MPS	Multimedia Priority Service

MRFP	Media Resource Function Processor
MSN	Multiple Subscriber Number
MSU	Message Signalling Unit
MWI	Message Waiting Indication
NOA	Nature Of Address indicator
NPDI	Number Portability Database Dip Indicator
OIP	Originating Identification Presentation
OIR	Originating Identification Restriction
OLI	Originating Line Information
O-MGCF	Outgoing MGCF
PI	Progress Indicator
PIDF	Presence Information Data Format
PSAP	Public Safety Answering Point
REV	Reverse Charging
RLC	Release Complete
RSC	Reset Circuit
RTCP	RTP Control Protocol
RTP	Real-time Transport Protocol
SAM	Subsequent Address Message
SCTP	Stream Control Transmission Protocol
SGW	Signalling Gateway
SPC	Signalling Preconfigured Channel
ST	Sending Terminated
STUN	Session Traversal Utilities for NAT
TCAP	Transaction Capabilities Application Part
TDM	Time Division Multiplex
TIP	Terminating Identification Presentation
TIR	Terminating Identification Restriction
TMR	Transmission Medium Requirement
TMU	Transmission Medium Used
TNL	Transport Network Layer
TNS	Transit Network Selection
TP	Terminal Portability
UA	User Agent
UAC	User Agent Client
UDI	Unrestricted Digital Information
UDI-TA	Unrestricted Digital Information with Tones/Announcements
UID	User Interactive Dialog
URI	Uniform Resource Identifier
USI	User Service Information
UUS	User-to-User Signalling
XML	eXtensible Markup Language

4 General

4.1 General interworking overview

The IM CN subsystem shall interwork with BICC and ISUP based legacy CS networks, e.g. PSTN, ISDN, CS PLMNs, in order to provide the ability to support basic voice calls (see 3GPP TS 22.228 [11]), between a UE located in the IM CN subsystem and user equipment located in a CS network.

For the ability to support the delivery of basic voice calls between the IM CN subsystem and CS networks, basic protocol interworking between SIP (as specified in 3GPP TS 24.229 [9]) and BICC or ISUP (as specified in ITU-T Recommendations Q.1902.1-6 [30] and ITU-T Recommendations Q.761 to Q.764 [4] respectively) has to occur at a control plane level, in order that call setup, call maintenance and call release procedures can be supported. The MGCF shall provide this protocol mapping functionality within the IM CN subsystem.

User plane interworking between the IM CN subsystem and CS network bearers (e.g. 64k TDM, ATM/AAL2 circuit or IP bearer) are supported by the functions within the IM-MGW. The IM-MGW resides in the IM CN subsystem and shall provide the bearer channel interconnection. The MGCF shall provide the call control to bearer setup association.

The IM CN subsystem shall interwork, at the control and user plane, with BICC and ISUP based legacy CS networks. The support of supplementary services shall be as defined in 3GPP TS 22.228 [11]. The MGCF and IM-MGW shall support the interworking of the IM CN subsystem to an external ISUP based CS network. They may also support interworking to a BICC based CS network where no 3GPP specific extension is applied. The MGCF and the IM-MGW may also support interworking to a BICC based CS network where 3GPP specific extensions in accordance with 3GPP TS 29.205 [14] are applied.

5 Network characteristics

5.1 Key characteristics of ISUP/BICC based CS networks

This signalling interface to a PSTN is either based on BICC Capability Set 2 as specified in ITU-T Recommendations Q.1902.1 to Q.1902.6 [30], or on ISUP (see ITU-T Recommendations Q.761 to Q.764 [4]).

The interface towards a CS-PLMN may either be one of the interfaces mentioned in the paragraph above or a signalling interface based on BICC with 3GPP specific extensions, as specified for the 3GPP Nc interface in 3GPP TS 29.205 [14], and the IM-MGW may support the 3GPP Nb interface, as specified in 3GPP TS 29.414 [25] and 3GPP TS 29.415 [26]. If the 3GPP Nc interface is applied as signalling interface, the 3GPP Nb interface is used as user plane interface and the Nb UP Framing protocol is applied.

5.2 Key characteristics of IM CN subsystem

The IM CN subsystem uses SIP to manage IP multimedia sessions in a 3GPP environment, it also uses Ipv6, as defined in RFC 2460 [39], as the transport mechanism for both SIP session signalling and media transport. The 3GPP profile of SIP defining the usage of SIP within the IM CN subsystem is specified in 3GPP TS 24.229 [9]. Example callflows are provided in 3GPP TS 24.228 [8].

6 Interworking with CS networks

6.1 Interworking reference model

Figure 1 details the reference model required to support interworking between the 3GPP IM CN subsystem and CS networks for IM basic voice calls.

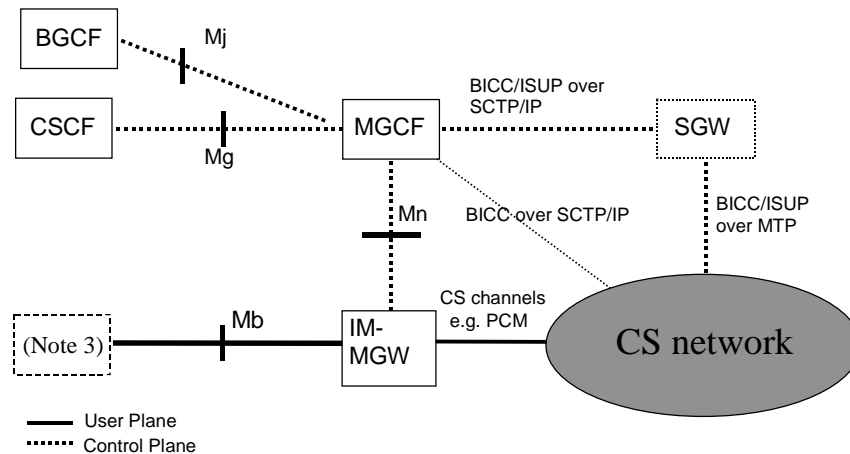

- NOTE 1: The logical split of the signalling and bearer path between the CS network and the IM CN subsystem is as shown, however the signalling and bearer may be logically directly connected to the IM-MGW.
- NOTE 2: The SGW may be implemented as a stand-alone entity or it may be located in another entity either in the CS network or the IM-MGW. The implementation options are not discussed in the present document.
- NOTE 3: The IM-MGW may be connected via the Mb to various network entities, such as a UE (via a GTP Tunnel to a GGSN), an MRFP, or an application server.
- NOTE 4: A SGW function is not required for certain signalling transports, where M3UA+SCTP+IP is used in CS network and IM-MGCF.

Figure 1: IM CN subsystem to CS network logical interworking reference model

6.1.1 Interworking reference points and interfaces

The reference points and network interfaces shown in figure 1 are as described:

Protocol for Mg reference point: The single call control protocol applied across the Mg reference point (i.e. between CSCF and MGCF) will be based on the 3GPP profile of SIP as defined in accordance with 3GPP TS 24.229 [9].

Protocol for Mn reference point: The Mn reference point describes the interfaces between the MGCF and IM-MGW, and has the properties as detailed in 3GPP TS 29.332 [15].

Protocol for Mj reference point: The single call control protocol applied across the Mj reference point (i.e. between BGCF and MGCF) will be based on the 3GPP profile of SIP as defined in accordance with 3GPP TS 24.229 [9].

Protocol for Mb reference point: The Mb reference point is defined in accordance with 3GPP TS 23.002 [10] and is Ipv6 based.

6.1.2 Interworking functional entities

6.1.2.1 Signalling Gateway Function (SGW)

This component performs the call related signalling conversion to or from BICC/ISUP based MTP transport networks to BICC/ISUP based SCTP/IP transport networks, and forwards the converted signalling to or from the MGCF. The functionality within SGW shall be in accordance with 3GPP TS 23.002 [10].

6.1.2.2 Media Gateway Control Function (MGCF)

This is the component within the IM CN subsystem, which controls the IM-MGW, and also performs SIP to BICC or SIP to ISUP call related signalling interworking.

The functionality defined within MGCF shall be defined in accordance with 3GPP TS 23.002 [10].

6.1.2.3 IP Multimedia – Media Gateway Function (IM-MGW)

This is the component within the IM CN subsystem, which provides the interface between the PS domain and the CS domain, and it shall support the functions as defined in accordance with 3GPP TS 23.002 [10].

6.2 Control plane interworking model

Within the IM CN subsystem, the 3GPP profile of SIP is used to originate and terminate IM sessions to and from the UE.

External CS networks use BICC or ISUP to originate and terminate voice calls to and from the IM CN subsystem.

Therefore, in order to provide the required interworking to enable inter network session control, the control plane protocols shall be interworked within the IM CN subsystem. This function is performed within the MGCF (see clause 6.1.2).

6.3 User plane interworking model

Within the IM CN subsystem, IPv6, and framing protocols such as RTP, are used to transport media packets to and from the IM CN subsystem entity like UE or MRFP.

External legacy CS networks use circuit switched bearer channels like TDM circuits (e.g. 64 kbits PCM), ATM/AAL2 circuit or IP bearers to carry encoded voice frames, to and from the IM CN subsystem.

Other CN networks use ATM/AAL 1 or AAL 2 or IP as a backbone, with different framing protocols.

Therefore, in order to provide the required interworking to enable media data exchange, the user plane protocols shall be translated within the IM CN subsystem. This function is performed within the IM-MGW (see clause 6.1.2).

7 Control plane interworking

Signalling from CS networks to or from IM CN subsystem, where the associated supported signalling protocols are SS7/M3UA+SCTP+IP and M3UA+SCTP+IP respectively, requires a level of interworking between the nodes across the Control Plane, i.e. the SS7 signalling function, SGW (if applicable), MGCF and SIP signalling function. This interworking is required in order to provide a seamless support of a user part, i.e. SIP and BICC+STC_{mtp} or SIP and ISUP.

The transport of SS7 signalling protocol messages of any protocol layer that is identified by MTP level 3, in SS7 terms, as a user part (MTP3-user) shall be accomplished in accordance with the protocol architecture defined in the following clauses. For the present document these protocol layers include, but are not limited to, Bearer Independent Call Control (BICC)+STC_{mtp} and ISDN User Part (ISUP).

7.1 General

The following clauses define the signalling interworking between the Bearer Independent Call Control (BICC) or ISDN User Part (ISUP) protocols and Session Initiation Protocol (SIP) with its associated Session Description Protocol (SDP) at a MGCF. The MGCF shall act as a Type A exchange (ITU-T Recommendation Q.764 [4]) for the purposes of ISUP and BICC Compatibility procedures. The services that can be supported through the use of the signalling interworking are limited to the services that are supported by BICC or ISUP and SIP based network domains.

BICC is the call control protocol used between Nodes in a network that incorporates separate call and bearer control. The BICC/ISUP capabilities or signalling information defined for national use is outside the scope of the present document. It does not imply interworking for national-specific capabilities is not feasible.

The capabilities of SIP and SDP that are interworked with BICC or ISUP are defined in 3GPP TS 24.229 [9].

Services that are common in SIP and BICC or ISUP network domains will seamlessly interwork by using the function of the MGCF. The MGCF will originate and/or terminate services or capabilities that do not interwork seamlessly across domains according to the relevant protocol recommendation or specification.

Table 1 lists the services seamlessly interworked and therefore within the scope of the present document.

Table 1: Interworking Capabilities between BICC/ISUP and SIP profile for 3GPP

Service
Speech/3.1 kHz audio
CS data Calls (optional)
En bloc address signalling
Overlap address signalling from the CS side towards the IMS
Out of band transport of DTMF tones and information. (BICC only)
Inband transport of DTMF tones and information. (BICC and ISUP)
Direct-Dialling-In (DDI)
Multiple Subscriber Number (MSN)
Calling Line Identification Presentation (CLIP)
Calling Line Identification Restriction (CLIR)
Connected line presentation (COLP)
Connected line restriction (COLR)
Carrier routing

7.2 Interworking between CS networks supporting ISUP and the IM CN subsystem

The control plane between CS networks supporting ISUP and the IM CN subsystem supporting SIP, where the underlying network is SS7 and IP respectively is as shown in figure 2.

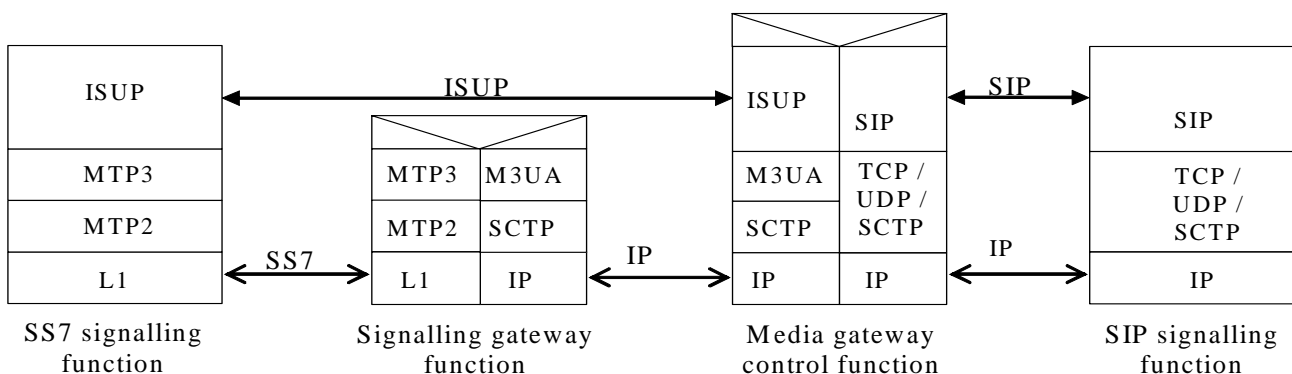

Figure 2: Control plane interworking between CS networks supporting ISUP and the IM CN subsystem

7.2.1 Services performed by network entities in the control plane

7.2.1.1 Services performed by the SS7 signalling function

The SS7 signalling function provides the capabilities to deliver or receive SS7 MTP3-User information (e.g. ISUP or BICC+STC_{mtp}) across the SS7 signalling network. The functional interface of the MTP, the MTP User parts and the signalling network are as detailed in ITU-T Recommendations Q.701 to Q.709 [3].

7.2.1.2 Services of the SGW

The SGW shall perform the functions as described in 3GPP TS 23.002 [10].

In order to support the seamless operation of the MTP3-User part information between networks incorporating SS7 and IP (either Ipv4, see RFC 791 [16], or Ipv6, see RFC 2460 [39]), the SGW shall support the services of MTP as well as the services of the M3UA (see 3GPP TS 29.202 [20]) and SCTP (see RFC 2960 [18]).

7.2.1.3 Services of the MGCF

The session handling and session control of the MGCF shall be as detailed in 3GPP TS 24.229 [9].

The MGCF shall provide the interaction, through the use of its interworking function, between the SS7 MTP3-User part information, e.g. ISUP, and SIP. The MGCF interworking function shall also provide the translation between the SS7 MTP3-User part information and SIP, where the interworking of SIP to ISUP and BICC+STC_{mtp} are detailed below.

7.2.1.4 Services of the SIP signalling function

The SIP signalling function is a logical entity that provides the capabilities to deliver or receive multimedia session information across the IM CN subsystem signalling system.

7.2.2 Signalling interactions between network entities in the control plane

7.2.2.1 Signalling between the SS7 signalling function and MGCF

The SGW shall enable the signalling interaction between the SS7 signalling function and the MGCF.

7.2.2.1.1 Signalling from MGCF to SS7 signalling function

For signalling from the MGCF to the SS7 signalling function, the SGW shall terminate the SCTP and M3UA protocol layers and deliver the MTP3-User protocol messages, e.g. ISUP messages, towards the SS7 signalling function. The SGW transmits and receives SS7 Message Signalling Units (MSUs) to and from the SS7 signalling function over standard SS7 network interfaces, using MTP to provide reliable transport of the messages.

7.2.2.1.2 Signalling from SS7 signalling function to MGCF

For signalling from the SS7 signalling function to the MGCF, the SGW shall terminate SS7 MTP2 and MTP3 protocol layers and deliver MTP3-User part information messages, e.g. ISUP, towards the MGCF. In order to direct messages received from the SS7 MTP3 network to the appropriate IP destination, e.g. MGCF, the SGW shall perform a message distribution function using the information received from the MTP3-User message. Message distribution at the SGW shall be performed in accordance with 3GPP TS 29.202 [20].

7.2.2.1.3 Services offered by SCTP and M3UA

The SGW internal protocol mapping and transportation between BICC or ISUP messages and IP encapsulated BICC or ISUP messages respectively is supported by the services of the M3UA adaptation layer and the underlying SCTP layer. The SGW shall allow for the transfer of MTP3-User signalling messages, e.g. BICC or ISUP, to and from an MGCF, where the peer MTP3-User protocol exists.

7.2.2.1.3.1 Services offered by SCTP

SCTP offers the ability to reliably transfer the SCTP User applications, e.g. M3UA, between the SCTP User application peers. The initialization procedure used for an association between two SCTP end-to-end peers, and the initialization to the SCTP User applications shall be performed as detailed in RCF 2960 [18].

7.2.2.1.3.2 Services offered by M3UA

When an association between two SCTP peers has been established, the use of M3UA shall provide the transport service in accordance with MTP (see ITU-T Recommendations Q.701 to Q.709 [3]) to the MTP3-User, e.g. ISUP.

7.2.2.2 Signalling between the MGCF and SIP signalling function

Signalling between the SIP signalling function and the MGCF uses the services of IP (RFC 2460 [39]), and transport protocol such as TCP (RFC 793 [24]) or UDP (RFC 768 [17]) or SCTP (RFC 2960 [18]) (see 3GPP TS 24.229 [9]), and SIP.

The naming and addressing concepts between the MGCF and SIP signalling function shall be detailed in accordance with 3GPP TS 23.228 [12]. The issues of general IP address management are discussed in 3GPP TS 23.221 [47].

7.2.3 SIP-ISUP protocol interworking

When a coding of a parameter value is omitted it implies that it is not affected by the interworking and the values are assigned by normal protocol procedures.

7.2.3.1 Incoming call interworking from SIP to ISUP at I-MGCF

7.2.3.1.1 Sending of IAM

On reception of a SIP INVITE requesting a session, the I-MGCF shall send an IAM message. The allowed sessions are given in clause 7.2.3.1.2.5.

An I-MGCF shall support both incoming INVITE requests containing SIP preconditions and 100rel extensions in the SIP Supported or Require header fields, and INVITE requests not containing these extensions, unless the Note below applies.

NOTE: If the I-MGCF is deployed in an IMS network that by local configuration serves no user requiring preconditions, the MGCF may not support incoming requests requiring preconditions.

The I-MGCF shall interwork forked INVITE requests with different request URIs.

If the SIP precondition extension is not included in the Supported or Require header field, the I-MGCF shall send an IAM immediately after the reception of the INVITE, as shown in figure 3. The I-MGCF shall set the continuity indicators to "Continuity check not required".

If a Continuity Check procedure is supported in the ISUP network and SIP precondition extension are included in the SIP Supported or Require header field, the I-MGCF shall send the IAM immediately after the reception of the INVITE, as shown in figure 3. If the received SDP indicates that precondition is fulfilled the I-MGCF shall set the continuity indicators to "continuity check is not required". If the received SDP indicates that precondition is not fulfilled the I-MGCF shall set the continuity indicators to "continuity check performed on a previous circuit". The procedure in figure 3 applies when the value of the continuity indicator is either set to "continuity check required", "continuity check performed on a previous circuit" or "continuity check not required". If the continuity indicator is set to "continuity check required" the corresponding procedures at the Mn interface described in clause 9.2.2.3 also apply.

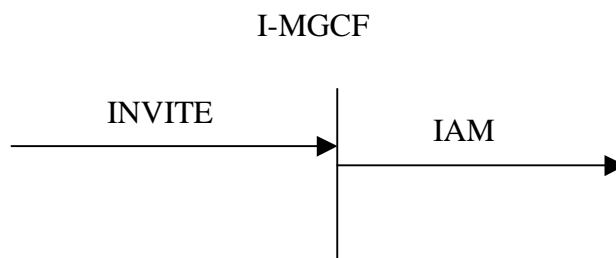

Figure 3: Receipt of an INVITE request (continuity procedure supported in the ISUP network)

If Continuity Check procedure is not supported in the ISUP network, and the SDP in the received INVITE request contains preconditions not met, the I-MGCF shall delay sending the IAM until the SIP preconditions are met and set the continuity indicators in the resulting IAM to "Continuity check not required".

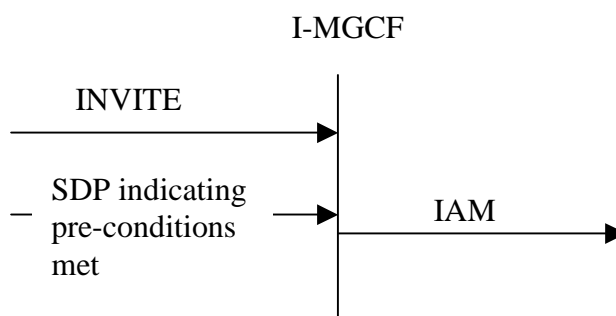

Figure 4: Receipt of an INVITE request (continuity procedure not supported in the ISUP network)

The I-MGCF shall reject an INVITE request for a session only containing unsupported media types by sending a status code 488 "Not Acceptable Here". If several media streams are contained in a single INVITE request, and if the I-MGCF does not support multimedia interworking according to Annex E, then the I-MGCF shall select one of the supported media streams, reserve the codec(s) for that media stream, and reject the other media streams and unselected codecs in the SDP answer, as detailed in IETF RFC 3264 [36]. If supported audio media stream(s) and supported non-audio media stream(s) are contained in a single INVITE request, an audio stream should be selected.

The I-MGCF shall include a To tag in the first backward non-100 provisional response, in order to establish an early dialog as described in IETF RFC 3261 [19].

If an MGCF discovers an emergency call it shall, depending on national requirements, map that to appropriate indication in ISUP.

According to IETF RFC 3261 [19] and IETF RFC 3264 [36], if an INVITE message is received without an SDP offer, then the I-MGCF sends an SDP offer in the first reliable non-failure message.

7.2.3.1.2 Coding of the IAM

7.2.3.1.2.0 General

The following ISDN user part parameters description can be found in ITU-T Recommendation Q.763 [4].

7.2.3.1.2.1 Called party number

The E.164 address encoded in the Request-URI shall be mapped to the called party number parameter of the IAM message.

Table 2: Coding of the called party number

INVITE→	IAM→	
Request-URI	Called Party Number	
E.164 address (format +CC NDC SN) (e.g. as User info portion of a SIP URI with user=phone, or as tel URI)	Address Signal: Analyse the information contained in received E.164 address. If CC is country code of the network in which the next hop terminates, then remove "+CC" and use the remaining digits to fill the Address signals. If CC is not the country code of the network in which the next hop terminates, then remove "+" and use the remaining digits to fill the Address signals. (NOTE 2)	
	Odd/even indicator: set as required	
	Nature of address indicator: Analyse the information contained in received E.164 address. If CC is country code of the network in which the next hop terminates, then set Nature of Address indicator to "National (significant) number". If CC is not the country code of the network in which the next hop terminates, then set Nature of Address indicator to "International number". (NOTE 1)	
	Internal Network Number Indicator: 1 routing to internal network number not allowed	
Numbering plan Indicator: 001 ISDN (Telephony) numbering plan (Rec. E.164)		
<i>national operator option for service numbers:</i> Non E.164 numbers (as a local-number with a phone-context in the User Info portion in a SIP URI with user=phone, or as a local number with a phone-context in a tel URI)	(NOTE 3)	Address Signal: use received non E.164 number to fill the Address signals with national significant number.
		Odd/even indicator: set as required
		Nature of address indicator: "National (significant) number". (NOTE 1)
		Internal Network Number Indicator: 1 routing to internal network number not allowed
		Numbering plan Indicator: 001 ISDN (Telephony) numbering plan (Rec. E.164)
	(NOTE 3)	Address Signal: Use received non E.164 number to fill the Address signals.
		Odd/even indicator: set as required
		Nature of address indicator: set Nature of Address indicator to "network-specific number" or to "reserved for national use".
		Internal Network Number Indicator: 1 routing to internal network number not allowed
		Numbering plan Indicator: Based on operator policy other numbering plan indicators than "001 ISDN (Telephony) numbering plan (Rec. E.164)" can be used e.g. depending on phone context value.
NOTE 1: The usage of "nature of address indicator" value "unknown" is allowed but the mapping is not specified in the present specification.		
NOTE 2: If PSTN XML and ISUP Sending Terminated (ST) signal are supported as a network option, then the PSTN XML sendingCompleteIndication, if present, is mapped to the sending terminated digit (hexadecimal digit F) in the address signals field of the Called Party Number parameter.		
NOTE 3: Depending on configuration, network-specific numbers (identified by phone context according to operator policy) should be translated into "ISDN (Telephony) numbering plan numbers (Rec. E.164)" unless such a mapping is not possible and local operator's policy requires keeping them in local format.		

7.2.3.1.2.2 Nature of connection indicators

bits BA Satellite indicator0 0 *no satellite circuit in the connection*bits DC Continuity check indicator0 0 *continuity check not required, if the continuity check procedure is not supported in the succeeding network (figure 4).*

0 1 *continuity check required*, if a continuity check shall be carried out on the succeeding circuit.
(figure 3)

1 0 *continuity check performed on a previous circuit otherwise*, if the continuity check procedure is supported in the succeeding network, but shall not be carried out on the succeeding circuit otherwise.
(figure 3)

bit E Echo control device indicator

1 *outgoing echo control device included*, for speech calls, e.g., TMR is "3.1KHz audio".

0 *outgoing echo control device not included*, for known data calls, e.g., TMR "64 kBit/s unrestricted" or HLC "Facsimile Group 2/3".

7.2.3.1.2.3 Forward call indicators

bits CB End-to-end method indicator

0 0 *no end-to-end method available (only link-by-link method available)*

bit D Interworking indicator

1 *interworking encountered*

As a network operator option, the value D = 0 "No interworking encountered" is used if the TMR = 64 kBit/s unrestricted is used.

NOTE: This avoids sending of a progress indicator with progress information 0 0 0 0 0 1 "Call is not end-to-end ISDN; further call progress information may be available in-band ", so the call will not be released for that reason by an ISDN terminal.

Bit E End-to-end information indicator (national use)

0 *no end-to-end information available*

bit F ISDN user part/BICC indicator

0 *ISDN user part/BICC not used all the way*

As a network operator option, the value F = 1 "ISDN user part/BICC used all the way" is used if the TMR = 64 kBit/s unrestricted is used.

NOTE: This avoids sending of a progress indicator with progress information 0 0 0 0 0 1 "Call is not end-to-end ISDN; further call progress information may be available in-band ", so the call will not be released for that reason by an ISDN terminal.

Bits HG ISDN user part/BICC preference indicator

if any used supplementary service requires ISUP or BICC all the way, depending on operator policy:

0 0 *ISDN user part/BICC preferred all the way, or*

1 0 *ISDN user part/BICC required all the way;*

Otherwise:

0 1 *ISDN user part/BICC not required all the way*

bit I ISDN access indicator

0 *originating access non-ISDN*

As a network operator option, the value I = 1 "originating access ISDN" is used if the TMR = 64 kBit/s unrestricted is used.

NOTE: This avoids sending of a progress indicator with progress information 0 0 0 0 1 1 "Originating access is non-ISDN", so the call will not be released for that reason by an ISDN terminal.

Bits KJ SCCP method indicator

0 0 *no indication*

If the PSTN XML is supported as a network option, the Forward Call indicators derived as shown in Table 02a shall take precedence.

Table 02a: Mapping of PSTN XML elements to Forward call indicators parameter

INVITE → PSTN XML	IAM → Forward call indicators parameter
PSTN XML with Progress indicator with Progress Description value 6 (Meaning: originating access ISDN)	bit D Interworking Indicator 0 "no interworking encountered (No. 7 signalling all the way)" bit F ISDN User Part indicator 1 "ISDN User Part used all the way" bit I ISDN access indicator 1 "originating access ISDN"
NOTE: Progress Indicator with Progress Description value "6" shall not be included in an ATP within the IAM.	

7.2.3.1.2.4 Calling party's category

See ANNEX C for the normative interworking of the CPC parameter.

7.2.3.1.2.4A Originating Line Information

The ISUP Originating Line Information parameter is defined by ANSI Standard ATIS-1000113 [117], Chapter 3.

See Annex H for the normative interworking of the OLI parameter as a network option.

7.2.3.1.2.5 Transmission medium requirement

The I-MGCF may either transcode the selected codec(s) to the codec on the PSTN side or it may attempt to interwork the media without transcoding. If the I-MGCF transcodes, it shall select the TMR parameter to "3.1 kHz audio". If the I-MGCF does not transcode, it should map the TMR, USI and Access Transport parameters from the selected codec according to Table 2a. However, if the I-MGCF supports the PSTN XML body as a network option, and if a PSTN XML body is received in the INVITE request and the I-MGCF selects media encoded in any of the formats in table 2a (G.711, Clearmode or t38) among the offered media, the I-MGCF shall derive these parameters from the XML body instead, as detailed in table 2b. The I-MGCF should only apply the mapping in table 2b if the TMR and USI values derived from the selected codec according to table 2a are equivalent with the values within the first Bearer Capability element in the PSTN XML, and otherwise the I-MGCF should apply the mapping according to table 2a.

The support of any of the media listed in table 2a is optional.

If no SDP is received from the remote peer (as described in clause 7.2.3.1.1), then the TMR parameter should be set to "3.1 kHz audio". Transcoding shall be applied as required.

Table 2a: Coding of TMR/USI/HLC from SDP: SIP to ISUP

	m= line		b= line (NOTE 4)	a= line	TMR parameter	USI parameter (optional) (NOTE 1)		HLC IE in the ATP parameter (optional)
<media>	<transport>	<fmt-list>	<modifier>:<bandwidth-value> (NOTE 5)	rtptime:<dynamic-PT> <encoding name> <clock rate>[<encoding parameters>]	TMR codes	Information Transfer Capability	User Information Layer 1 Protocol Indicator	High Layer Characteristics Identification
audio	RTP/AVP	0	N/A or AS: up to (64 kbit/s + RTP/UDP/IP overhead)	N/A	"3.1KHz audio"			(NOTE 3)
audio	RTP/AVP	Dynamic PT	N/A or AS: up to (64 kbit/s + RTP/UDP/IP overhead)	rtptime:<dynamic-PT> PCMU/8000	"3.1KHz audio"			(NOTE 3)
audio	RTP/AVP	8	N/A or AS: up to (64 kbit/s+ RTP/UDP/IP overhead)	N/A	"3.1KHz audio"			(NOTE 3)
audio	RTP/AVP	Dynamic PT	N/A or AS: up to (64 kbit/s + RTP/UDP/IP overhead)	rtptime:<dynamic-PT> PCMA/8000	"3.1KHz audio"			(NOTE 3)
audio	RTP/AVP	Dynamic PT	AS: (64 kbit/s+ RTP/UDP/IP overhead)	rtptime:<dynamic-PT> CLEARMODE/8000 (NOTE 2)	"64 kbit/s unrestricted" or "64 kbit/s preferred" (NOTE 7)	"Unrestricted digital information" (NOTE 6)		
image	Udptl [73]	t38 [73]	N/A or AS: up to (64 kbit/s + UDP/IP overhead)	Based on ITU-T T.38 [72] (NOTE 8)	"3.1 KHz audio"	"3.1 KHz audio"		"Facsimile Group 2/3"
image	tcp	t38 [73]	N/A or AS: up to (64 kbit/s + TCP/IP overhead)	Based on ITU-T T.38 [72]	"3.1 KHz audio"	"3.1 KHz audio"		"Facsimile Group 2/3"

NOTE 1: In this table the codec G.711 is used only as an example. Other codecs are possible.

NOTE 2: CLEARMODE is specified in RFC4040 [69].

NOTE 3: HLC is normally absent in this case. It is possible for HLC to be present with the value "Telephony", although 6.3.1/Q.939 indicates that this would normally be accompanied by a value of "Speech" for the Information Transfer Capability element.

NOTE 4: The MGCF should return an b:AS bandwidth modifier with a bandwidth of 64kbit/s + RTP/UDP/IP overhead in the SDP answer to request that the peer does not send with a higher bandwidth. If the received b=line indicates a bandwidth greater than 64kbit/s + RTP/UDP/IP overhead, the MGCF should also accept the incoming call.

NOTE 5: <bandwidth value> for <modifier> of AS is in units of kbit/s.

NOTE 6: In the case where the Clearmode codec appears together with speech codecs in the same m-line, the value "Unrestricted digital inf. w/tones/ann" is applicable but is mapped into the USI prime parameter (see clause 7.2.3.1.2.5a).

NOTE 7: The value "64 kbits preferred" should only be used if the Clearmode codec appears together with speech codecs in the same m-line and two PSTN XML Bearer Capability elements appear in the initial INVITE request as described in the clause 7.2.3.1.2.5a.

NOTE 8: Annex K describes recommended values.

Table 2b: Mapping of PSTN XML elements into ISUP Parameters

INVITE →		IAM →	
PSTN XML	Value	ISUP Parameter	Content
HighLayerCompatibility		Access Transport Parameter	High layer compatibility (NOTE 1)
LowLayerCompatibility			Low layer compatibility
BearerCapability (NOTE 2)		User Service Information	
HighLayerCompatibility		User Tele Service	High layer compatibility
BearerCapability (InformationTransferCapability) (NOTE 2)	Speech	TMR	Speech
	3.1 kHz audio		3.1 kHz audio
	Unrestricted digital information		64 kbit/s unrestricted
	Unrestricted digital information with tones/announcements		64 kbit/s unrestricted
NOTE 1: If two high layer compatibility information elements are received, they shall be transferred in the same order as received in the PSTN XML body in the INVITE message.			
NOTE 2: If there are two BCs present, see clause 7.2.3.1.2.5a.			
NOTE 3: The above mapping assumes that there is only a single BearerCapability present.			

7.2.3.1.2.5a Transmission medium requirement prime and USI prime (optional)

The procedures to support UDI-TA Fallback mechanism described in the present clause shall only apply if two PSTN XML Bearer Capability elements appear within the INVITE Request and the MGCF supports the PSTN XML body as a network option.

When all the following conditions apply:

- The INVITE request includes SDP with one m-line with at least two formats, and with the coding of the first two formats appearing in table 2a;
- the TMR and USI prime values derived from the first format in the m-line according to table 2a are equivalent with the values within the second Bearer Capability element in the PSTN XML;
- the TMR prime and USI values derived from the second format in the m-line according to table 2a are equivalent with the values within the first Bearer Capability element in the PSTN XML; and.
- the I-MGCF supports forwarding fallback signalling.

Then the I-MGCF shall

- if TMR "64 kBit/s preferred" is supported at the succeeding trunk:
 - map the first XML Bearer Capability element into the "USI" within the IAM;
 - map the the first PSTN XML BearerCapability (InformationTransferCapability) into the "TMR prime" within the IAM, applying the same mapping rules as specified for the mapping into the "TMR" in table 2b;
 - map the second XML Bearer Capability element (InformationTransferCapability) into the USI prime within the IAM;
 - set the TMR within the IAM to "64 kBit/s preferred";
 - configure the IM-MGW; and
 - store those values;
- if TMR "64 kBit/s preferred" is not supported at the succeeding trunk:
 - apply the procedures as described within clause 7.2.3.1.2.5, using the first Bearer Capability element in the PSTN XML and the second format in the m-line;
 - discard the second Bearer Capability element in the PSTN XML;

- select the second format in the m-line within the SDP answer; and
- configure the IM-MGW.

Otherwise (i.e. if some Bearer Capability element in the PSTN XML did not match the SDP), the I-MGCF shall:

- discard the XML Bearer Capability elements;
- if the I-MGCF received at least two formats within the m-line, select one of those formats, except for the CLEARMODE codec, within the SDP answer;
- apply the mapping for the selected format according to table 2a; and
- configure the IM-MGW accordingly

7.2.3.1.2.6 Calling party number

The SIP "Privacy" header is defined within IETF RFC 3323 [40]. The SIP "P-Asserted-Identity" header is defined in IETF RFC 3325 [41].

Table 3: Mapping of SIP From/P-Asserted-Identity/Privacy headers to CLI parameters

Has a "P-Asserted-Identity" header field (NOTE 2, NOTE 5, NOTE 6) been received?	Has a "From" header field (NOTE 3) containing a URI that encodes an E.164 address been received (NOTE 6)?	Calling Party Number parameter Address signals	Calling Party Number parameter APRI	Generic Number (additional calling party number) address signals	Generic Number parameter APRI
No	No	Network option to either include a network provided E.164 number (See table 4) or omit the Address signals.	Network option to set APRI to "presentation restricted" or "presentation allowed" (NOTE 4) (See table 5) As a network option the APRI "presentation restricted by network" (NOTE 7) can be used instead of the APRI "presentation restricted"	Parameter not included	Not applicable
No	Yes	Network option to either include a network provided E.164 number (See table 4) or omit the Address signals.	Network option to set APRI to "presentation restricted" or "presentation allowed" (NOTE 4) (See table 5) As a network option the APRI "presentation restricted by network" (NOTE 7) can be used instead of the APRI "presentation restricted"	Network option to either omit the parameter (if CgPN has been omitted) or derive from the "From" header (NOTE 1) (See table 6)	APRI = "presentation restricted" or "presentation allowed" depending on SIP Privacy header. (See table 6)
Yes	No	Derived from P-Asserted-Identity (See table 5)	APRI = "presentation restricted" or "presentation allowed" depending on SIP Privacy header. (See table 5)	Not included	Not applicable
Yes	Yes	Derived from P-Asserted-Identity (See table 5)	APRI = "presentation restricted" or "presentation allowed" depending on SIP Privacy header. (See table 5)	Network option to either omit the parameter or derive from the "From" header (NOTE 1) (See table 6)	APRI = "presentation restricted" or "presentation allowed" depending on SIP Privacy header. (see table 6)

Has a "P-Asserted-Identity" header field (NOTE 2, NOTE 5, NOTE 6) been received?	Has a "From" header field (NOTE 3) containing a URI that encodes an E.164 address been received (NOTE 6)?	Calling Party Number parameter Address signals	Calling Party Number parameter APRI	Generic Number (additional calling party number) address signals	Generic Number parameter APRI
<p>NOTE 1: This mapping effectively gives the equivalent of Special Arrangement to all SIP UAC with access to the I-MGCF.</p> <p>NOTE 2: It is possible that the P-Asserted-Identity header field includes both a tel URI and a SIP URI. In this case, either the tel URI or the SIP URI with user="phone" and a specific host portion, as selected by operator policy, may be used.</p> <p>NOTE 3: The "From" header may contain an "Anonymous User Identity". An "Anonymous User Identity" includes information that does not point to the calling party. IETF RFC 3261 recommends that the display-name component contain "Anonymous". That the Anonymous User Identity will take the form defined in TS 23.003 [74]. The Anonymous User Identity indicates that the calling party desired anonymity. The From header may also contain an Unavailable User Identity as defined in TS 23.003 [74], that indicates that the calling party is unknown.</p> <p>NOTE 4: A national option exists to set the APRI to "Address not available".</p> <p>NOTE 5: TS 24.229 [9] guarantees that the received number is an E.164 number formatted as an international number, with a "+" sign as prefix.</p> <p>NOTE 6: The E.164 numbers considered within the present document are composed by a Country Code (CC), followed by a National Destination Code (NDC), followed by a Subscriber Number (SN). On the IMS side, the numbers are international public telecommunication numbers ("CC"+"NDC"+"SN") and are prefixed by a "+" sign. On the CS side, it is a network option to omit the CC.</p> <p>NOTE 7: This is an ETSI specific value described within ETSI EN 300 356-1 [70].</p>					

Table 4: Setting of the network-provided BICC/ISUP calling party number parameter with a CLI (network option)

BICC/ISUP CgPN Parameter field	Value
Screening Indicator	"network provided"
Number Incomplete Indicator	"complete"
Number Plan Indicator	ISDN/Telephony (E.164)
Address Presentation Restricted Indicator	Presentation allowed/restricted As a network option the APRI value "presentation restricted by network" (NOTE) can be used instead of the APRI value "presentation restricted"
Nature of Address Indicator	If next BICC/ISUP node is located in the same country set to "National (Significant) number" else set to "International number"
Address signals	If NOA is "national (significant) number" no country code should be included. If NOA is "international number", then the country code of the network-provided number should be included.
NOTE : This is an ETSI specific value described within ETSI EN 300 356-1 [70]	

Table 5: Mapping of P-Asserted-Identity and privacy headers to the ISUP/BICC calling party number parameter

SIP Component	Value	BICC/ISUP Parameter / field	Value
P-Asserted-Identity header field (NOTE)	E.164 number	Calling Party Number	
		Number incomplete indicator	"Complete"
		Numbering Plan Indicator	"ISDN/Telephony (E.164)"
		Nature of Address Indicator	If CC encoded in the URI is equal to the CC of the country where MGCF is located AND the next BICC/ISUP node is located in the same country then set to "national (significant) number" else set to "international number"
		Screening indicator	Network Provided
Addr-spec	"CC" "NDC" "SN" from the URI	Address signal	If NOA is "national (significant) number" then set to "NDC" + "SN" If NOA is "international number" then set to "CC"+"NDC"+"SN"
Privacy header field is not present		APRI	"presentation allowed"
Privacy header field (IETF RFC 3323 [40])	priv-value	APRI	If the Privacy header field contains the values "id" (see IETF RFC 3325 [41]) and/or "header", the APRI shall be set to "presentation restricted". Otherwise, the APRI shall be set to "presentation allowed".
NOTE:	It is possible that a P-Asserted-Identity header field includes both a tel URI and a SIP URI. In this case, either the tel URI or the SIP URI with user="phone" and a specific host portion, as selected by operator policy, may be used.		

7.2.3.1.2.7 Generic number

Table 6: Mapping of SIP from header field to BICC/ISUP generic number (additional calling party number) parameter (network option)

SIP component	Value	BICC/ISUP parameter / field	Value
From header field	name-addr or addr-spec	Generic number Number Qualifier Indicator	<i>"additional calling party number"</i>
		Nature of Address Indicator	If CC encoded in the URI is equal to the CC of the country where MGCF is located AND the next BICC/ISUP node is located in the same country then set to <i>"national (significant) number"</i> else set to <i>"international number"</i>
		Number incomplete indicator	<i>"Complete"</i>
		Numbering Plan Indicator	<i>"ISDN/Telephony (E.164)"</i>
		Screening indicator	<i>"user provided not verified"</i>
Addr-spec	"CC" "NDC" + "SN" from the URI	Address signal	If NOA is <i>"national (significant) number"</i> then set to "NDC" + "SN" If NOA is <i>"international number"</i> then set to "CC"+"NDC"+"SN"
Privacy header field is not present		APRI	<i>"presentation allowed"</i>
Privacy header field (IETF RFC 3323 [40])	priv-value	APRI	If the Privacy header field contains the value <i>"user"</i> , the APRI shall be set to <i>"presentation restricted"</i> . Otherwise, the APRI shall be set to <i>"presentation allowed"</i> .

7.2.3.1.2.8 User service information

For coding of the USI see 7.2.3.1.2.5.

7.2.3.1.2.9 Hop Counter (National option)

The I-MGCF shall perform the following interworking procedure if the Hop Counter procedure is supported in the CS network.

At the I-MGCF the Max-Forwards SIP header shall be used to derive the Hop Counter parameter if applicable. Due to the different default values (that are based on network demands/provisions) of the SIP Max-Forwards header and the Hop Counter, a factor shall be used to adapt the Max Forwards to the Hop Counter at the I-MGCF. For example, the following guidelines could be applied:

- 1) Max-Forwards for a given message should be monotone decreasing with each successive visit to a SIP entity, regardless of intervening interworking, and similarly for Hop Counter.
- 2) The initial and successively mapped values of Max-Forwards should be large enough to accommodate the maximum number of hops that may be expected of a validly routed call.

Table 7 shows the principle of the mapping:

Table 7: Max forwards – hop counter

Max-Forwards	= X	Hop Counter	= INTEGER part of (X /Factor) =Y
NOTE: The Mapping of value X to Y should be done with the used (implemented) adaptation mechanism.			

The Principle of adoption could be implemented on a basis of the network provision, trust domain rules and bilateral agreement.

7.2.3.1.2.10 Progress Indicator

If the I-MGCF supports the PSTN XML body as a network option and an INVITE containing a PSTN XML body is received, an available "ProgressIndicator" element in the PSTN XML body shall be mapped into a Progress Indicator in the Access Transport Parameter of the sent IAM as shown in table 7.2.3.1.2.10.1.

Table 7.2.3.1.2.10.1: Contents of the Access Transport Parameter

INVITE →	IAM→
PSTN XML	Access Transport Parameter
Progress indicator	Progress indicator (NOTE)
NOTE: A ProgressIndicator with Progress Description value 6 shall not be included into the ISUP ATP, and is mapped instead to Forward call indicators parameter according to table 02a.	

7.2.3.1.2.11 Location Number

Location Number is defined in clause 3.30 of ITU-T Q.763 [4].

If the received INVITE message contains a P-Access-Network-Info header and the P-Access-Network-Info header contains an access-type with the value "GSTN" the MGCF shall:

- 1) If an access-info field with the value "gstn-location" is present and the value "operator-specific-GI" is not present, include an ISUP Location Number parameter in the outgoing IAM set as shown in table 7.2.3.1.2.11.1

As a network option:

- 1) If an access-info field with the value "operator-specific-GI" is present and the value "gstn-location" is not present, include an ISUP Location Number parameter in the outgoing IAM set as shown in table 7.2.3.1.2.11.3
- 2) If both values are present, include an ISUP Location Number parameter in the outgoing IAM set as shown in table 7.2.3.1.2.11.1 or table 7.2.3.1.2.11.3, based on local policy.

As a network option, if the P-Access-Network-Info header contains an access-type different from "GSTN" and an access-info parameter with the value "operator-specific-GI", the I-MGCF shall include an ISUP Location Number parameter in the outgoing IAM as shown in table 7.2.3.1.2.11.3.

Table 7.2.3.1.2.11.1: Contents of the location number parameter

INVITE →	IAM→
	Location Number parameter
P-Access-Network-Info with access-type="GSTN" and gstn-location parameter	Binary value derived from the gstn-location parameter of the P-Access-Network-Info
NOTE: The binary value shall be obtained by removing the quotes and converting each pair of consecutive character strings into an octet that has the equivalent hexadecimal representation	

Table 7.2.3.1.2.11.2: Mapping of P-Access-Network-Info to Location Number

INVITE→	IAM→
P-Access-Network-Info	Location Number
access type="GSTN" gstin-location=value	Address Signal: Copied from octet 3 to n of the binary representation of the gstin-location field
	Odd/even indicator: Copied from bit 8 octet 1 of the binary representation of the gstin-location field
	Nature of address indicator: Copied from bit 7 to 1 of octet 1 of the binary representation of the gstin-location field
	Internal Network Number Indicator: Copied from bit 8 of octet 2 of the binary representation of the gstin-location field
	Numbering plan Indicator: Copied from bit 7 to 5 of octet 2 of the binary representation of the gstin-location field
	Address presentation restricted indicator: If the SIP Privacy header field = header, APRI is set to "01 (presentation restricted)" otherwise APRI is copied from bit 4 and 3 of octet 2 of the binary representation of the gstin-location field
	Screening indicator: If the np parameter is present in the P-Access-Network-Info header field, set to "11 (network provided)" otherwise set from bit 2 and 1 of octet 2 of the binary representation of the gstin-location field

Table 7.2.3.1.2.11.3: Mapping of P-Access-Network-Info operator-specific-GI to Location Number

INVITE →	IAM→
	Location Number parameter
P-Access-Network-Info with access-info="operator-specific-GI" and operator-specific-GI parameter	
P-Access-Network-Info	Location Number
access-info="operator-specific-GI" operator-specific-GI=value	Address Signal : Copy the digits set by 2 digits per byte. In case of an odd number of address signals, the filler code 0000 is inserted after the last address signal.
	Odd/even indicator: Set as required
	Nature of address indicator: Set from an operator-configured value
	Internal Network Number Indicator: 1 routing to internal network number not allowed
	Numbering plan Indicator: Set from an operator-configured value
	Address presentation restricted indicator: If the SIP Privacy header field = header, APRI is set to "01 (presentation restricted)"
	Screening indicator: If the np parameter is present in the P-Access-Network-Info header field, set to "11 (network provided)"
NOTE: This mapping is only possible if the operator-specific-GI field of the P-Access-Network-Info header field contains a sequence of digits.	

7.2.3.1.2.12 Support of ICS call

If the received initial INVITE request contains a Feature Caps header field, defined in IETF RFC 6809 [142] with a "+g.3gpp.ics" header field parameter as specified in clause B.4 of 3GPP TS 24.292 [141] then according to operator policy the I-MGCF may mark a call as an "ICS call".

For the call marked as the "ICS call" the I-MGCF shall include in the outgoing IAM message a redirection information parameter field set as shown in table 7.2.3.1.2.12.1.

Table 7.2.3.1.2.12.1: Contents of the redirection information parameter field

INVITE →	IAM→	
Feature-Caps header field with g.3gpp.ics feature-capability indicator	Redirection information parameter field	
	Redirecting indicator	<i>Call diverted, all redirection info presentation restricted</i>
	Original redirection reason	<i>Unknown/not available</i>
	Redirecting reason	<i>Unknown/not available</i>
	Redirection counter	set to maximum value (NOTE)
NOTE: For instance, in ISUP ITU-T Q.763 [4], the Redirection counter parameter cannot exceed 5.		

7.2.3.1.2.13 UID capability indicators (National option)

UID capability indicators parameter is defined in ITU-T Recommendation Q.763 [4].

When a both-way media path is available, then it is possible to support user interactive dialogs prior to answer through the use of the P-Early-Media header field authorizing both-way media.

If the received initial INVITE request contains a P-Early-Media header field with the "supported" value and either the SDP in the INVITE request allows a send/receive media path or the INVITE request does not contain an SDP body then the UID capability indicators parameter in the outgoing IAM message may be set as shown in table 7.2.3.1.2.13.1.

Table 7.2.3.1.2.13.1: Contents of the UID capability indicators parameter

INVITE →	IAM→	
P-Early-Media with "supported" and either SDP with "sendrcv" (explicit or implied) or no SDP present	UID capability indicators parameter	
	Through-connection indicator	1 " <i>through-connection modification possible</i> "
	T9 timer indicator	0 " <i>no indication</i> "

7.2.3.1.2A Coding of the IAM when Number Portability is supported

This clause describes optional coding procedures when Number Portability is supported.

7.2.3.1.2A.1 Coding of the IAM when a Number Portability Routing Number is available

ITU-T Q.769.1 [92] describes three possible addressing methods for signalling of the Called Party E.164 address and Number Portability Routing Number (ITU-T Q.769.1 [92] uses the terms directory number and network routing number respectively). The choice of these methods is based on network operator and national requirements.

The following clauses describe how the IAM is populated, based on these methods, when a Number Portability Routing Number is available in the Request URI in the form of a Tel URI "rn=" parameter.

When the optional Number Portability Routing Number is available and supported, these procedures take precedence over procedures for coding of the Called Party Number described in clause 7.2.3.1.2.1.

If the Number Portability Database Dip Indicator is present within the Request-URI the procedures described in clause 7.2.3.1.2A.2 apply. When a Number Portability Routing Number is not available, the Called Party Number parameter is populated as described in clause 7.2.3.1.2.1.

7.2.3.1.2A.1.1 Separate Directory Number Addressing Method

Table 7a.0a: Coding of the called party number and called directory number with Number Portability Separate Directory Number Addressing Method

INVITE→	IAM→	
Request-URI	Called Party Number	Called Directory Number
Called Party E.164 address (format +CC NDC SN) (e.g. as User info in SIP URI with user=phone, or as tel URL) plus Number Portability Routing Number (format +CC NDC SN) (e.g. as Tel URI rn= parameter) plus Number Portability Database Dip Indicator as defined in IETF RFC 4694 [93] (e.g. as Tel URI npdi parameter)	Address Signal: Analyse the information contained in received Number Portability Routing Number. If the Number Portability Routing number contains an E.164 address, then remove "+CC" and use the remaining digits to fill the Address signal. Otherwise, use the digits of the Number Portability Routing number to fill the Address signal. (NOTE)	Address Signal: Remove "+CC" from the Called Party E.164 address and use the remaining digits to fill the Address signals.
	Odd/even indicator: set as required	Odd/even indicator: set as required
	Nature of address indicator: Set Nature of Address indicator to "Network routing number in national (significant) number 46isali". "National (significant) number" and "Network routing number in network specific number format" may alternately be chosen as described in ITU-T Q.769.1 [92]	Nature of address indicator: Set Nature of Address indicator to "National (significant) number".
	Internal Network Number Indicator: 1 routing to internal network number not allowed	Internal Network Number Indicator: 1 routing to internal network number not allowed
	Numbering plan Indicator: 001 ISDN (Telephony) numbering plan (Rec. E.164)	Numbering plan Indicator: 001 ISDN (Telephony) numbering plan (Rec. E.164)
NOTE: If PSTN XML and ISUP Sending Terminated (ST) signal are supported as a network option, then the PSTN XML sendingCompleteIndication, if present, is mapped to the sending terminated digit (hexadecimal digit F) in the address signals field of the Called Party Number parameter.		

7.2.3.1.2A.1.2 Concatenated Addressing Method

Table 7a.0b: Coding of the called party number with Number Portability Concatenated Addressing Method

INVITE→ Request-URI	IAM→ Called Party Number
Called Party E.164 address (format +CC NDC SN) (e.g. as User info in SIP URI with user=phone, or as tel URL) plus Number Portability Routing Number (format +CC NDC SN) (e.g. as Tel URI rn= parameter) plus Number Portability Database Dip Indicator as defined in IETF RFC 4694 [93] (e.g. as Tel URI npdi parameter)	Address Signal: Analyse the information contained in received Number Portability Routing Number. If the Number Portability Routing number contains an E.164 address, then remove "+CC" and use the remaining digits to fill the Address signal. Otherwise, use the digits of the Number Portability Routing number to fill the Address signal. Remove the "+CC" from the Called Party E.164 address and append the remaining digits to the Address signal. (NOTE)
	Odd/even indicator: set as required
	Nature of address indicator: set Nature of Address indicator to "Network routing number concatenated with called directory number" or "National (significant) number" as described in ITU-T Q.769.1 [92]
	Internal Network Number Indicator: 1 routing to internal network number not allowed
	Numbering plan Indicator: 001 ISDN (Telephony) numbering plan (Rec. E.164)
NOTE: If PSTN XML and ISUP Sending Terminated (ST) signal are supported as a network option, then the PSTN XML sendingCompleteIndication, if present, is mapped to the sending terminated digit (hexadecimal digit F) in the address signals field of the Called Party Number parameter.	

7.2.3.1.2A.1.3 Separate Network Routing Number Addressing Method

Table 7a.0c: Coding of the network routing number and called party number with Number Portability Separate Network Routing Number Addressing Method

INVITE→ Request-URI	IAM→	
	Network Routing Number	Called Party Number
Called Party E.164 address (format +CC NDC SN) (e.g. as User info in SIP URI with user=phone, or as tel URL) plus Number Portability Routing Number (format +CC NDC SN) (e.g. as Tel URI rn= parameter) plus Number Portability Database Dip Indicator as defined in IETF RFC 4694 [93] (e.g. as Tel URI npdi parameter)	Address Signal: Analyse the information contained in received Number Portability Routing Number. If the Number Portability Routing number contains an E.164 address, then remove "+CC" and use the remaining digits to fill the Address signal. Otherwise, use the digits of the Number Portability Routing number to fill the Address signal.	Address Signal: Remove "+CC" from the Called Party E.164 address and use the remaining digits to fill the Address signals. (NOTE)
	Odd/even indicator: set as required	Odd/even indicator: set as required
	Nature of address indicator: Set Nature of Address indicator to "Network routing number in national (significant) number format". "Network routing number in network specific number format" may alternately be chosen as described in ITU-T Q.769.1 [92]	Nature of address indicator: Set Nature of Address indicator to "National (significant) number".
	Numbering plan Indicator: 001 ISDN (Telephony) numbering plan (Rec. E.164)	Internal Network Number Indicator: 1 routing to internal network number not allowed Numbering plan Indicator: 001 ISDN (Telephony) numbering plan (Rec. E.164)
NOTE: If PSTN XML and ISUP Sending Terminated (ST) signal are supported as a network option, then the PSTN XML sendingCompleteIndication, if present, is mapped to the sending terminated digit (hexadecimal digit F) in the address signals field of the Called Party Number parameter.		

7.2.3.1.2A.2 Number Portability Forward Information

Network Operator or National policy may allow forward transfer of number portability status information, as described in ITU-T Q.769.1 [92]. In this case, the following coding applies.

Table 7a.0d: Coding of the number portability forward information

INVITE→ Request-URI	IAM→ Number Portability Forward Information
<p>Called Party E.164 address (format +CC NDC SN) (e.g. as User info in SIP URI with user=phone, or as tel URL) plus Number Portability Routing Number (format +CC NDC SN) (e.g. as Tel URI rn=parameter) plus Number Portability Database Dip Indicator as defined in IETF RFC 4694 [93] (e.g. as Tel URI npdi parameter)</p>	<p>If the Number Portability Database Dip Indicator is present, and there is no Number Portability Routing Number, set to "number portability query done for called number, non-ported called subscriber".</p> <p>If the Number Portability Database Dip Indicator is present, and a Number Portability Routing Number is present, set to "number portability query done for called number, ported called subscriber".</p> <p>If there is no Number Portability Database Dip Indicator, set to "number portability query not done for called number"</p>

7.2.3.1.2B Coding of the IAM for Carrier Routing

This clause describes optional coding procedures for carrier-based routing. The interworking of the CIC parameter is defined.

7.2.3.1.2B.1 Coding of the IAM when a Carrier Identification Code (CIC) is present

The procedures followed in clause 7.2.3.1.2.1 apply with the following addition.

Based on network configuration, if the tel-URI parameter in a tel-URI or the userinfo part of a SIP URI with user=phone in the Request-URI of an initial INVITE request, contains a "cic=" parameter, as defined in IETF RFC 4694 [93], the I-MGCF may extract the carrier identification code from the "cic=" field for routing the call. If the outgoing IAM message contains the Transit Network Selection (TNS) parameter, as defined in ITU-T Q.763 [4], based on network configuration the TNS may be populated using the carrier identification code from the "cic=" field. The format of the "cic" parameter (e.g. global-cic and local-cic) shall be compliant to IETF RFC 4694 [93].

7.2.3.1.2B.2 Void

7.2.3.1.3 Sending of COT

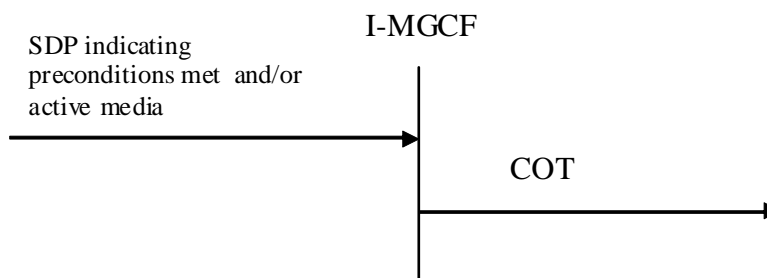

Figure 5: Sending of COT

If the IAM has already been sent, the Continuity message shall be sent indicating "continuity check successful", when all of the following conditions have been met:

- The requested remote preconditions (if any) in the IMS network have been met.
- The media stream previously set to inactive mode is set to active (as specified in IETF RFC 4566 [56]).

- Local preconditions have been fulfilled.
- A possible outstanding continuity check procedure is successfully performed on the outgoing circuit.

7.2.3.1.3A Sending of SAM

7.2.3.1.3A.1 General

The procedures in the present clause are only applicable if the I-MGCF supports the network option of overlap signalling, using either the in-dialog method or the multiple INVITEs method. Within one IMS only a single of those methods shall be used.

After the ISUP IAM message has been sent the I-MGCF can receive additional digits. The additional digits may either, as a network option, be received in:

- in-dialog SIP INFO requests ("legacy" mode of usage of the INFO method as defined in IETF RFC 6086 [133]), in-dialog method as specified in clause 7.2.3.1.3A.2 or
- in additional SIP INVITE requests, multiple INVITEs method as specified in 7.2.3.1.3A.3.

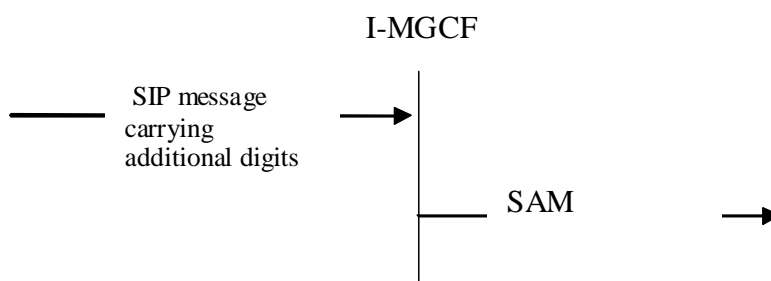

Figure 5a: Sending of SAM

7.2.3.1.3A.2 Additional digits received in in-dialog SIP INFO requests

If interworking of overlap signalling using the in-dialog method is supported by the I-MGCF, the ISUP IAM message has already been sent, but no ISUP ACM or REL message has been received, and a SIP INFO request carrying additional digits is received, then the I-MGCF shall generate a SAM and pass it to outgoing BICC/ISUP procedures. The SAM shall contain in its Subsequent Number parameter only the additional digits received in this SIP INFO request.

7.2.3.1.3A.3 Additional digits received in SIP INVITE requests

If interworking of overlap signalling using the multiple INVITEs method is supported by the I-MGCF, the ISUP IAM message has already been sent, but no ISUP ACM or REL message has been received, and the I-MGCF receives an INVITE with the same Call-ID and From tag as a previous INVITE which was associated with a BICC/ISUP call/bearer control instance currently existing on the BICC/ISUP side, then:

- If the number of digits in the Request-URI is greater than the number of digits already received for the communication, the I-MGCF shall generate a SAM and pass it to outgoing BICC/ISUP procedures. The SAM shall contain in its Subsequent Number parameter only the additional digits received in this Request-URI compared with the digits already received for the communication. The I-MGCF shall reply to any earlier INVITE with a 484 Address Incomplete response if this has not already been done.
- If the number of digits in the Request-URI is equal or less than the number of digits already received for the communication, then the I-MGCF shall immediately send a 484 Address Incomplete response for this INVITE. In this case, no SAM shall be sent to BICC/ISUP procedures.

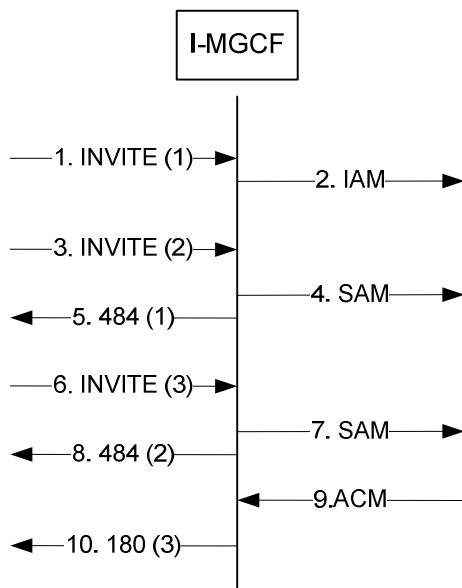

Figure 5b: Receipt of subsequent INVITE for multiple INVITEs method overlap signalling

On sending of a 484 Address Incomplete message for an INVITE transaction, the I-MGCF considers any offer/answer exchange initiated by the INVITE to be terminated. The new INVITE initiates a new offer/answer exchange. However, if resources have already been reserved and they can be reused within the new offer/answer exchange, the precondition signalling shall reflect the current status of the affected preconditions.

7.2.3.1.4 Sending of 180 ringing

7.2.3.1.4.0 General

The I-MGCF shall send the SIP 180 Ringing response when receiving any of the following messages:

- ACM with Called party's status indicator set to subscriber free.

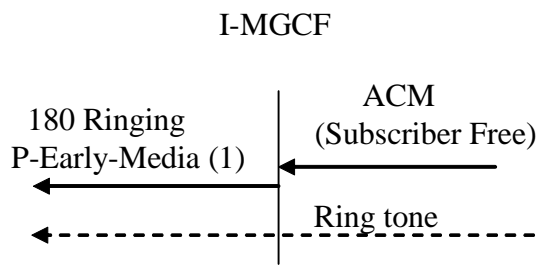

NOTE: Whether the P-Early-Media header field is included depends on whether the received INVITE contains a P-Early-Media header field with the "supported" parameter as described in IETF RFC 5009 [89] or based on local policy.

Figure 6: The receipt of ACM

- CPG with Event indicator set to alerting

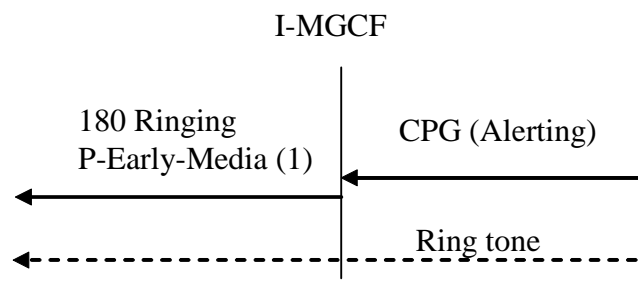

NOTE: Whether the P-Early-Media header field is included depends on whether the received INVITE contains a P-Early-Media header field with the "supported" parameter as described in IETF RFC 5009 [89] or based on local policy.

Figure 7: Receipt of CPG (Alerting)

For a speech call that is not identified as an "ICS call" as specified in clause 7.2.3.1.2.12, if the INVITE request includes the P-Early-Media header field, the I-MGCF shall include in the SIP 180 Ringing response a P-Early-Media header field authorizing backward early media, except when

- the I-MGCF has already sent a reliable provisional response (see IETF RFC 3262 [54]) including a P-Early-Media header, as defined in IETF RFC 5009 [89], and
- the most recently sent P-Early-Media header field authorized backward early media.

NOTE: If the I-MGCF signals the P-Early-Media header field authorizing backward early media, then the IMS can expect tones or announcements to the calling party to flow from the CS network via an MGW controlled by the I-MGCF. In particular, once the I-MGCF sends the 180 Ringing response, ringback is expected in media from the CS network.

If the INVITE request doesn't include the P-Early-Media header field with the "supported" parameter and if the speech call is not identified as the "ICS call" as specified in clause 7.2.3.1.2.12, then as a network option the I-MGCF may include in the SIP 180 Ringing response a P-Early-Media header field authorizing backward early media.

As a network option, an I-MGCF may generate a Call-Info header field, or an Alert-Info header field according to rules and procedures of IETF RFC 3261 [19] to provide media instead of the in-band media received from the PSTN.

For the speech call identified as the "ICS call" as specified in clause 7.2.3.1.2.12, if the I-MGCF has received the P-Early-Media header field in the initial INVITE request, the I-MGCF shall include in the SIP 180 Ringing response the P-Early-Media header field indicating the backward early media is not authorised, except when:

- the I-MGCF has already sent a reliable provisional response (see IETF RFC 3262 [54]) including a P-Early-Media header, as defined in IETF RFC 5009 [89]; and
- the most recently sent P-Early-Media header field did not authorize the backward early media.

If the P-Early-Media header field with the "supported" parameter was not included in the initial INVITE request, then as a network option the I-MGCF may include in the SIP 180 Ringing response the P-Early-Media header field indicating the backward early media is not authorised for the "ICS call".

7.2.3.1.4.0a PSTN XML body

The procedures in the present clause apply only if the I-MGCF supports the PSTN XML body as a network option. The I-MGCF shall map the Access Transport parameter received in the CPG or ACM into PSTN XML elements as shown in table 7a.0f and include this PSTN XML body in the 180 Ringing.

Table 7a.0f: Mapping of ISUP ATP Parameter into PSTN XML elements

←18x	←CPG or ACM	
PSTN XML	ISUP Parameter	Content
ProgressIndicator	Access Transport Parameter	Progress indicator
HighLayerCompatibility (NOTE 2)		High layer compatibility
LowLayerCompatibility (NOTE 2)		Low layer compatibility
BearerCapability (NOTE 1, NOTE 2)	Transmission medium used parameter (NOTE 1)	Bearer Capability
BearerCapability (NOTE 1, NOTE 2)		
NOTE 1: see clause 7.2.3.1.4.1 Transmission Medium Used parameter (TMU)		
NOTE 2: The I-MGCF shall only provide this IE if it interworks media encoded in any of the formats in table 2a (G.711, Clearmode, or t38) without transcoding. If both TMU and a BC in the ATP have been received, the BC in the ATP shall be mapped.		

The I-MGCF shall map a possibly available "ProgressIndicator" element in the ATP parameter within the ACM or CPG into a Progress Indicator in the PSTN XML body of the 180 Ringing. In addition, the I-MGCF shall map the Backward call indicators parameter and the Optional backward call indicators parameter (if present) within the ACM or CPG into other ProgressIndicator(s) in the PSTN XML body of the 180 Ringing as shown in table 7a.0g.

NOTE: The order of ProgressIndicators within the same PSTN XML body is irrelevant.

Table 7a.0g: Mapping of ISUP BCI and optional BCI parameters into PSTN XML ProgressIndicator

← 180 Ringing	←ACM or CPG
PSTN XML body with ProgressIndicator with "Progress Description" value No (Value of PI)	Backward call indicators parameter Optional backward call indicators parameter
No. 1 ("Call is not end-to-end ISDN: further call progress information may be available in-band")	Backward call indicators parameter ISDN User Part indicator 0 "ISDN User Part not used all the way"
No. 2 ("Destination address is non-ISDN")	Backward call indicators parameter ISDN User Part indicator 1 "ISDN User Part used all the way" ISDN access indicator 0 "Terminating access non-ISDN"
No. 7 ("Terminating access ISDN")	Backward call indicators parameter ISDN User Part indicator 1 "ISDN User Part used all the way" ISDN access indicator 1 "Terminating access ISDN"
No. 8 ("In-band information or an appropriate pattern is now available")	Optional backward call indicators parameter In-band information indicator "in-band information or an appropriate pattern is now available"
NOTE: The ProgressIndicator "Coding Standard" parameter shall be set to "00 (ITU-T standardized coding)". The default value for the ProgressIndicator "Location" parameter is "0011 (Transit Network)".	

7.2.3.1.4.0b Fallback by I-MGCF

If the I-MGCF supports the PSTN XML body as a network option and the I-MGCF received two PSTN XML Bearer Capability elements within the INVITE Request, but the succeeding trunk does not support TMR "64 kBit/s preferred" (as described in clause 7.2.3.1.2.5a), and if no corresponding elements were received in the Access Transport Parameter (see table 7a.0f), then the I-MGCF shall create a PSTN XML body containing the following elements, and include it in the 18x Response :

- a BearerCapability element, which shall be copied from the first BearerCapability element received in the PSTN XML in the INVITE;
- if two HighLayerCompatibility elements were present in the PSTN XML body in the INVITE, then a HighLayerCompatibility element, which shall be copied from the first HighLayerCompatibility element received in the PSTN XML in the INVITE; and

- a ProgressIndicator element with "Progress Description" value 5 ("Interworking has occurred and has resulted in a telecommunication service change"), "Coding Standard" value "00 (ITU-T standardized coding)", and default value "0011 (Transit Network)" for the "Location" parameter.

7.2.3.1.4.1 Fallback in a succeeding network: Transmission Medium Used parameter (TMU) received

The procedures in the present clause apply only if the I-MGCF supports the PSTN XML body as a network option and receives a Transmission Medium Used parameter (TMU).

NOTE: The I-MGCF will only receive a TMU parameter if it has applied the Fallback related procedures in clause 7.2.3.1.2.5a, including both a TMR and TMR Prime in the IAM, and fallback to the bearer capability identified in TMR Prime and USI occurred in a succeeding network.

If the I-MGCF receives a Transmission Medium Used parameter (TMU), the I-MGCF shall:

- If an BC is not available in the ATP in the Address Complete Message (ACM) or Call Progress Message (CPG), map the TMU value (Speech or 3.1 kHz audio) to the PSTN XML BearerCapability;
- If an BC is available in the ATP in the Address Complete Message (ACM) or Call Progress Message (CPG), include the received BC value in the PSTN XML BearerCapability;
- configure the IM-MGW to use the second format in the m-line in the SDP that has been received in the INVITE as codec at the IMS termination; and
- send SDP selecting the second format in the m-line of the SDP that has been received in the INVITE as soon as allowed according to SIP rules.

Table 7.2.3.1.4.1.1: Sending of BC fallback indication

← 180 Ringing or 183 Session Progress	← ACM/CPG	
PSTN XML BearerCapability = "Speech"	TMU ATP	"Speech" No BC
PSTN XML BearerCapability = "3.1 kHz audio"	TMU ATP	"3.1 kHz audio" No BC
PSTN XML BearerCapability received in the ATP ("speech" or "3.1 kHz audio")	TMU ATP	"Speech or 3.1 kHz audio" BC ("speech" or "3.1 kHz audio")

7.2.3.1.4A Sending of 183 Session Progress for early media scenarios

If SIP preconditions are used, the first 183 Session Progress will be sent after the reception of the INVITE request, before any ISUP message has been received from the CS network. The I-MGCF shall not include the P-Early-Media header field in any SIP message before it receives an ISUP ACM.

For a speech call, which is not identified as an "ICS call" as specified in clause 7.2.3.1.2.12, upon receipt of one of the following messages and if the I-MGCF has received the P-Early-Media header field in the INVITE request, and has not already sent a provisional response including a P-Early-Media header field with parameters indicating authorization of early media with the same directionality as determined by table 7.2.3.1.4A.1 or table 7.2.3.1.4A.2, then the I-MGCF shall send the 183 Session Progress response with a P-Early-Media header field authorizing early media as indicated:

- ACM with the value of the called party's status indicator "no indication" and one of the options described in table 7.2.3.1.4A.1. If the I-MGCF supports the PSTN XML body as a network option, the I-MGCF shall map parameters within the ACM into the PSTN XML body within the 183 as indicated in table 7.2.3.1.4A.1. Based on local configuration, the I-MGCF may also send a 183 Session Progress response with a P-Early-Media header field authorizing early media if it receives an ACM with other parameters than described in table 7.2.3.1.4A.1.

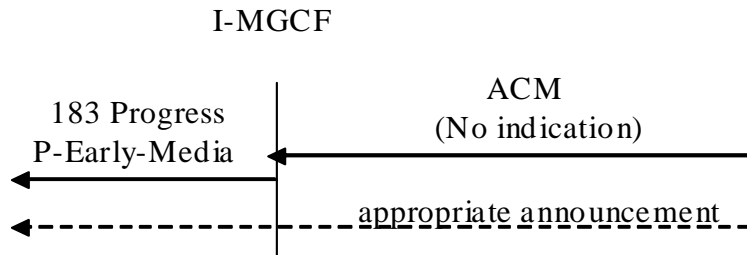

Figure 7c: Receipt of ACM "No indication"

Table 7.2.3.1.4A.1: ACM Parameters that trigger the 183 Session Progress response

←183 Session Progress	←ACM
P-Early-Media header field authorizing backward early media, if not already sent (NOTE 2)	Optional backward call indicators parameter In-band information indicator 1 "In-band info or an appropriate pattern is now available"
PSTN XML with ProgressIndicator with "Progress Description" value No. 8 ("In-band information or appropriate pattern is now available") (NOTE 1)	
PSTN XML with ProgressIndicator with "Progress Description" value No. 1 ("Call is not end-to-end ISDN: further call progress information may be available in-band") (NOTE 1)	Backward call indicators parameter ISDN User Part indicator 0 "ISDN User Part not used all the way"
PSTN XML with ProgressIndicator with "Progress Description" value No. 2 ("Destination address is non-ISDN") (NOTE 1)	Backward call indicators parameter ISDN User Part indicator 0 "ISDN User Part used all the way" ISDN access indicator 0 "Terminating access non-ISDN"
PSTN XML with ProgressIndicator with "Progress Description" value No. 7 ("Terminating access ISDN") (NOTE 1)	Backward call indicators parameter ISDN User Part indicator 1 "ISDN User Part used all the way" ISDN access indicator 1 "Terminating access ISDN"
P-Early-Media header field authorizing both-way early media, if not already sent (NOTE 2)	UID action indicators parameter Through-connection instruction indicator 1 "through-connect in both directions"
NOTE 1: The ProgressIndicator "Coding Standard" parameter shall be set to "00 (ITU-T standardized coding)". The default value for the ProgressIndicator "Location" parameter is "0011 (Transit Network)".	
NOTE 2: Setting of the P-Early-Media header field based on the UID action indicators parameter value of "through-connect in both directions" takes precedence over setting based on the Optional backward call indicators parameter value of "In-band info or an appropriate pattern is now available".	

NOTE 1: As a network option the I-MGCF can also map ACM into 183 in other cases than those described in table 7.2.3.1.4A.1.

- CPG message, when:

1. Event indicator is set to "in-band information or an appropriate pattern is now available", or
2. Event indicator is set to "Progress" and one of the options described in table 7.2.3.1.4A.2.

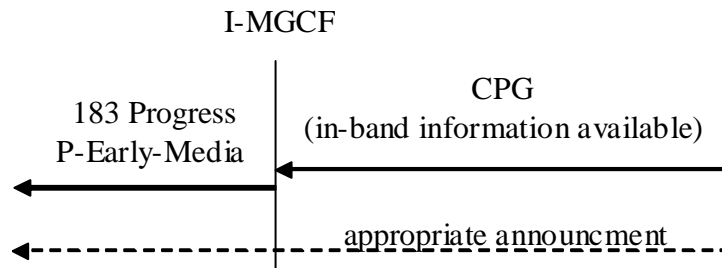

Figure 7d: Receipt of CPG (in-band information available)

Table 7.2.3.1.4A.2: CPG Parameters that trigger the 183 Session Progress response

←183 Session Progress	←CPG
P-Early-Media header field authorizing backward early media, if not already sent (NOTE 4)	Event indicator 000 0010 (progress)
PSTN XML with ProgressIndicator with "Progress Description" value No. 8 ("In-band information or appropriate pattern is now available") (NOTE 3)	Optional backward call indicators parameter In-band information indicator 1 "In-band info or an appropriate pattern is now available"
PSTN XML with ProgressIndicator with "Progress Description" value No. 1 (Call is not end-to-end ISDN: further progress information may be available in-band") (NOTE 3)	Event indicator 000 0010 (progress)
PSTN XML with ProgressIndicator with "Progress Description" value No. 2 ("Destination address is non-ISDN") (NOTE 3)	Backward call indicators parameter ISDN User Part indicator 0 "ISDN User Part not used all the way"
PSTN XML with ProgressIndicator with "Progress Description" value No. 7 ("Terminating access ISDN") (NOTE 3)	Backward call indicators parameter ISDN User Part indicator "ISDN User Part used all the way"
P-Early-Media header field authorizing both-way early media, if not already sent (NOTE 4)	ISDN access indicator 0 "Terminating access non-ISDN"
	Backward call indicators parameter ISDN User Part indicator "ISDN User Part used all the way"
	ISDN access indicator 1 "Terminating access ISDN"
	UID action indicators parameter Through-connection instruction indicator 1 "through-connect in both directions"
NOTE 1: The mapping of the contents in the CPG message is only relevant if the information received in the message is different compared to earlier received information, e.g., in the ACM message or a CPG message received prior to this message.	
NOTE 2: 183 Session Progress message including a P-Early-Media header authorizing early media may only be sent for a speech call.	
NOTE 3: The ProgressIndicator "Coding Standard" parameter shall be set to "00 (ITU-T standardized coding)". The default value for the ProgressIndicator "Location" parameter is "0011 (Transit Network)".	
NOTE 4: Setting of the P-Early-Media header field based on the UID action indicators parameter value of "through-connect in both directions" takes precedence over setting based on the Optional backward call indicators parameter value of "In-band info or an appropriate pattern is now available".	

NOTE 2: As a network option the I-MGCF can also map CPG into 183 in other cases than those described in table 7.2.3.1.4A.1.

If the INVITE request doesn't include the P-Early-Media header field with the "supported" parameter, then as a network option the I-MGCF may include in the SIP 180 Ringing response a P-Early-Media header field authorizing early media.

If the I-MGCF supports the PSTN XML body as a network option, the I-MGCF shall map the Access Transport Parameter received in the CPG or ACM into PSTN XML elements as shown in table 7a.0f and include this XML body in the 183 Session Progress. The I-MGCF shall include both a ProgressIndicator mapped from possibly received

Progress indicator element in the Access Transport Parameter and ProgressIndicators derived according to table 7.2.3.1.4A.1 or table 7.2.3.1.4A.2 in the PSTN XML body.

NOTE 3: The order of ProgressIndicators within the same PSTN XML body is irrelevant.

If the I-MGCF has applied UDI-TA fallback related procedures in clause 7.2.3.1.2.5a, the I-MGCF shall also apply the procedures in clauses 7.2.3.1.4.0b and 7.2.3.1.4.1, including the PSTN XML body in the 183 Session Progress.

As a network option, an I-MGCF may generate a Call-Info header field, or an Alert-Info header field according to rules and procedures of IETF RFC 3261 [19] to provide media instead of the in-band media received from the PSTN.

If the ACM or CPG contains an ISUP Cause, the MGCF may add a Reason header field containing the received Cause Value to the SIP 183 Session Progress provisional response as a network option. The mapping of the Cause Indicators parameter to the Reason header as shown in table 9a shall be applied. IETF RFC 6432 [115] describes the use of the Reason header field in responses. The Reason header field itself is described in IETF RFC 3326 [116].

7.2.3.1.4B Sending of 181Call is being forwarded

The I-MGCF shall send the SIP 181 Call is being forwarded when receiving any of the following messages:

- ACM with call diversion information not indicating that presentation is not allowed and optional backward call indicators indicate that in-band information is available.

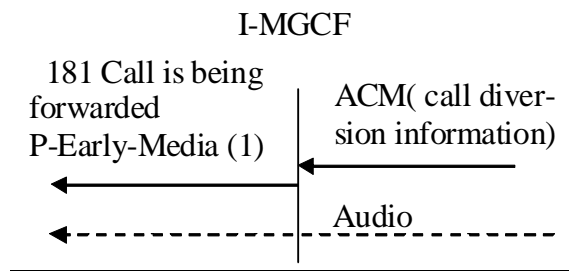

NOTE 1: Whether the P-Early-Media header field is included depends on whether the received INVITE contains a P-Early-Media header field with the "supported" parameter as described in IETF RFC 5009 [89] or based on local policy.

Figure 7c: The receipt of ACM (call diversion information)

- CPG with call diversion information not indicating that presentation is not allowed and optional backward call indicators indicate that in-band information is available.

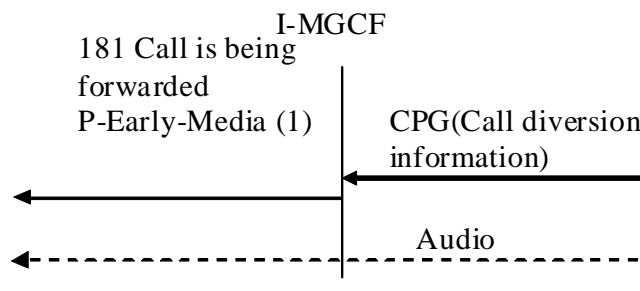

NOTE 1: Whether the P-Early-Media header field is included if the received INVITE contains a P-Early-Media header field with the "supported" parameter as described in IETF RFC 5009 [89] or based on local policy.

Figure 7d: Receipt of CPG (Call diversion information)

For a speech call, and if the INVITE request includes the P-Early-Media header, the I-MGCF shall include in the SIP 181 Call is being forwarded response a P-Early-Media header authorizing early media, except when

- the I-MGCF has already sent a reliable provisional response including a P-Early-Media header field, as defined in IETF RFC 5009 [89], or a 180 Ringing response; and

- the most recently sent P-Early-Media header field authorized early media.

NOTE: If the I-MGCF signals the P-Early-Media header field authorizing early media, then the IMS can expect tones or announcements to the calling party to flow from the CS network via an MGW controlled by the I-MGCF.

If the INVITE request doesn't include the P-Early-Media header field with the "supported" parameter, then as a network option the I-MGCF may include in the SIP 180 Ringing response a P-Early-Media header field authorizing early media.

7.2.3.1.4C Sending of 183 Session Progress for overlap signalling using the in-dialog method

If the I-MGCF supports the network option of overlap signalling using the in-dialog method, and the SIP INVITE request contained an indication that the 100rel extension is supported or required, the I-MGCF shall send a reliable 183 (Session Progress) response immediately after the reception of an INVITE request.

NOTE: If the INVITE request does not contain an indication that the 100rel extension is supported or required, it is assumed that overlap is not used, and that no further digits will be received.

7.2.3.1.4D Sending of 183 Session Progress to carry ISUP Cause

If the I-MGCF receives an ACM or CPG message containing an ISUP Cause, and if the I-MGCF does not send any SIP provisional response due to interworking procedures described in clauses 7.2.3.1.4A, for the ACM or CPG message, the I-MGCF may send a SIP 183 Session Progress with a Reason header field containing the received Cause Value as a network option. The mapping of the Cause Indicators parameter to the Reason header as shown in table 9a shall be applied. IETF RFC 6432 [115] describes the use of the Reason header field in responses. The Reason header field itself is described in IETF RFC 3326 [116].

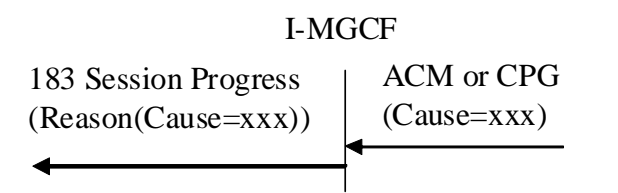

Figure 7.2.3.1.4D.1: The receipt of ACM or CPG with ISUP Cause

7.2.3.1.4E Sending of 183 Session Progress for ICS call

For a speech call identified as an "ICS call" as specified in clause 7.2.3.1.2.12 if the I-MGCF has received:

- ACM message with the value of the called party's status indicator "no indication" and the optional backward call indicators parameter field with the in-band information indicator set to "in-band information or an appropriate pattern is now available"; or
- CPG message with the event indicator of the event information parameter field set to:
 1. "in-band information or an appropriate pattern is now available"; or
 2. "progress" and the optional backward call indicators parameter field with the in-band information indicator set to "in-band information or an appropriate pattern is now available"; and
- if the received ACM or CPG message does not contain the cause indicators parameter field then:
 - a) if the I-MGCF has received a P-Early-Media header field in the initial INVITE request; and
 - b) the I-MGCF has not already sent a provisional response including the P-Early-Media header field with parameters indicating that a backward early media is not authorised;

the I-MGCF shall send the 183 Session Progress response with the P-Early-Media header field indicating the backward early media is not authorised. If the I-MGCF supports a PSTN XML body as a network option, the

I-MGCF shall map parameters within the ACM or CPG message into the PSTN XML body within the 183 Session Progress response as indicated in clause 7.2.3.1.4A; or

- otherwise if the received ACM or CPG message contains the cause indicators parameter field the I-MGCF shall send a final response to the initial INVITE request according to table 9 in clause 7.2.3.1.8 with a Reason header field containing the received (Q.850) cause value. The mapping of the cause indicators parameter field to the Reason header field as shown in table 9a shall be applied. IETF RFC 6432 [115] describes the use of the Reason header field in responses. The Reason header field itself is described in IETF RFC3326 [116].

7.2.3.1.5 Sending of the 200 OK (INVITE)

The following cases are possible trigger conditions for sending the 200 OK (INVITE):

- The reception of the ANM.

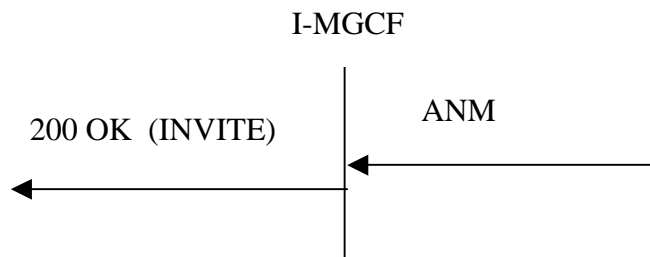

Figure 8: Receipt of ANM

- The reception of the CON message.

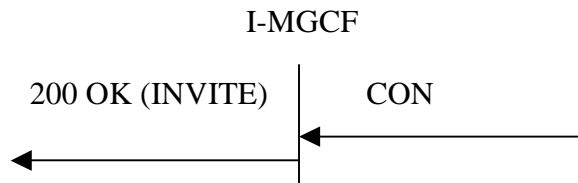

Figure 9: Receipt of CON

If the I-MGCF supports the PSTN XML body as a network option, the I-MGCF shall map the Access Transport Parameter received in the ANM or CON into PSTN XML elements as shown in table 7.2.3.1.5.1 and include this PSTN XML body in the 200 OK (INVITE).

On receipt of an ANM/CON message containing the ATP including the Bearer Capability set to "unrestricted digital information with tones/announcement" without TMU parameter the 200 OK message shall contain the PSTN XML Bearer Capability "unrestricted digital information with tones/announcement".

If the I-MGCF supports the PSTN XML body as a network option, the I-MGCF shall map an available BCI element in the ANM or CON into a ProgressIndicator in the PSTN XML body as shown in table 7.2.3.1.5.2; the I-MGCF shall include both a ProgressIndicator mapped from possibly received Progress indicator element in the Access Transport Parameter and ProgressIndicators derived according to table 7.2.3.1.5.2 in the PSTN XML.

NOTE 1: The order of ProgressIndicators within the same PSTN XML body is irrelevant.

Table 7.2.3.1.5.1: Mapping of ISUP ATP Parameter into PSTN XML elements

←200 OK	←ANM or CON	
PSTN XML	ISUP Parameter	Content
ProgressIndicator	Access Transport Parameter	Progress indicator
HighLayerCompatibility (NOTE 2)		High layer compatibility
LowLayerCompatibility (NOTE 2)		Low layer compatibility
BearerCapability (NOTE 1, NOTE 2)	Transmission medium used parameter (NOTE 1)	Bearer Capability
BearerCapability (NOTE 1, NOTE 2)		
NOTE 1: see clause 7.2.3.1.4.1 Transmission Medium Used parameter (TMU)		
NOTE 2: The I-MGCF shall only provide this IE if it interworks media encoded in any of the formats in table 2a (G.711, Clearmode, or t38) without transcoding. If both TMU and a BC in the ATP have been received, the BC in the ATP shall be mapped.		

Table 7.2.3.1.5.2: Mapping of ISUP BCI and optional BCI parameters into PSTN XML ProgressIndicator

← 200 OK	←ANM or CON
PSTN XML body with ProgressIndicator with "Progress Description" value No (Value of PI) (NOTE)	Content Backward call indicators parameter Optional backward call indicators parameter
No. 1 ("Call is not end-to-end ISDN: further call progress information may be available in-band")	Backward call indicators parameter ISDN User Part indicator 0 "ISDN User Part not used all the way"
No. 2 ("Destination address is non-ISDN")	Backward call indicators parameter ISDN User Part indicator 1 "ISDN User Part used all the way" ISDN access indicator 0 "Terminating access non-ISDN"
No. 7 ("Terminating access ISDN")	Backward call indicators parameter ISDN User Part indicator 1 "ISDN User Part used all the way" ISDN access indicator 1 "Terminating access ISDN"
No. 8 ("In-band information or an appropriate pattern is now available")	Optional backward call indicators parameter In-band information indicator 1 "in-band information or an appropriate pattern is now available"
NOTE: The ProgressIndicator "Coding Standard" parameter shall be set to "00 (ITU-T standardized coding)". The default value for the ProgressIndicator "Location" parameter is "0011 (Transit Network)".	

If the I-MGCF supports the PSTN XML body and receives a Transmission Medium Used (TMU) parameter,

NOTE 2: The I-MGCF will only receive a TMU parameter if it has applied the Fallback related procedures in clause 7.2.3.1.2.5a, including both a USI and TMR Prime parameter in the IAM, and fallback to the bearer capability identified in USI and TMR Prime occurred at the terminating side.

Then the I-MGCF shall:

- if a BC is not available in the ATP in the ANM or CON, map the TMU value (Speech or 3.1 kHz audio) to the PSTN XML BearerCapability element;
- if a BC is available in the ATP in the ANM or CON, include the received BC in the PSTN XML BearerCapability element;
- configure the IM-MGW to use the second format in the m-line in the SDP that has been received in the INVITE as codec at the IMS termination; and
- send SDP selecting the second format in the m-line of the SDP that has been received in the INVITE as soon as allowed according to SIP rules.

If the I-MGCF supports the PSTN XML body, has applied the Fallback related procedures in clause 7.2.3.1.2.5a, including both a TMR and TMR Prime in the IAM, and did not receive TMU in the ANM, CON, or any previous ISUP message,

NOTE 3: Fallback to the bearer capability identified in TMR did not occur at the terminating side.

Then the I-MGCF shall:

- configure the IM-MGW to use the first format in the m-line in the SDP offer that has been received in the INVITE as codec at the IMS termination; and
- send SDP selecting the first format in the m-line in the SDP offer at the first possibility according to SIP rules.

7.2.3.1.6 Sending of the Release message (REL)

The following are possible triggers for sending the Release message:

- Receipt of the BYE method

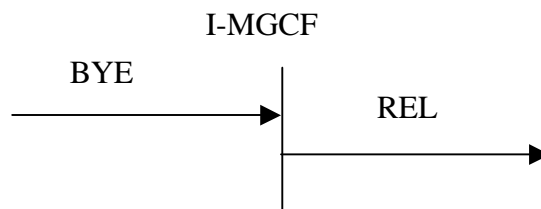

Figure 10: Receipt of the Bye method

- Receipt of the CANCEL method

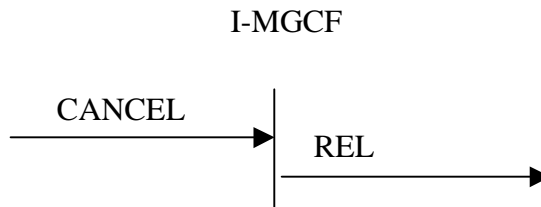

Figure 11: Receipt of Cancel method

Additional triggers are contained in table 10.

7.2.3.1.7 Coding of the REL

If the Reason header field with Q.850 Cause Value is included in the BYE or CANCEL request, then the Cause Value shall be mapped to the ISUP Cause Value field in the ISUP REL. The mapping of the Reason header to the Cause Indicators parameter is shown in table 8a. Table 8 shows the coding of the Cause Value in the REL if it is not available from the Reason header field. In both cases, the Location Field shall be set to "network beyond interworking point".

Table 8: Coding of REL

SIP Message →	REL →
Request	cause indicators parameter
BYE	Cause value No. 16 (normal clearing)
CANCEL	Cause value No. 16 (normal clearing)

Table 8a: Mapping of SIP Reason header fields into Cause Indicators parameter

Component of SIP Reason header field	Component value	BICC/ISUP Parameter field	Value
Protocol	"Q.850"	Cause Indicators parameter	–
protocol-cause	"cause = XX" (NOTE 1)	Cause Value	"XX" (NOTE 1)
–	–	Location	"network beyond interworking point"
NOTE 1: "XX" is the Cause Value as defined in ITU-T Recommendation Q.850 [38].			

Editor's Note: The mapping of reason headers towards the ISDN may be misused due to possible user creation of the reason header since there is no screening in IMS.

If the I-MGCF supports this PSTN XML body as a network option and the I-MGCF interworks media encoded in any of the formats in table 2a (G.711, Clearmode or t38) without transcoding, and if a PSTN XML body is received in the BYE or CANCEL request, the I-MGCF shall derive the Access Transport Parameter in the REL message from the PSTN XML body as shown in table 8b.

Table 8b: Mapping of PSTN XML elements into ISUP Parameters

BYE or CANCEL →	REL →	
PSTN XML	ISUP Parameter	Content
HighLayerCompatibility	Access Transport Parameter	High layer compatibility
LowLayerCompatibility		Low layer compatibility

7.2.3.1.8 Receipt of the Release Message

If the REL message is received and a final response (i.e. 200 OK (INVITE)) has already been sent, the I-MGCF shall send a BYE message.

NOTE: According to SIP procedures, in the case that the REL message is received and a final response (e.g. 200 OK (INVITE)) has already been sent (but no ACK request has been received) on the incoming side of the I-MGCF then the I-MGCF does not send a 487 Request terminated response and instead waits until the ACK request is received before sending a BYE message.

If the REL message is received and the final response (i.e. 200 OK (INVITE)) has not already been sent, the I-MGCF shall send a Status-Code 4xx (Client Error), 5xx (Server Error) or 6xx (Global Failure) response. The Status code to be sent is determined by examining the Cause value received in the REL message. Table 9 specifies the mapping of the cause values, as defined in ITU-T Recommendation Q.850 [38], to SIP response status codes. Cause values not appearing in the table shall have the same mapping as the appropriate class defaults according to ITU-T Recommendation Q.850 [38].

Table 9: Receipt of the Release message (REL)

← SIP Message Status code	← REL Cause indicators parameter
404 Not Found	Cause value No 1 (Unallocated (unassigned) number)
604 Does not exist anywhere	Cause value No 2 (No route to specified transit network)
604 Does not exist anywhere	Cause value No 3 (No route to destination)
500 Server Internal error	Cause value No 4 (Send special information tone)
404 Not Found	Cause value No 5 (Misdialed trunk prefix)
486 Busy Here	Cause value No 17 (User busy)
408 Request Timeout IF "ICS call" (NOTE 4) ELSE 480 Temporarily unavailable	Cause value No 18 (No user responding)
480 Temporarily unavailable	Cause value No 19 (No answer from user (user alerted))
408 Request Timeout IF "ICS call" (NOTE 4) ELSE 480 Temporarily unavailable	Cause value No 20 (Subscriber absent)
603 Decline IF location field is set to user ELSE 403 Forbidden	Cause value No 21 (Call rejected)
410 Gone	Cause value No 22 (Number changed)
410 Gone	Cause value No 23 (Redirection to new destination)
433 Anonymity Disallowed (NOTE 1)	Cause value No 24 (Call rejected due to feature at the destination)
483 Too Many Hops	Cause value No 25 (Exchange routing error)
480 Temporarily unavailable	Cause value No 26 (Non-selected user clearing)
502 Bad Gateway	Cause value No 27 (Destination out of order)
484 Address Incomplete	Cause value No 28 (Invalid number format (address incomplete))
501 Not Implemented	Cause value No 29 (Facility rejected)
480 Temporarily unavailable	Cause value No 31 (Normal, unspecified) (class default) (NOTE 2)
486 Busy here if Diagnostics indicator includes the (CCBS indicator = CCBS possible) else 503 Service Unavailable (NOTE 3)	Cause value No 34 (No circuit/channel available)
500 Server Internal error	Cause value No 38 (Network out of order)
503 Service Unavailable (NOTE 3)	Cause value No 41 (Temporary failure)
503 Service Unavailable (NOTE 3)	Cause value No 42 (Switching equipment congestion)
500 Server Internal error	Cause value No 43 (Access information discarded)
503 Service Unavailable (NOTE 3)	Cause value No 44 (Requested channel not available)
500 Server Internal error	Cause value No 46 (Precedence call blocked)
503 Service Unavailable (NOTE 3)	Cause value No 47 (Resource unavailable, unspecified) (class default)
488 Not acceptable here	Cause value No 50 (Requested facility not subscribed)
603 Decline	Cause value No 55 (Incoming class barred within Closed User Group (CUG))
603 Decline	Cause value No 57 (Bearer capability not authorised)
503 Service Unavailable (NOTE 3)	Cause value No 58 (Bearer capability not presently available)
501 Not Implemented	Cause value No 63 (Service option not available, unspecified) (class default)
500 Server Internal error	Cause value No 65 (Bearer capability not implemented)
501 Not Implemented	Cause value No 69 (Requested facility not implemented)
501 Not Implemented	Cause value No 70 (Only restricted digital information capability is available)
501 Not Implemented	Cause value No 79 (Service or option not implemented, unspecified) (class default)
403 Forbidden	Cause value No 87 (User not member of Closed User Group (CUG))
606 Not Acceptable	Cause value No 88 (Incompatible destination)
403 Forbidden	Cause value No 90 (Non existing Closed User Group (CUG))
500 Server Internal error	Cause value No 91 (Invalid transit network selection)
513 Message too large	Cause value No 95 (Invalid message, unspecified) (class default)
501 Not Implemented	Cause value No 97 (Message type non-existent or not implemented)
501 Not Implemented	Cause value No 98 (Message not compatible with call state or message type non-existent or not implemented)
501 Not Implemented	Cause value No 99 (Information element/parameter non-existent or not implemented)
504 Server timeout	Cause value No 102 (Recovery on timer expiry)

← SIP Message Status code	← REL Cause indicators parameter
501 Not Implemented	Cause value No 103 (Parameter non-existent or not implemented, passed on)
501 Not Implemented	Cause value No 110 (Message with unrecognised parameter, discarded)
400 Bad Request	Cause value No 111 (Protocol error, unspecified) (class default)
500 Server Internal error	Cause value No 127 (Interworking, unspecified) (class default)
NOTE 1: Anonymity Disallowed, IETF RFC 5079 [77] refers NOTE 2: Class 0 and class 1 have the same default value. NOTE 3: No Retry-After header field shall be included. NOTE 4: The I-MGCF identifies a call as an "ICS call" as specified in clause 7.2.3.1.2.12.	

A Reason header field containing the received (Q.850) Cause Value of the REL shall be added to the SIP final response or BYE request sent as a result of this subclause. The mapping of the Cause Indicators parameter to the Reason header is shown in table 9a. IETF RFC 6432 [115] describes the use of the Reason header field in responses. The Reason header field itself is described in IETF RFC 3326 [116].

Table 9a: Mapping of Cause Indicators parameter into SIP Reason header fields

Cause indicators parameter field	Value of parameter field	component of SIP Reason header field	component value
–	–	protocol	"Q.850"
Cause Value	"XX" (NOTE 1)	protocol-cause	"cause = XX" (NOTE 1)
–	–	reason-text	Should be filled with the definition text as stated in ITU-T Recommendation Q.850 [38]. (NOTE 2)
NOTE 1: "XX" is the Cause Value as defined in ITU-T Recommendation Q.850 [38]. NOTE 2: Due to the fact that the Cause Indicators parameter does not include the definition text as defined in table 1/Q.850 [38], this is based on provisioning in the I-MGCF.			

As a network option, an I-MGCF may generate an Error-Info header field according to rules and procedures of IETF RFC 3261 [19] to provide media instead of the in-band media received from the PSTN.

If the I-MGCF supports the PSTN XML body as a network option, the I-MGCF shall map the Access Transport Parameter received in the REL into PSTN XML elements as shown in table 9aa and include this PSTN XML body in the SIP final response or BYE.

Table 9aa: Mapping of ISUP Parameters into PSTN XML elements

← 4xx,5xx,6xx or BYE PSTN XML	← REL	
	ISUP Parameter	Content
ProgressIndicator	Access Transport Parameter	Progress indicator
HighLayerCompatibility (NOTE)		High layer compatibility
LowLayerCompatibility (NOTE)		Low layer compatibility
NOTE: The I-MGCF shall only provide this IE if it interworks media encoded in any of the formats in table 2a (G.711, Clearmode, or t38) without transcoding,		

7.2.3.1.9 Receipt of RSC, GRS or CGB (H/W oriented)

Upon receipt of a RSC, GRS or CGB (H/W oriented) message the following applies independently for each affected circuit:

- NOTE: For the RSC message, the circuit identified by the CIC is affected.
 For the GRS message, the affected circuits are identified by the CIC and the Range subfield of the Range and Status parameter.
 For the CGB message, the affected circuits are identified by the CIC and the Range and Status parameter.

If an initial address message has been sent for the affected circuit and after at least one backward message relating to that call has been received then:

- If the final response (i.e. 200 OK (INVITE)) has already been sent, the I-MGCF shall send a BYE message.
- If the final response (i.e. 200 OK (INVITE)) has not already been sent, the I-MGCF shall send a SIP response with Status-Code 480 Temporarily Unavailable.

A Reason header field containing the (Q.850) Cause Value of the REL message generated by the ISUP procedures shall be added to the SIP message (BYE or 480 response) to be sent by the SIP side of the I-MGCF.

7.2.3.1.9a Receipt of REFER

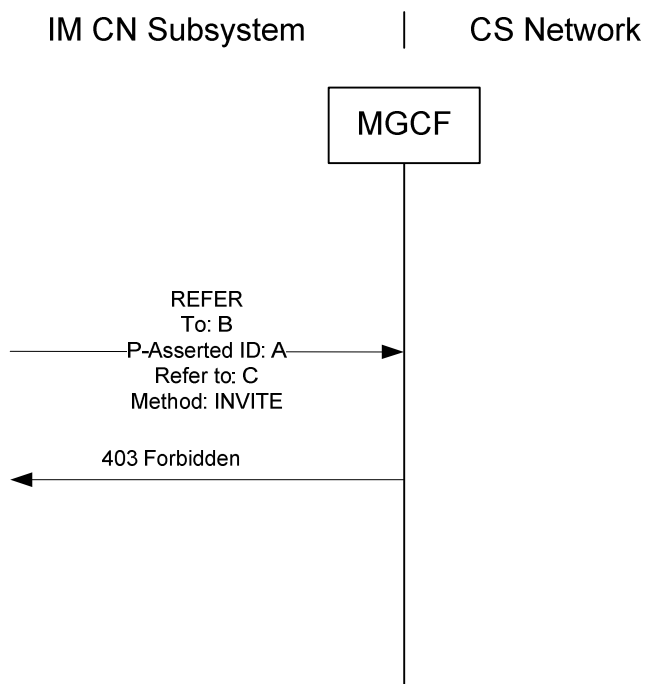

Figure 11a: Receipt of REFER method

Upon receipt of a REFER request at the MGCF, the default behaviour of the I-MGCF is to reject the REFER request with a 403 Forbidden response.

NOTE: The I-MGCF may also decide for example to execute the REFER request as specified in IETF RFC 3515 [75] as an operator option, but such handling is outside of the scope of the present document.

7.2.3.1.10 Autonomous Release at I-MGCF

Table 10 shows the trigger events at the MGCF and the release initiated by the MGCF when the call is traversing from SIP to ISUP/BICC.

A Reason header field containing the (Q.850) Cause Value of the REL message sent by the I-MGCF shall be added to the SIP Message (BYE request or final response) sent by the SIP side of the I-MGCF.

Editor's Note: It is FFS whether to indicate the cause value for internal error in the network to the user.

Table 10: Autonomous Release at I-MGCF

← SIP Response	Trigger event	REL → cause parameter
484 Address Incomplete	Determination that insufficient digits received.	Not sent.
480 Temporarily Unavailable	Congestion at the MGCF/Call is not routable.	Not sent.
BYE	ISUP/BICC procedures result in release after answer	According to ISUP/BICC procedures.
BYE	SIP procedures result in release after answer.	127 (Interworking unspecified)
500 Server Internal error	Call release due to the ISUP/BICC compatibility procedure (NOTE)	According to ISUP/BICC procedures.
484 Address Incomplete	Call release due to expiry of T7 within the ISUP/BICC procedures	According to ISUP/BICC procedures.
480 Temporarily Unavailable	Call release due to expiry of T9 within the BICC/ISUP procedures	According to BICC/ISUP procedures.
480 Temporarily Unavailable.	Other BICC/ISUP procedures result in release before answer.	According to BICC/ISUP procedures.
NOTE: MGCF receives unrecognized ISUP or BICC signalling information and determines that the call needs to be released based on the coding of the compatibility indicators, refer to ITU-T Recommendation Q.764 [4] and ITU-T Q.1902.4 [30].		

7.2.3.1.11 Internal through connection of the bearer path

The through connection procedure is described in clause 9.2.2.3.5.

7.2.3.2 Outgoing Call Interworking from ISUP to SIP at O-MGCF

7.2.3.2.1 Sending of INVITE

7.2.3.2.1.1 General

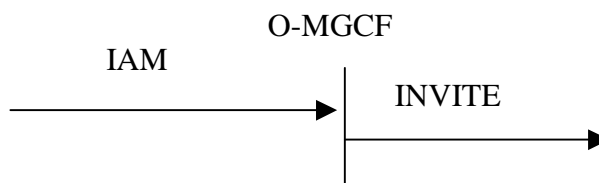

Figure 11b: Receipt of an IAM

Upon reception of an IAM message, the O-MGCF shall send a SIP INVITE request, as further detailed in the clauses below.

An O-MGCF shall support both the SIP preconditions and 100 rel extensions and indicate the support of the SIP preconditions and 100rel extensions in the INVITE request, unless the Note below applies.

NOTE: If the O-MGCF is deployed in an IMS network that by local configuration serves no user requiring preconditions, it may send the INVITE request without indicating support of preconditions.

7.2.3.2.1.2 Interaction with continuity check

If the Continuity Check indicator in the Nature of Connection Indicators parameter in the incoming IAM is set to indicate either "*continuity check required on this circuit*" or "*continuity check performed on previous circuit*", the O-MGCF should defer sending the INVITE request until receiving a COT message.

NOTE: If the Continuity Check indicator in the Nature of Connection Indicators parameter in the incoming IAM is set to indicate either "continuity check required on this circuit" or "continuity check performed on previous circuit" and the O-MGCF sends the INVITE request before receiving a COT message, the following considerations apply: If the receiving terminal is not supporting the SIP precondition and the SIP UPDATE method, clipping may occur. Furthermore, if the MGCF sets the SDP "inactive" attribute in the initial INVITE request and the receiving terminal is not supporting the SIP precondition, the interworking procedures within the present specification do not describe all necessary signalling interactions required to set up a call, in particular with respect to the sending of the re-INVITE that may also cause additional delay in the call setup. In addition, the interworking of the ringing indication might not be possible if the peer sends the ringing indication only as response to a re-INVITE.

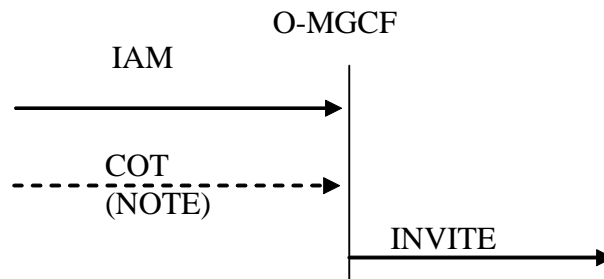

NOTE: Waiting for the COT is recommended, if the Continuity Check indicator in the Nature of Connection Indicators parameter in the incoming IAM is set to indicate either "continuity check required on this circuit" or "continuity check performed on previous circuit"

Figure 12: Receipt of an IAM (Waiting for the COT message)

7.2.3.2.1.3 IAM without calling party number

If no calling party number is received in the incoming IAM message, as a network option, the O-MGCF may send an INR message to request the calling party number and not send the INVITE request until receiving an INF message with calling party number. If no calling party number is received in the INF message, O-MGCF may reject or continue the call based on local configuration.

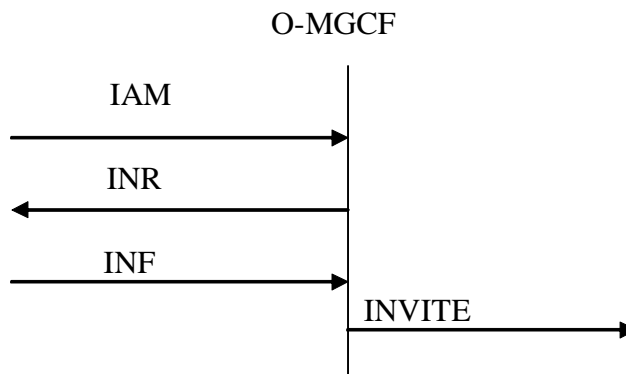

Figure 12a: Receipt of an IAM (Request for calling party number)

7.2.3.2.1.4 Terminating overlap signalling at MGCF

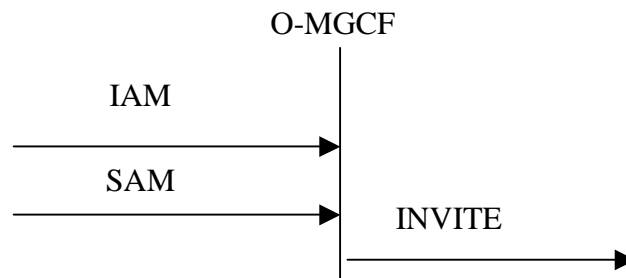

Figure 13: Receipt of an IAM (Overlap signalling in CS network)

After initiating the normal incoming BICC/ISUP call establishment procedures, determining the end of address signalling and selecting to route the call to the IMS domain, the O-MGCF shall send the initial INVITE.

The end of address signalling shall be determined by the earlier of the following criteria:

- a) by receipt of an end-of-pulsing (ST) signal; or
- b) by receipt of the maximum number of digits used in the national numbering plan; or
- c) by analysis of the called party number to indicate that a sufficient number of digits has been received to route the call to the called party; or
- d) by observing that timer $Ti/w1$ has expired after the receipt of the latest address message and the minimum number of digits required for routing the call have been received.

If the end of the address signalling is determined in accordance with criteria a) b) or c), the timer $Ti/w2$ is started when INVITE is sent. Also, if the PSTN XML body is supported as a network option, the O-MGCF shall insert the PSTN XML sendingCompleteIndication.

7.2.3.2.1.5 Fallback (optional)

The Fallback mechanism described in the present clause shall only apply if the O-MGCF supports the PSTN XML body as a network option, and propagates UDI-TA fallback signalling into the IMS as a network option.

NOTE: If the Fallback related signalling is not forwarded according to the procedures in the present subclause by the O-MGCF, the O-MGCF will apply the ISUP Fallback procedures when the IAM includes a TMR and a TMR prime parameter and a USI and USI Prime parameter.

When the IAM includes a TMR and a TMR prime parameter and a USI and USI Prime parameter then the O-MGCF shall:

- map the "USI Prime" into the "InformationTransferCapability" of the second BearerCapability element in the PSTN XML body;
- include SDP with one m-line of "audio" media type in the INVITE;
- map the "TMR" and "USI Prime" into a first offerered format in the SDP m-line according to table 10b;
- map the "USI" into the first Bearer Capability element in the PSTN XML body;
- map the "TMR prime" into the "InformationTransferCapability" of the first BearerCapability element in the PSTN XML body; and
- map the TMR prime and USI into a second offerered format in the SDP m-line according to table 10b.

7.2.3.2.1a Sending of INVITE without determining the end of address signalling

7.2.3.2.1a.1 General

As a network option, the O-MGCF is not required to determine the end of address signalling. In this case the O-MGCF shall send an initial INVITE when a preconfigured number of digits has been reached.

When the MGCF receives ISUP SAM messages the additional digits received in the SAMs may either be sent using the in-dialog overlap method as specified in clause 7.2.3.2.1a.2 or using the multiple INVITEs overlap method as specified in 7.2.3.2.1a.3. It depends on the network configuration which of these methods is applied. However, within one IMS only a single method shall be used.

7.2.3.2.1a.2 Additional digits sent with in-dialog overlap method

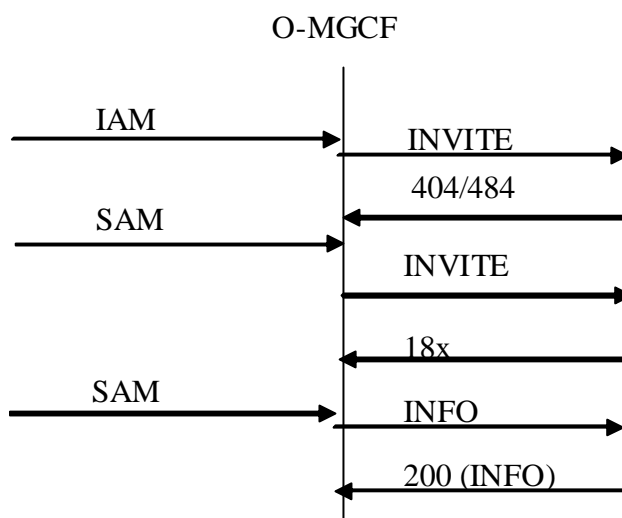

Figure 14: Overlap signalling using in-dialog INFOs in CS an IMS network

If the O-MGCF sends an initial SIP INVITE request before the end of address signalling is determined, the O-MGCF shall:

- use the SIP precondition extension within the SIP INVITE request;
- start timer $Ti/w2$;
- be prepared to process SAM as described below;
- be prepared to handle incoming SIP 18x provisional responses, establishing early dialogs; and
- be prepared to handle incoming SIP 404 or 484 error responses as detailed in clause 7.2.3.2.12.1.

NOTE: A SIP INVITE request with incomplete address information can be rejected with a SIP 404 or 484 error response.

On receipt of a SAM from the BICC/ISUP side, unless the O-MGCF has received a SIP 180 (Ringing) response for the call, the following O-MGCF procedures apply:

- The O-MGCF shall stop timer $Ti/w3$ (if it is running).
- If no response has been received for the previous INVITE request of the same call, the O-MGCF shall wait for the response and then apply the procedures in the next bullets to transfer the digits received in the SAM. If additional SAMs are received while the O-MGCF is waiting for the response for the previous SIP INVITE request, the digits within shall be combined with the digits of the previous SAMs.
- If an early dialog has not been established, and a SIP 404 or 484 error response has been received for the last previous SIP INVITE request for the same call, the O-MGCF shall send a SIP INVITE request complying to the following:

- The SIP INVITE request shall use the SIP preconditions extension.
- The SIP INVITE request shall include all digits received so far for this call in the Request-URI.
- The SIP INVITE request shall include the same Call-ID and From tag as the previous SIP INVITE request for the call.
- If an early dialog has been established, and a response has been received for any previously sent SIP INFO request ("legacy" mode of usage of the INFO method as defined in IETF RFC 6086 [133]), the O-MGCF shall send an in-dialog SIP INFO request complying the following:
 - The SIP INFO request shall only include the digits received since the previous SIP request with digits was sent (see Note).
- If no response has been received for the previous SIP INFO request, the O-MGCF shall wait for the response and then apply the procedures in the previous bullet to transfer digits received in the SAM. If additional SAMs are received while the O-MGCF is waiting for the response for the previous SIP INFO request, the digits within shall be combined with the digits of the previous SAMs.
- Restart $Ti/w2$.

If timer $Ti/w2$ has expired, or the O-MGCF has received a SIP 180 (Ringing) response for the call, the O-MGCF shall ignore subsequent SAMs received.

NOTE: The encoding of the digits within the SIP INFO request is described in clause 7.2.3.2.20.2.

Editor's note: It needs to be verified whether the timer procedures associated with the in-dialog method are correct.

7.2.3.2.1a.3 Additional digits sent using the multiple INVITEs overlap method

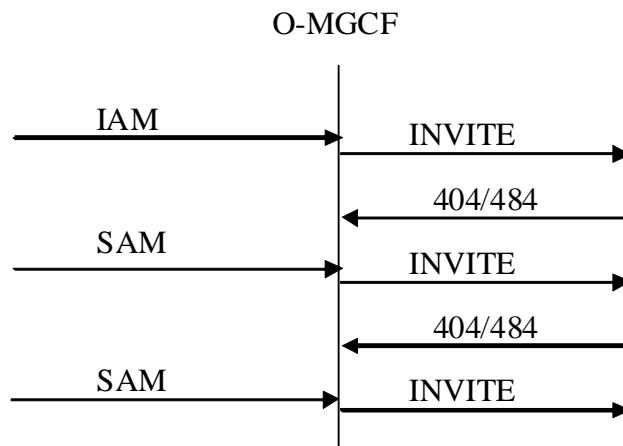

Figure 14a: Overlap signalling using multiple INVITEs in CS an IMS network

If the O-MGCF sends an SIP INVITE request before the end of address signalling is determined, the O-MGCF shall:

- use the SIP precondition extension within the SIP INVITE request;
- start timer $Ti/w2$; and
- be prepared to process SAM as described below; and
- be prepared to handle incoming SIP 404 or 484 error responses as detailed in clause 7.2.3.2.12.1.

NOTE: An SIP INVITE request with incomplete address information will be rejected with a SIP 404 or 484 error response.

On receipt of a SAM from the BICC/ISUP side, unless the O-MGCF has received a SIP 180 (Ringing) response for the call, the O-MGCF shall:

- stop timer $Ti/w3$ (if it is running);

- send an INVITE request complying to the following:
 - The SIP INVITE request shall use the SIP preconditions extension.
 - The SIP INVITE request shall include all digits received so far for this call in the Request-URI.
 - The SIP INVITE request shall include the same Call-ID and From tag as the previous SIP INVITE request for the call.
- restart Ti/w2;

If timer Ti/w2 has expired, or the O-MGCF has received a SIP 180 (Ringing) response for the call, the O-MGCF shall ignore subsequent SAMs received.

7.2.3.2.2 Coding of the INVITE

7.2.3.2.2.0 Overview

Table 10aa provides a summary of how the header fields within the outgoing INVITE message are populated.

Table 10aa: Interworked contents of the INVITE message

IAM→	INVITE→
Called Party Number	Request-URI To
Calling Party Number	P-Asserted-Identity Privacy From
Generic Number (<i>"additional calling party number"</i>)	From Privacy
Hop Counter	Max-Forwards
TMR/USI	Message Body (application/SDP)
Location Number	P-Access-Network-Info

7.2.3.2.2.1 REQUEST URI Header

The called party number parameter of the IAM message is used to derive Request URI of the INVITE Request. The Request URI is a tel URI or SIP URI with "user=phone" and shall contain:

- an E.164 International public telecommunication number prefixed by a "+" sign (e.g. tel:+4911231234567) , or
- a non E.164 number (national operator option for service numbers), expressed as a local number as per IETF RFC 3966 [97].

Table 10a: Mapping ISUP Called Party Number to SIP Request-URI and To header field

IAM		INVITE	
BICC/ISUP Parameter / field	Value	SIP component	Value
Called Party Number (NOTE 3)		Request-URI and To header field	display-name (optional) and addr-spec derived from Called Party Number parameter address signals
Nature of Address Indicator (NOTE 2) (NOTE 6)	"national (significant) number"	Tel URI or SIP URI	Insert "+CC" before the Address signals (NOTE 1)
	"international number"		Insert "+" before the Address signals
	"Network-specific number" or "reserved for national use"		according to local policies should either be: - a global number (+CC), if the called party number may be converted into an E.164 address OR, depending on operator's requirements may be converted into - local number (with a phone-context parameter) (NOTE 4) (NOTE 5)
NOTE 1: CC = Country Code of the network in which the O-MGCF is located.			
NOTE 2: The usage of "Nature of address indicator" value "unknown" is allowed but the mapping is not specified in the present specification.			
NOTE 3: If the address signals received in the ISUP Called Party Number contain a sending terminated signal (hexadecimal digit F), then this shall be discarded or if the O-MGCF supports the PSTN XML body as a network option then the PSTN XML sendingCompleteIndication shall be set.			
NOTE 4: Mapping between nature of address indicator values and phone-context values is provisioned in the MGCF. Setting of value of phone-context is depending on local operator's policies.			
NOTE 5: Network-specific number or reserved for national use shall be translated into E.164 format numbers except if local operator's policy requires keeping in local format (e.g. for national reasons E.164 numbers cannot be used for such purpose). In the later case the mapping shall be done as indicated in the table.			
NOTE 6: The values "Network routing number in national (significant) number format", "Network routing number in network specific number format" or "Network routing number concatenated with called directory number" are used when number portability is supported. For the mapping see clause 7.2.3.2.2A.			

7.2.3.2.2.2 SDP Media Description

If the O-MGCF indicates support of the SIP preconditions in the initial INVITE request and local preconditions have not been met, the SDP media description shall contain precondition information as per 3GPP TS 24.229 [9]. Depending on the coding of the continuity indicators different precondition information (IETF RFC 3312 [37]) is included. If the continuity indicator indicates "continuity performed on a previous circuit" or "continuity required on this circuit", and the INVITE is sent before receiving a COT, message (which is not recommended according to clause 7.2.3.2.1.1), then the O-MGCF shall indicate that the preconditions are not met. Otherwise the O-MGCF shall indicate whether the preconditions are met, dependent on the status of the local resource reservation.

If the O-MGCF determines that a speech call is incoming, the O-MGCF shall include the AMR codec transported according to IETF RFC 4867 [23] with the options listed in clause 5.1.1 of 3GPP TS 26.236 [32] in the SDP offer, unless the Note below applies. Within the SDP offer, the O-MGCF should also provide SDP RR and RS bandwidth modifiers specified in IETF RFC 3556 [59] to disable RTCP, as detailed in clause 7.4 of 3GPP TS 26.236 [32]. The O-MGCF may include other codecs according to operator policy.

NOTE: If the O-MGCF is deployed in an IMS network that by local configuration serves no user equipment that implements the AMR codec, then the AMR codec may be excluded from the SDP offer.

To avoid transcoding or to support non-speech services, the O-MGCF may add media derived from the incoming ISUP information according to table 10b. The support of the media listed in table 10b is optional. If the O-MGCF supports the PSTN XML body as a network option and adds media derived from the incoming ISUP information according to table 10b, the O-MGCF shall also map the media related ISUP information into the XML body as shown in table 7.2.3.2.2.7.1.

Table 10b: Coding of SDP media description lines from TMR/USI: ISUP to SIP

TMR parameter	USI parameter (Optional)		HLC IE in ATP (Optional)	m= line			b= line	a= line
TMR codes	Information Transfer-Capability	User Information Layer 1 Protocol Indicator	High Layer Characteristics Identification	<media>	<transport>	<fmt-list>	<modifier>: <bandwidth-value>	rtpmap:<dynamic-PT> <encoding name>/<clock rate>[/encoding parameters>
"speech"	"Speech"	"G.711 μ -law"	Ignore	audio	RTP/AVP	0 (and possibly 8) (NOTE 1)	AS: (64 + RTP/UDP/IP overhead)	rtpmap:0 PCMU/8000 (and possibly rtpmap:8 PCMA/8000) (NOTE 1)
"speech"	"Speech"	"G.711 μ -law"	Ignore	audio	RTP/AVP	Dynamic PT (and possibly a second Dynamic PT) (NOTE 1)	AS: (64 + RTP/UDP/IP overhead)	rtpmap:<dynamic-PT> PCMU/8000 (and possibly rtpmap:<dynamic-PT> PCMA/8000) (NOTE 1)
"speech"	"Speech"	"G.711 A-law"	Ignore	audio	RTP/AVP	8	AS: (64 + RTP/UDP/IP overhead)	rtpmap:8 PCMA/8000
"speech"	"Speech"	"G.711 A-law"	Ignore	audio	RTP/AVP	Dynamic PT	AS: (64 + RTP/UDP/IP overhead)	rtpmap:<dynamic-PT> PCMA/8000
"3.1 KHz audio"	USI Absent		Ignore	audio	RTP/AVP	8	AS: (64 + RTP/UDP/IP overhead)	rtpmap:8 PCMA/8000
"3.1 KHz audio"	"3.1 KHz audio"	"G.711 μ -law"	(NOTE 3)	audio	RTP/AVP	0 (and possibly 8) (NOTE 1)	AS: (64 + RTP/UDP/IP overhead)	rtpmap:0 PCMU/8000 (and possibly rtpmap:8 PCMA/8000) (NOTE 1)
"3.1 KHz audio"	"3.1 KHz audio"	"G.711 A-law"	(NOTE 3)	audio	RTP/AVP	8	AS: (64 + RTP/UDP/IP overhead)	rtpmap:8 PCMA/8000
"3.1 KHz audio"	"3.1 KHz audio"		"Facsimile Group 2/3"	image (NOTE 9)	Udptl [73]	t38[73]	AS: (64 + UDP/IP overhead)	Based on ITU-T T.38 [72]. (NOTE 8)
"3.1 KHz audio"	"3.1 KHz audio"		"Facsimile Group 2/3"	image (NOTE 9)	Tcp (NOTE 7)	t38[73]	AS: (64 + TCP/IP overhead)	Based on ITU-T T.38 [72]. (NOTE 8)
"3.1 KHz audio"	"3.1 KHz audio"		"Facsimile Group 2/3"	Audio (NOTE 9)	RTP/AVP	0, 8, or <dynamic-PT>	AS: (64 + RTP/UDP/IP overhead)	rtpmap:0 PCMA/8000 or rtpmap:8 PCMU/8000 or rtpmap:<dynamic-PT> PCMA/8000 or rtpmap:<dynamic-PT> PCMU/8000
"64 kbit/s preferred"	"Speech/ 3.1KHz audio" (NOTE 6)	N/A	Ignore	audio	RTP/AVP	Dynamic PT	AS: (64 + RTP/UDP/IP overhead)	rtpmap:<dynamic-PT> CLEARMODE/8000 (NOTE 2)(NOTE 4)
"64 kbit/s unrestricted"	"Unrestricted digital information"	N/A	Ignore	audio	RTP/AVP	Dynamic PT	AS: (64 + RTP/UDP/IP overhead)	rtpmap:<dynamic-PT> CLEARMODE/8000 (NOTE 2)(NOTE 5)

NOTE 1: Both PCMA and PCMU could be required.
NOTE 2: CLEARMODE is specified in IETF RFC 4040 [69].

TMR parameter	USI parameter (Optional)		HLC IE in ATP (Optional)	m= line			b= line	a= line
TMR codes	Information Transfer-Capability	User Information Layer 1 Protocol Indicator	High Layer Characteristics Identification	<media>	<transport>	<fmt-list>	<modifier>: <bandwidth-value>	rtpmap:<dynamic-PT> <encoding name>/<clock rate>[/encoding parameters]
<p>NOTE 3: HLC is normally absent in this case. It is possible for HLC to be present with the value "Telephony", although 6.3.1/ITU-T Q.939 indicates that this would normally be accompanied by a value of "Speech" for the Information Transfer Capability element.</p> <p>NOTE 4: After the CLEARMODE codec, additional speech codecs such as AMR and/or G.722 and/or G.711 available via transcoding or reframing should be offered in the same m-line.</p> <p>NOTE 5: As alternative or in addition to the m-line containing the CLEARMODE codec, an MGCF supporting the multimedia interworking detailed in Annex E may add an m-line for speech codecs and an m-line for video codecs as detailed in this Annex.</p> <p>NOTE 6: In this case, the USI prime parameter will also be present and will indicate "Unrestricted Digital Information with tones/announcements".</p> <p>NOTE 7: This value is not recommended in a network supporting MTSI clients as it is not supported by an MTSI client (see TS 24.173 [88]).</p> <p>NOTE 8: Annex K describes recommended values.</p> <p>NOTE 9: FAX can either be transported according to ITU-T recommendation T.38 [72] using the "image" media type or as inband Voice band data over IP using the "audio" media type.</p>								

7.2.3.2.2.3

P-Asserted-Identity, From and Privacy header fields

Table 12: Mapping BICC/ISUP CLI parameters to SIP header fields

Has a Calling Party Number parameter with complete E.164 number, and with Screening Indicator = UPVP or NP (NOTE 1) been received?	Calling Party Number APRI	Has a Generic Number (AcgPN) with a complete E.164 number and with Screening Indicator = UPNV been received?	Generic Number APRI	P-Asserted-Identity header field	From header field	Privacy header field
N	-	N	-	Header field not included	SIP URI with addr-spec of Unavailable User Identity (NOTE 2) (NOTE 6)	Header field not included
N	-	Y (NOTE 3)	"presentation allowed"	Header field not included	addr-spec derived from Generic Number (AcgPN) address signals or network provided value (NOTE 6)	Header field not included
N	-	Y (NOTE 3)	"presentation restricted"	Header field not included	SIP URI with addr-spec of Unavailable User Identity (NOTE 2) (NOTE 6)	Header field not included
					Derived from the Generic Number parameter address signals (see table 13) (NOTE 6) (NOTE 8)	priv-value =: "user" (See table 16).
Y	"presentation allowed"	N	-	Derived from Calling Party Number parameter address signals (See table 14)	Tel URI or SIP URI derived from Calling Party Number parameter address signals (See table 15) (NOTE 6)	Privacy header is not included or if included, "id" and "header" are not included (See table 16)
Y	"presentation allowed"	Y	"presentation allowed"	Derived from Calling Party Number parameter address signals (See table 14)	Derived from Generic Number (AcgPN) address signals (See table 13) (NOTE 6)	Privacy header is not included or if included, "id", "header" and "user" are not included (See table 16).
Y	"presentation allowed"	Y	"presentation restricted"	Derived from Calling Party Number parameter address signals (See table 14)	Tel URI or SIP URI derived from Calling Party Number parameter address signals (See table 15) (NOTE 6) (NOTE 9)	Privacy header is not included or if included, "id" and "header" are not included (See table 16).
					SIP URI with addr-spec of Anonymuous URI (NOTE 6) (NOTE 7) (NOTE 10)	Privacy header is not included or if included, "id" and "header" are not included (See table 16).

Has a Calling Party Number parameter with complete E.164 number, and with Screening Indicator = UPVP or NP (NOTE 1) been received?	Calling Party Number APRI	Has a Generic Number (AcgPN) with a complete E.164 number and with Screening Indicator = UPNV been received?	Generic Number APRI	P-Asserted-Identity header field	From header field	Privacy header field
					Derived from the Generic Number parameter address signals (see table 13) (NOTE 6) (NOTE 8)	priv-value =: "user". "id" and "header" are not included (See table 16).
Y	"presentation restricted"	N	-	Derived from Calling Party Number parameter address signals (See table 14)	SIP URI with addr-spec of Unavailable User Identity (NOTE 2) (NOTE 6)	priv-value =: "id". (See table 16)
Y	"presentation restricted"	Y	"presentation allowed"	Derived from Calling Party Number parameter address signals (See table 14)	Derived from Generic Number (AcgPN) address signals (See table 13) (NOTE 6)	priv-value =: "id".
Y	"presentation restricted"	Y	"presentation restricted"	Derived from Calling Party Number parameter address signals (See table 14)	SIP URI with addr-spec of Anonymous URI (NOTE 6) (NOTE 7) (NOTE 10)	priv-value =: "id"
					Derived from the Generic Number parameter address signals (see table 13) (NOTE 6) (NOTE 8)	priv-value =: "id", "user". (See table 16).
Y	"presentation restricted by network" (NOTE 4)	N	-	Header field not included.	Addr-spec is set to "unavailable@hostportion" (NOTE 5) (NOTE 6)	Privacy header is not included or if included, "id" and "header" are not included (See table 16)
Y	"presentation restricted by network"	Y	"presentation allowed"	Header field not included.	Derived from Generic Number (AcgPN) address signals (See table 13) (NOTE 6)	Privacy header is not included or if included, "id", "header" and "user" are not included (See table 16).
Y	"presentation restricted by network"	Y	"presentation restricted"	Header field not included.	Addr-spec is set to Anonymous URI (NOTE 6) (NOTE 7)	Privacy header is not included or if included, "id" and "header" are not included (See table 16).
					Derived from the Generic Number parameter address signals (see table 13) (NOTE 6) (NOTE 8)	priv-value =: "user". "id" and "header" are not included (See table 16).

Has a Calling Party Number parameter with complete E.164 number, and with Screening Indicator = UPVP or NP (NOTE 1) been received?	Calling Party Number APRI	Has a Generic Number (AcgPN) with a complete E.164 number and with Screening Indicator = UPNV been received?	Generic Number APRI	P-Asserted-Identity header field	From header field	Privacy header field
<p>NOTE 1: A Network Provided CLI in the CgPN parameter may occur on a call to IMS. Therefore in order to allow the "display" of this Network Provided CLI at a SIP UAS it shall be mapped into the SIP From header. It is also considered suitable to map into the P-Asserted-Identity header since in this context it is a fully authenticated CLI related exclusively to the calling line, and therefore as valid as a User Provided Verified and Passed CLI for this purpose.</p> <p>NOTE 2: The "From" header may contain an "Unavailable User Identity". An "Unavailable User Identity" includes information that does not point to the calling party and indicates that the caller's identity is unknown. The encoding of the "Unavailable User Identity" shall be as defined in TS 23.003 [74].</p> <p>NOTE 3: This combination of CgPN and AcgPN is an error case but is shown here to ensure consistent mapping across different implementations.</p> <p>NOTE 4: This is an ETSI specific value described within ETSI EN 300 356-1 [70].</p> <p>NOTE 5: The setting of the hostportion is according to operator policy.</p> <p>NOTE 6: In accordance with IETF RFC 3261 [19] procedures, a tag shall be added to the "From" header.</p> <p>NOTE 7: The "From" header may contain an "Anonymous User Identity". An "Anonymous User Identity" includes information that does not point to the calling party and indicates that the caller has withheld their identity. The encoding of the "Anonymous User Identity" shall be as defined in TS 23.003 [74].</p> <p>NOTE 8: As a network option, the "From" header may be derived from the Generic Number parameter address signals (see table 13). This option is only recommended to use within a trusted domain where an entity such as a TAS is configured to be inserted into the call path that is able to change the "From" Header content to an anonymous user identity (NOTE 7).</p> <p>NOTE 9: As a network option, the "From" header may be derived from the Calling Party Number parameter address signals (see table 15). This option is only recommended to use within a trusted domain where an entity such as a TAS is configured to be inserted into the call path that is able to change the "From" Header content to an anonymous user identity (NOTE 7).</p> <p>NOTE 10: Network option.</p>						

Table 13: Mapping of generic number (additional calling party number) to SIP from header fields

BICC/ISUP parameter / field	Value	SIP component	Value
Generic Number Number Qualifier Indicator	" <i>additional calling party number</i> "	From header field	display-name (optional) and addr-spec
Nature of Address Indicator	" <i>national (significant) number</i> "	Tel URI or SIP URI	Add CC (of the country where the MGCF is located) to GN address signals to construct E.164 number in URI. Prefix number with "+".
	" <i>international number</i> "		Map complete GN address signals to E.164 number in URI. Prefix number with "+".
Address signal	if NOA is " <i>national (significant) number</i> " then the format of the address signals is: NDC+ SN If NOA is " <i>international number</i> " then the format of the address signals is: CC + NDC + SN		
		Tel URI or SIP URI	CC+NDC+SN as E.164 number in URI. Prefix number with "+".

Table 14: Mapping of calling party number parameter to SIP P-Asserted-Identity header fields

BICC/ISUP Parameter / field	Value	SIP component	Value
Calling Party Number		P-Asserted-Identity header field	addr-spec and optionally display-name (NOTE)
Nature of Address Indicator	" <i>national (significant) number</i> "	Tel URI or SIP URI	Add CC (of the country where the MGCF is located) to CgPN address signals to construct E.164 number in URI. Prefix number with "+".
	" <i>international number</i> "		Map complete CgPN address signals to E.164 number in URI. Prefix number with "+".
Address signal	If NOA is " <i>national (significant) number</i> " then the format of the address signals is: NDC + SN If NOA is " <i>international number</i> " then the format of the address signals is: CC + NDC + SN	Tel URI or SIP URI	CC+NDC+SN as E.164 number in URI. Prefix number with "+"
NOTE: The display-name may be mapped from the corresponding telephone number if possible and allowed by network operator policies.			

Table 15: Mapping of BICC/ISUP Calling Party Number parameter to SIP From header fields

BICC/ISUP parameter / field	Value	SIP component	Value
Calling Party Number		From header field	
Nature of Address Indicator	"national (significant number)"	Tel URI or SIP URI (NOTE)	Add CC (of the country where the MGCF is located) to CgPN address signals then map to construct E.164 number in URI. Prefix number with "+".
	"international number"		Map complete CgPN address signals to construct E.164 number in URI. Prefix number with "+".
Address signal	If NOA is "national (significant) number" then the format of the address signals is: NDC + SN If NOA is "international number" then the format of the address signals is: CC + NDC + SN	Tel URI or SIP URI (NOTE)	CC+NDC+SN as E.164 number in URI. Prefix number with "+".
NOTE: A tel URI or a SIP URI with "user=phone" is used according to operator policy.			

Table 16: Mapping of BICC/ISUP APRI into SIP privacy header fields

BICC/ISUP parameter / field	Value	SIP component	Value
Calling Party Number		Privacy header field	priv-value
APRI	"presentation restricted"	Priv-value	"id" ("id" included only if the P-Asserted-Identity header is included in the SIP INVITE)
	"presentation allowed" or "presentation restricted by network"	Priv-value	omit Privacy header or Privacy header without "id" and "header" if other privacy service is needed
Generic Number (AcgPN)		Privacy header field	priv-value
APRI (NOTE)	"presentation restricted"	Priv-value	"user"
	"presentation allowed"	Priv-value	omit Privacy header or Privacy header without "user" if other privacy service is needed
NOTE: Mapping of Generic Number APRI is only applicable, if the Generic Number is mapped to the "From" header field (see table 12).			

7.2.3.2.2.3A "cpc" URI Parameter in P-Asserted-Identity Header

See Annex C for normative interworking of a Calling party's category to a "cpc" URI parameter within P-Asserted-Identity header field.

7.2.3.2.2.3B "oli" URI Parameter in P-Asserted-Identity Header

See Annex H for normative interworking of the "oli" URI parameter as a network option.

7.2.3.2.2.4 Max Forwards header

If the Hop Counter procedure is supported in the CS network, the O-MGCF shall use the Hop Counter parameter to derive the Max-Forwards SIP header. Due to the different default values (that are based on network demands/provisions) of the SIP Max-Forwards header and the Hop Counter, an adaptation mechanism shall be used to adopt the Hop Counter to the Max Forwards at the O-MGCF. For example, the following guidelines could be applied.

- a) Max-Forwards for a given message should be monotone decreasing with each successive visit to a SIP entity, regardless of intervening interworking, and similarly for Hop Counter.
- b) The initial and successively mapped values of Max-Forwards should be large enough to accommodate the maximum number of hops that may be expected of a validly routed call.

The table 17 shows the principle of the mapping:

Table 17: Hop counter-Max forwards

Hop Counter	= X	Max-Forwards	= Y = Integer part of (X * Factor)
NOTE: The Mapping of value X to Y should be done with the used (implemented) adaptation mechanism.			

The factor used to map from Hop Counter to Max-Forwards for a given call will depend on call origin, and will be provisioned at the O-MGCF based on network topology, trust domain rules, and bilateral agreement.

The Principle of adaptation could be implemented on a basis of the network provision, trust domain rules and bilateral agreement.

7.2.3.2.2.5 IMS Communication Service Identifier

For speech and video calls, the O-MGCF shall insert an IMS Communication Service Identifier, indicating the IMS Multimedia Telephony Communication Service.

The IMS Communication Service Identifier for the IMS Multimedia Telephony Communication Service is defined in 3GPP TS 24.173 [88].

7.2.3.2.2.6 P-Early-Media header field

For a speech call the O-MGCF may include the P-Early-Media header field with the "supported" parameter as described in IETF RFC 5009 [89] in each outgoing INVITE request.

- NOTE: The P-Early-Media header with the "supported" parameter can be ignored by terminating devices when not supporting the procedures described in IETF RFC 5009 [89].

7.2.3.2.2.7 PSTN XML elements

If the O-MGCF supports the PSTN XML body as a network option, the O-MGCF shall map ISUP information into the XML body as shown in table 7.2.3.2.2.7.1 and 7.2.3.2.2.8.1.

Table 7.2.3.2.2.7.1: Mapping of ISUP Parameters with PSTN XML elements

IAM →		INVITE →
ISUP Parameter	Content	PSTN XML
Access Transport Parameter	High layer compatibility	HighLayerCompatibility (NOTE 1, NOTE 2, NOTE 3)
	Low layer compatibility	LowLayerCompatibility (NOTE 3)
User Service Information		Bearer Capability (NOTE 3, NOTE 4)
User Teleservice Information	High layer compatibility	HighLayerCompatibility (NOTE 2, NOTE 3)
Called Party Number	Sending terminated signal (hexadecimal digit F)	sendingCompleteIndication
<p>NOTE 1: If two high layer compatibility information elements are received in the ATP of the IAM, they shall be transferred in the same order as received into the PSTN XML body within the INVITE.</p> <p>NOTE 2: In the normal case, the High layer compatibility information in the ATP is equal to the High layer compatibility in the User Teleservice Information parameter. In the PSTN XML body, no two identical High layer compatibility information shall be present. If an HLC is available both in the ATP and in the User Teleservice information, the HLC from the ATP should be mapped.</p> <p>NOTE 3: The O-MGCF shall only map this information element if the O-MGCF offers media formats which can be transferred by the IM-MGW without transcoding and are derived from the incoming ISUP information according to table 10b.</p> <p>NOTE 4: See clause 7.2.3.2.1.5.</p>		

7.2.3.2.2.8 Progress indicator

If the O-MGCF supports the PSTN XML body as a network option, the Forward call indicators parameter and an available "Progress indicator" element in the IAM shall be mapped into a ProgressIndicator in the PSTN XML body of the INVITE as shown in table 7.2.3.2.2.8.

Table 7.2.3.2.2.8: Coding of PSTN XML ProgressIndicator

IAM →		INVITE →	
Forward call indicators parameter		Access transport parameter	PSTN XML body with ProgressIndicator with "Progress Description" value No. (Value of PI)
ISDN User Part indicator	ISDN access indicator		
0 ("ISDN User Part not used all the way")	Value non-significant	Value non-significant	No. 1 (NOTE 1)
1 ("ISDN User Part used all the way")	0 ("originating access non – ISDN")	Value non-significant	No. 3 (NOTE 1)
1 ("ISDN User Part used all the way")	1 ("originating access ISDN")	Progress indicator No. (Value of PI)	ProgressIndicator mapped from Progress indicator received in the ATP (NOTE 2) and additional ProgressIndicator with "Progress Description" value No.6 (NOTE 1, NOTE 3)
1 ("ISDN User Part used all the way")	1 ("originating access ISDN")	Not present	No. 6 (NOTE 1)
<p>NOTE 1: The ProgressIndicator "Coding Standard" parameter shall be set to "00 (ITU-T standardized coding)". The default value for the ProgressIndicator "Location" parameter is "0011 (Transit Network)".</p> <p>NOTE 2: The entire Progress indicator, including the "Progress Description", "Coding Standard" and "Location" parameters shall be copied.</p> <p>NOTE 3: The order of ProgressIndicators within PSTN XML body is irrelevant.</p>			

7.2.3.2.2.9 P-Access-Network-Info

If the IAM message includes a location number ISDN user part parameter, the O-MGCF shall include a P-Access-Network-Info header. The P-Access-Network-Info shall be populated as shown in table 7.2.3.2.2.9.1.

Table 7.2.3.2.2.9.1: Coding of the P-Access-Network-Info header fields

BICC/ISUP parameter / field	SIP component	Value
Location Number	access-type	"GSTN"
	gstn-location (NOTE)	value of Location Number, in quotes
NOTE: Alternatively, as a network option, the value of the Location Number can populate the operator-specific-GI parameter. In this case, the operator-specific-GI is set to the text string between quotes with the sequence of digits found in octet 3 to N (except the filler) starting with the 1 st digit. The access-info parameter is set to "operator-specific-GI"		

Table 7.2.3.2.2.9.2: Mapping ISUP Location Number to SIP P-Access-Network-Info

IAM	INVITE
Location Number	P-Access-Network-Info
Parameter name	not mapped
Parameter length	not mapped
Parameter content	gstn-location set to the hexadecimal representation of the ISUP parameter content, encoded as a text string between quotes
NOTE 1: As specified in ITU-T Q.763 [4], the parameter content includes both the header fields (octets 1 and 2) and the address signals.	
NOTE 2: The parameter content includes the address presentation restricted indicator. This field is not mapped to the Privacy header field. It is upon network operator responsibility to remove the P-Access-Network-Info header field when leaving the trust domain, as specified in TS 24.229 [9].	
NOTE 3: If the screening indicator is set to network provided, a np parameter is added to the P-Access-Network-Info header field value.	

7.2.3.2.2.A Coding of the INVITE when Number Portability is supported

This clause describes optional coding procedures when Number Portability is supported.

7.2.3.2.2.A.1 REQUEST URI and To Header

When Number Portability is supported, the method used for signalling of the Called Party E.164 address and the Number Portability Routing Number determines the parameters of the IAM message used to derive the Request URI of the INVITE Request.

The number portability information (rn and npdi) shall not be mapped into the To header field.

ITU-T Q.769.1 [92] describes three possible addressing methods for signalling of the Called Party E.164 address and Number Portability Routing Number (ITU-T Q.769.1 [92] uses the terms directory number and network routing number respectively). The choice of these methods is based on network operator and national requirements.

The following clauses describe how the Request URI and To header fields are populated, based on these methods, when a Number Portability Routing Number is available in the IAM.

When the optional Number Portability Routing Number is available and supported, these procedures take precedence over procedures for coding of the Request URI and To header fields described in clause 7.2.3.2.2.1.

When a Number Portability Routing Number is not available, the Request URI and To Header fields are populated as described in clause 7.2.3.2.2.1, with the following addition: If a Number Portability Forward Information Parameter parameter is present in the IAM, containing a value of "number portability query done for called number, non-ported called subscriber", a tel URI npdi parameter [93] is added.

For the following clauses, the Request URI is a tel URI or SIP URI with "user=phone" and shall contain an International public telecommunication number prefixed by a "+" sign (e.g. <tel:+4911231234567>).

7.2.3.2.A.1.1 Separate Directory Number Addressing Method

Table 17a: Mapping ISUP to SIP Request-URI and To header field with Number Portability Separate Directory Number Addressing Method

IAM→		INVITE
Called Party Number	Called Directory Number	Request-URI and To Header Field
<p>Address Signal: Nature of address indicator: "Network routing number in national (significant) number format" or "National (significant) number" or "Network routing number in network specific number format" as described in ITU-T Q.769.1 [92] (NOTE 2)</p>	<p>Address Signal: Nature of address indicator: "National (significant) number".</p>	<p>The "telephone-subscriber" is populated from the Called Directory Number as follows: Insert "+CC" before the Address signals (NOTE 1)</p> <p>The Tel URI rn= parameter is populated from the Called Party Number as follows: Insert "+CC" before the Address signals (NOTE 1) and is added only to the Request-URI.</p> <p>Use of the local form of the rn= parameter is out of the scope of the present specification.</p> <p>Tel URI npdi parameter as defined in IETF RFC 4694 [93] is added only to the Request-URI.</p>
<p>NOTE 1: CC = Country Code of the network in which the O-MGCF is located. NOTE 2: If the address signals received in the ISUP Called Party Number contain a sending terminated signal (hexadecimal digit F), then this shall be discarded or if the PSTN XML is supported then the sendingCompleteIndication shall be included.</p>		

7.2.3.2.A.1.2 Concatenated Addressing Method

Table 17b: Mapping ISUP to SIP Request-URI and To header field with Number Portability Concatenated Number Addressing Method

IAM→	INVITE
Called Party Number	Request-URI and To Header Field
<p>Address Signal: Nature of address indicator: "Network routing number concatenated with called directory number" or "National (significant) number" as described in ITU-T Q.769.1 [92] (NOTE 2)</p>	<p>The "telephone-subscriber" is populated from the Called Party Number as follows: Remove the prefix representing the Number Portability Routing Number or the prefix prior to the directory number (NOTE3). Insert "+CC" before the Address signals (NOTE 1).</p> <p>The Tel URI rn= parameter is populated from the Called Party Number as follows and is added only to the Request-URI: Use all address digits contained within the Called Party Number or remove the digits that follow the prefix representing the Number Portability Routing Number Insert "+CC" before the Address signals (NOTE 1)</p> <p>Use of the local form of the rn= parameter is out of the scope of the present specification.</p> <p>Tel URI npdi parameter as defined in IETF RFC 4694 [93] is added only to the Request-URI.</p>
<p>NOTE 1: CC = Country Code of the network in which the O-MGCF is located. NOTE 2: If the address signals received in the ISUP Called Party Number contain a sending terminated signal (hexadecimal digit F), then this shall be discarded or if the PSTN XML is supported then the sendingCompleteIndication shall be included. NOTE 3: Based on national policy the whole Number Portability Routing number includes the Called Party Number and a prefix. In such cases only the Prefix has to be removed. Normally the Nature of address indicator indicates if the Number Portability Routing Number contains a Called Party Number and a prefix.</p>	

7.2.3.2.2A.1.3 Separate Network Routing Number Addressing Method

Table 17c: Mapping ISUP to SIP Request-URI and To header field with Number Portability Separate Network Routing Number Addressing Method

IAM→		INVITE
Network Routing Number	Called Party Number	Request-URI and To Header Field
Address Signal: Nature of address indicator: "Network routing number in national (significant) number format" or "Network routing number in network specific number format" as described in ITU-T Q.769.1 [92] (NOTE 2)	Address Signal: Nature of address indicator: "National (significant) number".	The "telephone-subscriber" is populated from the Called Party Number as follows: Insert "+CC" before the Address signals (NOTE 1) The Tel URI rn= parameter is populated from the Network Routing Number as follows and is added only to the Request-URI: Insert "+CC" before the Address signals (NOTE 1) Use of the local form of the rn= parameter is out of the scope of the present specification. Tel URI npdi parameter as defined in IETF RFC 4694 [93] is added only to the Request-URI.
NOTE 1: CC = Country Code of the network in which the O-MGCF is located. NOTE 2: If the address signals received in the ISUP Called Party Number contain a sending terminated signal (hexadecimal digit F), then this shall be discarded or if the PSTN XML is supported then the sendingCompleteIndication shall be included.		

7.2.3.2.2B Coding of the INVITE for Carrier Routeing

This clause describes optional coding procedures for carrier-based routeing.

7.2.3.2.2B.1 Mapping of "cic" in REQUEST URI Header

The procedures followed in clause 7.2.3.2.2.1 apply with the following addition.

If the Transit Network Selection parameter, defined according to ITU-T Q.761 [4], is included in the IAM message the O-MGCF, based on network configuration, may send the transit network selection information to the SIP network. In such a case the "cic=" parameter as defined in IETF RFC 4694 [93] is included in the SIP-Request URI and configured according to the table below.

Table 17d: Mapping of ISUP "Transit Network Selection" (TNS) to SIP "Carrier Identification Code" (CIC)

ISUP parameter/field	Value	SIP Component	Value
Transit Network Selection	Digits	Carrier id code in Userinfo of Request URI	"cic=carrier ID code" as defined in IETF RFC 4694 [93]

7.2.3.2.2B.2 Void

7.2.3.2.2C Coding of INVITE with instance-id in form of IMEI URN

An Emergency Access Transfer Function (EATF) that provides IMS-based mechanisms for enabling service continuity of IMS emergency sessions is described in 3GPP TS 23.237 [118]. A correlation of the call legs at the EATF is based on the equipment identifier.

A Mobile Equipment Identifier (MEI) parameter of the Mobile Service Transport (MST) Application Transport Parameter is defined in 3GPP TS 29.205 [14].

An instance-id is a SIP Contact header field parameter defined in IETF RFC 5626 [119]. When an IMEI is available, the instance-id shall take the form of an International Mobile station Equipment Identity (IMEI) URN as specified in IETF RFC 7254 [120].

When an O-MGCF receives the Mobile Service Transport (MST) Application Transport Parameter containing the Mobile Equipment Identifier (MEI) parameter within the IAM the O-MGCF shall perform the mapping to the "+sip.instance" Contact header field parameter according to table 7.2.3.2.2C.1.

Table 7.2.3.2.2C.1: Mapping of ISUP/BICC to SIP

→ IAM		→ INVITE	
ISUP Parameter	Value	SIP Component	Value
MST Application Transport Parameter	Mobile Equipment Identifier: IMEI	Contact header containing "+sip.instance" parameter in the form of IMEI URN	gmsa urn set to "imei" namespace
	Mobile Equipment Identifier: IMEISV		NOTE 1 NOTE 2
NOTE 1: The gsma-specifier "imei" is generated as: urn:gsma:imei:tac-snr-spare where "tac" represents 8 digits type allocation code (TAC), "snr" represents 4 digits serial number (SNR), and "spare" represents spare decimal digit as specified in TS 23.003 [74].			
NOTE 2: The Software Version Number is not interworked and thus the "svn" parameter is not included within the gsma urn.			

7.2.3.2.2.10 PSAP Call-back indication

If the O-MGCF based on the operator policy has determined that the received IAM message is a for the purpose of a PSAP call-back, then the O-MGCF shall include in the initial INVITE request a Priority header field with a "psap-callback" header field value as specified in IETF RFC 7090 [139]. The operator policy decision may be based the PSAP call-back indication in the received IAM message and/or any other information made available at O-MGCF.

NOTE: The PSAP call-back indication in the received IAM message depends on the national regulatory requirements applicable for the emergency services (e.g. calling party"s category parameter indicating priority/emergency call, pre-defined prefix in front of the called party number) and is outside the scope of this specification.

7.2.3.2.3 Receipt of CONTINUITY

This clause only applies if the O-MGCF has sent the INVITE request without waiting for an outstanding COT message (see clause 7.2.3.2.1).

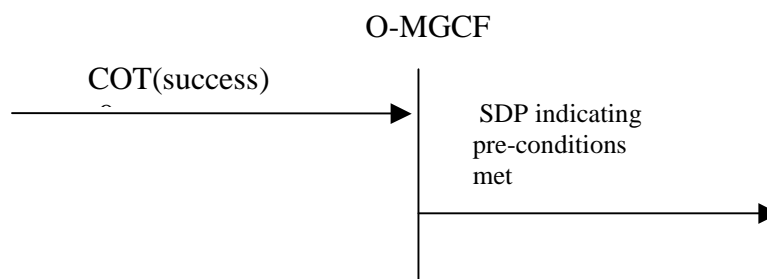

Figure 14a: Receipt of COT (success)

When the requested local preconditions (if any) have been met and if possible outstanding continuity procedures have successfully been completed (COT with the Continuity Indicators parameter set to "continuity check successful" is received), a SDP offer (e.g. a SIP UPDATE request, as defined in IETF RFC 3311 [55]) shall be sent for each early SIP dialogue for which the received provisional response indicated support of preconditions confirming that all the required local preconditions have been met.

NOTE: This procedure applies regardless of whether the early SIP dialog existed prior to the preconditions being fulfilled or is subsequently created.

7.2.3.2.4 Sending of ACM and awaiting answer indication

If the Address Complete Message (ACM) has not yet been sent, the following cases are possible trigger conditions that shall lead to the sending the address complete message (ACM):

- the detection of end of address signalling by the expiry of Timer T i/w₁ or,

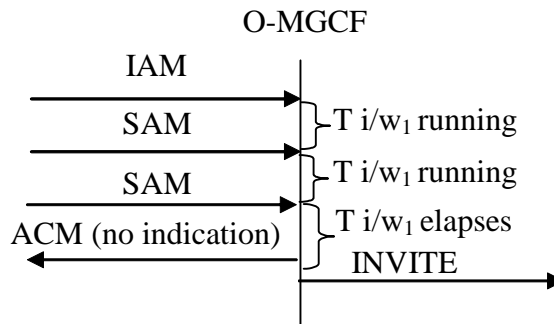

Figure 15: Sending of ACM T i/w₁ elapses

- the reception of the first 180 Ringing. An O-MGCF initiates the sending of an awaiting answer indication only if according to IETF RFC 5009 [89] backward early media is not authorized (the most recently received P-Early-Media header field is received does not authorize the backward early media or the P-Early-Media header field has not yet been received).

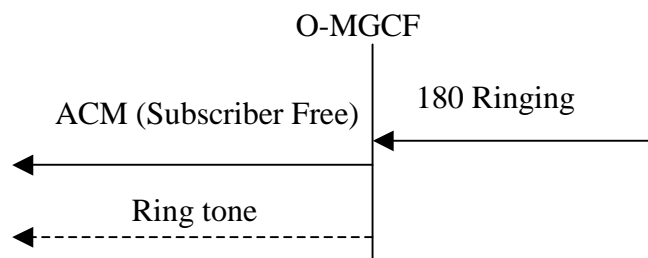

Figure 16: Sending of ACM (Receipt of first 180 Ringing and backward early media is not authorized)

Based on local knowledge that the call is transited to a PSTN network, the O-MGCF may decide not to generate the awaiting answer indication when receiving the 180 Ringing message and backward early media is not authorized according to IETF RFC 5009 [89].

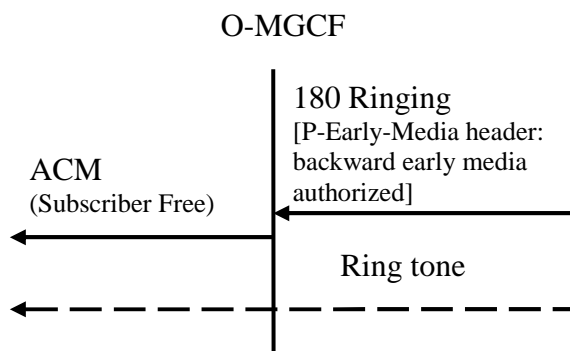

Figure 16a: Sending of ACM (Receipt of first 180 Ringing and backward early media is authorized)

- the reception of the first 181 Call is Being Forwarded.

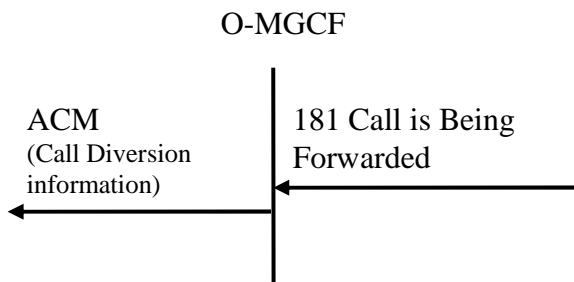

Figure 16b: Sending of ACM (Receipt of first 181 Call is Being Forwarded and backward early media is not authorized)

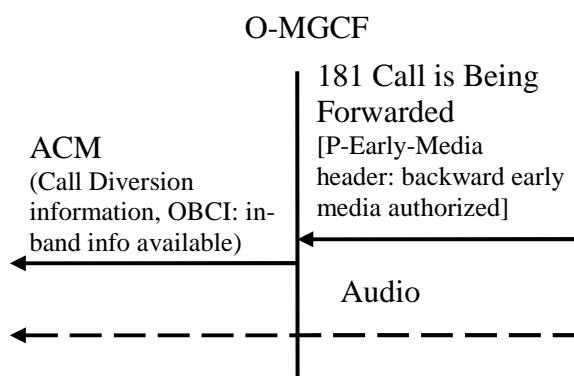

Figure 16c: Sending of ACM (Receipt of first 181 Call is Being Forwarded that includes authorization of early media)

- At an O-MGCF once all the following sub-conditions have been met: {1} the reception of the first 183 Session Progress that includes a P-Early-Media header field authorizing backward early media, and {2} SDP preconditions are not used, or applicable SDP preconditions have been met.

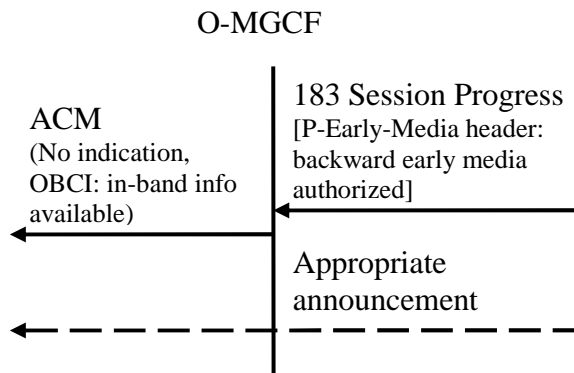

Figure 16d: Sending of ACM (Receipt of first 183 Session Progress that includes authorization of early media)

- As a network option, reception of 183 containing a SIP reason header with an Q.850 Cause Value.

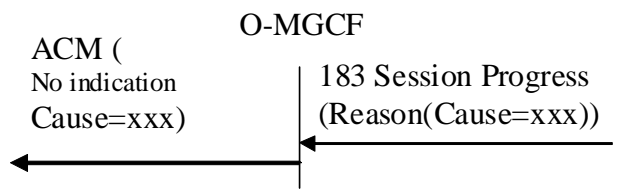

Figure 16e: Sending of ACM (Receipt of 183 Session Progress containing SIP Reason header)

- $T_{i/w 2}$ expires after the initial INVITE is sent.

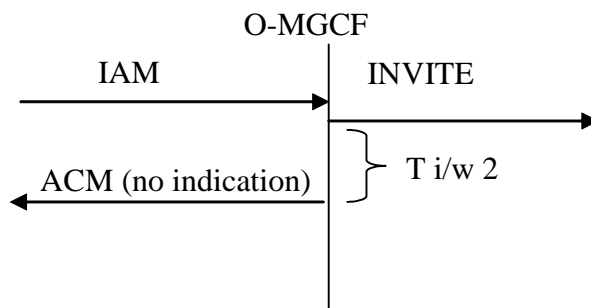

Figure 17: Sending of ACM ($T_{i/w 2}$ elapses)

The sending of an awaiting answer indication is described in clause 9.2.3.3.

When a 180 (Ringing) response is received with the Alert-Info header field at an O-MGCF supporting capabilities associated with the Alert-Info header field an O-MGCF may instruct the IM-MGW to play out early media available at the associated URL to the PSTN leg of the communication.

If the O-MGCF receives a 18x response with a P-Early-Media header field that changes the authorization of early media, the O-MGCF terminates the sending of the awaiting answer indication if the header field authorizes backward early media, and initiates the sending of the awaiting answer indication if the header field removes authorization of backward early media and if the O-MGCF has received the 180 Ringing response.

7.2.3.2.5 Coding of the ACM

7.2.3.2.5.0 General

The description of the following ISDN user part parameters can be found in ITU-T Recommendation Q.763 [4].

7.2.3.2.5.1 Backward call indicators

bits	<u>AB</u>	Charge indicator Contributors
	1 0	<i>charge</i>
bits	<u>DC</u>	Called party"s status indicator
	01	<i>subscriber free</i> if the 180 Ringing has been received.
	00	<i>no indication otherwise</i>
bits	<u>FE</u>	Called party"s category indicator
	0 0	<i>no indication</i>
bits	<u>HG</u>	End-to-end method indicator
	0 0	<i>no end-to-end method available</i>
bit	<u>I</u>	Interworking indicator

1 interworking encountered

As a network operator option, the value I = 0 "no interworking encountered" is used for TMR = 64 kBit/s unrestricted

NOTE: This avoids sending of a progress indicator with Progress information 0 0 0 0 0 1 "Call is not end-to-end ISDN; further call progress information may be available in-band", so the call will not be released for that reason by an ISDN terminal.

Bit I End-to-end information indicator
0 no end-to-end information available

bit K ISDN user part/BICC indicator
0 ISDN user part not used all the way

As a network operator option, the value K = 1 "ISDN user part/BICC used all the way" is used for TMR = 64 kBit/s unrestricted

NOTE: This avoids sending of a progress indicator with progress information 0 0 0 0 0 1 "Call is not end-to-end ISDN; further call progress information may be available in-band", so the call will not be released for that reason by an ISDN terminal.

Bit L Holding indicator (national use)
0 *holding not requested*

bit M ISDN access indicator
0 *terminating access non-ISDN*

As a network operator option, the value M = 1 "terminating access ISDN" is used for TMR = 64 kBit/s unrestricted.

NOTE: This avoids sending of a progress indicator with progress information 0 0 0 0 1 0 "Destination access is non-ISDN", so the call will not be released for that reason by an ISDN terminal.

Bit N Echo control device indicator
1 *incoming echo control device included*, for speech calls, e.g., TMR is "3.1KHz audio".
0 *incoming echo control device not included*, for known data calls, e.g., TMR "64 kBit/s unrestricted" or HLC "Facsimile Group 2/3".

If the PSTN XML body is supported as a network option, the Backward Call indicators parameters derived as shown in table 7.2.3.2.5.1.1 shall take precedence over the above Backward Call indicators parameter setting.

Table 7.2.3.2.5.1.1: Derivation of Backward Call Indicators from PSTN XML body

←ACM	← 180 Ringing or 183 Session Progress
Backward call indicators parameter Optional backward call indicators parameter	PSTN XML body with Progress indicator with "Coding Standard" value "00 (ITU-T standardized coding)" and with "Progress Description" No (Value of PI)
Backward call indicators parameter ISDN User Part indicator 0 "ISDN User Part not used all the way"	No. 1 ("Call is not end-to-end ISDN: further call progress information may be available in-band")
Backward call indicators parameter ISDN User Part indicator 0 "ISDN User Part used all the way" ISDN access indicator 0 "Terminating access non-ISDN"	No. 2 ("Destination address is non-ISDN")
Backward call indicators parameter Interworking indicator 0 "no interworking encountered" ISDN User Part indicator 1 "ISDN User Part used all the way" ISDN access indicator 1 "Terminating access ISDN"	No. 7 ("Terminating user ISDN")
Optional backward call indicators parameter In-band information indicator 1 "in-band information or an appropriate pattern is now available"	No. 8 ("In-band information or an appropriate pattern is now available")

7.2.3.2.5.2 Optional Backward call indicators

- Bit A 1 "in-band information or an appropriate pattern is now available" shall be set if 183 Session Progress or 181 Call is Being Forwarded response is received and according to IETF RFC 5009 [89] backward early media is authorized.

Table 7a0.4: Sending criteria of Optional backward call indicators parameter

←ACM	← 183 Session Progress or 181 Call is Being Forwarded
Optional backward call indicators parameter In-band information indicator in-band information or an appropriate pattern is now available	P-Early-Media header authorizing backward early media

7.2.3.2.5.3 Access Transport Parameter, Transmission medium used parameter

If the O-MGCF supports the PSTN XML body as a network option and if a PSTN XML body is received within the 180 ringing or 183 session progress, the O-MGCF shall store the received PSTN XML elements, replacing any previously stored PSTN XML elements on that dialog.

- NOTE: Multiple 18x responses can be received, both within a single dialog and in multiple dialogs. The PSTN XML bodies are stored on a per-dialog basis to be mapped to the ATP/TMU parameters on receipt of the 200 OK (see clause 7.2.3.2.9.2).

Table 7.2.3.2.5.3.1: Void

7.2.3.2.5.4 Progress indicator

If the O-MGCF supports the PSTN XML body as a network option and receives it in the 180 or 183, the O-MGCF shall store a "ProgressIndicator" element from the PSTN XML body on a per dialog basis and shall additionally map it into a Progress Indicator in the ACM as shown in table 7.2.3.2.5.4.1.

Table 7.2.3.2.5.4.1: Handling of the progress indicator

←ACM	←180/183
Access transport parameter	PSTN XML body with Progress indicator with "Coding Standard" value "00 (ITU-T standardized coding)" and with "Progress Description" No. (Value of PI)
Progress indicator (NOTE)	Progress indicator No. 1 / 2
Progress indicator (NOTE)	Progress indicator No. 8
NOTE: The entire Progress Indicator, including the "Progress Description", "Coding Standard" and "Location" parameters shall be copied.	

Table 7.2.3.2.5.4.2: Void

7.2.3.2.5.5 Cause Value

If the O-MGCF sends the ACM upon reception of a SIP 183 provisional response containing a SIP reason header with a Q.850 Cause value, the IO-MGCF may include the received Cause value within the ACM as a network option. The mapping of the Cause Indicators parameter to the Reason header as shown in table 8a shall be applied. IETF RFC 6432 [115] describes the use of the Reason header field in responses. The Reason header field itself is described in IETF RFC 3326 [116].

7.2.3.2.6 Sending of the Call Progress message (CPG)

7.2.3.2.6.0 General

If the Address Complete Message (ACM) has already been sent, the O-MGCF shall send the Call Progress message (CPG) in the following cases:

- Upon receipt of the SIP 180 Ringing provisional response. An O-MGCF should initiate the sending of an awaiting answer indication only if according to IETF RFC 5009 [89] backward early media is not authorized (the most recently received P-Early-Media header field does not authorize the backward early media or the P-Early-Media header field has not yet been received).

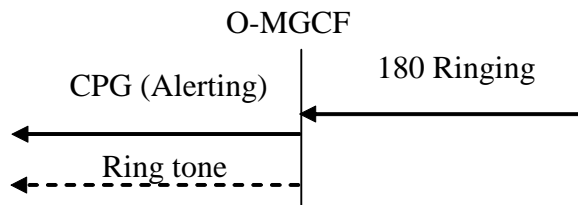

Figure 18: Sending of CPG(Alerting) (Receipt of 180 Ringing response and backward early media is not authorized)

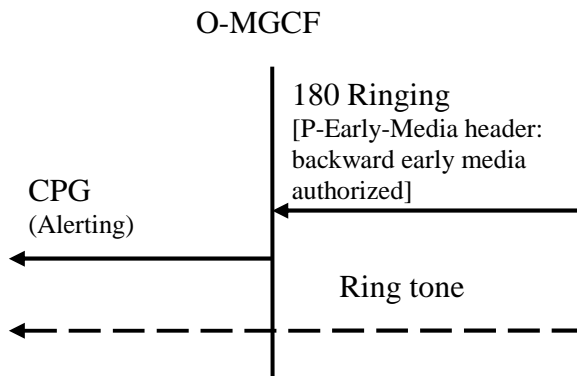

Figure 18a: Sending of CPG(Alerting) (Receipt of 180 Ringing response with authorization of early media)

Based on local knowledge that the call is transited to a PSTN network, the O-MGCF may decide not to generate the awaiting answer indication when receiving the 180 Ringing message and backward early media is not authorized according to IETF RFC 5009 [89].

- At an O-MGCF upon receipt of a 183 Session Progress that includes the first P-Early-Media header field authorizing backward early media.

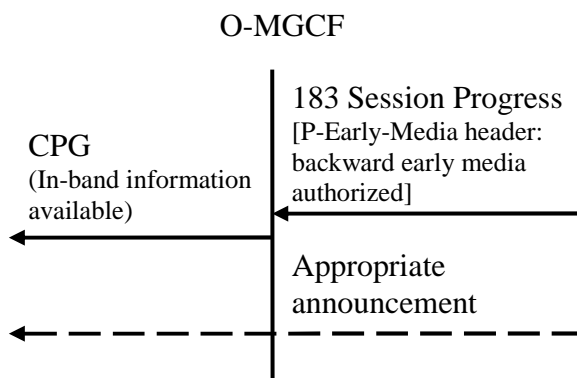

Figure 18b: Sending of CPG(in-band information available)

- Upon receipt of the 181 Call is Being Forwarded provisional response.

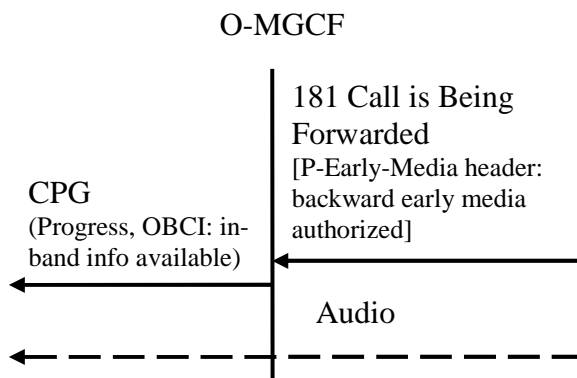

Figure 18c: Sending of CPG(Progress)

- As a network option, reception of 183 containing a SIP reason header with a Q.850 Cause Value.

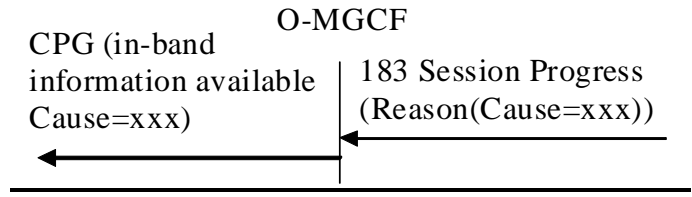

Figure 18d: Sending of CPG (Receipt of 183 Session Progress containing SIP Reason header)

If the O-MGCF receives a 18x response with P-Early-Media header that changes the authorization of early media, the O-MGCF terminates the sending of the awaiting answer indication if the header authorizes backward early media and initiates the sending of the awaiting answer indication if the header removes authorization of backward early media and if the O-MGCF has received the 180 Ringing response.

7.2.3.2.6.1 Handling of the progress indicator

If the O-MGCF supports the PSTN XML body as a network option and receives it in the 180 or 183, any "ProgressIndicator" element in the PSTN XML body shall be stored on a per-dialog basis as well as mapped as shown in tables 7.2.3.2.6.1.1 and 7.2.3.2.6.1.3.

Table 7.2.3.2.6.1.1: Mapping of progress indicator in PSTN XML body into ATP

←CPG	←180/183
Access transport parameter	PSTN XML body with Progress indicator X
Progress indicator (NOTE 1, NOTE 3)	Progress indicator No. 1 / 2
Progress indicator (NOTE 2, NOTE 3)	Progress indicator No. 4
Progress indicator No. 4 (NOTE 2, NOTE 4)	Progress indicator No. 7
NOTE 1: Values 1 ("call is not end-to-end ISDN: further call progress information may be available in-band") or 2 ("destination address is non-ISDN") shall be sent if Value 4 ("Call has returned to the ISDN") has been sent since value 1 or 2 was previously sent or if no value 1 or 2 was previously sent. NOTE 2: Value 4 ("Call has returned to the ISDN") shall be sent if value 1 ("call is not end-to-end ISDN: further call progress information may be available in-band") or 2 ("destination address is non-ISDN") was sent previously and no value 4 has been signalled since. NOTE 3: The entire Progress Indicator, including the "Progress Description", "Coding Standard" and "Location" parameters shall be copied. NOTE 4: The Progress Indicator "Coding Standard" parameter shall be set to "00 (ITU-T standardized coding)". The default value for the Progress Indicator "Location" parameter is "0100 (Public Network serving remote user)".	

Table 7.2.3.2.6.1.2: Void

Table 7.2.3.2.6.1.3: Mapping of progress indicator in PSTN XML body into Event Indicator

←CPG	←180/183
Event indicator	PSTN XML body with Progress indicator with "Coding Standard" value "00 (ITU-T standardized coding)" and with Progress Description value No. X
"In-band information or appropriate pattern is now available"	No. 8 "In-band information or appropriate pattern is now available"

7.2.3.2.7 Coding of the CPG

7.2.3.2.7.0 General

The description of the following ISDN user part parameters can be found in ITU-T Recommendation Q.763 [4].

7.2.3.2.7.1 Event information

bits	G-A	Event indicator
0 0 0 0 0 0 1		<i>alerting</i> if 180 Ringing response received
0 0 0 0 0 1 0		<i>progress</i> , if 181 Call is Being Forwarded response received
0 0 0 0 0 1 1		<i>in-band information or an appropriate pattern is now available</i> , if the received 183 Session Progress response and most recently received P-Early-Media header authorizes backward early media

NOTE: In national networks other values of the Event indicator may be used.

If the O-MGCF supports the PSTN XML body as a network option and receives in the 180 or 183 a "ProgressIndicator" element in the PSTN XML body with a "Coding Standard" value "00 (ITU-T standardized coding)" and with "Progress Description" value No. 8, instead of the mapping above, the O-MGCF shall map this "Progress Indicator" into the "Event Indicator" within the CPG as shown in table 7.2.3.2.6.1.3.

7.2.3.2.7.2 Access Transport Parameter

If the O-MGCF supports the PSTN XML body as a network option and if a PSTN XML body is received within the 180 ringing or 183 session progress, the O-MGCF shall store the contained information as described in clause 7.2.3.2.5.3, and additionally shall map this "Progress Indicator" into the ATP within the CPG as shown in table 7.2.3.2.6.1.1.

NOTE: Multiple 18x responses can be received, both within a single dialog and in multiple dialogs. The PSTN XML bodies are stored on a per-dialog basis to be mapped to the ATP parameter on receipt of the 200 OK (see clause 7.2.3.2.9.2).

7.2.3.2.7.3 Void

Table 17h: Void

Table 17j: Void

7.2.3.2.7.4 Handling of Backward Call indicators

The Backward Call indicator shall be derived as shown in clause 7.2.3.2.5.1. The Backward Call Indicators parameter is optional in the CPG message and shall only be included if any indicators have changed from those previously sent.

7.2.3.2.7.5 Optional Backward call indicators

Bit A 1 "in-band information or an appropriate pattern is now available" shall be set if 181 Call is Being Forwarded response is received and according to IETF RFC 5009 [89] the backward early media is authorized.

Table 17k: Sending criteria of Optional backward call indicators parameter

← CPG	← 181 Call is Being Forwarded
Optional backward call indicators parameter In-band information indicator in-band information or an appropriate pattern is now available	P-Early-Media header authorizing backward early media

7.2.3.2.7.6 Cause Value

If the O-MGCF sends the CPG upon reception of a SIP 183 provisional response containing a SIP reason header with a Q.850 Cause value, the O-MGCF may include the received Cause value within the ACM as a network option. The mapping of the Cause Indicators parameter to the Reason header as shown in table 8a shall be applied. IETF RFC 6432 [115] describes the use of the Reason header field in responses. The Reason header field itself is described in IETF RFC 3326 [116].

7.2.3.2.7a Receipt of 200 OK(INVITE)

Upon receipt of the first 200 OK (INVITE), the O-MGCF shall send an Answer Message (ANM) or Connect message (CON) as described in clauses 7.2.3.2.8 to 7.2.3.2.11.

The O-MGCF shall not progress any further early dialogues to established dialogues. Therefore, upon the reception of a subsequent final 200 (OK) response for any further dialogue for an INVITE request (e.g., due to forking), the O-MGCF shall:

- 1) acknowledge the response with an ACK request; and
- 2) send a BYE request to this dialog in order to terminate it.

If the received 200 OK (INVITE) response contains a Feature-Caps header field, defined in IETF RFC 6809 [142] with a "+g.3gpp.ics" header field parameter as specified in clause B.4 of 3GPP TS 24.292 [141] then according to operator policy the O-MGCF may mark a call as an "ICS call".

7.2.3.2.7b Internal through connection of the bearer path

The through connection procedure is described in clause 9.2.3.3.7.

7.2.3.2.8 Sending of the Answer Message (ANM)

Upon receipt of the first 200 OK (INVITE), if the Address Complete Message (ACM) has already been sent, the O-MGCF shall send the Answer Message (ANM) to the preceding exchange.

NOTE: Through connection and the stop of awaiting answer indication are described in clause 9.2.3.3

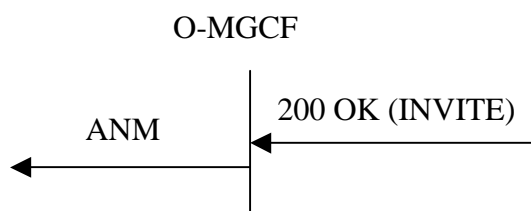

Figure 19: Sending of ANM

7.2.3.2.9 Coding of the ANM

7.2.3.2.9.1 Backwards Call Indicators

If Backwards Call Indicators are included in the ANM, then the coding of these parameters shall be as described in clause 7.2.3.2.5.1. The Backward Call Indicators parameter is optional in the ANM message and shall only be included if any indicators have changed from those previously sent.

7.2.3.2.9.2 Access Transport Parameter

If the O-MGCF supports the PSTN XML body as a network option and if a PSTN XML body is received within the 200 OK(INVITE) or has been previously stored from a 18x message, the O-MGCF shall map the most recently received information for the established dialog (i.e. the dialog for which the first 200 OK has been received) into the ANM as shown in table 7.2.3.2.9.2.1 except Progress Indicator value No. 3 or No. 8.

Table 7.2.3.2.9.2.1: Mapping of PSTN XML elements into ISUP Parameters

← ANM		← 200 OK / stored information from previous 18x
ISUP Parameter	Content	PSTN XML (NOTE 9)
Access Transport Parameter	Progress indicator (NOTE 5, NOTE 8)	ProgressIndicator with "Coding Standard" value "00 (ITU-T standardized coding)" and with "Progress Description" value No. 1 / 2
	Progress indicator with "Progress Description" value No. 4 (NOTE 4, NOTE 6, NOTE 9)	ProgressIndicator with "Coding Standard" value "00 (ITU-T standardized coding)" and with "Progress Description" value No. 7
	Progress indicator (NOTE 6, NOTE 8)	ProgressIndicator with "Coding Standard" value "00 (ITU-T standardized coding)" and with "Progress Description" value No. 4
	Progress indicator (NOTE 7, NOTE 8)	ProgressIndicator with "Coding Standard" value "00 (ITU-T standardized coding)" and with "Progress Description" value No. 5
	High layer compatibility (NOTE 1)	HighLayerCompatibility
	Bearer Capability	BearerCapability (NOTE 2)
	Bearer Capability ("UDI-TA")	BearerCapability ("UDI-TA") (NOTE 3)
<p>NOTE 1: This information element shall only be mapped if the O-MGCF transfers media types listed in table 10b without transcoding.</p> <p>NOTE 2: Applicable if the O-MGCF has not propagated UDI fallback signalling according to clause 7.2.3.2.1.5.</p> <p>NOTE 3: Applicable if the O-MGCF has propagated UDI fallback signalling according to clause 7.2.3.2.1.5. Only the value "UDI-TA" within the PSTN XML BC shall be mapped. Other values within the PSTN XML BC are mapped to TMU as described in clause 7.2.3.2.9.3.</p> <p>NOTE 4: ProgressIndicator No. 7 is not mapped into the ISUP ATP. However, it may be mapped into PI=4.</p> <p>NOTE 5: Values 1 ("call is not end-to-end ISDN: further call progress information may be available in-band") or 2 ("destination address is non-ISDN") shall be sent if Value 4 ("Call has returned to the ISDN") has been sent since value 1 or 2 was previously sent or if no value 1 or 2 was previously sent.</p> <p>NOTE 6: Value 4 ("Call has returned to the ISDN") shall be sent if value 1 ("call is not end-to-end ISDN: further call progress information may be available in-band") or 2 ("destination address is non-ISDN") was sent previously and no value 4 has been signalled since.</p> <p>NOTE 7: This value indicates a bearer service change and is present with an associated BearerCapability and indicates that fallback has occurred (i.e. TMR and TMR Prime present in IAM and the destination ISDN user has accepted the BearerCapability equating to TMR Prime).</p> <p>NOTE 8: The entire Progress Indicator, including the "Progress Description", "Coding Standard" and "Location" parameters shall be copied.</p> <p>NOTE 9: The Progress Indicator "Coding Standard" parameter shall be set to "00 (ITU-T standardized coding)". The default value for the Progress Indicator "Location" parameter is "0100 (Public Network serving remote user)".</p>		

7.2.3.2.9.3 Transmission Medium Used parameter (TMU)

The procedures in the present clause shall only apply if the O-MGCF supports the PSTN XML body, and has propagated UDI-TA fallback signalling according to clause 7.2.3.2.1.5.

If a Bearer Capability element within a PSTN XML body is received within the first 200 OK (INVITE) or has been previously stored from a 18x message relating to the now established dialog (i.e. the dialogue for which the first 200 OK has been received), the O-MGCF shall map the most recently received information (if any) into a TMU within the ANM as shown in table 7.2.3.2.9.3.1. If the most recently received PSTN XML BearerCapability is "UDI-TA", it shall be mapped into an ISUP Access Transport Parameter Bearer Capability (see clause 7.2.3.2.9.2).

NOTE: The TMU is only included if both the TMR and TMR Prime were received in the ISUP IAM and fallback has occurred.

Table 7.2.3.2.9.3.1 – Mapping to TMU parameter

← ANM TMU	← 200 OK / stored information from previous 18x PSTN XML BearerCapability
TMU = "Speech"	PSTN XML BearerCapability = "Speech"
TMU= "3.1 kHz audio"	PSTN XML BearerCapability = "3.1 kHz audio"
No mapping (fallback has not occurred)	PSTN XML BearerCapability = "UDI-TA"
TMU = "3.1 kHz audio"	PSTN XML BearerCapability not present

7.2.3.2.10 Sending of the Connect message (CON)

Upon receipt of the first 200 OK (INVITE), if the Address Complete Message (ACM) has not yet been sent, the O-MGCF shall send the Connect message (CON) to the preceding exchange.

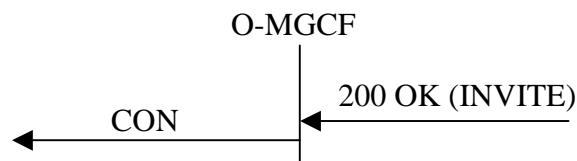

Figure 20: Sending of CON

7.2.3.2.11 Coding of the CON

7.2.3.2.11.0 General

The description of the following ISDN user part parameters can be found in ITU-T Recommendation Q.763 [4].

7.2.3.2.11.1 Backward call indicators

The Called Party's status indicator (Bit DC) of BCI parameter shall be set to "no indication". The other BCI indicators shall be set as described in clause 7.2.3.2.5.1

7.2.3.2.11.2 Access Transport Parameter

The O-MGCF shall apply the same procedure as described for the ANM in clause 7.2.3.2.9.2.

7.2.3.2.11.3 Transmission medium used parameter

The O-MGCF shall apply the same procedure as described for the ANM in clause 7.2.3.2.9.3.

7.2.3.2.11A Receipt of a reINVITE request

When a reINVITE request is received from the network containing a Call-Info header field the MGCF may instruct the IM-MGW to send media available at the associated URL to the PSTN leg of the communication.

7.2.3.2.12 Receipt of Status Codes 4xx, 5xx or 6xx

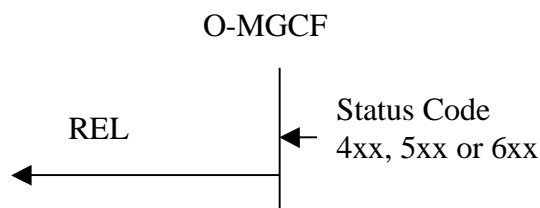

Figure 21: Receipt of Status codes 4xx, 5xx or 6xx

If a Reason header as described in IETF RFC 6432 [115] is included in a 4xx, 5xx, 6xx response, then the Cause Value of the Reason header shall be mapped to the ISUP Cause Value field in the ISUP REL message. The Reason header field itself is described in IETF RFC 3326 [116]. The mapping of the Reason header to the Cause Indicators parameter is shown in table 8a (see clause 7.2.3.1.7). Otherwise coding of the Cause value field in the REL message is derived from the SIP Status code received according to table 18. The Cause Indicators Parameter Values are defined in ITU-T Recommendation Q.850 [38].

In all cases where SIP itself specifies additional SIP side behaviour related to the receipt of a particular INVITE response these procedures should be followed in preference to the immediate sending of a REL message to BICC/ISUP.

If there are no SIP side procedures associated with this response, the REL shall be sent immediately.

NOTE Depending upon the SIP side procedures applied at the O-MGCF it is possible that receipt of certain 4xx/5xx/6xx responses to an INVITE may in some cases not result in any REL message being sent to the BICC/ISUP network. For example, if a 401 Unauthorized response is received and the O-MGCF successfully initiates a new INVITE containing the correct credentials, the call will proceed.

Table 18: 4xx/5xx/6xx Received on SIP side of O-MGCF

←REL (cause value)	←4xx/5xx/6xx SIP Message
Cause value No 111 (Protocol error, unspecified)	400 Bad Request
Cause value No 127 (Interworking, unspecified)	401 Unauthorized
Cause value No 127 (Interworking, unspecified)	402 Payment Required
Cause value No 79 (Service or option not implemented, unspecified)	403 Forbidden
Cause value No 1 (Unallocated (unassigned) number)	404 Not Found
Cause value No 127 (Interworking, unspecified)	405 Method Not Allowed
Cause value No 127 (Interworking, unspecified)	406 Not Acceptable
Cause value No 127 (Interworking, unspecified)	407 Proxy authentication required
Cause value No 102 (Recovery on timer expiry)	408 Request Timeout
Cause value No 22 (Number changed)	410 Gone
Cause value No 127 (Interworking, unspecified)	413 Request Entity too long
Cause value No 111 (Protocol error, unspecified)	414 Request-URI too long
Cause value No 127 (Interworking, unspecified)	415 Unsupported Media type
Cause value No 111 (Protocol error, unspecified)	416 Unsupported URI scheme
Cause value No 79 (Service or option not implemented, unspecified)	417 Unknown Resource-Priority
Cause value No 111 (Protocol error, unspecified)	420 Bad Extension
Cause value No 111 (Protocol error, unspecified)	421 Extension required
Cause value No 31 (Normal, unspecified)	422 Session Interval Too Small
Cause value No 127 (Interworking, unspecified)	423 Interval Too Brief
Cause value No 24 (Call rejected due to feature at the destination)	433 Anonymity Disallowed (NOTE 1)
Cause value No 127 (Interworking, unspecified)	440 Max-Breadth Exceeded
Cause value No 20 (Subscriber absent)	480 Temporarily Unavailable
Cause value No 127 (Interworking, unspecified)	481 Call/Transaction does not exist
Cause value No 127 (Interworking, unspecified)	482 Loop detected
Cause value No 25 (Exchange routing error)	483 Too many hops
Cause value No 28 (Invalid number format (address incomplete))	484 Address Incomplete
Cause value No 1 (Unallocated (unassigned) number)	485 Ambiguous
Cause value No 17 (User busy)	486 Busy Here
Cause value No 127 (Interworking, unspecified) or not interworked. (NOTE 2)	487 Request terminated
Cause value No 50 (Requested facility not subscribed)	488 Not acceptable here
Cause value No 127 (Interworking, unspecified)	493 Undecipherable
Cause value No 127 (Interworking, unspecified)	500 Server Internal error
Cause value No 79 (Service or option not implemented, unspecified)	501 Not implemented
Cause value No 27 (Destination out of order)	502 Bad Gateway
Cause value No 41 (Temporary failure)	503 Service Unavailable
Cause value No 102 (Recovery on timer expiry)	504 Server timeout
Cause value No 127 (Interworking, unspecified)	505 Version not supported
Cause value No 95 (Invalid message, unspecified)	513 Message too large
Cause value No 127 (Interworking, unspecified)	580 Precondition failure
Cause value No 17 (User busy)	600 Busy Everywhere
Cause value No 21 (Call rejected)	603 Decline
Cause value No 2 (No route to specified transit network)	604 Does not exist anywhere
Cause value No 88 (Incompatible destination)	606 Not Acceptable
NOTE 1: Anonymity Disallowed, IETF RFC 5079 [77] refers.	
NOTE 2: No interworking if the O-MGCF previously issued a CANCEL request for the INVITE.	
NOTE 3: The 4xx/5xx/6xx SIP responses that are not covered in this table are not interworked.	

If the O-MGCF supports the PSTN XML body as a network option and if a PSTN XML body is received within the 4xx/5xx/6xx, the O-MGCF shall map the contained information into the Access Transport Parameter of the REL as shown in clause 7.2.3.2.9.2.

When a 4xx, 5xx or 6xx SIP response to an INVITE request is received from the network containing an Error-Info header field, the O-MGCF, supporting the capabilities associated with the Error-Info header field, may instruct the IM-MGW to play out media available at the associated URL towards PSTN.

7.2.3.2.12.1 Special handling of 404 Not Found and 484 Address Incomplete responses after sending of INVITE without determining the end of address signalling

This clause is only applicable when the network option of Sending of INVITE without determining the end of address signalling is being used (see clause 7.2.3.2.1.a).

On receipt of a 404 Not Found or 484 Address Incomplete response while $Ti/w2$ is running, the O-MGCF shall start timer $Ti/w3$, if there are no other pending INVITE transactions for the corresponding call.

At the receipt of a SAM, a SIP 1xx provisional response or a SIP 200 OK (INVITE), the O-MGCF shall stop $Ti/w2$ and $Ti/w3$.

The O-MGCF shall send a REL message with Cause Value 28 towards the BICC/ISUP network if $Ti/w3$ expires.

7.2.3.2.13 Receipt of a BYE

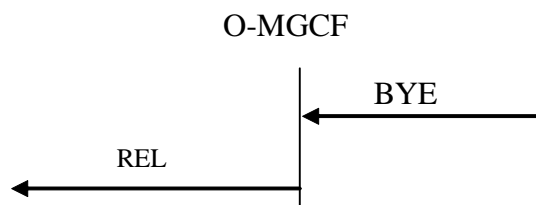

Figure 22: Receipt of BYE method

If a Reason header field with Q.850 Cause Value is included in the BYE request, then the Cause Value shall be mapped to the ISUP Cause Value field in the ISUP REL as shown in table 8a (see clause 7.2.3.1.7). Otherwise, the O-MGCF sends a REL message with Cause Code value 16 (Normal Call Clearing).

If the O-MGCF supports the PSTN XML body as a network option and if a PSTN XML body is received within the BYE, the O-MGCF shall map the contained information into the Access Transport Parameter of the REL as shown in clause 7.2.3.2.9.2.

7.2.3.2.14 Receipt of the Release Message

In the case that the REL message is received and a final response (i.e. 200 OK (INVITE)) has already been received the O-MGCF shall send a BYE request. If the final response (i.e. 200 OK (INVITE)) has not already been received the O-MGCF shall send a CANCEL method.

A Reason header field containing the received (Q.850) Cause Value of the REL message shall be added to the CANCEL or BYE request. The mapping of the Cause Indicators parameter to the Reason header is shown in table 9a (see clause 7.2.3.1.8).

If the O-MGCF supports the PSTN XML body as a network option, the O-MGCF shall map the contained information into a PSTN XML body within the BYE or CANCEL as shown in table 9aa.

7.2.3.2.15 Receipt of RSC, GRS or CGB (H/W oriented)

Upon receipt of a RSC, GRS or CGB (H/W oriented) message the following applies independently for each affected circuit:

- NOTE:
- For the RSC message, the circuit identified by the CIC is affected.
 - For the GRS message, the affected circuits are identified by the CIC and the Range subfield of the Range and Status parameter.
 - For the CGB message, the affected circuits are identified by the CIC and the Range and Status parameter.

If a final response (i.e. 200 OK (INVITE)) has already been received, the O-MGCF shall send a BYE method. If a final response (i.e. 200 OK (INVITE)) has not already been received, the O-MGCF shall send a CANCEL method.

A Reason header field containing the (Q.850) Cause Value of the REL message generated by the ISUP procedures shall be added to the SIP message (BYE or CANCEL request) to be sent by the SIP side of the O-MGCF.

Editor's Note: It is FFS whether to indicate the cause value for internal error in the network to the user.

7.2.3.2.16 Autonomous Release at O-MGCF

If the O-MGCF determines due to internal procedures that the call shall be released then the MGCF shall send

- A BYE method if the ACK has been sent.
- A CANCEL method before 200 OK (INVITE) has been received.

NOTE: The MGCF shall send the ACK method before it sends the BYE, if 200 OK (INVITE) is received.

A Reason header field containing the (Q.850) Cause Value of the REL message sent by the O-IWU shall be added to the SIP Message (BYE or CANCEL request) to be sent by the SIP side of the O-IWU.

Editor's Note: It is FFS whether to indicate the cause value for internal error in the network to the user.

Table 18a: Autonomous Release at O-MGCF

REL ← Cause parameter	Trigger event	→ SIP
As determined by BICC/ISUP procedure.	COT received with the Continuity Indicators parameter set to " <i>continuity check failed</i> " (ISUP only) or the BICC/ISUP timer T8 expires.	CANCEL or BYE according to the rules described in this subclause.
REL with cause value 47 (resource unavailable, unspecified).	Internal resource reservation unsuccessful	As determined by SIP procedure
As determined by BICC/ISUP procedure.	BICC/ISUP procedures result in generation of autonomous REL on BICC/ISUP side.	CANCEL or BYE according to the rules described in this subclause.
Depending on the SIP release reason.	SIP procedures result in a decision to release the call.	As determined by SIP procedure.

7.2.3.2.17 Special handling of 580 precondition failure received in response to either an INVITE or UPDATE

A 580 Precondition failure response may be received as a response either to an INVITE or to an UPDATE request.

7.2.3.2.17.1 580 Precondition failure response to an INVITE

Release with cause code as indicated in table 18 is sent immediately to the BICC/ISUP network.

7.2.3.2.17.2 580 Precondition failure response to an UPDATE within an early dialog

A BYE request is sent for the early dialog within which the UPDATE was sent.

If all the early dialogs that were generated from the INVITE request have answered the respective UPDATE request with 580 Precondition failure response then the O-MGCF shall send the Release message with Cause Code "127 Interworking" to the ISUP network.

7.2.3.2.18 Sending of CANCEL

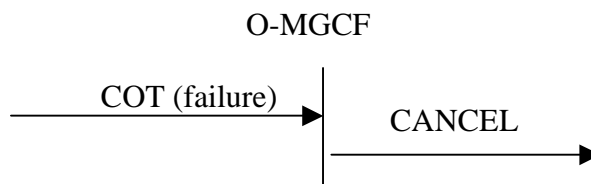

Figure 23: Receipt of COT (failure)

CANCEL shall be sent if the Continuity message is received with the Continuity Indicators parameter set to "*continuity check failed*" or the ISUP (or BICC) timer T8 expires.

A Reason header field containing the (Q.850) Cause Value 41 Temporary Failure shall be added to the CANCEL request to be sent by the SIP side of the O-MGCF.

7.2.3.2.19 Receipt of SIP redirect (3xx) response

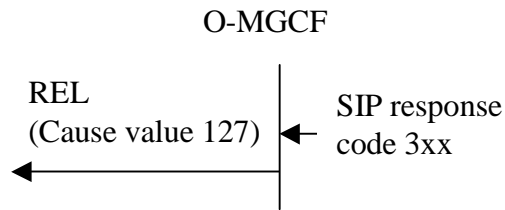

Figure 24: Receipt of SIP response code 3xx

When receiving a SIP response with a response code 3xx, the default behaviour of the O-MGCF is to release the call with a cause code value 127 (Interworking unspecified).

NOTE: The O-MGCF may also decide for example to redirect the call towards the URIs in the Contact header field of the response as an operator option, but such handling is outside of the scope of the present document.

7.2.3.2.20 Sending of INFO for overlap signalling using the in-dialog method

7.2.3.2.20.1 General

SIP INFO request ("legacy" mode of usage of the INFO method as defined in IETF RFC 6086 [133]) is used to carry additional digits when overlap signalling is sent using the in-dialog method as described in clause 7.2.3.2.1a.2, which is a network option. Clause 7.2.3.2.1a.2 also describes when the O-MGCF sends a SIP INFO request.

7.2.3.2.20.2 Encoding of the INFO

Table 18b provides a summary of how the header fields within the outgoing INFO messages are populated when in-dialog SIP INFO requests are used for overlap dialling.

Table 18b: Interworked contents of the INFO message

SAM→	INFO→
Digits	See TS 24.229 [9] clause 7.11.1.2

7.2.3.3 Timers

Table 19: Timers for interworking

Symbol	Time-out value	Cause for initiation	Normal termination	At expiry	Reference
Ti/w1	4 s to 6 s (default of 4 s)	When last address message is received and the minimum number of digits required for routing the call have been received.	At the receipt of fresh address information.	Send INVITE, send the address complete message	7.2.3.2.1 7.2.3.2.4 (NOTE 1)
Ti/w2	4 s to 20 s (default of 4 s)	When INVITE is sent unless the ACM has already been sent.	On reception of 180 Ringing , or 183 Session Progress and P-Early-Media header authorizing backward early media, or 181 Call is Being Forwarded, or 404 Not Found or 484 Address Incomplete for an INVITE transaction for which Ti/w3 is running, or 200 OK (INVITE).	Send ACM (no indication)	7.2.3.2.4 7.2.3.2.1 (NOTE 2)
Ti/w3	4-6 seconds (default of 4 seconds)	On receipt of 404 Not Found or 484 Address Incomplete if there are no other pending INVITE transactions for the corresponding call.	At the receipt of SAM	Send REL with Cause Value 28 to the BICC/ISUP side.	7.2.3.2.1A, 7.2.3.2.12.1 (NOTE 3)

NOTE 1: This timer is used when overlap signalling is received from BICC/ISUP network and converted to en-block signalling at the MGCF.
 NOTE 2: This timer is used to send an early ACM if a delay is encountered in receiving a response from the subsequent SIP network.
 NOTE 3: This timer is known as the "SIP dialog protection timer". This timer is only used where the O-MGCF is configured to send INVITE before end of address signalling is determined.

7.3 Interworking between CS networks supporting BICC and the IM CN subsystem

The control plane between CS networks supporting BICC and the IM CN subsystem supporting SIP, where the underlying network is SS7 and IP respectively is as shown in figures 25, 26 and 27.

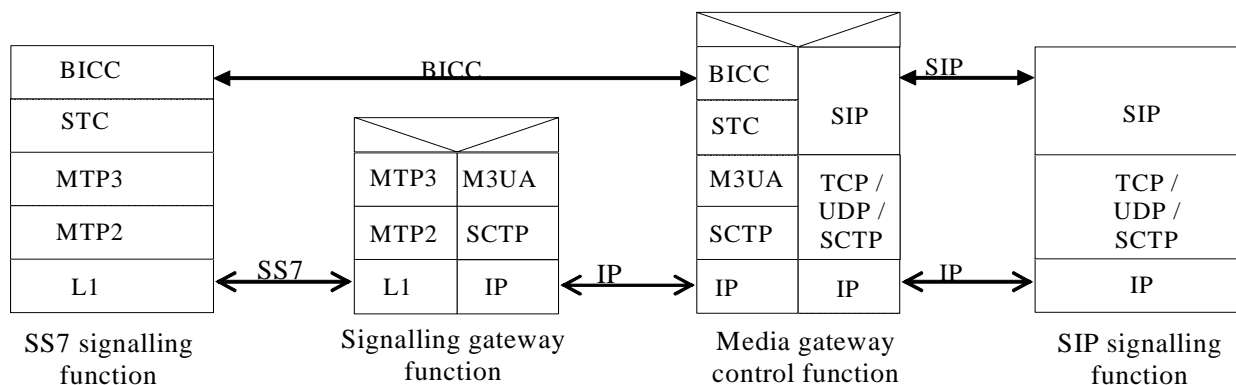

Figure 25: Control Plane interworking between CS networks supporting BICC over MTP3 and the IM CN subsystem

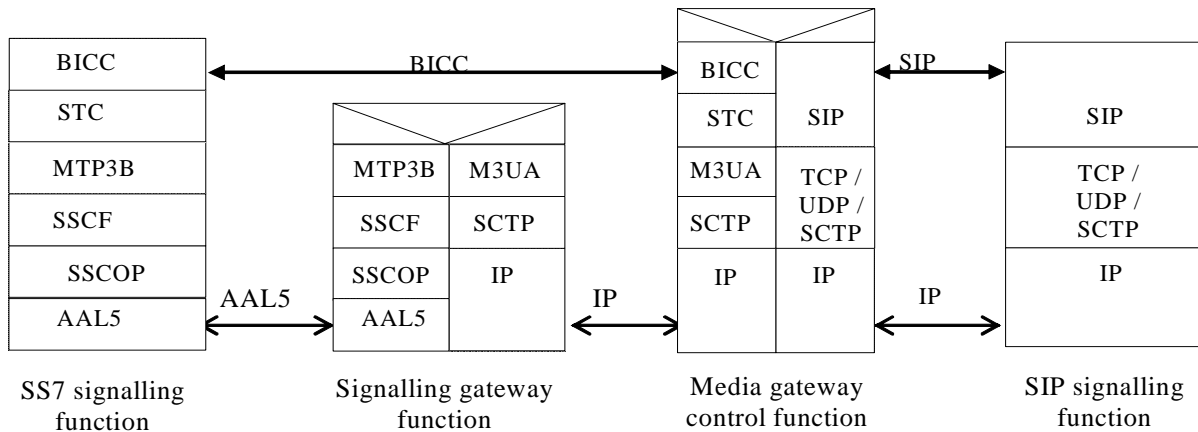

Figure 26: Control Plane interworking between CS networks supporting BICC over MTP3B over AAL5 and the IM CN subsystem

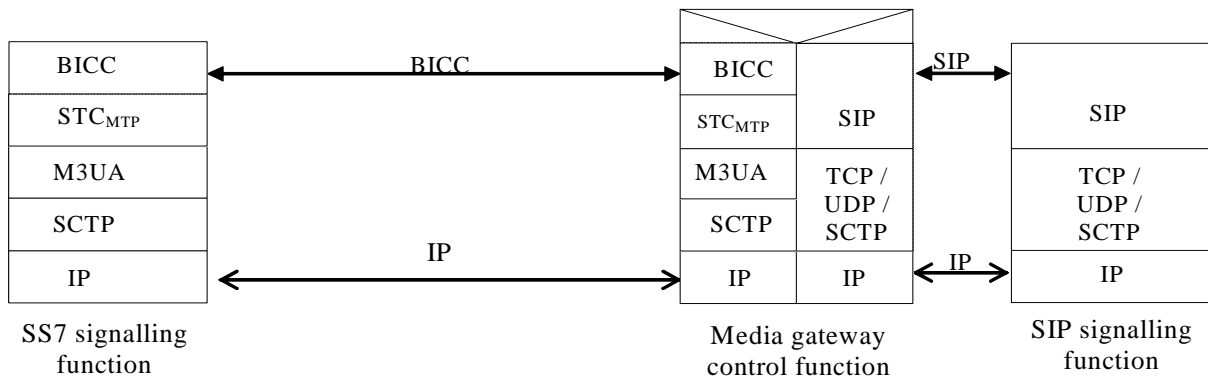

Figure 27: Control Plane interworking between CS networks supporting BICC over STC and M3UA and the IM CN subsystem

7.3.1 Services performed by network entities in the control plane

Services offered by the network entities in the control plane are as detailed in clause 7.2.1.

If ATM transport is applied between the SS7 Signalling function and the Signalling Gateway Function, they shall apply MTP3B (ITU-T Recommendation Q.2210 [46]) over SSCF (ITU-T Recommendation Q.2140 [45]) over SSCOP (ITU-T Recommendation Q.2110 [44]) over AAL5 (ITU-T Recommendation I.363.5 [43]) as depicted in figure 26.

If IP transport is applied between the SS7 Signalling function and the MGCF, they shall support and apply M3UA, Sctp and IP (either Ipv4, see RFC 791 [16], or Ipv6, see RFC 2460 [39]), as depicted in figure 27.

7.3.2 Signalling interactions between network entities in the control plane

7.3.2.1 Signalling between the SS7 signalling function and MGCF

See clause 7.2.2.1.

7.3.2.1.1 Signalling from MGCF to SS7 signalling function

See clause 7.2.2.1.1.

7.3.2.1.2 Signalling from SS7 signalling function to MGCF

See clause 7.2.2.1.2.

7.3.2.1.3 Services offered by STC, SCTP and M3UA

See clause 7.2.2.1.3.

7.3.2.1.3.1 Services offer by SCTP

See clause 7.2.2.1.3.1.

7.3.2.1.3.2 Services offered by M3UA

See clause 7.2.2.1.3.2.

7.3.2.1.3.3 Services offered by STC

STC provides the services for the transparent transfer of STC user information, e.g. BICC, between STC users, i.e. the SS7 signalling function and the MGCF (see 3GPP TS 29.205 [14]).

STC performs the functions of data transfer service availability reporting and congestion reporting to the STC user and User part availability control. See ITU-T Recommendation Q.2150.1 [29].

7.3.2.2 Signalling between the MGCF and SIP signalling function

See clause 7.2.2.2.

7.3.3 SIP-BICC protocol interworking

7.3.3.1 Incoming call interworking from SIP to BICC at I-MGCF

7.3.3.1.1 Sending of IAM

Clause 7.2.3.1.1 is applicable with the clarification that the Continuity Check procedure applies.

Figure 28: Void

7.3.3.1.2 Coding of IAM

The description of the following ISDN user part parameters can be found in ITU-T Recommendation Q.763 [4].

7.3.3.1.2.1 Called party number

See clause 7.2.3.1.2.1.

7.3.3.1.2.2 Nature of connection indicators

bits	<u>BA</u>	Satellite indicator
	0 0	<i>no satellite circuit in the connection</i>
bits	<u>DC</u>	Continuity indicator (BICC)
	0 0	<i>no COT to be expected, if the received SDP does not contain precondition information or indicates that all preconditions are fulfilled, and all local resource reservation is completed.</i>
	1 0	<i>COT to be expected, if the received SDP indicates that precondition is not fulfilled or any local resource reservation is not completed.</i>
Bit	<u>E</u>	Echo control device indicator
	1	<i>outgoing echo control device included</i>

7.3.3.1.2.3 Forward call indicators

See clause 7.2.3.1.2.3.

7.3.3.1.2.4 Calling party's category

See clause 7.2.3.1.2.4.

7.3.3.1.2.4A Originating Line Information

See clause 7.2.3.1.2.4A

7.3.3.1.2.5 Transmission medium requirement

See clause 7.2.3.1.2.5.

7.3.3.1.2.6 Calling party number

See clause 7.2.3.1.2.6.

7.3.3.1.2.7 Generic number

See clause 7.2.3.1.2.7.

7.3.3.1.2.8 User service information

See clause 7.2.3.1.2.8.

7.3.3.1.2.9 Hop counter (National option)

See clause 7.2.3.1.2.9.

7.3.3.1.2.10 Location Number

See clause 7.2.3.1.2.11.

7.3.3.1.2.11 Support of ICS call

See clause 7.2.3.1.2.12.

7.3.3.1.2.12 UID capability indicators (National option)

See clause 7.2.3.1.2.13.

7.3.3.1.2A Coding of the IAM when Number Portability is supported

See clause 7.2.3.1.2A.

7.3.3.1.2B Coding of the IAM for Carrier Routing

See clause 7.2.3.1.2B.

7.3.3.1.3 Sending of COT

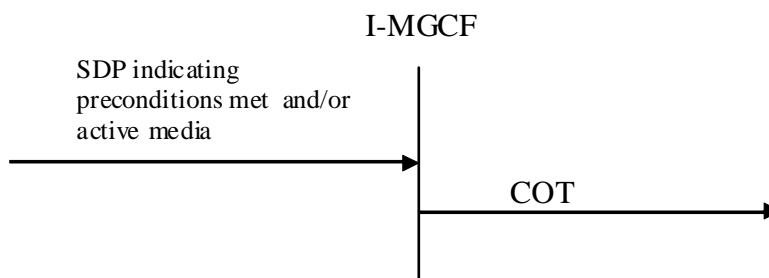

Figure 29: Sending of COT

If the IAM has already been sent, then the Continuity message shall be sent indicating "continuity check successful", when all of the following conditions have been met.

- When the requested remote preconditions (if any) in the IMS have been met.
- The media stream previously set to inactive mode is set to active (as specified in IETF RFC 4566 [56]).
- Local preconditions have been fulfilled.

7.3.3.1.3A Sending of SAM

See clause 7.2.3.1.3A.

7.3.3.1.4 Sending of 180 Ringing

See clause 7.2.3.1.4.

7.3.3.1.4A Sending of 183 Session Progress for early media scenarios

See clause 7.2.3.1.4A.

7.3.3.1.4B Sending of 181 Call is being forwarded

See clause 7.2.3.1.4B.

7.3.3.1.4C Sending of 183 Session Progress for overlap signalling using the in-dialog method

See clause 7.2.3.1.4C.

NOTE: If the network option of overlap signalling using the in-dialog method is applied at the I-MGCF in combination with the optional codec negotiation interworking with BICC in clause B.2., in order to meet the requirement in clause B.2.1 that the I-MGCF suspends the SDP answer procedure until it receives backward codec information from BICC, the 183 session progress response will not contain the SDP answer.

7.3.3.1.4D Sending of 183 Session Progress to carry ISUP Cause

See clause 7.2.3.1.4D.

7.3.3.1.4E Sending of 183 Session Progress for ICS call

See clause 7.2.3.1.4E.

7.3.3.1.5 Sending of the 200 OK (INVITE)

See clause 7.2.3.1.5.

7.3.3.1.6 Sending of the Release message (REL)

See clause 7.2.3.1.6.

7.3.3.1.7 Coding of the REL

See clause 7.2.3.1.7.

7.3.3.1.8 Receipt of the Release Message

See clause 7.2.3.1.8.

7.3.3.1.9 Receipt of RSC, GRS or CGB (H/W oriented)

See clause 7.2.3.1.9.

7.3.3.1.9a Receipt of REFER

See clause 7.2.3.1.9a.

7.3.3.1.9b Autonomous Release at I-MGCF

See clause 7.2.3.1.10.

7.3.3.1.10 Internal through connection of the bearer path

The through connection procedure is described in clauses 9.2.2.1.5 and 9.2.2.2.5.

7.3.3.1.11 Out of Band DTMF

If a SIP UA sends DTMF tones to the IM-MGW, the IM-MGW may report this information via the Mn interface to the MGCF. The MGCF shall send to the BICC network the APM message with the following values for the different parameters:

- Action indicator in accordance with the requested DTMF transport function;
- Signal in accordance with which DTMF digit to send;
- Duration in accordance with the required duration of the DTMF digit.

If the BICC network sends an APM message with DTMF signal, duration and action indicator to the MGCF, the MGCF may send this information to the IM-MGW via the Mn interface. The IM-MGW shall send the corresponding DTMF signal and duration information on the user plane of the IM CN subsystem according to RFC 4733 [105].

The interactions with the IM-MGW are shown in clause 9.2.8.

7.3.3.2 Outgoing Call Interworking from BICC to SIP at O-MGCF

7.3.3.2.1 Sending of INVITE

The following particularities apply for a BICC IAM received case, with regard to the already specified in clause 7.2.3.2.1.

The O-MGCF should defer sending the INVITE request until the BICC bearer setup and any local resource reservation is completed.

NOTE: If the O-MGCF sends the INVITE request before the BICC bearer setup and any local resource reservation is completed, the following considerations apply: If the receiving terminal is not supporting the SIP precondition, clipping may occur. Furthermore, if the MGCF sets the SDP "inactive" attribute in the initial INVITE request and the receiving terminal is not supporting the SIP precondition and the SIP UPDATE method, the interworking procedures within the present specification do not describe all necessary signalling interactions required to set up a call, in particular with respect to the sending of the re-INVITE that may also cause additional delay in the call setup. In addition, the interworking of the ringing indication might not be possible if the peer sends the ringing indication only as response to a re-INVITE.

The BICC bearer setup is completed when one of the following conditions is met:

- The event Bearer Set-up indication – for the forward bearer set-up case where the incoming Connect Type is "notification not required", which indicate successful completion of bearer set-up, is received by the Incoming bearer set-up procedure (ITU-T Recommendation Q.1902.4 [30] clause 7.5);
- Bearer Set-up Connect indication for the backward call set-up case, which indicate successful completion of bearer set-up, is received by the Incoming bearer set-up procedure (ITU-T Recommendation Q.1902.4 [30] clause 7.5);
- BNC set-up success indication for cases using bearer control tunnelling which indicate successful completion of bearer set-up, is received by the Incoming bearer set-up procedure (ITU-T Recommendation Q.1902.4 [30] clause 7.5).

7.3.3.2.1a Sending of INVITE without determining the end of address signalling

See clause 7.2.3.2.1a.

7.3.3.2.2 Coding of the INVITE

7.3.3.2.2.1 REQUEST URI Header

See clause 7.2.3.2.2.1

7.3.3.2.2.2 SDP Media Description

If the O-MGCF sends the INVITE request without waiting for the BICC bearer setup and any local resource reservation to complete, (which is not recommended according to clause 7.3.3.2.1) it shall indicate that SIP preconditions are not met when the initial INVITE request indicates support of the SIP preconditions.

The O-MGCF shall include the AMR codec transported according to IETF RFC 4867 [23] with the options listed in clause 5.1.1 of 3GPP TS 26.236 [32] in the SDP offer. Within the SDP offer, the O-MGCF should also provide SDP RR and RS bandwidth modifiers specified in IETF RFC 3556 [59] to disable RTCP, as detailed in clause 7.4 of 3GPP TS 26.236 [32].

7.3.3.2.2.3 P-Asserted-Identity and privacy header fields

See clause 7.2.3.2.2.3

7.3.3.2.2.3A "cpc" URI Parameter in P-Asserted-Identity Header

See clause 7.2.3.2.2.3A.

7.3.3.2.2.3B "oli" URI Parameter in P-Asserted-Identity Header

See clause 7.2.3.2.2.3B.

7.3.3.2.2.4 Max Forwards header

See clause 7.2.3.2.2.4

7.3.3.2.2.5 IMS Communication Service Identifier

For speech and video calls, the O-MGCF shall insert an IMS Communication Service Identifier, indicating the IMS Multimedia Telephony Communication Service.

The IMS Communication Service Identifier for the IMS Multimedia Telephony Communication Service is defined in 3GPP TS 24.173 [88].

7.3.3.2.2.6 P-Access-Network-Info

See clause 7.2.3.2.2.9.

7.3.3.2.2A Coding of the INVITE when number portability is supported

See clause 7.2.3.2.2A.

7.3.3.2.2B Coding of the INVITE for Carrier Routing

See clause 7.2.3.2.2B.

7.3.3.2.2C Coding of INVITE with instance-id in form of IMEI URN

See clause 7.2.3.2.2C.

7.3.3.2.2.7 PSAP Call-back indication

See clause 7.2.3.2.2.10.

7.3.3.2.3 Sending of UPDATE

This clause only applies if the O-MGCF sends the INVITE request before SIP preconditions are met (see clause 7.3.3.2.1).

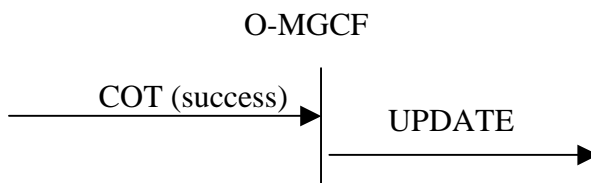

Figure 30: Receipt of COT (success)

The UPDATE request with a new SDP offer shall be sent for each early SIP dialogue for which the received provisional response indicated support of preconditions confirming that all the required local preconditions have been met when all the following conditions are met.

1. A Continuity message, with the Continuity Indicators parameter set to "continuity check successful" shall be received.
2. The reservation of requested local resources has been completed.

In addition, depending on which bearer set-up procedure used for the call one of the following condition shall be met:

- The event Bearer Set-up indication – for the forward bearer set-up case where the incoming Connect Type is "notification not required", which indicate successful completion of bearer set-up, is received by the Incoming bearer set-up procedure (ITU-T Recommendation Q.1902.4 [30] clause 7.5);
- Bearer Set-up Connect indication for the backward call set-up case, which indicate successful completion of bearer set-up, is received by the Incoming bearer set-up procedure (ITU-T Recommendation Q.1902.4 [30] clause 7.5);

- BNC set-up success indication for cases using bearer control tunnelling which indicate successful completion of bearer set-up, is received by the Incoming bearer set-up procedure, (ITU-T Recommendation Q.1902.4 [30] clause 7.5).

NOTE: This procedure applies regardless of whether the early SIP dialog existed prior to the preconditions being fulfilled or is subsequently created.

7.3.3.2.4 Sending of ACM and Awaiting Answer indication

See clause 7.2.3.2.4

The sending of an awaiting answer indication is described in clause 9.2.3.1. and clause 9.2.3.2.

7.3.3.2.5 Coding of the ACM

7.3.3.2.5.1 Backward call indicators

See clause 7.2.3.2.5.1

7.3.3.2.6 Sending of the Call Progress message (CPG)

See clause 7.2.3.2.6.

7.3.3.2.7 Coding of the CPG

7.3.3.2.7.1 Event information

See clause 7.2.3.2.7.1.

7.3.3.2.7.2 Optional Backward call indicators

See clause 7.2.3.2.7.5.

7.3.3.2.7a Receipt of 200 OK (INVITE)

See clause 7.2.3.2.7a.

7.3.3.2.7b Internal through connection of the bearer path

The through connection procedure is described in clauses 9.2.3.1.7 and 9.2.3.2.7.

7.3.3.2.8 Sending of the Answer Message (ANM)

See clause 7.2.3.2.8.

7.3.3.2.9 Coding of the ANM

See clause 7.2.3.2.9.

7.3.3.2.10 Sending of the Connect message (CON)

See clause 7.2.3.2.10.

7.3.3.2.11 Coding of the CON

See clause 7.2.3.2.11.

7.3.3.2.11.1 Void

7.3.3.2.11A Receipt of re-INVITE requests

See clause 7.2.3.2.11A.

7.3.3.2.12 Receipt of Status Codes 4xx, 5xx or 6xx

See clause 7.2.3.2.12.

7.3.3.2.13 Receipt of a BYE

See clause 7.2.3.2.13.

7.3.3.2.14 Receipt of the Release Message

See clause 7.2.3.2.14.

7.3.3.2.15 Receipt of RSC, GRS or CGB (H/W oriented)

See clause 7.2.3.2.15.

7.3.3.2.16 Out of Band DTMF

If a SIP UA sends DTMF tones to the IM-MGW, the IM-MGW may report this information via the Mn interface to the MGCF. The MGCF shall send to the BICC network the APM message with the following values for the different parameters:

- Action indicator in accordance with the requested DTMF transport function;
- Signal in accordance with which DTMF digit to send;
- Duration in accordance with the required duration of the DTMF digit.

If the BICC network sends an APM message with DTMF signal, duration and action indicator to the MGCF, the MGCF may send this information to the IM-MGW via the Mn interface. The IM-MGW shall send the corresponding DTMF signal and duration information on the user plane of the IM CN subsystem according to 4733 [105].

The interaction with the IM-MGW is shown in clause 9.2.8.

7.3.3.2.17 Sending of CANCEL

See clause 7.2.3.2.18.

7.3.3.2.18 Autonomous Release at O-MGCF

See clause 7.2.3.2.16.

7.3.3.2.19 Special handling of 580 precondition failure received in response to either an INVITE or UPDATE

See clause 7.2.3.2.17.

7.3.3.2.20 Receipt of SIP redirect (3xx) response

See clause 7.2.3.2.19.

7.3.3.2.21 Sending of INFO for overlap signalling using the in-dialog method

See clause 7.2.3.2.20.

7.3.3.3 Timers

See clause 7.2.3.3.

7.4 Supplementary Services

The following clauses describe the MGCF behaviour related to supplementary services as defined in ITU-T Recommendations Q.730 to ITU-T Q.737 [42] when interworking with an IMS which does not use a Multimedia Telephony Application Server (MTAS) providing supplementary services according to 3GPP according to 3GPP TS 24.173 [88]. The support of these supplementary services is optional. If the supplementary services are supported, the procedures described within this clause shall be applied.

7.4.1 Calling line identification presentation/restriction (CLIP/CLIR)

The inter working between the Calling Party Number parameter and the P-Asserted-ID header and vice versa used for the CLIP-CLIR service is defined in the clauses 7.2.3.1.2.6 and 7.2.3.2.2.3. This inter working is essentially the same as for basic call and differs only in that if the CLIR service is invoked the "Address Presentation Restriction Indicator (APRI)" (in the case of ISUP to SIP calls) or the "priv value" of the "calling" Privacy header field (in the case of SIP to ISUP calls) is set to the appropriate "restriction/privacy" value.

In the specific case of ISUP originated calls, use of the CLIP service additionally requires the ability to determine whether the number was network provided or provided by the access signalling system. Due to the possible SIP indication of the P-Asserted-Identity the Screening indicator is set to network provided as default. For the CLIP-CLIR service the mapping of the APRI from privacy header at the O-MGCF is described within table 16 in clause 7.2.3.2.2.3.

At the O-MGCF the presentation restricted indication shall be mapped to the Privacy header field values "id" and "header". This is described in table 12 in clause 7.2.3.2.2.3.

7.4.2 Connected line presentation and restriction (COLP/COLR)

7.4.2.0 General

The COLP/COLR services are only to be interworked between trusted nodes – that is before passing any COLP/COLR information over the SIP-BICC/ISUP boundary the MGCF shall satisfy itself that the nodes on the BICC/ISUP side to which the information is to be passed are trusted.

The procedure within clause 7.5.2 for the generic number ("additional connected number") mapping shall apply.

7.4.2.1 Incoming Call Interworking from SIP to BICC/ISUP at the I-MGCF

7.4.2.1.1 INVITE to IAM interworking (SIP to ISUP/BICC calls)

In the case of SIP to ISUP/BICC calls the I-MGCF may invoke the COLP service as an operator option by setting the "Connected Line Identity Request indicator" field of the "Optional forward call indicators" parameter of the IAM to "requested".

NOTE: This implies that all outgoing calls will invoke the COLP service.

7.4.2.1.2 ANM/CON to 200 OK (INVITE)

Tables 20 and 21 specify the interworking required in the case when the COLP has been automatically requested on behalf of the originating SIP node. The table also indicates the inter workings required if the COLP service has been invoked and the called party has or has not invoked the COLR service.

Table 20: Mapping to P-Asserted-Identity and Privacy Header Fields

SIP Component	Setting
P-Asserted-Identity	See table 21
Privacy	See table 22

Table 21: Mapping of connected number parameter to SIP P-Asserted-Identity header fields

BICC/ISUP parameter / field	Value	SIP component	Value
Connected Number		P-Asserted-Identity header field	
Nature of Address Indicator	"national (significant) number"	Tel URI or SIP URI (NOTE 1)	Add CC (of the country where the MGCF is located) to Connected PN address signals to construct E.164 number in URI. Prefix number with "+".
	"international number"		Map complete Connected address signals to construct E.164 number in URI. Prefix number with "+".
Address signal	If NOA is "national (significant) number" then the format of the address signals is: NDC + SN If NOA is "international number" then the format of the address signals is: CC + NDC + SN	Tel URI or SIP URI (NOTE 1)	CC+NDC+SN as E.164 number in URI. Prefix number with "+".
NOTE 1: A tel URI or a SIP URI with "user=phone" is used according to operator policy.			

Table 22: Mapping of BICC/ISUP APRIs into SIP privacy header fields

BICC/ISUP parameter / field	Value	SIP component	Value
Connected Number		Privacy header field	priv-value
APRI (See to determine which APRI to use for this mapping)	"presentation restricted"	Priv-value	"id" ("id" included only if the P-Asserted-Identity header is included in the SIP INVITE)
	"presentation allowed"	Priv-value	omit Privacy header or Privacy header without "id" and "header" if other privacy service is needed

7.4.2.2 Outgoing Call Interworking from BICC/ISUP to SIP at O-MGCF

7.4.2.2.1 IAM to INVITE interworking (ISUP to SIP calls)

The O-MGCF determines that the COLP service has been requested by the calling party by parsing the "Optional Forward Call Indicators" field of the incoming IAM. If the "Connected Line Identity Request indicator" is set to "requested" then the BICC/ISUP to SIP interworking node shall ensure that any backwards "connected party" information is interworked to the appropriate parameters of the ISUP ANM or CON message sent backwards to the calling party as detailed within this subclause.

The O-MGCF has to store the status of the "Connected Line Identity Request indicator".

7.4.2.2.2 1XX to ANM or CON interworking

If the P-Asserted-Identity header field is included within a 1XX SIP response, the identity shall be stored within the O-MGCF together with information about the SIP dialogue of the 1XX SIP response and shall be included within the ANM or CON message if required by the procedures described in clause 7.4.2.2.3. In accordance with ISUP procedures, a connected number shall not be included within the ACM message. The mapping of the of the P-Asserted-Identity and Privacy header fields is shown in tables 23 and 24.

7.4.2.2.3 200 OK (INVITE) to ANM/CON interworking

Tables 23 and 24 specify the interworking required in the case when the calling party has invoked the COLP service. The tables also indicate the interworking procedures required if the calling party has invoked the COLP service and the called party has or has not invoked the COLR service.

If no P-Asserted-Identity header field is provided within the 200 OK (INVITE) message, the stored information previously received in the last provisional 1xx response of the same SIP dialogue shall be used.

NOTE: Due to forking, other P-Asserted-Identities might have been received in different SIP dialogues.

If the Calling Party has requested the COLP service (as indicated by the stored request status) but the 200 OK (INVITE) and previous 1XX provisional responses do not include a P-Asserted-Identity header field, the O-MGCF shall set up a network provided Connected Number with an Address not Available indication.

If the P-Asserted-Identity is available then the Connected number has to be setup with the screening indication network provided. The mapping of the P-Asserted-Identity and Privacy (if available) is shown in table 24.

Table 23: Connected number parameter mapping

← ANM/CON	← 200 OK INVITE
Connected Number (Network Provided)	P-Asserted-ID
Address Presentation Restricted Indicator	Privacy Value Field

Table 24: Mapping of P-Asserted-Identity and privacy headers to the ISUP/BICC connected number parameter

SIP component	Value	BICC/ISUP parameter / field	Value
P-Asserted-Identity header field (NOTE)	E.164 number	Connected Number	
		Number incomplete indicator	"Complete"
		Numbering Plan Indicator	"ISDN/Telephony (E.164)"
		Nature of Address Indicator	If CC encoded in the URI is equal to the CC of the country where MGCF is located AND the next BICC/ISUP node is located in the same country then set to "national (significant) number" else set to "international number"
		Address Presentation Restricted Indicator (APRI)	Depends on priv-value in Privacy header.
		Screening indicator	Network Provided
Addr-spec	"CC" "NDC" "SN" from the URI	Address signal	if NOA is "national (significant) number" then set to "NDC" + "SN". If NOA is "international number" then set to "CC"+"NDC"+"SN".
Privacy header field is not present		APRI	Presentation allowed
Privacy header field	priv-value	APRI	"Address Presentation Restricted Indicator"
priv-value	"header"	APRI	Presentation restricted
	"user"	APRI	Presentation restricted
	"none"	APRI	Presentation allowed
	"id"	APRI	Presentation restricted
NOTE:	It is possible that a P-Asserted-Identity header field includes both a tel URI and a SIP URI. In this case, either the tel URI or the SIP URI with user="phone" and a specific host portion, as selected by operator policy, may be used.		

7.4.3 Direct Dialling In (DDI)

A direct dialling in call is a basic call and no additional treatment is required by the MGCF.

7.4.4 Malicious call identification

The actions of the MGCF at the ISUP/BICC side are described in ITU-T Recommendation Q.731.7 [42] under the clause "Interactions with other networks".

7.4.5 Subaddressing (SUB)

7.4.5.1 General

The ISDN subaddress information in ISUP is transported within the Access Transport Parameter. The coding of the subaddress parameter within the Access Transport Parameter is described within ETSI EN 300 403-1 [96]. The isdn-subaddress parameter "isub" carried within a tel or SIP URI is defined within RFC 3966 [97]. The isdn-subaddress encoding type parameter "isub-encoding" carried within a tel or SIP URI is defined within RFC 4715 [108].

7.4.5.2 Interworking at I-MGCF

The mapping in table 24ba of the isdn-subaddress parameter received within a tel or SIP URI of the initial INVITE request to the ISUP Access Transport Parameter encapsulating the subaddress information (calling party subaddress and/or called party subaddress information elements) to be sent within the IAM message shall be applied.

The mapping in table 24bb of the subaddress information (connected subaddress information element) received within an ANM message containing the ISUP Access Transport Parameter to the isdn-subaddress parameters "isub" and "isub-encoding" of a tel or SIP URI to be sent within a 200 OK (INVITE) shall be applied.

Table 24ba: Mapping of the isdn-subaddress received in an initial INVITE to the subaddress information sent in the IAM

SIP Message INVITE			ISUP Message IAM		
Source SIP header field and component	Source component value		ISUP Parameter field	Derived value of parameter field	
To header field including the isdn-subaddress (NOTE)	"isub=" 1*uric "uric" containing the subaddress digits	isub-encoding not present	Access Transport Parameter	called party subaddress	Type of subaddress = "NSAP" (000)
		"isub-encoding=nsap-ia5"			Type of subaddress = "NSAP" (000)
		"isub-encoding=nsap-bcd"			Type of subaddress = "NSAP" (000)
	"isub-encoding=nsap"	Type of subaddress = "NSAP" (000)			
"isub=" 1*uric ("uric" containing the subaddress digits) and isub-encoding does not contain nsap value		No mapping			
P-Asserted-Identity header Field including the isdn-subaddress	";isub=" 1*uric "uric" containing the subaddress digits	isub-encoding not present	Access Transport Parameter	calling party subaddress	Type of subaddress = "NSAP" (000)
		"isub-encoding=nsap-ia5"			Type of subaddress = "NSAP" (000)
		"isub-encoding=nsap-bcd"			Type of subaddress = "NSAP" (000)
	"isub-encoding=nsap"	Type of subaddress = "NSAP" (000)			
"isub=" 1*uric ("uric" containing the subaddress digits) and isub-encoding does not contain nsap value		No mapping			
NOTE: As an operator option, an isdn-subaddress within the Request-URI may also be mapped into the ISUP Access Transport parameter.					

Table 24bb: Mapping of the subaddress information received in an ANM to the isdn subaddress sent in the 200 OK (INVITE)

ISUP Message ANM		SIP Message 200 (OK)	
ISUP Parameter field	Source component value	Source SIP header field and component	Derived value of parameter field
Access Transport Parameter	connected subaddress and Type of subaddress = "NSAP" (000)	P-Asserted-Identity including the isdn-subaddress	";isub=" 1*uric and "isub-encoding=nsap-ia5" The subaddress digits included into the "uric" shall be derived from the Access Transport Parameter
	connected subaddress and Type of subaddress ≠ "NSAP" (000)	No mapping	

7.4.5.3 Interworking at O-MGCF

The mapping in table 24bc of the subaddress information received in the Access Transport Parameter (calling party subaddress and/or called party subaddress information elements) of the IAM message to the isdn-subaddress parameters "isub" and "isub-encoding" of a tel or SIP URI to be sent within the initial INVITE request shall be applied.

The mapping in table 24bd of the isdn-subaddress information received within a tel or SIP URI of a 200 OK (INVITE) to the subaddress information of the ISUP Access Transport Parameter (connected subaddress information element) to be sent within the ANM message shall be applied.

Table 24bc: Mapping of the subaddress information received in an IAM to the isdn-subaddress sent in the INVITE

ISUP IAM Message		SIP INVITE Message	
ISUP Parameter field	Source component value	Source SIP header field and component	Derived value of parameter field
Access Transport Parameter	called party subaddress and Type of subaddress = "NSAP" (000)	To header field including the isdn-subaddress, and, as an operator option, Request URI	";isub=" 1*uric and "isub-encoding=nsap-ia5" The subaddress digits included into the "uric" shall be derived from the Access Transport Parameter
	called party subaddress and Type of subaddress ≠ "NSAP" (000)	No mapping	
	calling party subaddress and Type of subaddress = "NSAP" (000)	P-Asserted-Identity header field including the isdn-subaddress	";isub=" 1*uric and "isub-encoding=nsap-ia5" The subaddress digits included into the "uric" shall be derived from the Access Transport Parameter
	calling party Subaddress and Type of Subaddress ≠ "NSAP" (000)	No mapping	

Table 24bd: Mapping of the isdn subaddress received in a 200OK to the subaddress information sent in the ANM

SIP Message 200 (OK)		ISUP Message ANM			
Source SIP header field and component	Source component value	ISUP Parameter field	Derived value of parameter field		
P-Asserted-Identity header Field including the isdn-subaddress	"isub=" 1*uric	Access Transport Parameter	connected subaddress	Type of subaddress = "NSAP" (000)	
	"uric" containing the subaddress digits			"isub-encoding=nsap-ia5"	Type of subaddress = "NSAP" (000)
				"isub-encoding=nsap-bcd"	Type of subaddress = "NSAP" (000)
	"isub=" 1*uric ("uric" containing the subaddress digits) and isub-encoding does not contain nsap value	No mapping			

7.4.6 Call Forwarding Busy (CFB)/ Call Forwarding No Reply (CFNR) / Call Forwarding Unconditional (CFU) / Call Deflection (CD)

7.4.6.1 General

A MGCF within an IMS network applying the Communication Diversion service uses the procedures defined in clause 7.5.4.

This clause describes additional interworking of call forwarding service information between a PSTN/PLMN network and an IMS network. This can also be used when interworking between SIP networks (e.g., IMS network interworking with enterprise networks making use of the History-Info header field with an escaped Reason header field as described in IETF RFC 7044 [91]). The procedures support the interworking of the diversion reason within the History-Info header field using an escaped Reason header field defined by IETF RFC 3326 [116] as described in IETF RFC 7044 [91] and also support the diversion cause using the "cause" URI parameter as described by IETF RFC 4458 [113].

If the MGCF is supporting the interworking of Call Forwarding and also applying the Communication Diversion services as defined by 3GPP TS 24.604 [60], it uses both IETF RFC 7044 [91] and IETF RFC 4458 [113] to signal the diversion reason. An IMS network supporting the interworking of Call Forwarding and not applying the IMS Communication Diversion supplementary service according to 3GPP TS 24.604 [60] uses IETF RFC 7044 [91] and can also use IETF RFC 4458 [113] based on network option.

When interworking the SIP History-Info header field to ISUP, and both the diversion reason based on IETF RFC 7044 [91] and IETF RFC 4458 [113] are present for the same diversion instance, the MGCF should use the "cause" URI parameter per IETF RFC 4458 [113] for deriving the ISUP. When the "cause" URI parameter per IETF RFC 4458 [113] is used, the corresponding interworking as described in clause 7.5.4 shall be applied for that diversion instance. Otherwise, the interworking as defined in the present clause should be applied.

When interworking from ISUP to the History-Info header field, to signal the diversion reason the MGCF should use the escaped Reason header field from IETF RFC 7044 [91] and apply the interworking procedures in the present subclause. The MGCF should also apply the interworking procedures described in clause 7.5.4 to use the "cause" URI parameter from IETF RFC 4458 [113] to signal the diversion reason.

In the event that the interworking procedures described in this clause as well as the interworking procedures in clause 7.5.4 are not applied, the actions of the MGCF at the ISUP/BICC side as described in ITU-T Recommendation Q.732.2-5 [42] under the clause "Interactions with networks not providing any call diversion information" may be applied as a network option.

7.4.6.2 Interworking at the O-MGCF

7.4.6.2.1 General

This clause describes the optional mapping of Call Forwarding information at the O-MGCF to the protocol-cause specified in IETF RFC 3326 [116].

7.4.6.2.2 Interworking SIP to ISUP

Table 7.4.6.2.2.1: Mapping of SIP messages to ISUP messages

←Message sent to ISUP	←Message Received from SIP	
ACM indicating call forwarding	181 (Call Is Being Forwarded) response	See table 7.4.6.2.2.6
CPG indicating call forwarding (see NOTE)	181 (Call Is Being Forwarded) response	See table 7.4.6.2.2.7
ACM indicating ringing	180 (Ringing) response	See table 7.4.6.2.2.8
CPG indicating alerting (see NOTE)	180 (Ringing) response	See table 7.4.6.2.2.9
ANM	200 (OK) response	See table 7.4.6.2.2.10
CON	200 (OK) response (Neither a 181 (Call Is Being Forwarded) response nor a 180 (Ringing) response was received)	See table 7.4.6.2.2.10
NOTE: A CPG will be sent if an ACM was already sent.		

Table 7.4.6.2.2.2: Mapping of History-Info header field to ISUP Redirection number

Source SIP header field and component	Source Component value	Redirection number	Derived value of parameter field
hi-targeted-to-uri of the hi-entry following the last hi-entry containing a Reason "headers" component as defined in IETF RFC 7044 [91] with cause value as listed in table 7.4.6.2.2.4. Appropriate global number portion of the hi-targeted-to-uri, assumed to be in form "+" CC + NDC + SN. (NOTE)	CC	Nature of address indicator	If CC is equal to the country code of the country where O-MGCF is located AND the next ISUP node is located in the same country, then set to " <i>national (significant) number</i> " else set to " <i>international number</i> ".
	CC, NDC, SN	Address signals	If NOA is " <i>national (significant) number</i> " then set to NDC + SN. If NOA is " <i>international number</i> " then set to CC + NDC + SN.
NOTE: If the SIP URI doesn't contain " <i>user=phone</i> ", mapping to redirection number is impossible, therefore no need to generate Redirection number and Redirection number restriction parameter (per table 7.4.6.2.2.3), Notification subscription options can't be set as " <i>presentation allowed with redirection number</i> ".			

Table 7.4.6.2.2.3: Mapping of History-Info header field to ISUP Redirection number restriction

Source SIP header field and component	Source Component value	Redirection number restriction	Derived value of parameter field
Privacy header field, or/and Privacy "headers" component of the hi-entry following the last hi-entry containing a Reason "headers" component as defined in IETF RFC 7044 [91] with cause value as listed in table 7.4.6.2.2.4	" <i>history</i> " or " <i>session</i> " or " <i>header</i> "	Presentation restricted indicator	" <i>Presentation restricted</i> "
	Privacy "headers" component of the hi-targeted-to-uri and Privacy header field absent or " <i>none</i> "		" <i>Presentation allowed</i> " or absent

Table 7.4.6.2.2.4: Mapping of hi-targeted-to-uri to ISUP Call Diversion Information

Source SIP header field and component	Source Component value	Call Diversion Information	Derived value of parameter field
Privacy "headers" component of the hi-targeted-to-uri or/and Privacy header field		Notification subscription options	If the priv-value "history" or "session" or "header" is received within the Privacy header field or the priv-value "history" is received within the "headers" component of the hi-targeted-to-uri representing the diverting URI(s) and within the hi-targeted-to-uri representing diverted-to URI then "presentation not allowed" shall be set. Otherwise, if the priv-value "history" is received only within the "headers" component of the hi-targeted-to-uri representing the diverted-to URI then "presentation allowed without redirection number" shall be set. (NOTE 1, NOTE 2) Otherwise, "presentation allowed with redirection number" shall be set.
hi-targeted-to-uri; Reason "headers" component as defined in IETF RFC 7044 [91] with cause parameter	Cause parameter value	Redirecting reason	
	302		<i>Deflection immediate response</i>
	486		<i>User busy</i>
	408		<i>No reply</i>
	503		<i>Mobile subscriber not reachable</i>
	all other cause values		<i>Unknown</i>
NOTE 1: diverting URI corresponds to the hi-targeted-to-uri of the hi-entry containing a hi-index value that match the "mp" header field parameter value of the diverted-to URI. If the diverted-to URI does not contain the "mp" header field parameter, the diverting URI corresponds to the hi-targeted-to-uri of the the last hi-entry containing a Reason "headers" component with cause parameter.			
NOTE 2: diverted-to URI corresponds to the hi-targeted-to-uri of the hi-entry following the last hi-entry containing a Reason "headers" component with cause parameter and is mapped to the Redirection number, see table 7.4.6.2.2.2.			

Table 7.4.6.2.2.5: Void

Table 7.4.6.2.2.6: Mapping of 181 (Call Is Being Forwarded) → ACM when ACM was not previously sent

Source SIP header field and component	Source Component value	ISUP Parameter	Derived value of parameter field
181 (Call Is Being Forwarded)		ACM	
		Generic notification indicator <i>Notification indicator</i>	<i>Call is diverting</i>
History-Info header field	See table 7.4.6.2.2.2	Redirection number	See table 7.4.6.2.2.2
Privacy "headers" component of the hi-targeted-to-uri or/and Privacy header field	See table 7.4.6.2.2.3	Redirection number restriction	See table 7.4.6.2.2.3
Privacy "headers" component of the hi-targeted-to-uri or/and Privacy header field	See table 7.4.6.2.2.4	Call diversion information <i>Notification subscription options</i>	See table 7.4.6.2.2.4
hi-targeted-to-uri; Reason "headers" component as defined in IETF RFC 7044 [91] with cause parameter	See table 7.4.6.2.2.4	Call diversion information <i>Redirecting reason</i>	See table 7.4.6.2.2.4

Table 7.4.6.2.2.7: Mapping of 181 (Call Is Being Forwarded) → CPG if ACM was already sent

Source SIP header field and component	Source Component value	ISUP Parameter	Derived value of parameter field
181 (Call Is Being Forwarded) response		CPG	
		Generic notification indicator <i>Notification indicator</i>	<i>Call is diverting</i>
hi-targeted-to-uri; Reason "headers" component as defined in IETF RFC 7044 [91] with cause parameter	486	Event information	<i>CFB (national use)</i>
	408 (see NOTE) all other values, or if appropriate "national use" value (CFB, CFNR or CFU) is not used in a network, or if no hi-targeted-to-uri "cause" URI parameter is contained in the SIP 181 (Call Is Being Forwarded) response.	Event indicator	<i>CFNR (national use)</i> <i>Progress</i>
History-Info header field	See table 7.4.6.2.2.2	Redirection number	See table 7.4.6.2.2.2
Privacy "headers" component of the hi-targeted-to-uri or/and Privacy header field	See table 7.4.6.2.2.3	Redirection number restriction	See table 7.4.6.2.2.3
Privacy "headers" component of the hi-targeted-to-uri or/and Privacy header field	See table 7.4.6.2.2.4	Call diversion information <i>Notification subscription options</i>	See table 7.4.6.2.2.4
hi-targeted-to-uri; Reason "headers" component as defined in IETF RFC 7044 [91] with cause parameter	See table 7.4.6.2.2.4	Call diversion information <i>Redirecting reason</i>	See table 7.4.6.2.2.4

NOTE: This appears in the cases of CFNR.

Table 7.4.6.2.2.8: Mapping of 180 (Ringing) → ACM when ACM was not previously sent

Source SIP header field and component	Source Component value	ISUP Parameter	Derived value of parameter field
180 (Ringing) response		ACM	
History-Info header field	If hi-targeted-to-uri of at least one History-Info hi-entry contains a Reason "headers" component as defined in IETF RFC 7044 [91].	Generic notification indicator <i>Notification indicator</i>	<i>Call is diverting</i>
History-Info header field	See table 7.4.6.2.2.2	Redirection number (NOTE)	See table 7.4.6.2.2.2
Privacy "headers" component of the hi-targeted-to-uri or/and Privacy header field	See table 7.4.6.2.2.3	Redirection number restriction (NOTE)	See table 7.4.6.2.2.3
Privacy "headers" component of the hi-targeted-to-uri or/and Privacy header field	See table 7.4.6.2.2.4	Call diversion information <i>Notification subscription options (NOTE)</i>	See table 7.4.6.2.2.4
hi-targeted-to-uri; Reason "headers" component as defined in IETF RFC 7044 [91] with cause parameter	See table 7.4.6.2.2.4	Call diversion information <i>Redirecting reason (NOTE)</i>	See table 7.4.6.2.2.4

NOTE: Parameter shall only be supplied if hi-targeted-to-uri contains a Reason "headers" component, as defined in IETF RFC 7044 [91] with cause value as listed in table 7.4.6.2.2.4.

The mapping described within table 7.4.6.2.2.8 can only appear if the communication has already undergone a Communications diversion in the IMS and the 180 (Ringing) is the first provisional response sent in backward direction.

The O-MGCF can indicate the call diversion information in the mapping of 180 (Ringing) provisional response to a CPG message in fact if the response before was a 181 (Call Is Being Forwarded).

Table 7.4.6.2.2.9: Mapping of 180 (Ringing) → CPG if ACM was already sent

Source SIP header field and component	Source Component value	ISUP Parameter	Derived value of parameter field
180 (Ringing) response		CPG	
		Generic notification indicator <i>Notification indicator</i>	Call is diverting
History-Info header field		Event information Event indicator	ALERTING
History-Info header field	See table 7.4.6.2.2.2	Redirection number (NOTE)	See table 7.4.6.2.2.2
Privacy "headers" component of the hi-targeted-to-uri or/and Privacy header field	See table 7.4.6.2.2.3	Redirection number restriction (NOTE)	See table 7.4.6.2.2.3
Privacy "headers" component of the hi-targeted-to-uri or/and Privacy header field	See table 7.4.6.2.2.4	Call diversion information <i>Notification subscription options</i> (NOTE)	See table 7.4.6.2.2.4
hi-targeted-to-uri; Reason "headers" component as defined in IETF RFC 7044 [91] with cause parameter	See table 7.4.6.2.2.4	Call diversion information <i>Redirecting reason</i> (NOTE)	See table 7.4.6.2.2.4
NOTE: Parameter shall only be supplied if hi-targeted-to-uri contains a Reason "headers" component, as defined in IETF RFC 7044 [91] with cause value as listed in table 7.4.6.2.2.4.			

The mapping in table 7.4.6.2.2.9 appears when a 181 (Call Is Being Forwarded) provisional response previously was mapped to an ACM. Therefore the state machine of the O-MGCF knows that a CDIV is in progress.

Table 7.4.6.2.2.10: Mapping of 200 (OK) response

Source SIP header field and component	Source Component value	ISUP Parameter	Derived value of parameter field
200 (OK) response		ANM/CON (NOTE)	
History-Info header field	See table 7.4.6.2.2.2	Redirection number	See table 7.4.6.2.2.2
Privacy "headers" component of the hi-targeted-to-uri or/and Privacy header field	See table 7.4.6.2.2.3	Redirection number restriction	See table 7.4.6.2.2.3
NOTE: Redirection number shall only be supplied if 200 (OK) response is mapped to ANM message.			

7.4.6.2.3 Interworking ISUP to SIP

For the interworking of 180 (Ringing) response and 200 (OK) response (to the INVITE request) to the regarding ISUP messages and parameters no additional procedures beyond the basic call procedures are needed.

To interwork the redirecting number at the O-MGCF it can be needed to create placeholder History-Info hi-entries. Such a History-Info hi-entry has to provide a hi-targeted-to-uri with a placeholder value "unknown@unknown.invalid", a Reason "headers" component with a cause parameter, a hi-index and an "mp" header field parameter as described within table 7.4.6.2.3.1.

Table 7.4.6.2.3.1: Mapping of IAM to SIP INVITE request

ISUP Parameter or IE	Derived value of parameter field	SIP component	Value
IAM		INVITE request	
Redirecting number		History-Info header field	hi-targeted-to-uri of the penultimate created hi-entry IF Redirection counter exceed 1 ELSE no mapping
Nature of address indicator:	"national (significant) number"	hi-targeted-to-uri	Add CC (of the country where the MGCF is located) to Redirecting number Address Signals to construct E.164 number in URI.
	"international number"		Map complete Redirecting number Address Signals to E.164 number in URI.
Address Signals	If NOA is "national (significant) number" then the format of the Address Signals is: NDC + SN If NOA is "international number" then the format of the Address Signals is: CC + NDC + SN	hi-targeted-to-uri	Addr-spec "+" CC NDC SN mapped to userinfo portion of SIP URI. (NOTE 5) Add "user=phone".
Redirecting number	APRI	Privacy "headers" component of the penultimate hi-targeted-to-uri entry in the History-Info header	Priv-value
	"presentation restricted"		"history"
	"presentation allowed"		Privacy header field absent or "none" (NOTE 3)
Redirection Information	Redirecting indicator	Privacy "headers" component of the penultimate hi-targeted-to-uri entry in the History-Info header	Priv-value
	Call diverted		"none" (NOTE 4)
	Call diverted, all redirection information presentation restricted		"history"
Redirection Information	Redirection counter 1	hi-index and mp-param (NOTE 7)	Number of diversions are shown to the number of levels in hi-index. Index for Original called number = 1 Index for Called party number = 1.1 and addition of "mp=1"
	2		Index for Original called number = 1 Index for Redirecting number = 1.1 and addition of "mp=1" Index for Called party number = 1.1.1 and addition of "mp=1.1"
	N		Index for Original called number = 1 Placeholder History-Info hi-entry with Index = 1.1 and addition of "mp=1" ... Fill up ... Index for Redirecting number = 1.[(N-1)*".1"] and addition of "mp" set to the hi-index value of the hi-targeted-to-uri that precede. Index for Called party number = 1.N* ".1" (e.g. N=3 → 1.1.1.1) and addition of

ISUP Parameter or IE	Derived value of parameter field	SIP component	Value
			"mp=1.[(N-1)*].1"
Redirection Information	Redirecting Reason and Original Redirection Reason (NOTE 1)	hi-targeted-to-uri; Reason "headers" component as defined in IETF RFC 7044 [91] with cause parameter.	Cause parameter value
	<i>unknown/not available</i>	For a placeholder History-Info hi-entry the value "404" shall be taken (NOTE 2).	404
	<i>unconditional</i>	Cause parameter for redirecting reason will be put in the entry of redirecting number, and cause parameter for original redirection reason will be put in the entry of original called number.	302
	<i>User Busy</i>		486
	<i>No reply</i>		408
	<i>Deflection during alerting</i>		302
	<i>Deflection immediate response</i>		302
<i>Mobile subscriber not reachable</i>		503	
Called Party Number	See Redirecting number Nature of address indicator and Address signal	History-Info header field see hi-targeted-to-uri	URI of the last hi-targeted-to-uri entry of History-Info header field (NOTE 6)
Original called number	See Redirecting number Nature of address indicator and Address signal	History-Info header field see hi-targeted-to-uri	URI of first hi-targeted-to-uri entry of History-Info header field (NOTE 5)
Original called number	APRI	Privacy "headers" component of the first hi-targeted-to-uri entry of History-Info header	Priv-value
	<i>"presentation restricted"</i>		<i>"history"</i>
	<i>"presentation allowed"</i>		<i>"none"</i>
<p>NOTE 1: Original Redirection Reason contains only the "unknown/not available" parameter</p> <p>NOTE 2: For all History-Info hi-entries except the last one a cause parameter in Reason "headers" component as defined in IETF RFC 7044 [91] has to be included.</p> <p>NOTE 3: If the Redirecting indicator has the value "Call diverted, all redirection information presentation restricted", the privacy value "history" shall be set.</p> <p>NOTE 4: If the redirecting number APRI has the value "presentation restricted", the privacy value "history" shall be set.</p> <p>NOTE 5: Used URI scheme shall be SIP URI. The Reason "headers" component with a cause parameter cannot be added if hi-targeted-to-uri is a tel URI.</p> <p>NOTE 6: The used URI scheme can be tel or SIP since the last hi-targeted-to-uri entry of the History-Info header field does not contain the Reason "headers" component with a cause parameter.</p> <p>NOTE 7: The hi-target-param defined in IETF RFC 7044 [91] defines the mp-param "mp" as a header field parameter that contains the value of the hi-index in the hi-entry with an hi-targeted-to-uri that reflects the Request-URI that was retargeted, thus identifying the "mapped from" target. Since the hi-entries are created based on the redirection counter to reflect the diverting/diverted-to entries, the hi-target-param "mp" shall be present in each entry except the first one.</p>			

7.4.6.3 Interworking at the I-MGCF

7.4.6.3.1 General

This clause describes the interworking of the Call Forwarding information at the I-MGCF.

7.4.6.3.2 Interworking from SIP to ISUP

Table 7.4.6.3.2.1: Mapping of SIP to ISUP messages

→Message received from SIP	→Message send to BICC/ISUP
INVITE request	IAM

Table 7.4.6.3.2.2: Mapping of History-Info header field to ISUP Redirecting number

Source SIP header field and component	Source Component value	Redirecting number	Derived value of parameter field
latest History-Info header field entry containing a Reason "headers" component as defined in IETF RFC 7044 [91] with cause parameter value as listed in the cause parameter row in table 7.4.6.2.2.4 (Note 1)		Redirecting number	
hi-targeted-to-uri appropriate global number portion of the URI, assumed to be in form "+" CC + NDC + SN	CC	Nature of address indicator	If CC is equal to the country code of the country where MGCF is located AND the next ISUP node is located in the same country, then set to " <i>national (significant) number</i> " else set to " <i>international number</i> "
	CC, NDC, SN	Address signals	If NOA is " <i>national (significant) number</i> " then set to NDC + SN. If NOA is " <i>international number</i> " then set to CC + NDC + SN
Privacy header field or/and Privacy "headers" component of the hi-entry in History-Info header field as specified in this table(NOTE 2)		APRI	If the priv-value " <i>history</i> " or " <i>session</i> " or " <i>header</i> " is received within the Privacy header field or if the priv-value " <i>history</i> " is received within the "headers" component of the hi-targeted-to-uri in the latest hi-entry containing a Reason "headers" component as defined in IETF RFC 7044 [91] with cause parameter then " <i>presentation restricted</i> " shall be set. Otherwise, " <i>presentation allowed</i> " shall be set.
NOTE 1: If the SIP URI doesn't contain " <i>user=phone</i> ", mapping to redirecting number is impossible, therefore no need to generate Redirecting number.			
NOTE 2: It is possible that an entry of the History-Info header field itself is marked as restricted or the whole History-Info header.			

Table 7.4.6.3.2.3: Mapping of History-Info header to ISUP Redirection Information

Source SIP header field and component	Source Component value	Redirection Information	Derived value of parameter field
Privacy header field, and in History-Info header field in the Privacy "headers" component of the last hi-targeted-to-uri containing a Reason "headers" component as defined in IETF RFC 7044 [91] with cause parameter value as listed in the cause parameter row in this table	"history" or "session" or "header"	Redirecting indicator	Call diverted, all redirection information presentation restricted
	Privacy header field and the privacy component of the hi-targeted-to-uri entry either absent or set to "none"		Call diverted
		Original redirection reason	Unknown/not available
Cause parameter in the last hi-targeted-to-uri containing a Reason "headers" component as defined in IETF RFC 7044 [91]	Cause parameter value	Redirecting Reason	
	302		Deflection immediate response
	486		User busy
	408		No reply
	503		Mobile subscriber not reachable
All other values	unknown		
Hi-index		Redirection counter	number of History-Info hi-entry containing a Reason "headers" component with a cause parameter with values as listed in the cause parameter row in this table (NOTE)
NOTE: If the determined number of redirection in SIP exceeds the ISUP maximum parameter value, the MGCF shall set the Redirection counter to its maximum value. For instance, in ISUP ITU-T Q.763 [4], the Redirection counter parameter cannot exceed 5.			

Table 7.4.6.3.2.4: Mapping of History-Info header field to ISUP Original Called number

Source SIP header field and component	Source Component value	Original called number	Derived value of parameter field
		Numbering Plan Indicator	"ISDN (Telephony) numbering plan (Recommendation E.164)"
hi-targeted-to-uri of 1 st hi-targeted-to-uri containing a Reason "headers" component as defined in IETF RFC 7044 [91] with cause parameter; appropriate global number portion of the URI, assumed to be in form "+" CC + NDC + SN (NOTE 1)	CC	Nature of address indicator	If CC is equal to the country code of the country where MGCF is located AND the next ISUP node is located in the same country, then set to "national (significant) number" else set to "international number"
	CC, NDC, SN	Address signals	If NOA is "national (significant) number" then set to NDC + SN. If NOA is "international number" then set to CC + NDC + SN
Privacy "headers" component in History-Info header field of the History-Info header field entry as defined above in this table (NOTE 2)	"history" or "session" or "header"	APRI	"presentation restricted"
	Privacy header field absent or "none"		"presentation allowed"
NOTE 1: If it is SIP URI and doesn't contain "user=phone", mapping to Original Called number is impossible, therefore no need to generate Original Called number.			
NOTE 2: It is possible that an entry of the History-Info header field itself is marked as restricted or the whole History-Info header.			

Table 7.4.6.3.2.5: Mapping of INVITE to IAM

INVITE		IAM	
History-Info header field	See table 7.4.6.3.2.2	Redirecting number	See table 7.4.6.3.2.2
History-Info header field	See table 7.4.6.3.2.3	Redirection Information	See table 7.4.6.3.2.3
History-Info header field	See table 7.4.6.3.2.4	Original Called Number	See table 7.4.6.3.2.4

7.4.6.3.3 Interworking from ISUP to SIP

Table 7.4.6.3.3.1: Mapping of ISUP to SIP Messages

←Message sent to SIP	←Message Received from BICC/ISUP	
181 (Call Is Being Forwarded)	ACM no indication with Redirection number and Call diversion information parameters (CFU, CFB, Cdi)	See table 7.4.6.3.3.3
180 (Ringing)	ACM indicating ringing, OBCI: "Call diversion may occur" (CFNR, Cda)	See clause 7.2.3.1.4
181 (Call Is Being Forwarded)	CPG indicating progress or subsequent diversion indicated in the CPG with Redirection number and Call diversion information parameters (CFNR, Cda)	See table 7.4.6.3.3.4
180 (Ringing)	CPG indicating ringing and Redirection number restriction parameter	See table 7.4.6.3.3.5
200 (OK)	ANM and Redirection number restriction parameter	See table 7.4.6.3.3.6

Table 7.4.6.3.3.2: Mapping of ISUP Redirection Number Restriction to History-Info header field

Redirection Number Restriction	Derived value of parameter field	SIP component	Value
Presentation restricted indicator	" <i>Presentation restricted</i> "	Privacy "headers" component of the hi-targeted-to-uri	" <i>History</i> "
	" <i>Presentation allowed</i> " or absent AND a previously received notification subscription options was NOT " <i>presentation not allowed</i> " OR was NOT " <i>presentation allowed without redirection number</i> "		Privacy header field absent or " <i>none</i> "

Table 7.4.6.3.3.3: Mapping of ACM → 181 (Call Is Being Forwarded) response

ISUP Parameter	Derived value of parameter field	SIP component	Value
Generic notification indicator <i>Notification indicator</i>	Call is diverting		
		1 st hi-entry of History-info header having an index = 1 (NOTE 1)	Placeholder URI "unknown@unknown.invalid"
Redirection number		2 nd hi-entry of History-Info header field having an index 1.1	hi-targeted-to-uri:
Nature of address indicator:	"national (significant) number"	hi-targeted-to-uri	Add CC (of the country where the MGCF is located) to Redirection number Address Signals to construct E.164 number in URI.
	"international number"		Map complete Redirection number Address Signals to E.164 number in URI.
Address Signals	If NOA is "national (significant) number" then the format of the Address Signals is: NDC + SN If NOA is "international number" then the format of the Address Signals is: CC + NDC + SN	hi-targeted-to-uri	Addr-spec "+" CC NDC SN mapped to userinfo portion of SIP URI (NOTE 3) Add "user=phone".
Call diversion information	Redirecting Reason	Reason "headers" component as defined in IETF RFC 7044 [91] with cause parameter in the penultimate hi-entry (NOTE 2)	Cause parameter value
	<i>Unknown</i>		404
	<i>Unconditional</i>		302
	<i>User busy</i>		486
	<i>No reply</i>		408
	<i>Deflection immediate response</i>		302
	<i>Deflection during alerting</i>		302
	<i>Mobile subscriber not reachable</i>	503	
	Notification subscription options	Privacy "headers" component associated with Redirection number hi-targeted-to-uri (NOTE 2)	
	<i>unknown</i>		Escaped Privacy value is set according to the rules of TS 24.604 [60] clause 4.5.2.6.4 item c A 181 (Call Is Being Forwarded) shall not be sent
<i>presentation not allowed</i>	Escaped Privacy value is set according to the rules of TS 24.604 [60] clause 4.5.2.6.4 item c		
<i>presentation allowed with redirection number</i>	Escaped Privacy value is set according to the rules of TS 24.604 [60] clause 4.5.2.6.4 item c		
<i>presentation allowed without redirection number</i>		Escaped Privacy value is set according to the rules of TS 24.604 [60] clause 4.5.2.6.4 item c	
NOTE 1: It is necessary to create two History-Info header entries to carry both Redirection number and Call diversion information. Since the original called number is not available from the ISUP message a placeholder URI is included in the first entry. Only two entries are provided because the number of diversions is not available.			
NOTE 2: Needs to be stored for a possible inclusion into subsequent messages.			

Table 7.4.6.3.3.4: Mapping of CPG → 181 (Call Is Being Forwarded) response

ISUP Parameter	Derived value of parameter field	SIP component	Value
Event information Event Indicator	Progress		
Generic notification indicator <i>Notification indicator</i>	Call is diverting		
		1 st hi-entry of History-Info header having an index =1 (NOTE 1)	Placeholder URI "unknown@unknown.invalid"
Redirection number		2 nd hi-entry of History-Info header field having an index = 1.1	hi-targeted-to-uri:
Nature of address indicator	"national (significant) number"	hi-targeted-to-uri	Add CC (of the country where the MGCF is located) to Redirection number Address Signals to construct E.164 number in URI.
	"international number"	hi-targeted-to-uri	Map complete Redirection number Address Signals to E.164 number in URI.
Address Signals	If NOA is "national (significant) number" then the format of the Address Signals is: NDC + SN If NOA is "international number" then the format of the Address Signals is: CC + NDC + SN	hi-targeted-to-uri	Addr-spec "+" CC NDC SN mapped to userinfo portion of SIP URI (NOTE 3) Add "user=phone".
Call diversion information	Redirecting Reason	Reason "headers" component as defined in IETF RFC 7044 [91] with cause parameter in the penultimate hi-entry (NOTE 2)	Cause parameter value
	<i>Unknown</i>		404
	<i>Unconditional</i>		302
	<i>User busy</i>		486
	<i>No reply</i>		408
	<i>Deflection immediate response</i>		302
	<i>Deflection during alerting</i>		302
	<i>Mobile subscriber not reachable</i>	503	
	Notification subscription options	Privacy "headers" component associated with Redirection number hi-targeted-to-uri (NOTE 2)	
	<i>unknown</i>		Escaped Privacy value is set according to the rules of TS 24.604 [60] clause 4.5.2.6.4 item c
<i>presentation not allowed</i>	A 181 (Call Is Being Forwarded) shall not be sent		
<i>presentation allowed with redirection number</i>	Escaped Privacy value is set according to the rules of TS 24.604 [60] clause 4.5.2.6.4 item c		
<i>presentation allowed without redirection number</i>		Escaped Privacy value is set according to the rules of TS 24.604 [60] clause 4.5.2.6.4 item c	
NOTE 1: It is necessary to create two History-Info header entries to carry both Redirection number and Call diversion information. Since the original called number is not available from the ISUP message a placeholder URI is included in the first entry. Only two entries are provided because the number of diversions is not available.			
NOTE 2: Needs to be stored for a possible inclusion into subsequent messages.			

Table 7.4.6.3.3.5 addresses two separate conditions: the CPG message is received from the diverting exchange in which case the Call diversion information parameter is included; and the CPG message is received from the diverted-to exchange in which case the Call diversion information parameter is not included. Interworking for both conditions is shown.

Table 7.4.6.3.3.5: Mapping of CPG → 180 (Ringing) response

ISUP Parameter	Derived value of parameter field	SIP component	Value	
Event information Event Indicator	Alerting			
		1 st hi-entry of History-Info header having an index = 1 (NOTE 1)	Placeholder URI "unknown@unknown.invalid"	
Call diversion information	Redirecting Reason	Reason "headers" component as defined in IETF RFC 7044 [91] with cause parameter in the penultimate hi-entry (NOTE 2)	Cause parameter value	
	<i>Unknown</i>		404	
	<i>Unconditional</i>		302	
	<i>User busy</i>		486	
	<i>No reply</i>		408	
	<i>Deflection immediate response</i>		302	
	<i>Deflection during alerting</i>		302	
	<i>Mobile subscriber not reachable</i>		503	
	Notification subscription options		Privacy "headers" component associated with Redirection number hi-targeted-to-uri (NOTE 2)	
	<i>unknown</i>			Escaped Privacy value is set according to the rules of TS 24.604 [60] clause 4.5.2.6.4 item c
<i>presentation not allowed</i>	The 180 (Ringing) response shall be sent without the the History-Info header field included			
<i>presentation allowed with redirection number</i>	Escaped Privacy value is set according to the rules of TS 24.604 [60] clause 4.5.2.6.4 item c			
	<i>presentation allowed without redirection number</i>	Escaped Privacy value is set according to the rules of TS 24.604 [60] clause 4.5.2.6.4 item c		
Redirection number		2 nd hi-entry of History-Info header field having an index = 1.1	See table 7.4.6.3.3.3	
If no Call diversion information parameter is present		Reason "headers" component as defined in IETF RFC 7044 [91] with cause parameter in the penultimate hi-entry	Value stored from a previous received ACM or CPG. See tables 7.4.6.3.3.3 and 7.4.6.3.3.4	
		Privacy "headers" component associated with Redirection number hi-targeted-to-uri	Value stored from a previous received ACM or CPG. See tables 7.4.6.3.3.3 and 7.4.6.3.3.4	
Redirection number restriction			See table 7.4.6.3.3.2	
NOTE 1: It is necessary to create two History-Info header entries to carry both Redirection number and Redirecting reason. Since the original called number is not available from the ISUP message a placeholder URI is included in the first entry. Only two entries are provided because the number of diversions is not available.				
NOTE 2: Needs to be stored for a possible inclusion into subsequent messages.				

Table 7.4.6.3.3.6: Mapping of ANM → 200 (OK) response (to INVITE request)

ISUP Parameter	Derived value of parameter field	SIP component	Value
		1 st hi-entry of History-Info header having an index = 1 (NOTE)	Placeholder URI "unknown@unknown.invalid"
Redirection number		2 nd hi-entry of History-Info header field having an index = 1.1	See table 7.4.6.3.3.3
		Reason "headers" component as defined in IETF RFC 7044 [91] with cause parameter in the penultimate hi-entry	Value stored from a previously received ACM or CPG. See tables 7.4.6.3.3.3 and 7.4.6.3.3.4
Redirection number restriction			See table 7.4.6.3.3.2
NOTE: It is necessary to create two hi-entries of History-Info header field to carry both Redirection number and Redirecting reason. Since the original called number is not available from the ISUP message a placeholder URI is included in the first entry. Only two entries are provided because the number of diversions is not available.			

7.4.7 Void

7.4.8 Explicit Call Transfer (ECT)

When the MGCF receives a FAC message with Generic notification indicator coded as "Call transfer active" or "call transfer alerting" and a CPG with Generic notification indicator coded as "Remote hold" was received previously for the current communication, the action described in table 24be applies. In all other cases the actions of the MGCF at the ISUP/BICC side are described in ITU-T Recommendation Q.732.7 [42] under the clause "Interactions with other networks".

Table 24be: Mapping between ISUP and SIP for the Explicit Communication Transfer supplementary service

ISUP message	Mapping
FAC with a "call transfer, active" or "call transfer, alerting" Generic notification indicator	As described for CPG message with a "remote retrieval" Generic notification indicator in Clause 7.4.10.2

7.4.9 Call Waiting

The actions of the MGCF at the ISUP/BICC side are described in ITU-T Q.733.1 [42] under the clause "Interactions with other networks".

7.4.10 Call Hold

The service is interworked as indicated in 3GPP TS 23.228 [12].

7.4.10.1 Session hold initiated from the IM CN subsystem side

The IMS network makes a hold request by sending an UPDATE or re-INVITE message with an "inactive" or a "sendonly" SDP attribute (refer to RFC 3264 [36]), depending on the current state of the session. Upon receipt of the hold request from the IMS side, the MGCF shall send a CPG message to the CS side with a "remote hold" *Generic notification indicator*. To resume the session, the IMS side sends an UPDATE or re-INVITE message with a "recvonly" or "sendrecv" SDP attribute, depending on the current state of the session. Upon receipt of the resume request from the IMS side, the MGCF shall send a CPG message to the CS side with a "remove retrieval" *Generic notification indicator*. However, the I-MGCF shall not send a CPG message upon reception of SDP containing "inactive" media within an

initial INVITE request establishing a new SIP dialogue and upon reception of the first subsequent SDP activating those media.

The user plane interworking of the hold/resume request is described in the clause 9.2.9.

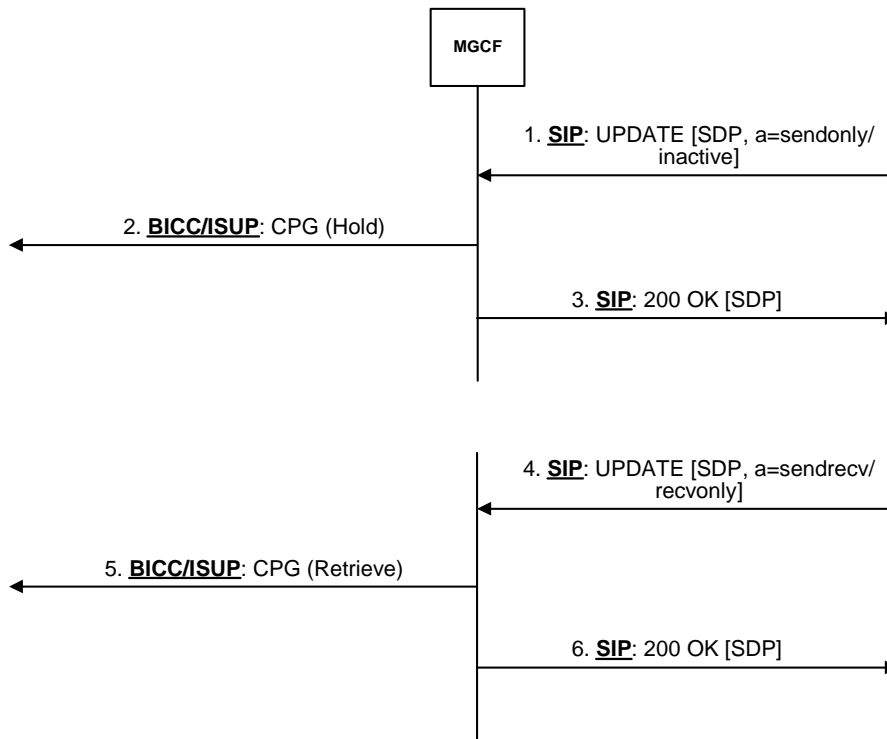

Figure 30a: Session hold/resume initiated from the IM CN subsystem side

7.4.10.2 Session hold initiated from the CS network side

If an MGCF receives a CPG message with "*remote hold*" and there is no dialog established towards the UE the MGCF shall send an UPDATE or re-INVITE request containing an SDP offer with "*sendonly*" or "*inactive*" media, as described in IETF RFC 3264 [36], when the first dialog is established. For an early dialog only UPDATE shall be used.

When an MGCF receives a CPG message with a "*remote hold*" Generic notification indicator and the media on the IMS side are "*sendrecv*" or "*recvonly*", the MGCF shall forward the hold request by sending an UPDATE request on the early dialog which was last established containing an SDP offer with "*sendonly*" if the stream was previously "*sendrecv*" or "*inactive*" if the stream was previously "*recvonly*" media, as described in IETF RFC 3264 [36].

If an additional early dialog is established during the "*remote hold*" condition the MGCF shall send an UPDATE request containing an SDP offer with "*sendonly*" or "*inactive*" media on the new early dialog, as described in IETF RFC 3264 [36].

If an UPDATE request with an SDP offer is received on one of the early dialogs for a call in the "*remote hold*" condition the MGCF shall send an appropriate SDP answer followed by a new UPDATE request including SDP with "*sendonly*" or "*inactive*" media on the dialog, as described in IETF RFC 3264 [36].

If an MGCF receives a 200 OK (INVITE) response on an early dialog for which the call is in a "*remote hold*" condition the MGCF shall send an UPDATE or re-INVITE request containing an SDP offer with "*sendonly*" or "*inactive*" media on the dialog where 200 OK (INVITE) was received, as described in IETF RFC 3264 [36]. If received SDP is indicating "*sendonly*" and the Contact header field of the remote party contained an "*isfocus*" header field parameter, defined in IETF RFC 3840 [135], the MGCF shall order the MGW to disconnect the media towards the IMS.

If the MGCF receives a CPG with Generic Notification Indicator "*remote retrieval*" and there is an early dialog on IMS side then a SIP UPDATE request (indicating call retrieval) shall be sent if the call hold service had been invoked on the early dialog before. For each subsequent early dialog for which the MGCF receives an 18x response or an UPDATE request with an SDP offer, the MGCF shall send SIP UPDATE indicating call retrieval after a possible SDP answer to the SDP offer, if that dialog had received a call hold indication before.

If the MGCF receives a CPG with Generic Notification Indicator "*remote retrieval*" and there is a confirmed dialog on IMS side then a SIP re-INVITE or UPDATE request (according to implementation option) shall be sent for this dialog only if the call hold service had been invoked for this dialog before. If the media path towards the IMS was disconnected due to an "*isfocus*" header field parameter, defined in IETF RFC 3840 [135], in the remote party Contact header field, media shall be resumed.

When an MGCF receives a CPG message with a "*remote retrieval*" Generic notification indicator and the media on the IMS side are "*sendonly*" or "*inactive*", the MGCF shall forward the resume request by sending an UPDATE or re-INVITE message containing an SDP offer with "*sendrecv*" if the stream was previously "*sendonly*" or "*recvonly*" if the stream was previously "*inactive*" media, as described in IETF RFC 3264 [36]. If the media path towards the IMS was disconnected due to an "*isfocus*" header field parameter, defined in IETF RFC 3840 [135], in the remote party Contact header field, media shall be resumed.

If the MGCF receives a CPG with "*remote hold*" or "*remote retrieval*" before answer, it shall forward the request using an UPDATE message. If the MGCF receives a CPG with "*remote hold*" or "*remote retrieval*" after answer, it should forward the request using re-INVITE but may use UPDATE.

If link aliveness information is required at the IM-MGW while the media are on hold, the MGCF should provide modified SDP RR and RS bandwidth modifiers specified in IETF RFC 3556 [59] within the UPDATE or re-INVITE messages holding and retrieving the media to temporarily enable RTCP while the media are on hold, as detailed in clause 7.4 of 3GPP TS 26.236 [32]. If no link aliveness information is required at the IM-MGW, the MGCF should provide the SDP RR and RS bandwidth modifiers previously used.

The interworking does not impact the user plane with the following exceptions:

- the MGCF provides modified SDP RR and RS bandwidth modifiers within the UPDATE or re-INVITE messages;
- the Contact header of the IMS remote party contains the "*isfocus*" header field parameter; or
- the MGCF has identified a speech call as an "ICS call" as specified in clause 7.2.3.1.2.12 or in clause 7.2.3.2.7a.

If the MGCF provides modified SDP RR and RS bandwidth modifiers to the IMS side, the MGCF shall also provide modified SDP RR and RS bandwidths to the IM-MGW, as described in the clause 9.2.10. If the Contact header of the IMS remote party contains the "*isfocus*" header field parameter, defined in IETF RFC 3840 [135], media shall not be provided towards the IMS network.

For a speech call that is identified as the "ICS call", upon reception of the CPG message with:

- a "*remote hold*" Generic notification indicator the MGCF shall request the IM-MGW to suspend sending media towards the IMS side; or
- a "*remote retrieval*" Generic notification indicator the MGCF shall request the IM-MGW to re-establish communication towards the IMS network if the MGCF requested the IM-MGW to suspend sending media on the "*remote hold*" request,

prior to sending of the UPDATE or re-INVITE message to the IMS side.

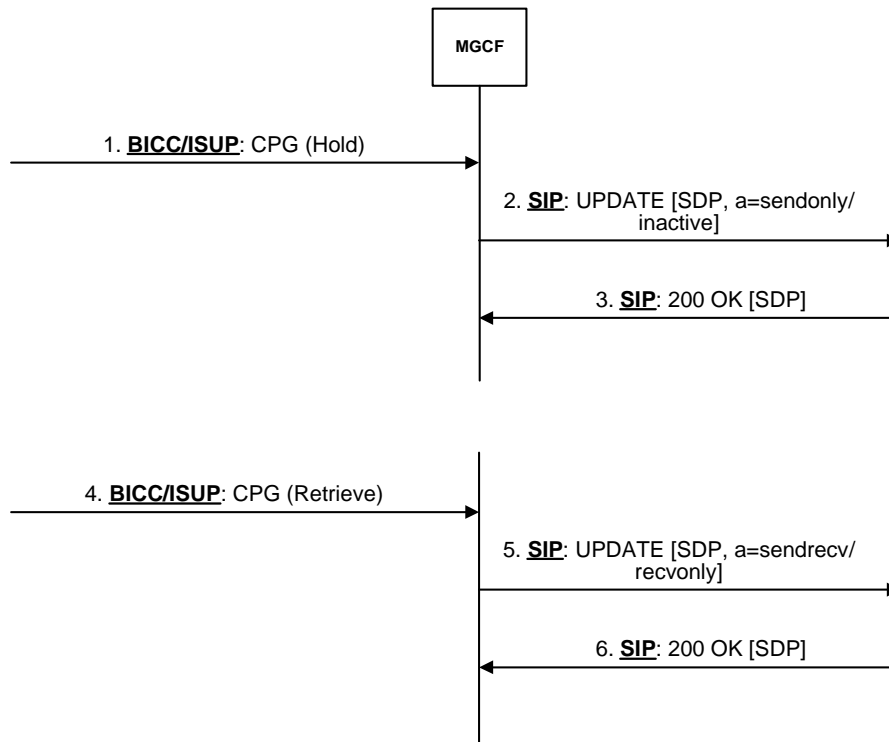

Figure 30b: Session hold/resume initiated from the CS network side

7.4.11 Call Completion on busy subscriber

The actions of the MGCF at the ISUP/BICC side are described in ITU-T Recommendation Q.733.3 [42] under the clause "Interactions with other networks".

7.4.12 Completion of Calls on No Reply (CCNR)

The actions of the MGCF at the ISUP/BICC side are described in ITU-T Recommendation Q.733.5 [42] under the clause "Interactions with other networks".

7.4.13 Terminal Portability (TP)

Terminal Portability is defined as an ISUP supplementary service within ITU-T Rec. Q.733.4. [42].

A Suspend message containing the Suspend/Resume indicators set to "ISDN subscriber initiated" shall be treated like a CPG with "remote hold" in clause 7.4.10. Resume message containing the Suspend/Resume indicators set to "ISDN subscriber initiated" shall be treated like a CPG with "remote retrieval" in clause 7.4.10.

7.4.14 Conference calling (CONF) / Three-Party Service (3PTY)

The default behaviour of the MGCF at the ISUP/BICC side is described in ITU-T Recommendation Q.734.1[42] under the clause "Interactions with other networks". In addition, the MGCF may apply the interworking from ISUP to SIP described in Table 24aa.

Alternatively, the MGCF may apply the interworking to the Conference supplementary service described in clause 7.5.6.

Table 24aa: Mapping between ISUP and SIP for the Conference Calling (CONF) and Three-Party Service (3PTY) supplementary service

ISUP message	Mapping
CPG with a "Conference established" Generic notification indicator	As described for CPG message with a "remote retrieval" Generic notification indicator in Clause 7.4.10.2
CPG with a "Conference disconnected" Generic notification indicator	As described for CPG message with a "remote retrieval" Generic notification indicator in Clause 7.4.10.2
CPG with an "isolated" Generic notification indicator	As described for CPG message with a "remote hold" Generic notification indicator in Clause 7.4.10.2
CPG with a "reattached" Generic notification indicator	As described for CPG message with a "remote retrieval" Generic notification indicator in Clause 7.4.10.2

7.4.15 Void

7.4.16 Closed User Group (CUG)

The actions of the MGCF at the ISUP/BICC side are described in ITU-T Recommendation Q.735.1 [42] under the clause 1.5.2.4.2 "Exceptional procedures".

7.4.17 Multi-Level Precedence and Pre-emption (MLPP)

The actions of the MGCF at the ISUP/BICC side are described in ITU-T Recommendation Q.735.3 [42] under the clause "Interactions with other networks".

7.4.18 Global Virtual Network Service (GVNS)

The actions of the MGCF at the ISUP/BICC side are described in ITU-T Recommendation Q.735.6 [42] under the clause "Interactions with other networks".

7.4.19 International telecommunication charge card (ITCC)

An International Telecommunication charge card call is a basic call and no additional treatment is required by the MGCF.

7.4.20 Reverse charging (REV)

The actions of the MGCF at the ISUP/BICC side are described in ITU-T Recommendation Q.736.3 [42] under the clause "Interactions with other networks".

7.4.21 User-to-User Signalling (UUS)

7.4.21.0 General

Procedures for the ISDN supplementary service "User-to-user signalling" are specified in ITU-T Recommendation Q.737.1 [42].

7.4.21.1 User-to-User Signalling (UUS) service 1 (implicit)

7.4.21.1.0 General

The coding of the User-user information element is described within ITU-T Recommendation Q.931 [148]. The User-user information element is carried within the ISDN user part parameter user-to-user information, as defined in ITU-T Recommendation Q.763 [4]. The User-to-User header field is defined within IETF RFC 7433 [99]. A package for interworking user-to-user information with the ISDN is defined by IETF RFC 7434 [99A].

7.4.21.1.1 Void

7.4.21.1.2 User-to-user information Interworking from SIP to ISUP

On the receipt of a User-to-User header field with the "purpose" header field parameter set to "isdn-uuu", or a User-to-User header field without a "purpose" parameter, with "encoding" header field parameter set to "hex" or without an "encoding" parameter, with "content" header field parameter set to "isdn-uuu" or without a "content" parameter, that is valid as defined by IETF RFC 7434 [99A], the MGCF shall map the content of the "uuu-data" field to the "protocol discriminator" and "user information" parameters of the User-user information element.

The "length of user-user contents" parameter shall be set by the MGCF according to the normal procedures.

The MGCF maps the messages transporting the user-to-user information according to the normal interworking procedures (see table 24ab).

Table 24ab: Mapping of the User-to-User header field to the ISUP user-to-user information parameter

SIP parameter →		→ ISUP parameter	
SIP header field	Source component value	ISUP parameter name	ISUP parameter field
User-to-User	uuu-data	User-to-user	Protocol discriminator and user information

7.4.21.1.3 User-to-user information Interworking from ISUP to SIP

On the receipt of the user-to-user information parameter the MGCF shall map the protocol discriminator and user information parameter fields to the uuu-data field of the User-to-User header field (see table 24ac).

If sent, the "purpose", "content" and "encoding" header field parameters are not mapped and are set in accordance with IETF RFC 7434 [99A].

The MGCF maps the messages transporting the user-to-user information parameters according to the normal interworking procedures.

Table 24ac: Mapping of the ISUP user-to-user information parameter to the User-to-User header field

→ ISUP parameter		→ SIP parameter	
ISUP parameter name	ISUP parameter field	SIP header field	Source component value
User-to-user	Protocol discriminator and user information	User-to-User	uuu-data (NOTE)
NOTE: The MGCF shall always send uuu-data as a token (see IETF RFC 7433 [99]). The letters used for the hex digits shall always be capital form.			

7.4.21.2 User-to-User Signalling (UUS) service 1 (explicit)

The actions of the MGCF at the ISUP/BICC side are described in ITU-T Recommendation Q.737.1 [42] under the clause "Interaction with other networks".

7.4.21.3 User-to-User Signalling (UUS) service 2 (explicit)

The actions of the MGCF at the ISUP/BICC side are described in ITU-T Recommendation Q.737.1 [42] under the clause "Interaction with other networks".

7.4.21.4 User-to-User Signalling (UUS) service 3 (explicit)

The actions of the MGCF at the ISUP/BICC side are described in ITU-T Recommendation Q.737.1 [42] under the clause "Interaction with other networks".

7.4.22 Multiple Subscriber Number (MSN)

A MSN call is a basic call and no additional treatment is required by the MGCF.

7.4.23 Anonymous Call rejection

7.4.23.0 General

The Anonymous Call rejection (ACR) supplementary service in the CS domain is described within 3GPP TS 23.088 [134]. The ETSI ACR service is described within ETSI EN 300 356-21 [71].

7.4.23.1 ISUP-SIP protocol interworking at the I-MGCF

If ISUP Cause Value field in the ISUP REL includes Cause Value 24 "*call rejected due to feature at the destination*" the I-MGCF shall map this to a 433 (Anonymity Disallowed) SIP response code as described in RFC 5079 [77].

7.4.23.2 SIP-ISUP protocol interworking at the O-MGCF

SIP response code 433 (Anonymity Disallowed) shall be mapped to the ISUP Cause Value field 24 "*call rejected due to feature at the destination*" in the ISUP REL.

7.4.24 Customized Alerting Tones (CAT) in the 3GPP CS domain

The Customized Alerting Tones (CAT) in the 3GPP CS domain service is described in 3GPP TS 23.205 [27].

To pass CAT early media from the CS network towards the IM CN subsystem, no special interworking procedures beyond basic call at the I-MGCF are required. The procedure to supply the "P-Early-Media" header field is described in clause 7.2.3.1.4, clause 7.2.3.1.4A and clause 7.2.3.1.4B.

7.5 IMS Supplementary Services

The following clauses describe the MGCF behaviour related to supplementary services as defined in ITU-T Recommendations Q.730 to ITU-T Q.737 [42] when interworking with an IMS which uses a Multimedia Telephony Application Server (MTAS) providing supplementary services according to 3GPP TS 24.173 [88]. The support of the related procedures is optional.

7.5.1 Originating Identification Presentation (OIP) and Originating Identification Restriction (OIR)

The mapping of Originating Identification Presentation (OIP) and Originating Identification Restriction (OIR); supplementary service with the CLIP/CLIR PSTN/ISDN Supplementary Service is the same mapping as described in clause 7.4.1. The Service itself is described within 3GPP TS 24.607 [63].

7.5.2 Terminating Identification Presentation (TIP) and Terminating Identification Restriction (TIR)

7.5.2.1 General

The protocol specification of the Terminating Identification Presentation and Terminating Identification Restriction supplementary services is described in 3GPP TS 24.608 [64].

The procedures for mapping of the connected number described within clause 7.4.2 shall apply.

7.5.2.2 Interworking at the O-MGCF

For the mapping of IAM to the INVITE request:

If an Optional forward call indicators parameter in the IAM is received where the bit H Connected line identity request indicator is set to "requested", then the option tag "from-change" shall be add to the Supported header field. See table 7.5.2.2.1.

Table 7.5.2.2.1: Mapping of ISUP IAM to SIP INVITE request

ISUP Parameter	Derived value of parameter field	Source SIP header field and component	Source Component value
Optional forward call indicator	<i>Connected line identity request indicator</i> is set to "requested"	Supported	"from-change"

NOTE: The presence of "from-change" enables the reception of Generic Number with Number qualifier parameter field set to additional connected, if available. As per 3GPP TS 24.608 [64] the presence of "from-change" tag is not a criterion for TIP service.

If a provisional or final response including the option tag "from-change" is received, then the O-MGCF shall:

- if a 200 (OK) response to the INVITE request is received, start timer T_{TIR1} ; and
- store the 200 (OK) response, without interworking it.

Otherwise the 200 (OK) response (to the INVITE request) shall be mapped as described in clause 7.2.3.2.7a.

If an UPDATE request is received containing a changed From header field before the timer T_{TIR1} expired, then the O-MGCF shall:

- stop timer T_{TIR1} ;
- map the From header field received in the UPDATE request to the Generic number in the ANM as shown in table 7.5.2.2.2 and table 7.5.2.2.3;
- if the UPDATE request includes a P-Asserted-Identity header field that is different from the one within the stored 200 (OK) response, the latest received P-Asserted-Identity header field shall be mapped to the connected number as described table 24; and
- map the parameters needed to be mapped of the stored 200 (OK) response to an ANM as described in clause 7.4.2.2.3, modified by the changed mapping steps of the From and P-Asserted-Identity header fields.

When T_{TIR1} expires, then the stored 200 (OK) response (to the INVITE request) response shall be mapped as described in clause 7.4.2.2.3.

Table 7.5.2.2.2: Mapping of SIP UPDATE request to ISUP ANM/CON

ANM/CON	UPDATE
Generic number	From header field

Table 7.5.2.3: Mapping of SIP From header field to ISUP Generic Number ("additional connected number") parameter

Source SIP header field and component	Source component value	Generic Number parameter field	Derived value of parameter field
–	–	Number Qualifier Indicator	" <i>additional connected number</i> "
From, userinfo component of URI assumed to be in form "+ CC + NDC + SN	CC	Nature of Address Indicator	If CC is equal to the country code of the country where I-MGCF is located AND the next ISUP node is located in the same country, then set to " <i>national (significant) number</i> " else set to " <i>international number</i> "
–	–	Number Incomplete Indicator	" <i>complete</i> "
–	–	Numbering Plan Indicator	" <i>ISDN (Telephony) numbering plan (Recommendation E.164)</i> "
Privacy, priv-value component	Privacy header field absent	Address Presentation Restricted Indicator (APRI)	" <i>presentation allowed</i> "
	" <i>none</i> "		" <i>presentation allowed</i> "
	" <i>header</i> "		" <i>presentation allowed</i> "
	" <i>use!</i> "		" <i>presentation restricted</i> "
	" <i>id</i> "		" <i>presentation allowed</i> "
–	–	Screening Indicator	" <i>user provided, not verified</i> "
From, userinfo component assumed to be in form "+ CC + NDC + SN	CC, NDC, SN	Address Signals	If NOA is " <i>national (significant) number</i> " then set to NDC + SN. If NOA is " <i>international number</i> " then set to CC + NDC + SN

7.5.2.3 Interworking at the I-MGCF

For the mapping of INVITE request to IAM:

- the bit *H Connected line identity request indicator* of the Optional forward call indicators parameter in the IAM shall be set to "requested".

Table 7.5.2.3.1: Void

If a received ISUP ANM includes an ISUP Generic Number ("additional connected number") parameter, then the I-MGCF shall send a 200 (OK) response (to the INVITE request) including an option tag "from-change" If the initial INVITE was received and the Supported header field contains the "from-change" tag, the 200 (OK) response is followed by an UPDATE request, containing the "additional connected number" copied into the From header field as shown in table 7.5.2.3.2.

The To header field of the UPDATE request is derived from the P-Asserted-Identity header field received within the initial INVITE request.

Table 7.5.2.3.2: Mapping of ANM Generic Number ("additional connected number") to SIP From header field in a SIP UPDATE request

ISUP Parameter/field	Value	SIP component	Value
Generic Number Number Qualifier Indicator	" <i>additional connected number</i> "	From header field	display-name (optional) and addr-spec
Nature of Address Indicator	" <i>national (significant) number</i> "	Addr-spec	Add "+" CC (of the country where the IWU is located) to Generic Number Address Signals then map to user portion of URI scheme used
	" <i>international number</i> "		Map complete Generic Number Address Signals used prefixed with a "+" to user portion of URI scheme used
Address Presentation restriction indicator (APRI)	" <i>presentation allowed</i> "		No Privacy header field or not " <i>user</i> "
	" <i>presentation restricted</i> "		" <i>user</i> "
Address Signals	if NOA is " <i>national (significant) number</i> " then the format of the address signals is: NDC + SN If NOA is " <i>international number</i> " then the format of the address signals is: CC + NDC + SN	Display-name (optional)	display-name shall be mapped from Address Signals, if network policy allows it
		Addr-spec	"+" CC NDC SN mapped to user portion of URI scheme used

A received connected number in an ANM shall be mapped to the P-Asserted-Identity header field as shown in table 21 of the UPDATE request.

7.5.2.4 Timer

Table 7.5.2.4.1 TIR timer definition

Symbol	Timeout value	Cause for initiation	Normal termination	At expiry
T _{TIR1}	100 – 2000 milliseconds (default 100 milliseconds)	On receipt of provisional or final response including the option tag "from-change"	At the receipt of an UPDATE	map the received 200OK to an ANM

7.5.3 void

7.5.4 Communication Diversion (CDIV)

7.5.4.1 General

The protocol specification of the Communication Diversion supplementary service is described in 3GPP TS 24.604 [60]. The mapping of Communication Diversion supplementary service with Call Diversion services PSTN/ISDN supplementary service including the mapping of the optional History-Info header field as defined in IETF RFC 7044 [91] is described.

The hi-target-param parameter set to "mp" as defined in IETF RFC 7044 [91] indicates that the target of the Request-URI was changed.

In case of interworking with networks which do not provide any notification of the communication diversion or communication redirection information (e.g. redirection counter) in the signalling system, the communication continues according to the basic call procedures.

In case of interworking with networks not supporting IETF RFC 7044 the "mp" header field parameter may not appear.

7.5.4.2 Interworking at the O-MGCF

7.5.4.2.1 General

For the mapping of IAM to the INVITE request no additional procedures beyond the basic call and interworking procedures are needed unless Call forwarding within the ISUP Network appeared.

With regard to the backward messages the following mapping is valid.

Table 7.5.4.2.1.1: Mapping of SIP messages to ISUP messages

←Message sent to ISUP	←Message Received from SIP	
ACM indicating call forwarding	181 (Call Is Being Forwarded) response	See table 7.5.4.2.1.6
CPG indicating call forwarding (see NOTE)	181 (Call Is Being Forwarded) response	See table 7.5.4.2.1.7
ACM indicating ringing	180 (Ringing) response	See table 7.5.4.2.1.8
CPG indicating Alerting (see NOTE)	180 (Ringing) response	See table 7.5.4.2.1.9
ANM	200 (OK) response	See table 7.5.4.2.1.10
CON	200 (OK) response (Neither a 181 (Call Is Being Forwarded) response nor a 180 (Ringing) response was received)	See table 7.5.4.2.1.10
NOTE: A CPG will be sent if an ACM was already sent.		

Table 7.5.4.2.1.2: Mapping of History-Info header field to ISUP Redirection number

Source SIP header field and component	Source Component value	Redirection number	Derived value of parameter field
hi-targeted-to-uri of the last History-Info hi-entry containing a "cause" URI parameter, as defined in IETF RFC 4458 [113]. (NOTE 2)	CC	Nature of address indicator	If CC is equal to the country code of the country where O-MGCF is located AND the next ISUP node is located in the same country, then set to " <i>national (significant) number</i> " else set to " <i>international number</i> ".
The global number portion of the hi-targeted-to-uri is assumed to be in form "+ CC + NDC + SN.(NOTE 1)	CC, NDC, SN	Address signals	If NOA is " <i>national (significant) number</i> " then set to NDC + SN. If NOA is " <i>international number</i> " then set to CC + NDC + SN.
NOTE 1: If the SIP URI doesn't contain " <i>user=phone</i> ", mapping to redirection number is impossible, therefore no need to generate Redirection number and Redirection number restriction indicator (per table 7.5.4.2.1.3), Notification subscription options can't be set as "presentation allowed with redirection number".			
NOTE 2: The hi-target-param parameter set to "mp" as defined in IETF RFC 7044 [91] indicates that the target of the Request-URI was changed and appears in this hi-targeted-to-uri. In case of interworking with networks not supporting IETF RFC 7044 the "mp" header field parameter may not appear.			

Table 7.5.4.2.1.3: Mapping of History-Info header field to ISUP Redirection number restriction

Source SIP header field and component	Source Component value	Redirection number restriction	Derived value of parameter field
Privacy "headers" component of the hi-targeted-to-uri or/and Privacy header field	" <i>history</i> " or " <i>session</i> " or " <i>header</i> "	Presentation restricted indicator	" <i>Presentation restricted</i> "
	Privacy "headers" component of the hi-targeted-to-uri and Privacy header field absent or " <i>none</i> "		" <i>Presentation allowed</i> " or absent

Table 7.5.4.2.1.4: Mapping of hi-targeted-to-uri to ISUP Call Diversion Information

Source SIP header field and component	Source Component value	Call Diversion Information	Derived value of parameter field
Privacy "headers" component of the hi-targeted-to-uri or/and Privacy header field		Notification subscription options	<p>If the priv-value "history" or "session" or "header" is received within the Privacy header field or the priv-value "history" is received within the "headers" component of the hi-targeted-to-uri representing the diverting URI(s) and within the hi-targeted-to-uri representing diverted-to URI then "presentation not allowed" shall be set</p> <p>Otherwise, if the priv-value "history" is received only within the "headers" component of the hi-targeted-to-uri representing the diverted-to URI then "presentation allowed without redirection number" shall be set. (NOTE 1, NOTE 2)</p> <p>Otherwise, "presentation allowed with redirection number" shall be set.</p>
"cause" URI parameter, as defined in IETF RFC 4458 [113] of the last History-Info hi-entry containing hi-targeted-to-uri with "cause" URI parameter. (NOTE 3)	Cause value	Call diversion information	Redirecting Reason
	404		Unknown
	302		Unconditional
	486		User busy
	408		No reply
	480		Deflection immediate
	503		Mobile subscriber not reachable
487	Deflection during alerting		
<p>NOTE 1: diverting URI corresponds to the hi-targeted-to-uri of the hi-entry containing a hi-index value that match the "mp" header field parameter value of the diverted-to URI. If the diverted-to URI does not contain the "mp" header field parameter, the diverting URI corresponds to the hi-targeted-to-uri of the hi-entry before the last hi-entry containing "cause" URI parameter.</p> <p>NOTE 2: diverted-to URI corresponds to the hi-targeted-to-uri of the last hi-entry containing "cause" URI parameter and is mapped to the Redirection number, see table 7.5.4.2.1.2.</p> <p>NOTE 3: The hi-target-param parameter set to "mp" as defined in IETF RFC 7044 [91] indicates that the target of the Request-URI was changed and appears in this hi-targeted-to-uri. In case of interworking with networks not supporting IETF RFC 7044 the "mp" header field parameter may not appear.</p>			

Table 7.5.4.2.1.5: Void

Table 7.5.4.2.1.6: Mapping of 181 (Call Is Being Forwarded) → ACM if no ACM was sent before

Source SIP header field and component	Source Component value	ISUP Parameter	Derived value of parameter field
181 (Call Is Being Forwarded)		ACM	
		Generic notification indicators	<i>Call is diverting</i>
History-Info header field	See table 7.5.4.2.1.2	Redirection number	See table 7.5.4.2.1.2
Privacy "headers" component of the hi-targeted-to-uri or/and Privacy header field	See table 7.5.4.2.1.3	Redirection number restriction	See table 7.5.4.2.1.3
Privacy "headers" component of the hi-targeted-to-uri or/and Privacy header field	See table 7.5.4.2.1.4	Call diversion information <i>Notification subscription options</i>	See table 7.5.4.2.1.4
hi-targeted-to-uri; "cause" URI parameter as defined in IETF RFC 4458 [113] of the last History-Info hi-entry containing such "cause" URI parameter. (NOTE)	See table 7.5.4.2.1.4	Call diversion information	Redirecting Reason See table 7.5.4.2.1.4
NOTE: The hi-target-param parameter set to "mp" as defined in IETF RFC 7044 [91] indicates that the target of the Request-URI was changed and appears in this hi-targeted-to-uri. In case of interworking with networks not supporting IETF RFC 7044 the "mp" header field parameter may not appear.			

Table 7.5.4.2.1.7: Mapping of 181 (Call Is Being Forwarded)→ CPG if ACM was already sent

Source SIP header field and component	Source Component value	ISUP Parameter	Derived value of parameter field
181 (Call Is Being Forwarded) response		CPG	
		Generic notification indicators	<i>Call is diverting</i>
"cause" URI parameter, as defined in IETF RFC 4458 [113] of the last History-Info hi-entry containing hi-targeted-to-uri with "cause" URI parameter.(NOTE 2)	486	Event indicator	<i>CFB (national use)</i>
	408 (see NOTE 1)		<i>CFNR (national use)</i>
	302		<i>CFU (national use)</i>
	Any other value, or if appropriate national use value CFB, CFNR or CFU is not used in a network. Or if no agreement exists between operators to use these values, or if no hi-targeted-to-uri with "cause" URI parameter is contained in the SIP 181.		<i>PROGRESS</i>
History-Info header field	See table 7.5.4.2.1.2	Redirection number	See table 7.5.4.2.1.2
Privacy "headers" component of the hi-targeted-to-uri or/and Privacy header field	See table 7.5.4.2.1.3	Redirection number restriction	See table 7.5.4.2.1.3
Privacy "headers" component of the hi-targeted-to-uri or/and Privacy header field	See table 7.5.4.2.1.4	Call diversion information <i>Notification subscription options</i>	See table 7.5.4.2.1.4
hi-targeted-to-uri; "cause" URI parameter, as defined in IETF RFC 4458 [113] of the last History-Info hi-entry containing such "cause" URI parameter. (NOTE 2)	See table 7.5.4.2.1.4	Call diversion information <i>Redirecting Reason</i>	See table 7.5.4.2.1.4
NOTE 1: This appears in the cases of CFNR.			
NOTE 2: The hi-target-param parameter set to "mp" as defined in IETF RFC 7044 [91] indicates that the target of the Request-URI was changed and appears in this hi-targeted-to-uri. In case of interworking with networks not supporting IETF RFC 7044 the "mp" header field parameter may not appear.			

Table 7.5.4.2.1.8: Mapping of 180 (Ringing) → ACM if no ACM was sent before

Source SIP header field and component	Source Component value	ISUP Parameter	Derived value of parameter field
180 (Ringing) response		ACM	
History-Info header field	If hi-targeted-to-uri of at least one History-Info hi-entry contains a "cause" URI parameter, as defined in IETF RFC 4458 [113].	Generic notification indicators	<i>Call is diverting</i>
History-Info header field	See table 7.5.4.2.1.2	Redirection number (NOTE 1)	See table 7.5.4.2.1.2
Privacy "headers" component of the hi-targeted-to-uri or/and Privacy header field	See table 7.5.4.2.1.3	Redirection number restriction (NOTE 1)	See table 7.5.4.2.1.3
Privacy "headers" component of the hi-targeted-to-uri or/and Privacy header field	See table 7.5.4.2.1.4	Call diversion information <i>Notification subscription options</i> (NOTE 1)	See table 7.5.4.2.1.4
hi-targeted-to-uri; "cause" URI parameter, as defined in IETF RFC 4458 [113] of the last History-Info hi-entry containing such "cause" URI parameter. (NOTE 2)	See table 7.5.4.2.1.4	Call diversion information <i>Redirecting Reason</i> (NOTE 1)	See table 7.5.4.2.1.4
NOTE 1: Parameter shall only be supplied if hi-targeted-to-uri of at least one History-Info hi-entry contains a "cause" URI parameter, as defined in IETF RFC 4458 [113].			
NOTE 2: The hi-target-param parameter set to "mp" as defined in IETF RFC 7044 [91] indicates that the target of the Request-URI was changed and appears in this hi-targeted-to-uri. In case of interworking with networks not supporting IETF RFC 7044 the "mp" header field parameter may not appear.			

The mapping described within table 7.5.4.2.1.8 can only appear if the communication has already undergone a Call Forwarding in the ISDN/PSTN and the 180 is the first provisional response sent in backward direction.

The IWU can indicate the call diversion in the mapping of 180 (Ringing) to CPG in fact if the response before was a 181 (Call is being forwarded).

Table 7.5.4.2.1.9: Mapping of 180 (Ringing) → CPG if ACM was already sent

Source SIP header field and component	Source Component value	ISUP Parameter	Derived value of parameter field
180 (Ringing) response		CPG	
History-Info header field	If hi-targeted-to-uri of at least one History-Info hi-entry contains a "cause" URI parameter, as defined in IETF RFC 4458 [113].	Generic notification indicators	<i>Call is diverting</i>
		Event indicator	<i>ALERTING</i>
History-Info header field	See table 7.5.4.2.1.2	Redirection number (NOTE 1)	See table 7.5.4.2.1.2
Privacy "headers" component of the hi-targeted-to-uri or/and Privacy header field	See table 7.5.4.2.1.3	Redirection number restriction (NOTE 1)	See table 7.5.4.2.1.3
Privacy "headers" component of the hi-targeted-to-uri or/and Privacy header field	See table 7.5.4.2.1.4	Call diversion information <i>Notification subscription options</i> (NOTE 1)	See table 7.5.4.2.1.4
hi-targeted-to-uri; "cause" URI parameter, as defined in IETF RFC 4458 [113] of the last History-Info hi-entry containing such "cause" URI parameter. (NOTE 2)	See table 7.5.4.2.1.4	Call diversion information <i>Redirecting Reason</i> (NOTE 1)	See table 7.5.4.2.1.4
NOTE 1: Parameter shall only be supplied if hi-targeted-to-uri of at least one History-Info hi-entry contains a "cause" URI parameter, as defined in IETF RFC 4458 [113].			
NOTE 2: The hi-target-param parameter set to "mp" as defined in IETF RFC 7044 [91] indicates that the target of the Request-URI was changed and appears in this hi-targeted-to-uri. In case of interworking with networks not supporting IETF RFC 7044 the "mp" header field parameter may not appear.			

The mapping in table 7.5.4.2.1.9 appears when a 181 previously was mapped to an ACM. Therefore the state machine of the MGCF knows that a CDIV is in Progress.

Table 7.5.4.2.1.10: Mapping of 200 (OK) response

Source SIP header field and component	Source Component value	ISUP Parameter	Derived value of parameter field
200 (OK) response		ANM/CON	
History-Info header field	See table 7.5.4.2.1.2	Redirection number (NOTE)	See table 7.5.4.2.1.2
Privacy "headers" component of the hi-targeted-to-uri or/and Privacy header field	See table 7.5.4.2.1.3	Redirection number restriction	See table 7.5.4.2.1.3
NOTE: Redirection number shall only be supplied if 200 (OK) response is mapped to ANM message.			

7.5.4.2.2 Call forwarding within the ISUP Network appeared

The following scenario shows if a Call Forwarding appears in the ISUP/PSTN and the diverted-to number is within the SIP network. Table 7.5.4.2.2.1 should be seen as an example.

For the mapping of 180 (Ringing) response and 200 (OK) response to the regarding ISUP messages and parameters no additional procedures beyond the basic call procedures are needed.

To interwork the redirecting number at the O-MGCF it can be needed to create placeholder History entries. Such a History entry has to provide a hi-targeted-to-uri with a placeholder value [unknown@unknown.invalid](#), a "cause" URI parameter and a hi-index and a mp-param as described within table 7.5.4.2.2.1.

Table 7.5.4.2.2.1: Mapping of IAM to SIP INVITE request

ISUP Parameter or IE	Derived value of parameter field	SIP component	Value
IAM		INVITE request	
Redirecting number		History-Info header field	hi-targeted-to-uri of the penultimate created hi-entry IF Redirection counter exceed 1 ELSE no mapping
Nature of address indicator:	"national (significant) number"	hi-targeted-to-uri	Add CC (of the country where the MGCF is located) to Redirecting number Address Signals to construct E.164 number in URI.
	"international number"		Map complete Redirecting number Address Signals to E.164 number in URI.
Address Signals	If NOA is "national (significant) number" then the format of the Address Signals is: NDC + SN If NOA is "international number" then the format of the Address Signals is: CC + NDC + SN	hi-targeted-to-uri	Addr-spec "+" CC NDC SN mapped to userinfo portion of SIP URI. (NOTE 5) Add "user=phone".
Redirecting number	APRI	Privacy header field that corresponds to the penultimate hi-targeted-to-uri entry in the History-Info header	Priv-value
	"presentation restricted"		"history"
	"presentation allowed"		Privacy header field absent or "none" (NOTE 3)
Redirection Information	Redirecting indicator	Privacy header field that corresponds to the penultimate hi-targeted-to-uri entry in the History-Info header	Priv-value
	Call diverted		"none" (NOTE 4)
	Call diverted, all redirection info presentation restricted		"history"
Redirection Information	Redirection counter 1	hi-index and mp-param (NOTE 7)	Number of diversions are shown due to the number of hi-index Entries Index for original called number = 1 Address Signals (CdPN) Number = 1.1 and addition "mp=1"
	2		Index for original called number = 1 Index for Redirecting number with Index = 1.1 and addition of "mp=1" Address Signals (CdPN) Number = 1.1.1 and addition of "mp=1.1"
	N		Index for original called number = 1 Placeholder History entry with Index = 1.1 and addition of "mp=1" ... Fill up ... Index for Redirecting Number with = 1.[(N-1)*".1"] and addition of "mp" set to the hi-index value of the hi-targeted-to-uri that precede. Index for Address Signals (CdPN) = 1.N* ".1" (e.g. N=3 → 1.1.1.1) and addition of mp=1.[(N-1)*].1
Redirection Information	Redirecting Reason and Original Redirection Reason (NOTE 1)	hi-targeted-to-uri; "cause" URI parameter, as defined in IETF RFC 4458 [113]. The Redirecting Reason shall be mapped to the last hi-targeted-to-uri. If the redirection counter is 2 or	cause value
	unknown		404
	unconditional		302
	User Busy		486

ISUP Parameter or IE	Derived value of parameter field	SIP component	Value
	<i>No reply</i>	higher, the Original Redirection Reason shall be mapped to the second hi-targeted-to-uri.	408
	<i>Deflection during alerting</i>		487
	<i>Deflection immediate response</i>	If the redirection counter is 3 or higher, for each hi-targeted-to-uri following a placeholder History entry the value "404" shall be taken (NOTE 2)	480
	<i>Mobile subscriber not reachable</i>		503
Called Party Number	See Redirecting number	History-Info header field see hi-targeted-to-uri	URI of the last hi-targeted-to-uri entry of History-Info header field
Original called number	See Redirecting number	History-Info header field see hi-targeted-to-uri	URI of first hi-targeted-to-uri entry of History-Info header field (NOTE 6)
Original called number	APRI	Privacy header field of the first hi-targeted-to-uri entry of History-Info header	Priv-value
	<i>"presentation restricted"</i>		<i>"history"</i>
	<i>"presentation allowed"</i>		<i>"none"</i>
NOTE 1: Original Redirection Reason contains only the "unknown" parameter			
NOTE 2: For all History entries except the first one a "cause" URI parameter as defined in IETF RFC 4458 [113] has to be included.			
NOTE 3: If the Redirecting Indicator has the value <i>"Call diverted, all redirection info presentation restricted"</i> , the privacy value <i>"history"</i> shall be set.			
NOTE 4: If the Redirecting Number APRI has the value <i>"presentation restricted"</i> , the privacy value <i>"history"</i> shall be set.			
NOTE 5: Used URI scheme shall be SIP URI. The "cause" URI parameter cannot be added if hi-targeted-to-uri is a tel URI.			
NOTE 6: The used URI scheme can be tel URI or SIP URI since the first hi-targeted-to-uri entry of the History-Info header field does not contain the "cause" URI parameter.			
NOTE 7: The hi-target-param defined in RFC7044 [91] defines the mp-param "mp" as a header field parameter that contains the value of the hi-index in the hi-entry with an hi-targeted-to-uri that reflects the Request-URI that was retargeted, thus identifying the "mapped from" target. Since the hi-entries are created based on the redirection counter to reflect the diverting/diverted-to entries, the hi-target-param "mp" shall be present in each entry except the first one.			

7.5.4.3 Interworking at the I-MGCF

Table 7.5.4.3.1: Mapping of SIP to ISUP messages

→Message received from SIP	→Message send to BICC/ISUP
INVITE request	IAM

Table 7.5.4.3.2: Mapping of History-Info header field to ISUP Redirecting number

Source SIP header field and component	Source Component value	Redirecting number	Derived value of parameter field
In History-Info SIP header field, hi-targeted-to-uri in hi-entry having a hi-index that match the mp-param value of the last hi-entry containing a mp-param and a "cause" URI parameter, as defined in IETF RFC 4458 [113].(NOTE 1)(NOTE 3)		Redirecting number	
hi-targeted-to-uri appropriate global number portion of the URI, assumed to be in form "+" CC + NDC + SN	CC	Nature of address indicator	If CC is equal to the country code of the country where MGCF is located AND the next ISUP node is located in the same country, then set to " <i>national (significant) number</i> " else set to " <i>international number</i> "
	CC, NDC, SN	Address signals	If NOA is " <i>national (significant) number</i> " then set to NDC + SN. If NOA is " <i>international number</i> " then set to CC + NDC + SN
Privacy header field or/and priv-value component of the hi-entry in History-Info header field specified in this table (NOTE 2)		APRI	If the priv-value " <i>history</i> " or " <i>session</i> " or " <i>header</i> " is received within the Privacy header field or if the priv-value " <i>history</i> " is received within the "headers" component of the hi-targeted-to-uri in hi-entry before last hi-entry containing a "cause" URI parameter then " <i>presentation restricted</i> " shall be set. Otherwise, " <i>presentation allowed</i> " shall be set.
NOTE 1: If the SIP URI doesn't contain " <i>user=phone</i> ", mapping to redirecting number is impossible, therefore no need to generate Redirecting number.			
NOTE 2: It is possible that an entry of the History-Info header field itself is marked as restricted or the whole History-Info header.			
NOTE 3: The hi-target-param parameter set to "mp" as defined in IETF RFC 7044 [91] indicates that the target of the Request-URI was changed and appears in the hi-targeted-to-uri. In case of interworking with networks not supporting IETF RFC 7044 the "mp" header field parameter may not appear. If the "mp" header field parameter is missing in the last hi-entry containing a "cause" URI parameter as defined in IETF RFC 4458 [113], the hi-entry to use is the entry just before.			

Table 7.5.4.3.3: Mapping of History-Info header to ISUP Redirection Information

Source SIP header field and component	Source Component value	Redirection Information	Derived value of parameter field
Privacy header field and priv-value of hi-entry having a hi-index that match the mp-param value of the last hi-entry containing a mp-param and a "cause" URI parameter as defined in IETF RFC 4458 [113] of the History-Info header field. (NOTE 2)	"history" or "session" or "header" for the Privacy header field or for the hi-targeted-to-uri entry	Redirecting indicator	<i>Call diverted, all redirection info presentation restricted</i>
	Privacy header field and the privacy component of the hi-targeted-to-uri entry either absent or "none"		<i>Call diverted</i>
		Original redirection reason	<i>Unknown</i>
Cause value in the last hi-targeted-to-uri containing a "cause" URI parameter as defined in IETF RFC 4458 [113] (NOTE 2)	cause value	Redirecting Reason	Redirecting Reason
	404		<i>Unknown/not available</i>
	302		<i>Unconditional</i>
	486		<i>User busy</i>
	408		<i>No reply</i>
	480		<i>Deflection immediate response</i>
	487		<i>Deflection during alerting</i>
503	<i>Mobile subscriber not reachable</i>		
Hi-index		Redirection counter	number of History entries containing a "cause" URI parameter with value as listed in the "cause" URI parameter row in this table (NOTE 1)
<p>NOTE 1: If the determined number of redirection in SIP exceeds the ISUP maximum parameter value, the MGCF shall set the Redirection counter to its maximum value. For instance, in ISUP ITU-T Q.763 [4], the Redirection counter parameter cannot exceed 5.</p> <p>NOTE 2: The hi-target-param parameter set to "mp" as defined in IETF RFC 7044 [91] indicates that the target of the Request-URI was changed and appears in the hi-targeted-to-uri. In case of interworking with networks not supporting IETF RFC 7044 the "mp" header field parameter may not appear. If the "mp" header field parameter is missing in the last hi-entry containing a "cause" URI parameter as defined in IETF RFC 4458 [113], the hi-entry to use is the entry just before.</p>			

Table 7.5.4.3.4: Mapping of History-Info header field to ISUP Original Called number

Source SIP header field and component	Source Component value	Original called number	Derived value of parameter field
		Numbering Plan Indicator	"ISDN (Telephony) numbering plan (Recommendation E.164)"
hi-targeted-to-uri of hi-entry having a hi-index that match the mp-param value of the 1 st hi-targeted-to-uri containing a mp-param and a "cause" URI parameter, as defined in IETF RFC 4458 [113]; the global number portion of the URI, is assumed to be in form "+ CC + NDC + SN (NOTE 1) (NOTE 3)	CC	Nature of address indicator	If CC is equal to the country code of the country where MGCF is located AND the next ISUP node is located in the same country, then set to "national (significant) number" else set to "international number"
	CC, NDC, SN	Address signals	If NOA is "national (significant) number" then set to NDC + SN. If NOA is "international number" then set to CC + NDC + SN
priv-value component in History-Info header field of the History-Info header field entry as defined above in this table (NOTE 2)	"history" or "session" or "header"	APRI	"presentation restricted"
	Privacy header field absent or "none"		"presentation allowed"
NOTE 1: If it is SIP URI and doesn't contain "user=phone", mapping to Original Called number is impossible, therefore no need to generate Original Called number			
NOTE 2: It is possible that an entry of the History-Info header field itself is marked as restricted or the whole History-Info header.			
NOTE 3: The hi-target-param parameter set to "mp" as defined in IETF RFC 7044 [91] indicates that the target of the Request-URI was changed and appears in the hi-targeted-to-uri. In case of interworking with networks not supporting IETF IETF RFC 7044 the "mp" header field parameter may not appear. If the "mp" header field parameter is missing in the last hi-entry containing a "cause" URI parameter as defined in IETF RFC 4458 [113], the hi-entry to use is the entry just before.			

Table 7.5.4.3.5: Mapping of INVITE to IAM

INVITE		IAM	
History-Info header field	See table 7.5.4.3.2	Redirecting number	See table 7.5.4.3.2
History-Info header field	See table 7.5.4.3.3	Redirection Information	See table 7.5.4.3.3
History-Info header field	See table 7.5.4.3.4	Original Called Number	See table 7.5.4.3.4

Table 7.5.4.3.6: Mapping of ISUP to SIP Messages

←Message sent to SIP	←Message Received from BICC/ISUP	
181 (Being forwarded)	ACM no indication with Redirection number and call diversion information (CFU, CFB, Cdi)	See table 7.5.4.3.8
180 (Ringing)	ACM indicating ringing, oBCi: Call diversion may occur (CFNR, Cda)	See clause 7.2.3.1.4
181 (Being forwarded)	CPG indicating progress or subsequent diversion indicated in the CPG with Redirection number and call diversion information (CFNR, Cda)	See table 7.5.4.3.9
180 (Ringing)	CPG indicating ringing and Redirection number restriction parameter	See table 7.5.4.3.10
200 (OK)	ANM and Redirection number restriction parameter	See table 7.5.4.3.11

Table 7.5.4.3.7: Mapping of ISUP Redirection Number Restriction to History-Info header field

Redirection Number Restriction	Derived value of parameter field	SIP component	Value
Presentation restricted indicator	<i>"Presentation restricted"</i>	privacy "headers"	<i>"History"</i>
	<i>"Presentation allowed"</i> or absent AND any previous received notification subscription option was NOT <i>"presentation not allowed"</i> AND was NOT <i>"presentation allowed without redirection number"</i>	component of the hi-targeted-to-uri	Privacy header field absent or <i>"none"</i>

Table 7.5.4.3.8: Mapping of ACM → 181 (Call Is Being Forwarded) response

ISUP Parameter	Derived value of parameter field	SIP component	Value
Generic notification indicators	Call is diverting		
Redirection number		History-Info header field with one hi-entry and the hi-target-param set to "mp"	hi-targeted-to-uri:
Nature of address indicator:	"national (significant) number"	hi-targeted-to-uri	Add CC (of the country where the MGCF is located) to Redirection number Address Signals to construct E.164 number in URI.
	"international number"		Map complete Redirection number Address Signals to E.164 number in URI.
Address Signals	If NOA is "national (significant) number" then the format of the Address Signals is: NDC + SN If NOA is "international number" then the format of the Address Signals is: CC + NDC + SN	hi-targeted-to-uri	Addr-spec "+" CC NDC SN mapped to userinfo portion of SIP URI. (NOTE 2) Add "user=phone".
Call diversion information	Redirecting Reason	IETF RFC 4458 [113]	cause value
	<i>Unknown/not available</i>	"cause" URI parameter in	404
	<i>Unconditional</i>	the hi-targeted-to-uri	302
	<i>User busy</i>	(NOTE 1)	486
	<i>No reply</i>		408
	<i>Deflection immediate response</i>		480
	<i>Deflection during alerting</i>		487
	<i>Mobile subscriber not reachable</i>		503
	Notification subscription option	privacy "headers" component of the hi-targeted-to-uri (NOTE 1)	Roles
	<i>unknown</i>		Escaped Privacy value is set according to the rules of TS 24.604 [60] clause 4.5.2.6.4 item c
<i>presentation not allowed</i>		A 181 Being Forwarded shall not be sent	
<i>presentation allowed with redirection number</i>		Escaped Privacy value is set according to the rules of TS 24.604 [60] clause 4.5.2.6.4 item c	
<i>presentation allowed without redirection number</i>		Escaped Privacy value is set according to the rules of TS 24.604 [60] clause 4.5.2.6.4 item c	
NOTE 1: Needs to be stored for a possible inclusion into subsequent messages.			
NOTE 2: Used URI scheme shall be SIP URI. The "cause" URI parameter cannot be added if hi-targeted-to-uri is a tel URI.			

Table 7.5.4.3.9: Mapping of CPG → 181 (Call Is Being Forwarded) response

ISUP Parameter	Derived value of parameter field	SIP component	Value
Event Indicator	Progress		
Generic notification indicators	Call is diverting		
Redirection number		History-Info header field with one hi-entry and the hi-target-param set to "mp"	hi-targeted-to-uri:
Nature of address indicator	"national (significant) number"	hi-targeted-to-uri	Add CC (of the country where the MGCF is located) to Redirection number Address Signals to construct E.164 number in URI.
	"international number"	hi-targeted-to-uri	Map complete Redirection number Address Signals to E.164 number in URI.
Address Signals	If NOA is "national (significant) number" then the format of the Address Signals is: NDC + SN If NOA is "international number" then the format of the Address Signals is: CC + NDC + SN	hi-targeted-to-uri	Addr-spec "+" CC NDC SN mapped to userinfo portion of SIP URI. (NOTE 2) Add "user=phone".
Call diversion information	Redirecting Reason	IETF RFC 4458 [113] "cause" URI parameter in the hi-targeted-to-uri (NOTE 1)	cause value
	<i>Unknown/not available</i>		404
	<i>Unconditional</i>		302
	<i>User busy</i>		486
	<i>No reply</i>		408
	<i>Deflection immediate response</i>		480
	<i>Deflection during alerting</i>		487
	<i>Mobile subscriber not reachable</i>	503	
	Notification subscription option	privacy "headers" component of the hi-targeted-to-uri (NOTE 1)	Roles
	<i>unknown</i>		Escaped Privacy value is set according to the rules of TS 24.604 [60] clause 4.5.2.6.4 items c
	<i>presentation not allowed</i>		A 181 Being Forwarded shall not be sent
	<i>presentation allowed with redirection number</i>		Escaped Privacy value is set according to the rules of TS 24.604 [60] clause 4.5.2.6.4 items c
	<i>presentation allowed without redirection number</i>		Escaped Privacy value is set according to the rules of TS 24.604 [60] clause 4.5.2.6.4 items c
NOTE 1: Needs to be stored for a possible inclusion into subsequent messages.			
NOTE 2: Used URI scheme shall be SIP URI. The "cause" URI parameter cannot be added if hi-targeted-to-uri is a tel URI.			

Table 7.5.4.3.10 addresses two separate conditions: the CPG is received from the diverting exchange in which case the Call diversion information is included; and the CPG is received from the diverted-to exchange in which case the Call diversion information is not included. Interworking for both conditions is shown.

Table 7.5.4.3.10: Mapping of CPG → 180 (Ringing) response

ISUP Parameter	Derived value of parameter field	SIP component	Value
Event Indicator	Alerting		
Redirection number		History-Info header field with one hi-entry and the hi-target-param set to "mp"	See table 7.5.4.3.8
Call diversion information	Redirecting Reason	IETF RFC 4458 [113] "cause" URI parameter in the hi-targeted-to-uri (NOTE 1)	cause value
	<i>Unknown/not available</i>		404
	<i>Unconditional</i>		302
	<i>User busy</i>		486
	<i>No reply</i>		408
	<i>Deflection immediate response</i>		480
	<i>Deflection during alerting</i>		487
	<i>Mobile subscriber not reachable</i>		503
	Notification subscription option	privacy "headers" component of the hi-targeted-to-uri (NOTE 1)	Roles
	<i>unknown</i>		Escaped Privacy value is set according to the rules of TS 24.604 [60] clause 4.5.2.6.4 item c
	<i>presentation not allowed</i>		The 180 Ringing response shall be sent without the the History-Info header field included
	<i>presentation allowed with redirection number</i>		Escaped Privacy value is set according to the rules of TS 24.604 [60] clause 4.5.2.6.4 item c
	<i>presentation allowed without redirection number</i>	Escaped Privacy value is set according to the rules of TS 24.604 [60] clause 4.5.2.6.4 item c	
If no Call diversion information parameter is present		IETF RFC 4458 [113] "cause" URI parameter in the hi-targeted-to-uri	Value stored from a previous received ACM or CPG. See tables 7.5.4.3.8 and 7.5.4.3.9.
		privacy "headers" component of the hi-targeted-to-uri	Value stored from a previous received ACM or CPG. See tables 7.5.4.3.8 and 7.5.4.3.9.
Redirection number restriction (NOTE 2)			See table 7.5.4.3.7
NOTE 1: Needs to be stored for a possible inclusion into subsequent messages.			
NOTE 2: This parameter may appear without Call diversion information parameter and Redirection number. In such cases, the O-MGCF shall send the previously sent and stored History-Info header field and set the priv-value in the History-Info header field as described in Table 7.5.4.3.7.			

Table 7.5.4.3.11: Mapping of ANM → 200 (OK) response (to INVITE request)

ISUP Parameter	Derived value of parameter field	SIP component	Value
Redirection number		History-Info header field with one hi-entry and the hi-target-param set to "mp"	See table 7.5.4.3.8
		IETF RFC 4458 [113] "cause" URI parameter in the hi-targeted-to-uri	cause value= as stored from a previous received ACM or CPG. See tables 7.5.4.3.8 and 7.5.4.3.9.
Redirection number restriction (NOTE)			See table 7.5.4.3.7
NOTE: This parameter may appear without Call diversion information parameter and Redirection number. In such cases, the O-MGCF shall send the previously sent and stored History-Info header field and set the priv-value in the History-Info header field as described in Table 7.5.4.3.7.			

7.5.5 Communication Hold (HOLD)

The mapping of Communication Hold supplementary service with Call Hold PSTN/ISDN Supplementary Service is the same mapping as described in clause 7.4.10. The Service itself is described within 3GPP TS 24.610 [65].

7.5.6 Conference call (CONF)

7.5.6.1 General

The protocol description of the CONF supplementary service is described in 3GPP TS 24.605 [61]. In this clause the interworking from the conference event package in accordance with IETF RFC 4575 [100] to the messages of the PSTN/ISDN CONF supplementary service is described. Note that an interworking from the PSTN/ISDN to the IMS is out of scope.

7.5.6.2 Subscribing for the conference event package

Based on local policy, the MGCF may subscribe for the conference event package on behalf of the PSTN/ISDN participant after the participant joins or is added to a conference.

When the conference event package option is implemented, and one of the following events occurs at the MGCF:

- a 200 (OK) response is received as a response to an initial INVITE request originated by the MGCF, where the Contact header field contains an "isfocus" parameter; or
- an ACK message is received which acknowledges a 200 (OK) response to the initial INVITE request, and the initial INVITE request is originated by the conferencing AS and contains an "isfocus" parameter in the Contact header field;

then the following steps shall be performed:

- 1) a SUBSCRIBE request shall be created according to IETF RFC 4575 [100], using the updated procedures from IETF RFC 6665 [138];
- 2) the Request URI is set to the Contact address of the conferencing AS;
- 3) the P-Asserted-Identity header field, the From header field and the Privacy header field are set with the same value as:
 - the P-Asserted-Identity header field, the From header field and the Privacy header field in the initial INVITE request originated by the MGCF; or
 - the P-Asserted-Identity header field, the To header field and the Privacy header field in a 1xx or 2xx response sent by the MGCF to the initial INVITE request from the conferencing AS.

7.5.6.3 Interworking the notification

NOTE: There is a need to differentiate between the procedures of interworking for a full and a partial type of notification.

When a full type of notification is received a check is made of the content. If the changes with respect a previous version of the notification have not been sent on to the PSTN/ISDN for this session, the MGCF shall perform an ISUP interaction towards the PSTN/ISDN. If the changes with respect a previous version of the notification have been sent to the PSTN/ISDN for this session, the MGCF shall not perform an ISUP interaction towards the PSTN/ISDN.

When a partial notification is received then it is assumed that a value of a received notification has changed, so the MGCF performs an ISUP interaction towards the PSTN/ISDN, as follows:

- Conference established:

Upon the receipt of a conference information document with the <conference-state-type> element *active* is set to "true", the MGCF shall send a CPG message to the PSTN/ISDN with a notification "*conference established*".

- Participant added:

Upon the receipt of a conference information document with the <endpoint-type> and the element *status of endpoint-status-type* is set to "connected" and it was not set to "on-hold" before and the Contact URI in the element *entity* is not the address of the served PSTN/ISDN participant, the MGCF shall send a CPG message to the PSTN/ISDN with a notification "*other party added*".

- Served PSTN/ISDN participant isolated:

Upon the receipt of a conference information document with the <endpoint-type> and the element *status of endpoint-status-type* is set to "on-hold" and it was set to "connected" before and the Contact URI in the element *entity* is the address of the served PSTN/ISDN participant, the MGCF shall send a CPG message to the PSTN/ISDN with a notification "*isolated*".

- Other participant isolated:

Upon the receipt of a conference information document with the <endpoint-type> and the element *status of endpoint-status-type* is set to "on-hold" and it was set to "connected" before and the Contact URI in the element *entity* is not the address of the served PSTN/ISDN participant, the MGCF shall send a CPG message to the PSTN/ISDN with a notification "*other party isolated*".

- Served PSTN/ISDN participant reattached:

Upon the receipt of a conference information document with the <endpoint-type> and the element *status of endpoint-status-type* is set to "connected" and it was set to "on-hold" before and the Contact URI in the element *entity* is the address of the served PSTN/ISDN participant, the MGCF shall send a CPG message to the PSTN/ISDN with a notification "*reattached*".

- Other participant reattached:

Upon the receipt of a conference information document with the <endpoint-type> and the element *status of endpoint-status-type* is set to "connected" and it was set to "on-hold" before and the Contact URI in the element *entity* is not the address of the served PSTN/ISDN participant, the MGCF shall send a CPG message to the PSTN/ISDN with a notification "*other party reattached*".

- Other party disconnected:

Upon the receipt of a conference information document with the <endpoint-type> and the element *status of endpoint-status-type* is set to "disconnected" and the element *joining-method of joining-type* is not set to "focus-owner", the MGCF shall send a CPG message to the PSTN/ISDN with a notification "*other party disconnected*".

7.5.7 Anonymous Communication Rejection (ACR) and Communication Barring (CB)

The Anonymous Communication rejection (ACR) and Communication Barring (CB) services are described within 3GPP TS 24.611 [67].

The mapping of Anonymus Communication Rejection supplementary service with Anonymus Call Rejection PSTN/ISDN Supplementary Service is described in clause 7.4.23.

The mapping for Communication Barring is in accordance with the basic call procedures as described in clauses 7.2.3.1.8 and 7.2.3.2.12.

7.5.8 Message Waiting Indication (MWI)

The Message Waiting Indication supplementary service is described within 3GPP TS 24.606 [62].

7.5.9 Malicious Communication Identification (MCID)

7.5.9.0 General

The protocol specification of the Malicious Communication Identification supplementary service is described in 3GPP TS 24.616 [102]. The XML MCID body used in related SIP messages is also specified in 3GPP TS 24.616 [102].

7.5.9.1 Interworking at the O-MGCF

7.5.9.1.0 General

If the MGCF supports the interworking of the MCID service the O-MGCF shall map a SIP INFO request ("legacy" mode of usage of the INFO method as defined in IETF RFC 6086 [133]) containing a XML mcid body with MCID XML Request schema to an Identification Request (IDR) message and an Identification response (IRS) message to a SIP INFO request containing a XML mcid body with MCID XML Response schema in accordance with table 7.5.9.1.1.

The IDR message shall be generated upon reception of the SIP INFO request containing a XML mcid body with MCID XML Request schema.

The SIP INFO request containing a XML mcid body with MCID XML Response schema shall be generated upon reception of the IRS message.

Table 7.5.9.1.1 Mapping between ISUP IDR and IRS and SIP messages

ISUP Message	SIP Message
IDR	INFO containing a XML mcid body with MCID XML Request schema
IRS	INFO containing a XML mcid body with MCID XML Response schema

7.5.9.1.1 Interworking of the MCID XML Request schema with the ISUP MCID request indicators

If the MGCF supports the interworking of the MCID service O-MGCF shall map the codes in the MCID XML elements to MCID request indicator and holding indicator parameter fields in accordance with table 7.5.9.1.1.1.

Table 7.5.9.1.1.1 Mapping between ISUP MCID request and holding indicators and MCID XML elements

ISUP Parameter		XML Element
bit A:	MCID request indicator	McidRequestIndicator
0	MCID not requested	type=0
1	MCID requested	type=1
bit B:	Holding indicator (national use)	HoldingIndicator
0	holding not requested	type=0
1	holding requested	type=1

7.5.9.1.2 Interworking of the ISUP MCID response indicators with the MCID XML Response schema

If the MGCF supports the interworking of the MCID service the O-MGCF shall map the codes in the MCID response indicator and hold provided indicator parameter field to the MCID XML elements in accordance with table 7.5.9.1.2.1.

Table 7.5.9.1.2.1 Mapping between ISUP MCID response and hold provided indicators and MCID XML elements

ISUP Parameter		XML Element
bit A:	MCID response indicator	McidResponseIndicator
0	MCID not included	type=0
1	MCID included	type=1
bit B:	<i>Hold provided indicator (national use)</i>	HoldingProvidedIndicator
0	holding not provided	type=0
1	holding provided	type=1

7.5.9.1.3 Interworking of the ISUP Calling Party Number in an Identification Response with the OrigPartyIdentity within the MCID XML Response schema

If the O-MGCF supports the interworking of the MCID service and receives an ISUP Identification Response containing a Calling Party Number with the screening indicator set to "*user provided, verified and passed*" or "*network provided*", the O-MGCF shall map the Calling Party Number to the MCID XML Response schema OrigPartyIdentity element applying the same mapping procedures as described in table 14 for the mapping into the SIP P-Asserted-Identity header and shall map the Calling Party Number APRI to the MCID XML Response schema OrigPartyPresentationRestriction element. If the Calling Party Number APRI has a value of "*presentation allowed*" then the MCID XML Response schema OrigPartyPresentationRestriction element shall be set to "*false*", otherwise it shall be set to "*true*".

7.5.9.1.4 Interworking of the ISUP Generic Number in an Identification Response with the GenericNumber within the MCID XML Response schema

If the O-MGCF supports the interworking of the MCID service and receives an ISUP Identification Response containing a Generic Number with the screening indicator set to "*user provided, verified and passed*", or "*user provided, not verified*", or "*network provided*", the O-MGCF shall map the Generic Number to the MCID XML Response schema GenericNumber element applying the same mapping procedures as described in table 13 for the mapping into the SIP From header and shall map the Generic Number APRI to the MCID XML Response schema GenericNumberPresentationRestriction element. If the Generic Number APRI has a value of "*presentation allowed*" then the MCID XML Response schema GenericNumberPresentationRestriction element shall be set to "*false*", otherwise it shall be set to "*true*".

7.5.9.2 Interworking at the I-MGCF

7.5.9.2.1 General

If the MGCF supports the interworking of the MCID service the I-MGCF shall map an Identification Request (IDR) message to a SIP INFO request ("legacy" mode of usage of the INFO method as defined in IETF RFC 6086 [133]) containing a XML mcid body with MCID XML Request schema and a SIP INFO request containing a XML mcid body with MCID XML Response schema to an Identification response (IRS) message in accordance with table 7.5.9.1.1.

7.5.9.2.2 Interworking of identification Request

The SIP INFO request containing a XML mcid body with MCID XML Request schema shall be generated upon reception of the IDR message. The I-MGCF shall map the codes in the MCID request indicator and holding indicator parameter fields to the MCID XML elements in accordance with table 7.5.9.1.1.1.

7.5.9.2.3 Interworking of identification Response

The IRS message shall be generated upon reception of the SIP INFO request containing a XML mcid body with MCID XML Response schema. The I-MGCF shall map the codes in the MCID XML elements to the MCID response indicator and hold provided indicator parameter fields in accordance with table 7.5.9.1.2.1.

If the received MCID XML Response schema contains an OrigPartyIdentity element, the I-MGCF shall map the OrigPartyIdentity to the Calling Party Number within the IRS applying the same mapping procedure as described in table 5 for the mapping from the SIP P-Asserted-Identity header, with the exception that the I-MGCF shall map the MCID XML Response schema OrigPartyPresentationRestriction element to the Calling Party Number APRI. If the MCID XML Response schema OrigPartyPresentationRestriction element has the value "true", the Calling Party Number APRI shall be set to "presentation restricted", and otherwise the Calling Party Number APRI shall be set to "presentation allowed".

If the received MCID XML Response schema contains an GenericNumber element, the I-MGCF shall map the GenericNumber to the Generic Number within the IRS applying the same mapping procedure as described in table 6 for the mapping from the From header, with the exception that the I-MGCF shall map the MCID XML Response schema GenericNumber PresentationRestriction element to the Generic Number APRI. If the MCID XML Response schema GenericNumberPresentationRestriction element has the value "true", the Generic Number APRI shall be set to "presentation restricted", and otherwise the Generic Number APRI shall be set to "presentation allowed".

7.5.10 Closed User Group (CUG)

7.5.10.0 General

The protocol specification of the Closed User Group supplementary service is described in 3GPP TS 24.654 [101].

7.5.10.1 Interworking at the I-MGCF

If the I-MGCF supports the interworking of CUG supplementary service, the I-MGCF shall map between the SIP and ISUP messages in accordance with table 7.5.10.1.1.

Table 7.5.10.1.1: Mapping of SIP messages to ISUP messages

SIP Message	ISUP Message
INVITE request containing a XML cug body with CUG XML schema	IAM containing the Closed user group interlock code Parameter and the closed user group call indicator of the Optional Forward Call Indicator Parameter

If the MGCF supports the interworking of CUG supplementary service, the I-MGCF shall interwork the CUG XML schema with the ISUP Closed user group interlock code parameter and the *Closed user group call indicator* of the optional forward call indicator parameter in accordance with tables 7.5.10.1.2 and 7.5.10.1.3.

Table 7.5.10.1.2: Mapping of the SIP XML CUG Element to the ISUP closed usergroup interlock code parameter

CUG XML Element	Source component value	ISUP Closed user group interlock code Parameter	derived value of parameter field
networkIndicator	networkIdentityType = 4 hexbinary coded digits (NOTE)	"Network Identity"	Octet 1 & Octet 2 including 4 binary coded digits derived from XML Network Identity
cugInterlockBinaryCode	sixteenbitType = 16 bit coded value	"Binary Code"	Octet 3 & Octet 4 including a 16 bit Binary Code derived from the XML Binary Code
NOTE: ISUP Closed user group interlock code Parameter Octet 1 contains "Network Identity" (NI) digits 1 & 2 and Octet 2 contains "Network Identity" digits 3 & 4. The networkIdentityType is filled with "Octet1 & Octet 2" = "NI digit 1, NI digit 2, NI digit 3, NI digit 4". Example: Digit 1=0, Digit 2=4, Digit 3=9, Digit 4=0 so the networkIdentityType is encoded with "0490".			

Table 7.5.10.1.3: Mapping of the SIP XML CUG Element to the ISUP closed user group call indicator included in the optional Forward Call Indicator Parameter

CUG XML Element	Source component value	ISUP "Optional Forward Call Indicator" Parameter	derived value of parameter field
cugCommunicationIndicator	Type=00	"closed user group call" indicator	non-CUG call
	Type=01		spare
	Type=10		closed user group call, outgoing access allowed
	Type=11		closed user group call, outgoing access not allowed

If the I-MGCF supports the interworking of CUG supplementary service, then if an INVITE request with the MIME including a cug XML element is received and the terminating network is not supporting CUG, the I-MGCF shall behave as shown in table 7.5.10.1.4.

Table 7.5.10.1.4: Action at the I-MGCF with a PSTN/ISDN network without CUG capability

cugCommunicationIndicator in INVITE request	Action at the I-MGCF
Type=11 (CUG without outgoing access)	Release the communication with 403
Type=10 (CUG with outgoing access)	Treat the communication as an ordinary call (NOTE)
Non-CUG	Treat the communication as an ordinary call
NOTE: The cugCommunicationIndicator shall not be mapped or if appropriate the CUG call indicator of the optional forward call indicator shall be set to non-CUG call.	

7.5.10.2 Interworking at the O-MGCF

If the MGCF supports the interworking of CUG supplementary service, the O-MGCF shall map between the SIP and ISUP messages in accordance with table 7.5.10.2.1

Table 7.5.10.2.1: Mapping of ISUP messages to SIP messages

ISUP Message	SIP Message
IAM containing the Closed user group interlock code Parameter and the closed user group call indicator of the Optional Forward Call Indicator Parameter	INVITE request containing a XML cug body with CUG XML schema

If the MGCF supports the interworking of CUG supplementary service, the MGCF shall interwork the CUG XML schema with the ISUP Closed user group interlock code parameter and the *Closed user group call indicator* of the optional forward call indicator parameter in accordance with tables 7.5.10.2.2 and table 7.5.10.2.3.

Table 7.5.10.2.2: Mapping of the ISUP closed usergroup interloccode to SIP XML CUG element

ISUP Closed user group interlock code Parameter	Source component value	CUG XML Element	derived value of parameter field
"Network Identity"	Octet 1 & Octet 2 including 4 binary coded digits	networkIndicator	networkIdentityType = 4 hexbinary coded digits derived from Network Identity (NOTE)
"Binary Code"	Octet 3 & Octet 4 including a 16 bit Binary Code	cugInterlockBinaryCode	sixteenbitType = 16 bit coded value derived from Binary Code
NOTE: ISUP Closed user group interlock code Parameter Octet 1 contains "Network Identity" (NI) digits 1 & 2 and Octet 2 contains "Network Identity" digits 3 & 4. The networkidentityType shall be filled with "Octet1 & Octet 2" = "NI digit 1, NI digit 2, NI digit 3, NI digit 4". Example: Digit 1=0, Digit 2=4, Digit 3=9, Digit 4=0 so the networkidentityType is encoded with "0490".			

Table 7.5.10.2.3: Mapping of the ISUP Closed user group call indicator to SIP XML CUG element

ISUP Optional Forward Call Indicator Parameter	Source component value	CUG XML Element	derived value of parameter field
closed user group call indicator	non-CUG call	cugCommunicationIndicator	Type=00
	spare		Type=01
	closed user group call, outgoing access allowed		Type=10
	closed user group call, outgoing access not allowed		Type=11

If the MGCF supports the interworking of CUG supplementary service, but the IMS is not supporting CUG, the procedures described in ITU Q.735.1 [42] shall apply if an INVITE request with the MIME body including a cug XML element is sent and the O-MGCF supports CUG supplementary service.

7.5.11 CCBS/CCNR

7.5.11.0 General

The protocol specification of the Completion of Communications to Busy Subscriber and Completion of Communications by No Reply supplementary services is described in 3GPP TS 24.642 [112].

SIP SUBSCRIBE and NOTIFY methods shall be used in accordance with the procedures defined in IETF RFC 6665 [138].

7.5.11.1 Interworking at the I-MGCF

If the I-MGCF supports the interworking of CCBS/CCNR supplementary services, the I-MGCF shall map between the SIP and ISUP messages in accordance with table 7.5.11.1.1.

Table 7.5.11.1.1: Mapping of ISUP and SIP messages

SIP Message	Parameter	ISUP Message	Parameter
← 180 Ringing	Call-Info header field with purpose header field parameter set to "call-completion" and "m" header field parameter set to "NR" (no reply) (NOTE 1)	← ACM	Called party's status indicator set to "Subscriber free" and CCNR possible indicator set to "CCNR possible" (NOTE 2)
← 180 Ringing	Call-Info header field with purpose header field parameter set to "call-completion" and "m" header field parameter set to "NR" (no reply) (NOTE 1)	← CPG	Event indicator set to "Alerting" and CCNR possible indicator set to "CCNR possible" (NOTE 2)
← 486 Busy here	Call-Info header field with purpose header field parameter set to "call-completion" and "m" header field parameter set to "BS" (busy subscriber) (NOTE 1)	← REL	Cause Indicator cause #17 with Diagnostic (CCBS indicator set to "CCBS possible") (NOTE 3)
→ INVITE	Request URI contains "m" SIP URI parameter or Call-Info header field contains "purpose" header field parameter set to "call-completion" and "m" header field parameter. (NOTE 1)	→ IAM	CCSS parameter set to "CCSS call" (NOTE 2) (NOTE 4)
<p>NOTE 1: The coding shall be in accordance with IETF RFC 6910 [106].</p> <p>NOTE 2: The coding shall be in accordance with ITU-T recommendation Q. 763 [4].</p> <p>NOTE 3: The coding shall be in accordance with ITU-T recommendation Q. 850 [38].</p> <p>NOTE 4: CCSS parameter set to the value "CCSS call" is included in the IAM if Request-URI contains the SIP URI parameter "m" i.e. creation of the CCSS parameter does not depend on the received value of the SIP URI parameter "m".</p>			

If the I-MGCF supports the interworking of CCBS/CCNR supplementary services, the I-MGCF shall map between the SIP and TCAP messages in accordance with table 7.5.11.1.2 and table 7.5.11.1.3.

Table 7.5.11.1.2: Mapping of SIP messages to TCAP messages

SIP Message	Parameter	TCAP Message	Parameter
SUBSCRIBE with m-parameter in Request URI set to "BS" or containing Call-Info header field with "purpose" parameter set to "call-completion" and m-parameter set to "BS" (NOTE 1)	Request URI (NOTE 5)	TC-Begin CCBS REQUEST (invoke)	CalledPartyNumber (NOTE 3)
	P-Asserted-Identity		CallingPartyNumber (NOTE 4)
			RetainSupported (NOTE 2)
SUBSCRIBE with m-parameter in Request URI set to "NR" or containing Call-Info header field with "purpose" parameter set to "call-completion" and m-parameter set to "NR" (NOTE 1)	Request URI (NOTE 5)	TC-Begin CCNR REQUEST (invoke)	CalledPartyNumber (NOTE 3)
	P-Asserted-Identity		CallingPartyNumber (NOTE 4)
			RetainSupported (NOTE 2)
PUBLISH with m-parameter in Request URI or m-parameter in Call-Info header field set to "BS" and body containing PIDF basic status set to "closed".		TC-Cont CCBS SUSPEND	
PUBLISH with m-parameter in Request URI or m-parameter in Call-Info header field set to "BS" and body containing PIDF basic status set to "open".		TC-Cont CCBS RESUME	
PUBLISH with m-parameter in Request URI or m-parameter in Call-Info header field set to "NR" and body containing PIDF basic status set to "closed".		TC-Cont CCBS SUSPEND	
PUBLISH with m-parameter in Request URI or m-parameter in Call-Info header field set to "NR" and body containing PIDF basic status set to "open".		TC-Cont CCBS RESUME	
SUBSCRIBE with m-parameter in Request URI or m-parameter in Call-Info header field set to "BS" and with Expires header set to "zero".		TC-End CCBS CANCEL	
SUBSCRIBE with m-parameter in Request URI or m-parameter in Call-Info header field set to "NR" and with Expires header set to "zero".		TC-End CCBS CANCEL	
NOTE 1: Expires header defines subscription duration / CC service duration timer (CC-T3). NOTE 2: Parameter is set by default, as retention option is supported in IMS by default. NOTE 3: Mapping of the Request URI header field to the CalledPartyNumber is done according to table 2 in clause 7.2.3.1.2.1. NOTE 4: Mapping of the P-Asserted Identity header field to the CallingPartyNumber is done according to table 5 in clause 7.2.3.1.2.6. NOTE 5: If URI of the MGCF was returned in the Call-Info header field in the 180 Ringing or 486 Busy here messages described in table 7.5.11.1.1, then the MGCF needs to remember the Request URI of the original INVITE for mapping to the CalledPartyNumber.			

Table 7.5.11.1.3: Mapping of TCAP messages to SIP messages

TCAP Message	Parameter	SIP Message	Parameter
TC-Cont CCBS REQUEST (return result)	RetainSupported	NOTIFY with cc-state parameter set to "queued"	cc-service-retention
TC-End CCBS/CCNR REQUEST (error result)	ShortTermDenial	480 Temporarily unavailable	
TC-End CCBS/CCNR REQUEST (error result)	LongTermDenial	403 Forbidden	
TC-End CCBS CANCEL		NOTIFY with the "reason" Subscription-State header field parameter set to "noresource"	
TC-Cont REMOTE USER FREE		NOTIFY with cc-state set to "ready" (NOTE 1)	
NOTE 1: This does not terminate the subscription AS-AS.			

7.5.11.2 Interworking at the O-MGCF

If the O-MGCF supports the interworking of CCBS/CCNR supplementary services, the O-MGCF shall map between the ISUP and SIP messages in accordance with table 7.5.11.2.1.

Table 7.5.11.2.1: Mapping of SIP and ISUP messages

ISUP Message	Parameter	SIP Message	Parameter
← ACM	Called party's status indicator set to "Subscriber free" and CCNR possible indicator set to "CCNR possible" (NOTE 2)	← 180 Ringing	Call-Info header field with purpose header field parameter set to "call-completion" (NOTE 1)
← CPG	Event indicator set to "Alerting" and CCNR possible indicator set to "CCNR possible" (NOTE 2) (NOTE 4)		
← REL	Cause Indicator cause #17 or #34 with Diagnostic (CCBS indicator set to "CCBS possible") (NOTE 3)	← 486 Busy here	Call-Info header field with purpose header field parameter set to "call-completion" (NOTE 1)
→ IAM	CCSS parameter set to "CCSS call" (NOTE 2)	→ INVITE	Request URI contains m-parameter and a Call-Info header field field, with purpose header field parameter set to "call-completion", and an m-parameter (NOTE 1) (NOTE 5)
NOTE 1: The coding shall be in accordance with IETF RFC 6910 [106]. NOTE 2: The coding shall be in accordance with ITU-T recommendation Q. 763 [4]. NOTE 3: The coding shall be in accordance with ITU-T recommendation Q. 850 [38]. NOTE 4: A CPG will be sent if an ACM was already sent. NOTE 5: Based on the operator policy the "m" SIP URI parameter in the Request-URI and m-parameter in Call-Info header field is set to the value "BS" or "NR".			

If the O-MGCF supports the interworking of CCBS/CCNR supplementary services, the O-MGCF shall map between the TCAP and SIP messages in accordance with table 7.5.11.2.2 and table 7.5.11.2.3.

Table 7.5.11.2.2: Mapping of TCAP messages to SIP messages

TCAP Message	Parameter	SIP Message	Parameter
TC-Begin CCBS REQUEST (invoke)	CalledPartyNumber	SUBSCRIBE with m-parameter in Request URI and m-parameter in Call-Info header field set to "BS" (NOTE 1)	To header (NOTE 2)
	CallingPartyNumber		Request-URI (NOTE 2)
TC-Begin CCNR REQUEST (invoke)	CalledPartyNumber	SUBSCRIBE with m-parameter in Request URI and m-parameter in Call-Info header field set to "NR" (NOTE 1)	From header (NOTE 3)
	CallingPartyNumber		P-Asserted-Identity (NOTE 4)
TC-Cont CCBS SUSPEND		PUBLISH with m-parameter in Request URI and m-parameter in Call-Info header field set to "BS" and body containing PIDF basic status set to "closed".	
		PUBLISH with m-parameter in Request URI and m-parameter in Call-Info header field set to "NR" and body containing PIDF basic status set to "closed".	
TC-Cont CCBS RESUME		PUBLISH with m-parameter in Request URI and m-parameter in Call-Info header field set to "BS" and body containing PIDF basic status set to "open".	
		PUBLISH with m-parameter in Request URI and m-parameter in Call-Info header field set to "NR" and body containing PIDF basic status set to "open".	
TC-End CCBS CANCEL		SUBSCRIBE with m-parameter in Request URI and m-parameter in Call-Info header field set to "BS" and with Expires header set to "0"	
		SUBSCRIBE with m-parameter in Request URI and m-parameter in Call-Info header field set to "NR" and with Expires header set to "0"	
<p>NOTE 1: Expires header defines subscription duration / CC service duration timer (CC-T3).</p> <p>NOTE 2: For the mapping of the CalledPartyNumber to the To header and Request-URI see table 10a in clause 7.2.3.2.2.1.</p> <p>NOTE 3: For the mapping of the CallingPartyNumber to the From header see table 15 in clause 7.2.3.2.2.3. If no CallingPartyNumber is available, the From header shall be set to a SIP URI with addr-spec of Unavailable User Identity as defined in TS 23.003 [74].</p> <p>NOTE 4: For the mapping of the CallingPartyNumber to the P-Asserted-Identity header see table 14 in clause 7.2.3.2.2.3. If no CallingPartyNumber is available, a P-Asserted-Identity header shall not be inserted.</p>			

Table 7.5.11.2.3: Mapping of SIP messages to TCAP messages

SIP Message	Parameter	TCAP Message	Parameter
NOTIFY with cc-state parameter set to "queued"	cc-service-retention	TC Cont CCBS/CCNR REQUEST (return result)	RetainSupported
480 Temporarily unavailable		TC-End CCBS/CCNR REQUEST (error result)	ShortTermDenial
403 Forbidden		TC-End CCBS/CCNR REQUEST (error result)	LongTermDenial
NOTIFY with the Subscription-State header field set to "terminated" and the "reason" parameter set to "noresource"		TC-End CCBS CANCEL	
NOTIFY with cc-state set to "ready" (NOTE)		TC-Cont REMOTE USER FREE	
NOTE: This does not terminate the subscription AS-AS.			

7.5.12 Communication Waiting (CW)

7.5.12.0 General

The protocol specification of the Communication Waiting supplementary service is described in 3GPP TS 24.615 [111].

7.5.12.1 Interworking at the I-MGCF

With regard to the backward messages of the Call Waiting PSTN/ISDN supplementary service, the following mapping is valid:

Table 7.5.12.1: Mapping of ISUP messages to SIP Messages

→Message Received from BICC/ISUP	→Message sent to SIP
ACM or CPG with generic notification indicator "Call is a waiting call" (NOTE 1).	180 Ringing with an Alert-Info header field set to "urn:alert:service:call-waiting" (NOTE 2).
NOTE 1: The coding shall be in accordance with ITU-T recommendation Q.733 [42].	
NOTE 2: The coding shall be in accordance with IETF RFC 7462 [107].	

7.5.12.2 Interworking at the O-MGCF

With regard to the backward messages of the Communication Waiting service, the following mapping is valid:

Table 7.5.12.2: Mapping of SIP messages to ISUP messages

←Message sent to ISUP	←Message Received from SIP
ACM or CPG with generic notification indicator "Call is a waiting call" (NOTE 1).	180 Ringing with an Alert-Info header field set to "urn:alert:service:call-waiting" (NOTE 2).
NOTE 1: The coding shall be in accordance with ITU-T recommendation Q733 [42].	
NOTE 2: The coding shall be in accordance with IETF RFC 7462 [107].	

7.5.13 Customized Alerting Tones (CAT)

7.5.13.1 General

The Customized Alerting Tones supplementary service is described in 3GPP TS 24.182 [132].

The interworking procedures in this clause enable the transport of customized alerting tones provided by an AS in the IM CN subsystem towards a caller in a CS network.

Based on operator options, one of three different models described in 3GPP TS 24.182 [132] is used in an IM CN subsystem to provide the CAT service. The CAT interworking procedures at the O-MGCF differ between these models and are described in 6.6.1 for each model in the subsequent clauses. Support of the interworking procedures for each of those models is optional.

I-MGCF procedures are not affected.

7.5.13.2 Early session model

7.5.13.2.1 Interworking at the O-MGCF

When CAT service is provided by using early session model as specified in 3GPP TS 24.182 [132], and if the O-MGCF supports early-session as a network option, then it shall include the option tag "early-session", as defined in IETF RFC 3959 [131], in Supported header field in each outgoing initial SIP INVITE request.

After receiving the first SIP 18x response including an early-session SDP, then the O-MGCF shall send the address complete message (ACM) or Call Progress message (CPG) with the Optional backward call indicators parameter set to "in-band information or an appropriate pattern is now available". If the SIP 18x response is the SIP 180 Ringing

response, then additionally the Called party's status indicator in the ACM message shall be set to "subscriber free" or the Event information in the CPG message shall be set to "ALERTING".

If the O-MGCF applies codec interworking procedures according to Annex B, it shall interwork the "session" disposition SDP (rather than the "early session" disposition SDP).

7.5.13.2.2 MGCF – IM-MGW Interaction for CAT service

7.5.13.2.2.1 General

When the IMS CAT is provided by using early session model as described in 3GPP TS 24.182 [132], the procedures described in clauses 9.2.3.1 to 9.2.3.3 shall be applied with the following additions.

7.5.13.2.2.2 IM CN subsystem side Early Session establishment

If the MGCF supports early-session as a network option, upon receipt of a SIP 18x response with an early-session SDP, the MGCF shall use the Configure IMS Resources procedure (signals 10 and 11 in figure 7.5.13.2.2.5-1, signals 7 and 8 in figure 7.5.13.2.2.5-2) to provide configuration data (derived from early session SDP received in signal 8 in figure 7.5.13.2.2.5-1 and local configuration data) to the IM-MGW as detailed below:

- The MGCF shall indicate the remote IP address and UDP port, i.e. the destination IP address and UDP port for data sent in the user plane towards the IM CN subsystem,
- The MGCF shall indicate the remote codec(s), i.e. the speech codec(s) for data sent in the user plane towards the IM CN subsystem.
- The MGCF should select the same codec(s) for early-session SDP with the codec(s) used for normal session SDP.
- The MGCF may indicate the local codec(s) and the local IP address and UDP port. The MGCF shall indicate the local codec(s) if a change is required.
- The MGCF may indicate that IP interface type is for MboIP.

The IM-MGW shall reply with the selected remote codec(s) and reserve resources for these codec(s). If local codec(s) were received, the IM-MGW shall also reply with the selected local codec(s) and reserve the corresponding resources.

The MGCF shall send the local codec(s), UDP port and IP address in the early-session SDP to the IMS in the PRACK messages (signal 12 in figure 7.5.13.2.2.5-1 and 7.5.13.2.2.5-2).

7.5.13.2.2.3 IM CN subsystem side normal Session establishment

When the MGCF receives a SIP 200(OK) response to the SIP INVITE request (signal 14 in figure 7.5.13.2.2.5-1, signal 15 in figure 7.5.13.2.2.5-2), it shall request the IM-MGW use the Configure IMS Resources procedure for normal session SDP (signals 15 and 16 in figure 7.5.13.2.2.5-1, signal 16 and 17 in figure 7.5.13.2.2.5-2) to provide configuration data (derived from SDP received in signal 8 in figure 7.5.13.2.2.5-1 and local configuration data) to the IM-MGW as detailed below:

- The MGCF shall indicate the remote IP address and UDP port, i.e. the destination IP address and UDP port for data sent in the user plane towards the IM CN subsystem,
- The MGCF shall indicate the remote codec(s), i.e. the speech codec(s) for data sent in the user plane towards the IM CN subsystem.
- The MGCF may indicate the local codec(s) and the local IP address and UDP port. The MGCF shall indicate the local codec(s) if a change is required.
- The MGCF may indicate that IP interface type is for MboIP.

The IM-MGW shall reply with the selected remote codec(s) and reserve resources for these codec(s). If local codec(s) were received, the IM-MGW shall also reply with the selected local codec(s) and reserve the corresponding resources.

7.5.13.2.2.4 Called party alerting

If the MGCF supports early-session as a network option, upon receipt of a SIP 18x provisional response with an early-session SDP, the MGCF shall not request the IM-MGW to provide an awaiting answer indication (ringing tone) to the calling party.

Editor's Note: The interaction with other supplementary services are FFS.

7.5.13.2.2.5 Message sequence chart

Figure 7.5.13.2.2.5-1 shows an example message sequence chart for an CS network originating Session Setup with ISUP, where IMS CAT is provided by early session model.

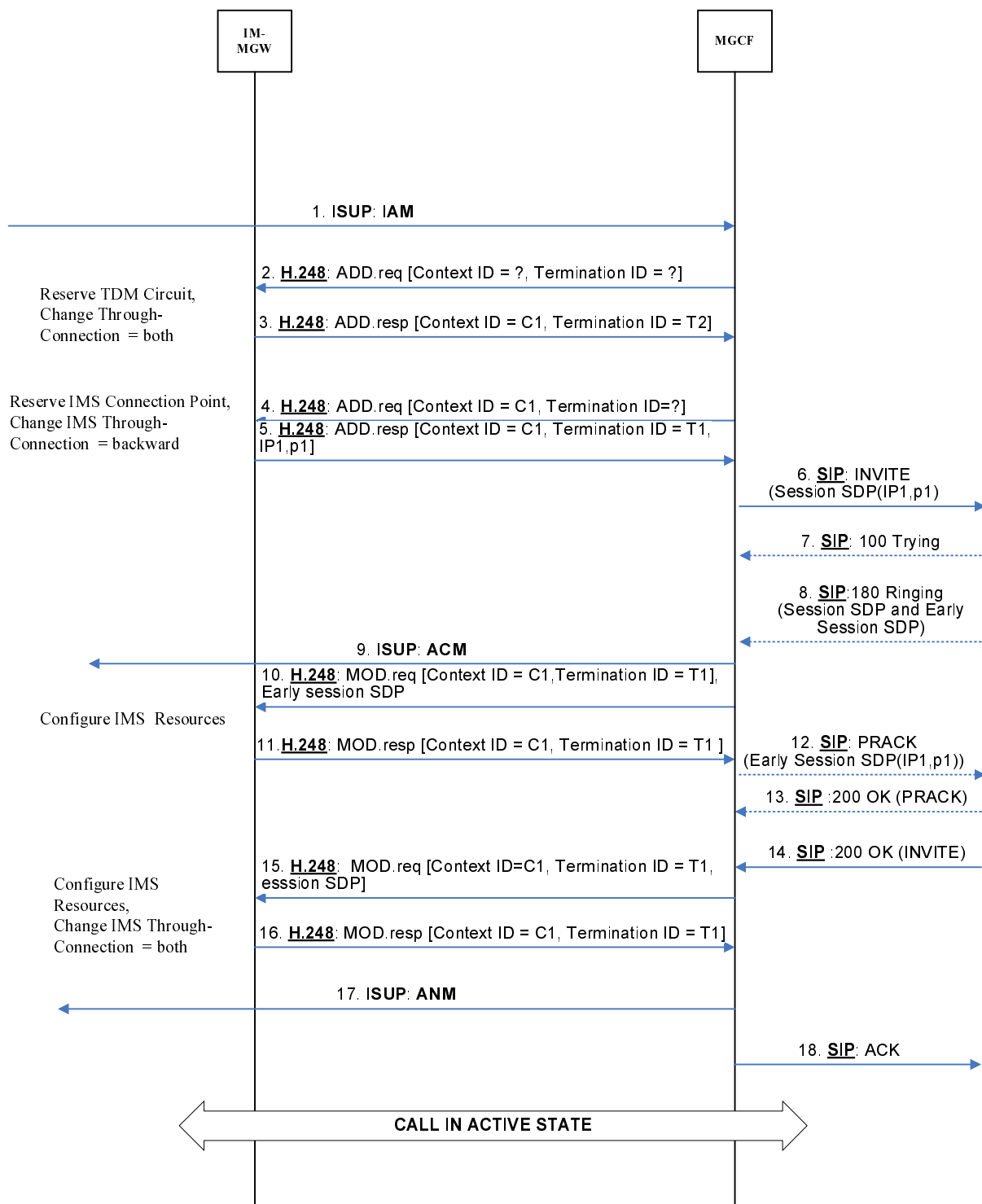

Figure 7.5.13.2.2.5-1: CS Network Originating Session with Early Session SDP, ISUP (message sequence chart)

Figure 7.5.13.2.2.5-2 shows an example message sequence chart for an CS network originating Session Setup with BICC, where IMS CAT is provided by early session model.

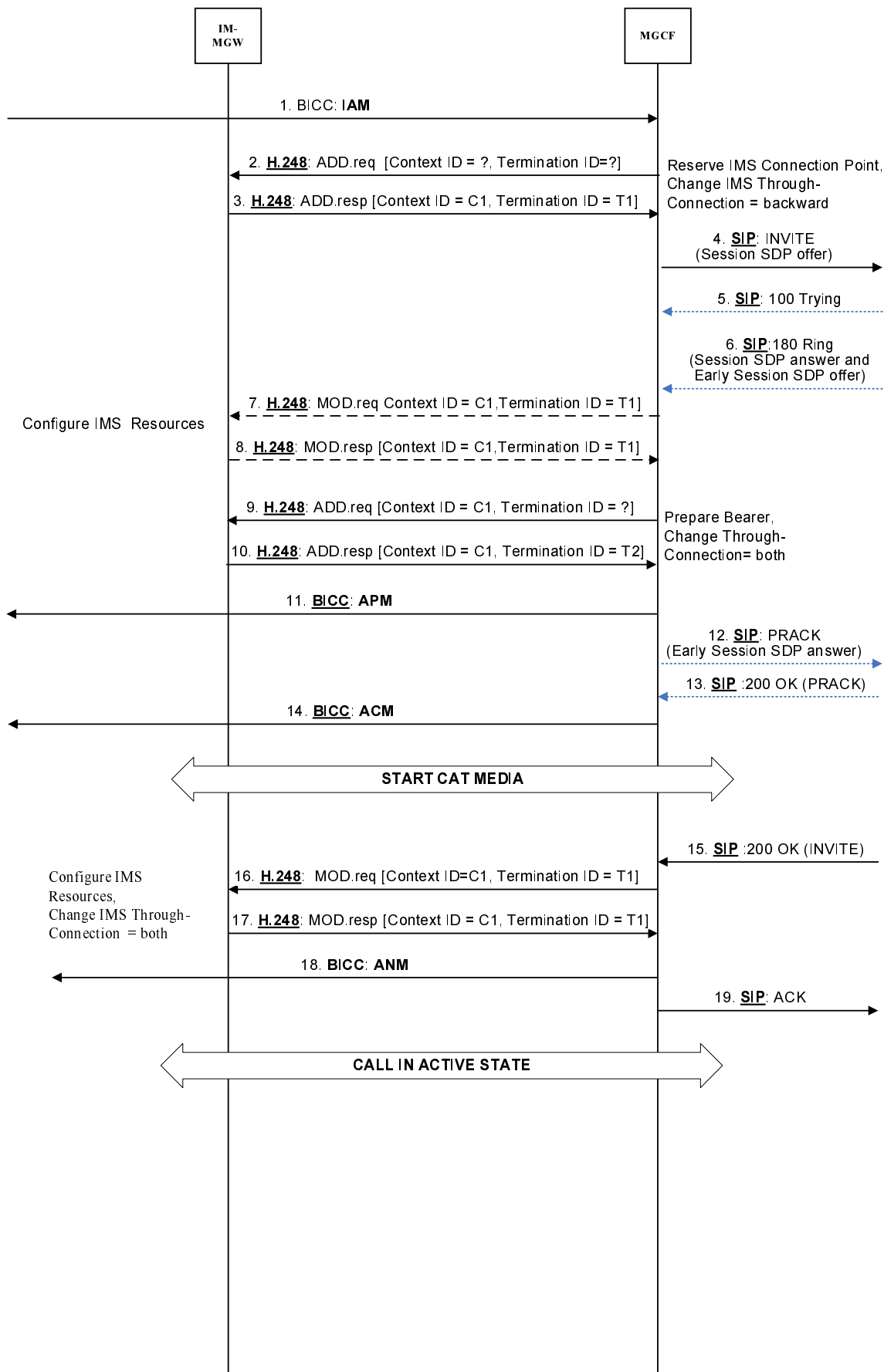

Figure 7.5.13.2.2.5-2: CS Network Originating Session with Early Session SDP, BICC (message sequence chart)

7.5.13.3 Forking model

Interworking at O-MGCF follows the basic call interworking procedures using the P-Early-Media header field and related procedures as described in clause 7.2.3.2.1, 7.2.3.2.2, 7.2.3.2.4, 7.2.3.2.5, 7.2.3.2.6, 7.2.3.2.7, 7.2.3.2.8, and 7.2.3.2.9.

The O-MGCF shall apply the procedures in clause 9.2.3.4 and shall use the P-Early-Media header field that authorizes early media as trigger to configure the IM-MGW as described in Clause 9.2.3.4.2.

7.5.13.4 Gateway model

Interworking at O-MGCF follow the basic call interworking procedures using the P-Early-Media header field and related procedures as described in clause 7.2.3.2.1, 7.2.3.2.2, 7.2.3.2.4, 7.2.3.2.5, 7.2.3.2.6, 7.2.3.2.7, 7.2.3.2.8, and 7.2.3.2.9.

Example callflows are shown in annex J

8 User plane interworking

8.1 Interworking between IM CN subsystem and bearer independent CS network

When the IM CN subsystem interworks with the bearer independent CS networks (e.g. CS domain of a PLMN, 3GPP TS 29.414 [25], 3GPP TS 29.415 [26], 3GPP TS 23.205 [27]), the Transport Network Layer (TNL) of the bearer independent CS network can be based e.g. on IP/UDP/RTP, or IP/UDP/RTP/IuFP, or ATM/AAL2/ framing protocol (e.g. Iu framing) transport techniques. Figure 31 shows the user plane protocol stacks for the IM CS subsystem and bearer independent CS network interworking. If the same AMR configuration is used on the CS network side as on the IMS side, transcoding is not required. However, there is still a need to interwork between RTP/UDP/IP/L2/L1 to TNL/L1.

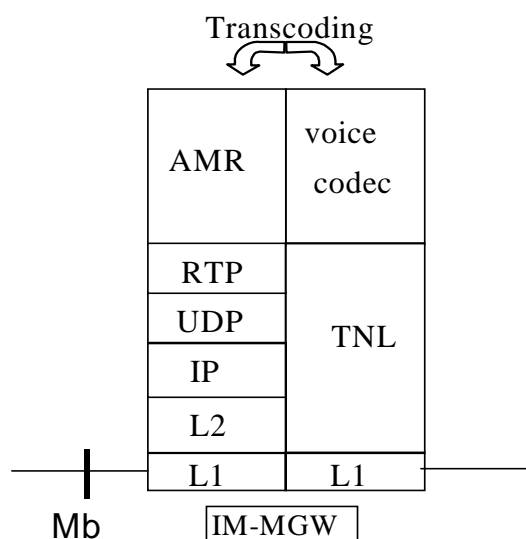

Figure 31/1: IM CN subsystem to bearer independent CS network user plane protocol stack

8.1.1 Transcoder-less Mb to Nb Interworking

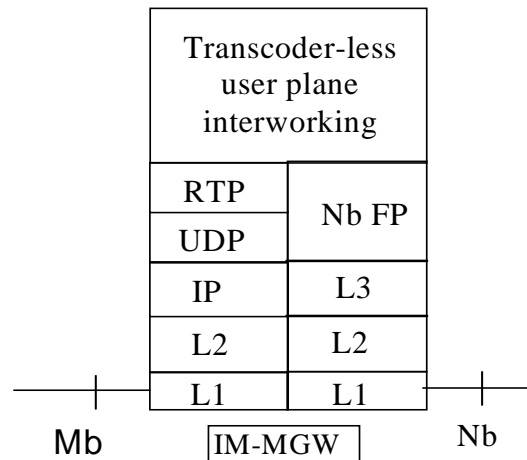

Figure 31/2: IM CN subsystem to bearer independent CS network user plane protocol stack (optional in the event the codecs on both sides are the same)

If no transcoder is inserted, the IM-MGW shall interwork the following procedures between the Nb and Mb interfaces.

8.1.1.1 Initialisation

There is no need to interwork initialisation procedures between Nb and Mb interfaces see 3GPP TS 29.415 [26].

8.1.1.2 Time alignment

The purpose of the time alignment procedure on the Nb interface is to minimise the buffer delay in the RNC for downlink transmissions by adjusting the vocoder time reference within the network. No such procedure exists on the Mb interface, so the IM-MGW shall return NACK indication time alignment not supported according to 3GPP TS 29.415 [26].

8.1.1.3 Rate control

The rate control procedure signals to the peer entity the maximum rate among the currently allowed rates at which it can receive codec frames. Rate control only applies to AMR family codec configurations with multiple active modes. On the Nb interface, IuFP provides for rate control via the exchange of RATE CONTROL and RATE CONTROL ACK PDUs. On the Mb interface, IETF RFC 4867 [23] provides for in-band rate control via the Codec Mode Request (CMR) field of every codec frame.

Interworking of rate control procedures at an IM-MGW between an Mb interface and a corresponding Nb interface only applies when the IM-MGW bridges compatible codec configurations between the interfaces without applying a transcoding function. An IM-MGW receiving a CMR from an Mb interface shall initiate the IuFP rate control procedure on the corresponding Nb interface. An IM-MGW receiving a rate control request on an Nb interface shall adjust the CMR field of outgoing speech frames on the corresponding Mb interface.

A IM-MGW may support the MTSI service defined in 3GPP TS 24.173 [88] and may then support codecs according to 3GPP TS 26.114 [104].

NOTE 1: Alternative codec specifications for the MTSI service are listed in 3GPP TS 24.173 [88].

If the IM-MGW supports the MTSI service with the codecs according to 3GPP TS 26.114 [104] the IM-MGW should support reception of RTCP-APP-CMR messages as specified in the clause 10.2.1 of 3GPP TS 26.114 [104] which can be sent by a MTSI client in the terminal. If the IM-MGW is in TrFO then RTCP-APP-CMR messages should be translated to the appropriate rate control method on the CS side (e.g. IuFP rate control or RTP based CMR) in the same way as for an RTP based CMR, described in the preceding paragraph.

NOTE 2: When the IM-MGW is transcoding at the Mb interface then any RTCP-APP-CMR requests received from the MTSI client in the terminal when the IM-MGW is transcoding will result in a change to DL codec mode towards the MTSI client terminal.

8.1.1.4 Frame quality indication

The Nb interface signals frame quality with the Frame Quality Classification (FQC) field of each speech frame PDU. See 3GPP TS 26.102 [50] and 3GPP TS 29.415 [26] for details. The FQC may have possible values: 0=frame_good; 1=frame_bad; 2=frame_bad_due_to_radio; and 3=spare. The Mb interface signals frame quality with the Q bit (frame quality indicator) field of each speech frame, as defined in IETF RFC 4867 [23]. The Q bit may have values: 1=speech_good; and 0=speech_bad or sid_bad.

Tables 24a and 24b provide the mapping between Mb and Nb interfaces.

Table 24a: Mapping of Mb (Q bit) onto Nb (FQC)

Mb – Qbit	Mb – FT	Nb – FQC
1	X	0
0	X	1

Table 24b: Mapping Nb onto Mb

Nb – FQC	Mb – Qbit	Mb – FT
0	1	NC
1	0	NO_DATA
2	0	NC

8.1.1.5 Framing

Even when the IM-MGW bridges compatible codec configurations between the Nb and Mb interfaces, the IM-MGW shall perform translation between the frame formats defined for the two interfaces, since all codec configurations have different framing procedures for the two interfaces. The framing details for Nb are defined in 3GPP TS 26.102 [50] and 3GPP TS 29.415 [26], although they do not describe the framing for ITU-T codecs other than G.711. The framing details for Mb are defined in IETF RFC 4867 [23], IETF RFC 3550 [51], IETF RFC 3551 [52] and IETF RFC 3555 [53].

8.1.1.6 Transcoding

Transcoding at the IM-MGW is avoided when the IM-MGW bridges compatible codec configurations between the Nb and Mb interfaces. Otherwise transcoding is necessary, which eliminates the need to interwork other user plane procedures between the interfaces.

8.1.1.7 Discontinuous transmission

When the IM-MGW bridges compatible codec configurations between the Nb and Mb interfaces, the DTX procedures are normally interworked transparently by translating between the framing formats on the interfaces. All the ITU-T and AMR family codecs have configurations that are compatible between the Mb and Nb interfaces.

8.1.1.8 Timing and sequence information

The IM-MGW shall always correct out-of-sequence delivery between Nb and Mb interfaces, either by re-ordering frames, or by dropping frames that are out of sequence.

When the IuFP frame numbers are based on time and if the IM-MGW bridges compatible codec configurations between the Nb and Mb interfaces, it shall either correct jitter before forwarding PDUs or interwork the RTP timestamp (see RFC 3550 [51]) with the IuFP Frame Number (see 3GPP TS 29.415 [26]) so that both the RTP timestamp and IuFP frame number similarly reflect the nominal sampling instant of the user data in the packet.

NOTE: Correcting jitter may cause additional delay.

The RTP sequence number (see RFC 3550 [51]) is handled independently on Mb, i.e. it is not interworked with the IuFP Frame Number (see 3GPP TS 29.415 [26]).

8.2 Interworking between IM CN subsystem and TDM-based CS network

It shall be possible for the IM CN subsystem to interwork with the TDM based CS networks (e.g. PSTN, ISDN or CS domain of a PLMN). Figure 32 describes the user plane protocol stack to provide the particular interworking.

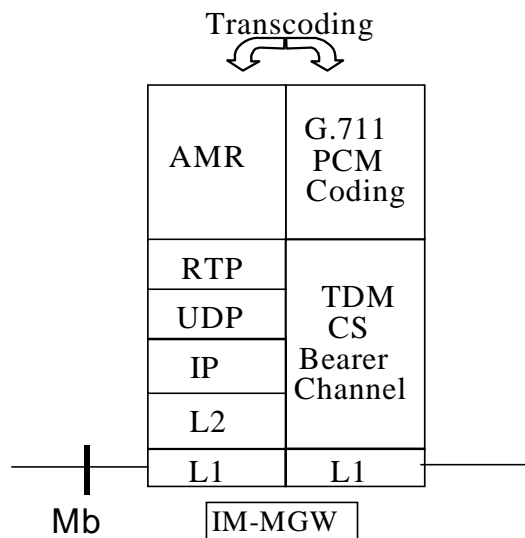

Figure 32: IM CN subsystem to TDM-based CS network user plane protocol stack

8.3 Transcoding requirements

The IM CN subsystem supports the AMR codec as the native codec for basic voice services. For IM CN subsystem terminations, the IM MGW shall support the transport of AMR over RTP according to IETF RFC 4867 [23]. The MGCF shall support the options of IETF RFC 4867 [23] listed within clause 5.1.1 of 3GPP TS 26.236 [32].

It shall be possible for the IM CN subsystem to interwork with the CS networks (e.g. PSTN, ISDN or a CS domain of a PLMN) by supporting AMR to G.711 transcoding (see ITU-T Recommendation G.711 [1]) in the IM-MGW. The IM-MGW may also perform transcoding between AMR and other codec types supported by CS networks.

8.4 Diffserv code point requirements

The IM-MGW shall perform DiffServ Code Point (DSCP) markings (see RFC 2474 [21]) on the IP packets sent towards the IM CN subsystem entity like UE or MRFP across the Mb interface to allow DiffServ compliant routers and GGSNs to schedule the traffic accordingly.

The IETF Differentiated Services architecture (see RFC 2475 [22]) shall be used to provide QoS for the external bearer service.

The DSCP shall be operator configurable.

8.5 DTMF handling

When sending DTMF inband towards the CS network, the MGW shall comply with the encoding requirements in 3GPP TS 23.014 [103]; in particular the requirements for the minimum length of a tone and for the minimum gap between two subsequent tones shall be ensured.

When detecting DTMF digits arriving from the CS side, the MGW shall comply with 3GPP TS 23.014 [103] (by checking that a valid digit with minimum duration and minimum gap has been received) before initiating an RTP Telephony Event to the IMS interface.

When sending DTMF towards the IMS side according to the IETF RFC 4733 [105] RTP Payload format, the MGW shall comply with the DTMF encoding requirements of Annex G.2 of 3GPP TS 26.114 [104], in particular the minimum duration of 65ms shall be ensured. It is optional if the RTP Telephony Event is sent as a number of "RTP Events" with interim durations (e.g. every 20ms or 40ms in line with the speech packetisation time) or as a single "RTP Event" with the at least 65ms duration.

9 MGCF – IM-MGW Interaction

9.1 Overview

The MGCF shall control the functions of the IM-MGW, which are used to provide the connection between media streams of an IP based transport network and bearer channels from a CS network.

The MGCF shall interact with the IM-MGW across the Mn reference point. The MGCF shall terminate the signalling across the Mn interface towards the IM-MGW and the IM-MGW shall terminate the signalling from the MGCF.

The signalling interface across the Mn reference point shall be defined in accordance with ITU-T Recommendation H.248.1 [2] and shall conform to 3GPP specific extensions as detailed in 3GPP TS 29.332 [15].

The present specification describes Mn signalling procedures and their interaction with BICC/ISUP and SIP signalling in the control plane, and with user plane procedures. 3GPP TS 29.332 [15] maps these signalling procedures to H.248 messages and defines the required packages and parameters.

9.2 Mn signalling interactions

The following paragraphs describe the Mn interface procedures triggered by SIP and BICC signalling relayed in MGCF.

The SIP signalling occurring at the MGCF is described in 3GPP TS 24.229 [9].

All message sequence charts in this clause are examples.

9.2.1 Network model

Figure 33 shows the network model, applicable to BICC and ISUP cases. The broken line represents the call control signalling. The dotted line represents the bearer control signalling (if applicable) and the user plane. The MGCF uses one context with two terminations in the IM-MGW. The termination T1 is used towards the IM CN subsystem entity and the bearer termination T2 is used for the bearer towards the succeeding CS network element.

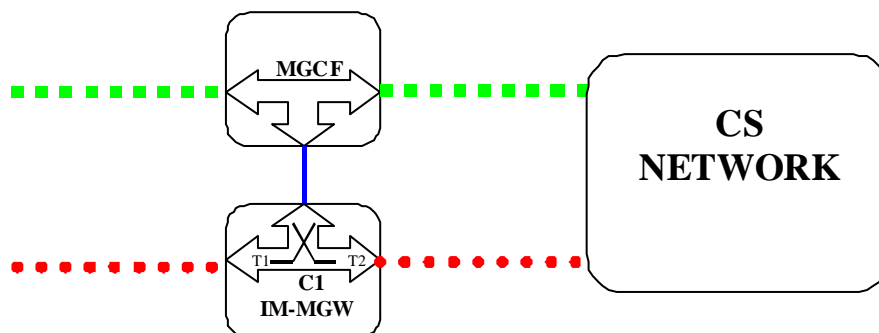

Figure 33: Network model

9.2.2 Basic IM CN subsystem originated session

9.2.2.1 BICC forward bearer establishment

9.2.2.1.1 IM-MGW selection

The MGCF shall select an IM-MGW for the bearer connection before it performs the CS network side bearer establishment. This may happen either before sending the IAM or after receiving the APM message (signal 5 or signal 6 in figure 34). In the latter case, the IM-MGW selection may be based on a possibly received MGW-id from the succeeding node.

9.2.2.1.2 CS network side bearer establishment

The MGCF shall either select bearer characteristics or request the IM-MGW to select and provide the bearer characteristics for the CS network side bearer connection before sending the IAM. In the latter case the MGCF shall use the Prepare Bearer procedure, not shown in figure 34, to request the IM-MGW to select the bearer characteristics. After the succeeding node has provided a bearer address and a binding reference in the APM, the MGCF shall use the Establish Bearer procedure to request the IM-MGW to establish a bearer towards the destination CS-MGW. The MGCF shall provide the IM-MGW with the bearer address, the binding reference and the bearer characteristics (signal 7 in figure 34).

9.2.2.1.3 IM CN subsystem side termination reservation

On receipt of an initial INVITE (signal 1 in figure 34) the MGCF shall initiate the Reserve IMS Connection Point and Configure Remote Resources procedure (signal 3 and 4 in figure 34). From the received SDP and local configuration data the MGCF:

- Shall send the appropriate remote codec(s), the remote UDP port and the remote IP address to the IM-MGW. The remote UDP port and IP address refer to the destination of user plane data sent towards the IM CN subsystem. The remote codec(s) are the codec(s) the IM-MGW may select for user plane data sent towards the IM CN subsystem.
- Shall indicate to the IM-MGW the appropriate local codec(s) and request a local IP address and UDP port. The local IP address and UDP port are used by the IM-MGW to receive user plane data from the IM CN subsystem. The local codec(s) are the codec(s) the IM-MGW may select to receive user plane data from the IM CN subsystem.
- If DTMF support together with speech support is required, the reserve value indicator shall be set to "true".
- May indicate that IP interface type is for MboIP.

The IM-MGW

- Shall reply to the MGCF with the selected local codec(s) and the selected remote codec(s) and the selected local UDP port and IP address.
- Shall reserve resources for those codec(s).

The MGCF shall send the local codec(s), UDP port and IP address to the IMS in the Session Progress (signal 9 in figure 34).

9.2.2.1.4 IM CN subsystem side session establishment

Dependent on what the MGCF receives in the PRACK message (signal 10 in figure 34), the MGCF may initiate the Configure IMS Resources procedure. If no SDP is received, or if the received SDP does not contain relevant changes compared to the previous SDP sent to the IMS in signal 9 in figure 34, the procedure is not invoked. Otherwise the MGCF shall use the Configure IMS Resources procedure to provide to the IM-MGW:

- The appropriate remote codec(s), the remote UDP port and the remote IP address.
- Optionally the appropriate local codec(s), UDP port and IP address.

- If DTMF support together with speech support is required, the reserve value indicator shall be set to "true".
- May indicate that IP interface type is for MboIP.

The IM-MGW shall:

- Reply to the MGCF with the selected remote codec(s),
- Reply to the MGCF with the selected local codec(s) if the MGCF supplied local codec(s),
- Update the codec reservation and remote IP address and remote UDP port in accordance with the received information.

The MGCF shall include the selected codec(s) and UDP port and IP address in a 200 OK (PRACK) (signal 11 in figure 34) sent back to the IMS.

9.2.2.1.5 Through-connection

During the Prepare Bearer and Establish Bearer procedures, the MGCF shall either use the Change Through-Connection procedure to request the IM-MGW to backward through-connect the BICC terminations, or the MGCF shall use this procedure to both-way through-connect the BICC termination already on this stage (signal 7 in figure 34). During the Reserve IMS Connection Point procedure:

- if the MGCF has been identified a call as an "ICS call" as specified in clause 7.3.3.1.2.12 the MGCF shall request the IM MGW to suspend sending media towards the IMS side by setting the through-connection of the IM CN subsystem side termination to "not through-connected" using the Change IMS Through Connection procedure (signal 3 in figure 34); and
- otherwise the MGCF shall use the Change IMS Through-Connection procedure to request the IM-MGW to backward through-connect the IMS termination (signal 3 in figure 34).

When the MGCF receives a BICC ACM or CPG message with an UID action indicators parameter with the through-connection instruction indicator set to "*through-connect in both directions*" the MGCF shall request the IM-MGW to both-way through-connect the terminations using the Change IMS Through-Connection or Change Through-Connection procedures (signal 18 in figure 34), unless those terminations are already both-way through-connected.

When the MGCF receives the BICC:ANM answer indication, it shall request the IM-MGW to both-way through-connect the termination using the Change Through-Connection or Change IMS Through-Connection procedures (signal 24 in figure 34), unless those terminations are already both-way through-connected.

9.2.2.1.6 Codec handling

The IM-MGW may include a speech transcoder based upon the speech coding information provided to each termination.

9.2.2.1.7 Failure handling in MGCF

If any procedure between the MGCF and the IM-MGW is not completed successfully the default action by the MGCF is to release the session, as described in clause 9.2.6. If the MGCF receives a Bearer Released procedure from the IM-MGW the default action by the MGCF is to release the session as described in clause 9.2.7.

NOTE: As an implementation option the MGCF may also decide for example to only release the resources in the IM-MGW that caused the failure, possibly select a new IM-MGW for the connection and continue the call establishment using new resources in the selected IM-MGW but such handling is outside of the scope of the present document.

9.2.2.1.8 Message sequence chart

Figure 34 shows the message sequence chart for the IM CN subsystem originating session with BICC forward bearer establishment where the selection of IM-MGW is done before the sending of the IAM. In the chart the MGCF requests the seizure of an IM CN subsystem side termination. When the APM is received from the succeeding node, the MGCF requests the seizure of a CS network side bearer termination and the establishment of the bearer. When the MGCF

receives an answer indication, it requests the IM-MGW to both-way through-connect the terminations. Dashed lines represent optional or conditional messages.

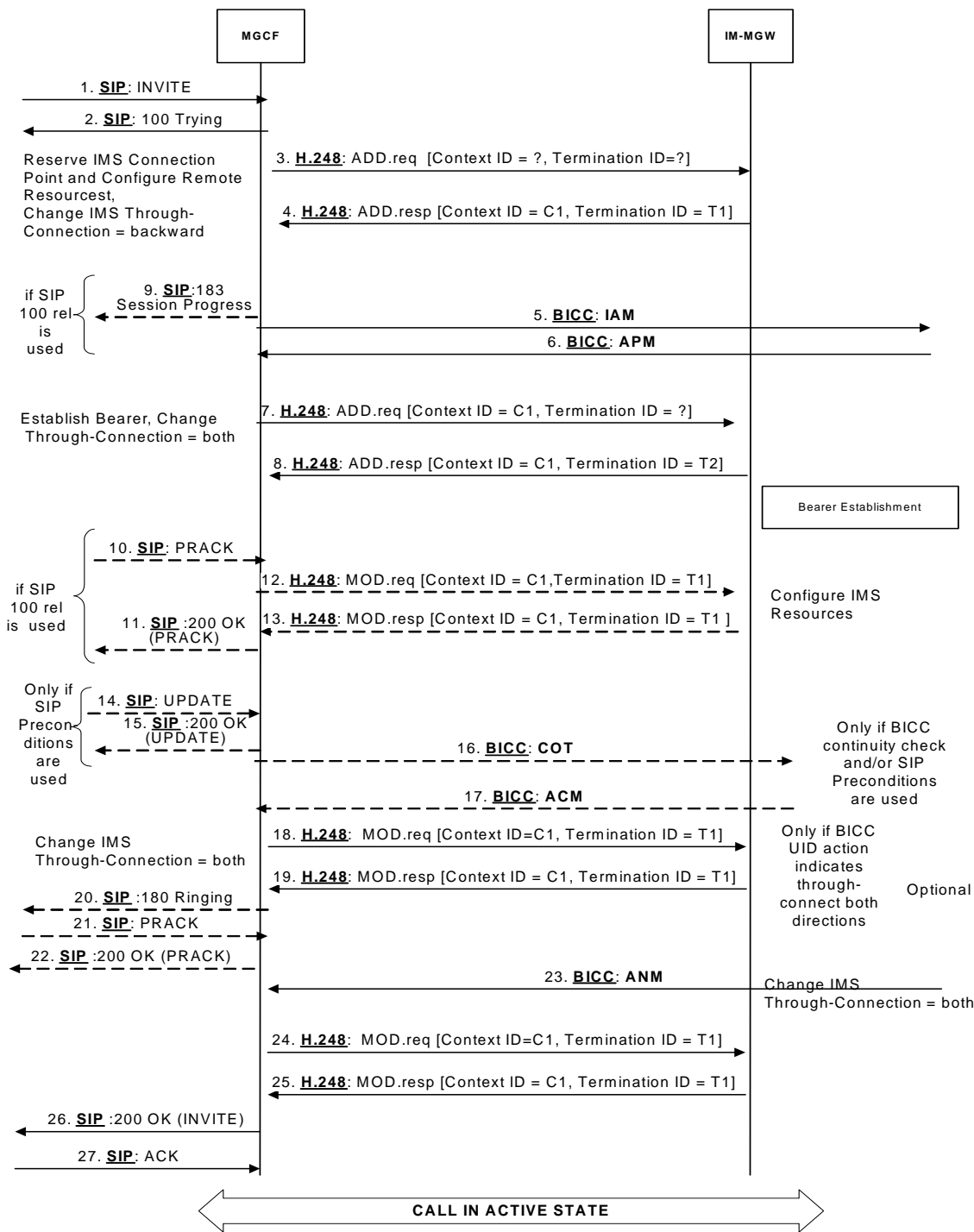

Figure 34: Basic IM CN Subsystem originating session, BICC forward bearer establishment (message sequence chart)

9.2.2.2 BICC backward bearer establishment

9.2.2.2.1 IM-MGW selection

The MGCF shall select an IM-MGW for the bearer connection before it performs the IM CN subsystem session establishment or the CS network side bearer establishment, and before it sends the IAM (signal 8 in figure 35).

9.2.2.2.2 IM CN subsystem side termination reservation

On receipt of an initial INVITE (signal 1 in figure 35) the MGCF shall initiate the Reserve IMS Connection Point and Configure Remote Resources procedure (signal 3 and 4 in figure 35). From the received SDP and local configuration data the MGCF:

- Shall send the appropriate remote codec(s), the remote UDP port and the remote IP address to the IM-MGW. The remote UDP port and IP address refer to the destination of user plane data sent towards the IM CN subsystem. The remote codec(s) are the codec(s) the IM-MGW may select for user plane data sent towards the IM CN subsystem.
- Shall indicate to the IM-MGW the appropriate local codec(s) and request a local IP address and UDP port. The local UDP port and IP address are used by the IM-MGW to receive user plane data from the IM CN subsystem. The local codec(s) are the codec(s) the IM-MGW may select to receive user plane data from the IM CN subsystem.
- If DTMF support together with speech support is required, the reserve value indicator shall be set to "true".
- May indicate that IP interface type is for MboIP.

The IM-MGW shall

- Reply to the MGCF with the selected local codec(s) and the selected remote codec(s) and the selected local UDP port and IP address.
- Reserve resources for those codec(s).

The MGCF shall send the local codec(s), UDP port and IP address to the IMS in the Session Progress (signal 5 in figure 35).

9.2.2.2.3 IM CN subsystem side session establishment

Dependent on what the MGCF receives in the PRACK message (signal 9 in figure 35) the MGCF may initiate the Select Configure IMS Resources procedure (signals 10 and 11 in figure 35). If no SDP is received, or if the received SDP does not contain relevant changes compared to the previous SDP the procedure is not invoked. Otherwise the MGCF shall use the Configure IMS Resources procedure to provide to the IM-MGW:

- the appropriate remote codec(s), the remote UDP port and the remote IP address.
- optionally if DTMF support together with speech support is required, the reserve value indicator shall be set to "true".
- May indicate that IP interface type is for MboIP.

The IM-MGW shall:

- Reply to the MGCF with the selected remote codec(s).
- Reply to the MGCF with the selected local codec(s), if the MGCF supplied local codec(s).
- Update the codec reservation and remote IP address and remote UDP port in accordance with the received information.

The MGCF shall include the selected codec(s), IP address and UDP port in an 200 OK (PRACK) (signal 12 in figure 35) sent back to the IMS

9.2.2.2.4 CS network side bearer establishment

The MGCF shall request the IM-MGW to prepare for the CS network side bearer establishment using the Prepare Bearer procedure before sending the IAM to the succeeding node. Within this procedure, the MGCF shall request the IM-MGW to provide a bearer address and a binding reference, and the MGCF shall either provide the IM-MGW with the preferred bearer characteristics or it shall request the IM-MGW to select and provide the bearer characteristics (signal 6 in figure 35). After the IM-MGW has replied with the bearer address, the binding reference and the bearer characteristics (if requested), the MGCF sends the IAM to the succeeding node (signal 8 in figure 35).

9.2.2.2.5 Through-connection

During the Prepare Bearer procedure, the MGCF shall either use the Change Through-Connection procedure to request the IM-MGW to backward through-connect the BICC termination, or the MGCF shall use this procedure to both-way through-connect the BICC termination already on this stage (signal 6 in figure 35). During the Reserve IMS Connection Point procedure:

- if the MGCF has been identified a call as an "ICS call" as specified in clause 7.3.3.1.2.12 the MGCF shall request the IM-MGW to suspend sending media towards the IMS side by setting the through-connection of the IM CN subsystem side termination to "not through-connected" using the Change IMS Through-Connection procedure (signal 3 in figure 35); and
- otherwise the MGCF shall use the Change IMS Through-Connection procedure to request the IM-MGW to backward through-connect the IMS termination (signal 3 in figure 35).

When the MGCF receives an BICC ACM or CPG message with an UID action indicators parameter with the through-connection instruction indicator set to "*through-connect in both directions*" the MGCF shall request the IM-MGW to both-way through-connect the terminations using the Change IMS Through-Connection or Change Through-Connection procedures (signal 17 in figure 35), unless those terminations are already both-way through-connected.

When the MGCF receives the BICC:ANM answer indication, it shall request the IM-MGW to both-way through-connect the terminations using the Change Through-Connection or Change IMS Through-Connection procedures (signal 23 in figure 35), unless those terminations are already both-way through-connected.

9.2.2.2.6 Codec handling

The IM-MGW may include a speech transcoder based upon the speech coding information provided to each termination.

9.2.2.2.7 Failure handling in MGCF

If any procedure between the MGCF and the IM-MGW is not completed successfully the default action by the MGCF is to release the session as described in clause 9.2.6. If the MGCF receives a Bearer Released procedure from the IM-MGW the default action by the MGCF is to release the session, as described in clause 9.2.7.

NOTE: As an implementation option the MGCF may also decide for example to only release the resources in the IM-MGW that caused the failure, possibly select a new IM-MGW for the connection and continue the call establishment using new resources in the selected IM-MGW but such handling is outside of the scope of the present document.

9.2.2.2.8 Message sequence chart

Figure 35 shows the message sequence chart for the IM CN subsystem originating session with BICC backward bearer establishment. In the chart the MGCF requests the seizure of an IM CN subsystem side termination and a CS network side bearer termination. When the MGCF receives an answer indication, it requests the IM-MGW to both-way through-connect the terminations. Dashed lines represent optional or conditional messages.

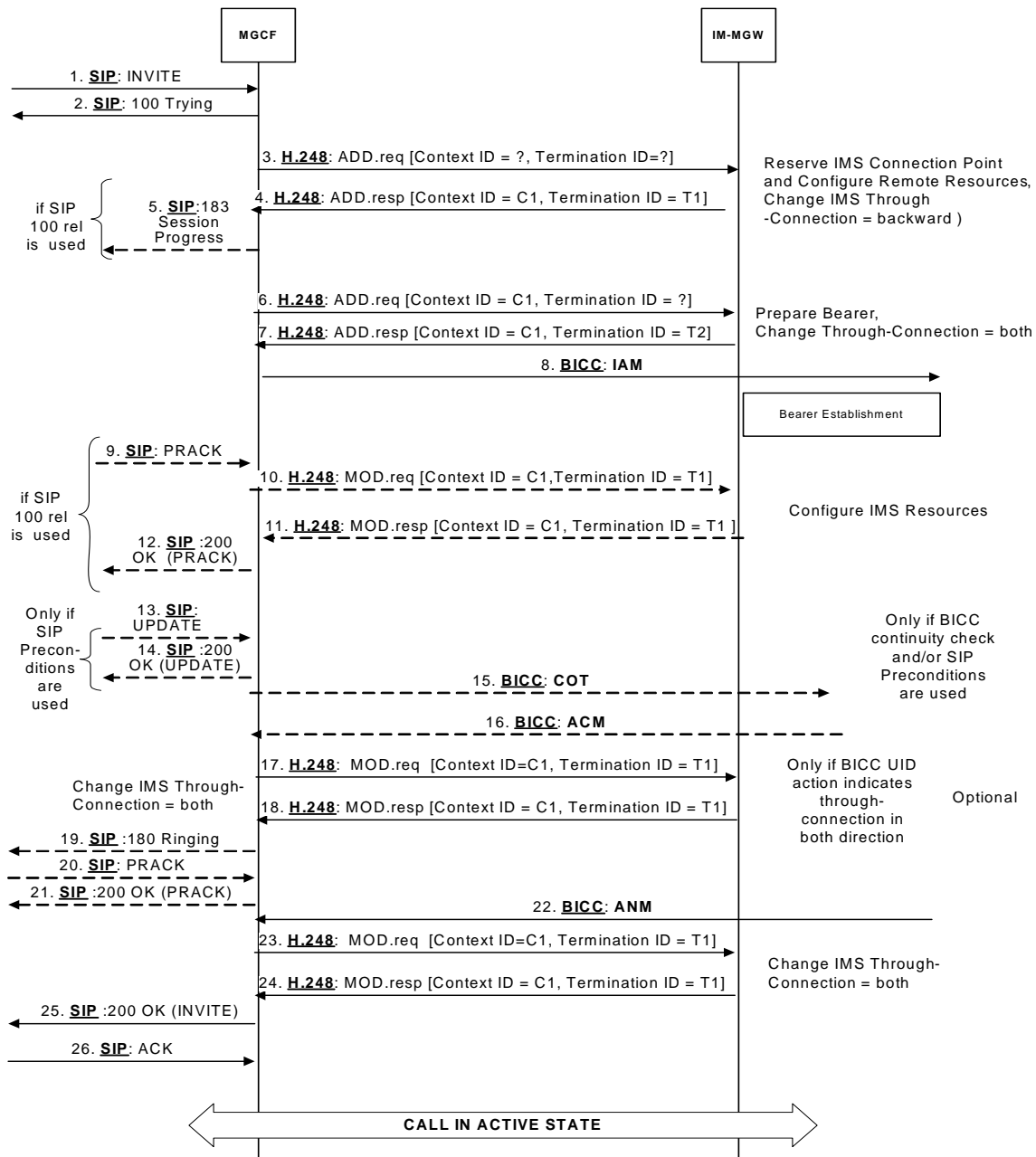

Figure 35: Basic IM CN Subsystem originating session, BICC backward bearer establishment (message sequence chart)

9.2.2.3 ISUP

9.2.2.3.1 IM-MGW selection

The MGCF shall select an IM-MGW with circuits to the given destination in the CS domain before it performs the IM CN subsystem session establishment and before it sends the IAM (signal 8 in figure 36).

9.2.2.3.2 IM CN subsystem side termination reservation

On receipt of an initial INVITE (signal 1 in figure 36) the MGCF shall initiate the Reserve IMS Connection Point and Configure Remote Resources procedure (signal 3 and 4 in figure 36). From the received SDP and local configuration data the MGCF:

- shall send the appropriate remote codec(s), the remote UDP port and the remote IP address to the IM-MGW. The remote UDP port and IP address refer to the destination of user plane data sent towards the IM CN subsystem.

The remote codec(s) are the codec(s) the IM-MGW may select for user plane data sent towards the IM CN subsystem.

- shall indicate to the IM-MGW the appropriate local codec(s) and request a local IP address and UDP port. The local IP address and UDP port are used by the IM-MGW to receive user plane data from the IM CN subsystem. The local codec(s) are the codec(s) the IM-MGW may select to receive user plane data from the IM CN subsystem.
- If DTMF support together with speech support is required, the reserve value indicator shall be set to "true".
- May indicate that IP interface type is for MboIP.

The IM-MGW shall

- reply to the MGCF with the selected local codec(s) and the selected remote codec(s) and the selected local UDP port and IP address.
- reserve resources for those codec(s).

The MGCF shall send selected local codec(s) and the selected remote codec and the selected local UDP port and IP address to the IMS in the Session Progress (signal 5 in figure 36)

9.2.2.3.3 IM CN subsystem side session establishment

Dependent on what the MGCF receives in the PRACK message (signal 9 in figure 35) the MGCF may initiate the Configure IMS Resources procedure. If no SDP is received, or if the received SDP does not contain relevant changes compared to the previous SDP, the procedure is not invoked. Otherwise the MGCF shall use the Configure IMS Resources procedure to provide to the IM-MGW:

- the appropriate remote codec(s), the remote UDP port and the remote IP address.
- optionally the appropriate local codec(s), UDP port and IP address.
- If DTMF support together with speech support is required, the reserve value indicator shall be set to "true".
- May indicate that IP interface type is for MboIP.

The IM-MGW shall:

- reply to the MGCF with the selected remote codec.
- reply to the MGCF with the selected local codec(s), if the MGCF supplied local codec(s).
- update the codec reservation and remote IP address and UDP port in accordance with the received information.

The MGCF shall include the selected codec(s) UDP port and IP address in 200 OK (PRACK) (signal 12 in figure 36) sent back to the IMS.

9.2.2.3.4 CS network side circuit reservation

The MGCF shall request the IM-MGW to reserve a circuit using the Reserve TDM Circuit procedure. The MGCF sends the IAM to the succeeding node including the reserved circuit identity.

9.2.2.3.5 Through-connection

During the Reserve TDM Circuit and Reserve IMS Connection Point procedures, the MGCF shall either use the Change TDM Through-Connection procedure to request the IM-MGW to backward through-connect the termination, or the MGCF shall use this procedure to both-way through-connect the TDM termination already on this stage (signal 6 in figure 36). During the Reserve IMS connection Point procedure:

- if the MGCF has been identified a call as an "ICS call" as specified in clause 7.2.3.1.2.12 the MGCF shall request the IM-MGW to suspend sending media towards the IMS side by setting the through-connection of the IM CN subsystem side termination to "not through-connected" using the Change IMS Through-Connection procedure (signal 3 in figure 36); and

- otherwise the MGCF shall use the Change IMS through-connection procedure to request the IM-MGW to backward through-connect the IMS termination (signal 3 in figure 36).

When the MGCF receives an ISUP ACM or CPG message with an UID action indicators parameter with the through-connection instruction indicator set to "*through-connect in both directions*" the MGCF shall request the IM-MGW to both-way through-connect the terminations using the Change IMS Through-Connection or Change TDM Through-Connection procedures (signal 17 in figure 36), unless those terminations are already both-way through-connected.

When the MGCF receives the ISUP:ANM answer indication, it shall request the IM-MGW to both-way through-connect the terminations using the Change IMS Through-Connection or Change TDM Through-Connection procedures (signal 23 in figure 36), unless those terminations are already both-way through-connected.

9.2.2.3.6 Continuity check

The MGCF may request a continuity check on the connection towards the CS network within the IAM message. In this case, the MGCF shall use the Continuity Check procedure towards the IM-MGW to request the generation of a continuity check tone on the TDM termination. The IM-MGW shall then use the Continuity Check Verify procedure to notify the MGCF of an incoming continuity check tone on the corresponding circuit. In addition to other conditions detailed in clause 7, the MGCF shall wait until receiving this notification before sending the COT. (Not depicted in figure 36)

9.2.2.3.7 Codec handling

The IM-MGW may include a speech transcoder based upon the speech coding information provided to each termination.

9.2.2.3.8 Voice processing function

A voice processing function located on the IM-MGW may be used to achieve desired acoustic quality on the terminations. If the voice processing function is used, the MGCF shall request the activation of it in the termination towards the CS network using the Activate TDM Voice Processing Function procedure (signal 23 in figure 36).

9.2.2.3.9 Failure handling in MGCF

If any procedure between the MGCF and the IM-MGW is not completed successfully session shall be released as described in clause 9.2.6. If the MGCF receives a Bearer Released procedure from the IM-MGW the default action by the MGCF is to release the session as described in clause 9.2.7.

9.2.2.3.10 Message sequence chart

Figure 36 shows the message sequence chart for the IM CN subsystem originating session. In the chart the MGCF requests the seizure of an IM CN subsystem side termination and a CS network side bearer termination. When the MGCF receives an answer indication, it requests the IM-MGW to both-way through-connect the terminations. The MGCF requests the possible activation of the voice processing functions for the bearer terminations. Dashed lines represent optional or conditional messages.

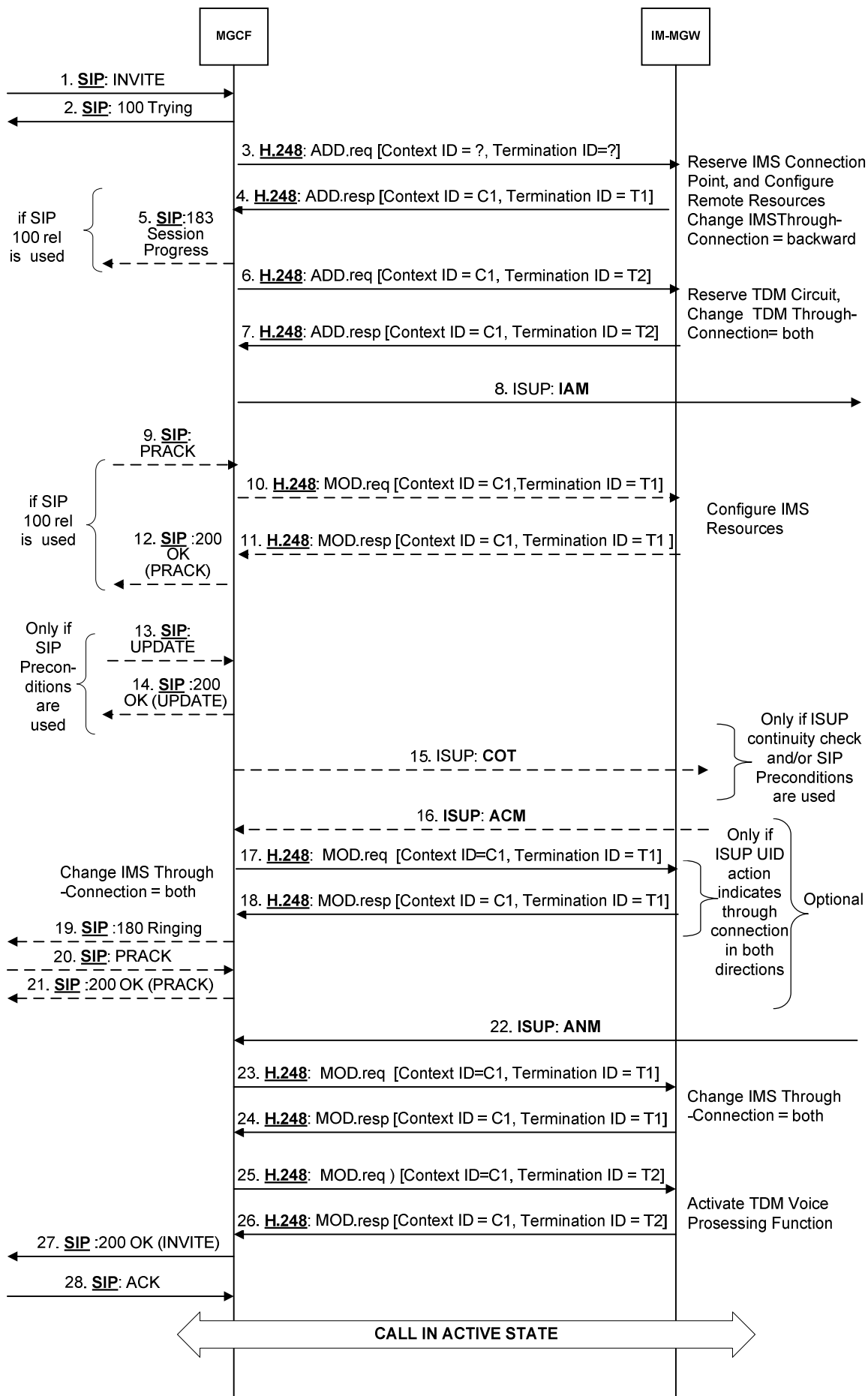

Figure 36: Basic IM CN Subsystem originating session, ISUP (message sequence chart)

9.2.3 Basic CS network originated session

9.2.3.1 BICC forward bearer establishment

9.2.3.1.1 IM-MGW selection

The MGCF shall select an IM-MGW for the bearer connection before it performs the IM CN subsystem session establishment or the CS network side bearer establishment.

9.2.3.1.2 IM CN subsystem side termination reservation

The MGCF shall derive from configuration data one or several appropriate local codec(s) the IM-MGW may use to receive user plane data from the IM CN subsystem. The MGCF shall use the Reserve IMS Connection Point procedure (signals 2 and 3 in figure 37). Within this procedure, the MGCF shall indicate the local codec(s) and request a local IP address and UDP port from the IM-MGW. The local IP address and UDP port are used by the IM-MGW to receive user plane data from the IM CN subsystem. If DTMF support together with speech support is required, or if the resources for multiple speech codecs shall be reserved at this stage, the reserve value indicator shall be set to "true".

The MGCF may also indicate that the IP interface type is for MboIP.

The IM-MGW shall reply to the MGCF with the selected local codec(s) and the selected local IP address and UDP port.

The MGCF shall send this information in the INVITE (signal 4 in figure 37) to the IM CN subsystem.

9.2.3.1.3 IM CN subsystem side session establishment

The MGCF shall use the Configure IMS Resources procedure (signals 7 and 8 or 23a and 23b in figure 37) to provide configuration data (derived from SDP received in signal 6 in figure 37 and local configuration data) to the IM-MGW as detailed below:

- The MGCF shall indicate the remote IP address and UDP port, i.e. the destination IP address and UDP port for data sent in the user plane towards the IM CN subsystem,
- The MGCF shall indicate the remote codec(s), i.e. the speech codec(s) for data sent in the user plane towards the IM CN subsystem.
- The MGCF may indicate the local codec(s) and the local IP address and UDP port. The MGCF shall indicate the local codec(s) if a change is required.
- If DTMF support together with speech support is required, the reserve value indicator shall be set to "true".
- The MGCF may indicate that IP interface type is for MboIP.

The IM-MGW shall reply with the selected remote codec(s) and reserve resources for these codec(s). If local codec(s) were received, the IM-MGW shall also reply with the selected local codec(s) and reserve the corresponding resources.

If the selected local codec(s) differ from the codec(s) received in the SDP of signal 6 in figure 37 (if any), the MGCF shall send the local reserved codec(s), and the local IP address and UDP port in the PRACK (signal 9 in figure 37) to the IMS.

If the selected local codec(s) differ from the codec(s) received in the SDP of signal 23 in figure 37 (if any), the MGCF shall send the local reserved codec(s), and the local IP address and UDP port in an re-INVITE or UPDATE (not depicted in figure 37) to the IMS.

9.2.3.1.4 CS network side bearer establishment

The MGCF shall request the IM-MGW to prepare for the CS network side bearer establishment using the Prepare Bearer procedure (signals 11 and 12 in figure 37). Within this procedure, the MGCF shall request the IM-MGW to provide a bearer address, a binding reference and optionally notify when the bearer is established. The MGCF shall also provide the IM-MGW with the bearer characteristics that was received from the preceding node in the IAM. After the

IM-MGW has replied with the bearer address and the binding reference, the MGCF provides the APM message (signals 13 in figure 37) to the preceding node. The MGCF may also provide the IM-MGW-id in the APM message.

9.2.3.1.5 Called party alerting

The MGCF shall request the IM-MGW to provide an awaiting answer indication (ringing tone) to the calling party using the Send Tone procedure (signals 20 and 21 in figure 37) , when the following condition is satisfied:

- the MGCF receives the first 180 Ringing message, unless this message or some previous SIP provisional response contained a P-Early-Media header field that authorizes early media.

9.2.3.1.6 Called party answer

When the MGCF receives a 200 OK message (signal 23 in figure 34), it shall request the IM-MGW to stop providing the ringing tone to the calling party using the Stop Tone procedure (signals 26 and 27 in figure 37).

9.2.3.1.7 Through-Connection

During the Prepare Bearer procedure, the MGCF shall either use the Change Through-Connection procedure to request the IM-MGW to backward through-connect the BICC termination, or the MGCF shall use this procedure to both-way through-connect the BICC termination already on this stage (signals 11 and 12 in figure 37). During the Reserve IMS Connection Point procedure, the MGCF shall use the Change IMS Through-Connection procedure to request the IM-MGW to backward through-connect the IMS termination (signals 2 and 3 in figure 37).

When the MGCF receives the SIP 200 OK(INVITE) (signal 23 in figure 37), it requests the IM-MGW to both-way through-connect the terminations using the Change IMS Through-Connection or Change Through-Connection procedures (signals 28 and 29 in figure 37), unless those terminations are already both-way through-connected.

9.2.3.1.8 Codec handling

The IM-MGW may include a speech transcoder based upon the speech coding information provided to each termination.

9.2.3.1.9 Failure handling in MGCF

If any procedure between the MGCF and the IM-MGW is not completed successfully, the default action by the MGCF is to release the session as described in clause 9.2.6. If the MGCF receives a Bearer Released procedure from the IM-MGW the default action by the MGCF is to release the session, as described in clause 9.2.7.

NOTE: As an implementation option the MGCF may also decide for example to only release the resources in the IM-MGW that caused the failure, possibly select a new IM-MGW for the connection and continue the call establishment using new resources in the selected IM-MGW but such handling is outside of the scope of the present document.

9.2.3.1.10 Message sequence chart

Figure 37 shows the message sequence chart for the CS network originating session with BICC forward bearer establishment. In the chart the MGCF requests the seizure of the IM CN subsystem side termination and CS network side bearer termination. When the MGCF receives an answer indication, it requests the IM-MGW to both-way through-connect the terminations. Dashed lines represent optional or conditional messages.

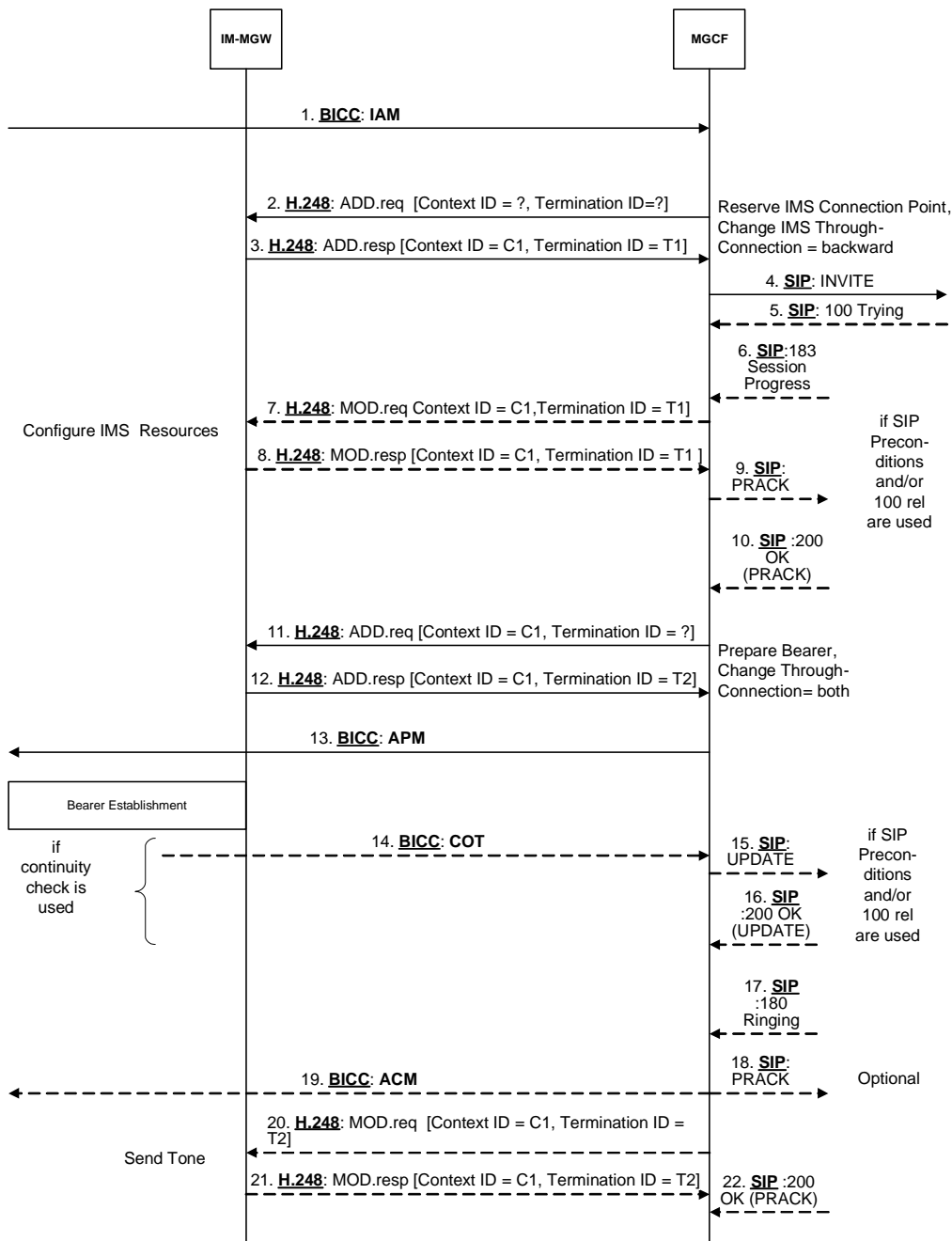

Figure 37/1: Basic CS Network Originating Session, Forward Bearer Establishment (message sequence chart)

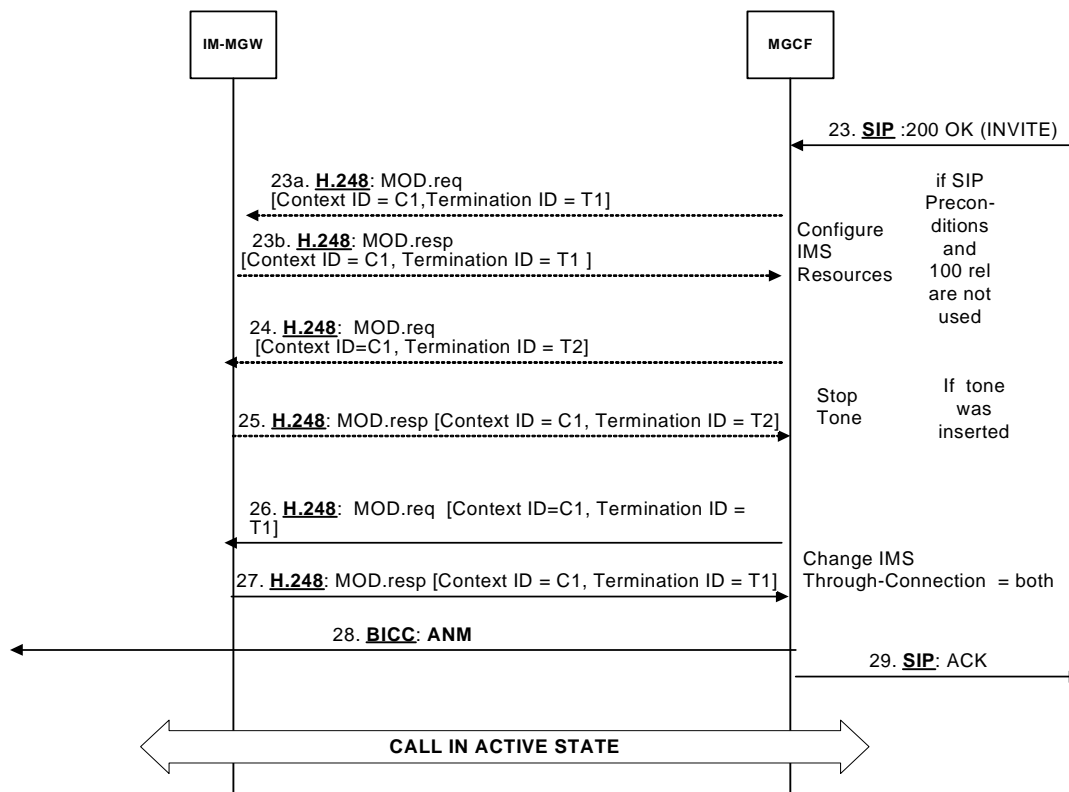

Figure 37/2: Basic CS Network Originating Session, Forward Bearer Establishment (message sequence chart continue)

9.2.3.2 BICC Backward bearer establishment

9.2.3.2.1 IM-MGW selection

The MGCF shall select an IM-MGW for the bearer connection before it performs the IM CN subsystem session establishment or the CS network side bearer establishment.

9.2.3.2.2 CS network side bearer establishment

The MGCF shall request the IM-MGW to establish a bearer using the Establish Bearer procedure (signals 2 and 3 in figure 38). The MGCF provides the IM-MGW with the bearer address, the binding reference and the bearer characteristics that were received from the preceding node in the IAM (signal 1 in figure 38).

9.2.3.2.3 IM CN subsystem side termination reservation

The MGCF shall derive from configuration data one or several appropriate local codec(s) the IM-MGW may use to receive user plane data from the IM CN subsystem. The MGCF shall use the Reserve IMS Connection Point procedure (signals 2 and 3 in figure 38). Within this procedure, the MGCF shall indicate the local codec(s) and request a local IP address and UDP port from the IM-MGW. The local IP address and UDP port are used by the IM-MGW to receive user plane data from the IM CN subsystem. If DTMF support together with speech support is required, or if the resources for multiple speech codecs shall be reserved at this stage, the reserve value indicator shall be set to "true".

The MGCF may also indicate that the IP interface type is for MboIP.

The IM-MGW shall reply to the MGCF with the selected local codec(s) and the selected local IP address and UDP port.

The MGCF shall send this information in the INVITE (signal 6 in figure 38) to the IM CN subsystem.

9.2.3.2.4 IM CN subsystem side session establishment

The MGCF shall use the Configure IMS Resources procedure (signals 9 and 10 or 22a and 22b in figure 38) to provide configuration data (derived from SDP received in signal 8 in figure 38 and local configuration data) to the IM-MGW as detailed below:

- The MGCF shall indicate the remote IP address and UDP port, i.e. the destination IP address and UDP port for data sent in the user plane towards the IM CN subsystem
- The MGCF shall indicate the remote codec(s), i.e. the speech codec(s) for data sent in the user plane towards the IM CN subsystem.
- The MGCF may indicate the local codec(s) and the local IP address and UDP port. The MGCF shall indicate the local codec(s) if a change is required.
- If DTMF support together with speech support is required, the reserve value indicator shall be set to "true".
- The MGCF may indicate that IP interface type is for MboIP.

The IM-MGW shall reply with the selected remote codec(s) and reserve resources for this codec. If local codec(s) were received, the IM-MGW shall also reply with the selected local codec(s) and reserve the corresponding resources.

If the selected local codec(s) differ from the codec(s) received in the SDP of signal 8 in figure 38 (if any), the MGCF shall send the reserved speech codec(s), and the local IP address and UDP port in the PRACK (signal 11 in figure 38) to the IMS.

If the selected local codec(s) differ from the codec(s) received in the SDP of signal 22 in figure 38 (if any), the MGCF shall send the local reserved codec(s), and the local IP address and UDP port in an re-INVITE or UPDATE (not depicted in figure 38) to the IMS.

9.2.3.2.5 Called party alerting

The MGCF shall request the IM-MGW to provide an awaiting answer indication (ringing tone) to the calling party using the Send Tone procedure (signals 19 and 20 in figure 38) , when the following conditions is satisfied:

- the MGCF receives the first 180 Ringing message, unless this message or some previous SIP provisional response contained a P-Early-Media header field that authorizes early media.

9.2.3.2.6 Called party answer

When the MGCF receives a 200 OK message (signal 22 in figure 38), it shall request the IM-MGW to stop providing the ringing tone to the calling party using the Stop Tone procedure (signals 23 and 24 in figure 38).

9.2.3.2.7 Through-Connection

During the Establish Bearer procedure, the MGCF shall either use the Change Through-Connection procedure to request the IM-MGW to backward through-connect the BICC termination, or the MGCF shall use this procedure to both-way through-connect the BICC termination already on this stage (signals 2 and 3 in figure 38). During the Reserve IMS Connection Point procedure, the MGCF shall use the Change IMS Through-Connection procedure to request the IM-MGW to backward through-connect the IMS termination (signals 4 and 5 in figure 38).

When the MGCF receives the SIP 200 OK(INVITE) (signal 22 in figure 38), it shall request the IM-MGW to both-way through-connect the bearer using the Change IMS Through-Connection or Change Through-Connection procedure (signals 25 and 26 in figure 38), unless those terminations are already both-way through-connected.

9.2.3.2.8 Codec handling

The IM-MGW may include a speech transcoder based upon the speech coding information provided to each termination.

9.2.3.2.9 Failure handling in MGCF

If any procedure between the MGCF and the IM-MGW is not completed successfully, the default action by the MGCF is to release the session as described in clause 9.2.6. If the MGCF receives a Bearer Released procedure from the IM-MGW the default action by the MGCF is to release the session as described in clause 9.2.7.

NOTE: As an implementation option the MGCF may also decide for example to only release the resources in the IM-MGW that caused the failure, possibly select a new IM-MGW for the connection and continue the call establishment using new resources in the selected IM-MGW but such handling is outside of the scope of the present document.

9.2.3.2.10 Message sequence chart

Figure 38 shows the message sequence chart for the CS network originating session with BICC backward bearer establishment. In the chart the MGCF requests seizure of the IM CN subsystem side termination and CS network side bearer termination. When the MGCF receives an answer indication, it requests the IM-MGW to both-way through-connect the terminations. Dashed lines represent optional or conditional messages.

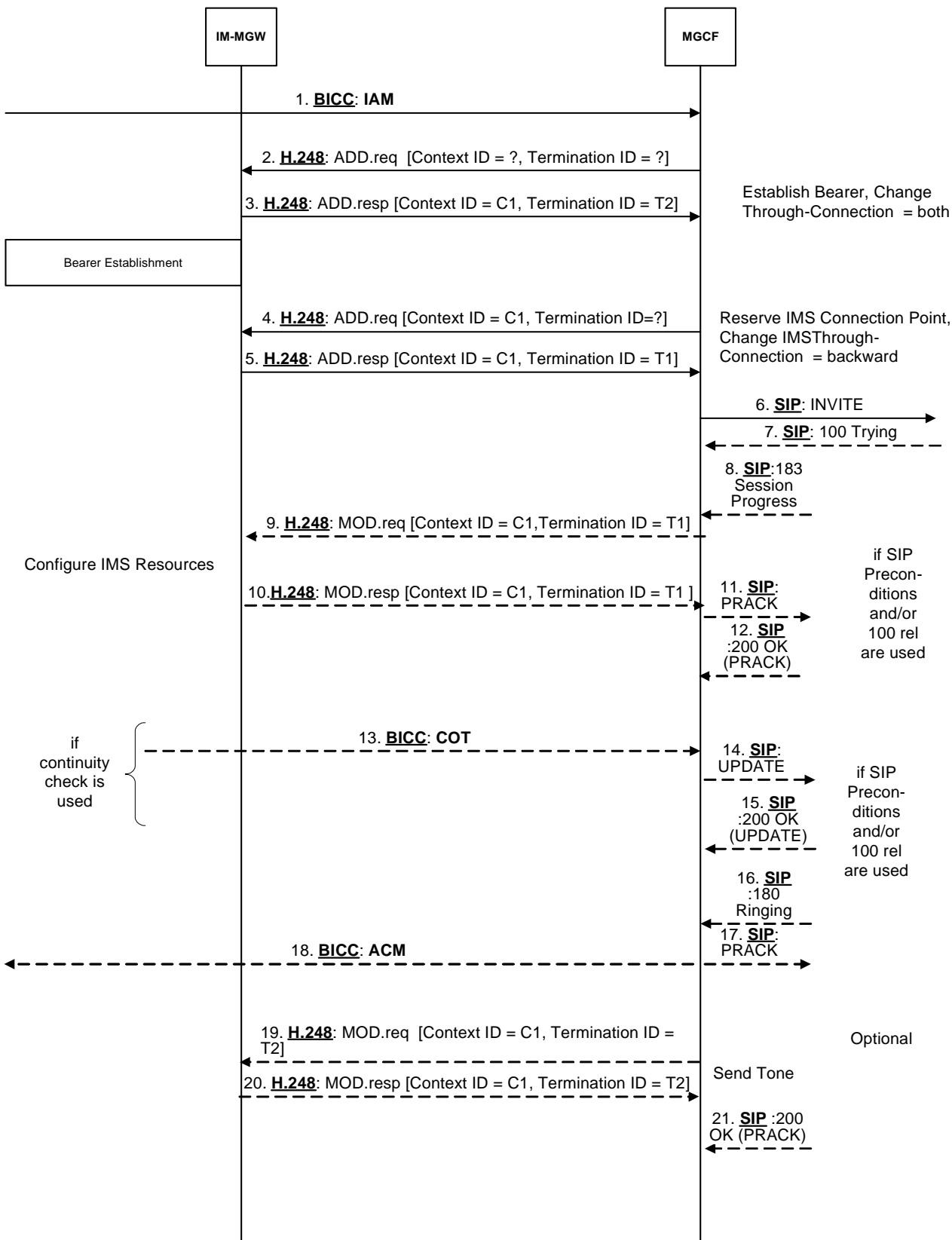

Figure 38/1: Basic CS Network Originating Session, BICC Backward Bearer Establishment (message sequence chart)

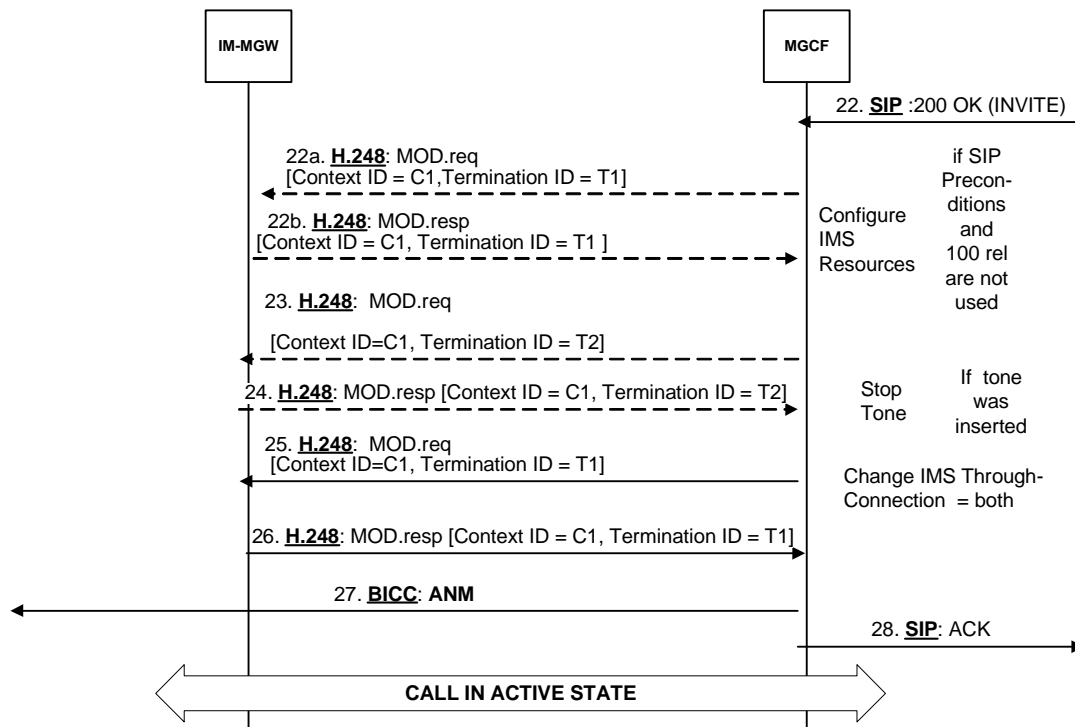

Figure 38/2: Basic CS Network Originating Session, BICC Backward Bearer Establishment (message sequence chart continue)

9.2.3.3 ISUP

9.2.3.3.1 IM-MGW selection

The MGCF selects the IM-MGW based on the received circuit identity in the IAM.

9.2.3.3.2 CS network side circuit reservation

The MGCF shall request the IM-MGW to reserve a circuit using the Reserve TDM Circuit procedure.

9.2.3.3.3 IM CN subsystem side termination reservation

The MGCF shall derive from configuration data one or several appropriate local codec(s) the IM-MGW may use to receive user plane data from the IM CN subsystem. The MGCF shall use the Reserve IMS Connection Point procedure (signals 2 and 3 in figure 39). Within this procedure, the MGCF shall indicate the local codec(s) and request a local IP address and UDP port from the IM-MGW. The local IP address and UDP port are used by the IM-MGW to receive user plane data from the IM CN subsystem. If DTMF support together with speech support is required, or if the resources for multiple speech codecs shall be reserved at this stage, the reserve value indicator shall be set to "true".

The MGCF may also indicate that the IP interface type is for MboIP.

The IM-MGW shall reply to the MGCF with the selected local codec(s) and the selected local IP address and UDP port.

The MGCF shall send this information in the INVITE (signal 6 in figure 39) to the IM CN subsystem.

9.2.3.3.4 IM CN subsystem side session establishment

The MGCF shall use the Configure IMS Resources procedure (signals 9 and 10 or 22a and 22b in figure 39) to provide configuration data (derived from SDP received in signal 8 in figure 39 and local configuration data) as detailed below:

- The MGCF shall indicate the remote IP address and UDP port, i.e. the destination IP address and UDP port for data sent in the user plane towards the IM CN subsystem.
- The MGCF shall indicate the remote codec(s), i.e. the speech codec(s) for data sent in the user plane towards the IM CN subsystem.
- The MGCF may indicate the local codec(s) and the local IP address and UDP port. The MGCF shall indicate the local codec(s) if a change is required.
- If DTMF support together with speech support is required, the reserve value indicator shall be set to "true".
- The MGCF may indicate that IP interface type is for MboIP.

The IM-MGW shall reply with the selected remote codec(s) and reserve resources for these codec(s). If local codec(s) were received, the IM-MGW shall also reply with the selected local codec(s) and reserve the corresponding resources.

If the selected local codec(s) differ from the codec(s) received in the SDP of signal 8 in figure 39 (if any), the MGCF shall send the reserved speech codec(s), and the local IP address and UDP port in the PRACK (signal 11 in figure 39) to the IMS.

If the selected local codec(s) differ from the codec(s) received in the SDP of signal 22 in figure 39 (if any), the MGCF shall send the local reserved codec(s), and the local IP address and UDP port in an re-INVITE or UPDATE (not depicted in figure 39) to the IMS.

9.2.3.3.5 Called party alerting

The MGCF shall request the IM-MGW to provide an awaiting answer indication (ringing tone) to the calling party using the Send TDM Tone procedure (signals 19 and 20 in figure 39), when the following condition is satisfied:

- the MGCF receives the first 180 Ringing message, unless this message or some previous SIP provisional response contained a P-Early-Media header field that authorizes early media.

9.2.3.3.6 Called party answer

When the MGCF receives a 200 OK message (signal 22 in figure 39), it shall request the IM-MGW to stop providing the ringing tone to the calling party using the Stop TDM Tone procedure (signals 23 and 24 in figure 39).

9.2.3.3.7 Through-Connection

Within the Reserve TDM Circuit procedure, the MGCF shall either use the Change TDM Through-Connection procedure to request the IM-MGW to backward through-connect the TDM termination, or the MGCF shall use this procedure to both-way through-connect the TDM termination already on this stage (signals 2 and 3 in figure 39). During the Reserve IMS Connection Point procedure, the MGCF shall use the Change IMS Through-Connection procedure to request the IM-MGW to backward through-connect the IMS termination (signals 4 and 5 in figure 39).

When the MGCF receives the SIP 200 OK(INVITE) message, it shall request the IM-MGW to both-way through-connect the terminations using the Change IMS Through-Connection or Change TDM Through-Connection procedure (signals 25 and 26 in figure 39), unless those terminations are already both-way through-connected.

9.2.3.3.8 Continuity Check

If a continuity check on the connection towards the CS network is requested in the IAM message, the MGCF shall use the Continuity Check Response procedure towards the IM-MGW to request loop-back of a received continuity check tone on the TDM circuit. Upon reception of the COT message, the MGCF shall use the Continuity Check Response procedure towards the IM-MGW to request the removal of the loop-back. (Not depicted in figure 39)

9.2.3.3.9 Codec handling

The IM-MGW may include a speech transcoder based upon the speech coding information provided to each termination.

9.2.3.3.10 Voice Processing function

A voice processing function located on the IM-MGW may be used to achieve desired acoustic quality on the terminations. If the voice processing function is used, the MGCF shall request the activation of it in the termination towards the CS network using the Activate TDM Voice Processing Function procedure (signal 23 in figure 39).

9.2.3.3.11 Failure handling in MGCF

If any procedure between the MGCF and the IM-MGW is not completed successfully, the session shall be released as described in clause 9.2.6. If the MGCF receives a Bearer Released procedure from the IM-MGW the default action by the MGCF is to release the session as described in clause 9.2.7.

9.2.3.3.12 Message sequence chart

Figure 39 shows the message sequence chart for the CS network originating Session with ISUP. In the chart the MGCF requests seizure of the IM CN subsystem side termination and CS network side bearer termination. When the MGCF receives an answer indication, it requests the IM-MGW to both-way through-connect the terminations. The MGCF may request the possible activation of the voice processing functions for the terminations. Dashed lines represent optional or conditional messages.

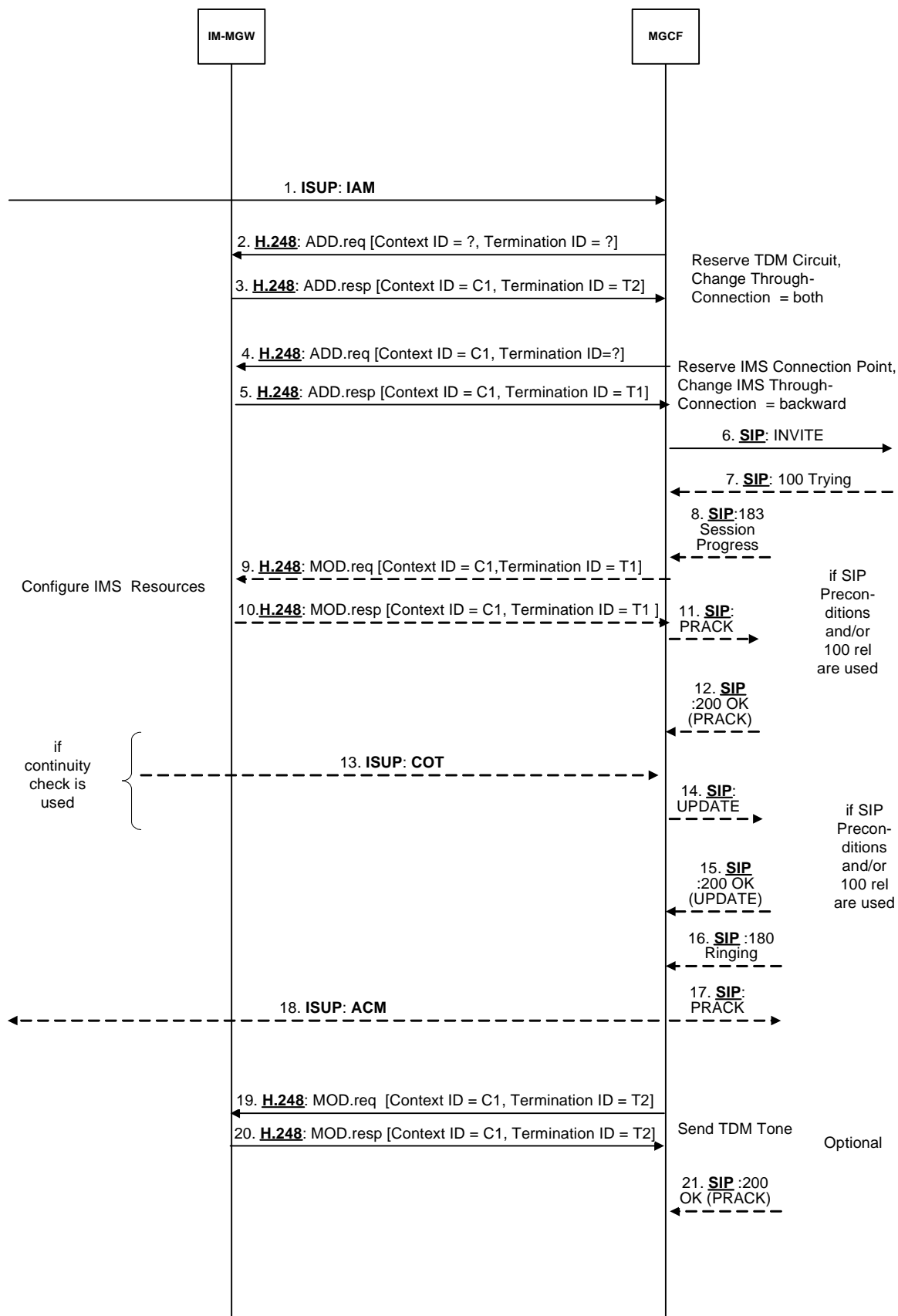

Figure 39/1: Basic CS Network Originating Session, ISUP (message sequence chart)

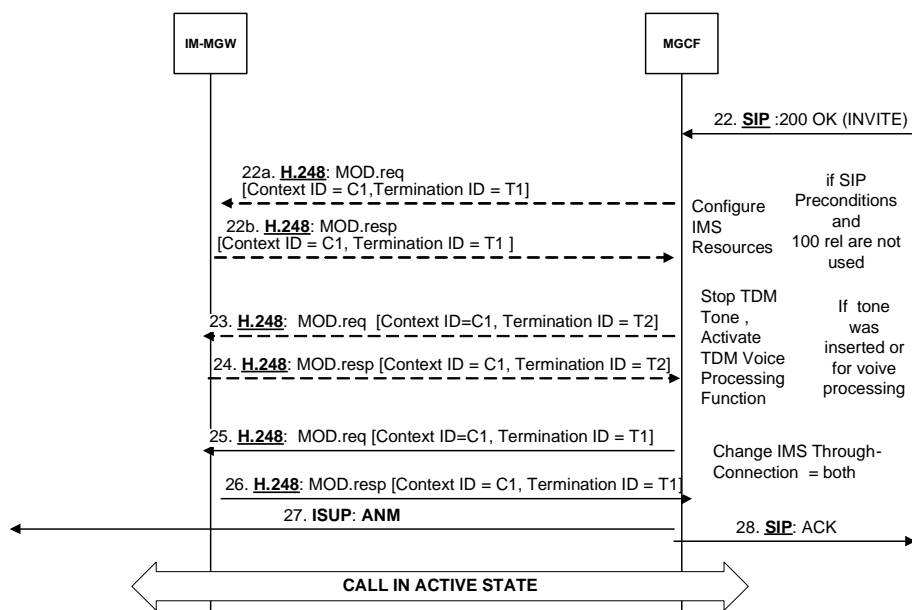

Figure 39/2: Basic CS Network Originating Session, ISUP (message sequence chart continue)

9.2.3.4 Handling of Forking

The procedures described in clauses 9.2.3.1 to 9.2.3.3 shall be applied with the following additions.

9.2.3.4.1 Detection of Forking

According to SIP procedures, the O-MGCF inspects the tags in the "to" SIP header fields of provisional and final responses to identify the SIP dialogue the response belongs to. If responses belonging to different dialogues are received (signals 8 and 13 in figure 39a), the INVITE request (signal 6 in figure 39a) has been forked.

9.2.3.4.2 IM CN subsystem side session establishment

If SDP is received in a provisional response and more than one SIP dialogue exists (signal 13 in figure 39a), the MGCF may either refrain from reconfiguring the IM-MGW, or it may use the Configure IMS Resources procedure (signals 14 and 15 in figure 39a) as detailed below:

- If the MGCF receives a SIP provisional response containing a P-Early-Media header field that authorizes early media, the MGCF shall provide the remote IP address and UDP port, and the remote codec selected from the received SDP and local configuration data, corresponding to the SIP dialogue of the SIP provisional response containing a P-Early-Media header field that authorizes early media. The IM-MGW may be configured to use the remote IP address and port information as source filter for incoming packages to prevent that early media from other early SIP dialogues interfere. The MGCF may also provide an IP address and port source filter that disallows early media from other early dialogues without an early media authorization in order to prevent that such unauthorized early media interfere with the authorized early media. (NOTE 1, NOTE 2)
- If the MGCF did not receive any SIP provisional response containing a P-Early-Media header field that authorizes early media, the MGCF may compare the selected local codecs of the different dialogues (which the MGCF selects due to the received SDP answer and local configuration data). If different local codecs are selected for the different dialogues, the MGCF may include all these codecs in the "local IMS resources", and set the "reserve value" to indicate that resources for all these codecs shall be reserved. Alternatively, the MGCF may only include the codecs received in the last SDP in the "local IMS resources".
- If the MGCF did not receive any SIP provisional response containing a P-Early-Media header field that authorizes early media, the MGCF may update the "remote IMS resources" with the information received in the latest SDP. The MGCF should provide the remote IP address and UDP port, and the remote codec selected from the received SDP and local configuration data. (NOTE 3)

NOTE 1: The O-MGCF can use the P-Early-Media header field (IETF RFC 5009 [89]) to determine whether the media associated with a forked dialog is authorized and thus eligible for a through connection. In the presence of early media for multiple dialogs due to forking, if the IM-MGW is able to identify the media associated with a dialog (i.e., if symmetric RTP is used by the peer and the IM-MGW can use the remote SDP information to determine the source of the media), then the O-MGCF/IM-MGW can selectively establish a through-connection for an authorized early media flow.

NOTE 2: The behaviour of an O-MGCF upon the possible reception of SIP provisional responses containing P-Early-Media header fields that authorize early media for several early dialogues is left unspecified.

NOTE 3: The behaviour in the third bullet is beneficial if forking is applied in a sequential manner.

9.2.3.4.3 IM CN subsystem side session establishment completion

Upon reception of the first final 2xx response (signal 32 in figure 39a), the MGCF shall use the Configure IMS Resources procedure (signals 35 and 36 in figure 39a) as detailed below unless the IM-MGW is already configured accordingly:

- If the remote IMS resources configured at the IM-MGW do not match the remote resources selected for the established dialogue of the final response, the MGCF shall provide the remote IP address and UDP port from the latest received SDP of this established dialogue, and the remote codec selected from the latest received SDP of this established dialogue and local configuration data within the "remote IMS resources".
- If the local IMS resources configured at the IM-MGW contain more codecs than selected for the established dialogue of the final response, the MGCF should update the "local IMS resources" with the selected local codec derived from the latest SDP of this established dialogue and local configuration data. The "reserve value" may be cleared unless it is required for DTMF.
- The IM-MGW may be configured to use the remote IP address and port information as source filter for incoming packages to prevent that early media from other early SIP dialogues interfere with the media of the established dialogue. The MGCF may also provide an IP address and port source filter that disallows early media from other early dialogues in order to prevent that such early media interfere with the media of the established dialogue. If the MGCF has provided a source filter selecting media of another SIP early dialogue, it shall remove or update this source filter.

9.2.3.4.4 Message sequence chart

Figure 39a shows an example message sequence chart for a CS network originating Session Setup with ISUP, where forking occurs.

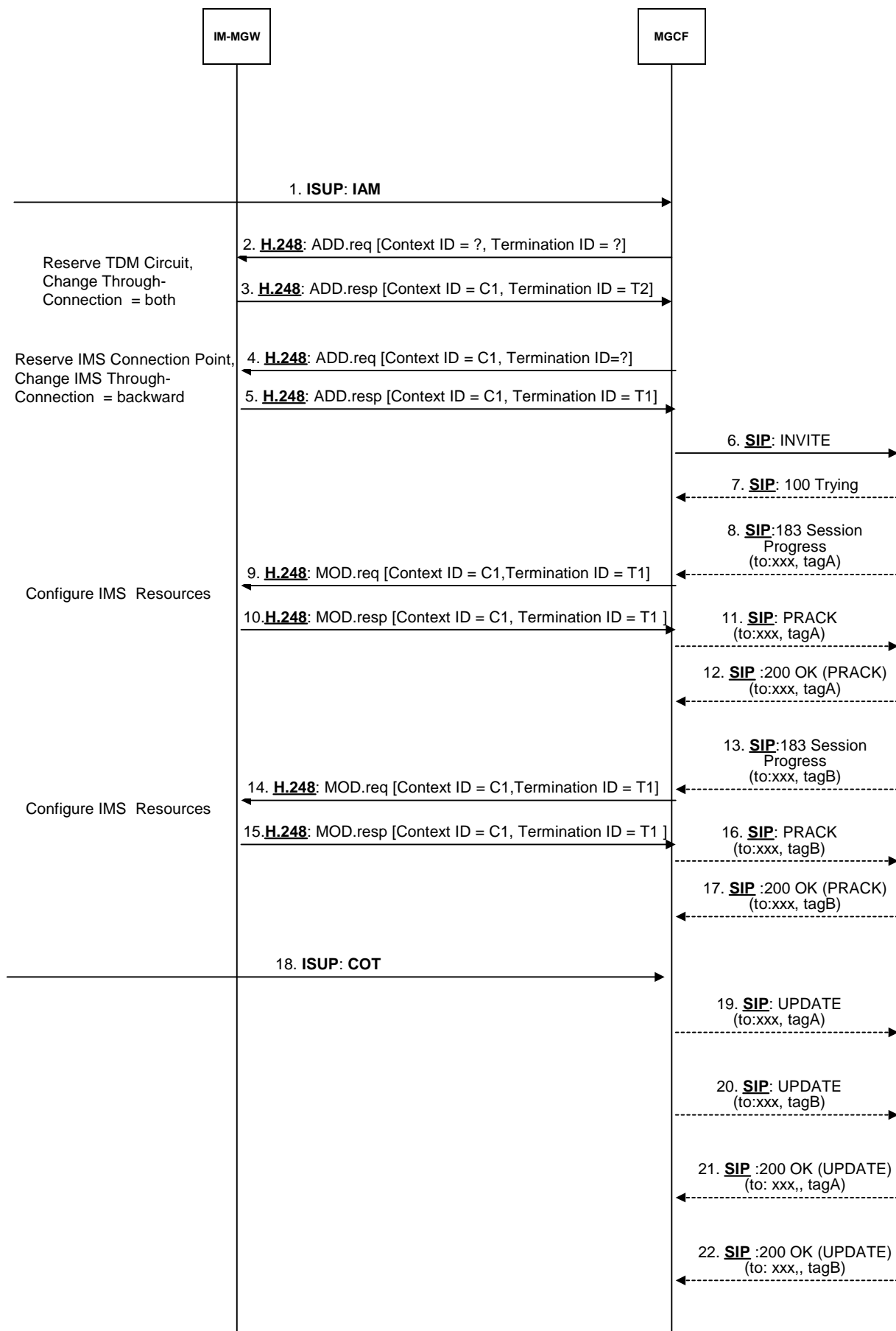

Figure 39a/1: CS Network Originating Session with forking, ISUP (message sequence chart)

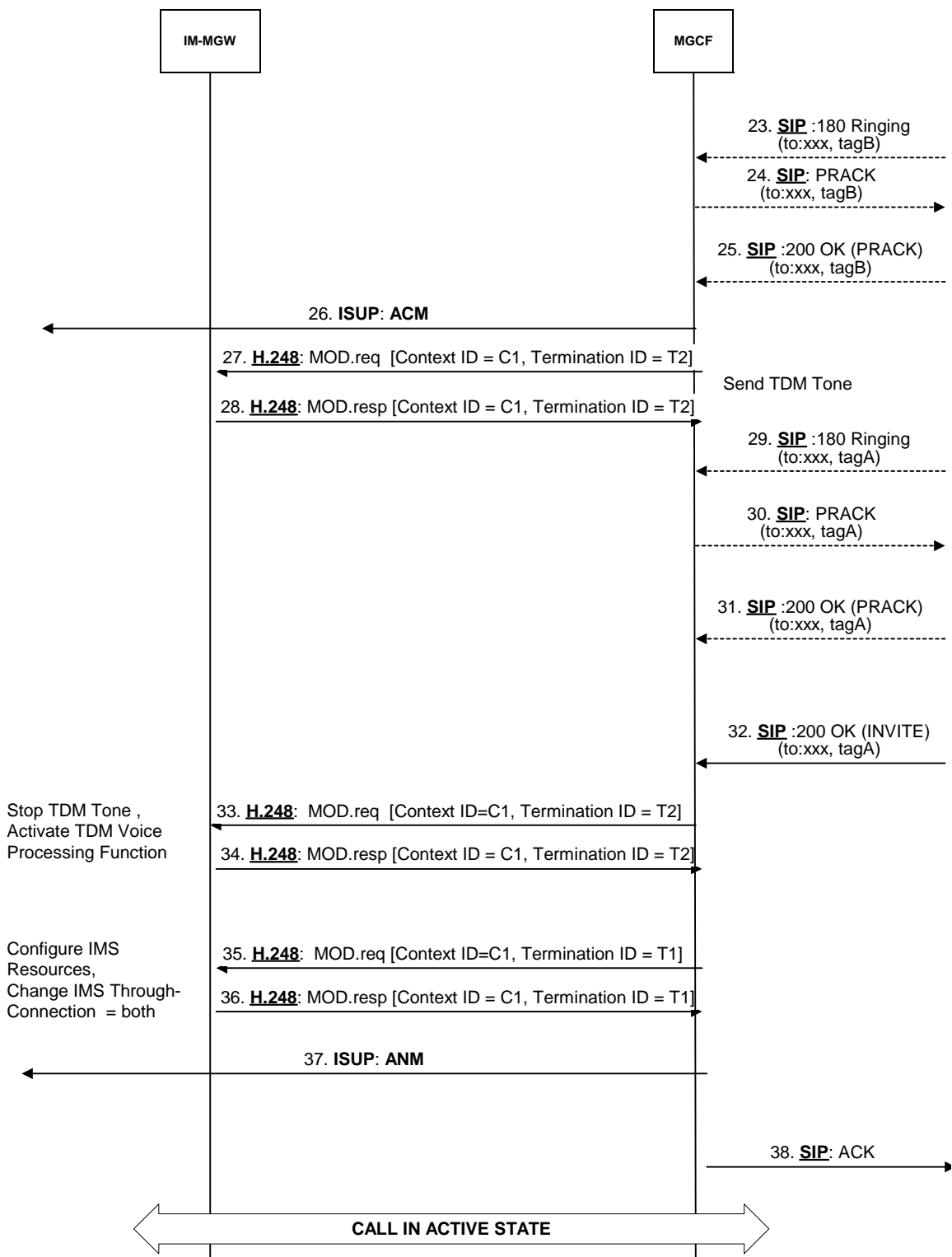

Figure 39a/2: CS Network Originating Session with forking, ISUP (message sequence chart continue)

9.2.4 Session release initiated from IM CN subsystem side

9.2.4.1 BICC

9.2.4.1.1 Session release in the IM CN subsystem side

When the MGCF has received a BYE message from the IM CN subsystem side, the MGCF shall release resources in the IM-MGW serving the relevant Mb interface connection by using the "Release IMS Termination" procedure (signals 5 and 6 in figure 40). After receiving the BYE message, the MGCF shall also send a 200 OK [BYE] message towards the IM CN subsystem (signal 2 in figure 40).

9.2.4.1.2 Session release in the CS network side

When the MGCF has received a BYE message from the IM CN subsystem side, the MGCF shall send a REL message to the succeeding node (signal 3 in figure 40). Once the succeeding node has responded with the RLC message (signal 6 in figure 40), the MGCF shall release the resources for the CS network side in the IM-MGW. If any resources were seized in the IM-MGW, the MGCF shall use the "Release Bearer", "Change Through-Connection" and "Release Termination" procedures (signals 7 to 10 in figure 40) to indicate to the IM-MGW that the CS network side bearer termination shall be removed and the bearer shall be released towards the succeeding MGW.

9.2.4.1.3 Message sequence chart

Figure 40 shows the message sequence chart for the session release initiated from the IM CN subsystem side.

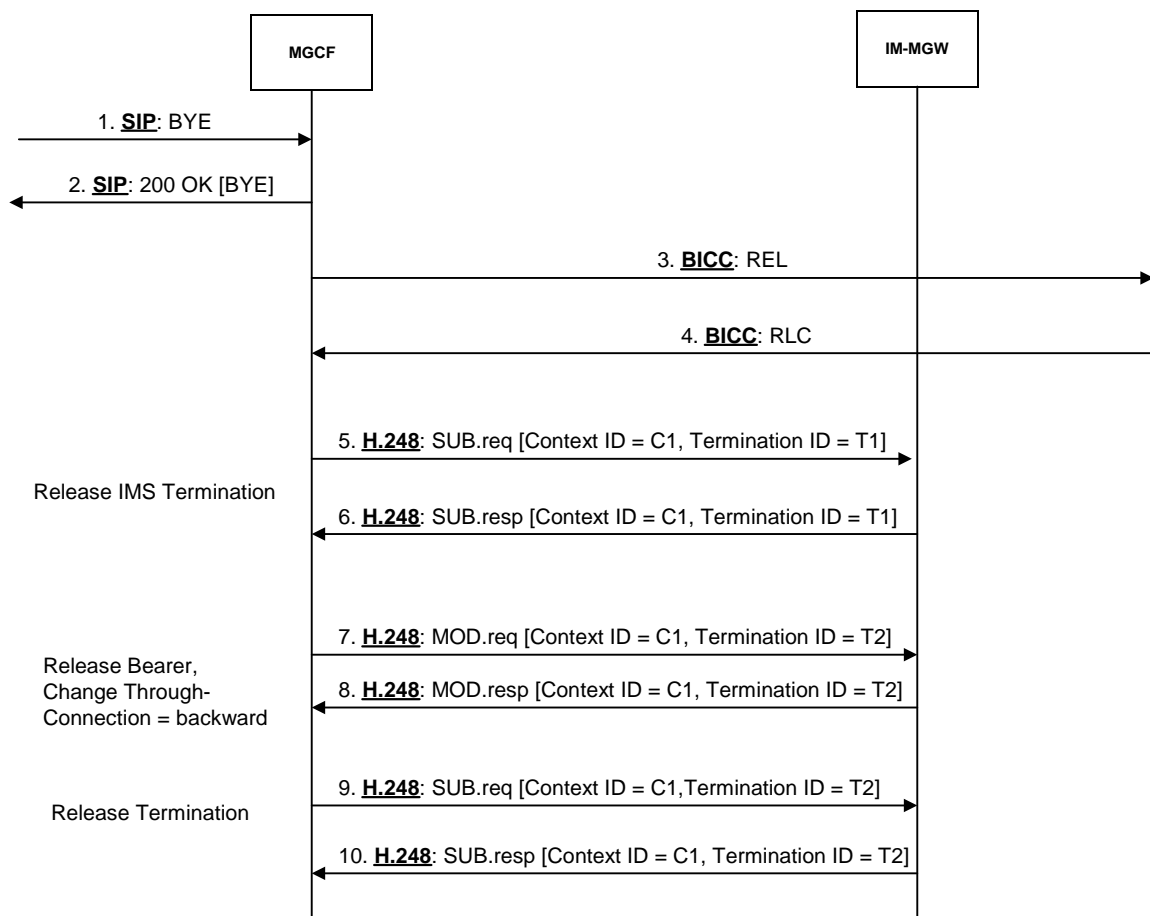

Figure 40: Session release from IM CN subsystem side for BICC (message sequence chart)

9.2.4.2 ISUP

9.2.4.2.1 Session release in the IM CN subsystem side

When the MGCF has received a BYE message from the IM CN subsystem side, the MGCF shall release resources in the IM-MGW serving the relevant Mb interface connection by using the "Release IMS Termination" procedure (signals 4 and 5 in figure 41). After receiving the BYE message, the MGCF shall also send a 200 OK [BYE] message towards the IM CN subsystem (signal 2 in figure 41).

9.2.4.2.2 Session release in the CS network side

When the MGCF has received a BYE message from the IM CN subsystem side, the MGCF shall send a REL message to the succeeding node (signal 3 in figure 41). After sending the REL message, the MGCF shall expect a RLC message (signal 8 in figure 41) from the succeeding node. The MGCF shall also release the resources for the CS network side in the IM-MGW. If any resources were seized in the IM-MGW, the MGCF shall use the "Release TDM Termination" procedure (signals 6 to 7 in figure 41) to indicate to the IM-MGW that the CS network side bearer termination can be released.

9.2.4.2.3 Message sequence chart

Figure 41 shows the message sequence chart for the session release initiated from the IM CN subsystem side.

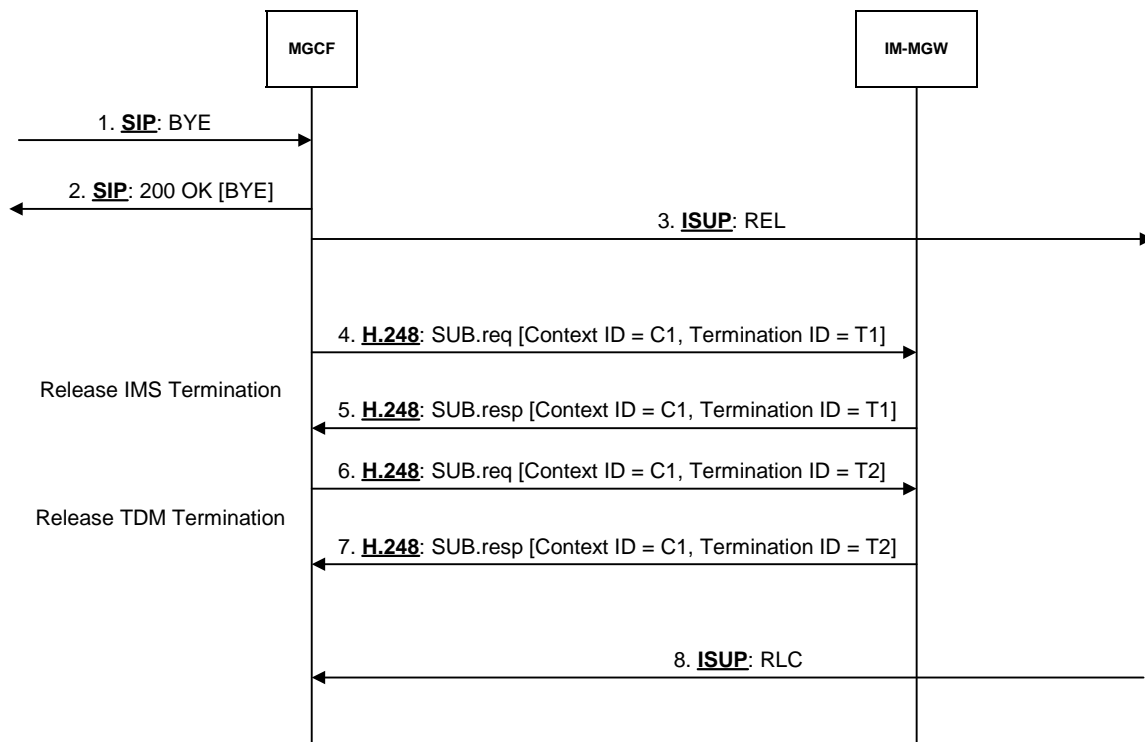

Figure 41: Session release from IM CN subsystem side for ISUP (message sequence chart)

9.2.5 Session release initiated from CS network side

9.2.5.1 BICC

9.2.5.1.1 Session release in the CS network side

When the MGCF receives a REL message from the preceding node (signal 1 in figure 42), the MGCF shall release resources for the CS network side in the IM-MGW. If any resources were seized in the IM-MGW, the MGCF shall use the "Release Bearer", "Change Through-Connection" and "Release Termination" procedures to indicate to the IM-MGW that the CS network side bearer termination shall be removed and the bearer shall be released towards the

preceding MGW (signal 3 to 6 in figure 42). After completion of resource release, the MGCF shall send a RLC message towards the preceding node.

9.2.5.1.2 Session release in the IM CN subsystem side

When the MGCF receives a REL message from the preceding node (signal 1 in figure 42), the MGCF shall send a BYE message to the IM CN subsystem (signal 2 in figure 42) and the MGCF shall release the resources in the IM-MGW serving the relevant Mb interface connection by using the "Release IMS Termination" procedure (signals 7 and 8 in figure 42). The MGCF shall also expect to receive a 200 OK [BYE] message from the IM CN subsystem side (signal 10 in figure 42).

9.2.5.1.3 Message sequence chart

Figure 42 shows the message sequence chart for the session release initiated from the CS network side.

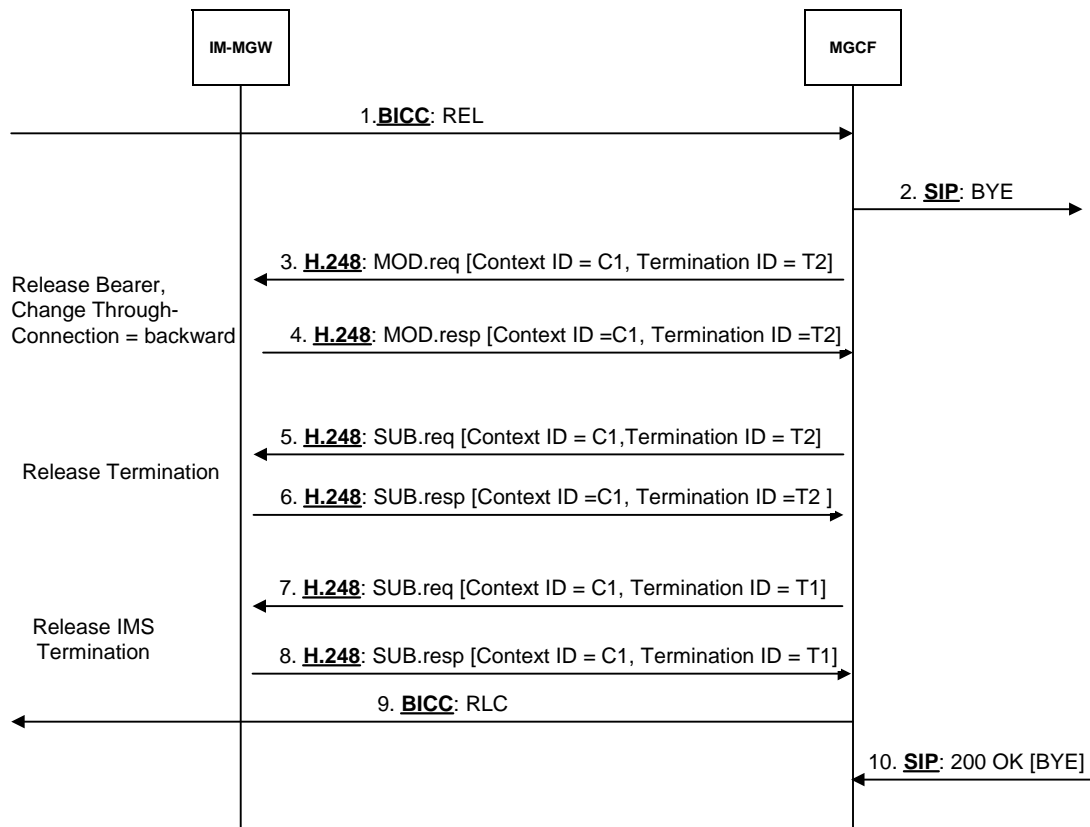

Figure 42: Session release from CS network side for BICC (message sequence chart)

9.2.5.2 ISUP

9.2.5.2.1 Session release in the CS network side

When the MGCF receives a REL message from the preceding node (signal 1 in figure 43), the MGCF shall release resources for the CS network side in the IM-MGW. If any resources were seized in the IM-MGW, the MGCF shall use the "Release TDM Termination procedures" to indicate to the IM-MGW that the CS network side bearer termination can be released (signal 3 to 4 in figure 43). After completion of resource release, the MGCF shall send a RLC message towards the preceding node.

9.2.5.2.2 Session release in the IM CN subsystem side

When the MGCF receives a REL message from the preceding node (signal 1 in figure 43), the MGCF shall send a BYE message to the IM CN subsystem (signal 2 in figure 43) and the MGCF shall release the resources in the IM-MGW serving the relevant Mb interface connection by using the "Release IMS Termination" procedure (signal 5 to 6 in figure

43). The MGCF shall also expect to receive a 200 OK [BYE] message from the IM CN subsystem side (signal 8 in figure 43).

9.2.5.2.3 Message sequence chart

Figure 43 shows the message sequence chart for the session release initiated from the CS network side.

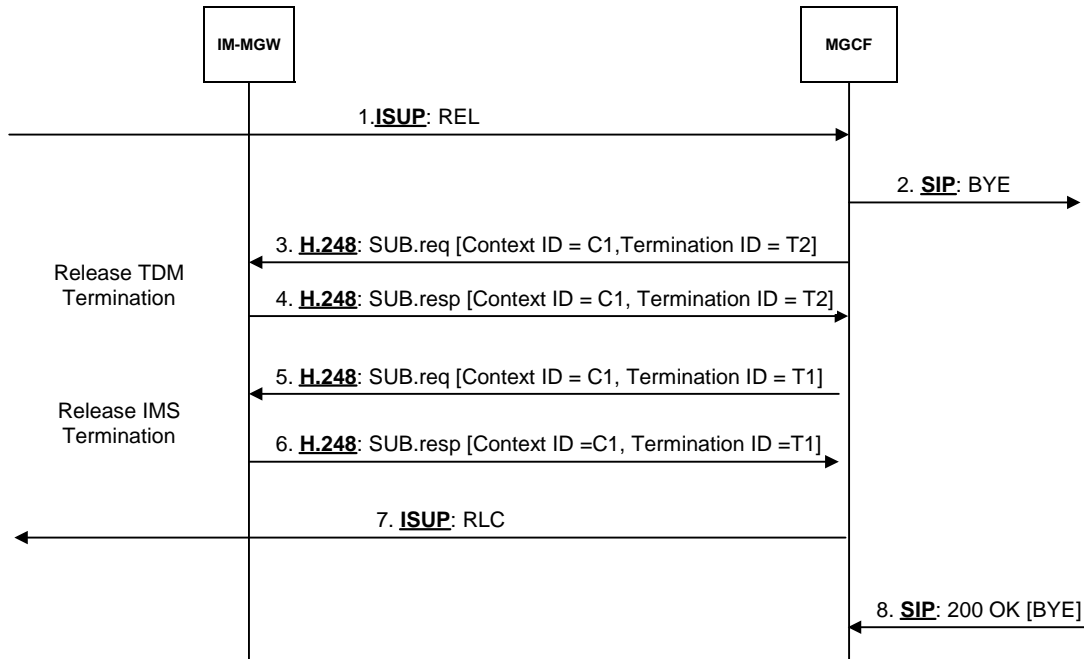

Figure 43: Session release from CS network side for ISUP (message sequence chart)

9.2.6 Session release initiated by MGCF

9.2.6.1 BICC

9.2.6.1.1 Session release in the CS network side

The MGCF shall send a REL message to the succeeding node on the CS network side (signal 1 in figure 44). Once the succeeding node has responded with the RLC message (signal 3 in figure 44), the MGCF shall release the resources for the CS network side in the IM-MGW. If any resources were seized in the IM-MGW, the MGCF shall use the "Release Bearer", "Change Through-Connection" and "Release Termination" procedures to indicate to the IM-MGW that the CS network side bearer termination shall be removed and the bearer shall be released towards the succeeding MGW (signal 4 to 7 in figure 44).

9.2.6.1.2 Session release in the IM CN subsystem side

The MGCF shall send a BYE message to the IM CN subsystem side (signal 2 in figure 44) and the MGCF shall release the resources in the IM-MGW serving the relevant Mb interface connection by using the "Release IMS Termination" procedure (signals 8 and 9 in figure 44). The MGCF shall also expect to receive a 200 OK [BYE] message is received from the IM CN subsystem side (signal 10 in figure 44).

9.2.6.1.3 Message sequence chart

Figure 44 shows the message sequence chart for the session release initiated by the MGCF.

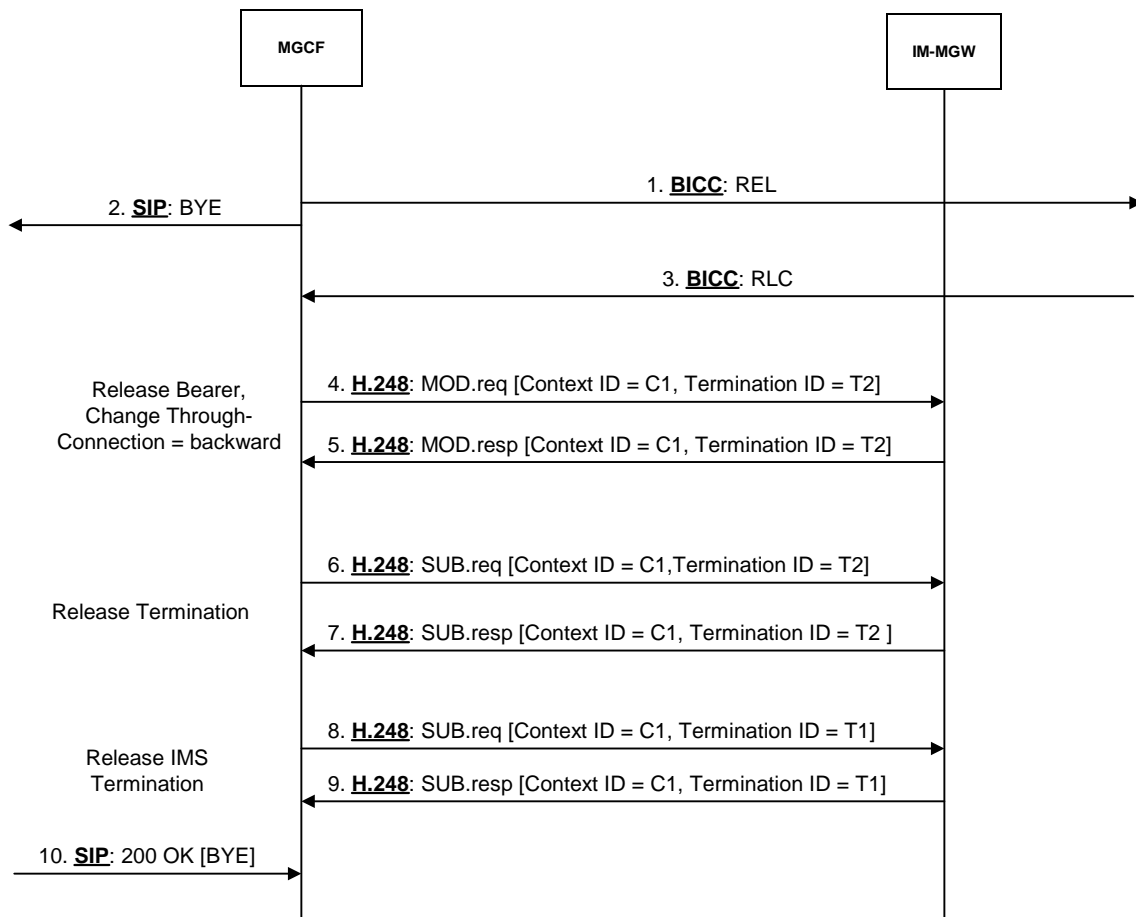

Figure 44: Session release initiated by MGCF for BICC (message sequence chart)

9.2.6.2 ISUP

9.2.6.2.1 Session release in the CS network side

The MGCF shall send a REL message to the succeeding node on the CS network side (signal 2 in figure 45) and the MGCF shall release the resources for the CS network side in the IM-MGW. If any resources were seized in the IM-MGW, the MGCF shall use the "Release TDM Termination" procedure to indicate to the IM-MGW that the CS network side termination shall be released (signal 5 to 6 in figure 45). The MGCF shall also expect to receive a RLC message from the succeeding node on the CS network side (signal 7 in figure 45).

9.2.6.2.2 Session release in the IM CN subsystem side

The MGCF shall send a BYE message to the IM CN subsystem side (signal 1 in figure 45) and the MGCF shall release the resources in the IM-MGW serving the relevant Mb interface connection by using the "Release IMS Termination" procedure (signal 5 to 6 in figure 45). The MGCF shall also expect to receive a 200 OK [BYE] message from the IM CN subsystem side (signal 8 in figure 45).

9.2.6.2.3 Message sequence chart

Figure 45 shows the message sequence chart for the session release initiated by the MGCF.

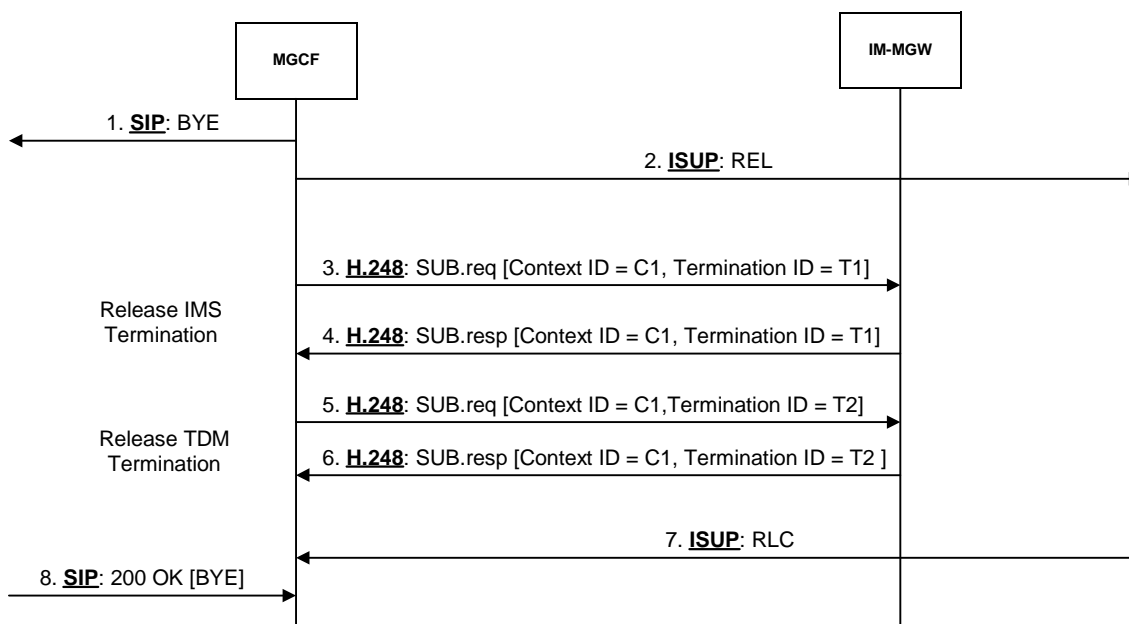

Figure 45: Session release initiated by MGCF for ISUP (message sequence chart)

9.2.7 Session release initiated by IM-MGW

9.2.7.1 BICC

9.2.7.1.1 Session release in the CS network side

Upon receiving from the IM-MGW a "Bearer Released" procedure (signal 1a and 2a in figure 46) or "IMS Bearer Released" procedure (signal 1b and 2b in figure 46) or a "MGW Out-of-Service" procedure indicating an immediate release (H248 ServiceChangeMethod="Forced") (not depicted in figure 46), the MGCF shall send a REL message to the succeeding node on the CS network side (signal 3 in figure 46). Once the succeeding node has responded with the RLC message (signal 5 in figure 46), the MGCF shall release the resources for the CS network side in the IM-MGW, unless the "MGW Out-of-Service" procedure was received. If any resources were seized in the IM-MGW, the MGCF shall use the "Release Termination" procedure to indicate to the IM-MGW that the CS network side bearer termination shall be removed (signals 6 and 7 in figure 46).

NOTE: Other actions related to MGW Out-Of-Service procedure is defined in 3GPP TS 23.205 [27].

9.2.7.1.2 Session release in the IM CN subsystem side

Upon receiving from the IM-MGW a "Bearer Released" procedure (signals 1a and 2a in figure 46) or "IMS Bearer Released" procedure (signal 1b and 2b in figure 46) or a "MGW Out-of-Service" procedure indicating an immediate release (H248 ServiceChangeMethod="Forced") (not depicted in figure 46), the MGCF shall send a BYE/CANCEL message to the IM CN subsystem side (signal 4 in figure 46). Upon receiving from the IM-MGW a "Bearer Released" procedure or "IMS Bearer Released" procedure, the MGCF shall also release the resources in the IM-MGW serving the relevant Mb interface connection by using the "Release IMS Termination" procedure (signals 8 and 9 in figure 46). The MGCF shall also expect to receive a 200 OK [BYE] message from the IM CN subsystem side (signal 10 in figure 46).

NOTE: Other actions related to MGW-Out-Of-Service procedure is defined in 3GPP TS 23.205 [27].

9.2.7.1.3 Message sequence chart

Figure 46 shows the message sequence chart for the session release initiated by the IM-MGW.

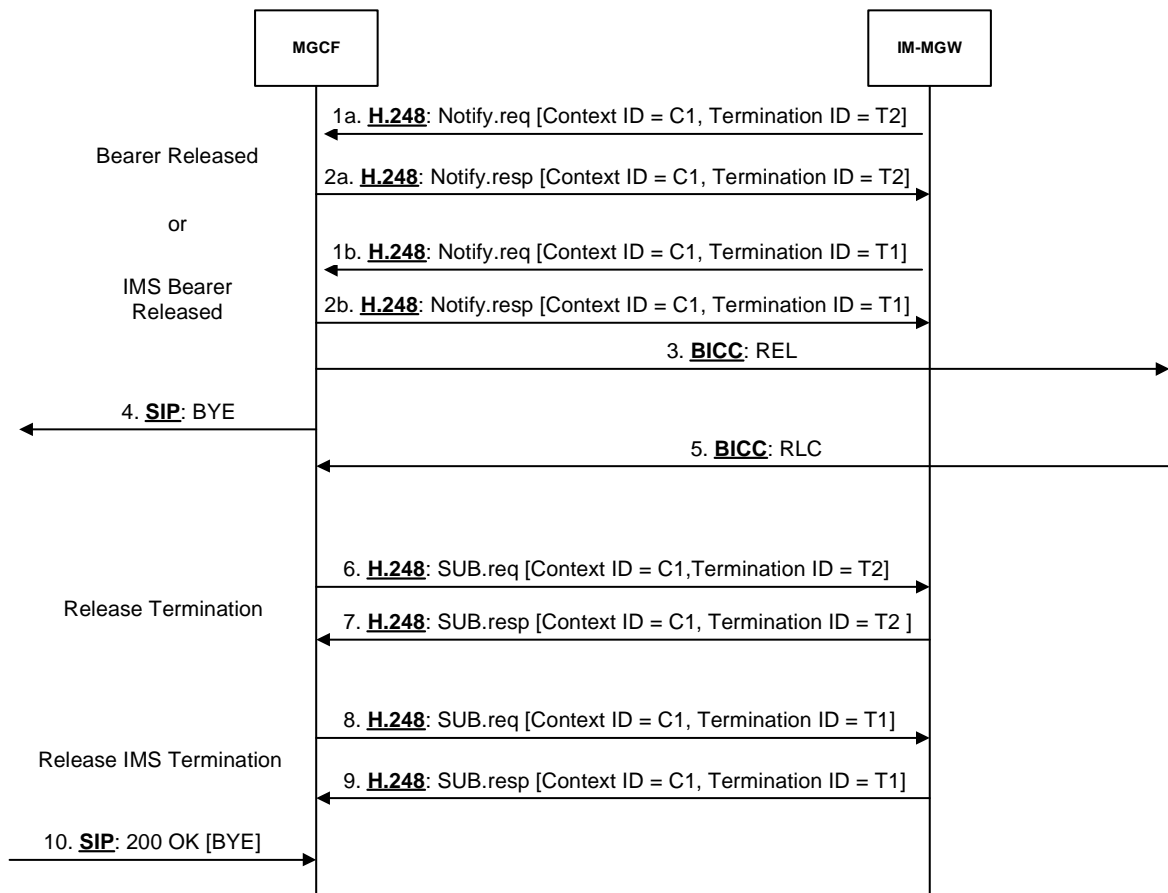

Figure 46: Session release initiated by the IM-MGW for BICC (message sequence chart)

9.2.7.2 ISUP

9.2.7.2.1 Session release in the CS network side

Upon receiving from the IM-MGW a "Termination Out-of-Service" procedure indicating an immediate release (signals 1a and 2a in figure 47), a "Bearer Released" procedure (signal 1b and 2b in figure 47), a "IMS Bearer Released" procedure (signal 1c and 2c in figure 47) or a "MGW Out-of-Service procedure" (not depicted in figure 47) indicating an immediate release (H248 ServiceChangeMethod="Forced") the MGCF shall send a REL message to the succeeding node (signal 3 in figure 47). Upon receiving from the IM-MGW a "Termination Out-of-Service" message procedure indicating an immediate release or a "Bearer Released" procedure, the MGCF shall also release the resources for the corresponding CS network side termination(s) in the IM-MGW. If any resources were seized in the IM-MGW, the MGCF shall use the "Release TDM Termination" procedure to indicate to the IM-MGW that the CS network side bearer termination can be removed (signals 7 and 8 in figure 47). The MGCF also expects to receive a RLC message on the CS network side (signal 9 in figure 47) before the circuit is reselectable.

NOTE: Other actions related to "MGW-Out-Of-Service" procedure are defined in 3GPP TS 23.205 [27].

9.2.7.2.2 Session release in the IM CN subsystem side

Upon receiving from the IM-MGW a "Termination Out-of-Service" procedure indicating an immediate release (signal 1a and 2a in figure 47) on the CS termination in the context, a "Bearer Released" procedure (signal 1b and 2b in figure 47), an "IMS Bearer Released" procedure (signal 1c and 2c in figure 47) or a "MGW Out-of-Service procedure" (not depicted in figure 47) indicating an immediate release, (H248 ServiceChangeMethod="Forced") the MGCF shall send a BYE/CANCEL message to the IM CN subsystem side (signal 4 in figure 47). Upon receiving from the IM-MGW a "Termination Out-of-Service" procedure indicating an immediate release on the CS termination in the context, a "Bearer Released" procedure or an "IMS Bearer Released" procedure, the MGCF shall also release the resources in the IM-MGW for the corresponding terminations towards the IM CN subsystem using the "Release IMS Termination"

procedure (signals 5 and 6 in figure 47). The MGCF also expects to receive a 200 OK [BYE] message from the IM CN subsystem side (signal 10 in figure 47).

NOTE: Other actions related to "MGW-Out-Of-Service" procedure are defined in 3GPP TS 23.205 [27].

9.2.7.2.3 Message sequence chart

Figure 47 shows the message sequence chart for the session release initiated by the IM-MGW.

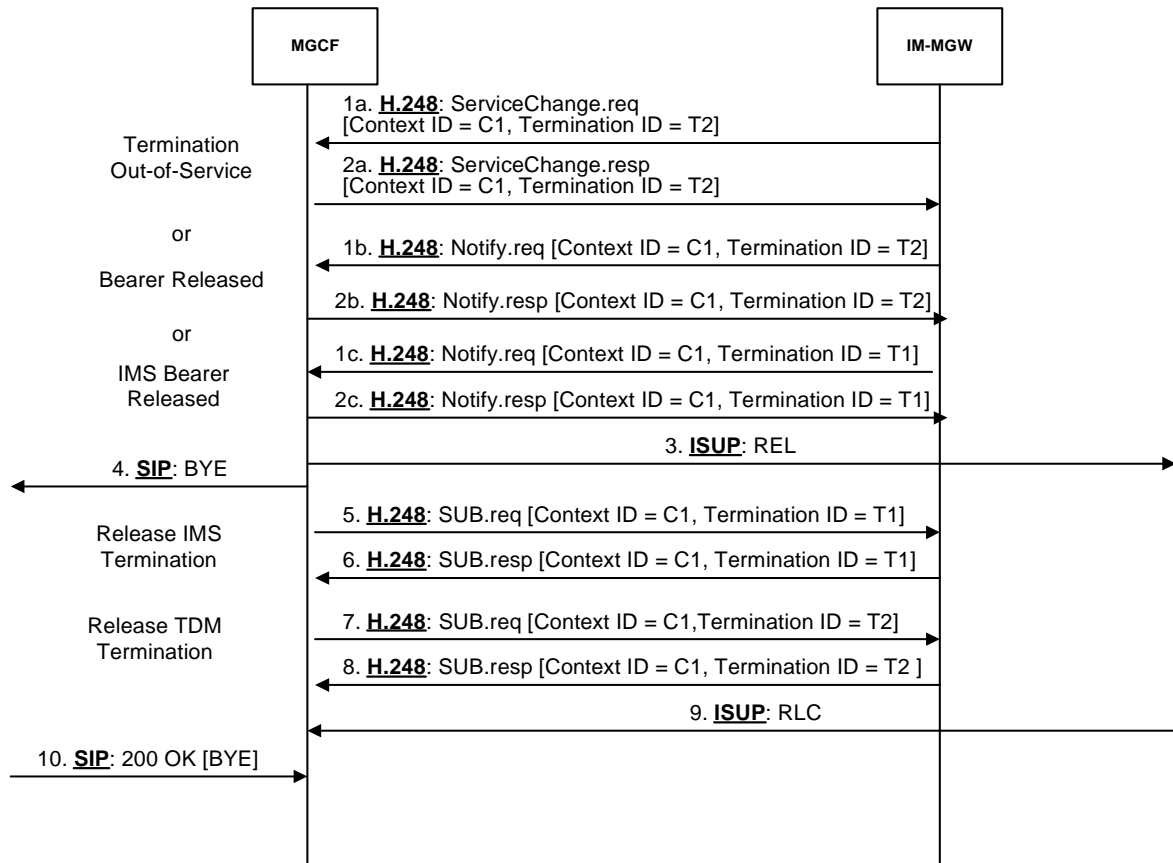

Figure 47: Session release initiated by the IM-MGW for ISUP (message sequence chart)

9.2.8 Handling of RTP telephone events

DTMF digits, telephony tones and signals (telephone events) can be transferred using different mechanisms. For the IM CN Subsystem, 3GPP TS 24.229 [9] defines the usage of the RTP payload format defined for DTMF Digits, Telephony Tones and Telephony Signals in RFC 4733 [105]. When BICC signalling is used in the CS network, telephony signals may be sent either inband or out-of-band as defined in ITU-T Recommendation Q.1902.4 [30] and in ITU-T Recommendation Q.765.5 [35]. If ISUP signalling is used the DTMF tones are sent inband. The following paragraphs describe the Mn interface procedures to transfer DTMF between RTP format defined in RFC 4733 [105] and the CS CN.

Before the actual usage of the telephony signals can occur the sending/receiving of telephone events need to be agreed with the SDP offer-answer mechanism defined in RFC 3264 [36]. The outcome of the negotiation can be e.g. that no telephone events are sent in RTP payload, telephone events are sent only in one direction or in both directions. If the outcome of the negotiation is that RTP payload telephone-events are sent in both directions, the IM-MGW may nevertheless be configured to interwork only mobile originated telephone-events.

When the offer-answer mechanism based session parameters negotiation results in an agreement that telephone events are sent in the RTP payload and the needed preconditions are fulfilled, telephone events can be sent in RTP payload. This negotiation can be done at call control signalling phase or during an ongoing call.

If the MGCF and IM-MGW support the reception and/or transmission of the RTP MIME type "telephone event" (as defined in RFC 4733 [105]) with the IMS, the following applies:

- For CS Network Originating Sessions, the MGCF shall include the MIME type "telephone events" with default events in the first SDP offer. After the usage of telephone events is agreed in the subsequent offer-answer parameter exchanges and the needed preconditions defined in RFC 3312 [37] are fulfilled, telephone events can be sent as RTP payload.
- In case of IM CN Subsystem Originating Sessions, the MGCF shall accept the MIME type "telephone events" with default events in any SDP answer when it received such an offer.

9.2.8.1 Sending DTMF digits out-of-band to CS CN (BICC)

For the IM CN subsystem terminated session, the MGCF shall use the "Configure IMS Resources" procedure as described in clause 9.2.3. For the IM CN subsystem originating session, the MGCF shall use the "Reserve IMS Connection Point and Configure Remote Resources" procedure as described in clause 9.2.2. If DTMF is supported, the MGCF shall include "telephone event" along with the selected speech codecs within the "local IMS resources" Parameter of these procedures. The same termination shall be used to receive and transmit DTMF and speech of the same call.

Furthermore, the MGCF shall use the "Detect IMS RTP Tel Signal" procedure to request the MGW to detect incoming telephone events from the IMS and notify the MGCF about the detected events. The MGW shall use the "Notify IMS RTP Tel Event" procedure for this notification. The termination used to receive DTMF shall be placed in the same context used for the speech of the same call. The MGCF shall request to be notified when the MGW detects the end of a digit and may also request to be notified when the MGW detects the start of a digit. An IM-MGW not supporting the notification about the detection of the start of a digit may ignore the request to provide this notification. If the IM-MGW received a "Detect IMS RTP Tel Event" procedure for a termination, the IM-MGW shall not forward inband to the CS network any DTMF received at this termination.

Figure 48 shows an example message sequence chart when a DTMF digit is received from the IM CN subsystem in the RTP payload and the MGCF has requested to be notified only about the detection of the end of a digit. Figure 48a shows an example message sequence chart when a DTMF digit is received from the IM CN subsystem in the RTP payload and the MGCF has requested to be notified about the detection of the start and the end of a digit.

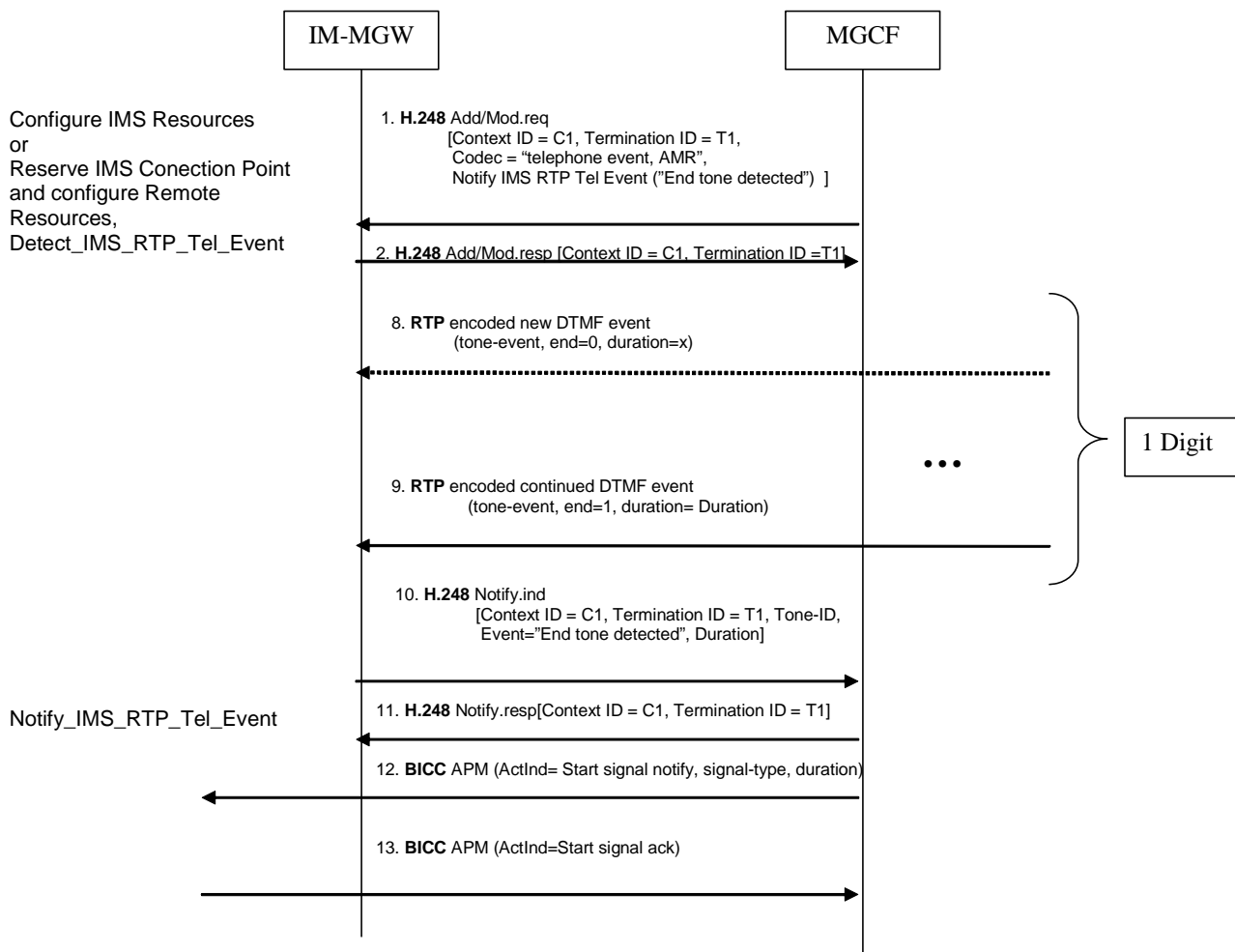

Figure 48: Activation of notification of DTMF digits received in RTP and examples of sending the digits out-of-band to CS CN, a whole digit received by IM-MGW before sending further (message sequence chart)

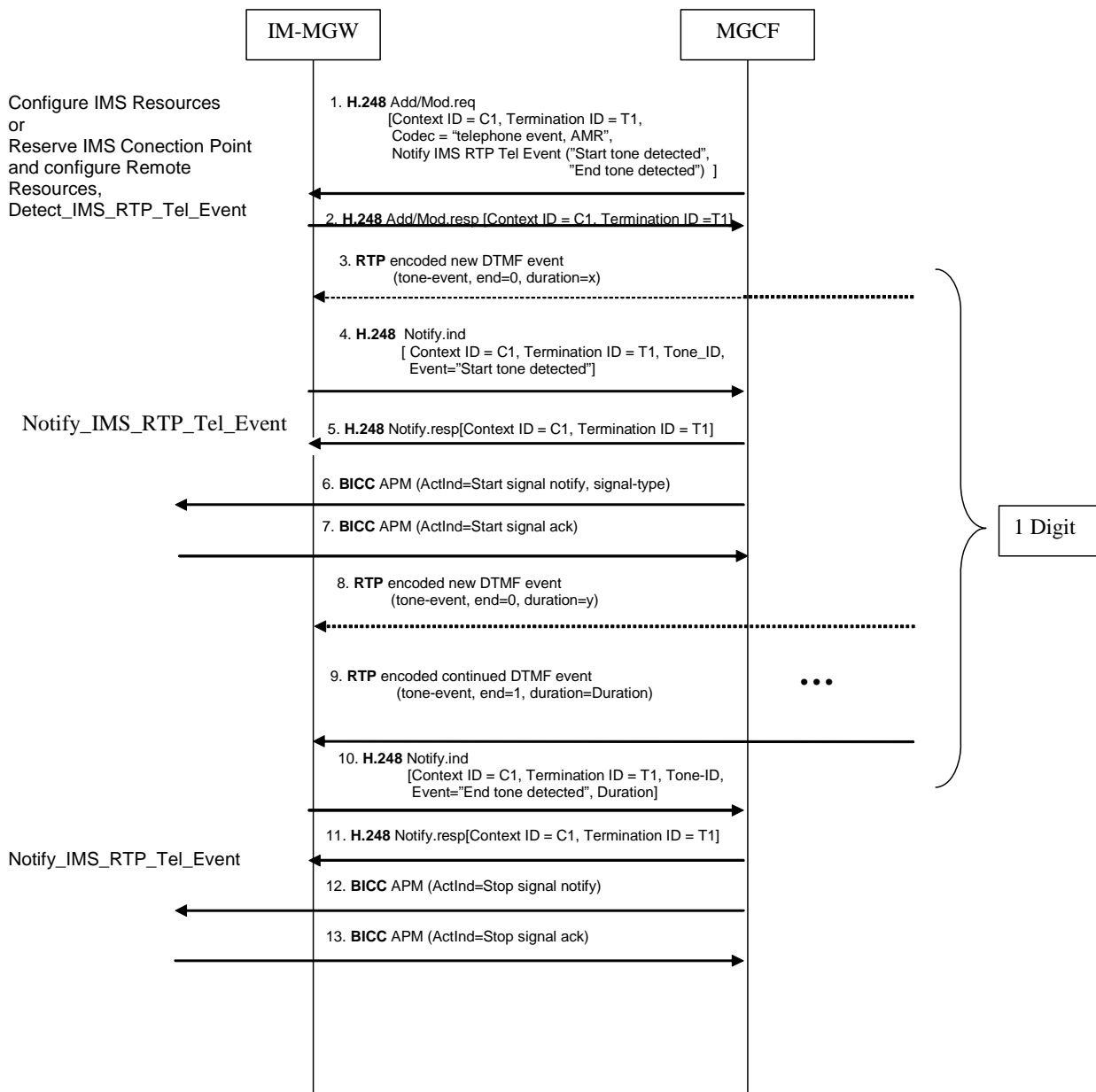

Figure 48a: Activation of notification of DTMF digits received in RTP and examples of sending the digits out-of-band to CS CN, IM-MGW starts sending the digit further when the start of the digit is recognized (message sequence chart)

9.2.8.2 Sending and receiving DTMF digits inband to/from CS CN (ISUP or BICC)

For the IM CN subsystem terminated session, the MGCF shall use the "Configure IMS Resources" procedure as described in clause 9.2.3. For the IM CN subsystem originating session, the MGCF shall use the "Reserve IMS Connection Point and Configure Remote Resources" procedure as described in clause 9.2.2. If DTMF is supported and the MGCF wants to configure the IM_MGW to send and receive DTMF to/from the CS network side, the MGCF shall include "telephone event" along with the selected speech codecs within the "local IMS resources" parameter of these procedures to request the MGW to detect incoming telephone events and transform them into speech signals on the CS side and shall not apply the "Detect IMS RTP Tel Event" procedure. When receiving this configuration, an MGW supporting DTMF shall detect DTMF encoded according as RTP Tel Event and transform this into DTMF tones encoded within the speech codec used at the CS CN network and may in addition optionally detect incoming telephone events received inband from the CS CN network and transform them into telephone events on the IMS side. The same termination shall be used to receive and transmit DTMF and speech of the same call.

Figure 49 shows the message sequence chart to configure the IM-MGW to receive DTMF detection on the IMS side and transfer the DTMF inband on the CS side. When receiving this configuration, the IM-MGW may in addition optionally detect DTMF inband on the CS side and transmit DTMF on the IMS side.

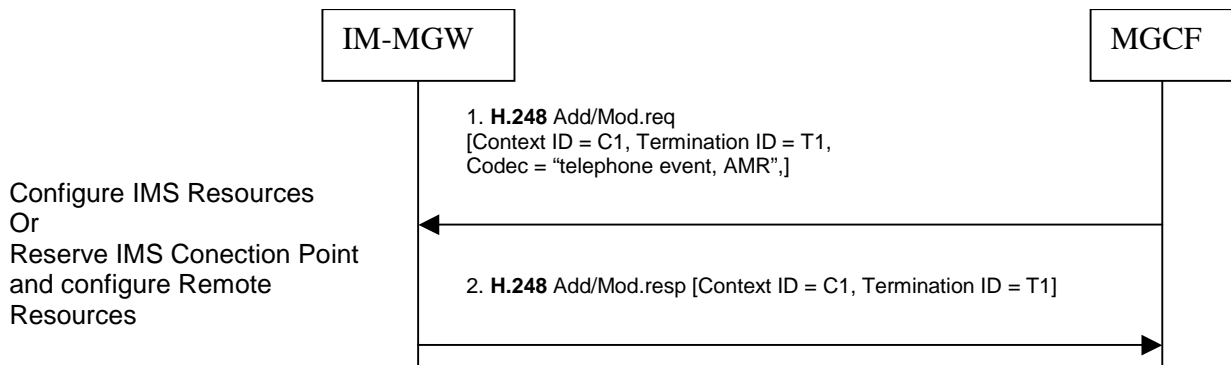

Figure 49: Activation of processing of DTMF digits received in RTP for sending the digits inband to CS CN (message sequence chart)

9.2.8.3 Receiving DTMF digits out-of-band from CS CN (BICC)

For the IM CN subsystem terminated session, the MGCF shall use the "Configure IMS Resources" procedure as described in clause 9.2.3. For the IM CN subsystem originating session, the MGCF shall use the "Reserve IMS Connection Point and Configure Remote Resources" procedure as described in clause 9.2.2. If DTMF is supported, the MGCF shall include "telephone event" along with the selected speech codecs within the "local IMS resources" Parameter of these procedures. The same termination shall be used to receive and transmit DTMF and speech of the same call.

Furthermore, the MGCF shall use the "Send IMS RTP Tel Event" and may use the "Stop IMS RTP Tel Event" procedures to request the MGW to play out DTMF to the IM CN subsystem whenever it receives out-of-band DTMF indications from the BICC network.

Figure 49a shows an example message sequence chart when DTMF digits are transmitted to the IM CN subsystem in the RTP payload. For the first digit, the received APM message contains all information including the duration and only a single notification is received. For the second digit, the start and the end of the DTMF digit are notified separately.

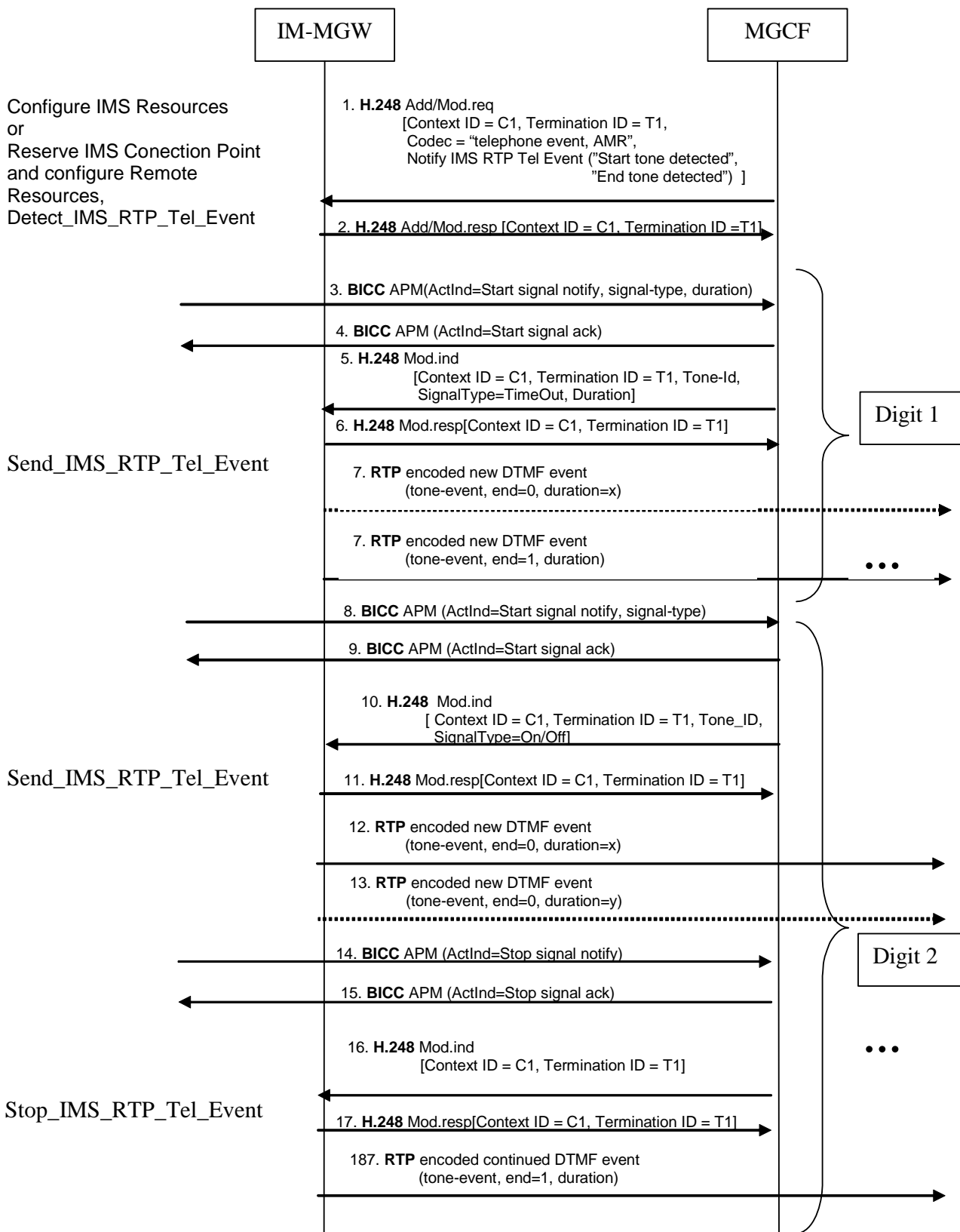

Figure 49a: Examples of receiving DTMF digits out-of-band from the CS CN and transmitting them in RTP (message sequence chart)

9.2.9 Session hold initiated from IM CN subsystem

The network model in the clause 9.2.1 shall apply here.

Hold request

When the IMS network makes a hold request by sending an UPDATE or re-INVITE message (signal 1 of figure 50), the MGCF shall request the IM-MGW to suspend sending media towards the IMS side by changing the through-connection of the IM CN subsystem side termination to "not through-connected" (signal 2 of figure 50). If the IMS side provides modified SDP RR or RS bandwidth modifiers, as specified in IETF RFC 3556 [59], within the hold request, the MGCF shall use the Configure IMS Resources Mn procedure to forward this information to the IM-MGW (not depicted in figure 50, but may be combined with signal 2). The MGCF shall send a CPG (Hold) message to the succeeding CS network node to indicate that the session is on hold (signal 4 of figure 50). Simultaneously a SIP message acknowledging the Hold request is sent to the IMS side (signal 7 of figure 50, acknowledged by signal 7.a if the INVITE method is used).

If the MGCF has identified a speech call as an "ICS call" as specified in clause 7.2.3.1.2.12 or in clause 7.2.3.2.7a the MGCF shall not apply an announcement to the party on hold. Otherwise, an announcement may be applied to the party on hold, depending on the held party's status, using the Play Announcement procedure (for BICC) or the Play TDM Announcement procedure (for ISUP, signal 5 in figure 50). The hold operation shall not block RTCP flows.

Resume request

When the IMS network makes a request to retrieve the session on hold by sending an UPDATE or re-INVITE message (signal 8 of figure 50), the MGCF shall request the IM-MGW to re-establish communication towards the IMS network by changing the through-connection of the IM CN subsystem side termination to both-way through-connected (signal 11 of figure 50). If the IMS side provides modified SDP RR or RS bandwidth modifiers, as specified in IETF RFC 3556 [59], within the retrieve request, the MGCF shall use the Configure IMS Resources Mn procedure to forward this information to the IM-MGW (not depicted in figure 50, but may be combined with signal 11). Possible announcements to the party on hold shall be stopped using the Stop Announcement procedure (for BICC) or the Stop TDM Announcement procedure (for ISUP, signal 9 in figure 50). The MGCF shall send a CPG (Retrieve) message to the succeeding CS network node to indicate that the session is retrieved (signal 13 of figure 50).

Message sequence chart

Figure 50 shows the message sequence chart for the call hold and retrieval procedures.

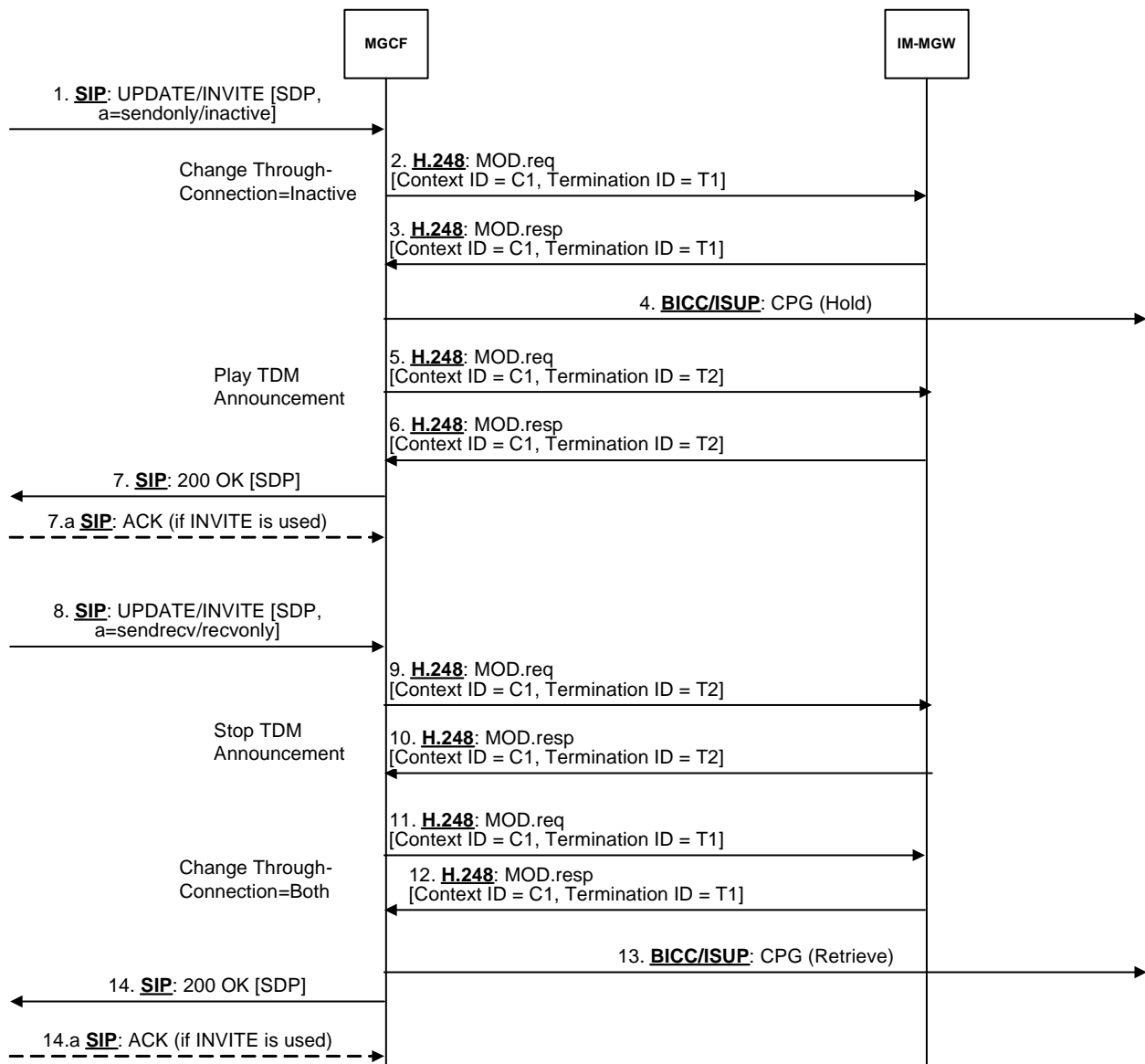

NOTE: For an "ICS call" signals 5, 6, 9 and 10 will not be sent since the MGCF will not request an announcement from the IM-MGW.

Figure 50: Session hold/resume from IM CN subsystem

9.2.10 Session hold initiated from CS network

When an MGCF receives a CPG message with a "remote hold" Generic notification indicator (signal 1 of figure 51), the MGCF forwards the hold request by sending an UPDATE or re-INVITE message containing SDP with "sendonly" or "inactive" media (signal 4 of figure 51).

When an MGCF receives a CPG message with a "remote retrieval" Generic notification indicator (signal 6 of figure 51), the MGCF forwards the resume request by sending an UPDATE or re-INVITE message containing SDP with "sendrecv" or "recvonly" media (signal 9 of figure 51).

If the MGCF receives a CPG with "remote hold" or "remote retrieval" before answer, it shall forward the request using an UPDATE message. If the MGCF receives a CPG with "remote hold" or "remote retrieval" after answer, it should forward the request using re-INVITE but may use UPDATE.

If link aliveness information is required at the IM-MGW while the media are on hold, the MGCF should provide to the modified SDP RR and RS bandwidth modifiers specified in IETF RFC 3556 [59] within the SDP offers in the UPDATE or re-INVITE messages holding and retrieving the media to temporarily enable RTCP while the media are on hold, as detailed in clause 7.4 of 3GPP TS 26.236 [32]. If no link aliveness information is required at the IM-MGW, the MGCF should provide the SDP RR and RS bandwidth modifiers previously used.

The interworking does not impact the user plane, unless the MGCF:

- provides modified SDP RR and RS bandwidth modifiers in the UPDATE or re-INVITE messages. If the MGCF provides modified SDP RR and RS bandwidth modifiers in the UPDATE or re-INVITE messages, the MGCF shall also provide modified SDP RR and RS bandwidths to the IM-MGW using the Configure IMS Resources procedures (signals 2-3 and 7-8 of figure 51).; or
- has identified a speech call as an "ICS call" as specified in clause 7.2.3.1.2.12 or in clause 7.2.3.2.7a. When the MGCF receives from the CS network:
 - a) a hold request the MGCF shall request the IM-MGW to suspend sending media towards the IMS side by changing the through-connection of the IM CN subsystem side termination to "not through-connected" (not depicted in figure 51, but may be combined with signal 2) prior to sending of the UPDATE or re-INVITE message containing the SDP offer with "*sendonly*" or "*inactive*" media; or
 - b) a request to retrieve the session on hold and if the MGCF requested the IM-MGW to suspend sending media on the hold request the MGCF shall request the IM-MGW to re-establish communication towards the IMS network by changing the through-connection of the IM CN subsystem side termination to "both-way through-connected" (not depicted in figure 51, but may be combined with signal 7) prior to sending of the UPDATE or re-INVITE message containing the SDP offer with "*sendrecv*" or "*recvonly*" media.

Message sequence chart

Figure 51 shows the message sequence chart for the call hold and retrieval procedures

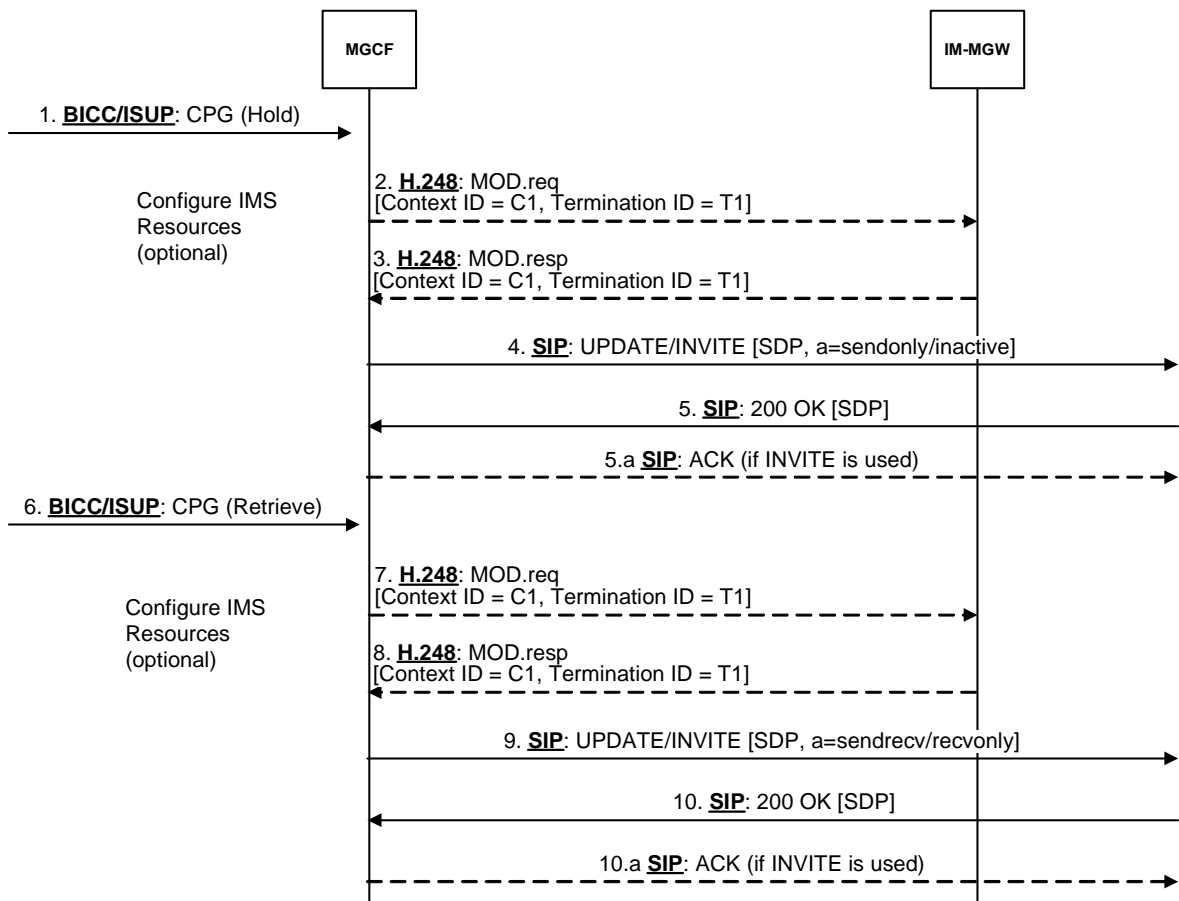

Figure 51: Session hold/resume from CS network

9.2.11 Explicit Congestion Notification Support

9.2.11.1 General

A MGCF and IM-MGW may support Multimedia Telephony using Explicit Congestion Notification (see IETF RFC 3168 [129], IETF RFC 6679 [130], and 3GPP TS 26.114 [104]), and may then act as an ECN endpoint to enable ECN with a local ECN-capable terminal within a local network that properly handles ECN-marked packets.

9.2.11.1a Incoming Call Interworking from SIP to ISUP/BICC at I-MGCF

If the MGCF receives a SDP Offer containing ECN negotiation, see IETF RFC 6679 [130], and if all of the following statements are true:

- the MGCF supports ECN according to 3GPP TS 26.114 [104];
- the IM-MGW supports ECN according to 3GPP TS 26.114 [104];
- the IM-MGW knows (via configuration) that the preceding (IMS) network supports ECN according to 3GPP TS 26.114 [104]; and
- the IM-MGW supports at least some of the initialisation methods offered within the "a=ecn-capable-rtp",

NOTE 1: Only the "leap" initialisation method is supported over the Mn interface in this release.

The MGCF shall:

- act as an end point for ECN;

- select an initialisation method supported by the IM-MGW;
- determine if application specific feedback or ECN feedback messages shall be used, taking into account whether the IM-MGW supports ECN feedback messages, and the negotiation procedures in 3GPP TS 26.114 [104];
- determine if ECN XR summary reports can be used, taking into account whether they are supported at the IM-MGW and the negotiation procedures in 3GPP TS 26.114 [104];
- return an SDP Answer according to 3GPP TS 26.114 [104] and the capabilities of the IM-MGW, containing the "a=ecn-capable-rtp" attribute; and

NOTE 2: ECN XR summary reports and RTCP AVPF ECN feedback message are not supported in this release.

- indicate to the IM-MGW that it shall apply the ECN procedures (according to 3GPP TS 26.114 [104]) and act as an ECT endpoint.

The IM-MGW should not send RTCP XR ECN summary reports.

9.2.11.1b Outgoing Call Interworking from ISUP/BICC to SIP at O-MGCF

When creating the SDP Offer the MGCF may initiate ECN negotiation (in accordance with 3GPP TS 26.114 [104]), indicating the capabilities of the IM-MGW (e.g. supported initialisation methods, support of ECN feedback message, and support of ECN XR summary reports).

NOTE: ECN XR summary reports and RTCP AVPF ECN feedback message are not supported in this release.

If the MGCF receives the SDP Answer also containing ECN attributes (indicating successful ECN negotiation) then it shall indicate to the IM-MGW that it shall apply the ECN procedures (according to 3GPP TS 26.114 [104]) and act as an ECT endpoint.

The IM-MGW should not send RTCP XR ECN summary reports.

9.2.11.1c Detection of ECN failures by IM-MGW

If the IM-MGW detects an ECN-related error case, for example non-ECT in the received packets when ECT(0) was expected or detecting a very high packet loss rate when ECN is used, the IM-MGW shall notify the MGCF. The MGCF should then initiate a session re-negotiation to disable ECN.

9.2.11.2 Message sequence chart

Figure 9.2.11.2.1 shows the message sequence chart example for requesting Explicit Congestion Notification.

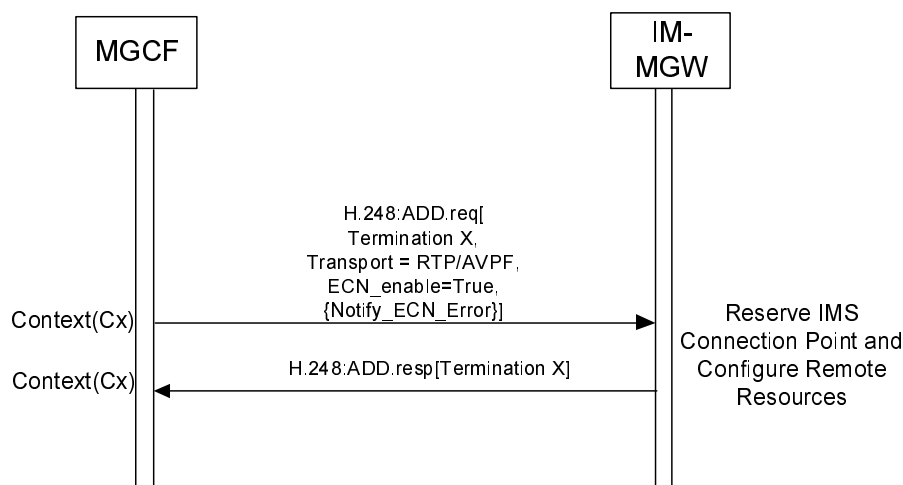

Figure 9.2.11.2.1: Procedure to Request ECN

Upon receipt of a request to apply Explicit Congestion Notification the IM-MGW shall set the ECN field of the IP header in accordance with 3GPP TS 26.114 [104] when sending any data packets.

Upon receipt of any IP headers indicating ECN Congestion Experienced (ECN-CE) the IM-MGW shall trigger rate adaptation in accordance with 3GPP TS 26.114 [104].

Figure 9.2.11.2.2 shows the message sequence chart example for an ECN Failure Event.

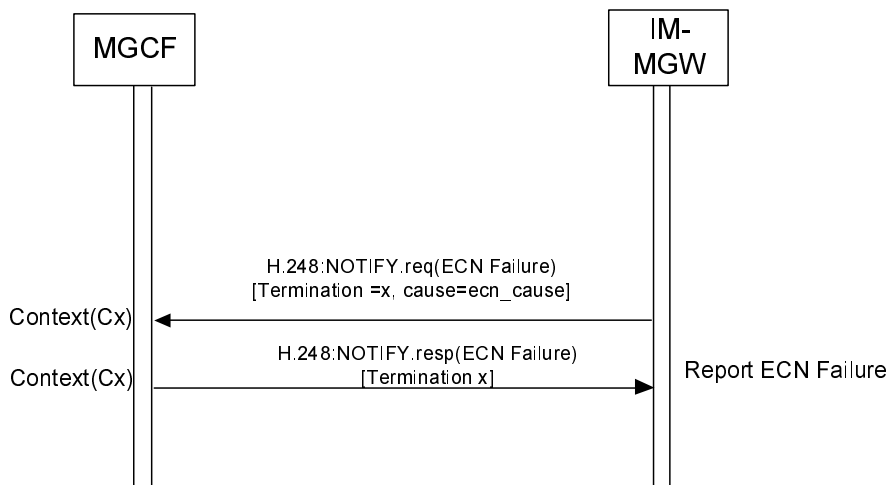

Figure 9.2.11.2.2: Procedure to Report ECN Failure

When the MGCF receives a Notification indicating that a failure has occurred, the MGCF may trigger a new SDP offer to 218isalg ECN.

9.2.12 Interactive Connectivity Establishment Support

9.2.12.1 General

The MGCF and the IM-MGW may support ICE functionality as specified in IETF RFC 5245 [143] and 3GPP TS 24.229 [9] to support a UE residing behind a remote NAT. The present clause describes the requirements for MGCF and IM-MGW when the ICE procedures are supported.

Support of full ICE functionality is optional, but if ICE is supported, the MGCF and IM-MGW shall at least support ICE lite as specified in IETF RFC 5245 [143].

The MGCF and IM-MGW shall only use host candidates as local ICE candidates.

NOTE 1: MGCF and IM-MGW are not located behind a NAT (from perspective of the ICE deployment model according to Figure 1 in RFC 5245 [143]).

When the MGCF detects no ICE parameters in the received SDP, it shall not configure the IM-MGW to apply any ICE and STUN related procedures (see IETF RFC 5389 [144]) toward the call leg from where the SDP has been received.

Any IM-MGW supporting ICE shall advertise its support of incoming STUN continuity check procedures. An IM-MGW supporting full ICE procedures shall in addition advertise its support for originating STUN connectivity check procedures.

If the IM-MGW does not indicate the support of STUN procedures, or if the MGCF is configured not to apply ICE toward a call leg, the MGCF shall not configure the IM-MGW to apply STUN procedures.

9.2.12.2 ICE lite

If the MGCF is configured to use ICE lite, or supports only ICE lite, or controls an IM-MGW that only support ICE lite, the procedures in the present clause apply.

If the MGCF receives an initial SDP offer with ICE candidate information but no "a=ice-lite" attribute, the MGCF:

- shall request the IM-MGW for each media line where it decides to use ICE to reserve an ICE host candidate and provide its address information and a related ICE user name fragment and password;

NOTE 1: Requesting only one host candidate per m-line prevents that the MGCF will receive "a=remote-candidates" SDP attributes in a subsequent SDP. Requesting separate ufrag and password for each media line simplifies H.248 encoding.

- shall configure the IM-MGW to act as STUN server at the host candidate address, i.e. to answer STUN connectivity checks;
- may provide received remote ICE candidates and the received related ICE user name fragment and password to the IM-MGW;
- shall include the host candidate and related ICE user name fragment and password received from the IM-MGW in the SDP answer it sends; and
- shall include the "a=ice-lite" attribute in the SDP answer it sends.

If the MGCF receives SDP offer with ICE candidate information and an "a=ice-lite" attribute, the MGCF shall not apply ICE and shall not include any ICE related SDP attributes in the SDP answer.

NOTE 2: This avoids that the ICE lite peer needs to send extra SDP offers to complete ICE procedures.

If the MGCF sends an SDP offer and ICE is to be applied, the MGCF:

- shall request the IM-MGW to reserve a host candidate for each media line where it decides to use ICE and provide its address information, user name fragment and password;
- shall configure the IM-MGW to act as STUN server at the host candidate address, i.e. to answer STUN connectivity checks;
- shall include the host candidate provided by the IM-MGW and related ICE user name fragment and password in the SDP offer it forwards; and
- shall include the "a=ice-lite" attribute in the SDP offer.

If the MGCF then receives an SDP answer with candidate information from the call leg where ICE is to be applied, the MGCF may provide received remote ICE candidates and the received related ICE user name fragment and password to the IM-MGW.

After the initial SDP offer-answer exchange, the MGCF can receive a new offer from the peer that includes updated address and port information in the SDP "c=" line, "m=" line, or "a=rtcp" line SDP attributes. If the ICE user name fragment and password in the SDP offer differ from the ones received in the previous SDP (i.e. the peer restarts ICE), the MGCF shall apply the same procedures as for the initial SDP offer.

When receiving a request for a host candidate for a media line, the IM-MGW shall allocate one host candidate for that media line and send it to the MGCF within the reply. The IP address and port shall be the same as indicated separately as Local IP Resources. The IM-MGW shall also indicate that it supports ICE lite in the reply.

When receiving a request for an ICE user name fragment and password, the IM-MGW shall generate an ICE user name fragment and password and send it to the MGCF within the reply. The IM-MGW shall store the password and user name fragment to be able to authenticate incoming STUN binding request according to clause 7.2 of IETF RFC 5245 [143].

When receiving a request to act as STUN server, the IM-MGW shall be prepared to answer STUN binding request according to clause 7.2 of IETF RFC 5245 [143]. Once a STUN binding request with the "USE-CANDIDATE" flag has been received, the IM-MGW may send media towards the source of the binding request.

9.2.12.3 Full ICE

If the MGCF supports and is configured to use full ICE, and controls an IM-MGW that supports full ICE, the procedures in the present clause apply.

If the MGCF receives an initial SDP offer with ICE candidate information, the MGCF:

- shall request the IM-MGW for each media line where it decides to use ICE to reserve an ICE host candidate and provide its address information and a related ICE user name fragment and password;

NOTE 1: Requesting only one host candidate per m-line prevents that the MGCF will receive "a=remote-candidates" SDP attributes in a subsequent SDP. Requesting separate ufrag and password for each media line simplifies H.248 encoding.

- shall configure the IM-MGW to act as STUN server at the host candidate address, i.e. to answer STUN connectivity checks;
- shall provide received remote ICE candidates and the received related ICE user name fragment and password to the IM-MGW;
- shall include the host candidate and related ICE user name fragment and password received from the IM-MGW in the SDP answer it sends;
- shall determine the role of MGCF in ICE (controlling or controlled) according to clause 5.2 of IETF RFC 5245 [143];
- shall configure the IM-MGW to perform connectivity checks in accordance with the determined ICE role;
- shall configure the IM-MGW to report connectivity check results; and
- shall configure the IM-MGW to report a new peer reflexive candidate if discovered during the connectivity check.

If the MGCF sends an SDP offer and ICE is to be applied, the MGCF:

- shall request the IM-MGW to reserve a host candidate for each media line were it decides to use ICE and provide its address information, ICE user name fragment and password;
- shall configure the IM-MGW to act as STUN server at the host candidate address, i.e. to answer STUN connectivity checks; and
- shall include the host candidate provided by the IM-MGW and related ICE user name fragment and password in the SDP offer it sends.

If the MGCF then receives an SDP answer with candidate information from the call leg where ICE is to be applied, the MGCF:

- shall provide received remote ICE candidates and the received related ICE user name fragment and password to the IM-MGW;
- shall determine the role of MGCF in ICE (controlling or controlled) according to clause 5.2 of IETF RFC 5245 [143];
- shall configure the IM-MGW to perform connectivity checks in accordance with the determined ICE role;
- shall configure the IM-MGW to report connectivity check results; and
- shall configure the IM-MGW to report a new peer reflexive candidate if discovered during the connectivity check.

When the MGCF is informed by the IM-MGW about new peer reflexive candidate(s) discovered by the connectivity checks, the MGCF shall configure the IM-MGW to perform additional connectivity checks for those candidates,

When the MGCF is informed by the IM-MGW about successful candidate pairs determined by the connectivity checks, the MGCF shall send a new SDP offer to its peer with contents according to clause 9.2.2.2 of IETF RFC 5245 [143] if it has the controlling role and the highest-priority candidate pair differs from the default candidates in previous SDP.

After the initial SDP offer-answer exchange, the MGCF can receive a new offer from the peer that includes updated address and port information in the SDP "c=" line, "m=" line, or "a=rtp=" line SDP attributes. If the ICE user name fragment and password in the SDP offer are the same as received in the previous SDP, the MGCF shall then configure the IM-MGW to send media towards the address and port in the SDP "c=" line, "m=" line. If the STUN user name and password in the SDP offer differ from the ones received in the previous SDP (i.e. the peer restarts ICE), the MGCF shall apply the same procedures as for the initial SDP offer.

When receiving a request for a host candidate for a media line, the IM-MGW shall allocate one host candidate for that media line and send it to the MGCF within the reply. The IP address and port shall be the same as indicated separately as Local IP Resources.

When receiving a request for an ICE user name fragment and password, the IM-MGW shall generate an ICE user name fragment and password and send it to the MGCF within the reply. The IM-MGW shall store the password and user name fragment to be able to authenticate incoming STUN binding request according to clause 7.2 of IETF RFC 5245 [143].

When receiving a request to act as STUN server, the IM-MGW shall be prepared to answer STUN binding request according to clause 7.2 of IETF RFC 5245 [143]. Once a STUN binding request with the "USE-CANDIDATE" flag has been received, the IM-MGW may send media towards the source of the binding request.

When receiving a request to perform connectivity checks and to report connectivity check results, the IM-MGW:

- shall compute ICE candidate pairs according to clause 5.7 of IETF RFC 5245 [143];
- shall schedule checks for the ICE candidate pairs according to clause 5.8 of IETF RFC 5245 [143];
- shall send STUN connectivity checks for the scheduled checks according to clause 7.1 of IETF RFC 5245 [143];
- shall inform the MGCF about successful candidate pairs determined by the connectivity checks;
- shall inform the MGCF about new peer reflexive candidate(s) discovered by the connectivity checks; and
- should send media using the highest priority candidate pair for which connectivity checks have been completed.

9.2.12.4 Procedures for Interactive Connectivity Establishment (ICE)

9.2.12.4.1 ICE lite

Figure 9.2.12.4.1.1 shows a message sequence chart example for performing the ICE lite procedure towards the offerer.

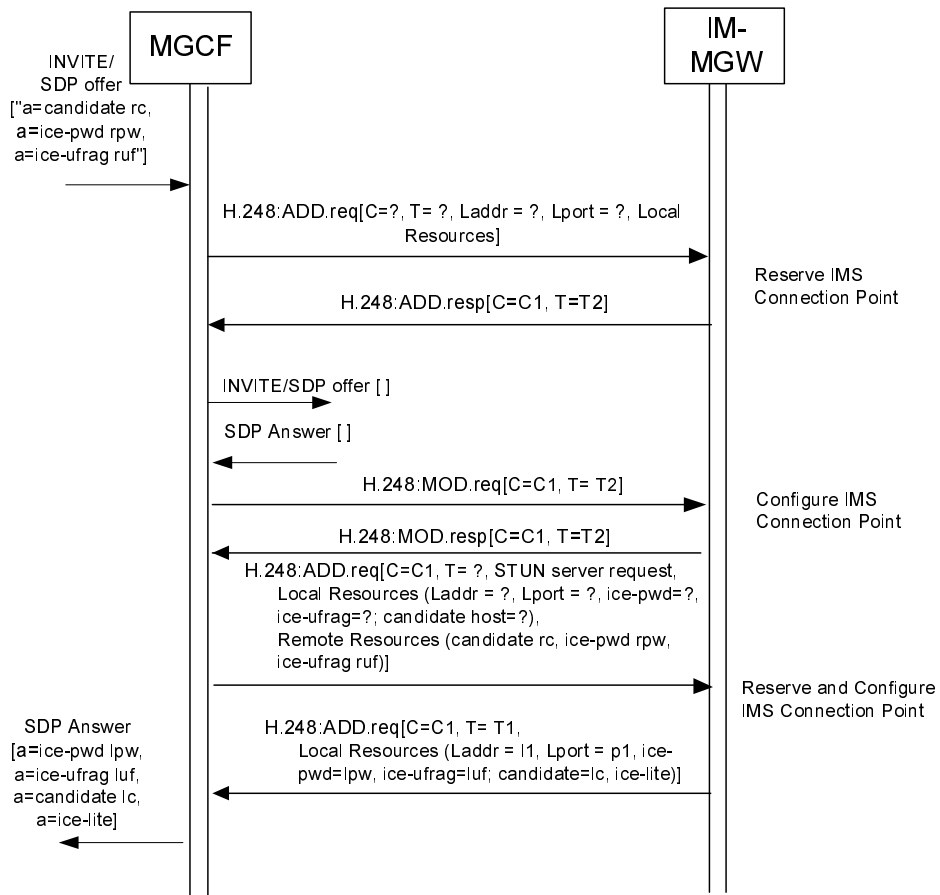

Figure 9.2.12.4.1.1: Procedure for interactive connectivity establishment using ICE lite towards the offerer

9.2.12.4.2 Full ICE

Figure 9.2.12.4.2.1 shows a message sequence chart example for performing the full ICE procedure towards the offerer.

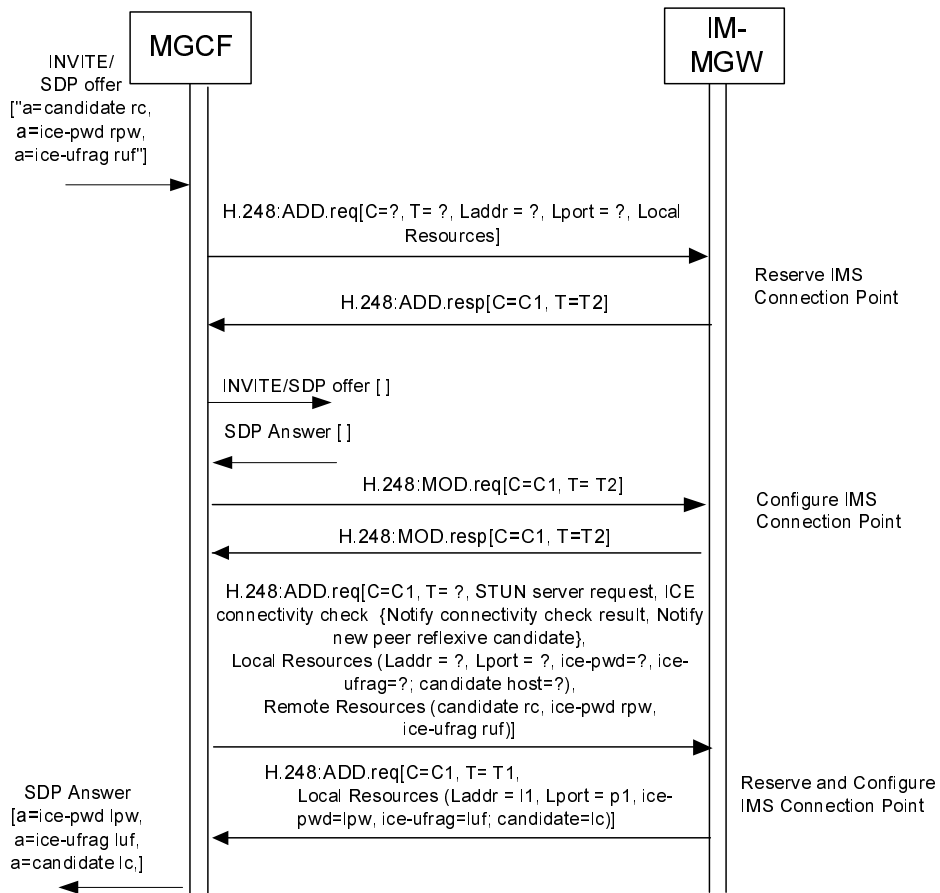

Figure 9.2.12.4.2.1: Procedure for interactive connectivity establishment using full ICE towards the offerer

9.2.12.4.3 Connectivity check result notification (full ICE)

Figure 9.2.12.4.3.1 shows the message sequence chart example for an ICE connectivity check result Event.

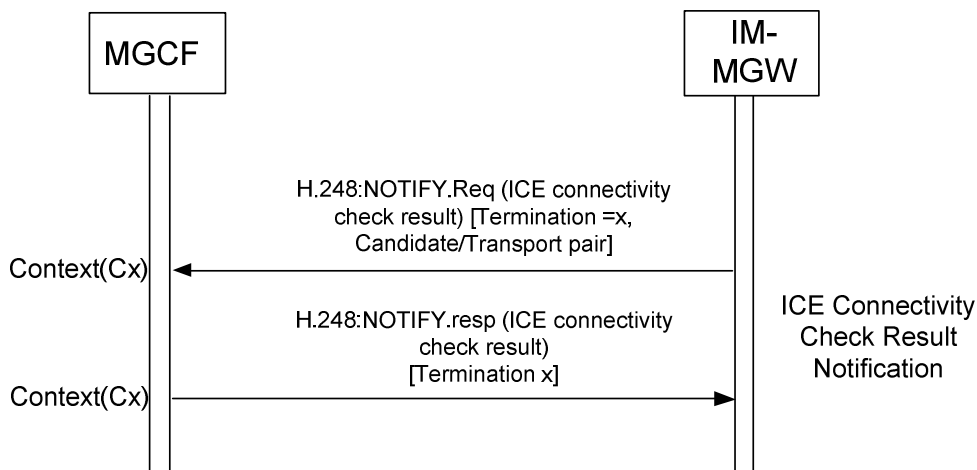

Figure 9.2.12.4.3.1: Procedure to report ICE connectivity check result

9.2.12.4.4 New peer reflexive candidate notification (full ICE)

Figure 9.2.12.4.4.1 shows the message sequence chart example for additional connectivity check when new peer reflexive candidate is discovered in full ICE.

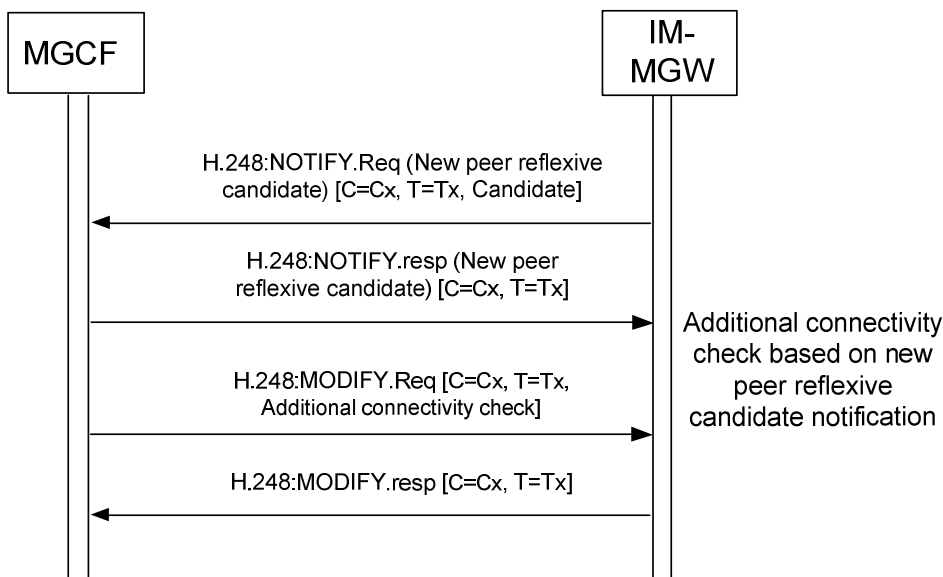

Figure 9.2.12.4.4.1: Procedure to perform additional connectivity check upon the report of new peer reflexive candidate

9.2.13 Codec Parameters Handling

9.2.13.1 Handling of common codec parameters

Table 9.2.13.1.1 describes the MGCF handling of codec related parameters applicable to multiple codecs when the MGCF sends an SDP offer.

Table 9.2.13.1.1: MGCF handling of common codec parameters when the MGCF acts as SDP offerer

Parameter	Handling of common codec parameter in the sent SDP offer	Handling of common codec parameter in the received SDP answer
ptime (NOTE)	The MGCF may add the parameter with a value according to configured preferences to the SDP offer.	If a ptime parameter is included in the received SDP answer, the MGCF shall supply the parameter to the IM-MGW for the termination towards the answerer in the remote descriptor.
maxptime (NOTE)	The MGCF may add the parameter with a value according to the IM-MGW capabilities to the SDP offer.	If a maxptime parameter is included in the received SDP answer, the MGCF shall supply the parameter to the IM-MGW for the termination towards the answerer in the remote descriptor.

NOTE 2: This SDP attribute is defined in IETF RFC 4566 [56]. It applies to all codecs offered in an SDP media line.

When receiving an SDP offer, the MGCF shall handle the codec related parameters applicable to multiple codecs as described in table 9.2.13.1.2.

Table 9.2.13.1.2: MGCF handling of common codec parameters when the MGCF acts as SDP answerer

Parameter	Handling of common codec parameter in the received SDP offer	Handling of common codec parameter in the sent SDP answer
ptime (NOTE)	If a ptime parameter is included in the received SDP offer, the MGCF shall supply the parameter to the IM-MGW for the termination towards the offerer in the remote descriptor.	The MGCF may add the parameter with a value according to configured preferences to the SDP answer.
maxptime (NOTE)	If a maxptime parameter is included in the received SDP offer, the MGCF shall supply the parameter to the IM-MGW for the termination towards the offerer in the remote descriptor.	The MGCF may add the parameter with a value according to the IM-MGW capabilities to the SDP answer.
NOTE: This SDP attribute is defined in IETF RFC 4566 [56]. It applies to all codecs offered in an SDP media line.		

IM-MGW handling of codec related parameters applicable to multiple codecs shall follow table 5.13.1.2 in 3GPP TS 23.334 [145].

9.2.13.2 EVS speech codec

The Enhanced Voice Services (EVS) speech codec is defined in 3GPP TS 26.441 [146]. Its RTP payload type is defined in 3GPP TS 26.445 [147], and procedures for its usage as IMS Multimedia Telephony speech codec are defined in 3GPP TS 26.114 [104].

The MGCF and the IM-MGW may support transcoding to and from the EVS speech codec. If they do so, the procedures in the present clause apply.

Table 9.2.13.2.1 describes the MGCF handling of EVS codec parameters when the MGCF sends an SDP offer for an EVS payload type, and that EVS payload type is selected in the answer. In addition, rules for the parameter handling in 3GPP TS 26.445 [147] shall apply.

Table 9.2.13.2.1: MGCF handling of EVS related SDP parameters when the MGCF adds the EVS payload type to the SDP offer it sends out

Parameter	Handling for EVS payload type added to an SDP offer	Handling if offered EVS payload type is accepted in the SDP answer
evs-mode-switch (NOTE 1)	If the MGCF expects that interworking between AMR-WB and EVS is required, it shall include the evs-mode-switch with value 1. Otherwise the MGCF shall not include the evs-mode-switch.	If an evs-mode-switch parameter is contained in the SDP answer, the MGCF shall forward this parameter to the IM-MGW for the termination towards the answerer in the remote descriptor.
hf-only (NOTE 1)	If the MGCF is configured to negotiate using only the header-full EVS RTP payload format, the MGCF shall include the hf-only parameter with a value 1.	If an hf-only parameter is contained in the SDP answer, the MGCF shall forward this parameter to the IM-MGW in the remote descriptor.
dtx (NOTE 1)	If the usage of DTX is not desired in the sending and receiving direction (e.g. due to DTX capabilities of expected codecs to transcode with), the MGCF shall include the dtx parameter with a value 0.	If a dtx parameter is contained in the SDP answer, the MGCF shall forward this parameter to the IM-MGW in the remote descriptor.
dtx-recv (NOTE 1)	If receiving DTX is not desired, the MGCF shall include the dtx-recv parameter with a value 0.	If a dtx-recv parameter is contained in the SDP answer, the MGCF shall forward this parameter to the IM-MGW in the remote descriptor.
br (NOTE 1)	If the MGCF desires the same bit rate range for the send and receive direction in EVS primary mode, and wants to restrict the bit rate range to match IM-MGW capabilities and possible configured policies, it shall supply the br parameter in the SDP offer it sends. Otherwise the MGCF shall not include this parameter in the SDP offer. If the MGCF also supplies the bw, bw-send or bw-recv parameter, the value of the br parameter shall be compatible with the values of those parameters.	If a br parameter is contained in the SDP answer, the MGCF shall forward this parameter to the IM-MGW in the remote descriptor.
br-send (NOTE 1)	If the MGCF desires a different bit rate (range) for the send and receive direction in EVS primary mode, and wants to restrict the bit rate range for the send direction to match IM-MGW capabilities and possible configured policies, it shall supply the br-send parameter in the SDP offer it sends. Otherwise the MGCF shall not include this parameter in the SDP offer. If the MGCF also supplies the bw or bw-send parameter, the value of the br-send parameter shall be compatible with the values of those parameters.	If a br-send parameter is contained in the SDP answer, the MGCF shall forward this parameter to the IM-MGW in the remote descriptor.
br-recv (NOTE 1)	If the MGCF desires a different bit rate (range) for the send and receive direction in EVS primary mode, and wants to restrict the bit rate range for the receive direction to match IM-MGW capabilities and possible configured policies, it shall supply the br-recv parameter in the SDP offer it sends. Otherwise the MGCF shall not include this parameter in the SDP offer. If the MGCF also supplies the bw or bw-recv parameter, the value of the br-recv parameter shall be compatible with the values of those parameters.	If a br-recv parameter is contained in the SDP answer, the MGCF shall forward this parameter to the IM-MGW in the remote descriptor.
bw (NOTE 1)	If the MGCF desires the same sampling bandwidth(s) for the send and receive direction in EVS primary mode, and wants to restrict the sampling bandwidths to match IM-MGW capabilities, sampling bandwidths of expected codecs EVS will	If a bw parameter is contained in the SDP answer, the MGCF shall forward this parameter to the IM-MGW in the remote descriptor.

	be transcoded to, and possible configured policies, it shall supply the bw parameter in the SDP offer it sends. Otherwise the MGCF shall not include this parameter in the SDP offer.	
bw-send (NOTE 1)	If the MGCF desires different sampling bandwidths for the send and receive direction in EVS primary mode, and wants to restrict the sampling bandwidths in the send direction to match IM-MGW capabilities, sampling bandwidths of expected codecs EVS will be transcoded to and possible configured policies, it shall supply the bw-send parameter in the SDP offer it sends. Otherwise the MGCF shall not include this parameter in the SDP offer.	If a bw-send parameter is contained in the SDP answer, the MGCF shall forward this parameter to the IM-MGW in the remote descriptor.
bw-recv (NOTE 1)	If the MGCF desires different sampling bandwidths for the send and receive direction in EVS primary mode, and wants to restrict the sampling bandwidths in the receive direction to match IM-MGW capabilities, sampling bandwidths of expected codecs EVS will be transcoded to, and possible configured policies, it shall supply the bw-recv parameter in the SDP offer it sends. Otherwise the MGCF shall not include this parameter in the SDP offer.	If a bw-recv parameter is contained in the SDP answer, the MGCF shall forward this parameter to the IM-MGW in the remote descriptor.
cmr (NOTE 1)	If the MGCF desires to disable codec mode requests within the RTP payload of the EVS primary mode (due to the IM-MGW capabilities or policies), it shall include the cmr parameter with value -1 in the SDP offer it sends.	If a cmr parameter is contained in the SDP answer, the MGCF shall forward this parameter to the IM-MGW in the remote descriptor.
ch-aw-recv (NOTE 1)	The MGCF shall include the ch-aw-recv parameter in the SDP offer if it desires to control the channel-aware-mode of EVS in the receive direction, e.g. to disable it with value -1. The MGCF shall consider the capabilities of the IM-MGW when it chooses an appropriate value.	If a ch-aw-recv parameter is contained in the SDP answer, the MGCF shall forward this parameter to the IM-MGW in the remote descriptor.
number of channels (NOTE 2)	The MGCF shall only include the "number of channels" parameter in the SDP offer if it desires to send or receive multiple channels. If the desired number of channels in the send and receive direction differs, the MGCF shall include the higher value. The MGCF should consider the number of channels of expected codecs EVS will be transcoded to.	If a "number of channels" parameter is contained in the SDP answer, the MGCF shall forward this parameter to the IM-MGW in the remote descriptor.
ch-send (NOTE 1)	The MGCF shall only include the ch-send parameter in the SDP offer if it desires to send multiple channels, with different numbers of channels in the send and receive direction. The MGCF should consider the number of channels of expected codecs EVS will be interworked with.	If a ch-send parameter is contained in the SDP answer, the MGCF shall forward this parameter to the IM-MGW in the remote descriptor.
ch-recv (NOTE 1)	The MGCF shall only include the ch-recv parameter in the SDP offer if it desires to receive multiple channels, with different numbers of channels in the send and receive direction. The MGCF should consider the number of channels of expected codecs EVS will be interworked with..	If a ch-recv parameter is contained in the SDP answer, the MGCF shall forward this parameter to the IM-MGW in the remote descriptor.
mode-set (NOTE 4)	The MGCF shall only include the mode-set parameter in the SDP offer if it desires to restrict the mode-set of AMR-WB IO mode.	If a mode-set parameter is contained in the SDP answer, the MGCF shall forward this parameter to the IM-MGW in the remote

	The MGCF should only restrict the mode-set if the expected codec EVS will be interworked with is AMR-WB and has a restricted mode set.	descriptor.
mode-change-period (NOTE 3)	The MGCF shall only include the mode-change-period parameter with value 2 in the SDP offer if it desires to restrict the mode change period of received packets in AMR-WB IO mode. The MGCF should only restrict the mode-change-period if the expected codec EVS will be interworked with is AMR-WB and has such a restriction.	If a mode-change-period parameter is contained in the SDP answer, the MGCF shall forward this parameter to the IM-MGW in the remote descriptor.
mode-change-capability (Note 3)	The MGCF shall include the mode-change-capability parameter with value 2 in the SDP offer if it is capable of restricting the mode change period of packets it sends in AMR-WB IO mode. The MGCF should consider the mode-change-period of the expected codec EVS will be interworked with if this is AMR-WB.	If a mode-change-capability parameter is contained in the SDP answer, the MGCF may forward this parameter to the IM-MGW in the remote descriptor.
mode-change-neighbor (NOTE 3)	The MGCF shall only include the mode-change-neighbor parameter in the SDP offer if it desires to restrict the mode change within received packets of AMR-WB IO mode to neighboring modes. The MGCF should consider the mode-change-neighbor parameter of the expected codec EVS will be interworked with if this is AMR-WB.	If a mode-change-neighbor parameter is contained in the SDP answer, the MGCF shall forward this parameter to the IM-MGW in the remote descriptor.
max-red (NOTE 5)	The MGCF shall only include the max-red parameter in the SDP offer if it desires to restrict the maximum redundancy of received packets. MGCF shall consider the capabilities of the IM-MGW, and should consider a max-red parameter of the expected codec EVS will be interworked with if this is AMR-WB.	If a max-red parameter is contained in the SDP answer, the MGCF shall forward this parameter to the IM-MGW in the remote descriptor.
3gpp_mtsi_app_adapt (NOTE 4)	If the IM-MGW supports RTCP APP based adaptation messages defined in TS 26.114 [104], and the MGCF has a policy to negotiate the usage of those messages, the MGCF shall include the 3gpp_mtsi_app_adapt SDP attribute indicating the supported APP messages in the SDP offer.	If a 3gpp_mtsi_app_adapt attribute is contained in the SDP answer, the MGCF shall forward this parameter to the IM-MGW in the remote descriptor.
<p>NOTE 1: This MIME parameter of the EVS RTP payload type is defined in TS 26.445 [147]. It is encapsulated within the SDP "a=fmtp" attribute defined IETF RFC 4566 [56].</p> <p>NOTE 2: This number of channels are encoded as "encoding parameters" of the SDP "a=rtpmap" attribute defined in IETF RFC 4566 [56].</p> <p>NOTE 3: This MIME parameter of the EVS RTP payload type relates to AMR-WB IO mode and is defined in IETF RFC 4867 [23]. It is encapsulated within the SDP "a=fmtp" attribute defined IETF RFC 4566 [56].</p> <p>NOTE 4: This SDP attribute is defined in TS 26.114 [104]. It applies to all codecs offered in an SDP media line. However, some values are specific to EVS.</p> <p>NOTE 5: This MIME parameter of the EVS RTP payload type is defined in IETF RFC 4867 [23]. It is encapsulated within the SDP "a=fmtp" attribute defined IETF RFC 4566 [56].</p>		

When receiving an SDP offer that contains an EVS codec payload type, the MGCF shall handle the EVS codec parameters as described in table 9.2.13.2.2. In addition, rules for the parameter handling in 3GPP TS 26.445 [147] shall apply.

Table 9.2.13.2.2: MGCF handling of EVS related SDP parameters when the MGCF receives the EVS payload type in an SDP offer

Parameter	Handling of EVS payload type parameter received in the SDP offer	EVS payload type supplied in the SDP answer
evs-mode-switch (NOTE 1)	If an evs-mode-switch parameter is contained in the SDP offer and the MGCF select the EVS payload type, the MGCF shall forward this parameter to the IM-MGW for the termination towards the offerer in the remote descriptor.	If an evs-mode-switch parameter is contained in the SDP offer, the MGCF shall include the evs-mode-switch parameter with unmodified value in the SDP answer. Otherwise, if the MGCF decides to interwork between AMR-WB and EVS, it shall include the evs-mode-switch with value 1. Otherwise the MGCF shall not include the evs-mode-switch. If the MGCF supplies the evs-mode-switch in the SDP answer, it shall also supply it to the IM-MGW in the local descriptor for the termination towards the offerer with the same value.
hf-only (NOTE 1)	If an hf-only parameter is contained in the SDP offer and the MGCF select the EVS payload type, the MGCF shall forward this parameter to the IM-MGW for the termination towards the offerer in the remote descriptor.	If an hf-only parameter is contained in the SDP offer, the MGCF shall include the hf-only parameter with unmodified value in the SDP answer. Otherwise, if the MGCF is configured to negotiate using only the header-full EVS RTP payload format, the MGCF shall include the hf-only parameter with a value 1. If the MGCF supplies the hf-only parameter in the SDP answer, it shall also supply it to the IM-MGW in the local descriptor for the termination towards the offerer with the same value.
dtx (NOTE 1)	If an dtx parameter is contained in the SDP offer and the MGCF select the EVS payload type, the MGCF shall forward this parameter to the IM-MGW for the termination towards the offerer in the remote descriptor.	If a dtx parameter is contained in the SDP offer, the MGCF shall include the dtx parameter with unmodified value in the SDP answer. Otherwise, if the usage of DTX is not desired (e.g. due to DTX capabilities of expected codecs to transcode with), the MGCF shall include the dtx parameter with a value 0. If the MGCF supplies the dtx parameter in the SDP answer, it shall also supply it to the IM-MGW in the local descriptor for the termination towards the offerer with the same value.
dtx-recv (NOTE 1)	If an dtx-recv parameter is contained in the SDP offer and the MGCF select the EVS payload type, the MGCF shall forward this parameter to the IM-MGW for the termination towards the offerer in the remote descriptor.	If the reception of DTX is not desired, the MGCF shall include the dtx-recv parameter with a value 0. If the MGCF supplies the dtx parameter in the SDP answer, it should also supply it to the IM-MGW in the local descriptor for the termination towards the offerer with the same value.
br (NOTE 1)	If a br parameter is contained in the SDP offer, the MGCF shall check if the IM-MGW supports the indicated bitrates, or a subset of them, in EVS primary mode in the send and receive direction. If the indicated bitrates, and even each subset of them, are not supported, the MGCF shall not select the EVS payload type. If the MGCF selects the EVS payload type, it shall forward this parameter to the IM-MGW for the termination towards the offerer in the remote descriptor.	If a br parameter is contained in the SDP offer, the MGCF shall select a bitrate value, which is either the received br value or a subset of it, based on IM-MGW capabilities and possible configured policies, and shall include the br parameter with the selected value that is also supplied towards the IM-MGW in the SDP answer. Otherwise, if the MGCF desires the same bit rate range for the send and receive direction in EVS primary mode, and wants to restrict the bit rate range to match IM-

		<p>MGW capabilities and possible configured policies, the MGCF shall supply the br parameter in the SDP answer it sends. Otherwise the MGCF shall not include this parameter in the SDP answer.</p> <p>If the MGCF also supplies the bw, bw-send or bw-recv parameter, the value of the br parameter shall be compatible with the values of those parameters.</p> <p>If the MGCF supplies the br parameter in the SDP answer, it shall also supply to the IM-MGW the br parameter in the local descriptor for the termination towards the offerer with the same value.</p>
br-send (NOTE 1)	<p>If a br-send parameter is contained in the SDP offer, the MGCF shall check if the IM-MGW supports the indicated bitrates, or a subset of them, in EVS primary mode in the receive direction. If the indicated bitrates, and even each subset of them, are not supported, the MGCF shall not select the EVS payload type. If the MGCF selects the EVS payload type, it shall forward this parameter to the IM-MGW for the termination towards the offerer in the remote descriptor.</p>	<p>If a br-recv parameter is contained in the SDP offer, the MGCF shall select a bitrate value, which is either the received br-recv value or a subset of it, based on IM-MGW capabilities and possible configured policies, and the MGCF shall include the br-send parameter with the selected value that is also supplied towards the IM-MGW in the SDP answer.</p> <p>Otherwise, if the MGCF desires a different bit rate (range) for the send and receive direction in EVS primary mode, and wants to restrict the bit rate range for the send direction to match IM-MGW capabilities and possible configured policies, it shall supply the br-send parameter in the SDP answer it sends.</p> <p>Otherwise the MGCF shall not include the br-send parameter in the SDP answer.</p> <p>If the MGCF also supplies the bw or bw-send parameter, the value of the br-send parameter shall be compatible with the values of those parameters.</p> <p>If the MGCF supplies the br-send parameter in the SDP answer, it shall also supply to the IM-MGW the br-send parameter in the local descriptor for the termination towards the offerer with the same value.</p>
br-recv (NOTE 1)	<p>If a br-recv parameter is contained in the SDP offer, the MGCF shall check if the IM-MGW supports the indicated bitrates, or a subset of them, in EVS primary mode in the send direction. If the indicated bitrates, and even each subset of them, are not supported, the MGCF shall not select the EVS payload type. If the MGCF selects the EVS payload type, it shall forward this parameter to the IM-MGW for the termination towards the offerer in the remote descriptor.</p>	<p>If a br-send parameter is contained in the SDP offer, the MGCF shall select a bitrate value, which is either the received br-send value or a subset of it, based on IM-MGW capabilities and possible configured policies, and the MGCF shall include the br-recv parameter with the selected value that is also supplied towards the IM-MGW in the SDP answer.</p> <p>Otherwise, if the MGCF desires a different bit rate (range) for the send and receive direction in EVS primary mode, and wants to restrict the bit rate range for the receive direction to match IM-MGW capabilities and possible configured policies, it shall supply the br-recv parameter in the SDP answer it sends.</p> <p>Otherwise the MGCF shall not include the br-recv parameter in the answer.</p> <p>If the MGCF also supplies the bw or bw-recv parameter, the value of the br-recv parameter shall be compatible with the values of those parameters.</p> <p>If the MGCF supplies the br-recv parameter in the SDP answer, it shall also</p>

		supply to the IM-MGW the br-recv parameter in the local descriptor for the termination towards the offerer with the same value.
bw (NOTE 1)	If a bw parameter is contained in the SDP offer, the MGCF shall check if the IM-MGW supports the indicated sampling bandwidth(s), or a subset of them, in EVS primary mode in the send and receive direction. If the indicated sampling bandwidth(s), and even each subset of them, are not supported, the MGCF shall not select the EVS payload type. If the MGCF selects the EVS payload type, it shall forward this parameter to the IM-MGW for the termination towards the offerer in the remote descriptor.	If a bw parameter is contained in the SDP offer, the MGCF shall select a sampling bandwidth value, which is either the received bw value or a subset of it, based on IM-MGW capabilities, possible configured policies, and the bw range of other codecs to transcode with, and the MGCF shall include the bw parameter with the selected value that is also supplied towards the IM-MGW in the SDP answer. Otherwise, if the MGCF desires the same sampling bandwidth(s) for the send and receive direction in EVS primary mode, and wants to restrict the sampling bandwidth(s) to match IM-MGW capabilities, possible configured policies, and the bw range of other codecs to transcode with, the MGCF shall supply the bw parameter in the SDP answer it sends. Otherwise the MGCF shall not include this parameter in the answer. If the MGCF also supplies the br, br-send or br-recv parameter, the value of the bw parameter shall be compatible with the values of those parameters. If the MGCF supplies the bw parameter in the SDP answer, it shall also supply to the IM-MGW the bw parameter in the local descriptor for the termination towards the offerer with the same value.
bw-send (NOTE 1)	If a bw-send parameter is contained in the SDP offer, the MGCF shall check if the IM-MGW supports the indicated sampling bandwidths, or a subset of them, in EVS primary mode in the receive direction. If the indicated sampling bandwidths, and even each subset of them, are not supported, the MGCF shall not select the EVS payload type. If the MGCF selects the EVS payload type, it shall forward this parameter to the IM-MGW for the termination towards the offerer in the remote descriptor.	If a bw-recv parameter is contained in the SDP offer, the MGCF shall select a sampling bandwidths value, which is either the received bw-recv value or a subset of it, based on IM-MGW capabilities, possible configured policies, and the bw range of other codecs to transcode with, and the MGCF shall include the bw-send parameter with the selected value in the SDP answer. Otherwise, if the MGCF desires a different sampling bandwidths for the send and receive direction in EVS primary mode, and wants to restrict the sampling bandwidths for the send direction to match IM-MGW capabilities, possible configured policies, and the bw range of other codecs to transcode with, the MGCF shall supply the bw-send parameter in the SDP answer it sends. Otherwise the MGCF shall not include the br-send parameter in the SDP answer. If the MGCF also supplies the bw or bw-send parameter, the value of the br-send parameter shall be compatible with the values of those parameters. If the MGCF supplies the bw-send parameter in the SDP answer, it shall also supply to the IM-MGW the bw-send parameter in the local descriptor for the termination towards the offerer with the same value.
bw-recv (NOTE 1)	If a br-recv parameter is contained in the SDP offer, the MGCF shall check if the IM-	If a bw-send parameter is contained in the SDP offer, the MGCF shall select a

	<p>MGW supports the indicated sampling bandwidths, or a subset of them, in EVS primary mode in the send direction. If the indicated sampling bandwidths, and even each subset of them, are not supported, the MGCF shall not select the EVS payload type. If the MGCF selects the EVS payload type, it shall forward the bw-recv parameter to the IM-MGW for the termination towards the offerer in the remote descriptor.</p>	<p>sampling bandwidths value, which is either the received bw-send value or a subset of it, based on IM-MGW capabilities, possible configured policies, and the bw range of other codecs to transcode with, and the MGCF shall include the bw-recv parameter with the selected value in the SDP answer. Otherwise, if the MGCF desires a different sampling bandwidths for the send and receive direction in EVS primary mode, and wants to restrict the sampling bandwidths for the receive direction to match IM-MGW capabilities, possible configured policies, and the bw range of other codecs to transcode with, the MGCF shall supply the bw-recv parameter in the SDP answer it sends.</p> <p>Otherwise the MGCF shall not include the bw-recv parameter in the SDP answer. If the MGCF also supplies the br or br-recv parameter, the value of the bw-recv parameter shall be compatible with the values of those parameters.</p> <p>If the MGCF supplies the bw-send parameter in the SDP answer, it shall also supply it to the IM-MGW in the local descriptor for the termination towards the offerer with the same value.</p>
cmr (NOTE 1)	<p>If a cmr parameter is contained in the SDP offer and the MGCF select the EVS payload type, the MGCF shall forward this parameter to the IM-MGW for the termination towards the offerer in the remote descriptor.</p>	<p>If a cmr parameter is contained in the SDP offer, the MGCF shall include the cmr parameter with unmodified value in the SDP answer.</p> <p>Otherwise, if the IM-MGW desires to disable codec mode requests within the RTP payload of the EVS primary mode (due to the IM-MGW capabilities and possible configured policies), it shall include the cmr parameter with value -1 in the SDP answer it sends</p> <p>If the MGCF supplies the cmr parameter in the SDP answer, it shall also supply it to the IM-MGW in the local descriptor for the termination towards the offerer with the same value.</p>
ch-aw-recv (NOTE 1)	<p>If a ch-aw-recv parameter is contained in the SDP offer the MGCF shall check if the IM-MGW supports the indicated mode in the send direction. If the indicated mode is not supported, the MGCF shall not select the EVS payload type. If the MGCF selects the EVS payload type, the MGCF shall forward this parameter to the IM-MGW for the termination towards the offerer in the remote descriptor.</p>	<p>If the MGCF it desires to control the channel-aware mode of EVS in the receive direction, e.g. to disable it with value -1, it shall include the ch-aw-recv parameter in the SDP offer and shall also supply the ch-aw-recv parameter to the IM-MGW in the local descriptor for the termination towards the offerer with the same value. The MGCF shall consider the capabilities of the IM-MGW when it chooses an appropriate value.</p>
number of channels (NOTE 2)	<p>If a "number of channels" parameter is contained in the SDP offer the MGCF shall check if the IM-MGW supports the indicated number of channels. If the indicated number of channels is not supported, the MGCF shall not select the EVS payload type. If the MGCF selects the EVS payload type, the MGCF shall forward this parameter to the IM-MGW for the termination towards the offerer in the remote descriptor.</p>	<p>If a "number of channels" parameter is contained in the SDP offer, the MGCF shall include the "number of channels" parameter with unmodified value in the SDP answer and shall also supply it to the IM-MGW in the local descriptor for the termination towards the offerer with the same value.</p>
ch-send (NOTE 1)	<p>If a ch-send parameter is contained in the SDP offer the MGCF shall check if the IM-</p>	<p>If a ch-recv parameter is contained in the SDP offer, the MGCF shall include the ch-</p>

	<p>MGW supports the indicated number of channels in the receive direction. If the indicated number of channels is not supported, the MGCF shall not select the EVS payload type. If the MGCF selects the EVS payload type, the MGCF shall forward the ch-send parameter to the IM-MGW for the termination towards the offerer in the remote descriptor.</p>	<p>send parameter with unmodified value in the SDP answer and shall also supply the ch-send parameter to the IM-MGW in the local descriptor for the termination towards the offerer with the same value.</p>
ch-recv (NOTE 1)	<p>If a ch-recv parameter is contained in the SDP offer the MGCF shall check if the IM-MGW supports the indicated number of channels in the send direction. If the indicated number of channels is not supported, the MGCF shall not select the EVS payload type. If the MGCF selects the EVS payload type for transcoding, the MGCF shall forward the ch-recv parameter to the IM-MGW for the termination towards the offerer in the remote descriptor.</p>	<p>If a ch-send parameter is contained in the SDP offer, the MGCF shall include the ch-recv parameter with unmodified value in the SDP answer and shall also supply the ch-recv parameter to the IM-MGW in the local descriptor for the termination towards the offerer with the same value.</p>
mode-set (NOTE 3)	<p>If a mode-set parameter is contained in the SDP offer and the MGCF select the EVS payload type, the MGCF shall forward this parameter to the IM-MGW for the termination towards the offerer in the remote descriptor.</p>	<p>If a mode-set parameter is contained in the SDP offer, the MGCF shall include the mode-set parameter with unmodified value in the SDP answer. Otherwise, if AMR-WB is used to interwork with, the MGCF should include the mode-set parameter with a value indicating the mode that was negotiated for AMR-WB (or omit it if no restrictions applied before). If the MGCF supplies the mode-set parameter in the SDP answer, it shall also supply it to the IM-MGW in the local descriptor for the termination towards the offerer with the same value.</p>
mode-change-period (NOTE 3)	<p>If a mode-change-period parameter is contained in the SDP offer and the MGCF select the EVS payload type, the MGCF shall forward this parameter to the IM-MGW for the termination towards the offerer in the remote descriptor.</p>	<p>If AMR-WB is used to interwork with, the MGCF should include the mode-change-period parameter with a value indicating the mode that was negotiated for AMR-WB (or omit it if no restrictions applied before) in the SDP answer. If the MGCF supplies the mode-change-period parameter in the SDP answer, it shall also supply it to the IM-MGW in the local descriptor for the termination towards the offerer with the same value.</p>
mode-change-capability (NOTE 3)	<p>If a mode-change-capability (Note 4) parameter is contained in the SDP offer and the MGCF select the EVS payload type, the MGCF may forward this parameter to the IM-MGW for the termination towards the offerer in the remote descriptor.</p>	<p>If AMR-WB is used to interwork with, the MGCF should include the mode-change-capability parameter with a value indicating the mode that was negotiated for AMR-WB (or omit it if no restrictions applied before) in the SDP answer. If the MGCF supplies the mode-change-capability parameter in the SDP answer, it may also supply it to the IM-MGW in the local descriptor for the termination towards the offerer with the same value.</p>
mode-change-neighbor (NOTE 3)	<p>If a mode-change-neighbor parameter is contained in the SDP offer and the MGCF select the EVS payload type, the MGCF shall forward this parameter to the IM-MGW for the termination towards the offerer in the remote descriptor.</p>	<p>If AMR-WB is used to interwork with, the MGCF should include the mode-change-neighbor parameter with a value indicating the mode that was negotiated for AMR-WB (or omit it if no restrictions applied before) in the SDP answer. If the MGCF supplies the mode-change-neighbor parameter in the SDP answer, it shall also supply it to the IM-MGW in the local descriptor for the termination towards the offerer with the same value.</p>
max-red (NOTE 5)	<p>If a max-red parameter is contained in the</p>	<p>The MGCF shall only include the max-red</p>

	SDP offer and the MGCF select the EVS payload type, the MGCF shall forward this parameter to the IM-MGW for the termination towards the offerer in the remote descriptor.	parameter in the SDP answer if it desires to restrict the maximum redundancy of received packets. When selecting the value of the max-red parameter, the MGCF shall consider the capabilities of the IM-MGW. If the MGCF supplies the max-red parameter in the SDP answer, it shall also supply it to the IM-MGW in the local descriptor for the termination towards the offerer with the same value.
3gpp_mtsi_app_adapt (NOTE 4)	If a 3gpp_mtsi_app_adapt SDP attribute is contained in the SDP answer, and the MGCF select the EVS payload type, the MGCF shall forward this parameter to the IM-MGW the MGCF shall forward this parameter to the IM-MGW in the remote descriptor.	If the IM-MGW supports RTCP APP based adaptation messages defined in TS 26.114 [104], and the MGCF has a policy to negotiate the usage of those messages, the MGCF shall include the 3gpp_mtsi_app_adapt SDP attribute indicating the allowed APP messages in the SDP answer.
<p>NOTE 1: This MIME parameter of the EVS RTP payload type is defined in TS 26.445 [147]. It is encapsulated within the SDP "a=fmtp" attribute defined IETF RFC 4566 [56].</p> <p>NOTE 2: This number of channels are encoded as "encoding parameters" of the SDP "a=rtpmap" attribute defined in IETF RFC 4566 [56].</p> <p>NOTE 3: This MIME parameter of the EVS RTP payload type relates to AMR-WB IO mode and is defined in IETF RFC 4867 [23]. It is encapsulated within the SDP "a=fmtp" attribute defined IETF RFC 4566 [56].</p> <p>NOTE 4: This SDP attribute is defined in TS 26.114 [104]. It applies to all codecs offered in an SDP media line. However, some values are specific to EVS</p> <p>NOTE 5: This MIME parameter of the EVS RTP payload type is defined in IETF RFC 4867 [23]. It is encapsulated within the SDP "a=fmtp" attribute defined IETF RFC 4566 [56].</p>		

IM-MGW handling of EVS codec parameters shall follow table 5.13.2.3 in 3GPP TS 23.334 [145]. The IM-MGW should support transcoding of EVS with bandwidths (sampling rates) which are supported by codec the IM-MGW is capable to transcode EVS to/from (e.g. NB for AMR, and WB for AMR-WB).

9.3 Mn Signalling procedures

This clause describes of logical signalling procedures (i.e. message identifiers are not part of the protocol) between the MGCF and IM-MGW. The procedures within this clause are intended to be implemented using the standard H.248 procedure as defined in] ITU recommendation H.248.1 [2] with appropriate parameter combinations.

9.3.1 Procedures related to terminations towards the IM CN Subsystem

A mapping of the procedures defined here to H.248 procedures and parameters is provided in 3GPP TS 29.332 [15].

9.3.1.1 Reserve IMS connection point

This procedure is used to reserve local connection addresses and local resources.

Table 25: Procedures toward the IM Subsystem: Reserve IMS connection point

Procedure	Initiated	Information element name	Information element required	Information element description
Reserve IMS Connection Point	MGCF	Context/Context Request	M	This information element indicates the existing context or requests a new context for the bearer termination.
		Priority information	O	This information element requests the IM-MGW to apply priority treatment for the terminations and bearer connections in the specified context.
		IMS Termination Request	M	This information element requests a new IMS termination for the bearer to be established.
		Local IMS Resources/	M	This information element indicates the resource(s) (i.e. codecs) for which the IM-MGW shall be prepared to receive user data,
		IP Interface Type	O	This information element indicates the used interface type
		ReserveValue	O	This information element indicates if multiple local IMS resources are to be reserved.
		Local Connection Addresses Request	M	This information element requests an IP address and port number on the IM-MGW that the remote end can send user plane data to.
		Notify termination heartbeat	M	This information element requests termination heartbeat indications.
		Notify Released Bearer	O	This information element requests a notification of a released bearer.
		IP Realm Identifier	O	This information element indicates the IP realm of the IP termination.
		ECN Enable	O	This information element requests the IM-MGW to apply ECN procedures
		ECN Initiation Method	C	This information element specifies the ECN Initiation method and requests the IM-MGW to perform IP header settings as an ECN endpoint. It may be included only if ECN is enabled.
		Notify ECN Failure Event	C	This information element requests a notification if an ECN failure occurs. It may only be supplied if ECN is enabled.
		Diffserv Code Point	O	This information element requests the IM-MGW to apply a specific Diffserv Code Point to the IP headers.
		ICE password request	O	This information element is present if MGCF requests an ICE password.
		ICE Ufrag request	O	This information element is present if MGCF requests an ICE ufrag.
ICE host candidate request	O	This information element is present if MGCF requests an ICE host candidate.		
STUN server request	O	This information element is present if MGCF requests the IM-MGW to answer STUN connectivity checks for ICE.		
Reserve IMS Connection Point Ack	IM-MGW	Context	M	This information element indicates the context where the command was executed.
		IMS Termination	M	This information element indicates the IMS termination where the command was executed.

Procedure	Initiated	Information element name	Information element required	Information element description
		Local IMS Resources	M	This information element indicates the resources that the IM-MGW has reserved to receive the user plane data from the IMS.
		Local Connection Addresses	M	This information element indicates the IP address and port on the IM-MGW that shall receive user plane data from IMS.
		ICE password	C	This information element shall be present only if it was contained in the request. It indicates the ICE password assigned by the IM-MGW.
		ICE Ufrag	C	This information element shall be present only if it was contained in the request. It indicates the ICE Ufrag assigned by the IM-MGW.
		ICE host candidate	C	This information element shall be present only if it was contained in the request. It indicates the ICE host candidate assigned by the IM-MGW.
		ICE lite indication	C	This information element shall be present only if an ICE host candidate request was contained in the request, and the IM-MGW supports ICE lite, but not full ICE. It indicates that the IM-MGW only supports ICE lite.

9.3.1.2 Configure IMS resources

This procedure is used to select multimedia-processing resources for an Mb interface connection.

Table 26: Procedures toward the IM Subsystem: Select Local, Select Remote IMS Processing Resource

Procedure	Initiated	Information element name	Information element required	Information element description
Configure IMS Resources	MGCF	Context	M	This information element indicates the existing context.
		IMS Termination	M	This information element indicates the existing bearer termination.
		Local IMS Resources	O	This information element indicates the resources (i.e. codec) that the IM-MGW may use on the reception of user plane data.
		Remote IMS Resources	M	This information element indicates the resources (i.e. codec) that the IM-MGW may send user plane data to.
		Local Connection Addresses	O	This information element indicates the IP address and port on the IM-MGW that the IMS user can send user plane data to.
		Remote Connection Addresses	M	This information element indicates the IP address and port that the IM-MGW can send user plane data to.
		IP Interface Type	O	This information element indicates the used interface type
		Reserve Value	O	This information element indicates if multiple IMS resources are to be reserved.
		Remote Connection Addresses Source Filter	O	This information element indicates an optional source filter restricting the IP addresses and ports that the IM-MGW shall accept as source for incoming user plane data. If this information element is set, the IM-MGW shall silently discard incoming user plane data from disallowed sources.

Procedure	Initiated	Information element name	Information element required	Information element description
		ECN Enable	O	This information element requests the IM-MGW to apply ECN procedures.
		ECN Initiation Method	C	This information element specifies the ECN Initiation method and requests the IM-MGW to perform IP header settings as an ECN endpoint. It may be included only if ECN is enabled.
		Notify ECN Failure Event	C	This information element requests a notification if an ECN failure occurs. It may only be supplied if ECN is enabled.
		ICE Connectivity Check	C	This information element requests the IM-MGW to perform ICE connectivity check as defined by IETF RFC 5245 [143]. It is only applicable for full ICE.
		Notify ICE Connectivity Check Result	C	This information element requests a notification of ICE connectivity check result. It is only applicable for full ICE.
		Notify New Peer Reflexive Candidate	C	This information element requests a notification of new peer reflexive candidate was discovered during a connectivity check. It is only applicable for full ICE.
		Additional ICE Connectivity Check	C	This information element requests the IM-MGW to perform additional ICE connectivity check as defined by IETF RFC 5245 [143]. It is only applicable for full ICE.
		ICE received candidate	O	This information element is present if MGCF indicates a received candidate for ICE.
		ICE received password	O	This information element is present if MGCF indicates a received password for ICE.
		Allowed RTCP APP message types	O	This information element is present if the MGCF allows the IM-MGW to send RTCP APP packets of the indicated types. The IM-MGW shall not send other RTCP APP packets. If the parameter is not supplied, the IM-MGW shall not send any RTCP APP packets.
Configure IMS Resources Ack	IM-MGW	Context	M	This information element indicates the context where the command was executed.
		IMS Termination	M	This information element indicates the IMS termination where the command was executed.
		Local IMS Resource	O	This information element indicates the resources that the IM-MGW has reserved to receive the user plane data from the far end.
		Remote IMS Resource	M	This information element indicates the resource (i.e. codec) that the IM-MGW shall use to send user data to.
		Local Connection Address	O	This information element indicates the IP address and port on the IM-MGW that the remote end can send user plane data to.
		Remote Connection Address	M	This information element indicates the IP address and port that the IM-MGW can send user plane data to.

9.3.1.3 Reserve IMS Connection point and configure remote resources

This procedure is used to reserve multimedia-processing resources for an Mb interface connection.

Table 27: Procedures toward the IM Subsystem: reserve local, reserve remote IMS connection point

Procedure	Initiated	Information element name	Information element required	Information element description
Reserve IMS Connection Point and Configure Remote Resources	MGCF	Context/Context Request	M	This information element indicates the existing context or requests a new context for the bearer termination.
		Priority information	O	This information element requests the IM-MGW to apply priority treatment for the terminations and bearer connections in the specified context.
		IMS Termination/IMS Termination Request	M	This information element indicates the existing bearer termination or requests a new IMS termination for the bearer to be established.
		Local IMS Resources	M	This information element indicates the resource(s) (i.e. codecs) for which the IM-MGW shall be prepared to receive user data,
		Remote IMS Resources	M	This information element indicates the resources (i.e. codec) that the IM-MGW shall use to send user data in the IMS.
		IP Interface Type	O	This information element indicates the used interface type
		Reserve Value	O	This information element indicates if multiple IMS resources are to be reserved.
		Local Connection Address request	M	This information element requests an IP address and a port number on the IM-MGW that the remote end can send user plane data to.
		Remote Connection Addresses	M	This information element indicates the IP address and ports at an IMS user that the IM-MGW can send user plane data to.
		Notify termination heartbeat	M	This information element requests termination heartbeat indications.
		Notify Released Bearer	O	This information element requests a notification of a released bearer.
		IP Realm Identifier	O	This information element indicates the IP realm of the IP termination.
		ECN Enable	O	This information element requests the IM-MGW to apply ECN procedures and IP header settings as an ECN endpoint.
		ECN Initiation Method	C	This information element specifies the ECN Initiation method and requests the IM-MGW to perform IP header settings as an ECN endpoint. It may be included only if ECN is enabled.
		Notify ECN Failure Event	C	This information element requests a notification if an ECN failure occurs. It may only be supplied if ECN is enabled.
		Diffserv Code Point	O	This information element requests the IM-MGW to apply a specific Diffserv Code Point to the IP headers.
		STUN server request	O	This information element is present if MGCF requests the IM-MGW to answer STUN connectivity checks for ICE.
		ICE Connectivity Check	C	This information element requests the IM-MGW to perform ICE connectivity check as defined by IETF RFC 5245 [143]. It is only applicable for full ICE.
		Notify ICE Connectivity Check Result	C	This information element requests a notification of ICE connectivity check result. It is only applicable for full ICE.
Notify New Peer Reflexive Candidate	C	This information element requests a notification of new peer reflexive candidate was discovered during a connectivity check. It is only applicable for full ICE.		

Procedure	Initiated	Information element name	Information element required	Information element description
		ICE password request	O	This information element is present if MGCF requests an ICE password.
		ICE Ufrag request	O	This information element is present if MGCF requests an ICE ufrag.
		ICE host candidate request	O	This information element is present if MGCF requests an ICE host candidate.
		ICE received candidate	O	This information element is present if MGCF indicates a received candidate for ICE.
		ICE received password	O	This information element is present if MGCF indicates a received password for ICE.
		ICE received Ufrag	O	This information element is present if MGCF indicates a received Ufrag for ICE.
		Allowed RTCP APP message types	O	This information element is present if the MGCF allows the IM-MGW to send RTCP APP packets of the indicated types. The IM-MGW shall not send other RTCP APP packets. If the parameter is not supplied, the MRFO shall not send any RTCP APP packets.
Reserve IMS Connection Point and Configure Remote Resources Ack	IM-MGW	Context	M	This information element indicates the context where the command was executed.
		IMS Termination	M	This information element indicates the IMS termination where the command was executed.
		Local IMS Resources	M	This information element indicates the resources that the IM-MGW has reserved to receive the user plane data from IMS.
		Remote IMS Resources	M	This information element indicates the resource (i.e. codec) that the IM-MGW shall use to send user data.
		Local Connection Addresses	M	This information element indicates the IP address on the IM-MGW that shall receive user plane data from the IMS.
		ICE password	C	This information element shall be present only if it was contained in the request. It indicates the ICE password assigned by the IM-MGW.
		ICE Ufrag	C	This information element shall be present only if it was contained in the request. It indicates the ICE Ufrag assigned by the IM-MGW.
		ICE host candidate	C	This information element shall be present only if it was contained in the request. It indicates the ICE host candidate assigned by the IM-MGW.
		ICE lite indication	C	This information element shall be present only if an ICE host candidate request was contained in the request, and the IM-MGW supports ICE lite, but not full ICE. It indicates that the IM-MGW only supports ICE lite.

9.3.1.4 Release IMS termination

This procedure is used by the MGCF to release a termination towards the IMS and free all related resources.

Table 28: Release IMS termination

Procedure	Initiated	Information element name	Information element required	Information element description
Release IMS Termination	MGCF	Context	M	This information element indicates the context for the bearer termination.
		Bearer Termination	M	This information element indicates the bearer termination to be released.
Release IMS Termination Ack	IM-MGW	Context	M	This information element indicates the context where the command was executed.
		Bearer Termination	M	This information element indicates the bearer termination where the command was executed.

9.3.1.5 Detect IMS RTP Tel event

This procedure is used by the MGCF to request from the MGW the detection of telephony events signalled within RTP according to RFC 4733 [105] and the notification of received telephony events. This procedure is the same as that is defined in the clause "Detect DTMF" in 3GPP TS 23.205 [27].

Table 29: VOID

9.3.1.6 Notify IMS RTP Tel event

This procedure is used by the MGW to notify the MGCF about the detection of telephony events signalled within RTP according to RFC 4733 [105]. This procedure is the same as that defined in the clause "Report DTMF" in 3GPP TS 23.205 [27].

Table 30: VOID

9.3.1.7 Void

9.3.1.8 Send IMS RTP Tel event

This procedure is used by the MGCF to request from the MGW to signal a telephone event within RTP according to RFC 4733 [105]. This procedure is the same as that defined in the clause "Send DTMF" in 3GPP TS 23.205 [27].

9.3.1.9 Stop IMS RTP Tel event

This procedure is used by the MGW to request from the MGW to stop signalling a telephone event within RTP according to RFC 4733 [105]. This procedure is the same as that defined in the clause "Stop DTMF" in 3GPP TS 23.205 [27].

9.3.1.10 Termination heartbeat indication

This procedure is used to report indication of hanging termination.

Table 30a: Procedures between (G)MSC server and MGW: Hanging termination indication

Procedure	Initiated	Information element name	Information element required	Information element description
Termination heartbeat indication	MGW	Context	M	This information element indicates the context for the bearer termination.
		Bearer Termination	M	This information element indicates the bearer termination for which the termination heartbeat is reported.
		Termination heartbeat	M	Hanging Termination event, as defined in TS 29.332 [15].
Termination heartbeat indication Ack	(G)MSC-S	Context	M	This information element indicates the context where the command was executed.

9.3.1.11 IMS Bearer Released

This procedure is used by the IM-MGW to indicate towards the MGCF that an error occurred on an IMS termination which requires the release of the termination. This procedure is the same as that defined in the clause "Bearer Released" in 3GPP TS 23.205 [27].

9.3.1.12 End IMS RTP Tel event

This procedure is used by the MGCF to indicate to the IM-MGW to stop detection of telephony events signalled within RTP according to IETF RFC 4733 [105]. This procedure is the same as that is defined in the clause "Stop Detect DTMF" in 3GPP TS 23.205 [27].

9.3.1.13 IMS Send Tone

This procedure is used by the MGCF to order the IM-MGW to generate a tone at termination towards IMS. This procedure is the same as that defined in the clause "Send Tone" in 3GPP TS 23.205 [27].

9.3.1.14 IMS Stop Tone

This procedure is used by the MGCF to order the IM-MGW to stop generating a tone at a termination towards IMS. This procedure is the same as that defined in the clause "Stop Tone" in 3GPP TS 23.205 [27].

9.3.1.15 IMS Tone Completed

This procedure is used by the IM-MGW to indicate to the MGCF that a tone has finished being generated at a termination. This procedure is the same as that defined in the clause "Tone Completed" in 3GPP TS 23.205 [27].

9.3.1.16 ECN Failure Indication

This procedure is used to report ECN related errors (see clause 9.2.11.1c).

Table 9.3.1.16.1: Procedures toward the IM Subsystem: ECN Failure Indication

Procedure	Initiated	Information element name	Information element required	Information element description
ECN Failure Indication	IM-MGW	Context	M	This information element indicates the context for the bearer termination.
		Bearer Termination	M	This information element indicates the bearer termination for which the ECN failure is reported.
		ECN Failure Indication	M	This IE indicates an ECN failure event.
ECN Failure Indication Ack	MGCF	Context	M	This information element indicates the context where the command was executed.
		Bearer Termination	M	This information element indicates the bearer termination where the command was executed

9.3.1.17 ICE Connectivity Check Result Notification

This procedure is used to report ICE connectivity check result for Full ICE.

Table 9.3.1.17.1: Procedures between MGCF and IM-MGW: ICE Connectivity Check Result Notification

Procedure	Initiated	Information element name	Information element required	Information element description
ICE Connectivity Check Result Notification	IM-MGW	Context	M	This information element indicates the context for the bearer termination.
		Bearer Termination	M	This information element indicates the bearer termination for which the ICE Connectivity Check Result is reported.
		ICE Connectivity Check Result	M	This information element indicates an ICE Connectivity Check Result event.
ICE Connectivity Check Result Notification Ack	MGCF	Context	M	This information element indicates the context where the command was executed.
		Bearer Termination	M	This information element indicates the bearer termination where the command was executed.

9.3.1.18 ICE New Peer Reflexive Candidate Notification

This procedure is used to report ICE new peer reflexive candidate for Full ICE.

Table 9.3.1.18.1: Procedures between MGCF and IM-MGW: ICE New Peer Reflexive Candidate Notification

Procedure	Initiated	Information element name	Information element required	Information element description
ICE New Peer Reflexive Candidate Notification	IM-MGW	Context	M	This information element indicates the context for the bearer termination.
		Bearer Termination	M	This information element indicates the bearer termination for which the ICE New Peer Reflexive Candidate is reported.
		ICE New Peer Reflexive Candidate	M	This information element indicates an ICE New Peer Reflexive Candidate event.
ICE New Peer Reflexive Candidate Notification Ack	MGCF	Context	M	This information element indicates the context where the command was executed.
		Bearer Termination	M	This information element indicates the bearer termination where the command was executed.

9.3.2 Procedures related to a termination towards an ISUP network

A mapping of the procedures defined here to H.248 procedures and parameters is provided in 3GPP TS 29.332 [15].

9.3.2.1 Reserve TDM circuit

This procedure is used by the MGCF to reserve a TDM circuit in the IM-MGW towards the preceding/succeeding CS network element.

Table 31: Reserve TDM circuit procedure

Procedure	Initiated	Information element name	Information element required	Information element description
Reserve TDM Circuit	MGCF	Context/Context Request	M	This information element indicates the existing context or requests a new context for the bearer termination.
		Bearer Termination	M	This information element indicates the physical bearer termination for the TDM circuit.
		Bearer Service Characteristics	M	This information element indicates the bearer service requested by the user.
		Notify termination heartbeat	O	This information element requests termination heartbeat indications.
		Notify Released Bearer	O	This information element requests a notification of a released bearer
Reserve Circuit Ack	IM-MGW	Context	M	This information element indicates the context where the command was executed.

9.3.2.2 Change TDM through-connection

This procedure is used by the MGCF to modify the through-connection (forward, backward, both-way, inactive) of a TDM termination at the IM-MGW towards the PSTN.

This procedure is the same as Change Through Connection in 3GPP TS 23.205 [27].

9.3.2.3 Activate TDM voice-processing function

This procedure is used by the MGCF to activate or de-activate a voice processing function of a TDM termination at the IM-MGW towards the PSTN. This voice processing function may include a cancellation for electronic echoes.

This procedure is the same as Activate Voice Processing Function in 3GPP TS 23.205 [27].

9.3.2.4 Send TDM tone

This procedure is used by the MGCF to order the IM-MGW to generate a tone at a TDM termination towards the PSTN.

This procedure is the same as Send Tone in 3GPP TS 23.205 [27].

9.3.2.5 Stop TDM tone

This procedure is used by the MGCF to order the IM-MGW to stop generating a tone at a TDM termination towards the PSTN.

This procedure is the same as Stop tone in 3GPP TS 23.205 [27].

9.3.2.6 Play TDM announcement

This procedure is used by the MGCF to order the IM-MGW to generate an announcement at a TDM termination towards the PSTN. The MGCF may request a notification that the announcement is completed. This procedure is the same as Play Announcement in 3GPP TS 23.205 [27]. This procedure is optional.

9.3.2.7 TDM announcement completed

This procedure is used by the IM-MGW to notify the MGCF that an announcement at a TDM termination towards the PSTN is completed. This procedure is the same as Announcement Completed in 3GPP TS 23.205 [27]. This procedure is optional.

9.3.2.8 Stop TDM announcement

This procedure is the same as Stop Announcement in 3GPP TS 23.205 [27]. This procedure is used by the MGCF to order the IM-MGW to stop generating an announcement at a TDM termination towards the PSTN. This procedure is optional.

9.3.2.9 Continuity check

This procedure is used by the MGCF to order the IM-MGW to generate a continuity check tone at a TDM termination towards the PSTN and to inform the MGCF about the result of the continuity check as soon as the continuity check tone is received or a time-out occurs. This procedure is optional.

Table 32: Continuity check procedure

Procedure	Initiated	Information element name	Information element required	Information element description
Continuity check	MGCF	Context/Context Request	M	This information element indicates the existing context or requests a new context for the bearer termination.
		TDM Termination	M	This information element indicates the existing bearer termination
		Request for continuity tone sending	M	This information request the IM-MGW to apply the continuity check procedure on the indicated TDM termination
		Request for continuity check tone detection	M	This information request the IM-MGW to inform e continuity check procedure on the indicated TDM termination

9.3.2.10 Continuity check verify

This procedure is used by the IM-MGW to indicate towards the MGCF that the continuity check at a TDM termination towards the PSTN has been completed and to return the result of the check: success or failure. This procedure is optional.

Table 33: Continuity check verify procedure

Procedure	Initiated	Information element name	Information element required	Information element description
Continuity check Verify	IM-MGW	Context/t	M	This information element indicates the context where the command was executed.
		TDM Termination	M	This information element indicates the TDM termination involved in the procedure
		Outcome of the continuity check	M	This information element indicates the outcome of the continuity check (successful/unsuccessful)

9.3.2.11 Continuity check response

This procedure is used by the MGCF to order the IM-MGW to loop back an incoming continuity check tone at a TDM termination towards the PSTN. This procedure is optional.

Table 34: Continuity check response procedure

Procedure	Initiated	Information element name	Information element required	Information element description
Continuity check response	MGCF	Context/Context Request	M	This information element indicates the existing context or requests a new context for the bearer termination.
		TDM Termination	M	This information element indicates the existing bearer termination
		Request for loop back of the continuity tone	M	This information request the IM-MGW to loop back the continuity check tone on the indicated TDM termination

9.3.2.12 Release TDM termination

This procedure is used by the MGCF to release a TDM termination at the IM-MGW towards the PSTN and free all related resources.

Table 35: Release TDM termination procedure

Procedure	Initiated	Information element name	Information element required	Information element description
Release TDM Termination	MGCF	Context	M	This information element indicates the context for the bearer termination.
		Bearer Termination	M	This information element indicates the bearer termination to be released.
Release TDM Termination Ack	IM-MGW	Context	M	This information element indicates the context where the command was executed.
		Bearer Termination	M	This information element indicates the bearer termination where the command was executed.

9.3.2.13 Termination Out-of-Service

This procedure is used by the IM-MGW to indicate towards the MGCF that one or several physical termination(s) will go out of service. This procedure is the same as Termination Out-of-Service in 3GPP TS 23.205 [27].

9.3.2.14 Termination heartbeat indication

This procedure is used to report indication of hanging termination.

Table 35a: Procedures between (G)MSC server and MGW: Hanging termination indication

Procedure	Initiated	Information element name	Information element required	Information element description
Termination heartbeat indication	MGW	Context	M	This information element indicates the context for the bearer termination.
		Bearer Termination	M	This information element indicates the bearer termination for which the termination heartbeat is reported.
		Termination heartbeat	M	Hanging termination event, as defined in TS 29.332 [15].
Termination heartbeat indication Ack	(G)MSC-S	Context	M	This information element indicates the context where the command was executed.

9.3.2.15 Bearer Released

This procedure is used by the IM-MGW to indicate towards the MGCF that an error occurred on a physical termination which requires the release of the termination. This procedure is the same as Bearer Released in 3GPP TS 23.205 [27].

9.3.2.16 TDM tone completed

This procedure is used by the IM-MGW to MGCF to indicate that a tone has finished being generated at a TDM termination.

This procedure is the same as Tone Completed in 3GPP TS 23.205 [27].

9.3.3 Procedures related to a termination towards a BICC network

The call related procedures detailed in table 36 shall be supported. Those procedures are defined in 3GPP TS 29.332 [15].

Table 36: Required procedures defined in 3GPP TS 29.332 [15]

Procedure defined in TS 29.332 [15]	Remarks
Establish Bearer	
Prepare Bearer	
Change Through-Connection	
Release Bearer	
Release Termination	
Bearer Established	
Bearer Released	
Send Tone	
Stop Tone	
Tone completed	
Play Announcement	Optional
Stop Announcement	Optional
Announcement Completed	Optional
Confirm Char	Optional
Modify Bearer Characteristics	Optional
Reserve Char	Optional
Bearer Modified	Optional
Activate Voice Processing Function	Optional
Tunnel Information Down	Conditional: For IP Transport at BICC termination
Tunnel Information Up	Conditional: For IP Transport at BICC termination
Termination Out-of-Service	
Termination heartbeat indication	

9.3.4 Non-call related procedures

The procedures from 3GPP TS 23.205 [27] detailed in table 37 shall be applied for the IM-MGW handling component of the Mn interface.

Table 37: Non-call related procedures

Procedure defined in TS 29.332 [15]	Corresponding Procedure defined in TS 23.205 [27]	Remarks
IM-MGW Out of service	MGW Out of Service	
IM-MGW Communication Up	MGW Communication Up	
IM-MGW Restoration	MGW Restoration	
IM-MGW Register	MGW Register	
IM-MGW Re-register	MGW Re-register	
MGCF Ordered Re-register	(G)MSC Server Ordered Re-register	
MGCF Restoration	(G)MSC Server Restoration	
MGCF Out of Service	(G)MSC Server Out of Service	
Termination Out-of-Service	Termination Out-of-Service	The "Termination Out-of-Service procedure" is used as call-related H.248 command as well
Termination Restoration	Termination Restoration	
Audit Value	Audit Value	
Audit Capability	Audit Capability	
Command Rejected	Command Rejected	The "Command Rejected" procedure may be used in response both to call-related and non-call-related H.248 Commands.
IM-MGW Capability Change	Capability Update	
IM-MGW Resource Congestion Handling – Activate	MGW Resource Congestion Handling – Activate	
IM-MGW Resource Congestion Handling – Indication	MGW Resource Congestion Handling – Indication	
Control association monitoring	Control association monitoring	
Inactivity timeout activation	Inactivity timeout activation	
Inactivity timeout indication	Inactivity timeout indication	
Hanging termination detection	Hanging termination detection	
Hanging termination detection	Hanging termination detection	

9.3.5 Multiple IP Realms

The procedures to support multiple IP realms in the present clause are optional.

Figure 9.3.5.1 shows a scenario where multiple IP realms are applied.

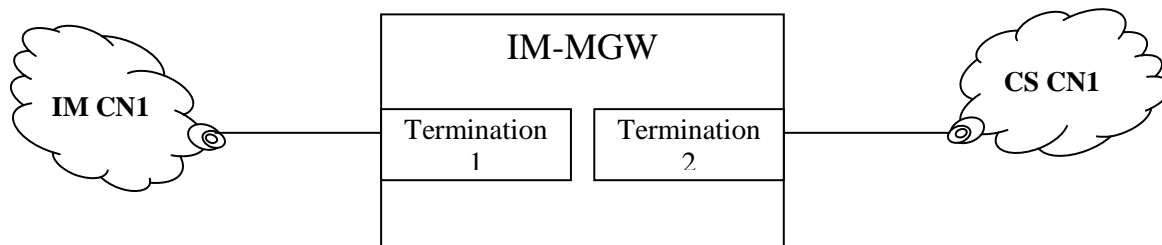

Figure 9.3.5.1 Multiple IP realms scenario

Shown in figure 9.3.5, the IM CN1 and CS CN1 represent separate IP realms. The definition of IP realm is specified in IETF RFC 2663[90].

The termination1 and termination2 are connected with different IP realms in the IM-MGW separately.

For establishing session when multiple IP realms are used in the IM-MGW, the MGCF may indicate the IP realm identifier to the IM-MGW. The IM-MGW shall assign the IP termination with the indicated IP realm.

A default IP realm may be configured in IM-MGW such that if the IM-MGW has not received the IP realm identifier and the IM-MGW supports multiple IP realms then the default IP realm shall be used.

If the IM-MGW does not support the option to indicate an IP realm then it is free to select any IP port.

9.4 Multimedia Priority Service (MPS) Support

9.4.1 General

The Multimedia Priority Service (MPS) is specified in 3GPP TS 22.153 [136]. The MGCF/IM-MGW may support the priority treatment of a call/session identified as an MPS call/session. If MPS is supported then upon receipt of the MPS priority information in the call control signalling:

- The MGCF shall recognise the call/session as having priority.
- The MGCF shall send the Priority information for a context to the IM-MGW to enable the priority treatment described below related to the IM-MGW.
- The MGCF shall apply priority handling to H.248 transactions related to priority calls/sessions when network resources are congested, e.g., preferential treatment in any queues or buffers.
- If the H.248 control association utilises a transport with the possibility for prioritisation, the MGCF may apply priority using the appropriate prioritisation procedures.
- If the MPS Priority service requires a specific MPS DSCP setting, the MGCF shall configure the IM-MGW to apply a specific MPS DSCP marking to the user data transport packets to indicate that the packets are of a higher priority than those for normal calls.
- If the IM-MGW receives an indication to apply a specific MPS DSCP marking to the user data transport packets, it shall apply this DSCP marking to the IP headers.

NOTE 1: Support of Diffserv procedures by the IMS-MGW assumes an operator uses Diffserv for prioritising user plane traffic related to an MPS call/session.

- When the MGCF marks a Context with Priority information, the IM-MGW may use the Priority information for selecting resources for the media and 249isalignme transport with priority. The following actions may be taken by the IM-MGW if it has reached a congested state:
 - i) seize priority reserved resources; or
 - ii) if resources are completely congested, indicate that in a Command Response error code.

NOTE 2: The Priority information can be used to derive Layer 2 QoS marking and trigger priority identification and priority treatment for other QoS technologies than Diffserv.

This clause describes the Mn signalling procedures and their interactions with SIP signalling in the control plane and with user plane procedures to support the requirements for MPS. These Mn signalling procedures may or may not apply depending on the network configuration (e.g. whether the IM-MGW is shared by multiple MGCFs or whether the MGCF controls multiple IM-MGWs for a given route – Media Gateway Group).

The MGCF can receive a SIP INVITE with MPS priority information (see 3GPP TS 23.228 [12], clause 5.21).

9.4.2 IM-MGW Resource Congestion in ADD response, request is queued

If the MGCF requests a resource via the Reserve IMS Connection Point and configure remote resources procedure or Reserve IMS Connection Point procedure and receives an error indicating that the requested resource could not be seized (e.g. H.248 error code #510 "insufficient resources") and the MGCF does not have an alternative IM-MGW through which it can route the call/session, the MGCF queues the priority call/session and gives it priority over any further Reserve IMS Connection Point and configure remote resources or Reserve IMS Connection Point procedures for

lower priority calls/sessions towards this IM-MGW until the requested resource for this queued call/session is successfully seized. The example sequence is shown in Figure 9.4.2.1.

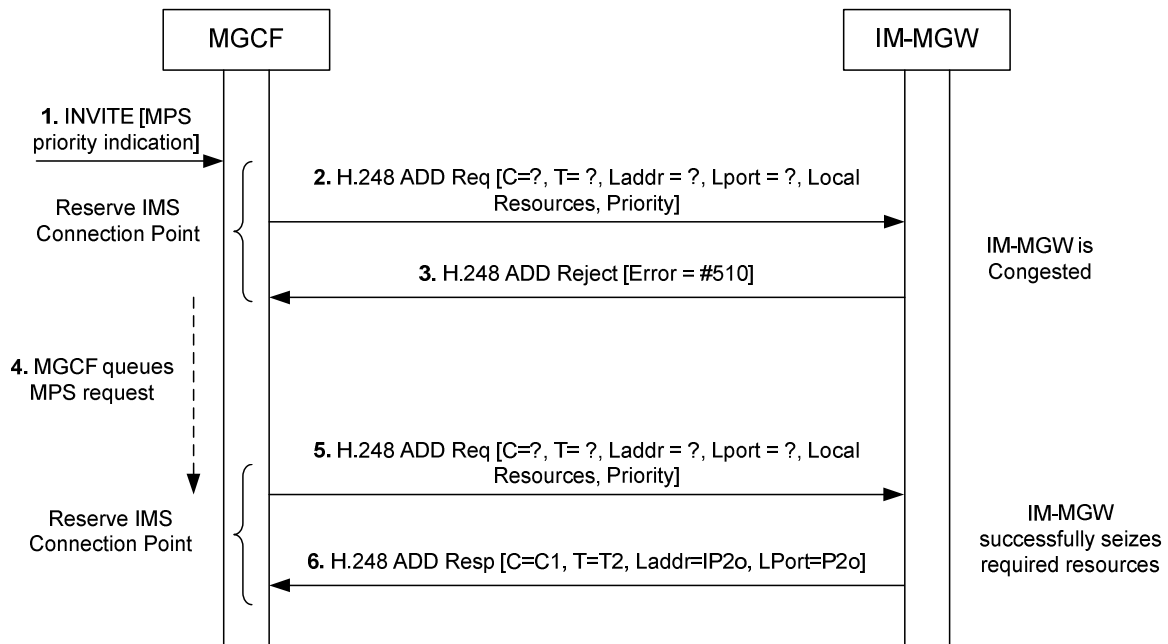

Figure 9.4.2.1: Request to Reserve MPS priority call resources when IM-MGW is congested

9.4.3 IM-MGW Resource Congestion in ADD response, MGCF seizes new IM-MGW

If the MGCF requests a resource via the Reserve IMS Connection Point and configure remote resources procedure or Reserve IMS Connection Point procedure and receives an error indicating that the requested resources could not be seized due to congestion (e.g. H.248 error code #510 "insufficient resources") and Media Gateway Groups are implemented the MGCF seizes a new IM-MGW from the same Media Gateway Group before resorting to any queuing of the priority call/session (as described in clause 9.4.2) to enable the MPS call/session to proceed as early as possible.

9.4.4 IM-MGW Priority Resource Allocation

If the IM-MGW supports the Priority information (e.g. determined through provisioning or package profile), the MGCF requests a resource via the Reserve IMS Connection Point and configure remote resources procedure or Reserve IMS Connection Point procedure and includes the Priority information. The IM-MGW may then provide priority allocation of resources once a congestion threshold is reached. The example sequence is shown in Figure 9.4.4.1. If the IM-MGW is completely congested it shall indicate this to the MGCF as described in clause 9.4.2.

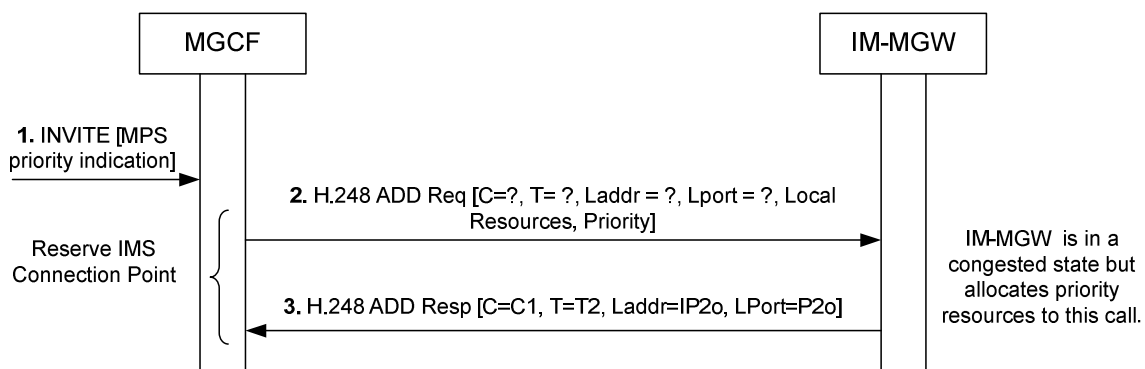

Figure 9.4.4.1: Request to reserve MPS priority call resources when IM-MGW is congested, priority resources are allocated

The IM-MGW may also provide priority allocation for resources requested via a subsequent Configure IMS resources procedure not including Priority information if the related context has been marked with priority information during the Reserve IMS Connection Point procedure or Reserve IMS Connection point and configure remote resources procedure.

9.4.5 IM-MGW Priority User Data marking

The MGCF may request the streams associated to an MPS call/session to be marked with a certain priority code point as described in clause 8.4. The IM-MGW shall then mark each IP packet header accordingly. The example sequence is shown in Figure 9.4.5.1.

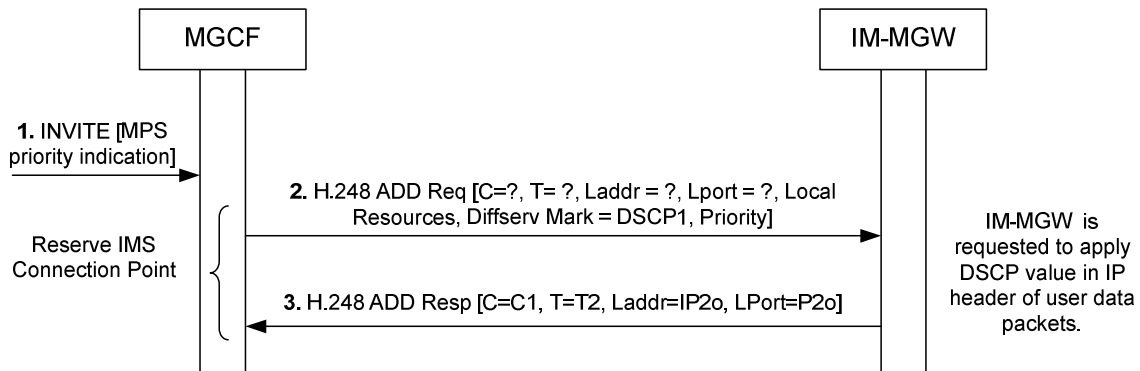

Figure 9.4.5.1: Request to reserve IMS resources and apply DSCP marking for MPS

Annex A (informative):
Void

Annex B (normative): Codec Negotiation between a BICC CS network and the IM CN subsystem

B.1 Introduction

This annex describes optional procedures for interworking of codec negotiation between a BICC CS network and the IM CN subsystem.

B.2 Control plane interworking

The following optional procedures apply in addition to the procedures of clause 7.3 when both the BICC CS network and the IM CN subsystem support codec negotiation. All five variations of the bearer set-up procedures defined in clauses 7.4 and 7.5 of ITU-T Q.1902.4 [30] are supported. The codec negotiation procedures are also independent of the procedures for interworking between continuity procedures and SDP preconditions.

B.2.1 Incoming call interworking from SIP to BICC at I-MGCF

B.2.1.1 Sending of IAM

When the I-MGCF receives an INVITE with SDP offer, the I-MGCF shall follow the procedures of clause B.2.5 to convert the list of codecs in the SDP offer into a Supported Codec List for transmission in the outgoing IAM, according to clause 8.3.1 of ITU-T Q.1902.4 [30], and deleting those codecs not supported at the IM-MGW. When generating the Supported Codec List, the I-MGCF should add to the SDP offer all codec configurations for which it can provide transcoding. The I-MGCF shall allocate any IM-MGW resources as necessary to support the chosen bearer set-up procedures towards the BICC CS network.

When the I-MGCF receives an INVITE without SDP offer, the I-MGCF shall continue call establishment without interworking of codec negotiation procedures. The mid-call interworking procedures of clause B.2.3 and clause B.2.4 may still apply.

B.2.1.2 Sending of SDP answer

The I-MGCF shall suspend the SDP answer procedure until it receives backward codec information from the BICC serving node terminating codec negotiation. When the I-MGCF receives the backward codec information, it shall select a codec configuration for use on the bearer interface to the IM CN subsystem from the codecs in the SDP offer, format an SDP answer based on this selected codec, send the SDP answer to the offerer in the appropriate SIP message (e.g., a reliable 18x response), and complete bearer establishment procedures. To avoid allocating a transcoder at the IM-MGW, the I-MGCF should preferably select a codec for the IM CN subsystem by converting the Selected Codec from the BICC CS network into an SDP answer according to the procedures of clause B.2.5, if allowed by the SDP offer/answer rules. Otherwise the I-MGCF should select the highest priority codec from the codecs in the received SDP offer supported by the IM-MGW for insertion in the SDP answer. Note that the I-MGCF stores the Available Codec List and does not send it to the offerer in the SDP answer. Codec negotiation is complete so it is not necessary for the offerer to begin a second phase offer/answer exchange using the PRACK request.

B.2.2 Outgoing call interworking from BICC to SIP at O-MGCF

B.2.2.1 Sending of INVITE

When the O-MGCF receives an IAM, the O-MGCF shall follow the procedures of clause B.2.5 to convert the Supported Codec List from the IAM into an SDP offer for transmission in the outgoing INVITE request, according to

RFC 3264, deleting those codecs not supported at the IM-MGW. When generating the SDP offer, the O-MGCF should include all codec configurations for which it can provide transcoding in addition to those converted from the Supported Codec List. The O-MGCF shall include at least one AMR codec configuration in the SDP offer. The O-MGCF shall allocate any IM-MGW resources as necessary to support the inclusion of session address information in the SDP offer towards the IM CN subsystem.

B.2.2.2 Responding to serving node initiating codec negotiation

The O-MGCF shall suspend the incoming bearer set-up procedure while waiting for receipt of the SDP answer from the IM CN subsystem. When the O-MGCF receives the SDP answer while suspending the incoming bearer set-up procedure, it shall select a codec configuration for use on the bearer interface to the IM CN subsystem from the codecs in the SDP answer, construct the Available Codec List for the BICC CS network from the list of codecs received in the Supported Codec List by removing codecs not supported at the IM-MGW, choose the Selected Codec for the BICC CS network from the codecs in the Available Codec List, initiate the second SDP offer/answer exchange with the IM CN subsystem using the codec selected for the IM CN subsystem, if necessary, and resume the incoming bearer set-up procedure in the BICC CS network. The O-MGCF should select codecs for the bearer interfaces to the BICC CS network and IM CN subsystem in such a way as to avoid transcoding at the IM-MGW and minimize speech degradation, if possible, according to clause B.2.5. Otherwise the O-MGCF should choose the highest priority codec from the Available Codec List as the Selected Codec for the BICC CS network, and the highest priority codec from the codecs in the SDP answer as the codec for the IM CN subsystem. If the SDP answer only included a single voice codec, then there is no need for a second SDP offer/answer exchange, and the codec selected for the IM CN subsystem is the codec in the SDP answer.

Certain BICC timers or events can force completion of the incoming bearer set-up procedure before the O-MGCF receives the SDP answer from the IM CN subsystem. In this case, the O-MGCF shall perform the terminating codec negotiation procedure according to clause 8.3.3 of ITU-T Q.1902.4 [30], including all supported codecs in the Available Codec List, and shall resume the incoming bearer set-up procedure without waiting any longer for the SDP answer.

When an SDP answer arrives from the IM CN subsystem in response to the SDP offer in an INVITE request after the BICC incoming bearer set-up procedure has started, the O-MGCF shall select a codec configuration for use on the bearer interface to the IM CN subsystem from the codecs in the SDP answer, choose a new Selected Codec for the BICC CS network from the codecs in the Available Codec List constructed during incoming bearer set-up, and initiate the second SDP offer/answer exchange with the IM CN subsystem using the codec selected for the IM CN subsystem, if necessary. The O-MGCF should select codecs for the bearer interfaces to the BICC CS network and IM CN subsystem in such a way as to avoid transcoding at the IM-MGW and minimize speech degradation, if possible, according to clause B.2.5. Otherwise the O-MGCF should select the highest priority codecs from the available options for the two bearer interfaces. If the SDP answer only included a single voice codec, then there is no need for a second SDP offer/answer exchange, and the codec selected for the IM CN subsystem is the codec in the SDP answer. When the call in the BICC CS network enters a state capable of supporting codec modification, if the new Selected Codec is different from the Selected Codec chosen during the incoming bearer set-up procedure for the BICC CS network, the O-MGCF should initiate the codec modification procedure towards the BICC CS network using the new Selected Codec, according to clause 10.4.1 of ITU-T Q.1902.4 [30].

B.2.3 Mid-call interworking from SIP to BICC at I-MGCF or O-MGCF

B.2.3.1 Receipt of SDP offer

When the MGCF receives a SIP message (e.g. UPDATE request or re-INVITE request) with an SDP offer that is not associated with incoming call bearer establishment or preconditions, if the call is in a state capable of supporting BICC codec negotiation, the MGCF shall follow the procedures of clause B.2.5 to convert the list of codecs in the SDP offer into a Supported Codec List, delete those codecs in the Supported Codec List not supported at the IM-MGW, and initiate the mid-call codec negotiation procedure according to clause 10.4.4 of ITU-T Q.1902.4 [30], by sending an APM with the Supported Codec List and an Action indicator set to "mid-call codec negotiation". When generating the Supported Codec List, the MGCF should add to the SDP offer all codec configurations for which it can provide transcoding.

When the MGCF receives a SIP message with an SDP offer that is not associated with incoming call bearer establishment or preconditions, if the call is not in a state capable of supporting BICC codec negotiation, the MGCF shall respond to the SDP offer with existing procedures for the IM CN subsystem. When the call is in a state capable of

supporting BICC codec negotiation, the MGCF may send a re-INVITE request without SDP towards the IM CN subsystem, soliciting a response with an SDP offer, thereby restarting the codec negotiation interworking procedure.

B.2.3.2 Generating SDP answer

After initiating a BICC codec negotiation procedure towards the BICC CS network in response to receipt of a SIP message with an SDP offer from the IM CN subsystem, the MGCF shall suspend the SDP answer procedure until it receives codec information from the succeeding BICC serving node. If the succeeding serving node returns a successful response, the MGCF shall select a codec configuration for use on the bearer interface to the IM CN subsystem from the codecs in the SDP offer, format an SDP answer based on this selected codec, send the SDP answer to the offerer in the appropriate SIP message (e.g. 200 OK (UPDATE) or 200 OK (INVITE)), send an APM to the succeeding serving node with an Action indicator set to "successful codec modification", and complete bearer establishment procedures. To avoid allocating a transcoder at the IM-MGW, the MGCF should preferably select a codec for the IM CN subsystem by converting the Selected Codec from the BICC CS network into an SDP answer according to the procedures of clause B.2.5, if allowed by the SDP offer/answer rules. Otherwise the MGCF should select the highest priority codec from the codecs in the received SDP offer supported by the IM-MGW for insertion in the SDP answer. Note that the MGCF stores the Available Codec List and does not send it to the offerer in the SDP answer.

If the succeeding serving node returns an Action indicator set to "mid-call codec negotiation failure", the MGCF either should send a 488 response to the SDP offerer indicating rejection of the initial SDP offer, or should select the highest priority codec from the codecs in the received SDP offer supported by the IM-MGW, format an SDP answer based on this selected codec, and send the SDP answer to the offerer in the appropriate SIP message. If the MGCF sends a 488 response to the SDP offerer, it should continue the call with the bearer configuration in place before initiating this codec negotiation procedure.

B.2.4 Mid-call interworking from BICC to SIP at I-MGCF or O-MGCF

B.2.4.1 Receipt of mid-call codec negotiation request

When the MGCF receives an APM with an Action indicator set to "mid-call codec negotiation", the MGCF shall follow the procedures of clause B.2.5 to convert the Supported Codec List from the APM into an SDP offer for transmission in an appropriate SIP message (e.g. re-INVITE request) towards the IM CN subsystem, according to RFC 3264 [36], deleting those codecs not supported at the IM-MGW. When generating the SDP offer, the MGCF should include all codec configurations for which it can provide transcoding in addition to those converted from the Supported Codec List. The MGCF shall include at least one AMR codec configuration in the SDP offer.

B.2.4.2 Responding to serving node initiating mid-call codec negotiation

The MGCF shall delay responding to the mid-call codec negotiation from the BICC CS network until it receives a response to the SDP offer from the IM CN subsystem. If the MGCF receives an SDP answer, it shall construct the Available Codec List for the BICC CS network from the list of codecs received in the Supported Codec List by removing codecs not supported at the IM-MGW, choose the Selected Codec for the BICC CS network from the codecs in the Available Codec List, and complete the mid-call codec negotiation procedure towards the preceding serving node according to clause 10.4.5 of ITU-T Q.1902.4 [30]. The MGCF should choose the Selected Codec for the BICC CS network in such a way as to avoid transcoding at the IM-MGW and minimize speech degradation, if possible, according to clause B.2.5. Otherwise the MGCF should choose the highest priority codec from the Available Codec List for the Selected Codec for the BICC CS network. If the MGCF receives an APM from the preceding serving node with an Action indicator set to "codec modification failure", then the MGCF may initiate a new SDP offer/answer exchange towards the IM CN subsystem in an attempt to recreate the bearer configuration in place before this codec negotiation procedure began.

If the MGCF receives a 488 response or other failure response (e.g. 3xx-6xx) to the SDP offer, either it should reject the mid-call codec negotiation from the BICC CS network by sending an APM with an Action indicator set to "mid-call codec negotiation failure" towards the preceding serving node, or it should continue as if it received an SDP answer with no change in codec selected for the IM CN subsystem. If the MGCF sends an APM with an Action indicator set to "mid-call codec negotiation failure", it should continue the call with the bearer configuration in place before initiating this codec negotiation procedure.

B.2.4.3 Receipt of codec modification request

If the MGCF receives an APM from a BICC CS network that includes an Action indicator set to "modify codec" with no change in the selected codec, it shall act as a serving node terminating codec modification, according to clause 10.4.2 of ITU-T Q.1902.4 [30], without interworking the procedure with the IM CN subsystem.

If the MGCF receives an APM from a BICC CS network that includes an Action indicator set to "modify codec" and the new selected codec in the message is different from the Selected Codec at the IM-MGW bearer interface to the BICC CS network, the MGCF either may act as a serving node terminating codec modification, according to clause 10.4.2 of ITU-T Q.1902.4 [30], without interworking the procedure with the IM CN subsystem, or may follow the procedures of clause B.2.5 to convert the new Available Codec List (with new priority order) from the APM into an SDP offer for transmission in an appropriate SIP message (e.g. re-INVITE request) towards the IM CN subsystem, according to RFC 3264 [36], deleting those codecs not supported at the IM-MGW. When generating the SDP offer, the MGCF should include all codec configurations for which it can provide transcoding in addition to those converted from the new Available Codec List. The MGCF shall include at least one AMR codec configuration in the SDP offer.

If the MGCF sends a SIP message with an SDP offer towards the IM CN subsystem in response to receipt of a BICC codec modification request, then it shall delay responding to the BICC codec modification request until it receives a response to the SDP offer from the IM CN subsystem. When the MGCF receives either an SDP answer or a rejection of the SDP offer within the appropriate SIP message (e.g. 200 OK (INVITE)) from the IM CN subsystem, it shall decide whether to accept or reject the BICC codec modification procedure and complete the procedure for a BICC serving node terminating codec modification, according to clause 10.4.2 of ITU-T Q.1902.4 [30].

If the MGCF sends an APM with an Action indicator set to "codec modification failure" in response to receipt of a codec modification request, the preceding BICC serving node may retry the request with a mid-call codec negotiation using an APM including an Action indicator set to "mid-call negotiation" and a Supported Codec List with a new priority order encouraging selection of a new codec.

B.2.5 Codec parameter translation between BICC CS network and the IM CN subsystem

The IM CN subsystem uses the Session Description Protocol (SDP, defined in IETF RFC 4566 [56]) to select and potentially re-negotiate the codec type and configuration and associated bearer format attributes to be used in the user plane. IETF RFC 3550 [51] defines the Real Time Protocol (RTP) for framing of all codecs in the user plane, IETF RFC 3551 [52] and IETF RFC 3555 [53] define the framing details for many of the ITU-T codecs, and IETF RFC 4867 [23] defines framing details for the AMR family of codecs. This clause will focus only on codec-specific SDP parameters not already constrained by clause 5.1.1 of 3GPP TS 26.236 [32]. The signalling plane of the IM CN subsystem uses SDP offer/answer procedures defined in IETF RFC 3264 [36] to select the desired codec type and configuration for the user plane from a prioritized list of codec types and configurations and to re-negotiate the user plane attributes as necessary.

The bearer independent CS network uses the Single Codec and Codec List information elements of the Application Transport Mechanism (APM) defined in ITU-T Recommendation Q.765.5 [35] to negotiate (offer and select) and potentially re-negotiate the codec type and configuration and associated bearer format attributes to be used in the user plane. 3GPP TS 29.414 [25] and 3GPP TS 29.415 [26] define the IuFP framing protocol for all codecs in the user plane for both ATM and IP transport, and 3GPP TS 26.102 [50] provides the framing details for AMR and PCM family codecs. The Codec List information element of the APM comprises multiple instances of the Single Codec information element in priority order, as shown in figure 13 of ITU-T Recommendation Q.765.5 [35]. Figure 14 of ITU-T Recommendation Q.765.5 [35] defines the Single Codec information element. Clause 11.1.7.2 of ITU-T Recommendation Q.765.5 [35] defines the encoding of the Single Codec information element for the ITU-T codecs. 3GPP TS 26.103 [57] defines the encoding of the Single Codec information element for the 3GPP codecs, and table 7.11.3.1.3-2 of 3GPP TS 28.062 [58] defines the preferred configurations of the narrowband AMR codecs (Config-NB-Code) for interoperation with TFO. The signalling plane of the bearer independent CS network uses the APM to negotiate the desired codec type and configuration for the user plane from the prioritized list of codec types and to re-negotiate the user plane attributes as necessary.

The following clauses define the translations between the SDP payload format parameters of the IM CN subsystem and the corresponding subfields of the Single Codec information element of the bearer independent CS network for certain 3GPP and ITU-T codecs. Following these translation rules will in many cases allow the IM-MGW to perform interworking between the framing protocols on the bearer interfaces to the BICC CS network and the IM CN subsystem without transcoding. Implementations may signal other codec types not listed herein or other codec configurations of

codec types listed herein. Implementations may also choose to perform transcoding between codec configurations signalled separately for the bearer interfaces to the networks, if necessary, but voice quality may suffer.

B.2.5.1 Codec parameters for 3GPP AMR-NB codecs

Table B.1 shows the correspondence between the codec format parameters in the Single Codec information element (TS 26.103 [57]) and the SDP for the 3GPP narrowband AMR codecs (IETF RFC 4867 [23]).

Table B.1: Mapping between Single Codec subfields and SDP parameters for 3GPP AMR-NB codecs

Single Codec information element		SDP payload format parameters		
Codec Identification	ACS, SCS, OM, MACS	Payload Type number	Encoding name	Other Parameters (NOTE 1) (NOTE 2)
FR_AMR or OHR_AMR or HR_AMR	OM=0 or Selected Codec Type	dynamic	AMR	mode-set=values corresponding to ACS (NOTE 3)
FR_AMR or OHR_AMR or HR_AMR	(OM=1 or OM not present) and (Supported Codec List or Available Codec List)	dynamic	AMR	mode-set=select from values corresponding to ACS, SCS and MACS (NOTE 3)
UMTS_AMR	OM=0 or Selected Codec Type	dynamic	AMR	mode-set=values corresponding to ACS
UMTS_AMR	(OM=1 or OM not present) and (Supported Codec List or Available Codec List)	dynamic	AMR	mode-set=select from values corresponding to ACS, SCS and MACS (NOTE 4)
UMTS_AMR_2	OM=0 or Selected Codec Type	dynamic	AMR	mode-set=values corresponding to ACS (NOTE 5)
UMTS_AMR_2	(OM=1 or OM not present) and (Supported Codec List or Available Codec List)	dynamic	AMR	mode-set=select from values corresponding to ACS, SCS and MACS (NOTE 3) (NOTE 5)
<p>NOTE 1: Table 1 of IETF RFC 4867 [23] provides the correspondence between codec rates and AMR modes for use when generating the "mode-set" parameter. When all modes are selected for use, the "mode-set" parameter shall not be included in SDP.</p> <p>NOTE 2: SDP payload format configurations in this table with only one value in the "mode-set" parameter shall not include the "mode-change-period" and "mode-change-neighbor" parameters.</p> <p>NOTE 3: Payload types for FR_AMR, OHR_AMR and HR_AMR with more than one value in the "mode-set" parameter shall include the "mode-change-period=2", "mode-change-capability=2" parameters and should include the "mode-change-neighbor=1" parameter.</p> <p>NOTE 4: IETF RFC 4867 [23] does not currently provide a mechanism to signal the SCS, MACS or OM parameters in SDP, nor does it distinguish between the different AMR-NB codec types. Each AMR-NB codec type in the Supported Codec List or the Available Codec List with OM=1 should be translated into a list of SDP payload formats in priority order, where each includes a "mode-set" parameter with a unique value derived from the ACS, SCS and MACS. Each "mode-set" should correspond to a codec configuration that is compatible with the given codec type according to the compatibility rules defined in clauses 11 and 12 of TS 28.062 [58].</p> <p>NOTE 5: Payload types for UMTS_AMR_2 should include the "mode-change-period=2", "mode-change-capability=2" and "mode-change-neighbor=1" parameters, normally used for signalling GSM AMR codecs, to assure end-to-end interoperability with OoBTC and TFO. Its actual capabilities would otherwise be signalled without these parameters.</p>				

Definitions:

Supported Codec List: contains the offered Codec Types and Configuration-possibilities of the node initiating codec negotiation in BICC (see also 3GPP TS 23.153). The Supported Codec List is sent from the initiating node forward to the terminating node. The Supported Codec List corresponds to an SDP offer during codec negotiation.

Available Codec List: contains the offered Codec Types and Configuration-possibilities of the contiguous portion of the connection between initiating and terminating BICC nodes, including all intermediate nodes through the BICC network(s). The Available Codec List is sent from the BICC node terminating codec negotiation backward to the initiating node. The Available Codec List corresponds to information sometimes available in a first-round SDP answer. The Available Codec List might not represent an end-to-end view of the available Codec Types and Configuration-possibilities when traversing both BICC and SIP networks.

Selected Codec Type: is determined by the node terminating codec negotiation. It specifies exactly the Codec Type and one unique Codec Configuration for the call. The Selected Codec Type corresponds to the final SDP answer.

When translating from a Single Codec information element to the equivalent SDP payload format parameters, where either OM=0 (in the Supported or Available Codec List) or the information element is the Selected Codec Type, the SDP shall include a single payload type and any associated parameters from the corresponding row in table B.1. When translating from a Single Codec information element to the equivalent SDP payload format parameters, where OM=1 in the Supported or Available Codec List, the SDP shall only include payload formats corresponding to Codec Configurations compatible with the offered ACS, SCS and MACS, according to table B.1. Since the number of compatible payload formats can be large, implementations should select a reasonable subset of the higher-priority payload formats for inclusion in the SDP. When translating a list of Single Codec information elements into SDP, duplicate payload types (matching on all parameters) shall be removed.

The following guidelines shall apply when translating from an SDP payload format specification to a Single Codec information element:

- If there is no "mode-set" parameter for a payload format in the SDP and the SDP is to be translated into a Supported or Available Codec List, then the corresponding Single Codec subfields shall be OM=1, MACS=8, all SCS modes offered, and ACS modes offered. Alternatively it is sufficient to specify only the Codec Type (see below) and omit the other parameters.
- If there is no "mode-set" parameter for a payload format in an SDP answer that is to be translated into a Selected Codec Type, then the corresponding Single Codec subfields shall be derived from the payload type in the SDP offer (to which the SDP answer was sent in response).
- If there is a "mode-set" parameter for a payload format in the SDP, then the corresponding Single Codec subfields shall be OM=0 and ACS modes selected according to the value of "mode-set". The SCS shall be set identical to the ACS and MACS shall be set to the number of modes in the ACS. If this "mode-set" does not represent a valid configuration for the Codec Type (determined by OoBTC procedures), then the payload format shall not be translated.
- If a payload format in an SDP offer that is to be translated into a Supported Codec List includes "mode-change-period=2" parameter or includes "mode-change-capability=2" parameter, then the Codec Identification value for the corresponding Single Codec shall be FR_AMR.
- If a payload format in an SDP answer that is to be translated into a Selected Codec Type or Available Codec List includes "mode-change-period=2", then the Codec Identification value for the corresponding Single Codec shall be one of FR_AMR, HR_AMR, OHR_AMR or UMTS_AMR_2, if offered in the Supported Codec List.
- If a payload format in an SDP offer that is to be translated into a Supported Codec List does not include "mode-change-period=2" parameter and does not include "mode-change-capability=2" parameter, then the Codec Identification value for the corresponding Single Codec shall be UMTS_AMR.
- If a payload format in an SDP answer that is to be translated into a Selected Codec Type or Available Codec List does not include "mode-change-period=2" parameter and does not include "mode-change-capability=2" parameter, then the Codec Identification value for the corresponding Single Codec shall be one of UMTS_AMR_2, FR_AMR, HR_AMR, OHR_AMR or UMTS_AMR, if offered in the Supported Codec List.

B.2.5.2 Codec parameters for 3GPP AMR-WB codecs

Table B.2 shows the correspondence between the codec format parameters in the Single Codec information element (TS 26.103 [57]) and the SDP for the 3GPP wideband AMR codecs (IETF RFC 4867 [23]).

Table B.2: Mapping between Single Codec subfields and SDP parameters for 3GPP AMR-WB codecs

Single Codec information element		SDP payload format parameters		
Codec Identification	Config-WB-Code	Payload Type number	Encoding name	Other Parameters (NOTE 1)
FR_AMR-WB or OHR_AMR-WB	0	dynamic	AMR-WB	mode-set=0,1,2
OFR_AMR-WB or UMTS_AMR-WB	0	dynamic	AMR-WB	mode-set=0,1,2 (NOTE 2)
OFR_AMR-WB or UMTS_AMR-WB	1	dynamic dynamic dynamic	AMR-WB AMR-WB AMR-WB	mode-set=0,1,2 mode-set=0,1,2,8 mode-set=0,1,2,4 (NOTE 2)
OFR_AMR-WB or UMTS_AMR-WB	2	dynamic	AMR-WB	mode-set=0,1,2,4 (NOTE 2)
OFR_AMR-WB or UMTS_AMR-WB	3	dynamic dynamic dynamic	AMR-WB AMR-WB AMR-WB	mode-set=0,1,2,4 mode-set=0,1,2,8 mode-set=0,1,2 (NOTE 2)
OFR_AMR-WB or UMTS_AMR-WB	4	dynamic	AMR-WB	mode-set=0,1,2,8 (NOTE 2)
OFR_AMR-WB or UMTS_AMR-WB	5	dynamic dynamic dynamic	AMR-WB AMR-WB AMR-WB	mode-set=0,1,2,8 mode-set=0,1,2,4 mode-set=0,1,2 (NOTE 2)
NOTE 1: Payload types for FR_AMR-WB, OHR_AMR-WB and OFR_AMR-WB shall include the "mode-change-period=2" and "mode-change-capability=2" parameters and should include the "mode-change-neighbor=1" parameter.				
NOTE 2: Payload types for UMTS_AMR-WB should include the "mode-change-period=2", "mode-change-capability=2" and "mode-change-neighbor=1" parameters, normally used for signalling GSM AMR-WB codecs, to assure end-to-end interoperability with OoBTC and TFO. Its actual capabilities would otherwise be signalled without these parameters.				

When translating from a Single Codec information element to the equivalent SDP payload format parameters, the SDP shall include a distinct payload type and any associated parameters for each row in the table that matches the Config-WB-Code parameter. For example, OFR_AMR-WB with Config-WB-Code=3 can generate three SDP payload types for AMR-WB, each including the "mode-change-period=2" parameter, the "mode-change-neighbor=1" parameter, and the "mode-set" parameter with value sets "0,1,2,4", "0,1,2,8", and "0,1,2", respectively. When translating a list of Single Codec information elements into SDP, duplicate payload types (matching on all parameters) shall be removed.

The following guidelines shall apply when translating from one or more SDP payload format specifications to a Single Codec information element:

- Payload formats that match except for different values of "mode-set" shall be represented with the fewest values of Config-WB-Code, while retaining the priority represented by the order of the payload formats in the SDP. For example, three SDP payload types for AMR-WB, each including the "mode-change-period=2" parameter, the "mode-change-neighbor=1" parameter, and the "mode-set" parameter with value sets "0,1,2,4", "0,1,2,8", and "0,1,2", respectively, will generate Config-WB-Code=3.
- If there is no "mode-set" parameter for a payload format in the SDP and the SDP is to be translated into a Supported or Available Codec List, then the corresponding Single Codec shall have a Config-WB-Code value of 1.
- If there is no "mode-set" parameter for a payload format in an SDP answer that is to be translated into a Selected Codec Type, then the corresponding Config-WB-Code value shall be derived from the payload type in the SDP offer (to which the SDP answer was sent in response).
- If a payload format in an SDP offer that is to be translated into a Supported Codec List includes "mode-change-period=2" parameter or includes "mode-change-capability=2" parameter, then the Codec Identification value for the corresponding Single Codec shall be OFR_AMR-WB.
- If a payload format in an SDP answer is to be translated into a Selected Codec Type or Available Codec List, then the Codec Identification value for the corresponding Single Codec shall be one of OFR_AMR-WB, FR_AMR-WB, OHR_AMR-WB or UMTS_AMR-WB, if offered in the Supported Codec List.

- If a payload format in an SDP offer that is to be translated into a Supported Codec List does not include "mode-change-period=2" parameter and does not include "mode-change-capability=2" parameter, then the payload format shall not be translated.

B.2.5.3 Codec parameters for 3GPP non-AMR codecs

Table B.3 shows the correspondence between the codec format parameters in the Single Codec information element (TS 26.103 [57]) and the SDP for the 3GPP non-AMR codecs (IETF RFC 4867 [23], IETF RFC 3551 [52], IETF RFC 3555 [53] and IETF RFC 5993 [114]).

Table B.3: Mapping between Single Codec subfields and SDP parameters for 3GPP non-AMR codecs

Single Codec information element Codec Identification	SDP payload format parameters		
	Payload Type number	Encoding name	Other Parameters
GSM FR	3	GSM	
GSM HR	dynamic	GSM-HR-08	
GSM EFR (NOTE 1)	dynamic	GSM-EFR	
GSM EFR (NOTE 2)	dynamic	AMR	mode-set=7
TDMA EFR (NOTE 2)	dynamic	AMR	mode-set=4
PDC EFR (NOTE 2)	dynamic	AMR	mode-set=3
NOTE 1: This translation for GSM EFR (GSM-EFR) is preferred to the alternative (AMR mode-set=7) if it is supported by the IM-MGW.			
NOTE 2: AMR DTX is not compatible with the DTX schemes for any of the codecs in this list. The IM-MGW may support these configurations without transcoding by providing interworking between the DTX procedures and frame encodings on the bearer interfaces to the BICC CS network and the IM CN subsystem.			

B.2.5.4 Codec parameters for ITU-T codecs

Table B.4 shows the correspondence between the codec format parameters in the Single Codec information element (Clause 11.1.7 of ITU-T Q.765.5 [35]) and the SDP for the ITU-T codecs (Table 4 of RFC 3551 [52], and RFC 3555 [53]).

Table B.4: Mapping between Single Codec subfields and SDP parameters for ITU-T codecs

Single Codec information element			SDP payload format parameters		
Codec Type subfield	Codec Name	Codec Configuration subfield (dcba)	Payload Type number	Encoding name	Other Parameters
00000001	G.711 64 kbit/s A-law	N/A	8	PCMA	
00000010	G.711 64 kbit/s μ -law	N/A	0	PCMU	
00000011	G.711 56 kbit/s A-law	N/A	N/A	N/A	
00000100	G.711 56 kbit/s μ -law	N/A	N/A	N/A	
00000101	G.722 (SB-ADPCM)	N/A	9	G722	
00000110	G.723.1	N/A	4	G723	annexa=no
00000111	G.723.1 Annex A (silence suppression)	N/A	4	G723	
00001000	G.726 (ADPCM)	xxx1 xx1x x1xx 1xxx	dynamic dynamic dynamic dynamic	G726-16 G726-24 G726-32 G726-40	
00001001	G.727 (Embedded ADPCM)	xxxx	N/A	N/A	
00001010	G.728	111 (subsets of defined rates not supported)	15	G728	
00001011	G.729 (CS-ACELP)	xx1 x1x 1xx	dynamic 18 dynamic	G729D G729 G729E	annexb=no annexb=no annexb=no
00001100	G.729 Annex B (silence suppression)	xx1 x1x 1xx	dynamic 18 dynamic	G729D G729 G72"E"	
NOTE: An "x" in a bit position of the Codec Configuration subfield indicates a "don't care" value. The SDP payload description for each listed codec includes a clock rate of 8000 Hz. TS 26.102 [50] only describes the BICC CS network framing for the PCM codecs.					

When translating from a Single Codec information element to the equivalent SDP payload format parameters, the SDP shall include a distinct payload type and any associated parameters for each matching instance of the Codec Configuration subfield. For example, G.726 (ADPCM) with Codec Configuration subfield "0101" shall generate SDP payload types for G726-32 and G726-16.

When translating from an SDP payload format specification to the Single Codec information element, each SDP payload type should be represented by one matching Single Codec information element. For example, SDP payload types for G729 and G729E may generate one Single Codec information element for "G.729 Annex B" with Codec Configuration subfield "110". The G729 and G729E codecs may alternately be represented by two Single Codec information elements for "G.729 Annex B" with Codec Configuration subfields "100" and "010", respectively, if it is necessary to indicate preference between them.

B.3 MGCF – IM-MGW interaction during interworking of codec negotiation

B.3.1 Basic IM CN subsystem originated session

This clause shows an example of the interworking of codec negotiation between an IM CN subsystem and a BICC CS network during session establishment for an IM CN subsystem originated session. The example applies to BICC forward bearer establishment. Similar procedures apply to the other four versions of bearer establishment procedure applicable to the BICC CS network. The exchange of codec information is identical in all five cases, but there are differences in the sequence of operations associated with bearer establishment within the BICC CS network.

B.3.1.1 BICC forward bearer establishment

B.3.1.1.1 IM-MGW selection

The MGCF shall select an IM-MGW for the bearer connection before it performs the CS network side bearer establishment. This may happen either before sending the IAM or after receiving the APM message (signal 3 or signal 4 in figure B.1). In the latter case, the IM-MGW selection may be based on a possibly received MGW-id from the succeeding node.

B.3.1.1.2 CS network side bearer establishment

The MGCF shall either select bearer characteristics or request the IM-MGW to select and provide the bearer characteristics for the CS network side bearer connection before sending the IAM. In the latter case the MGCF shall use the Prepare Bearer procedure, not shown in figure B.1, to request the IM-MGW to select the bearer characteristics. After the succeeding node has provided a bearer address and a binding reference in the APM, the MGCF shall use the Establish Bearer procedure to request the IM-MGW to establish a bearer towards the destination CS-MGW. The MGCF shall provide the IM-MGW with the bearer address, the binding reference and the bearer characteristics (signal 5 in figure B.1).

B.3.1.1.3 IM CN subsystem side session establishment

When the MGCF receives the Selected Codec from the succeeding serving node in the CS network (signal 4 in figure B.1) and selects a codec for use in the IM CN subsystem, the MGCF shall initiate the Reserve IMS Connection Point and Configure Remote Resources procedure (signal 7 and 8 in figure B.1). From the received SDP and selected configuration data the MGCF:

- Shall send the appropriate remote codec(s), the remote UDP port and the remote IP address to the IM-MGW. The remote UDP port and IP address refer to the destination of user plane data sent towards the IM CN subsystem. The remote codec(s) are the codec(s) the IM-MGW may select for user plane data sent towards the IM CN subsystem.
- Shall indicate to the IM-MGW the appropriate local codec(s) and request a local IP address and UDP port. The local IP address and UDP port are used by the IM-MGW to receive user plane data from the IM CN subsystem. The local codec(s) are the codec(s) the IM-MGW may select to receive user plane data from the IM CN subsystem.
- If DTMF support together with speech support is required, the reserve value indicator shall be set to "true".

The IM-MGW

- Shall reply to the MGCF with the selected local codec(s) and the selected remote codec(s) and the selected local UDP port and IP address.
- Shall reserve resources for those codec(s).

The MGCF shall send the local codec(s), UDP port and IP address to the IMS in the Session Progress (signal 9 in figure B.1).

B.3.1.1.4 Through-connection

During the Prepare Bearer and Establish Bearer procedures, the MGCF shall either use the Change Through-Connection procedure to request the IM-MGW to backward through-connect the BICC terminations, or the MGCF shall use this procedure to both-way through-connect the BICC termination already on this stage (signal 5 in figure B.1). During the Reserve IMS Connection Point procedure:

- if the MGCF has been identified a call as an "ICS call" as specified in clause 7.3.3.1.2.n the MGCF shall request the IM-MGW to suspend sending media towards the IMS side by setting the through-connection of the IM CN subsystem side termination to "not through-connected" using the Change IMS Through-Connection procedure (signal 7 in figure B.1); and
- otherwise the MGCF shall use the Change IMS Through-Connection procedure to request the IM-MGW to backward through-connect the IMS termination (signal 7 in figure B.1).

When the MGCF receives the BICC:ANM answer indication, it shall request the IM-MGW to both-way through-connect the termination using the Change Through-Connection or Change IMS Through-Connection procedures (signal 20 in figure B.1), unless those terminations are already both-way through-connected.

B.3.1.1.5 Codec handling

The IM-MGW may include a speech transcoder based upon the speech coding information provided to each termination.

B.3.1.1.6 Failure handling in MGCF

If any procedure between the MGCF and the IM-MGW is not completed successfully the default action by the MGCF is to release the session, as described in clause 9.2.6. If the MGCF receives a Bearer Released procedure from the IM-MGW the default action by the MGCF is to release the session as described in clause 9.2.7.

NOTE: As an implementation option the MGCF may also decide for example to only release the resources in the IM-MGW that caused the failure, possibly select a new IM-MGW for the connection and continue the call establishment using new resources in the selected IM-MGW but such handling is outside of the scope of the present document.

B.3.1.1.7 Message sequence chart

Figure B.1 shows the message sequence chart for the IM CN subsystem originating session with BICC forward bearer establishment where the selection of IM-MGW is done after receipt of the APM. The MGCF then requests the seizure of a CS network side bearer termination and the establishment of the bearer. When the MGCF receives an answer indication, it requests the IM-MGW to both-way through-connect the terminations.

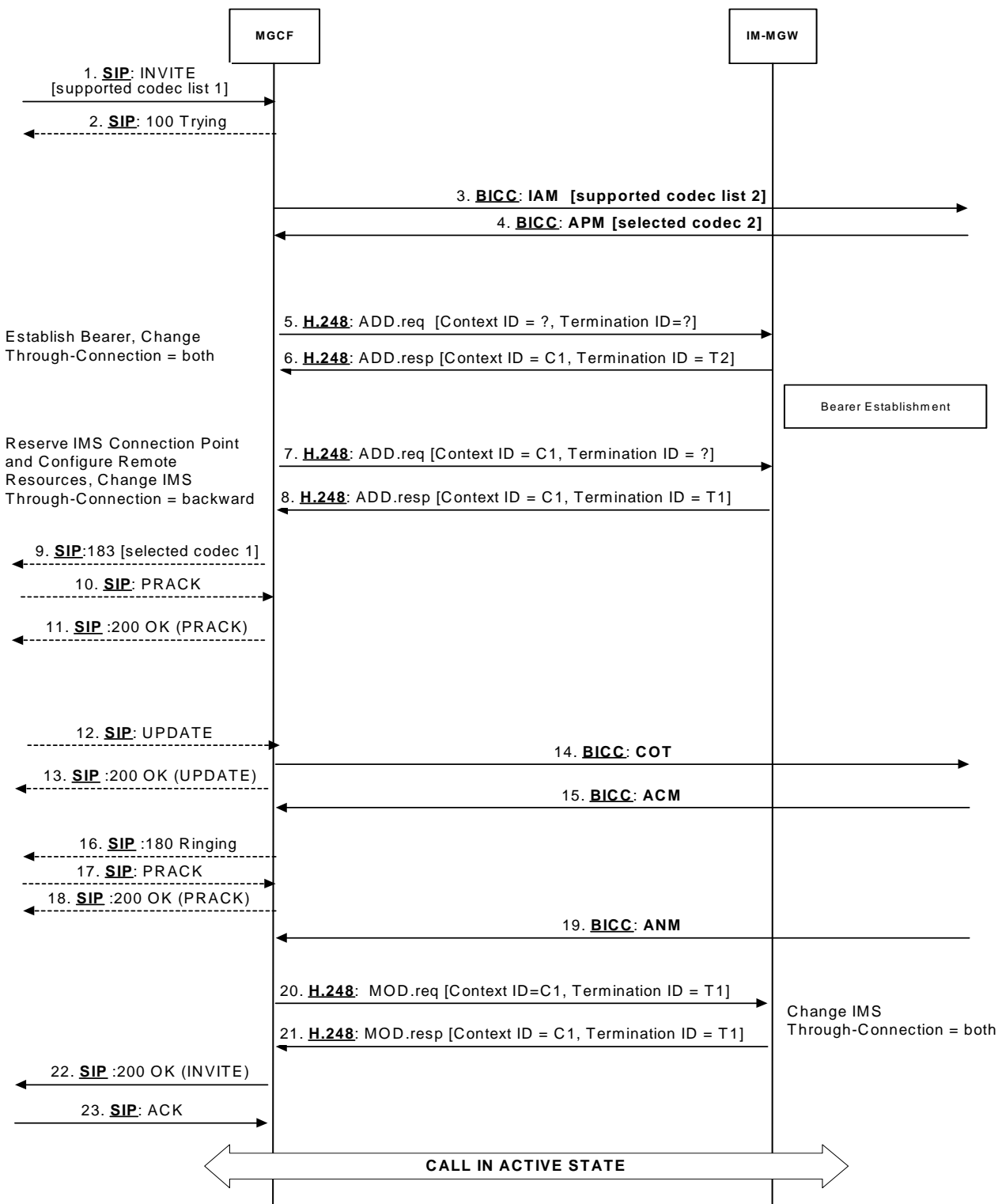

Figure B.1: Basic IM CN Subsystem originating session, BICC forward bearer establishment (message sequence chart)

B.3.2 Basic CS network originated session

This clause shows an example of the interworking of codec negotiation between a BICC CS network and an IM CN subsystem during session establishment for a BICC CS network originated session. The example applies to BICC forward bearer establishment. Similar procedures apply to the other four versions of bearer establishment procedure applicable to the BICC CS network. The exchange of codec information is identical in all five cases, but there are differences in the sequence of operations associated with bearer establishment within the BICC CS network.

B.3.2.1 BICC forward bearer establishment

B.3.2.1.1 IM-MGW selection

The MGCF shall select an IM-MGW for the bearer connection before it performs the IM CN subsystem session establishment or the CS network side bearer establishment.

B.3.2.1.2 IM CN subsystem side termination reservation

The MGCF shall derive from the codec negotiation procedure one or several appropriate local codec(s) the IM-MGW may use to receive user plane data from the IM CN subsystem. The MGCF shall use the Reserve IMS Connection Point procedure (signals 2 and 3 in figure B.2/1). Within this procedure, the MGCF shall indicate the local codec(s) and request a local IP address and UDP port from the IM-MGW. The local IP address and UDP port are used by the IM-MGW to receive user plane data from the IM CN subsystem. If DTMF support together with speech support is required, or if the resources for multiple speech codecs shall be reserved at this stage, the reserve value indicator shall be set to "true".

The IM-MGW shall reply to the MGCF with the selected local codec(s) and the selected local IP address and UDP port.

The MGCF shall send this information in the INVITE (signal 4 in figure B.2/1) to the IM CN subsystem.

B.3.2.1.3 IM CN subsystem side session establishment

The MGCF shall use the Configure IMS Resources procedure (signals 7 and 8 in figure B.2/1) to provide configuration data (derived from SDP received in signal 6 in figure B.2/1 and the codec negotiation procedure) to the IM-MGW as detailed below:

- The MGCF shall indicate the remote IP address and UDP port, i.e. the destination IP address and UDP port for data sent in the user plane towards the IM CN subsystem,
- The MGCF shall indicate the remote codec(s), i.e. the speech codec(s) for data sent in the user plane towards the IM CN subsystem.
- The MGCF may indicate the local codec(s) and the local IP address and UDP port. The MGCF shall indicate the local codec(s) if a change is required.
- IF DTMF support together with speech support is required, the reserve value indicator shall be set to "true".

The IM-MGW shall reply with the selected remote codec(s) and reserve resources for these codec(s). If local codec(s) were received, the IM-MGW shall also reply with the selected local codec(s) and reserve the corresponding resources.

If the selected local codec(s) differ from the codec(s) received in the SDP of signal 6 in figure B.2/1, the MGCF shall send the local reserved codec(s), and the local IP address and UDP port in the PRACK (signal 9 in figure B.2/1) to the IMS.

B.3.2.1.4 CS network side bearer establishment

The MGCF shall request the IM-MGW to prepare for the CS network side bearer establishment using the Prepare Bearer procedure (signals 11 and 12 in figure B.2/1). Within this procedure, the MGCF shall request the IM-MGW to provide a bearer address, a binding reference and optionally notify when the bearer is established. The MGCF shall also provide the IM-MGW with the bearer characteristics determined by the codec negotiation procedure. After the IM-MGW has replied with the bearer address and the binding reference, the MGCF provides the APM message (signal 13 in figure B.2/1) to the preceding node. The MGCF may also provide the IM-MGW-id in the APM message.

B.3.2.1.5 Called party alerting

The MGCF shall request the IM-MGW to provide an awaiting answer indication (ringing tone) to the calling party using the Send Tone procedure (signals 21 and 22 in figure B.2/1), when the following condition is satisfied:

- the MGCF receives the first 180 Ringing message

B.3.2.1.6 Called party answer

When the MGCF receives a 200 OK message (signal 23 in figure B.2/2), it shall request the IM-MGW to stop providing the ringing tone to the calling party using the Stop Tone procedure (signals 26 and 27 in figure B.2/2).

B.3.2.1.7 Through-Connection

During the Prepare Bearer procedure, the MGCF shall either use the Change Through-Connection procedure to request the IM-MGW to backward through-connect the BICC termination, or the MGCF shall use this procedure to both-way through-connect the BICC termination already on this stage (signals 11 and 12 in figure B.2/1). During the Reserve IMS Connection Point procedure, the MGCF shall use the Change IMS Through-Connection procedure to request the IM-MGW to backward through-connect the IMS termination (signals 2 and 3 in figure B.2/1).

When the MGCF receives the SIP 200 OK(INVITE) (signal 23 in figure B.2/2), it requests the IM-MGW to both-way through-connect the terminations using the Change IMS Through-Connection or Change Through-Connection procedures (signals 28 and 29 in figure B.2/2), unless those terminations are already both-way through-connected.

B.3.2.1.8 Codec handling

The IM-MGW may include a speech transcoder based upon the speech coding information provided to each termination.

B.3.2.1.9 Failure handling in MGCF

If any procedure between the MGCF and the IM-MGW is not completed successfully, the default action by the MGCF is to release the session as described in clause 9.2.6. If the MGCF receives a Bearer Released procedure from the IM-MGW the default action by the MGCF is to release the session, as described in clause 9.2.7.

NOTE: As an implementation option the MGCF may also decide for example to only release the resources in the IM-MGW that caused the failure, possibly select a new IM-MGW for the connection and continue the call establishment using new resources in the selected IM-MGW but such handling is outside of the scope of the present document.

B.3.2.1.10 Message sequence chart

Figures B.2/1 and B.2/2 show the message sequence chart for the CS network originating session with BICC forward bearer establishment.

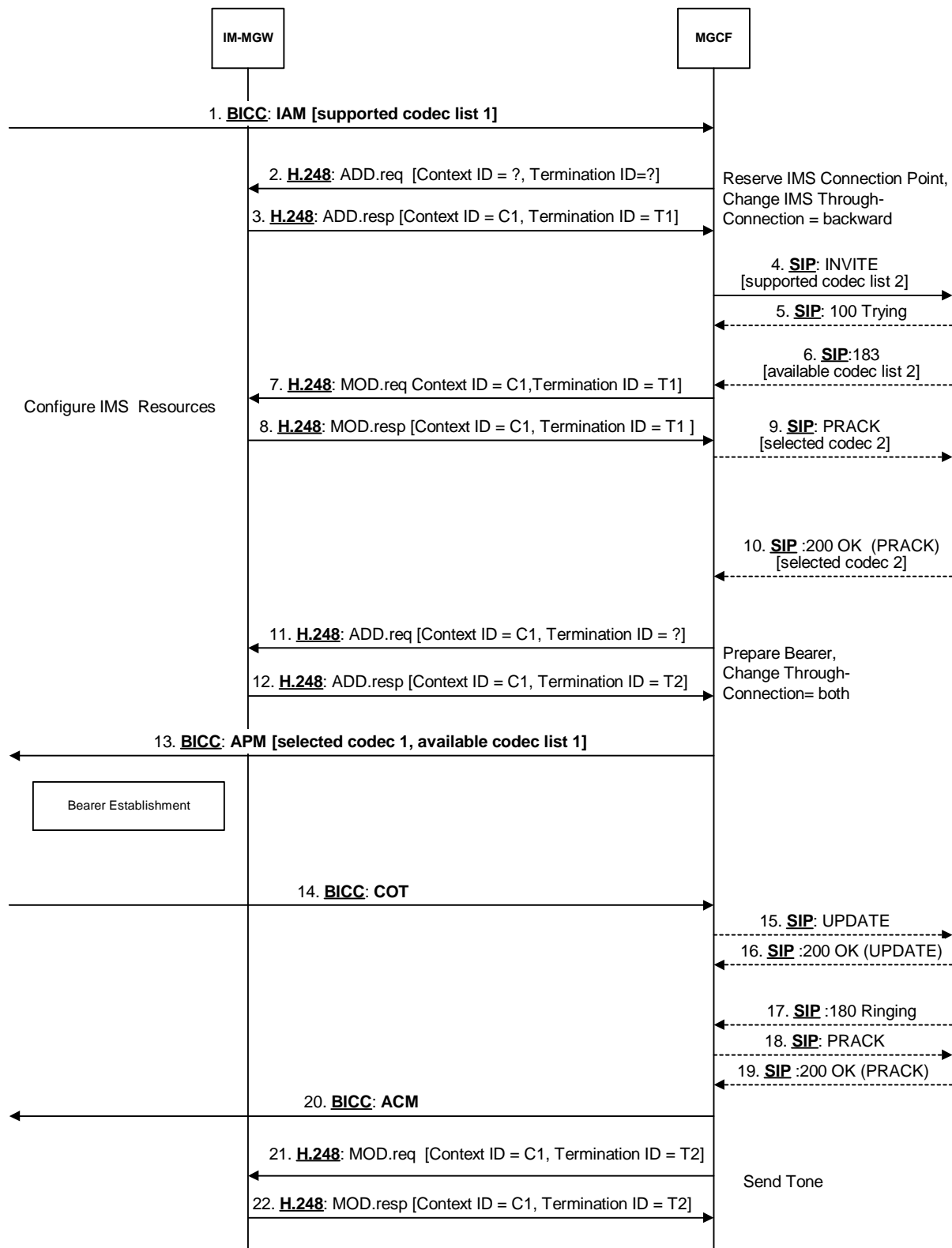

Figure B.2/1: Basic CS Network Originating Session, BICC forward bearer establishment (message sequence chart)

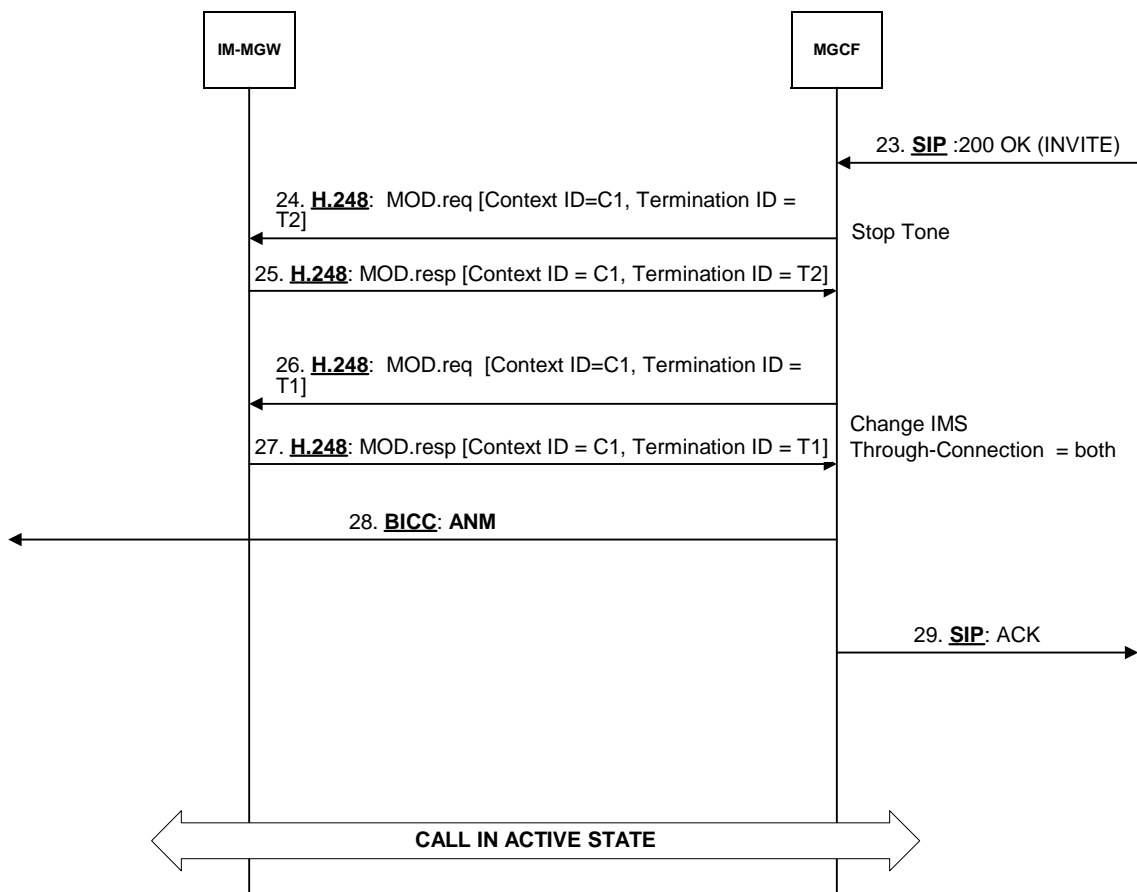

Figure B.2/2: Basic CS Network Originating Session, BICC forward bearer establishment (message sequence chart continued)

B.3.3 CS network initiated mid-call codec negotiation

Figure B.3 shows the CS network initiated mid-call codec negotiation procedure interworking with the IM CN subsystem. When the MGCF selects the codecs for the CS network and the IM CN subsystem (after signal 3 in figure B.3), the MGCF shall modify the CS network termination and the IM CN subsystem termination on the IM-MGW to conform to the newly selected configuration data on the two interfaces. The MGCF may perform bearer operations (not shown) at the IM-MGW before interworking the initial codec modification request (signal 2 in figure B.3) to determine new connection information, if necessary, or to verify resource availability.

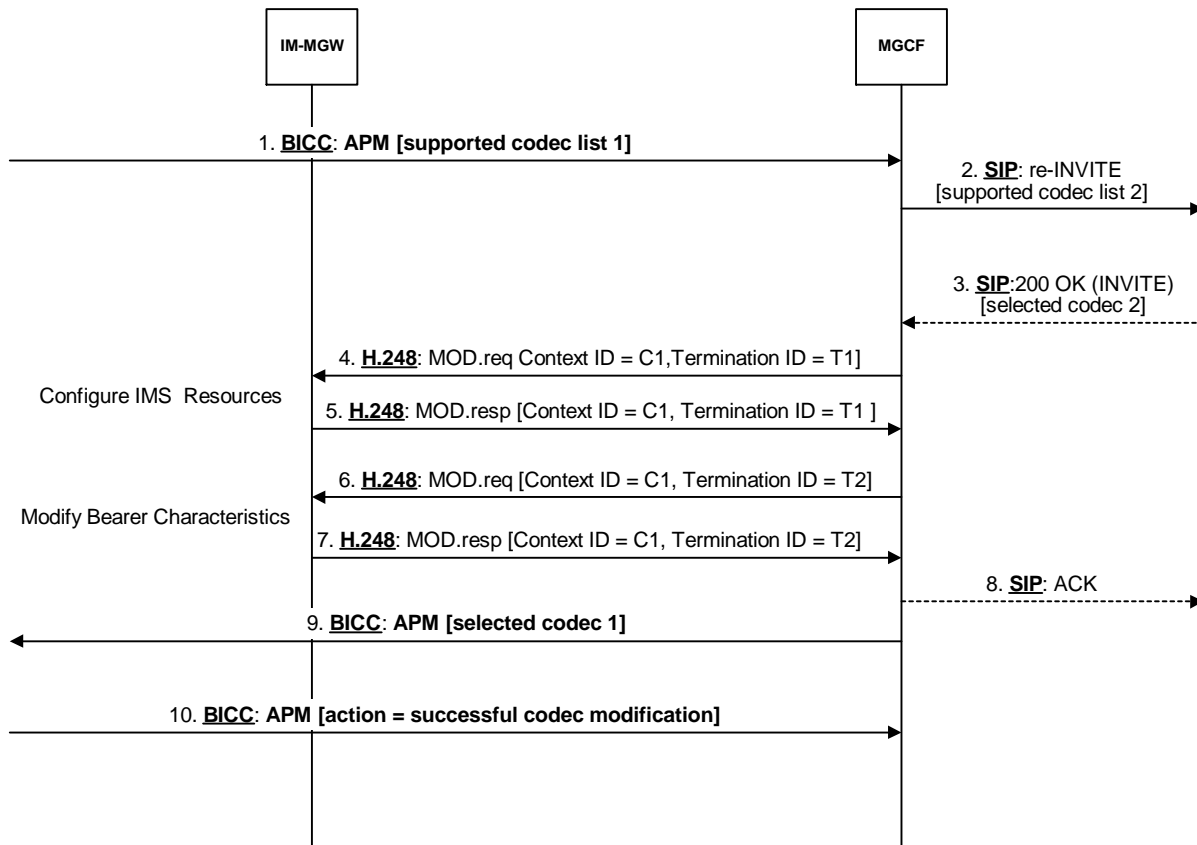

Figure B.3: CS network initiated mid-call codec negotiation (message sequence chart)

B.3.4 IM CN subsystem initiated mid-call codec negotiation

Figure B.4 shows the IM CN subsystem initiated mid-call codec negotiation procedure interworking with a BICC CS network. When the MGCF selects the codecs for the CS network and the IM CN subsystem (after signal 3 in figure B.4), the MGCF shall modify the CS network termination and the IM CN subsystem termination on the IM-MGW to conform to the newly selected configuration data on the two interfaces. The MGCF may perform bearer operations (not shown) at the IM-MGW before interworking the initial codec modification request (signal 2 in figure B.3) to determine new connection information, if necessary, or to verify resource availability. The MGCF may also perform bearer operations (not shown) at the IM-MGW after sending the final APM (signal 8 in figure B.4) to modify transport bandwidth, if necessary.

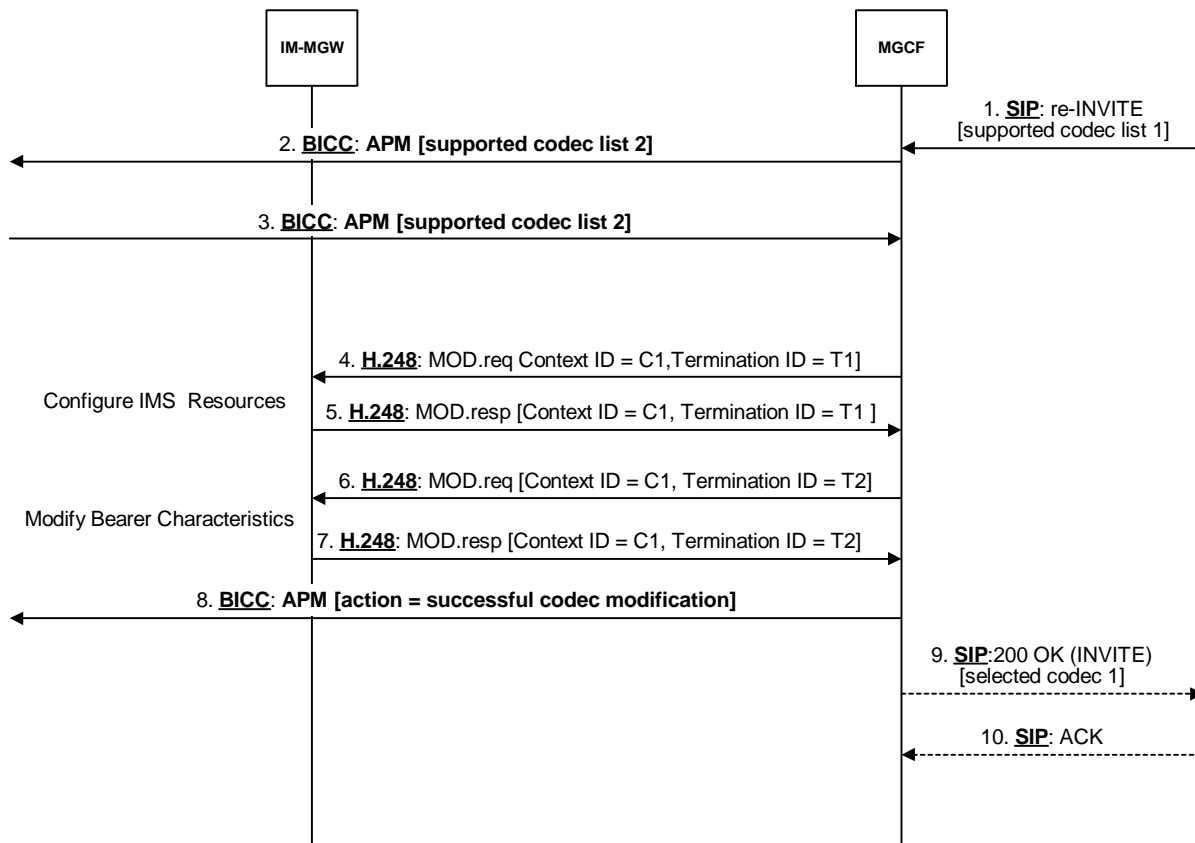

Figure B.4: IM CN subsystem initiated mid-call codec negotiation (message sequence chart)

Annex C (normative): Interworking of CPC parameter

The CPC extension to tel-URI Parameter is defined in clause 7.2A.12 of 3GPP TS 24.229 [9]. The SIP "Accept-Language" header is defined in IETF RFC 3261 [19].

C.1 Interworking SIP to ISUP

Table C.1.1 shows the mapping of a "cpc" URI parameter received within tel URI or the userinfo part of SIP URI with user="phone" in a P-Asserted-Identity header in the initial INVITE request to the Calling party's category parameter in the ISUP IAM. When the "cpc" URI parameter value "operator" is received the I-MGCF shall use an Accept-Language header field to determine the value of the Calling party's category parameter.

Table C.1.1: Mapping of the CPC parameter to the ISUP Calling party's category parameter

SIP Parameters		ISUP Parameters
"cpc" URI parameter in P-Asserted-Identity (NOTE 2)	Accept-Language	Calling party's category
operator	fr	operator, language French
operator	en	operator, language English
operator	de	operator, language German
operator	ru	operator, language Russian
operator	es	operator, language Spanish
ordinary		ordinary calling subscriber
test		test call
payphone		payphone
unknown		calling party's category unknown at this time (national use)
mobile-hplmn		mobile terminal located in the home PLMN
mobile-vplmn		mobile terminal located in a visited PLMN
emergency		emergency service call per ANSI Standard ATIS-1000113.2005 [117] (NOTE 1)
NOTE 1: This is a national/regional specific value. Interworking shall only occur when interconnecting with indicated national network.		
NOTE 2: In case the "cpc" URI parameter is absent or contains values that are not mapped per this table then the ISUP shall contain the default CPC value "ordinary calling subscriber".		

In case the Accept-Language header field is not received or contains values that are not in this table then based on operator policy the Calling party's category parameter shall contain the CPC value "operator, language X" (where X is one of the following languages: French, English, German, Russian or Spanish) or national/regional specific value.

C.2 Interworking ISUP to SIP

Table C.2.1 shows the mapping of a Calling party's category received in an ISUP IAM to a "cpc" URI parameter within tel URI or the userinfo part of SIP URI with user="phone" in the P-Asserted-Identity header. When the Calling party's category parameter value "operator, language x" is received the O-MGCF shall generate an Accept-Language header field with the value that corresponds to language x.

Table C.2.1: Mapping of the ISUP Calling party's category parameter to the CPC parameter

ISUP Parameter calling party's category	SIP Parameters		
	"cpc" URI parameter in P-Asserted-Identity	Accept-Language	
operator, language French	operator	fr	
operator, language English	operator	en	
operator, language German	operator	de	
operator, language Russian	operator	ru	
operator, language Spanish	operator	es	
ordinary calling subscriber	ordinary	-	
test call	test		
payphone	payphone		
calling party's category unknown at this time (national use)	unknown		
mobile terminal located in the home PLMN	mobile-hplmn		
mobile terminal located in a visited PLMN	mobile-vplmn		
emergency service call per ANSI Standard ATIS-10001 13.2005 [117] (NOTE 1)	emergency		
NOTE 1: This is a national/regional specific value. Interworking shall only occur when interconnecting with indicated national network.			
NOTE 2: In case the calling party's category contains values that are not in this table then based on operator policy the "cpc" URI parameter may be omitted or may contain national/regional specific value.			

Annex D:
Void

Annex E (normative): Multimedia interworking between the IP Multimedia Core Network (CN) Subsystem (IMS) and Circuit Switched (CS) networks

E.1 Basic Multimedia calls interworking between the IMS and CS Networks scenarios

The Interworking between Circuit switched multimedia telephony service, as described in 3GPP TS 26.110 [78] and 3GPP TS 26.111 [79], and packet switched multimedia services, as described in 3GPP TS 26.235 [80] and 3GPP TS 26.236 [32] is addressed.

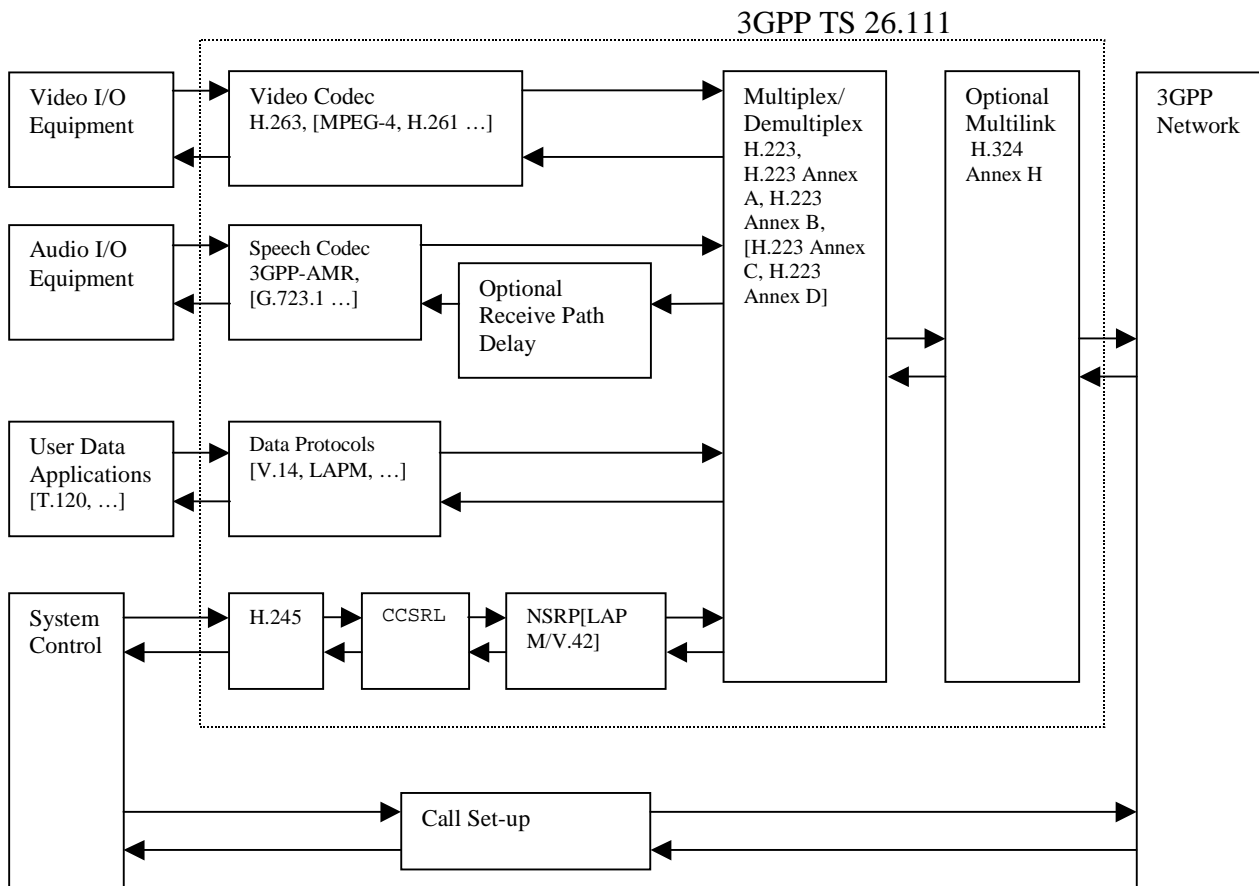

Figure E.1.1.1 Overview of relevant CS-Domain Protocols (from 3GPP TS 26.110 [78])

E.2 Control plane interworking

E.2.1 General

In addition to the control plane Interworking between SIP and ISUP or BICC, interactions between the H.245 signalling at the CS side and SIP/SDP signalling are described.

The establishment of the H.223 multiplexing protocol and the subsequent H.245 signalling procedures take place after the set-up and both-way through-connection of the CS bearer.

E.2.2 Functionalities required in the MGCF for multimedia calls support

In addition to the control plane Interworking between SIP and ISUP or BICC, the MGCF needs to mediate interactions between the H.245 signalling or MONA (Media Oriented Negotiation Acceleration) procedures at the CS side and SIP/SDP signalling at the IMS side. The interactions between H.245 signalling or MONA procedures and SIP/SDP signalling should aim at avoiding media transcoding by selecting the same codec for the CS side and the PS side.

NOTE: Detailed procedures for the mapping between SDP parameters and H.245 parameters are not specified in the present release.

E.2.3 IM CN subsystem originated session

E.2.3.1 Preconditions used at IMS side

E.2.3.1.1 Interactions between H.245 or MONA and SIP/SDP

Figure E.2.3.1.1.1 shows examples of interactions between H.245 or MONA procedures and SIP/SDP for IM CN subsystem originated session. Most SIP and ISUP or BICC messages are intentionally omitted, since the SDP may be embedded in various SIP messages and since the in-band H.245 Messages are not tightly coupled with out-of-band ISUP or BICC messages.

Figure E.2.3.1.1.1 assumes that the IMS peer uses the SIP precondition extension to indicate that preconditions have not yet been met.

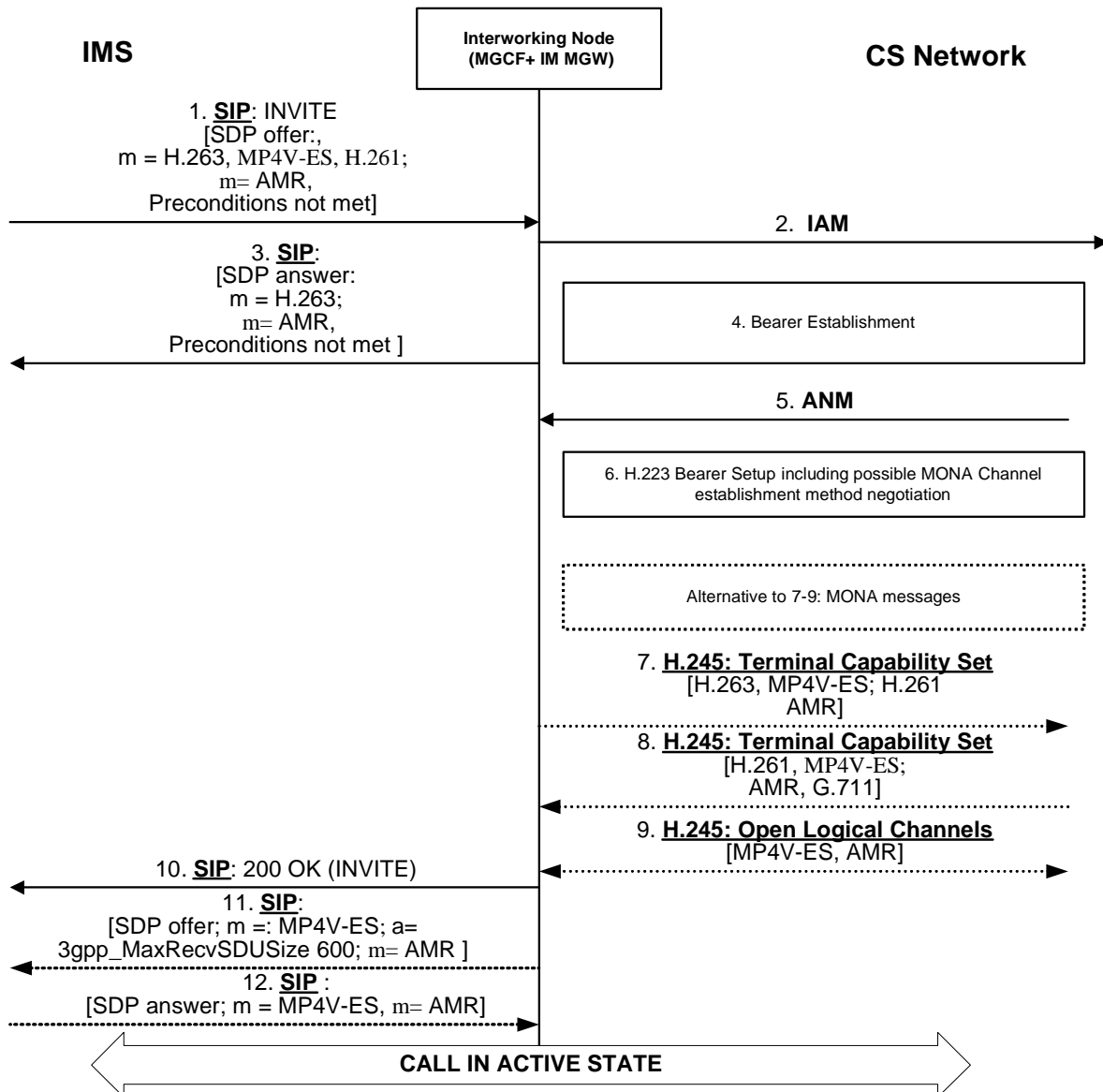

**Figure E.2.3.1.1.1: Interactions between H.245 and SIP/SDP for IM CN subsystem originated session
IMS peer indicates unmet local preconditions**

Upon receipt of a SIP INVITE request containing speech and video Codecs (signal 1 in figure E.2.3.1.1.1) the Interworking Node (consisting of MGCF and IM-MGW) starts the call set-up for multimedia call at the CS side by sending an IAM requesting an UDI bearer (signal 2 in figure E.2.3.1.1.1).

If SDP local preconditions, which are not yet met, are contained in signal 1, the Interworking node should immediately send an SDP answer to allow for the IMS-side bearer set-up to progress. The Interworking node selects codecs supported by the IM-MGW and likely to be supported within the CS network and communicates the selected codecs towards the IMS side within an SDP answer message (signal 3 in figure E.2.3.1.1.1). If these codecs are contained in the SDP offer, the Interworking Node should select the H.263 codec and may select other codec from the SDP offer in addition. The interworking node should include a b:AS bandwidth modifier with a bandwidth suitable for the selected codec(s), but not higher than 64kbit/s plus RTP/UDP/IP overhead, in the SDP answer to request that the peer does not send media with a higher bandwidth.

The Interworking Node shall engage in an H.223 bearer setup (step 6 in figure E.2.3.1.1.1). If the interworking Node supports MONA (Media Oriented Negotiation Acceleration), it shall first attempt a MONA Channel establishment method negotiation according to Annex K of ITU-T Recommendation H.324 [81]. If the interworking node does not support MONA, it shall use the multiplexing level negotiation procedures of Annex C of H.324 [81]. If the

Interworking Node supports MONA, but the remote peer does not do so, a fallback to the multiplexing level negotiation procedures of Annex C of H.324 [81] will occur.

If both the Interworking Node and the remote CS terminal support MONA procedures, the MONA procedures as per ITU-T Recommendation H.324 Annex K [81] may be used to replace the H.245 negotiation (signals 7 – 9) as shown in figure E.2.3.1.1.1.

If MONA procedures are not used, the following applies:

- After the completion of the H.223 bearer setup at the CS side, the Interworking Node shall send a Terminal Capability Set message describing its own capabilities (signal 7 in figure E.2.3.1.1.1). Unless the Interworking Node supports transcoding, the Interworking Node shall only send codecs that have been offered at the IM CN subsystem side (as received in signal 1 in figure E.2.3.1.1.1) within this message.
- The Interworking Node will receive an H.245 Terminal Capability Set message describing the supported Codecs at the peer's side (signal 8 in figure E.2.3.1.1.1).
- The codecs contained both in the sent and received terminal capability set messages may be selected at the CS side. The final decision of the selected codecs at the CS side is taken when the H.245 open logical Channels message (signal 9 in figure E.2.3.1.1.1) is sent or received. The direction of this message is determined by the H.245 master-slave determination procedure.

If the Interworking Node does not transcode, it should indicate the codecs selected within the H.245 negotiation (signal 11 in figure E.2.3.1.1.1) or within the MONA procedures and enable any media that have previously been put on hold at the IMS side after the completion of the H.245 negotiation or MONA procedures.

The interworking node should include in step 11 of figure E.2.3.1.1.1 the SDP "a" attribute "3gpp_MaxRecvSDUSize" indicating the maximum SDU size of the application data that can be transmitted to the receiver without segmentation, as specified in clause 12.2.4.6 of 3GPP TS 26.114 [104].

E.2.3.2 Preconditions not used at IMS side

E.2.3.2.1 Interactions between H.245 or MONA and SIP/SDP

Figure E.2.3.2.1.1 shows examples of interactions between H.245 or MONA procedures and SIP/SDP for IM CN subsystem originated session. Most SIP and ISUP or BICC messages are intentionally omitted, since the SDP may be embedded in various SIP messages and since the in-band H.245 Messages are not tightly coupled with out-of-band ISUP or BICC messages.

Figure E.2.3.2.1.1 assumes that the IMS peer does not use the SIP precondition extension.

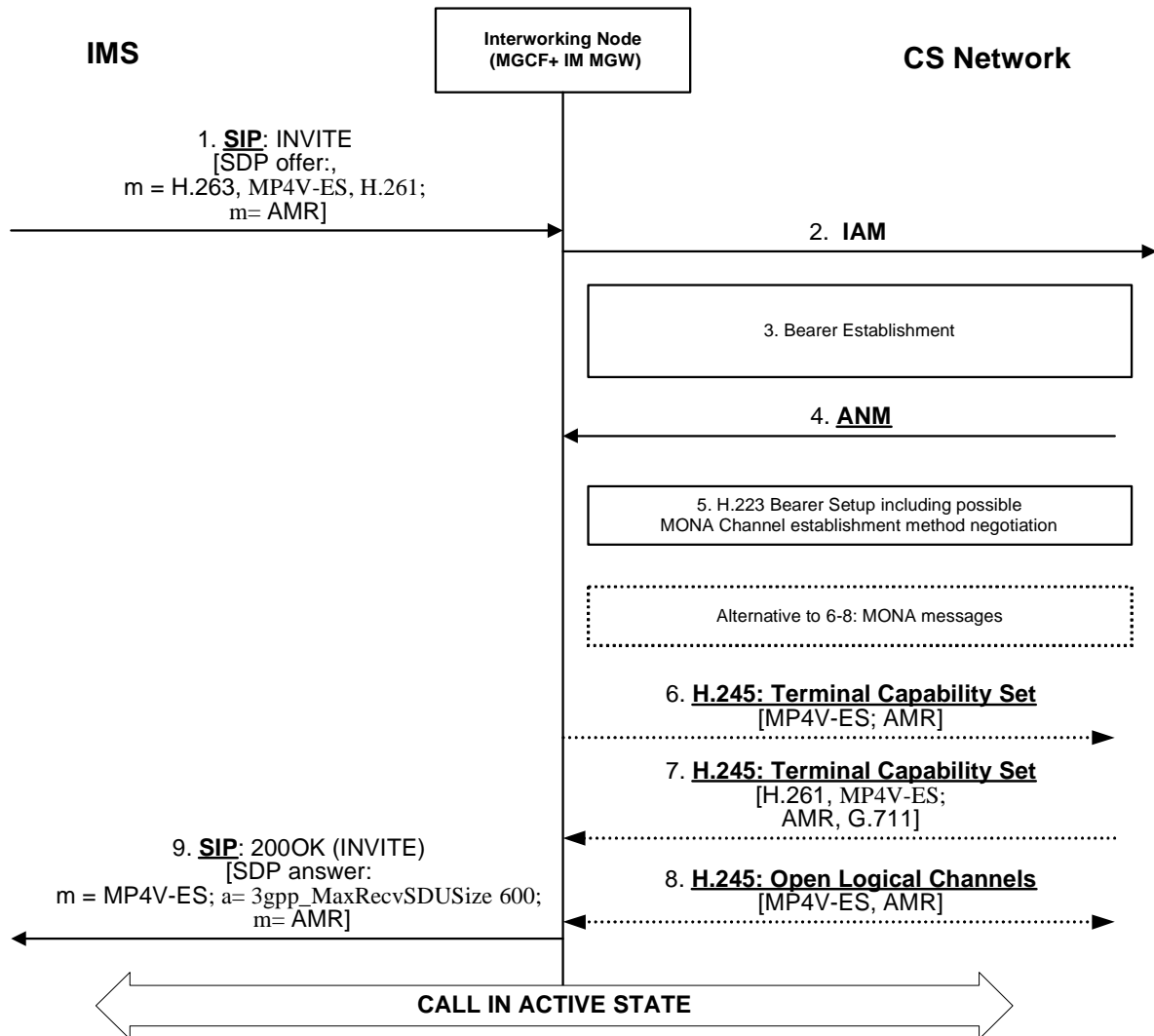

Figure E.2.3.2.1.1 Interactions between H.245 and SIP/SDP for IM CN subsystem originated session IMS peer does not use SIP preconditions

Upon receipt of a SIP INVITE request containing speech and video Codecs (signal 1 in figure E.2.3.2.1.1) the Interworking Node (consisting of MGCF and IM-MGW) starts the call set-up for multimedia call at the CS side by sending an IAM requesting an UDI bearer (signal 2 in figure E.2.3.2.1.1).

If no unmet local SDP preconditions are contained in signal 1, the Interworking node should defer sending an SDP answer until the H.245 negotiation or MONA procedures is/are completed.

The Interworking Node shall engage in an H.223 bearer setup (step 5 in figure E.2.3.2.1.1). If the interworking Node supports MONA (Media Oriented Negotiation Acceleration), it shall first attempt a MONA Channel establishment method negotiation according to Annex K of ITU-T Recommendation H.324 [81]. If the interworking node does not support MONA, it shall use the multiplexing level negotiation procedures of Annex C of H.324 [81]. If the Interworking Node supports MONA, but the remote peer does not do so, a fallback to the multiplexing level negotiation procedures of Annex C of H.324 [81] will occur.

If both the Interworking Node and the remote CS terminal support MONA procedures, the MONA procedures as per ITU-T Recommendation H.324 [81] Annex K may be used to replace the H.245 negotiation (signals 6 – 8) as shown in figure E.2.3.2.1.1.

If MONA procedures are not used, the following applies:

- After the completion of the H.223 bearer setup at the CS side, the Interworking Node shall send a Terminal Capability Set message describing its own capabilities (signal 6 in figure E.2.3.2.1.1). Unless the Interworking

Node supports transcoding, the Interworking Node shall only send codecs that have been offered at the IM CN subsystem side (as received in signal 1 in figure E.2.3.2.1.1) within this message.

- The Interworking Node will receive an H.245 Terminal Capability Set message describing the supported Codecs at the peer's side (signal 7 in figure E.2.3.2.1.1).
- The codecs contained both in the sent and received terminal capability set message may be selected at the CS side. The final decision of the selected codecs at the CS side is taken when the H.245 open logical Channels message (signal 8 in figure E.2.3.2.1.1) is sent or received. The direction of this message is determined by the H.245 master-slave determination procedure.

If the Interworking Node does not transcode, it shall send an SDP answer (signal 9 in figure E.2.3.2.1.1) indicating the codecs selected within the H.245 negotiation or within the MONA procedures after the completion of the H.245 negotiation or MONA procedures. The interworking node should include a b:AS bandwidth modifier with a bandwidth suitable for the selected codec(s), but not higher than 64kbit/s plus RTP/UDP/IP overhead, in the SDP answer to request that the peer does not send media with a higher bandwidth.

The interworking node should include in Step 9 of figure E.2.3.2.1.1 the SDP "a" attribute "3gpp_MaxRecvSDUSize" indicating the maximum SDU size of the application data that can be transmitted to the receiver without segmentation, as specified in clause 12.2.4.6 of 3GPP TS 26.114 [104].

E.2.3.3 Fallback to speech at session establishment

If SCUDIF Fallback (see 3GPP TS 23.172 [121]) occurs on the CS side, the APM message contains a speech codec as "Selected Codec". The MGCF shall then disable the video "m-line" in the first SDP answer, if not yet sent, and complete the call-setup in the same way as for a normal speech call. If the SDP answer was already sent (precondition used), the MGCF shall update the SIP session to speech by sending a SIP UPDATE message with a relevant SDP.

If in a non-SCUDIF case (ISUP or BICC without SCUDIF) the called CS terminal or network rejects the video call setup by sending a REL message to the MGCF, the MGCF releases the CS video call being established, re-establishes the CS call in a speech only mode sending a new IAM with a speech BCIE to the CS network and updates the IM CN leg codecs to a speech only codec. Then the call/session continues as in a speech only case. If the interworking node does not support the fallback, it shall release the session.

E.2.4 CS network originated session

E.2.4.1 Interactions between SIP/SDP and H.245 or MONA

E.2.4.1.1 Normal Call setup

Figure E.2.4.1.1 shows examples of interactions between H.245 or MONA and SIP/SDP for the CS network originated session. Most SIP and ISUP or BICC messages are intentionally omitted, since the SDP may be embedded in various SIP messages and since the in-band H.245 Messages are not tightly coupled with out-of-band ISUP or BICC messages.

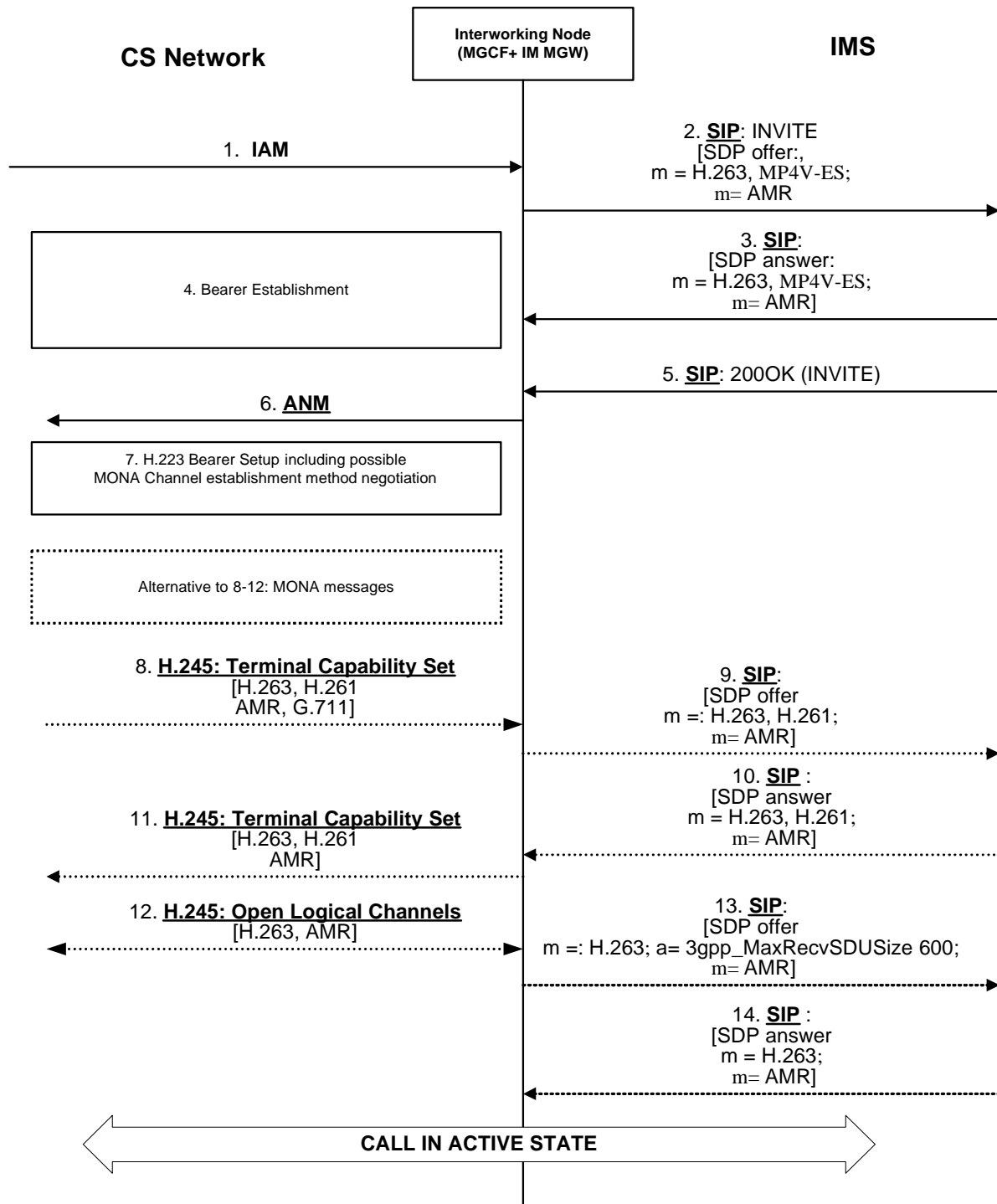

NOTE: Messages 3 and 5 may be combined in some scenarios.

Figure E.2.4.1.1: Interactions between H.245 and SIP/SDP for CS network originated session

Upon receipt of an IAM request for a multimedia Call (signal 1 in figure E.2.4.1.1) the Interworking Node (consisting of MGCF and IM-MGW) starts the call set-up for multimedia call at the IM CN subsystem side by sending an INVITE request (signal 2 in figure E.2.4.1.1). For the INVITE request, the Interworking Node selects codecs supported by the IM-MGW and likely to be supported within the CS Network. The Interworking Node should select the H.263 codec and may select other codec in addition. The interworking node should add a b:AS bandwidth modifier with a bandwidth suitable for the selected codec(s), but not higher than 64kbit/s plus RTP/UDP/IP overhead, in the SDP offer to request that the peer does not send media with a higher bandwidth.

NOTE: The SDP coding to express that either a combined voice and video call, or a voice call, or a Clearmode codec, or some other data call is desired is not defined in the present release.

The Interworking Node shall engage in an H.223 bearer setup (step 7 in figure E.2.4.1.1). If the interworking Node supports MONA (Media Oriented Negotiation Acceleration), it shall first attempt a MONA Channel establishment method negotiation according to Annex K of ITU-T Recommendation H.324 [81]. If the interworking node does not support MONA, it shall use the multiplexing level negotiation procedures of Annex C of H.324 [81]. If the Interworking Node supports MONA, but the remote peer does not do so, a fallback to the multiplexing level negotiation procedures of Annex C of H.324 [81] will occur.

If both the Interworking Node and the remote CS terminal support MONA procedures, the MONA procedures as per ITU-T Recommendation H.324 [81] Annex K may be used to replace the H.245 negotiation (signals 8, 11 and 12) as shown in figure E.2.4.1.1. Furthermore, the SIP codec renegotiation in signals 9 and 10 is then also not applicable.

If MONA procedures are not used, the following applies:

- After the completion of the H.223 bearer setup at the CS side the Interworking Node will receive a H.245 Terminal Capability Set message describing the supported Codecs at the peer's side (signal 8 in figure E.2.4.1.1).
- Due to information received in a Terminal Capability Set message (signal 8 in figure E.2.4.1.1), the Interworking node may send an SDP offer at the IMS side (signal 9 in figure E.2.4.1.1), to offer additional codecs supported at the CS side but not contained in the first SDP offer (signal 2 in figure E.2.4.1.1), or to restrict the selected codecs at the IMS side to codecs which are available at the CS side.

NOTE: It is not clear if the addition of codecs not included in previous SDP exchange has any impacts on IMS procedures, e.g. resource reservation related procedures.

- The Interworking Node shall send a Terminal Capability Set message describing its own capabilities (signal 11 in figure E.2.4.1.1). Unless the Interworking Node supports transcoding, the Interworking node shall only send codecs that are also negotiated at the IM CN subsystem side (as received in signal 3 in figure E.2.4.1.1) within this message. The Interworking Node may defer sending the Terminal Capability Set message for some time to attempt to receive the peer's Terminal Capability set message and perform a possible IMS-side codec re-negotiation. However, to avoid blocking situations, the Interworking Node shall not defer sending the Terminal Capability Set message for an excessive period of time.
- The codecs contained both in the sent and received Terminal Capability Set message may be selected at the CS side. The final decision of the selected codecs at the CS side is taken when the H.245 open logical Channels message (signal 12 in figure E.2.4.1.1) is sent or received. The direction of this message is determined by the H.245 master-slave determination procedure.

If the Interworking Node does not transcode, it should indicate the codecs selected within the H.245 negotiation or within MONA procedures after the completion of the H.245 negotiation (signal 13 in figure E.2.4.1.1) or MONA procedures.

The interworking node should include in Step 11 of figure E.2.4.1.1 the SDP "a" attribute "3gpp_MaxRecvSDUSize" indicating the maximum SDU size of the application data that can be transmitted to the receiver without segmentation, as specified in clause 12.2.4.6 of 3GPP TS 26.114 [104].

E.2.4.1.2 Call setup if multimedia call can not be recognized in an unambiguous manner

If the Interworking Node is not able to determine from the information within the IAM request whether a multimedia call or some other type of data call is requested (for example, if only TMR=UDI but no BC IE is contained in the IAM), the Interworking Node may also include appropriate codecs for other possible types of data call it supports in the INVITE request. If video and audio codecs are contained in the first SDP answer (signal 3), the Interworking Node should continue to attempt to set up a multimedia call as described in clause E.2.4.1.1. Otherwise, calls are set up as described in clause 7.2.3.2.

E.2.4.1.3 Fallback to speech during call setup

The called party can reject the video component in the SDP offer (signal 2 in figure E.2.4.1.1) by returning an SDP answer where the video related m-line is disabled (in signal 3 in figure E.2.4.1.1).

If the MGCF receives an SDP answer during call setup where the video related m-line is disabled, it shall react as follows:

- If the MGCF has received a SCUDIF call setup from the CS side (MuMe and speech codecs in IAM message, see 3GPP TS 23.172 [121]), the MGCF shall apply a SCUDIF fallback to speech on the CS side. The MGCF shall use a speech codec as Selected Codec and exclude the MuMe codec from the available codec list.
- If the MGCF has received a multimedia call setup without SCUDIF from the CS side, and the CS network supports CS fallback, the MGCF should terminate the call.

NOTE 1: A call termination can trigger the caller's device to set up a new speech call.

NOTE 2: Other procedures to maintain the CS call, e.g. disabling the video component on the CS side or providing a suitable video announcement and discarding received video media from the CS side, are FFS.

E.2.4.2 CS originated – IM CN transit – CS terminated

Figure E.2.4.2.1 describes ISUP and SIP/SDP interactions in a CS originated – IM CN transit – CS terminated case with a clear channel through the IM CN. An interworking node A receives an IAM message with a UDI H.223 & H.245 video call request (message 1). If the interworking node A supports both CS/IMS video interworking and a clearmode codec / clear channel, it may send both audio and video codecs and a clearmode codec and a UDI & H.223 & H.245 video indication in the INVITE message towards the IMS (message 2). The message is received by an interworking node B. The interworking node B sends an IAM message with a UDI & H.223 & H.245 video call request to the terminating CS network (message 3). If the interworking node B supports a clearmode codec / clear channel, it may send a SIP response with a clearmode codec towards the calling side to indicate that a clear channel can be established between the IMS interworking nodes (message 5). After the called party answers, the interworking node B sends a SIP 200 OK (Invite) with the clearmode codec to the calling node to indicate that a clear channel can be established (message 11). After the called party has answered the call, either MONA procedures are performed and the H.223 bearer is established or the H.223 bearer is established and the H.245 signalling is performed (step 14 in figure E.2.4.2.1).

If the interworking node A does not support CS-IMS video interworking, but supports a clearmode codec / clear channel, it sends the INVITE message with a clearmode codec and UDI & H.223 & H.245 indication, but without a video codec, to allow the establishment of a CS video call through a clear channel. The interworking node A may also send an audio codec (alone or with a clearmode codec) to allow a fallback to speech. The interworking node B either accepts the clearmode and sends the corresponding IAM message with a UDI & H.223 & H.245 request (message 3) and SIP response with a clearmode codec (message 5 or 11), or accepts the speech mode and sends the corresponding IAM message with a speech request (message 3) and SIP response with a speech codec (messages 5, 11), or rejects the INVITE message if the requested codec(s) cannot be supported.

The format of the indication of UDI & H.223 & H.245 from interworking node A to interworking node B is defined in Annex F "PSTN XML Scheme". UDI & H.223 & H.245 indication is conveyed in PSTN XML body within "BearerCapability" ("InformationTransferCapability" and "UserInfoLayerProtocol") and "LowLayerCompatibility" elements. Elements are defined in ETSI EN 300 403-1 (V1.3.2) [96] clause 4.5.5 and in ISUP transported in the ATP is in Q.761-Q.764 [4] clause 3.5.

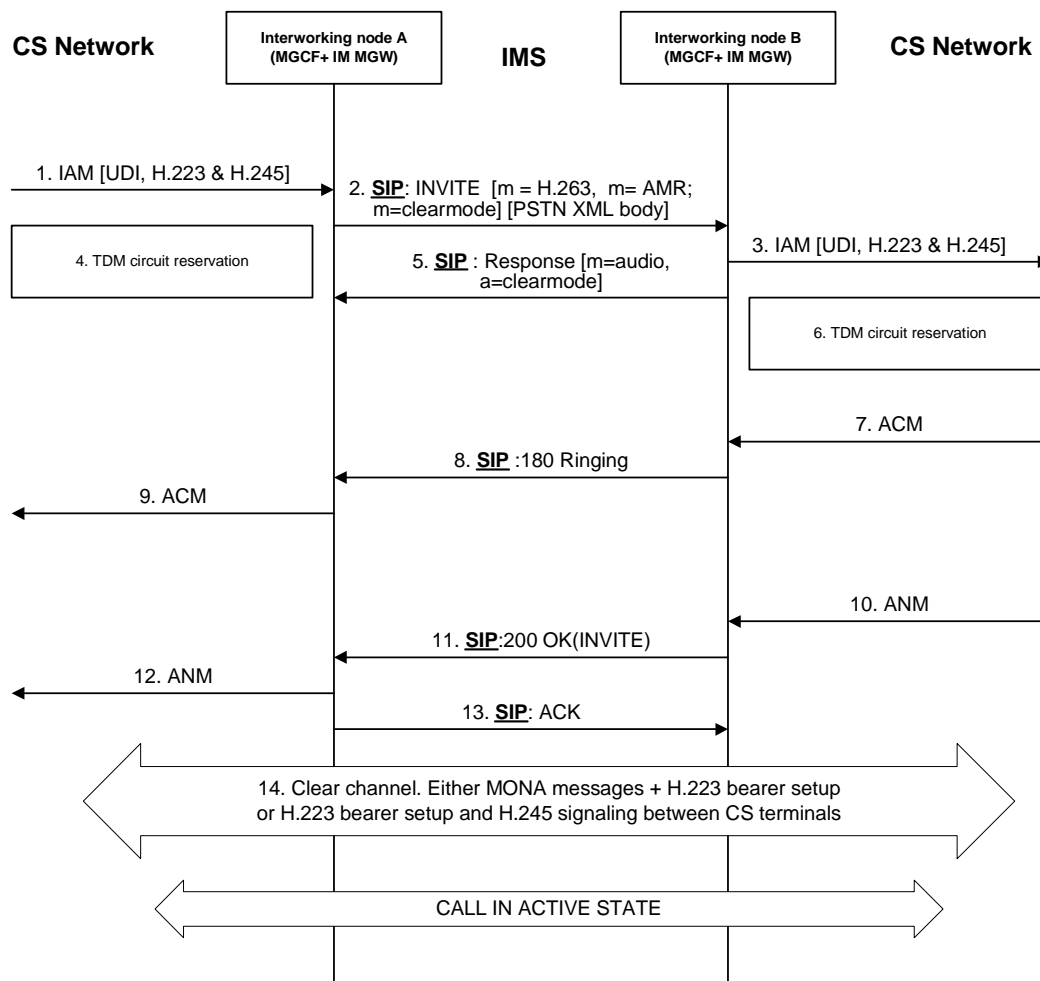

Figure E.2.4.2.1: ISUP and SIP/SDP interactions in a CS originated – IM CN transit - CS terminated case with a clear channel through the IM CN

E.2.5 Service change

E.2.5.2.1 SCUDIF

E.2.5.2.1.0 General

SCUDIF is standardised in 3GPP TS 23.172 [121].

E.2.5.2.1.1 IM CN subsystem originated change

E.2.5.2.1.1.1 Change from multimedia to speech

Figure E.2.5.2.1.1.1.1 shows an IM CN subsystem originated modification from multimedia to speech during an ongoing session when the CS leg supports BICC. The interworking node receives an INVITE message that indicates the dropping of the video media from the session, message 1. The interworking node can only accept the dropping of the media component and sends a corresponding codec modification request to the BICC network, message 2, and acknowledges the INVITE with a 200 OK message. The BICC network indicates a successful codec modification, message 5.

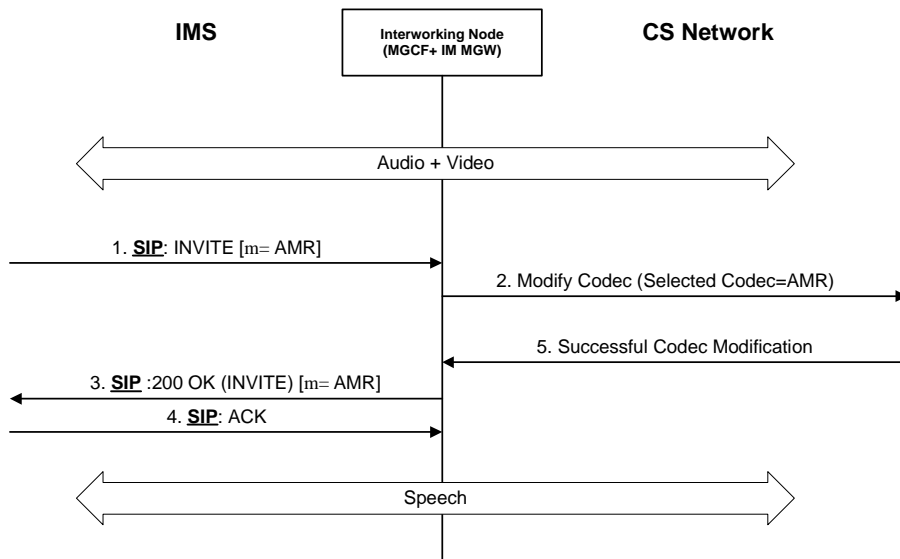

Figure E.2.5.2.1.1.1: IM CN subsystem originated modification from multimedia to speech when the CS leg supports BICC

Editor's note: Handling of a case, where a codec is received in BICC negotiation but not included in the available codec list negotiated previously, is ffs.

E.2.5.2.1.1.2 Change from speech to multimedia

Figure E.2.5.2.1.1.2.1 shows an IM CN subsystem originated modification from speech to multimedia during an ongoing session when the CS leg supports BICC. The interworking node receives an INVITE message that offers the adding of a video media to the ongoing speech session, message 1. The interworking node accepts the offer and sends a corresponding codec modification request to the BICC network, message 2. The BICC network indicates a successful codec modification, message 3. The interworking node acknowledges the INVITE with a 200 OK message after the MONA or H.245 in-band negotiation in step 4 is completed.

If the codec modification is not successful in the BICC network, the interworking node responds to the INVITE message with the speech codec in the 200 OK message to retain the speech only session.

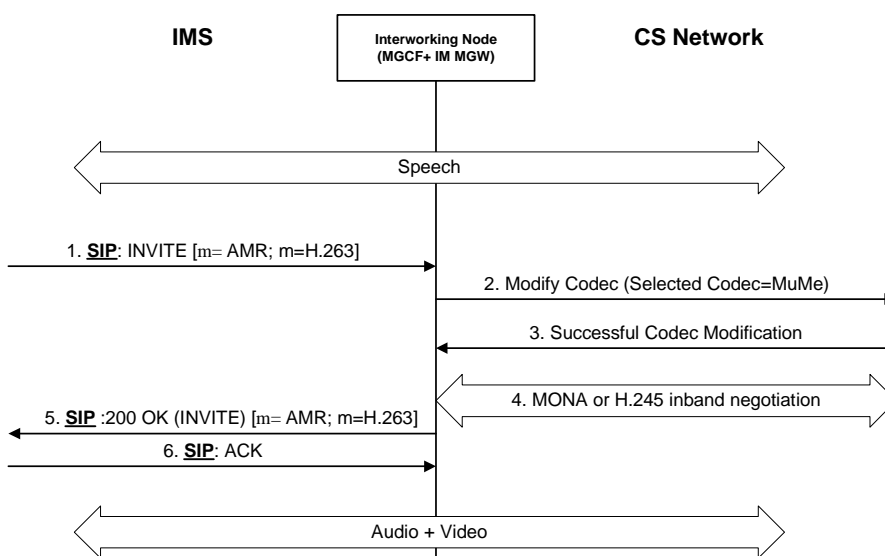

Figure E.2.5.2.1.1.2.1: IM CN subsystem originated modification from speech to multimedia when the CS leg supports BICC

E.2.5.2.1.2 CS network originated change

E.2.5.2.1.2.1 Change from multimedia to speech

Figure E.2.5.2.1.2.1.1 shows a CS network originated modification from multimedia to speech during an ongoing session when the CS leg supports BICC. The interworking node receives a Modify Codec message that indicates the dropping of the video media from the session, message 1. The interworking node accepts the dropping of the video component and sends a corresponding INVITE message to the IM CN subsystem, message 2, and acknowledges the codec modification request to the BICC network, message 3. The IM CN subsystem acknowledges the INVITE dropping the video media with a 200 OK, message 4.

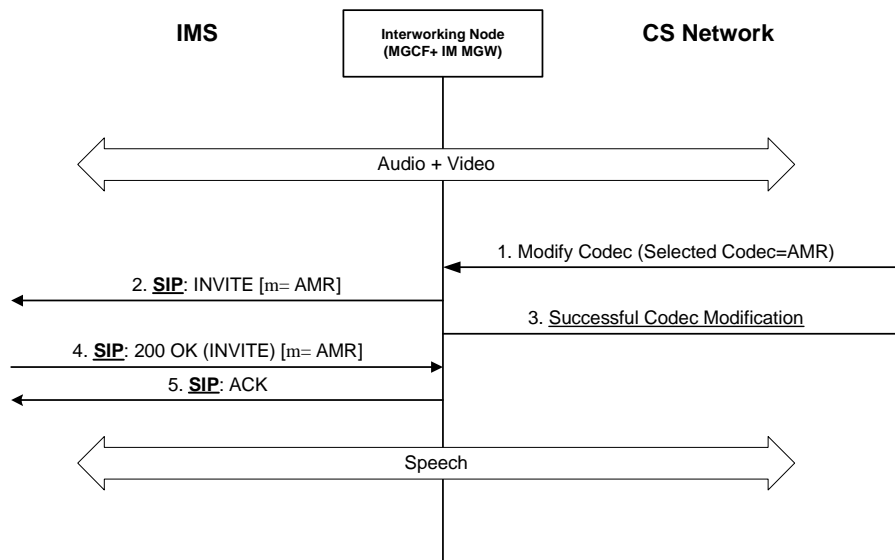

Figure E.2.5.2.1.2.1.1: CS network originated modification from multimedia to speech when the CS leg supports BICC

E.2.5.2.1.2.2 Change from speech to multimedia

Figure E.2.5.2.1.2.2.1 shows a CS network originated modification from speech to multimedia during an ongoing session when the CS leg supports BICC. The interworking node receives a Modify Codec message that indicates the adding of a video media to the ongoing speech session, message 1. The interworking node accepts the offer and sends a corresponding INVITE message to the IM CN subsystem, message 2. The IM CN subsystem acknowledges the INVITE adding the video media with a 200 OK, message 3, and acknowledges the codec modification request to the BICC network, message 4. The interworking node may have to update the codecs, messages 7 and 8, after the MONA or H.245 in-band negotiation in step 6.

If the IM CN subsystem does not accept the addition of the video media to the session, the interworking node rejects the modify codec request to retain the speech only session.

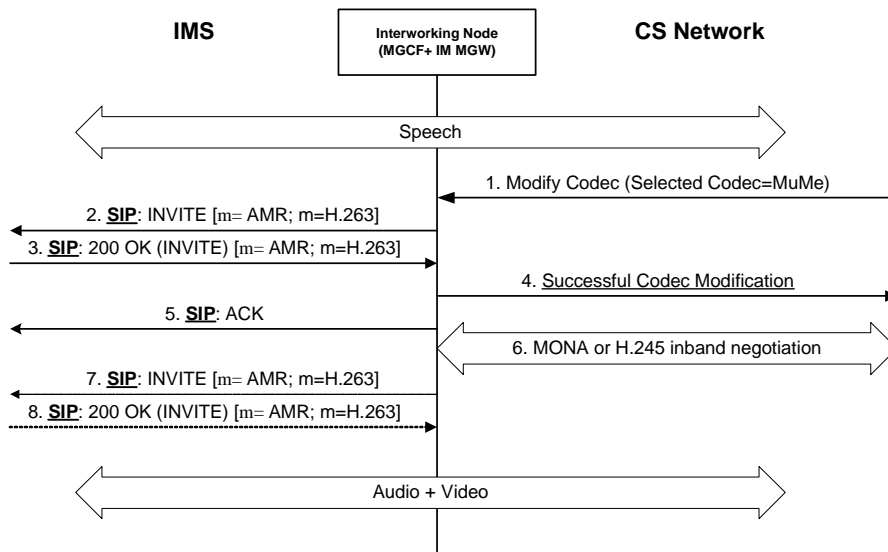

Figure E.2.5.2.1.2.2.1: CS network originated modification from speech to multimedia when the CS leg supports BICC

E.2.5.2.2 Non-SCUDIF case (ISUP or BICC without SCUDIF)

E.2.5.2.2.1 Change from multimedia to audio

Figure E.2.5.2.2.1.1 shows an IM CN subsystem originated modification from multimedia to audio during an ongoing session when the CS leg supports ISUP or BICC without SCUDIF. The interworking node receives an INVITE message that indicates the dropping of the video media from the session, message 1. The interworking node can only accept the dropping of the media component and acknowledges the INVITE with a 200 OK, message 2. There are three alternative ways to handle the issue:

- The video component stays on in the CS leg. The interworking node may use the video component to send an announcement to the CS terminal to inform the user about the change of the end-to-end connection to audio only. Refer to figure E.2.5.2.2.1.1.
- The interworking node initiates an H.245 in-band negotiation to close the video channel.
- The interworking node terminates the session.

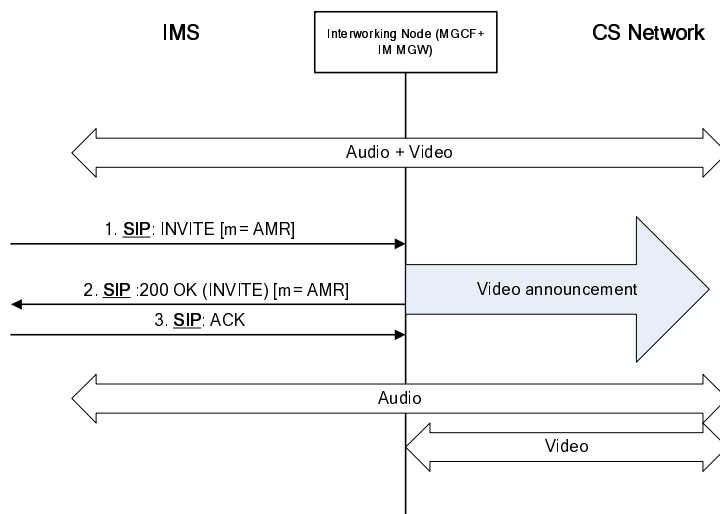

Figure E.2.5.2.2.1.1: IM CN subsystem originated modification from multimedia to speech when the CS leg supports ISUP or BICC without SCUDIF

E.2.5.2.2.2 Change from speech to multimedia

Figure E.2.5.2.2.1 shows an IM CN subsystem originated attempt to change from speech to multimedia during an ongoing session when the CS leg supports ISUP or BICC without SCUDIF. The interworking node receives an INVITE message that offers the adding of a video media to the ongoing speech session, message 1. The interworking node turns down the offer and responds to the INVITE message with the speech codec in the 200 OK message to retain the speech only session, message 2.

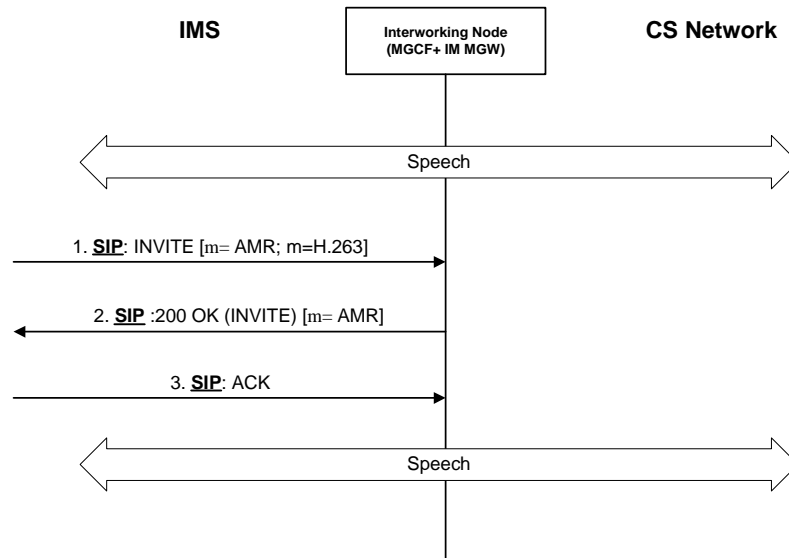

Figure E.2.5.2.2.1: IM CN subsystem originated modification from speech to multimedia when the CS leg supports ISUP or BICC without SCUDIF

E.2.6 Call release

E.2.6.1 Call release initiated from the IM CN subsystem side

When the MGCF has received a BYE message (signal 1 in figure E.2.6.1.1) from the IM CN subsystem side, the MGCF may end the H.245 session between the IM-MGW and the CS network side (signal 3 in figure E.2.6.1.1) firstly.

NOTE: A call release using only ISUP/BICC signalling at the CS side proceeds faster. H.324 terminals can handle situations where they do not receive H.245 call release signalling (see clause 7.5.2 of ITU-T Recommendation H.324 [81]), and this scenario also occurs e.g. at loss of coverage or when a node transporting H.223 transparently releases the call.

The procedure of ending the H.245 session is defined in the clause E.4. After receiving the BYE message, the MGCF shall also send a 200 OK [BYE] message (signal 2 in figure E.2.6.1.1) towards the IM CN subsystem.

After ending the H.245 session, the MGCF shall send a REL message (signal 4 in figure E.2.6.1.1) to the succeeding node. If the IM CN subsystem interworks with ISUP based CS network, the interworking node shall release the resources for the IMS side and the CS network side (signal 6 in figure E.2.6.1.1) after sending the REL message. If the IM CN subsystem interworks with BICC based CS network, the interworking node shall release the resources for the IMS side and the CS network side (signal 6 in figure E.2.6.1.1) upon receiving the RLC message (signal 5 in figure E.2.6.1.1) from the CS network side. The procedures of releasing the resources for the IMS side and the CS network side are specified in the present 3GPP TS in clause 7.

Figure E.2.6.1.1 shows the message sequence chart for the multimedia call release initiated from the IM CN subsystem side.

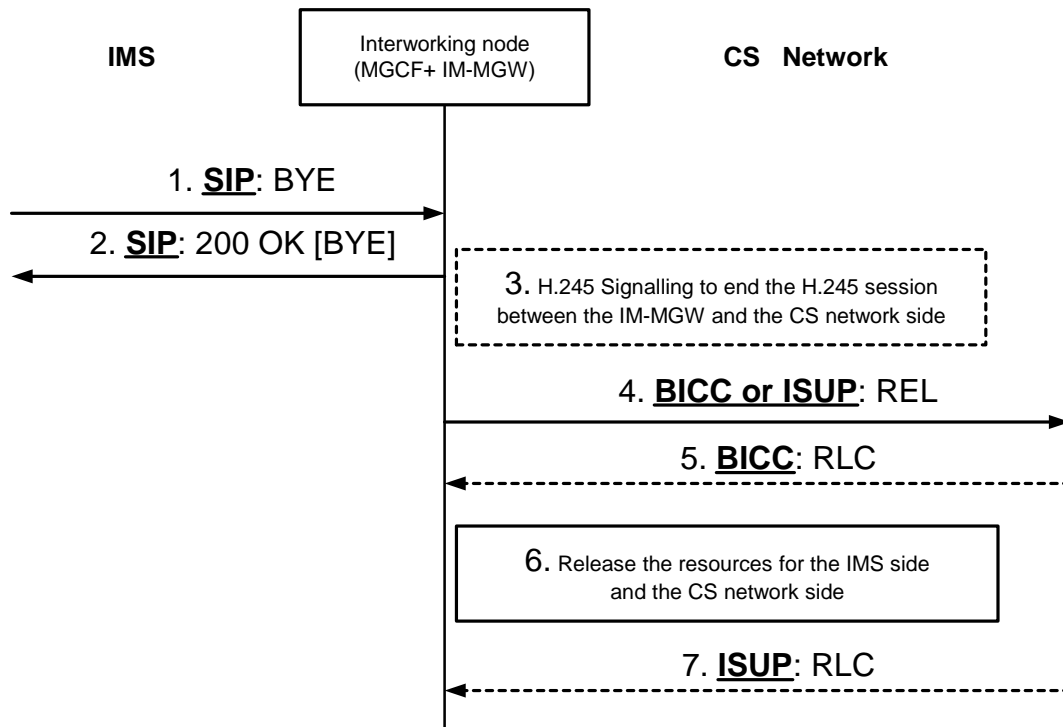

NOTE: Signal 7 is omitted when IM CN subsystem interworks with BICC based CS network and Signal 5 is omitted when IM CN subsystem interworks with ISUP based CS network.

Figure E.2.6.1.1: Call release initiated from the IM CN subsystem side

E.2.6.2 Call release initiated from the CS network side

If the CS network side initiates the call release, it possibly ends the H.245 session with explicit signalling (signal 1 in figure E.2.6.2.1). The CS network side sends a REL message (signal 2 in figure E.2.6.2.1) towards the IM CN subsystem. The procedure of ending the H.245 session is defined in the clause E.4.

When the MGCF receives a REL message (signal 2 in figure E.2.6.2.1) from the preceding node, the MGCF sends a BYE message (signal 3 in figure E.2.6.2.1) to the IM CN subsystem. After receiving the REL message, the interworking node also releases the resources for the IMS side and the CS network side (signal 4 in figure E.2.6.2.1). The procedure of the releasing the resources for the IMS side and the CS network side are specified in the present 3GPP TS in clause 7. After completion of resource release, the MGCF sends a RLC message (signal 5 in figure E.2.6.2.1) towards the preceding node. Figure E.2.6.2.1 shows the message sequence chart for the multimedia call release initiated from the CS network side.

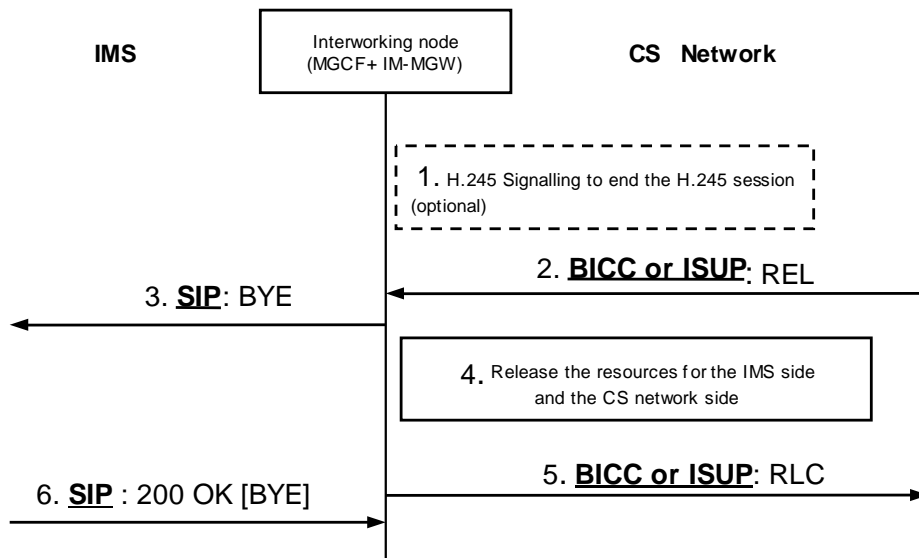

Figure E.2.6.2.1: Call release initiated from the CS network side

E.2.6.3 Call release initiated from the interworking node

The interworking node may end the H.245 session between the IM-MGW and the CS network side (signal 1 in figure E.2.6.3.1) firstly. The procedure of ending the H.245 session is defined in the clause E.4.

NOTE: A Call Release using only SIP and ISUP/BICC signalling may proceed faster. H.324 terminals can handle situations where they do not receive H.245 call release signalling (see clause 7.5.2 of ITU-T Recommendation H.324 [81]), and this scenario also occurs e.g. at loss of coverage or when a node transporting H.223 transparently releases the call.

To release the call, the MGCF shall send a REL message (signal 2 in figure E.2.6.3.1) to the succeeding node on the CS network side. The MGCF shall also send a BYE message (signal 3 in figure E.2.6.3.1) to the IM CN subsystem side.

If the IM CN subsystem interworks with ISUP based CS network, the interworking node shall release the resources for the IMS side and the CS network side (signal 5 in figure E.2.6.3.1) after sending the REL message. If the IM CN subsystem interworks with BICC based CS network, the interworking node shall release the resources for the IMS side and the CS network side upon receiving the RLC message (signal 4 in figure E.2.6.3.1) from the CS network side. The procedures of releasing the resources for the IMS side and the CS network side are specified in the present 3GPP TS in clause 7. Figure E.2.6.3.1 shows the message sequence chart for the multimedia call release initiated from the interworking node.

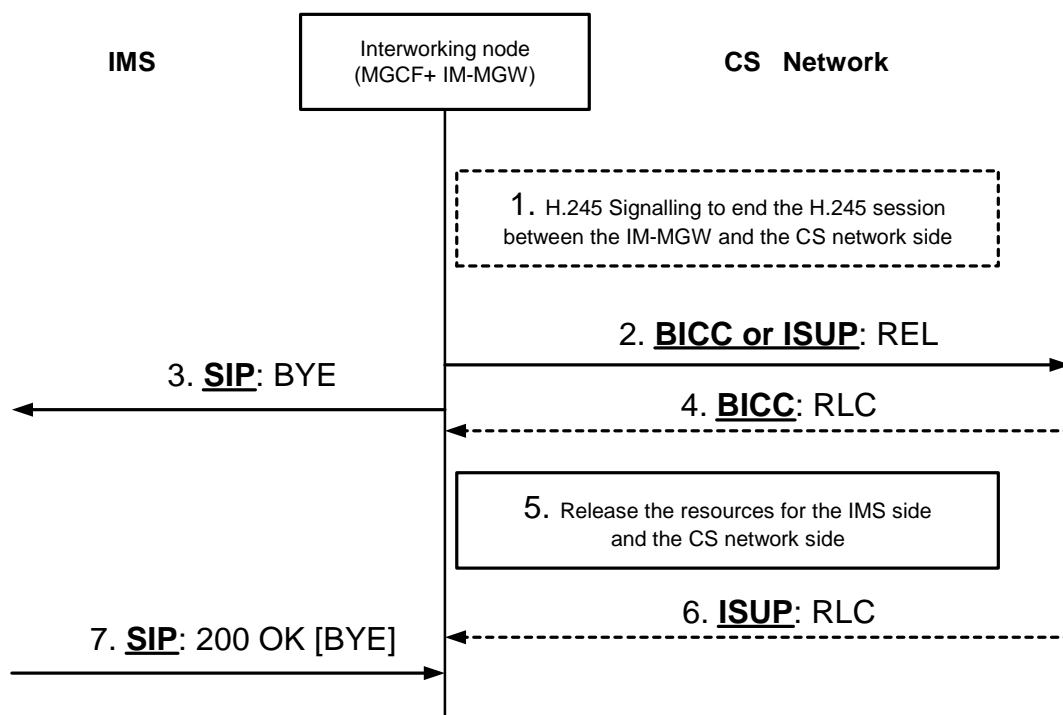

NOTE: Signal 6 is omitted when IM CN subsystem interworks with BICC based CS network and Signal 4 is omitted when IM CN subsystem interworks with ISUP based CS network.

Figure E.2.6.3.1: Call release initiated from the interworking node

E.3 User plane interworking

E.3.1 Functionalities required in the IM-MGW for multimedia calls support

To enable a multimedia Interworking, the IM-MGW needs to support the reframing of the H.263 video codec and the AMR audio codec between CS transport and PS transport as a minimum. The IM-MGW may also support the reframing of other codecs and the transcoding of audio and/or video codecs.

At the CS side, the IM-MGW needs to terminate the H.223 protocol and multiplex / de-multiplex audio, video and H.245 signalling. How H.245 related information (e.g. H.245 messages or extracted information) is communicated between the MGCF and the IM-MGW is described in clause E.4.

E.4 MGCF and IM-MGW interactions

E.4.1 Introduction

This clause describes requirements for extensions to the Mn interface protocol in 3GPP TS 29.332 [15] needed to support the Interworking of multimedia calls. ITU-T Recommendation H.248.1 [2] is used at the Mn interface.

The H.245 signalling shall be handled by the MGCF. Upon reception of the H.245 messages from the CS side at the IM-MGW, the IM-MGW shall forward those H.245 messages as binary data within H.248 messages over the Mn interface towards the MGCF. Upon reception of encapsulated binary H.245 messages within H.248 messages, the IM-MGW shall forward those H.245 messages towards the CS side.

NOTE: Procedures to support MONA (see Annex K of ITU-T Recommendation H.324 [81]) over the Mn interface are not defined in the present Release. Furthermore, the signalling flows in clause E.2 may not show MONA related signalling in sufficient detail for MONA related Mn interface interactions.

E.4.2 Mn signalling interactions

E.4.2.1 Introduction

The following Clauses describe the Mn interface procedures triggered by H.245 signalling received in the IM-MGW and SIP and RTCP and BICC or ISUP signalling received in the MGCF.

All message sequence charts in these Clauses are examples.

E.4.2.2 H.248 Context Model

The H.248 context model depicted in figure E.4.2.2.1 shall be applied for Multimedia Interworking.

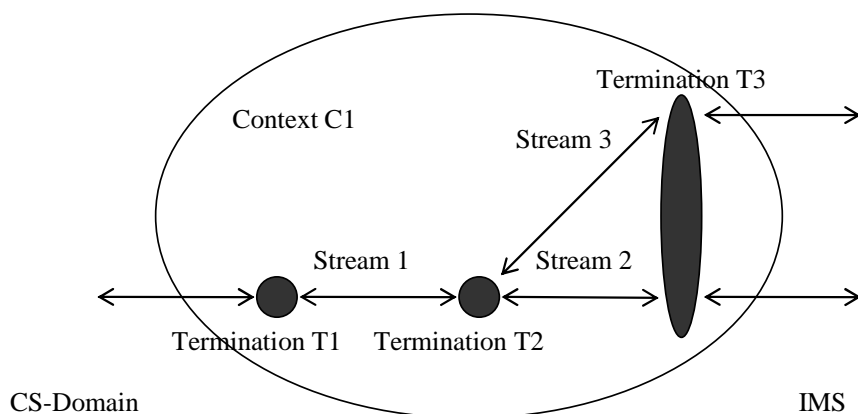

Termination:

T1 CS-Domain (CS-Bearer (BS30) for H.245 control, Speech, Video)

T2 Multiplexing (H.245 control, Speech, Video)

T3 Video (own RTP-stream) + Speech (own RTP-stream)

Stream:

Stream1 (between T1 and T2) data (H.245 control, speech, Video)

Stream2 (between T2 and T3) Video

Stream3 (between T2 and T3) Speech

Figure E.4.2.2.1: H.248 Context Model for Multimedia Interworking

E.4.2.3 Transport of H.245 messages between the MGCF and IM-MGW

E.4.2.3.1 General

H.245 messages shall be transported between the IM-MGW and MGCF over the Mn interface using H.248 Events (from the IM-MGW towards the MGCF) and H.248 Signals (from the MGCF towards the IM-MGW). The Events/Signals shall contain the following information:

- H.245 message (binary).

E.4.2.3.2 Transport from MGCF to IM-MGW

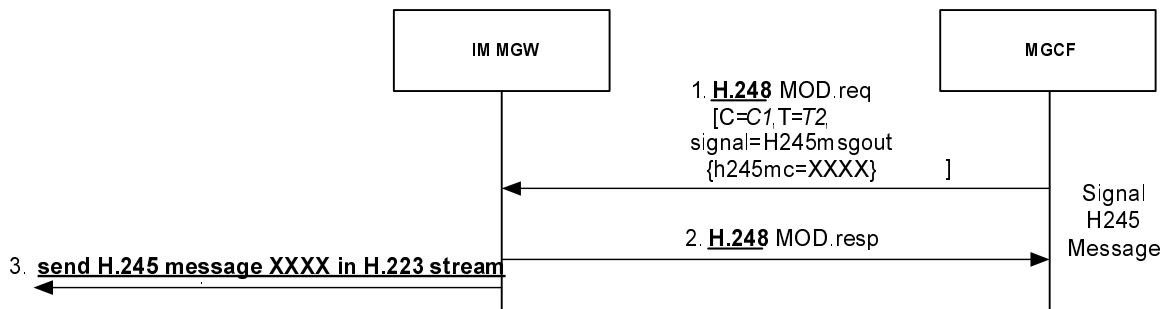

Figure E.4.2.3.2.1: Mn signalling interactions for sending H.245 message

In Signal 1, the MGCF requests the IM-MGW to send an H.245 message to the CS side. To request the IM-MGW to send a H.245 message to the CS side, the MGCF shall send an H.248 signal to the IM-MGW with the complete H.245 message content.

NOTE: In order for this command to succeed, Termination T1 towards the CS side needs to be configured. If a sending of an H.245 message and a removal of termination T1 is desired, the MGCF needs to apply signal 1 before removing T1.

Upon reception of this signal, the IM-MGW shall send the encapsulated H.245 message within the H.248 signal, through the H.245 control channel to the CS side (signal 3).

E.4.2.3.3 Transport from IM-MGW to MGCF

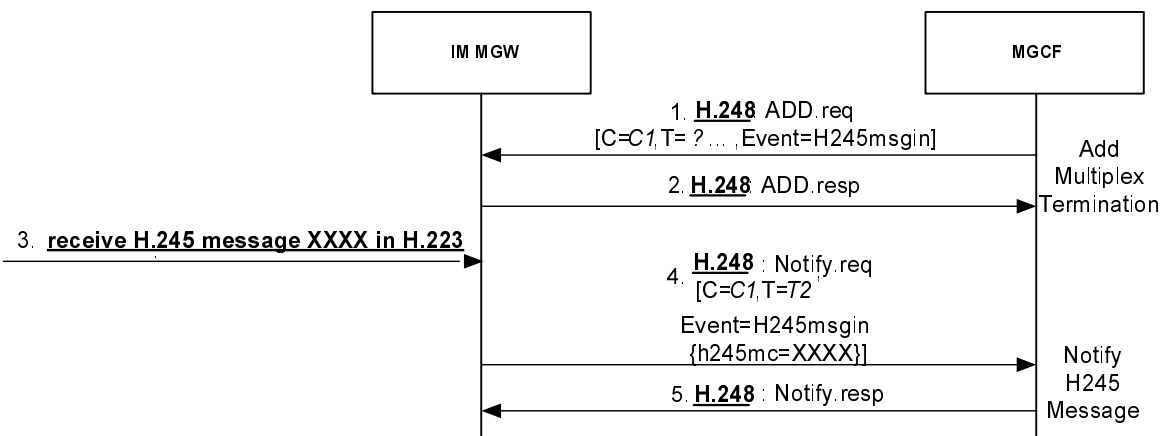

Figure E.4.2.3.3.1: Mn signalling interactions for receiving H.245 message

In signal 1, the MGCF requests the IM-MGW to detect received H.245 message from the CS side and forward them to the MGCF. To request the IM-MGW to detect and forward a H.245 message to the CS side, the MGCF shall send a suitable H.248 event to the IM-MGW. The event may be indicated through an H.248 ADD command.

In signal 3, the IM-MGW receives an H.245 message from the CS side. Upon reception of an H.245 message from the CS side, the IM-MGW shall de-multiplex the H.245 message from the H.223 stream and forward the H.245 message to the MGCF within an H.248 Notify command (signal 4).

E.4.2.4 Call establishment procedure

The following information shall be provided from the MGCF towards the IM-MGW:

- Properties to start H.223 Negotiation.
- Request for events for Notification of H.245 message received by the IM-MGW.
- Signals to provide H.245 messages that the IM-MGW shall send towards the CS side.

- Properties to provide incoming and outgoing H.223 multiplex table.
- Properties to provide H.223 logical channel parameters.
- Property to provide remote H.223 capabilities.

The Highest Multiplexing Level shall be predefined in the IM-MGW.

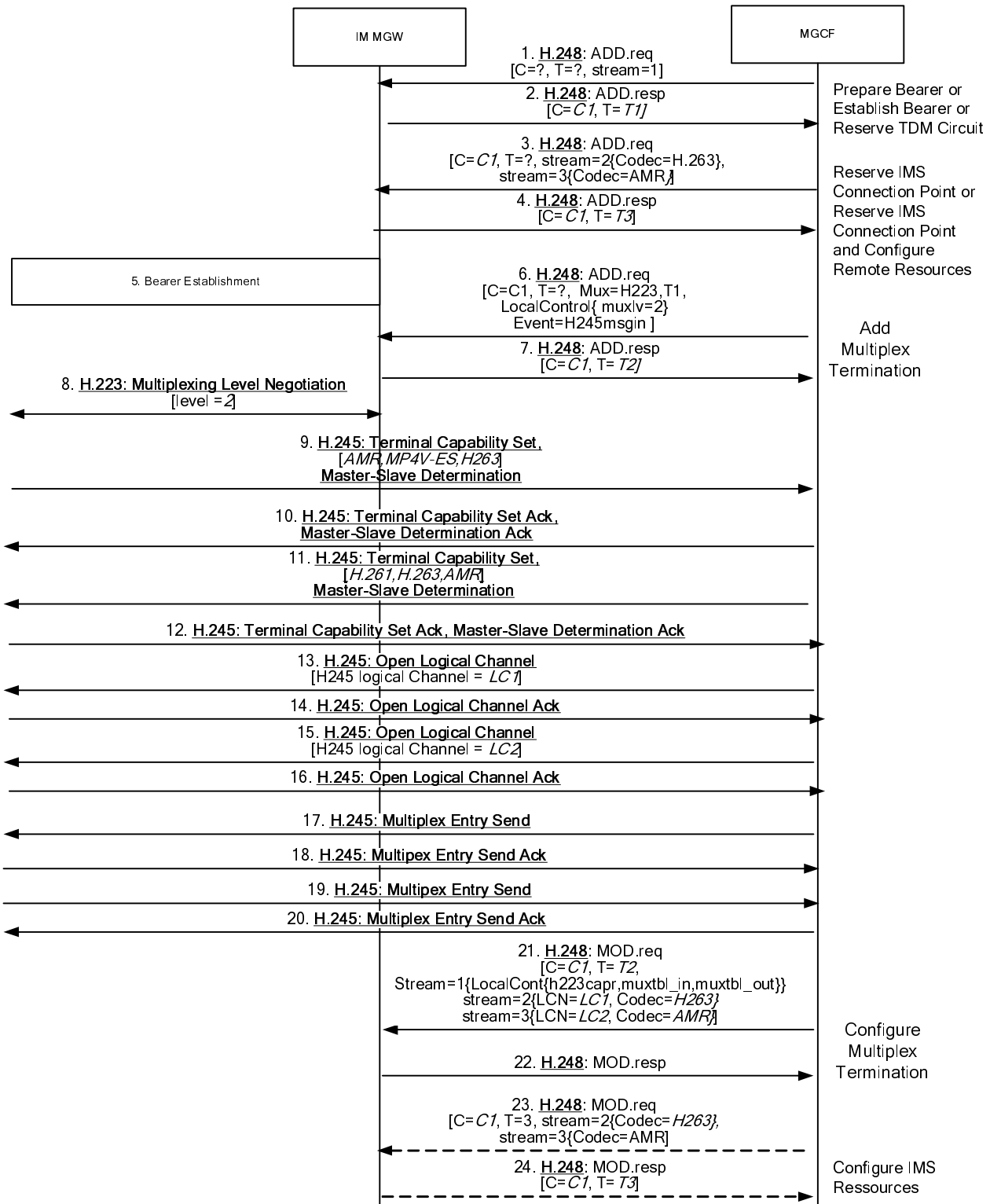

NOTE 1: All H.245 messages (from Signal 9 to Signal 18) are transported through the IM-MGW between the MGCF and the CS side, using the procedures described in clause E.4.2.3

NOTE 2: Signals 21 and 22 are omitted if the same codec information has already been provisioned in signal 3.

Figure E.4.2.4.1: Mn signalling interactions for H.245 termination at the MGCF

The MGCF shall request terminations towards the CS network (Signal 1 and 2) and towards the IMS (Signal 3 and 4). For the terminations towards the IMS, the MGCF provides an estimate about the applicable codecs in the required information elements "Local IMS Resources" (for both "Reserve IMS Connection Point" procedure and "Reserve IMS

Connection Point and Configure Remote Resources" procedure) and possibly "Remote IMS Resources" (only for "Reserve IMS Connection Point and Configure Remote Resources" procedure).

The MGCF shall request that the H.223 stream is (de-)multiplexed at the MUX termination T2, and that the H.245 control in H.223 Logical channel 0 is separated (signal 6). Furthermore, the MGCF shall request that the H.223 negotiation is started, and shall request to be notified about all H.245 messages received by the IM-MGW.

The IM-MGW shall start the H.223 Multiplexing Level Negotiation after receipt of the corresponding request from the MGCF and CS bearer establishment (Signal 8).

Upon reception of a H.245 Terminal Capability Set message (Signal 9), the MGCF sends a H.245 Acknowledgment message (Signal 10).

The MGCF shall know the H.324 related capabilities of the IM-MGW before starting the H.245 capability negotiation with the CS side, e.g. through configuration. The H.245 Terminal Capability Set message send by the MGCF (Signal 11) should include the codecs which are supported by both the IMS side and the IM-MGW, and the codecs which could be transcoded by the IM-MGW from the codecs supported by the IMS side.

The MGCF may defer sending the Terminal Capability Set message (Signal 11) for some time to wait for codec information from the CS peer's Terminal Capability Set message and perform a possible IMS-side codec re-negotiation. To avoid blocking situations, the MGCF shall not defer sending the signal for an excessive period of time.

To avoid the CS side selecting the codecs that need to be transcoded at the IM-MGW, the MGCF should aim to be the master in the H.245 master-slave determination procedure (Signals 9 to 12). The MGCF shall set the Terminal Type parameter as a number larger than 128 in the H.245 Master Slave Determination message. The H.245 master-slave determination procedure could be combined with the messages used for the H.245 capability exchange.

The codecs contained both in the sent and received terminal capability set message may be selected at the CS side. The final decision of the selected codecs at the CS side is taken with the H.245 open logical channel procedure (Signals 13 to 16).

After the completion of the H.245 multiplex table exchange procedure (Signals 17 to 20), the MGCF shall configure the multiplexing termination T2 by indicating to the IM-MGW the contents of the incoming and outgoing multiplex tables (Signal 21).

If codec information needs to be changed compared to what has been provisioned in signal 3, the MGCF shall also configure T3 with the appropriate video and/or speech codec(s) (signal 23).

The call is in the active state.

E.4.2.5 Handling of H.245 indication message

E.4.2.5.1 Overview

The MGCF shall support the following H.245 indication messages: Function Not Understood Indication / Function Not Supported Indication, Jitter Indication. The MGCF may support the H.245 User Input Indication message. All these H.245 messages are conveyed between the MGCF and the CS side through the IM-MGW, as described in clause E.4.2.3.

E.4.2.5.2 Function Not Understood / Function Not Supported message

This indication message is used to return requests, responses and commands that are not understood back to the transmitter.

If the MGCF receives a Function Not Understood or Function Not Supported message from the CS side, the MGCF may choose to attempt simpler H.245 interaction than the previous H.245 interaction that caused this indication. If this is not possible, the MGCF may release the call.

If the MGCF receives a H.245 request, response or command that can not be understood, the MGCF shall send H.245 Function Not Supported indication message to the CS side.

E.4.2.5.3 User Input Indication message

The User-Input-Indication message is used e.g. to transport the in-band DTMF information in the H.324 system.

The MGCF and IM-MGW may support transporting the DTMF information both from the CS side to the IMS side, and from the IMS side to the CS side.

Upon Receipt of a H.245 User-Input-Indication message, the MGCF may apply the procedures in clause 9.2.8.3 to request the IM-MGW to send corresponding RTP telephone-event(s) towards the IMS side.

Upon receipt of RTP telephone events from the IMS, the MGCF will be notified by the IM-MGW using the procedures in clause 9.2.8.1, if the MGCF has previously configured the IM-MGW as also described in this subclause. Upon receipt of the notification, the MGCF may send a H.245 User-Input-Indication message to the CS side.

E.4.2.6 Handling of H.245 Command message

E.4.2.6.1 Overview

The MGCF shall support the End Session command message. The MGCF may support the Flow Control command message and the videoFastUpdatePicture message. All these H.245 messages are conveyed between the MGCF and the CS side by the IM-MGW, as described in clause E.4.2.3.

E.4.2.6.2 Flow control command

The flow control command is used to restrict the upper limit of bit rate of either a single logical channel or the whole multiplex stream. The MGCF may support the flow control command received from the CS side.

NOTE: It is very unlikely that the MGCF will receive a Flow control command, as the capability of controlling the video bit rate during a video call was neither implemented nor tested for Ues offering 3G-324M since R99, due to the lack of such a necessity in WCDMA where a fixed 64 kbps bearer is maintained to continuously transport 3G-324M PDUs.

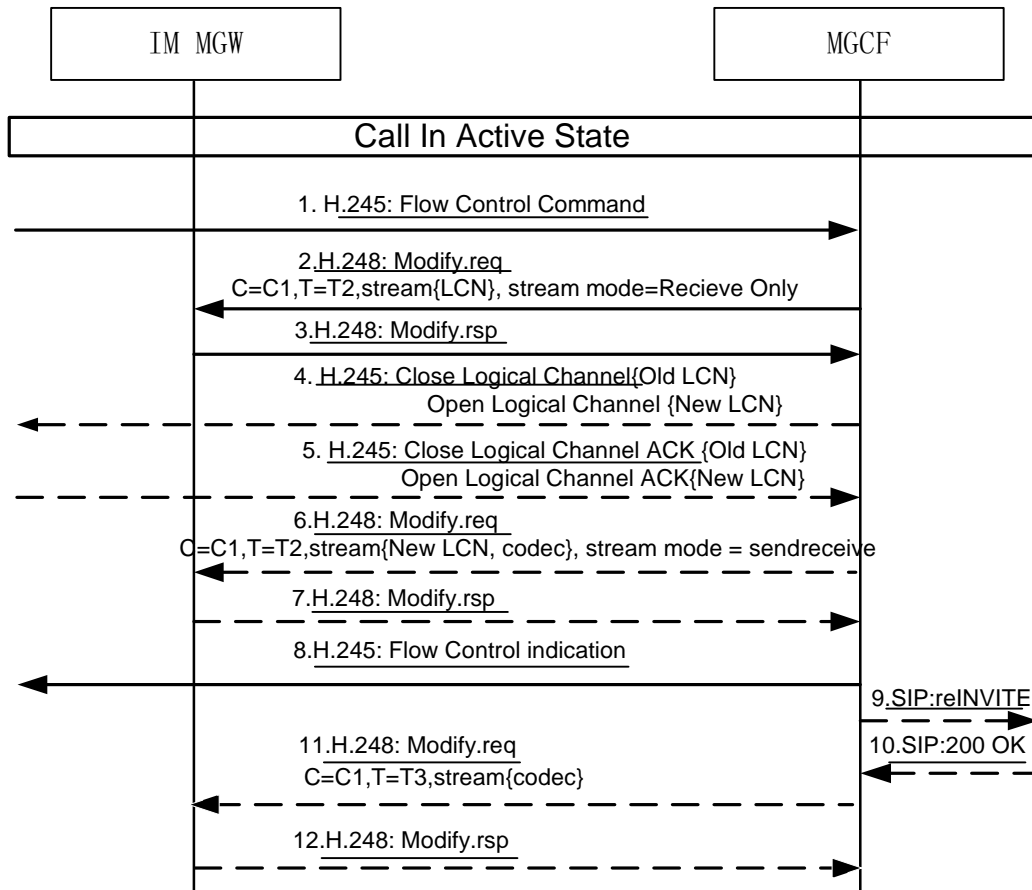

Figure E.4.2.6.2.1: Mn procedure of Flow control command

In Signal 1, the MGCF receives the Flow Control Command from the CS side.

If the minimum bitrate of the current codec is larger than the bitrate requested by the H.245 Flow Control Command message, the MGCF indicates the IM-MGW to stop the transmission of the media stream over the logical channel (signal 2). Then the MGCF may select another codec that can satisfy the requested bitrate limit. In signal 4, the MGCF closes the old logical channel and opens a new logical channel with new codec to satisfy the bitrate limit in the CS side. In signal 6, the MGCF indicates the IM-MGW to modify the LCN, codec and stream mode of the multiplexing termination. In signal 8, the MGCF sends flow control indication message to CS side with the current maximum bitrate. If the MGCF chooses to change the CS-side codec, the MGCF may also adjust the codec at the IMS side accordingly. To do so, the MGCF may need to re-negotiate the codec at the IMS side using a SIP re-INVITE message (signals 9 and 10). In addition, the MGCF may modify the codec of IMS termination accordingly (signal 11).

The MGCF may also apply interworking procedure towards RTCP at the IMS side as described in clause E.4.2.8 when receiving a H.245 Flow Control Command.

E.4.2.6.3 End Session Command

The end session command is used to close the H.245 control channel after all the logical channels have been closed.

The MGCF may send an end session command to the CS side through the IM-MGW to release a call.

If the MGCF receives an end session command from the CS side, it shall release the call if the call is in the active state.

E.4.2.6.4 videoFastUpdatePicture

The MGCF may apply interworking procedure towards RTCP as described in clause E.4.2.8 when receiving a H.245 videoFastUpdatePicture message. The MGCF may also be triggered by the procedures in clause E.4.2.8 to send a H.245 videoFastUpdatePicture message.

When receiving frequent H.245 videoFastUpdatePicture messages for a SCUDIF call (see 3GPP TS 23.172 [121]), an MGCF should initiate a service-change from multimedia to speech and remove the IMS MTSI video component with SIP/SDP signalling. When receiving frequent H.245 videoFastUpdatePicture messages for a non-SCUDIF call, an MGCF should disable the CS video and remove the IMS MTSI video component with SIP/SDP signalling.

NOTE: In a congestion situation at the IMS side, frequent packet losses might occur and dropping the video component may serve as a counter-measure to reduce the packet loss frequency. However, CS terminals might not be able to initiate such a switch-over to voice, but might rather react with repeated H.245 videoFastUpdatePicture message.

E.4.2.7 Mn Signalling Interactions to support the Media Oriented Negotiation Acceleration (MONA)

E.4.2.7.1 Overview

Media Oriented Negotiation Acceleration (MONA), as specified in ITU-T H.324[81] provides simplified procedures that allow for a faster call set-up of a H.324 Multimedia call than standard H.324 procedures, and also allow for a fallback to standard H.324 procedures if either party does not support the enhanced procedures.

The support of MONA is optional for an IM-MGW and MGCF supporting multimedia interworking, as no call failure but only a fallback to standard H.324 setup procedures will occur if the procedures are not supported.

MONA "preference message" signalling is used instead of H.324 Multiplexing level negotiation. Should standard H.324 Multiplexing level stuffing flags be received, a fallback to standard H.324 procedures is triggered. The sending of MONA preference messages is repeated by each MONA capable H.324 terminal until a reception is acknowledged by the peer. During this phase, two PDU types may optionally be attached by MONA terminals to these preference messages:

- Media Preconfigured Channel (MPC) PDUs: MONA defines a small number of preconfigured H.223 channels for the most widespread audio and video codecs (AMR, AMR-WB, H.264 MPEG4 and H.263). Media PDUs for these codecs may be attached to the MONA "preference message" during the call setup.
- Signalling Preconfigured Channel (SPC) PDUs: These PDUs are H.245 generic request messages with special parameters defined by MONA. These PDUs may also be attached to MONA preference messages.

According to MONA, each MONA capable terminal shall support at least one of these PDU types. The MONA capability of the IM-MGW can be audited by the MGCF.

The MONA preference message exchange in combination with attached MPC or SPC PDUs may result in the establishment of the desired media channels without further H.245 signalling. Otherwise, H.245 will be used after the MONA preference message exchange is acknowledged to negotiate media channels, but MONA defines some accelerated H.245 procedures (ACP) to speed up these H.245 procedures.

The design of Mn procedures to support MONA is guided by the following considerations:

- The H.245 handling should be performed in the MGCF to keep procedures aligned as far as possible with standard Mn procedures to support H.324 interworking.
- The MGCF should also control MONA preference message exchange procedures in order to maintain the agreed architectural work split between MGCF and IM-MGW in analogy to the H.245 handling.
- However, the IM-MGW needs to understand the MONA preference messages at least to a sufficient degree to de-encapsulate the possibly attached MPC and SBC PDUs.
- Furthermore, the frequent retransmissions of MONA preference messages required by MONA procedures are to be performed by the IM-MGW autonomously to avoid unnecessary load at the Mn interface and the MGCF.
- Furthermore, for resource reservation at the IM-MGW, it is assumed that the IM-MGW has knowledge about supported predefined Media Preconfigured Channel configurations as specified in clause K.9.2 of H.324 [81] in order to limit the amount of information transferred in the Mn interface when establishing MPC channels. The offered channel resources are reserved by the IM-MGW.

- In order to avoid increasing call establishment time when interworking with legacy terminals and at the same time avoid unnecessary load at the Mn interface, the MGCF may initiate both MONA and legacy H.245 procedures simultaneously in parallel. The MGCF shall in this case arm a legacy detection event with an embedded signal descriptor including the initial legacy H.245 message. The IM-MGW will only send the signal in case a fallback condition to legacy is detected.

Editor's note: It is FFS whether the mux-level-indication event can be used as a legacy detection event, and whether it is more feasible than the mechanism for legacy detection described.

E.4.2.7.2 Mn Interactions for MONA preference messages

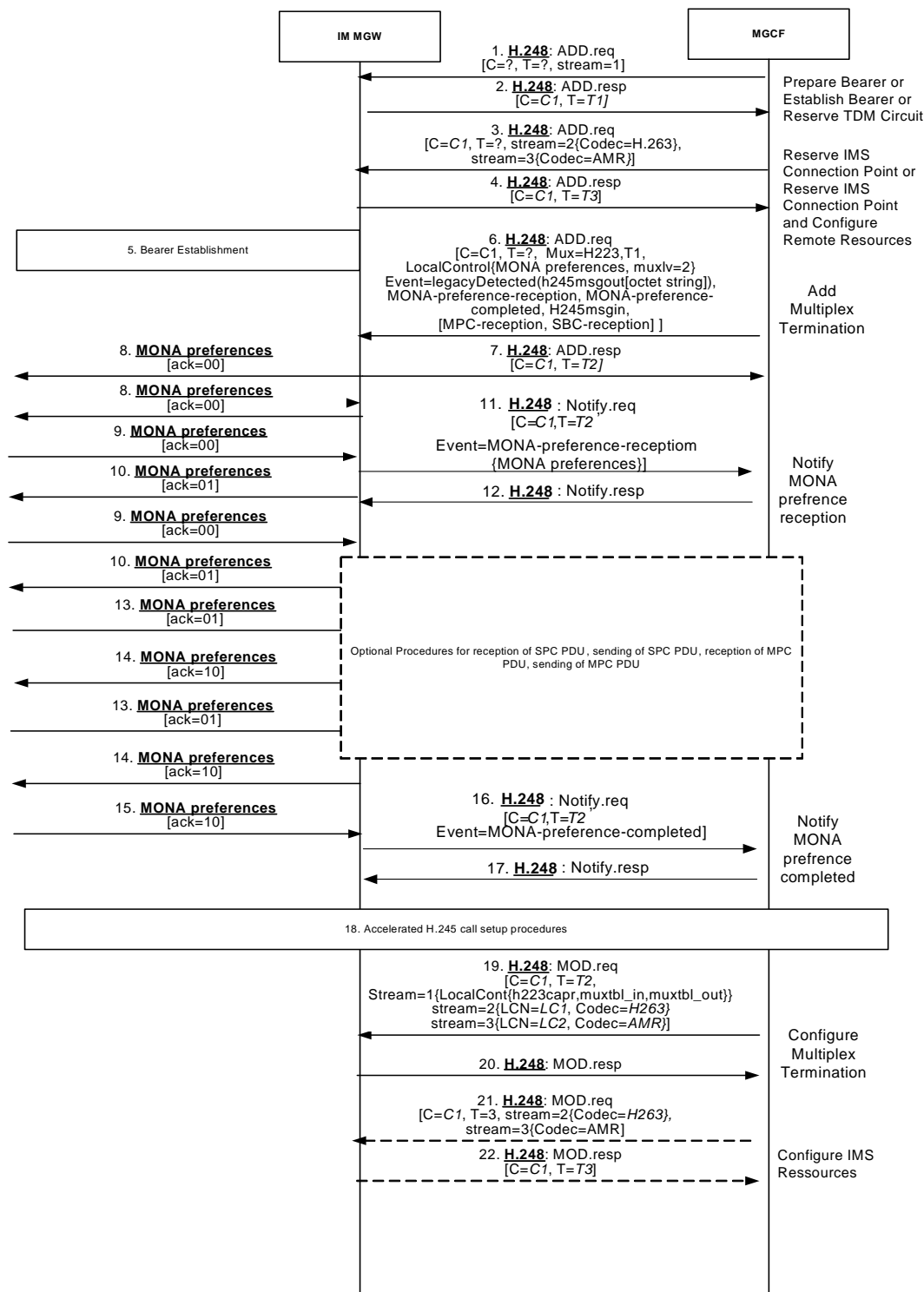

NOTE 1: MONA preference messages are repeated several times. One repetition is shown for each such message, with the same signal number as the first message.

NOTE 2: The Context model in figure E.4.2.2.1 is assumed in this call flow.

Figure E.4.2.7.2.1: Mn signalling interactions for MONA preference messages

The MGCF shall request terminations towards the CS network (Signal 1 and 2) and towards the IMS (Signal 3 and 4). For the terminations towards the IMS, the MGCF provides an estimate about the applicable codecs in the required information elements "Local IMS Resources" (for both "Reserve IMS Connection Point" procedure and "Reserve IMS

Connection Point and Configure Remote Resources" procedure) and possibly "Remote IMS Resources" (only for "Reserve IMS Connection Point and Configure Remote Resources" procedure).

The MGCF shall request that the H.223 stream is (de-)multiplexed at the MUX termination T2 (signal 6). Furthermore, the MGCF shall request that MONA preferences negotiation is started, and shall provision the MONA preferences to be indicated by the IM-MGW. The MGCF shall encode the MONA preferences as described in clause K.6 of ITU-T H.324 [81]. The MGCF shall take the H.324 related capabilities of the IM-MGW into account in the MONA preferences. The MGCF can know these capabilities by configuration. The IM-MGW will only support symmetric codec usage. If several codec alternatives are offered for MPC, it is the responsibility of the MGCF to ensure that symmetric codecs are established by not selecting transmit codec until the receive channel has been opened by MPC media. The MGCF shall also request to be notified about the reception of the remote MONA preferences and about the completion of the MONA preference exchange, or an H.245 message on the H.223 control channel. The MGCF may also initiate standard H.245 signalling in parallel in order to minimize the time for a legacy interworking fallback. This is done by arming a legacy detection event including an embedded signal descriptor. The embedded signal is the initial H.245 message out signal (including H.245 TCS+MSD) to send in case fallback to legacy interworking is detected. The IM-MGW will only send the embedded signal in case it detects H.223 related indications of a legacy interworking as specified in clause K.7.1.2 in H.324 [81]. Upon receiving the legacy detected event, the MGCF continues with standard H.245 call setup procedures waiting for the reception of a remote H.245 TCS as well as acknowledgements on the sent H.245 TCS+MSD. If the MGCF indicates the capability to receive SPC PDUs within the MONA preferences, it shall also request to be notified about incoming SPC PDUs, as detailed in clause E.4.2.7.4. If the MGCF indicates the capability to receive any MPC PDUs within the MONA preferences, it shall also request to be notified about incoming MPC PDUs, as detailed in clause E.4.2.7.3.

The IM-MGW shall start sending MONA preference messages after receipt of the corresponding request from the MGCF and CS bearer establishment (Signal 8). The IM-MGW shall repeat sending those messages and increment the acknowledgment bits of sent MONA preference messages when receiving incoming MONA preference messages according to MONA procedures (signals 8, 10, 14).

After sending at least 10 MONA preference messages, while the IM-MGW continues to send and receive MONA preference messages, it shall attach MPC or SPC PDUs if requested to do so by the MGCF as described in clauses E.4.2.7.3 and E.4.2.7.4, respectively. If the IM-MGW receives preference messages with an attachment, it shall inspect the first octet of that attachment that will contain a MUX code according to table K.15 of ITU-T H.324 [81] that identifies the attached PDU as either a MPC PDU of one of the predefined channels or a SPC PDU. The IM-MGW shall handle the attached MPC or SPC PDUs as described in clause E.4.2.7.3 and E.4.2.7.4, respectively.

After sending at least 10 MONA preference messages, the IM-MGW should insert stuffing flags indicating the multiplexing level received from the MGCF between MONA preference messages as described in clause K.7.1.1 of ITU-T H.324 [81].

The IM-MGW shall notify the MGCF when receiving the first incoming MONA preference message (Signals 11 and 12) and forward the received information. Subsequent incoming MONA preference message will be identical apart from possible increments in the acknowledgement bits. The IM-MGW shall not notify the MGCF about these messages. Upon reception of the notification of a MONA preference message, the MGCF shall compare the received MONA preferences message with the preferences message it sent and react as described in clause 7.1 of ITU-T H.324 [81].

When receiving an incoming MONA preference message with acknowledgment bits 10 or receiving the first non-empty H.223 MUX PDU, the IM-MGW shall notify the MGCF about the completion of the MONA preference exchange procedure (signals 16 and 17). The notification shall be only triggered by the one of the two events which occurs first. If the IM-MGW is not configured to send and detect SPCs, the IM-MGW shall then stop sending MONA preference messages and, if a MONA preference message with acknowledgment bits 10 has been received, it shall also stop receiving MONA preference messages. If the IM-MGW is configured to send and detect SPCs, the IM-MGW shall continue sending and receiving MONA Preference messages encapsulating the SPC/MOS messages until the MGCF configures the IM-MGW stop sending and detecting SPCs.

NOTE: In the unlikely case that a first non-empty H.223 MUX-PDU is received before the first MONA Preference Message has been received, the IM-MGW will continue the detection of incoming MONA Preference Messages and will apply the Notify-MONA-preference-Reception-procedure after the Notify-MONA-preference-completed procedure.

After receiving the notification about the completion of the MONA preference exchange procedure, and a completion of the possible subsequent accelerated H.245 setup procedures, the MGCF shall configure the multiplexing termination T2 by indicating to the IM-MGW the contents of the incoming and outgoing multiplex tables (Signal 19), and may modify the selected codecs at both the MUX and the IMS side (signal 21).

E.4.2.7.3 Mn Interactions for MONA MPCs

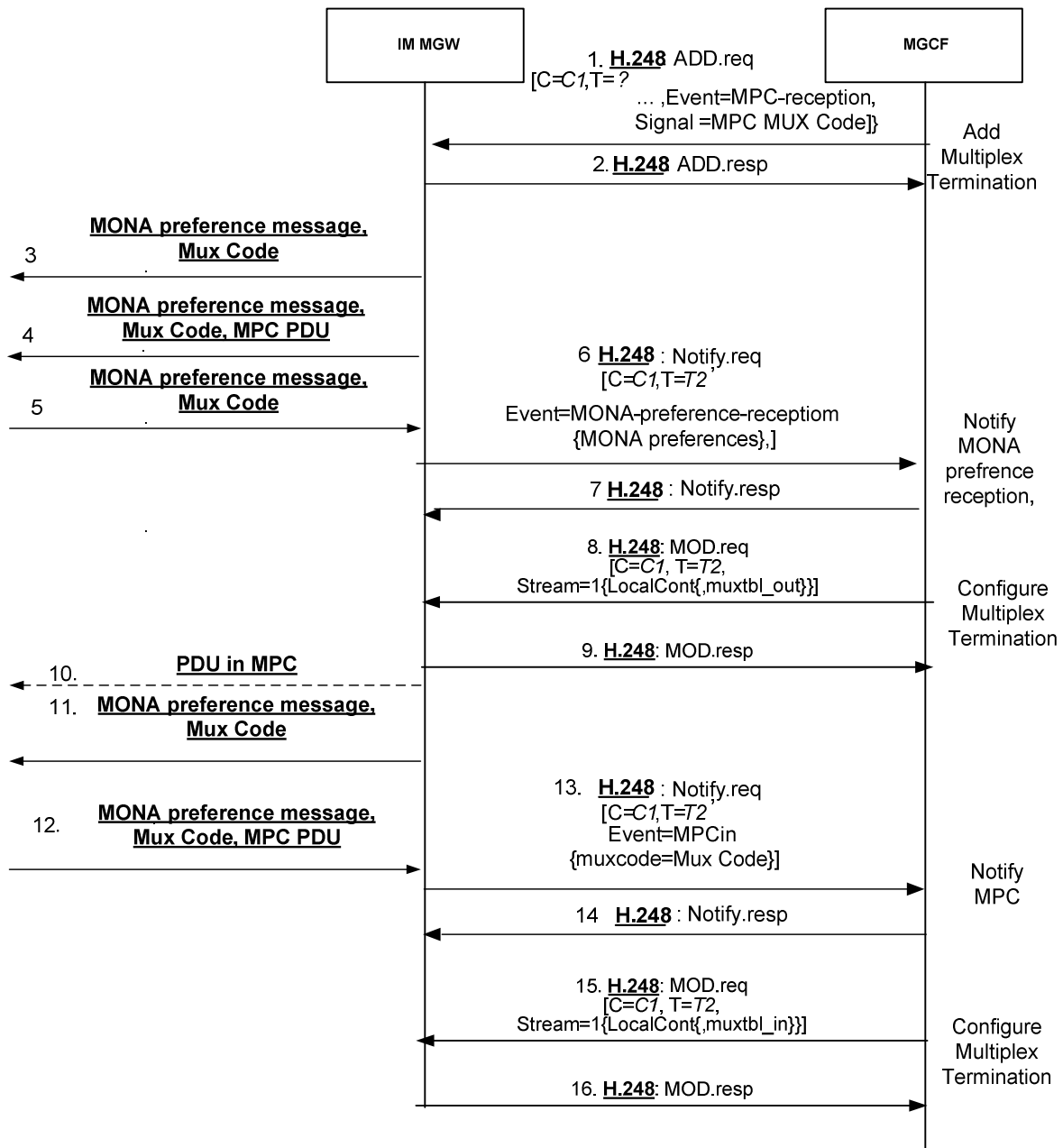

NOTE 1: MONA preference messages are repeated several times. One repetition is shown for each such message, with the same signal number as the first message.

NOTE 2: The Context model in figure E.4.2.2.1 is assumed in this call flow.

Figure E.4.2.7.3.1: Mn interactions for MONA MPCs

If the MGCF indicates the ability to receive any predefined MPCs channel types in the MONA preferences messages, the MGCF shall request the IM-MGW to report the channel type of received MPC PDUs (Signal 1 in figure E.4.2.7.3.1, Event "MPC Reception").

If the MGCF intends to use MPCs for sending media during the MONA setup, the MGCF shall request the IM-MGW to send available media encoded according to the media predefined channel types defined by MONA (signal 1 in figure E.4.2.7.3.1, Signal "MPC MUX Code") while the MONA preference exchange described in clause E.4.2.7.2 is ongoing. The MGCF should select channel types for codecs which are supported by both the IMS side and the IM-

MGW, and/or for codecs which could be transcoded by the IM-MGW from the codecs supported by the IMS side. The MGCF shall only include one channel type per each desired media type (audio, video) in the "MPC MUX Code" signal. The MGCF may also configure the MGW to receive these channels at the same time by supplying the Incoming Multiplex Table IE in the Add Multiplex Termination Procedure.

Upon reception of this request, the IM-MGW shall forward any media received from the IMS side in MPC PDUs of the corresponding predefined channel type attached to MONA preference messages, transcoding the media if required (Signal 4).

According to the procedures in clause E.4.2.7.2, the IM-MGW will notify the MGCF (signal 6) when receiving the first incoming MONA preference message (Signals 5). The MGCF shall then analyse the Media Preconfigured Channel Receive bits within the MONA preference message and configure the MGW accordingly:

- If MPC(s) that the MGCF has previously configured within the "MPC MUX Code" signal are supported according to these bits, the MGCF shall configure the IM-MGW to send these MPC using the predefined channels (signal 10) by supplying the corresponding Outgoing Multiplex Table in the Configure Multiplex Termination procedure (signal 8).
- If some of the MPC(s) that the MGCF has previously configured within the "MPC MUX Code" signal are not supported according to these bits, the MGCF shall configure the IM-MGW to terminate the media on those MPC(s) by modifying the MPC Mux Code signal using the Configure Multiplex Termination procedure. In addition, the MGCF may configure the IM-MGW to send media on other supported MPC(s) by supplying the corresponding Outgoing Multiplex Table in the Configure Multiplex Termination procedure (not shown in figure E.4.2.7.3.1).
- If all of the MPC(s) that the MGCF has previously configured within the "MPC MUX Code" signal are not supported according to these bits, the MGCF shall configure the IM-MGW to terminate MPC operations in those unsupported channels. The MGCF shall either remove the MPC Mux Code signal using the Stop MPC procedure or configure the IM-MGW to send media on other supported MPC(s) by supplying the corresponding Outgoing Multiplex Table in the Configure Multiplex Termination procedure (not shown in figure E.4.2.7.3.1).

When the MGCF provides an Outgoing Multiplex Table, the IM-MGW shall terminate sending any MPC PDUs as attachments to MONA preference message.

NOTE: Any previously provisioned "MPC MUX Code" signal becomes irrelevant.

When being notified about the receipt of the first incoming MONA preference message, the MGCF may also analyse the Media Preconfigured Channel Receive bits within the MONA preference message and configure the MGW with a suitable Incoming Multiplex Table using the Configure Multiplex Termination procedure (not shown in figure E.4.2.7.3.1).

If the IM-MGW receives the first MONA preference message with attached MPC PDU of a given predefined channel type (signal 12), or if the IM-MGW receives the first non-empty H.223 MUX PDU of a given predefined channel type which has been configured with the Incoming Multiplex Table, and the MGCF has requested a notification about such an event, the IM-MGW shall notify the MGCF about the received channel type (signal 13). The IM-MGW shall not notify the MGCF about subsequent receptions of MPC PDUs of the same channel type.

Upon reception of such a notification, if the IM-MGW supports the indicated channel type and has not yet been configured to receive media of that channel type, and if the MGCF has previously indicated the capability to receive MPCs of that channel type within MONA preference messages, the MGCF shall configure the IM-MGW to receive media of that channel type and forward them to the IMS side by supplying the Incoming Multiplex Table IE in the Configure Multiplex Termination procedure (Signal 15).

If the MGCF determines (e.g. after receipt of signal 5 or signal 12) that some desired media channels can not be established using the MPC procedures, the MGCF should use accelerated H.245 procedures as defined by MONA to set up media channels. Corresponding H.245 messages shall be transported transparently between the IM-MGW and the MGCF using the "Signal H.245 message" and "Notify H.245 message" procedures.

The MGCF can receive a forwarded MONA preference message from the IM-MGW when the MGCF has already configured the IM-MGW to send media on an MPC. If the processing of this message in the MGCF leads to the conclusion that MPC procedures need to be aborted because SPC preferred (SPP) is determined, the MGCF shall configure the IM-MGW to terminate MPC operations by removing the MPC related event MPC-reception and MPC Mux Code signal using the Stop MPC procedure.

E.4.2.7.4 Mn Interactions for MONA SPCs

E.4.2.7.4.1 General

H.245 PDUs for SPC shall be transported between the IM-MGW and MGCF over the Mn interface using H.248 Events (from the IM-MGW towards the MGCF) and H.248 Signals (from the MGCF towards the IM-MGW). The Events/Signals shall contain the following information:

- H.245 message (binary).

The related procedures are distinct from the procedures in clause E.4.2.3, since the PDUs are received or sent by the IM-MGW using the SPC, i.e. as attachment to MONA preference messages.

If the MGCF supports SPCs, it shall comply with the SPC procedures in clause K.8 of ITU-T H.324 [81]. The repetition of sending the same SPCs will be handled by the IM-MGW. When the MGCF receives an acknowledgement from the CS side it shall request the IM-MGW to stop the repetition sending of the SPCs,

Within the sent SPC PDUs, the MGCF should include the codecs which are supported by both the IMS side and the IM-MGW, and the codecs which could be transcoded by the IM-MGW from the codecs supported by the IMS side.

E.4.2.7.4.2 Transport from MGCF to IM-MGW

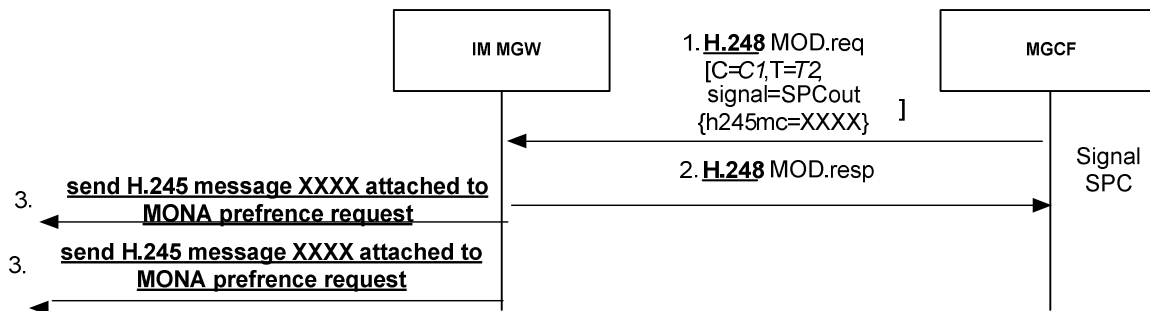

NOTE 1: MONA preference messages are repeated several times. One repetition is shown for each such message, with the same signal number as the first message.

NOTE 2: The Context model in figure E.4.2.2.1 is assumed in this call flow.

Figure E.4.2.7.4.2.1: Mn interactions for sending MONA SPCs

In Signal 1, the MGCF requests the IM-MGW to send an H.245 message to the CS side. To request the IM-MGW to send a H.245 message to the CS side, the MGCF shall send an H.248 signal to the IM-MGW with the complete H.245 message content.

Upon reception of this signal, the IM-MGW shall send the encapsulated H.245 message within the H.248 signal, as attachment to a MONA preference message as described in clause K.9.4 of ITU-T H.324 [81] (signal 3). It should repeat sending this H.245 message as attachment to subsequent MONA preference messages.

E.4.2.7.4.3 Transport from IM-MGW to MGCF

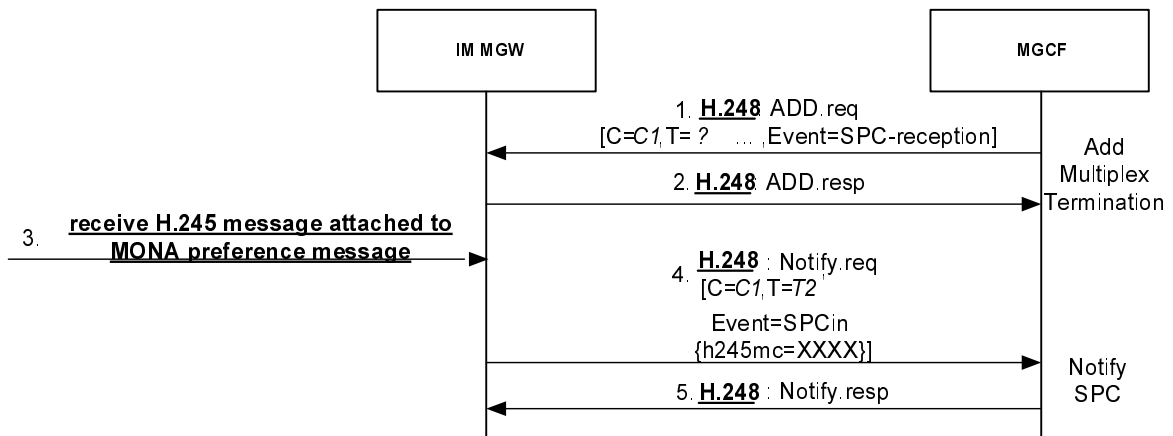

NOTE 1: MONA preference messages are repeated several times. One repetition is shown for each such message, with the same signal number as the first message.
 NOTE 2: The Context model in figure E.4.2.2.1 is assumed in this call flow.

Figure E.4.2.7.4.3.1: Mn interactions for receiving MONA SPCs

In signal 1, the MGCF requests the IM-MGW to detect received H.245 message from the CS side in SPC PDUs attached to MONA preference messages and forward them to the MGCF. To request the IM-MGW to detect and forward these H.245 message, the MGCF shall send a suitable H.248 event to the IM-MGW. The event may be indicated through an H.248 ADD command.

In signal 3, the IM-MGW receives an H.245 message from the CS side attached as SPC PDU to a MONA preference message. Upon reception of such an H.245 message from the CS side, the IM-MGW may check, based on bitwise comparison of the previously received H.245 message, if it has already forwarded the same H.245 message to the MGCF, in which case the IM-MGW may choose not to forward the same H.245 message to the MGCF. Otherwise the IM-MGW shall forward the H.245 message to the MGCF within an H.248 Notify command (signal 4).

NOTE: According to H.324 [81] a MOS request Ack message shall be sent to every received MOS request. If the IM-MGW chooses, based on the bitwise comparison, not to forward the received H.245 message to the MGCF, no MOS request Ack message will be generated. However, the MGCF will request the IM-MGW to automatically retransmit the MOS request Ack message generated by the MGCF itself.

If the IM-MGW does not support forwarding SPC PDUs or has not been requested by the MGCF to forward these PDUs, it shall discard received SPC PDUs.

E.4.2.7.4.4 Termination of SPC procedure

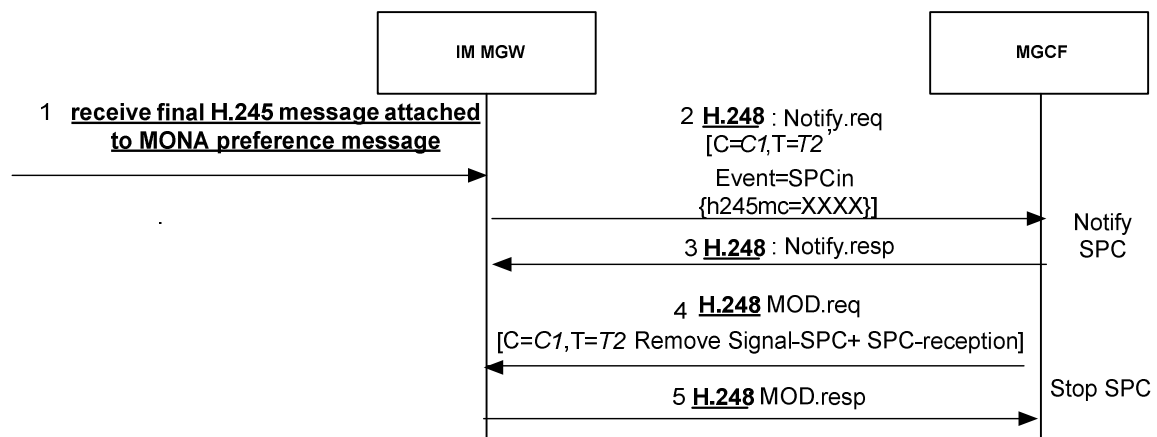

NOTE 2: The Context model in figure E.4.2.2.1 is assumed in this call flow.

Figure E.4.2.7.4.4.1: Mn interactions for terminating SPC procedure

If the processing of an incoming MONA Preference Message in the MGCF leads to the conclusion that SPC procedures need to be aborted as a result of the test of the SPC bits, the MGCF shall configure the IM-MGW to terminate SPC operations by removing the SPC related event SPC-reception and SPCout signal using the Stop SPC procedure. In this case, H.245 signalling may be started simultaneously.

If the MGCF determines the completion of the SPC procedures according to clause K.8 of ITU-T H.324 [81] (based on incoming signal 1 in figure E.4.2.7.4.4.1), the MGCF shall configure the IM-MGW to stop sending and detecting SPCs (signal 4 in figure E.4.2.7.4.4.1).

E.4.2.7.5 Mn Interactions for fallback from MONA procedures to standard H.324 setup

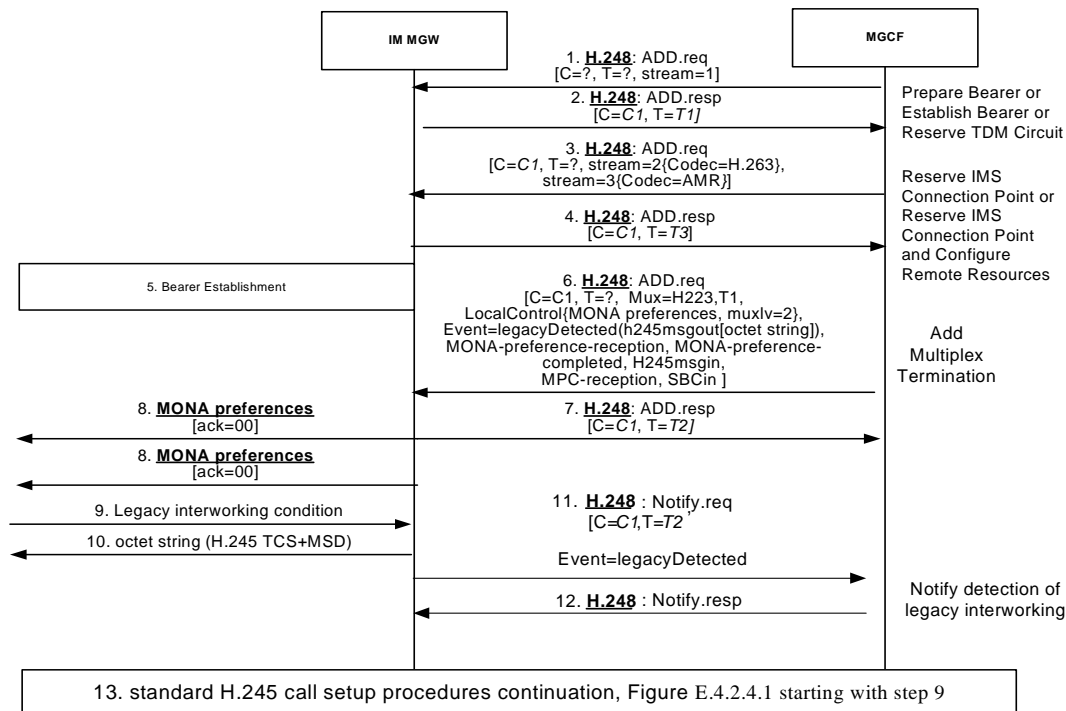

NOTE 1: MONA preference messages are repeated several times. One repetition is shown for each such message, with the same signal number as the first message.

NOTE 2: The Context model in figure E.4.2.2.1 is assumed in this call flow.

Figure E.4.2.7.5.1: Mn signalling interactions for fallback from MONA procedures to standard H.324 setup

When the MGCF requests that the MONA preferences negotiation is started, the MGCF may also initiate standard H.245 signalling towards the IM-MGW that shall only be sent in case the IM-MGW detects legacy interworking. The MGCF arms an event to detect legacy interworking with an embedded signal descriptor including an H.245 message out signal. The embedded H.245 signal is the initial H.245 TCS+MSD signal to send in case fallback to legacy interworking is detected. The MGCF shall also request to be notified about a H.245 message on the H.223 control channel. The MGCF shall also provision a multiplexing level which will be advertised by the IM-MGW (Signal 6).

If the IM-MGW detects a legacy interworking condition (signal 9), it shall stop sending MONA preference messages, including those MONA messages used to encapsulate MPC or SPC. The IM-MGW shall engage in normal H.324 multiplexing level negotiations. In case the MGCF armed a legacy detection event, the embedded H.245 signal shall be sent by the IM-MGW (signal 10). The legacy detection event is sent to the MGCF (signal 11).

The MGCF shall upon detection of legacy interworking stop MONA procedures and continue with standard H.245 call set up procedures, as depicted in figure E.4.2.4.1 starting with step 9.

If the IM-MGW receives a normal H.245 message (not depicted), it shall also forward this message to the MGCF. If the MGCF receives such a H.245 message during the MONA call setup, and this H.245 message is a normal Terminal

Capability Set message, the MGCF shall also stop MONA procedures and continue with standard H.245 call set up procedures, as depicted in figure E.4.2.4.1 starting with step 9.

To stop MONA related procedures at the IM-MGW, the MGCF shall remove the MONA related signals that were active (MONA Preferences, SPCout, MPC Mux Code; note that MONA Preference and SPCout causes the MGW to send the MONA Preference message or the contained H.245 message several times) and events (MonaPreferenceReception, MonaPreferenceCompleted, SPC-reception and MPC-reception, using the Stop MONA Negotiation procedure.

E.4.2.8 Interworking between RTCP messages and H.245 messages

E.4.2.8.1 Overview

The following clauses describe the interworking procedures between the RTCP messages listed in table E.4.2.8.1.1, which are used to enhance the quality of the media distribution by MTSI terminals at the IMS side, and the corresponding H.245 messages in 3G-324M at the CS side listed in table E.4.2.8.1.1.

As the H.245 protocol is terminated at the MGCF and RTCP is received at the IM-MGW, Mn procedures to support the transfer of RTCP related information are defined in the following Clauses to support this interworking.

Table E.4.2.8.1.1: RTCP and H.245 messages that may be interworked

RTCP Messages	H.245 messages	Remarks
Picture Loss Indication (PLI) ([109])	VideoFastUpdatePicture	
Temporary Maximum Media Stream Bit Rate Request (TMMBR) ([110])	Flow Control Command/ Flow Control Indication	This interworking procedure is not recommended. The reception of TMMBR at the IMS side is expected to be more frequent than the reception of Flow Control Command at the CS side.

NOTE 1: It is very unlikely that the MGCF will receive a Flow control command, as the capability of controlling the video bit rate during a video call was neither implemented nor tested for Ues offering 3G-324M since R99, due to the lack of such a necessity in WCDMA where a fixed 64 kbps bearer is maintained to continuously transport 3G-324M PDUs.

NOTE 2: Terminals are expected to support receiving the FlowControlCommand, as this is a mandatory feature in clause 6.4.3 in H.324. But most terminals would not really follow the received FlowControlCommand, but rather ignore it. However, for older 3G-324M terminal lock-up or system crash was not uncommon during IOTs. Therefore safe handling of this command is not guaranteed absolutely

The interworking shown in table E.4.2.8.1.1 is only applicable if video is relayed without transcoding.

If transcoding is applied, the IM-MGW should adopt its transcoder accordingly if receiving the RTCP messages listed in table E.4.2.8.1.1, and the MGCF should configure the transcoder in the IM-MGW accordingly if it receives the H.245 messages in table E.4.2.8.1.1.

For an MGCF and IM-MGW that support video interworking as specified in the present Annex E, the support of the procedures in the present clause E.4.2.8.2 and E.4.2.8.3 is optional.

E.4.2.8.2 IM CN subsystem originated RTCP messages

The MGCF may configure the IM-MGW to detect specific received RTCP packets and forward information derived from it by providing a bit pattern(s) for bits 3-15 of incoming RTCP packets as filter criterion in an event descriptor of event "RTCP-interworking". Bits 3-7 in the RTCP packet represent the Feedback message type (FMT), and bits 8-15 in the RTCP packet represent the Payload type (PT) RTCP header fields, see IETF RFC 4585 [109]. For instance, to request that an AVPF Picture Loss Indication (PLI) packet is detected for interworking, the MGCF needs to configure a combination of PT=206 (Payload-specific FB message) and FMT=1 (see IETF RFC 4585 [109]). To request that a AVPF Temporary Maximum Media Bit-rate Request (TMMBR) packet is detected for interworking, the MGCF needs to configure a combination of PT=205 (transport layer feedback message) and FMT=3 (see IETF RFC 5104 [110]).

A IM-MGW configured in this way shall check after receiving an incoming RTCP Packet if it is of a desired type, as expressed by a bit pattern received from the MGCF. An incoming RTCP message can be of compound format and contain several RTCP packets. The IM-MGW shall then perform the check separately for each packet. If the IM-MGW determines that the received RTCP packet is of a desired type, the IM-MGW shall send information derived from the RTCP message as ObservedEventsDescriptor Parameter(s) of event "RTCP-interworking" in an H.248 "Notify" message to the MGCF.

The information derived from the RTCP message to be sent to the MGCF is listed in table E.4.2.8.2.1. Information elements in table E.4.2.8.2.1 shall only be sent if the corresponding RTCP message has been received.

Table E.4.2.8.2.1: RTCP information elements to be notified over Mn

RTCP message	Information elements transported over Mn interface	Remarks
Picture Loss Indication (PLI) ([109])	UpdatePicture	
Temporary Maximum Media Stream Bit Rate Request (TMMBR) ([110])	MaxBitRate	This information indicates the maximum media stream bit rate as received within the TMMBR.

Figure E.4.2.8.2.2.1 shows examples of interactions between RTCP and H.245 for IM CN subsystem originated feedback on the quality of the media distribution.

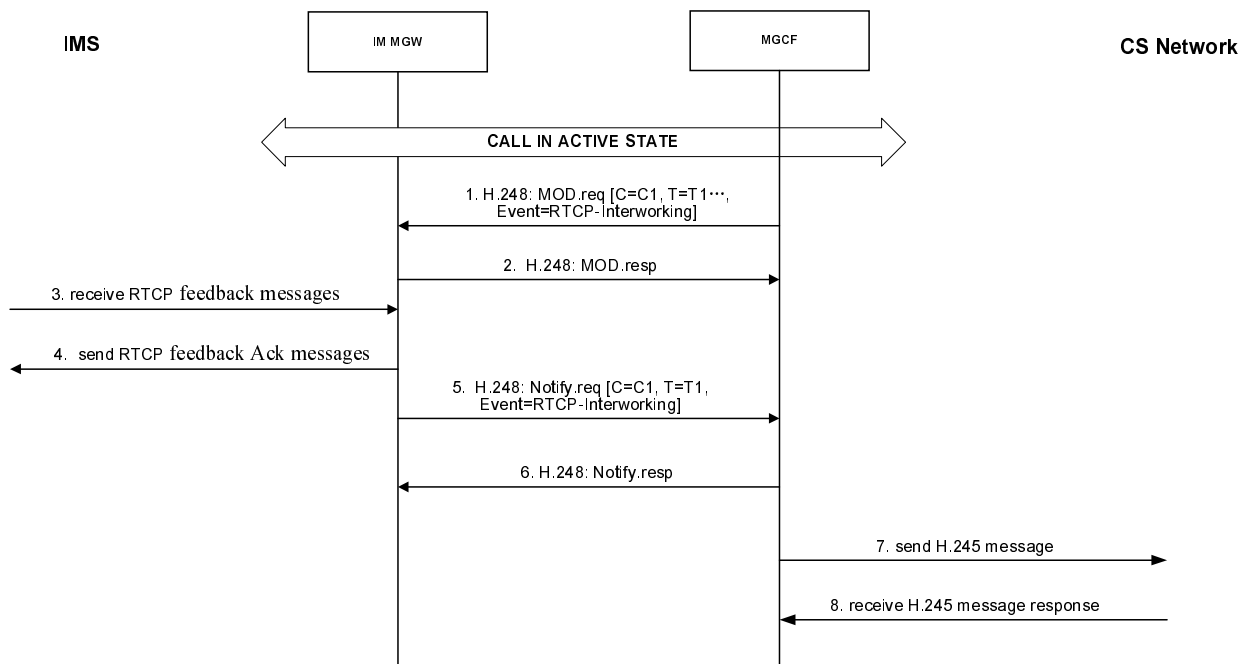

Figure E.4.2.8.2.2.1: Interactions between RTCP and H.245 for IM CN subsystem originated RTCP feedback on the quality of the media distribution

In signal 1, the MGCF requests the IM-MGW to detect received RTCP feedback message from the IMS side and notify the feedback information elements to the MGCF when the interworking is required. To request the IM-MGW to detect and notify these feedback information elements, the MGCF shall send the "RTCP-interworking" H.248 event to the IM-MGW. The event may be indicated through an H.248 MOD command.

In signal 3, the IM-MGW receives a RTCP feedback message from the IMS side.

In signal 5, the IM-MGW notifies the feedback information elements from RTCP message to the MGCF.

In signal 7, the MGCF send the corresponding H.245 message to the CS side to request for the media adaption.

E.4.2.8.3 CS network originated H.245 messages

Figure E.4.2.8.3.2.1 shows examples of interactions between H.245 and RTCP for CS network originated feedback on the quality of the media distribution.

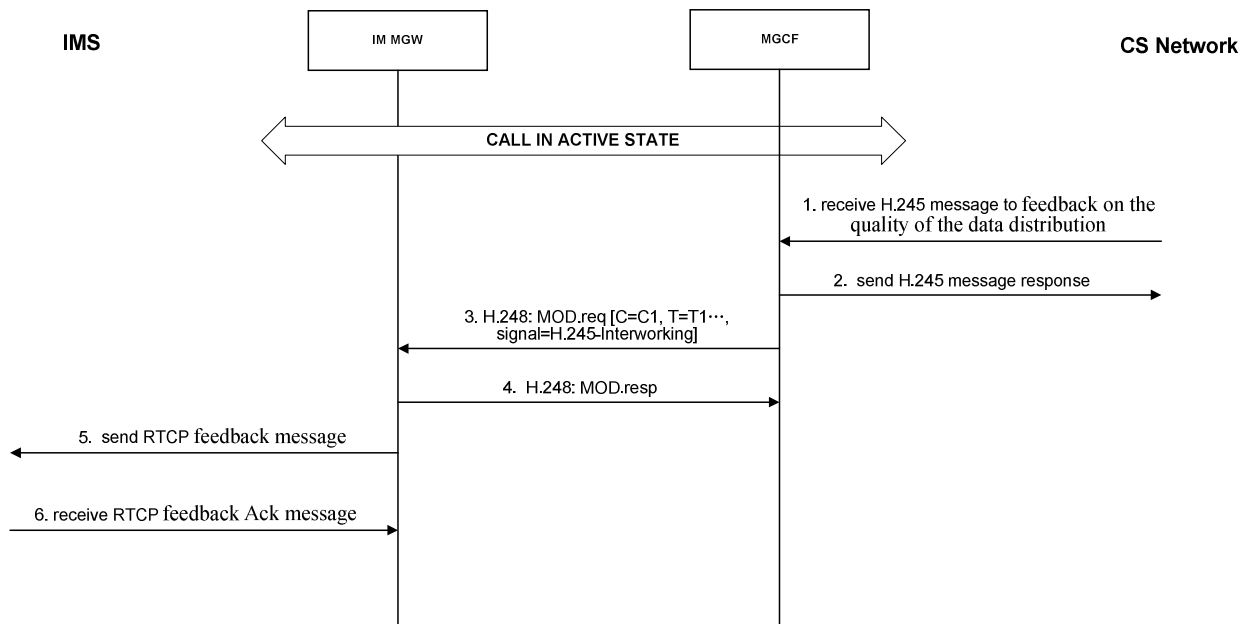

Figure E.4.2.8.3.2.1: Interactions between H.245 and RTCP for CS network originated H.245 feedback on the quality of the media distribution

In signal 1, the MGCF receives an H.245 feedback message from the CS side.

In signal3, the MGCF requests the IM_MGW to send an RTCP message provisioning the signal "H.245 interworking" with parameters identifying information to be transported within this RTCP message.

In signal5, the IM-MGW send the corresponding RTCP message to the IMS side to request for the media adaption.

To request the IM-MGW to send an RTCP message, the MGCF shall send the corresponding information elements listed in table E.4.2.8.3.2.1 as parameters of the "H.245-interworking signal" over the Mn interface.

Table E.4.2.8.3.2.1: Feedback information elements to be indicated

RTCP message	Information elements transported over Mn interface	Remarks
Picture Loss Indication (PLI) ([109])	UpdatePicture	
Temporary Maximum Media Stream Bit Rate Request (TMMBR) ([110])	MaxBitRate	This information indicates the maximum media stream bit rate to be sent within the TMMBR.

E.4.3 Mn Signalling procedures

E.4.3.1 Overview

This clause describes the logical signalling procedures (i.e. message identifiers are not part of the protocol) between the MGCF and IM-MGW. The procedures within this clause are intended to be implemented using the standard H.248 procedure as defined in ITU recommendation H.248.1 [2] with appropriate parameter combinations.

E.4.3.2 Add Multiplex Termination

This procedure is used to add a termination to multiplex/demultiplex H.223. This procedure containing the MuxDescriptor with H.223 value enables the IM-MGW to start the H.324 Multiplexing Level Negotiation.

Table E.4.3.2.1: Add Multiplex Termination Procedure

Procedure	Initiated	Information element name	Information element required	Information element description
Add Multiplex Termination	MGCF	Context	M	This information element indicates the existing context.
		Termination	M	This information element requests a new termination
		MuxDescriptor	M	This information element indicates that data multiplexed according to H223 shall be received, and from which termination.
		Notify Termination Heartbeat	M	This information element requests termination heartbeat indications
		Notify Released Bearer	O	This information element requests a notification of a released bearer.
		Incoming H.245 message Notification Request	M	This Event shall indicate that a Notification about H.245 messages received by the IM-MGW is requested by the MGCF
		MONA Preferences	O	This information element requests the MGW to start a MONA negotiation and provisions MONA preferences to be indicated by the IM-MGW, encoded as described in clause K.6 of ITU-T H.324 [81]
		MONA Preference Reception	O	This information element requests a notification of the reception of the first MONA preference message.
		MONA Preference Completed	O	This information element requests a notification of the reception of the first MONA preference message with indication that the MONA preference negotiation is completed.
		Legacy Detected	O	This information element requests a notification of a legacy interworking condition. The Event Descriptor also embeds a signal descriptor including an H.245 message out signal which shall be send when legacy interworking is detected
		MPC Reception	O	This information element requests a notification of the reception of the first MONA preference message with attached MPC.
		SPC Reception	O	This information element requests a notification of the reception of a MONA preference message with attached SPC.
		Incoming Multiplex Table	O	This information element indicates the value of the H245 MultiplexEntrySend message and allows the MGW to identify incoming H.223 MUX PDUs of the channel types given in the table.
MPC Mux Code	O	This information element requests the MGW to send available media in MPCs and indicates the channel type to use for sending media.		
Add Multiplex Termination Ack	IM-MGW	Context	M	This information element indicates the context where the command was executed.
		Termination	M	This information element indicates the new termination where the command was executed.

E.4.3.3 Configure Multiplex Termination

This procedure is used to configure a termination to multiplex/demultiplex H.223. It is also used to exclude some of the outgoing MPC channel types due to the MONA Preference received from the peer.

Table E.4.3.3.1: Configure Multiplex Termination Procedure

Procedure	Initiated	Information element name	Information element required	Information element description
Configure Multiplex Termination	MGCF	Context	M	This information element indicates the existing context.
		Termination	M	This information element indicates the termination
		Remote H223 Capability	O	This information element indicates the remote H223 capabilities, as received by the MGCF. The element shall not be included if the MPC Mux Code IE is included.
		Incoming Multiplex Table	O	This information element indicates the value of the H245 MultiplexEntrySend message, as received by the MGCF from the remote H.245 peer. Either this element or the MPC Mux Code IE shall be included.
		Outgoing Multiplex Table	O	This information element indicates the value of the H245 MultiplexEntrySend message, as sent by the MGCF towards the remote H.245 peer. Either this element or the MPC Mux Code IE shall be included.
		MPC Mux Code	O	This information element requests the MGW to continue sending available media in MPC and indicates the channel type to use for sending media. It is used in this procedure only to restrict the list of channel types indicated previously in the Add Multiplex Termination procedure. Either this element or the Incoming and Outgoing Multiplex Table elements shall be included.
Configure Multiplex Termination Ack	IM-MGW	Context	M	This information element indicates the context where the command was executed.
		Termination	M	This information element indicates the termination where the command was executed.

E.4.3.4 Signal H245 Message

This procedure is used to send a H245 message to the IM-MGW that the IM-MGW shall forward towards the CS side within H.223.

Table E.4.3.4.1: Signal H245 Message Procedure

Procedure	Initiated	Information element name	Information element required	Information element description
Signal H245 Message	MGCF	Context	M	This information element indicates the existing context.
		Termination	M	This information element indicates the termination
		Signal	M	This information element indicates the signal to request forwarding of a H245 message towards the CS side within H.223
		H.245 message	M	This information element indicates the H.245 message to be forwarded
Signal H245 Message Ack	IM-MGW	Context	M	This information element indicates the context where the command was executed.
		Termination	M	This information element indicates the termination where the command was executed.

E.4.3.5 Notify H245 Message

This procedure is used by the IM-MGW to notify the MGCF that the IM-MGW has received a H245 message from the CS side within H.223.

Table E.4.3.5.1: Notify H245 Message Procedure

Procedure	Initiated	Information element name	Information element required	Information element description
Notify H245 Message	IM-MGW	Context	M	This information element indicates the existing context.
		Termination	M	This information element indicates the termination
		Event	M	This information element indicates the event to indicate that a H245 message has been received from the CS side within H.223
		H.245 message	M	information element indicates the received H.245 message
Notify H245 Message Ack	MGCF	Context	M	This information element indicates the context where the command was executed.
		Termination	M	This information element indicates the termination where the command was executed.

E.4.3.6 Notify MONA Preference Reception

This procedure is used by the IM-MGW to notify the MGCF that the IM-MGW has received the first MONA preference Message from the CS side.

Table E.4.3.6.1: Notify MONA Preference Reception Procedure

Procedure	Initiated	Information element name	Information element required	Information element description
Notify H245 Message	IM-MGW	Context	M	This information element indicates the existing context.
		Termination	M	This information element indicates the termination
		Event	M	This information element indicates the event to indicate that a MONA Preference Message has been received
		MONA Preferences	M	This information element indicates the received MONA preference message
Notify H245 Message Ack	MGCF	Context	M	This information element indicates the context where the command was executed.
		Termination	M	This information element indicates the termination where the command was executed.

E.4.3.7 Notify MONA Preference Completed

This procedure is used by the IM-MGW to notify the MGCF that the IM-MGW has received the first MONA preference Message with indication that the MONA preference negotiation is completed.

Table E.4.3.7.1: Notify MONA Preference Completed Procedure

Procedure	Initiated	Information element name	Information element required	Information element description
Notify H245 Message	IM-MGW	Context	M	This information element indicates the existing context.
		Termination	M	This information element indicates the termination
		Event	M	This information element indicates the event to indicate that the first MONA preference Message with indication that the MONA preference negotiation is completed received
Notify H245 Message Ack	MGCF	Context	M	This information element indicates the context where the command was executed.
		Termination	M	This information element indicates the termination where the command was executed.

E.4.3.8 Signal SPC

This procedure is used to send a H245 message to the IM-MGW that the IM-MGW shall forward towards the CS side using the SPC, i.e. as attachment to MONA preference messages.

Table E.4.3.8.1: Signal SPC Procedure

Procedure	Initiated	Information element name	Information element required	Information element description
Signal H245 Message	MGCF	Context	M	This information element indicates the existing context.
		Termination	M	This information element indicates the termination
		Signal	M	This information element indicates the signal to request forwarding of a H245 message towards the CS side using the SPC, i.e. as attachment to MONA preference messages
		H.245 message	M	This information element indicates the H.245 message to be forwarded
Signal H245 Message Ack	IM-MGW	Context	M	This information element indicates the context where the command was executed.
		Termination	M	This information element indicates the termination where the command was executed.

E.4.3.9 Notify SPC

This procedure is used by the IM-MGW to notify the MGCF that the IM-MGW has received a H245 message from the CS side in SPC PDUs attached to MONA preference messages.

Table E.4.3.9.1: Notify SPC Procedure

Procedure	Initiated	Information element name	Information element required	Information element description
Notify H245 Message	IM-MGW	Context	M	This information element indicates the existing context.
		Termination	M	This information element indicates the termination
		Event	M	This information element indicates the event to indicate that a H245 message has been received from the CS side in SPC PDUs attached to MONA preference messages
		H.245 message	M	information element indicates the received H.245 message
Notify H245 Message Ack	MGCF	Context	M	This information element indicates the context where the command was executed.
		Termination	M	This information element indicates the termination where the command was executed.

E.4.3.10 Notify MPC

This procedure is used by the IM-MGW to notify the MGCF that the IM-MGW has received the first MONA preference message with attached MPC from the CS side.

Table E.4.3.10.1: Notify MPC Procedure

Procedure	Initiated	Information element name	Information element required	Information element description
Notify H245 Message	IM-MGW	Context	M	This information element indicates the existing context.
		Termination	M	This information element indicates the termination
		Event	M	This information element indicates the event to indicate that the first MONA preference message with attached MPC has been received.
		MuxCode	M	information element that indicates the received Channel Type
Notify H245 Message Ack	MGCF	Context	M	This information element indicates the context where the command was executed.
		Termination	M	This information element indicates the termination where the command was executed.

E.4.3.11 Notify Detection of Legacy Interworking

This procedure is used by the IM-MGW to notify the MGCF that the IM-MGW detects a legacy interworking condition that causes it to abort MONA procedures.

Table E.4.3.11.1: Notify Detection of Legacy Interworking Procedure

Procedure	Initiated	Information element name	Information element required	Information element description
Notify H245 Message	IM-MGW	Context	M	This information element indicates the existing context.
		Termination	M	This information element indicates the termination
		Event	M	This information element indicates the event to indicate that a legacy interworking condition has been detected.
Notify H245 Message Ack	MGCF	Context	M	This information element indicates the context where the command was executed.
		Termination	M	This information element indicates the termination where the command was executed.

E.4.3.12 Request RTCP-Interworking

This procedure is used by the MGCF to request the IM-MGW to detect the RTCP feedback message on the quality of the media distribution requiring interworking.

Table E.4.3.12.1: Request RTCP-Interworking

Procedure	Initiated	Information element name	Information element required	Information element description
Request RTCP-Interworking	MGCF	Context	M	This information element indicates the existing context.
		Termination	M	This information element indicates an existing
		RTCPfilter	M	This information element provides one or several bit pattern(s) for bits 3-15 of an RTCP packet. Information from RTCP packets that match those patterns shall be notified to the MGCF.
		RTCP-Interworking	M	This information element requests a notification about information derived from the incoming RTCP packet types denoted by RTCPfilter.
Request RTCP-Interworking Ack	IM-MGW	Context	M	This information element indicates the context where the command was executed.
		Termination	M	This information element indicates the new termination where the command was executed.

E.4.3.13 Notify RTCP-Interworking

This procedure is used by the IM-MGW to notify the MGCF the feedback information elements when the IM-MGW detects a RTCP feedback message on the quality of the media distribution requiring interworking.

Table E.4.3.13.1: Notify of RTCP-Interworking

Procedure	Initiated	Information element name	Information element required	Information element description
Notify RTCP-Interworking	IM-MGW	Context	M	This information element indicates the existing context.
		Termination	M	This information element indicates the termination
		UpdatePicture	C	This information element shall be included upon reception of a RTCP PLI message. It indicates the request of sending of full intra-pictures.
		MaxBitRate	C	This information element shall be included upon reception of a RTCP TMMBR message. It shall contain the bandwidth as indicated in the RTCP TMMBR message excluding the overhead indicated in the RTCP TMMBR message.
Notify RTCP-Interworking Ack	MGCF	Context	M	This information element indicates the context where the command was executed.
		Termination	M	This information element indicates the termination where the command was executed.

E.4.3.14 Signal-H.245-Interworking

This procedure is used by the MGCF to indicate the IM-MGW the feedback information elements when a H.245 feedback message on the quality of the media distribution requiring interworking is received.

Table E.4.3.14.1: Signal H.245-Interworking

Procedure	Initiated	Information element name	Information element required	Information element description
Signal H.245-Interworking	MGCF	Context	M	This information element indicates the existing context.
		Termination	M	This information element indicates the termination
		UpdatePicture	C	This information element indicates the request to send a RTCP PLI message.
		MaxBitRate	C	This information element indicates the request to send a RTCP TMBR message. It shall contain the bandwidth as indicated in the RTCP TMMBR message excluding the overhead indicated in the RTCP TMMBR message.
Signal H.245-Interworking Ack	IM-MGW	Context	M	This information element indicates the context where the command was executed.
		Termination	M	This information element indicates the termination where the command was executed.

E.4.3.15 Stop MPC

This procedure is used by the MGC to indicate to the MG that it is no longer allowed to send MPC media encapsulated in MONA Preference messages and that it shall stop MPC detection.

Table E.4.3.15.1: Stop MPC

Procedure	Initiated	Information element name	Information element required	Information element description
Stop MPC	MGCF	Context	M	This information element indicates the existing context.
		Termination	M	This information element indicates the termination
		Stop MPC Reception	M	This information element indicates that the reception of MPC encapsulated in MONA Preference Messages shall be stopped.
		Stop MPC Sending	M	This information element requests that the sending of the MPC shall be stopped.
Stop MPC Ack	IM-MGW	Context	M	This information element indicates the context where the command was executed.
		Termination	M	This information element indicates the termination where the command was executed.

E.4.3.16 Stop SPC

This procedure is used by the MGC to indicate to the MG that it is no longer allowed to send MPC media encapsulated in MONA Preference messages and that it shall stop SPC detection.

Table E.4.3.16.1: Stop MPC

Procedure	Initiated	Information element name	Information element required	Information element description
Stop SPC	MGCF	Context	M	This information element indicates the existing context.
		Termination	M	This information element indicates the termination
		Stop SPC Sending	M	This information element requests that the sending of SPC encapsulated in MONA Preference messages shall be stopped.
		Stop SPC Detection	M	This information element requests that the detection of received SPC encapsulated in MONA Preference Message shall be stopped.
Stop SPC Ack	IM-MGW	Context	M	This information element indicates the context where the command was executed.
		Termination	M	This information element indicates the termination where the command was executed.

E.4.3.17 Stop MONA Negotiation

This procedure is used by the MGC to request the MG to stop all MONA negotiation related procedures.

Table E.4.3.17.1: Stop MONA Negotiation

Procedure	Initiated	Information element name	Information element required	Information element description
Stop MONA Negotiation	MGCF	Context	M	This information element indicates the existing context.
		Termination	M	This information element indicates the termination
		Stop MONA Preference Message Sending	M	This information element requests that the sending of MONA Preference messages be stopped.
		Stop MONA Detection	M	This information element requests that the detection of first MONA Preference Message and of the MONA negotiation completion be stopped.
		Stop SPC Sending	C	This information element requests that the sending of SPC encapsulated in MONA Preference messages be stopped. Required only if SPC sending was previously configured.
		Stop SPC Detection	C	This information element requests that the detection of received SPC encapsulated in MONA Preference Message be stopped. Required only if SPC reception was previously configured.
		Stop MPC Reception	C	This information element indicates that the reception of MPC encapsulated in MONA Preference Messages shall be stopped. Required only if MPC reception was previously configured.
		Stop MPC Sending	C	This information element requests that the sending of the MPC shall be stopped. Required only if MPC sending was previously configured.
Stop MONA Negotiation Ack	IM-MGW	Context	M	This information element indicates the context where the command was executed.
		Termination	M	This information element indicates the termination where the command was executed.

Annex F (normative): PSTN XML Scheme

F.1 Scope

This Annex defines the PSTN XML Schema to be used for providing the BearerCapability, Low Layer Compatibility, High Layer Compatibility and Progress indicator embedded as body in SIP messages.

The support of this PSTN XML Schema is a network option.

F.2 MIME type

The XML schema defined in the present Annex is registered at IANA as "application/vnd.etsi.pstn+xml" MIME type.

If the XML scheme is embedded in SIP messages as body, the Content-Type header shall be set to "application/vnd.etsi.pstn+xml" and the Content-Disposition shall be set to "signal" with the "handling" parameter set to "optional".

F.3 XML Schema definition

```
<?xml version="1.0" encoding="UTF-8"?>
<xs:schema xmlns:xs="http://www.w3.org/2001/XMLSchema" xmlns="http://uri.etsi.org/ngn/params/xml/simservs/pstn"
xmlns:ns1="http://uri.etsi.org/ngn/params/xml/simservs/pstn" targetNamespace="http://uri.etsi.org/ngn/params/xml/simservs/pstn"
elementFormDefault="qualified">
  <xs:annotation>
    <xs:documentation>XML Schema definition for mapping of some PSTN into SIP MIME Bodies</xs:documentation>
  </xs:annotation>
  <!--Definition of simple types-->
  <xs:simpleType name="OneBitType">
    <xs:restriction base="xs:string">
      <xs:pattern value="[0-1]"/>
    </xs:restriction>
  </xs:simpleType>
  <xs:simpleType name="TwoBitType">
    <xs:restriction base="xs:string">
      <xs:pattern value="[0-1][0-1]"/>
    </xs:restriction>
  </xs:simpleType>
  <xs:simpleType name="ThreeBitType">
    <xs:restriction base="xs:string">
      <xs:pattern value="[0-1][0-1][0-1]"/>
    </xs:restriction>
  </xs:simpleType>
  <xs:simpleType name="FourBitType">
    <xs:restriction base="xs:string">
      <xs:pattern value="[0-1][0-1][0-1][0-1]"/>
    </xs:restriction>
  </xs:simpleType>
  <xs:simpleType name="FiveBitType">
    <xs:restriction base="xs:string">
      <xs:pattern value="[0-1][0-1][0-1][0-1][0-1]"/>
    </xs:restriction>
  </xs:simpleType>
  <xs:simpleType name="SixBitType">
    <xs:restriction base="xs:string">
      <xs:pattern value="[0-1][0-1][0-1][0-1][0-1][0-1]"/>
    </xs:restriction>
  </xs:simpleType>
```

```

<xs:simpleType name="SevenBitType">
  <xs:restriction base="xs:string">
    <xs:pattern value="[0-1][0-1][0-1][0-1][0-1][0-1][0-1]" />
  </xs:restriction>
</xs:simpleType>
<!--Definition of complex types-->
<!--Definition of BearerCapability Octets-->
<xs:complexType name="BCOctet3Type">
  <xs:sequence>
    <xs:element name="CodingStandard" type="TwoBitType"/>
    <xs:element name="InformationTransferCapability" type="FiveBitType"/>
  </xs:sequence>
</xs:complexType>
<xs:complexType name="BCOctet4Type">
  <xs:sequence>
    <xs:element name="TransferMode" type="TwoBitType"/>
    <xs:element name="InformationTransferRate" type="FiveBitType"/>
  </xs:sequence>
</xs:complexType>
<xs:complexType name="BCOctet4-1Type">
  <xs:sequence>
    <xs:element name="RateMultiplier" type="SevenBitType"/>
  </xs:sequence>
</xs:complexType>
<xs:complexType name="BCOctet5Type">
  <xs:sequence>
    <xs:element name="Layer1Identification" type="TwoBitType"/>
    <xs:element name="UserInfoLayer1Protocol" type="FiveBitType"/>
  </xs:sequence>
</xs:complexType>
<xs:complexType name="BCOctet5aType">
  <xs:sequence>
    <xs:element name="SynchronousAsynchronous" type="OneBitType"/>
    <xs:element name="Negotiation" type="OneBitType"/>
    <xs:element name="UserRate" type="FiveBitType"/>
  </xs:sequence>
</xs:complexType>
<xs:complexType name="BCOctet5bV110Type">
  <xs:sequence>
    <xs:element name="IntermediateRate" type="TwoBitType"/>
    <xs:element name="NIConTX" type="OneBitType"/>
    <xs:element name="NIConRX" type="OneBitType"/>
    <xs:element name="FlowControlOnTX" type="OneBitType"/>
    <xs:element name="FlowControlOnRX" type="OneBitType"/>
  </xs:sequence>
</xs:complexType>
<xs:complexType name="BCOctet5bV120Type">
  <xs:sequence>
    <xs:element name="RateAdaptionHeader" type="OneBitType"/>
    <xs:element name="MultipleFrameEstablishmentSupport" type="OneBitType"/>
    <xs:element name="ModeOfOperation" type="OneBitType"/>
    <xs:element name="LogicalLinkIdentifier" type="OneBitType"/>
    <xs:element name="Assignor" type="OneBitType"/>
    <xs:element name="InbandOutbandNegotiation" type="OneBitType"/>
  </xs:sequence>
</xs:complexType>
<xs:complexType name="BCOctet5cType">
  <xs:sequence>
    <xs:element name="NumberOfStopBits" type="TwoBitType"/>
    <xs:element name="NumberOfDataBits" type="TwoBitType"/>
    <xs:element name="Parity" type="ThreeBitType"/>
  </xs:sequence>
</xs:complexType>
<xs:complexType name="BCOctet5dType">
  <xs:sequence>
    <xs:element name="DuplexMode" type="OneBitType"/>
    <xs:element name="ModemType" type="SixBitType"/>
  </xs:sequence>
</xs:complexType>

```

```

<xs:complexType name="BCOctet6Type">
  <xs:sequence>
    <xs:element name="Layer2Identification" type="TwoBitType"/>
    <xs:element name="UserInfoLayer2Protocol" type="FiveBitType"/>
  </xs:sequence>
</xs:complexType>
<xs:complexType name="BCOctet7Type">
  <xs:sequence>
    <xs:element name="Layer3Identification" type="TwoBitType"/>
    <xs:element name="UserInfoLayer3Protocol" type="FiveBitType"/>
  </xs:sequence>
</xs:complexType>
<xs:complexType name="BCOctet7aType">
  <xs:sequence>
    <xs:element name="AdditionalLayer3Info" type="FourBitType"/>
  </xs:sequence>
</xs:complexType>
<xs:complexType name="BCOctet7bType">
  <xs:sequence>
    <xs:element name="AdditionalLayer3Info" type="FourBitType"/>
  </xs:sequence>
</xs:complexType>
<!--Definition of High Layer Compatibility Octets-->
<xs:complexType name="HLOctet3Type">
  <xs:sequence>
    <xs:element name="CodingStandard" type="TwoBitType"/>
    <xs:element name="Interpretation" type="ThreeBitType"/>
    <xs:element name="PresentationMethod" type="TwoBitType"/>
  </xs:sequence>
</xs:complexType>
<xs:complexType name="HLOctet4Type">
  <xs:sequence>
    <xs:element name="HighLayerCharacteristics" type="SevenBitType"/>
  </xs:sequence>
</xs:complexType>
<xs:complexType name="HLOctet4aMaintenanceType">
  <xs:sequence>
    <xs:element name="HighLayerCharacteristics" type="SevenBitType"/>
  </xs:sequence>
</xs:complexType>
<xs:complexType name="HLOctet4aAudioType">
  <xs:sequence>
    <xs:element name="VideoTelephonyCharacteristics" type="SevenBitType"/>
  </xs:sequence>
</xs:complexType>
<!--Definition of Low Layer Compatibility Octets-->
<xs:complexType name="LLOctet3Type">
  <xs:sequence>
    <xs:element name="CodingStandard" type="TwoBitType"/>
    <xs:element name="InformationTransferCapability" type="FiveBitType"/>
  </xs:sequence>
</xs:complexType>
<xs:complexType name="LLOctet3aType">
  <xs:sequence>
    <xs:element name="NegotiationIndicator" type="OneBitType"/>
  </xs:sequence>
</xs:complexType>
<xs:complexType name="LLOctet4Type">
  <xs:sequence>
    <xs:element name="TransferMode" type="TwoBitType"/>
    <xs:element name="InformationTransferRate" type="FiveBitType"/>
  </xs:sequence>
</xs:complexType>
<xs:complexType name="LLOctet4-1Type">
  <xs:sequence>
    <xs:element name="RateMultiplier" type="SevenBitType"/>
  </xs:sequence>
</xs:complexType>
<xs:complexType name="LLOctet5Type">

```

```

    <xs:sequence>
      <xs:element name="Layer1Identification" type="TwoBitType"/>
      <xs:element name="UserInfoLayer1Protocol" type="FiveBitType"/>
    </xs:sequence>
  </xs:complexType>
  <xs:complexType name="LLOctet5aType">
    <xs:sequence>
      <xs:element name="SynchronousAsynchronous" type="OneBitType"/>
      <xs:element name="Negotiation" type="OneBitType"/>
      <xs:element name="UserRate" type="FiveBitType"/>
    </xs:sequence>
  </xs:complexType>
  <xs:complexType name="LLOctet5bV110Type">
    <xs:sequence>
      <xs:element name="IntermediateRate" type="TwoBitType"/>
      <xs:element name="NIConTX" type="OneBitType"/>
      <xs:element name="NIConRX" type="OneBitType"/>
      <xs:element name="FlowControlOnTX" type="OneBitType"/>
      <xs:element name="FlowControlOnRX" type="OneBitType"/>
    </xs:sequence>
  </xs:complexType>
  <xs:complexType name="LLOctet5bV120Type">
    <xs:sequence>
      <xs:element name="RateAdaptionHeader" type="OneBitType"/>
      <xs:element name="MultipleFrameEstablishmentSupport" type="OneBitType"/>
      <xs:element name="ModeOfOperation" type="OneBitType"/>
      <xs:element name="LogicalLinkIdentifier" type="OneBitType"/>
      <xs:element name="Assignor" type="OneBitType"/>
      <xs:element name="InbandOutbandNegotiation" type="OneBitType"/>
    </xs:sequence>
  </xs:complexType>
  <xs:complexType name="LLOctet5cType">
    <xs:sequence>
      <xs:element name="NumberOfStopBits" type="TwoBitType"/>
      <xs:element name="NumberOfDataBits" type="TwoBitType"/>
      <xs:element name="Parity" type="ThreeBitType"/>
    </xs:sequence>
  </xs:complexType>
  <xs:complexType name="LLOctet5dType">
    <xs:sequence>
      <xs:element name="DuplexMode" type="OneBitType"/>
      <xs:element name="ModemType" type="SixBitType"/>
    </xs:sequence>
  </xs:complexType>
  <xs:complexType name="LLOctet6Type">
    <xs:sequence>
      <xs:element name="Layer2Identification" type="TwoBitType"/>
      <xs:element name="UserInfoLayer2Protocol" type="FiveBitType"/>
    </xs:sequence>
  </xs:complexType>
  <xs:complexType name="LLOctet6aHDLCType">
    <xs:sequence>
      <xs:element name="Mode" type="TwoBitType"/>
    </xs:sequence>
  </xs:complexType>
  <xs:complexType name="LLOctet6aUserSpecificType">
    <xs:sequence>
      <xs:element name="UserSpecificLayer2Information" type="SevenBitType"/>
    </xs:sequence>
  </xs:complexType>
  <xs:complexType name="LLOctet6bType">
    <xs:sequence>
      <xs:element name="WindowSize" type="SevenBitType"/>
    </xs:sequence>
  </xs:complexType>
  <xs:complexType name="LLOctet7Type">
    <xs:sequence>
      <xs:element name="Layer3Identification" type="TwoBitType"/>
      <xs:element name="UserInfoLayer3Protocol" type="FiveBitType"/>
    </xs:sequence>
  </xs:complexType>

```

```

    </xs:sequence>
  </xs:complexType>
  <xs:complexType name="LLOctet7aUserSpecificType">
    <xs:sequence>
      <xs:element name="OptionalLayer3Information" type="SevenBitType"/>
    </xs:sequence>
  </xs:complexType>
  <xs:complexType name="LLOctet7aX25Type">
    <xs:sequence>
      <xs:element name="Mode" type="TwoBitType"/>
    </xs:sequence>
  </xs:complexType>
  <xs:complexType name="LLOctet7bX25Type">
    <xs:sequence>
      <xs:element name="DefaultPacketSize" type="FourBitType"/>
    </xs:sequence>
  </xs:complexType>
  <xs:complexType name="LLOctet7cType">
    <xs:sequence>
      <xs:element name="PacketWindowSize" type="SevenBitType"/>
    </xs:sequence>
  </xs:complexType>
  <xs:complexType name="LLOctet7aTR9577Type">
    <xs:sequence>
      <xs:element name="AdditionalLayer3Info" type="FourBitType"/>
    </xs:sequence>
  </xs:complexType>
  <xs:complexType name="LLOctet7bTR9577Type">
    <xs:sequence>
      <xs:element name="AdditionalLayer3Info" type="FourBitType"/>
    </xs:sequence>
  </xs:complexType>
  <xs:complexType name="DispOctet3Type">
    <xs:sequence>
      <xs:element name="DisplayInformation" type="SevenBitType"/>
    </xs:sequence>
  </xs:complexType>
  <!--Definition of the information elements-->
  <xs:complexType name="BearerCapabilityType">
    <xs:sequence>
      <xs:element name="Bcoctet3" type="BCOctet3Type"/>
      <xs:element name="Bcoctet4" type="BCOctet4Type"/>
      <xs:element name="Bcoctet4-1" type="BCOctet4-1Type" minOccurs="0"/>
      <xs:element name="Bcoctet5" type="BCOctet5Type" minOccurs="0"/>
      <xs:element name="Bcoctet5a" type="BCOctet5aType" minOccurs="0"/>
      <xs:element name="Bcoctet5bV110" type="BCOctet5bV110Type" minOccurs="0"/>
      <xs:element name="Bcoctet5bV120" type="BCOctet5bV120Type" minOccurs="0"/>
      <xs:element name="Bcoctet5c" type="BCOctet5cType" minOccurs="0"/>
      <xs:element name="Bcoctet5d" type="BCOctet5dType" minOccurs="0"/>
      <xs:element name="Bcoctet6" type="BCOctet6Type" minOccurs="0"/>
      <xs:element name="Bcoctet7" type="BCOctet7Type" minOccurs="0"/>
      <xs:element name="Bcoctet7a" type="BCOctet7aType" minOccurs="0"/>
      <xs:element name="Bcoctet7b" type="BCOctet7bType" minOccurs="0"/>
    </xs:sequence>
  </xs:complexType>
  <xs:complexType name="HighLayerCompatibilityType">
    <xs:sequence>
      <xs:element name="HLOctet3" type="HLOctet3Type"/>
      <xs:element name="HLOctet4" type="HLOctet4Type"/>
      <xs:element name="HLOctet4aMaintenance" type="HLOctet4aMaintenanceType" minOccurs="0"/>
      <xs:element name="HLOctet4aAudio" type="HLOctet4aAudioType" minOccurs="0"/>
    </xs:sequence>
  </xs:complexType>
  <xs:complexType name="LowLayerCompatibilityType">
    <xs:sequence>
      <xs:element name="LLOctet3" type="LLOctet3Type"/>
      <xs:element name="LLOctet3a" type="LLOctet3aType" minOccurs="0"/>
      <xs:element name="LLOctet4" type="LLOctet4Type"/>
      <xs:element name="LLOctet4-1" type="LLOctet4-1Type" minOccurs="0"/>
    </xs:sequence>
  </xs:complexType>

```

```

<xs:element name="LLOctet5" type="LLOctet5Type" minOccurs="0"/>
<xs:element name="LLOctet5a" type="LLOctet5aType" minOccurs="0"/>
<xs:element name="LLOctet5bV110" type="LLOctet5bV110Type" minOccurs="0"/>
<xs:element name="LLOctet5bV120" type="LLOctet5bV120Type" minOccurs="0"/>
<xs:element name="LLOctet5c" type="LLOctet5cType" minOccurs="0"/>
<xs:element name="LLOctet5d" type="LLOctet5dType" minOccurs="0"/>
<xs:element name="LLOctet6" type="LLOctet6Type" minOccurs="0"/>
<xs:element name="LLOctet6aHDLc" type="LLOctet6aHDLcType" minOccurs="0"/>
<xs:element name="LLOctet6aUserSpecific" type="LLOctet6aUserSpecificType" minOccurs="0"/>
<xs:element name="LLOctet6b" type="LLOctet6bType" minOccurs="0"/>
<xs:element name="LLOctet7" type="LLOctet7Type" minOccurs="0"/>
<xs:element name="LLOctet7aUserSpecific" type="LLOctet7aUserSpecificType" minOccurs="0"/>
<xs:element name="LLOctet7aX25" type="LLOctet7aX25Type" minOccurs="0"/>
<xs:element name="LLOctet7bX25" type="LLOctet7bX25Type" minOccurs="0"/>
<xs:element name="LLOctet7c" type="LLOctet7cType" minOccurs="0"/>
<xs:element name="LLOctet7aTR9577" type="LLOctet7aTR9577Type" minOccurs="0"/>
<xs:element name="LLOctet7bTR9577" type="LLOctet7bTR9577Type" minOccurs="0"/>
</xs:sequence>
</xs:complexType>
<xs:complexType name="DisplayType">
  <xs:sequence>
    <xs:element name="DispOctet3" type="DispOctet3Type"/>
  </xs:sequence>
</xs:complexType>
<!--Definition of progress indicator-->
<xs:complexType name="ProgressOctet3Type">
  <xs:sequence>
    <xs:element name="CodingStandard" type="TwoBitType"/>
    <xs:element name="Location" type="FourBitType"/>
  </xs:sequence>
</xs:complexType>
<xs:complexType name="ProgressOctet4Type">
  <xs:sequence>
    <xs:element name="ProgressDescription" type="SevenBitType"/>
  </xs:sequence>
</xs:complexType>
<xs:complexType name="ProgressIndicatorType">
  <xs:sequence>
    <xs:element name="ProgressOctet3" type="ProgressOctet3Type"/>
    <xs:element name="ProgressOctet4" type="ProgressOctet4Type"/>
  </xs:sequence>
</xs:complexType>
<!--Definition of document structure-->
<xs:element name="PSTN">
  <xs:complexType>
    <xs:sequence>
      <xs:element name="BearerCapability" type="BearerCapabilityType" minOccurs="0" maxOccurs="2"/>
      <xs:element name="HighLayerCompatibility" type="HighLayerCompatibilityType" minOccurs="0"
maxOccurs="2"/>
      <xs:element name="LowLayerCompatibility" type="LowLayerCompatibilityType" minOccurs="0"/>
      <xs:element name="ProgressIndicator" type="ProgressIndicatorType" minOccurs="0" maxOccurs="unbounded"/>
      <xs:element name="Display" type="DisplayType" minOccurs="0" maxOccurs="unbounded"/>
      <xs:element name="sendingCompleteIndication" minOccurs="0"/>
    </xs:sequence>
  </xs:complexType>
</xs:element>
</xs:schema>

```

F.4 IANA registration template

Within the present subclause, information required for an IANA registration at <http://www.iana.org/cgi-bin/mediatypes.pl> is provided.

1. Media Type Name

Application

2. Subtype name

"vnd.etsi.pstn+xml" (Vendor Tree)

3. Required parameters

none

4. Optional parameters

none

5. Encoding considerations

binary

6. Security considerations

The security considerations for XML in RFC 3023 apply.

Modifications of the MIME body by a man-in-the-middle can have severe consequences:

The information derived from ISUP that can be transported with this MIME body influence the call handling of the SIP session that is being setup.

However, this MIME body is used only attached to SIP messages, and modifications of other parts of the SIP signalling will lead to comparable consequences. Protection of the SIP signalling will also protect the present MIME body. The SIP signalling should be protected as described in RFC 3261.

7. Interoperability considerations

None

8. Published specification

TS 29.163

9. Applications which use this media type

This MIME type is used as a message body within SIP messages.

It is used for sending information derived from ISUP or DSS1 signalling with no SIP equivalent.

10. Additional information

Magic number(s): none (see RFC 3023)

File extension(s): ".xml" (see RFC 3023)

Macintosh File Type Code(s): "Text" (see RFC 3023)

Object Identifier(s) or OID(s): none

11. Intended usage

Limited Use

12. Other Information/General Comment

The content of this MIME type is UTF-8 encoded. The charset parameter is not used.

Annex G (informative): Void

NOTE: The former contents of this annex are now contained in 3GPP TS 24.229 [9].

Annex H (normative): Interworking of Originating Line Information (OLI) parameter (network option)

H.1 Interworking SIP to ISUP

The "oli" URI parameter received within tel URI or the userinfo part of SIP URI with user="phone" (as defined in clause 7.2A.12 of 3GPP TS 24.229 [9]) received in a P-Asserted-Identity header in the initial INVITE request shall be used to set the ISUP IAM OLI parameter. In case the P-Asserted-Identity URI "oli" parameter is absent then the ISUP IAM OLI parameter shall be omitted.

H.2 Interworking ISUP to SIP

The ISUP IAM OLI parameter shall be used to set the "oli" URI parameter within tel URI or the userinfo part of SIP URI with user="phone" parameter (as defined in clause 7.2A.12 of 3GPP TS 24.229 [9]) of a P-Asserted-Identity header in the initial INVITE request. In case the ISUP IAM OLI parameter is absent then the P-Asserted-Identity URI "oli" parameter shall be omitted from the initial INVITE request.

Annex I (normative):

GTT interworking between the IP Multimedia Core Network (CN) Subsystem (IMS) and Circuit Switched (CS) networks

I.1 Overview of GTT interworking between the IMS and Circuit Switched (CS) networks

The support of Global Text Telephony (GTT) is optional, but may be required by national regulatory requirements. If GTT is supported, the procedures described within this Annex shall be applied.

Global Text Telephony (GTT) offers real time conversation in text, optionally combined with voice. GTT is mainly used for distant conversation with hearing or speech impaired users.

GTT is supported in IMS via the Real-Time Text protocol over RTP, using IETF SIP/SDP for the negotiation of the text media and IETF RFC 4103 [124] RTP-text for transport, with text coded according to ITU-T Recommendation T.140 [123]. See 3GPP TS 23.226 [122], 3GPP TS 26.114 [104], 3GPP TS 26.235 [80] and 3GPP TS 26.236 [32].

In PSTN, different specified systems for text telephony exist and are used in different regions, e.g. Baudot (in US), EDT, V.21, Bell103, Minitel and V.18. They all use different modem technologies within PCM and different character coding for the transmission of text. They are described in the annexes of ITU-T Recommendation V.18 [125]. ITU-T Recommendation V.18 [125] is an international text telephone modem standard with an automodem mechanism that enables communication with all the different kinds of PSTN text telephone systems. Any party of a GTT call may at any time initiate text or send voice. Speech and text may be used in an alternating manner during a conversation on the PSTN. It is also possible that speech is transferred in one direction and text in the opposite direction. However, speech and text can not be used in the same direction at the same time in most sub-modes of V.18.

In the 3GPP CS radio interface, a dedicated CTM modem is used (see 3GPP TS 26.226 [126]), which is terminated within the CS domain and interworked to PSTN inband text telephony format.

Interworking between Real-Time Text over RTP within IMS and PSTN text telephony is provided at the MGCF / IM-MGW by the MGCF triggering the insertion of an Interworking (conversion) function within the IM-MGW which then behaves in accordance with ITU-T Recommendation V.18 [125] or any of its specific sub-modes.

The support of this Interworking function between IP-based Real-Time Text over RTP and modem based transmission of real-time text is optional both at the MGCF and IM-MGW, but can be required by national regulatory bodies. If this Interworking function is supported, the procedures described within this Annex shall be applied.

The Interworking function in the IM-MGW shall support the detection of text modem signals on the CS side and the conversion between text/modem signals and Real-Time Text over RTP.

The IM_MGW shall support at least one of the sub-modes listed in ITU-T Recommendation V.18 [125] (e.g. Baudot). The support of any of the sub-modes is optional.

The procedures to detect and convert text/modem involve expensive MGW resources. The present GTT interworking procedures intend to allow cost effective implementations by avoiding additional load or resources in MGW for calls not using text telephony (which represent most of the calls).

It is assumed that IMS terminals supporting text media will not automatically offer text media, but that this will be instead governed by terminal configuration options and user interactions to suit the communication preferences and abilities of the user. However, an IMS terminal desiring to set up a GTT call will offer Real-Time Text media, possibly in parallel to voice media. The IMS-MGW shall then provide the conversion between Real-Time Text over RTP and text/modem signals. On the contrary, if the mobile does not request Real-Time Text support, no Interworking function is necessary. An IMS Multimedia terminal configured to use Real-Time Text Telephony but receiving an SDP offer for voice-only media will accept this offer and then send an own subsequent SDP offer adding text media. When receiving such a subsequent offer for text media, the IMS-MGW shall provide the conversion between Real-Time Text over RTP and text/modem signals at the CS interface. On the contrary, if the mobile does not offer Real-Time Text, no Interworking function is necessary.

1.2 Control plane interworking

1.2.1 General

Before text conversation can begin, a call shall first be established, from PSTN to IMS or vice-versa. The ISUP or BICC signalling to/from the PSTN indicates a "speech" call, without any GTT indication.

The IMS user may request a text connection from the beginning of a call, or add request for Real-Time Text media at a later stage in a call that was originally established with audio only.

1.2.2 Functionalities required in the MGCF for GTT calls support

In addition to the control plane interworking between SIP and ISUP or BICC (see clause 7), the MGCF shall support the negotiation of the Real-Time Text payload type (T.140 Text Conversation MIME media type as specified by IETF RFC 4103 [124]) in a distinct SDP m-line.

1.2.3 IM CN subsystem originated session

1.2.3.1 Initial INVITE with an SDP offer including a text media line

Figure I.2.3.1.1 shows an example call flow where the IMS terminal requests Real-Time Text telephony by sending an SDP offer including one audio line and one text media line within an initial INVITE message.

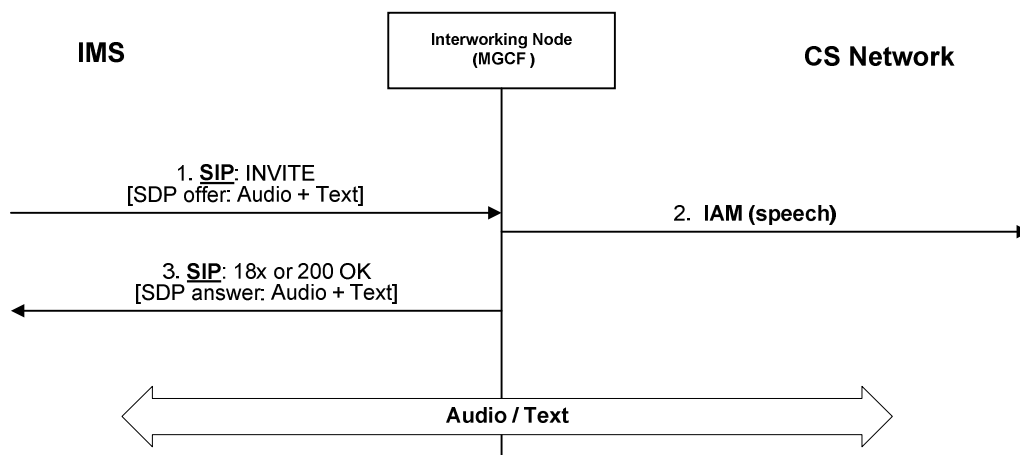

Figure I.2.3.1.1: IM CN subsystem originated session – Initial INVITE offering audio and text

Upon receipt of a SIP INVITE request offering text media (possibly combined with audio media) (signal 1 in figure I.2.3.1.1) the Interworking Node (MGCF) starts the call set-up at the CS side by sending an IAM requesting a speech with G.711 codec only or 3.1 KHz bearer (signal 2 in figure I.2.3.1.1), and completes the call setup on IMS and CS side using the procedures specified in clause 7, but returning an SDP answer including Real-Time Text media (possibly combined with audio media if audio media has been offered) (signal 3 in figure I.2.3.1.1).

The MGCF triggers the insertion an Interworking function in the IM-MGW for the duration of the call if a Real-Time Text media stream is established.

The MGCF reserves corresponding Real-Time Text media resources in the IM-MGW and activate the Interworking function, and if resources were available, return an SDP answer with audio and Real-Time Text.

1.2.4 CS network originated session

1.2.4.1 General

When starting the session setup signalling from a CS based network towards the IMS, the MGCF has no knowledge whether the CS side terminal supports and will accept to use text telephony.

1.2.4.2 Initial INVITE with an SDP offer including audio only

The MGCF offers only audio media when setting up a call towards the IMS and waits for IMS terminals desiring Real-Time Text media to send a new offer adding Real-Time Text media attribute prior to inserting an Interworking function in the IM-MGW. If the MGCF receives a new offer adding Real-Time Text media and applies signalling with OoBTC on the CS CN, the MGCF shall apply appropriate OoBTC procedures to only select G.711 audio codec on the CS call leg.

Figure I.2.4.2.1 shows an example call flow.

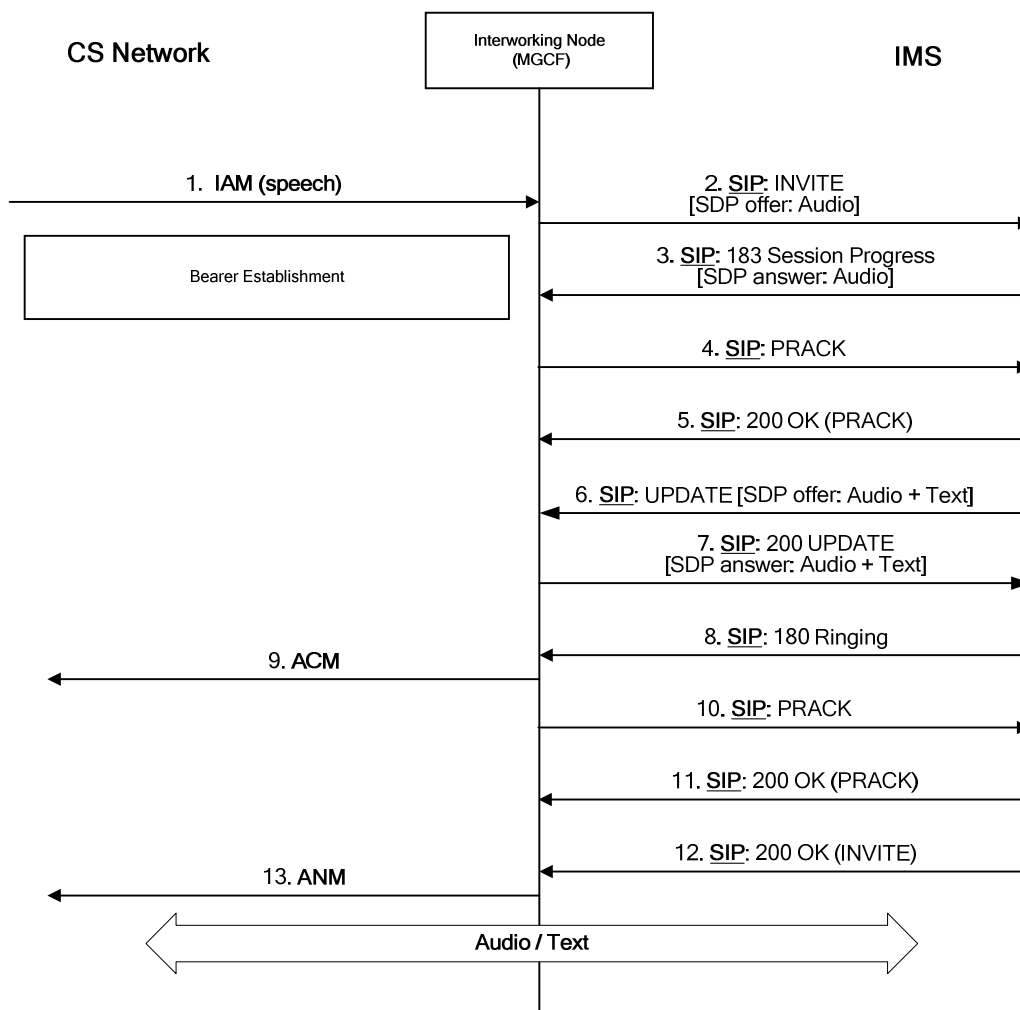

Figure I.2.4.2.1: CS originated session – Initial INVITE offering audio only

Upon receipt of an IAM request for a speech or 3.1 KHz audio call (signal 1 in figure I.2.4.2.1) the Interworking Node (MGCF) starts the call set-up at the IM CN subsystem side by sending an INVITE request (signal 2 in figure I.2.4.2.1) offering audio media applying the interworking procedures in Clause 7.

IMS terminals supporting GTT and configured to use it will send a new SDP offer including an audio and a Real-Time Text media line within a subsequent UPDATE or re-INVITE request.

When GTT interworking between IMS and CS networks is required, the MGCF shall reserve corresponding Real-Time Text media resources in the IM-MGW and thereby request the insertion of the Interworking function, and if resources were available, return an SDP answer with audio and Real-Time Text media attributes.

1.2.5 Subsequent SDP offer/answer exchange adding text to an audio session

If only audio media has been offered in the initial SDP offer, the IMS terminal can also request GTT support by sending a new SDP offer including audio and Real-Time Text when a SIP dialogue (early or confirmed) has already been established.

The MGCF shall then trigger the insertion of an Interworking function in the IM-MGW following the same principles as those specified in clause I.2.3.14. However, if OoBTC signalling is supported and a codec other than PCM (default G.711) has been selected at the CS network, then a codec modification is required to G.711. Otherwise No additional ISUP or BICC signalling towards the CS network is required.

1.3 User plane interworking

1.3.1 Functionalities required in the IM-MGW for GTT support

An IM-MGW supporting GTT interworking between IMS and CS network shall support:

- Real-Time Text as specified in 3GPP TS 26.235 [80], 3GPP TS 26.236 [32] and 3GPP TS 26.114 [104] for a Multimedia Telephony Service Indicator (MTSI) compliant IM-MGW; this includes:
 - requirement to support ITU-T Recommendation T.140 [123] Text Conversation MIME media type and RTP-text transport as specified by IETF RFC 4103 [124] and ITU-T Recommendation T.140 [123] Text Conversation presentation coding;
 - recommended support of redundancy coding variant specified in IETF RFC 4103 [124] for error resilience;
 - PSTN based text telephony using ITU-T Recommendation V.18 [4] or any of its specific sub-modes.

NOTE: One specific text telephone protocol of the ITU-T Recommendation V.18 standard, called "*Baudot Code*" (Baudot modulation at 45.45 baud), is particularly important for support of emergency calls in US.

1.3.2 Monitoring of text/modem signals on the CS side

When the IMS session is setup with text media (possibly combined with audio media), the MGCF thereby requests the IM-MGW to monitor the CS termination for possible receipt of text telephone signals, in order to detect whether the CS user wishes to transit from voice to text during a voice call. The IM-MGW shall be provisioned with the text telephone mode(s) for which the termination should be monitored. The presence of the text media in the IMS session is an explicit indication that monitoring of text telephone signals is required.

When monitoring for text telephony signals the IM-MGW should listen on the CS side voice line for text telephone signals, and shall not transmit modem tones from the CS side termination to IMS side termination until one of the following occurs:

- 1) If the PSTN terminal is a carrier-based device and transmits answer tone. The IM-MGW shall then resolve the text telephone mode according to V.18 procedures and then operate in that mode;
- 2) If the PSTN terminal is a carrier-less device, the end user starts sending characters such that these may be detected by the IM-MGW. The IM-MGW shall then detect the text telephone mode and then operate in that mode.

If the IMS terminal transmits text characters first the IM-MGW shall initiate a text connection toward the CS network and resolve the textphone type, so that communication can continue in text mode.

See ITU-T Recommendation V.18 [125] for a detailed description of those procedures.

1.3.3 Multiplexing between the CS and IMS streams

The IM-MGW should remain in speech mode until such time that text is detected from either user. The IM-MGW shall detect modem signals on the CS termination and decide based on this detection if the media received from the CS side is interworked to the speech or the text media stream on the IMS side. In the media direction towards the CS network, the IM-MGW needs to multiplex both media streams into the PCM signal.

The following procedures provide further information on the procedures to be followed by the IM-MGW, for normative behaviour the ITU-T Recommendation V.18 [125] shall be followed.

- Carrier text phone:
 - After a carrier mode text connection is established, loss of carrier can be taken as the indication that the audio stream on the IMS termination shall be connected with the (PCM) interface of the line on the CS termination.
 - When the text carrier reappears on the CS termination, or text is received from the text media stream on the IMS termination, the IM-MGW connects the text stream on the IMS termination with the (PCM) interface of the line on the CS termination.
- Carrierless text phone:
 - When the V.18 modem detects text, the textphone CS termination stops feeding the audio stream of the IMS termination, and instead inserts the detected and T.140 converted characters into the text stream of the IMS termination. This mode is continued as long as characters keep coming from the PSTN textphone. When no more characters arrive, and no textphone signal is received within 1 second, the audio channel is again fed to the audio stream of the IMS termination. If new text comes from the V.18 side, the process is repeated.
 - If text is received from the text stream of the IMS termination when V.18 is not actively receiving text, no media shall be applied to the IMS audio stream, and the characters are sent to the V.18 modem for transmission. When all text is transmitted and no more is received for two seconds, the audio channels are enabled again. Since the carrierless systems are one-way alternate transmission systems, transmission of characters is possible only in one direction at a time. Once started, reception is given priority. Characters received from text stream of the IMS termination while V.18 is busy receiving should be buffered (up to a reasonable limit).

1.3.4 Conversion between text/modem and Real-Time Text over RTP

The legacy PSTN textphone modes have limited character sets. For all legacy modes, the text received through the V.18 modem shall be converted if necessary in the RTP/T.140 format for the text stream on the IMS termination, according to the rules in ITU-T Recommendation. T.140 [123] and IETF RFC 4103 [124], and vice-versa.

Redundancy may be used as specified in IETF RFC 4103 [124]. Use or not of redundancy is derived from the text media description configured on the IMS termination (RTP/RED/T.140).

1.4 MGCF and IM-MGW interactions

1.4.1 Introduction

This clause describes requirements for extensions to the Mn interface protocol in 3GPP TS 29.332 [15] needed to support the Interworking of Real-Time Text Telephony media in IMS with text/modem calls in CS domain.

1.4.2 Mn signalling interactions

1.4.2.1 Introduction

The following clauses describe the Mn interface procedures.

All message sequence charts in these clauses are examples.

I.4.2.2 H.248 Context Model

The H.248 context model depicted in figure I.4.2.2.1 shall be applied for interworking Real-Time Text media in IMS to text/modem in CS.

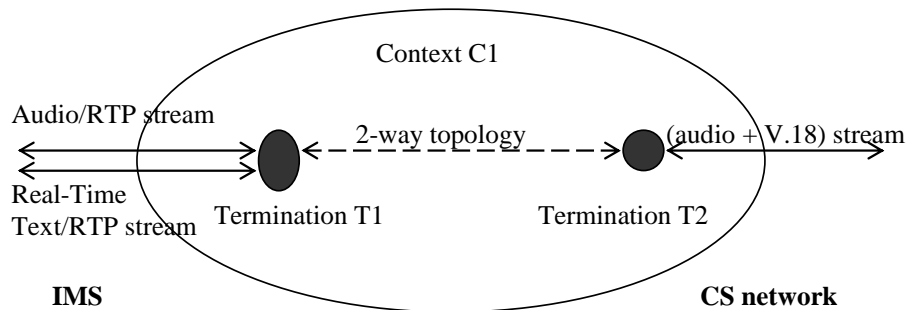

Figure I.4.2.2.1: H.248 Context Model for GTT support

The H.248 context contains one IP termination (IMS side) with two streams (one stream for Real-Time Text/RTP, another stream for audio/RTP), plus a TDM, AAL2 or IP termination (CS side) with one single stream carrying both voice via PCM and V.18 text telephony.

I.4.2.3 Specific Mn signalling for GTT

The following information shall be provided from the MGCF towards the IM-MGW:

- SDP with audio and Real-Time Text m-lines for the IMS termination;
- PCM (G.711) codec for the CS side termination.

This shall trigger the IM-MGW to insert an IWF to support RTT to PSTN text telephony conversion. If the topology is incoming (or bothway) from the CS network the IM-MGW shall monitor for text telephony and convert to RTT towards the IMS network. If the topology is outgoing (or bothway) to the CS network the IM-MGW shall multiplex RTT payload into the PCM stream.

I.4.2.4 IM CN subsystem originated session between the MGCF and IM-MGW

I.4.2.4.1 Initial INVITE with an SDP offer including Real-Time Text

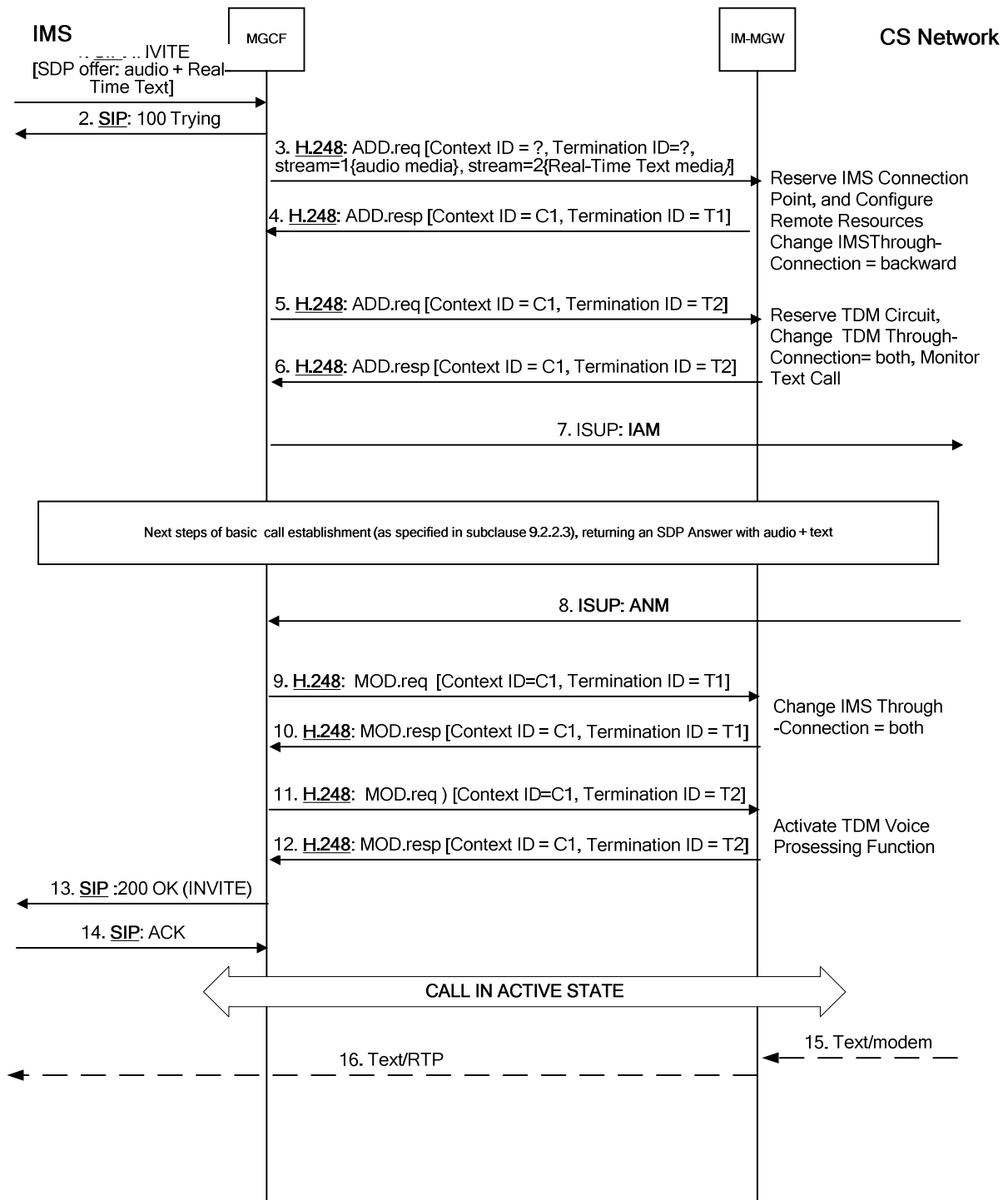

Figure I.4.2.4.1.1: Example Mn signalling interactions for IMS originated session with audio and text

The Mn signalling interactions specified in clause 9.2.2.3 shall apply, with the following differences.

When reserving the IMS termination, the MGCF shall configure two streams; one for the audio and one for the Real-Time Text media line, with their respective media description (signal 3 in figure I.4.2.4.1.1). Monitoring of text

telephony at the CS side termination is indicated by the inclusion of Real-Time Text media at the IMS side termination and by the topology being bothway or incoming from the CS side.

The text telephone mode(s) for which the CS side termination is monitored shall be provisioned in the IM-MGW.

I.4.2.5 CS network originated session

I.4.2.5.1 Initial INVITE with an SDP offer only including audio

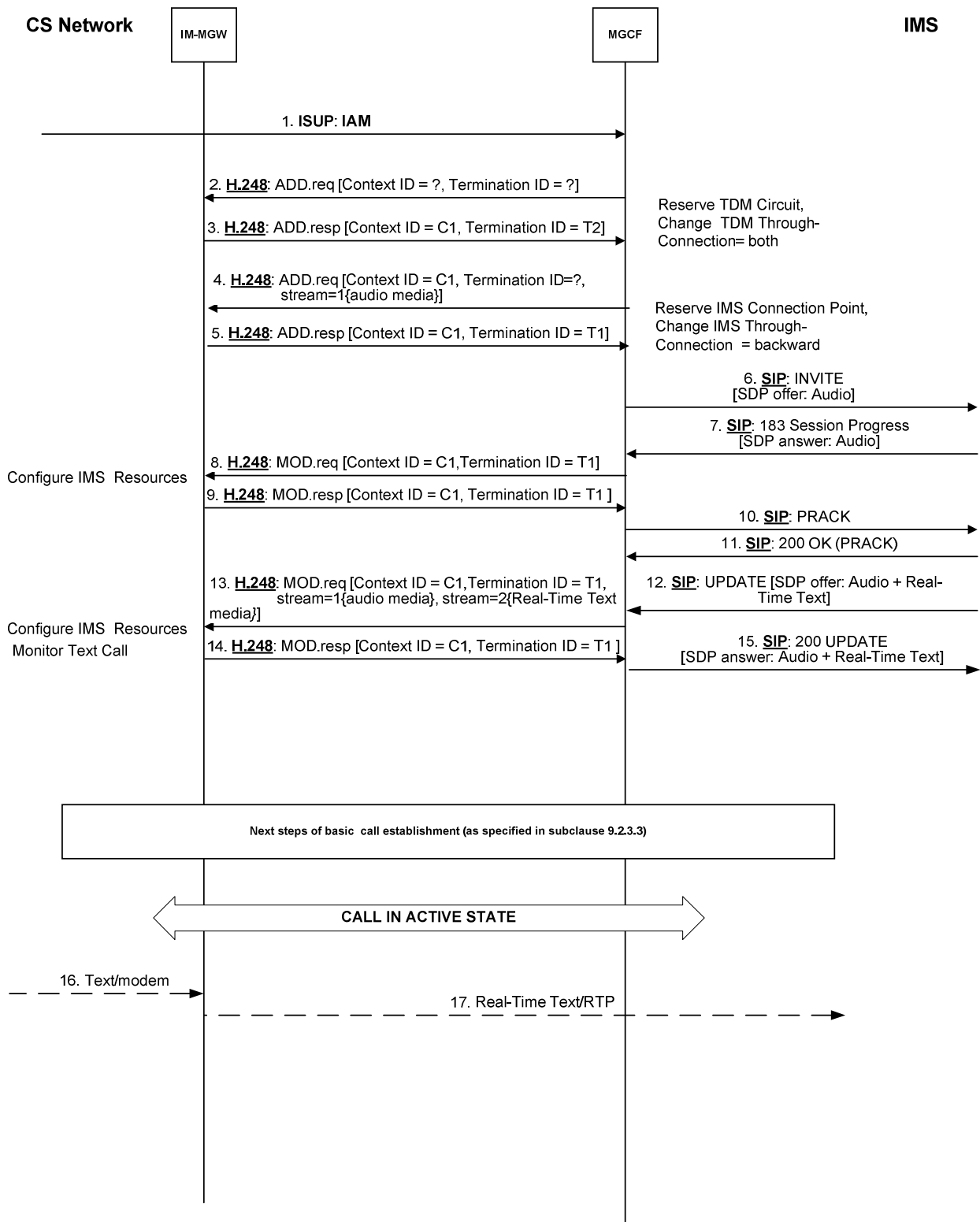

Figure I.4.2.5.1.1: Mn signalling interactions for CS originated session – Initial INVITE with audio only

The Mn signalling interactions specified in clause 9.2.3.3 shall apply, with the following differences.

Upon receipt of a subsequent SDP offer from the IMS terminal including the audio and Real-Time Text media lines, the MGCF shall add an additional text stream to the IMS termination and configure it with the remote media description (signal 13 in figure I.4.2.5.1.1).

I.4.3 Mn Signalling procedures

I.4.3.1 Overview

This clause describes the logical signalling procedures (i.e. message identifiers are not part of the protocol) between the MGCF and IM-MGW. The procedures within this clause are intended to be implemented using the standard H.248 procedure as defined in ITU recommendation H.248.1 [2] with appropriate parameter combinations.

The procedures "Reserve IMS connection point" and "Configure IMS resources" and "Reserve IMS Connection point and configure remote resources" shall allow the configuration of two media streams; one for audio and one for Real-Time Text on the IMS termination. See clause 9.3.1.

Annex J (informative): Call Flow for Customized Alerting Tone (CAT) interworking between CS network and IMS

J.1 Introduction

This annex describes procedures for interworking Customized Alerting Tone (CAT) between the IMS and CS Networks.

J.2 IMS CAT provided by the terminating IMS user using gateway model towards user served in CS networks

Callflows for providing IMS CAT provided by the terminating IMS user towards user served in CS networks are based on procedures specified in 3GPP TS 24.182 [132], with procedures for MGCF as shown in the following clauses.

J.2.1 Callflow without using precondition mechanism

The following callflow shows the case when precondition mechanism is not used, and 100rel extension is used.

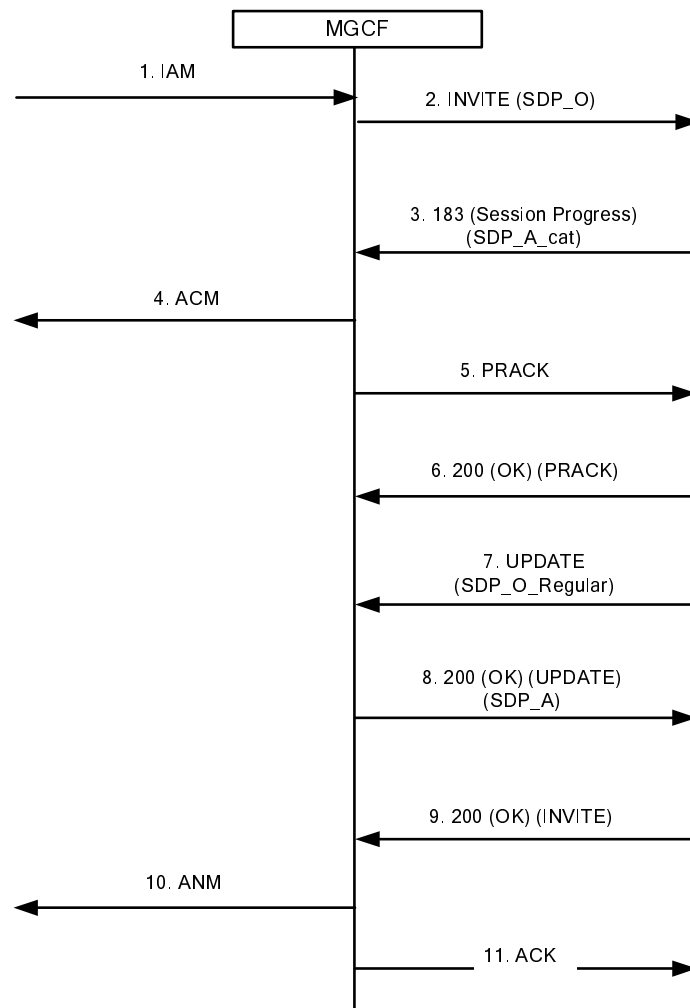

Figure J.2.1: CAT gateway model callflow without using precondition mechanism

The content of the SDP message body described in figure J.2.1 is meant to be as follows:

- SDP_O in step 2 indicates the SDP offer inserted by the MGCF;
- SDP_A_cat in step 3 indicates the SDP answer received by the MGCF, which in general is the SDP answer generated by the CAT AS based on the content for CAT media;
- SDP_O_Regular in step 7 indicates the SDP offer received by the MGCF, which in general is the SDP offer sent by the CAT AS based on the SDP answer received by the terminating UE; and
- SDP_A in step 8 indicates the SDP answer generated by the MGCF.

Upon receiving IAM (see figure J.2.1 step 1), MGCF sends SIP INVITE request containing the SDP offer to terminating IMS (see figure J.2.1 step 2).

Upon receiving 183 (Session Progress) response to the SIP INVITE request containing SDP answer (see figure J.2.1 step 3), MGCF sends ACM to the originating CS network (see figure J.2.1 step 4). Also, MGCF sends a PRACK request towards terminating IMS (see figure J.2.1 step 5). A 200 (OK) response will be received later as a result of the PRACK request (see figure J.2.1 step 6).

Upon receiving SIP UPDATE request from terminating IMS with a SDP offer (see figure J.2.1 step 7), MGCF sends a 200 (OK) response to the terminating IMS with an SDP answer (see figure J.2.1 step 8).

Upon receiving 200 (OK) response to the INVITE request sent in figure J.2.1 step 2 (see figure J.2.1 step 9), MGCF sends an ANM to the originating CS network (see figure J.2.1 step 10).

Annex K (normative): T.38 interworking between the IP Multimedia Core Network (CN) Subsystem (IMS) and Circuit Switched (CS) networks

K.1 General

This annex provides optional interworking procedures to support facsimile transported according to ITU-T Recommendation T.38 [72] transported according to IETF RFC 3362 [73] in the "UDPTL" transport format. Related Mn Signalling Procedures are also described.

To enhance interoperability, recommendations for an MGCF T.38 configuration are also provided.

NOTE: Alternatively, facsimile can also be transported as inband voice band data over IP.

K.2 Recommend T.38 configuration

UDPTL is recommended as T.38 transport.

NOTE: MTSI client use UDPTL as transport (see 3GPP TS 24.173 [88]).

Table X.2.1 lists values for the T.38 SDP attributes that are recommended to be supported.

Table K.2.1: Recommended configuration for T.38 SDP attribute values

T38FaxVersion	Version 2 or higher. (NOTE 1)
T38MaxBitRate	14 400
T38FaxFillBitRemoval	FALSE
T38FaxTranscodingMMR	FALSE
T38FaxTranscodingJBIG	FALSE
T38FaxRateManagement	"transferredTCF"
T38FaxMaxBuffer	1800
T38FaxMaxDatagram	At least 150
T38FaxMaxIFP	40 (NOTE 2)
T38FaxUdpEC	"t38UDPRedundancy"
T38FaxUdpECDepth	Minred: 1; Maxred: 2 (NOTE 2)
T38FaxUdpFECMaxSpan	3 (NOTE 2)
T38ModemType	"t38G3FaxOnly" (NOTE 2)
NOTE 1: Version 0 is the default value that applies if the T38FaxVersion SDP attribute is not signalled. No SDP attributes are defined in this T.38 version 0. With version 4, default values for the SDP attributes apply if the attributes are omitted.	
NOTE 2: Only applicable for T.38 version 4.	

K.3 Handling T.38 SDP attributes at the I-MGCF

Table K.3.1: Action at I-MGCF depending on SDP T.38 attribute values in SDP offer

	Handling of received SDP offer	Value provided in sent SDP answer
T38FaxVersion	Accept any value. Provide to the IM-MGW the received value or the maximum supported value at the IM-MGW (whatever is lower).	If I-MGCF supports received version, reply with that version. Otherwise reply with highest supported version. Provide value sent in the answer also to the IM-MGW.
T38MaxBitRate	Accept any value in the offer. Provide to the IM-MGW the received value or the maximum supported value at the IM-MGW (whatever is lower).	Supply value according to IM-MGW capabilities in the answer.
T38FaxFillBitRemoval	Accept offer with or without this attribute.	Do not include parameter in the answer. (NOTE 2).
T38FaxTranscodingMMR	Accept offer with or without this attribute.	Do not include parameter in the answer. (NOTE 2)
T38FaxTranscodingJBIG	Accept offer with or without this attribute.	Do not include parameter in the answer. (NOTE 2)
T38FaxRateManagement	Only accept calls with "transferredTCF" in the offer for T38FaxVersion 2 or higher. Otherwise reject offer (NOTE 3).	Supply "transferredTCF" value in the answer
T38FaxMaxBuffer	Accept any value in the offer. Provide to the IM-MGW the received value or the maximum supported value at the IM-MGW (whatever is lower).	Supply value according to IM-MGW capabilities in the answer.
T38FaxMaxDatagram	Accept any value in the offer. Provide to the IM-MGW the received value or the maximum supported value at the IM-MGW (whatever is lower).	Supply value according to IM-MGW capabilities in the answer.
T38FaxMaxIFP	Accept any value in the offer. If T.38 version 4 is supported by the MGW, provide to the IM-MGW the received value or the maximum supported value at the IM-MGW (whatever is lower).	If T.38 version 4 is indicated in the answer, supply value according to IM-MGW capabilities in the answer. Otherwise omit the SDP attribute from the answer.
T38FaxUdpEC	Accept value in the offer according to IM-MGW capabilities and provide it to the IM-MGW. Otherwise reject offer (NOTE 3).	Supply value according to IM-MGW capabilities in the answer.
T38FaxUdpECDepth	Accept any value in the offer. If T.38 version 4 is supported by the IM-MGW, provide to the IM-MGW the received value.	If T.38 version 4 is indicated in the answer, supply value according to IM-MGW capabilities in the answer. Otherwise omit the SDP attribute.
T38FaxUdpFECMaxSpan	Accept any value in the offer. If T.38 version 4 is supported by the IM-MGW, provide to the IM-MGW the received value.	If T.38 version 4 is indicated in the answer, supply value according to IM-MGW capabilities in the answer. Otherwise omit the SDP attribute.
T38ModemType	Accept any value in the offer. If T.38 version 4 is supported by the IM-MGW, provide to the IM-MGW the received value.	Do not include parameter in the answer. (NOTE 2)
T38VendorInfo	Accept any value in the offer.	Do not include parameter in the answer.
<p>NOTE 1: With Version 4, default values for the SDP attributes apply if the attributes are omitted.</p> <p>NOTE 2: In the Mn H.248 profile the IM-MGW does not modify the T.30 bit stream encapsulated within T.38 when passing it to or from the CS network.</p> <p>NOTE 3: If other offered media lines are acceptable, set port in media line to zero. Otherwise reject offer in INVITE request by sending the SIP status code 488 "Not Acceptable Here".</p> <p>NOTE 4: "Any value" means any valid value that conforms to ITU-T Recommendation T.38 [72].</p>		

K.4 Handling T.38 SDP attributes at the O-MGCF

Table K.4.1: T.38 SDP attributes values supplied by the O-MGCF and actions at O-MGCF depending on SDP attribute values in SDP answer

	Value provided in sent SDP offer	Handling of received SDP answer
T38FaxVersion	Supply highest version supported at MGCF and IM-MGW, maximum 3 (NOTE 1).	Accept any value. Provide to the IM-MGW the received value or the maximum supported value at the IM-MGW (whatever is lower).
T38MaxBitRate	Supply value according to IM-MGW capabilities.	Accept any value and provide it to the IM-MGW.
T38FaxFillBitRemoval	Do not include parameter (NOTE 2).	Accept offer with value "FALSE" or parameter omitted. (NOTE 3)
T38FaxTranscodingMMR	Do not include parameter (NOTE 2).	Accept offer with value "FALSE" or parameter omitted. (NOTE 3)
T38FaxTranscodingJBIG	Do not include parameter (NOTE 2).	Accept offer with value "FALSE" or parameter omitted. (NOTE 3)
T38FaxRateManagement	Supply "transferredTCF" value.	Only accept calls with "transferredTCF" in the answer for T38FaxVersion 2 or higher. (NOTE 3)
T38FaxMaxBuffer	Supply value according to IM-MGW capabilities.	Accept any value and provide it to the IM-MGW.
T38FaxMaxDatagram	Supply value according to IM-MGW capabilities	Accept any value and provide it to the IM-MGW.
T38FaxMaxIFP	If T.38 version 4 is indicated in the offer, supply value according to IM-MGW capabilities. Otherwise omit the parameter.	Accept any value. If T.38 version 4 is supported by the IM-MGW, provide it to the IM-MGW.
T38FaxUdpEC	Supply value according to IM-MGW capabilities.	Accept value according to MGW capabilities and provide it to the IM-MGW. (NOTE 3)
T38FaxUdpECDepth	If T.38 version 4 is indicated in the offer, supply value according to IM-MGW capabilities. Otherwise omit the parameter.	Accept any value. If T.38 version 4 is supported by the IM-MGW, provide it to the IM-MGW.
T38FaxUdpFECMaxSpan	If T.38 version 4 is indicated in the offer, supply value according to IM-MGW capabilities. Otherwise omit the parameter.	Accept any value. If T.38 version 4 is supported by the IM-MGW, provide it to the IM-MGW.
T38ModemType	Do not include parameter (NOTE 2).	Accept any value. If T.38 version 4 is supported by the IM-MGW, provide it to the IM-MGW.
T38VendorInfo	Do not include parameter.	Accept any value.
NOTE 1: With Version 4, default values for the SDP attributes apply if the attributes are omitted.		
NOTE 2: In the Mn H.248 profile the IM-MGW does not modify the T.30 bit stream encapsulated within T.38 when passing it to or from the CS network.		
NOTE 3: Due to SDP offer-answer procedures for this attribute, an unacceptable value in the SDP answer is due to a protocol error. The error handling at the O-MGCF is left unspecified.		
NOTE 4: "Any value" means any valid value that conforms to ITU-T Recommendation T.38 [72].		

K.5 Applicable T.38 SDP attributes at the Mn Interface

This clause lists T.38 related SDP attributes that can be signalled towards the IM-MGW as part of the codec information within the "Local IMS Resources" and "Remote IMS Resources" parameters within the "Reserve IMS connection point", "Configure IMS resources" and "Reserve IMS Connection point and configure remote resources" procedures described in clause 9.

Table K.5.1: Applicable T.38 SDP attributes at the Mn Interface

Attribute	Remarks
T38FaxVersion	T.38 SDP attributes shall only be provisioned for Version 2 or higher. Version 0 applies if attribute is omitted.
T38MaxBitRate	
T38FaxMaxBuffer	
T38FaxMaxDatagram	
T38FaxMaxIFP	Only if T.38 version 4 is supported by the IM-MGW
T38FaxUdpEC	
T38FaxUdpECDepth	Only if T.38 version 4 is supported by the IM-MGW
T38FaxUdpFECMaxSpan	Only if T.38 version 4 is supported by the IM-MGW
T38ModemType	Only if T.38 version 4 is supported by the IM-MGW

Annex L (informative): Change history

Change history							
Date	TSG #	TSG Doc.	CR	Rev	Subject/Comment	Old	New
2013-06	CP#60	CP-130344	747	1	Privacy mapping clarifications	11.7.0	12.0.0
2013-09	CP#61	CP-130546	761	1	Updating IMEI URN draft reference	12.0.0	12.1.0
2013-09	CP#61	CP-130556	762	1	Call back from PSAP	12.0.0	12.1.0
2013-09	CP#61	CP-130540	767	1	Interworking of ISDN subaddress information at O-MGCF	12.0.0	12.1.0
2013-09	CP#61	CP-130538	773	1	Erroneous reference to Table 17	12.0.0	12.1.0
2013-09	CP#61	CP-130545	781	1	Mapping Location Number to P-Access-Network-Info header field	12.0.0	12.1.0
2013-09	CP#61	CP-130562	782	1	From mapping clarifications	12.0.0	12.1.0
2013-09	CP#61	CP-130562	783	1	P-Early-Media header in MGCF	12.0.0	12.1.0
2013-09	CP#61	CP-130538	788	1	UDI & H.223 & H.245 indication	12.0.0	12.1.0
2013-12	CP#62	CP-130662	796	1	Reference Update: draft-ietf-salud-alert-info-urns	12.1.0	12.2.0
2013-12	CP#62	CP-130667	800		Updating IMEI URN draft reference	12.1.0	12.2.0
2013-12	CP#62	CP-130695	801	1	Usage of IETF RFC 4575	12.1.0	12.2.0
2013-12	CP#62	CP-130696	803		Reference update: draft-ietf-ecrit-psap-callback	12.1.0	12.2.0
2013-12	CP#62	CP-130695	804	1	Update to IETF RFC 6665	12.1.0	12.2.0
2014-02	CP#63	CP-140067	807		Updating IMEI URN draft reference	12.2.0	12.3.0
2014-02	CP#63	CP-140089	802	2	Support of terminating ICS calls	12.2.0	12.3.0
2014-02	CP#63	CP-140089	791	4	Support for both-way early media for UID	12.2.0	12.3.0
2014-03	-	-	-	-	"B.X" corrected in "B.4" in clause 7.2.3.1.2.12	12.3.0	12.3.1
2014-06	CP#64	CP-140355	820	1	Correction on the ISUP parameter name in the mapping table	12.3.1	12.4.0
2014-06	CP#64	CP-140380	814	-	Reference update: RFC 7090 (draft-ietf-ecrit-psap-callback)	12.3.1	12.4.0
2014-06	CP#64	CP-140395	813	2	ICE support for Mn interface stage 2	12.3.1	12.4.0
2014-06	CP#64	CP-140398	812	2	CS originating call hold during ICS call	12.3.1	12.4.0
2014-09	CT-65	CP-140527	0825	-	Updating IMEI URN draft reference to RFC 7254	12.4.0	12.5.0
2014-09	CT-65	CP-140532	0826	1	Correction of the abbreviation NOA	12.4.0	12.5.0
2014-09	CT-65	CP-140542	0827	1	ICE: miscellaneous corrections	12.4.0	12.5.0
2014-12	CT-66	CP-140917	0828		ICS call: reference correction	12.5.0	12.6.0
2014-12	CT-66	CP-140917	0829	1	Announcement suppression for IMS hold request	12.5.0	12.6.0
2014-12	CT-66	CP-140933	831	1	Adding support for EVS codec	12.5.0	12.6.0
2014-12	CT-66	CP-140917	832	1	Note 4 in Table 3 for mapping to CLI parameter	12.5.0	12.6.0
2014-12	CT-66	CP-140917	833	4	Appearance of Redirection Number Restriction parameter	12.5.0	12.6.0
2014-12	CT-66	CP-140924	836	4	Inclusion of RFC7044	12.5.0	12.6.0
2015-03	CT-67	CP-150121	862		Correction of EVS related reference number	12.6.0	12.7.0
2015-03	CT-67	CP-150095	860	1	Reference update for UUSIW	12.6.0	12.7.0
2015-03	CT-67	CP-150097	854	2	Correction of APRI Mapping for Generic Number	12.6.0	12.7.0
2015-03	CT-67	CP-150108	848	1	Correction to attribute "a=inactive" in initial INVITE	12.6.0	12.7.0
2015-03	CT-67	CP-150121	867		Removal of duplicated reference	12.6.0	12.7.0
2015-06	CT-68	CP-150336	0872	-	Reference Update: RFC7462 (alert-info urns)	12.7.0	12.8.0
2015-06	CT-68	CP-150335	0885	2	User-to-user information interworking	12.7.0	12.8.0
2015-06	CT-68	CP-150338	0892	1	APRI Mapping for mutiple Privacy header values	12.7.0	12.8.0
2015-06	CT-68	CP-150351	0894	-	Bearer Termination in Acknowledgements	12.7.0	12.8.0
2015-06	CT-68	CP-150334	0900	3	URI scheme in History-Info header field	12.7.0	12.8.0
2015-06	CT-68	CP-150353	0903	1	EVS corrections	12.7.0	12.8.0
2015-09	CT-69	CP-150470	0911	1	Indication of "no backward early media" for ICS call	12.8.0	12.9.0
2015-09	CT-69	CP-150462	0919	2	Sending of IAM at I-MGCF for SIP-BICC-interworking	12.8.0	12.9.0
2015-12	CT-70	CP-150670	0930	2	URI scheme in History-Info header field	12.9.0	12.10.0
2015-12	CT-70	CP-150655	0932	1	ICS call: removal of non-interworking requirement	12.9.0	12.10.0
2015-12	CT-70	CP-150670	0945	1	Removal for the unsupported SIPS URI scheme	12.9.0	12.10.0

History

Document history		
V12.5.0	October 2014	Publication
V12.6.0	January 2015	Publication
V12.7.0	April 2015	Publication
V12.8.0	July 2015	Publication
V12.9.0	October 2015	Publication
V12.10.0	January 2016	Publication