

# ETSI TS 129 204 V18.0.0 (2024-05)



**Digital cellular telecommunications system (Phase 2+) (GSM);  
Universal Mobile Telecommunications System (UMTS);  
Signalling System No. 7 (SS7) security gateway;  
Architecture, functional description and protocol details  
(3GPP TS 29.204 version 18.0.0 Release 18)**



---

**Reference**

RTS/TSGC-0429204vi00

---

**Keywords**

GSM,UMTS

**ETSI**

650 Route des Lucioles  
F-06921 Sophia Antipolis Cedex - FRANCE

---

Tel.: +33 4 92 94 42 00 Fax: +33 4 93 65 47 16

Siret N° 348 623 562 00017 - APE 7112B  
Association à but non lucratif enregistrée à la  
Sous-Préfecture de Grasse (06) N° w061004871

---

**Important notice**

The present document can be downloaded from:

<https://www.etsi.org/standards-search>

The present document may be made available in electronic versions and/or in print. The content of any electronic and/or print versions of the present document shall not be modified without the prior written authorization of ETSI. In case of any existing or perceived difference in contents between such versions and/or in print, the prevailing version of an ETSI deliverable is the one made publicly available in PDF format at [www.etsi.org/deliver](http://www.etsi.org/deliver).

Users of the present document should be aware that the document may be subject to revision or change of status.

Information on the current status of this and other ETSI documents is available at

<https://portal.etsi.org/TB/ETSIDeliverableStatus.aspx>

If you find errors in the present document, please send your comment to one of the following services:

<https://portal.etsi.org/People/CommitteeSupportStaff.aspx>

If you find a security vulnerability in the present document, please report it through our  
Coordinated Vulnerability Disclosure Program:

<https://www.etsi.org/standards/coordinated-vulnerability-disclosure>

---

**Notice of disclaimer & limitation of liability**

The information provided in the present deliverable is directed solely to professionals who have the appropriate degree of experience to understand and interpret its content in accordance with generally accepted engineering or other professional standard and applicable regulations.

No recommendation as to products and services or vendors is made or should be implied.

No representation or warranty is made that this deliverable is technically accurate or sufficient or conforms to any law and/or governmental rule and/or regulation and further, no representation or warranty is made of merchantability or fitness for any particular purpose or against infringement of intellectual property rights.

In no event shall ETSI be held liable for loss of profits or any other incidental or consequential damages.

Any software contained in this deliverable is provided "AS IS" with no warranties, express or implied, including but not limited to, the warranties of merchantability, fitness for a particular purpose and non-infringement of intellectual property rights and ETSI shall not be held liable in any event for any damages whatsoever (including, without limitation, damages for loss of profits, business interruption, loss of information, or any other pecuniary loss) arising out of or related to the use of or inability to use the software.

---

**Copyright Notification**

No part may be reproduced or utilized in any form or by any means, electronic or mechanical, including photocopying and microfilm except as authorized by written permission of ETSI.

The content of the PDF version shall not be modified without the written authorization of ETSI.

The copyright and the foregoing restriction extend to reproduction in all media.

© ETSI 2024.  
All rights reserved.

---

# Intellectual Property Rights

## Essential patents

IPRs essential or potentially essential to normative deliverables may have been declared to ETSI. The declarations pertaining to these essential IPRs, if any, are publicly available for **ETSI members and non-members**, and can be found in ETSI SR 000 314: "*Intellectual Property Rights (IPRs); Essential, or potentially Essential, IPRs notified to ETSI in respect of ETSI standards*", which is available from the ETSI Secretariat. Latest updates are available on the ETSI Web server (<https://ipr.etsi.org/>).

Pursuant to the ETSI Directives including the ETSI IPR Policy, no investigation regarding the essentiality of IPRs, including IPR searches, has been carried out by ETSI. No guarantee can be given as to the existence of other IPRs not referenced in ETSI SR 000 314 (or the updates on the ETSI Web server) which are, or may be, or may become, essential to the present document.

## Trademarks

The present document may include trademarks and/or tradenames which are asserted and/or registered by their owners. ETSI claims no ownership of these except for any which are indicated as being the property of ETSI, and conveys no right to use or reproduce any trademark and/or tradename. Mention of those trademarks in the present document does not constitute an endorsement by ETSI of products, services or organizations associated with those trademarks.

**DECT™**, **PLUGTESTS™**, **UMTS™** and the ETSI logo are trademarks of ETSI registered for the benefit of its Members. **3GPP™** and **LTE™** are trademarks of ETSI registered for the benefit of its Members and of the 3GPP Organizational Partners. **oneM2M™** logo is a trademark of ETSI registered for the benefit of its Members and of the oneM2M Partners. **GSM®** and the GSM logo are trademarks registered and owned by the GSM Association.

---

# Legal Notice

This Technical Specification (TS) has been produced by ETSI 3rd Generation Partnership Project (3GPP).

The present document may refer to technical specifications or reports using their 3GPP identities. These shall be interpreted as being references to the corresponding ETSI deliverables.

The cross reference between 3GPP and ETSI identities can be found under <https://webapp.etsi.org/key/queryform.asp>.

---

# Modal verbs terminology

In the present document "**shall**", "**shall not**", "**should**", "**should not**", "**may**", "**need not**", "**will**", "**will not**", "**can**" and "**cannot**" are to be interpreted as described in clause 3.2 of the [ETSI Drafting Rules](#) (Verbal forms for the expression of provisions).

"**must**" and "**must not**" are **NOT** allowed in ETSI deliverables except when used in direct citation.

# Contents

Intellectual Property Rights .....	2
Legal Notice .....	2
Modal verbs terminology.....	2
Foreword.....	4
Introduction .....	4
1 Scope .....	5
2 References .....	5
3 Definitions and abbreviations.....	5
3.1 Definitions .....	5
3.2 Abbreviations .....	6
4 Network architecture .....	6
4.1 Scenarios .....	6
4.1.1 Outbound traffic (not yet protected) from own to foreign NE.....	7
4.1.2 Inbound traffic from foreign to own NE .....	7
4.1.3 Inbound transit traffic .....	8
4.1.4 Outbound transit traffic (not relayed) .....	9
4.1.5 Outbound traffic from own to own NE.....	9
4.1.6 Inbound traffic from own to own NE .....	10
4.1.7 Outbound traffic from foreign to own NE .....	11
4.1.8 Inbound traffic from own to foreign NE.....	11
4.1.9 Outbound traffic (already protected) from own to foreign NE .....	12
4.1.10 Outbound transit traffic (relayed by SRF) .....	13
5 Detailed Behaviour of the SS7 Security Gateway.....	13
5.1 TCAP user traffic .....	13
5.1.1 General.....	13
5.1.2 Interactions with Mobile Number Portability .....	28
5.1.3 Interactions with SCCP segmentation.....	28
5.1.4 Protocol details .....	29
5.1.4.1 Transformation of unprotected message to protected message .....	29
5.1.4.2 Transformation of protected message to unprotected message .....	33
5.1.4.3 Handling of received XUDTS messages and UDTS messages.....	36
<b>Annex A (informative): Change history .....</b>	<b>39</b>
History .....	40

---

# Foreword

This Technical Specification has been produced by the 3<sup>rd</sup> Generation Partnership Project (3GPP).

The contents of the present document are subject to continuing work within the TSG and may change following formal TSG approval. Should the TSG modify the contents of the present document, it will be re-released by the TSG with an identifying change of release date and an increase in version number as follows:

Version x.y.z

where:

- x the first digit:
  - 1 presented to TSG for information;
  - 2 presented to TSG for approval;
  - 3 or greater indicates TSG approved document under change control.
- y the second digit is incremented for all changes of substance, i.e. technical enhancements, corrections, updates, etc.
- z the third digit is incremented when editorial only changes have been incorporated in the document.

---

# Introduction

The absence of security in Signalling System No. 7 (SS7) networks is an identified security weakness in 2G systems. This was formerly perceived not to be a problem, since the SS7 networks were the provinces of a small number of large institutions. This is no longer the case, and so there is now a need for security precautions.

For 3G systems it is a clear goal to be able to protect inter-network SS7 signalling protocols. The protection is done by security gateways which are located at the network border. As a consequence intra network SS7 signalling is not protected and network elements other than Security Gateways are not impacted.

---

# 1 Scope

The present document provides functional description of the SS7 Security Gateway. The document covers also network architecture, routing considerations, and protocol details.

---

## 2 References

The following documents contain provisions which, through reference in this text, constitute provisions of the present document.

- References are either specific (identified by date of publication, edition number, version number, etc.) or non-specific.
- For a specific reference, subsequent revisions do not apply.
- For a non-specific reference, the latest version applies. In the case of a reference to a 3GPP document (including a GSM document), a non-specific reference implicitly refers to the latest version of that document *in the same Release as the present document*.

- [1] 3GPP TS 29.002: "Mobile Application Part (MAP) specification".
- [2] 3GPP TS 29.078: "Customized Applications for Mobile network Enhanced Logic (CAMEL) Phase 4; CAMEL Application Part (CAP) specification".
- [3] ETSI ETS 300 358: "ISDN Completion of Calls to Busy Subscriber (CCBS) supplementary service; Functional capabilities and information flows".
- [4] 3GPP TS 23.066: "Support of GSM Mobile Number Portability (MNP) stage 2".
- [5] ITU-T Recommendation Q.773: "Specifications of Signalling System No.7; Transaction capabilities formats and encoding".
- [6] 3GPP TS 33.200: "3G Security; Network Domain Security (NDS); Mobile Application Part (MAP) application layer security".
- [7] ITU-T Recommendation E.164: "The international public telecommunication numbering plan".
- [8] 3GPP TS 33.204: "3G Security; Network Domain Security (NDS); Transaction Capabilities Application Part (TCAP) user security".
- [9] ITU-T Recommendations Q.711 to Q.716 (07/96), White Book Signalling Connection Control Part (SCCP).
- [10] 3GPP TS 21.905: "Vocabulary for 3GPP Specifications".

---

## 3 Definitions and abbreviations

### 3.1 Definitions

For the purposes of the present document, the terms and definitions given in TR 21.905 [10] and the following apply. A term defined in the present document takes precedence over the definition of the same term, if any, in TR 21.905 [10].

TCAP user:	Application Part identified by one of the following SCCP Subsystem Numbers:
	0000 0110 HLR (MAP)
	0000 0111 VLR (MAP)
	0000 1000 MSC (MAP)
	0000 1001 EIR (MAP)
	0000 1010 is allocated for evolution (possible Authentication Centre)
	1001 0001 GMLC (MAP)

1001 0010	CAP
1001 0011	gsmSCF (MAP) or IM-SSF (MAP) or Presence Network Agent
1001 0101	SGSN (MAP)
1001 0110	GGSN (MAP)
0000 1011	SSAP

## 3.2 Abbreviations

For the purposes of the present document, the following abbreviations apply:

CC	Country Code
GSMA	Global System for Mobile communications Association
IV	Initialisation Vector
MAC	Message Authentication Code
MNP	Mobile Number Portability
MSISDN	Mobile Station International ISDN Number
NDC	National Destination Code
NE	Network Entity
PLMN	Public Land Mobile Network
RN	Routing Number
SAD	Security Association Database
SEG	Security Gateway
SPD	Security Policy Database
SPI	Security Parameter Index
SRF	Signalling Relay Function
TCAP	Transaction Capabilities Application Part
UDT	SCCP Unitdata message
XUDT	SCCP Extended Unitdata message

---

## 4 Network architecture

In a PLMN that employs SS7 Security Gateways all TCAP user signalling messages entering or leaving the PLMN have to transit an SS7 Security Gateway which belongs to the PLMN and which performs the protection of leaving (i.e. outbound) messages and the protection checking and de-protection or blocking of entering (i.e. inbound) messages.

One or several SS7 Security Gateways may be employed within a PLMN.

An SS7 Security Gateway may be co-located with any TCAP user NE or it may stand alone. However, for the purpose of this document and without imposing any restrictions, it is assumed that the SS7 Security Gateway is a stand alone entity.

It is further assumed that the SS7 Security Gateways are located at the border of the PLMN i.e. inbound messages transit an SS7 Security Gateway before they reach any other node within the PLMN, and outbound messages transit an SS7 Security Gateway immediately before reaching a node outside the PLMN.

SS7 routing is not impacted by the SS7 Security Gateway Architecture. As a consequence SS7 Security Gateways are stateless at TCAP level: No TCAP dialogue states are maintained in the SS7 Security Gateway since the outbound dialogue request message may transit a different SS7 Security Gateway than the corresponding inbound dialogue response message; similarly the inbound dialogue request message may transit a different SS7 Security Gateway than the corresponding outbound dialogue response message.

### 4.1 Scenarios

SS7 Security Gateways perform protection, de-protection, blocking and unmodified passing of TCAP user messages depending on the scenario as described below:

Note that scenarios 4.1.5, 4.1.6, 4.1.7, 4.1.8, and 4.1.9 are not applicable if all PLMN's TCAP user NEs are interconnected by PLMN internal signalling links and routing tables are set up not to allow these scenarios.

### 4.1.1 Outbound traffic (not yet protected) from own to foreign NE

This scenario is shown in figure 4.1.1. The message is originated at a NE inside the PLMN. It may transit several transit nodes inside the PLMN before it reaches the SS7 Security Gateway. This SS7 Security Gateway protects the message according to the relevant Security Policy with the relevant Security Association. The message may then transit several nodes outside the PLMN (including an SS7 Security Gateway) before it reaches its destination.

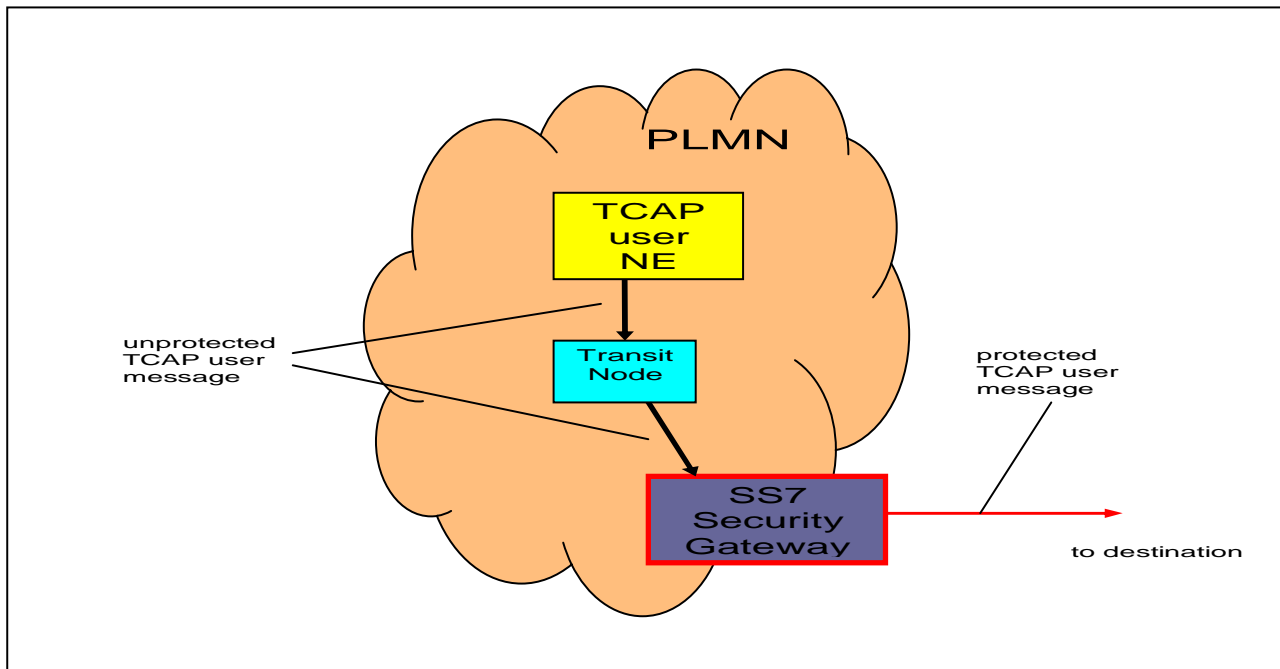


Figure 4.1.1: Outbound traffic (not yet protected) from own to foreign NE

### 4.1.2 Inbound traffic from foreign to own NE

This scenario is shown in figure 4.1.2. The message is originated at a NE outside the PLMN. It may transit several transit nodes (including an SS7 Security Gateway) outside the PLMN before it reaches the PLMN's SS7 Security Gateway. This SS7 Security Gateway checks whether the message is correctly protected according to the relevant security association. If it is not, the message is blocked (discarded), otherwise it is de-protected. To determine the relevant security association the fact that the message may have been relayed by an MNP-SRF in a transit network (see Clause 4.1.10 and 5.1.2) needs to be taken into account. After successful de-protection the message may then transit several nodes inside the PLMN before it reaches the TCAP user NE.



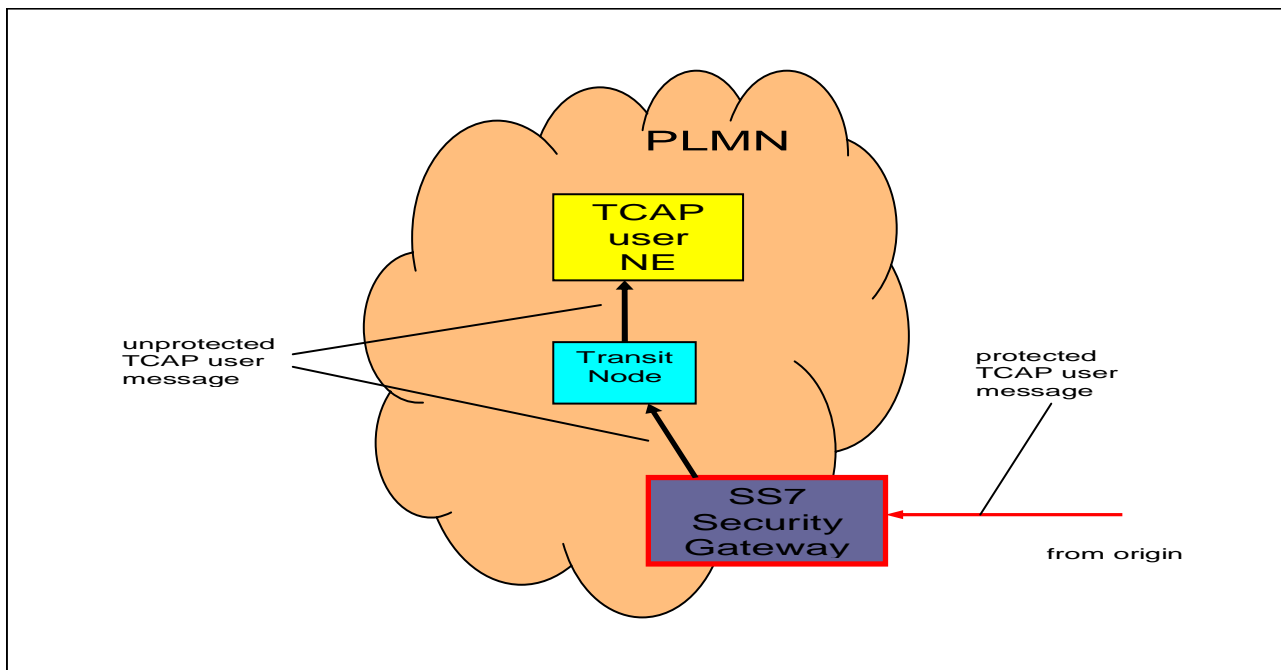


Figure 4.1.2: Inbound traffic from foreign to own NE

### 4.1.3 Inbound transit traffic

This scenario is shown in figure 4.1.3. The message is originated at a NE outside the transit PLMN. It may transit several transit nodes outside the transit PLMN before it reaches the SS7 Security Gateway in inbound direction. This SS7 Security Gateway passes the message unmodified. The message may then transit several transit nodes inside the transit PLMN, another SS7 Security Gateway of the transit PLMN in outbound direction (see Clause 4.1.4), and several transit nodes outside the transit and destination PLMN (potentially including an SS7 Security Gateway) before it reaches the destination PLMN.

Note: A PLMN operator may decide not to act as transit network for specific or all combinations of origin and destination. In this case the SS7 Security Gateway may block the inbound message.

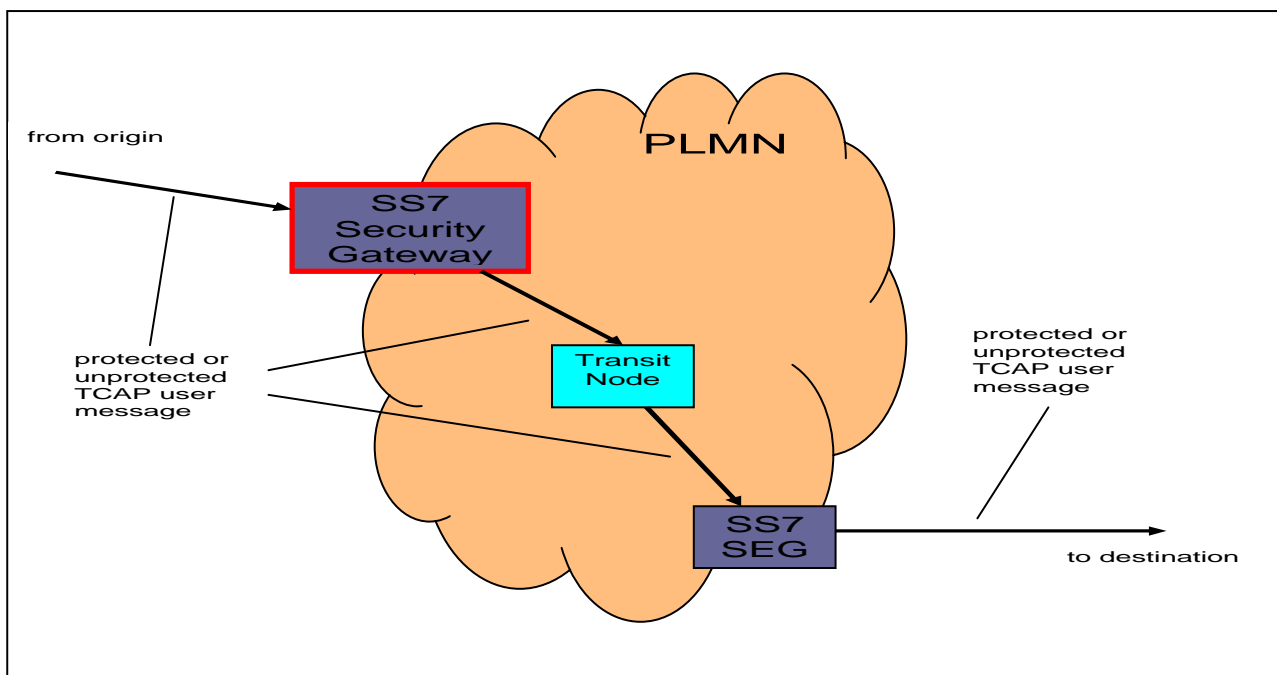


Figure 4.1.3: Inbound transit traffic

#### 4.1.4 Outbound transit traffic (not relayed)

This scenario is shown in figure 4.1.4. The message is originated at a NE outside the transit PLMN. It may transit several transit nodes outside the transit PLMN (including an SS7 Security Gateway), an SS7 Security Gateway of the transit PLMN in inbound direction (see Clause 4.1.3), and several transit nodes inside the transit PLMN before it reaches the SS7 Security Gateway in outbound direction. This SS7 Security Gateway passes the message unmodified. The message may then transit several transit nodes outside the transit and destination PLMN (potentially including an SS7 Security Gateway) before it reaches the destination PLMN.

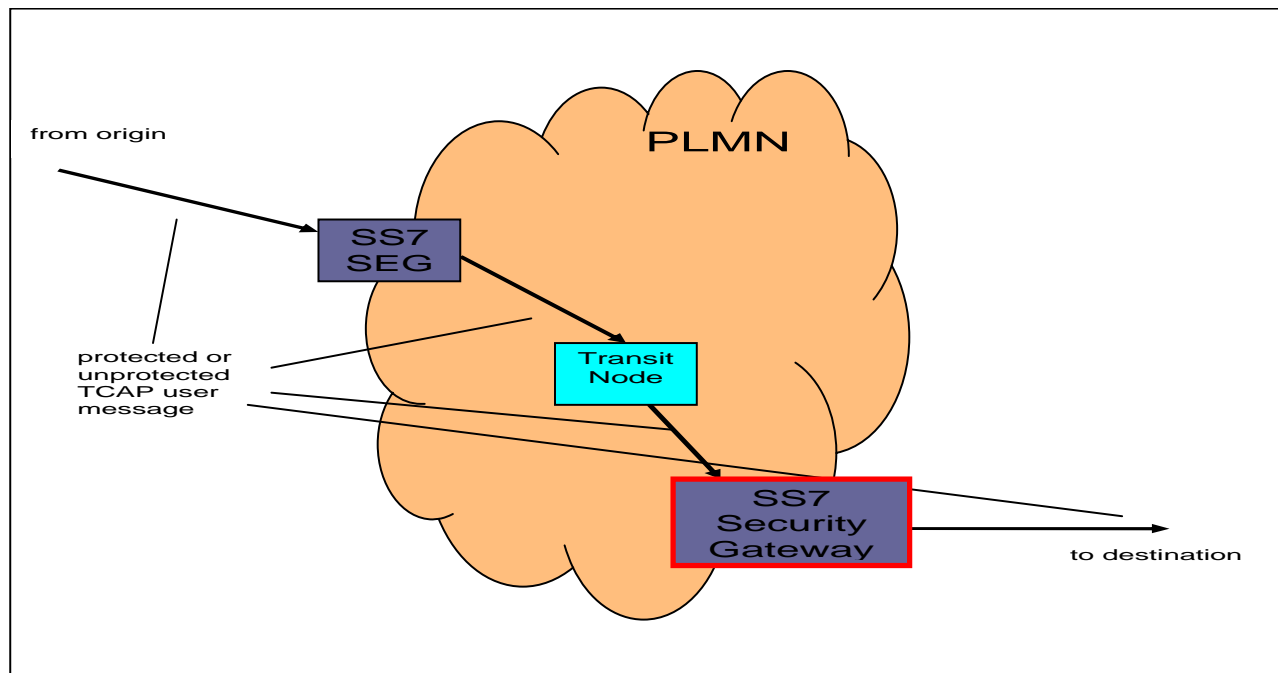


Figure 4.1.4: Outbound transit traffic (not relayed)

#### 4.1.5 Outbound traffic from own to own NE

This scenario is shown in figure 4.1.5. The message is originated at a NE inside the PLMN. It may transit several transit nodes inside the PLMN before it reaches the SS7 Security Gateway in outbound direction. This SS7 Security Gateway protects the message according to the relevant Security Association. The message may then transit several transit nodes outside the PLMN, another SS7 Security Gateway of the PLMN in inbound direction (see Clause 4.1.6) and several transit nodes within the PLMN before it reaches the destination NE inside the PLMN.

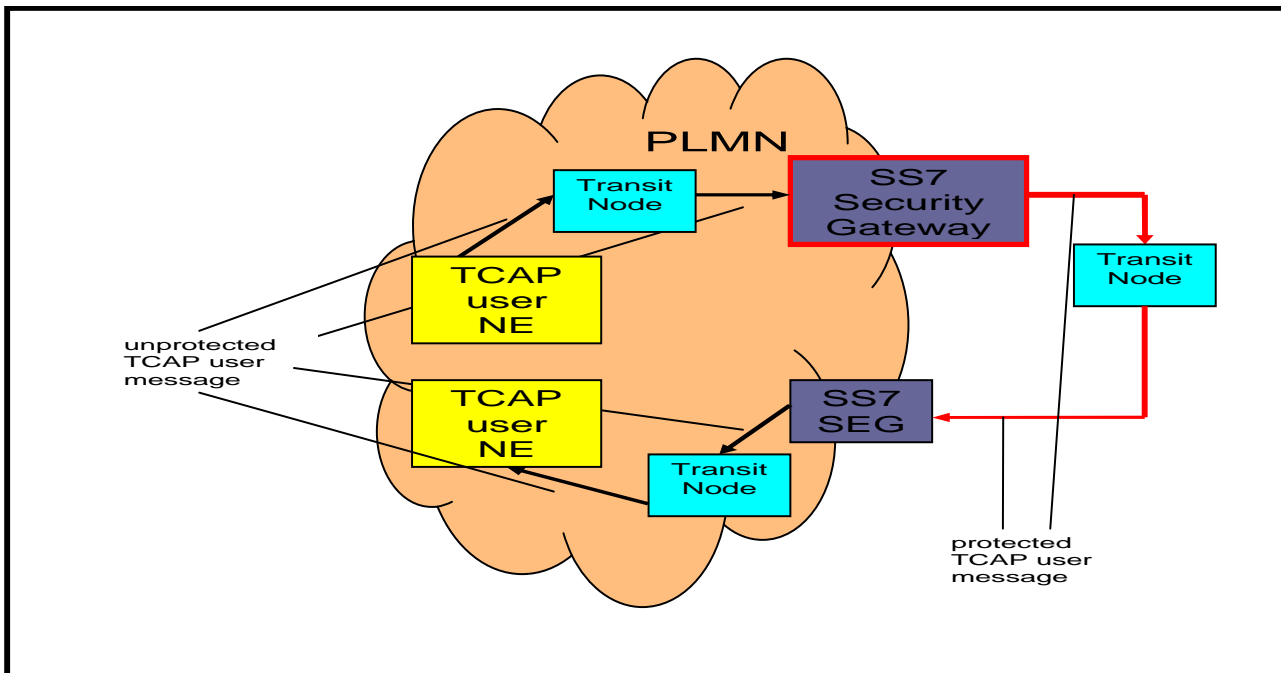


Figure 4.1.5: Outbound traffic from own to own NE

### 4.1.6 Inbound traffic from own to own NE

This scenario is shown in figure 4.1.6. The message is originated at a NE inside the PLMN. It may transit several transit nodes inside the PLMN, an SS7 Security Gateway of the PLMN in outbound direction (see Clause 4.1.5), and several transit nodes outside the PLMN before it reaches the SS7 Security Gateway in inbound direction. This SS7 Security Gateway checks whether the message is correctly protected according to the relevant Security Association. If it is not, the message is blocked (discarded), otherwise it is de-protected. The message may then transit several transit nodes inside the PLMN before it reaches the destination NE inside the PLMN.

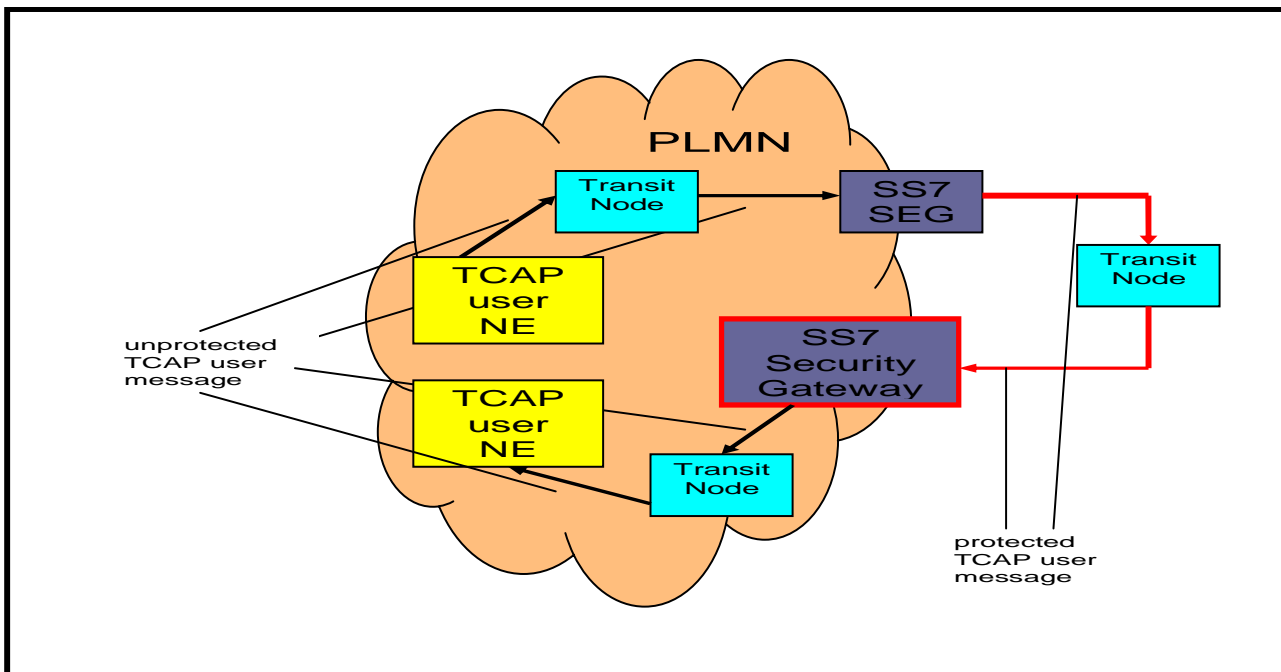


Figure 4.1.6: Inbound traffic from own to own NE

### 4.1.7 Outbound traffic from foreign to own NE

This scenario is shown in figure 4.1.7. The message is originated at a NE outside the PLMN. It may transit several transit nodes outside the PLMN, an SS7 Security Gateway of the PLMN in inbound direction (see Clause 4.1.2), and several transit nodes inside the PLMN before it reaches the SS7 Security Gateway in outbound direction. This SS7 Security Gateway protects the message according to the reverse relevant Security Association. The message may then transit several transit nodes outside the PLMN, another SS7 Security Gateway of the PLMN in inbound direction (see Clause 4.1.2) and several transit nodes within the PLMN before it reaches the destination NE inside the PLMN.

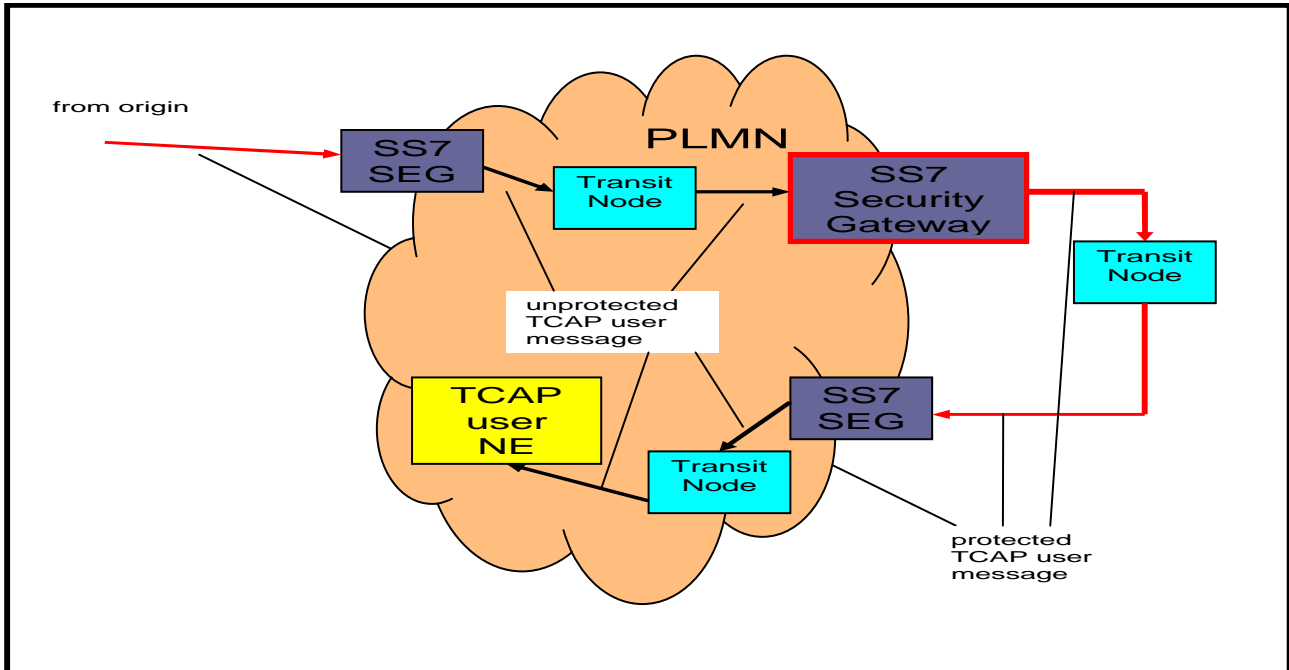


Figure 4.1.7: Outbound traffic from foreign to own NE

### 4.1.8 Inbound traffic from own to foreign NE

This scenario is shown in figure 4.1.8. The message is originated at a NE inside the PLMN. It may transit several transit nodes inside the PLMN, an SS7 Security Gateway of the PLMN in outbound direction (see Clause 4.1.1), and several transit nodes outside the PLMN before it reaches the SS7 Security Gateway in inbound direction. This SS7 Security Gateway checks whether the message is correctly protected according to the relevant security association. If it is not, the message is blocked (discarded); otherwise it is passed unmodified. The message may then transit several transit nodes inside the PLMN, another SS7 Security Gateway of the PLMN in outbound direction (see Clause 4.1.9) and several transit nodes outside the PLMN (including an SS7 Security Gateway) before it reaches the destination NE outside the PLMN.

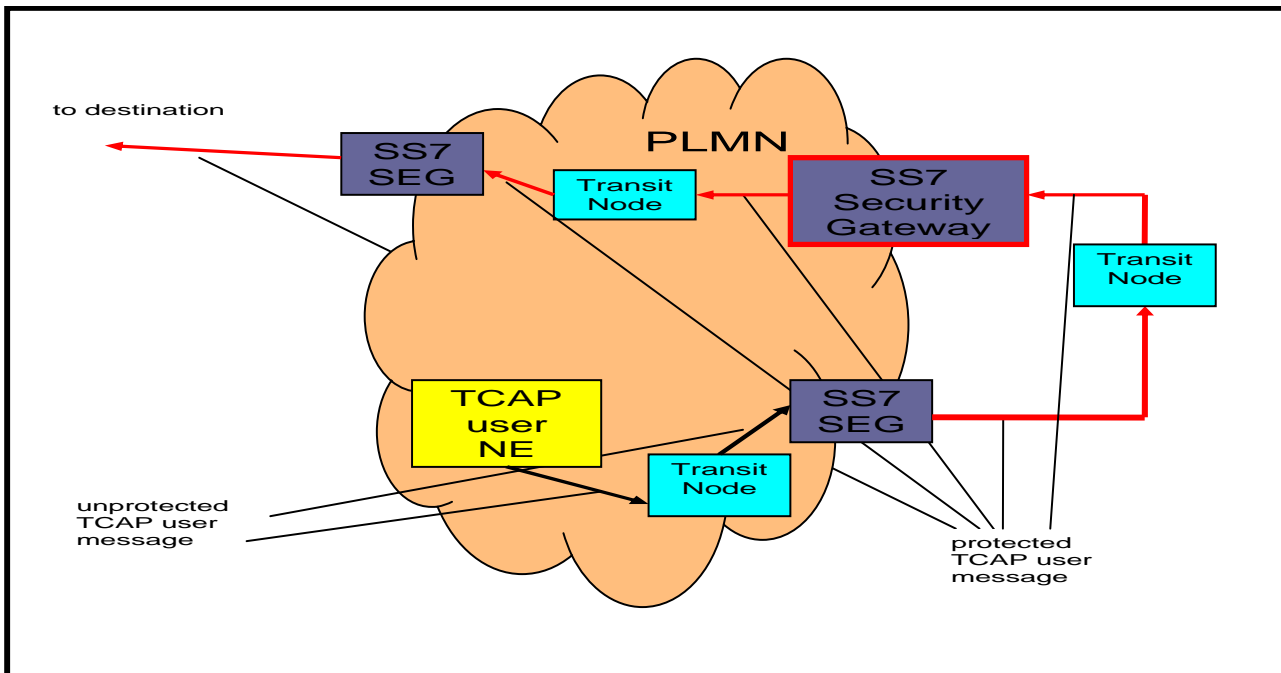


Figure 4.1.8: Inbound traffic from own to foreign NE

#### 4.1.9 Outbound traffic (already protected) from own to foreign NE

This scenario is shown in figure 4.1.9. The message is originated at a NE inside the PLMN. It may transit several transit nodes inside the PLMN, an SS7 Security Gateway of the PLMN in outbound direction (see Clause 4.1.1), several transit nodes outside the PLMN, an SS7 Security Gateway of the PLMN in inbound direction (see Clause 4.1.8), and several transit nodes inside the PLMN before it reaches the SS7 Security Gateway. This SS7 Security Gateway passes the message unmodified. The message may then transit several transit nodes outside the PLMN (including an SS7 Security Gateway) before it reaches the destination NE outside the PLMN.

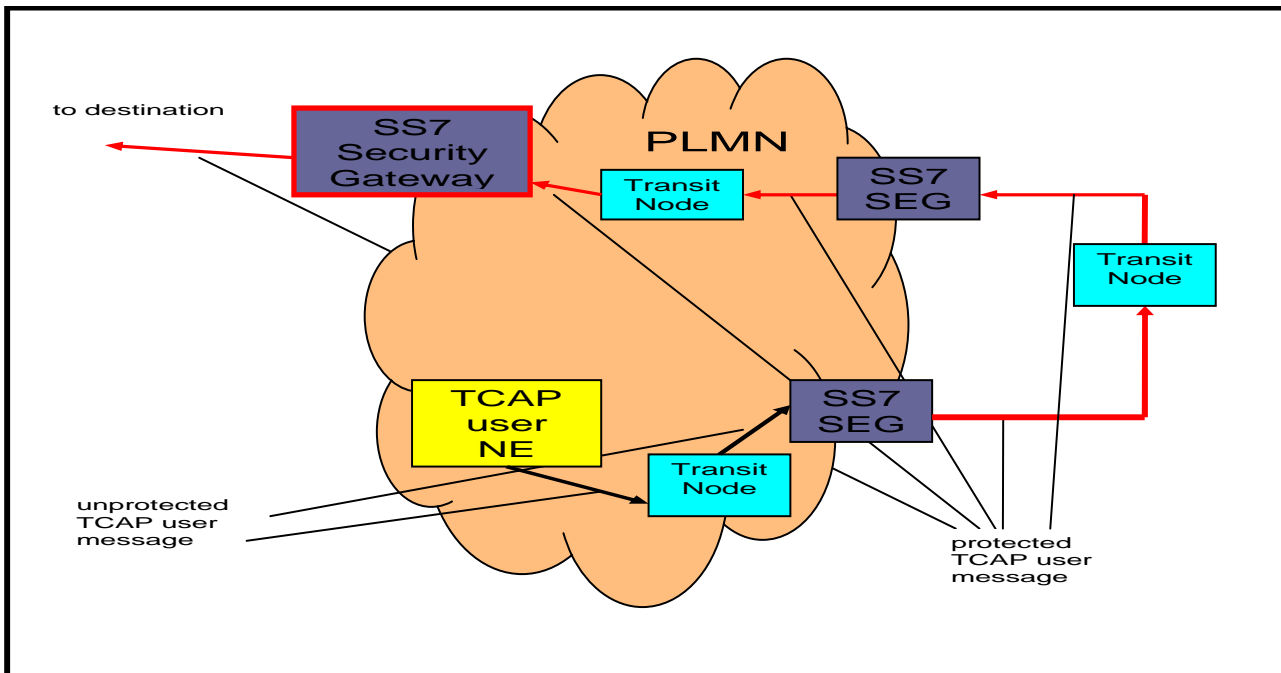


Figure 4.1.9: Outbound traffic (already protected) from own to foreign NE

### 4.1.10 Outbound transit traffic (relayed by SRF)

This scenario is shown in figure 4.1.10. The message (originally destined for the PLMN) is originated at a NE outside the transit PLMN. It may transit several transit nodes outside the transit PLMN (including an SS7 Security Gateway), an SS7 Security Gateway of the transit PLMN in inbound direction (see Clause 4.1.2), several transit nodes inside the transit PLMN, and an MNP-SRF which replaces the SCCP called party address of the message before it reaches the SS7 Security Gateway in outbound direction. This SS7 Security Gateway recognizes that the message was relayed by an SRF by analyzing the SCCP called party address and protects the message with the relevant Security Association. The message may then transit several transit nodes outside the transit and destination PLMN (potentially including an SS7 Security Gateway) before it reaches the destination PLMN.

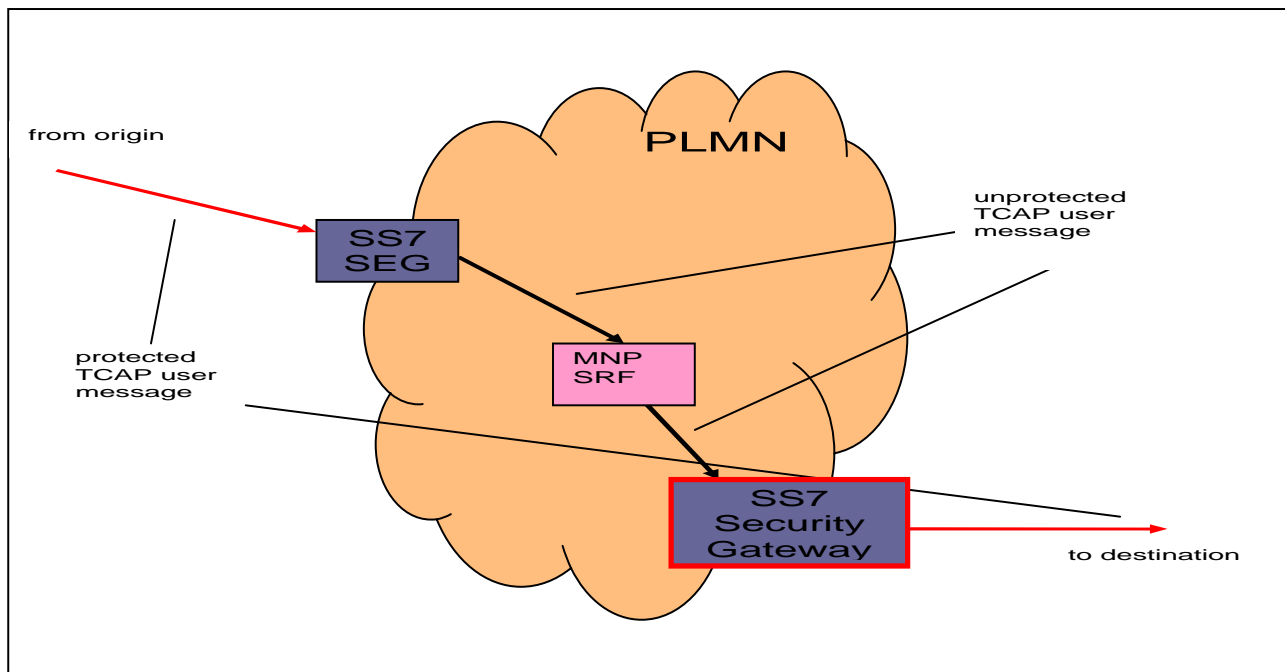


Figure 4.1.10: Outbound transit traffic (relayed by SRF)

## 5 Detailed Behaviour of the SS7 Security Gateway

### 5.1 TCAP user traffic

#### 5.1.1 General

With regard to TCAP user traffic the SS7 Security Gateway performs message protection, protection checking and de-protection, transparent passing, and blocking of messages depending on the message's origin (SCCP calling party address), the message's destination (SCCP called party address), and the message's direction (inbound or outbound) as shown in figure 5.1.1.

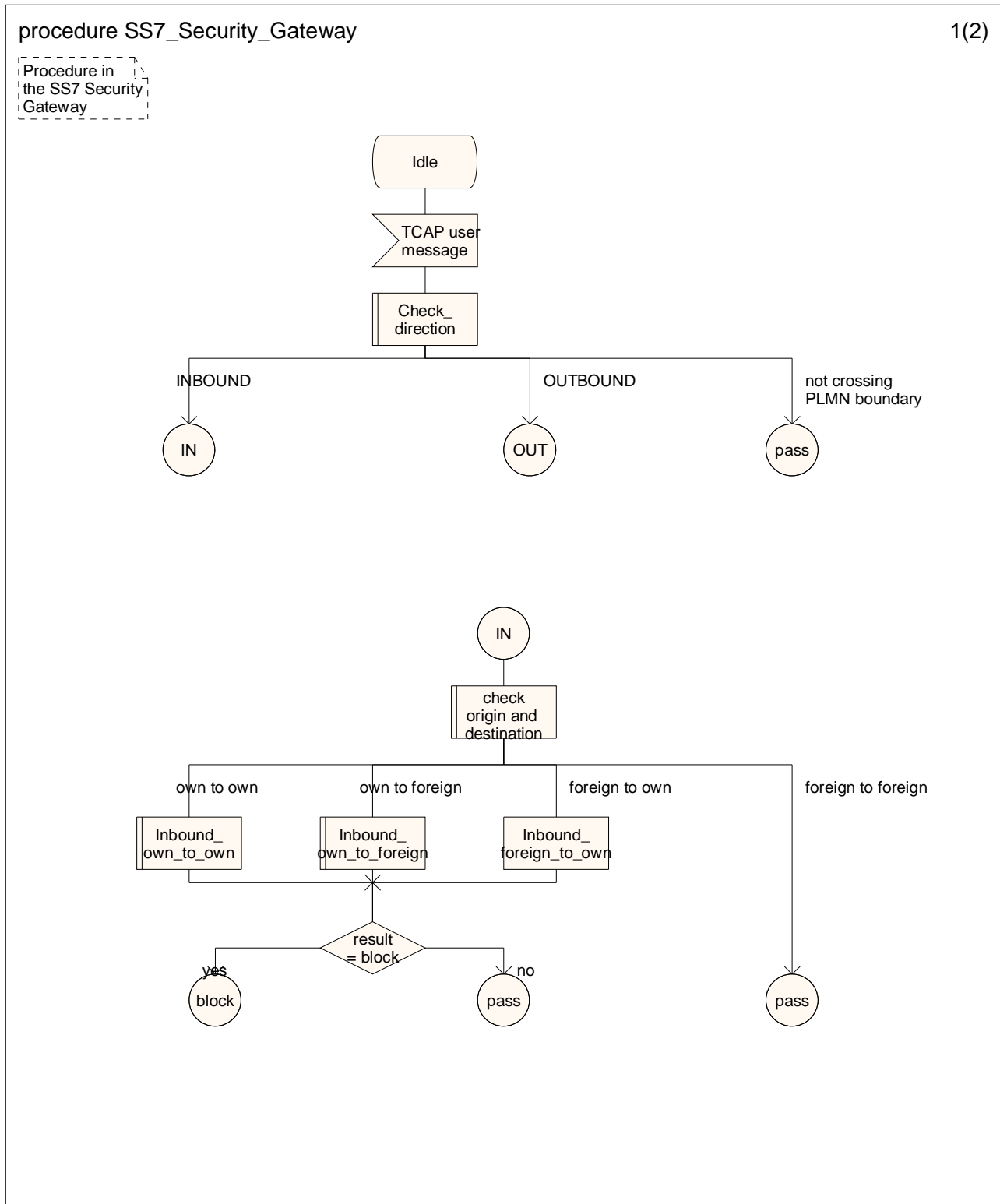


Figure 5.1.1 Process SS7 Security Gateway (sheet 1 of 2)

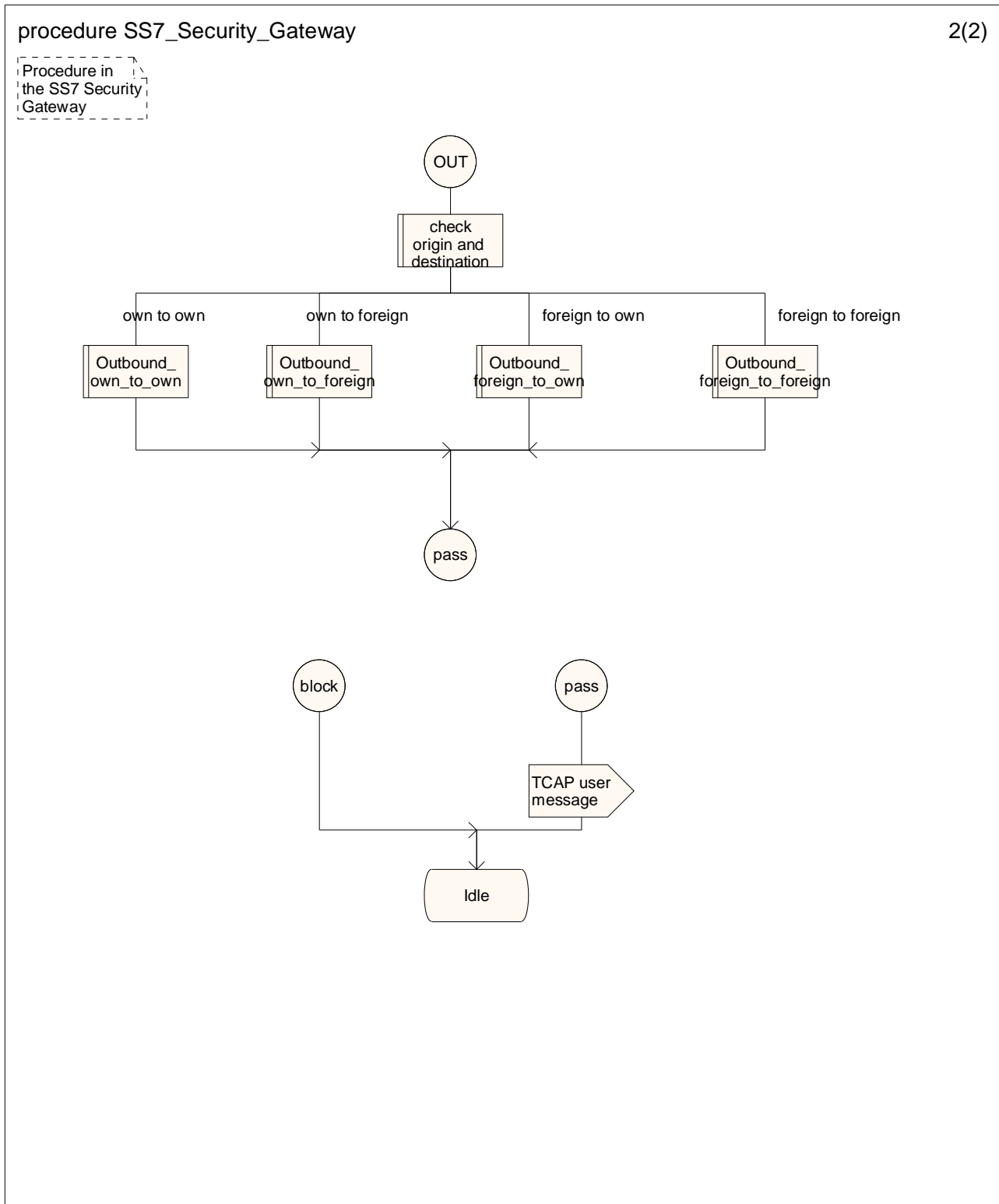


Figure 5.1.1 Process SS7 Security Gateway (sheet 2 of 2)



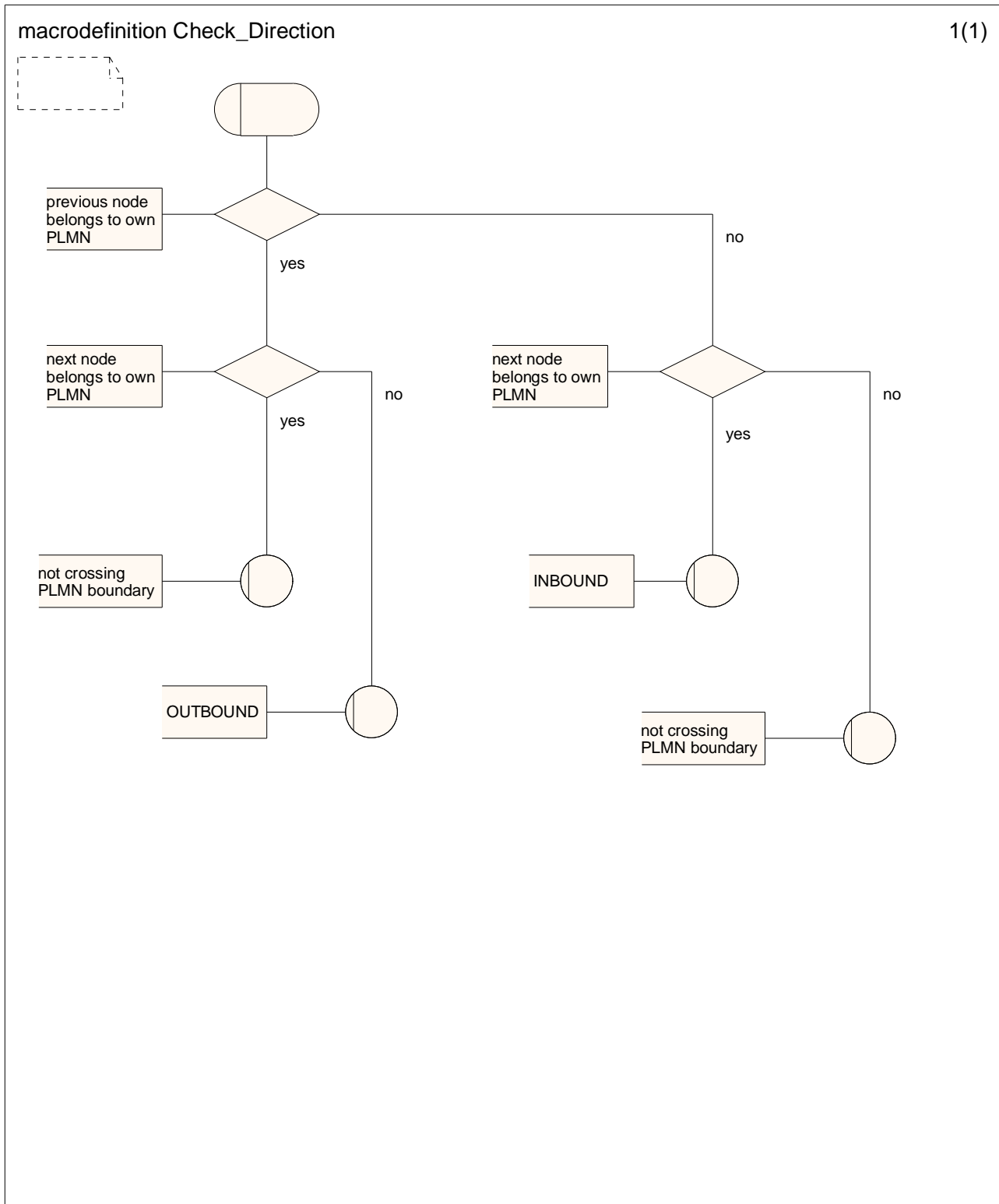
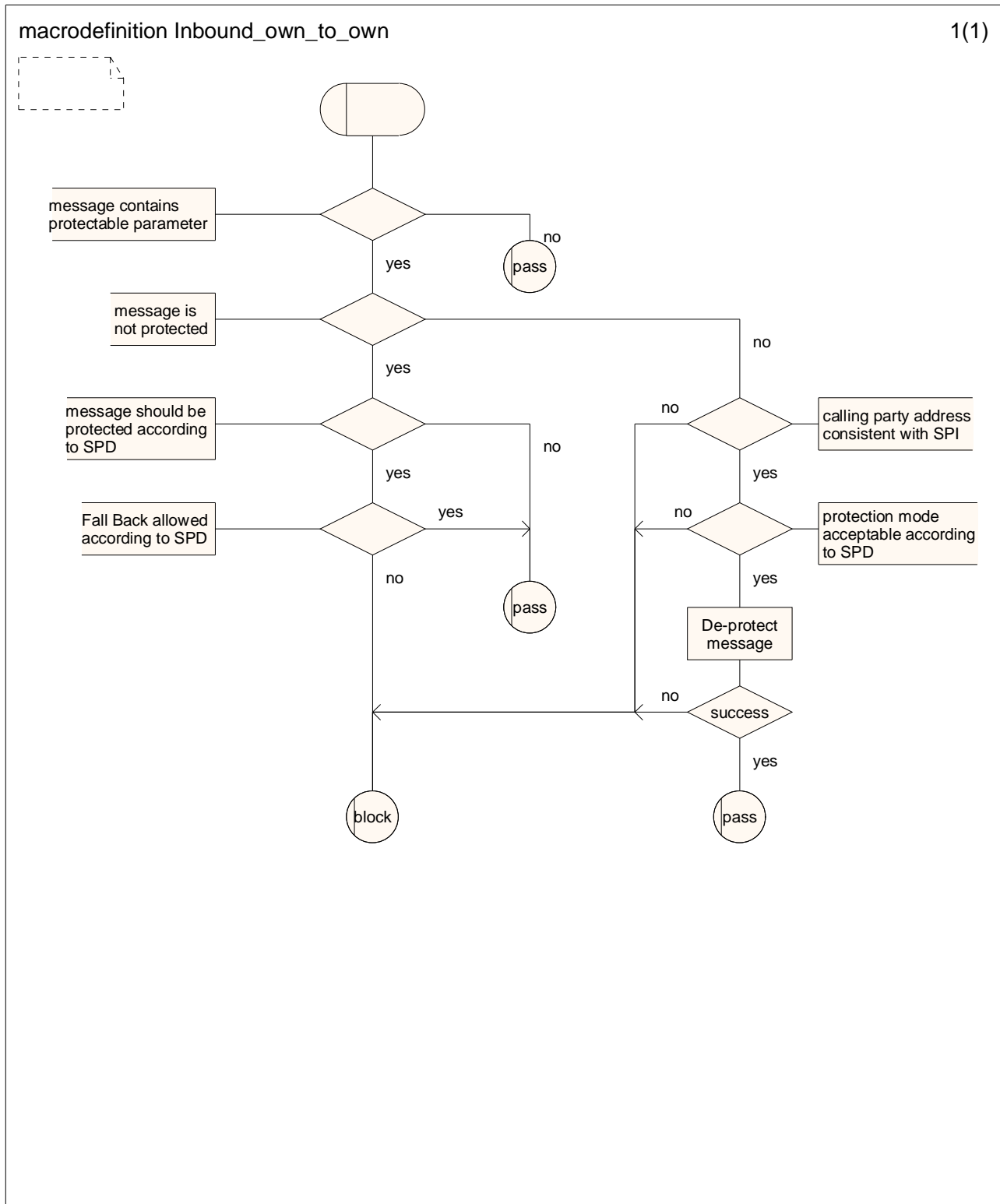


Figure 5.1.2 Macro Check\_Direction (sheet 1 of 1)



**Figure 5.1.3 Macro Inbound\_own\_to\_own (sheet 1 of 1)**

The decision box "message contains protectable parameter" takes the "yes"-exit if user-information is present in the Dialogue Portion, or a parameter is present in an Invoke or ReturnError Component, or a result is present in a ReturnResult Component.

The decision box "message is not protected" takes the "no"-exit if user-information within the Dialogue Portion is identified by the object identifier ss7-ProtectedDialogueAS or

operationCode within an Invoke or ReturnResult Component takes the global value ss7-ProtectedDialogueAS or errorCode within an ReturnError Component takes the global value ss7-ProtectedDialogueAS.

The decision box "message should be protected according to SPD" takes the "yes"-exit if the message's SCCP calling party address identifies a PLMN for which an SPD entry for incoming messages exists.

The decision box "fall back allowed according to SPD" takes the "yes"-exit if the SPD entry for incoming messages is marked "fall back allowed".

The decision box "calling party address consistent with SPI" takes the "yes"-exit if the SPI within the message's Security Header points to an SA that was negotiated with the PLMN derived from the message's SCCP calling party address.

The decision box "protection mode acceptable according to SPD" takes the "yes"-exit if the protection mode within the message's Security Header is found in the SPD-entry for incoming messages.

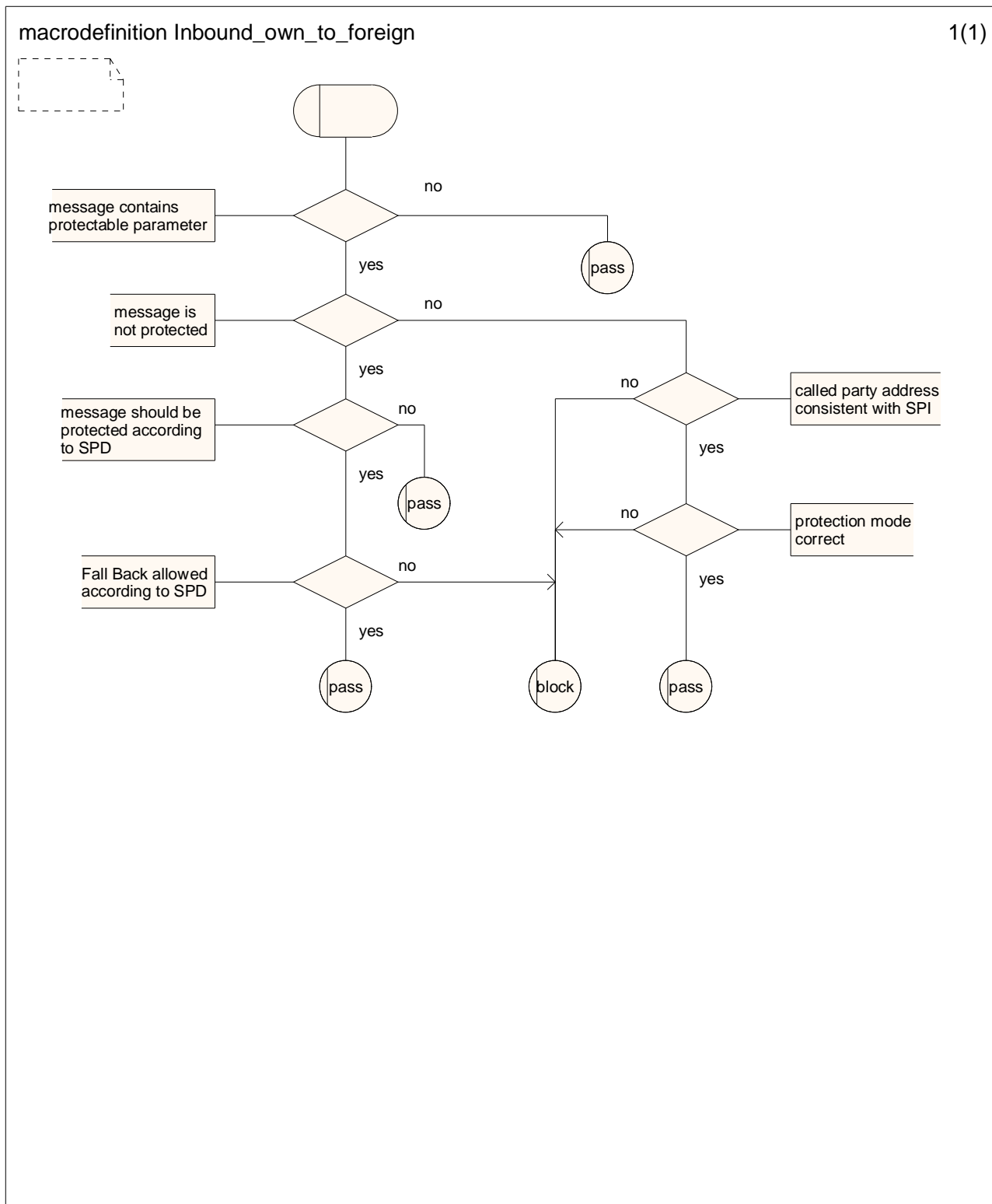


Figure 5.1.4 Macro Inbound\_own\_to\_foreign (sheet 1 of 1)

The decision box "message contains protectable parameter" takes the "yes"-exit if user-information is present in the Dialogue Portion, or a parameter is present in an Invoke or ReturnError Component, or a result is present in a ReturnResult Component.

The decision box "message is not protected" takes the "no"-exit if user-information within the Dialogue Portion is identified by the object identifier ss7-ProtectedDialogueAS or

operationCode within an Invoke or ReturnResult Component takes the global value ss7-ProtectedDialogueAS or errorCode within an ReturnError Component takes the global value ss7-ProtectedDialogueAS.

The decision box "message should be protected according to SPD" takes the "yes"-exit if the message's SCCP called party address identifies a PLMN for which an SPD entry for outgoing messages exists.

The decision box "fall back allowed according to SPD" takes the "yes"-exit if the SPD entry for outgoing messages is marked "fall back allowed".

The decision box "called party address consistent with SPI" takes the "yes"-exit if the SPI within the message's Security Header points to an SA that was negotiated with the PLMN derived from the message's SCCP called party address.

The decision box "protection mode correct" takes the "yes"-exit if the presence/absence of octets 10 and 11 within the message's Security Header is consistent with the protection mode in the SPD-entry for outgoing messages. Note that octets 10 and 11 of the Security Header are only used to construct the IV which is not needed (and shall therefore be absent) if the protection mode is "authenticity and integrity".

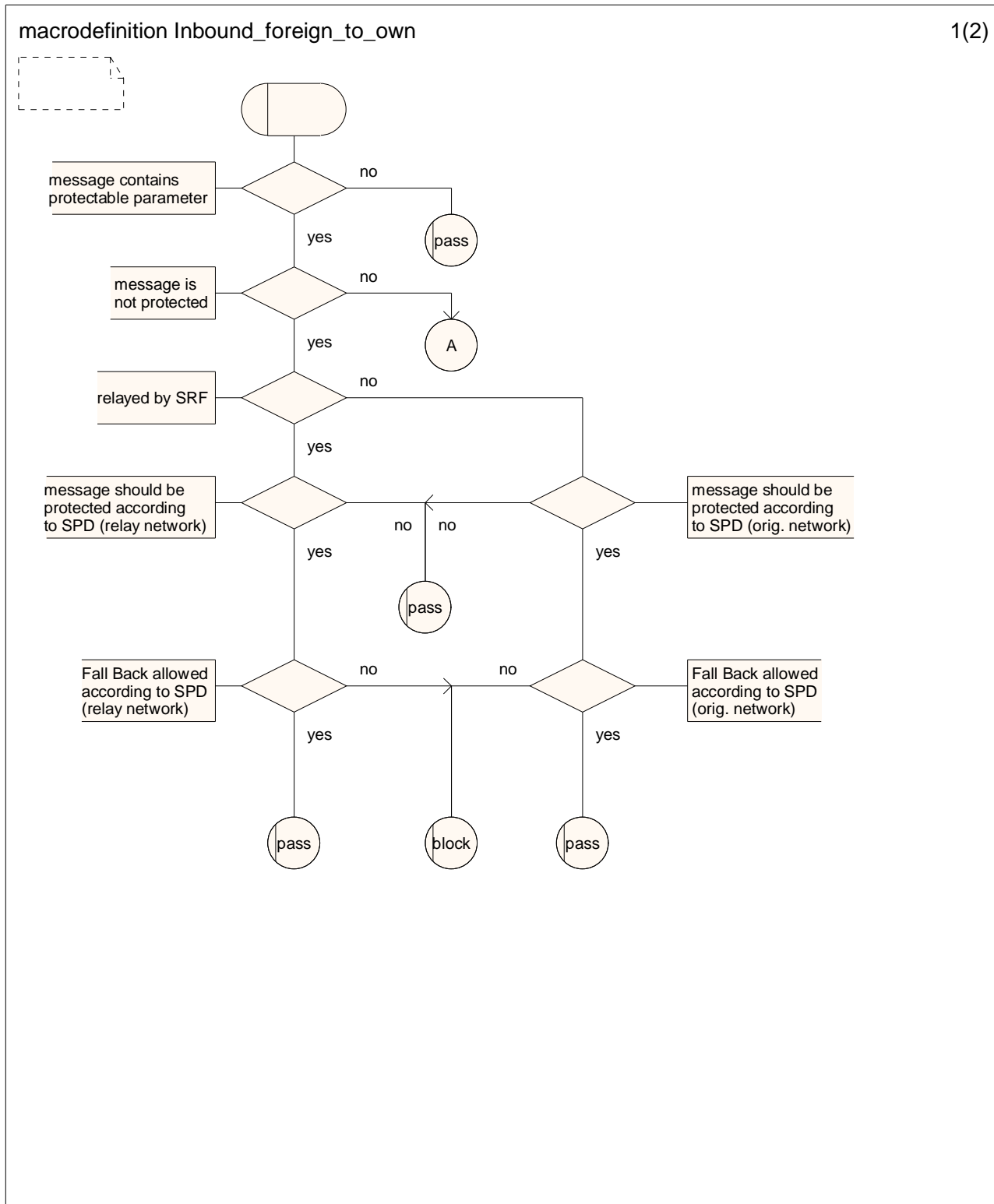


Figure 5.1.5 Macro Inbound\_foreign\_to\_own (sheet 1 of 2)

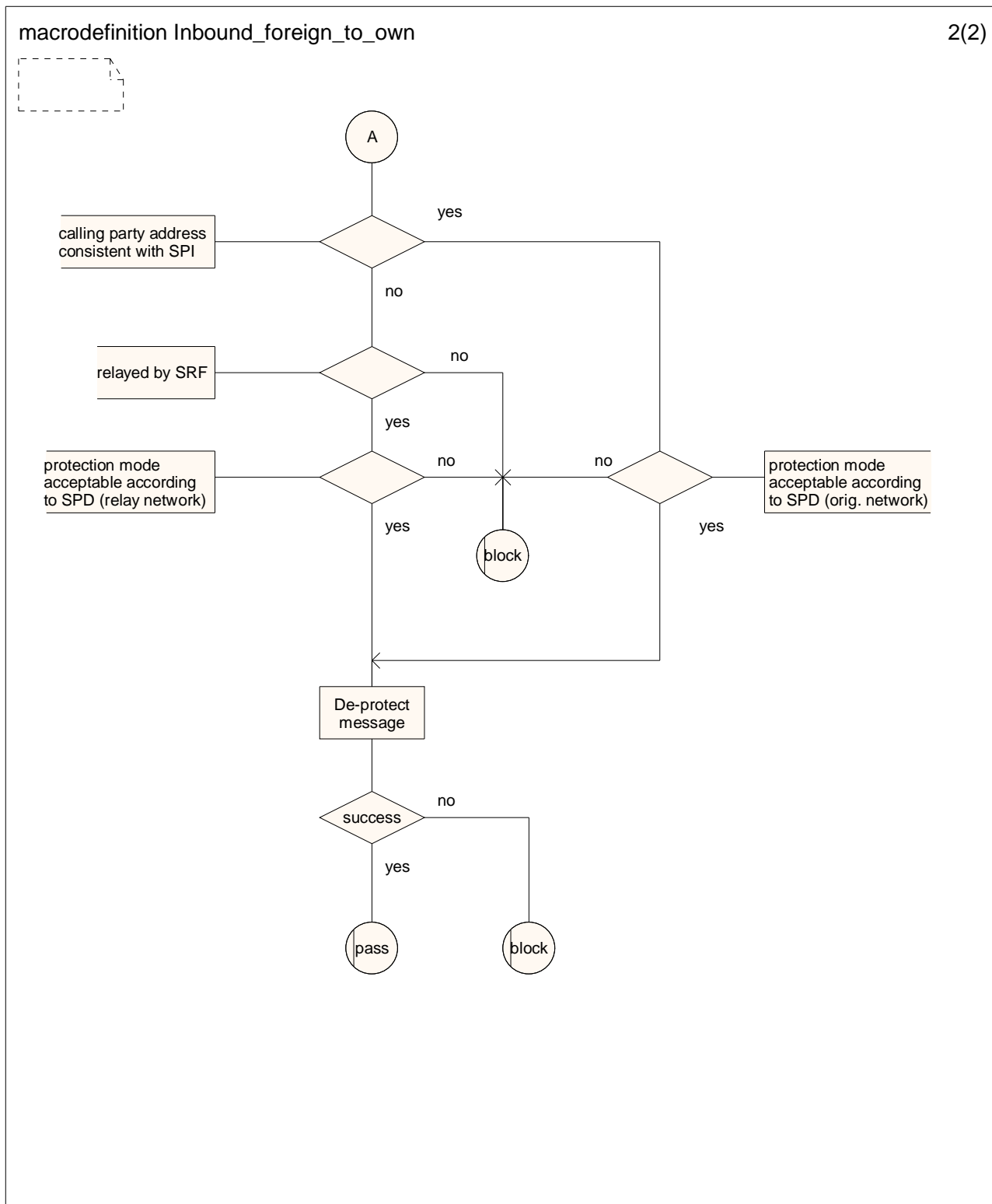


Figure 5.1.5 Macro Inbound\_foreign\_to\_own (sheet 2 of 2)

The decision box "message contains protectable parameter" takes the "yes"-exit if user-information is present in the Dialogue Portion, or a parameter is present in an Invoke or ReturnError Component, or a result is present in a ReturnResult Component.

The decision box "message is not protected" takes the "no"-exit if user-information within the Dialogue Portion is identified by the object identifier ss7-ProtectedDialogueAS or

operationCode within an Invoke or ReturnResult Component takes the global value ss7-ProtectedDialogueAS or errorCode within an ReturnError Component takes the global value ss7-ProtectedDialogueAS.

The decision box "relayed by SRF" takes the "yes"-exit if the SCCP called party address consists of a Routing Number (RN) pointing to the own network and an MSISDN pointing to a relay network within the portability cluster.

The decision box "message should be protected according to SPD (relay network)" takes the "yes"-exit if an SPD entry for incoming messages exists for the relay network.

The decision box "Fall Back allowed according to SPD (relay network)" takes the "yes"-exit if the SPD entry for incoming messages (from the relay network) is marked "fall back allowed".

The decision box "message should be protected according to SPD (orig. network)" takes the "yes"-exit if the message's SCCP calling party address identifies a PLMN for which an SPD entry for incoming messages exists.

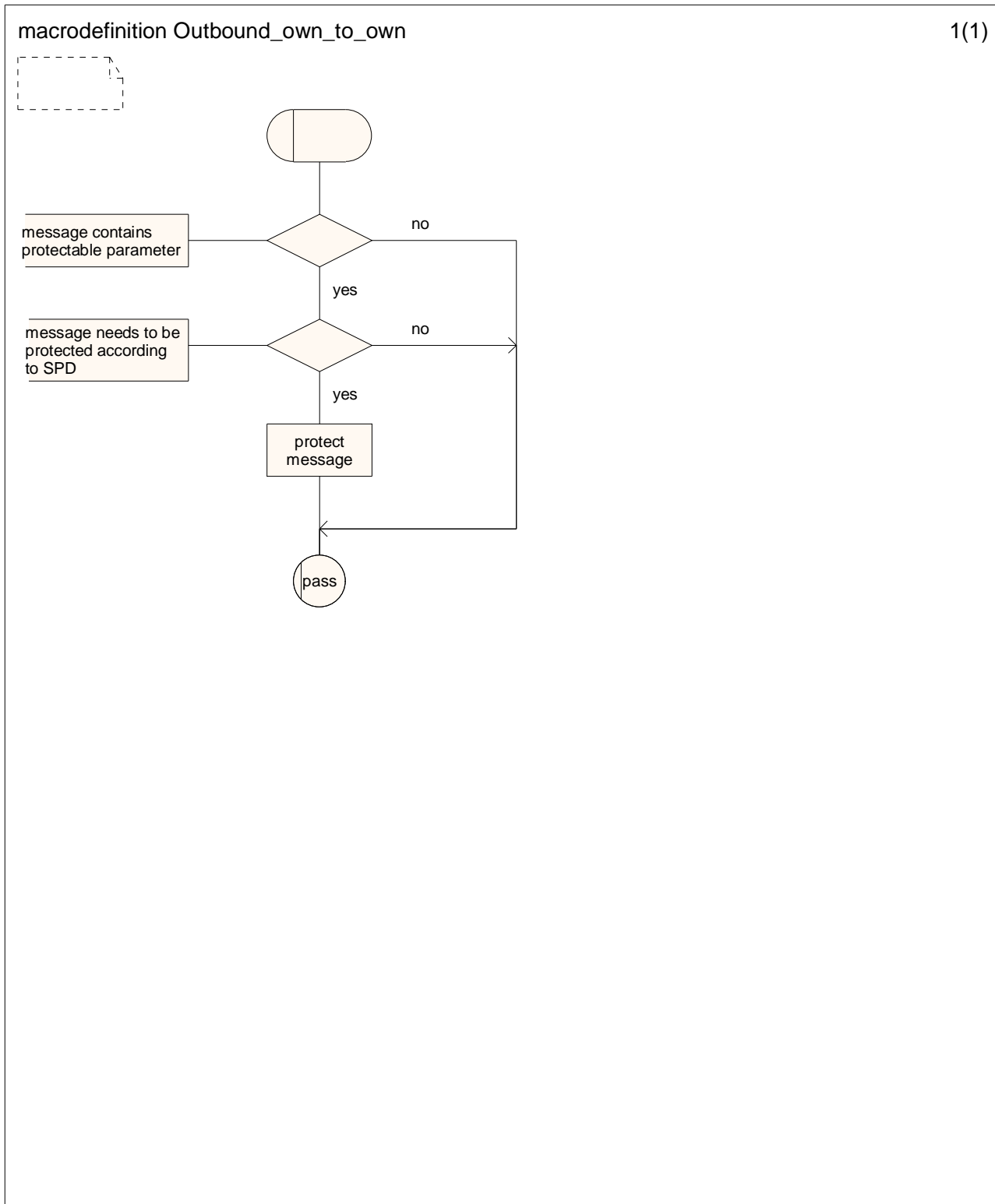
The decision box "Fall Back allowed according to SPD (relay network)" takes the "yes"-exit if the SPD entry for incoming messages (from the network identified by the SCCP calling party address) is marked "fall back allowed".

The decision box "calling party address consistent with SPI" takes the "yes"-exit if the SPI within the message's Security Header points to an SA that was negotiated with the PLMN derived from the message's SCCP calling party address.

The decision box "protection mode acceptable according to SPD (relay network)" takes the "yes"-exit if the presence/absence of octets 10 and 11 within the message's Security Header is consistent with a protection mode found in the SPD-entry (for incoming messages from the network identified by the SPI). Note that octets 10 and 11 of the Security Header are only used to construct the IV which is not needed (and shall therefore be absent) if the protection mode is "authenticity and integrity".

The decision box "protection mode acceptable according to SPD (orig. network)" takes the "yes"-exit if the presence/absence of octets 10 and 11 within the message's Security Header is consistent with a protection mode found in the SPD-entry (for incoming messages from the network identified by the SCCP calling party address). Note that octets 10 and 11 of the Security Header are only used to construct the IV which is not needed (and shall therefore be absent) if the protection mode is "authenticity and integrity".

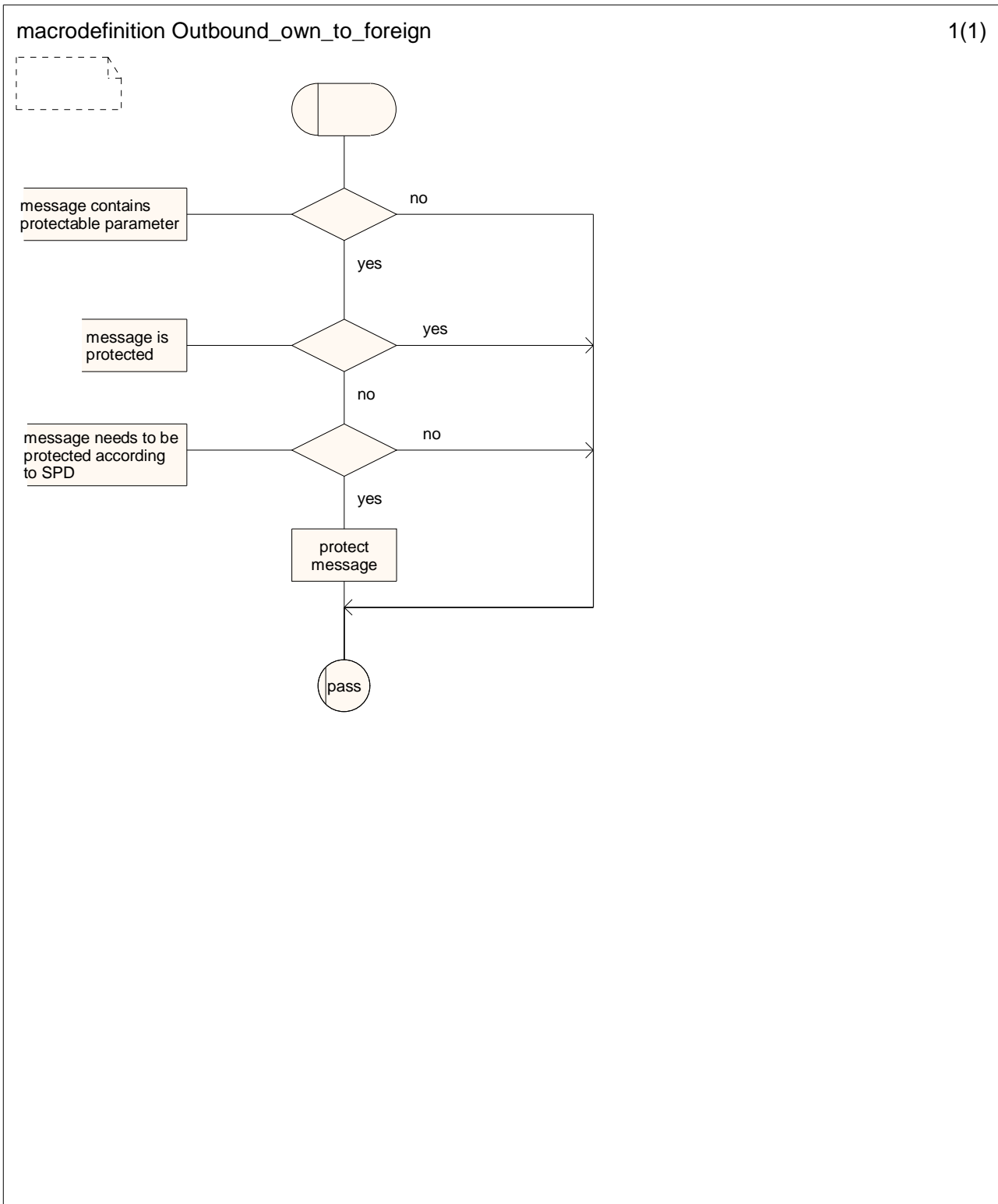




**Figure 5.1.6 Macro Outbound\_own\_to\_own (sheet 1 of 1)**

The decision box "message contains protectable parameter" takes the "yes"-exit if user-information is present in the Dialogue Portion, or a parameter is present in an Invoke or ReturnError Component, or a result is present in a ReturnResult Component.

The decision box "message needs to be protected according to SPD" takes the "yes"-exit if an SPD entry for outgoing messages exists (for messages sent to the own network).



**Figure 5.1.7 Macro Outbound\_own\_to\_foreign (sheet 1 of 1)**

The decision box "message contains protectable parameter" takes the "yes"-exit if user-information is present in the Dialogue Portion, or a parameter is present in an Invoke or ReturnError Component, or a result is present in a ReturnResult Component.

The decision box "message is protected" takes the "yes"-exit if user-information within the Dialogue Portion is identified by the object identifier ss7-ProtectedDialogueAS or

operationCode within an Invoke or ReturnResult Component takes the global value ss7-ProtectedDialogueAS or errorCode within an ReturnError Component takes the global value ss7-ProtectedDialogueAS.

The decision box "message needs to be protected according to SPD" takes the "yes"-exit if an SPD entry for outgoing messages exists (for messages sent to the network identified by the SCCP called party address).

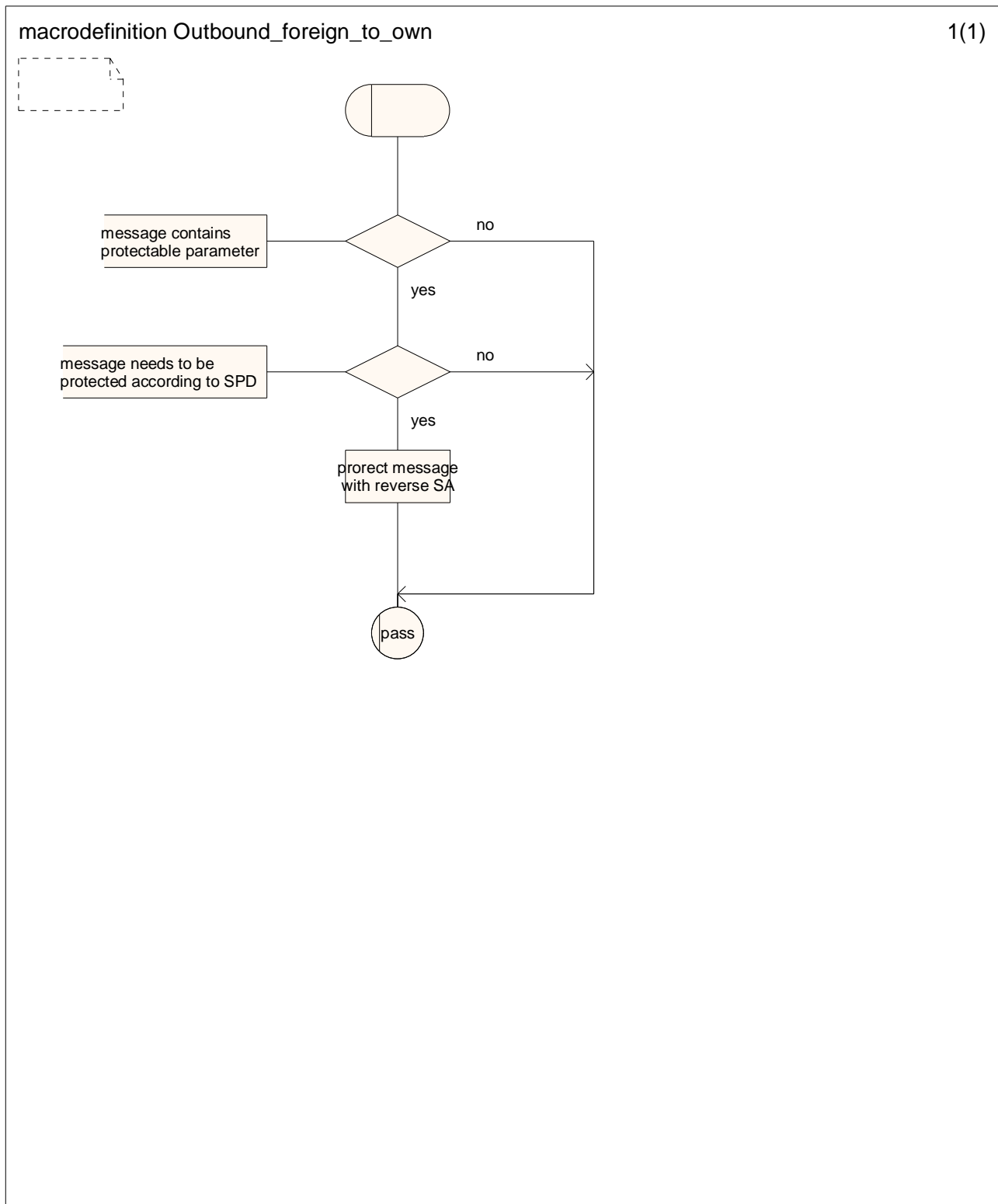


Figure 5.1.8 Macro Outbound\_foreign\_to\_own (sheet 1 of 1)

The decision box "message contains protectable parameter" takes the "yes"-exit if user-information is present in the Dialogue Portion, or

a parameter is present in an Invoke or ReturnError Component, or a result is present in a ReturnResult Component.

The decision box "message needs to be protected according to SPD" takes the "yes"-exit if an SPD entry for incoming messages exists (for messages received from the network identified by the SCCP calling party address). If more than one acceptable protection modes are present, one may be chosen.

The task box "protect message with reverse SA" performs protection of the message with the SA that is to be used for de-protection when receiving messages from the network in question.

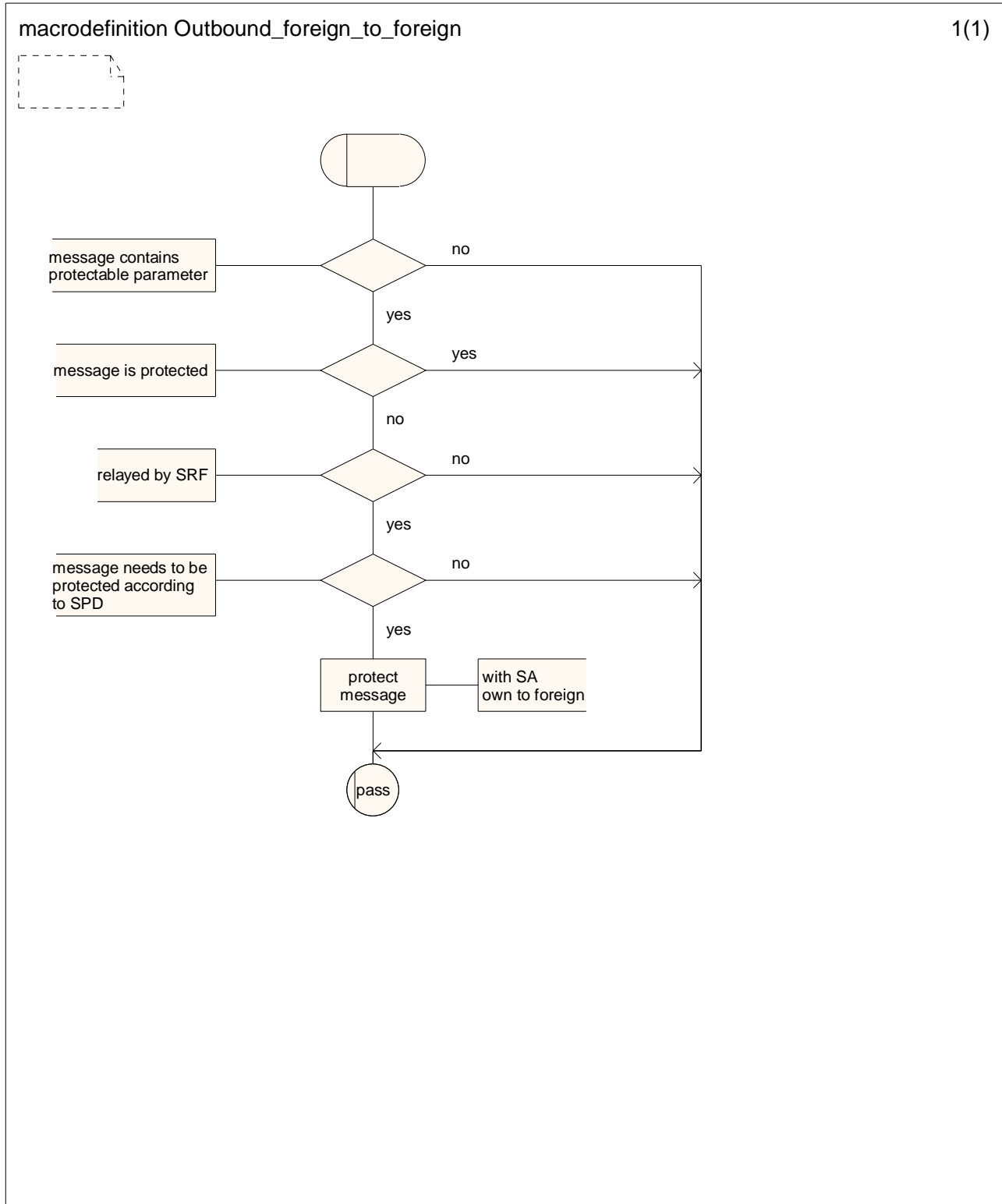


Figure 5.1.9 Macro Outbound\_foreign\_to\_foreign (sheet 1 of 1)

The decision box "message contains protectable parameter" takes the "yes"-exit if user-information is present in the Dialogue Portion, or a parameter is present in an Invoke or ReturnError Component, or a result is present in a ReturnResult Component.

The decision box "message is protected" takes the "yes"-exit if user-information within the Dialogue Portion is identified by the object identifier ss7-ProtectedDialogueAS or operationCode within an Invoke or ReturnResult Component takes the global value ss7-ProtectedDialogueAS or errorCode within an ReturnError Component takes the global value ss7-ProtectedDialogueAS.

The decision box "relayed by SRF" takes the "yes"-exit if the SCCP called party address consists of a Routing Number (RN) pointing to the own network and an MSISDN pointing to a relay network within the portability cluster.

The decision box "message needs to be protected according to SPD" takes the "yes"-exit if an SPD entry for outgoing messages exists (for messages sent to the network identified by the SCCP called party address).

### 5.1.2 Interactions with Mobile Number Portability

In Mobile Number Portability scenarios (see 3GPP TS 23.066 [4]) a Signalling Relay Function (SRF) may relay SCCP traffic by modifying the SCCP called party address as shown in figure 4.1.10.

A relayed message's SCCP called party address consists of a Routing Number (RN) and an MSISDN (see 3GPP TS 23.066 [4]).

An SS7 Security Gateway needs to recognize (by analyzing the SCCP called party address) whether or not a message was relayed in order to

- a) distinguish outbound transit traffic relayed by an SRF in the own network (which needs to be protected) from other outbound transit traffic (which needs to be passed transparently), and to
- b) distinguish inbound terminating traffic relayed by an SRF within the portability cluster (where the check needs to be based on the policy identified by the MSISDN within the SCCP called party address) from other inbound terminating traffic (where the check needs to be based on the policy identified by the SCCP calling party address).

NOTE : In MNP-SRF scenarios, when the relaying PLMN does not make use of TCAP-User Security, messages sent from a source PLMN to a destination PLMN via the relaying PLMN are unprotected although protection may be desired for messages sent from the source PLMN to the destination PLMN. Network operators may therefore want to negotiate use of TCAP-User Security with all PLMNs of a portability cluster.

### 5.1.3 Interactions with SCCP segmentation

When the incoming SCCP message makes use of SCCP segmenting (i.e. several XUDT messages are received rather than one UDT or a single XUDT message) the SS7 Security Gateway has to perform reassembling before processing the message, and it may have to perform segmenting before sending the processed message.

It may happen that the received SCCP message (containing an unprotected TCAP user payload) is not segmented (UDT or single XUDT), but after security processing the message's length is increased, so that the processed message needs to be segmented before it is sent. This situation may be undesired (since transfer of XUDT messages is not guaranteed by all transit networks) but cannot be avoided by the SS7 Security Gateway (see note).

Note: The support of message segmentation at the SCCP layer in all transit networks could be enforced by mandating the usage of the White Book SCCP [9]. GSMA would work with International Carriers to ensure that fully operationally-verified support of XUDT is available before TCAPsec gateways are deployed.

It may also happen that the received (protected) message is segmented (several XUDTs), but after security processing the message's length is decreased, so that the processed message does not need to be segmented before it is sent. In this case the de-protecting SS7 Security Gateway needs to know some SCCP-details of the original unprotected message as sent from the originating NE to the protecting SS7 Security Gateway. These original SCCP information needs to be transported within the TCAP-user parameter of the protected message. Depending on this information the de-protecting SS7-Security Gateway can decide whether to send a UDT or a single XUDT message towards the destination. .

In cases where the received unprotected message is not segmented but the (to be) sent protected message needs to be segmented, the SS7 Security Gateway has to replace the message's SCCP calling party address with its own address. This is to guarantee uniqueness of the combination of the SCCP calling party address and the Segmentation local reference in the (to be) sent message. The original SCCP calling party address needs to be transported within the TCAP-user parameter of the (first segment of the) protected message.

If the received protected message contains an original SCCP calling party address within the TCAP-user parameter, the de-protecting SS7 Security Gateway has to replace the SCCP calling party address with the original SCCP calling party address before forwarding the de-protected message to the destination.

An SS7 Security Gateway that has sent a segmented, protected message with a replaced SCCP calling party address may receive an SCCP XUDTS message with its own address as called party address. In this case the SS7 Security Gateway shall retrieve the original SCCP calling party address, the original TCAP Message type and TCAP transaction id from the data parameter of the received XUDTS message and construct a UDT message with unmodified Return cause, called party address replaced with the retrieved original calling party address, unmodified calling party address, and Data parameter containing the retrieved TCAP message type and TCAP transaction id, and forward it to the destination.

## 5.1.4 Protocol details

### 5.1.4.1 Transformation of unprotected message to protected message

The unprotected TCAP-user message is either transported within an SCCP UDT message or it is transported within a single SCCP XUDT message or it is segmented over several SCCP XUDT messages. Other SCCP message types are not subject to protection.

The transformation process is done in 3 steps:

#### Step 1: SCCP re-assembly of the unprotected message

In a first step the unprotected message is transformed into an intermediate unprotected representation which is made up of the following parameters:

SCCP Message type	
SCCP Protocol class	
SCCP Hop counter (optional)	
SCCP Called party address	
SCCP Calling party address	
SCCP Segmentation local reference (optional)	
SCCP Importance (optional)	
SCCP Data (made up of the following parameters:	TCAP Message type
	TCAP orig. Transaction Id (optional)
	TCAP dest. Transaction Id (optional)
	TCAP Dialogue Portion (optional)
	TCAP Component Portion (optional))

If the unprotected message was transported within an SCCP UDT message, the intermediate unprotected representation of the message takes the following values:

SCCP Message type	UDT
SCCP Protocol class	same as in the received UDT message
SCCP Hop counter	absent
SCCP Called party address	same as in the received UDT message
SCCP Calling party address	same as in the received UDT message
SCCP Segmentation local reference	absent
SCCP Importance	absent
SCCP Data	same as in the received UDT message

If the unprotected message was transported within a single SCCP XUDT message, the intermediate unprotected representation of the message takes the following values:

SCCP Message type	XUDT
SCCP Protocol class	same as in the received XUDT message
SCCP Hop counter	same as in the received XUDT message
SCCP Called party address	same as in the received XUDT message
SCCP Calling party address	same as in the received XUDT message
SCCP Segmentation local reference	absent
SCCP Importance	same as in the received XUDT message
SCCP Data	same as in the received XUDT message

If the unprotected message was segmented over several SCCP XUDT messages, the intermediate unprotected representation of the message takes the following values:

SCCP Message type	XUDT
SCCP Protocol class	same as in the first received XUDT message
SCCP Hop counter	same as in the first received XUDT message
SCCP Called party address	same as in the first received XUDT message
SCCP Calling party address	same as in the first received XUDT message
SCCP Segmentation local reference	same as in the first received XUDT message
SCCP Importance	same as in the first received XUDT message
SCCP Data	concatenation of the received segments (for details of the re-assembly procedure see ITU-T Q.714 [9])

## Step 2: Protection

In a second step the intermediate unprotected representation is transformed into an intermediate protected representation which is made up of the following parameters:

SCCP Hop counter (optional)	
SCCP Called party address	
SCCP Calling party address	
SCCP Segmentation local reference (optional)	
SCCP Importance (optional)	
Original SCCP info (made up of the following parameters:	Original SCCP Calling party address (optional)
	Original SCCP Message type
	Original SCCP Protocol class)
Original TCAP info (made up of the following parameters:	Original TCAP Message type
	otid (optional)
	dtid (optional))
TCAPsec Security header	
TCAPsec Cipher- or Cleartext	
TCAPsecMAC	

The intermediate unprotected representation of the message takes the following values:

SCCP Hop counter	same as SCCP Hop counter in the intermediate unprotected representation
SCCP Called party address	same as in the intermediate unprotected representation
SCCP Calling party address	same as in the intermediate unprotected representation
SCCP Segmentation local reference	same as in the intermediate unprotected representation
SCCP Importance	same as SCCP Importance in the intermediate unprotected representation
Original SCCP info made up of the following parameters:	
Original SCCP Message type	same as SCCP Message type in the intermediate unprotected representation
Original SCCP Protocol class	same as SCCP Protocol class in the intermediate unprotected representation
Original TCAP info made up of the following parameters:	
Original TCAP Message type	same as TCAP Message type in the intermediate unprotected representation

TCAP otid	same as TCAP orig. Transaction Id in the intermediate unprotected representation
TCAP dtid	same as TCAP dest. Transaction Id in the intermediate unprotected representation
TCAPsec Security header	See 3GPP TS 33.204 [8]
TCAPsec Cipher- or Cleartext	result of applying the encryption function to the concatenation of Dialogue Portion and Component Portion of the intermediate unprotected representation (ciphertext), or concatenation of Dialogue Portion and Component Portion of the intermediate unprotected representation (cleartext)
TCAPsec MAC	result of applying the integrity function to the concatenation of Security header and Cipher- or Cleartext of the intermediate protected representation.

### Step 3: SCCP segmentation of the protected message

In a third step the intermediate protected representation is transformed into a single SCCP UDT message, a single SCCP XUUDT message, or several SCCP XUUDT messages depending on the Original SCCP Message type of the intermediate protected representation and the need for segmentation as follows:

If the Original SCCP Message type in the intermediate protected representation takes the value "UDT" and the message need not be segmented, it is transformed into a single SCCP UDT message with following parameter values:

Message Type	UDT
Protocol class	same as Original SCCP Protocol class in the intermediate protected representation
Called party address	same as SCCP Called party address in the intermediate protected representation
Calling party address	same as SCCP Calling party address in the intermediate protected representation
Data	(see below)

If the Original SCCP Message type in the intermediate protected representation takes the value "XUUDT" and the message need not be segmented, it is transformed into a single SCCP XUUDT message with following parameter values:

Message Type	XUUDT
Protocol class	same as Original SCCP Protocol class in the intermediate protected representation
Hop counter	same as Original SCCP Hop counter in the intermediate protected representation
Called party address	same as SCCP Called party address in the intermediate protected representation
Calling party address	same as SCCP Calling party address in the intermediate protected representation
Data	(see below)
Segmentation	absent
Importance	same as Original SCCP Importance in the intermediate protected representation

If the Original SCCP Message type in the intermediate protected representation takes the value "UDT" and the message needs to be segmented, it is transformed into several SCCP XUUDT message with following parameter values:

Message Type	XUUDT
Protocol class	first segment: class 1 (in sequence delivery), return option: same as in Original SCCP Protocol class in the intermediate protected representation subsequent segment: class 1 (in sequence delivery), return option: no special options
Hop counter	absent
Called party address	same as SCCP Called party address in the intermediate protected representation
Calling party address	the SS7 Security Gateway's own address
Data	(segment of see below)
Segmentation	see [9]
Importance	absent

If the Original SCCP Message type in the intermediate protected representation takes the value "XUUDT" and the message needs to be segmented, it is transformed into several SCCP XUUDT message with following parameter values:

Message Type	XUUDT
Protocol class	first segment: class 1 (in sequence delivery), return option: same as in Original SCCP Protocol class in the intermediate protected representation subsequent segment: class 1 (in sequence delivery), return option: no special options
Hop counter	same as Original SCCP Hop counter in the intermediate protected representation



Called party address	same as SCCP Called party address in the intermediate protected representation
Calling party address	if SCCP Segmentation Local reference is present in the intermediate protected representation: same as SCCP Calling party address in the intermediate protected representation; otherwise: the SS7 Security Gateway's own address
Data	(segment of see below)
Segmentation	see [9]; if SCCP Segmentation Local reference is present in the intermediate protected representation, the same value shall be used.
Importance	same as Original SCCP Importance in the intermediate protected representation.

The SCCP Data parameter (re-assembled) shall take the following value:

TCAP Message type	unidirectional
TCAP DialoguePortion	absent
TCAP ComponentPortion	one invoke component with:
invokeId	(any legal value)
linkedId	absent
operationCode	local value 90 (secureTransport)
parameter	ANY DEFINED BY operationCode

```
SS7-Secure-Transport-Operation-and-DataTypes {
    itu-t identified-organization (4) etsi (0) mobileDomain (0)
    gsm-Network (1) modules (3) ss7-Secure-Transport-Operation-and-DataTypes (27) version1 (1)}
```

DEFINITIONS

IMPLICIT TAGS

::=

BEGIN

EXPORTS

    secureTransport

;

IMPORTS

    OPERATION

FROM Remote-Operations-Information-Objects {

    joint-iso-itu-t remote-operations(4)

    informationObjects(5) version1(0)}

;

```
secureTransport OPERATION ::= {
    ARGUMENT
        SecureTransportArg
    CODE local:90 }
```

```
SecureTransportArg ::= SEQUENCE {
    originalSCCP-Info [0] OriginalSCCP-Info OPTIONAL,
    originalTCAP-Info [1] OriginalTCAP-Info,
    protectedPayload [2] ProtectedPayload
}
```

```
OriginalSCCP-Info ::= SEQUENCE {
    originalSCCP-MessageType [0] OriginalSCCP-MessageType OPTIONAL,
    -- original SCCP-MessageType shall be present if it is different from the actual
    -- SCCP-Message type; otherwise it may be absent
    originalSCCP-ProtocolClass [1] OriginalSCCP-ProtocolClass OPTIONAL
    -- originalSCCP-ProtocolClass shall be present if it is different from the actual
    -- SCCP-Protocol class (first segment); otherwise it may be absent.
    originalSCCP-CallingPartyAddress [2] OriginalSCCP-CallingPartyAddress OPTIONAL,
    -- originalSCCP-CallingPartyAddress shall be present if and only if the actual
    -- SCCP Calling party address is the SS7 Security Gateway's own address
}
```

```
OriginalSCCP-MessageType ::= ENUMERATED {
    udt (9),
    xudt (17) }
-- this parameter shall take the value of the Original SCCP Message type from the
-- intermediate protected representation
```

```
OriginalSCCP-ProtocolClass ::= OCTET STRING(SIZE(1))
-- coded according to ITU-T Q.713
```

```
OriginalSCCP-CallingPartyAddress ::= OCTET STRING(SIZE(3..18))
-- coded according to ITU-T Q.713
-- Octet 1: Address indicator
-- Octets 2 - n: Address
```

```
OriginalTCAP-Info ::= SEQUENCE {
    originalTCAP-MessageType          OriginalTCAP-MessageType,
    otid                               OTID                               OPTIONAL,
    dtid                               DTID                               OPTIONAL,
}
```

```
OriginalTCAP-MessageType ::= ENUMERATED {
    unidirectional (97),
    begin (98),
    end (100),
    continue (101),
    abort (103)}
-- this parameter shall take the value of the Original TCAP Message type from the
-- intermediate protected representation
```

```
OTID ::= OCTET STRING(SIZE(1..4))
-- OTID shall take the value of the TCAP otid from the intermediate protected
-- representation
```

```
DTID ::= OCTET STRING(SIZE(1..4))
-- DTID shall take the value of the TCAP dtid from the intermediate protected
-- representation
```

```
ProtectedPayload ::= OCTET STRING(SIZE(13..3438))
-- The protected payload is the concatenation of
-- 9 or 11 octets SecurityHeader,
-- n octets ciphertext or cleartext, and
-- 4 octets MAC

-- The SecurityHeader is coded as follows (see 3GPP TS 33.204 [8]):
-- Octets 1-4: SPI
-- Octets 5-8: TVP. The TVP is a 32 bit time stamp. Its value is binary coded
-- and indicates the number of intervals of 100 milliseconds
-- elapsed since 1st January 2002, 0:00:00 UTC
-- Octet 9: Indicator Byte with bits 7-1 spare and bit 0 if set indicates presence of
-- Octets 10-11
-- Octet 10: SS7 SEG-Id
-- Octet 11: Prop
```

END

### 5.1.4.2 Transformation of protected message to unprotected message

The protected TCAP-user message is either transported within an SCCP UDT message or it is transported within a single SCCP XUDT message or it is segmented over several SCCP XUDT messages. Other SCCP message types are not subject to protection.

The transformation process is done in 3 steps:

#### Step 1: SCCP re-assembly of the protected message

In a first step the protected message is transformed into the intermediate protected representation (see chapter 5.1.4.1):

If the protected message was transported within an SCCP UDT message, the intermediate protected representation of the message takes the following values:

SCCP Hop counter	absent
SCCP Called party address	same as in the received UDT message
SCCP Calling party address	same as in the received UDT message
SCCP Segmentation local reference	absent
SCCP Importance	absent
Original SCCP info	
Original SCCP Calling party address	absent
Original SCCP Message type	UDT
Original SCCP Protocol class	same as SCCP Protocol class in the received UDT message
Original TCAP info	
Original TCAP Message type	same as Original TCAP Message type in the TCAP-invoke component parameter of the received message
otid	same as otid in the TCAP-invoke component parameter of the received message
dtid	same as dtid in the TCAP-invoke component parameter of the received message
TCAPsec Security header	same as received in the TCAP-invoke component parameter of the received message
TCAPsec Cipher- or Cleartext	same as received in the TCAP-invoke component parameter of the received message
TCAPsec MAC	same as received in the TCAP-invoke component parameter of the received message

If the protected message was transported within a single SCCP XUDT message, the intermediate protected representation of the message takes the following values:

SCCP Hop counter	same as in the received XUDT message
SCCP Called party address	same as in the received XUDT message
SCCP Calling party address	same as in the received XUDT message
SCCP Segmentation local reference	absent
SCCP Importance	same as in the received XUDT message
Original SCCP info	
Original SCCP Calling party address	absent
Original SCCP Message type	same as OriginalSCCP-MessageType in the TCAP-invoke component parameter of the received message
Original SCCP Protocol class	same as OriginalSCCP-ProtocolClass in the TCAP-invoke component parameter of the received message
Original TCAP info	
Original TCAP Message type	same as Original TCAP Message type in the TCAP-invoke component parameter of the received message
otid	same as otid in the TCAP-invoke component parameter of the received message
dtid	same as dtid in the TCAP-invoke component parameter of the received message
TCAPsec Security header	same as received in the TCAP-invoke component parameter of the received message
TCAPsec Cipher- or Cleartext	same as received in the TCAP-invoke component parameter of the received message
TCAPsec MAC	same as received in the TCAP-invoke component parameter of the received message

If the protected message was transported within several SCCP XUDT message, the intermediate protected representation of the message takes the following values:

SCCP Hop counter	same as in the first received XUDT message
SCCP Called party address	same as in the first received XUDT message

SCCP Calling party address	same as in the first received XUDT message
SCCP Segmentation local reference	same as in the first received XUDT message
SCCP Importance	same as in the first received XUDT message
Original SCCP info	
Original SCCP Calling party address	same as OriginalSCCP-CallingPartyAddress in the TCAP-invoke component parameter of the received reassembled message
Original SCCP Message type	same as OriginalSCCP-MessageType in the TCAP-invoke component parameter of the received reassembled message
Original SCCP Protocol class	same as OriginalSCCP-ProtocolClass in the TCAP-invoke component parameter of the received reassembled message
Original TCAP info	
Original TCAP Message type	same as OriginalTCAP-MessageType in the TCAP-invoke component parameter of the received reassembled message
otid	same as otid in the TCAP-invoke component parameter of the received reassembled message
dtid	same as dtid in the TCAP-invoke component parameter of the received reassembled message
TCAPsec Security header	same as received in the TCAP-invoke component parameter of the received reassembled message
TCAPsec Cipher- or Cleartext	same as received in the TCAP-invoke component parameter of the received reassembled message
TCAPsec MAC	same as received in the TCAP-invoke component parameter of the received reassembled message

## Step 2: De-Protection

In a second step the intermediate protected representation is transformed into an intermediate unprotected representation (see chapter 5.1.4.1):

The intermediate unprotected representation of the message takes the following values:

SCCP Message type	same as OriginalSCCP-MessageType from the TCAP-invoke component's parameter of the intermediate protected representation
SCCP Protocol class	same as OriginalSCCP-ProtocolClass from the TCAP-invoke component's parameter of the intermediate protected representation
SCCP Hop counter	same as SCCP Hop counter in the intermediate protected representation
SCCP Called party address	same as SCCP Called party address in the intermediate protected representation
SCCP Calling party address	if OriginalSCCP-CallingPartyAddress is present in the intermediate protected representation, its value is taken; otherwise same as SCCP Calling party address of the intermediate protected representation
SCCP Segmentation local reference	if SCCP Message type in the intermediate unprotected representation is XUDT, then same as in the intermediate protected representation; otherwise absent.
SCCP Importance	same as in the intermediate unprotected representation
SCCP Data :	
TCAP Message type	same as OriginalTCAP-MessageType in the intermediate protected representation
TCAP orig. Transaction Id	same as otid in the intermediate protected representation
TCAP dest. Transaction Id	same as dtid in the intermediate protected representation
TCAP Dialogue Portion (optional)	First part of the cleartext (as indicated by TAG and LENGTH according to BER). If encryption was applied then ciphertext needs to be converted first to cleartext
TCAP Component Portion (optional)	second part of the cleartext (as indicated by TAG and LENGTH according to BER). If encryption was applied then ciphertext needs to be converted first to cleartext

### Step 3: SCCP segmentation of the unprotected message

In a third step the intermediate unprotected representation is transformed into a single SCCP UDT message, a single SCCP XUDT message, or several SCCP XUDT messages depending on the SCCP Message type of the intermediate unprotected representation and the need for segmentation as follows:

If the SCCP Message type in the intermediate unprotected representation is "UDT", it is transformed into a single SCCP UDT message with following parameter values:

Message Type	UDT
Protocol class	same as SCCP Protocol class in the intermediate unprotected representation
Called party address	same as SCCP Called party address in the intermediate unprotected representation
Calling party address	same as SCCP Calling party address in the intermediate unprotected representation
Data	same as SCCP Data in the intermediate unprotected representation

If the SCCP Message type in the intermediate unprotected representation is "XUDT" and the message does not need to be segmented, it is transformed into a single SCCP XUDT message with following parameter values:

Message type	XUDT
Protocol class	same as SCCP Protocol class in the intermediate unprotected representation
Hop counter	same as SCCP Hop counter in the intermediate unprotected representation
Called party address	same as SCCP Called party address in the intermediate unprotected representation
Calling party address	same as SCCP Calling party address in the intermediate unprotected representation
Data	same as SCCP Data in the intermediate unprotected representation
Segmentation	absent
Importance	same as SCCP Importance in the intermediate unprotected representation

If the SCCP Message type in the intermediate unprotected representation is "XUDT" and the message needs to be segmented, it is transformed into several SCCP XUDT message with following parameter values:

Message type (all segments)	XUDT
Protocol class (first segment)	class 1 (in sequence delivery), return option: same as in SCCP Protocol class of the intermediate unprotected representation
(subsequent segments)	class 1 (in sequence delivery), return option: no special options
Hop counter (all segments)	same as SCCP Hop counter in the intermediate unprotected representation
Called party address (all segments)	same as SCCP Called party address in the intermediate unprotected representation
Calling party address (all segments)	same as SCCP Calling party address in the intermediate unprotected representation
Data	segment of SCCP Data from the intermediate unprotected representation (see ITU-T Q.714 [9])
Segmentation	see [9]. Local reference shall be taken from the intermediate unprotected representation
Importance (all segments)	same as SCCP Importance in the intermediate unprotected representation

#### 5.1.4.3 Handling of received XUDTS messages and UDTS messages

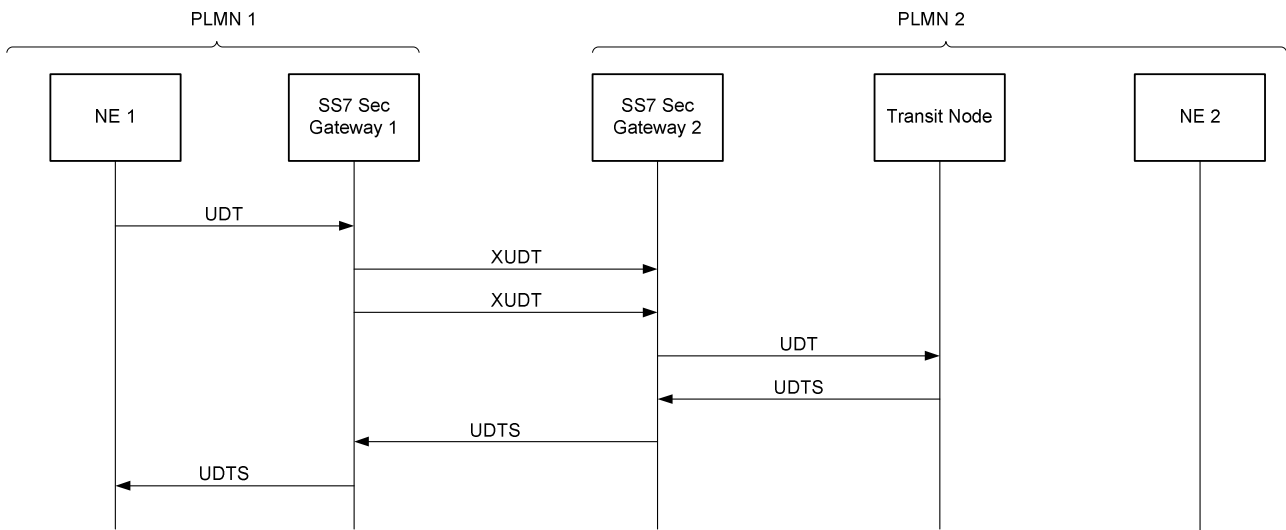
An SS7 Security Gateway shall not try to re-assemble XUDTS messages, since the SCCP option "return on error" is not set for subsequent XUDT segments. As a consequence the SS7 Security Gateway shall not try to protect or de-protect XUDTS messages (fragments) or UDTS messages. However, special handling of XUDTS messages and UDTS messages is required as follows:

##### Outbound direction

Instead of re-assembling and protecting the XUDTS messages or protecting UDTS messages, the SS7 Security Gateway shall remove the TCAP Dialogue Portion and the TCAP Component Portion from the SCCP Data parameter before sending the XUDTS message or UDTS message. This is in order not to pass the cleartext (or fragment of the cleartext) in outbound direction. SCCP message type and addresses shall not be changed.

An example is shown in figure 5.1.4.3-1: A transit node in PLMN 2 cannot deliver the UDT message and therefore returns an UDTS message. SS7 Security Gateway 2 in PLMN 2 removes the cleartext (TCAP dialogue portion and TCAP component portion) from the SCCP data parameter. SS7 Security Gateway 1 in PLMN 1 recognizes that the

received UDTS message does not contain a TCAP unidirectional message with a secure transport invoke component and therefore it does not modify the SCCP message.



**Figure 5.1.4.3-1: XUDTS messages and UDTS messages (Outbound direction)**

**Inbound direction**

Instead of re-assembling and de-protecting the XUDTS messages or de-protecting UDTS messages, the SS7 Security Gateway shall analyze the SCCP Called party address. If it matches with the SS7 Security Gateway's own address, it shall recover the OriginalSCCP-CallingPartyAddress from the (fragment in the) data parameter and replace the SCCP Called party address with the recovered value. In any case the SS7 Security Gateway shall recover and analyze the TCAP Message type from the (fragment in the) data parameter. If the recovered value is "unidirectional" and a invoke component with operation code "secure transport" is included, the SS7 Security Gateway shall recover the originalTCAP-MessageType, otid, and dtid from the OriginalTCAP-Info, replace the TCAP Message type with the original TCAP-MessageType, insert otid and dtid and remove the remaining material from the SCCP data parameter. If the received message is an XUDTS message and the original SCCP Message type was UDT then the SS7 Security shall modify the SCCP Message type to UDTS.

An example is shown in figure 5.1.4.3-2: A transit node in a transit network cannot deliver the XUDT messages and therefore returns an XUDTS message (note that the second XUDT does not have the SCCP return option set). SS7 Security Gateway 1 in PLMN 1 recognizes that the received XUDTS message does contain a TCAP unidirectional message with a secure transport invoke component and therefore, since the original SCCP-MessageType is UDT, modifies the SCCP Message type from XUDTS to UDTS. Furthermore, the TCAP MessageType is modified from unidirectional to the original TCAP-MessageType, the Transaction Ids are inserted, and the remaining material (fragment of the ciphertext) is removed.

In addition the SS7 Security Gateway 1 in PLMN 1 recognizes that the received XUDTS message does contain SS7 Security Gateway 1's own address as SCCP Called party address and therefore replaces it with the original SCCPCalling party address.

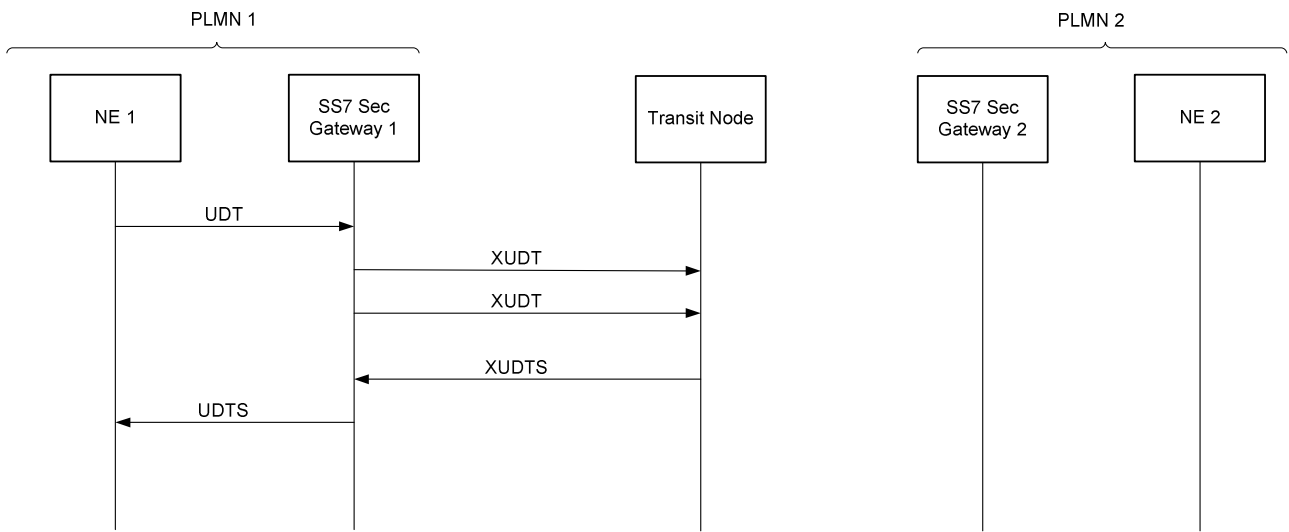


Figure 5.1.4.3-2: XUDTS messages and UDT/UDTS messages (inbound direction)

## Annex A (informative): Change history

Change history							
Date	Meeting	TDoc	CR	Rev	Cat	Subject/Comment	New version
2006-06	CT#32	CP-060320				Approved as version 7.0.0	7.0.0
2006-09	CT#33	CP-060413	000 1			Addition of abbreviations and correction of a note	7.1.0
2008-12	CT#42					Upgraded unchanged from Rel-7	8.0.0
2009-12	-	-	-			Update to Rel-9 version (MCC)	9.0.0
2011-03	-	-	-			Update to Rel-10 version (MCC)	10.0.0
2012-09	-	-	-			Update to Rel-11 version (MCC)	11.0.0
2014-09	-	-	-			Update to Rel-12 version (MCC)	12.0.0
2015-12	CT#70	-	-			Update to Rel-13 version (MCC)	13.0.0
2017-03	CT#75	-	-			Update to Rel-14 version (MCC)	14.0.0
2018-06	CT#80	-	-			Update to Rel-15 version (MCC)	15.0.0
2020-07	CT#88e	-	-			Update to Rel-16 version (MCC)	16.0.0
2022-04	-	-	-	-	-	Update to Rel-17 version (MCC)	17.0.0
2024-03	-	-	-	-	-	Update to Rel-18 version (MCC)	18.0.0



---

# History

<b>Document history</b>		
V18.0.0	May 2024	Publication