

ETSI TS 129 244 V15.9.0 (2020-07)



**LTE;
5G;
Interface between the Control Plane and the User Plane nodes
(3GPP TS 29.244 version 15.9.0 Release 15)**



Reference

RTS/TSGC-0429244vf90

Keywords

5G,LTE

ETSI

650 Route des Lucioles
F-06921 Sophia Antipolis Cedex - FRANCE

Tel.: +33 4 92 94 42 00 Fax: +33 4 93 65 47 16

Siret N° 348 623 562 00017 - NAF 742 C
Association à but non lucratif enregistrée à la
Sous-Préfecture de Grasse (06) N° 7803/88

Important notice

The present document can be downloaded from:

<http://www.etsi.org/standards-search>

The present document may be made available in electronic versions and/or in print. The content of any electronic and/or print versions of the present document shall not be modified without the prior written authorization of ETSI. In case of any existing or perceived difference in contents between such versions and/or in print, the prevailing version of an ETSI deliverable is the one made publicly available in PDF format at www.etsi.org/deliver.

Users of the present document should be aware that the document may be subject to revision or change of status.

Information on the current status of this and other ETSI documents is available at

<https://portal.etsi.org/TB/ETSIDeliverableStatus.aspx>

If you find errors in the present document, please send your comment to one of the following services:

<https://portal.etsi.org/People/CommitteeSupportStaff.aspx>

Copyright Notification

No part may be reproduced or utilized in any form or by any means, electronic or mechanical, including photocopying and microfilm except as authorized by written permission of ETSI.

The content of the PDF version shall not be modified without the written authorization of ETSI.

The copyright and the foregoing restriction extend to reproduction in all media.

© ETSI 2020.

All rights reserved.

DECT™, **PLUGTESTS™**, **UMTS™** and the ETSI logo are trademarks of ETSI registered for the benefit of its Members.

3GPP™ and **LTE™** are trademarks of ETSI registered for the benefit of its Members and of the 3GPP Organizational Partners.

oneM2M™ logo is a trademark of ETSI registered for the benefit of its Members and of the oneM2M Partners.

GSM® and the GSM logo are trademarks registered and owned by the GSM Association.

Intellectual Property Rights

Essential patents

IPRs essential or potentially essential to normative deliverables may have been declared to ETSI. The information pertaining to these essential IPRs, if any, is publicly available for **ETSI members and non-members**, and can be found in ETSI SR 000 314: "*Intellectual Property Rights (IPRs); Essential, or potentially Essential, IPRs notified to ETSI in respect of ETSI standards*", which is available from the ETSI Secretariat. Latest updates are available on the ETSI Web server (<https://ipr.etsi.org/>).

Pursuant to the ETSI IPR Policy, no investigation, including IPR searches, has been carried out by ETSI. No guarantee can be given as to the existence of other IPRs not referenced in ETSI SR 000 314 (or the updates on the ETSI Web server) which are, or may be, or may become, essential to the present document.

Trademarks

The present document may include trademarks and/or tradenames which are asserted and/or registered by their owners. ETSI claims no ownership of these except for any which are indicated as being the property of ETSI, and conveys no right to use or reproduce any trademark and/or tradename. Mention of those trademarks in the present document does not constitute an endorsement by ETSI of products, services or organizations associated with those trademarks.

Legal Notice

This Technical Specification (TS) has been produced by ETSI 3rd Generation Partnership Project (3GPP).

The present document may refer to technical specifications or reports using their 3GPP identities. These shall be interpreted as being references to the corresponding ETSI deliverables.

The cross reference between 3GPP and ETSI identities can be found under <http://webapp.etsi.org/key/queryform.asp>.

Modal verbs terminology

In the present document "**shall**", "**shall not**", "**should**", "**should not**", "**may**", "**need not**", "**will**", "**will not**", "**can**" and "**cannot**" are to be interpreted as described in clause 3.2 of the [ETSI Drafting Rules](#) (Verbal forms for the expression of provisions).

"**must**" and "**must not**" are **NOT** allowed in ETSI deliverables except when used in direct citation.

Contents

Intellectual Property Rights	2
Legal Notice	2
Modal verbs terminology.....	2
Foreword.....	11
1 Scope	13
2 References	13
3 Definitions, symbols and abbreviations	15
3.1 Definitions	15
3.2 Abbreviations	15
4 Protocol Stack	16
4.1 Introduction	16
4.2 UDP Header and Port Numbers	17
4.2.1 General.....	17
4.2.2 Request Message	18
4.2.3 Response Message	18
4.3 IP Header and IP Addresses	18
4.3.1 General.....	18
4.3.2 Request Message	18
4.3.3 Response Message	18
4.4 Layer 2	18
4.5 Layer 1	18
5 General description.....	19
5.1 Introduction	19
5.2 Packet Forwarding Model	19
5.2.1 General.....	19
5.2.1A Packet Detection Rule Handling	21
5.2.1A.1 General	21
5.2.1A.2 PDI Optimization	21
5.2.1A.2A Provisioning of SDF filters	22
5.2.1A.3 Bidirectional SDF Filters	22
5.2.1A.4 Application detection with PFD.....	23
5.2.2 Usage Reporting Rule Handling	23
5.2.2.1 General	23
5.2.2.2 Provisioning of Usage Reporting Rule in the UP function	23
5.2.2.2.1 General	23
5.2.2.2.2 Credit pooling (for EPC)	27
5.2.2.3 Reporting of Usage Report to the CP function.....	27
5.2.2.3.1 General	27
5.2.2.3.2 Credit pooling.....	30
5.2.2.4 Reporting of Linked Usage Reports to the CP function.....	30
5.2.3 Forwarding Action Rule Handling.....	31
5.2.3.1 General	31
5.2.4 Buffering Action Rule Handling.....	32
5.2.4.1 General	32
5.2.4.2 Provisioning of Buffering Action Rule in the UP function	32
5.2.5 QoS Enforcement Rule Handling	33
5.2.5.1 General	33
5.2.5.2 Provisioning of QoS Enforcement Rule in the UP function.....	33
5.2.6 Combined SGW/PGW Architecture	33
5.3 Data Forwarding between the CP and UP Functions	33
5.3.1 General.....	33
5.3.2 Sending of End Marker Packets.....	34
5.3.3 Forwarding of Packets Subject to Buffering in the CP Function.....	35

5.3.3.1	General	35
5.3.3.2	Forwarding of Packets from the UP Function to the CP Function	35
5.3.3.3	Forwarding of Packets from the CP Function to the UP Function	36
5.3.4	Data Forwarding between the CP and UP Functions with one PFCP-u Tunnel per UP Function or PDN	36
5.3.4.1	General	36
5.3.4.2	Forwarding of Packets from the UP Function to the CP Function	36
5.3.4.3	Forwarding of Packets from the CP Function to the UP Function	37
5.4	Policy and Charging Control	37
5.4.1	General	37
5.4.2	Service Detection and Bearer/QoS Flow Binding	37
5.4.3	Gating Control	38
5.4.4	QoS Control	38
5.4.5	DL Flow Level Marking for Application Detection	39
5.4.6	Usage Monitoring	39
5.4.7	Traffic Redirection	40
5.4.8	Traffic Steering	41
5.4.9	Provisioning of Predefined PCC/ADC Rules	41
5.4.10	Charging	42
5.4.11	(Un)solicited Application Reporting	43
5.4.12	Service Identification for Improved Radio Utilisation for GERAN	44
5.4.13	Transport Level Marking	44
5.5	F-TEID Allocation and Release	44
5.5.1	General	44
5.5.2	F-TEID allocation in the CP function	45
5.5.3	F-TEID allocation in the UP function	45
5.6	PFCP Session Handling	45
5.6.1	General	45
5.6.2	Session Endpoint Identifier Handling	45
5.6.3	Modifying the Rules of an Existing PFCP Session	45
5.7	Support of Lawful Interception	46
5.7.1	General	46
5.7.2	Lawful Interception in EPC	46
5.7.3	Lawful Interception in 5GC	46
5.8	PFCP Association	46
5.8.1	General	46
5.8.2	Behaviour with an Established PFCP Association	47
5.8.3	Behaviour without an Established PFCP Association	48
5.9	Usage of Vendor-specific IE	48
5.10	Error Indication Handling	48
5.11	User plane inactivity detection and reporting	48
5.12	Suspend and Resume Notification procedures	49
5.13	Ethernet traffic (for 5GC)	49
5.13.1	General	49
5.13.2	Address Resolution Protocol or IPv6 Neighbour Solicitation Response by SMF	50
5.13.3	Address Resolution Protocol or IPv6 Neighbour Solicitation Response by UPF	50
5.13.3A	Provisioning of MAC addresses and SDF filters in Ethernet Packet Filters	51
5.13.4	Bidirectional Ethernet Filters	51
5.13.5	Reporting of UE MAC addresses to the SMF	51
5.14	Support IPv6 Prefix Delegation	52
5.15	Signalling based Trace (De)Activation	52
5.16	Framed Routing	52
5.17	5G UPF (for 5GC)	52
5.17.1	Introduction	52
5.17.2	Uplink Classifier and Branching Point	52
5.17.3	Data Forwarding during handovers between 5GS and EPS	53
6	Procedures	54
6.1	Introduction	54
6.2	PFCP Node Related Procedures	54
6.2.1	General	54
6.2.2	Heartbeat Procedure	54

6.2.2.1	General	54
6.2.2.2	Heartbeat Request	54
6.2.2.3	Heartbeat Response	54
6.2.3	Load Control Procedure	54
6.2.3.1	General	54
6.2.3.2	Principles.....	54
6.2.3.3	Load Control Information	55
6.2.3.3.1	General Description.....	55
6.2.3.3.2	Parameters	55
6.2.3.3.2.1	Load Control Sequence Number.....	55
6.2.3.3.2.2	Load Metric.....	56
6.2.3.3.3	Frequency of Inclusion.....	56
6.2.4	Overload Control Procedure	57
6.2.4.1	General	57
6.2.4.2	Principles.....	57
6.2.4.3	Overload Control Information.....	57
6.2.4.3.1	General Description.....	57
6.2.4.3.2	Parameters	58
6.2.4.3.2.1	Overload Control Sequence Number	58
6.2.4.3.2.2	Period of Validity.....	59
6.2.4.3.2.3	Overload Reduction Metric.....	59
6.2.4.3.3	Frequency of Inclusion	60
6.2.4.4	Message Throttling.....	60
6.2.4.4.1	General	60
6.2.4.4.2	Throttling algorithm – "Loss".....	60
6.2.4.4.2.1	Description.....	60
6.2.4.5	Message Prioritization.....	61
6.2.4.5.1	Description	61
6.2.4.5.2	Based on the Message Priority Signalled in the PFCP Message	61
6.2.5	PFCP PFD Management Procedure	62
6.2.5.1	General	62
6.2.5.2	CP Function Behaviour	62
6.2.5.3	UP Function Behaviour.....	62
6.2.6	PFCP Association Setup Procedure	63
6.2.6.1	General	63
6.2.6.2	PFCP Association Setup Initiated by the CP Function	63
6.2.6.2.1	CP Function Behaviour	63
6.2.6.2.2	UP Function behaviour.....	63
6.2.6.3	PFCP Association Setup Initiated by the UP Function	64
6.2.6.3.1	UP Function Behaviour	64
6.2.6.3.2	CP Function Behaviour	64
6.2.7	PFCP Association Update Procedure.....	64
6.2.7.1	General	64
6.2.7.2	PFCP Association Update Procedure Initiated by the CP Function	64
6.2.7.2.1	CP Function Behaviour	64
6.2.7.2.2	UP Function Behaviour	64
6.2.7.3	PFCP Association Update Procedure Initiated by UP Function.....	65
6.2.7.3.1	UP Function Behaviour	65
6.2.7.3.2	CP Function Behaviour	65
6.2.8	PFCP Association Release Procedure.....	65
6.2.8.1	General	65
6.2.8.2	CP Function Behaviour	65
6.2.8.3	UP Function behaviour	66
6.2.9	PFCP Node Report Procedure	66
6.2.9.1	General	66
6.2.9.2	UP Function Behaviour.....	66
6.2.9.3	CP Function behaviour.....	66
6.3	PFCP Session Related Procedures.....	66
6.3.1	General.....	66
6.3.2	PFCP Session Establishment Procedure	66
6.3.2.1	General	66
6.3.2.2	CP Function Behaviour	66

6.3.2.3	UP Function Behaviour.....	67
6.3.3	PFCP Session Modification Procedure.....	67
6.3.3.1	General.....	67
6.3.3.2	CP Function behaviour.....	67
6.3.3.3	UP Function Behaviour.....	67
6.3.4	PFCP Session Deletion Procedure.....	68
6.3.4.1	General.....	68
6.3.4.2	CP Function Behaviour.....	68
6.3.4.3	UP Function Behaviour.....	68
6.3.5	PFCP Session Report Procedure.....	68
6.3.5.1	General.....	68
6.3.5.2	UP Function Behaviour.....	68
6.3.5.3	CP Function Behaviour.....	68
6.4	Reliable Delivery of PFCP Messages.....	69
7	Messages and Message Formats.....	69
7.1	Transmission Order and Bit Definitions.....	69
7.2	Message Format.....	69
7.2.1	General.....	69
7.2.2	Message Header.....	70
7.2.2.1	General Format.....	70
7.2.2.2	PFCP Header for Node Related Messages.....	70
7.2.2.3	PFCP Header for Session Related Messages.....	71
7.2.2.4	Usage of the PFCP Header.....	71
7.2.2.4.1	General.....	71
7.2.2.4.2	Conditions for Sending SEID=0 in PFCP Header.....	72
7.2.3	Information Elements.....	72
7.2.3.1	General.....	72
7.2.3.2	Presence Requirements of Information Elements.....	72
7.2.3.3	Grouped Information Elements.....	73
7.2.3.4	Information Element Type.....	74
7.3	Message Types.....	74
7.4	PFCP Node Related Messages.....	74
7.4.1	General.....	74
7.4.2	Heartbeat Messages.....	75
7.4.2.1	Heartbeat Request.....	75
7.4.2.2	Heartbeat Response.....	75
7.4.3	PFCP PFD Management.....	75
7.4.3.1	PFCP PFD Management Request.....	75
7.4.3.2	PFCP PFD Management Response.....	76
7.4.4	PFCP Association messages.....	77
7.4.4.1	PFCP Association Setup Request.....	77
7.4.4.2	PFCP Association Setup Response.....	78
7.4.4.3	PFCP Association Update Request.....	79
7.4.4.4	PFCP Association Update Response.....	79
7.4.4.5	PFCP Association Release Request.....	79
7.4.4.6	PFCP Association Release Response.....	80
7.4.4.7	PFCP Version Not Supported Response.....	80
7.4.5	PFCP Node Report Procedure.....	80
7.4.5.1	PFCP Node Report Request.....	80
7.4.5.1.1	General.....	80
7.4.5.1.2	User Plane Path Failure Report IE within PFCP Node Report Request.....	80
7.4.5.2	PFCP Node Report Response.....	81
7.4.5.2.1	General.....	81
7.4.6	PFCP Session Set Deletion.....	81
7.4.6.1	PFCP Session Set Deletion Request.....	81
7.4.6.2	PFCP Session Set Deletion Response.....	81
7.5	PFCP Session Related Messages.....	82
7.5.1	General.....	82
7.5.2	PFCP Session Establishment Request.....	82
7.5.2.1	General.....	82
7.5.2.2	Create PDR IE within PFCP Session Establishment Request.....	84

7.5.2.3	Create FAR IE within PFCP Session Establishment Request	86
7.5.2.4	Create URR IE within PFCP Session Establishment Request	89
7.5.2.5	Create QER IE within PFCP Session Establishment Request	93
7.5.2.6	Create BAR IE within PFCP Session Establishment Request	95
7.5.2.7	Create Traffic Endpoint IE within Sx Session Establishment Request	95
7.5.3	PFCP Session Establishment Response	96
7.5.3.1	General	96
7.5.3.2	Created PDR IE within PFCP Session Establishment Response	97
7.5.3.3	Load Control Information IE within PFCP Session Establishment Response	97
7.5.3.4	Overload Control Information IE within PFCP Session Establishment Response	98
7.5.3.5	Created Traffic Endpoint IE within PFCP Session Establishment Response	98
7.5.4	PFCP Session Modification Request	98
7.5.4.1	General	98
7.5.4.2	Update PDR IE within PFCP Session Modification Request	102
7.5.4.3	Update FAR IE within PFCP Session Modification Request	103
7.5.4.4	Update URR IE within PFCP Session Modification Request	104
7.5.4.5	Update QER IE within PFCP Session Modification Request	108
7.5.4.6	Remove PDR IE within PFCP Session Modification Request	110
7.5.4.7	Remove FAR IE within PFCP Session Modification Request	110
7.5.4.8	Remove URR IE within PFCP Session Modification Request	110
7.5.4.9	Remove QER IE PFCP Session Modification Request	110
7.5.4.10	Query URR IE within PFCP Session Modification Request	111
7.5.4.11	Update BAR IE within PFCP Session Modification Request	111
7.5.4.12	Remove BAR IE within PFCP Session Modification Request	111
7.5.4.13	Update Traffic Endpoint IE within PFCP Session Modification Request	111
7.5.4.14	Remove Traffic Endpoint IE within PFCP Session Modification Request	112
7.5.5	PFCP Session Modification Response	113
7.5.5.1	General	113
7.5.5.2	Usage Report IE within PFCP Session Modification Response	114
7.5.6	PFCP Session Deletion Request	115
7.5.7	PFCP Session Deletion Response	116
7.5.7.1	General	116
7.5.7.2	Usage Report IE within PFCP Session Deletion Response	116
7.5.8	PFCP Session Report Request	117
7.5.8.1	General	117
7.5.8.2	Downlink Data Report IE within PFCP Session Report Request	118
7.5.8.3	Usage Report IE within PFCP Session Report Request	119
7.5.8.4	Error Indication Report IE within PFCP Session Report Request	121
7.5.9	PFCP Session Report Response	122
7.5.9.1	General	122
7.5.9.2	Update BAR IE within PFCP Session Report Response	122
7.6	Error Handling	123
7.6.1	Protocol Errors	123
7.6.2	Different PFCP Versions	124
7.6.3	PFCP Message of Invalid Length	124
7.6.4	Unknown PFCP Message	124
7.6.5	Unexpected PFCP Message	124
7.6.6	Missing Information Elements	124
7.6.7	Invalid Length Information Element	125
7.6.8	Semantically incorrect Information Element	125
7.6.9	Unknown or unexpected Information Element	125
7.6.10	Repeated Information Elements	125
8	Information Elements	126
8.1	Information Elements Format	126
8.1.1	Information Element Format	126
8.1.2	Information Element Types	127
8.2	Information Elements	131
8.2.1	Cause	131
8.2.2	Source Interface	133
8.2.3	F-TEID	133
8.2.4	Network Instance	134

8.2.5	SDF Filter	135
8.2.6	Application ID	136
8.2.7	Gate Status	136
8.2.8	MBR	137
8.2.9	GBR	137
8.2.10	QER Correlation ID	138
8.2.11	Precedence	138
8.2.12	Transport Level Marking	138
8.2.13	Volume Threshold	139
8.2.14	Time Threshold	139
8.2.15	Monitoring Time	139
8.2.16	Subsequent Volume Threshold	140
8.2.17	Subsequent Time Threshold	140
8.2.18	Inactivity Detection Time	141
8.2.19	Reporting Triggers	141
8.2.20	Redirect Information	142
8.2.21	Report Type	143
8.2.22	Offending IE	143
8.2.23	Forwarding Policy	143
8.2.24	Destination Interface	144
8.2.25	UP Function Features	144
8.2.26	Apply Action	145
8.2.27	Downlink Data Service Information	146
8.2.28	Downlink Data Notification Delay	146
8.2.29	DL Buffering Duration	147
8.2.30	DL Buffering Suggested Packet Count	147
8.2.31	PFCPSMReq-Flags	148
8.2.32	PFCPSRRsp-Flags	148
8.2.33	Sequence Number	149
8.2.34	Metric	149
8.2.35	Timer	149
8.2.36	Packet Detection Rule ID (PDR ID)	150
8.2.37	F-SEID	150
8.2.38	Node ID	151
8.2.39	PFD Contents	151
8.2.40	Measurement Method	153
8.2.41	Usage Report Trigger	154
8.2.42	Measurement Period	155
8.2.43	Fully qualified PDN Connection Set Identifier (FQ-CSID)	155
8.2.44	Volume Measurement	156
8.2.45	Duration Measurement	157
8.2.46	Time of First Packet	157
8.2.47	Time of Last Packet	157
8.2.48	Quota Holding Time	158
8.2.49	Dropped DL Traffic Threshold	158
8.2.50	Volume Quota	158
8.2.51	Time Quota	159
8.2.52	Start Time	159
8.2.53	End Time	160
8.2.54	URR ID	160
8.2.55	Linked URR ID IE	160
8.2.56	Outer Header Creation	161
8.2.57	BAR ID	162
8.2.58	CP Function Features	162
8.2.59	Usage Information	163
8.2.60	Application Instance ID	163
8.2.61	Flow Information	163
8.2.62	UE IP Address	164
8.2.63	Packet Rate	164
8.2.64	Outer Header Removal	165
8.2.65	Recovery Time Stamp	166
8.2.66	DL Flow Level Marking	167

8.2.67	Header Enrichment	167
8.2.68	Measurement Information.....	168
8.2.69	Node Report Type.....	168
8.2.70	Remote GTP-U Peer	169
8.2.71	UR-SEQN	169
8.2.72	Activate Predefined Rules	170
8.2.73	Deactivate Predefined Rules	170
8.2.74	FAR ID	170
8.2.75	QER ID	171
8.2.76	OCI Flags.....	171
8.2.77	PFCP Association Release Request	171
8.2.78	Graceful Release Period.....	172
8.2.79	PDN Type	172
8.2.80	Failed Rule ID.....	173
8.2.81	Time Quota Mechanism.....	173
8.2.82	User Plane IP Resource Information.....	174
8.2.83	User Plane Inactivity Timer	175
8.2.84	Multiplier	175
8.2.85	Aggregated URR ID IE.....	175
8.2.86	Subsequent Volume Quota	176
8.2.87	Subsequent Time Quota.....	176
8.2.88	RQI	176
8.2.89	QFI.....	177
8.2.90	Query URR Reference	177
8.2.91	Additional Usage Reports Information	177
8.2.92	Traffic Endpoint ID	178
8.2.93	MAC address	178
8.2.94	C-TAG (Customer-VLAN tag).....	179
8.2.95	S-TAG (Service-VLAN tag).....	179
8.2.96	Ethertype.....	180
8.2.97	Proxying.....	180
8.2.98	Ethernet Filter ID	180
8.2.99	Ethernet Filter Properties	181
8.2.100	Suggested Buffering Packets Count.....	181
8.2.101	User ID	181
8.2.102	Ethernet PDU Session Information.....	182
8.2.103	MAC Addresses Detected.....	182
8.2.104	MAC Addresses Removed.....	183
8.2.105	Ethernet Inactivity Timer	183
8.2.106	Subsequent Event Quota	184
8.2.107	Subsequent Event Threshold.....	184
8.2.108	Trace Information	184
8.2.109	Framed-Route	185
8.2.110	Framed-Routing	185
8.2.111	Framed-IPv6-Route	185
8.2.112	Event Quota	185
8.2.113	Event Threshold.....	186
8.2.114	Event Time Stamp	186
8.2.115	Averaging Window.....	186
8.2.116	Paging Policy Indicator (PPI)	187
8.2.117	APN/DNN.....	187
8.2.118	3GPP Interface Type.....	187
Annex A (Informative): PFCP Load and Overload Control Mechanism.....		189
A.1	Throttling Algorithms.....	189
A.1.1	"Loss" Throttling Algorithm.....	189
A.1.1.1	Example of Possible Implementation.....	189
Annex B (Normative): CP and UP Selection Functions with Control and User Plane Separation.....		190
B.1	CP Selection Function	190
B.1.1	General.....	190

B.2	UP Selection Function.....	190
B.2.1	General.....	190
B.2.2	SGW-U Selection Function	190
B.2.3	PGW-U Selection Function	191
B.2.4	Combined SGW-U/PGW-U Selection Function.....	191
B.2.5	TDF-U selection function	192
B.2.6	UP Selection Function Based on DNS.....	192
B.2.6.1	General	192
B.2.6.2	SGW-U Selection Function Based on DNS	192
B.2.6.3	PGW-U Selection Function Based on DNS	192
B.2.6.4	Combined SGW-U/PGW-U Selection Function Based on DNS	193
Annex C (Informative): Examples scenarios		194
C.1	General	194
C.2	Charging Support	194
C.2.1	Online Charging.....	194
C.2.1.1	Online Charging Call Flow – Normal Scenario	194
C.2.1.2	Online Charging Call Flow with Credit Pooling.....	196
C.2.1.2.1	General	196
C.2.1.2.2	Example Call Flow 1	196
C.2.1.2.3	Example Call Flow 2	198
Annex D(Informative): Change history		201
History		204

Foreword

This Technical Specification has been produced by the 3rd Generation Partnership Project (3GPP).

The contents of the present document are subject to continuing work within the TSG and may change following formal TSG approval. Should the TSG modify the contents of the present document, it will be re-released by the TSG with an identifying change of release date and an increase in version number as follows:

Version x.y.z

where:

- x the first digit:
 - 1 presented to TSG for information;
 - 2 presented to TSG for approval;
 - 3 or greater indicates TSG approved document under change control.
- y the second digit is incremented for all changes of substance, i.e. technical enhancements, corrections, updates, etc.
- z the third digit is incremented when editorial only changes have been incorporated in the document.

In the present document, modal verbs have the following meanings:

- shall** indicates a mandatory requirement to do something
- shall not** indicates an interdiction (prohibition) to do something

The constructions "shall" and "shall not" are confined to the context of normative provisions, and do not appear in Technical Reports.

The constructions "must" and "must not" are not used as substitutes for "shall" and "shall not". Their use is avoided insofar as possible, and they are not used in a normative context except in a direct citation from an external, referenced, non-3GPP document, or so as to maintain continuity of style when extending or modifying the provisions of such a referenced document.

- should** indicates a recommendation to do something
- should not** indicates a recommendation not to do something
- may** indicates permission to do something
- need not** indicates permission not to do something

The construction "may not" is ambiguous and is not used in normative elements. The unambiguous constructions "might not" or "shall not" are used instead, depending upon the meaning intended.

- can** indicates that something is possible
- cannot** indicates that something is impossible

The constructions "can" and "cannot" are not substitutes for "may" and "need not".

- will** indicates that something is certain or expected to happen as a result of action taken by an agency the behaviour of which is outside the scope of the present document
- will not** indicates that something is certain or expected not to happen as a result of action taken by an agency the behaviour of which is outside the scope of the present document
- might** indicates a likelihood that something will happen as a result of action taken by some agency the behaviour of which is outside the scope of the present document

might not indicates a likelihood that something will not happen as a result of action taken by some agency the behaviour of which is outside the scope of the present document

In addition:

is (or any other verb in the indicative mood) indicates a statement of fact

is not (or any other negative verb in the indicative mood) indicates a statement of fact

The constructions "is" and "is not" do not indicate requirements.

1 Scope

The present document specifies the Packet Forwarding Control Protocol (PFCP) used on the interface between the control plane and the user plane function.

PFCP shall be used over:

- the Sxa, Sxb, Sxc and the combined Sxa/Sxb reference points specified in 3GPP TS 23.214 [2].
- the Sxa' and Sxb' reference points specified in 3GPP TS 33.107 [20]. In the rest of this specification, no difference is made between Sxa and Sxa', or between Sxb and Sxb'. The Sxa' and Sxb' reference points reuse the protocol specified for the Sxa and Sxb reference points, but comply in addition with the security requirements specified in clause 8 of 3GPP 33.107 [20].

the N4 interface specified in 3GPP TS 23.501 [28] and 3GPP TS 23.502 [29].

In this specification the term CP function applies to control plane nodes such as SGW-C, PGW-C, TDF-C and SMF.

In this specification the term UP function applies to control plane nodes such as SGW-U, PGW-U, TDF-U and UPF.

The prefix PFCP in message and procedure names is used to indicate that messages and procedures are common and used on Sx and N4 reference point. A PFCP session refers to both Sx and/or N4 sessions. PFCP association are describing procedures to establish associations between EPC nodes (SGW-C/PGW-C/TDF-C and SGW-U/PGW-U/TDF-U) and also between 5G nodes (SMF and UPF).

In the related stage 2 specifications the prefix Sx and N4 is used for these common procedures realised by PFCP

Clauses or paragraphs that only apply to EPC or 5GC are indicated by the label "for EPC" or "for 5GC".

2 References

The following documents contain provisions which, through reference in this text, constitute provisions of the present document.

- References are either specific (identified by date of publication, edition number, version number, etc.) or non-specific.
- For a specific reference, subsequent revisions do not apply.
- For a non-specific reference, the latest version applies. In the case of a reference to a 3GPP document (including a GSM document), a non-specific reference implicitly refers to the latest version of that document *in the same Release as the present document*.

- [1] 3GPP TR 21.905: "Vocabulary for 3GPP Specifications".
- [2] 3GPP TS 23.214: "Architecture enhancements for control and user plane separation of EPC nodes; Stage 2".
- [3] 3GPP TS 29.281: "General Packet Radio System (GPRS) Tunnelling Protocol User Plane (GTPv1-U)".
- [4] IETF RFC 768: "User Datagram Protocol".
- [5] IETF RFC 791: "Internet Protocol".
- [6] IETF RFC 2460: "Internet Protocol, Version 6 (IPv6) Specification".
- [7] 3GPP TS 23.203: "Policy and charging control architecture; Stage 2".
- [8] 3GPP TS 29.212: "Policy and Charging Control (PCC); Reference points".
- [9] 3GPP TS 29.274: "3GPP Evolved Packet System. Evolved GPRS Tunnelling Protocol for EPS (GTPv2)".

- [10] 3GPP TS 36.413: "Evolved Universal Terrestrial Radio Access Network (E-UTRAN); S1 Application Protocol (S1AP)".
- [11] 3GPP TS 29.213: "Policy and Charging Control signalling flows and Quality of Service (QoS) parameter mapping".
- [12] IETF RFC 5905: "Network Time Protocol Version 4: Protocol and Algorithms Specification".
- [13] IETF RFC 2474: "Definition of the Differentiated Services Field (DS Field) in the IPv4 and IPv6 Headers".
- [14] 3GPP TS 23.401: "General Packet Radio Service (GPRS) enhancements for Evolved Universal Terrestrial Radio Access Network (E-UTRAN) access".
- [15] 3GPP TS 22.153: "Multimedia Priority Service".
- [16] IETF RFC 4006: "Diameter Credit Control Application".
- [17] 3GPP TS 32.251: "Telecommunication management; Charging management; Packet Switched (PS) domain charging".
- [18] 3GPP TS 32.299: "Telecommunication management; Charging management; Diameter charging application".
- [19] 3GPP TS 23.060: "General Packet Radio Service (GPRS); Service description; Stage 2".
- [20] 3GPP TS 33.107: "3G security; Lawful interception architecture and functions".
- [21] 3GPP TS 29.251: "Gw and Gwn reference points for sponsored data connectivity".
- [22] IETF RFC 2474, "Definition of the Differentiated Services Field (DS Field) in the IPv4 and IPv6 Headers".
- [23] IETF RFC 7230: "Hypertext Transfer Protocol (HTTP/1.1): Message Syntax and Routing".
- [24] 3GPP TS 23.007: "Restoration procedures".
- [25] 3GPP TS 29.303: "Domain Name System Procedures; Stage 3"
- [26] IETF RFC 5905: "Network Time Protocol Version 4: Protocol and Algorithms Specification".
- [27] IETF RFC 1035: "Domain Names - Implementation and Specification".
- [28] 3GPP TS 23.501: "System Architecture for the 5G System"
- [29] 3GPP TS 23.502: "Procedures for the 5G System"
- [30] IEEE 802.1Q: "Virtual Bridged Local Area Networks"
- [31] IEEE 802.3: "IEEE Standard for Ethernet"
- [32] IETF RFC 826: "An Ethernet Address Resolution Protocol or Converting Network Protocol Addresses".
- [33] IETF RFC 4861: "Neighbor Discovery for IP version 6 (IPv6)". .
- [34] 3GPP TS 38.415: "NG-RAN; PDU Session User Plane Protocol".
- [35] 3GPP TS 32.422: "Telecommunication management; Subscriber and equipment trace; Trace control and configuration management".
- [36] IETF RFC 4282: "The Network Access Identifier".
- [37] IETF RFC 2865: "Remote Authentication Dial In User Service (RADIUS)".
- [38] IETF RFC 3162: "RADIUS and IPv6".

- [39] 3GPP TS 29.061: "Interworking between the Public Land Mobile Network (PLMN) supporting packet based services and Packet Data Networks (PDN)".
- [40] 3GPP TS 23.527: "5G System; Restoration procedures".
- [41] 3GPP TS 29.512: "5G System; Session Management Policy Control Service; Stage 3".
- [42] 3GPP TS 38.300: "NR; NR and NG-RAN Overall Description; Stage 2".
- [43] 3GPP TS 29.510: "5G System; Network Function Repository Services; Stage 3".
- [44] 3GPP TS 23.503: "Policy and Charging Control Framework for the 5G System".
- [45] 3GPP TS 32.255: "Telecommunication management; Charging management; 5G data connectivity domain charging; Stage 2".
- [46] 3GPP TS 29.512: "Session Management Policy Control Service, Stage 3".
- [47] 3GPP TS 33.127: "Security; Lawful Interception (LI) architecture and functions".
- [48] 3GPP TS 23.003: "Numbering, addressing and identification".
- [49] 3GPP TS 29.561: "5G System; Interworking between 5G Network and external Data Networks; Stage 3".

3 Definitions, symbols and abbreviations

3.1 Definitions

For the purposes of the present document, the terms and definitions given in 3GPP TR 21.905 [1] and the following apply. A term defined in the present document takes precedence over the definition of the same term, if any, in 3GPP TR 21.905 [1].

Match Field: a field of the Packet Detection Information of a Packet Detection Rule against which a packet is attempted to be matched.

Matching: comparing the set of header fields of a packet to the match fields of the Packet Detection Information of a Packet Detection Rule.

CP function: A node with a Control Plane function (see 3GPP TS 23.214[2]) supporting one or more PFCP entities. A Control Plane function, i.e. a Control Plane Node, is identified by the Node ID, that is set to either an FQDN or an IP address.

UP function: A node with a User Plane function (see 3GPP TS 23.214[2]) supporting one or more PFCP entities. A User Plane function, i.e. a User Plane Node, is identified by the Node ID, that is set to either a FQDN or an IP address.

PFCP Entity: An endpoint in a CP (or UP) function supporting PFCP, that is identified by the IP address. The IP address of a PFCP entity may or may not be the IP address included in the Node ID.

3.2 Abbreviations

For the purposes of the present document, the abbreviations given in 3GPP TR 21.905 [1] and the following apply. An abbreviation defined in the present document takes precedence over the definition of the same abbreviation, if any, in 3GPP TR 21.905 [1].

ADC	Application Detection and Control
BAR	Buffering Action Rule
CP	Control Plane
DDoS	Distributed Denial of Service
DEI	Drop Eligible Indicator
DSCP	Differentiated Services Code Point

eMPS	enhanced Multimedia Priority Service
FAR	Forwarding Action Rule
F-SEID	Fully Qualified SEID
F-TEID	Fully Qualified TEID
IP	Internet Protocol
IPv4	Internet Protocol version 4
IPv6	Internet Protocol version 6
LMISF	LI Mirror IMS State Function
NR	New Radio
PCC	Policy and Charging Control
PCP	Priority Code Point
PCEF	Policy and Charging Enforcement Function
PCRF	Policy and Charging Rule Function
PDI	Packet Detection Information
PDR	Packet Detection Rule
PFCP	Packet Forwarding Control Protocol
PFD	Packet Flow Description
PGW	PDN Gateway
PGW-C	PDN Gateway Control plane function
PGW-U	PDN Gateway User plane function
QER	QoS Enforcement Rule
S8HR	S8 Home Routed
SDF	Service Data Flow
SEID	Session Endpoint Identifier
SGW	Serving Gateway
SGW-C	Serving Gateway Control plane function
SGW-U	Serving Gateway User plane function
SX3LIF	Split X3 LI Interworking Function
TDF	Traffic Detection Function
TDF-C	Traffic Detection Function Control plane function
TDF-U	Traffic Detection Function User plane function
ToS	Type of Service
TSSF	Traffic Steering Support Function
UDP	User Datagram Protocol
UP	User Plane
URR	Usage Reporting Rule
VID	VLAN Identifier

4 Protocol Stack

4.1 Introduction

The protocol stack for the control plane over the Sxa, Sxb, Sxc and combined Sxa/Sxb reference points shall be as depicted in Figure 4.1-1. Clauses 4.2 and 4.3 further specify the related UDP and IP requirements.

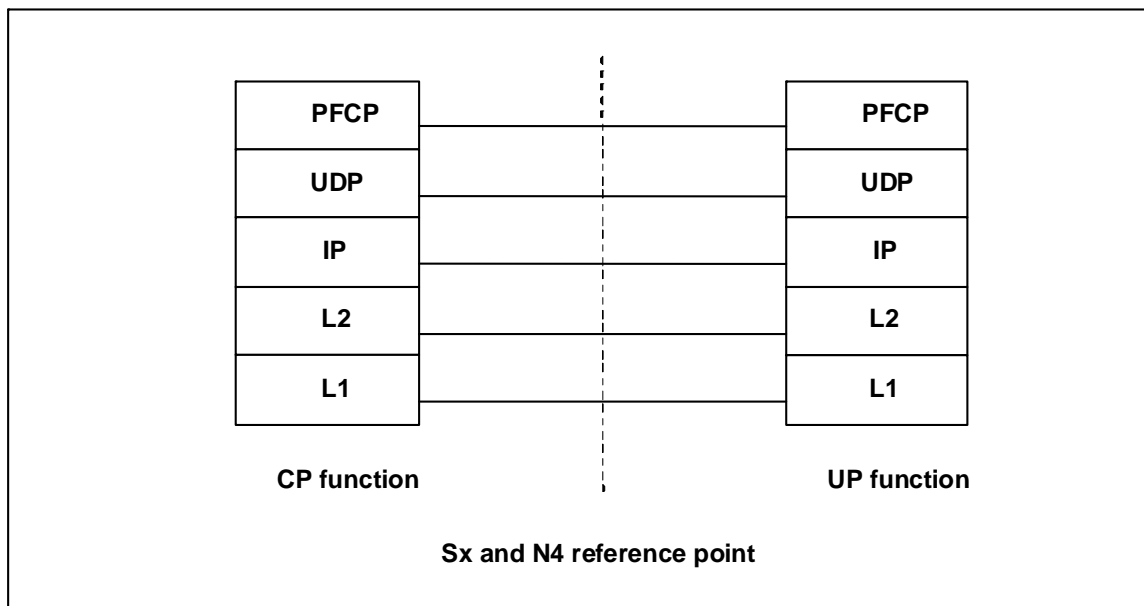

Figure 4.1-1: Control Plane stack over Sxa, Sxb, Sxc and combined Sxa/Sxb and N4

The protocol stack for the user plane over the Sxa, Sxb and N4 reference points (see clause 5.3) shall be as depicted in Figure 4.1-2. 3GPP TS 29.281 [3] further specifies the related GTP-U, UDP and IP requirements. Both IPv4 and IPv6 shall be supported.

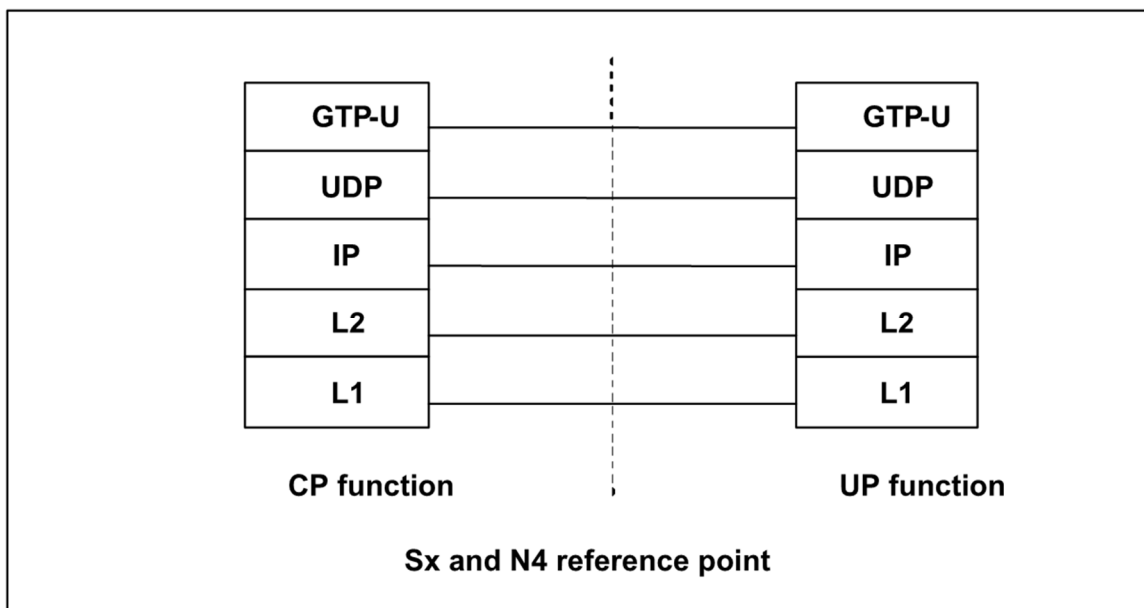

Figure 4.1-2: User Plane stack over Sxa, Sxb, combined Sxa/Sxb and N4

4.2 UDP Header and Port Numbers

4.2.1 General

A User Datagram Protocol (UDP) compliant with IETF RFC 768 [4] shall be used.

4.2.2 Request Message

The UDP Destination Port number for a Request message shall be 8805. It is the registered port number for PFCP.

The UDP Source Port for a Request message is a locally allocated port number at the sending entity.

NOTE: The locally allocated source port number can be reused for multiple Request messages.

4.2.3 Response Message

The UDP Destination Port value of a Response message shall be the value of the UDP Source Port of the corresponding Request message.

The UDP Source Port of a Response message shall be the value from the UDP Destination Port of the corresponding message.

4.3 IP Header and IP Addresses

4.3.1 General

In this clause, "IP" refers either to IPv4 as defined by IETF RFC 791 [5] or IPv6 as defined by IETF RFC 2460 [6]. A PFCP entity shall support both IPv4 and IPv6.

4.3.2 Request Message

The IP Destination Address of a Request message shall be an IP address of the peer entity.

During the establishment of an PFCP Session, the CP and the UP functions select and communicate to each other the IP Destination Address at which they expect to receive subsequent Request messages related to that PFCP Session. The CP and the UP functions may change this IP address subsequently during an PFCP Session Modification procedure.

The IP Source Address of a Request message shall be an IP address of the sending entity.

4.3.3 Response Message

The IP Destination Address of a Response message shall be copied from the IP Source Address of the corresponding Request message.

The IP Source Address of a Response message shall be copied from the IP destination address of the corresponding Request message.

4.4 Layer 2

Typically Ethernet should be used as a Layer 2 protocol, but operators may use any other technology.

4.5 Layer 1

Operators may use any appropriate Layer 1 technology.

5 General description

5.1 Introduction

The architecture reference model with Control and User Plane Separation of EPC nodes is described in clause 4.2 of 3GPP TS 23.214 [2].

The architecture reference model with SMF and UPF of 5GC nodes is described in clause 4.2 of 3GPP TS 23.501 [28].

This clause specifies the high level principles of the PFCP protocol and describe how 3GPP functionalities are realised on the Sxa, Sxb, Sxc and N4 reference points, e.g. Packet Forwarding, Policy and Charging Control, Lawful Interception.

5.2 Packet Forwarding Model

5.2.1 General

The packet forwarding scenarios supported over the Sxa, Sxb and Sxc reference points are specified in 3GPP TS 23.214 [2].

The packet forwarding scenarios supported over the N4 reference point are specified in 3GPP TS 23.501 [28] and 3GPP TS 23.502 [29].

The CP function controls the packet processing in the UP function by establishing, modifying or deleting PFCP Session contexts and by provisioning (i.e. adding, modifying or deleting) PDRs, FARs, QERs, URRs and/or BAR per PFCP session context, whereby an PFCP session context may correspond:

- for EPC, to an individual PDN connection, a TDF session, or a standalone session not tied to any PDN connection or TDF session used e.g. for forwarding Radius, Diameter or DHCP signalling between the PGW-C and the PDN.
- for 5GC, to an individual PDU session or a standalone PFCP session not tied to any PDU session.

Each PDR shall contain a PDI, i.e. one or more match fields against which incoming packets are matched, and may be associated to the following rules providing the set of instructions to apply to packets matching the PDI:

- one FAR, which contains instructions related to the processing of the packets as follows:
 - an Apply Action parameter, which indicates whether the UP function shall forward, duplicate, drop or buffer the packet with or without notifying the CP function about the arrival of a DL packet;
 - forwarding, buffering and/or duplicating parameters, which the UP function shall use if the Apply Action parameter requests the packets to be forwarded, buffered or duplicated respectively. These parameters may remain configured in the FAR regardless of the Apply Action parameter value, to minimize the changes to the FAR during the transitions of the UE between the idle and connected modes. The buffering parameters, when present, shall be provisioned in a BAR created at the PFCP session level and referenced by the FAR.

NOTE 1: Buffering refers here to the buffering of the packet in the UP function. The UP function is instructed to forward DL packets to the CP function when applying buffering in the CP function. See clause 5.3.1.

- zero, one or more QERs, which contains instructions related to the QoS enforcement of the traffic;
- zero, one or more URRs, which contains instructions related to traffic measurement and reporting.

A FAR, a QER and a URR shall only be associated to one or multiple PDRs of the same PFCP session context.

The QoS Enforcement Rule Correlation ID shall be assigned by the CP function to correlate QERs from multiple PFCP session contexts. For instance, the enforcement of APN-AMBR in the PGW-U shall be achieved by setting the same QoS Enforcement Rule Correlation ID to the QERs from different PFCP sessions associated with all the PDRs corresponding to the non-GBR bearers of all the UE's PDN connections to the same APN. The QERs that are associated to the same QoS Enforcement Rule Correlation ID in multiple PFCP sessions shall be provisioned, with the same QER

contents, in each of these PFCP sessions. The QoS Enforcement Rule Correlation ID shall be only used to enforce the APN-AMBR when the UE is in EPC, it may be provided by the CP function over N4 to the UP function for a PDU session may move to EPC in a later stage.

The following principles shall apply for the provisioning of PDRs in the UP function:

- The CP function shall not provision more than one PDR with the same match fields in the PDI (i.e. with the same set of match fields and with the same value). The CP function may provision PDRs with the same value for a subset of the match fields of the PDI but not all;
- different PDRs of a same PFCP session may overlap, e.g. the CP function may provision two PDRs which differ by having one match field set to a specific value in one PDR and the same match field not included in the other PDR (thus matching any possible value);
- different PDRs of different PFCP sessions shall not overlap, i.e. there shall be at least one PDR in each PFCP session which differs by at least one different (and not wildcarded) match field in their PDI, such that any incoming user plane packet may only match PDRs of a single PFCP session;

NOTE 2: It is allowed for instance to provision in a PGW-U a same uplink PDR, matching any uplink traffic towards a particular application server's IP address, in two different PFCP sessions of two different UEs, as long as each PFCP session is also provisioned with another uplink PDR set with the respective UE IP address and/or uplink F-TEIDu, which allows the PGW-U to identify the PFCP session to which the packet corresponds.

- As an exception to the previous principle, the CP function may provision a PDR with all match fields wildcarded (i.e. all match fields omitted in the PDI) in a separate PFCP session, to control how the UP function shall process packets unmatched by any PDRs of any other PFCP session. The CP function may provision the UP function to send these packets to the CP function or to drop them. The UP function shall grant the lowest precedence to this PDR.

On receipt of a user plane packet, the UP function shall perform a lookup of the provisioned PDRs and:

- identify first the PFCP session to which the packet corresponds; and
- find the first PDR matching the incoming packet, among all the PDRs provisioned for this PFCP session, starting with the PDRs with the highest precedence and continuing then with PDRs in decreasing order of precedence. Only the highest precedence PDR matching the packet shall be selected, i.e. the UP function shall stop the PDRs lookup once a matching PDR is found.

A packet matches a PDR if all the match fields which are identified with different IE type in the PDI of the PDR are matching the corresponding packet header fields unless specified otherwise. If a match field is not included in the PDI, it shall be considered as matching all possible values in the header field of the packet. If the match field is present and does not include a mask, the match field shall be considered as matching the corresponding header field of the packet if it has the same value. If the match field is present and includes a mask (e.g. IP address with a prefix mask), the match field shall be considered as matching the corresponding header field of the packet if it has the same value for the bits which are set in the mask. If a match field has multiple instances, i.e. there are several IEs with the same IE type, a packet matches this match field if any instance is matching the corresponding packet header field.

The match fields of the PDI shall correspond to outer and/or inner packet header fields, e.g. uplink bearer binding verification in the PGW-U may be achieved by configuring a PDR with the PDI containing the local GTP-U F-TEID (for outer IP packet matching) and the SDF filters of the data flows mapped to the bearer (for inner IP packet matching).

NOTE 3: A DL PDR can be provisioned with a UE IP address together with a Framed-Route or a Framed-IPv6-Route either in the PDI IE or in the Create Traffic Endpoint IE; in such case, the PDR is matched if the packet matches either the UE IP address or the Framed-Route (Framed-IPv6-Route).

The UP function should drop packets unmatched by any PDRs.

The packet processing flow in the UP function is illustrated in Figure 5.2.1-1.

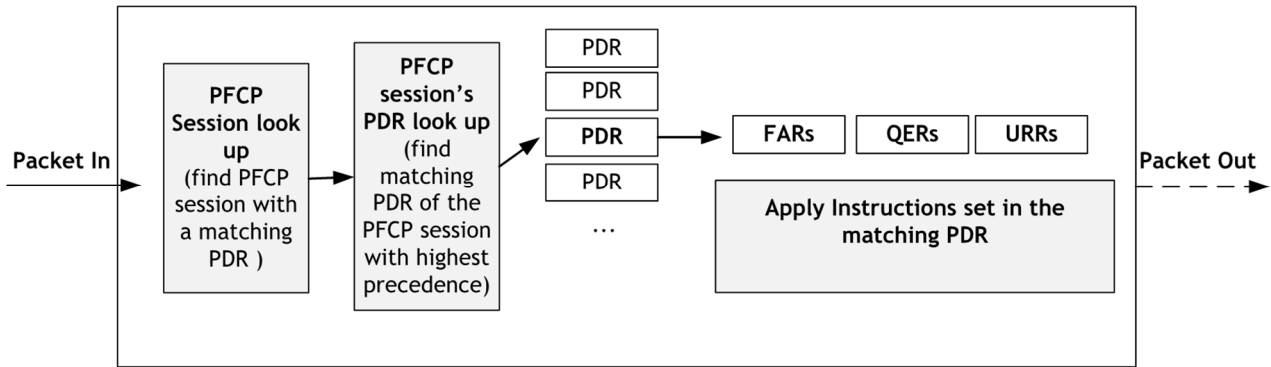

Figure 5.2.1-1: Packet processing flow in the UP function

At the deletion of an PFPC session, the UP function shall delete the PFPC session context and all the associated non-preconfigured rules.

NOTE 3: Deleting a QER in one PFPC session does not result in deleting another QER in another PFPC session even when these two QERs have the same QER ID and/or are associated with the same QER Correlation ID.

A UP Function controlled by multiple CP functions shall handle Rule IDs from the different CP functions independently from each other.

Rule ID used for PDR, FAR, BAR, QER or URR is uniquely identifying a rule of the corresponding rule type within a session.

5.2.1A Packet Detection Rule Handling

5.2.1A.1 General

When provisioning a PDR in the UP function, the CP function shall provide the PDI with the following information:

- the source interface of the incoming packets;
- a combination of the parameters, that incoming packets are requested to match, among: Local F-TEID, Network Instance, UE IP address, SDF Filter(s) and/or Application ID. For 5GC, the PDI may additionally contain one or more QFI(s) to detect traffic pertaining to specific QoS flow(s), Ethernet Packet Filter(s) and/or Ethernet PDU Session Information (see clause 5.13.1).

The requirements for provisioning an SDF filter in the PDI are specified in clauses 5.2.1A.2A and 5.2.1A.3.

The CP function may provision the parameters, that incoming packets are requested to match, in the UP function by:

- providing the parameters individually in each PDI of the PFPC session; or
- optionally, if the PDI Optimization feature is supported by the UP function, by providing the parameters which may be common to multiple PDIs of a same PFPC session in a Traffic Endpoint IE and by referencing this Traffic Endpoint in the PDI(s) of the PFPC session. See clause 5.2.1A.2. A Traffic Endpoint may include a Local F-TEID, Network Instance, UE IP address and/or Ethernet PDU Session Information (see clause 5.13.1).

NOTE: A Traffic Endpoint can correspond to a GTP-u endpoint, an SGi or an N6 endpoint.

5.2.1A.2 PDI Optimization

PDI Optimization is an optional feature which may be supported by the CP and UP Functions. This feature allows the CP function to optimize the signaling towards the UP function by creating the information that are common to multiple PDRs as a Traffic Endpoint with a Traffic Endpoint ID and then referring to this common information from multiple PDRs. The Traffic Endpoint ID shall be unique within an PFPC session. When a PDI refers to a Traffic Endpoint, the

parameters that are in the Traffic Endpoint shall not be once again provided in the PDI. The CP function may update the Traffic Endpoint at any time.

If a Traffic Endpoint is updated, all the PDRs that refer to this Traffic Endpoint in the UP function shall use the updated information.

If F-TEID allocation is performed in the UP function, the UP function shall allocate and store the F-TEID associated to the Traffic Endpoint. When the UP function provides the allocated F-TEID to the CP function in the PFCP Session Establishment response or PFCP Session Modification response message, the CP function shall update the Traffic Endpoint information stored in the CP function with the received F-TEID.

The CP function should use a Traffic Endpoint ID created in a different PFCP message only after getting the confirmation from the UP function of the Traffic Endpoint ID creation.

If the CP function deletes a Traffic Endpoint, the UP Function shall delete all the PDRs that refer to this Traffic Endpoint.

NOTE 1: The requirements specified in clause 5.2.2.3.1 for reporting usage reports to the CP function also apply if the deletion of the Traffic Endpoint results in deleting the last PDR associated to a URR.

NOTE2: For EPC, the Remove Traffic Endpoint IE can be used to delete a bearer for which multiple PDRs exist (with the same Traffic Endpoint ID).

5.2.1A.2A Provisioning of SDF filters

When provisioning an SDF Filter in a PDI, the CP function shall:

- copy the Flow Description if it is received from the PCRF (or PCF), in the corresponding PDI of a PDR regardless of whether the PDR is for matching uplink or downlink traffic;

NOTE 1 The Flow Description received from the PCRF (or PCF) is set assuming downlink flows only, see clause 5.4.2 of 3GPP TS 29.212 [8]. The CP function uses the Flow-Direction AVP received from the PCRF (or PCF) to determine the actual direction and thus the source interface of the packet flows described in the Flow Description.

- for traffic from CP-function or SGi-LAN:
 - If the traffic is intended to be forwarded to the UE, the CP function shall provision the Flow Description with IPFilterRule "source" parameters set to correspond to the CP function or SGi-LAN and the IPFilterRule "destination" parameters correspond to the UE;
 - If the traffic is intended to be forwarded to the PDN, the CP function shall provision the Flow Description with IPFilterRule "source" parameters set to correspond to the CP function or SGi-LAN and the IPFilterRule "destination" parameters correspond to the PDN.

The UP function shall apply the SDF filter based on the Source Interface of the PDR as follows (see also clause 8.2.5):

- when the Source Interface is CORE, this indicates that the filter is for downlink data flow, so the UP function shall apply the Flow Description as is;
- when the Source Interface is ACCESS, this indicates that the filter is for uplink data flow, so the UP function shall swap the source and destination address/port in the Flow Description;
- when the Source Interface is CP-function or SGi-LAN, the UP function shall use the Flow Description as is.

5.2.1A.3 Bidirectional SDF Filters

The CP function may provision bidirectional SDF Filters in the UP function (see clause 8.2.5), i.e. SDF Filters that may be associated to both uplink and downlink PDRs of a same PFCP/N4 session, as follows:

- when provisioning a bidirectional SDF Filter the first time for an PFCP/N4 session, the CP function shall provision the SDF filter definition together with a SDF Filter ID uniquely identifying the SDF Filter among all the SDF Filters provisioned for a given PFCP/N4 Session;

- the CP function may then provision a PDR for the same PFCP/N4 session but the opposite direction, by provisioning the SDF Filter ID in the SDF filter ID field of the PDI, without provisioning again the SDF filter definition;
- the UP function shall apply any modification of a bidirectional SDF Filter to all PDRs of the PFCP/N4 session making use of this SDF Filter;
- upon deletion of a PDR making use of a bidirectional SDF Filter, the UP function shall still apply the SDF Filter for any other PDR making use of the SDF Filter.

The requirements specified for provisioning SDF filters in clause 5.2.1A.2A shall also apply when provisioning bidirectional SDF Filters.

5.2.1A.4 Application detection with PFD

The detection information for a given application may be provisioned by the CP function to the UP function via PFD management procedure. See clause 6.2.5.

The PFDE (PFD Enhancement) feature may be optionally supported by the CP function and UP function. When the feature is supported in both the CP function and UP function, the CP function may provision a PFD Contents IE including a property (i.e. either flow description, or URL or Domain Name/Domain Name Protocol) with multiple values.

NOTE 1: It is assumed, when the PFDE feature is not supported, a PFD Contents can only include a property with one value.

When the UP function attempts to detect the traffic pertaining to an application by using the application's PFDs (see clause 7.4.3.1 and 8.2.39), the UP function shall consider:

- the application is detected if the incoming traffic matches at least one PFD Contents;
- one PFD Contents is matched if the incoming traffic matches every property contained in the corresponding PFD Contents IE; the incoming traffic matches one property (i.e. flow description, URL and Domain Name/Domain Name Protocol) if it matches at least one value of the property.

NOTE 2: Interpretation of the Custom PFD Content is implementation specific.

5.2.2 Usage Reporting Rule Handling

5.2.2.1 General

The CP function shall provision URR(s) for a PFCP session in a PFCP Session Establishment Request or a PFCP Session Modification Request to request the UP function to:

- measure the network resources usage in terms of traffic data volume, duration (i.e. time) and/or events, according to the provisioned Measurement Method; and
- send a usage report to the CP function, when the measurement reaches a certain threshold, periodically or when detecting a certain event, according to the provisioned Reporting Triggers or when an immediate report is requested within an PFCP Session Modification Request.

NOTE: The UP function sends a usage report without performing network resources usage measurements when being requested to detect and report the the start of an SDF or application traffic.

5.2.2.2 Provisioning of Usage Reporting Rule in the UP function

5.2.2.2.1 General

When provisioning a URR, the CP function shall provide the reporting trigger(s) in the Reporting Triggers IE of the URR which shall cause the UP function to generate and send a Usage Report for this URR to the CP function. When adding or removing reporting trigger(s) to or from the URR, the CP function shall provide the new complete list of applicable reporting triggers in the Reporting Triggers IE in the PFCP Session Modification Request message.

For the volume-based measurement method, the CP function may provision:

- the Volume Threshold IE, to request the UP function to generate a usage report when the measured traffic reaches the threshold;
- the Volume Quota IE, to request the UP function to stop forwarding packets (or only allow forwarding of some limited user plane traffic, based on operator policy in the UP function) and, if no Volume Threshold is provisioned, to also generate a usage report, when the measured traffic reaches the quota;
- the Dropped DL Traffic Threshold IE, to request the UP function to generate a usage report when the downlink traffic that is being dropped reaches the threshold; and/or

NOTE 1: For EPC, the Dropped DL Traffic Threshold can be armed in a SGW-U for triggering the PGW Pause of Charging feature (see 3GPP TS 23.401 [14]). For 5GC, the Dropped DL Traffic Threshold can be armed in a UPF for triggering the SMF Pause of Charging feature (see 3GPP TS 23.502 [29]).

- a Measurement Information with the 'Measurement Before QoS Enforcement' flag set to "1", to request the UP function to measure the traffic usage before any QoS enforcement.

For the time-based measurement method, the CP function may provision:

- a Time Threshold IE, to request the UP function to generate a usage report when the measured traffic reaches the threshold;
- a Time Quota, to request the UP function to stop forwarding packets (or only allow forwarding of some limited user plane traffic, based on operator policy in the UP function) and, if no Time Threshold is provisioned, to also generate a usage report, when the measured traffic reaches the quota;
- a Measurement Information with the "Immediate Start Time Metering" flag set to "1", to request the UP function to start time metering immediately at receiving the flag; otherwise, the UP function shall start time metering when the first packet is received; and/or
- an Inactivity Detection Time, to request the UP function to suspend the time measurement when no packets are received during the provisioned Inactivity Detection Time. The time measurement shall then be resumed by the UP function when subsequent traffic is received. If an Inactivity Detection Time value of zero is provided, or if no Inactivity Detection Time has been provided by the CP function, the time measurement shall be performed continuously until a new non-zero Inactivity Detection Time is received or the time-based usage measurement is stopped. See Figure 5.2.2.2-1:

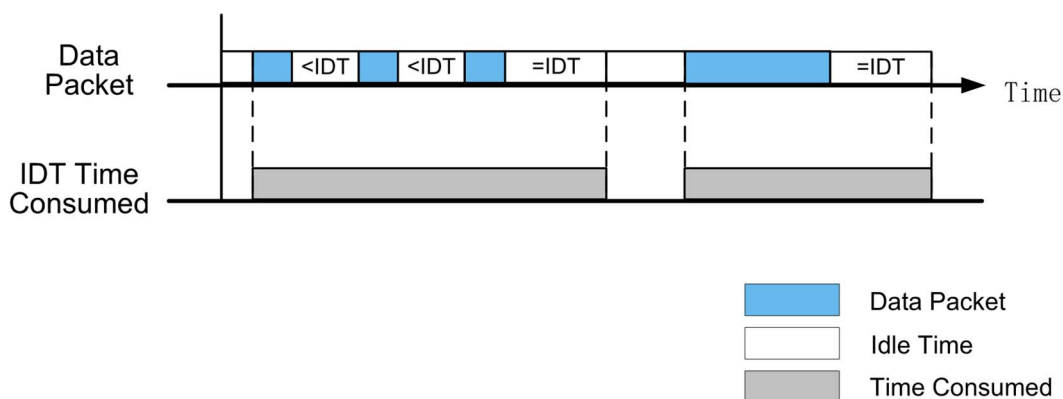

Figure 5.2.2.2-1: IDT based charging

NOTE 2: The Inactivity Detection Time can be set to the Quota Consumption Timer if received. The Inactivity Detection Time is not used to control when the time metering starts.

- For EPC, a Time Quota Mechanism, including a Base Time Interval Type, which is either Continuous Time Period (CTP) or Discrete Time Period (DTP), and a Base Time Interval (BTI), to the UP function. See clause 6.5.7 in 3GPP TS 32.299[18].
- For CTP (Continuous Time Period), the time measurement starts from the time that traffic has occurred up to the first Base Time Interval (BTI) which contains no traffic. The time measurement shall include the last Base Time

Interval, i.e. the one which contained no traffic. The time measurement resumes by the UP function when subsequent traffic is received. See Figure 5.2.2.2-2:

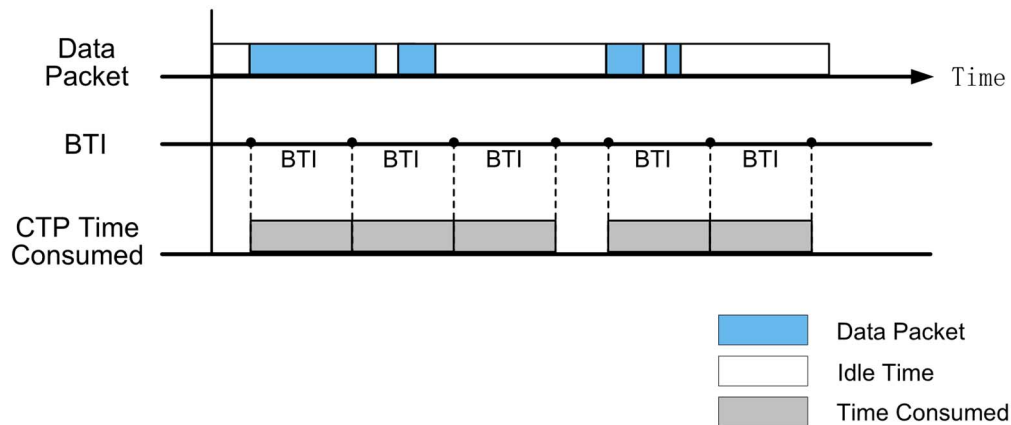

Figure 5.2.2.2-2: CTP based charging

- For DTP (Discrete Time Period), the time measurement starts from the time that traffic has occurred up to the Base Time Interval end. The time measurement shall be resumed by the UP function when subsequent traffic is received. See Figure 5.2.2.2-3:

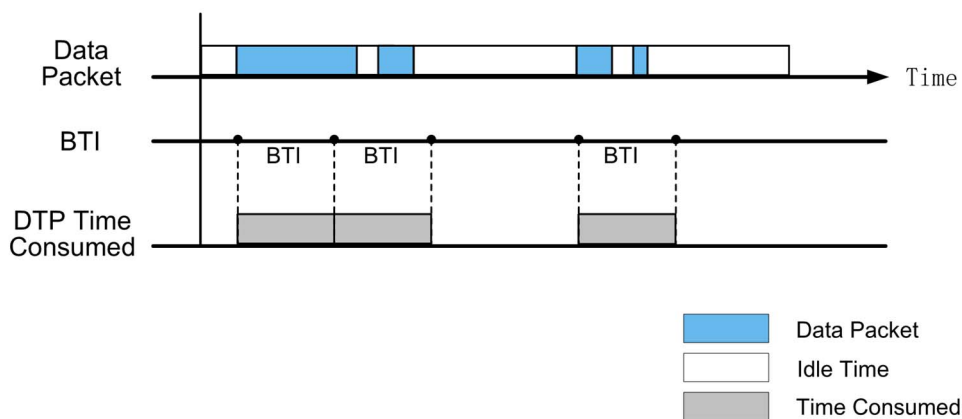

Figure 5.2.2.2-3: DTP based charging

When the time-based measurement method applies, and when the Envelope Reporting is required for EPC, the CP function shall request the UP function to report the usage by setting the reporting trigger to Envelope Closure in addition to other Reporting Trigger(s), in the Reporting Triggers IE. The CP function may indicate the UP function to report for just time, time and volume, time and events, or time and volume and number of events by setting Measurement Method accordingly. The CP function may set the Reduced Application Detection Information flag in the Measurement Information of the URR, when requesting the detection of start and stop of an application solely for the purpose of envelope reporting for EPC.

The CP function may provision a Volume Threshold, a Volume Quota, or both (and/or respectively a Time Threshold, a Time Quota, or both).

When both a Volume (or Time) Threshold and a Volume (or Time) Quota are provisioned, the UP function shall send a usage report only when reaching the Volume (or Time) Threshold; when subsequently reaching the Volume (or Time) Quota, the UP function shall stop forwarding packets (or only allow forwarding of some limited user plane traffic, based on operator policy in the UP function) without sending a new usage report to the CP function.

NOTE 3: For online charging, the Volume Threshold (or Time Threshold) can be set in a PGW-U or TDF-U to the value of the granted volume (or time) quota minus the volume (or time) quota threshold, such as to get a usage report from the UP function when the volume (or time) based credit falls below the remaining quota thresholds provided by the OCS.

NOTE 4: The Volume Quota or Time Quota can be armed in a PGW-U or TDF-U for online charging to enable the traffic to be forwarded up to an intermediate or final quotas granted by the OCS. The CP function can provision both a Volume (or Time) Threshold and a Volume (or Time) Threshold to request the UP function to:

- send a usage report when the consumed resources reach the volume (or time) usage threshold provided by the OCS, and
- to stop forwarding packets (or only allow forwarding of some limited user plane traffic, based on operator policy in the UP function), without sending a second usage report, when the granted volume (or time) quota is exhausted.

For event based measurement method, the CP function may provision:

- the Event Threshold IE, to request the UP function to generate a usage report when the number of events reaches the event threshold;
- the Event Quota IE, to request the UP function to stop forwarding packets applicable to the event (or only allow forwarding of some limited user plane traffic, based on operator policy in the UP function) and, if no Event threshold is provisioned, to also generate a usage report, when the number of events reaches the event quota;

NOTE 5: An event is preconfigured with one or more event detection logic in the UPF. Each event detection logic is associated with an Application ID. The CP function activates the detection and reporting of an event by provisioning PDR(s) with the PDI set to an Application ID and by provisioning a URR with an event threshold or event quota reporting trigger. The CP function identifies an event reported in a Usage Report by the URR ID.

For all the measurement methods (i.e. volume, time or event), the CP function may also provision:

- a Quota Holding Time, to request the UP function to send a usage report and to also stop forwarding packets (or only allow forwarding of some limited user plane traffic, based on operator policy in the UP function) when no packets have been received for the duration indicated in this parameter;

NOTE 6: A Quota Holding Time can be armed in a PGW-U or TDF-U for online charging to request the UP function to send a Usage Report when the Quota Holding Time provided by the OCS (see 3GPP TS 32.299 [18]) expires. The UP function can be instructed in the same Usage Reporting Rule with the Report Triggers – START to generate a new Usage Report upon receiving any subsequent packets associated with this URR.

- a Monitoring Time IE and zero or more Additional Monitoring IEs, to request the UP function to measure the network resources usage before and after the monitoring time in separate counts and to re-apply the volume and/or time, and/or event thresholds at the monitoring time. The CP function may additionally provision a Subsequent Volume (or Time or Event) Threshold IE and/or a Subsequent Volume (or Time or Event) Quota IE, for a volume (or time or event) based measurement. When being provisioned with a Monitoring Time, the UP function shall:
 - reset its usage thresholds at the monitoring time to the value provided in the Subsequent Volume (or Time or Event) Threshold IE, if provisioned in the URR, or to the remaining value of the Volume (or Time or Event) threshold used before the monitoring time (i.e. excluding the already accumulated volume or time usage);
 - shall indicate the usage up to the Monitoring time and usage after the Monitoring time in the first usage report after the Monitoring Time is reached;
- a Measurement Period, indicating the period to generate periodic usage reports to the CP function.

If the UP function indicated support of the Quota Action feature in the UP Function Features IE, when the CP function provisions a Volume Quota or Time Quota in a URR, the CP function may also provision the "FAR ID for Quota Action" IE identifying the substitute FAR the UP function shall apply, for the traffic identified by the PDR to which the URR is associated, when exhausting any of these quotas. This FAR may require the UP function to drop the packets or redirect the traffic towards a redirect destination as specified in clause 5.4.7.

NOTE 7: A PDR can be associated with multiple URRs. If one of these URRs requires the UP function to drop the user data packets, e.g. when the Quota has been exhausted, the other URRs associated to the PDR need also to stop their measurements, except for URRs including the Measurement Information with the 'Measurement Before QoS Enforcement' flag set to "1".

The CP function may request at any time the UP function to activate or deactivate a network resources usage measurement, using the Inactive Measurement flag of the Measurement Information IE of the URR.

NOTE 8: This can be used in a PGW-U for the PGW Pause of Charging procedure (see 3GPP TS 23.401 [14]).

5.2.2.2.2 Credit pooling (for EPC)

For EPC, when the Credit Pool feature is supported and the CP function (e.g. PGW-C) is instructed to handle a Credit Pool for a given Gy Session, the CP function shall create a URR for the Credit Pool, and in this URR, the CP function:

- shall include one Aggregated URR ID IE per URR sharing the credit pool, including the URR ID of the URR sharing the credit pool and the associated Multiplier to measure the abstract service units the corresponding traffic consumes from the credit pool;
- shall set the Time or Volume Threshold or Quota IE to the value calculated as specified in IETF RFC 4006 [16] according to the Measurement Method.

NOTE 1: The value can be calculated using the following formula:

$$S = Q1*M1 + Q2*M2 + \dots + Qn*Mn,$$

where the S is the quota for the credit pool, Qn is the quota and Mn is the multiplier for each Rating Group (RG) which are provided via the Multiple Services Credit Control from the OCS.

A URIn is defined for each of RG.

NOTE 2: When the Measurement Method is set to the combined volume/duration, the Time and Volume Threshold or Quota are calculated independently.

- may set the Reporting Trigger to reporting upon reaching a volume or time threshold or quota;
- may set the Measurement Method to the data volume, duration (i.e. time), combined volume/duration according to the Measurement Method set in the URRs in the Credit Pool.

NOTE 3: The UP function is instructed to handle a Credit Pool when a G-S-U-Pool-Reference AVP is included within a Multiple Services Credit Control from the OCS. A Credit Pool is identified by the G-S-U-Pool-Identifier AVP. See clause 6.3.11, 6.4.3 and 6.4.4 of 3GPP TS 32.299 [18].

In addition, the CP function shall also include the Linked URR IE, set to the Credit Pool URR ID, in all the URRs which are sharing the credit pool (i.e. which are associated with RGs sharing the Credit Pool).

5.2.2.3 Reporting of Usage Report to the CP function

5.2.2.3.1 General

When detecting that a provisioned reporting trigger occurs, the UP function shall generate a Usage Report for the related URR and send it to the CP function by initiating the PFCP Session Report procedure.

When providing usage report information for a URR in a message, the UP function shall include the UR-SEQN (Usage Report Sequence Number) identifying the order in which a Usage Report is generated for the given URR. The UR-SEQN (Usage Report Sequence Number) shall be set to "0" for the first Usage Report and incremented for every subsequent Usage Report generated by the UP function for the URR. The UP function shall also indicate the trigger that causes the usage report to be generated in the Usage Report Trigger IE.

Upon generating a usage report for a URR towards the CP function, the UP function shall:

- reset its ongoing measurement counts for the related URR (i.e. the UP function shall report in a usage report the network resources usage measurement since the last usage report for that URR);
- re-apply all the thresholds (Volume/Time/Event Threshold) provisioned for the related URR, if the usage report was triggered due to one of the thresholds being reached; and
- continue to apply all the provisioned URR(s) and perform the related network resources usage measurement(s), until getting any further instruction from the CP function.

When receiving a new threshold or quota from the CP function for a measurement that is already ongoing in the UP function, the UP function shall consider its ongoing measurements counts for the related URR against the new threshold or quota to determine when to send its next usage report to the CP function. At receiving a new quota with value set to zero, the UP function shall:

- apply the FAR identified in the FAR ID for Quota Action IE if the CP function has provisioned it, otherwise the UP function shall stop forwarding packets (or only allow forwarding of some limited user plane traffic, based on operator policy in the UP function), and
- report in a usage report the network resources usage measurement since the last usage report for that URR.

NOTE 1: The UP function determines when to send its next usage report to the CP function by deducting from the newly provisioned threshold or quota the traffic it has forwarded since its last usage report. As an example, if the UP function has forwarded 10 Mbytes of traffic since its last usage report to the CP function and the CP function provisions a new volume threshold or quota of 100 Mbytes, the UP function sends its next usage report upon forwarding an additional 90 Mbytes traffic.

NOTE 2: When receiving a new threshold or quota from the CP function for a measurement that is already ongoing in the UP function and if the UP function has already generated the usage report but had not sent it, the UP function can send the usage report before performing the update of the URR.

When reporting the network resources usage before and after a Monitoring Time, the UP function shall send two Usage Reports in the PFCP message (e.g. PFCP Session Report Request) for the same URR ID. Each Usage Report shall then include the Usage Information IE indicating whether the reported network resource usage was consumed before or after the Monitoring Time. Omission of this IE in a Usage Report indicates that no monitoring time has occurred. The UP function shall send Usage Reports soon after the occurrence of the Monitoring Time.

NOTE 3: The UP function needs to take care to smooth the signalling load towards the CP function if Usage Reports need to be generated for a large number of PFCP sessions after the occurrence of the Monitoring Time.

For the volume-based measurement method, the UP function shall report the traffic usage after any QoS enforcement. Additionally, if the CP function requested to measure the traffic usage before QoS enforcement, the UP function shall also report corresponding measurements, when measurements need to be reported for the traffic usage after QoS enforcement, by sending two Usage Reports in the PFCP message (e.g. PFCP Session Report Request) for the same URR ID. Each Usage Report shall then include the Usage Information IE indicating whether the reported network resource usage corresponds to the traffic before or after QoS enforcement. Thresholds provisioned in a URR shall apply to the traffic usage after any QoS enforcement.

For the volume-based measurement method, the UP function shall include all the counters (Total, Uplink and Downlink) of the URR in the Volume Measurement IE in the Usage Report IE.

A usage report triggered only due to the Dropped DL Traffic Threshold shall not contain any measurement information.

When being instructed to remove a URR or the last PDR associated to a URR, the UP function shall include a Usage Report in the PFCP Session Modification Response or in an additional PFCP Session Report Request if there are non-null measurements to report for the URR, and shall reset its ongoing measurements for the URR that is removed, or dissociated from the last PDR.

When being instructed to deactivate a network resources usage measurement via the Inactive Measurement flag of the Measurement Information IE of the URR, the UP function shall stop measuring the network resources usage (against the volume/time/event threshold/quota) and store the current measurement counts which will be resumed when the URR is activated again. The UP function shall not generate a usage report upon the deactivation of the URR and it shall send a usage report during the period when the URR is deactivated for the following scenarios:

- if the Quota Holding Time is expired and if the reporting trigger QUHTI is set;

NOTE 4: The Quota Holding Time can have been started before the URR is deactivated or starts from the moment when the URR is deactivated since no quota will be consumed.

- if it is the time for a periodic reporting and if the reporting trigger PERIO is set;
- if it is required to send a usage report for this URR when a usage report is reported for a linked URR and if the reporting trigger LIUSA is set;

- if it is required to send an immediate report upon a query for the URR, or the URR is removed, dissociated from the last PDR.

NOTE 5: Multiple usage reports can be required to be reported to the CP function when deleting a PDR that is the last one to be associated to multiple URRs.

The CP function may request the UP function, in an PFCP Session Modification Request, to report its ongoing network resources measurement for one or multiple URRs of the PFCP session. In this case, the UP function shall:

- generate usage report(s) (based on the existing definition of any URR(s) included in the PFCP Session Modification Request message before any update) for the URR(s) being queried and for any associated linked usage reports (see clause 5.2.2.4) for which there are non-null measurements to report,
- include them in the PFCP Session Modification Response or in additional PFCP Session Report Request messages; and
- proceed as specified above upon generating a usage report for a URR towards the CP function, with the following additions:
 - if the PFCP Session Modification Request includes the Update URR IE (for the URR being queried) with a Volume or Time Threshold, the UP function shall re-apply the threshold received in the request;
 - otherwise, if a threshold had been set for the URR that is queried, since the usage report is not triggered due to the threshold being reached, the UP function shall adjust the threshold by subtracting the time/volume reported in the usage report to determine when to generate the next report.

NOTE 6: Upon reaching a threshold that was adjusted due to a URR query as specified above, the UP function re-applies then the threshold that was provisioned in the URR (i.e. not the value of the adjusted threshold).

NOTE 7: The CP function can query a URR without including a Volume or Time Threshold in the PFCP Session Modification Request e.g. when it needs to close a traffic volume/service container (see clause 5.2.3.10.3 of 3GPP TS 32.251 [17]).

NOTE 8: The CP function can query a URR including a Volume or Time Threshold in the PFCP Session Modification Request e.g. when it needs to close a CDR (see clause 5.2.3.10.3 of 3GPP TS 32.251 [17]). In such a case, the CP function can include the same threshold for the URR being queried in the Update URR IE in the PFCP Session Modification Request message to trigger the UP function to re-apply the threshold.

NOTE 9: It is up to the CP function to request the UP function to generate an immediate report (or not) as specified above when the CP function modifies a URR or any other rules of the PFCP session. As an exception, the UP function always generates an immediate report when being instructed to remove a URR.

When additional PFCP Session Report Request messages need to be sent, the UP function shall indicate, either in the PFCP Session Modification Response or in one PFCP Session Report Request, how many usage reports will be sent in PFCP Session Report Request messages. If this is indicated in one PFCP Session Report Request, the PFCP Session Modification Response shall indicate that more reports will follow by setting the AURI flag of the Additional Usage Reports Information IE. Besides, if the PFCP Session Modification Request included the Query URR Reference IE, usage reports sent in response to the query in the PFCP Session Modification Response and/or additional PFCP Session Report Request messages shall include the Query URR Reference IE set to the same value as received in the PFCP Session Modification Request.

When the reporting trigger "Envelope Closure" is set in the corresponding Usage Reporting Rule, the UP function shall generate a usage report with the measurement of the time and/or volume as instructed in the Measurement Method:

- when the Inactivity Detection Time (if included) is expired;
- when detecting no usage for the first Base Time Interval if the Base Time Interval Type in the Time Quota Mechanism is set to CTP; or
- at the end of each of base time interval if the Base Time Interval Type in the Time Quota Mechanism is set to DTP.

NOTE 10: Events (e.g. application detection information) are reported individually and independently from the usage report sent for envelope closure.

At the PFCP session termination, the UP function shall indicate to the CP function, in the PFCP Session Deletion Response, the resources that have been consumed for each URR that was provisioned in the PFCP session since the last usage report (respective to each URR).

Upon receiving the Usage Report from the UP function, the CP function may initiate PFCP Session Modification procedure as result of the communication with the PCRF or OCS, as described in clause 5.3 of 3GPP TS 23.214 [2], e.g. by:

- modifying the URR (e.g. changing the Volume/Time threshold, Volume/Time quota, disabling the usage monitoring);
- creating a new FAR (e.g. for redirect) and/or modifying the existing FAR; or
- modifying the QER (s) in the PFCP session.

5.2.2.3.2 Credit pooling

When a URR is received with at least one Aggregated URRs IE included, the UP function:

- shall calculate the traffic usage of the URR by applying the Multiplier(s) and aggregating the traffic usage from all URRs indicated in the Aggregated URRs IE(s), as specified in IETF RFC 4006 [16];

NOTE 1: The usage of this URR is calculated using the following formula:

$$C1*M1 + C2*M2 + \dots + Cn*Mn = U,$$

where U is the usage counted by this URR, Cn is the usage counted by each aggregated URR (i.e. URR for each RG sharing the credit pool), and Mn is the multiplier for each aggregated URR.

- shall generate a report when the counted usage exceeds the threshold;
- shall generate a report if the threshold is not provided, and stop packets forwarding (or only allow forwarding of some limited user plane traffic, based on operator policy in the UP function) for all Aggregated URRs when the counted usage exceeds the quota.

NOTE 2: The handling of the aggregated URR(s), e.g. generating a Usage Report upon the Reporting Trigger(s) is not impacted by handling of this URR for the Credit Pool.

5.2.2.4 Reporting of Linked Usage Reports to the CP function

The CP function may instruct the UP function to generate a Usage Report for a URR "X" when a Usage Report is generated for another URR "Y", by:

- provisioning the URR "X" with the Reporting Triggers IE set to Linked Usage Reporting; and
- including in the URR "X" the Linked URR ID IE set to the URR ID of the URR "Y".

NOTE 1: This can be used by the CP function e.g. to request the UP function to report a Usage Report for an SDF (i.e. URR "X") when the UP function reports a Usage Report for a bearer (i.e. URR "Y").

NOTE 2: This can be used by the CP function e.g. to request the UP function to report a Usage Report for a RG (i.e. URR "X") when the UP function reports a Usage Report for a credit pool to which this RG pertain (i.e. URR "Y").

When a usage report is to be generated for the URR "Y", regardless of the condition which triggers the report, the UP function shall also send a Usage Report for the URR "X" with the accumulated usage information, and the Usage Report Trigger IE set to Linked Usage Reporting.

NOTE 3: This also applies e.g. when an immediate usage report is requested for the URR "Y" within a PFCP session Modification Request.

The URR "Y" may be linked to more URRs than just URR "X".

A RG level URR may be linked to IP-CAN bearer level URR as well as IP-CAN Session level URR to enable the CP function to generate a CDR on the different level. In such case, a URR "X" may link to more URRs than just URR "Y".

5.2.3 Forwarding Action Rule Handling

5.2.3.1 General

The CP function shall provision one and only one FAR for each PDR provisioned in an PFCP session. The FAR provides instructions to the UP function on how to process the packets matching the PDR.

By setting the appropriate flag(s) in the Apply Action IE in the FAR (see clause 8.2.26), the CP function may request the UP function to:

- drop the packets, by setting the DROP flag;
- forward the packets, by setting the FORW flag and by provisioning the Forwarding Parameters providing instructions on how to forward the packets;
- buffer downlink packets by setting the BUFF flag and by optionally provisioning buffering parameters providing instructions on how to buffer the packets;
- notify the CP function about the arrival of a first DL packet being buffered, by setting the NOCP flag;
- duplicate the packets, by setting the DUPL flag and by provisioning the Duplicating Parameters providing instructions on how to forward the duplicated packets.

The CP function may request the UP function to duplicate packets that are to be dropped, forwarded or buffered.

The CP function may provision one or more FAR(s) per PFCP session. Different FARs of a same PFCP session may be provisioned with a different Apply Action flags, e.g. to enable the forwarding of downlink data packets for some PDRs while requesting to buffer downlink data packets for other PDRs.

NOTE 1: This is necessary to establish or release a partial set of radio access bearers in UTRAN.

When instructed to buffer and notify the CP function about the arrival of a DL packet, the UP function shall notify the CP function, when it receives a first downlink packet for a given FAR (in EPC), or when it receives a first downlink packet for each QoS flow for a given FAR (in 5GC), by sending an PFCP Session Report Request including a Downlink Data Report IE identifying the PDR(s) for which downlink packets have been received.

NOTE 2: Receipt of downlink packets on PDRs associated to different FARs can result in sending multiple PFCP Session Report Request messages for the same PFCP session.

NOTE 3: Receipt of downlink packets pertaining to different QoS flows associated to the same FAR can result in sending multiple PFCP Session Report Request messages for the same PFCP session. The CP function identifies the QFI based on the PDR ID (when different PDRs are used for different QoS flows) or based on the Downlink Data Service Information IE.

If the UP function indicated support of Header Enrichment of UL traffic (see clause 8.2.25), the CP function may provide the UP function with header enrichment information for uplink traffic, by including one or more Header Enrichment IE(s) in the FAR. In this case, the UP function should use this information to enrich the header of the uplink traffic (e.g. HTTP header enrichment).

NOTE 4: It is not defined how to support SGi PtP tunnelling mechanisms other than based on UDP/IP encapsulation (such as PMIPv6/GRE, L2TP, GTP-C/U, see clause 4.3.17.8.3.3.3 of 3GPP TS 23.401 [14]) for Non-IP PDN connections.

If the UP function indicated support of PDI optimisation (see clause 8.2.25), the CP function may include in the forwarding parameters of the FAR the Linked Traffic Endpoint ID, if it is available, identifying the traffic Endpoint allocated for this PFCP session to receive the traffic in the reverse direction.

NOTE 5: This information can enable an SGW-U or PGW-U to correlate the UL and DL traffic (i.e. PDRs) sent over a same bearer.

Assuming for instance an PFCP session provisioned in a PGW-U with:

- an UL PDR 1 (for an S5/S8 bearer 1) with Source Interface "Access" associated to an UL Traffic Endpoint ID "1" (comprising the IP address, a local TEID and optionally a network instance),

- a DL PDR 1 with Source Interface "Core", UE IP address and SDF 1,

the CP function sets the Linked Traffic Endpoint in the DL FAR 1 (associated to DL PDR 1) to the UL Traffic Endpoint "1", which allows the PGW-U to correlate the uplink and downlink PDRs for the same bearer (i.e. that UL PDR 1 associated to UL Traffic Endpoint "1", and DL PDR1 associated to DL FAR 1 with Linked Traffic Endpoint set to UL Traffic Endpoint "1", use the same S5/S8 bearer).

NOTE 6: The Linked Traffic Endpoint can possibly refer to a Traffic Endpoint in the reverse direction requested to be created in the same PFCP request.

5.2.4 Buffering Action Rule Handling

5.2.4.1 General

A BAR provides instructions to control the buffering behaviour of the UP function for all the FARs of the PFCP session set with an Apply Action parameter requesting the packets to be buffered and associated to this BAR.

The CP function may create a BAR for an PFCP session and associate it to the FAR(s) of the PFCP session in an PFCP Session Establishment Request or an PFCP Session Modification Request to request the UP function to apply a specific buffering behaviour for packets requested to be buffered and associated to this BAR.

The CP function may modify the following buffering instructions provided in a BAR as follows:

- the Downlink Data Notification Delay in an PFCP Session Modification Request (for EPC); or
- the Downlink Data Notification Delay (for EPC), DL Buffering Duration and/or DL Buffering Suggested Packet Count in an PFCP Session Report Response message.

NOTE: The CP function needs to provision a (possibly empty) BAR and associate it to the FARs of the PFCP session when establishing or modifying the PFCP session to be able to modify the BAR in an PFCP Session Report Response.

If the UP Function has indicated support of the feature UL/DL Buffering Control (UDBC), the CP function may provide the Suggested Buffering Packet Count IE in a BAR which is created during a PFCP Session Establishment procedure or a PFCP Session Modification procedure, and the CP function may modify it in a subsequent PFCP Session Modification Request, and/or a PFCP Session Report Response message. The same BAR may be associated with all the FARs in a PFCP session to indicate that all Service Data Flows in the PFCP Session share the same buffer in the UP function for the PFCP Session.

In this release of the specification, at most one BAR may be created per PFCP session.

5.2.4.2 Provisioning of Buffering Action Rule in the UP function

The CP function may provision the following buffering parameters in a BAR:

- For EPC, the Downlink Data Notification Delay IE, to request the UP function to delay the sending of an PFCP Session Report Request, between receiving a downlink data packet and notifying the CP function about it, if the UP function indicated support of the Downlink Data Notification Delay parameter (see clause 8.2.28);
- the DL Buffering Duration IE, to request the UP function to buffer the downlink data packet for an extended duration without sending any further notification to the CP function about the arrival of DL data packets, if the UP function indicated support of the DL Buffering Duration parameter (see clause 8.2.25);
- the DL Buffering Suggested Packet Count, to request the UP function to buffer the suggested number of downlink data packets, when extended buffering of downlink data packet is required in the UP function.
- the Suggested Buffering Packet Count IE if the UP Function has indicated support of the feature UDBC, to indicate the number of packets (including both uplink or downlink) that the CP function suggests to be buffered in the UP function, until it receives new instructions from the CP function, e.g. when the new Quota is granted.

The UP function shall stop applying the DL Buffering Duration and DL Buffering Suggested Packet Count parameters and shall delete these parameters from the BAR (without explicit request from the CP function) when extended buffering of downlink data packets ends in the UP function.

NOTE: The CP function will provide the DL Buffering Duration and DL Buffering Suggested Packet Count parameters again when re-invoking extended buffering of downlink data packets.

The UP function shall stop applying buffering when new instruction is received from the CP function. The buffered packets shall be either dropped or forwarded following the packet forwarding model specified in clause 5.2.1 and taking into consideration that the buffered Packets have been already processed earlier.

5.2.5 QoS Enforcement Rule Handling

5.2.5.1 General

The CP function shall provision QER(s) for an PFCP session in an PFCP Session Establishment Request or an PFCP Session Modification Request to request the UP function to perform QoS enforcement of the user plane traffic.

5.2.5.2 Provisioning of QoS Enforcement Rule in the UP function

The CP function may request the UP function to perform the following QoS enforcement actions in a QER:

- Gating Control, as specified in clause 5.4.3;
- QoS Control, i.e. MBR, GBR or Packet Rate enforcement, as specified in clause 5.4.4;
- DL flow level marking for application detection, as specified in clause 5.4.5;
- SCI (Service Class Indicator) marking for service identification for improved radio utilisation for GERAN, as specified in clause 5.4.12;
- for 5GC reflective QoS for uplink traffic.

5.2.6 Combined SGW/PGW Architecture

The usage of a combined SGW/PGW remains possible in a deployment with separated control and user planes, see clause 4.2.2 of 3GPP TS 23.214 [2]. This is enabled by supporting a combined Sxa/Sxb interface with a common packet forwarding model, message and parameter structure for non-combined and combined cases.

The following additional requirements shall apply to a combined Sxa/Sxb interface between a combined SGW/PGW-C and a combined SGW/PGW-U:

- all the functionalities specified for Sxa and Sxb shall be supported, possibly concurrently, over a combined Sxa/Sxb association;
- a single PFCP session may be setup to support both the functionalities of an SGW-U and PGW-U;
- the CP function may provision PDRs, QERs, URRs, FARs (possibly with a buffering instruction) and BAR, possibly concurrently, for the same PFCP session;
- the CP function may provision concurrently parameters in a message or for the PFCP session that are applicable to Sxa and Sxb.

5.3 Data Forwarding between the CP and UP Functions

5.3.1 General

Forwarding of user plane data between the CP and UP functions may take place as part of the following scenarios (see 3GPP TS 23.214 [2] for EPC and 3GPP TS 23.501 [28] for 5GC).

Table 5.3.1-1: Data forwarding scenarios between the CP and UP functions

	Scenario description	Data forwarding direction	For EPC applicable to	For 5GC applicable to
1	Forwarding of user-plane packets between the UE and the CP function.	UP to CP function CP to UP function	PGW	UPF to SMF SMF to UPF
2	Forwarding of packets between the CP function and the external PDN (over SGI) / DN (over N6).	UP to CP function CP to UP function	PGW	UPF to SMF SMF to UPF
3	Forwarding of packets subject to buffering in the CP function.	UP to CP function CP to UP function	SGW	UPF to SMF SMF to UPF
4	Forwarding of End Marker Packets constructed by the CP function to a downstream node.	CP to UP function	SGW, PGW	SMF to UPF

User plane packets shall be forwarded between the CP and UP functions by encapsulating the user plane packets using GTP-U encapsulation (see 3GPP TS 29.281 [3]).

For forwarding data from the UP function to the CP function, the CP function shall provision PDR(s) per PFCP session context, with the PDI identifying the user plane traffic to forward to the CP function and with a FAR set with the Destination Interface "CP function side" and set to perform GTP-U encapsulation and to forward the packets to a GTP-u F-TEID uniquely assigned in the CP function per PFCP session and PDR. The CP function shall then identify the PDN connection and the bearer to which the forwarded data belongs by the F-TEID in the header of the encapsulating GTP-U packet.

For forwarding data from the CP function to the UP function, the CP function shall provision one or more PDR(s) per PFCP session context, with the PDI set with the Source Interface "CP function side" and identifying the GTP-u F-TEID uniquely assigned in the UP function per PDR, and with a FAR set to perform GTP-U decapsulation and to forward the packets to the intended destination. URRs and QERs may also be configured.

For EPC PFCP session contexts may correspond to individual PDN connections, TDF sessions, or standalone sessions not tied to any PDN connection or TDF session used e.g. for forwarding RADIUS, Diameter or DHCP signalling between the PGW-C and the PDN or for forwarding End Marker packets from the PGW-C or SGW-C to a downstream SGW-U or eNodeB.

For 5GC PFCP session contexts may correspond to individual PDU sessions or standalone sessions not tied to any PDU sessions used e.g. for forwarding RADIUS, Diameter or DHCP signalling between the SMF and the DN or for forwarding End Marker packets from the SMF to a downstream UPF or NG-RAN.

For EPC the CP function may establish one Sx-u tunnel per:

- bearer of PDN connection e.g. for the data forwarding scenarios 1 and 3;
- UP function or PDN e.g. for the data forwarding scenario 1, 2 and 4.

For 5GC the CP function may establish one N4-u tunnel per:

- PDU session e.g. for the data forwarding scenarios 1 and 3;
- UP function or DN e.g. for the data forwarding scenario 1, 2 and 4.

Requirements for forwarding packets subject to buffering in the CP function between the UP and CP functions (scenario 3) are further specified in clause 5.3.3.

Requirements for sending End Marker packets (scenario 4) are further specified in clause 5.3.2.

5.3.2 Sending of End Marker Packets

The construction of End Marker packets may either be done in the CP function or UP function, based on network configuration, as specified in clause 5.8 of 3GPP TS 23.214 [2] for EPC and in clause 5.8.2.9 of 3GPP TS 23.501 [28] for 5GC. The support of End Marker packets by the UP function is optional.

If the UP function indicated support of End Marker packets constructed in the UP function, the CP function shall request the UP function to construct and send End Marker packets by sending a Session Modification Request including FAR(s) with the new downstream F-TEID and with the SNDEM (Send End Marker Packets) flag set.

For End Marker packets constructed in the CP function, the CP function shall:

- establish (once) one standalone PFCP session not tied to any PDN connection, per the UP function, for forwarding End Marker packets, and provision the UP function to perform one GTP-U decapsulation and to forward the resulting packets without any further change towards the destination IP address of these packets;
- construct the GTP-U End Marker packets, with the destination IP address and TEID set according to the old F-TEID value, and with a source IP address set according to the UP function's F-TEID value (e.g. S1 or Iu SGW F-TEID or NG-u UPF F-TEID);
- encapsulate the constructed GTP-U End Marker packets in GTP-U packets according to the principles specified in clause 5.3.1 for data forwarding between the CP function and the UP function, and send them towards the F-TEID assigned in the UP function for the above PFCP session, after receipt of the PFCP Session Modification Response indicating that the UP function has switched to a new F-TEID.

Upon receipt of a PFCP Session Modification Request modifying the F-TEID in the Outer Header Creation of a FAR, the UP function shall send the Response message only after having switched to the new F-TEID.

5.3.3 Forwarding of Packets Subject to Buffering in the CP Function

5.3.3.1 General

The following requirements shall apply to the data forwarding scenario 3 of Table 5.3.1-1 in addition to the requirements specified in clause 5.3.1.

The CP function shall establish one Sx-u tunnel per bearer of a PDN connection / one N4-u tunnel per PDU session when applying the data forwarding scenario 3.

5.3.3.2 Forwarding of Packets from the UP Function to the CP Function

For EPC, regardless of whether the downlink traffic received by the UP function consists of T-PDUs (i.e. user data packet, see 3GPP TS 29.281 [3]) for a combined SGW/PGW-U, or G-PDUs (i.e. T-PDU plus a GTP-U header) for a SGW-U, the downlink traffic shall be forwarded from the UP function to the CP function as G-PDUs with the GTP-U header set to the IP address and TEID uniquely assigned in the CP function for the Sx-u tunnel corresponding to the bearer of the PDN connection.

NOTE 1: An SGW-U receiving G-PDUs from an S5/S8 bearer forwards the same G-PDUs towards the SGW-C but with the IP address and TEID in the GTP-U header changed to the SGW-C IP address and TEID of the corresponding Sx-u tunnel.

For 5GC, regardless of whether the downlink traffic received by the UP function consists of T-PDUs (i.e. user data packet, see 3GPP TS 29.281 [3]) for an PSA-UPF, or G-PDUs (i.e. T-PDU plus a GTP-U header) for an I-UPF, the downlink traffic shall be forwarded from the UP function to the CP function as G-PDUs with the GTP-U header set to the IP address and TEID uniquely assigned in the CP function for the N4-u tunnel corresponding to the PDU session of the PDN connection.

NOTE 2: An I-UPF receiving G-PDUs from an N9 GTPU tunnel forwards the same G-PDUs towards the SMF but with the IP address and TEID in the GTP-U header changed to the SMF IP address and TEID of the corresponding N4-u tunnel.

To forward the user plane data to be buffered in the CP function from the UP function, the CP function shall provision:

- for EPC, a PDR per bearer of the PDN connection, matching the received downlink user plane packets and for a (non-combined) SGW-U, with the field Outer Header Removal Description in the Outer Header Removal IE set to "0" or "1" for IPv4 or IPv6 respectively;
- for 5GC, a PDR per PDU session, matching the received downlink user plane packets and for an I-UPF, with the field Outer Header Removal Description in the Outer Header Removal IE set to "0" or "1" for IPv4 or IPv6 respectively;

- a FAR instructing the UP function to forward the received downlink data to the CP function, with the field Outer Header Creation Description in the Outer Header Creation set to "0" or "1".

NOTE 3: The PDR can be provisioned in the UP function before applying data forwarding to the CP function.

For EPC, G-PDUs sent from the UP function to the CP function over the Sx-u tunnel shall include any GTP-U extension header(s):

- possibly received by the UP function over the S5/S8 bearers and stored during the Outer Header Removal;
- possibly created by the UP function as part of a QER rule.

For 5GC, G-PDUs sent from the UP function to the CP function over the N4-u tunnel shall include any GTP-U extension header(s):

- possibly received by the UP function over the N9 PDU sessions and stored during the Outer Header Removal;
- possibly created by the UP function as part of a QER rule.

5.3.3.3 Forwarding of Packets from the CP Function to the UP Function

Likewise, when subsequently sending the downlink traffic buffered in the CP function back to the UP function, the downlink traffic shall be forwarded:

- for EPC, over Sx-u as G-PDUs with the GTP-U header set to the IP address and TEID uniquely assigned in the UP function for the Sx-u tunnel set up for the corresponding bearer of the PDN connection.
- for 5GC, over N4-u as G-PDUs with the GTP-U header set to the IP address and TEID uniquely assigned in the UP function for the N4-u tunnel set up for the corresponding PDU session.

G-PDUs sent over Sx-u / N4-u shall include GTP-U extension header(s) possibly received earlier from the UP function.

To forward the user plane data from the CP function to the UP function, the CP function shall provision:

a PDR per bearer of the PDN connection (for EPC) or per PDU session (for 5GC), with an IP address and TEID uniquely assigned in the UP function for the Sx-u / N4-u tunnel, and with the field Outer Header Removal Description in the Outer Header Removal IE set to "0" or "1";

- a FAR enabling the UP function to forward the received downlink data from the CP function towards the RAN, with the field Outer Header Creation Description in the Outer Header Creation set to "0" or "1".

G-PDUs sent from the UP function towards the RAN shall include GTP-U extension header(s) possibly received from the CP function.

5.3.4 Data Forwarding between the CP and UP Functions with one PFCP-u Tunnel per UP Function or PDN

5.3.4.1 General

The following requirements shall apply to the data forwarding scenario 1 and 2 of Table 5.3.1-1, when establishing one PFCP-u tunnel per UP function or PDN, in addition to the requirements specified in clause 5.3.1.

5.3.4.2 Forwarding of Packets from the UP Function to the CP Function

Regardless of whether the traffic received by the UP function consists of T-PDUs (i.e. user data packet, see 3GPP TS 29.281 [3]) from SGi / N6 or G-PDUs (i.e. T-PDU plus a GTP-U header) from the UE, the traffic shall be forwarded from the UP function to the CP function as G-PDUs with the GTP-U header set to the IP address and TEID uniquely assigned in the CP function for the PFCP-u tunnel corresponding to the UP function or PDN.

To forward the user plane data to from the UP function, the CP function shall provision:

- for supporting data forwarding scenario "1" as specified in clause 5.3.1, an additional PDR for a PFCP session established for a PDN connection or a PDU session which requires such data forwarding, matching the received user plane packets from uplink direction. The Outer Header Removal IE shall not be present if the complete G-PDU is required to be forwarded, otherwise the Outer Header Removal IE shall be present and set to "0" or "1" for IPv4 or IPv6 respectively;
- for supporting data forwarding scenario "2" as specified in clause 5.3.1, a PDR matching the received user plane packets from downlink direction;
- a FAR instructing the UP function to forward the received data to the CP function, with the field Outer Header Creation Description in the Outer Header Creation set to "0" or "1" for IPv4 or IPv6 respectively, and the Outer GTP-U header set to the IP address and TEID uniquely assigned in the CP function for the Sx-u tunnel.

5.3.4.3 Forwarding of Packets from the CP Function to the UP Function

When sending user plane data from the CP function, the traffic shall be forwarded over PFCP-u as:

- T-PDUs encapsulated in GTP-U with the GTP-U header set to the IP address and TEID uniquely assigned in the UP function for the PFCP-u tunnel set up for the UP function or PDN or DN for traffic to be sent towards SGi or N6, or
- G-PDUs encapsulated in GTP-U with the outer GTP-U header set to the IP address and TEID uniquely assigned in the UP function for the PFCP-u tunnel set up for the UP function and with the inner GTP-U header set to the F-TEID assigned by the downstreams GTP-U peer (e.g. SGW, I-UPF) to the bearer over which the data shall be sent.

To forward the user plane data from the CP function to the UP function, the CP function shall provision:

- a PDR per UP function, with an IP address and TEID uniquely assigned in the UP function for the PFCP-u tunnel, and with the field Outer Header Removal Description in the Outer Header Removal IE set to "0" or "1";
- a FAR enabling the UP function to forward the received data from the CP function.

5.4 Policy and Charging Control

5.4.1 General

This clause describe how Policy and Charging Control requirements are supported over the Sxa, Sxb, Sxc and N4 reference points.

5.4.2 Service Detection and Bearer/QoS Flow Binding

Service detection refers to the process that identifies the packets belonging to a service data flow or application. For EPC, see clauses 6.2.2.2 and 6.8.1 of 3GPP TS 23.203 [7]. For 5GC, see clause 6.2.2.2 of 3GPP TS 23.503 [44].

For EPC, bearer binding is the procedure that associates service data flow(s) to an IP-CAN bearer deemed to transport the service data flow. UL bearer binding verification refers to the process of discarding uplink packets due to no matching service data flow template for the uplink direction. See clauses 6.1.1.4 and 6.2.2.2 of 3GPP TS 23.203 [7].

For 5GC, QoS flow binding is the procedure that associates service data flow(s) to a QoS flow deemed to transport the service data flow. UL QoS flow binding verification refers to the process of discarding uplink packets due to no matching QoS flow for the uplink direction. See clause 6.1.3.2.4 of 3GPP TS 23.503 [44] and clause 5.7.1.7 of 3GPP TS 23.501 [28].

Service detection is controlled over the Sxa, Sxb, Sxc and N4 reference points by configuring Packet Detection Information in PDRs to match the intended service data flows or application.

For EPC, the mapping of DL traffic to bearers is achieved by configuring and associating FARs to the downlink PDRs, with FARs set to forward the packets to the appropriate downstream bearers (S5/S8 or S1/S12/S4/Iu).

For 5GC, the mapping of DL traffic to QoS flows is achieved by configuring QERs with QFI(s) for the QoS flow marking and associating FARs to the downlink PDRs, with FARs set to forward the packets to the appropriate downstream GTP-U tunnel (N9 or N3).

For EPC, uplink bearer binding verification is achieved by configuring Packet Detection Information in uplink PDRs containing the local F-TEID of the uplink bearer, the UE IP address (source IP address to match for the incoming packet), and the SDF filter(s) or the Application ID. As a result, uplink packets received on the uplink bearer but that do not match the SDF filter(s) or Application detection filter associated to the uplink PDRs are discarded.

For 5GC, uplink QoS flow binding verification (see clause 5.7.1.7 of 3GPP TS 23.501 [28]) is achieved by configuring Packet Detection Information in uplink PDRs containing the local F-TEID of the uplink PDU session, the UE IP address (source IP address to match for the incoming packet), the QFI of the QoS flow and the SDF filter(s) or the Application ID. As a result, uplink packets received on the uplink PDU session but that do not match the SDF filter(s) or Application detection filter and QFI associated to the uplink PDRs are discarded.

NOTE 1: For PCC Rules that contain an application identifier (i.e. that refer to an application detection filter), uplink traffic can be received on other IP-CAN bearers than the one determined by the binding mechanism. The detection of the uplink part of the service data flow can be activated in parallel on other bearers with non-GBR QCI (e.g. the default bearer) in addition to the bearer where the PCC rule is bound to. See clauses 6.1.1.1 and 6.2.2.2 of 3GPP TS 23.203 [7]. Therefore the uplink PDRs for these bearers can be provisioned with the PDI containing this service data flow and the local F-TEID of the uplink bearer.

NOTE 2: To avoid the PGW-U discarding packets due to no matching service data flow template, the operator can apply open PCC rules (with wildcarded SDF filters) to allow for the passage of packets that do not match any other candidate SDF template. Therefore an uplink PDR can be provisioned with the PDI containing only the local F-TEID of the uplink bearer.

NOTE 3: Uplink bearer binding does not apply to Non-IP PDN connections.

NOTE 4: The UPF can be provisioned with a PDR (with low precedence) which contains the CN tunnel info, QFI and filter information that can detect any unwanted/unauthorized traffic with this QFI so that such traffic can be dropped with or without being counted before.

5.4.3 Gating Control

Gating control refers to the process within the user plane function (i.e. PGW-U and TDF-U for EPC, UPF for 5GC) of enabling or disabling the forwarding of IP packets, belonging to a service data flow or detected application's traffic, to pass through to the desired endpoint (for EPC see clause 4.3.2 of 3GPP TS 23.203 [7] and for 5GC see clause 4.3.3.1 of 3GPP TS 23.503 [44]).

The PGW-C and TDF-C (for EPC) and the SMF (for 5GC) controls the gating in the PGW-U and TDF-U (for EPC) and in the UPF (for 5GC) by creating PDR(s) for the service data flow(s) or application's traffic to be detected, and by associating a QER, including the Gate Status IE, to the PDRs.

The Gate Status IE indicates whether the service data flow or detected application traffic is allowed to be forwarded (the gate is open) or shall be discarded (the gate is closed) in the uplink and/or in downlink directions.

The PGW-U and TDF-U (for EPC) and the UPF (for 5GC) shall identify UL and DL flows by the Source Interface IE in the PDI of the PDRs or the Destination Interface IE in the FARs. The PGW-U and TDF-U (for EPC) and the UPF (for 5GC) shall apply UL and DL gating accordingly.

5.4.4 QoS Control

QoS control refers to the authorization and enforcement of the maximum QoS that is authorized:

- for EPC,
 - at the session level (APN-AMBR, TDF session UL and DL bitrates, or UL and DL Packet Rate of a PDN connection);
 - at the bearer level (GBR, MBR for GBR bearers);

- at the service data flow (SDF) or application level.
- for 5GC,
 - at the session level (Session-AMBR or UL and DL Packet Rate of a PDU session)
 - at the QoS Flow level;
 - at the service data flow (SDF) or application level.

See clause 4.3.3 of 3GPP TS 23.203 [7] clause 4.5.5 of 3GPP TS 29.212 [8] and clause 4.7.7 of 3GPP TS 23.401 [14].

The CP function shall control the QoS enforcement in the UP function by:

- creating the necessary PDR(s) to represent the service data flow, application, QoS Flow (for 5GC), bearer or session, if not already existing;
- creating QERs for the QoS enforcement at session level, SDF/application level;
- creating QERs for the QoS enforcement of the aggregate of SDFs with the same GBR QCI;
- creating QERs for the QoS enforcement of the aggregate of SDFs with the same GBR QFI (for 5GC);
- associating the session level QER to all the PDRs defined for the session;
- associating the SDF or application QER to the PDRs associated to the SDF or application;
- associating the QER of the aggregate of SDFs to the PDRs associated to SDFs or applications that share the QER.

The same QER may be associated to UL and DL PDRs. The UP function shall identify the UL and DL flows by the Source Interface IE in the PDRs or the Destination Interface IE in the FARs. The UP function shall enforce the QoS for the UL or DL flows accordingly.

The CP function shall map the precedence of a PCC rule to the precedence of the PDRs associated to the corresponding service data flows.

5.4.5 DL Flow Level Marking for Application Detection

DL flow level marking is performed using DL DSCP marking. DL DSCP marking for application indication refers to the process in the TDF of marking detected downlink application traffic with a DSCP value received within an installed ADC rule matching this traffic. See Annex U of 3GPP TS 23.203 [7] and clauses 4.5.2.7 and 4b.5.14 of 3GPP TS 29.212 [8].

DL DSCP marking for application indication is controlled by the TDF-C by associating a QER, including the ToS or Traffic Class within the DL Flow Level Marking IE, to the PDR matching the DL traffic to be marked. The TDF-U performs the DL DSCP marking for the detected DL traffic and sends the marked packet to the PGW-U.

If a tunnelling protocol is used between the TDF-U and the PGW-U, the DSCP value for service data flow detection shall be carried in the inner IP header.

The TDF-C may stop the DL DSCP marking for the application during the PFCP session by removing the related QER or removing the DL Flow Level Marking IE from the related QER, the TDF-U shall then stop such function consequently.

Policy and charging control in the downlink direction by the PCEF for an application detected by the TDF is performed by the PGW-C configuring a PDR with a PDI containing an SDF Filter with the corresponding DSCP value.

5.4.6 Usage Monitoring

Usage Monitoring Control refers to the process of monitoring the user plane traffic in the PGW-U, TDF-U or UPF for the accumulated usage of network resources per:

- individual or group of service data flows;

- individual or group of applications;
- PDU session, possibly excluding an individual SDF or a group of service data flow(s) (for 5GC);
- IP-CAN session, possibly excluding an individual SDF or a group of service data flow(s) (for EPC), and/or
- TDF session, possibly excluding an individual application or a group of application(s) (for EPC).

For EPC, see clauses 4.4, 6.2.2.3 and 6.6 of 3GPP TS 23.203 [7] and clauses 4.5.16, 4.5.17, 4b.5.6, 4b.5.7 of 3GPP TS 29.212 [8].

For 5GC, see clauses 4.3.4 and 6.2.2.3 of 3GPP TS 23.503 [44] and clauses 4.2.2.10, 4.2.3.11, 4.2.4.10, 4.2.6.2.5, 4.2.6.5.3 of 3GPP TS 29.512 [41].

Usage Monitoring Control is supported over the Sxb, Sxc and N4 reference points by activating in the UP function the reporting of usage information towards the CP function, as specified in clauses 5.3 and 7.8.4 of 3GPP TS 23.214 [2] and in clause 5.8.2.6.2 of 3GPP TS 23.501 [28].

The CP function shall control the Usage Reporting in the UP function by:

- creating the necessary PDR(s) to represent the service data flow, application or session;
- creating a URR for each Monitoring key; and
- associating the URR to:
 - all the PDRs of the PFCP session, for usage monitoring at IP-CAN or TDF session level, possibly excluding the PDRs matching the SDFs or Applications excluded from the usage monitoring at session level; or
 - the PDR(s) of the PFCP session associated to the individual or group of SDF(s) or Application(s), for usage monitoring at SDF or application level.

5.4.7 Traffic Redirection

Traffic Redirection refers to the process of redirecting uplink application traffic, in a PGW, TDF or UPF, towards a redirect destination, e.g. redirect some HTTP flows to a service provisioning page. For EPC, see clause 6.1.13 of 3GPP TS 23.203 [7] and clauses 4.5.2.6 and 4b.5.1.4 of 3GPP TS 29.212 [8]. For 5GC, see clause 6.1.3.12 of 3GPP TS 23.503 [44] and clause 4.2.6.2.4 of 3GPP TS 29.512 [46].

The redirect destination may be provided by the PCRF/PCF or be preconfigured in the CP function or in the UP function.

For EPC, the traffic redirection may be enforced in the CP function or in the UP function. For 5GC, the traffic redirection may be enforced in the UP function only. If the traffic that the UP function can support may be subject to traffic redirection, traffic redirection enforcement in the UP function shall be supported by the UP function. The UP function reports to the CP function whether it supports traffic redirection enforcement in the UP function via the UP Function Features IE (see clause 8.2.25).

NOTE: A UP function that supports traffic not requiring traffic redirection does not need to support traffic redirection enforcement in the UP function. The CP function can select a UP function supporting traffic redirection enforcement in the UP function for users or services which may require traffic redirection.

To enforce the traffic redirection in the CP function, the CP function shall instruct the UP function to forward the applicable user traffic to the CP function, as specified in clause 5.3.1.

To enforce the traffic redirection in the UP function, the CP function shall:

- create the necessary PDR(s) to represent the traffic to be redirected, if not already existing;
- create a FAR with:
 - the Redirect Information IE including the redirect destination, if the traffic needs to be redirected towards a redirect destination provided by the CP function; a redirect destination provided by the CP function shall prevail over a redirect destination preconfigured in the UP function; ;

- For HTTP traffic redirection, the Redirection Address Type shall be set to "URL" and the CP function shall set the Destination Interface IE in the FAR to "Access" (to forward the HTTP response message with a status code indicating redirect). For other types of traffic redirection, the Destination Interface IE in the FAR may be set to "Core".

or

- the Forwarding Policy IE including the identifier of the forwarding policy to apply, if the traffic needs to be redirected towards a redirect destination preconfigured in the UP function;
- associate the FAR to the above PDRs of the PFCP session.

5.4.8 Traffic Steering

Traffic Steering refers to the process of applying a specific (S)Gi-LAN traffic steering policy in the PCEF or TDF (or TSSF), or a specific N6-LAN traffic steering policy in the UPF (PDU Session Anchor), for the purpose of steering the subscriber's traffic to appropriate operator or 3rd party service functions (e.g. NAT, antimalware, parental control, DDoS protection) in the (S)Gi-LAN or N6-LAN, per service data flows level or applications level.

Application Function influencing traffic routing (see clause 5.6.7 of 3GPP TS 23.501 [28]) also uses traffic steering for the purpose of steering the subscriber's traffic over N6, e.g. to a local access to a Data Network.

The UP function shall set the TRST feature flag in the UP Function Features IE if it supports Traffic Steering (see clause 8.2.25).

Traffic Steering is supported over the Sxb, Sxc and N4 reference points by instructing the UP function to apply a specific Forwarding Policy, that is locally configured in the UP function and that can be used for the uplink, the downlink or for both directions. A Forwarding Policy is identified by a Forwarding Policy Identifier. Traffic steering is alternatively supported over the N4 reference point by instructing the UP function to route packets according to N6 routing information in the FAR (e.g. providing an IP address in the Outer Header Creation).

When so instructed, the UP function shall perform the necessary actions to enforce the forwarding policy referenced by the CP function, e.g. performing packet marking and routing the traffic towards the service functions within the (S)Gi-LAN or N6-LAN.

See 3GPP TS 23.203 [7], 3GPP TS 29.212 [8] and 3GPP TS 23.501 [28].

The CP function shall control Traffic Steering towards SGi-LAN, N6-LAN or N6 in the UP function by:

- creating the necessary PDRs to represent the service data flows or applications to be steered;
- creating a FAR with the Forwarding Policy IE including the Forwarding Policy Identifier set to the Traffic Steering Policy Identifier, or creating a FAR with a Outer Header Creation with the destination IP address; and
- associating the FAR to the above PDRs of the PFCP session.

The CP function shall control the processing of the traffic received from the (S)Gi-LAN or N6-LAN in the UP function as specified in the rest of this specification for traffic received from any other interface, but with PDR(s) including a PDI with the Source Interface indicating "SGi-LAN/N6-LAN". The UP function shall distinguish packets coming from (S)Gi-LAN/N6-LAN based on local configuration.

5.4.9 Provisioning of Predefined PCC/ADC Rules

A Predefined PCC rule is preconfigured in the PCEF, e.g. a PGW (for EPC) or SMF (for 5GC). Predefined PCC rules can be activated or deactivated by the PCRF/PCF at any time. The Predefined PCC rules may be grouped allowing the PCRF/PCF to dynamically activate a set of PCC rules.

For EPC a predefined ADC rule is preconfigured in the TDF. In the case of solicited reporting, the Predefined ADC rules can be activated or deactivated by the PCRF at any time. Predefined ADC rules within the TDF may be grouped allowing the PCRF to dynamically activate a set of ADC rules.

For the definition of PCC and ADC rules see clauses 4.3.1 and 4b.3.2 of 3GPP TS 29.212 [8] and clause 5.6.2.6 of 3GPP TS 29.512 [41].

The CP function may enforce an activated predefined PCC or ADC rule by the PCRF/PCF in the UP function by:

- determining the service data filters or application IDs referred by the activated predefined PCC or ADC rule(s) and the corresponding QoS and charging control information respectively;
- creating the necessary PDR(s) to identify the service data flow(s), application(s) that the predefined PCC or ADC rule refer to, if not already existing;
- creating the necessary QER for the QoS enforcement at service data flow or application level accordingly;
- creating the necessary FAR if a new FAR needs to be created as result of Bearer binding (for EPC) or QoS flow binding (for 5GC) and QoS control for forwarding the detected service data flow or application traffic, or to redirect or to apply traffic steering control if included in the predefined PCC/ADC rule;
- creating the necessary URR(s) for each monitoring key, charging key, combination of Charging Key and Service ID, or combination of Charging Key, Sponsor ID and Application Service Provider Id if included in the predefined PCC or ADC rule;

And then:

- associating the created URR(s) to the newly created PDR(s);
- associating the existing FAR or the new FAR to the newly created PDR(s);

Optionally, the traffic handling policies common to many PFCP sessions (i.e. predefined QER(s)/FAR(s)/URR(s)) may be configured in the UP function. The CP function may activate these traffic handling policies by including the Activate Predefined Rules IE within:

- the Create PDR IE in an PFCP Session Establishment Request; or
- the Update PDR IE in an PFCP Session Modification Request.

For traffic matching PDR(s) associated with the activated predefined rules, the UP function shall enforce the rules, e.g. for URR, the UP function shall generate Usage Report(s) and send it to the CP function and the CP function shall be able to handle the usage reports as described in clause 5.2.2.

NOTE: The URR IDs used in reports triggered by a predefined rule in UP function are also pre-configured at the CP function.

For deactivating predefined rules which are activated in the UP function, the CP function shall include the Deactivate Predefined Rules IE in the Update PDR IE in an PFCP Session Modification Request to inform the UP function to deactivate the corresponding predefined rules for the related PDR.

5.4.10 Charging

For EPC, the charging requirements for online and offline charging in the PS domain specified in 3GPP TS 32.251 [17] shall be preserved with a split SGW, PGW and TDF architecture.

For 5GC, the charging requirements for online and offline charging in the 5G data connectivity domain are specified in 3GPP TS 32.255 [45].

Charging is supported by the CP function by activating in the UP function the measurement and reporting of the accumulated usage of network resources per:

- for EPC:
 - IP-CAN bearer, for an SGW;
 - IP-CAN bearer, IP-CAN session and/or individual or group of service data flows, for a PGW;
 - TDF session and/or individual or group of applications, for a TDF;
- for 5GC:
 - PDU session and/or individual or group of service data flows, for an SMF

- QoS Flow, for an SMF.

See clauses 5.3 and 7.8.4 of 3GPP TS 23.214 [2].

The CP function shall control the usage measurement and reporting in the UP function by:

- creating the necessary PDR(s) to represent the service data flow, application, bearer or session, if not already existing;
- creating URR(s) for each Charging Key, combination of Charging Key and Service ID, or combination of Charging Key, Sponsor ID and Application Service Provider Id;
- associating the URR(s) to the relevant PDRs defined for the PFCP session, for usage reporting at IP-CAN bearer, IP-CAN session, TDF session, SDF or application level.

For online charging, the CP function shall provision the URR with the Volume (or Time) Quota, and with the Volume (or Time) Quota if a quota threshold was received from the OCS, as specified in clause 5.2.2.2. Besides, when the OCS provides a final quota and requests to redirect the traffic towards a redirect destination when exhausting this quota, the CP function shall redirect the traffic towards a redirect destination as specified in clause 5.4.7 upon being notified that the final quota has been reached; to permit HTTP traffic redirection, the UP function should have at least one HTTP packet, e.g. the UP function may store one packet when reaching the Volume (or Time) Quota. An example call flow is depicted in Annex C.2.1.1.

To avoid the risk of signalling storms between the CP and UP functions at times of tariff change, the CP function may include the Monitoring Time IE and zero or more Additional Monitoring IEs in the URR and set it to the time of tariff change to request the UP function to report separately the resource usage before and after the time of tariff change (see e.g. clause 6.3.7.1 of 3GPP TS 32.299 [18]).

5.4.11 (Un)solicited Application Reporting

For EPC, (un)solicited Application Reporting refers to the process of reporting the start or stop of applications by the TDF or PCEF. See 3GPP TS 23.203 [3] and 3GPP TS 29.212 [8].

For 5GC, solicited Application Reporting refers to the process of reporting the start or stop of applications by the SMF to the PCF. See 3GPP TS 23.503 [44] and 3GPP TS 29.512 [41]. Unsolicited application reporting is not applicable for 5GC.

The CP function shall instruct the UP function to detect and report applications by:

- creating the necessary PDR(s) to represent the applications to detect;
- creating a URR with the Reporting Trigger IE set to detect the start and/or stop of Traffic;
- associating the URR to the PDR.

For unsolicited application reporting, an PFCP session which is not linked to any specific TDF session may be established and the PDI in the PDR(s) does not contain any UE IP address.

When detecting the start or stop of an application, the UP function shall then initiate the PFCP Session Report procedure and send a Usage Report with the Usage Report Trigger set to 'Start of Traffic' or 'Stop of Traffic'. The UP function shall also include the following information in the Usage Report:

- when reporting the start of an application:
 - the Application ID;
 - the Flow Information including the Flow Description and the Flow Direction, if the traffic flow information is deducible;
 - the Application-Instance-Identifier, if the traffic flow information is deducible; and
 - if no UE IP address was provisioned in the PDI, the UE's IP address, and the Network instance when multiple PDNs with overlapping IP addresses are used in the UP function.

NOTE: When the CP function instructs the UP function to perform unsolicited application reporting, the PDI in the corresponding PDR has no UE IP address.

- when reporting the stop of an application:
 - the Application ID;
 - the Application-Instance-Identifier, if an Application Identifier was provided when reporting the start of the application;
 - if no UE IP address was provisioned in the PDI, the UE's IP address, and the Network instance when multiple PDNs with overlapping IP addresses are used in the UP function.

The UP function shall only report the Application ID when detecting the start or stop of an application and the Reduced Application Detection Information flag is set in the Measurement Information of the URR, e.g. for envelope reporting.

5.4.12 Service Identification for Improved Radio Utilisation for GERAN

Service Identification for improved radio utilization for GERAN refers to the process in the PGW of marking DL user plane traffic with a Service Class Indicator (SCI) value. See clause 5.3.5.3 of 3GPP TS 23.060 [19].

This is controlled by the PGW-C by associating a QER, including the Service Class Indicator within the DL Flow Level Marking IE, to the PDR matching the DL traffic to be marked. The PGW-U performs the SCI marking for the detected DL traffic and sends the packet with the GTP-U Service Class Indicator Extension Header downstreams.

The PGW-C may stop the SCI marking during the PFCP session by removing the related QER or removing the DL Flow Level Marking IE from the related QER, the PGW-U shall then stop such function consequently.

5.4.13 Transport Level Marking

For EPC, transport level marking is performed on a per EPS bearer basis in the SGW and PGW. Transport level marking refers to the process of marking traffic with a DSCP value based on the locally configured mapping from the QCI and optionally the ARP priority level.

For 5GC, transport level marking is performed on a per QoS flow basis. Transport level marking refers to the process of marking traffic at the UPF with a DSCP value based on the mapping from the 5QI, the Priority Level (if explicitly signalled) and optionally the ARP priority level configured at the SMF.

Transport level marking shall be controlled by the CP function by providing the DSCP in the ToS or Traffic Class within the Transport Level Marking IE in the FAR that is associated to the PDR matching the traffic to be marked. The UP function shall perform the transport level marking for the detected traffic and sends the marked packet to the peer entity.

The CP function may change transport level marking by changing the Transport Level Marking IE in the related FAR.

5.5 F-TEID Allocation and Release

5.5.1 General

F-TEID shall be allocated either by the CP function or the UP function. The support of F-TEID allocation by the CP function is mandatory. The support of F-TEID allocation by the UP function is optional. See clause 5.4 of 3GPP TS 23.214 [2].

The UP function shall set the FTUP feature flag in the UP Function Features IE if it supports F-TEID allocation in the UP function (see clause 8.2.25). If so, the CP function shall determine whether F-TEIDs are allocated by the CP function or the UP function based on network configuration. The same F-TEID allocation option shall be used by all the CP functions controlling a particular UP function. The UP function shall reject a request to establish a new PDR with a different F-TEID allocation option than the option used for already created PDRs (by the same or a different CP function), with the cause "Invalid F-TEID allocation option".

5.5.2 F-TEID allocation in the CP function

When performing F-TEID allocation in the CP function, the CP function shall assign the Local F-TEID IE of the PDR IE (see Table 7.5.2.2-1) and provide the assigned F-TEID value to the UP function.

5.5.3 F-TEID allocation in the UP function

When performing F-TEID allocation in the UP function, the CP function shall request the UP function to allocate the F-TEID by setting the CHOOSE flag in the Local F-TEID IE of the PDR IE (see Table 7.5.2.2-1). The Source Interface IE indicates for which interface the F-TEID is to be assigned.

The CP function may request the UP function to allocate the same F-TEID to several PDRs to be created within one single PFCP Session Establishment Request or PFCP Session Modification Request by:

- setting the CHOOSE flag in the Local F-TEID IE of each PDR to be created with a new F-TEID, and
- setting the CHOOSE ID field of the Local F-TEID IE, for each PDR to be created with the same F-TEID, with the same CHOOSE ID value.

or, if the UP function indicated support of the PDI optimization (see clause 8.2.25), by:

- including the Local F-TEID IE only in the Create Traffic Endpoint IE and by setting the CHOOSE flag in the Local F-TEID IE of this IE; and
- including the Traffic Endpoint ID in all the PDRs to be created with the same F-TEID.

If the PDR(s) is created successfully, the UP function shall return the F-TEID(s) it has assigned to the PDR(s) or to the Traffic Endpoint(s) in the PFCP Session Establishment Response or PFCP Session Modification Response.

Upon receiving a request to remove a PDR or a Traffic Endpoint, or to delete an PFCP session, the UP function shall free the F-TEID(s) that was assigned to the PDR if there is no more PDR with the same F-TEID, to the Traffic Endpoint or to the PFCP Session.

5.6 PFCP Session Handling

5.6.1 General

The following clauses provide details on PFCP Sessions handling.

5.6.2 Session Endpoint Identifier Handling

The SEID uniquely identifies an PFCP session at an IP address of a PFCP entity. The F-SEID is the Fully Qualified SEID and it contains the SEID and IP address. The PFCP endpoint locally assigns the SEID value the peer PFCP side has to use when transmitting message. The SEID values are exchanged between PFCP endpoints using PFCP messages. The PFCP entity communicates to the peer PFCP entity the SEID value at which it expects to receive all subsequent control plane messages related to that PFCP session via the "F-SEID" IE.

The PFCP session related messages shall share the same F-SEID for the PFCP session. A F-SEID shall be released after the PFCP session is released.

5.6.3 Modifying the Rules of an Existing PFCP Session

The following principles shall apply, unless specified otherwise in the specification.

When modifying an existing PFCP session, the CP function shall only provide in the PFCP Request message the requested changes compared to what was previously provisioned in the UP function for this PFCP session, i.e. the CP function shall:

- include IEs which needs to be newly provisioned in the UP function;
- include IEs which need to be provisioned with a modified value;

- remove IEs which need to be removed from the set of parameters previously provisioned in the UP function, as further specified below.

The CP function shall remove IEs which needs to be removed by either:

- removing the entire Rule if no other parameter of that rule needs to remain provisioned in the UP function, e.g. by including the Remove URR IE in the PFCP Session Modification Request; or
- updating the Rule including the IEs to be removed with a null length, e.g. by including the Update URR IE in the PFCP Session Modification Request with the IE(s) to be removed with a null length.

The CP function shall set a URR ID and/or QER ID with a length "0" in the Update PDR IE within PFCP Session Modification Request, to request the UP function to stop applying the URRs and/or QERs for this PDR.

Upon receipt of an PFCP Request which modifies an existing PFCP session, the UP function shall add, update or remove the parameters as instructed by the CP function, as defined above, and shall keep unchanged the set of parameters previously provisioned in the UP function which are neither modified nor removed.

5.7 Support of Lawful Interception

5.7.1 General

This clause specifies lawful interception with PFCP in EPC.

5.7.2 Lawful Interception in EPC

Requirements for support of Lawful Interception with a split SGW or PGW are specified in clauses 12.9 and 20.4 of 3GPP TS 33.107 [20].

User plane packets shall be forwarded from the UP function to the SX3LIF (or LMISF for S8HR) by encapsulating the user plane packets using GTP-U encapsulation (see 3GPP TS 29.281 [3]).

The CP function shall instruct the UP function to duplicate the packets to be intercepted and to forward them to the SX3LIF (or to the LMISF for S8HR) as specified in clause 5.2.3.

For forwarding data from the UP function to the SX3LIF (or LMISF for S8HR), the CP function shall set the DUPL flag in the Apply Action and set the Duplicating Parameters in the FAR, associated to the PDRs of the traffic to be intercepted, with the Destination Interface "LI Function" and set to perform GTP-U encapsulation and to forward the packets to a GTP-u F-TEID uniquely assigned in the SX3LIF (or LMISF for S8HR) for the traffic to be intercepted. The SX3LIF (or LMISF for S8HR) shall then identify the intercepted traffic by the F-TEID in the header of the encapsulating GTP-U packet.

5.7.3 Lawful Interception in 5GC

Requirements for support of Lawful Interception with SMF and UPF are specified in clauses 6.2.3 of 3GPP TS 33.127 [47]. The PFCP protocol is not used for Lawful Interception in 5GC.

5.8 PFCP Association

5.8.1 General

An PFCP Association shall be set up between the CP function and the UP function prior to establishing PFCP sessions on that UP function. Only one PFCP association shall be setup between a given pair of CP and UP functions, even if the CP and/or UP function exposes multiple IP addresses.

The CP function and the UP function shall support the PFCP Association Setup procedure initiated by the CP function (see clause 6.2.6.2). The CP function and the UP function may additionally support the PFCP Association Setup procedure initiated by the UP function (see clause 6.2.6.3).

A CP function may have PFCP Associations set up with multiple UP functions. A UP function may have PFCP Associations set up with multiple CP functions.

A CP function or a UP function shall be identified by a unique Node ID. A Node ID may be set to an FQDN or an IP address (see clause 8.2.38).

Prior to establishing an PFCP Association, the function responsible for establishing the PFCP Association (e.g. CP function) shall look up a peer function (e.g. UP function), e.g. using DNS procedures (see 3GPP TS 29.303 [25]), NRF procedures (see 3GPP TS 29.510 [43]) or local configuration. If the peer function is found to support multiple IP addresses (in the look up information), one of these addresses (any one) shall be used as destination IP address to send the PFCP Association Setup Request. Once the PFCP Association is established, any of the IP addresses of the peer function (found during the look-up) may then be used to send subsequent PFCP node related messages and PFCP session establishment requests for that PFCP Association.

NOTE 1: The look up information (e.g. in DNS, NRF or local configuration of the function responsible for establishing the PFCP association) needs to be configured consistently with the addressing information of the peer function. If a FQDN is configured to identify a function in DNS or NRF, then the Node ID of that function included in PFCP messages need to be set to the same FQDN. For instance, if the CP function is responsible for establishing the PFCP association, a UP function that exposes multiple IP addresses (for PFCP node related messages and PFCP session establishment requests) needs to be configured in the look up information as one (single) UP function that is associated to multiple IP addresses.

NOTE 2: PFCP session related messages for sessions that are already established are sent to the IP address received in the F-SEID allocated by the peer function. This IP address need not be configured in the look up information. See clause 4.3.2 and 4.3.3.

5.8.2 Behaviour with an Established PFCP Association

When an PFCP Association is established with a UP function, the CP function:

- shall provision node related parameters (i.e. parameters that apply to all PFCP sessions) in the UP function, if any, e.g. PFDs;
- shall provision the UP function with the list of features (affecting the UP function behaviour) the CP function supports, if any, e.g. support of load and/or overload control;
- shall check the responsiveness of the UP function using the Heartbeat procedure as specified in clause 6.2.2;
- may establish PFCP sessions on that UP function;
- shall refrain from attempting to establish new PFCP sessions on the UP function, if the UP function has indicated it will shut down gracefully.

When an PFCP Association is established with a CP function, the UP function:

- shall update the CP function with the list of features it supports;
- shall update the CP function with its load and/or overload control information, if load and/or overload control is supported by the CP and UP functions;
- may update the CP function with the set of its IP resources available for use by the CP function, when F-TEID allocation is performed by the CP function;

NOTE: The CP function can be aware of the available IP resources in the UP function e.g. based on the UP function reporting this information over Sx using Sx node related messages, or by other implementation specific means.

- shall accept PFCP Session related messages from that CP function (unless prevented by other reasons, e.g. overload);
- shall check the responsiveness of the CP function using the Heartbeat procedure as specified in clause 6.2.2;
- shall indicate to the CP function if it will shut down within a graceful period and, when possible, if it fails and becomes out of service.

5.8.3 Behaviour without an Established PFCP Association

When an PFCP Association is not established with a UP function, the CP function:

- shall reject any incoming PFCP Session related messages from that UP function, with a cause indicating that no PFCP association exists with the peer entity.

When an PFCP Association is not yet established with a CP function, the UP function:

- shall reject any incoming PFCP Session related messages from that CP function, with a cause indicating that no PFCP association exists with the peer entity.

5.9 Usage of Vendor-specific IE

Vendor-specific IEs are defined to cover requirements and features not specified by 3GPP.

NOTE 1: When a IE is intended to be used by more than one vendor, the definition of the IE is encouraged to be specified by 3GPP to ease implementation and interoperability.

NOTE 2: The PFCP entities can use Vendor-specific IE(s) in the PFCP message relevant to the PFCP Association Setup procedure to learn which vendor specific enhancements are supported by the peer.

In a network with Vendor specific enhancements, unrecognized vendor specific IEs shall be handled as unknown optional IEs.

5.10 Error Indication Handling

Upon receipt of a GTP-U Error Indication message, the UP function:

- shall identify the related PFCP session for which the message is received; and
- shall initiate an PFCP Session Report procedure, towards the CP function controlling this PFCP session, to send an Error Indication Report including the remote F-TEID signalled in the GTP-U Peer Address IE and the Tunnel Endpoint Identifier Data I IE of the GTP-U Error Indication (see clause 7.3.1 of 3GPP TS 29.281 [3]).

For EPC, upon receipt of an Error Indication Report, the CP function shall then identify the bearer for which the Error Indication Report is received using the remote F-TEID included in the report and proceed as specified in clauses 21.7 and 21.8 of 3GPP TS 23.007 [24], i.e.:

- modify the PFCP session to instruct the UP function to buffer DL packets;
- modify the PFCP session to delete the PDR and FAR, when having to delete a bearer; or
- delete the PFCP session, when having to delete the PDN connection.

For 5GC, upon receipt of an Error Indication Report, the SMF shall proceed as specified in clause 5.3 of 3GPP TS 23.527 [40].

5.11 User plane inactivity detection and reporting

Clause 5.4.4.1 of 3GPP TS 23.401 [14] requires the PGW to initiate the release of an inactive emergency PDN connection.

Clause 4.3.7 and 4.3.2.2.2 of 3GPP TS 23.502 [29] requires the SMF to be able to initiate the deactivation of the UP connection of an existing PDU session without user plane activity for a given inactivity period, except for the H-SMF for the home routed roaming scenario or except for an always-on PDU session as described in clause 5.6.8 of 3GPP TS 23.501 [28].

The CP function may request the UP function to detect and report when no user plane packets are received for an PFCP session, by provisioning the User Plane Inactivity Timer IE in the PFCP Session Establishment Request or PFCP Session Modification Request.

Upon being provisioned with this IE, the UP function shall monitor the user plane activity of the PFCP session, and report any user plane inactivity exceeding the duration indicated by this IE by sending an PFCP Session Report Request with the Report Type set to UPIR (User Plane Inactivity Report). The UP function shall then continue to process any further user plane packets as instructed by the rules provisioned for the PFCP session, until receiving any new instruction from the CP function.

5.12 Suspend and Resume Notification procedures

Upon receipt of a Suspend Notification message, the PGW-C should request the PGW-U to discard packets received for the suspended PDN connection by:

- setting the DROP flag in the Apply Action IE of the FARs of the corresponding PFCP session, or
- setting the gate fields in the Gate Status IE of QERs to the value CLOSED.

Upon being requested to resume the PDN connection, the PGW-C should re-allow the PGW-U to forward the packets for the PDN connection (unless not permitted for other reasons) by:

- setting the FORW flag in the Apply Action IE of the FARs of the corresponding PFCP session or
- setting the gate fields in the Gate Status IE of QERs to the value OPEN.

5.13 Ethernet traffic (for 5GC)

5.13.1 General

An SMF and UPF may support Ethernet PDU sessions, as specified in clause 5.6.10.2 of 3GPP TS 23.501[28].

For a PFCP session set up for an Ethernet PDU session, the SMF shall:

- include the PDN Type IE set to "Ethernet" in the PFCP Session Establishment Request;
- provision PDR(s), for uplink and/or downlink traffic, with Ethernet Packet Filter(s), based on at least any combination of:
 - Source/destination MAC address;
 - Ethertype as defined in IEEE 802.3 [31];
 - Customer-VLAN tag (C-TAG) and/or Service-VLAN tag (S-TAG) VID fields as defined in IEEE 802.1Q [30];
 - Customer-VLAN tag (C-TAG) and/or Service-VLAN tag (S-TAG) PCP/DEI fields as defined in IEEE 802.1Q [30];
 - IP Packet Filter Set, in case Ethertype indicates IPv4/IPv6 payload. ;
 - Ethernet PDU Session Information, only possible for a DL PDR, that identifies all (DL) Ethernet packets matching the PDU session as follows, based on the N6 Ethernet configuration in the UPF for the associated Network Instance (see clause 5.6.10.2 of 3GPP TS 23.501 [28]):
 - DL traffic based on the MAC address(es) and/or C-TAG and/or S-TAG used by the UE for the UL traffic, for configurations where more than one PDU Session to the same DNN (e.g. for more than one UE) corresponds to the same N6 interface;
 - DL traffic from the N6 interface associated to the PDU session, for configurations where there is a one-to-one relationship between a PDU Session and a N6 interface (in which case the UPF does not need to be aware of MAC addresses and/or C-TAG and/or S-TAG used by the UE in order to route down-link traffic).

NOTE 1: For instance, the SMF can provision a DL PDR with just an "Ethernet PDU Session Information", in a Traffic Endpoint ID or in a PDI, or Ethernet Packet Filters in a PDI, or both an "Ethernet PDU Session Information" in a Traffic Endpoint ID and Ethernet Packet Filters in a PDI.

The SMF may also request a UPF, acting as a PDU session anchor, to:

- redirect Address Resolution Protocol (ARP) (see IETF RFC 826 [32]) or IPv6 Neighbour Solicitation traffic (see IETF RFC 4861 [33]) to the SMF as specified in clause 5.13.2, or to respond to ARP or IPv6 Neighbour Solicitation based on the local cache information as specified in clause 5.13.3;
- report the MAC (Ethernet) addresses used as source address of frames sent UL by the UE, as specified in clause 5.13.5.

For a PFCP session set up for an Ethernet PDU session, the UPF shall:

- detect Ethernet traffic, based on Ethernet Packet Filter(s) provisioned in PDR(s) by the SMF, and process the Ethernet traffic as instructed in the FAR, QER(s) and URR(s) associated to the PDR(s);
- forward Address Resolution Protocol (see IETF RFC 826 [32]) or IPv6 Neighbour Solicitation messages (see IETF RFC 4861 [33]) to the SMF, as specified in clause 5.13.2, if so required by the SMF.
- respond to Address Resolution Protocol (see IETF RFC 826 [32]) or IPv6 Neighbour Solicitation (see IETF RFC 4861 [33]) based on the local cache information, as specified in clause 5.13.3, if so required by the SMF;

NOTE 2: Ethernet Preamble and Start of Frame delimiter are not sent over 5GS.

NOTE 3: How the UPF/SMF builds the ARP or the IPv6 Neighbour cache is not specified in this release and is implementation specific.

5.13.2 Address Resolution Protocol or IPv6 Neighbour Solicitation Response by SMF

If the SMF requests the UPF to forward all Address Resolution Protocol (ARP) (see IETF RFC 826 [32]) or IPv6 Neighbour Solicitation (see IETF RFC 4861 [33]) traffic to the SMF to respond to the ARP or IPv6 Neighbour Solicitation based on the local cache information for Ethernet PDU sessions, the SMF shall provision a PDR in the UPF with:

- an Ethernet Packet Filter containing EtherType 2054 (hexadecimal 0x0806) and associate the PDR with a FAR, for forwarding ARP traffic to the SMF; and/or
- a PDI containing an application ID such that the identified application ID matches against EtherType 34525 (hexadecimal 0x86DD), IPv6 Next Header type as 58 and ICMP Field Type as 135 and associate the PDR with a FAR, for forwarding IPv6 Neighbour Solicitation traffic to the SMF.

In this case, the user plane packets shall be forwarded between the CP and UP functions by encapsulating the user plane packets using GTP-U encapsulation (see clause 5.3.1).

The SMF shall respond to ARP and/or IPv6 Neighbour Solicitation as specified in 3GPP TS 23.501 [28], clause 5.6.10.2 in this case.

5.13.3 Address Resolution Protocol or IPv6 Neighbour Solicitation Response by UPF

If the SMF requests the UPF to respond to Address Resolution Protocol (ARP) (see IETF RFC 826 [32]) or IPv6 Neighbour Solicitation (see IETF RFC 4861 [33]) based on the local cache information for an Ethernet PDU session, the SMF shall provision a PDR in the UPF with:

- an Ethernet Packet Filter containing EtherType 2054 (hexadecimal 0x0806) and associate the PDR with a FAR that has the ARP bit in Proxying IE of the Forwarding Parameters IE set to "1"; or
- a PDI containing an application ID such that the identified application ID matches against EtherType 34525 (hexadecimal 0x86DD), IPv6 Next Header type as 58 and ICMP Field Type as 135 and associate the PDR with a FAR that has the INS bit in Proxying IE of the Forwarding Parameters IE set to "1".

The UPF shall respond to ARP and/or IPv6 Neighbour Solicitation as specified in 3GPP TS 23.501 [28], clause 5.6.10.2 in this case.

5.13.3A Provisioning of MAC addresses and SDF filters in Ethernet Packet Filters

The provisioning of an SDF Filter in an Ethernet Packet Filter shall follow the requirements specified for provisioning an SDF Filter in clause 5.2.1A.2A.

Likewise, the source and destination MAC addresses information, when provisioned, shall be set as for downlink Ethernet flows. The UP function shall apply source and destination MAC addresses information based on the Source Interface of the PDR, according to the same principles as specified in clause 5.2.1A.2A, e.g. swapping the source and destination MAC addresses information if the Source Interface is ACCESS, and applying them as provisioned if the Source Interface is CORE.

5.13.4 Bidirectional Ethernet Filters

The CP function may provision bidirectional Ethernet Filters in the UP function (see clause 7.5.2.2-x), i.e. Ethernet filters that may be associated to both uplink and downlink PDRs of a same PFCP session, as follows:

- when provisioning a bidirectional Ethernet Filter the first time for an PFCP session, the CP function shall set the BIDE (Bidirectional Ethernet Filter) flag in the Ethernet Filter Properties IE and provision the Ethernet filter definition together with a Ethernet Filter ID uniquely identifying the Ethernet Filter among all the Ethernet Filters provisioned for a given PFCP session; the source and destination MAC addresses information, in a bidirectional Ethernet filter, shall be set as for downlink Ethernet flows;
- the CP function may then provision a PDR for the same PFCP session but the opposite direction, by provisioning the Ethernet Filter ID in the Ethernet filter ID field of the PDI, without provisioning again the Ethernet Filter Properties and Ethernet filter definition.;
- when being provisioned with a bidirectional Ethernet Filter in a PDR, the UP function shall apply the Ethernet filter according to the direction of the PDR as specified in clause 5.13.3A, i.e. the UP function shall apply the Ethernet filter parameters provisioned for the Ethernet filter ID, but with swapping the source and destination MAC addresses, and the source and destination IP addresses if any, if the PDR is set for uplink Ethernet flows;
- the UP function shall apply any modification of a bidirectional Ethernet Filter to all PDRs of the PFCP session making use of this Ethernet Filter;
- upon deletion of a PDR making use of a bidirectional Ethernet Filter, the UP function shall still apply the Ethernet Filter for any other PDR making use of the Ethernet Filter.

The requirements specified for provisioning of MAC addresses and SDF Filters in clause 5.13.A shall also apply when provisioning bidirectional Ethernet Filters.

5.13.5 Reporting of UE MAC addresses to the SMF

In a PFCP Session Establishment Request or a PFCP Session Modification Request, the SMF may request the UPF to start or stop (in a PFCP Session Modification Request only) reporting the UE MAC addresses, i.e. the different MAC (Ethernet) addresses used as source address of frames sent UL by the UE in a PDU Session, by:

- creating a URR requesting the UPF to report Ethernet traffic information (i.e. with the Reporting Trigger set to 'MAC Addresses Reporting'); and
- associating the URR to the PDR provisioned for the UL traffic of the PDU session.

The SMF may additionally request the UPF to detect and report when no user plane packets are received for an UE MAC address, by provisioning the Ethernet Inactivity Timer IE in the URR.

When being requested to start reporting the UE MAC addresses, the UPF shall:

- report immediately any UE MAC addresses known to be associated to the PDU session (e.g. if the request to start monitoring of traffic is received after the PFCP session establishment and if the UPF monitors the UE MAC addresses for the routing of DL traffic);
- report new UE MAC addresses that are detected subsequently;

- report UE MAC addresses that are removed subsequently from the PDU session, based on the detection of absence of traffic during the Ethernet Inactivity Timer, if this timer is provisioned in the URR.

NOTE: Numerous UE MAC addresses can be used by a same PDU session. The UP function can defer a bit the reporting of newly detected or removed UE MAC addresses to allow the reporting of multiple UE MAC addresses in a same usage report. Details are implementation specific.

5.14 Support IPv6 Prefix Delegation

Clause 5.3.1.2.6 of 3GPP TS 23.401 [14] specifies the requirements for IPv6 Prefix Delegation via DHCPv6, that allow assigning a single network prefix shorter than the default /64 prefix to a PDN connection.

When assigning additional IPv6 prefixes (i.e. prefixes in addition to the default prefix) to a UE, the CP function shall provision/update the UE IP Address IE in the UP function with the IPv6D flag set to "1" and IPv6 Prefix Delegation Bits field to indicating the length of IPv6 Prefix for delegation.

5.15 Signalling based Trace (De)Activation

The UP function shall set the TRACE feature flag in the UP Function Features IE if it supports Trace (see 3GPP TS 32.422 [35]).

If the UP function indicated support of Trace, the CP function may activate a trace session during a PFCP session establishment or a PFCP session modification procedure, by including the Trace Information IE in the PFCP Session Establishment Request or PFCP Session Modification Request.

The CP function may deactivate an on-going trace session by including the Trace Information IE with a null length in a PFCP Session Modification Request.

There shall be at most one trace session activated per PFCP session at a time.

5.16 Framed Routing

Framed routing allows to support an IP network behind a UE, such that a range of IP addresses or IPv6 prefixes is reachable over a single PDU session, e.g. for enterprise connectivity. Framed routes are IP routes behind the UE. The UPF advertizes relevant IP routes to receive packets destined to these destination IP addresses or IPv6 prefixes and to forward these packets over the PDU session. See clause 5.6.14 of 3GPP TS 23.501 [28], IETF RFC 2865 [37], IETF RFC 3162 [38]) and the Framed-Route, Framed-Routing and Framed-IPv6-Route AVPs specified in 3GPP TS 29.061 [39] and 3GPP TS 29.561 [49].

Framed routing is defined only for PDN connections and PDU sessions of the IP type (IPv4, IPv6, IPv4v6).

A UPF may indicate support of framed routing by setting the FRRT flag in the UP Function Features IE. If so, the CP function may include Framed-Route IEs, the Frame-Routing IE and Framed-IPv6-Route IEs in DL PDRs to describe framed routes associated to the PDU session.

5.17 5G UPF (for 5GC)

5.17.1 Introduction

The following clauses describe the 5GS specific functionalities of a UP function.

5.17.2 Uplink Classifier and Branching Point

The Uplink Classifier and Branching Point functionalities refer to the capability of the UPF to route uplink traffic flows of the same PFCP session (PDU session) to two or more PDU Sessions Anchors, and to route the downlink traffic flows from these PDU Session Anchors on the tunnel towards the UE. They are defined in 3GPP TS 23.501 [28] and 3GPP TS 23.502 [29].

Uplink Classifier is supported for PDU sessions of type IPv4, IPv6, IPv4v6 or Ethernet. The routing of the uplink traffic flows to different PDU Session Anchors is based e.g. on the destination IP address/Prefix of the uplink packets for an IP PDU session.

Branching Point is supported for multi-homed PDU sessions of type IPv6, i.e. PDU sessions with multiple IPv6 prefixes. The routing of the uplink traffic flows to different PDU Session Anchors is based on the source IP prefix of the uplink packets.

The SMF may insert an Uplink Classifier or Branching Point, during a PDU session establishment or modification, by provisioning:

- two or more UL PDRs, with the appropriate Packet Detection Information, and with corresponding FARs to route the uplink traffic flows towards the appropriate PDU Session Anchors;
- two or more DL PDRs, with the appropriate Packet Detection Information, and with one (or more FARs) to route the downlink traffic flows on the tunnel towards the UE.

NOTE 1: This uses the generic functionalities of the PFCP protocol described in this specification, with two or more DL PDRs (for the traffic coming from the different PDU session anchors).

NOTE 2: A UPF acting as an Uplink Classifier or Branching Point can also behave as a PDU Session Anchor for the PDU session.

The SMF may remove an Uplink Classifier or Branching Point, during a PDU session modification, by removing the UL (or modifying the FAR associated to the UL PDR) and DL PDRs that were setup for the traffic to/from the PDU Session Anchor(s) to be removed.

5.17.3 Data Forwarding during handovers between 5GS and EPS

Data forwarding during handovers between 5GS and EPS is supported as follows (see 3GPP TS 38.300 [42]):

- For 5G to 4G handover, the source NG-RAN node sends one or several end markers including one QFI of those QoS flows mapped to the same E-RAB and sends the end marker packets to the UPF over the PDU session tunnel. UPF removes the QFI and maps to an appropriate E-RAB tunnel towards SGW.
- For 4G to 5G handover, the source eNB forwards the received end markers in the EPS bearer tunnel to the SGW which forwards them to the UPF. The UPF adds one QFI among the QoS flows mapped to that E-RAB to the end markers and sends those end markers to the target NG-RAN node in the per PDU session tunnel.

To forward data (G-PDUs and End Marker packets) during a 5GS to EPS handover, the SMF shall:

- provision one PDR per E-RAB (that supports data forwarding for at least one QoS flow), with the list of QFIs that are mapped to the E-RAB;
- request the UPF to remove the GTP-U PDU Session Container extension header (including the QFI) from the data by including the GTP-U Extension Header Deletion field set to 'PDU Session Container' in the Outer Header Removal IE of the PDR(s);
- associate to each PDR a FAR to forward the data to the GTP-U tunnel of the corresponding E-RAB, i.e. with an Outer Header Creation IE containing the F-TEID of the (forwarding) SGW for the corresponding forwarding GTP-U tunnel;

To forward data (G-PDUs and End Marker packets) during an EPS to 5GS handover, the SMF shall:

- provision one PDR per E-RAB (that supports data forwarding for at least one QoS flow);
- create and associate one QER with each PDR, including the QFI IE set to the QFI value of one of the QoS flows mapped to the E-RAB, to request the UPF to insert a GTP-U PDU Session Container extension header including the QFI;
- create one FAR for each data forwarding tunnel in 5GS (i.e. per PDU session), with an Outer Header Creation IE containing the F-TEID of the target NG-RAN for the corresponding forwarding GTP-U tunnel;
- associate each PDR to the corresponding FAR (i.e. to forward the data of each E-RAB to the data forwarding tunnel of the corresponding PDU session).

6 Procedures

6.1 Introduction

The following clauses specify the procedures supported over the Sxa, Sxb and Sxc reference points.

6.2 PFCP Node Related Procedures

6.2.1 General

The following clauses specify the node related procedures over the Sxa, Sxb, Sxc and N4 reference points. The behaviour of the CP function and UP function when sending and receiving a node related message is described.

6.2.2 Heartbeat Procedure

6.2.2.1 General

Two messages are specified for PFCP heartbeat procedure: Heartbeat Request and Heartbeat Response. The use of these messages is further specified in clause 19A of 3GPP TS 23.007 [24] for EPC, and in clause 4 of 3GPP TS 23.527 [40] for 5GC.

6.2.2.2 Heartbeat Request

The CP function or the UP function may send an Heartbeat Request on a path to the peer node to find out if it is alive. Heartbeat Request messages may be sent for each peer with which an PFCP control association is established.

A CP function or UP function shall be prepared to receive an Heartbeat Request at any time (even from unknown peers) and it shall reply with an Heartbeat Response.

6.2.2.3 Heartbeat Response

The message shall be sent as a response to a received Heartbeat Request.

6.2.3 Load Control Procedure

6.2.3.1 General

Load Control is an optional feature defined over the Sxa, Sxb, Sxc and N4 reference points.

Load control enables the UP function to send its load information to the CP function to adaptively balance the PFCP session load across the UP functions according to their effective load. The load information reflects the operating status of the resources of the UP function.

Load control allows for better balancing of the PFCP session load, so as to attempt to prevent overload in the first place (preventive action). Load control does not trigger overload mitigation actions even if the UP function reports a high load.

Load control and overload control may be supported and activated independently in the network, based on operator's policy.

6.2.3.2 Principles

The UP function may signal its Load Control Information to reflect the operating status of its resources, at the node level, allowing the receiving CP function to use this information to augment the UP function selection procedures.

The Load Control Information is piggybacked in PFCP request or response messages such that the exchange of Load Control Information does not trigger extra signalling.

NOTE: The inclusion of Load Control Information in existing messages means that the frequency of transmission of load control information increases as the session load increases, allowing for faster feedback and thus better regulation of the load.

The calculation of the Load Control Information is implementation dependent and its calculation and transfer shall not add significant additional load to the node itself and to its corresponding peer nodes.

6.2.3.3 Load Control Information

6.2.3.3.1 General Description

A PFCP message may contain one instance of the Load Control Information (LCI) IE.

When providing load control information in a message for the first time or subsequently, the UP function shall always include the full set of load control information, i.e. all the node level instance of the Load Control Information, even if only a subset of the load control information has changed. The Load Control Sequence Number shall be incremented whenever the load control information is changed (see clause 6.2.3.3.2.1).

Load Control Information shall be linked to the Node ID (i.e. FQDN or the IP address used during the UP function selection) of the UP function providing the Information.

The receiver shall overwrite any stored load control information of a peer with the newly received load control information from the same peer node if the new load control information is more recent than the old information as indicated by the Load Control Sequence Number, e.g. if the receiver has stored an instance of the load control information for a peer node, it overwrites this instance with the new instance received in a message from the same peer node.

The receiver shall consider all the parameters received in the same instance of the LCI IE in conjunction while using this information for UP function selection.

The parameters are further defined in clause 6.2.3.3.2.

Load control information may be extended with new parameters in future versions of the specification. Any new parameter will have to be categorized as:

- Non-critical optional parameters: the support of these parameters is *not critical* for the receiver. The receiver can successfully and correctly comprehend the load control information instance, containing one or more of these parameters, by using the other parameters and ignoring the non-critical optional parameter.
- Critical optional parameters: the support of these parameters is *critical* for the receiver to correctly comprehend the instance of the load control information containing one or more of these parameters.

The sender may include one or more non-critical optional parameters within any instance of the LCI IE without having the knowledge of the receiver's capability to support the same. However, the sender shall only include one or more critical optional parameter in an instance of the LCI IE towards a receiver if the corresponding receiver is known to support those parameters. The sender may be aware of this either via signalling methods or by configuration (this will have to be defined when introducing any such new parameter in future).

6.2.3.3.2 Parameters

6.2.3.3.2.1 Load Control Sequence Number

The Load Control Sequence number contains a value that indicates the sequence number associated with the LCI IE. This sequence number shall be used to differentiate any two LCI IEs generated at two different instances by the same UP function. The Load Control Sequence Number shall be supported (if load control is supported) and shall always be present in the LCI IE.

The UP function generating this information shall increment the Load Control Sequence Number whenever modifying some information in the Load Control Information IE. The Load Control Sequence Number shall not be incremented

otherwise. The UP function may use the time, represented in an unsigned integer format, of the generation of the Load Control Information to populate the Load Control Sequence Number.

This parameter shall be used by the receiver of the Load Control Information IE to properly collate out-of-order load control information, e.g. due to PFCP retransmissions. This parameter shall also be used by the receiver of the LCI IE to determine whether the newly received load control information has changed compared to load control information previously received from the same node earlier.

NOTE: The PFCP sequence number cannot be used for collating out-of-order load control information as e.g. load control information may be sent in both PFCP requests and responses, using independent PFCP sequence numbering.

If the receiving entity has already received and stored load control information from the peer UP function, the receiving CP function shall update its load control information only if the Load Control Sequence Number received in the new load control information is higher than the stored value of the Load Control Sequence Number associated with the peer UP function. However due to roll-over of the Load Control Sequence Number or restart of the node, the Load Control Sequence Number may be reset to an appropriate base value by the peer UP function, hence the receiving entity shall be prepared to receive (and process) a Load Control Sequence Number parameter whose value is less than the previous value.

6.2.3.3.2 Load Metric

The Load Metric parameter shall indicate the current load level of the originating node. The computation of the Load Metric is left to implementation. The node may consider various aspects, such as the used capacity of the UP function, the load in the node (e.g. memory/CPU usage in relationship to the total memory/CPU available, etc.).

The Load Metric represents the current load level of the sending node as a percentage within the range of 0 to 100, where 0 means no or 0% load and 100 means maximum or 100% load reached (i.e. no further load is desirable).

The Load Metric shall be supported (if load control is supported). The Load Metric shall always be included in the Load Control Information.

Considering the processing requirement of the receiver of the Load Control Information (e.g. handling of the new information, tuning the node selection algorithm to take the new information into account), the sender should refrain from advertising every small variation (e.g. with the granularity of 1 or 2), in the Load Metric which does not result in useful improvement in node selection logic at the receiver. During the typical operating condition of the sender, a larger variation in the Load Metric, e.g. 5 or more units, should be considered as reasonable enough for advertising the new Load Control Information and thus justifying the processing requirement (to handle the new information) of the receiver.

NOTE: The range of the Load Metric, i.e. 0 to 100, does not mandate the sender to collect its own load information at every increment/decrement and hence to advertise the change of Load Metric with a granularity of 1%. Based on various implementation specific criteria, such as: the architecture, session and signalling capacity, the current load and so on, the sender is free to define its own logic and periodicity with which its own load information is collected.

6.2.3.3.3 Frequency of Inclusion

How often the sender includes the load control information is implementation specific. The sender shall ensure that new/updated load control information is propagated to the target CP functions within an acceptable delay, such that the purpose of the information (i.e. effective load balancing) is achieved. The sender may include the LCI IE e.g. as follows:

- the sender may include Load Control Information towards a peer only when the new/changed value has not already been provided to that peer;
- the sender may include the Load Control Information in each and every message (extended with LCI IE) towards the peer;
- the sender may include Load Control Information periodically, i.e. include the information during a first period then cease to do so during a second period.

The sender may also implement a combination of one or more of the above approaches. Besides, the sender may also decide to include the Load Control Information only in a subset of the applicable PFCP messages.

The receiver shall be prepared to receive the load control information in any of the PFCP messages extended with an LCI IE and upon such reception, shall be able act upon the received load control information.

6.2.4 Overload Control Procedure

6.2.4.1 General

Overload Control is an optional feature defined over the Sxa, Sxb, Sxc and N4 reference points.

Overload control enables a UP function becoming or being overloaded to gracefully reduce its incoming signalling load by instructing its peer CP functions to reduce sending traffic according to its available signalling capacity to successfully process the traffic. A UP function is in overload when it operates over its signalling capacity which results in diminished performance (including impacts to handling of incoming and outgoing traffic).

Overload control aims at shedding the incoming traffic as close to the traffic source as possible generally when an overload has occurred (reactive action), so to avoid spreading the problem inside the network and to avoid using resources of intermediate nodes in the network for signalling that would anyhow be discarded by the overloaded node.

Load control and overload control may be supported and activated independently in the network, based on operator's policy.

6.2.4.2 Principles

When a UP function determines that the offered incoming signalling traffic is growing (or is about to grow) beyond its nominal capacity, the UP function may signal its overload, at node level granularity, to its peer CP functions by including Overload Control Information in PFCP signalling which provides guidance to the receiving CP functions to decide actions which lead to signalling traffic mitigation towards the sender of the information. This helps in preventing severe overload and hence potential breakdown of the UP function.

The Overload Control Information is piggybacked in PFCP request or response messages such that the exchange of Overload Control Information does not trigger extra signalling.

NOTE: The inclusion of Overload Control Information in existing messages means that the frequency of transmission of overload control information increases as the signalling load increases, thus allowing for faster feedback and better regulation.

The calculation of the Overload Control Information is implementation dependent and its calculation and transfer shall not add significant additional load to the node itself and to its corresponding peer nodes. The calculation of Overload Control Information should not severely impact the resource utilization of the UP function, especially considering the overload situation.

The overload control feature should continue to allow for preferential treatment of priority users (eMPS) and emergency services.

The overload mitigation actions based on the reception of the overload related information received from the UP function will not be standardized.

6.2.4.3 Overload Control Information

6.2.4.3.1 General Description

A PFCP message may contain one instance of the Overload Control Information (OCI) IE.

When providing overload control information in a message for the first time or subsequently, the UP function shall always include the full set of overload control information, i.e. all the node level instance of the Overload Control Information, even if only a subset of the overload control information has changed. The Overload Control Sequence Number shall be incremented whenever the Overload control information is changed (see clause 6.2.4.3.2.1).

The receiver shall overwrite any stored overload control information of a peer with the newly received overload control information from the same peer node if the new overload control information is more recent than the old information as indicated by the Overload Control Sequence Number, e.g. if the receiver has stored an instance of the Overload control

information for a peer node, it overwrites this instance with the new instance received in a message from the same peer node.

The receiver shall consider all the parameters received in the same instance of the OCI IE in conjunction while applying the overload mitigation action.

The parameters are further defined in clause 6.2.4.3.2.

Overload control information may be extended with new parameters in future versions of the specification. Any new parameter will have to be categorized as:

- Non-critical optional parameters: the support of these parameters is *not critical* for the receiver. The receiver can successfully and correctly comprehend the Overload control information instance, containing one or more of these parameters, by using the other parameters and ignoring the non-critical optional parameter.
- Critical optional parameters: the support of these parameters is *critical* for the receiver to correctly comprehend the instance of the Overload control information containing one or more of these parameters.

The sender may include one or more non-critical optional parameters within any instance of the OCI IE without having the knowledge of the receiver's capability to support the same. However, the sender shall only include one or more critical optional parameter in an instance of the OCI IE towards a receiver if the corresponding receiver is known to support those parameters. The sender may be aware of this either via signalling methods or by configuration (this will have to be defined when introducing any such new parameter in future).

The Overload Control Information shall be associated by default to the PFCP entity corresponding to the peer node's IP address of the PFCP session, over which the OCI IE is received, i.e. to the IP address received within the "UP F-SEID" IE.

Alternatively, the UP function may send Overload Control Information which is associated with the Node ID of the UP function (i.e. FQDN or the IP address used during the UP function selection). In that case, the UP function shall provide an explicit indication that the OCI IE included in the message belongs to the Node ID.

6.2.4.3.2 Parameters

6.2.4.3.2.1 Overload Control Sequence Number

The PFCP protocol requires retransmitted messages to have the same contents as the original message. Due to PFCP retransmissions, the overload control information received by a CP function at a given time may be less recent than the overload control information already received from the same UP function. The Overload Control Sequence Number aids in sequencing the overload control information received from an overloaded UP function. The Overload Control Sequence Number contains a value that indicates the sequence number associated with the Overload Control Information IE. This sequence number shall be used to differentiate between two OCI IEs generated at two different instants, by the same UP function.

The Overload Control Sequence Number parameter shall be supported (when supporting the overload control feature) and shall always be present in the Overload Control Information IE.

The UP function generating this information shall increment the Overload Control Sequence Number whenever modifying some information in the OCI IE. The Overload Control Sequence Number shall not be incremented otherwise. The UP function may use the time, represented in an unsigned integer format, of the generation of the overload control information, to populate the Overload Control Sequence Number.

This parameter shall be used by the receiver of the OCI IE to properly collate out-of-order OCI IEs, e.g. due to PFCP retransmissions. This parameter shall also be used by the receiver of the OCI IE to determine whether the newly received overload control information has changed compared to the overload control information previously received from the same UP function. If the newly received overload control information has the same Overload Control Sequence Number as the previously received overload control information from the same UP function, then the receiver may simply discard the newly received overload control information whilst continuing to apply the overload abatement procedures, as per the previous value.

NOTE 1: The timer corresponding to the Period of Validity (see clause 6.2.4.3.2.2) is not restarted if the newly received overload control information has the same Overload Control Sequence Number as the previously received overload control information. If the overload condition persists and the overloaded UP function needs to extend the duration during which the overload information applies, the sender needs to provide a new overload control information with an incremented Overload Control Sequence Number (even if the parameters within the overload control information have not changed).

NOTE 2: The PFCP Sequence Number cannot be used for collating out-of-order overload information as e.g. overload control information may be sent in both PFCP requests and responses, using independent PFCP sequence numbering.

If the receiving CP function already received and stored overload control information, which is still valid, from the overloaded UP function, the receiving entity shall update its overload control information, only if the Overload-Sequence-Number received in the new overload control information is larger than the value of the Overload Control Sequence Number associated with the stored information. However due to roll-over of the Overload Control Sequence Number or restart of the UP function, the Overload Control Sequence Number may be reset to an appropriate base value by the peer UP function, hence the receiving entity shall be prepared to receive (and process) an Overload Control Sequence Number parameter whose value is less than the previous value.

6.2.4.3.2.2 Period of Validity

The Period of Validity indicates the length of time during which the overload condition specified by the OCI IE is to be considered as valid (unless overridden by subsequent new overload control information).

An overload condition shall be considered as valid from the time the OCI IE is received until the period of validity expires or until another OCI IE with a new set of information (identified using the Overload Control Sequence Number) is received from the same UP function (at which point the newly received overload control information shall prevail). The timer corresponding to the period of validity shall be restarted each time an OCI IE with a new set of information (identified using the Overload Control Sequence Number) is received. When this timer expires, the last received overload control information shall be considered outdated and obsolete, i.e. any associated overload condition shall be considered to have ceased.

The Period of Validity parameter shall be supported (when supporting overload control).

The Period of Validity parameter achieves the following:

- it avoids the need for the overloaded UP function to include the Overload Control Information IE in every PFCP messages it signals to its peer CP functions when the overload state does not change; thus it minimizes the processing required at the overloaded UP function and its peer CP functions upon sending/receiving PFCP signalling;
- it allows to reset the overload condition after some time in the peer CP functions having received an overload indication from the overloaded UP function, e.g. if no signalling traffic takes place between these PFCP entities for some time due to overload mitigation actions. This also removes the need for the overloaded UP function to remember the list of CP functions to which it has sent a non-null overload reduction metric and to which it would subsequently need to signal when the overload condition ceases, if the Period of Validity parameter was not defined.

6.2.4.3.2.3 Overload Reduction Metric

The Overload Reduction Metric shall have a value in the range of 0 to 100 (inclusive) which indicates the percentage of traffic reduction the sender of the overload control information requests the receiver to apply. An Overload Reduction Metric of "0" always indicates that the UP function is not in overload (that is, no overload abatement procedures need to be applied) for the indicated scope.

Considering the processing requirement of the receiver of the Overload Control Information, e.g. to perform overload control based on the updated Overload Reduction Metric, the sender should refrain from advertising every small variation, e.g. with the granularity of 1 or 2, in the Overload Reduction Metric which does not result in useful improvement for mitigating the overload situation. During the typical operating condition of the sender, a larger variation in the Overload Reduction Metric, e.g. 5 or more units, should be considered as reasonable enough for advertising a new Overload Reduction Metric Information and thus justifying the processing requirement (to handle the new information) of the receiver.

NOTE: The range of Overload Reduction Metric, i.e. 0 to 100, does not mandate the sender to collect its own overload information at every increment/decrement and hence to advertise the change of Overload Reduction Metric with a granularity of 1%. Based on various implementation specific criteria, such as the architecture, session and signalling capacity, the current load/overload situation and so on, the sender is free to define its own logic and periodicity with which its own overload control information is collected.

The computation of the exact value for this parameter is left as an implementation choice at the sending UP function.

The Overload Reduction Metric shall be supported (when supporting overload control) and shall always be present in the OCI IE.

The inclusion of the OCI IE signals an overload situation is occurring, unless the Overload Reduction Metric is set to "0", which signals that the overload condition has ceased. Conversely, the absence of the OCI IE in a message does not mean that the overload has abated.

6.2.4.3.3 Frequency of Inclusion

How often or when the sender includes the overload control information is implementation specific. The sender shall ensure that new/updated overload control information is propagated to the target receivers with an acceptable delay, such that the purpose of the information, (i.e. the effective overload control protection) is achieved. The following are some of the potential approaches the sender may implement for including the OCI IE:

- the sender may include OCI IE towards a receiver only when the new/changed value has not already been provided to the given receiver;
- the sender may include the OCI IE in a subset of the messages towards the receiver;
- the sender may include the OCI IE periodically, i.e. include the information during a first period then cease to do so during a second period.

The sender may also implement a combination of one or more of the above approaches. Besides, the sender may also include the OCI IE only in a subset of the applicable PFCP messages.

The receiver shall be prepared to receive the overload control information received in any of the PFCP messages extended with an OCI IE and upon such reception, shall be able act upon the received information.

6.2.4.4 Message Throttling

6.2.4.4.1 General

As part of the overload mitigation, a CP function shall reduce the total number of messages, which would have been sent otherwise, towards the overloaded peer based on the information received within the Overload Control Information. This shall be achieved by discarding a fraction of the messages in proportion to the overload level of the target peer. This is called "message throttling".

Message throttling shall only apply to Request messages. Response messages should not be throttled since that would result in the retransmission of the corresponding request message by the sender.

A CP function supporting PFCP overload control shall support and use the "Loss" algorithm as specified in this clause, for message throttling.

6.2.4.4.2 Throttling algorithm – "Loss"

6.2.4.4.2.1 Description

An overloaded UP function shall ask its peers to reduce the number of requests they would ordinarily send by signalling Overload Control Information including the requested traffic reduction, as a percentage, within the "Overload-Reduction-Metric", as specified in clause 6.2.4.3.2.

The recipients of the "Overload-Reduction-Metric" shall reduce the number of requests sent by that percentage, either by redirecting them to an alternate destination if possible (e.g. the PFCP Session Establishment Request message may be redirected to an alternate UP function), or by failing the request and treating it as if it was rejected by the destination UP function.

For example, if a sender requests another peer to reduce the traffic it is sending by 10%, then that peer shall throttle 10% of the traffic that would have otherwise been sent to this UP function.

The overloaded UP function should periodically adjust the requested traffic reduction based e.g. on the traffic reduction factor that is currently in use, the current system utilization (i.e. the overload level) and the desired system utilization (i.e. the target load level), and/or the rate of the current overall received traffic.

Annex A.1 provides an (informative) example of a possible implementation of the "Loss" algorithm, amongst other possible methods.

NOTE 1: This algorithm does not guarantee that the future traffic towards the overloaded UP function will be less than the past traffic but it ensures that the total traffic sent towards the overloaded UP function is less than what would have been sent without any throttling in place. If after requesting a certain reduction in traffic, the overloaded UP function receives more traffic than in the past, whilst still in overload, leading to the worsening rather than an improvement in the overload level, then the overloaded UP function can request for more reduction in traffic. Thus, by periodically adjusting the requested traffic reduction, the overloaded node can ensure that it receives, approximately, the amount of traffic which it can handle.

NOTE 2: Since the reduction is requested as a percentage, and not as an absolute amount, this algorithm achieves a good useful throughput towards the overloaded node when the traffic conditions vary at the source nodes (depending upon the events generated towards these source nodes by other entities in the network), as a potential increase of traffic from some source nodes can possibly be compensated by a potential decrease of traffic from other source nodes.

6.2.4.5 Message Prioritization

6.2.4.5.1 Description

When performing message throttling:

- PFCP requests related to priority traffic (i.e. eMPS as described in 3GPP TS 22.153 [15]) and emergency have the highest priority. Depending on regional/national requirements and network operator policy, these PFCP requests shall be the last to be throttled, when applying traffic reduction, and the priority traffic shall be exempted from throttling due to PFCP overload control up to the point where the requested traffic reduction cannot be achieved without throttling the priority traffic;
- for other types of sessions, messages throttling should consider the relative priority of the messages so that the messages which are considered as low priority are considered for throttling before the other messages. The relative priority of the messages may be derived from the relative priority of the procedure for which the message is being sent or may be derived from the session parameters such as APN, QCI, ARP and/or Low Access Priority Indicator (LAPI).

NOTE: A random throttling mechanism, i.e. discarding the messages without any special consideration, could result in an overall poor congestion mitigation mechanism and bad user experience.

An overloaded node may also apply these message prioritization schemes when handling incoming initial messages during an overloaded condition, as part of a self-protection mechanism.

6.2.4.5.2 Based on the Message Priority Signalled in the PFCP Message

Message prioritization may be performed by an overloaded node, when handling incoming messages during an overloaded condition, based on the relative PFCP message priority signalled in the PFCP header (see clause 7.2.2.3).

A PFCP entity shall determine whether to set and use the message priority in PFCP signalling, based on operator policy. The requirements specified in this clause shall apply if message priority in PFCP signalling is used.

A sending PFCP entity shall determine the relative message priority to signal in the message according to the principles specified in clause 6.2.4.5.1. If the message affects multiple bearers, the relative message priority should be determined considering the highest priority ARP among all the bearers.

A PFCP entity should set the same message priority in a Response message as received in the corresponding Request message.

For incoming PFCP messages that do not have a message priority in the PFCP header, the receiving PFCP entity:

- shall apply a default priority, if the incoming message is a Request message;
- should apply the message priority sent in the Request message, if the incoming message is a Response message.

This feature should be supported homogenously across the CP functions and UP functions in the network, otherwise an overloaded node will process Request messages received from the non-supporting nodes according to the default priority while Request messages received from supporting nodes will be processed according to the message priority signalled in the PFCP message.

6.2.5 PFCP PFD Management Procedure

6.2.5.1 General

The PFCP PFD Management procedure may be used by the CP function and UP function to provision PFDs (e.g. received from the PFDF as specified in clauses 5.11.4 and 6.5.2 of 3GPP TS 23.214 [2]) to the UP function, for one or more Application Identifiers.

Support of this procedure is optional for the CP function and the UP function. The UP function shall set the PFDM feature flag in the UP Function Features IE if it supports the PFD Management procedure (see clause 8.2.25).

The UP function shall store the PFDs provisioned per Application Identifier. These PFDs shall apply to all the PFCP session established in the UP function, for all the controlling CP functions, i.e. the scope of a PFD is not limited to the PFCP sessions established by the CP function which provisioned the PFD.

NOTE: Application identifiers preconfigured in the UP function, if any, need to be distinct from application identifiers provisioned via PFD management procedure.

6.2.5.2 CP Function Behaviour

The CP function initiates the PFCP PFD Management procedure to provision PFDs in the UP function, for one or more Application Identifier(s).

The CP function:

- shall send the PFCP PFD Management Request message, including the full set of PFD IDs and PFD contents to be provisioned in the UP function per Application Identifier.

When the CP function receives an PFCP PFD Management Response with cause success, the CP function shall consider that the PFDs have been provisioned as requested.

6.2.5.3 UP Function Behaviour

When the UP function receives a PFCP PFD Management Request message, it shall:

- if no Application ID's PFDs IE is present in the request (i.e. empty message),
 - delete all the PFDs received and stored earlier for all Application Identifier(s) provisioned via the PFD Management Procedure;
- if at least one Application ID's PFDs IE is present in the request,
 - delete all the PFDs received and stored earlier for the indicated Application Identifier(s);
 - store all the PFDs received in the request for the indicated Application Identifier(s);
- send a PFCP PFD Management Response with the cause "success", if the above operations were performed successfully.
- if a PFD is removed/modified and this PFD was used to detect application traffic related to an application identifier in a PDR created/activated for a PFCP session and the UP function has reported the application start to the CP function for the application instance corresponding to this PFD as defined in clause 5.4.11 ((Un)solicited Application Reporting), the UP function shall report the application stop to the CP function for the

corresponding application instance identifier as defined in clause 5.4.11 if the removed/modified PFD in UP results in the stop of the application instance is not being able to be detected. See clause 5.11.4 of 3GPP TS 23.214 [2].

6.2.6 PFCP Association Setup Procedure

6.2.6.1 General

The PFCP Association Setup procedure shall be used to setup an PFCP association between a CP function and a UP function, to enable the CP function to use the resources of the UP function subsequently, i.e. establish PFCP Sessions.

The setup of an PFCP association may be initiated by the CP function (see clause 6.2.6.2) or the UP function (see clause 6.2.6.3).

The CP function and the UP function shall support the PFCP Association Setup initiated by the CP function. The CP function and the UP function may additionally support the PFCP Association Setup initiated by the UP function.

6.2.6.2 PFCP Association Setup Initiated by the CP Function

6.2.6.2.1 CP Function Behaviour

The CP function initiates the PFCP Association Setup procedure to request to setup an PFCP association towards a UP function prior to establishing a first PFCP session on this UP function.

The CP function:

- shall retrieve an IP address of the UP function to send the PFCP Association Setup Request, as specified in clause 5.8.1.
- shall send the PFCP Association Setup Request with the Node ID of the CP function;
- shall include the list of optional features the CP function supports which may affect the UP function behaviour, if any.

The CP function shall only initiate PFCP Session related signalling procedures toward a UP function after it receives the PFCP Association Setup Response with a successful cause from this UP function.

The CP function shall determine whether the UP function supports Sxa, Sxb, Sxc and/or combined Sxa/Sxb by local configuration or optionally via DNS if deployed.

6.2.6.2.2 UP Function behaviour

When receiving an PFCP Association Setup Request, the UP function:

- if the request is accepted:
 - shall store the Node ID of the CP function as the identifier of the PFCP association;
 - shall send an PFCP Association Setup Response with a successful cause, its Node ID, and information of all supported optional features in the UP function and optionally the available user plane resources, e.g. IP address(es) or F-TEID range;
- shall send an PFCP Version Not Supported Response if the PFCP header of the request indicates a PFCP protocol version that is not supported by the UP function;
- otherwise, shall send an PFCP Association Setup Response with an appropriate error cause if the request is rejected.

6.2.6.3 PFCP Association Setup Initiated by the UP Function

6.2.6.3.1 UP Function Behaviour

The UP function initiates the PFCP Association Setup procedure to request to setup an PFCP association towards a CP function. The UP function is configured with a set of CP functions to which it shall establish an PFCP association.

The UP function:

- shall retrieve an IP address of the CP function, e.g. based on local configuration in the UP function;
- shall send the PFCP Association Setup Request including the Node ID of the UP function and information of all supported optional features in the UP function and optionally the available user plane resources, e.g. IP address(es) or F-TEID range.

6.2.6.3.2 CP Function Behaviour

When receiving an PFCP Association Setup Request, the CP function:

- if the request is accepted:
 - shall store the Node ID of the UP function as the identifier of the PFCP association;
 - shall send an PFCP Association Setup Response with a successful cause, its Node ID, and information of the list of optional features the CP function supports which may affect the UP function behaviour, if any;
- shall send an PFCP Version Not Supported Response if the PFCP header of the request indicates a PFCP protocol version that is not supported by the CP function;
- otherwise, shall send an PFCP Association Setup Response with an appropriate error cause if the request is rejected.

The CP function shall only initiate PFCP Session related signalling procedures toward a UP function after it has sent the PFCP Association Setup Response with a successful cause to the UP function.

The CP function shall determine the UP function supports Sxa, Sxb, Sxc and/or combined Sxa/Sxb by local configuration or optionally via DNS if deployed.

6.2.7 PFCP Association Update Procedure

6.2.7.1 General

The PFCP Association Update procedure shall be used to modify an existing PFCP association between the CP function and the UP function. It may be initiated by the UP function or by the CP function to update the supported features or available resources of the UP function.

6.2.7.2 PFCP Association Update Procedure Initiated by the CP Function

6.2.7.2.1 CP Function Behaviour

The CP function initiates the PFCP Association Update procedure to report changes to the PFCP association to the UP function, e.g. to update the supported features.

6.2.7.2.2 UP Function Behaviour

When receiving an PFCP Association Update Request, the UP function:

- shall update the list of optional features of the CP function, when received;
- shall send an PFCP Association Update Response with an appropriate error cause if the Node ID is not known by the UP Function;

- shall return an PFCP Association Update Response with a successful cause value, if the PFCP Association Update Request is handled successfully.

6.2.7.3 PFCP Association Update Procedure Initiated by UP Function

6.2.7.3.1 UP Function Behaviour

The UP function initiates the PFCP Association Update procedure to report changes to the PFCP association to the CP function, e.g. change of optional features, change of the available user plane resources, an indication to request to release the PFCP association.

The UP function may send an PFCP Association Update Request to request the CP function to perform the release of the PFCP association, optionally providing a Graceful Release Period. After reception of the PFCP Association Update Response, the UP function shall consider that the PFCP association is still setup until receiving an PFCP Association Release Request.

6.2.7.3.2 CP Function Behaviour

When receiving an PFCP Association Update Request, the CP function:

- shall update the list of optional features of the UP function, when received;
- shall send an PFCP Association Update Response with an appropriate error cause if the Node ID is not known by the CP Function;
- shall return an PFCP Association Update Response with a successful cause value if the PFCP Association Update Request is handled successfully.

If the UP function has requested to release the PFCP association in the PFCP Association Update Request, the CP function should initiate an PFCP Association Release Request to release the PFCP association, as soon as possible if no Graceful Release Period was included in the request or before the expiry of the Graceful Release Period. The CP function should stop creating new PFCP sessions in the UP function during the Graceful Release Period. When the final usage report(s) for a PFCP Session (upon being deleted) is required, e.g. based on operator policies, the CP function should initiate a PFCP Session Deletion Procedure to collect the usage reports per PFCP Session affected by the release of PFCP Association before the Graceful Release Period is expired.

If the UP function has included User Plane IP Resource Information IE in the PFCP Association Update Request message, the CP function shall use it to overwrite the User Plane IP Resource Information previously received from the UP function.

6.2.8 PFCP Association Release Procedure

6.2.8.1 General

The PFCP Association Release procedure shall be used to terminate the PFCP association between the CP Function and the UP Function due to e.g. OAM reasons. The PFCP Association Release Request may be initiated by the CP function.

When the final usage report(s) for a PFCP Session is required, e.g. based on the operator policies, the CP function should retrieve the final usage reports for the PFCP Sessions affected by the release of PFCP Association, i.e. by initiating a PFCP Session Deletion Procedure towards the UP function for every PFCP session, before it initiates PFCP Association Release Request.

6.2.8.2 CP Function Behaviour

If the CP function initiates the PFCP Association Release procedure to release an existing PFCP association, the CP function:

- shall delete locally all the PFCP sessions related to that PFCP association when receiving the PFCP Association Release Response with the cause value success.

6.2.8.3 UP Function behaviour

When the UP function receives an PFCP Association Release Request, the UP function:

- shall delete all the PFCP sessions related to that PFCP association locally;
- shall delete the PFCP association and any related information (e.g. Node ID of the CP function);
- shall send an PFCP Association Release Response with a successful cause.

NOTE: The UP function always accepts an PFCP Association Release Request.

6.2.9 PFCP Node Report Procedure

6.2.9.1 General

The PFCP Node Report procedure shall be used by the UP function to report information to the CP function which is not related to a specific PFCP session, e.g. to report a user plane path failure affecting all the PFCP sessions towards a remote GTP-U peer.

6.2.9.2 UP Function Behaviour

The UP function shall initiate the PFCP Node Report procedure to report information to the CP function. The UP function:

- shall send the PFCP Node Report Request message, including the information to be reported.

When the UP function receives an PFCP Node Report Response with the cause success, the UP function shall consider the information successfully delivered to the CP function.

6.2.9.3 CP Function behaviour

When the CP function receives an PFCP Node Report Request message, it shall:

- process the information being reported as appropriate and send an PFCP Node Report Response with the cause "success";
- otherwise return an appropriate error cause value.

6.3 PFCP Session Related Procedures

6.3.1 General

The following clauses describe the session related procedures over the Sxa, Sxb and Sxc reference points. The behaviour of the CP function and UP function when sending and receiving session related messages is described.

6.3.2 PFCP Session Establishment Procedure

6.3.2.1 General

The PFCP Session Establishment procedure shall be used to setup an PFCP session between CP function and UP function and configure Rules in the UP function so that the UP function can handle incoming packets.

6.3.2.2 CP Function Behaviour

The CP function initiates the PFCP Session Establishment procedure to create a PFCP session for a PDN connection, or IP-CAN session or TDF session or for applying a certain IP packets treatment which is not associated with any PDN connection or TDF session.

The CP function:

- shall send the PFCP Session Establishment Request message with a new PFCP F-SEID together with Rules to be created;
- may assign a local F-TEID for the access side and/or core side and provide it in the PDI, if F-TEID allocation is performed in the CP function.

When the CP function receives an PFCP Session Establishment Response with cause success, the CP function shall continue with the procedure which triggered the PFCP Session Establishment procedure.

6.3.2.3 UP Function Behaviour

When the UP function receives an PFCP Session Establishment Request message it shall:

- store and apply the rules received in the request and send an PFCP Session Establishment Response with cause "success", if all rules in the PFCP Session Establishment Request are stored and applied;
- Otherwise, if at least one rule failed to be stored or applied, return an appropriate error cause value with the Rule ID of the Rule causing the first error, discard all the received rules and not create any PFCP session context.

6.3.3 PFCP Session Modification Procedure

6.3.3.1 General

The PFCP Session Modification procedure shall be used to modify an existing PFCP session, e.g. to configure a new rule, to modify an existing rule, to delete an existing rule.

6.3.3.2 CP Function behaviour

The CP function initiates the PFCP Session Modification procedure to modify an existing PFCP session, e.g. triggered by an modification of PDN connection, IP CAN session or TDF session.

The CP function shall:

- include a complete PDI if the PDI in the existing PDR is to be updated;
- remove locally the reference to a rule in the PDRs when the related Rule is deleted;
- provide all the new, updated or deleted Rules. The Updated Rules shall contain only the information which are changed, added and/or deleted.

The CP function shall not include multiple updates in a PFCP Modification Request message, e.g. Create PDR, Update PDR and Remove PDR, for the same rule identified by the Rule ID.

When the CP function receives an PFCP Session Modification Response with the cause "success" it shall continue with the procedure which has initiated the PFCP Session Modification procedure.

6.3.3.3 UP Function Behaviour

When the UP function receives a PFCP Session Modification Request it shall:

- send the PFCP Session Modification Response message with a rejection cause value set to "Session context not found" if the F-SEID included in the PFCP Session Modification Request message is unknown;
- reject a modification request which would relate to a rule not existing in the UP function;
- discard any updates on the PFCP session context included in the PFCP Session Modification Request message if the request is rejected and send an PFCP Session Modification Response with an appropriate error cause together with additional information e.g. indicating the first Rule ID of the Rule causing the error. In this case, the UP function shall continue with the existing PFCP session context for the PFCP session as if the PFCP Session Modification Request had not been received;

- remove all rules identified by a Rule ID to be removed and remove the Rule ID from the PDR(s) from where they are referenced;
- send the PFCP Session Modification Response with an acceptance cause value if all the requested modifications are accepted and performed successfully.

6.3.4 PFCP Session Deletion Procedure

6.3.4.1 General

The PFCP Session Deletion procedure shall be used to delete an existing PFCP session between the CP function and the UP function.

6.3.4.2 CP Function Behaviour

The CP function initiates an PFCP Session Deletion procedure towards the UP function to delete an existing PFCP session e.g. when the corresponding PDN is deleted.

The CP shall:

- send an PFCP Session Deletion Request with the F-SEID identifying the PFCP session.

When the CP function receives PFCP Session Deletion Response with cause success, the CP function shall continue with the procedure which triggers the PFCP Session Deletion procedure.

6.3.4.3 UP Function Behaviour

When the UP function receives a PFCP Session Deletion Request it shall:

- send the PFCP Session Deletion Response message with a rejection cause set to "Session context not found" if the F-SEID include in the PFCP Session Deletion Request message is unknown;
- send the PFCP Session Deletion Response message with an acceptance cause if the PFCP session and associated rules are deleted successfully, and include any pending Usage Report(s) in the message.

6.3.5 PFCP Session Report Procedure

6.3.5.1 General

The PFCP Session Report procedure shall be used by the UP function to report information related to the PFCP session to the CP function.

6.3.5.2 UP Function Behaviour

The UP function shall initiate the PFCP Session Report procedure to report information related to an PFCP session to the CP function. The UP function:

- shall send the PFCP Session Report Request message, identifying the PFCP session for which the report is sent and including the information to be reported.

When the UP function receives an PFCP Session Report Response with the cause success, the UP function shall consider the information to be successfully delivered to the CP function.

6.3.5.3 CP Function Behaviour

When the CP function receives an PFCP Session Report Request message, it shall:

- send the PFCP Session Report Response message with a rejection cause set to "Session context not found" if the F-SEID included in the PFCP Session Report Request message is unknown;

- process the information being reported as appropriate and send an PFCP Session Report Response with the cause "success";
- otherwise return an appropriate error cause value.

6.4 Reliable Delivery of PFCP Messages

Reliable delivery of PFCP messages is accomplished by retransmission of these messages as specified in this clause.

A PFCP entity shall maintain, for each triplet of local IP address, local UDP port and remote peer's IP address, a sending queue with Request messages to be sent to that peer. Each message shall be sent with a Sequence Number and be held until a corresponding Response is received or until the PFCP entity ceases retransmission of that message. The Sequence Number shall be unique for each outstanding Request message sourced from the same IP/UDP endpoint. A PFCP entity may have several outstanding Requests waiting for replies.

When sending a Request message, the sending PFCP entity shall start a timer T1. The sending entity shall consider that the Request message has been lost if a corresponding Response message has not been received before the T1 timer expires. If so, the sending entity shall retransmit the Request message, if the total number of retry attempts is less than N1 times. The setting of the T1 timer and N1 counter is implementation specific.

A retransmitted PFCP message shall have the same message content, including the same PFCP header, UDP ports, source and destination IP addresses as the originally transmitted message.

A Request and its Response message shall have the same Sequence Number value, i.e. the Sequence Number in the PFCP header of the Response message shall be copied from the respective Request message. A Request and its Response messages are matched based on the Sequence Number and the IP address and UDP port.

Not counting retransmissions, a Request message shall be answered with a single Response message. Duplicated Response messages shall be discarded by the receiver. A received Response message not matching an outstanding Request message waiting for a reply should be discarded.

The PFCP entity should inform the upper layer when detecting an unsuccessful transfer of a Request message to enable the controlling upper entity to take any appropriate measure.

7 Messages and Message Formats

7.1 Transmission Order and Bit Definitions

PFCP messages shall be transmitted in network octet order starting with octet 1 with the most significant bit sent first.

The most significant bit of an octet in a PFCP message is bit 8. If a field in a PFCP message spans over several octets, the most significant bit is bit 8 of the octet with the lowest number, unless specified otherwise.

7.2 Message Format

7.2.1 General

The format of a PFCP message is depicted in Figure 7.2.1-1.

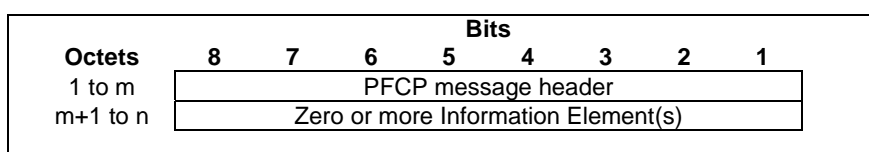

Figure 7.2.1-1: PFCP Message Format

A PFCP message shall contain the PFCP message header and may contain subsequent information element(s) dependent on the type of message.

7.2.2 Message Header

7.2.2.1 General Format

PFCP messages use a variable length header. The message header length shall be a multiple of 4 octets. Figure 7.2.2.1-1 illustrates the format of the PFCP Header.

Octets	Bits							
	8	7	6	5	4	3	2	1
1	Version			Spare	Spare	Spare	MP	S
2	Message Type							
3	Message Length (1 st Octet)							
4	Message Length (2 nd Octet)							
m to k(m+7)	If S flag is set to "1", then SEID shall be placed into octets 5-12. Otherwise, SEID field is not present at all.							
n to (n+2)	Sequence Number							
(n+3)	Spare							

Figure 7.2.2.1-1: General format of PFCP Header

Where:

- if S = 0, SEID field is not present, k = 0, m = 0 and n = 5;
- if S = 1, SEID field is present, k = 1, m = 5 and n = 13.

The usage of the PFCP header is defined in clause 7.2.2.4.

Octet 1 bits shall be encoded as follows:

- Bit 1 represents the SEID flag (T).
- Bit 2 represents the "MP" flag (see clause 7.2.2.4.1).
- Bit 3 to 5 are spare, the sender shall set them to "0" and the receiving entity shall ignore them.
- Bits 6-8 represent the Version field.

7.2.2.2 PFCP Header for Node Related Messages

The PFCP message header for the node related messages shall not contain the SEID field, but shall contain the Sequence Number field, followed by one spare octet as depicted in figure 7.2.2.2-1. The spare bits shall be set to zero by the sender and ignored by the receiver. For the Version Not Supported Response message, the Sequence Number may be set to any number and shall be ignored by the receiver.

Octets	Bits							
	8	7	6	5	4	3	2	1
1	Version			Spare	Spare	Spare	MP=0	S=0
2	Message Type							
3	Message Length (1 st Octet)							
4	Message Length (2 nd Octet)							
5	Sequence Number (1 st Octet)							
6	Sequence Number (2 nd Octet)							
7	Sequence Number (3 rd Octet)							
8	Spare							

Figure 7.2.2.2-1: PFCP Message Header for node related messages

7.2.2.3 PFCP Header for Session Related Messages

For The PFCP message header, for session related messages, shall contain the SEID and Sequence Number fields followed by one spare octet. The PFCP header is depicted in figure 7.2.2.3-1. The spare bits shall be set to zero by the sender and ignored by the receiver.

Octets	Bits							
	8	7	6	5	4	3	2	1
1	Version			Spare	Spare	Spare	MP	S=1
2	Message Type							
3	Message Length (1 st Octet)							
4	Message Length (2 nd Octet)							
5	Session Endpoint Identifier (1 st Octet)							
6	Session Endpoint Identifier (2 nd Octet)							
7	Session Endpoint Identifier (3 rd Octet)							
8	Session Endpoint Identifier (4 th Octet)							
9	Session Endpoint Identifier (5 th Octet)							
10	Session Endpoint Identifier (6 th Octet)							
11	Session Endpoint Identifier (7 th Octet)							
12	Session Endpoint Identifier (8 th Octet)							
13	Sequence Number (1 st Octet)							
14	Sequence Number (2 nd Octet)							
15	Sequence Number (3 rd Octet)							
16	Message Priority				Spare			

Figure 7.2.2.3-1: PFCP message Header for session related messages

7.2.2.4 Usage of the PFCP Header

7.2.2.4.1 General

The format of the PFCP header is specified in clause 7.2.2.

The usage of the PFCP header shall be as defined below.

The first octet of the header shall be used in the following way:

- Bit 1 represents the "S" flag, which indicates if SEID field is present in the PFCP header or not. If the "S" flag is set to "0", then the SEID field shall not be present in the PFCP header. If the "S" flag is set to "1", then the SEID field shall immediately follow the Length field, in octets 5 to 12. Apart from the node related messages, in all PFCP messages the value of the "S" flag shall be set to "1".
- Bit 2 represents the "MP" flag. If the "MP" flag is set to "1", then bits 8 to 5 of octet 16 shall indicate the message priority.
- Bit 3 is a spare bit. The sending entity shall set it to "0" and the receiving entity shall ignore it.
- Bit 4 is a spare bit. The sending entity shall set it to "0" and the receiving entity shall ignore it.
- Bit 5 is a spare bit. The sending entity shall set it to "0" and the receiving entity shall ignore it.
- Bits 6 to 8, which represent the PFCP version, shall be set to decimal 1 ("001").

The usage of the fields in octets 2 - n of the header shall be as specified below.

- Octet 2 represents the Message type field, which shall be set to the unique value for each type of control plane message. Message type values are specified in Table 7.3-1 "Message types".
- Octets 3 to 4 represent the Message Length field. This field shall indicate the length of the message in octets excluding the mandatory part of the PFCP header (the first 4 octets). The SEID (if present) and the Sequence Number shall be included in the length count. The format of the Length field of information elements is specified in clause 8.2 "Information Element Format".

- When S=1, Octets 5 to 12 represent the Session Endpoint Identifier (SEID) field. This field shall unambiguously identify a session endpoint in the receiving Packet Forward Control entity. The Session Endpoint Identifier is set by the sending entity in the PFCP header of all control plane messages to the SEID value provided by the corresponding receiving entity (CP or UP function). If a peer's SEID is not available the SEID field shall be present in a PFCP header, but its value shall be set to "0", "Conditions for sending SEID=0 in PFCP header".

NOTE: The SEID in the PFCP header of a message is set to the SEID value provided by the corresponding receiving entity regardless of whether the source IP address of the request message and the IP Destination Address provided by the receiving entity for subsequent request messages are the same or not.

- Octets 13 to 15 represent PFCP Sequence Number field.

7.2.2.4.2 Conditions for Sending SEID=0 in PFCP Header

If a peer's SEID is not available, the SEID field shall still be present in the header and its value shall be set to "0" in the following messages:

- PFCP Session Establishment Request message on Sxa/Sxb/Sxc;
- If a node receives a message for which it has no session, i.e. if SEID in the PFCP header is not known, it shall respond with "Session context not found" cause in the corresponding response message to the sender, the SEID used in the PFCP header in the response message shall be then set to "0";
- If a node receives a request message containing protocol error, e.g. Mandatory IE missing, which requires the receiver to reject the message as specified in clause 7.6, it shall reject the request message. For the response message, the node should look up the remote peer's SEID and accordingly set SEID in the PFCP header and the message cause code. As an implementation option, the node may not look up the remote peer's SEID and set the PFCP header SEID to "0" in the response message. However in this case, the cause value shall not be set to "Session not found".

7.2.3 Information Elements

7.2.3.1 General

The format of PFCP Information Elements are defined in clause 8.2.

7.2.3.2 Presence Requirements of Information Elements

IEs within PFCP messages shall be specified with one of the following presence requirement:

- **Mandatory:** this means that the IE shall be included by the sending entity, and that the receiver diagnoses a "Mandatory IE missing" error when detecting that the IE is not present. A response including a "Mandatory IE missing" cause, shall include the type of the missing IE.
- **Conditional:** this means that:
 - the IE shall be included by sending entity if the conditions specified are met;
 - the receiver shall check the conditions as specified in the corresponding message type description, based on the parameter combination in the message and/or on the state of the receiving node, to infer if a conditional IE shall be expected. Only if a receiver has sufficient information, if a conditional IE, which is necessary for the receiving entity to complete the procedure, is missing, then the receiver shall abort the procedure.
- **Conditional-Optional:** this means that:
 - the IE shall be included by a sending entity complying with the version of the specification, if the conditions specified in the relevant protocol specification are met. An entity, which is at an earlier version of the protocol and therefore is not up-to-date, cannot send this IE;
 - the receiver need not check the presence of the IE in the message. If the receiver checks the presence of the Conditional-Optional IE, then the IE's absence shall not trigger any of the error handling procedures. The handling of an absence or erroneous such IEs shall be treated as Optional IEs as specified in clause 7.6.

- Optional: this means that:
 - the IE shall be included as a service option. Therefore, the IE may be included or not in a message. The handling of an absent optional IE, or an erroneous optional IE is specified in clause 7.6.

For conditional IEs, the clause describing the PFCP message explicitly defines the conditions under which the inclusion of each IE becomes mandatory or optional for that particular message. These conditions shall be defined so that the presence of a conditional IE only becomes mandatory if it is critical for the receiving entity. The definition might reference other protocol specifications for final terms used as part of the condition.

For grouped IEs, the presence requirement of the embedded IE shall follow the rules:

- If the grouped IE is Mandatory within a given message: the presence requirements of individual embedded IEs are as stated within the Mandatory grouped IE for the given message;
- if the grouped IE is Conditional within a given message: if the embedded IE in the grouped IE is Mandatory or Conditional, this embedded IE is viewed as Conditional IE by the receiver. If the embedded IE in the grouped IE is Conditional-Optional, this embedded IE is viewed as Optional IE by the receiver. If the embedded IE in the grouped IE is Optional, this embedded IE is viewed as Optional IE by the receiver;
- if the grouped IE is Conditional-Optional within a given message: if the embedded IE in the grouped IE is Mandatory or Conditional, this embedded IE is viewed as Conditional-Optional IE by the receiver. If the embedded IE in the grouped IE is Conditional-Optional, this embedded IE is viewed as Optional IE by the receiver. If the embedded IE in the grouped IE is Optional, this embedded IE is viewed as Optional IE by the receiver;
- if the grouped IE is Optional within a given message: all embedded IEs in the grouped IE are viewed as Optional IEs by the receiver.

In all of the above cases, appropriate error handling as described in clause 7.6 shall be applied for protocol errors of the embedded IEs.

Only the Cause IE at message level shall be included in the response if the Cause contains a value that indicates that the request is not accepted, regardless of whether there are other mandatory or conditional IEs defined for a given response message. The following are exceptions:

- the Node ID and Offending IE shall be included as per the requirements specified for the corresponding response message;
- the Load Control Information, Overload Control Information and the Failed Rule ID IEs may be included in an PFCP session related message.

If the Cause IE at Grouped IE level contains a value that indicates that the Grouped IE is not handled correctly, the other IEs in this Grouped IE, other than the Cause IE, may not be included.

7.2.3.3 Grouped Information Elements

A Grouped IE is an IE which may contain other IEs.

Grouped IEs have a length value in the TLV encoding, which includes the added length of all the embedded IEs. Overall coding of a grouped IE with 4 octets long IE header is defined in clause 8.2. Each IE within a grouped IE also shall also contain 4 octets long IE header.

Grouped IEs are not marked by any flag or limited to a specific range of IE type values. The clause describing an IE in this specification shall explicitly state if it is a Grouped IE.

NOTE: Each entry into each Grouped IE creates a new scope level. Exit from the grouped IE closes the scope level. The PFCP message level is the top most scope.

If more than one grouped IEs of the same type, but for a different purpose are sent with a message, these IEs shall have different IE types.

If more than one grouped IEs of the same type and for the same purpose are sent with a message, these IEs shall have exactly the same IE type to represent a list.

7.2.3.4 Information Element Type

An IE in a PFCP message or Grouped IE is identified by its IE Type and described by a specific row in the corresponding tables in clause 7.

If several IEs with the same Type are included in a PFCP message or Grouped IE, they represent a list for the corresponding IE name.

An IE Type value uniquely identifies a specific IE.

One IE type value is specified for Vendor Specific IEs.

7.3 Message Types

The PFCP message types to be used over the Sxa, Sxb, Sxc and N4 reference points are defined in Table 7.3-1.

Table 7.3-1: Message Types

Message Type value (Decimal)	Message	Applicability			
		Sxa	Sxb	Sxc	N4
0	Reserved				
	PFCP Node related messages				
1	PFCP Heartbeat Request	X	X	X	X
2	PFCP Heartbeat Response	X	X	X	X
3	PFCP PFD Management Request	-	X	X	X
4	PFCP PFD Management Response	-	X	X	X
5	PFCP Association Setup Request	X	X	X	X
6	PFCP Association Setup Response	X	X	X	X
7	PFCP Association Update Request	X	X	X	X
8	PFCP Association Update Response	X	X	X	X
9	PFCP Association Release Request	X	X	X	X
10	PFCP Association Release Response	X	X	X	X
11	PFCP Version Not Supported Response	X	X	X	X
12	PFCP Node Report Request	X	X	X	X
13	PFCP Node Report Response	X	X	X	X
14	PFCP Session Set Deletion Request	X	X	-	
15	PFCP Session Set Deletion Response	X	X	-	
16 to 49	For future use				
	PFCP Session related messages				
50	PFCP Session Establishment Request	X	X	X	X
51	PFCP Session Establishment Response	X	X	X	X
52	PFCP Session Modification Request	X	X	X	X
53	PFCP Session Modification Response	X	X	X	X
54	PFCP Session Deletion Request	X	X	X	X
55	PFCP Session Deletion Response	X	X	X	X
56	PFCP Session Report Request	X	X	X	X
57	PFCP Session Report Response	X	X	X	X
58 to 99	For future use				
	Other messages				
100 to 255	For future use				

7.4 PFCP Node Related Messages

7.4.1 General

This clause specifies the node related messages used over the Sxa, Sxb, Sxc and N4 reference points.

7.4.2 Heartbeat Messages

7.4.2.1 Heartbeat Request

Table 7.4.2.1-1: Information Elements in Heartbeat Request

Information elements	P	Condition / Comment	IE Type
Recovery Time Stamp	M	This IE shall contain the time stamp when the PFCP entity was started see clause 19A of 3GPP TS 23.007 [24].	Recovery Time Stamp

7.4.2.2 Heartbeat Response

Table 7.4.2.2-1: Information Elements in Heartbeat Response

Information elements	P	Condition / Comment	IE Type
Recovery Time Stamp	M	This IE shall contain the time stamp when the PFCP entity was started see clause 19A of 3GPP TS 23.007 [24].	Recovery Time Stamp

7.4.3 PFCP PFD Management

7.4.3.1 PFCP PFD Management Request

Table 7.4.3.1-1: Information Elements in PFCP PFD Management Request

Information elements	P	Condition / Comment	Appl.				IE Type
			Sx a	Sx b	Sx c	N4	
Application ID's PFDs	C	This IE shall contain an Application Identifier and the associated PFDs to be provisioned in the UP function. Several IEs with the same IE type may be present to provision PFDs for multiple Application IDs. The UP function shall delete all the PFDs received and stored earlier for all the Application IDs if this IE is absent in the message.	-	X	X	X	Application ID's PFDs

Table 7.4.3.1-2: Application ID's PFDs

Octet 1 and 2		Application ID's PFDs IE Type = 58 (decimal)					
Octets 3 and 4		Length = n					
Information elements	P	Condition / Comment	Appl.				IE Type
			Sx a	Sx b	Sx c	N4	
Application ID	M	This IE shall identify the Application ID for which PFDs shall be provisioned in the UP function.	-	X	X	X	Application ID
PFD context	C	This IE shall be present if the PFD needs to be provisioned in the UP function. When present, it shall describe the PFD to be provisioned in the UP function. Several IEs with the same IE type may be present to provision multiple PFDs for this Application ID. When this IE is absent, the UP function shall delete all the PFDs received and stored earlier in the UP function for this Application ID.	-	X	X	X	PFD context

Table 7.4.3.1-3: PFD context

Octet 1 and 2		PFD context IE Type = 59 (decimal)					
Octets 3 and 4		Length = n					
Information elements	P	Condition / Comment	Appl.				IE Type
			Sx a	Sx b	Sx c	N4	
PFD Contents	M	This IE shall describe the PFD to be provisioned in the UP function. Several IEs with the same IE type may be present to provision multiple contents for this PFD. (NOTE 1)	-	X	X	X	PFD Contents
NOTE 1 The CP function shall only provision a PFD Contents including a property with multiple values if the UP function supports PFDE feature. See clauses 8.2.25 and 8.2.39.							

7.4.3.2 PFCP PFD Management Response

Table 7.4.3.2-1: Information Elements in PFCP PFD Management Response

Information elements	P	Condition / Comment	Appl.				IE Type
			Sx a	Sx b	Sx c	N4	
Cause	M	This IE shall indicate the acceptance or the rejection of the corresponding request message.	-	X	X	X	Cause
Offending IE	C	This IE shall be included if the rejection is due to an conditional or mandatory IE missing or faulty.	-	X	X	X	Offending IE

7.4.4 PFCP Association messages

7.4.4.1 PFCP Association Setup Request

Table 7.4.4.1-1: Information Elements in a PFCP Association Setup Request

Information elements	P	Condition / Comment	IE Type
Node ID	M	This IE shall contain the unique identifier of the sending Node.	Node ID
Recovery Time Stamp	M	This IE shall contain the time stamp when the CP or UP function was started, see clause 19A of 3GPP TS 23.007 [24]. (NOTE)	Recovery Time Stamp
UP Function Features	C	This IE shall be present if the UP function sends this message and the UP function supports at least one UP feature defined in this IE. When present, this IE shall indicate the features the UP function supports.	UP Function Features
CP Function Features	C	This IE shall be present if the CP function sends this message and the CP function supports at least one CP feature defined in this IE. When present, this IE shall indicate the features the CP function supports.	CP Function Features
User Plane IP Resource Information	O	This IE may be present if the UP function sends this message. When present, this IE shall contain an IPv4 and/or an IPv6 address, together with a TEID range that the CP function shall use to allocate GTP-U F-TEID in the UP function. Several IEs with the same IE type may be present to represent multiple User Plane IP Resources.	User Plane IP Resource Information
NOTE: A PFCP function that receives a PFCP Association Setup Request shall proceed with <ul style="list-style-type: none"> - establishing the PFCP association and - deleting the existing PFCP association and associated PFCP sessions, if a PFCP association was already established for the Node ID received in the request, regardless of the Recovery Timestamp received in the request. 			

7.4.4.2 PFCP Association Setup Response

Table 7.4.4.2-1: Information Elements in a PFCP Association Setup Response

Information elements	P	Condition / Comment	IE Type
Node ID	M	This IE shall contain the unique identifier of the sending Node.	Node ID
Cause	M	This IE shall indicate the acceptance or the rejection of the corresponding request message.	Cause
Recovery Time Stamp	M	This IE shall contain the time stamp when the CP or UP function was started, see clause 19A of 3GPP TS 23.007 [24]. (NOTE)	Recovery Time Stamp
UP Function Features	C	This IE shall be present if the UP function sends this message and the UP function supports at least one UP feature defined in this IE. When present, this IE shall indicate the features the UP function supports.	UP Function Features
CP Function Features	C	This IE shall be present if the CP function sends this message and the CP function supports at least one CP feature defined in this IE. When present, this IE indicates the features the CP function supports.	CP Function Features
User Plane IP Resource Information	O	This IE may be present if the UP function sends this message. When present, this IE shall contain an IPv4 and/or an IPv6 address, together with a TEID range that the CP function shall use to allocate GTP-U F-TEID in the UP function. Several IEs with the same IE type may be present to represent multiple User Plane IP Resources.	User Plane IP Resource Information
NOTE: A PFCP function shall ignore the Recovery Timestamp received in PFCP Association Setup Response message.			

7.4.4.3 PFCP Association Update Request

Table 7.4.4.3-1: Information Elements in a PFCP Association Update Request

Information elements	P	Condition / Comment	IE Type
Node ID	M	This IE shall contain the unique identifier of the sending Node.	Node ID
UP Function Features	O	If present, this IE shall indicate the supported Features when the sending node is the UP function.	UP Function Features
CP Function Features	O	If present, this IE shall indicate the supported Features when the sending node is the CP function.	CP Function Features
PFCP Association Release Request	C	This IE shall be present if the UP function requests the CP function to release the PFCP association.	PFCP Association Release Request
Graceful Release Period	C	This IE shall be present if the UP function requests a graceful release of the PFCP association.	Graceful Release Period
User Plane IP Resource Information	O	This IE may be present if the UP function sends this message. When present, this IE shall contain an IPv4 and/or an IPv6 address, together with a TEID range that the CP function shall use to allocate GTP-U F-TEID in the UP function. Several IEs with the same IE type may be present to represent multiple User Plane IP Resources.	User Plane IP Resource Information

7.4.4.4 PFCP Association Update Response

Table 7.4.4.4-1: Information Elements in a PFCP Association Update Response

Information elements	P	Condition / Comment	IE-Type
Node ID	M	This IE shall contain the unique identifier of the sending Node.	Node ID
Cause	M	This IE shall indicate the acceptance or the rejection of the corresponding request message.	Cause
UP Function Features	O	If present, this IE shall indicate the supported Features when the sending node is the UP function.	UP Function Features
CP Function Features	O	If present, this IE shall indicate the supported Features when the sending node is the CP function.	CP Function Features

7.4.4.5 PFCP Association Release Request

Table 7.4.4.5-1: Information Elements in a PFCP Association Release Request

Information elements	P	Condition / Comment	IE Type
Node ID	M	This IE shall contain the unique identifier of the sending Node.	Node ID

7.4.4.6 PFCP Association Release Response

Table 7.4.4.6-1: Information Elements in a PFCP Association Release Response

Information elements	P	Condition / Comment	IE type
Node ID	M	This IE shall contain the unique identifier of the sending Node.	Node ID
Cause	M	This IE shall indicate the acceptance or the rejection of the corresponding request message.	Cause

7.4.4.7 PFCP Version Not Supported Response

This message shall only contain the PFCP header. The PFCP protocol version in the PFCP header shall indicate the highest PFCP Version that the sending entity supports.

NOTE: The PFCP Version Not Supported Response message can be received by a PFCP entity when sending the very first message to a PFCP peer only supporting earlier version(s) of the protocol.

7.4.5 PFCP Node Report Procedure

7.4.5.1 PFCP Node Report Request

7.4.5.1.1 General

The PFCP Node Report Request shall be sent over the Sxa, Sxb, Sxc and N4 interface by the UP function to report information to the CP function that is not specific to an PFCP session.

Table 7.4.5.1.1-1: Information Elements in PFCP Node Report Request

Information elements	P	Condition / Comment	Appl.				IE Type
			Sx a	Sx b	Sx c	N4	
Node ID	M	This IE shall contain the unique identifier of the sending Node.	X	X	X	X	Node ID
Node Report Type	M	This IE shall indicate the type of the report.	X	X	X	X	Node Report Type
User Plane Path Failure Report	C	This IE shall be present if the Node Report Type indicates a User Plane Path Failure Report.	X	X	-	X	User Plane Path Failure Report

7.4.5.1.2 User Plane Path Failure Report IE within PFCP Node Report Request

Table 7.4.5.1.2-1: User Plane Path Failure Report IE within PFCP Node Report Request

Octet 1 and 2		User Plane Path Failure Report IE Type = 102 (decimal)					
Octets 3 and 4		Length = n					
Information elements	P	Condition / Comment	Appl.				IE Type
			Sx a	Sx b	Sx c	N4	
Remote GTP-U Peer	M	This IE shall include the IP address of the remote GTP-U peer towards which a user plane path failure has been detected. More than one IE with this type may be included to represent multiple remote GTP-U peers towards which a user plane path failure has been detected.	X	X	-	X	Remote GTP-U Peer

7.4.5.2 PFCP Node Report Response

7.4.5.2.1 General

The PFCP Node Report Response shall be sent over the Sxa, Sxb; Sxc and N4 interface by the CP function to the UP function as a reply to the PFCP Node Report Request.

Table 7.4.5.2.1-1: Information Elements in PFCP Node Report Response

Information elements	P	Condition / Comment	Appl.				IE Type
			Sx a	Sx b	Sx c	N4	
Node ID	M	This IE shall contain the unique identifier of the sending Node.	X	X	X	X	Node ID
Cause	M	This IE shall indicate the acceptance or the rejection of the corresponding request message.	X	X	X	X	Cause
Offending IE	C	This IE shall be included if the rejection cause is due to a conditional or mandatory IE missing or faulty.	X	X	X	X	Offending IE

7.4.6 PFCP Session Set Deletion

7.4.6.1 PFCP Session Set Deletion Request

The PFCP Session Set Deletion Request shall be sent over the Sxa and Sxb interface by the CP function to request the UP function to delete the PFCP sessions affected by a partial failure.

The PFCP Session Set Deletion Request shall be also sent over the Sxa and Sxb interface by the UP function to request the CP function to delete the PFCP sessions affected by a partial failure.

Table 7.4.6.1-1: Information Elements in a PFCP Session Set Deletion Request

Information elements	P	Condition / Comment	Appl.				IE Type
			Sx a	Sx b	Sx c	N4	
Node ID	M	This IE shall contain the node identity of the originating node of the message.	X	X	-		Node ID
SGW-C FQ-CSID	C	This IE shall be included according to the requirements in clause 23 of 3GPP TS 23.007 [24].	X	X	-		FQ-CSID
PGW-C FQ-CSID	C	This IE shall be included according to the requirements in clause 23 of 3GPP TS 23.007 [24].	X	X	-		FQ-CSID
SGW-U FQ-CSID	C	This IE shall be included according to the requirements in clause 23 of 3GPP TS 23.007 [24].	X	-	-		FQ-CSID
PGW-U FQ-CSID	C	This IE shall be included according to the requirements in clause 23 of 3GPP TS 23.007 [24].	-	X	-		FQ-CSID
TWAN FQ-CSID	C	This IE shall be included according to the requirements in clause 23 of 3GPP TS 23.007 [24].	-	X	-		FQ-CSID
ePDG FQ-CSID	C	This IE shall be included according to the requirements in clause 23 of 3GPP TS 23.007 [24].	-	X	-		FQ-CSID
MME FQ-CSID	C	This IE shall be included according to the requirements in clause 23 of 3GPP TS 23.007 [24].	X	X	-		FQ-CSID

7.4.6.2 PFCP Session Set Deletion Response

The PFCP Session Set Deletion Response shall be sent over the Sxa and Sxb interface by the UP function or the CP function as a reply to the PFCP Session Set Deletion Request.

Table 7.4.6.2-1: Information Elements in a PFCP Session Set Deletion Response

Information elements	P	Condition / Comment	Appl.				IE Type
			Sx a	Sx b	Sx c	N4	

Node ID	M	This IE shall contain the unique identifier of the sending node.	X	X	-		Node ID
Cause	M	This IE shall indicate the acceptance or the rejection of the corresponding request message.	X	X	-		Cause
Offending IE	C	This IE shall be included if the rejection is due to an conditional or mandatory IE missing or faulty.	X	X	-		Offending IE

7.5 PFCP Session Related Messages

7.5.1 General

This clause specifies the session related messages used over the Sxa, Sxb and Sxc reference points.

7.5.2 PFCP Session Establishment Request

7.5.2.1 General

The PFCP Session Establishment Request shall be sent over the Sxa, Sxb, Sxc and N4 interface by the CP function to establish a new PFCP session context in the UP function.

Table 7.5.2.1-1: Information Elements in an PFCP Session Establishment Request

Information elements	P	Condition / Comment	Appl.				IE Type
			Sx a	Sx b	Sx c	N4	

Node ID	M	This IE shall contain the unique identifier of the sending Node.	X	X	X	X	Node ID
CP F-SEID	M	This IE shall contain the unique identifier allocated by the CP function identifying the session.	X	X	X	X	F-SEID
Create PDR	M	This IE shall be present for at least one PDR to be associated to the PFCP session. Several IEs with the same IE type may be present to represent multiple PDRs. See Table 7.5.2.2-1.	X	X	X	X	Create PDR
Create FAR	M	This IE shall be present for at least one FAR to be associated to the PFCP session. Several IEs with the same IE type may be present to represent multiple FARs. See Table 7.5.2.3-1.	X	X	X	X	Create FAR
Create URR	C	This IE shall be present if a measurement action shall be applied to packets matching one or more PDR(s) of this PFCP session. Several IEs within the same IE type may be present to represent multiple URRs. See Table 7.5.2.4-1.	X	X	X	X	Create URR
Create QER	C	This IE shall be present if a QoS enforcement or QoS marking action shall be applied to packets matching one or more PDR(s) of this PFCP session. Several IEs within the same IE type may be present to represent multiple QERs. See Table 7.5.2.5-1.	-	X	X	X	Create QER
Create BAR	O	When present, this IE shall contain the buffering instructions to be applied by the UP function to any FAR of this PFCP session set with the Apply Action requesting the packets to be buffered and with a BAR ID IE referring to this BAR. See table 7.5.2.6-1.	X	-	-	X	Create BAR
Create Traffic Endpoint	C	This IE may be present if the UP function has indicated support of PDI optimization. Several IEs within the same IE type may be present to represent multiple Traffic Endpoints. See Table 7.5.2.7-1.	X	X	X	X	Create Traffic Endpoint
PDN Type	C	This IE shall be present if the PFCP session is setup for an individual PDN connection or PDU session (see clause 5.2.1). When present, this IE shall indicate whether this is an IP or non-IP PDN connection/PDU session or, for 5GC, an Ethernet PDU session.	X	X	-	X	PDN Type
SGW-C FQ-CSID	C	This IE shall be included according to the requirements in clause 23 of 3GPP TS 23.007 [24].	X	X	-		FQ-CSID
MME FQ-CSID	C	This IE shall be included when received on the S11 interface or on S5/S8 interface according to the requirements in clause 23 of 3GPP TS 23.007 [24].	X	X	-	-	FQ-CSID
PGW-C FQ-CSID	C	This IE shall be included according to the requirements in clause 23 of 3GPP TS 23.007 [24].	X	X	-	-	FQ-CSID
ePDG FQ-CSID	C	This IE shall be included according to the requirements in clause 23 of 3GPP TS 23.007 [24].	-	X	-	-	FQ-CSID
TWAN FQ-CSID	C	This IE shall be included according to the requirements in clause 23 of 3GPP TS 23.007 [24].	-	X	-	-	FQ-CSID
User Plane Inactivity Timer	O	This IE may be present to request the UP function to send a User Plane Inactivity Report when no user plane packets are received for this PFCP session for a duration exceeding the User Plane Inactivity Timer. When present, it shall contain the duration of the inactivity period after which a User Plane Inactivity Report shall be generated.	-	X	X	X	User Plane Inactivity Timer
User ID	O	This IE may be present, based on operator policy. It shall only be sent if the UP function is in a trusted environment. See NOTE.	X	X	X	X	User ID
Trace Information	O	When present, this IE shall contain the trace instructions to be applied by the UP function for this PFCP session.	X	X	X	X	Trace Information

APN/DNN	O	This IE may be present, if related functionalities in the UP function require the APN/DNN information. See NOTE 2.	X	X	-	X	APN/DNN
NOTE 1: This can be used for troubleshooting problems in the UP function affecting a subscriber.							
NOTE 2: The CP function may provide additional information (e.g. APN/DNN) to the UP function, e.g. used by the forwarding rules pre-defined in UP function (some forwarding rules are APN specific), used by the UP function for performance measurement, etc.							

7.5.2.2 Create PDR IE within PFCP Session Establishment Request

The Create PDR grouped IE shall be encoded as shown in Figure 7.5.2.2-1.

Table 7.5.2.2-1: Create PDR IE within PFCP Session Establishment Request

Octet 1 and 2		Create PDR IE Type = 1(decimal)					
Octets 3 and 4		Length = n					
Information elements	P	Condition / Comment	Appl.				IE Type
			Sx a	Sx b	Sx c	N4	
PDR ID	M	This IE shall uniquely identify the PDR among all the PDRs configured for that PFCP session.	X	X	X	X	PDR ID
Precedence	M	This IE shall indicate the PDR's precedence to be applied by the UP function among all PDRs of the PFCP session, when looking for a PDR matching an incoming packet.	-	X	X	X	Precedence
PDI	M	This IE shall contain the PDI against which incoming packets will be matched. See Table 7.5.2.2-2.	X	X	X	X	PDI
Outer Header Removal	C	This IE shall be present if the UP function is required to remove one or more outer header(s) from the packets matching this PDR.	X	X	-	X	Outer Header Removal
FAR ID	C	This IE shall be present if the Activate Predefined Rules IE is not included or if it is included but it does not result in activating a predefined FAR. When present this IE shall contain the FAR ID to be associated to the PDR.	X	X	X	X	FAR ID
URR ID	C	This IE shall be present if a measurement action shall be applied to packets matching this PDR. When present, this IE shall contain the URR IDs to be associated to the PDR. Several IEs within the same IE type may be present to represent a list of URRs to be associated to the PDR.	X	X	X	X	URR ID
QER ID	C	This IE shall be present if a QoS enforcement or QoS marking action shall be applied to packets matching this PDR. When present, this IE shall contain the QER IDs to be associated to the PDR. Several IEs within the same IE type may be present to represent a list of QERs to be associated to the PDR.	-	X	X	X	QER ID
Activate Predefined Rules	C	This IE shall be present if Predefined Rule(s) shall be activated for this PDR. When present this IE shall contain one Predefined Rules name. Several IEs with the same IE type may be present to represent multiple "Activate Predefined Rules" names.	-	X	X	X	Activate Predefined Rules

Table 7.5.2.2-2: PDI IE within PFCP Session Establishment Request

Octet 1 and 2		PDI IE Type = 2 (decimal)					
Octets 3 and 4		Length = n					
Information elements	P	Condition / Comment	Appl.				IE Type
			Sx a	Sx b	Sx c	N4	

Source Interface	M	This IE shall identify the source interface of the incoming packet.	X	X	X	X	Source Interface
Local F-TEID	O	This IE shall not be present if Traffic Endpoint ID is present. If present, this IE shall identify the local F-TEID to match for an incoming packet. The CP function shall set the CHOOSE (CH) bit to 1 if the UP function supports the allocation of F-TEID and the CP function requests the UP function to assign a local F-TEID to the PDR.	X	X	-	X	F-TEID
Network Instance	O	This IE shall not be present if Traffic Endpoint ID is present. If present, this IE shall identify the Network instance to match for the incoming packet. See NOTE 1, NOTE2.	X	X	X	X	Network Instance
UE IP address	O	This IE shall not be present if Traffic Endpoint ID is present. If present, this IE shall identify the source or destination IP address to match for the incoming packet. (NOTE 5)	-	X	X	X	UE IP address
Traffic Endpoint ID	C	This IE may be present if the UP function has indicated the support of PDI optimization. If present, this IE shall uniquely identify the Traffic Endpoint for that PFCP session.	X	X	X	X	Traffic Endpoint ID
SDF Filter	O	If present, this IE shall identify the SDF filter to match for the incoming packet. Several IEs with the same IE type may be present to provision a list of SDF Filters. The full set of applicable SDF filters, if any, shall be provided during the creation or the modification of the PDI. See NOTE 3.	-	X	X	X	SDF Filter
Application ID	O	If present, this IE shall identify the Application ID to match for the incoming packet.	-	X	X	X	Application ID
Ethernet PDU Session Information	O	This IE may be present to identify all the (DL) Ethernet packets matching an Ethernet PDU session (see clause 5.13.1).	-	-	-	X	Ethernet PDU Session Information
Ethernet Packet Filter	O	If present, this IE shall identify the Ethernet PDU to match for the incoming packet. Several IEs with the same IE type may be present to represent a list of Ethernet Packet Filters. The full set of applicable Ethernet Packet filters, if any, shall be provided during the creation or the modification of the PDI.	-	-	-	X	Ethernet Packet Filter
QFI	O	If present, this IE shall identify the QoS Flow Identifier to match for the incoming packet. Several IEs with the same IE type may be present to provision a list of QFIs. When present, the full set of applicable QFIs shall be provided during the creation or the modification of the PDI.	-	-	-	X	QFI
Framed-Route	O	This IE may be present for a DL PDR if the UPF indicated support of Framed Routing (see clause 8.2.25). If present, this IE shall describe a framed route. Several IEs with the same IE type may be present to provision a list of framed routes. (NOTE 5)	-	X	-	X	Framed-Route
Framed-Routing	O	This IE may be present for a DL PDR if the UPF indicated support of Framed Routing (see clause 8.2.25). If present, this IE shall describe a framed route.	-	X	-	X	Framed-Routing
Framed-IPv6-Route	O	This IE may be present for a DL PDR if the UPF indicated support of Framed Routing (see clause 8.2.25). If present, this IE shall describe a framed IPv6 route. Several IEs with the same IE type may be present to provision a list of framed IPv6 routes. (NOTE 5)	-	X	-	X	Framed-IPv6-Route
Source Interface Type	O	This IE may be present to indicate the 3GPP interface type of the source interface, if required by functionalities in the UP Function, e.g. for performance measurements.	X	X	-	X	3GPP Interface Type

NOTE 1: The Network Instance parameter is needed e.g. in the following cases:

- PGW/TDF UP function supports multiple PDNs with overlapping IP addresses;
- SGW UP function is connected to PGWs in different IP domains (S5/S8);
- PGW UP function is connected to SGWs in different IP domains (S5/S8);
- SGW UP function is connected to eNodeBs in different IP domains;
- UPF is connected to 5G-ANs in different IP domains.

NOTE 2: When a Local F-TEID is provisioned in the PDI, the Network Instance shall relate to the IP address of the F-TEID. Otherwise, the Network Instance shall relate to the UE IP address if provisioned or the destination IP address in the SDF filter if provisioned

NOTE 3: SDF Filter IE(s) shall not be present if Ethernet Packet Filter IE(s) is present.

NOTE 4: When several SDF filter IEs are provisioned, the UP function shall consider that the packets are matched if matching any SDF filter. The same principle shall apply for Ethernet Packet Filters and QFIs.

NOTE 5: If both the UE IP Address and the Framed-Route (or Framed-IPv6-Route) are present, the packets which are considered being matching the PDR shall match at least one of them.

Table 7.5.2.2-3: Ethernet Packet Filter IE within PFCP Session Establishment Request

Octet 1 and 2		Ethernet Packet Filter IE Type = 132 (decimal)					
Octets 3 and 4		Length = n					
Information elements	P	Condition / Comment	Appl.				IE Type
			Sx a	Sx b	Sx c	N4	
Ethernet Filter ID	C	This shall be present if Bidirectional Ethernet filter is required. This IE shall uniquely identify an Ethernet Filter among all the Ethernet Filters provisioned for a given PFCP session.	-	-	-	X	Ethernet Filter ID
Ethernet Filter Properties	C	This IE shall be present when provisioning a bidirectional Ethernet Filter the first time (see clause 5.x.4).	-	-	-	X	Ethernet Filter Properties
MAC address	O	If present, this IE shall identify the MAC address. This IE may be present up to 16 times.	-	-	-	X	MAC address
Ethertype	O	If present, this IE shall identify the Ethertype.	-	-	-	X	Ethertype
C-TAG	O	If present, this IE shall identify the Customer-VLAN tag.	-	-	-	X	C-TAG
S-TAG	O	If present, this IE shall identify the Service-VLAN tag.	-	-	-	X	S-TAG
SDF Filter	O	If packet filtering is required, for Ethernet frames with Ethertype indicating IPv4 or IPv6 payload, this IE shall describe the IP Packet Filter Set. Several IEs with the same IE type may be present to represent a list of SDF filters.	-	-	-	X	SDF Filter

7.5.2.3 Create FAR IE within PFCP Session Establishment Request

The Create FAR grouped IE shall be encoded as shown in Figure 7.5.2.3-1.

Table 7.5.2.3-1: Create FAR IE within PFCP Session Establishment Request

Octet 1 and 2		Create FAR IE Type = 3 (decimal)					
Octets 3 and 4		Length = n					
Information elements	P	Condition / Comment	Appl.				IE Type
			Sx a	Sx b	Sx c	N4	

FAR ID	M	This IE shall uniquely identify the FAR among all the FARs configured for that PFCP session.	X	X	X	X	FAR ID
Apply Action	M	This IE shall indicate the action to apply to the packets, See clauses 5.2.1 and 5.2.3.	X	X	X	X	Apply Action
Forwarding Parameters	C	This IE shall be present when the Apply Action requests the packets to be forwarded. It may be present otherwise. When present, this IE shall contain the forwarding instructions to be applied by the UP function when the Apply Action requests the packets to be forwarded. See table 7.5.2.3-2.	X	X	X	X	Forwarding Parameters
Duplicating Parameters	C	This IE shall be present when the Apply Action requests the packets to be duplicated. It may be present otherwise. When present, this IE shall contain the forwarding instructions to be applied by the UP function for the traffic to be duplicated, when the Apply Action requests the packets to be duplicated. Several IEs with the same IE type may be present to represent to duplicate the packets to different destinations. See NOTE 1. See table 7.5.2.3-3.	X	X	-	-	Duplicating Parameters
BAR ID	O	When present, this IE shall contain the BAR ID of the BAR defining the buffering instructions to be applied by the UP function when the Apply Action requests the packets to be buffered.	X	-	-	X	BAR ID
NOTE 1: The same user plane packets may be required, according to operator's policy and configuration, to be duplicated to different SX3LIFs.							

Table 7.5.2.3-2: Forwarding Parameters IE in FAR

Octet 1 and 2	Forwarding Parameters IE Type = 4 (decimal)						
Octets 3 and 4	Length = n						
Information elements	P	Condition / Comment	Appl.				IE Type
			Sx a	Sx b	Sx c	N4	

Destination Interface	M	This IE shall identify the destination interface of the outgoing packet.	X	X	X	X	Destination Interface
Network Instance	O	When present, this IE shall identify the Network instance towards which to send the outgoing packet. See NOTE 1.	X	X	X	X	Network Instance
Redirect Information	C	This IE shall be present if the UP function is required to enforce traffic redirection towards a redirect destination provided by the CP function.	-	X	X	X	Redirect Information
Outer Header Creation	C	This IE shall be present if the UP function is required to add one or more outer header(s) to the outgoing packet. If present, it shall contain the F-TEID of the remote GTP-U peer when adding a GTP-U/UDP/IP header, or the Destination IP address and/or Port Number when adding a UDP/IP header or an IP header or the C-TAG/S-TAG (for 5GC). See NOTE 2.	X	X	-	X	Outer Header Creation
Transport Level Marking	C	This IE shall be present if the UP function is required to mark the IP header with the DSCP marking as defined by IETF RFC 2474 [22]. When present for EPC, it shall contain the value of the DSCP in the TOS/Traffic Class field set based on the QCI, and optionally the ARP priority level, of the associated EPS bearer, as described in clause 5.10 of 3GPP TS 23.214 [2]. When present for 5GC, it shall contain the value of the DSCP in the TOS/Traffic Class field set based on the 5QI, the Priority Level (if explicitly signalled), and optionally the ARP priority level, of the associated QoS flow, as described in clause 5.8.2.7 of 3GPP TS 23.501 [28].	X	X	-	X	Transport Level Marking
Forwarding Policy	C	This IE shall be present if a specific forwarding policy is required to be applied to the packets. It shall be present if the Destination Interface IE is set to SGi-LAN / N6-LAN. It may be present if the Destination Interface is set to Core, Access, or CP-Function. See NOTE 2. When present, it shall contain an Identifier of the Forwarding Policy locally configured in the UP function.	-	X	X	X	Forwarding Policy
Header Enrichment	O	This IE may be present if the UP function indicated support of Header Enrichment of UL traffic. When present, it shall contain information for header enrichment.	-	X	X	X	Header Enrichment
Linked Traffic Endpoint ID	C	This IE may be present, if it is available and the UP function indicated support of the PDI optimisation feature, (see clause 8.2.25). When present, it shall identify the Traffic Endpoint ID allocated for this PFCP session to receive the traffic in the reverse direction (see clause 5.2.3.1).	X	X	-	X	Traffic Endpoint ID
Proxying	C	This IE shall be present if proxying is to be performed by the UP function. When present, this IE shall contain the information that the UPF shall respond to Address Resolution Protocol and / or IPv6 Neighbour Solicitation based on the local cache information for the Ethernet PDUs.	-	-	-	X	Proxying
Destination Interface Type	O	This IE may be present to indicate the 3GPP interface type of the destination interface, if required by functionalities in the UP Function, e.g. for performance measurements.	X	X	-	X	3GPP Interface Type

NOTE 1: The Network Instance parameter is needed e.g. in the following cases:

- PGW/TDF UP function supports multiple PDNs with overlapping IP addresses;
- SGW UP function is connected to PGWs in different IP domains (S5/S8);
- PGW UP function is connected to SGWs in different IP domains (S5/S8);
- SGW UP function is connected to eNodeBs in different IP domains;
- UPF is connected to 5G-ANs in different IP domains.

NOTE 2: If the Outer Header Creation and Forwarding Policy are present, the UP function shall put the user plane packets in the user plane tunnel by applying Outer Header Creation, after enforcing the required Forwarding Policy.

Table 7.5.2.3-3: Duplicating Parameters IE in FAR

Octet 1 and 2	Duplicating Parameters IE Type = 5 (decimal)						
Octets 3 and 4	Length = n						
Information elements	P	Condition / Comment	Appl.				IE Type
			Sx a	Sx b	Sx c	N4	
Destination Interface	M	This IE shall identify the destination interface of the outgoing packet.	X	X	-	-	Destination Interface
Outer Header Creation	C	This IE shall be present if the UP function is required to add one or more outer header(s) to the outgoing packet. If present, it shall contain the F-TEID of the remote GTP-U peer. See NOTE 1.	X	X	-	-	Outer Header Creation
Transport Level marking	C	This IE shall be present if the UP function is required to mark the IP header with the DSCP marking as defined by IETF RFC 2474 [22]. When present, it shall contain the value of the DSCP in the TOS/Traffic Class field.	X	X	-	-	Transport Level Marking
Forwarding Policy	C	This IE shall be present if a specific forwarding policy is required to be applied to the packets. When present, it shall contain an Identifier of the Forwarding Policy locally configured in the UP function.	X	X	-	-	Forwarding Policy
NOTE 1: If the Outer Header Creation and Forwarding Policy are present, the UP function shall put the user plane packets in the user plane tunnel by applying Outer Header Creation, after enforcing the required Forwarding Policy.							

7.5.2.4 Create URR IE within PFCP Session Establishment Request

The Create URR grouped IE shall be encoded as shown in Figure 7.5.2.4-1.

Table 7.5.2.4-1: Create URR IE within PFCP Session Establishment Request

Octet 1 and 2	Create URR IE Type = 6 (decimal)						
Octets 3 and 4	Length = n						
Information elements	P	Condition / Comment	Appl.				IE Type
			Sx a	Sx b	Sx c	N4	

URR ID	M	This IE shall uniquely identify the URR among all the URRs configured for this PFCP session.	X	X	X	X	URR ID
Measurement Method	M	This IE shall indicate the method for measuring the network resources usage, i.e. whether the data volume, duration (i.e. time), combined volume/duration, or event shall be measured.	X	X	X	X	Measurement Method
Reporting Triggers	M	This IE shall indicate the trigger(s) for reporting network resources usage to the CP function, e.g. periodic reporting or reporting upon reaching a threshold, or envelope closure.	X	X	X	X	Reporting Triggers
Measurement Period	C	This IE shall be present if periodic reporting is required. When present, it shall indicate the period for generating and reporting usage reports.	X	X	X	X	Measurement Period
Volume Threshold	C	This IE shall be present if volume-based measurement is used and reporting is required upon reaching a volume threshold. When present, it shall indicate the traffic volume value after which the UP function shall report network resources usage to the CP function for this URR.	X	X	X	X	Volume Threshold
Volume Quota	C	This IE shall be present if volume-based measurement is used and the CP function needs to provision a Volume Quota in the UP function (see clause 5.2.2.2) When present, it shall indicate the Volume Quota value.	-	X	X	X	Volume Quota
Event Threshold	C	This IE shall be present if event-based measurement is used and reporting is required upon reaching an event threshold. When present, it shall indicate the number of events after which the UP function shall report to the CP function for this URR.	-	X	X	X	Event Threshold
Event Quota	C	This IE shall be present if event-based measurement is used and the CP function needs to provision an Event Quota in the UP function (see clause 5.2.2.2) When present, it shall indicate the Event Quota value.	-	X	X	X	Event Quota
Time Threshold	C	This IE shall be present if time-based measurement is used and reporting is required upon reaching a time threshold. When present, it shall indicate the time usage after which the UP function shall report network resources usage to the CP function for this URR.	X	X	X	X	Time Threshold
Time Quota	C	This IE shall be present if time-based measurement is used and the CP function needs to provision a Time Quota in the UP function (see clause 5.2.2.2) When present, it shall indicate the Time Quota value	-	X	X	X	Time Quota
Quota Holding Time	C	This IE shall be present, for a time, volume or event-based measurement, if reporting is required and packets are no longer permitted to pass on when no packets are received during a given inactivity period. When present, it shall contain the duration of the inactivity period.	-	X	X	X	Quota Holding Time
Dropped DL Traffic Threshold	C	This IE shall be present if reporting is required when the DL traffic being dropped exceeds a threshold. When present, it shall contain the threshold of the DL traffic being dropped.	X	-	-	X	Dropped DL Traffic Threshold
Monitoring Time	O	When present, this IE shall contain the time at which the UP function shall re-apply the volume or time threshold.	X	X	X	X	Monitoring Time
Subsequent Volume Threshold	O	This IE may be present if the Monitoring Time IE is present and volume-based measurement is used. When present, it shall indicate the traffic volume value after which the UP function shall report network resources usage to the CP function for this URR for the period after the Monitoring Time.	X	X	X	X	Subsequent Volume Threshold
Subsequent Time Threshold	O	This IE may be present if the Monitoring Time IE is present and time-based measurement is used. When present, it shall indicate the time usage after which the UP function shall report network resources usage to the CP function for this URR for the period after the Monitoring Time.	X	X	X	X	Subsequent Time Threshold

Subsequent Volume Quota	O	This IE may be present if Monitoring Time IE is present and volume-based measurement is used (see clause 5.2.2.2). When present, it shall indicate the Volume Quota value which the UP function shall use for this URR for the period after the Monitoring Time.	-	X	X	X	Subsequent Volume Quota
Subsequent Time Quota	O	This IE may be present if Monitoring Time IE is present and time-based measurement is used (see clause 5.2.2.2). When present, it shall indicate the Time Quota value which the UP function shall use for this URR for the period after the Monitoring Time.	-	X	X	X	Subsequent Time Quota
Subsequent Event Threshold	O	This IE may be present if the Monitoring Time IE is present and event-based measurement is used. When present, it shall indicate the number of events after which the UP function shall report to the CP function for this URR for the period after the Monitoring Time.	-	X	X	X	Subsequent Event Threshold
Subsequent Event Quota	O	This IE may be present if Monitoring Time IE is present and event-based measurement is used (see clause 5.2.2.2). When present, it shall indicate the Event Quota value which the UP function shall use for this URR for the period after the Monitoring Time.	-	X	X	X	Subsequent Event Quota
Inactivity Detection Time	C	This IE shall be present if time-based measurement is used and the time measurement need to be suspended when no packets are received during a given inactivity period. When present, it shall contain the duration of the inactivity period.	-	X	X	X	Inactivity Detection Time
Linked URR ID	C	This IE shall be present if linked usage reporting is required. When present, this IE shall contain the linked URR ID which is related with this URR (see clause 5.2.2.4). Several IEs with the same IE type may be present to represent multiple linked URRs which are related with this URR.	-	X	X	X	Linked URR ID
Measurement Information	C	This IE shall be included if any of the following flag is set to "1". Applicable flags are: - Measurement Before QoS Enforcement Flag: this flag shall be set to "1" if the traffic usage before any QoS Enforcement is requested to be measured. - Inactive Measurement Flag: this flag shall be set to "1" if the measurement shall be paused (inactive). The measurement shall be performed (active) if the bit is set to "0" or if the Measurement Information IE is not present in the Create URR IE. - Reduced Application Detection Information Flag: this flag may be set to "1", if the Reporting Triggers request to report the start or stop of application, to request the UP function to only report the Application ID in the Application Detection Information, e.g. for envelope reporting. - Immediate Start Time Metering Flag: this flag may be set to "1" if time-based measurement is used and the UP function is requested to start the time metering immediately at receiving the flag.	-	X	X	X	Measurement Information
Time Quota Mechanism	C	This IE shall be present if time-based measurement based on CTP or DTP is used.	-	X	-	-	Time Quota Mechanism
Aggregated URRs	C	This IE shall be included if the URR is used to support a Credit Pool. Several IEs with the same IE type may be present to provide multiple aggregated URRs.	-	X	-	-	Aggregated URRs

FAR ID for Quota Action	C	This IE may be present if the Volume Quota IE and/or the Time Quota IE and/or Event Quota IE is provisioned in the URR and the UP Function indicated support of the Quota Action feature. When present, it shall contain the identifier of the substitute FAR the UP function shall apply, for the traffic associated to this URR, when exhausting any of these quotas. See NOTE 1.	-	X	X	X	FAR ID
Ethernet Inactivity Timer	C	This IE shall be present if Ethernet traffic reporting is used and the SMF requests the UP function to also report inactive UE MAC addresses. When present, it shall contain the duration of the Ethernet inactivity period.	-	-	-	X	Ethernet Inactivity Timer
Additional Monitoring Time	O	When present, this IE shall contain the time at which the UP function shall re-apply the volume or time or event threshold/quota provisioned in the IE. Several IEs with the same IE type may be present to provide multiple Monitoring Times.	X	X	X	X	Additional Monitoring Time

NOTE 1: The substitute FAR used when exhausting a Volume Quota or Time Quota may be set to drop the packets or redirect the traffic towards a redirect destination as specified in clause 5.4.7.

Table 7.5.2.4-2: Aggregated URRs

Octet 1 and 2	Aggregated URRs = 118 (decimal)						
Octets 3 and 4	Length = n						
Information elements	P	Condition / Comment	Appl.				IE Type
			Sx a	Sx b	Sx c	N4	
Aggregated URR ID	M	This IE shall be present for the aggregated URR ID of the URR sharing the credit pool.	-	X	-	-	Aggregated URR ID
Multiplier	M	This IE shall be included to measure the abstract service units the traffic of the corresponding aggregated URR consumes from the credit pool.	-	X	-	-	Multiplier

Table 7.5.2.4-3: Additional Monitoring Time

Octet 1 and 2	Additional Monitoring Time = 147 (decimal)						
Octets 3 and 4	Length = n						
Information elements	P	Condition / Comment	Appl.				IE Type
			Sx a	Sx b	Sx c	N4	

Monitoring Time	M	This IE shall be present and contain the time at which the UP function shall re-apply the volume or time threshold/quota.	X	X	X	X	Monitoring Time
Subsequent Volume Threshold	O	This IE may be present if the Monitoring Time IE is present and volume-based measurement is used. When present, it shall indicate the traffic volume value after which the UP function shall report network resources usage to the CP function for this URR for the period after the Monitoring Time.	X	X	X	X	Subsequent Volume Threshold
Subsequent Time Threshold	O	This IE may be present if the Monitoring Time IE is present and time-based measurement is used. When present, it shall indicate the time usage after which the UP function shall report network resources usage to the CP function for this URR for the period after the Monitoring Time.	X	X	X	X	Subsequent Time Threshold
Subsequent Volume Quota	O	This IE may be present if Monitoring Time IE is present and volume-based measurement is used (see clause 5.2.2.2). When present, it shall indicate the Volume Quota value which the UP function shall use for this URR for the period after the Monitoring Time.	-	X	X	X	Subsequent Volume Quota
Subsequent Time Quota	O	This IE may be present if Monitoring Time IE is present and time-based measurement is used (see clause 5.2.2.2) When present, it shall indicate the Time Quota value which the UP function shall use for this URR for the period after the Monitoring Time.	-	X	X	X	Subsequent Time Quota
Subsequent Event Threshold	O	This IE may be present if the Monitoring Time IE is present and event-based measurement is used. When present, it shall indicate the number of events after which the UP function shall report to the CP function for this URR for the period after the Monitoring Time.	-	X	X	X	Event Threshold
Subsequent Event Quota	O	This IE may be present if Monitoring Time IE is present and event-based measurement is used (see clause 5.2.2.2). When present, it shall indicate the Event Quota value which the UP function shall use for this URR for the period after the Monitoring Time.	-	X	X	X	Event Quota

7.5.2.5 Create QER IE within PFCP Session Establishment Request

The Create QER grouped IE shall be encoded as shown in Figure 7.5.2.5-1.

Table 7.5.2.5-1: Create QER IE within PFCP Session Establishment Request

Octet 1 and 2		Create QER IE Type = 7 (decimal)					
Octets 3 and 4		Length = n					
Information elements	P	Condition / Comment	Appl.				IE Type
			Sx a	Sx b	Sx c	N4	

QER ID	M	This IE shall uniquely identify the QER among all the QER configured for that PFCP session	-	X	X	X	QER ID
QER Correlation ID	C	This IE shall be present if the UP function is required to correlate the QERs of several PFCP sessions, for APN-AMBR enforcement of multiple UE's PDN connections to the same APN.	-	X	-	X	QER Correlation ID
Gate Status	M	This IE shall indicate whether the packets are allowed to be forwarded (the gate is open) or shall be discarded (the gate is closed) in the uplink and/or downlink directions.	-	X	X	X	Gate Status
Maximum Bitrate	C	<p>This IE shall be present if an MBR enforcement action shall be applied to packets matching this PDR. When present, this IE shall indicate the uplink and/or downlink maximum bit rate to be enforced for packets matching the PDR.</p> <p>For EPC, this IE may be set to the value of:</p> <ul style="list-style-type: none"> - the APN-AMBR, for a QER that is referenced by all the PDRs of the non-GBR bearers of a PDN connection; - the TDF session MBR, for a QER that is referenced by all the PDRs of a TDF session; - the bearer MBR, for a QER that is referenced by all the PDRs of a bearer; - the SDF MBR, for a QER that is referenced by all the PDRs of a SDF. <p>For 5GC, this IE may be set to the value of:</p> <ul style="list-style-type: none"> - the Session-AMBR, for a QER that is referenced by all the PDRs of the non-GBR QoS flows of a PDU session; - the QoS Flow MBR, for a QER that is referenced by all the PDRs of a QoS Flow; - the SDF MBR, for a QER that is referenced by all the PDRs of a SDF. 	-	X	X	X	MBR
Guaranteed Bitrate	C	<p>This IE shall be present if a GBR has been authorized to packets matching this PDR. When present, this IE shall indicate the authorized uplink and/or downlink guaranteed bit rate.</p> <p>This IE may be set to the value of:</p> <ul style="list-style-type: none"> - the aggregate GBR, for a QER that is referenced by all the PDRs of a GBR bearer; - the QoS Flow GBR, for a QER that is referenced by all the PDRs of a QoS Flow (for 5GC); - the SDF GBR, for a QER that is referenced by all the PDRs of a SDF. 	-	X	X	X	GBR
Packet Rate	C	<p>This IE shall be present if a Packet Rate enforcement action (in terms of number of packets per time interval) shall be applied to packets matching this PDR. When present, this IE shall indicate the uplink and/or downlink maximum packet rate to be enforced for packets matching the PDR.</p> <p>This IE may be set to the value of:</p> <ul style="list-style-type: none"> - downlink packet rate for Serving PLMN Rate Control, for a QER that is referenced by all PDRs of the UE belonging to the PDN connection using Clot EPS Optimizations as described in 3GPP TS 23.401 [2]) - uplink and/or downlink packet rate for APN Rate Control, for a QER that is referenced by all the PDRs of the UE belonging to PDN connections to the same APN using Clot EPS Optimizations as described in 3GPP TS 23.401 [2]). 	-	X	-		Packet Rate

DL Flow Level Marking	C	This IE shall be set if the UP function is required to mark the packets for QoS purposes: <ul style="list-style-type: none"> - by the TDF-C, for DL flow level marking for application indication (see clause 5.4.5); - by the PGW-C, for setting the GTP-U Service Class Indicator extension header for service indication towards GERAN (see clause 5.4.12). 	-	X	X	-	DL Flow Level Marking
QoS flow identifier	C	This IE shall be present if the QoS flow identifier shall be inserted by the UPF.	-	-	-	X	QFI
Reflective QoS	C	This IE shall be present if the UP function is required to insert a Reflective QoS Identifier to request reflective QoS for uplink traffic.	-	-	-	X	RQI
Paging Policy Indicator	C	This IE shall be present if the UPF is required to set the Paging Policy Indicator (PPI) in outgoing packets (see clause 5.4.3.2 of 3GPP TS 23.501 [28]) When present, it shall be set to the PPI value to set.	-	-	-	X	Paging Policy Indicator
Averaging Window	O	This IE may be present if the UP function is required to use a different Averaging window than the default one. (NOTE)	-	-	-	X	Averaging Window
NOTE: As 5QI is not signalled over N4, one default averaging window shall be pre-configured in the UPF.							

7.5.2.6 Create BAR IE within PFCP Session Establishment Request

The Create BAR grouped IE shall be encoded as shown in Figure 7.5.2.6-1.

Table 7.5.2.6-1: Create BAR IE within PFCP Session Establishment Request

Octet 1 and 2		Create BAR IE Type = 85 (decimal)					
Octets 3 and 4		Length = n					
Information elements	P	Condition / Comment	Appl.				IE Type
			Sx a	Sx b	Sx c	N4	
BAR ID	M	This IE shall uniquely identify the BAR provisioned for that PFCP session.	X	-	-	X	BAR ID
Downlink Data Notification Delay	C	This IE shall be present if the UP function indicated support of the Downlink Data Notification Delay parameter (see clause 8.2.28) and the UP function has to delay the notification to the CP function about the arrival of DL data packets. When present, it shall contain the delay the UP function shall apply between receiving a downlink data packet and notifying the CP function about it, when the Apply Action parameter requests to buffer the packets and notify the CP function.	X	-	-	-	Downlink Data Notification Delay
Suggested Buffering Packets Count	C	This IE may be present if the UP Function indicated support of the the feature UDBC. When present, it shall contain the number of packets that are suggested to be buffered when the Apply Action parameter requests to buffer the packets. The packets that exceed the limit shall be discarded.		X	X	X	Suggested Buffering Packets Count

7.5.2.7 Create Traffic Endpoint IE within Sx Session Establishment Request

The Create Traffic Endpoint grouped IE shall be encoded as shown in Figure 7.5.2.7-1.

Table 7.5.2.7-1: Create Traffic Endpoint IE within PFCP Session Establishment Request

Octet 1 and 2		Create Traffic Endpoint IE Type = 127(decimal)					
Octets 3 and 4		Length = n					
Information elements	P	Condition / Comment	Appl.				IE Type
			Sx a	Sx b	Sx c	N4	
Traffic Endpoint ID	M	This IE shall uniquely identify the Traffic Endpoint for that PFCP session.	X	X	X	X	Traffic Endpoint ID
Local F-TEID	O	If present, this IE shall identify the local F-TEID to match for an incoming packet. The CP function shall set the CHOOSE (CH) bit to 1 if the UP function supports the allocation of F-TEID and the CP function requests the UP function to assign a local F-TEID to the Traffic Endpoint.	X	X	-	X	F-TEID
Network Instance	O	If present, this IE shall identify the Network instance to match for the incoming packet. See NOTE 1, NOTE2.	X	X	X	X	Network Instance
UE IP address	O	If present, this IE shall identify the source or destination IP address to match for the incoming packet. (NOTE 3)	-	X	X	X	UE IP address
Ethernet PDU Session Information	O	This IE may be present to identify all the (DL) Ethernet packets matching an Ethernet PDU session (see clause 5.13.1).	-	-	-	X	Ethernet PDU Session Information
Framed-Route	O	This IE may be present for a DL PDR if the UPF indicated support of Framed Routing (see clause 8.2.25). If present, this IE shall describe a framed route. Several IEs with the same IE type may be present to provision a list of framed routes. (NOTE 3)	-	X	-	X	Framed-Route
Framed-Routing	O	This IE may be present for a DL PDR if the UPF indicated support of Framed Routing (see clause 8.2.25). If present, this IE shall describe the framed routing associated to a framed route.	-	X	-	X	Framed-Routing
Framed-IPv6-Route	O	This IE may be present for a DL PDR if the UPF indicated support of Framed Routing (see clause 8.2.25). If present, this IE shall describe a framed IPv6 route. Several IEs with the same IE type may be present to provision a list of framed IPv6 routes. (NOTE 3)	-	X	-	X	Framed-IPv6-Route
<p>NOTE 1: The Network Instance parameter is needed e.g. in the following cases:</p> <ul style="list-style-type: none"> - PGW/TDF UP function supports multiple PDNs with overlapping IP addresses; - SGW UP function is connected to PGWs in different IP domains (S5/S8); - PGW UP function is connected to SGWs in different IP domains (S5/S8); - SGW UP function is connected to eNodeBs in different IP domains; - UPF is connected to 5G-ANs in different IP domains. <p>NOTE 2: When a Local F-TEID is provisioned in the Traffic Endpoint, the Network Instance shall relate to the IP address of the F-TEID. Otherwise, the Network Instance shall relate to the UE IP address.</p> <p>NOTE 3: If both the UE IP Address and the Framed-Route (or Framed-IPv6-Route) are present, the packets which are considered being matching the PDR shall match at least one of them.</p>							

7.5.3 PFCP Session Establishment Response

7.5.3.1 General

The PFCP Session Establishment Response shall be sent over the Sxa, Sxb, Sxc and N4 interface by the UP function to the CP function as a reply to the PFCP Session Establishment Request.

Table 7.5.3.1-1: Information Elements in a PFCP Session Establishment Response

Information elements	P	Condition / Comment	Appl.				IE Type
			Sx a	Sx b	Sx c	N4	

Node ID	M	This IE shall contain the unique identifier of the sending Node.	X	X	X	X	Node ID
Cause	M	This IE shall indicate the acceptance or the rejection of the corresponding request message.	X	X	X	X	Cause
Offending IE	C	This IE shall be included if the rejection is due to a conditional or mandatory IE missing or faulty.	X	X	X	X	Offending IE
UP F-SEID	C	This IE shall be present if the cause is set to "Request accepted (success)". When present, it shall contain the unique identifier allocated by the UP function identifying the session.	X	X	X	X	F-SEID
Created PDR	C	This IE shall be present if the cause is set to "success" and the UP function was requested to allocate the local F-TEID for the PDR. When present, this IE shall contain the PDR information associated to the PFCP session. There may be several instances of this IE. See table 7.5.3.2-1.	X	X	-	X	Created PDR
Load Control Information	O	The UP function may include this IE if it supports the load control feature and the feature is activated in the network. See Table 7.5.3.3-1.	X	X	X	X	Load Control Information
Overload Control Information	O	During an overload condition, the UP function may include this IE if it supports the overload control feature and the feature is activated in the network. See Table 7.5.3.4-1.	X	X	X	X	Overload Control Information
SGW-U FQ-CSID	C	This IE shall be included according to the requirements in clause 23 of 3GPP TS 23.007 [24].	X	-	-	-	FQ-CSID
PGW-U FQ-CSID	C	This IE shall be included according to the requirements in clause 23 of 3GPP TS 23.007 [24].	-	X	-	-	FQ-CSID
Failed Rule ID	C	This IE shall be included if the Cause IE indicates a rejection due to a rule creation or modification failure.	X	X	X	X	Failed Rule ID
Created Traffic Endpoint	C	This IE shall be present if the cause is set to "success" and the UP function was requested to allocate a local F-TEID in a Create Traffic Endpoint IE. When present, it shall contain the local F-TEID to be used for this Traffic Endpoint. There may be several instances of this IE.	X	X	-	X	Created Traffic Endpoint

7.5.3.2 Created PDR IE within PFCP Session Establishment Response

The Created PDR grouped IE shall be encoded as shown in Figure 7.5.3.2-1.

Table 7.5.3.2-1: Created PDR IE within PFCP Session Establishment Response

Octet 1 and 2	Created PDR IE Type = 8 (decimal)						
Octets 3 and 4	Length = n						
Information elements	P	Condition / Comment	Appl.				IE Type
			Sx a	Sx b	Sx c	N4	
PDR ID	M		X	X	-	X	PDR ID
Local F-TEID	C	If the UP function allocates the F-TEID, this IE shall be present and shall contain the local F-TEID to be used for this PDR.	X	X	-	X	F-TEID

7.5.3.3 Load Control Information IE within PFCP Session Establishment Response

The Load Control Information grouped IE shall be encoded as shown in Figure 7.5.3.3-1.

Table 7.5.3.3-1: Load Control Information IE within PFCP Session Establishment Response

Octet 1 and 2		Load Control Information IE Type = 51 (decimal)					
Octets 3 and 4		Length = n					
Information elements	P	Condition / Comment	Appl.				IE Type
			Sx a	Sx b	Sx c	N4	
Load Control Sequence Number	M	See clause 6.2.3.3.2 for the description and use of this parameter.	X	X	X	X	Sequence Number
Load Metric	M	See clause 6.2.3.3.2 for the description and use of this parameter.	X	X	X	X	Metric

7.5.3.4 Overload Control Information IE within PFCP Session Establishment Response

The Overload Control grouped IE shall be encoded as shown in Figure 7.5.3.4-1.

Table 7.5.3.4-1: Overload Control Information IE within PFCP Session Establishment Response

Octet 1 and 2		Overload Control Information IE Type = 54 (decimal)					
Octets 3 and 4		Length = n					
Information elements	P	Condition / Comment	Appl.				IE Type
			Sx a	Sx b	Sx c	N4	
Overload Control Sequence Number	M	See clause 6.2.4.3.2 for the description and use of this parameter.	X	X	X	X	Sequence Number
Overload Reduction Metric	M	See clause 6.2.4.3.2 for the description and use of this parameter.	X	X	X	X	Metric
Period of Validity	M	See clause 6.2.4.3.2 for the description and use of this parameter.	X	X	X	X	Timer
Overload Control Information Flags	C	This IE shall be included if any of flag in this IE is set.	X	X	X	X	OCI Flags

7.5.3.5 Created Traffic Endpoint IE within PFCP Session Establishment Response

The Created Traffic Endpoint grouped IE shall be encoded as shown in Figure 7.5.3.5-1.

Table 7.5.3.5-1: Created Traffic Endpoint IE within PFCP Session Establishment Response

Octet 1 and 2		Created Traffic Endpoint IE Type = 128 (decimal)					
Octets 3 and 4		Length = n					
Information elements	P	Condition / Comment	Appl.				IE Type
			Sx a	Sx b	Sx c	N4	
Traffic Endpoint ID	M	This IE shall uniquely identify the Traffic Endpoint for that PFCP session.	X	X	-	X	Traffic Endpoint ID
Local F-TEID	C	If the UP function allocates the F-TEID, this IE shall be present and shall contain the local F-TEID to be used for this Traffic Endpoint.	X	X	-	X	F-TEID

7.5.4 PFCP Session Modification Request

7.5.4.1 General

The PFCP Session Modification Request is used over the Sxa, Sxb, Sxc and N4 interface by the CP function to request the UP function to modify the PFCP session.

Table 7.5.4.1-1: Information Elements in a PFCP Session Modification Request

Information elements	P	Condition / Comment	Appl.				IE Type
			Sx a	Sx b	Sx c	N4	

CP F-SEID	C	This IE shall be present if the CP function decides to change its F-SEID for the PFCP session. The UP function shall use the new CP F-SEID for subsequent PFCP Session related messages for this PFCP Session. See Note 2.	X	X	X	X	F-SEID
Remove PDR	C	When present, this IE shall contain the PDR Rule which is requested to be removed. See Table 7.5.4-6-1. Several IEs within the same IE type may be present to represent a list of PDRs to remove.	X	X	X	X	Remove PDR
Remove FAR	C	When present, this IE shall contain the FAR Rule which is requested to be removed. See Table 7.5.4-7-1. Several IEs within the same IE type may be present to represent a list of FARs to remove.	X	X	X	X	Remove FAR
Remove URR	C	When present, this shall contain the URR Rule which is requested to be removed. See Table 7.5.4-8-1. Several IEs within the same IE type may be present to represent a list of URRs to remove.	X	X	X	X	Remove URR
Remove QER	C	When present, this IE shall contain the QER Rule which is requested to be removed. See Table 7.5.4-9-1. Several IEs within the same IE type may be present to represent a list of QERs to remove.	-	X	X	X	Remove QER
Remove BAR	C	When present, this IE shall contain the BAR Rule which is requested to be removed. See Table 7.5.4.12-1.	X	-	-	X	Remove BAR
Remove Traffic Endpoint	C	When present, this IE shall contain the Traffic Endpoint ID identifying the traffic endpoint to be removed, if the UP function has indicated support of PDI optimization. All the PDRs that refer to the removed Traffic Endpoint shall be deleted. See Table 7.5.4.14-1.	X	X	X	X	Remove Traffic Endpoint
Create PDR	C	This IE shall be present if the CP function requests the UP function to create a new PDR. See Table 7.5.2.2-1. Several IEs within the same IE type may be present to represent a list of PDRs to create.	X	X	X	X	Create PDR
Create FAR	C	This IE shall be present if the CP function requests the UP function to create a new FAR. See Table 7.5.2.3-1. Several IEs within the same IE type may be present to represent a list of FARs to create.	X	X	X	X	Create FAR
Create URR	C	This IE shall be present if the CP function requests the UP function to create a new URR. See Table 7.5.2.4-1. Several IEs within the same IE type may be present to represent a list of URRs to create.	X	X	X	X	Create URR
Create QER	C	This IE shall be present if the CP function requests the UP function to create a new QER. See Table 7.5.2.5-1. Several IEs within the same IE type may be present to represent a list of QERs to create.	-	X	X	X	Create QER
Create BAR	C	This IE shall be present if the CP function requests the UP function to create a new BAR. See Table 7.5.2.6-1.	X	-	-	X	Create BAR
Create Traffic Endpoint	C	When present this IE shall contain the information associated with the Traffic Endpoint to be created, if the UP function has indicated support of PDI optimization. See Table 7.5.2.7-1.	X	X	X	X	Create Traffic Endpoint
Update PDR	C	This IE shall be present if a PDR previously created for the PFCP session need to be modified. See Table 7.5.4.2-1. Several IEs within the same IE type may be present to represent a list of PDRs to update.	X	X	X	X	Update PDR
Update FAR	C	This IE shall be present if a FAR previously created for the PFCP session need to be modified. See Table 7.5.4.3-1. Several IEs within the same IE type may be present to represent a list of FARs to update.	X	X	X	X	Update FAR
Update URR	C	This IE shall be present if URR(s) previously created for the PFCP session need to be modified. Several IEs within the same IE type may be present to represent a list of modified URRs. Previously URRs that are not modified shall not be included. See Table 7.5.4.4-1.	X	X	X	X	Update URR

Update QER	C	This IE shall be present if QER(s) previously created for the PFCP session need to be modified. Several IEs within the same IE type may be present to represent a list of modified QERs. Previously created QERs that are not modified shall not be included. See Table 7.5.4.5-1.	-	X	X	X	Update QER
Update BAR	C	This IE shall be present if a BAR previously created for the PFCP session needs to be modified. A previously created BAR that is not modified shall not be included. See Table 7.5.4.11-1.	X	-	-	X	Update BAR
Update Traffic Endpoint	C	When present this IE shall contain the information associated with the traffic endpoint to be updated, if the UP function has indicated support of PDI optimization. All the PDRs that refer to the Traffic Endpoint shall use the updated Traffic Endpoint information. See Table 7.5.4.13-1.	X	X	X	X	Update Traffic Endpoint
PFCPSMReq-Flags	C	This IE shall be included if at least one of the flags is set to "1". - DROBU (Drop Buffered Packets): the CP function shall set this flag if the UP function is requested to drop the packets currently buffered for this PFCP session (see NOTE 1). - QAURR (Query All URRs): the CP function shall set this flag if the CP function requests immediate usage report(s) for all the URRs previously provisioned for this PFCP session (see NOTE 3).	X	-	-	X	PFCPSMReq-Flags
Query URR	C	This IE shall be present if the CP function requests immediate usage report(s) to the UP function. Several IEs within the same IE type may be present to represent a list of URRs for which an immediate report is requested. See Table 7.5.4.10-1. See NOTE 3.	X	X	X	X	Query URR
PGW-C FQ-CSID	C	This IE shall be included according to the requirements in clause 23 of 3GPP TS 23.007 [24].	X	X	-	-	FQ-CSID
SGW-C FQ-CSID	C	This IE shall be included according to the requirements in clause 23 of 3GPP TS 23.007 [24].	X	X	-	-	FQ-CSID
MME FQ-CSID	C	This IE shall be included according to the requirements in clause 23 of 3GPP TS 23.007 [24].	X	X	-	-	FQ-CSID
ePDG FQ-CSID	C	This IE shall be included according to the requirements in clause 23 of 3GPP TS 23.007 [24].	-	X	-	-	FQ-CSID
TWAN FQ-CSID	C	This IE shall be included according to the requirements in clause 23 of 3GPP TS 23.007 [24].	-	X	-	-	FQ-CSID
User Plane Inactivity Timer	C	This IE shall be present if it needs to be changed.	-	X	X	X	User Plane Inactivity Timer
Query URR Reference	O	This IE may be present if the Query URR IE is present or the QAURR flag is set to "1". When present, it shall contain a reference identifying the query request, which the UP function shall return in any usage report sent in response to the query.	X	X	X	X	Query URR Reference
Trace Information	O	When present, this IE shall contain the trace instructions to be applied by the UP function for this PFCP session. A Trace Information with a null length indicates that the trace session shall be deactivated.	X	X	X	X	Trace Information

NOTE 1:	The CP function may request the UP function to drop the packets currently buffered for the PFCP session when using extended buffering of downlink data packets, buffering is performed in the UP function and the DL Data Buffer Expiration Time is handled by the CP function. In this case, when the DL Data Buffer Expiration Time expires, the CP function shall send a PFCP Session Modification Request including the DROBU flag (to drop the downlink data packets currently buffered in the UP function) and updating the Apply Action within the FARs of this PFCP session to request the UP function to start buffering the downlink data packets with notifying the arrival of subsequent downlink data packets. See clause 5.9.3 of 3GPP TS 23.214 [2].
NOTE 2:	When changing the CP F-SEID of an established PFCP Session, the CP function shall be able to handle any incoming PFCP Session related messages sent by the UP function with the previous CP F-SEID for a duration at least longer than twice the PFCP retransmission timer (N1xT1).
NOTE 3:	The QAURR (Query All URRs) flag in the PFCPSMReq-Flags IE and the Query URR IE are exclusive from each other in a PFCP Session Modification Request.

7.5.4.2 Update PDR IE within PFCP Session Modification Request

The Update PDR grouped IE shall be encoded as shown in Figure 7.5.4.2-1.

Table 7.5.4.2-1: Update PDR IE within PFCP Session Modification Request

Octet 1 and 2		Update PDR IE Type = 9 (decimal)					
Octets 3 and 4		Length = n					
Information elements	P	Condition / Comment	Appl.				IE Type
			Sx a	Sx b	Sx c	N4	
PDR ID	M	This IE shall uniquely identify the PDR among all the PDRs configured for that PFCP session.	X	X	X	X	PDR ID
Outer Header Removal	C	This IE shall be present if it needs to be changed.	X	X	-	X	Outer Header Removal
Precedence	C	This IE shall be present if there is a change in the PDR's precedence to be applied by the UP function among all PDRs of the PFCP session, when looking for a PDR matching an incoming packet.	-	X	X	X	Precedence
PDI	C	This IE shall be present if there is a change within the PDI against which incoming packets will be matched. When present, this IE shall replace the PDI previously stored in the UP function for this PDR. See Table 7.5.2.2-2.	X	X	X	X	PDI
FAR ID	C	This IE shall be present if it needs to be changed	X	X	X	X	FAR ID
URR ID	C	This IE shall be present if a measurement action shall be applied or no longer applied to packets matching this PDR. When present, this IE shall contain the list of all the URR IDs to be associated to the PDR.	X	X	X	X	URR ID
QER ID	C	This IE shall be present if a QoS enforcement action shall be applied or no longer applied to packets matching this PDR. When present, this IE shall contain the list of all the QER IDs to be associated to the PDR.	-	X	X	X	QER ID
Activate Predefined Rules	C	This IE shall be present if new Predefined Rule(s) needs to be activated for the PDR. When present this IE shall contain one Predefined Rules name. Several IEs with the same IE type may be present to represent multiple "Activate Predefined Rules" names.	-	X	X	X	Activate Predefined Rules
Deactivate Predefined Rules	C	This IE shall be present if Predefined Rule(s) needs to be deactivated for the PDR. When present this IE shall contain one Predefined Rules name. Several IEs with the same IE type may be present to represent multiple "Activate Predefined Rules" names.	-	X	X	X	Deactivate Predefined Rules
NOTE:	The IEs which do not need to be modified shall not be included in the Update PDR IE. The UP function shall continue to behave according to the values previously received for IEs not present in the Update PDR IE.						

7.5.4.3 Update FAR IE within PFCP Session Modification Request

The Update FAR grouped IE shall be encoded as shown in Figure 7.5.4.3-1.

Table 7.5.4.3-1: Update FAR IE within PFCP Session Modification Request

Octet 1 and 2	Update FAR IE Type = 10 (decimal)						
Octets 3 and 4	Length = n						
Information elements	P	Condition / Comment	Appl.				IE Type
			Sx a	Sx b	Sx c	N4	
FAR ID	M	This IE shall identify the FAR to be updated.	X	X	X	X	FAR ID
Apply Action	C	This IE shall be present if it is changed.	X	X	X	X	Apply Action
Update Forwarding parameters	C	This IE shall be present if it is changed. See table 7.5.4.3-2.	X	X	X	X	Update Forwarding Parameters
Update Duplicating Parameters	C	This IE shall be present if it is changed. See table 7.5.4.3-3. Several IEs with the same IE type may be present to request to duplicate the packets to different destinations.	X	X	-	-	Update Duplicating Parameters
BAR ID	C	This IE shall be present if the BAR ID associated to the FAR needs to be modified.	X	-	-	X	BAR ID

Table 7.5.4.3-2: Update Forwarding Parameters IE in FAR

Octet 1 and 2	Update Forwarding Parameters IE Type = 11 (decimal)						
Octets 3 and 4	Length = n						
Information elements	P	Condition / Comment	Appl.				IE Type
			Sx a	Sx b	Sx c	N4	

Destination Interface	C	This IE shall only be provided if it is changed. When present, it shall indicate the destination interface of the outgoing packet.	X	X	X	X	Destination Interface
Network instance	C	This IE shall only be provided if it is changed.	X	X	X	X	Network Instance
Redirect Information	C	This IE shall be present if the instructions regarding the redirection of traffic by the UP function need to be modified.	-	X	X	X	Redirect Information
Outer Header Creation	C	This IE shall only be provided if it is changed. See NOTE 1.	X	X	-	X	Outer Header Creation
Transport Level Marking	C	This IE shall only be provided if it is changed	X	X	-	X	Transport Level Marking
Forwarding Policy	C	This IE shall only be provided if it is changed. See NOTE 1.	-	X	X	X	Forwarding Policy
Header Enrichment	C	This IE shall only be provided if it is changed	-	X	X	X	Header Enrichment
PFCPSMReq-Flags	C	This IE shall be included if at least one of the flags is set to "1". - SNDEM (Send End Marker Packets): this IE shall be present if the CP function modifies the F-TEID of the downstream node in the Outer Header Creation IE and the CP function requests the UP function to construct and send GTP-U End Marker messages towards the old F-TEID of the downstream node.	X	X	-	X	PFCPSMReq-Flags
Linked Traffic Endpoint ID	C	This IE may be present, if it is changed and the UP function indicated support of the PDI optimization feature, (see clause 8.2.25). When present, it shall identify the Traffic Endpoint ID allocated for this PFCP session to receive the traffic in the reverse direction (see clause 5.2.3.1).	X	X	-	X	Traffic Endpoint ID
Destination Interface Type	C	This IE shall be present to indicate the 3GPP interface type of the destination interface, if the value has changed.	X	X	-	X	3GPP Interface Type
NOTE 1: If the Outer Header Creation and Forwarding Policy are present, the UP function shall put the user plane packets in the user plane tunnel by applying Outer Header Creation, after enforcing the required Forwarding Policy.							

Table 7.5.4.3-3: Update Duplicating Parameters IE in FAR

Octet 1 and 2		Update Duplicating Parameters IE Type = 105 (decimal)					
Octets 3 and 4		Length = n					
Information elements	P	Condition / Comment	Appl.				IE Type
			Sx a	Sx b	Sx c	N4	
Destination Interface	C	This IE shall only be provided if it is changed. When present, it shall indicate the destination interface of the outgoing packet.	X	X	-	-	Destination Interface
Outer Header Creation	C	This IE shall only be provided if it is changed. See NOTE 1.	X	X	-	-	Outer Header Creation
Transport Level Marking	C	This IE shall only be provided if it is changed.	X	X	-	-	Transport Level Marking
Forwarding Policy	C	This IE shall only be provided if it is changed. See NOTE 1.	-	X	-	-	Forwarding Policy
NOTE 1: If the Outer Header Creation and Forwarding Policy are present, the UP function shall put the user plane packets in the user plane tunnel by applying Outer Header Creation, after enforcing the required Forwarding Policy.							

7.5.4.4 Update URR IE within PFCP Session Modification Request

The Update URR grouped IE shall be encoded as shown in Figure 7.5.4.4-1.

Table 7.5.4.4-1: Update URR IE within PFCP Session Modification Request

Octet 1 and 2	Update URR IE Type = 13 (decimal)						
Octets 3 and 4	Length = n						
Information elements	P	Condition / Comment	Appl.				IE Type
			Sx a	Sx b	Sx c	N4	

URR ID	M	This IE shall uniquely identify the URR among all the URRs configured for that PFCP session	X	X	X	X	URR ID
Measurement Method	C	This IE shall be present if the measurement method needs to be modified. When present, this IE shall indicate the method for measuring the network resources usage, i.e. whether the data volume, duration (i.e. time), combined volume/duration, or event shall be measured.	X	X	X	X	Measurement Method
Reporting Triggers	C	This IE shall be present if the reporting triggers needs to be modified. When present, this IE shall indicate the trigger(s) for reporting network resources usage to the CP function, e.g. periodic reporting or reporting upon reaching a threshold, or envelope closure.	X	X	X	X	Reporting Triggers
Measurement Period	C	This IE shall be present if the Measurement Period needs to be modified. When present, it shall indicate the period for generating and reporting usage reports.	X	X	X	X	Measurement Period
Volume Threshold	C	This IE shall be present if the Volume Threshold needs to be modified. When present, it shall indicate the traffic volume value after which the UP function shall report network resources usage to the CP function for this URR.	X	X	X	X	Volume Threshold
Volume Quota	C	This IE shall be present if the Volume Quota needs to be modified. When present, it shall indicate the Volume Quota value.	-	X	X	X	Volume Quota
Time Threshold	C	This IE shall be present if the Time Threshold needs to be modified. When present, it shall indicate the time usage after which the UP function shall report network resources usage to the CP function for this URR.	X	X	X	X	Time Threshold
Time Quota	C	This IE shall be present if the Time Quota needs to be modified. When present, it shall indicate the Time Quota value.	-	X	X	X	Time Quota
Event Threshold	C	This IE shall be present if Event Threshold needs to be modified. When present, it shall indicate the number of events after which the UP function shall report to the CP function for this URR.	-	X	X	X	Event Threshold
Event Quota	C	This IE shall be present if Event Quota needs to be modified. When present, it shall indicate the Event Quota value.	-	X	X	X	Event Quota
Quota Holding Time	C	This IE shall be present if the Quota Holding Time needs to be modified. When present, it shall contain the duration of the Quota Holding Time.	-	X	X	X	Quota Holding Time
Dropped DL Traffic Threshold	C	This IE shall be present if the Dropped DL Threshold needs to be modified. When present, it shall contain the threshold of the DL traffic being dropped.	X	-	-	X	Dropped DL Traffic Threshold
Monitoring Time	C	This IE shall be present if the Monitoring Time needs to be modified. When present, this IE shall contain the time at which the UP function shall re-apply the volume or time threshold.	X	X	X	X	Monitoring Time
Subsequent Volume Threshold	C	This IE shall be present if the Subsequent Volume Threshold needs to be modified and volume-based measurement is used. When present, it shall indicate the traffic volume value after which the UP function shall report network resources usage to the CP function for this URR for the period after the Monitoring Time.	X	X	X	X	Subsequent Volume Threshold
Subsequent Time Threshold	C	This IE shall be present if the Subsequent Time Threshold needs to be modified. When present, it shall indicate the time usage value after which the UP function shall report network resources usage to the CP function for this URR for the period after the Monitoring Time.	X	X	X	X	Subsequent Time Threshold

Subsequent Volume Quota	C	This IE shall be present if the Subsequent Volume Quota needs to be modified. When present, it shall indicate the Volume Quota value which the UP function shall use for this URR for the period after the Monitoring Time.	-	X	X	X	Subsequent Volume Quota
Subsequent Time Quota	C	This IE shall be present if the Subsequent Time Quota needs to be modified. When present, it shall indicate the Time Quota value which the UP function shall use for this URR for the period after the Monitoring Time.	-	X	X	X	Subsequent Time Quota
Subsequent Event Threshold	O	This IE shall be present if the Subsequent Event Threshold needs to be modified. When present, it shall indicate the number of events after which the UP function shall report to the CP function for this URR for the period after the Monitoring Time.	-	X	X	X	Subsequent Event Threshold
Subsequent Event Quota	O	This IE shall be present if the Subsequent Event Quota needs to be modified. When present, it shall indicate the Event Quota value which the UP function shall use for this URR for the period after the Monitoring Time.	-	X	X	X	Subsequent Event Quota
Inactivity Detection Time	C	This IE shall be present if the Inactivity Detection Time needs to be modified. When present, it shall indicate the duration of the inactivity period after which time measurement needs to be suspended when no packets are received during this inactivity period.	-	X	X	X	Inactivity Detection Time
Linked URR ID	C	This IE shall be present if linked usage reporting is required. When present, this IE shall contain the linked URR ID which is related with this URR (see clause 5.2.2.4). Several IEs with the same IE type may be present to represent multiple linked URRs which are related with this URR.	-	X	X	X	Linked URR ID
Measurement Information	C	This IE shall be included if any of the following flag is set to "1". Applicable flags are: - Inactive Measurement Flag: this flag shall be set to "1" if the measurement shall be paused (inactive). The measurement shall be performed (active) if the bit is set to "0" or if the Measurement Information IE is not present in the Update URR IE. - Reduced Application Detection Information Flag: this flag may be set to "1", if the Reporting Triggers request to report the start or stop of application, to request the UP function to only report the Application ID in the Application Detection Information, e.g. for envelope reporting. - Immediate Start Time Metering Flag: this flag may be set to "1" if time-based measurement is used and the UP function is requested to start the time metering immediately at receiving the flag.	-	X	-	X	Measurement Information
Time Quota Mechanism	C	This IE shall be present if time-based measurement based on CTP or DTP needs to be modified.	-	X	-	-	Time Quota Mechanism
Aggregated URRs	C	This IE shall be included if the Aggregated URRs IE needs to be modified. See Table 7.5.2.4-2. Several IEs with the same IE type may be present to provision multiple aggregated URRs. When present, this IE shall provide the complete list of the aggregated URRs.	-	X	-	-	Aggregated URRs

FAR ID for Quota Action	C	This IE shall be present if the FAR ID for Quota Action IE needs to be modified. This IE may be present if the Volume Quota IE or the Time Quota IE or Event Quota IE is newly provisioned in the URR and the UP Function indicated support of the Quota Action. When present, it shall contain the identifier of the substitute FAR the UP function shall apply, for the traffic associated to this URR, when exhausting any of these quotas. See NOTE 1.	-	X	X	X	FAR ID
Ethernet Inactivity Timer	C	This IE shall be present if the Ethernet Inactivity Timer needs to be modified. When present, it shall contain the duration of the Ethernet inactivity period.	-	-	-	X	Ethernet Inactivity Timer
Additional Monitoring Time	O	This IE shall be present if the additional Monitoring Time needs to be modified. When present, this IE shall contain the time at which the UP function shall re-apply the volume or time or event threshold/quota. See Table 7.5.2.4-3. The CP function shall provide the full set of Additional Monitoring Times IE(s). The UP function shall replace any Additional Monitoring Times IE(s) provisioned earlier by the new set of received IE(s).	X	X	X	X	Additional Monitoring Time

NOTE 1: The substitute FAR used when exhausting a Volume Quota or Time Quota may be set to drop the packets or redirect the traffic towards a redirect destination as specified in clause 5.4.7.

7.5.4.5 Update QER IE within PFCP Session Modification Request

The Update QER grouped IE shall be encoded as shown in Figure 7.5.4.5-1.

Table 7.5.4.5-1: Update QER IE within PFCP Session Modification Request

Octet 1 and 2	Update QER IE Type = 14 (decimal)						
Octets 3 and 4	Length = n						
Information elements	P	Condition / Comment	Appl.				IE Type
			Sx a	Sx b	Sx c	N4	

QER ID	M	This IE shall uniquely identify the QER among all the QERs configured for that PFCP session	-	X	X	X	QER ID
QER Correlation ID	C	This IE shall be present if the QER correlation ID in this QER needs to be modified. See NOTE 1.	-	X	-	X	QER Correlation ID
Gate Status	C	This IE shall be present if the Gate Status needs to be modified. When present, it shall indicate whether the packets are allowed to be forwarded (the gate is open) or shall be discarded (the gate is closed) in the uplink and/or downlink directions. See NOTE 1.	-	X	X	X	Gate Status
Maximum Bitrate	C	This IE shall be present if an MBR enforcement action applied to packets matching this PDR need to be modified. When present, this IE shall indicate the uplink and/or downlink maximum bit rate to be enforced for packets matching the PDR. For EPC, this IE may be set to the value of: <ul style="list-style-type: none"> - the APN-AMBR, for a QER that is referenced by all the PDRs of the non-GBR bearers of a PDN connection; - the TDF session MBR, for a QER that is referenced by all the PDRs of a TDF session; - the bearer MBR, for a QER that is referenced by all the PDRs of a bearer; - the SDF MBR, for a QER that is referenced by all the PDRs of a SDF. For 5GC, this IE may be set to the value of: <ul style="list-style-type: none"> - the Session-AMBR, for a QER that is referenced by all the PDRs of the non-GBR QoS flows of a PDU session; - the QoS Flow MBR, for a QER that is referenced by all the PDRs of a QoS Flow; - the SDF MBR, for a QER that is referenced by all the PDRs of a SDF. See NOTE 1.	-	X	X	X	MBR
Guaranteed Bitrate	C	This IE shall be present if a GBR authorization to packets matching this PDR needs to be modified. When present, this IE shall indicate the authorized uplink and/or downlink guaranteed bit rate. This IE may be set to the value of: <ul style="list-style-type: none"> - the aggregate GBR, for a QER that is referenced by all the PDRs of a GBR bearer; - the QoS Flow GBR, for a QER that is referenced by all the PDRs of a QoS Flow (for 5GC); - the SDF GBR, for a QER that is referenced by all the PDRs of a SDF. See NOTE 1.	-	X	X	X	GBR
Packet Rate	C	This IE shall be present if a Packet Rate enforcement action (in terms of number of packets per time interval) need to be modified for packets matching this PDR.	-	X	-		Packet Rate
DL Flow Level Marking	C	This IE shall be set if the DL Flow Level Marking IE needs to be modified. See NOTE 1.	-	X	X	-	DL Flow Level Marking
QoS flow identifier	C	This IE shall be present if it needs to be modified.	-	-	-	X	QFI
Reflective QoS	C	This IE shall be present if it needs to be modified.	-	-	-	X	RQI
Paging Policy Indicator	C	This IE shall be present if it needs to be modified.	-	-	-	X	Paging Policy Indicator
Averaging Window	O	This IE may be present if the UP function is required to modify the Averaging Window. (NOTE 2)	-	-	-	X	Averaging Window

NOTE 1: The IEs which do not need to be modified shall not be included in the Update QER IE. The UP function shall continue to behave according to the values previously received for IEs not present in the Update QER IE.

NOTE 2: As 5QI is not signalled over N4, one default averaging window shall be pre-configured in the UPF.

7.5.4.6 Remove PDR IE within PFCP Session Modification Request

The Remove PDR grouped IE shall be encoded as shown in Figure 7.5.4.6-1.

Table 7.5.4.6-1: Remove PDR IE within PFCP Session Modification Request

Octet 1 and 2		Remove PDR IE Type = 15 (decimal)					
Octets 3 and 4		Length = n					
Information elements	P	Condition / Comment	Appl.				IE Type
			Sx a	Sx b	Sx c	N4	
PDR ID	M	This IE shall identify the PDR to be deleted.	X	X	X	X	PDR ID

7.5.4.7 Remove FAR IE within PFCP Session Modification Request

The Remove FAR grouped IE shall be encoded as shown in Figure 7.5.4.7-1.

Table 7.5.4.7-1: Remove FAR IE within PFCP Session Modification Request

Octet 1 and 2		Remove FAR IE Type = 16 (decimal)					
Octets 3 and 4		Length = n					
Information elements	P	Condition / Comment	Appl.				IE Type
			Sx a	Sx b	Sx c	N4	
FAR ID	M	This IE shall identify the FAR to be deleted.	X	X	X	X	FAR ID

7.5.4.8 Remove URR IE within PFCP Session Modification Request

The Remove URR grouped IE shall be encoded as shown in Figure 7.5.4.7-1.

Table 7.5.4.8-1: Remove URR IE within PFCP Session Modification Request

Octet 1 and 2		Remove URR IE Type = 17 (decimal)					
Octets 3 and 4		Length = n					
Information elements	P	Condition / Comment	Appl.				IE Type
			Sx a	Sx b	Sx c	N4	
URR ID	M	This IE shall identify the URR to be deleted.	X	X	X	X	URR ID

7.5.4.9 Remove QER IE PFCP Session Modification Request

The Remove QER grouped IE shall be encoded as shown in Figure 7.5.4.9-1.

Table 7.5.4.9-1: Remove QER IE PFCP Session Modification Request

Octet 1 and 2		Remove QER IE Type = 18 (decimal)					
Octets 3 and 4		Length = n					
Information elements	P	Condition / Comment	Appl.				IE Type
			Sx a	Sx b	Sx c	N4	
QER ID	M	This IE shall identify the QER to be deleted.	-	X	X	X	QER ID

7.5.4.10 Query URR IE within PFCP Session Modification Request

The Query URR grouped IE shall be encoded as shown in Figure 7.5.4.10-1.

Table 7.5.4.10-1: Query URR IE within PFCP Session Modification Request

Octet 1 and 2		Query URR IE Type = 77 (decimal)					
Octets 3 and 4		Length = n					
Information elements	P	Condition / Comment	Appl.				IE Type
			Sx a	Sx b	Sx c	N4	
URR ID	M	This IE shall identify the URR being queried.	X	X	X	X	URR ID

7.5.4.11 Update BAR IE within PFCP Session Modification Request

The Update BAR grouped IE shall be encoded as shown in Figure 7.5.4.11-1.

Table 7.5.4.11-1: Update BAR IE within PFCP Session Modification Request

Octet 1 and 2		Update BAR IE Type = 86 (decimal)					
Octets 3 and 4		Length = n					
Information elements	P	Condition / Comment	Appl.				IE Type
			Sx a	Sx b	Sx c	N4	
BAR ID	M	This IE shall identify the BAR Rule to be modified.	X	-	-	X	BAR ID
Downlink Data Notification Delay	C	This IE shall be present if the UP function indicated support of the Downlink Data Notification Delay parameter (see clause 8.2.28) and the Downlink Data Notification Delay needs to be modified. When present, it shall contain the delay the UP function shall apply between receiving a downlink data packet and notifying the CP function about it, when the Apply Action parameter requests to buffer the packets and notify the CP function.	X	-	-	X	Downlink Data Notification Delay
Suggested Buffering Packets Count	C	This IE may be present if the UP Function indicated support of the the feature UDBC. When present, it shall contain the number of packets that are suggested to be buffered when the Apply Action parameter requests to buffer the packets. The packets that exceed the limit shall be discarded.		X	X	X	Suggested Buffering Packets Count

7.5.4.12 Remove BAR IE within PFCP Session Modification Request

The Remove BAR grouped IE shall be encoded as shown in Figure 7.5.4.12-1.

Table 7.5.4.12-1: Remove BAR IE within PFCP Session Modification Request

Octet 1 and 2		Remove BAR IE Type = 87 (decimal)					
Octets 3 and 4		Length = n					
Information elements	P	Condition / Comment	Appl.				IE Type
			Sx a	Sx b	Sx c	N4	
BAR ID	M	This IE shall identify the BAR to be deleted.	X	-	-	X	BAR ID

7.5.4.13 Update Traffic Endpoint IE within PFCP Session Modification Request

The Update Traffic Endpoint grouped IE shall be encoded as shown in Figure 7.5.4.13-1.

Table 7.5.4.13-1: Update Traffic Endpoint IE within PFCP Session Modification Request

Octet 1 and 2		Update Traffic Endpoint Type = 129 (decimal)					
Octets 3 and 4		Length = n					
Information elements	P	Condition / Comment	Appl.				IE Type
			Sx a	Sx b	Sx c	N4	
Traffic Endpoint ID	M	This IE shall uniquely identify the Traffic Endpoint to be modified for that PFCP session.	X	X	X	X	Traffic Endpoint ID
Local F-TEID	C	This IE shall be present if it needs to be changed. The CP function shall set the CHOOSE (CH) bit to 1 if the UP function supports the allocation of F-TEID and the CP function requests the UP function to assign a local F-TEID to the PDR. See NOTE.	X	-	-	X	F-TEID
Network Instance	O	If present, this IE shall identify the Network instance to match for the incoming packet. See NOTE.	X	X	X	X	Network Instance
UE IP address	C	This IE shall be present if it needs to be changed. See NOTE.	-	X	X	X	UE IP address
Framed-Route	C	This IE shall be present for a DL PDR if the UPF indicated support of Framed Routing (see clause 8.2.25) and it needs to be changed. If present, this IE shall describe a framed route. Several IEs with the same IE type may be present to provision a list of framed routes.	-	X	-	X	Framed-Route
Framed-Routing	C	This IE shall be present for a DL PDR if the UPF indicated support of Framed Routing (see clause 8.2.25) and it needs to be changed. If present, this IE shall describe the framed routing associated to a framed route.	-	X	-	X	Framed-Routing
Framed-IPv6-Route	C	This IE shall be present for a DL PDR if the UPF indicated support of Framed Routing (see clause 8.2.25) and it needs to be changed. If present, this IE shall describe a framed IPv6 route. Several IEs with the same IE type may be present to provision a list of framed IPv6 routes.	-	X	-	X	Framed-IPv6-Route
<p>NOTE: The IEs which do not need to be modified shall not be included in the Update Traffic Endpoint IE. The UP function shall continue to behave according to the values previously received for IEs not present in the Update Traffic Endpoint IE. F-TEID may be changed if the SGW-C has received the "Change F-TEID support Indication" over the S11/S4 interface (for an IDLE state UE initiated TAU/RAU procedure to allow the SGW changing the GTP-U F-TEID).</p>							

7.5.4.14 Remove Traffic Endpoint IE within PFCP Session Modification Request

The Remove Traffic Endpoint grouped IE shall be encoded as shown in Figure 7.5.4.14-1.

Table 7.5.4.14-1: Remove Traffic Endpoint IE within PFCP Session Modification Request

Octet 1 and 2		Remove Traffic Endpoint IE Type = 130 (decimal)					
Octets 3 and 4		Length = n					
Information elements	P	Condition / Comment	Appl.				IE Type
			Sx a	Sx b	Sx c	N4	
Traffic Endpoint ID	M	This IE shall identify the Traffic Endpoint to be deleted.	X	X	X	X	Traffic Endpoint ID

7.5.5 PFCP Session Modification Response

7.5.5.1 General

The PFCP Session Modification Response shall be sent over the Sxa, Sxb, Sxc and N4 interface by the UP function to the CP function as a reply to the PFCP Session Modification Request.

Table 7.5.5.1-1: Information Elements in a PFCP Session Modification Response

Information elements	P	Condition / Comment	Appl.				IE Type
			Sx a	Sx b	Sx c	N4	

Cause	M	This IE shall indicate the acceptance or the rejection of the corresponding request message.	X	X	X	X	Cause
Offending IE	C	This IE shall be included if the rejection is due to a conditional or mandatory IE missing or faulty.	X	X	X	X	Offending IE
Created PDR	C	This IE shall be present if the cause is set to "success", new PDR(s) were requested to be created and the UP function was requested to allocate the local F-TEID for the PDR(s). When present, this IE shall contain the PDR information associated to the PFCP session. See Table 7.5.3.2-1.	X	X	-	X	Created PDR
Load Control Information	O	The UP function may include this IE if it supports the load control feature and the feature is activated in the network. See Table 7.5.3.3-1.	X	X	X	X	Load Control Information
Overload Control Information	O	During an overload condition, the UP function may include this IE if it supports the overload control feature and the feature is activated in the network.	X	X	X	X	Overload Control Information
Usage Report	C	This IE shall be present if: - the Query URR IE was present or the QAURR flag was set to "1" in the PFCP Session Modification Request, - traffic usage measurements for that URR are available at the UP function, and - the UP function decides to return some or all of the requested usage reports in the PFCP Session Modification Response. This IE shall be also present if: - a URR or the last PDR associated to a URR has been removed, - non-null traffic usage measurements for that URR are available in the UP function, and - the UP function decides to return some or all of the related usage reports in the PFCP Session Modification Response (see clause 5.2.2.3.1). Several IEs within the same IE type may be present to represent a list of Usage Reports.	X	X	X	X	Usage Report
Failed Rule ID	C	This IE shall be included if the Cause IE indicates a rejection due to a rule creation or modification failure.	X	X	X	X	Failed Rule ID
Additional Usage Reports Information	C	This IE shall be included if the Query URR IE was present or the QAURR flag was set to "1" in the PFCP Session Modification Request, and usage reports need to be sent in additional PFCP Session Report Request messages (see clause 5.2.2.3.1). When present, this IE shall either indicate that additional usage reports will follow, or indicate the total number of usage reports that need to be sent in PFCP Session Report Request messages.	X	X	X	X	Additional Usage Reports Information
Created/Updated Traffic Endpoint	C	This IE shall be present if the cause is set to "success", Traffic Endpoint(s) were requested to be created or updated, and the UP function was requested to allocate the local F-TEID for the Traffic Endpoint(s). When present, this IE shall contain the Traffic Endpoint information associated to the PFCP session. See Table 7.5.3.5-1.	X	X	-	X	Created Traffic Endpoint

7.5.5.2 Usage Report IE within PFCP Session Modification Response

The Usage Report grouped IE shall be encoded as shown in Figure 7.5.5.2-1.

Table 7.5.5.2-1: Usage Report IE within PFCP Session Modification Response

Octet 1 and 2		Usage Report IE Type = 78 (decimal)					
Octets 3 and 4		Length = n					
Information elements	P	Condition / Comment	Appl.				IE Type
			Sx a	Sx b	Sx c	N4	
URR ID	M	This IE shall identify the URR for which usage is reported.	X	X	X	X	URR ID
UR-SEQN	M	This IE shall uniquely identify the Usage Report for the URR (see clause 5.2.2.3).	X	X	X	X	UR-SEQN
Usage Report Trigger	M	This IE shall identify the trigger for this report.	X	X	X	X	Usage Report Trigger
Start Time	C	This IE shall be present, except if the Usage Report Trigger indicates 'Start of Traffic', 'Stop of Traffic' or 'MAC Addresses Reporting'. When present, this IE shall provide the timestamp when the collection of the information in this report was started.	X	X	X	X	Start Time
End Time	C	This IE shall be present, except if the Usage Report Trigger indicates 'Start of Traffic', 'Stop of Traffic' or 'MAC Addresses Reporting'. When present, this IE shall provide the timestamp when the collection of the information in this report was generated.	X	X	X	X	End Time
Volume Measurement	C	This IE shall be present if a volume measurement needs to be reported.	X	X	X	X	Volume Measurement
Duration Measurement	C	This IE shall be present if a duration measurement needs to be reported.	X	X	X	X	Duration Measurement
Time of First Packet	C	This IE shall be present if available for this URR.	-	X	X	X	Time of First Packet
Time of Last Packet	C	This IE shall be present if available for this URR.	-	X	X	X	Time of Last Packet
Usage Information	C	This IE shall be present if the UP function reports Usage Reports before and after a Monitoring Time or before and after QoS enforcement. When present, it shall indicate whether the usage is reported for the period before or after that time, or before or after QoS enforcement.	X	X	X	X	Usage Information
Query URR Reference	C	This IE shall be present if this usage report is sent as a result of a query URR received in an PFCP Session Modification Request and the Query URR Reference IE was present in the PFCP Session Modification Request. When present, it shall be set to the Query URR Reference value received in the PFCP Session Modification Request.	X	X	X	X	Query URR Reference
Ethernet Traffic Information	C	This IE shall be present if Ethernet Traffic Information needs to be reported.	-	-	-	X	Ethernet Traffic Information

7.5.6 PFCP Session Deletion Request

The PFCP Session Deletion Request shall be sent over the Sxa, Sxb, Sxc and N4 interface by the CP function to request the UP function to delete the PFCP session.

Table 7.5.6-1: Information Elements in a PFCP Session Deletion Request

Information elements	P	Condition / Comment	Appl.				IE Type
			Sx a	Sx b	Sx c	N4	

7.5.7 PFCP Session Deletion Response

7.5.7.1 General

The PFCP Session Deletion Response shall be sent over the Sxa, Sxb, Sxc and N4 interface by the UP function to the CP function as a reply to the PFCP Session Deletion Request.

Table 7.5.7.1-1: Information Elements in a PFCP Session Deletion Response

Information elements	P	Condition / Comment	Appl.				IE Type
			Sx a	Sx b	Sx c	N4	
Cause	M	This IE shall indicate the acceptance or the rejection of the corresponding request message.	X	X	X	X	Cause
Offending IE	C	This IE shall be included if the rejection is due to an conditional or mandatory IE missing or faulty.	X	X	X	X	Offending IE
Load Control Information	O	The UP function may include this IE if it supports the load control feature and the feature is activated in the network. See Table 7.5.3.3-1.	X	X	X	X	Load Control Information
Overload Control Information	O	During an overload condition, the UP function may include this IE if it supports the overload control feature and the feature is activated in the network. See Table 7.5.3.4-1.	X	X	X	X	Overload Control Information
Usage Report	C	This IE shall be present if a URR had been provisioned in the UP function for the PFCP session being deleted and traffic usage measurements for that URR are available at the UP function. Several IEs within the same IE type may be present to represent a list of Usage Reports.	X	X	X	X	Usage Report

7.5.7.2 Usage Report IE within PFCP Session Deletion Response

The Usage Report grouped IE shall be encoded as shown in Figure 7.5.7.2-1.

Table 7.5.7.2-1: Usage Report IE within PFCP Session Deletion Response

Octet 1 and 2	Usage Report IE Type = 79 (decimal)						
Octets 3 and 4	Length = n						
Information elements	P	Condition / Comment	Appl.				IE Type
			Sx a	Sx b	Sx c	N4	

URR ID	M	This IE shall identify the URR for which usage is reported.	X	X	X	X	URR ID
UR-SEQN	M	This IE shall uniquely identify the Usage Report for the URR (see clause 5.2.2.3).	X	X	X	X	UR-SEQN
Usage Report Trigger	M	This IE shall identify the trigger for this report.	X	X	X	X	Usage Report Trigger
Start Time	C	This IE shall be present, except if the Usage Report Trigger indicates 'Start of Traffic', 'Stop of Traffic' or 'MAC Addresses Reporting'. When present, this IE shall provide the timestamp when the collection of the information in this report was started.	X	X	X	X	Start Time
End Time	C	This IE shall be present, except if the Usage Report Trigger indicates 'Start of Traffic', 'Stop of Traffic' or 'MAC Addresses Reporting'. When present, this IE shall provide the timestamp when the collection of the information in this report was generated.	X	X	X	X	End Time
Volume Measurement	C	This IE shall be present if a volume needs to be reported.	X	X	X	X	Volume Measurement
Duration Measurement	C	This IE shall be present if a duration measurement needs to be reported.	X	X	X	X	Duration Measurement
Time of First Packet	C	This IE shall be present if available for this URR.	-	X	X	X	Time of First Packet
Time of Last Packet	C	This IE shall be present if available for this URR.	-	X	X	X	Time of Last Packet
Usage Information	C	This IE shall be present if the UP function reports Usage Reports before and after a Monitoring Time, or before and after QoS enforcement. When present, it shall indicate whether the usage is reported for the period before or after that time, or before or after QoS enforcement.	X	X	X	X	Usage Information
Ethernet Traffic Information	C	This IE shall be present if Ethernet Traffic Information needs to be reported. See Table 7.5.8.3-3.	-	-	-	X	Ethernet Traffic Information

7.5.8 PFCP Session Report Request

7.5.8.1 General

The PFCP Session Report Request shall be sent over the Sxa, Sxb, Sxc and N4 interface by the UP function to report information related to an PFCP session to the CP function.

Table 7.5.8-1: Information Elements in a PFCP Session Report Request

Information elements	P	Condition / Comment	Appl.				IE Type
			Sx a	Sx b	Sx c	N4	

Report Type	M	This IE shall indicate the type of the report.	X	X	X	X	Report Type
Downlink Data Report	C	This IE shall be present if the Report Type indicates a Downlink Data Report.	X	-	-	X	Downlink Data Report
Usage Report	C	This IE shall be present if the Report Type indicates a Usage Report. Several IEs within the same IE type may be present to represent a list of Usage Reports.	X	X	X	X	Usage Report
Error Indication Report	C	This IE shall be present if the Report Type indicates an Error Indication Report.	X	X	-	X	Error Indication Report
Load Control Information	O	The UP function may include this IE if it supports the load control feature and the feature is activated in the network. See Table 7.5.3.3-1.	X	X	X	X	Load Control Information
Overload Control Information	O	During an overload condition, the UP function may include this IE if it supports the overload control feature and the feature is activated in the network. See Table 7.5.3.4-1.	X	X	X	X	Overload Control Information
Additional Usage Reports Information	C	This IE shall be included in one additional PFCP Session Report Request message, if the PFCP Session Modification Response indicated that more reports would follow (i.e. if the AURI flag was set to "1") (see clause 5.2.2.3.1). When present, this IE shall indicate the total number of usage reports that need to be sent in PFCP Session Report Request messages.	X	X	X	X	Additional Usage Reports Information

7.5.8.2 Downlink Data Report IE within PFCP Session Report Request

The Downlink Data Report grouped IE shall be encoded as shown in Figure 7.5.8.2-1.

Table 7.5.8.2-1: Downlink Data Report IE within PFCP Session Report Request

Octet 1 and 2		Downlink Data Report IE Type = 83 (decimal)					
Octets 3 and 4		Length = n					
Information elements	P	Condition / Comment	Appl.				IE Type
			Sx a	Sx b	Sx c	N4	
PDR ID	M	This IE shall identify the PDR for which downlink data packets have been received at the UP function. More than one IE with this type may be included to represent multiple PDRs having received downlink data packets.	X	-	-	X	PDR ID
Downlink Data Service Information	C	This IE shall be included for an PFCP session with an IP PDN type, if the UP function supports the Paging Policy Differentiation feature (see clause 4.9 of 3GPP TS 23.401 [14]) and clause 5.4.3.2 of 3GPP TS 23.501 [28]). When present, for each PDR and for each packet that triggers a Downlink Data Notification, the UP function shall copy, into the Paging Policy Indication value within this IE, the value of the DSCP in TOS (IPv4) or TC (IPv6) information received in the IP payload of the GTP-U packet from the PGW (see IETF RFC 2474 [13]). For 5GC, this IE shall also be included over N4, for each PDR and for each packet that triggers a Downlink Data Notification, if the QFI of the downlink data packet is available. One IE with this type shall be included per PDR ID reported in the message. When multiple PDR ID IEs are present in the message, the Downlink Data Service Information IEs shall be reported according to the order of the PDR ID IEs.	X	-	-	X	Downlink Data Service Information

7.5.8.3 Usage Report IE within PFCP Session Report Request

The Usage Report grouped IE shall be encoded as shown in Figure 7.5.8.3-1.

Table 7.5.8.3-1: Usage Report IE within PFCP Session Report Request

Octet 1 and 2	Usage Report IE Type = 80 (decimal)						
Octets 3 and 4	Length = n						
Information elements	P	Condition / Comment	Appl.				IE Type
			Sx a	Sx b	Sx c	N4	

URR ID	M	This IE shall identify the URR for which usage is reported.	X	X	X	X	URR ID
UR-SEQN	M	This IE shall uniquely identify the Usage Report for the URR (see clause 5.2.2.3).	X	X	X	X	UR-SEQN
Usage Report Trigger	M	This IE shall identify the trigger for this report.	X	X	X	X	Usage Report Trigger
Start Time	C	This IE shall be present, except if the Usage Report Trigger indicates 'Start of Traffic', 'Stop of Traffic' or 'MAC Addresses Reporting'. When present, this IE shall provide the timestamp when the collection of the information in this report was started.	X	X	X	X	Start Time
End Time	C	This IE shall be present, except if the Usage Report Trigger indicates 'Start of Traffic', 'Stop of Traffic' or 'MAC Addresses Reporting'. When present, this IE shall provide the timestamp when the collection of the information in this report was generated.	X	X	X	X	End Time
Volume Measurement	C	This IE shall be present if a volume measurement needs to be reported.	X	X	X	X	Volume Measurement
Duration Measurement	C	This IE shall be present if a duration measurement needs to be reported.	X	X	X	X	Duration Measurement
Application Detection Information	C	This IE shall be present if application detection information needs to be reported.	-	X	X	X	Application Detection Information
UE IP address	C	This IE shall be present if the start or stop of an application has been detected and no UE IP address was provisioned in the PDI. See NOTE 1.	-	-	X	X	UE IP address
Network Instance	C	This IE shall be present if the start or stop of an application has been detected, no UE IP address was provisioned in the PDI and multiple PDNs with overlapping IP addresses are used in the UP function. See NOTE 1.	-	-	X	X	Network Instance
Time of First Packet	C	This IE shall be present if available for this URR.	-	X	X	X	Time of First Packet
Time of Last Packet	C	This IE shall be present if available for this URR.	-	X	X	X	Time of Last Packet
Usage Information	C	This IE shall be present if the UP function reports Usage Reports before and after a Monitoring Time, or before and after QoS enforcement. When present, it shall indicate whether the usage is reported for the period before or after that time, or before or after QoS enforcement.	X	X	X	X	Usage Information
Query URR Reference	C	This IE shall be present if this usage report is sent as a result of a query URR received in an PFCP Session Modification Request and the Query URR Reference IE was present in the PFCP Session Modification Request. When present, it shall be set to the Query URR Reference value received in the PFCP Session Modification Request.	X	X	X	X	Query URR Reference
Event Time Stamp	C	This IE shall be present, if the report is related to an event. When present, it shall be set to the time when the event occurs. Several IEs with the same IE type may be present to report multiple occurrences for an event for this URR ID.	-	X	X	X	Event Time Stamp
Ethernet Traffic Information	C	This IE shall be present if Ethernet Traffic Information needs to be reported. See Table 7.5.8.3-3.	-	-	-	X	Ethernet Traffic Information

NOTE 1: This is the case for unsolicited application reporting by the TDF. The Network instance is required when the UE IP address cannot be used to determine the corresponding PDN connection.

Table 7.5.8.3-2: Application Detection Information IE within Usage Report IE

Octet 1 and 2	Application Detection Information IE Type = 68 (decimal)						
Octets 3 and 4	Length = n						
Information elements	P	Condition / Comment	Appl.				IE Type
			Sx a	Sx b	Sx c	N4	

Application ID	M	This IE shall identify the Application ID for which a start or stop of traffic is reported.	-	X	X	X	Application ID
Application Instance ID	C	When present, this IE shall identify the Application Instance Identifier for which a start or stop of traffic is reported. It shall be present, when reporting the start of an application, if the Reduced Application Detection Information flag was not set in the Measurement Information and if the flow information for the detected application is deducible. It shall be present, when reporting the stop of an application, if the Reduced Application Detection Information flag was not set in the Measurement Information and if it was provided when reporting the start of the application.	-	X	X	X	Application Instance ID
Flow Information	C	When present, this IE shall contain the flow information for the detected application. It shall be present, when reporting the start of an application, if the Reduced Application Detection Information flag was not set in the Measurement Information and if the flow information for the detected application is deducible.	-	X	X	X	Flow Information

Table 7.5.8.3-3: Ethernet Traffic Information IE within Usage Report IE

Octet 1 and 2	Ethernet Traffic Information IE Type = 143 (decimal)						
Octets 3 and 4	Length = n						
Information elements	P	Condition / Comment	Appl.				IE Type
			Sx a	Sx b	Sx c	N4	
MAC Addresses Detected	C	This IE shall be present if one or more new MAC addresses have been detected. When present, it shall identify the MAC (Ethernet) addresses newly detected as source address of frames sent UL by the UE.	-	-	-	X	MAC Addresses Detected
MAC Addresses Removed	C	This IE shall be present if one or more new MAC addresses have been removed. When present, it shall identify the MAC (Ethernet) addresses that have been inactive for a duration exceeding the Ethernet inactivity Timer.	-	-	-	X	MAC Addresses Removed

7.5.8.4 Error Indication Report IE within PFCP Session Report Request

The Error Indication Report grouped IE shall be encoded as shown in Figure 7.5.8.4-1.

Table 7.5.8.4-1: Error Indication Report IE within PFCP Session Report Request

Octet 1 and 2	Error Indication Report IE Type = 99 (decimal)						
Octets 3 and 4	Length = n						
Information elements	P	Condition / Comment	Appl.				IE Type
			Sx a	Sx b	Sx c	N4	
Remote F-TEID	M	This IE shall identify the remote F-TEID of the GTP-U bearer for which an Error Indication has been received at the UP function. More than one IE with this type may be included to represent multiple remote F-TEID for which an Error Indication has been received.	X	X	-	X	F-TEID

7.5.9 PFCP Session Report Response

7.5.9.1 General

The PFCP Session Report Response shall be sent over the Sxa, Sxb, Sxc and N4 interface by the CP function to the UP function as a reply to the PFCP Session Report Request.

Table 7.5.9.1-1: Information Elements in a PFCP Session Report Response

Information elements	P	Condition / Comment	Appl.				IE Type
			Sx a	Sx b	Sx c	N4	
Cause	M	This IE shall indicate the acceptance or the rejection of the corresponding request message.	X	X	X	X	Cause
Offending IE	C	This IE shall be included if the rejection is due to a conditional or mandatory IE missing or faulty.	X	X	X	X	Offending IE
Update BAR	C	This IE shall be present if a BAR previously created for the PFCP session needs to be modified. A previously created BAR that is not modified shall not be included. See Table 7.5.9.2-1.	X	-	-	X	Update BAR
PFCPSRRsp-Flags	C	This IE shall be included if at least one of the flags is set to "1". - DROBU (Drop Buffered Packets): the CP function shall set this flag if the UP function needs to drop the packets currently buffered for this PFCP session (see NOTE 1).	X	-	-	X	PFCPSRRsp-Flags

NOTE 1: The CP function may request the UP function to drop the packets currently buffered for the PFCP session, when buffering is performed in the UP function, upon receipt of an PFCP Session Report Request notifying the CP function about the arrival of downlink data packets for which the CP function decides to throttle the corresponding Downlink Data Notification message over S11/S4 and. See clause 5.9.3 of 3GPP TS 23.214 [2].

7.5.9.2 Update BAR IE within PFCP Session Report Response

The Update BAR grouped IE shall be encoded as shown in Figure 7.5.9.2-1.

Table 7.5.9.2-1: Update BAR IE in PFCP Session Report Response

Octet 1 and 2	Update BAR IE Type = 12 (decimal)						
Octets 3 and 4	Length = n						
Information elements	P	Condition / Comment	Appl.				IE Type
			Sx a	Sx b	Sx c	N4	

BAR ID	M	This IE shall identify the BAR Rule to be modified.	X	-	-	X	BAR ID
Downlink Data Notification Delay	C	This IE shall be present if the UP function indicated support of the Downlink Data Notification Delay parameter (see clause 8.2.25) and the Downlink Data Notification Delay needs to be modified. When present, it shall contain the delay the UP function shall apply between receiving a downlink data packet and notifying the CP function about it, when the Apply Action parameter requests to buffer the packets and notify the CP function.	X	-	-	X	Downlink Data Notification Delay
DL Buffering Duration	C	This IE shall be present if the UP function indicated support of the DL Buffering Duration parameter (see clause 8.2.25) and extended buffering of downlink data packet is required in the UP function. When present, this IE shall indicate the duration during which the UP function shall buffer the downlink data packets without sending any further notification to the CP function about the arrival of DL data packets.	X	-	-	X	DL Buffering Duration
DL Buffering Suggested Packet Count	O	This IE may be present if extended buffering of downlink data packet is required in the UP function. When present, this IE shall indicate the maximum number of downlink data packets suggested to be buffered in the UP function.	X	-	-	X	DL Buffering Suggested Packet Count
Suggested Buffering Packets Count	C	This IE may be present if the UP Function indicated support of the feature UDBC. When present, it shall contain the number of packets that are suggested to be buffered when the Apply Action parameter requests to buffer the packets. The packets that exceed the limit shall be discarded.		X	X	X	Suggested Buffering Packets Count
NOTE 1: If the Apply Action requests the UP function to buffer and notify the CP function and the DL Buffering Duration is set, the UP function shall not notify the CP function for the duration indicated by the DL Buffering Duration.							

7.6 Error Handling

7.6.1 Protocol Errors

A protocol error is defined as a message or an Information Element received from a peer entity with an unknown type, or if it is unexpected, or if it has an erroneous content.

The term silently discarded is used in the following clauses to mean that the receiving PFCP entity's implementation shall discard such a message without further processing or that the receiving PFCP entity discards such an IE and continues processing the message. The conditions for the receiving PFCP entity to silently discard an IE are specified in the subsequent clauses.

The handling of unknown, unexpected or erroneous PFCP messages and IEs shall provide for the forward compatibility of PFCP. Therefore, the sending PFCP entity shall be able to safely include in a message a new conditional-optional or an optional IE. Such an IE may also have a new type value. Any legacy receiving PFCP entity shall, however, silently discard such an IE and continue processing the message.

If a protocol error is detected by the receiving PFCP entity, it should log the event including the erroneous message and may include the error in a statistical counter.

For Response messages containing a rejection Cause value, see clause 7.2.3.2.

The receiving PFCP entity shall apply the error handling specified in the subsequent clauses.

If the received erroneous message is a reply to an outstanding PFCP message, the PFCP transaction layer shall stop retransmissions and notify the PFCP application layer of the error even if the reply is silently discarded.

7.6.2 Different PFCP Versions

If a PFCP entity receives a message of an unsupported PFCP version, it shall return an PFCP Version Not Supported Response message and silently discard the received message.

7.6.3 PFCP Message of Invalid Length

If a PFCP entity receives a message, which is too short to contain the respective PFCP header, the PFCP-PDU shall be silently discarded.

If a PFCP entity receives a Request message within an IP/UDP packet of a length that is inconsistent with the value specified in the Length field of the PFCP header, then the receiving PFCP entity should log the error and shall send the Response message with Cause IE value set to "Invalid Length".

If a PFCP entity receives a Response message within an IP/UDP packet of a length that is inconsistent with the value specified in the Length field of the PFCP header, then the receiving PFCP entity should log the error and shall silently discard the message.

7.6.4 Unknown PFCP Message

If a PFCP entity receives a message with an unknown Message Type value, it shall silently discard the message.

7.6.5 Unexpected PFCP Message

If a PFCP entity receives an unexpected request message, for example a known message that is sent over an interface for which the message is not defined, or a message that is sent over an interface for which the message is defined, but the direction is incorrect, then the PFCP entity shall silently discard the message and shall log an error.

If a PFCP entity receives an unexpected response message which is not a request message, for example a message for which there is no corresponding outstanding request, it shall discard the message and may log an error.

7.6.6 Missing Information Elements

A PFCP entity shall check if all mandatory IEs are present in the received Request message. Apart from Echo Request message, if one or more mandatory information elements are missing in the received Request message, the PFCP entity should log the error and shall send a Response message with Cause IE value set to "Mandatory IE missing" with the type of the missing mandatory IE.

If a PFCP entity receives a Response message with Cause IE value set to "Mandatory IE missing", it shall notify its upper layer.

A PFCP entity shall check if all mandatory IEs are present in the received Response message without a rejection Cause value. If one or more mandatory information elements are missing, the PFCP entity shall notify the upper layer and should log the error.

A PFCP entity shall check if conditional information elements are present in the received Request message, if possible (i.e. if the receiving entity has sufficient information available to check if the respective conditions were met). If one or more conditional information elements are missing, a PFCP entity should log the error and shall send a Response message with Cause IE value set to "Conditional IE missing" together with the type of the missing conditional IE.

A PFCP entity shall check if conditional information elements are present in the received Response message without a rejection Cause value, if possible (i.e. if the receiving entity has sufficient information available to check if the respective conditions were met). If one or more conditional information elements are missing, a PFCP entity shall notify the upper layer and should log the error.

For Response messages containing a rejection Cause value, see clause 7.2.3.2.

Absence of an optional information element shall not trigger any error handling.

7.6.7 Invalid Length Information Element

An information element has an invalid length when the actual length of the IE is different from the value of the Length field in the IE header. Here, the actual length of the IE means the length of the content field of the received IE.

If a PFCP message contains more than one information elements and one or more of them have invalid length, the receiving PFCP entity can detect which of the IEs have invalid length only in the following cases:

- If the Length value in the IE header is greater than the overall length of the message;
- If the invalid length IE is the last one in the message.

Apart from Echo Request message, if a receiving PFCP entity detects information element with invalid length in a Request message, it shall send an appropriate error response with Cause IE value set to "Invalid length" together with the type of the offending IE.

7.6.8 Semantically incorrect Information Element

Apart from Echo Request message, the receiver of a PFCP signalling message Request including a mandatory or a verifiable conditional information element with a semantically invalid Value shall discard the request, should log the error, and shall send a response with Cause IE value set to "Mandatory IE incorrect" together with a type and instance of the offending IE.

The receiver of a PFCP signalling message Response including a mandatory or a verifiable conditional information element with a semantically invalid Value shall notify the upper layer that a message with this sequence number has been received and should log the error.

If a PFCP entity receives an information element with a value which is shown as reserved, it shall treat that information element as invalid and should log the error. If the invalid IE is received in a Request, and it is a mandatory IE or a verifiable conditional IE, the PFCP entity shall send a response with Cause set to "Mandatory IE incorrect" together with a type and instance of the offending IE.

The principle is: the use of reserved values invokes error handling; the use of spare values can be silently discarded and for IEs with spare values used, processing shall be continued ignoring the spare values.

The receiver of a PFCP signalling message including an optional information element with a Value that is not in the range defined for this information element value shall discard this IE, but shall treat the rest of the message as if this IE was absent and continue processing. The receiver shall not check the content of an information element field that is defined as "spare".

All semantically incorrect optional information elements in a PFCP signalling message shall be treated as not present in the message.

7.6.9 Unknown or unexpected Information Element

The receiver of a PFCP message including an unexpected information element with a known Type value that is not defined for this message shall discard the IE and log an error. The receiver shall process the message.

NOTE: An Information Element in an encoded PFCP message or grouped IE is identified by the IE Type.

7.6.10 Repeated Information Elements

An Information Element is repeated if there is more than one IE with the same IE Type in the scope of the PFCP message (or in the scope of the grouped IE). Such an IE is a member in a list.

If an information element is repeated in a PFCP signalling message in which repetition of the information element is not specified, only the contents of the information element appearing first shall be handled and all subsequent repetitions of the information element shall be ignored. When the number of repetitions of information elements is specified, only the contents of specified repeated information elements shall be handled and all subsequent repetitions of the information element shall be ignored.

8 Information Elements

8.1 Information Elements Format

8.1.1 Information Element Format

Figure 8.1.1-1 depicts the format of an Information Element.

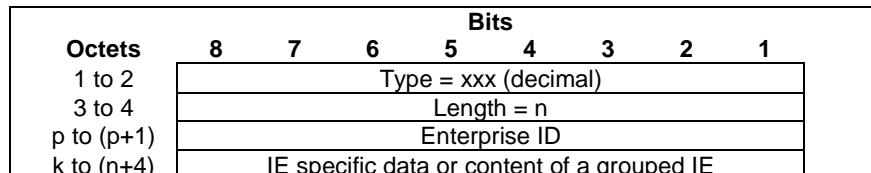

Figure 8.1.1-1: Information Element Format

NOTE 1: If the Bit 8 of Octet 1 is not set, this indicates that the IE is defined by 3GPP and the Enterprise ID is absent. If Bit 8 of Octet 1 is set, this indicates that the IE is defined by a vendor and the Enterprise ID is present identified by the Enterprise ID.

An IE has the following mandatory fields:

- Type: this field indicates the type of the Information Element. IE type values within the range of 0 to 32767 are reserved for IE defined by 3GPP and are listed in clause 8.1.2 IE type values within the range of 32768 to 65535 are used for vendor-specific IE and the value allocation is controlled by the vendor.
- Length: this field contains the length of the IE excluding the first four octets, which are common for all IEs (Type and Length) and is denoted "n" in Figure 8.1.1-1 and in Figure 8.1.1-2. Bit 8 of the lowest numbered octet is the most significant bit and bit 1 of the highest numbered octet is the least significant bit.

An IE has the following optional fields:

- Enterprise ID: if the IE type value is within the range of 32768 to 65535, this field shall contain the IANA-assigned "SMI Network Management Private Enterprise Codes" value of the vendor defining the IE. The Enterprise ID set to "10415" (IANA-assigned "SMI Network Management Private Enterprise Codes") shall not be used for the vendor specific IEs.

For illustration, Figure 8.1.1-2 depicts the format of a Information Element (IE) defined by 3GPP and is specified in this specification. For IE's defined by 3GPP, the IE type shall be within the range of 0 to 32767.

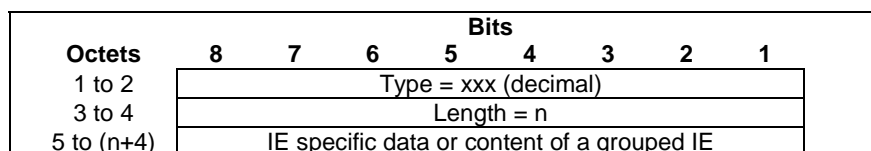

Figure 8.1.1-2: 3GPP defined Information Element Format

NOTE 2: Bit 8 of Octet 1 is not set. This indicates that the Information Element type value has been allocated by 3GPP.

For illustration, Figure 8.1.1-3 depicts the format of a vendor-specific Information Element, which content is not specified and the IE type value shall be within the range of 32768 to 65535.

Octets	Bits						
	8	7	6	5	4	3	2
1 to 2	Type = xxx (decimal)						
3 to 4	Length = n						
5 to 6	Enterprise ID						
7 to (n+4)	IE specific data or content of a grouped IE						

Figure 8.1.1-3: Vendor-Specific Information Element Format

NOTE 3: Bit 8 of Octet 1 is set. This indicates that the IE type value has been allocated by the vendor identified by the Enterprise ID. The content of this IE is vendor specific and therefore out of scope of this specification.

8.1.2 Information Element Types

A PFCP message may contain several IEs. In order to have forward compatible type definitions for the PFCP IEs, all of them shall be TLV (Type, Length, Value) coded. PFCP IE type values are specified in the Table 8.1.2-1. The last column of this table indicates whether the IE is:

- Fixed Length: the IE has a fixed set of fields, and a fixed number of octets;
- Variable Length: the IE has a fixed set of fields, and has a variable number of octets.
For example, the last octets may be numbered similar to "5 to (n+4)". In this example, if the value of the length field, n, is 0, then the last field is not present;
- Extendable: the IE has a variable number of fields, and has a variable number of octets.
The last fields are typically specified with the statement: "These octet(s) is/are present only if explicitly specified". The legacy receiving entity shall ignore the unknown octets.

An IE of any of the above types may have a null length as specified in clause 5.6.3. This shall not be considered as an error by the receiving PFCP entity.

In order to improve the efficiency of troubleshooting, it is recommended that the IEs should be arranged in the signalling messages as well as in the grouped IEs, according to the order the IEs are listed in the message definition table or grouped IE definition table in clause 7. However the receiving entity shall be prepared to handle the messages with IEs in any order.

Within IEs, certain fields may be described as spare. These bits shall be transmitted with the value set to "0". To allow for future features, the receiver shall not evaluate these bits.

Table 8.1.2-1: Information Element Types

IE Type value (Decimal)	Information elements	Comment / Reference	Number of Fixed Octets
0	Reserved		
1	Create PDR	Extendable / Table 7.5.2.2-1	Not Applicable
2	PDI	Extendable / Table 7.5.2.2-2	Not Applicable
3	Create FAR	Extendable / Table 7.5.2.3-1	Not Applicable
4	Forwarding Parameters	Extendable / Table 7.5.2.3-2	Not Applicable
5	Duplicating Parameters	Extendable / Table 7.5.2.3-3	Not Applicable
6	Create URR	Extendable / Table 7.5.2.4-1	Not Applicable
7	Create QER	Extendable / Table 7.5.2.5-1	Not Applicable
8	Created PDR	Extendable / Table 7.5.3.2-1	Not Applicable
9	Update PDR	Extendable / Table 7.5.4.2-1	Not Applicable
10	Update FAR	Extendable / Table 7.5.4.3-1	Not Applicable
11	Update Forwarding Parameters	Extendable / Table 7.5.4.3-2	Not Applicable
12	Update BAR (PFCP Session Report Response)	Extendable / Table 7.5.9.2-1	Not Applicable
13	Update URR	Extendable / Table 7.5.4.4	Not Applicable
14	Update QER	Extendable / Table 7.5.4.5	Not Applicable
15	Remove PDR	Extendable / Table 7.5.4.6	Not Applicable
16	Remove FAR	Extendable / Table 7.5.4.7	Not Applicable
17	Remove URR	Extendable / Table 7.5.4.8	Not Applicable
18	Remove QER	Extendable / Table 7.5.4.9	Not Applicable
19	Cause	Fixed / Clause 8.2.1	1
20	Source Interface	Extendable / Clause 8.2.2	1
21	F-TEID	Extendable / Clause 8.2.3	q-4
22	Network Instance	Variable Length / Clause 8.2.4	Not Applicable
23	SDF Filter	Extendable / Clause 8.2.5	v+2-4
24	Application ID	Variable Length / Clause 8.2.6	Not Applicable
25	Gate Status	Extendable / Clause 8.2.7	1
26	MBR	Extendable / Clause 8.2.8	10
27	GBR	Extendable / Clause 8.2.9	10
28	QER Correlation ID	Extendable / Clause 8.2.10	4
29	Precedence	Extendable / Clause 8.2.11	4
30	Transport Level Marking	Extendable / Clause 8.2.12	2
31	Volume Threshold	Extendable / Clause 8.2.13	q+7-4
32	Time Threshold	Extendable / Clause 8.2.14	4
33	Monitoring Time	Extendable / Clause 8.2.15	4
34	Subsequent Volume Threshold	Extendable / Clause 8.2.16	q+7-4
35	Subsequent Time Threshold	Extendable / Clause 8.2.17	4
36	Inactivity Detection Time	Extendable / Clause 8.2.18	4
37	Reporting Triggers	Extendable / Clause 8.2.19	2
38	Redirect Information	Extendable / Clause 8.2.20	(8+a-1)-4
39	Report Type	Extendable / Clause 8.2.21	1
40	Offending IE	Fixed / Clause 8.2.22	2
41	Forwarding Policy	Extendable / Clause 8.2.23	k-4
42	Destination Interface	Extendable / Clause 8.2.24	1
43	UP Function Features	Extendable / Clause 8.2.25	1
44	Apply Action	Extendable / Clause 8.2.26	1
45	Downlink Data Service Information	Extendable / Clause 8.2.27	1
46	Downlink Data Notification Delay	Extendable / Clause 8.2.28	1
47	DL Buffering Duration	Extendable / Clause 8.2.29	1
48	DL Buffering Suggested Packet Count	Variable / Clause 8.2.30	Not Applicable
49	PFCPSMReq-Flags	Extendable / Clause 8.2.31	1
50	PFCPSRRsp-Flags	Extendable / Clause 8.2.32	1
51	Load Control Information	Extendable / Table 7.5.3.3-1	Not Applicable
52	Sequence Number	Fixed Length / Clause 8.2.33	4
53	Metric	Fixed Length / Clause 8.2.34	1
54	Overload Control Information	Extendable / Table 7.5.3.4-1	Not Applicable
55	Timer	Extendable / Clause 8.2.35	1
56	PDR ID	Extendable / Clause 8.2.36	2
57	F-SEID	Extendable / Clause 8.2.37	p+15-4
58	Application ID's PFDs	Extendable / Table 7.4.3.1-2	Not Applicable

IE Type value (Decimal)	Information elements	Comment / Reference	Number of Fixed Octets
59	PFD context	Extendable / Table 7.4.3.1-3	Not Applicable
60	Node ID	Extendable / Clause 8.2.38	o-4
61	PFD contents	Extendable / Clause 8.2.39	v-4
62	Measurement Method	Extendable / Clause 8.2.40	1
63	Usage Report Trigger	Extendable / Clause 8.2.41	1
64	Measurement Period	Extendable / Clause 8.2.42	4
65	FQ-CSID	Extendable / Clause 8.2.43	(q+1)-4
66	Volume Measurement	Extendable / Clause 8.2.44	q+7-4
67	Duration Measurement	Extendable / Clause 8.2.45	4
68	Application Detection Information	Extendable / Table 7.5.8.3-2	Not Applicable
69	Time of First Packet	Extendable / Clause 8.2.46	4
70	Time of Last Packet	Extendable / Clause 8.2.47	4
71	Quota Holding Time	Extendable / Clause 8.2.48	4
72	Dropped DL Traffic Threshold	Extendable / Clause 8.2.49	m+7-4
73	Volume Quota	Extendable / Clause 8.2.50	q+7-4
74	Time Quota	Extendable / Clause 8.2.51	4
75	Start Time	Extendable / Clause 8.2.52	4
76	End Time	Extendable / Clause 8.2.53	4
77	Query URR	Extendable / Table 7.5.4.10-1	Not Applicable
78	Usage Report (Session Modification Response)	Extendable / Table 7.5.5.2-1	Not Applicable
79	Usage Report (Session Deletion Response)	Extendable / Table 7.5.7.2-1	Not Applicable
80	Usage Report (Session Report Request)	Extendable / Table 7.5.8.3-1	Not Applicable
81	URR ID	Extendable / Clause 8.2.54	4
82	Linked URR ID	Extendable / Clause 8.2.55	4
83	Downlink Data Report	Extendable / Table 7.5.8.2-1	Not Applicable
84	Outer Header Creation	Extendable / Clause 8.2.56	r+1-4
85	Create BAR	Extendable / Table 7.5.2.6-1	Not Applicable
86	Update BAR (Session Modification Request)	Extendable / Table 7.5.4.11-1	Not Applicable
87	Remove BAR	Extendable / Table 7.5.4.12-1	Not Applicable
88	BAR ID	Extendable / Clause 8.2.57	1
89	CP Function Features	Extendable / Clause 8.2.58	1
90	Usage Information	Extendable / Clause 8.2.59	1
91	Application Instance ID	Variable Length / Clause 8.2.60	Not Applicable
92	Flow Information	Extendable / Clause 8.2.61	m-4
93	UE IP Address	Extendable / Clause 8.2.62	p+15-1
94	Packet Rate	Extendable / Clause 8.2.63	p+2-4
95	Outer Header Removal	Extendable / Clause 8.2.64	1
96	Recovery Time Stamp	Extendable / Clause 8.2.65	4
97	DL Flow Level Marking	Extendable / Clause 8.2.66	p+1-4
98	Header Enrichment	Extendable / Clause 8.2.67	q-4
99	Error Indication Report	Extendable / Table 7.5.8.4-1	Not Applicable
100	Measurement Information	Extendable / Clause 8.2.68	1
101	Node Report Type	Extendable / Clause 8.2.69	1
102	User Plane Path Failure Report	Extendable / Table 7.4.5.1.2-1	Not Applicable
103	Remote GTP-U Peer	Extendable / Clause 8.2.70	p+15-4
104	UR-SEQN	Fixed Length / Clause 8.2.71	4
105	Update Duplicating Parameters	Extendable / Table 7.5.4.3-3	Not Applicable
106	Activate Predefined Rules	Variable Length / Clause 8.2.72	Not Applicable
107	Deactivate Predefined Rules	Variable Length / Clause 8.2.73	Not Applicable
108	FAR ID	Extendable / Clause 8.2.74	4
109	QER ID	Extendable / Clause 8.2.75	4
110	OCI Flags	Extendable / Clause 8.2.76	1
111	PCFP Association Release Request	Extendable / Clause 8.2.77	1
112	Graceful Release Period	Extendable / Clause 8.2.78	1
113	PDN Type	Extendable / Clause 8.2.79	1

IE Type value (Decimal)	Information elements	Comment / Reference	Number of Fixed Octets
114	Failed Rule ID	Extendable / Clause 8.2.80	p-4
115	Time Quota Mechanism	Extendable / Clause 8.2.81	5
116	User Plane IP Resource Information	Extendable / Clause 8.2.82	l+1-4
117	User Plane Inactivity Timer	Extendable / Clause 8.2.83	4
118	Aggregated URRs	Extendable / Table 7.5.2.4-2	Not Applicable
119	Multiplier	Fixed / Clause 8.2.84	12
120	Aggregated URR ID	Fixed / Clause 8.2.85	4
121	Subsequent Volume Quota	Extendable / Clause 8.2.86	q+7-4
122	Subsequent Time Quota	Extendable / Clause 8.2.87	4
123	RQI	Extendable / Clause 8.2.88	1
124	QFI	Extendable / Clause 8.2.89	m-4
125	Query URR Reference	Extendable / Clause 8.2.90	4
126	Additional Usage Reports Information	Extendable / Clause 8.2.91	2
127	Create Traffic Endpoint	Extendable / Table 7.5.2.7	Not Applicable
128	Created Traffic Endpoint	Extendable / Table 7.5.3.5	Not Applicable
129	Update Traffic Endpoint	Extendable / Table 7.5.4.13	Not Applicable
130	Remove Traffic Endpoint	Extendable / Table 7.5.4.14	Not Applicable
131	Traffic Endpoint ID	Extendable / Clause 8.2.92	1
132	Ethernet Packet Filter	Extendable / Table 7.5.2.2-3	Not Applicable
133	MAC address	Extendable / Clause 8.2.93	s-1-4
134	C-TAG	Extendable / Clause 8.2.94	3
135	S-TAG	Extendable / Clause 8.2.95	3
136	Ethertype	Extendable / Clause 8.2.96	2
137	Proxying	Extendable / Clause 8.2.97	1
138	Ethernet Filter ID	Extendable / Clause 8.2.98	4
139	Ethernet Filter Properties	Extendable / Clause 8.2.99	1
140	Suggested Buffering Packets Count	Extendable / Clause 8.2.100	
141	User ID	Extendable / Clause 8.2.101	h-1-4
142	Ethernet PDU Session Information	Extendable / Clause 8.2.102	1
143	Ethernet Traffic Information	Extendable / Table 7.5.8.3-3	Not Applicable
144	MAC Addresses Detected	Extendable / Clause 8.2.103	7
145	MAC Addresses Removed	Extendable / Clause 8.2.104	7
146	Ethernet Inactivity Timer	Extendable / Clause 8.2.105	4
147	Additional Monitoring Time	Extendable / Table 7.5.2.4-3	Not Applicable
148	Event Quota	Extendable / Clause 8.2.112	4
149	Event Threshold	Extendable / Clause 8.2.113	4
150	Subsequent Event Quota	Extendable / Clause 8.2.106	4
151	Subsequent Event Threshold	Extendable / Clause 8.2.107	4
152	Trace Information	Extendable / Clause 8.2.108	q-4
153	Framed-Route	Variable Length / Clause 8.2.109	Not Applicable
154	Framed-Routing	Fixed Length / Clause 8.2.110	4
155	Framed-IPv6-Route	Variable Length / Clause 8.2.111	Not Applicable
156	Event Time Stamp	Extendable / Clause 8.2.114	4
157	Averaging Window	Extendable / Clause 8.2.115	4
158	Paging Policy Indicator	Extendable / Clause 8.2.116	1
159	APN/DNN	Variable Length / Clause 8.2.117	Not Applicable
160	3GPP Interface Type	Extendable / Clause 8.2.118	1
161 to 65535	Spare. For future use.		

8.2 Information Elements

8.2.1 Cause

Cause IE is coded as depicted in Figure 8.2.1-1.

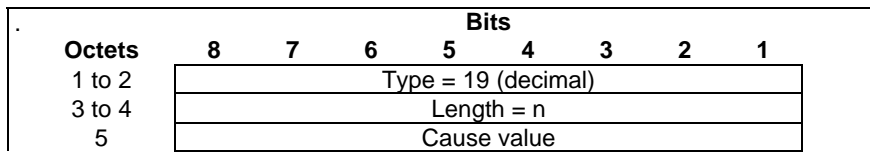

Figure 8.2.1-1: Cause

The Cause value shall be included in a response message. In a response message, the Cause value indicates the acceptance or the rejection of the corresponding request message. The Cause value indicates the explicit reason for the rejection.

Table 8.2.1-1: Cause values

Message Type	Cause value (decimal)	Meaning	Description
	0	Reserved.	Shall not be sent and if received the Cause shall be treated as an invalid IE
Acceptance in a response	1	Request accepted (success)	"Request accepted (success)" is returned when the PFCP entity has accepted a request.
	2-63	Spare.	This value range shall be used by Cause values in an acceptance response message. See NOTE 1.
Rejection in a response	64	Request rejected (reason not specified)	This cause shall be returned to report an unspecified rejection cause
	65	Session context not found	This cause shall be returned, if the F-SEID included in a PFCP Session Modification/Deletion Request message is unknown.
	66	Mandatory IE missing	This cause shall be returned when the PFCP entity detects that a mandatory IE is missing in a request message
	67	Conditional IE missing	This cause shall be returned when the PFCP entity detects that a Conditional IE is missing in a request message.
	68	Invalid length	This cause shall be returned when the PFCP entity detects that an IE with an invalid length in a request message
	69	Mandatory IE incorrect	This cause shall be returned when the PFCP entity detects that a Mandatory IE is incorrect in a request message, e.g. the Mandatory IE is malformed or it carries an invalid or unexpected value.
	70	Invalid Forwarding Policy	This cause shall be used by the UP function in the PFCP Session Establishment Response or PFCP Session Modification Response message if the CP function attempted to provision a FAR with a Forwarding Policy Identifier for which no Forwarding Policy is locally configured in the UP function.
	71	Invalid F-TEID allocation option	This cause shall be used by the UP function in the PFCP Session Establishment Response or PFCP Session Modification Response message if the CP function attempted to provision a PDR with a F-TEID allocation option which is incompatible with the F-TEID allocation option used for already created PDRs (by the same or a different CP function).
	72	No established PFCP Association	This cause shall be used by the CP function or the UP function if they receive a PFCP Session related message from a peer with which there is no established PFCP Association.
	73	Rule creation/modification Failure	This cause shall be used by the UP function if a received Rule failed to be stored and be applied in the UP function.
74	PFCP entity in congestion	This cause shall be returned when a PFCP entity has detected node level congestion and performs overload control, which does not allow the request to be processed.	

	75	No resources available	This cause shall be returned to indicate a temporary unavailability of resources to process the received request.
	76	Service not supported	This cause shall be returned when a PFCP entity receives a message requesting a feature or service that is not supported.
	77	System failure	This cause shall be returned to indicate a system error condition.
	78 to 255	Spare for future use in a response message. See NOTE 2.	This value range shall be used by Cause values in a rejection response message. See NOTE 2.
<p>NOTE 1: This value is or may be used in future version of the specification. If the receiver cannot comprehend the value, it shall be interpreted as an unspecified acceptance cause. Unspecified/unrecognized acceptance cause shall be treated in the same ways as the cause value 1 "Request accepted (success)".</p> <p>NOTE 2: This value is or may be used in a future version of the specification. If the receiver cannot comprehend the value, it shall be interpreted as an unspecified rejection cause. Unspecified/unrecognized rejection cause shall be treated in the same ways as the cause value 32 "Request rejected (reason not specified)".</p>			

8.2.2 Source Interface

The Source Interface IE type shall be encoded as shown in Figure 8.2.2-1. It indicates the type of the interface from which an incoming packet is received.

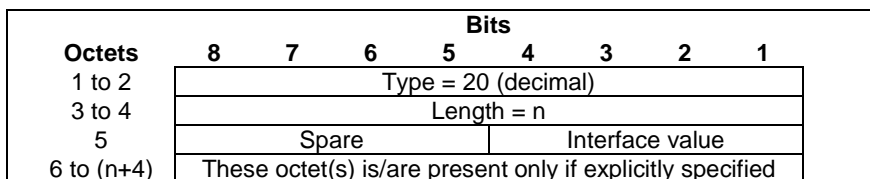

Figure 8.2.2-1: Source Interface

The Interface value shall be encoded as a 4 bits binary integer as specified in in Table 8.2.2-1.

Table 8.2.2-1: Interface value

Interface value	Values (Decimal)
Access	0
Core	1
SGi-LAN/N6-LAN	2
CP-function	3
Spare	4 to 15
<p>NOTE 1: The "Access" and "Core" values denote an uplink and downlink traffic direction respectively.</p> <p>NOTE 2: For indirect data forwarding, the Source Interface in the PDR and the Destination Interface in the FAR shall both be set to "Access", in the forwarding SGW(s). The Interface value does not infer any traffic direction, in PDRs and FARs set up for indirect data forwarding, i.e. with both the Source and Destination Interfaces set to Access.</p>	

8.2.3 F-TEID

The F-TEID IE type shall be encoded as shown in Figure 8.2.3-1. It indicates an F-TEID.

Octets	Bits							
	8	7	6	5	4	3	2	1
1 to 2	Type = 21 (decimal)							
3 to 4	Length = n							
5	Spare			CHID	CH	V6	V4	
6 to 9	TEID							
m to (m+3)	IPv4 address							
p to (p+15)	IPv6 address							
q	CHOOSE ID							
k to (n+4)	These octet(s) is/are present only if explicitly specified							

Figure 8.2.3-1: F-TEID

The following flags are coded within Octet 5:

- Bit 1 – V4: If this bit is set to "1" and the CH bit is not set, then the IPv4 address field shall be present, otherwise the IPv4 address field shall not be present.
- Bit 2 – V6: If this bit is set to "1" and the CH bit is not set, then the IPv6 address field shall be present, otherwise the IPv6 address field shall not be present.
- Bit 3 – CH (CHOOSE): If this bit is set to "1", then the TEID, IPv4 address and IPv6 address fields shall not be present and the UP function shall assign an F-TEID with an IP4 or an IPv6 address if the V4 or V6 bit is set respectively. This bit shall only be set by the CP function.
- Bit 4 – CHID (CHOOSE ID): If this bit is set to "1", then the UP function shall assign the same F-TEID to the PDRs requested to be created in a PFCP Session Establishment Request or PFCP Session Modification Request with the same CHOOSE ID value. This bit may only be set to "1" if the CH bit is set to "1". This bit shall only be set by the CP function.
- Bit 5 to 8: Spare, for future use and set to "0".

At least one of the V4 and V6 flags shall be set to "1", and both may be set to "1" for both scenarios:

- when the CP function is allocating F-TEID, i.e. both IPv4 address field and IPv6 address field may be present;
- or when the UP function is requested to allocate the F-TEID, i.e. when CHOOSE bit is set to "1", and the IPv4 address and IPv6 address fields are not present.

Octet 6 to 9 (TEID) shall be present and shall contain a GTP-U TEID, if the CH bit in octet 5 is not set. When the TEID is present, if both IPv4 and IPv6 addresses are present in the F-TEID IE, then the TEID value shall be shared by both addresses.

Octets "m to (m+3)" and/or "p to (p+15)" (IPv4 address / IPv6 address fields), if present, it shall contain the respective IP address values.

Octet q shall be present and shall contain a binary integer value if the CHID bit in octet 5 is set to "1".

8.2.4 Network Instance

The Network Instance IE type shall be encoded as shown in Figure 8.2.4-1. It indicates a Network instance.

Octets	Bits						
	8	7	6	5	4	3	2
1 to 2	Type = 22 (decimal)						
3 to 4	Length = n						
5 to (n+4)	Network Instance						

Figure 8.2.4-1: Network Instance

The Network instance field shall be encoded as an OctetString and shall contain an identifier which uniquely identifies a particular Network instance (e.g. PDN instance) in the UP function. It may be encoded as a Domain Name or an Access Point Name (APN) as per clause 9.1 of 3GPP TS 23.003 [2]. In the latter case, the PDN Instance field may

contain the APN Network Identifier only or the full APN with both the APN Network Identifier and the APN Operator Identifier as specified in 3GPP TS 23.003 [2] clauses 9.1.1 and 9.1.2.

NOTE: The APN field is not encoded as a dotted string as commonly used in documentation.

8.2.5 SDF Filter

The SDF Filter IE type shall be encoded as shown in Figure 8.2.5-1. It contains an SDF Filter, i.e. a single IP flow packet filter.

Octets	Bits						
	8	7	6	5	4	3	2
1 to 2	Type = 23 (decimal)						
3 to 4	Length = n						
5	Spare		BID	FL	SPI	TTC	FD
6	Spare						
m to (m+1)	Length of Flow Description						
(m+2) to p	Flow Description						
s to (s+1)	ToS Traffic Class						
t to (t+3)	Security Parameter Index						
v to (v+2)	Flow Label						
w to (w+3)	SDF Filter ID						
x to (n+4)	These octet(s) is/are present only if explicitly specified						

Figure 8.2.5-1: SDF Filter

The following flags are coded within Octet 5:

- Bit 1 – FD (Flow Description): If this bit is set to "1", then the Length of Flow Description and the Flow Description fields shall be present, otherwise they shall not be present.
- Bit 2 – TTC (ToS Traffic Class): If this bit is set to "1", then the ToS Traffic Class field shall be present, otherwise the ToS Traffic Class field shall not be present.
- Bit 3 – SPI (Security Parameter Index): If this bit is set to "1", then the Security Parameter Index field shall be present, otherwise the Security Parameter Index field shall not be present.
- Bit 4 – FL (Flow Label): If this bit is set to "1", then the Flow Label field shall be present, otherwise the Flow Label field shall not be present.
- Bit 5 – BID (Bidirectional SDF Filter): If this bit is set to "1", then the SDF Filter ID shall be present, otherwise the SDF Filter ID shall not be present.
- Bit 6 to 8: Spare, for future use and set to "0".

The Flow Description field, when present, shall be encoded as an OctetString as specified in clause 5.4.2 of 3GPP TS 29.212 [8].

The ToS Traffic Class field, when present, shall be encoded as an OctetString on two octets as specified in clause 5.3.15 of 3GPP TS 29.212 [8].

The Security Parameter Index field, when present, shall be encoded as an OctetString on four octets and shall contain the IPsec security parameter index (which is a 32-bit field), as specified in clause 5.3.51 of 3GPP TS 29.212 [8].

The Flow Label field, when present, shall be encoded as an OctetString on 3 octets as specified in clause 5.3.52 of 3GPP TS 29.212 [8] and shall contain an IPv6 flow label (which is a 20-bit field). The bits 8 to 5 of the octet "v" shall be spare and set to zero, and the remaining 20 bits shall contain the IPv6 flow label.

An SDF Filter may:

- be a pattern for matching the IP 5 tuple (source IP address or IPv6 network prefix, destination IP address or IPv6 network prefix, source port number, destination port number, protocol ID of the protocol above IP). In the pattern:

- a value left unspecified in a filter matches any value of the corresponding information in a packet;
- an IP address may be combined with a prefix mask;
- port numbers may be specified as port ranges;
- the pattern can be extended by the Type of Service (TOS) (IPv4) / Traffic class (IPv6) and Mask;
- consist of the destination IP address and optional mask, protocol ID of the protocol above IP, the Type of Service (TOS) (IPv4) / Traffic class (IPv6) and Mask and the IPsec Security Parameter Index (SPI);
- consist of the destination IP address and optional mask, the Type of Service (TOS) (IPv4) / Traffic class (IPv6) and Mask and the Flow Label (IPv6).

NOTE 1: The details about the IPsec Security Parameter Index (SPI), the Type of Service (TOS) (IPv4) / Traffic class (IPv6) and Mask and the Flow Label (IPv6) are defined in 3GPP TS 23.060 [19] clause 15.3.

- extend the packet inspection beyond the possibilities described above and look further into the packet. Such service data flow filters need to be predefined in the PGW-U, as specified in clause 5.11 of 3GPP TS 23.214 [2].

NOTE 2: Such filters may be used to support filtering with respect to a service data flow based on the transport and application protocols used above IP, e.g. for HTTP and WAP. Filtering for further application protocols and services can also be supported.

The SDF Filter ID, when present, shall be encoded as an Unsigned32 binary integer value. It shall uniquely identify an SDF Filter among all the SDF Filters provisioned for a given PFCP Session. The source/destination IP address and port information, in a bidirectional SDF Filter, shall be set as for downlink IP flows. The SDF filter for the opposite direction has the same parameters, but having the source and destination address/port parameters swapped. When being provisioned with a bidirectional SDF filter in a PDR, the UP function shall apply the SDF filter as specified in clause 5.2.1A.2A.

8.2.6 Application ID

The Application ID IE type shall be encoded as shown in Figure 8.2.6-1. It contains an Application Identifier referencing an application detection filter in the UP function (e.g. its value may represent an application such as a list of URLs).

Octets	Bits						
	8	7	6	5	4	3	2
1 to 2	Type = 24 (decimal)						
3 to 4	Length = n						
5 to (n+4)	Application Identifier						

Figure 8.2.6-1: Application ID

The Application Identifier shall be encoded as an OctetString (see 3GPP TS 29.212 [8]).

8.2.7 Gate Status

The Gate Status IE shall be encoded as shown in Figure 8.2.7-1. It indicates whether the service data flow or application's traffic is allowed to be forwarded (gate is open) or shall be discarded (gate is closed) in uplink and/or in downlink direction.

Octets	Bits						
	8	7	6	5	4	3	2
1 to 2	Type = 25 (decimal)						
3 to 4	Length = n						
5	Spare			UL Gate		DL Gate	
6 to (n+4)	These octet(s) is/are present only if explicitly specified						

Figure 8.2.7-1: Gate Status

Table 8.2.7-1: UL Gate

UL Gate	Value (Decimal)
OPEN	0
CLOSED	1
For future use. Shall not be sent. If received, shall be interpreted as the value "1".	2, 3

Table 8.2.7-2: DL Gate

DL Gate	Value (Decimal)
OPEN	0
CLOSED	1
For future use. Shall not be sent. If received, shall be interpreted as the value "1".	2, 3

8.2.8 MBR

The MBR IE type shall be encoded as shown in Figure 8.2.8-1. It indicates the maximum bit rate allowed for the uplink and downlink directions.

Octets	Bits							
	8	7	6	5	4	3	2	1
1 to 2	Type = 26 (decimal)							
3 to 4	Length = n							
5 to 9	UL MBR							
10 to 14	DL MBR							
15 to (n+4)	These octet(s) is/are present only if explicitly specified							

Figure 8.2.8-1: MBR

The UL/DL MBR fields shall be encoded as kilobits per second (1 kbps = 1000 bps) in binary value. The UL/DL MBR fields may require converting values in bits per second to kilobits per second when the UL/DL MBR values are received from an interface other than GTPv2 interface. If such conversions result in fractions, then the value of UL/DL MBR fields shall be rounded upwards. The range of UL/DL MBR is specified in 3GPP TS 36.413 [10].

NOTE: The encoding is aligned on the encoding specified in 3GPP TS 29.274 [9].

8.2.9 GBR

The GBR IE type shall be encoded as shown in Figure 8.2.9-1. It indicates the guaranteed bit rate authorized for the uplink and/or downlink directions.

Octets	Bits							
	8	7	6	5	4	3	2	1
1 to 2	Type = 27 (decimal)							
3 to 4	Length = n							
5 to 9	UL GBR							
10 to 14	DL GBR							
15 to (n+4)	These octet(s) is/are present only if explicitly specified							

Figure 8.2.9-1: GBR

The UL/DL GBR fields shall be encoded as kilobits per second (1 kbps = 1000 bps) in binary value. The UL/DL GBR fields may require converting values in bits per second to kilobits per second when the UL/DL GBR values are received from an interface other than GTPv2 interface. If such conversions result in fractions, then the value of UL/DL GBR fields shall be rounded upwards. The range of UL/DL GBR is specified in 3GPP TS 36.413 [10].

NOTE: The encoding is aligned on the encoding specified in 3GPP TS 29.274 [9].

8.2.10 QER Correlation ID

The QER Correlation ID IE type shall be encoded as shown in Figure 8.2.10-1. It contains a QoS Enforcement Rule Correlation ID to correlate QERs from different PFCP sessions. The QER Correlation ID shall be dynamically assigned by the CP function and provisioned by the CP function in different PFCP sessions to correlate QERs used in these PFCP sessions.

NOTE: A QER Correlation ID is not a Rule ID. It is only a correlation number to correlate QERs from different PFCP sessions.

Octets	Bits							
	8	7	6	5	4	3	2	1
1 to 2	Type = 28 (decimal)							
3 to 4	Length = n							
5 to 8	QER Correlation ID value							
9 to (n+4)	These octet(s) is/are present only if explicitly specified							

Figure 8.2.10-1: QER Correlation ID

The QER Correlation ID value shall be encoded as an Unsigned32 binary integer value.

8.2.11 Precedence

The Precedence IE type shall be encoded as shown in Figure 8.2.11-1. It defines the relative precedence of a PDR among all the PDRs provisioned within an PFCP session, when looking for a PDR matching an incoming packet.

Octets	Bits							
	8	7	6	5	4	3	2	1
1 to 2	Type = 29 (decimal)							
3 to 4	Length = n							
5 to 8	Precedence value							
9 to (n+4)	These octet(s) is/are present only if explicitly specified							

Figure 8.2.11-1: Precedence

The Precedence value shall be encoded as an Unsigned32 binary integer value. The lower precedence values indicate higher precedence of the PDR, and the higher precedence values indicate lower precedence of the PDR when matching a packet.

8.2.12 Transport Level Marking

The Transport Level Marking IE type shall be encoded as shown in Figure 8.2.12-1. It indicates the DSCP to be used for UL/DL transport level marking.

Octets	Bits							
	8	7	6	5	4	3	2	1
1 to 2	Type = 30 (decimal)							
3 to 4	Length = n							
5 to 6	ToS/Traffic Class							
7 to (n+4)	These octet(s) is/are present only if explicitly specified							

Figure 8.2.12-1: Transport Level Marking

The ToS/Traffic Class shall be encoded on two octets as an OctetString. The first octet shall contain the DSCP value in the IPv4 Type-of-Service or the IPv6 Traffic-Class field and the second octet shall contain the ToS/Traffic Class mask field, which shall be set to "0xFC". See clause 5.3.15 of 3GPP TS 29.212 [8].

NOTE: The original ECN bits in the IP header of user plane packets are not changed after applying transport level marking.

8.2.13 Volume Threshold

The Volume Threshold IE contains the traffic volume thresholds to be monitored by the UP function. It shall be encoded as shown in Figure 8.2.13-1.

Octets	Bits							
	8	7	6	5	4	3	2	1
1 to 2	Type = 31 (decimal)							
3 to 4	Length = n							
5	Spare			DLVO	ULVO	TOVO		
				L	L	L		
m to (m+7)	Total Volume							
p to (p+7)	Uplink Volume							
q to (q+7)	Downlink Volume							
s to (n+4)	These octet(s) is/are present only if explicitly specified							

Figure 8.2.13-1: Volume Threshold

The following flags are coded within Octet 5:

- Bit 1 – TOVOL: If this bit is set to "1", then the Total Volume field shall be present, otherwise the Total Volume field shall not be present.
- Bit 2 – ULVOL: If this bit is set to "1", then the Uplink Volume field shall be present, otherwise the Uplink Volume field shall not be present.
- Bit 3 – DLVOL: If this bit is set to "1", then the Downlink Volume field shall be present, otherwise the Downlink Volume field shall not be present.
- Bit 4 to 8: Spare, for future use and set to "0".

At least one bit shall be set to "1". Several bits may be set to "1".

The Total Volume, Uplink Volume and Downlink Volume fields shall be encoded as an Unsigned64 binary integer value. They shall contain the total, uplink or downlink number of octets respectively.

8.2.14 Time Threshold

The Time Threshold IE contains the traffic duration threshold to be monitored by the UP function. It shall be encoded as shown in Figure 8.2.14-1.

Octets	Bits						
	8	7	6	5	4	3	2
1 to 2	Type = 32 (decimal)						
3 to 4	Length = n						
5 to 8	Time Threshold						
9 to (n+4)	These octet(s) is/are present only if explicitly specified						

Figure 8.2.14-1: Time Threshold

The Time Threshold field shall be encoded as an Unsigned32 binary integer value. It shall contain the duration in seconds.

8.2.15 Monitoring Time

The Monitoring Time IE indicates the time at which the UP function is expected to reapply the thresholds. It shall be encoded as shown in Figure 8.2.15-1.

Octets	Bits						
	8	7	6	5	4	3	2
1 to 2	Type = 33 (decimal)						
3 to 4	Length = n						
5 to 8	Monitoring Time						
9 to (n+4)	These octet(s) is/are present only if explicitly specified						

Figure 8.2.15-1: Monitoring Time

The Monitoring Time field shall indicate the monitoring time in UTC time. Octets 5 to 8 shall be encoded in the same format as the first four octets of the 64-bit timestamp format as defined in clause 6 of IETF RFC 5905 [12].

NOTE: The encoding is defined as the time in seconds relative to 00:00:00 on 1 January 1900.

8.2.16 Subsequent Volume Threshold

The Subsequent Volume Threshold IE contains the subsequent traffic volume thresholds to be monitored by the UP function after the Monitoring Time. It shall be encoded as shown in Figure 8.2.16-1.

Octets	Bits							
	8	7	6	5	4	3	2	1
1 to 2	Type = 34 (decimal)							
3 to 4	Length = n							
5	Spare				DLVO	ULVO	TOVO	
					L	L	L	
m to (m+7)	Total Volume							
p to (p+7)	Uplink Volume							
q to (q+7)	Downlink Volume							
s to (n+4)	These octet(s) is/are present only if explicitly specified							

Figure 8.2.16-1: Subsequent Volume Threshold

The following flags are coded within Octet 5:

- Bit 1 – TOVOL: If this bit is set to "1", then the Total Volume field shall be present, otherwise the Total Volume field shall not be present.
- Bit 2 – ULVOL: If this bit is set to "1", then the Uplink Volume field shall be present, otherwise the Uplink Volume field shall not be present.
- Bit 3 – DLVOL: If this bit is set to "1", then the Downlink Volume field shall be present, otherwise the Downlink Volume field shall not be present.
- Bit 4 to 8: Spare, for future use and set to "0".

At least one bit shall be set to "1". Several bits may be set to "1".

The Total Volume, Uplink Volume and Downlink Volume fields shall be encoded as an Unsigned64 binary integer value. They shall contain the total, uplink or downlink number of octets respectively.

8.2.17 Subsequent Time Threshold

The Subsequent Time Threshold IE contains the subsequent traffic duration threshold to be monitored by the UP function after the Monitoring Time. It shall be encoded as shown in Figure 8.2.17-1.

Octets	Bits							
	8	7	6	5	4	3	2	1
1 to 2	Type = 35 (decimal)							
3 to 4	Length = n							
5 to 8	Subsequent Time Threshold							
9 to (n+4)	These octet(s) is/are present only if explicitly specified							

Figure 8.2.17-1: Subsequent Time Threshold

The Subsequent Time Threshold field shall be encoded as an Unsigned32 binary integer value. It shall contain the duration in seconds.

8.2.18 Inactivity Detection Time

The Inactivity Detection Time IE contains the inactivity time period, in seconds, to be monitored by the UP function. It shall be encoded as shown in Figure 8.2.18-1.

Octets	Bits							
	8	7	6	5	4	3	2	1
1 to 2	Type = 36 (decimal)							
3 to 4	Length = n							
5 to 8	Inactivity Detection Time							
9 to (n+4)	These octet(s) is/are present only if explicitly specified							

Figure 8.2.18-1: Inactivity Detection Time

The Inactivity Detection Time field shall be encoded as an Unsigned32 binary integer value.

8.2.19 Reporting Triggers

The Reporting Triggers IE shall be encoded as shown in Figure 8.2.19-1. It indicates the reporting trigger(s) for the UP function to send a report to the CP function.

Octets	Bits							
	8	7	6	5	4	3	2	1
1 to 2	Type = 37 (decimal)							
3 to 4	Length = n							
5	LIUSA	DROT	STOP	STAR	QUHT	TIMT	VOLT	PERI
		H	T	T	I	H	H	O
6	Spare	Spare	EVEQ	EVET	MACA	ENVC	TIMQ	VOLQ
			U	H	R	L	U	U
7 to (n+4)	These octet(s) is/are present only if explicitly specified							

Figure 8.2.19-1: Reporting Triggers

Octet 5 shall be encoded as follows:

- Bit 1 – PERIO (Periodic Reporting): when set to "1", this indicates a request for periodic reporting.
- Bit 2 – VOLTH (Volume Threshold): when set to "1", this indicates a request for reporting when the data volume usage reaches a volume threshold
- Bit 3 – TIMTH (Time Threshold): when set to "1", this indicates a request for reporting when the time usage reaches a time threshold.
- Bit 4 – QUHTI (Quota Holding Time): when set to "1", this indicates a request for reporting when no packets have been received for a period exceeding the Quota Holding Time.
- Bit 5 – START (Start of Traffic): when set to "1", this indicates a request for reporting when detecting the start of an SDF or Application traffic.

- Bit 6 – STOPL (Stop of Traffic): when set to "1", this indicates a request for reporting when detecting the stop of an SDF or Application Traffic.
- Bit 7 - DROTH (Dropped DL Traffic Threshold): when set to "1", this indicates a request for reporting when the DL traffic being dropped reaches a threshold.
- Bit 8: - LIUSA (Linked Usage Reporting): when set to "1", this indicates a request for linked usage reporting, i.e. a request for reporting a usage report for a URR when a usage report is reported for a linked URR (see clause 5.2.2.4).

Octet 6 shall be encoded as follows:

- Bit 1 –VOLQU (Volume Quota): when set to "1", this indicates a request for reporting when a Volume Quota is exhausted.
- Bit 2 – TIMQU (Time Quota): when set to "1", this indicates a request for reporting when a Time Quota is exhausted.
- Bit 3 – ENVCL (Envelope Closure): when set to "1", this indicates a request for reporting when conditions for closure of envelope is met (see clause 5.2.2.3).
- Bit 4 – MACAR (MAC Addresses Reporting): when set to "1", this indicates a request for reporting the MAC (Ethernet) addresses used as source address of frames sent UL by the UE.
- Bit 5 – EVETH (Event Threshold): when set to "1", this indicates a request for reporting when an event threshold is reached. .
- Bit 6 – EVEQU (Event Quota): when set to "1", this indicates a request for reporting when an Event Quota is reached.
- Bits 7 to 8: Spare, for future use and set to "0".

At least one bit shall be set to "1". Several bits may be set to "1".

8.2.20 Redirect Information

Redirect Information is coded as depicted in Figure 8.2.20-1.

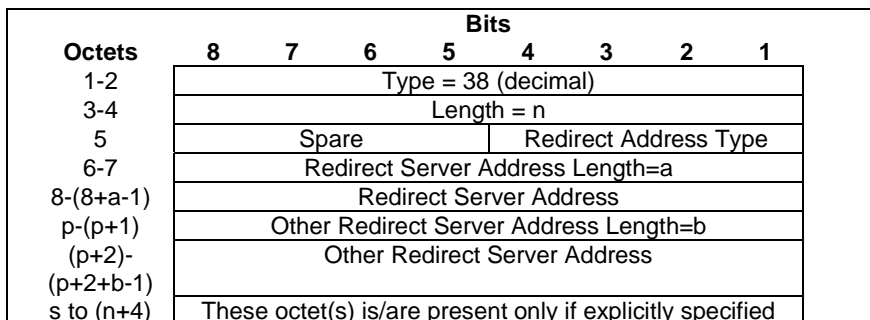

Figure 8.2.20-1: Redirect Information

Redirect Address Type indicates the type of the Redirect Address. It shall be encoded as defined in Table 8.2.20-1.

Table 8.2.20-1: Redirect Address Type

Redirect Address Type	Value (Decimal)
IPv4 address	0
IPv6 address	1
URL	2
SIP URI	3
IPv4 and IPv6 addresses	4
Spare, for future use.	5 to 15

The Redirect Server Address Length shall indicate the length of the Redirect Server Address.

The Redirect Server Address shall be encoded in UTF8String format and shall contain the address of the redirect server (e.g. HTTP redirect server, SIP server) with which the end user is to be connected, as specified in clauses 8.38 and 8.39 of IETF RFC 4006 [16].

If the Redirect Address type is set to "IPv4 and IPv6 address", the Redirect Information IE shall include an IPv4 address and an IPv6 address in the Redirect Server Address IE and Other Redirect Server Address.

8.2.21 Report Type

The Report Type IE shall be encoded as shown in Figure 8.2.21-1. It indicates the type of the report the UP function sends to the CP function.

Octets	Bits							
	8	7	6	5	4	3	2	1
1 to 2	Type = 39 (decimal)							
3 to 4	Length = n							
5	Spare				UPIR	ERIR	USAR	DLDR
6 to (n+4)	These octet(s) is/are present only if explicitly specified							

Figure 8.2.21-1: Report Type

Octet 5 shall be encoded as follows:

- Bit 1 – DLDR (Downlink Data Report): when set to "1", this indicates Downlink Data Report
- Bit 2 – USAR (Usage Report): when set to "1", this indicates a Usage Report
- Bit 3 – ERIR (Error Indication Report): when set to "1", this indicates an Error Indication Report.
- Bit 4 – UPIR (User Plane Inactivity Report): when set to "1", this indicates a User Plane Inactivity Report.
- Bit 5 to 8 – Spare, for future use and set to "0".

At least one bit shall be set to "1". Several bits may be set to "1".

8.2.22 Offending IE

Offending IE IE is coded as depicted in Figure 8.2.22-1.

Octets	Bits							
	8	7	6	5	4	3	2	1
1 to 2	Type = 40 (decimal)							
3 to 4	Length = 2							
5 to 6	Type of the offending IE							

Figure 8.2.22-1: Offending IE

The offending IE shall contain a mandatory IE type, if the rejection is due to a conditional or mandatory IE is faulty or missing.

8.2.23 Forwarding Policy

The Forwarding Policy IE type shall be encoded as shown in Figure 8.2.23-1. It indicates a specific forwarding policy to apply to packets.

Octets	Bits						
	8	7	6	5	4	3	2
1 to 2	Type = 41 (decimal)						
3 to 4	Length = n						
5	Forwarding Policy Identifier Length						
j to k	Forwarding Policy Identifier						
m to (n+4)	These octet(s) is/are present only if explicitly specified						

Figure 8.2.23-1: Forwarding Policy

The Forwarding Policy Identifier Length shall indicate the length of the Forwarding Policy Identifier.

The Forwarding Policy Identifier shall be encoded as an Octet String containing a reference to a pre-configured Forwarding Policy in the UP function, with a maximum length of 255 octets.

8.2.24 Destination Interface

The Destination Interface IE type shall be encoded as shown in Figure 8.2.24-1. It indicates the type of the interface towards which an outgoing packet is sent.

Octets	Bits						
	8	7	6	5	4	3	2
1 to 2	Type = 42 (decimal)						
3 to 4	Length = n						
5	Spare			Interface value			
6 to (n+4)	These octet(s) is/are present only if explicitly specified						

Figure 8.2.24-1: Destination Interface

The Interface value shall be encoded as a 4 bits binary integer as specified in Table 8.2.24-1.

Table 8.2.24-1: Interface value

Interface value	Values (Decimal)
Access (NOTE 1, NOTE 3, NOTE 4)	0
Core (see NOTE 1)	1
SGi-LAN/N6-LAN	2
CP- Function	3
LI Function (see NOTE 2)	4
Spare	5 to 15

NOTE 1: The "Access" and "Core" values denote a downlink and uplink traffic direction respectively.

NOTE 2: LI Function may denote an SX3LIF or an LMISF. See clause 5.7.

NOTE 3: For indirect data forwarding, the Source Interface in the PDR and the Destination Interface in the FAR shall both be set to "Access", in the forwarding SGW(s). The Interface value does not infer any traffic direction, in PDRs and FARs set up for indirect data forwarding, i.e. with both the Source and Destination Interfaces set to Access.

NOTE 4: For a HTTP redirection, the Source Interface in the PDR to match the uplink packets to be redirected and the Destination Interface in the FAR to enable the HTTP redirection shall both be set to "Access".

8.2.25 UP Function Features

The UP Function Features IE indicates the features supported by the UP function. It is coded as depicted in Figure 8.2.25-1.

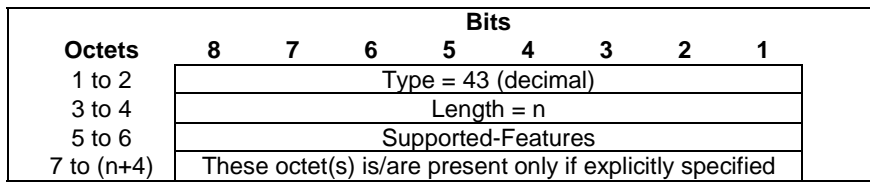

Figure 8.2.25-1: UP Function Features

The UP Function Features IE takes the form of a bitmask where each bit set indicates that the corresponding feature is supported. Spare bits shall be ignored by the receiver. The same bitmask is defined for all PFCP interfaces.

The following table specifies the features defined on PFCP interfaces and the interfaces on which they apply.

Table 8.2.25-1: UP Function Features

Feature Octet / Bit	Feature	Interface	Description
5/1	BUCP	Sxa, N4	Downlink Data Buffering in CP function is supported by the UP function.
5/2	DDND	Sxa, N4	The buffering parameter 'Downlink Data Notification Delay' is supported by the UP function.
5/3	DLBD	Sxa, N4	The buffering parameter 'DL Buffering Duration' is supported by the UP function.
5/4	TRST	Sxb, Sxc, N4	Traffic Steering is supported by the UP function.
5/5	FTUP	Sxa, Sxb, N4	F-TEID allocation / release in the UP function is supported by the UP function.
5/6	PFDM	Sxb, Sxc, N4	The PFD Management procedure is supported by the UP function.
5/7	HEEU	Sxb, Sxc, N4	Header Enrichment of Uplink traffic is supported by the UP function.
5/8	TREU	Sxb, Sxc, N4	Traffic Redirection Enforcement in the UP function is supported by the UP function.
6/1	EMPU	Sxa, Sxb, N4	Sending of End Marker packets supported by the UP function.
6/2	PDIU	Sxa, Sxb, Sxc, N4	Support of PDI optimised signalling in UP function (see clause 5.2.1A.2).
6/3	UDBC	Sxb, Sxc, N4	Support of UL/DL Buffering Control
6/4	QUOAC	Sxb, Sxc, N4	The UP function supports being provisioned with the Quota Action to apply when reaching quotas.
6/5	TRACE	Sxa, Sxb, Sxc, N4	The UP function supports Trace (see clause 5.x).
6/6	FRRT	Sxb, N4	The UP function supports Framed Routing (see IETF RFC 2865 [37] and IETF RFC 3162 [38]).
6/7	PFDE	Sxb, N4	The UP function supports a PFD Contents including a property with multiple values.
Feature Octet / Bit: The octet and bit number within the Supported-Features IE, e.g. "5 / 1". Feature: A short name that can be used to refer to the octet / bit and to the feature. Interface: A list of applicable interfaces to the feature. Description: A clear textual description of the feature.			

8.2.26 Apply Action

The Apply Action IE indicates the action(s) the UP function is required to apply to packets. It is coded as shown in Figure 8.2.26-1.

Octets	Bits							
	8	7	6	5	4	3	2	1
1 to 2	Type = 44 (decimal)							
3 to 4	Length = n							
5	Spare	Spare	Spare	DUPL	NOCP	BUFF	FOR W	DROP
6 to (n+4)	These octet(s) is/are present only if explicitly specified							

Figure 8.2.26-1: Apply Action

The octet 5 shall be encoded as follows:

- Bit 1 – DROP (Drop): when set to "1", this indicates a request to drop the packets.
- Bit 2 – FORW (Forward): when set to "1", this indicates a request to forward the packets.
- Bit 3 – BUFF (Buffer): when set to "1", this indicates a request to buffer the packets.
- Bit 4 – NOCP (Notify the CP function): when set to "1", this indicates a request to notify the CP function about the arrival of a first downlink packet being buffered.
- Bit 5 – DUPL (Duplicate): when set to "1", this indicates a request to duplicate the packets.
- Bit 6 to 8 – Spare, for future use and set to "0".

One and only one of the DROP, FORW and BUFF flags shall be set to "1".

The NOCP flag may only be set if the BUFF flag is set.

The DUPL flag may be set with any of the DROP, FORW, BUFF and NOCP flags.

8.2.27 Downlink Data Service Information

The Downlink Data Service Information IE is used to carry downlink data service information. It is coded as shown in Figure 8.2.27-1.

Octets	Bits							
	8	7	6	5	4	3	2	1
1 to 2	Type = 45 (decimal)							
3 to 4	Length = n							
5	Spare						QFII	PPI
m	Spare		Paging Policy Indication value					
p	Spare		QFI					
q to (n+4)	These octet(s) is/are present only if explicitly specified							

Figure 8.2.27-1: Downlink Data Service Information

The PPI flag in octet 5 indicates whether the Paging Policy Indication value in octet 'm' shall be present. If PPI is set to '1', then the Paging Policy Indication value shall be present. If PPI is set to '0', then octet 'm' shall not be present.

The Paging Policy Indication value, in octet 'm', shall be encoded as the DSCP in TOS (IPv4) or TC (IPv6) information received in the IP payload of the GTP-U packet from the PGW (see IETF RFC 2474 [13]).

The QFII flag in octet 5 indicates whether the QFI value in octet 'p' shall be present. If QFII is set to '1', then the QFI value shall be present. If QFII is set to '0', then octet 'p' shall not be present.

The QFI value, in octet 'p', shall be encoded as the octet 5 of the QFI IE in clause 8.2.89.

8.2.28 Downlink Data Notification Delay

The Downlink Data Notification Delay IE indicates the delay the UP function shall apply between receiving a downlink data packet and notifying the CP function about the arrival of the packet. It is coded as depicted in Figure 8.2.28-1.

Octets	Bits						
	8	7	6	5	4	3	2
1 to 2	Type = 46 (decimal)						
3 to 4	Length = n						
5	Delay Value in integer multiples of 50 millisecs, or zero						
6 to (n+4)	These octet(s) is/are present only if explicitly specified						

Figure 8.2.28-1: Downlink Data Notification Delay

Delay Value shall be set to zero in order to clear a previously set delay condition.

8.2.29 DL Buffering Duration

The DL Buffering Duration IE indicates the duration during which the UP function is requested to buffer the downlink data packets. It is coded as shown in figure 8.2.29-1 and table 8.2.29.1.

Octets	Bits						
	8	7	6	5	4	3	2
1 to 2	Type = 47 (decimal)						
3 to 4	Length = n						
5	Timer unit			Timer value			
6 to (n+4)	These octet(s) is/are present only if explicitly specified						

Figure 8.2.29-1: DL Buffering Duration

Table 8.2.29.1: DL Buffering Duration

Timer value Bits 5 to 1 represent the binary coded timer value.
Timer unit Bits 6 to 8 defines the timer value unit as follows: Bits 8 7 6 0 0 0 value is incremented in multiples of 2 seconds 0 0 1 value is incremented in multiples of 1 minute 0 1 0 value is incremented in multiples of 10 minutes 0 1 1 value is incremented in multiples of 1 hour 1 0 0 value is incremented in multiples of 10 hours 1 1 1 value indicates that the timer is infinite
Other values shall be interpreted as multiples of 1 minute in this version of the protocol.
Timer unit and Timer value both set to all "zeros" shall be interpreted as an indication that the timer is stopped.

8.2.30 DL Buffering Suggested Packet Count

The DL Buffering Suggested Packet Count IE indicates the maximum number of downlink data packets suggested to be buffered in the UP function for this PFCP session. It is coded as depicted in Figure 8.2.30-1.

Octets	Bits						
	8	7	6	5	4	3	2
1 to 2	Type = 48 (decimal)						
3 to 4	Length = n						
5 to n+4	Packet Count Value						

Figure 8.2.30-1: DL Buffering Suggested Packet Count

The Packet Count value is encoded with the number of octets defined in the Length field, e.g. when n=2, the range of the Packet Count value is from 0 to 65535.

The length shall be set to "1" or "2" octets.

8.2.31 PFCPSMReq-Flags

The PFCPSMReq-Flags IE indicates flags applicable to the PFCP Session Modification Request message. It is coded as depicted in Figure 8.2.31-1.

Octets	Bits							
	8	7	6	5	4	3	2	1
1 to 2	Type = 49 (decimal)							
3 to 4	Length = n							
5	Spare	Spare	Spare	Spare	Spare	QAUR R	SNDE M	DROB U
6 to (n+4)	These octet(s) is/are present only if explicitly specified							

Figure 8.2.31-1: PFCPSMReq-Flags

The following bits within Octet 5 shall indicate:

- Bit 1 – DROBU (Drop Buffered Packets): if this bit is set to "1", it indicates that the UP function shall drop all the packets currently buffered for the PFCP session, if any, prior to further applying the action specified in the Apply Action value of the FARs.
- Bit 2 – SNDEM (Send End Marker Packets): if this bit is set to "1", it indicates that the UP function shall construct and send End Marker packets towards the old F-TEID of the downstream node when switching to the new F-TEID.
- Bit 3 – QAURR (Query All URRs): if this bit is set to "1", it indicates that the UP function shall return immediate usage report(s) for all the URRs previously provisioned for this PFCP session.
- Bit 4 to 8 – Spare, for future use, shall be set to "0" by the sender and discarded by the receiver.

8.2.32 PFCPSRRsp-Flags

The PFCPSRRsp-Flags IE indicates flags applicable to the PFCP Session Report Response message. It is coded as depicted in Figure 8.2.32-1.

Octets	Bits							
	8	7	6	5	4	3	2	1
1 to 2	Type = 50 (decimal)							
3 to 4	Length = n							
5	Spare	Spare	Spare	Spare	Spare	Spare	Spare	DROB U
6 to (n+4)	These octet(s) is/are present only if explicitly specified							

Figure 8.2.32-1: PFCPSRRsp-Flags

The following bits within Octet 5 shall indicate:

- Bit 1 – DROBU (Drop Buffered Packets): if this bit is set to "1", it indicates that the UP function shall drop all the packets currently buffered for the PFCP session, if any, prior to further applying the action specified in the Apply Action value of the FARs.
- Bit 2 to 8 – Spare, for future use, shall be set to "0" by the sender and discarded by the receiver.

8.2.33 Sequence Number

The Sequence Number IE shall be encoded as shown in Figure 8.2.33-1. It contains an Unsigned32 binary integer value.

Octets	Bits						
	8	7	6	5	4	3	2
1 to 2	Type = 52 (decimal)						
3 to 4	Length = n						
5 to 8	Sequence Number						

Figure 8.2.33-1: Sequence Number

8.2.34 Metric

The Metric IE shall be encoded as shown in Figure 8.2.34-1. It indicates a percentage and may take binary coded integer values from and including 0 up to and including 100. Other values shall be considered as 0.

Octets	Bits						
	8	7	6	5	4	3	2
1 to 2	Type = 53 (decimal)						
3 to 4	Length = n						
5	Metric						

Figure 8.2.34-1: Metric

8.2.35 Timer

The purpose of the Timer IE is to specify specific timer values. The Timer IE shall be encoded as shown in Figure 8.2.35-1 and table 8.2.35.1.

Octets	Bits						
	8	7	6	5	4	3	2
1 to 2	Type = 55 (decimal)						
3 to 4	Length = n						
5	Timer unit			Timer value			
6 to (n+4)	These octet(s) is/are present only if explicitly specified						

Figure 8.2.35-1: Timer

Table 8.2.35.1: Timer information element

<p>Timer value Bits 5 to 1 represent the binary coded timer value.</p> <p>Timer unit Bits 6 to 8 defines the timer value unit for the timer as follows: Bits 8 7 6 0 0 0 value is incremented in multiples of 2 seconds 0 0 1 value is incremented in multiples of 1 minute 0 1 0 value is incremented in multiples of 10 minutes 0 1 1 value is incremented in multiples of 1 hour 1 0 0 value is incremented in multiples of 10 hours 1 1 1 value indicates that the timer is infinite</p> <p>Other values shall be interpreted as multiples of 1 minute in this version of the protocol.</p> <p>Timer unit and Timer value both set to all "zeros" shall be interpreted as an indication that the timer is stopped.</p>

8.2.36 Packet Detection Rule ID (PDR ID)

The PDR ID IE is coded as depicted in Figure 8.2.36-1.

Octets	8	7	6	5	4	3	2	1
1 to 2	Type = 56 (decimal)							
3 to 4	Length = n							
5 to 6	Rule ID							
7 to (n+4)	These octet(s) is/are present only if explicitly specified							

Figure 8.2.36-1: PDR ID

Octets 5 to 6 contain the Rule ID and shall be encoded as an integer.

8.2.37 F-SEID

F-SEID is coded as depicted in Figure 8.2.37-1.

Octets	8	7	6	5	4	3	2	1
1 to 2	Type = 57 (decimal)							
3 to 4	Length = n							
5	Spare	Spare	Spare	Spare	Spare	Spare	V4	V6
6 to 13	SEID							
m to (m+3)	IPv4 address							
p to (p+15)	IPv6 address							
k to (n+4)	These octet(s) is/are present only if explicitly specified							

Figure 8.2.37-1: F-SEID

The following flags are coded within Octet 5:

- Bit 1 – V6: If this bit is set to "1", then IPv6 address field shall be present in the F-SEID, otherwise the IPv6 address field is not present at all.
- Bit 2 – V4: If this bit is set to "1", then IPv4 address field shall be present in the F-SEID, otherwise the IPv4 address field is not present at all.

- Bit 3 to 8 are spare and reserved for future use.

At least one of V4 and V6 shall be set to "1", and both may be set to "1".

Octets "m to (m+3)" and/or "p to (p+15)" (IPv4 address / IPv6 address fields), if present, contain respective address values.

8.2.38 Node ID

The Node ID IE shall contain an FQDN or an IPv4/IPv6 address. It shall be encoded as shown in Figure 8.2.38-1.

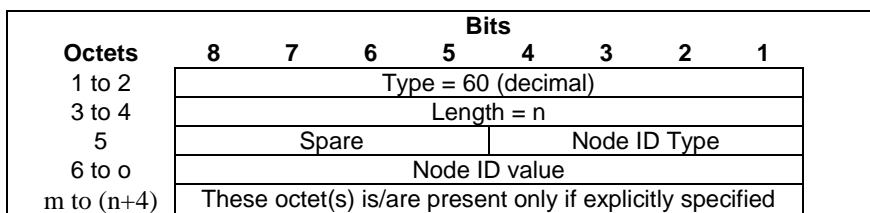

Figure 8.2.38-1: Node ID

Node ID Type indicates the type of the Node ID value. It shall be encoded as a 4 bits binary integer as specified in Table 8.2.38-2.

Table 8.2.38-2: Node ID Type

Node ID Type Value (Decimal)	Node ID Type
0	IPv4 address
1	IPv6 address
2	FQDN
3 to 15	Spare, for future use.

If the Node ID is an IPv4 address, the Node ID value length shall be 4 Octet.

If the Node ID is an IPv6 address, the Node ID value length shall be 16 Octet.

If the Node ID is an FQDN, the Node ID value encoding shall be identical to the encoding of a FQDN within a DNS message of clause 3.1 of IETF RFC 1035 [27] but excluding the trailing zero byte.

NOTE 1: The FQDN field in the IE is not encoded as a dotted string as commonly used in DNS master zone files.

8.2.39 PFD Contents

The PFD Contents IE type shall be encoded as shown in Figure 8.2.39-1. It contains the description of a PFD.

Octets	Bits							
	8	7	6	5	4	3	2	1
1 to 2	Type = 61 (decimal)							
3 to 4	Length = n							
5	ADNP	AURL	AFD	DNP	CP	DN	URL	FD
6	Spare							
m to (m+1)	Length of Flow Description							
(m+2) to p	Flow Description							
q to (q+1)	Length of URL							
(q+2) to r	URL							
s to (s+1)	Length of Domain Name							
(s+2) to t	Domain Name							
u to (u+1)	Length of Custom PFD Content							
(u+2) to v	Custom PFD Content							
w to (w+1)	Length of Domain Name Protocol							
(w+2) to x	Domain Name Protocol							
y to (y+1)	Length of Additional Flow Description							
(y+2) to z	Additional Flow Description							
a to (a+1)	Length of Additional URL							
(a+2) to b	Additional URL							
c to (c+1)	Length of Additional Domain Name and Domain Name Protocol							
(c+2) to d	Additional Domain Name and Domain Name Protocol							
e to (n+4)	These octet(s) is/are present only if explicitly specified							

Figure 8.2.39-1: PFD Contents

The following flags are coded within Octet 5 in the Figure 8.2.39-1:

- Bit 1 – FD (Flow Description): If this bit is set to "1", then the Length of Flow Description and the Flow Description fields shall be present, otherwise they shall not be present.
- Bit 2 – URL (URL): If this bit is set to "1", then the Length of URL and the URL fields shall be present, otherwise they shall not be present.
- Bit 3 – DN (Domain Name): If this bit is set to "1", then the Length of Domain Name and the Domain Name fields shall be present, otherwise they shall not be present.
- Bit 4 – CP (Custom PFD Content): If this bit is set to "1", then the Length of Custom PFD Content and the Custom PFD Content fields shall be present, otherwise they shall not be present.
- Bit 5 – DNP (Domain Name Protocol): If this bit is set to "1", then the Length of Domain Name Protocol and the Domain Name Protocol shall be present, otherwise they shall not be present; and if this bit is set to "1", the Length of Domain Name and the Domain Name fields shall also be present.
- Bit 6 – AFD (Additional Flow Description): If this bit is set to "1", the Length of Additional Flow Description and the Additional Flow Description field shall be present, otherwise they shall not be present.
- Bit 7 – AURL (Additional URL): If this bit is set to "1", the Length of Additional URL and the Additional URL field shall be present, otherwise they shall not be present.
- Bit 8 – ADNP (Additional Domain Name and Domain Name Protocol): If this bit is set to "1", the Length of Additional Domain Name and Domain Name Protocol, and the Additional Domain Name and Domain Name Protocol field shall be present, otherwise they shall not be present.

The Flow Description field, when present, shall be encoded as an OctetString as specified in clause 6.4.3.7 of 3GPP TS 29.251 [21].

The Domain Name field, when present, shall be encoded as an OctetString as specified in clause 6.4.3.9 of 3GPP TS 29.251 [21].

The URL field, when present, shall be encoded as an OctetString as specified in clause 6.4.3.8 of 3GPP TS 29.251 [21].

The Domain Name Protocol field, when present, shall be encoded as an OctetString as specified in clause 6.4.3.x of 3GPP TS 29.251 [21].

Additional instance(s) of the Flow Description shall be encoded as shown in Figure 8.2.39-2. The encoding of Flow Description 2, 3 up to m field are the same as the Flow Description field specified in clause 8.2.39.

Octets	Bits						
	8	7	6	5	4	3	2
(y+2) to (y+3)	Length of Flow Description 2						
(y+4) to i	Flow Description 2						
j to (j+1)	Length of Flow Description 3						
(j+2) to k	FlowDescription 3						
	...						
l to (l+1)	Length of Flow Description m						
(l+2) to z	Flow Description m						

Figure 8.2.39-2: Additional Flow Description field

Additional instance(s) of the URL shall be encoded as shown in 8.2.39-3. The encoding of URL 2, 3 up to m fields are the same as the URL field.

Octets	Bits						
	8	7	6	5	4	3	2
(a+2) to (a+3)	Length of URL 2						
(a+4) to o	URL 2						
pa to (pa+1)	Length of URL 3						
(pa+2) to pb	URL 3						
	...						
pc to (pc+1)	Length of URL m						
(pc+2) to b	URL m						

Figure 8.2.39-3: Additional URL field

Additional instance(s) of the Domain Name and Domain Name Protocol shall be encoded as shown in 8.2.39-4. The encoding of Domain Name 2, 3, up to m fields and Domain Name Protocol 2, 3 up to m fields are the same as the Domain Name field and Domain Name Protocol field respectively.

Octets	Bits						
	8	7	6	5	4	3	2
(c+2) to (c+3)	Length of Domain Name 2						
(c+4) to pd	Domain Name 2						
pe to (pe+1)	Length of Domain Name Protocol 2						
(pe+2) to pf	Domain Name Protocol 2						
pg to (pg+1)	Length of Domain Name 3						
(pg+2) to ph	Domain Name 3						
pi to (pi+1)	Length of Domain Name Protocol 3						
(pi+2) + pj	Domain Name Protocol 3						
	...						
pk to (pk+1)	Length of Domain Name m						
(pk+2) to pl	Domain Name m						
pm to (pm+1)	Length of Domain Name Protocol m						
(pm+2) to d	Domain Name Protocol m						

Figure 8.2.39-4: Additional Domain Name and Domain Name Protocol field

8.2.40 Measurement Method

The Measurement Method IE shall be encoded as shown in Figure 8.2.40-1. It indicates the method for measuring the usage of network resources.

Octets	Bits							
	8	7	6	5	4	3	2	1
1 to 2	Type = 62 (decimal)							
3 to 4	Length = n							
5	Spare	Spare	Spare	Spare	Spare	EVEN T	VOLU M	DURA T
6 to (n+4)	These octet(s) is/are present only if explicitly specified							

Figure 8.2.40-1: Measurement Method

Octet 5 shall be encoded as follows:

- Bit 1 – DURAT (Duration): when set to "1", this indicates a request for measuring the duration of the traffic.
- Bit 2 – VOLUM (Volume): when set to "1", this indicates a request for measuring the volume of the traffic.
- Bit 3 – EVENT (Event): when set to "1", this indicates a request for measuring the events.
- Bit 4 to 8: Spare, for future use and set to "0".

At least one bit shall be set to "1". Several bits may be set to "1".

8.2.41 Usage Report Trigger

The Usage Report Trigger IE shall be encoded as shown in Figure 8.2.41-1. It indicates the trigger of the usage report.

Octets	Bits							
	8	7	6	5	4	3	2	1
1 to 2	Type = 63 (decimal)							
3 to 4	Length = n							
5	IMME R	DROT H	STOP T	STAR T	QUHT I	TIMT H	VOLT H	PERI O
6	EVET H	MACA R	ENVC L	MONI T	TERM R	LIUSA	TIMQ U	VOLQ U
7	Spare							EVEQ U
8 to (n+4)	These octet(s) is/are present only if explicitly specified							

Figure 8.2.41-1: Usage Report Trigger

Octet 5 shall be encoded as follows:

- Bit 1 – PERIO (Periodic Reporting): when set to "1", this indicates a periodic report.
- Bit 2 – VOLTH (Volume Threshold): when set to "1", this indicates that the data volume usage reaches a volume threshold.
- Bit 3 – TIMTH (Time Threshold): when set to "1", this indicates that the time usage reaches a time threshold.
- Bit 4 – QUHTI (Quota Holding Time): when set to "1", this indicates that no packets have been received for a period exceeding the Quota Holding Time.
- Bit 5 – START (Start of Traffic): when set to "1", this indicates that the start of traffic is detected.
- Bit 6 – STOPT (Stop of Traffic): when set to "1", this indicates that the stop of traffic is detected.
- Bit 7 - DROTH (Dropped DL Traffic Threshold): when set to "1", this indicates that the DL traffic being dropped reaches a threshold.
- Bit 8 – IMMERR (Immediate Report): when set to "1", this indicates an immediate report reported on CP function demand.

Octet 6 shall be encoded as follows:

- Bit 1 – VOLQU (Volume Quota): when set to "1", this indicates that the Volume Quota has been exhausted.
- Bit 2 – TIMQU (Time Quota): when set to "1", this indicates that the Time Quota has been exhausted.
- Bit 3 - LIUSA (Linked Usage Reporting): when set to "1", this indicates a linked usage report, i.e. a usage report being reported for a URR due to a usage report being also reported for a linked URR (see clause 5.2.2.4).
- Bit 4 – TERMR (Termination Report): when set to "1", this indicates a usage report being reported (in a PFCP Session Deletion Response) for a URR due to the termination of the PFCP session, or a usage report being reported (in a PFCP Session Modification Response) for a URR due to the removal of the URR.
- Bit 5 – MONIT (Monitoring Time): when set to "1", this indicates a usage report being reported for a URR due to the Monitoring Time being reached.
- Bit 6 – ENVCL (Envelope Closure): when set to "1", this indicates the usage report is generated for closure of an envelope (see clause 5.2.2.3).
- Bit 7 – MACAR (MAC Addresses Reporting): when set to "1", this indicates a usage report to report MAC (Ethernet) addresses used as source address of frames sent UL by the UE.
- Bits 8: EVETH (Event Threshold): when set to "1", this indicates a usage report is generated when an event threshold is reached.

Octet 7 shall be encoded as follows:

- Bit 1 – EVEQU (Event Quota): when set to "1", this indicates that the Event Quota has been exhausted.
- Bit 2 to 8: Spare, for future use and set to "0".

At least one bit shall be set to "1". Several bits may be set to "1".

8.2.42 Measurement Period

The Measurement Period IE contains the period, in seconds, for generating periodic usage reports. It shall be encoded as shown in Figure 8.2.42-1.

Octets	Bits							
	8	7	6	5	4	3	2	1
1 to 2	Type = 64 (decimal)							
3 to 4	Length = n							
5 to 8	Measurement Period							
9 to (n+4)	These octet(s) is/are present only if explicitly specified							

Figure 8.2.42-1: Measurement Period

The Measurement Period field shall be encoded as an Unsigned32 binary integer value.

8.2.43 Fully qualified PDN Connection Set Identifier (FQ-CSID)

A fully qualified PDN Connection Set Identifier (FQ-CSID) identifies a set of PDN connections belonging to an arbitrary number of UEs on a SGW-C, PGW-C, SGW-U and PGW-U. The FQ-CSID is used on Sxa and Sxb interfaces.

The size of CSID is two octets. The FQ-CSID is coded as follows:

Octets	Bits						
	8	7	6	5	4	3	2
1 to 2	Type = 65 (decimal)						
3 to 4	Length = n						
5	FQ-CSID Node-ID Type			Number of CSIDs= m			
6 to p	Node-Address						
(p+1) to (p+2)	First PDN Connection Set Identifier (CSID)						
(p+3) to (p+4)	Second PDN Connection Set Identifier (CSID)						
...	...						
q to q+1	m-th PDN Connection Set Identifier (CSID)						
(q+2) to (n+4)	These octet(s) is/are present only if explicitly specified						

Figure 8.2.43-1: FQ-CSID

Where FQ-CSID Node-ID Type values are:

- 0 indicates that Node-Address is a global unicast IPv4 address and p = 9.
- 1 indicates that Node-Address is a global unicast IPv6 address and p = 21.
- 2 indicates that Node-Address is a 4 octets long field with a 32 bit value stored in network order, and p= 9. The coding of the field is specified below:
 - Most significant 20 bits are the binary encoded value of (MCC * 1000 + MNC).
 - Least significant 12 bits is a 12 bit integer assigned by an operator to an MME, SGW-C, SGW-U, PGW-C or PGW-U. Other values of Node-Address Type are reserved.

Values of Number of CSID other than 1 are only employed in the PFCP Session Deletion Request.

The node that creates the FQ-CSID (i.e. SGW-C for SGW-C FQ-CSID, SGW-U for SGW-U FQ-CSID, PGW-C for PGW-C FQ-CSID and PGW-U for PGW-U FQ-CSID) needs to ensure that the Node-ID is globally unique and the CSID value is unique within that node.

8.2.44 Volume Measurement

The Volume Measurement IE contains the measured traffic volumes. It shall be encoded as shown in Figure 8.2.44-1.

Octets	Bits							
	8	7	6	5	4	3	2	1
1 to 2	Type = 66 (decimal)							
3 to 4	Length = n							
5	Spare				DLVO	ULVO	TOVO	
					L	L	L	
m to (m+7)	Total Volume							
p to (p+7)	Uplink Volume							
q to (q+7)	Downlink Volume							
s to (n+4)	These octet(s) is/are present only if explicitly specified							

Figure 8.2.44-1: Volume Measurement

The following flags are coded within Octet 5:

- Bit 1 – TOVOL: If this bit is set to "1", then the Total Volume field shall be present, otherwise the Total Volume field shall not be present.
- Bit 2 – ULVOL: If this bit is set to "1", then the Uplink Volume field shall be present, otherwise the Uplink Volume field shall not be present.

- Bit 3 – DLVOL: If this bit is set to "1", then the Downlink Volume field shall be present, otherwise the Downlink Volume field shall not be present.
- Bit 4 to bit 8: Spare, for future use and set to "0".

At least one bit shall be set to "1". Several bits may be set to "1".

The Total Volume, Uplink Volume and Downlink Volume fields shall be encoded as an Unsigned64 binary integer value. They shall contain the total, uplink or downlink number of octets respectively.

8.2.45 Duration Measurement

The Duration Measurement IE type shall be encoded as shown in Figure 8.2.45-1. It contains the used time in seconds.

Octets	Bits							
	8	7	6	5	4	3	2	1
1 to 2	Type = 67 (decimal)							
3 to 4	Length = n							
5 to 8	Duration value							
9 to (n+4)	These octet(s) is/are present only if explicitly specified							

Figure 8.2.45-1: Duration Measurement

The Duration value shall be encoded as an Unsigned32 binary integer value.

8.2.46 Time of First Packet

The Time of First Packet IE indicates the time stamp for the first IP packet transmitted for a given usage report. It shall be encoded as shown in Figure 8.2.46-1.

Octets	Bits							
	8	7	6	5	4	3	2	1
1 to 2	Type = 69 (decimal)							
3 to 4	Length = n							
5 to 8	Time of First Packet							
9 to (n+4)	These octet(s) is/are present only if explicitly specified							

Figure 8.2.46-1: Time of First Packet

The Time of First Packet field shall contain a UTC time. Octets 5 to 8 shall be encoded in the same format as the first four octets of the 64-bit timestamp format as defined in clause 6 of IETF RFC 5905 [12].

NOTE: The encoding is defined as the time in seconds relative to 00:00:00 on 1 January 1900.

8.2.47 Time of Last Packet

The Time of Last Packet IE indicates the time stamp for the last IP packet transmitted for a given usage report. It shall be encoded as shown in Figure 8.2.47-1.

Octets	Bits							
	8	7	6	5	4	3	2	1
1 to 2	Type = 70 (decimal)							
3 to 4	Length = n							
5 to 8	Time of Last Packet							
9 to (n+4)	These octet(s) is/are present only if explicitly specified							

Figure 8.2.47-1: Time of Last Packet

The Time of Last Packet field shall contain a UTC time. Octets 5 to 8 shall be encoded in the same format as the first four octets of the 64-bit timestamp format as defined in clause 6 of IETF RFC 5905 [12].

NOTE: The encoding is defined as the time in seconds relative to 00:00:00 on 1 January 1900.

8.2.48 Quota Holding Time

The Quota Holding Time IE type shall be encoded as shown in Figure 8.2.48-1. It contains the quota holding time in seconds.

Octets	Bits						
	8	7	6	5	4	3	2
1 to 2	Type = 71 (decimal)						
3 to 4	Length = n						
5 to 8	Quota Holding Time value						
9 to (n+4)	These octet(s) is/are present only if explicitly specified						

Figure 8.2.48-1: Quota Holding Time

The Quota Holding Time value shall be encoded as an Unsigned32 binary integer value.

8.2.49 Dropped DL Traffic Threshold

The Dropped DL Traffic Threshold IE type shall be encoded as shown in Figure 8.2.49-1. It contains the dropped DL traffic volume thresholds to be monitored by the UP function.

Octets	Bits							
	8	7	6	5	4	3	2	1
1 to 2	Type = 72 (decimal)							
3 to 4	Length = n							
5	Spare					DLBY	DLPA	
m to (m+7)	Downlink Packets							
o to (o+7)	Number of Bytes of Downlink Data							
s to (n+4)	These octet(s) is/are present only if explicitly specified							

Figure 8.2.49-1: Dropped DL Traffic Threshold

The following flags are coded within Octet 5:

- Bit 1 – DLPA: If this bit is set to "1", then the Downlink Packets field shall be present, otherwise the Downlink Packets field shall not be present.
- Bit 2 – DLBY: If this bit is set to "1", then the Number of Bytes of Downlink Data field shall be present, otherwise the Number of Bytes of Downlink Data field shall not be present.- Bit 3 to 8: Spare, for future use and set to "0".

The Downlink Packets fields shall be encoded as an Unsigned64 binary integer value. It shall contain a number of downlink packets.

The Number of Bytes of Downlink Data fields shall be encoded as an Unsigned64 binary integer value. It shall contain the number of bytes of the downlink data.

8.2.50 Volume Quota

The Volume Quota IE type shall be encoded as shown in Figure 8.2.50-1. It contains the volume quota to be monitored by the UP function.

Octets	Bits							
	8	7	6	5	4	3	2	1
1 to 2	Type = 73 (decimal)							
3 to 4	Length = n							
5	Spare				DLVO	ULVO	TOVO	
					L	L	L	
m to (m+7)	Total Volume							
p to (p+7)	Uplink Volume							
q to (q+7)	Downlink Volume							
S to (n+4)	These octet(s) is/are present only if explicitly specified							

Figure 8.2.50-1: Volume Quota

The following flags are coded within Octet 5:

- Bit 1 – TOVOL: If this bit is set to "1", then the Total Volume field shall be present, otherwise the Total Volume field shall not be present.
- Bit 2 – ULVOL: If this bit is set to "1", then the Uplink Volume field shall be present, otherwise the Uplink Volume field shall not be present.
- Bit 3 – DLVOL: If this bit is set to "1", then the Downlink Volume field shall be present, otherwise the Downlink Volume field shall not be present.
- Bit 4 to bit 8: Spare, for future use and set to "0".

At least one bit shall be set to "1". Several bits may be set to "1".

The Total Volume, Uplink Volume and Downlink Volume fields shall be encoded as an Unsigned64 binary integer value. They shall contain the total, uplink or downlink number of octets respectively.

8.2.51 Time Quota

The Time Quota IE type shall be encoded as shown in Figure 8.2.51-1. It contains the time quota to be monitored by the UP function.

Octets	Bits						
	8	7	6	5	4	3	2
1 to 2	Type = 74 (decimal)						
3 to 4	Length = n						
5 to 8	Time Quota value						
9 to (n+4)	These octet(s) is/are present only if explicitly specified						

Figure 8.2.51-1: Time Quota

The Time Quota value shall be encoded as an Unsigned32 binary integer value. It contains a duration in seconds.

8.2.52 Start Time

The Start Time IE indicates the time at which the UP function started to collect the charging information. It shall be encoded as shown in Figure 8.2.52-1.

Octets	Bits						
	8	7	6	5	4	3	2
1 to 2	Type = 75 (decimal)						
3 to 4	Length = n						
5 to 8	Start Time						
9 to (n+4)	These octet(s) is/are present only if explicitly specified						

Figure 8.2.52-1: Start Time

The Start Time field shall contain a UTC time. Octets 5 to 8 shall be encoded in the same format as the first four octets of the 64-bit timestamp format as defined in clause 6 of IETF RFC 5905 [12].

NOTE: The encoding is defined as the time in seconds relative to 00:00:00 on 1 January 1900.

8.2.53 End Time

The End Time IE indicates the time at which the UP function ended to collect the charging information. It shall be encoded as shown in Figure 8.2.53-1.

Octets	Bits							
	8	7	6	5	4	3	2	1
1 to 2	Type = 76 (decimal)							
3 to 4	Length = n							
5 to 8	End Time							
9 to (n+4)	These octet(s) is/are present only if explicitly specified							

Figure 8.2.53-1: End Time

The End Time field shall contain a UTC time. Octets 5 to 8 shall be encoded in the same format as the first four octets of the 64-bit timestamp format as defined in clause 6 of IETF RFC 5905 [12].

NOTE: The encoding is defined as the time in seconds relative to 00:00:00 on 1 January 1900.

8.2.54 URR ID

The URR ID IE type shall be encoded as shown in Figure 8.2.54-1. It contains a Usage Reporting Rule ID.

Octets	Bits							
	8	7	6	5	4	3	2	1
1 to 2	Type = 81 (decimal)							
3 to 4	Length = n							
5 to 8	URR ID value							
9 to (n+4)	These octet(s) is/are present only if explicitly specified							

Figure 8.2.54-1: URR ID

The URR ID value shall be encoded as an Unsigned32 binary integer value.

The bit 8 of octet 5 is used to indicate if the Rule ID is dynamically allocated by the CP function or predefined in the UP function. If set to "0", it indicates that the Rule is dynamically provisioned by the CP Function. If set to "1", it indicates that the Rule is predefined in the UP Function.

8.2.55 Linked URR ID IE

The Linked URR ID IE type shall be encoded as shown in Figure 8.2.55-1. It contains the URR ID of a linked URR.

Octets	Bits							
	8	7	6	5	4	3	2	1
1 to 2	Type = 82 (decimal)							
3 to 4	Length = n							
5 to 8	Linked URR ID value							
9 to (n+4)	These octet(s) is/are present only if explicitly specified							

Figure 8.2.55-1: Linked URR ID

The Linked URR ID value shall be encoded as an Unsigned32 binary integer value.

8.2.56 Outer Header Creation

The Outer Header Creation IE type shall be encoded as shown in Figure 8.2.56-1. It contains the instructions to create an Outer Header.

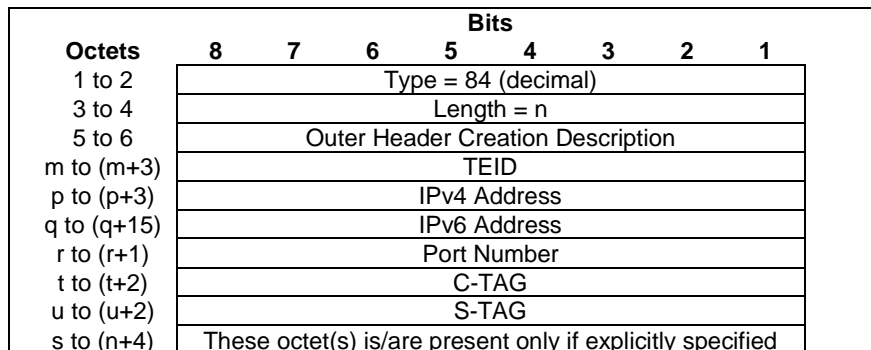

Figure 8.2.56-1: Outer Header Creation

The Outer Header Creation Description field, when present, shall be encoded as specified in Table 8.2.56-1. It takes the form of a bitmask where each bit indicates the outer header to be created in the outgoing packet. Spare bits shall be ignored by the receiver.

Table 8.2.56-1: Outer Header Creation Description

Octet / Bit	Outer Header to be created in the outgoing packet
5/1	GTP-U/UDP/IPv4 (NOTE 1), (NOTE 3)
5/2	GTP-U/UDP/IPv6 (NOTE 1), (NOTE 3)
5/3	UDP/IPv4 (NOTE 2, NOTE 5)
5/4	UDP/IPv6 (NOTE 2, NOTE 5)
5/5	IPv4 (NOTE 5)
5/6	IPv6 (NOTE 5)
5/7	C-TAG (see NOTE 4)
5/8	S-TAG (see NOTE 4)
NOTE 1: The SGW-U/I-UPF shall also create GTP-U extension header(s) if any has been stored for this packet, during a previous outer header removal (see clause 8.2.64).	
NOTE 2: This value may apply to UL packets sent by a PGW-U for non-IP PDN connections with SGi tunnelling based on UDP/IP encapsulation (see clause 4.3.17.8.3.3.2 of 3GPP TS 23.401 [14]).	
NOTE 3: The SGW-U/I-UPF shall set the GTP-U message type to the value stored during the previous outer header removal.	
NOTE 4: This value may apply to UL packets sent by a UPF for Ethernet PDU sessions over N6 (see clause 5.8.2.11.6 of 3GPP TS 23.501 [28]).	
NOTE 5: This value may apply e.g. to UL packets sent by a UPF (PDU Session Anchor) over N6, when explicit N6 traffic routing information is provided to the SMF (see clause 5.6.7 of 3GPP TS 23.501 [28]).	

At least one bit of the Outer Header Creation Description field shall be set to "1". Bits 5/1 and 5/2 may both be set to "1" if an F-TEID with both an IPv4 and IPv6 addresses has been assigned by the GTP-U peer. In this case, the UP function shall send the outgoing packet towards the IPv4 or IPv6 address.

The TEID field shall be present if the Outer Header Creation Description requests the creation of a GTP-U header. Otherwise it shall not be present. When present, it shall contain the destination GTP-U TEID to set in the GTP-U header of the outgoing packet.

The IPv4 Address field shall be present if the Outer Header Creation Description requests the creation of an IPv4 header. Otherwise it shall not be present. When present, it shall contain the destination IPv4 address to set in the IPv4 header of the outgoing packet.

The IPv6 Address field shall be present if the Outer Header Creation Description requests the creation of an IPv6 header. Otherwise it shall not be present. When present, it shall contain the destination IPv6 address to set in the IPv6 header of the outgoing packet.

The Port Number field shall be present if the Outer Header Creation Description requests the creation of a UDP/IP header (i.e. it is set to the value 4). Otherwise it shall not be present. When present, it shall contain the destination Port Number to set in the UDP header of the outgoing packet.

The C-TAG field shall be present if the Outer Header Creation Description requests the setting of the C-Tag in Ethernet packet. Otherwise it shall not be present. When present, it shall contain the destination Customer-VLAN tag to set in the Customer-VLAN tag header of the outgoing packet.

The S-TAG field shall be present if the Outer Header Creation Description requests the setting of the S-Tag in Ethernet packet. Otherwise it shall not be present. When present, it shall contain the destination Service-VLAN tag to set in the Service-VLAN tag header of the outgoing packet.

8.2.57 BAR ID

The BAR ID IE type shall be encoded as shown in Figure 8.2.57-1. It contains a Buffering Action Rule ID.

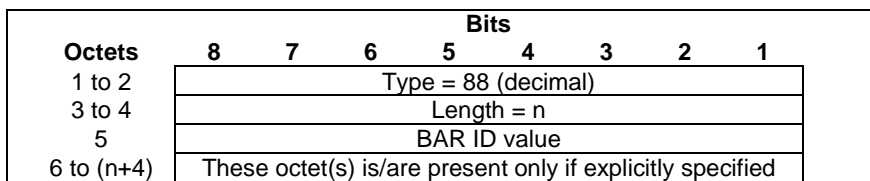

Figure 8.2.57-1: BAR ID

The BAR ID value shall be encoded as a binary integer value.

8.2.58 CP Function Features

The CP Function Features IE indicates the features supported by the CP function. Only features having an impact on the (system-wide) UP function behaviour are signalled in this IE. It is coded as depicted in Figure 8.2.58-1.

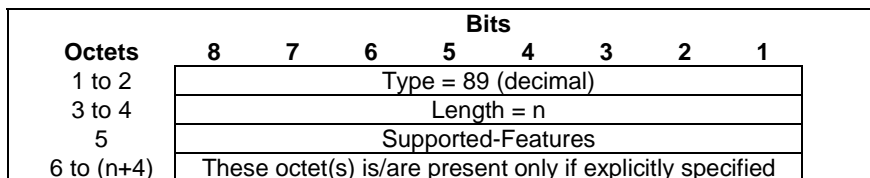

Figure 8.2.58-1: CP Function Features

The CP Function Features IE takes the form of a bitmask where each bit set indicates that the corresponding feature is supported. Spare bits shall be ignored by the receiver. The same bitmask is defined for all PFCP interfaces.

The following table specifies the features defined on PFCP interfaces and the interfaces on which they apply.

Table 8.2.58-1: CP Function Features

Feature Octet / Bit	Feature	Interface	Description
5/1	LOAD	Sxa, Sxb, Sxc, N4	Load Control is supported by the CP function.
5/2	OVRL	Sxa, Sxb, Sxc, N4	Overload Control is supported by the CP function.

Feature Octet / Bit: The octet and bit number within the Supported-Features IE, e.g. "5 / 1".

Feature: A short name that can be used to refer to the octet / bit and to the feature.

Interface: A list of applicable interfaces to the feature.

Description: A clear textual description of the feature.

8.2.59 Usage Information

The Usage Information IE shall be encoded as shown in Figure 8.2.59-1. It provides additional information on the Usage Report.

Octets	Bits							
	8	7	6	5	4	3	2	1
1 to 2	Type = 90 (decimal)							
3 to 4	Length = n							
5	Spare				UBE	UAE	AFT	BEF
6 to (n+4)	These octet(s) is/are present only if explicitly specified							

Figure 8.2.59-1: Usage Information

Octet 5 shall be encoded as follows:

- Bit 1 – BEF (Before): when set to "1", this indicates usage before a monitoring time.
- Bit 2 – AFT (After): when set to "1", this indicates a usage after a monitoring time.
- Bit 3 – UAE (Usage After Enforcement): when set to "1", this indicates a usage after QoS enforcement.
- Bit 4 – UBE (Usage Before Enforcement): when set to "1", this indicates a usage before QoS enforcement.
- Bits 5 to 8: Spare, for future use and set to "0".

8.2.60 Application Instance ID

The Application Instance ID IE type shall be encoded as shown in Figure 8.2.60-1. It contains an Application Instance Identifier referencing an application instance for which the start or stop of traffic is reported to the CP function.

Octets	Bits							
	8	7	6	5	4	3	2	1
1 to 2	Type = 91 (decimal)							
3 to 4	Length = n							
5 to (n+4)	Application Instance Identifier							

Figure 8.2.60-1: Application Instance ID

The Application Instance Identifier shall be encoded as an OctetString (see 3GPP TS 29.212 [8]).

8.2.61 Flow Information

The Flow Information IE type shall be encoded as shown in Figure 8.2.61-1. It contains the description of a flow information.

Octets	Bits							
	8	7	6	5	4	3	2	1
1 to 2	Type = 92 (decimal)							
3 to 4	Length = n							
5	Spare				Flow Direction			
6 to 7	Length of Flow Description							
8 to m	Flow Description							
p to (n+4)	These octet(s) is/are present only if explicitly specified							

Figure 8.2.61-1: Flow Information

The Flow Direction field, when present, shall be encoded as defined in Table 8.2.61-1.

Table 8.2.61-1: Flow Direction

Flow Direction	Value (Decimal)
Unspecified	0
Downlink (traffic to the UE)	1
Uplink (traffic from the UE)	2
Bidirectional	3
For future use. Shall not be sent. If received, shall be interpreted as the value "0".	4 to 7

The Flow Description field, when present, shall be encoded as an OctetString as specified in clause 5.4.2 of 3GPP TS 29.212 [8].

8.2.62 UE IP Address

The UE IP Address IE type shall be encoded as shown in Figure 8.2.62-1. It contains a source or destination IP address.

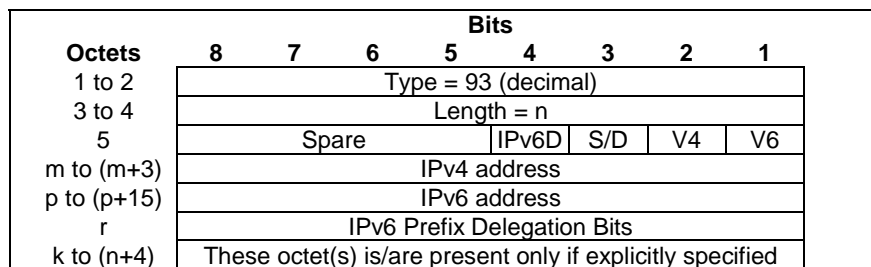
**Figure 8.2.62-1: UE IP Address**

The following flags are coded within Octet 5:

- Bit 1 – V6: If this bit is set to "1", then the IPv6 address field shall be present in the UE IP Address, otherwise the IPv6 address field shall not be present.
- Bit 2 – V4: If this bit is set to "1", then the IPv4 address field shall be present in the UE IP Address, otherwise the IPv4 address field shall not be present.
- Bit 3 – S/D: This bit is only applicable to the UE IP Address IE in the PDI IE. It shall be set to "0" and ignored by the receiver in IEs other than PDI IE. In the PDI IE, if this bit is set to "0", this indicates a Source IP address; if this bit is set to "1", this indicates a Destination IP address.
- Bit 4 – IPv6D: This bit is only applicable to the UE IP address IE in the PDI IE and when V6 bit is set to "1". If this bit is set to "1", then the IPv6 Prefix Delegation Bits field shall be present, otherwise the UP function shall consider IPv6 prefix is default /64.
- Bit 5 to 8 Spare, for future use and set to "0".

Octets "m to (m+3)" or "p to (p+15)" (IPv4 address / IPv6 address fields), if present, shall contain the address value.

Octet r, if present, shall contain the number of bits is allocated for IPv6 prefix delegation, e.g. if /60 prefix is used, the value is set to "4". When using UE IP address IE in a PDI to match the packets, the UP function shall only use the IPv6 prefix part and ignore the interface identifier part.

8.2.63 Packet Rate

The Packet Rate IE contains the packet rate thresholds to be enforced by the UP function. It shall be encoded as shown in Figure 8.2.63-1.

Octets	Bits							
	8	7	6	5	4	3	2	1
1 to 2	Type = 94 (decimal)							
3 to 4	Length = n							
5	Spare					DLPR	ULPR	
m	Spare				Uplink Time Unit			
(m+1) to (m+2)	Maximum Uplink Packet Rate							
p	Spare				Downlink Time Unit			
(p+1) to (p+2)	Maximum Downlink Packet Rate							
q to (n+4)	These octet(s) is/are present only if explicitly specified							

Figure 8.2.63-1: Packet Rate

The following flags are coded within Octet 5:

- Bit 1 – ULPR (Uplink Packet Rate): If this bit is set to "1", then octets m to (m+2) shall be present, otherwise these octets shall not be present.
- Bit 2 – DLPR (Downlink Packet Rate): If this bit is set to "1", then octets p to (p+2) shall be present, otherwise these octets shall not be present.
- Bit 3 to 8: Spare, for future use and set to "0".

At least one bit in Octet 5 shall be set to "1". Several bits may be set to "1".

When present, octets m to (m+2) indicate the maximum number of uplink packets allowed to be sent within the uplink time unit.

When present, octets p to (p+2) indicate the maximum number of downlink packets allowed to be sent within the downlink time unit.

Table 8.2.63.1: Uplink/Downlink Time Unit

Uplink/Downlink Time unit
Bits 1 to 3 define the time unit as follows:
Bits
3 2 1
0 0 0 minute
0 0 1 6 minutes
0 1 0 hour
0 1 1 day
1 0 0 week
Other values shall be interpreted as 000 in this version of the protocol.

The Maximum Uplink/Downlink Packet Rate shall be encoded as an Unsigned 16 binary integer value. They shall indicate the maximum number of uplink/downlink packets allowed to be sent in the indicated uplink/downlink time unit respectively.

8.2.64 Outer Header Removal

The Outer Header Removal IE type shall be encoded as shown in Figure 8.2.64-1. It contains the instructions to remove an Outer Header.

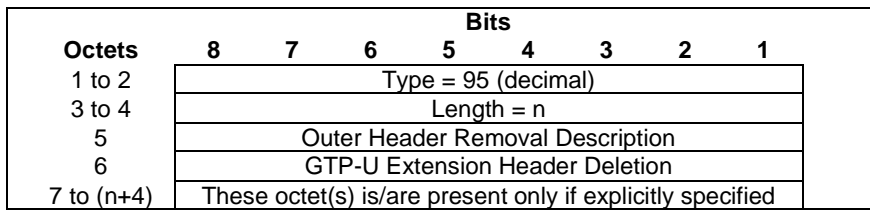

Figure 8.2.64-1: Outer Header Removal

The Outer Header Removal Description field, when present, shall be encoded as specified in Table 8.2.64-1.

Table 8.2.64-1: Outer Header Removal Description

Outer Header to be removed from the incoming packet	Value (Decimal)
GTP-U/UDP/IPv4 (NOTE 1), (NOTE 2)	0
GTP-U/UDP/IPv6 (NOTE 1), (NOTE 2)	1
UDP/IPv4 (NOTE 3, NOTE 6)	2
UDP/IPv6 (NOTE 3, NOTE 6)	3
IPv4 (NOTE 6)	4
IPv6 (NOTE 6)	5
GTP-U/UDP/IP (NOTE 4)	6
VLAN S-TAG (See NOTE 5)	7
S-TAG and C-TAG (See NOTE 5)	8
For future use. Shall not be sent. If received, shall be interpreted as the value "1".	9 to 255
NOTE 1: The SGW-U/I-UPF shall store GTP-U extension header(s) required to be forwarded for this packet (as required by the comprehension rules of Figure 5.2.1-2 of 3GPP TS 29.281 [3]) that are not requested to be deleted by the GTP-U Extension Header Deletion field.	
NOTE 2: The SGW-U/I-UPF shall store the GTP-U message type for a GTP-U signalling message which is required to be forwarded, e.g. for an End Marker message.	
NOTE 3: This value may apply to DL packets received by a PGW-U for non-IP PDN connections with SGi tunnelling based on UDP/IP encapsulation (see clause 4.3.17.8.3.3.2 of 3GPP TS 23.401 [14]).	
NOTE 4: The CP function shall use this value to instruct UP function to remove the GTP-U/UDP/IP header regardless it is IPv4 or IPv6.	
NOTE 5: This value may apply to DL packets received by a UPF over N6 for Ethernet PDU sessions over (see clause 5.8.2.11.3 of 3GPP TS 23.501 [28]).	
NOTE 6: This value may apply e.g. to DL packets received by a UPF (PDU Session Anchor) over N6, when explicit N6 traffic routing information is provided to the SMF (see clause 5.6.7 of 3GPP TS 23.501 [28]).	

The GTP-U Extension Header Deletion field (octet 6) shall be present if it is required to delete GTP-U extension header(s) from incoming GTP-PDUs. Octet 6 shall be absent if all GTP-U extension headers required to be forwarded shall be stored as indicated in NOTE 1 of Table 8.2.64-1.

The GTP-U Extension Header Deletion field, when present, shall be encoded as specified in Table 8.2.64-2. It takes the form of a bitmask where each bit provides instructions on the information to be deleted from the incoming GTP-PDU packet. Spare bits shall be ignored by the receiver.

Table 8.2.64-2: GTP-U Extension Header Deletion

Octet / Bit	GTP-U Extension Header to be deleted from incoming packet
6/1	PDU Session Container (NOTE)
NOTE:	This value shall be used for data forwarding during a 5GS to EPS handover for a UPF that supports EPS-5GS interworking (see clause 5.17.3).

8.2.65 Recovery Time Stamp

The Recovery Time Stamp IE is coded as shown in Figure 8.2.65-1. It indicates the UTC time when the PFCP entity started. Octets 5 to 8 are encoded in the same format as the first four octets of the 64-bit timestamp format as defined in clause 6 of IETF RFC 5905 [26].

NOTE: The encoding is defined as the time in seconds relative to 00:00:00 on 1 January 1900.

Octets	Bits						
	8	7	6	5	4	3	2
1 to 2	Type = 96 (decimal)						
3 to 4	Length = n						
5 to 8	Recovery Time Stamp value						
9 to (n+4)	These octet(s) is/are present only if explicitly specified						

Figure 8.2.65-1: Recovery Time Stamp

8.2.66 DL Flow Level Marking

The DL Flow Level Marking IE type shall be encoded as shown in Figure 8.2.66-1.

Octets	Bits						
	8	7	6	5	4	3	2
1 to 2	Type = 97 (decimal)						
3 to 4	Length = n						
5	Spare				SCI		TTC
m to (m+1)	ToS/Traffic Class						
p to (p+1)	Service Class Indicator						
q to (n+4)	These octet(s) is/are present only if explicitly specified						

Figure 8.2.66-1: DL Flow Level Marking

The following flags are coded within Octet 5:

- Bit 1 – TTC (ToS/Traffic Class): If this bit is set to "1", then the ToS/Traffic Class field shall be present, otherwise the ToS/Traffic Class field shall not be present.
- Bit 2 – SCI (Service Class Indicator): If this bit is set to "1", then the Service Class Indicator field shall be present, otherwise the Service Class Indicator field shall not be present.
- Bit 3 to 8: Spare, for future use and set to "0".

The ToS/Traffic Class field, when present, shall be encoded on two octets as an OctetString. The first octet shall contain the IPv4 Type-of-Service or the IPv6 Traffic-Class field and the second octet shall contain the ToS/Traffic Class mask field. See clause 5.3.15 of 3GPP TS 29.212 [8].

Octets p and (p+1) of the Service Class Indicator field, when present, shall be encoded respectively as octets 2 and 3 of the Service Class Indicator Extension Header specified in Figure 5.2.2.3-1 of 3GPP TS 29.281 [3].

8.2.67 Header Enrichment

The Header Enrichment IE type shall be encoded as shown in Figure 8.2.67-1. It contains information for header enrichment.

Octets	Bits						
	8	7	6	5	4	3	2
1 to 2	Type = 98 (decimal)						
3 to 4	Length = n						
5	Spare			Header Type			
6	Length of Header Field Name						
7 to m	Header Field Name						
p	Length of Header Field Value						
(p+1) to q	Header Field Value						
s to (n+4)	These octet(s) is/are present only if explicitly specified						

Figure 8.2.67-1: Header Enrichment

Header Type indicates the type of the Header. It shall be encoded as defined in Table 8.2.67-1.

Table 8.2.67-1: Header Type

Header Type	Value (Decimal)
HTTP	0
Spare, for future use.	1 to 31

Length of Header Field Name indicates the length of the Header Field Name.

Header Field Name shall be encoded as an OctetString.

Length of Header Field Value indicates the length of the Header Field Value.

Header Field Value shall be encoded as an OctetString.

For a HTTP Header Type, the contents of the Header Field Name and Header Field Value shall comply with the HTTP header field format (see clause 3.2 of IETF RFC 7230 [23]).

8.2.68 Measurement Information

The Measurement Information IE shall be encoded as shown in Figure 8.2.68-1. It provides information on the requested measurement information.

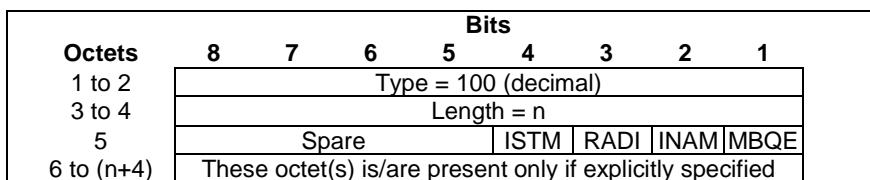

Figure 8.2.68-1: Measurement Information

Octet 5 shall be encoded as follows:

- Bit 1 – MBQE (Measurement Before QoS Enforcement): when set to "1", this indicates a request to measure the traffic usage before QoS enforcement.
- Bit 2 – INAM (Inactive Measurement): when set to "1", this indicates that the measurement shall be paused (inactive).
- Bit 3 – RADI (Reduced Application Detection Information): when set to "1", this indicates that the Application Detection Information reported to the CP function, upon detecting the start or stop of an application, shall only contain the Application ID.
- Bit 4 – ISTM (Immediate Start Time Metering): when set to "1", this indicates that time metering shall start immediately when the flag is received.
- Bits 5 to 8: Spare, for future use and set to "0".

8.2.69 Node Report Type

The Node Report Type IE shall be encoded as shown in Figure 8.2.69-1. It indicates the type of the node report the UP function sends to the CP function.

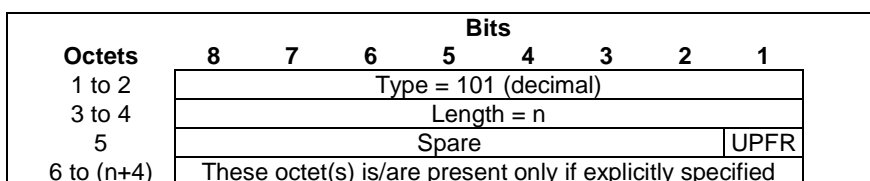

Figure 8.2.69-1: Node Report Type

Octet 5 shall be encoded as follows:

- Bit 1 – UPFR (User Plane Path Failure Report): when set to "1", this indicates a User Plane Path Failure Report.
- Bit 2 to 8 – Spare, for future use and set to "0".

At least one bit shall be set to "1". Several bits may be set to "1".

8.2.70 Remote GTP-U Peer

The Remote GTP-U Peer IE shall be encoded as depicted in Figure 8.2.70-1.

Octets	Bits							
	8	7	6	5	4	3	2	1
1 to 2	Type = 103 (decimal)							
3 to 4	Length = n							
5	Spare			NI	DI	V4	V6	
m to (m+3)	IPv4 address							
p to (p+15)	IPv6 address							
q to (q+1)	Length of Destination Interface field							
(q+2) to r	Destination Interface field							
s to (s+1)	Length of Network Instance field							
(s+2) to t	Network Instance field							
k to (n+4)	These octet(s) is/are present only if explicitly specified							

Figure 8.2.70-1: Remote GTP-U Peer

The following flags are coded within Octet 5:

- Bit 1 – V6: If this bit is set to "1", then the IPv6 address field shall be present, otherwise the IPv6 address field shall not be present.
- Bit 2 – V4: If this bit is set to "1", then the IPv4 address field shall be present, otherwise the IPv4 address field shall not be present.
- Bit 3 – DI: If this bit is set to "1", then the Length of Destination Interface field and the Destination Interface field shall be present, otherwise both the Length of Destination Interface field and the Destination Interface field shall not be present.
- Bit 4 – NI: If this bit is set to "1", then the Length of Network Instance field and the Network Instance field shall be present, otherwise both the Length of Network Instance field and the Network Instance field shall not be present.
- Bit 5 to 8 - Spare, for future use and set to "0".

Either the V4 or the V6 bit shall be set to "1".

Octets "m to (m+3)" and/or "p to (p+15)" (IPv4 address / IPv6 address fields), if present, shall contain the respective address values.

The Destination Interface field, when present, shall be encoded as the same as Destination Interface IE specified in clause 8.2.24.

The Network Instance field, when present, shall be encoded as the same as Network Instance IE specified in clause 8.2.4.

8.2.71 UR-SEQN

The UR-SEQN (Usage Report Sequence Number) IE identifies the order in which a usage report is generated for a given URR. It shall be encoded as shown in Figure 8.2.71-1.

Octets	Bits						
	8	7	6	5	4	3	2
1 to 2	Type = 104 (decimal)						
3 to 4	Length = n						
5 to 8	UR-SEQN						

Figure 8.2.71-1: UR-SEQN

The UR-SEQN value shall be encoded as an Unsigned32 binary integer value.

8.2.72 Activate Predefined Rules

The Activate Predefined Rules IE type shall be coded as shown in Figure 8.2.72-1. It shall indicate a Predefined Rules Name, referring to one or more predefined rules which need to be activated in the UP function.

Octets	Bits						
	8	7	6	5	4	3	2
1 to 2	Type = 106 (decimal)						
3 to 4	Length = n						
5 to (n+4)	Predefined Rules Name						

Figure 8.2.72-1: Activate Predefined Rules

The Predefined Rules Name field shall be encoded as an OctetString.

8.2.73 Deactivate Predefined Rules

The Deactivate Predefined Rules IE type shall be coded as shown in Figure 8.2.73-1. It shall indicate a Predefined Rules Name, referring to one or more predefined rules which need to be deactivated in the UP function.

Octets	Bits						
	8	7	6	5	4	3	2
1 to 2	Type = 107 (decimal)						
3 to 4	Length = n						
5 to (n+4)	Predefined Rules Name						

Figure 8.2.73-1: Deactivate Predefined Rules

The Predefined Rules Name field shall be encoded as an OctetString.

8.2.74 FAR ID

The FAR ID IE type shall be encoded as shown in Figure 8.2.74-1. It shall contain a Forwarding Action Rule ID.

Octets	Bits						
	8	7	6	5	4	3	2
1 to 2	Type = 108 (decimal)						
3 to 4	Length = n						
5 to 8	FAR ID value						
9 to (n+4)	These octet(s) is/are present only if explicitly specified						

Figure 8.2.74-1: FAR ID

The FAR ID value shall be encoded as an Unsigned32 binary integer value.

The bit 8 of octet 5 is used to indicate if the Rule ID is dynamically allocated by the CP function or predefined in the UP function. If set to "0", it indicates that the Rule is dynamically provisioned by the CP Function. If set to "1", it indicates that the Rule is predefined in the UP Function.

8.2.75 QER ID

The QER ID IE type shall be encoded as shown in Figure 8.2.75-1. It shall contain a QoS Enforcement Rule ID.

Octets	Bits							
	8	7	6	5	4	3	2	1
1 to 2	Type = 109 (decimal)							
3 to 4	Length = n							
5 to 8	QER ID value							
9 to (n+4)	These octet(s) is/are present only if explicitly specified							

Figure 8.2.75-1: QER ID

The QER ID value shall be encoded as an Unsigned32 binary integer value.

The bit 8 of octet 5 is used to indicate if the Rule ID is dynamically allocated by the CP function or predefined in the UP function. If set to "0", it indicates that the Rule is dynamically provisioned by the CP Function. If set to "1", it indicates that the Rule is predefined in the UP Function.

8.2.76 OCI Flags

The OCI Flags IE shall contain the flags for overload control related information. It shall be encoded as shown in Figure 8.2.76-1.

Octets	Bits							
	8	7	6	5	4	3	2	1
1 to 2	Type = 110 (decimal)							
3 to 4	Length = n							
5	Spare							AOCI
6 to (n+4)	These octet(s) is/are present only if explicitly specified							

Figure 8.2.76-1: OCI Flags

The following flags are coded within Octet 5:

- Bit 1 – AOCI: Associate OCI with Node ID: The UP function shall set this flag to 1 if it has included the "Overload Control Information" and if this information is to be associated with the Node ID (i.e. FQDN or the IP address used during the UP function selection) of the serving UP function. This flag shall be set to "1" by the UP function, if the "Overload Control Information" is included in the PFCP Session Establishment Response and the Cause IE is set to a rejection cause value.
- Bit 2 to 8: Spare, for future use and set to "0".

8.2.77 PFCP Association Release Request

The PFCP Association Release Request IE shall be encoded as shown in Figure 8.2.77-1.

Octets	Bits							
	8	7	6	5	4	3	2	1
1 to 2	Type = 111 (decimal)							
3 to 4	Length = n							
5	Spare							SARR
6 to (n+4)	These octet(s) is/are present only if explicitly specified							

Figure 8.2.77-1: PFCP Association Release Request

The following flags are coded within Octet 5:

- Bit 1 – SARR (PFCP Association Release Request): If this bit is set to "1", then the UP function requests the release of the PFCP association.
- Bit 2 to 8: Spare, for future use and set to "0".

8.2.78 Graceful Release Period

The purpose of the Graceful Release Period IE is to specify a specific time for a graceful release. The Graceful Release Period IE shall be encoded as shown in Figure 8.2.78-1 and table 8.2.78.1.

Octets	Bits						
	8	7	6	5	4	3	2
1 to 2	Type = 112 (decimal)						
3 to 4	Length = n						
5	Timer unit			Timer value			
6 to (n+4)	These octet(s) is/are present only if explicitly specified						

Figure 8.2.78-1: Graceful Release Period

Table 8.2.78.1: Graceful Release Period information element

<p>Timer value Bits 5 to 1 represent the binary coded timer value.</p> <p>Timer unit Bits 6 to 8 defines the timer value unit for the timer as follows:</p> <p>Bits</p> <p>8 7 6</p> <p>0 0 0 value is incremented in multiples of 2 seconds 0 0 1 value is incremented in multiples of 1 minute 0 1 0 value is incremented in multiples of 10 minutes 0 1 1 value is incremented in multiples of 1 hour 1 0 0 value is incremented in multiples of 10 hours 1 1 1 value indicates that the timer is infinite</p> <p>Other values shall be interpreted as multiples of 1 minute in this version of the protocol.</p> <p>Timer unit and Timer value both set to all "zeros" shall be interpreted as an indication that the timer is stopped.</p>

8.2.79 PDN Type

The PDN Type IE shall be encoded as shown in Figure 8.2.79-1. It indicates the type of a PDN connection (IP, Ethernet or Unstructured).

Octets	Bits						
	8	7	6	5	4	3	2
1 to 2	Type = 113 (decimal)						
3 to 4	Length = n						
5	Spare			PDN Type			
6 to (n+4)	These octet(s) is/are present only if explicitly specified						

Figure 8.2.79-1: PDN Type

Table 8.2.79-1: PDN Type

PDN Type	Value (Decimal)
IPv4	1
IPv6	2
IPv4v6	3
Non-IP	4
Ethernet	5
For future use. Shall not be sent.	0, 6, 7

8.2.80 Failed Rule ID

The Failed Rule ID IE type shall be encoded as shown in Figure 8.2.80-1. It shall identify the Rule which failed to be created or modified.

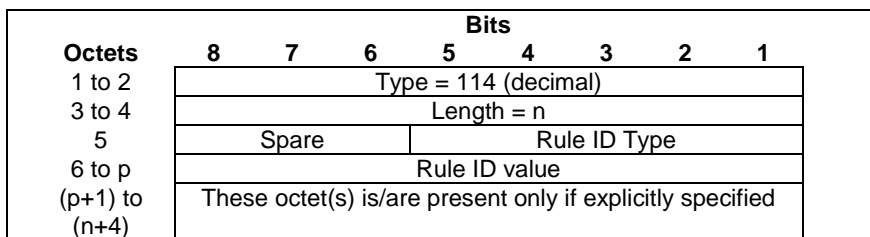

Figure 8.2.80-1: Failed Rule ID

The Rule ID Type shall be encoded as a 5 bits binary integer value as specified in Table 8.2.80-1.

Table 8.2.80-1: Rule ID Type

Rule ID Type	Value (Decimal)
PDR	0
FAR	1
QER	2
URR	3
BAR	4
For future use. Shall not be sent. If received, shall be interpreted as the value "1".	5 to 31

The length and the value of the Rule ID value field shall be set as specified for the PDR ID, FAR ID, QER ID, URR ID and BAR ID IE types respectively.

8.2.81 Time Quota Mechanism

The Time Quota Mechanism type shall be encoded as shown in Figure 8.2.81-1.

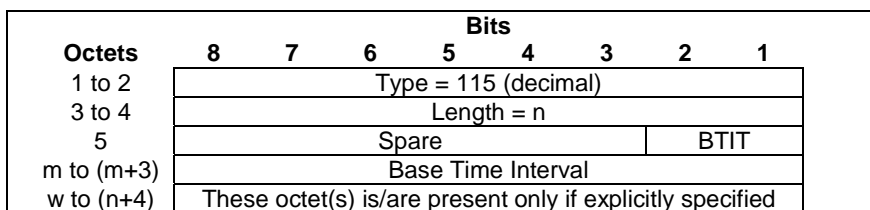

Figure 8.2.81-1: Time Quota Mechanism

BTIT (Base Time Interval Type) indicates the type of the interval to be provided in the Base Time Interval field.

Table 8.2.81-1: Base Time Interval Type

Base Time Interval Type	Value (Decimal)
CTP	0
DTP	1
Spare, for future use.	2 to 3

The Base Time Interval, shall be encoded as Unsigned32 as specified in clause 7.2.29 of 3GPP TS 32.299 [18].

8.2.82 User Plane IP Resource Information

The User Plane IP Resource Information IE type shall be encoded as shown in Figure 8.2.82-1.

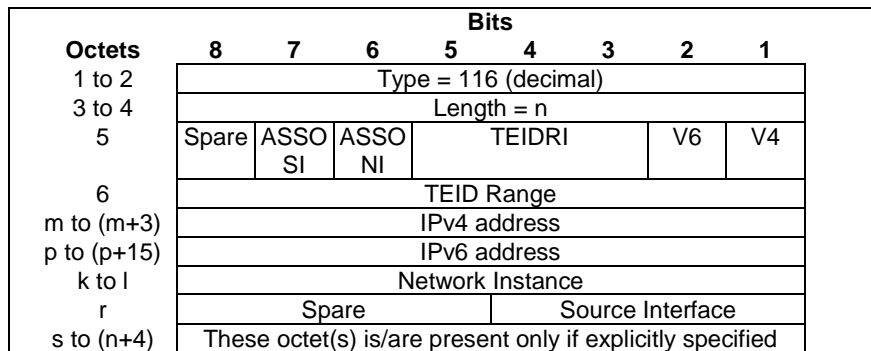

Figure 8.2.82-1: User Plane IP Resource Information

The following flags are coded within Octet 5:

- Bit 1 – V4: If this bit is set to "1", then the IPv4 address field shall be present, otherwise the IPv4 address field shall not be present.
- Bit 2 – V6: If this bit is set to "1", then the IPv6 address field shall be present, otherwise the IPv6 address field shall not be present.
- Bit 3-5 – TEID Range Indication (TEIDRI): the value of this field indicates the number of bits in the most significant octet of a TEID that are used to partition the TEID range, e.g. if this field is set to "4", then the first 4 bits in the TEID are used to partition the TEID range.
- Bit 6 – Associated Network Instance (ASSONI): if this bit is set to "1", then the Network Instance field shall be present, otherwise the Network Instance field shall not be present.
- Bit 7 – Associated Source Interface (ASSOSI): if this bit is set to "1", then the Source Interface field shall be present, otherwise the Source Interface field shall not be present.
- Bit 8: Spare, for future use and set to "0".

At least one of the V4 and V6 flags shall be set to "1", and both may be set to "1".

If both the ASSONI and ASSOSI flags are set to "0", this shall indicate that the User Plane IP Resource Information provided can be used by CP function for any Network Instance and any Source Interface of GTP-U user plane in the UP function.

Octet 6 (TEID Range) shall be present if the TEID Range Indication is not set to zero and shall contain a value of the bits which are used to partition the TEID range. E.g. if the TEID Range Indication is set to "4", then Octet 6 shall be one of values between 0 and 15. When TEID Range Indication is set to zero, the Octet 6 shall not be present, the TEID is not partitioned, i.e. all TEID values are available for use by the CP function.

Octets "m to (m+3)" and/or "p to (p+15)" (IPv4 address / IPv6 address fields), if present, shall contain the respective IP address values.

Octets "k to l", if present, shall contain a Network Instance value as encoded in octet "5 to n+4" of the Figure 8.2.4-1 in clause 8.2.4, identifying a Network Instance with which the IP address or TEID Range is associated.

Octet r, if present, shall contain a Source Interface value as encoded in octet 5 of the Figure 8.2.2-1 in clause 8.2.2, identifying the Source Interface with which the IP address or TEID Range is associated.

8.2.83 User Plane Inactivity Timer

The User Plane Inactivity Timer IE contains the inactivity time period, in seconds, to be monitored by the UP function. It shall be encoded as shown in Figure 8.2.83-1.

Octets	Bits							
	8	7	6	5	4	3	2	1
1 to 2	Type = 117 (decimal)							
3 to 4	Length = n							
5 to 8	User Plane Inactivity Timer							
9 to (n+4)	These octet(s) is/are present only if explicitly specified							

Figure 8.2.83-1: User Plane Inactivity Timer

The User Plane Inactivity Timer field shall be encoded as an Unsigned32 binary integer value. The timer value "0" shall be interpreted as an indication that user plane inactivity detection and reporting is stopped.

8.2.84 Multiplier

The Multiplier IE type shall be encoded as shown in Figure 8.2.84-1. It contains a Multiplier (see IETF RFC 4006 [16]) to measure the abstract service units the traffic of an aggregated URR consumes from the credit pool.

Octets	Bits							
	8	7	6	5	4	3	2	1
1 to 2	Type = 119 (decimal)							
3 to 4	Length = 12							
5 to 12	Value-Digits							
13 to 16	Exponent							

Figure 8.2.84-1: Multiplier

The Value-Digit value and Exponent value shall be encoded as binary integer value, and set the value as in Value-Digit AVP and Exponent AVP as specified in 3GPP TS 32.299 [18].

8.2.85 Aggregated URR ID IE

The Aggregated URR ID IE type shall be encoded as shown in Figure 8.2.85-1. It contains a URR ID.

Octets	Bits							
	8	7	6	5	4	3	2	1
1 to 2	Type = 120 (decimal)							
3 to 4	Length = 4							
5 to 8	URR ID value							

Figure 8.2.85-1: Aggregated URR ID

Each URR ID value shall be encoded as an Unsigned32 binary integer value.

8.2.86 Subsequent Volume Quota

The Subsequent Volume Quota IE type shall be encoded as shown in Figure 8.2.86-1. It contains the volume quota to be monitored by the UP function after the Monitoring Time.

Octets	Bits							
	8	7	6	5	4	3	2	1
1 to 2	Type = 121 (decimal)							
3 to 4	Length = n							
5	Spare			DLVO	ULVO	TOVO		
				L	L	L		
m to (m+7)	Total Volume							
p to (p+7)	Uplink Volume							
q to (q+7)	Downlink Volume							
S to (n+4)	These octet(s) is/are present only if explicitly specified							

Figure 8.2.86-1: Subsequent Volume Quota

The following flags are coded within Octet 5:

- Bit 1 – TOVOL: If this bit is set to "1", then the Total Volume field shall be present, otherwise the Total Volume field shall not be present.
- Bit 2 – ULVOL: If this bit is set to "1", then the Uplink Volume field shall be present, otherwise the Uplink Volume field shall not be present.
- Bit 3 – DLVOL: If this bit is set to "1", then the Downlink Volume field shall be present, otherwise the Downlink Volume field shall not be present.
- Bit 4 to bit 8: Spare, for future use and set to "0".

At least one bit shall be set to "1". Several bits may be set to "1".

The Total Volume, Uplink Volume and Downlink Volume fields shall be encoded as an Unsigned64 binary integer value. They shall contain the total, uplink or downlink number of octets respectively.

8.2.87 Subsequent Time Quota

The Subsequent Time Quota IE type shall be encoded as shown in Figure 8.2.87-1. It contains the time quota to be monitored by the UP function after the Monitoring Time.

Octets	Bits							
	8	7	6	5	4	3	2	1
1 to 2	Type = 122 (decimal)							
3 to 4	Length = n							
5 to 8	Time Quota value							
9 to (n+4)	These octet(s) is/are present only if explicitly specified							

Figure 8.2.87-1: Subsequent Time Quota

The Time Quota value shall be encoded as an Unsigned32 binary integer value. It contains a duration in seconds.

8.2.88 RQI

The RQI IE shall be encoded as shown in Figure 8.2.88-1. It indicates if Reflective QoS applies for the UL.

Octets	Bits							
	8	7	6	5	4	3	2	1
1 to 2	Type = 123 (decimal)							
3 to 4	Length = n							
5	Spare							RQI
6 to (n+4)	These octet(s) is/are present only if explicitly specified							

Figure 8.2.88-1: RQI

The value of RQI flag shall be set as specified in clause 5.5.3.4 of 3GPP TS 38.415 [34].

8.2.89 QFI

The QFI IE type shall be encoded as shown in Figure 8.2.89-1. It contains an QoS flow identifier identifying a QoS flow in a 5G system filter.

Octets	Bits							
	8	7	6	5	4	3	2	1
1 to 2	Type = 124 (decimal)							
3 to 4	Length = n							
5	Spare				QFI value			
p to (n+4)	These octet(s) is/are present only if explicitly specified							

Figure 8.2.89-1: QFI

The QFI value shall be encoded as binary integer value, as specified in clause 5.5.3.3 of 3GPP TS 38.415 [34].

8.2.90 Query URR Reference

The Query URR Reference IE type shall be encoded as shown in Figure 8.2.90-1. It shall contain the reference of a query request for URR(s).

Octets	Bits							
	8	7	6	5	4	3	2	1
1 to 2	Type = 125 (decimal)							
3 to 4	Length = n							
5 to 8	Query URR Reference value							
9 to (n+4)	These octet(s) is/are present only if explicitly specified							

Figure 8.2.90-1: Query URR Reference

The Query URR Reference value shall be encoded as an Unsigned32 binary integer value.

8.2.91 Additional Usage Reports Information

The Number of Additional Usage Reports IE type shall be encoded as shown in Figure 8.2.91-1. It shall either indicate that additional usage reports will follow, or contain the number of usage reports which need to be sent in additional PFCP Session Report Request messages, in response to a PFCP Session Modification Request querying URR(s).

Octets	Bits							
	8	7	6	5	4	3	2	1
1 to 2	Type = 126 (decimal)							
3 to 4	Length = n							
5	AURI	Number of Additional Usage Reports value						
6	Number of Additional Usage Reports value							
7 to (n+4)	These octet(s) is/are present only if explicitly specified							

Figure 8.2.91-1: Additional Usage Reports Information

The Number of Additional Usage Reports value shall be encoded as an unsigned binary integer value on 15 bits. Bit 7 of Octet 5 is the most significant bit and bit 1 of Octet 6 is the least significant bit.

The bit 8 of octet 5 shall encode the AURI (Additional Usage Reports Indication) flag:

- when set to "1", it indicates that additional usage reports will follow. In this case, the Number of Additional Usage Reports value shall be set to "0" by the sender and ignored by the receiver;
- when set to "0", the Number of Additional Usage Reports value shall be set to the total number of additional usage reports to be sent in PFCP Session Report Request messages.

8.2.92 Traffic Endpoint ID

The Traffic Endpoint ID IE type shall be encoded as shown in Figure 8.2.92-1. It shall contain a Traffic Endpoint ID.

Octets	Bits						
	8	7	6	5	4	3	2
1 to 2	Type = 131 (decimal)						
3 to 4	Length = n						
5	Traffic Endpoint ID value						
6 to (n+4)	These octet(s) is/are present only if explicitly specified						

Figure 8.2.92-1: Traffic Endpoint ID

The Traffic Endpoint ID value shall be encoded as a binary integer value within the range of 0 to 255.

8.2.93 MAC address

The MAC address IE shall be encoded as shown in Figure 8.2.93-1. It shall contain a MAC address value.

Octets	Bits							
	8	7	6	5	4	3	2	1
1 to 2	Type = 133 (decimal)							
3 to 4	Length = n							
5	spare			UDES	USO	DEST	SOU	R
m to (m+5)	Source MAC address value							
n to (n+5)	Destination MAC address value							
o to (o+5)	Upper Source MAC address value							
p to (p+5)	Upper Destination MAC address value							
s to (n+4)	These octet(s) is/are present only if explicitly specified							

Figure 8.2.93-1: MAC address

The following flags are coded within Octet 5:

- Bit 1 – SOUR (Source): If this bit is set to "1", then the source MAC address value is provided.
- Bit 2 – DEST (Destination): If this bit is set to "1", then the destination MAC address value is provided.
- Bit 3 – USOU (Source): If this bit is set to "1", then the source MAC address value contains the lower value and Upper Source MAC address value contains the upper value of an MAC address range.
- Bit 4 – UDES (Destination): If this bit is set to "1", then the destination MAC address value contains the lower value and Upper Destination MAC address value contains the upper value of an MAC address range.- Bit 5 to 8: Spare, for future use and set to "0".

Octets "m to (m+5)" or "n to (n+5)" and "o to (o+5)" or "p to (p+5)", if present, shall contain a MAC address value (12-digit hexadecimal numbers).

8.2.94 C-TAG (Customer-VLAN tag)

The C-TAG IE shall be encoded as shown in Figure 8.2.94-1. It shall contain the Customer-VLAN tag (C-TAG) as defined in IEEE 802.1Q [30].

Octets	Bits							
	8	7	6	5	4	3	2	1
1 to 2	Type = 134 (decimal)							
3 to 4	Length = n							
5	Spare					VID	DEI	PCP
6	C-VID value				DEI Flag	PCP value		
7	C-VID Value							
8 to (n+4)	These octet(s) is/are present only if explicitly specified							

Figure 8.2.94-1: C-TAG (Customer-VLAN tag)

The following flags are coded within Octet 5:

- Bit 1 – PCP: If this bit is set to "1", then PCP Value field shall used by the receiver, otherwise the PCP Value field shall be ignored.
- Bit 2 – DEI: If this bit is set to "1", then DEI flag field shall used by the receiver, otherwise the DEI flag field shall be ignored.
- Bit 3 – VID: If this bit is set to "1", then C-VID value field shall used by the receiver, otherwise the VID Value field shall be ignored.
- Bit 4 to 8 – spare and reserved for future use.

The PCP value, DEI flag and C-VID Value shall follow the encoded as specified in IEEE 802.1Q [30] tag format.

8.2.95 S-TAG (Service-VLAN tag)

The S-TAG IE type shall be encoded as shown in Figure 8.2.95-1. It shall contain Service-VLAN tag (S-TAG) as defined in IEEE 802.1Q [30]

Octets	Bits							
	8	7	6	5	4	3	2	1
1 to 2	Type = 135 (decimal)							
3 to 4	Length = n							
5	Spare					VID	DEI	PCP
6	S-VID value				DEI Flag	PCP value		
7	S-VID value							
8 to (n+4)	These octet(s) is/are present only if explicitly specified							

Figure 8.2.95-1: S-TAG (Service-VLAN tag)

The following flags are coded within Octet 5:

- Bit 1 – PCP: If this bit is set to "1", then PCP Value field shall used by the receiver, otherwise the PCP Value field shall be ignored.
- Bit 2 – DEI: If this bit is set to "1", then DEI flag field shall used by the receiver, otherwise the DEI flag field shall be ignored.
- Bit 3 – VID: If this bit is set to "1", then VID value field shall used by the receiver, otherwise the VID Value field shall be ignored.
- Bit 4 to 8 – spare and reserved for future use.

The PCP value, DEI flag and V-VID Value shall follow the encoded as specified in IEEE 802.1Q [30] tag format.

8.2.96 Ethertype

The Ethertype IE type shall be encoded as shown in Figure 8.2.96-1. It contains an Ethertype as defined in IEEE 802.3 [31].

Octets	Bits							
	8	7	6	5	4	3	2	1
1 to 2	Type = 136 (decimal)							
3 to 4	Length = n							
5 to 6	Ethertype							
7 to (n+4)	These octet(s) is/are present only if explicitly specified							

Figure 8.2.96-1: Ethertype

8.2.97 Proxying

The Proxying IE shall be encoded as shown in Figure 8.2.97-1. It specifies if responding to Address Resolution Protocol (ARP) (see IETF RFC 826 [32]) and / or IPv6 Neighbour Solicitation (see IETF RFC 4861 [33]) as specified in clause 5.6.10.2 of 3GPP TS 23.501 [28], functionality for the Ethernet PDUs is performed in UPF.

Octets	Bits								
	8	7	6	5	4	3	2	1	
1 to 2	Type = 137 (decimal)								
3 to 4	Length = n								
5	Spare					INS	ARP		
6 to (n+4)	These octet(s) is/are present only if explicitly specified								

Figure 8.2.97-1: Proxying

The following flags are coded within Octet 5:

- Bit 1 – ARP: If this bit is set to "1", then responding ARP is performed in UPF based on local cache information.
- Bit 2 – INS: If this bit is set to "1", then responding to IPv6 Neighbour Solicitation is performed in UPF based on local cache information.
- Bit 3 to 8 – spare and reserved for future use.

8.2.98 Ethernet Filter ID

The Ethernet Filter ID IE type shall be encoded as shown in Figure 8.2.98-1.

Octets	Bits							
	8	7	6	5	4	3	2	1
1 to 2	Type = 138 (decimal)							
3 to 4	Length = n							
5 to 8	Ethernet Filter ID value							
10 to (n+4)	These octet(s) is/are present only if explicitly specified							

Figure 8.2.98-1: Ethernet Filter ID

The Ethernet Filter ID value shall be encoded as an Unsigned32 binary integer value.

8.2.99 Ethernet Filter Properties

The Ethernet Filter Properties IE type shall be encoded as shown in Figure 8.2.99-1.

Octets	Bits						
	8	7	6	5	4	3	2
1 to 2	Type = 139 (decimal)						
3 to 4	Length = n						
5	Spare						BIDE
6 to (n+4)	These octet(s) is/are present only if explicitly specified						

Figure 8.2.99-1: Ethernet Filter Properties

The following flags are coded within Octet 5:

- Bit 1 – BIDE (Bidirectional Ethernet Filter): If this bit is set to "1", then the Ethernet Filter identified by the Ethernet Filter ID is bidirectional.
- Bit 2 to 8 – spare and reserved for future use.

8.2.100 Suggested Buffering Packets Count

The Suggested Buffering Packets Count IE indicates the number of packets (including both UL and DL packets) that are suggested to be buffered by the UP function while waiting for the new instruction from the CP function. It is coded as depicted in Figure 8.2.100-1.

Octets	Bits						
	8	7	6	5	4	3	2
1 to 2	Type = 140 (decimal)						
3 to 4	Length = n						
5	Packet Count value						
6 to (n+4)	These octet(s) is/are present only if explicitly specified						

Figure 8.2.100-1: Suggested Buffering Packets Count

The Packet Count value is encoded in octet 5 and the range of the Packet Count value is from 0 to 255.

8.2.101 User ID

The User ID IE type shall be encoded as shown in Figure 8.2.101-1.

Octets	Bits							
	8	7	6	5	4	3	2	1
1 to 2	Type = 141 (decimal)							
3 to 4	Length = n							
5	Spare			NAIF	MSIS DNF	IMEIF	IMSIF	
6	Length of IMSI							
7 to a	IMSI							
b	Length of IMEI							
(b+1) to c	IMEI							
d	Length of MSISDN							
(d+1) to e	MSISDN							
f	Length of NAI							
(f+1) to g	NAI							
h to (n+4)	These octet(s) is/are present only if explicitly specified							

Figure 8.2.101-1: User ID

The following flags are coded within Octet 5:

- Bit 1 – IMSIF: If this bit is set to "1", then the Length of IMSI and IMSI fields shall be present, otherwise these fields shall not be present.
- Bit 2 – IMEIF: If this bit is set to "1", then the Length of IMEI and IMEI fields shall be present, otherwise these fields shall not be present.
- Bit 3 – MSISDNF: If this bit is set to "1", then the Length of MSISDN and MSISDN fields shall be present, otherwise these fields shall not be present.
- Bit 4 – NAIF: If this bit is set to "1", then the Length of NAI and NAI fields shall be present, otherwise these fields shall not be present.
- Bit 5 to 8: Spare, for future use and set to "0".

One or more flags may be set to "1".

The coding of IMSI field, from octets 7 to 'a' shall be encoded as the octets 5 to n+4 of the IMSI IE type specified in clause 8.3 of 3GPP TS 29.274 [9].

The coding of IMEI field, in octets 'b+1' to 'c' shall be encoded as the octets 5 to n+4 of the MEI IE type specified in clause 8.10 of 3GPP TS 29.274 [9].

The coding of MSISDN field, in octets 'd+1' to 'e' shall be encoded as the octets 5 to n+4 of the MSISDN IE type specified in clause 8.11 of 3GPP TS 29.274 [9].

The NAI field, in octets 'f+1' to 'g' shall be encoded as an Octet String (see IETF RFC 4282 [36]).

8.2.102 Ethernet PDU Session Information

Ethernet PDU Session Indication is coded as depicted in Figure 8.2.102-1.

Octets	Bits						
	8	7	6	5	4	3	2
1 to 2	Type = 142 (decimal)						
3 to 4	Length = n						
5	Spare						ETHI
k to (n+4)	These octet(s) is/are present only if explicitly specified						

Figure 8.2.102-1: Ethernet PDU Session Information

The following flags are coded within Octet 5:

- Bit 1 – ETHI (Ethernet Indication): This bit shall be set to "1". This refers to all the DL traffic matching the Ethernet PDU session (see clause 5.13.1).
- Bit 2 to 8 are spare and reserved for future use.

8.2.103 MAC Addresses Detected

The MAC Addresses Detected IE shall be encoded as shown in Figure 8.2.103-1. It shall contain a list of MAC address values.

Octets	Bits						
	8	7	6	5	4	3	2
1 to 2	Type = 144 (decimal)						
3 to 4	Length = n						
5	Number of MAC addresses (k)						
6 to 11	MAC address value 1						
o to (o+5)	MAC address value 2						
p to (p+5)	...						
q to (q+5)	MAC address value k						
s to (n+4)	These octet(s) is/are present only if explicitly specified						

Figure 8.2.103-1: MAC addresses Detected

Octet 5 shall encode the number of 48-bit MAC addresses.

MAC address values shall be encoded as 12-digit hexadecimal numbers.

8.2.104 MAC Addresses Removed

The MAC Addresses Removed IE shall be encoded as shown in Figure 8.2.104-1. It shall contain a list of MAC address values.

Octets	Bits						
	8	7	6	5	4	3	2
1 to 2	Type = 145 (decimal)						
3 to 4	Length = n						
5	Number of MAC addresses (k)						
6 to 11	MAC address value 1						
o to (o+5)	MAC address value 2						
p to (p+5)	...						
q to (q+5)	MAC address value k						
s to (n+4)	These octet(s) is/are present only if explicitly specified						

Figure 8.2.104-1: MAC addresses Removed

Octet 5 shall encode the number of 48-bit MAC addresses.

MAC address values shall be encoded as 12-digit hexadecimal numbers.

8.2.105 Ethernet Inactivity Timer

The Ethernet Inactivity Timer IE contains the inactivity time period, in seconds, to be monitored by the UP function, to detect that a UE MAC address is inactive. It shall be encoded as shown in Figure 8.2.105-1.

Octets	Bits						
	8	7	6	5	4	3	2
1 to 2	Type = 146 (decimal)						
3 to 4	Length = n						
5 to 8	Ethernet Inactivity Timer						
9 to (n+4)	These octet(s) is/are present only if explicitly specified						

Figure 8.2.105-1: Ethernet Inactivity Timer

The Ethernet Inactivity Timer field shall be encoded as an Unsigned32 binary integer value.

8.2.106 Subsequent Event Quota

The Subsequent Event Quota IE type shall be encoded as shown in Figure 8.2.106-1. It contains the event quota to be monitored by the UP function.

Octets	Bits							
	8	7	6	5	4	3	2	1
1 to 2	Type = 150 (decimal)							
3 to 4	Length = n							
5 to 8	Subsequent Event Quota							
13 to (n+4)	These octet(s) is/are present only if explicitly specified							

Figure 8.2.106-1: Subsequent Event Quota

The Subsequent Event Quota field shall be encoded as an Unsigned32 binary integer value.

8.2.107 Subsequent Event Threshold

The Subsequent Event Threshold IE contains the Number of events after which the measurement report is to be generated by the UP function. It shall be encoded as shown in Figure 8.2.107-1.

Octets	Bits							
	8	7	6	5	4	3	2	1
1 to 2	Type = 151 (decimal)							
3 to 4	Length = n							
5 to 8	Subsequent Event Threshold							
13 to (n+4)	These octet(s) is/are present only if explicitly specified							

Figure 8.2.107-1: Subsequent Event Threshold

The Subsequent Event Threshold field shall be encoded as an Unsigned32 binary integer value.

8.2.108 Trace Information

The Trace Information IE type shall be encoded as shown in Figure 8.2.108-1. It contains the trace control and configuration parameters to apply for the PFCP session.

Octets	Bits							
	8	7	6	5	4	3	2	1
1 to 2	Type = 152 (decimal)							
3 to 4	Length = n							
5	MCC digit 2				MCC digit 1			
6	MNC digit 3				MCC digit 3			
7	MNC digit 2				MNC digit 1			
8 to 10	Trace ID							
11	Length of Triggering Events							
12 to m	Triggering Events							
m+1	Session Trace Depth							
m+2	Length of List of Interfaces							
(m+3) to p	List of Interfaces							
p+1	Length of IP Address of Trace Collection Entity							
(p+2) to q	IP Address of Trace Collection Entity							
(q+1) to (n-4)	These octet(s) is/are present only if explicitly specified							

Figure 8.2.108-1: Trace Information

Octets 5 to 10 represent the Trace Reference parameter as defined in clause 5.6 of 3GPP TS 32.422 [35].

Triggering Events, Session Trace Depth, List of Interfaces and IP Address of Trace Collection Entity are specified in 3GPP TS 32.422 [35].

Octets "(p+2) to q" shall contain an IPv4 address value (4 octets) or IPv6 address value (16 octets).

See 3GPP TS 24.008 [5], clause 10.5.1.4, Mobile Identity, for the coding of MCC and MNC. If MNC is 2 digits long, bits 5 to 8 of octet 6 are coded as "1111".

8.2.109 Framed-Route

The Framed-Route IE describes a framed route. It shall be encoded as shown in Figure 8.2.109-1.

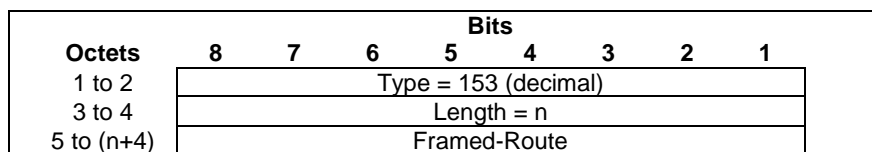

Figure 8.2.109-1: Framed-Route

The Framed-Route field shall be encoded as an Octet String as the value part of the Framed-Routing AVP specified in IETF RFC 2865 [37].

8.2.110 Framed-Routing

The Framed-Routing IE describes the frame routing of a framed route. It shall be encoded as shown in Figure 8.2.110-1.

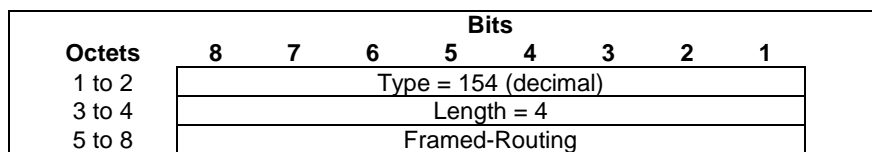

Figure 8.2.110-1: Framed-Routing

The Framed-Routing field shall be encoded as the value part of the Framed-Routing AVP specified in IETF RFC 2865 [37].

8.2.111 Framed-IPv6-Route

The Framed-IPv6-Route IE describes a framed IPv6 route. It shall be encoded as shown in Figure 8.2.111-1.

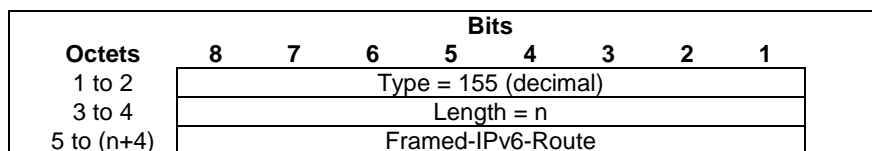

Figure 8.2.z-1: Framed-IPv6-Route

The Framed-IPv6-Route field shall be encoded as an Octet String as the value part of the Framed-IPv6-Route AVP specified in IETF RFC 3162 [38].

8.2.112 Event Quota

The Event Quota IE type shall be encoded as shown in Figure 8.2.112-1. It contains the event quota to be monitored by the UP function.

Octets	Bits							
	8	7	6	5	4	3	2	1
1 to 2	Type = 148 (decimal)							
3 to 4	Length = n							
5 to 8	Subsequent Event Quota							
13 to (n+4)	These octet(s) is/are present only if explicitly specified							

Figure 8.2.112-1: Event Quota

The Event Quota field shall be encoded as an Unsigned32 binary integer value.

8.2.113 Event Threshold

The Event Threshold IE contains the Number of events after which the measurement report is to be generated by the UP function. It shall be encoded as shown in Figure 8.2.113-1.

Octets	Bits							
	8	7	6	5	4	3	2	1
1 to 2	Type = 149 (decimal)							
3 to 4	Length = n							
5 to 8	Event Threshold							
13 to (n+4)	These octet(s) is/are present only if explicitly specified							

Figure 8.2.113-1: Event Threshold

The Event Threshold field shall be encoded as an Unsigned32 binary integer value.

8.2.114 Event Time Stamp

The Event Time Stamp IE indicates the time stamp when the event occurs in a given usage report. It shall be encoded as shown in Figure 8.2.114-1.

Octets	Bits							
	8	7	6	5	4	3	2	1
1 to 2	Type = 156 (decimal)							
3 to 4	Length = n							
5 to 8	Event Time Stamp							
9 to (n+4)	These octet(s) is/are present only if explicitly specified							

Figure 8.2.114-1: Event Time Stamp

The Event Time Stamp field shall contain a UTC time. Octets 5 to 8 shall be encoded in the same format as the first four octets of the 64-bit timestamp format as defined in clause 6 of IETF RFC 5905 [12].

NOTE: The encoding is defined as the time in seconds relative to 00:00:00 on 1 January 1900.

8.2.115 Averaging Window

The Averaging Window IE shall contain the duration over which the GFBR and MFBR is calculated (see clause 5.7.3.6 of 3GPP TS 23.501 [28]). It shall be encoded as shown in Figure 8.2.115-1.

Octets	Bits						
	8	7	6	5	4	3	2
1 to 2	Type = 157 (decimal)						
3 to 4	Length = n						
5 to 8	Averaging Window						
9 to (n+4)	These octet(s) is/are present only if explicitly specified						

Figure 8.2.115-1: Averaging Window

The Averaging Window field shall be encoded as an Unsigned32 binary integer value. It shall contain the duration in ms.

8.2.116 Paging Policy Indicator (PPI)

The Paging Policy Indicator (PPI) IE indicates a PPI value for paging policy differentiation. It shall be encoded as shown in Figure 8.2.116-1.

Octets	Bits						
	8	7	6	5	4	3	2
1 to 2	Type = 158 (decimal)						
3 to 4	Length = n						
5	Spare				PPI value		
6 to (n+4)	These octet(s) is/are present only if explicitly specified						

Figure 8.2.116-1: Paging Policy Indicator (PPI)

The PPI value shall be encoded as a value between 0 and 7, as specified in clause 5.5.3.7 of 3GPP TS 38.415 [34].

8.2.117 APN/DNN

Access Point Name (APN) / Data Network Name (DNN) is transferred from CP function to UP function.

Octets	Bits						
	8	7	6	5	4	3	2
1 to 2	Type = 159 (decimal)						
3 to 4	Length = n						
5 to (n+4)	APN/DNN						

Figure 8.2.117-1: APN/DNN

The encoding the APN/DNN field follows 3GPP TS 23.003 [2] clause 9.1. The content of the APN/DNN field shall be the full APN/DNN with both the APN/DNN Network Identifier and APN/DNN Operator Identifier being present as specified in 3GPP TS 23.003 [2] clauses 9.1.1 and 9.1.2, 3GPP TS 23.060 [19] Annex A and 3GPP TS 23.401 [14] clauses 4.3.8.1.

NOTE: The APN/DNN field is not encoded as a dotted string as commonly used in documentation.

8.2.118 3GPP Interface Type

The 3GPP Interface Type IE shall be encoded as shown in Figure 8.2.118-1. It indicates the 3GPP interface type of the Source Interface within the PDR IE, or the 3GPP interface type of the Destination Interface within the FAR IE.

Octets	Bits					
	8	7	6	5	4	3 2 1
1 to 2	Type = 160 (decimal)					
3 to 4	Length = n					
5	Spare		Interface Type value			
6 to (n+4)	These octet(s) is/are present only if explicitly specified					

Figure 8.2.118-1: 3GPP Interface Type

The 3GPP Interface Type value shall be encoded as a 6 bits binary integer as specified in in Table 8.2.118-1.

Table 8.2.118-1: Interface Type value

Interface value	Values (Decimal)
S1-U	0
S5 /S8-U	1
S4-U	2
S11-U	3
S12-U	4
Gn/Gp-U	5
S2a-U	6
S2b-U	7
eNodeB GTP-U interface for DL data forwarding	8
eNodeB GTP-U interface for UL data forwarding	9
SGW/UPF GTP-U interface for DL data forwarding	10
N3 3GPP Access	11
N3 Trusted Non-3GPP Access	12
N3 Untrusted Non-3GPP Access	13
N3 for data forwarding	14
N9	15
Spare	16 to 64

Annex A (Informative): PFCP Load and Overload Control Mechanism

A.1 Throttling Algorithms

A.1.1 "Loss" Throttling Algorithm

A.1.1.1 Example of Possible Implementation

This clause provides an example of a possible implementation of the "Loss" algorithm, amongst other possible methods.

It is possible to make use of a statistical loss function (e.g., random selection of messages to throttle based on the indicated percentage) to decide if the given message can be sent or need to be throttled. For example, the source node generates a random number between (0, 100) for each message which is a potential candidate for throttling. To realize 10% throttling, messages with a random number 10 or less are throttled and hence this achieves approximately a 10% reduction in the overall traffic. The actual traffic reduction might vary slightly from the requested percentage, albeit by an insignificant amount.

The algorithm can select certain messages to throttle in priority. For example, implementations can distinguish between higher-priority and lower-priority messages, and drop the lower-priority messages in favour of dropping the higher priority messages, as long as the total reduction in traffic conforms to the requested reduction in effect at the time. For example, in the 50-50 distribution of high priority and low priority messages, 20% reduction to low priority messages and 0% reduction to high priority messages need to be applied in order to achieve the effective reduction in traffic by 10% towards the overloaded node.

Annex B (Normative): CP and UP Selection Functions with Control and User Plane Separation

B.1 CP Selection Function

B.1.1 General

The SGW-C and PGW-C selection function shall follow the principles specified in 3GPP TS 29.303 [25] for the SGW and PGW selection functions without Control and User Plane Separation.

The following additional considerations apply with Control and User Plane Separation:

1. At most one SGW-C shall be selected per user at any time.
2. The service area of an SGW-C function shall be aligned with the service area of the corresponding SGW-U functions (see clause 4.3.4 of 3GPP TS 23.214 [2]). All the SGW-U functions in the service area shall have a full meshed connectivity with all the eNBs of TAs and/or all RNCs/BSCs of RAs served by that service area.
3. The SGW dynamic load reported to the MME/SGSN and the PGW dynamic load reported to the MME/SGSN or TWAN/ePDG should take into account the operating status of the CP and UP functions' resources that the SGW-C/PGW-C is controlling. See clause 6.2.3 for how the CP function obtains load control information from the UP function.
4. For Dedicated Core Networks (see clause 5.8 of 3GPP TS 29.303 [25]), an SGW-C or PGW-C function shall be declared in DNS as dedicated to certain mapped UE usage types if the CP function or if all the UP functions it controls are dedicated to certain mapped UE usage types. In this case, the CP function shall be provisioned in DNS with all the mapped UE usage types that both the CP function and its UP functions support.
5. The MME/SGSN shall be able to select an SGW-C and a PGW-C optimized for NR, e.g. for UEs indicating support of dual connectivity with NR in NAS signalling to the MME or SGSN and without subscription restriction to use NR as secondary RAT, according to the requirements specified in clause 5.12.2 of 3GPP TS 29.303 [25]. The SGW-C and the PGW-C optimized for NR may be a combined SGW-C/PGW-C function optimized for the NR.

B.2 UP Selection Function

B.2.1 General

The following requirements apply for the selection of the UP function:

- the SGW-C, PGW-C and TDF-C shall be responsible for the selection of the SGW-U, PGW-U and TDF-U respectively;
- an SGW-C may select different SGW-U functions for different PDN connections of a same user.

It is implementation specific how to support the UP selection function requirements specified in this clause. Clause B.2.6 specifies one possible implementation.

B.2.2 SGW-U Selection Function

The SGW-C shall be able to select the SGW-U considering the following parameters:

- the SGW-U location and the user 's location (i.e. ECGI, eNodeB ID or TAI for E-UTRAN, RAI or RNC-ID for UTRAN);

- the SGW-U's capabilities and the capabilities required for the particular UE session to establish;
- the mapped UE Usage Type (when dedicating SGW-U to specific Dedicated Core Networks);
- the SGW-U's dynamic load;
- the SGW-U's relative static capacity (versus other SGW-U's);
- the UP Function Selection Information Flags, indicating whether it is desired to select an SGW-U optimized for NR, as specified in 3GPP TS 29.274 [9].

Based on local policy, if the user's location information is required to be used for selecting the UP function, the SGW-C shall determine the list of candidate SGW-U's taking into account the user 's location (ECGI, eNodeB ID or TAI for E-UTRAN, RAI or RNC-ID for UTRAN).

The SGW-C shall select, among the candidate SGW-U functions, an SGW-U function which supports all the capabilities required for the particular UE session, considering the information received during the PFCP Association Setup.

B.2.3 PGW-U Selection Function

The PGW-C shall be able to select the PGW-U considering the following parameters:

- the requested APN for the PDN connection;
- the PGW-U location and the user 's location;
- the PGW-U's capabilities and the capabilities required for the particular UE session to establish;
- the mapped UE Usage Type (when dedicating PGW-U to specific Dedicated Core Networks);
- the PGW-U's dynamic load;
- the PGW-U's relative static capacity (versus other PGW-U's);
- whether a PDN connection already exists for the same UE and APN, in which case the same PGW-U shall be selected (to enable APN-AMBR enforcement);
- the UP Function Selection Information Flags, indicating whether it is desired to select a PGW-U optimized for NR, as specified in 3GPP TS 29.274 [9].

NOTE: The SGW-U and PGW-U location can be configured in the SGW-C and PGW-C or derived from DNS procedures as specified in clause B.2.2.

If the PGW-C already assigned a PGW-U to the UE for the requested APN (e.g. UE with multiple PDN connections to the same APN), the PGW-C shall select the same PGW-U for the new PDN connection.

If a non-null IPv4 address and/or a IPv6 prefix is received in the PDN Address Allocation (PAA) IE in the Create Session Request, e.g. static address assignment in the user subscription, the PGW-C shall select a PGW-U which can support the requested UE's IP address and/or IPv6 prefix.

Otherwise, the PGW-C shall determine the list of candidate PGW-U's taking into account the requested APN.

The PGW-C shall select, among the candidate PGW-U functions, a PGW-U function which supports all the capabilities required for the particular UE session, considering the information received during the PFCP Association Setup.

B.2.4 Combined SGW-U/PGW-U Selection Function

A Combined SGW-C/PGW-C function shall be able to select a combined SGW-U/PGW-U function. This shall be possible for all the UE's PDN connections, as shown in Figure B.2.1-1.

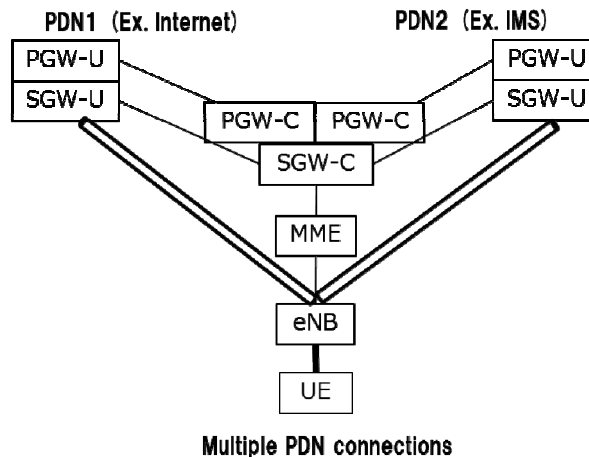

Figure B.2.4 -1: SGW-U/PGW-U collocation with Control and User Plane Separation

A combined SGW-C/PGW-C function shall select the SGW-U and PGW-U as defined respectively in B.2.2 and B.2.3, with the following additions:

- the combined SGW-C/PGW-C function shall select the best couple of SGW-U and PGW-U (e.g. the combined SGW-U/PGW-U function), for the requested APN, among all candidate couples of (SGW-U, PGW-U), instead of selecting independently the SGW-U and the PGW-U.

B.2.5 TDF-U selection function

The TDF-C shall be able to select the TDF-U as specified in clause 5.12.5 of 3GPP TS 23.214 [2].

B.2.6 UP Selection Function Based on DNS

B.2.6.1 General

This clause specifies optional DNS procedures to select the SGW-U and PGW-U functions and the requirements which apply when these procedures are supported.

The relative static capacity of an SGW-U and PGW-U may be configured in the DNS.

The Node ID of an SGW-U and PGW-U may take the form of a canonical node name to allow the selection of a SGW-U and PGW-U with the best topological match.

B.2.6.2 SGW-U Selection Function Based on DNS

The SGW-C shall retrieve the list of candidate SGW-U's using DNS procedures taking into account the user's location (ECGI, eNodeB ID or TAI for E-UTRAN, RAI or RNC-ID for UTRAN), as specified in 3GPP TS 29.303 [25].

In non-roaming or LBO scenarios where the PGW-U is already selected (e.g. TAU with SGW change) and when it is preferred to select a collocated node or a topologically closer node, the SGW-C shall try to select an SGW-U collocated with the PGW-U.

B.2.6.3 PGW-U Selection Function Based on DNS

The PGW-C shall retrieve the list of candidate PGW-U's using DNS procedures taking into account the requested APN, as specified in 3GPP TS 29.303 [25].

In non-roaming or LBO scenarios, when it is preferred to select a collocated node or a topologically closer node, i.e. when such preference is indicated in the canonical node names of the PGW-U functions in the DNS (using "topon" as the first label of canonical node name), the PGW-C shall give precedence to collocation of SGW-U and PGW-U, then to topological closeness (i.e. pairs of SGW-U and PGW-U with canonical node names with the highest number of matching labels). This requires the SGW-C to provide the SGW-U Node ID to the PGW-C.

B.2.6.4 Combined SGW-U/PGW-U Selection Function Based on DNS

A combined SGW-C/PGW-C function shall select the SGW-U and PGW-U as defined respectively in B.2.4, B.2.6.2 and B.2.6.3.

Annex C (Informative): Examples scenarios

C.1 General

This clause provides example call flows illustrating how the CP function can provision the UP function to support certain functionalities.

This Annex is informative and the normative descriptions in this specification and in 3GPP TS 23.214 [2] prevail over the descriptions in this Annex if there is any difference.

C.2 Charging Support

C.2.1 Online Charging

C.2.1.1 Online Charging Call Flow – Normal Scenario

Figure C.2.1.1-1 illustrates the exchanges taking place over the Sxb or Sxc reference points when applying online charging. In this example, the OCS grants quotas by chunks of 100 Mbytes and requests the CP function to request new credits when the remaining credit falls below 10 Mbytes.

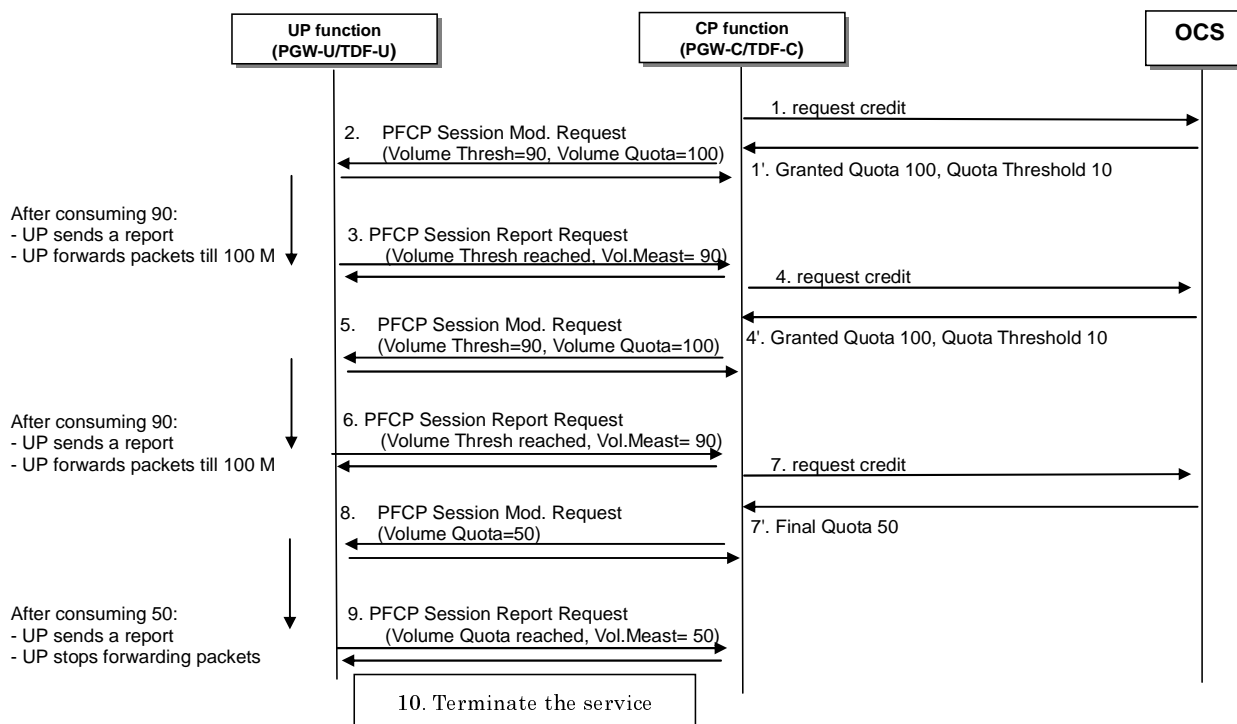

Figure C.2.1.1-1: Online charging with intermediate and final quotas

1. Upon the request from the CP function, the OCS grants an intermediate quota of 100 Mbytes and requests the CP function to request a new credit when the remaining credit falls below 10 Mbytes.
2. The CP function sends an PFCP Session Modification Request to the UP function with an Update URR IE including the Volume Threshold IE set to 90 Mbytes and the Volume Quota IE set to 100 Mbytes.
3. Upon reaching the Volume Threshold (i.e. 90 Mbytes), the UP function sends an PFCP Session Report Request to the CP function with a Usage Report IE including the Usage Report Trigger set to "Volume Threshold" and

the Volume Measurement set to 90 Mbytes. The UP function continues to pass on traffic until reaching the Volume Quota (i.e. an extra 10 Mbytes of traffic can be passed on).

4. Upon the request from the CP function, the OCS grants a new intermediate quota of 100 Mbytes and requests the CP function to request a new credit when the remaining credit falls below 10 Mbytes.
5. The CP function sends an PFCP Session Modification Request to the UP function with an Update URR IE including the Volume Threshold IE set to 90 Mbytes and the Volume Quota IE set to 100 Mbytes. If the UP function had forwarded e.g. 5 Mbytes of traffic since the last usage report, the UP function knows that it shall send the next usage report upon passing on an extra 85 Mbytes of traffic.
6. Upon reaching the Volume Threshold (i.e. 90 Mbytes), the UP function sends an PFCP Session Report Request to the CP function with a Usage Report IE including the Usage Report Trigger set to "Volume Threshold" and the Volume Measurement set to 90 Mbytes. The UP function continues to pass on traffic until reaching the Volume Quota (i.e. an extra 10 Mbytes of traffic can be passed on).
7. Upon the request from the CP function, the OCS grants a new final quota of 50 Mbytes and requests the CP function to terminate the service or to redirect the traffic towards a redirect destination when the quota is consumed.
8. The CP function sends an PFCP Session Modification Request to the UP function with an Update URR IE including the Volume Quota IE set to 50 Mbytes. If the UP function had forwarded e.g. 5 Mbytes of traffic since the last usage report, the UP function knows that it shall send the next usage report upon passing on an extra 45 Mbytes of traffic.
9. Upon reaching the Volume Quota (i.e. 50 Mbytes), the UP function sends an PFCP Session Report Request to the CP function with a Usage Report IE including the Usage Report Trigger set to "Volume Quota" and the Volume Measurement set to 50 Mbytes. The UP function stops passing on traffic.
10. Upon being notified that the final quota has been reached, the CP function terminates the service (e.g. by preventing the traffic of the corresponding SDF to further pass on in the UP function) or redirects the traffic towards a redirect destination by provisioning a Redirect Information IE within the FAR associated to the traffic.

Figure C.2.1.1-2 illustrates the exchanges taking place over the Sxb or Sxc reference points when applying online charging and the UP function supports being provisioned with the Quota Action to apply when reaching quotas. This example is similar to the previous one, but the CP function provisions the UP function with the action to apply when reaching the final quota.

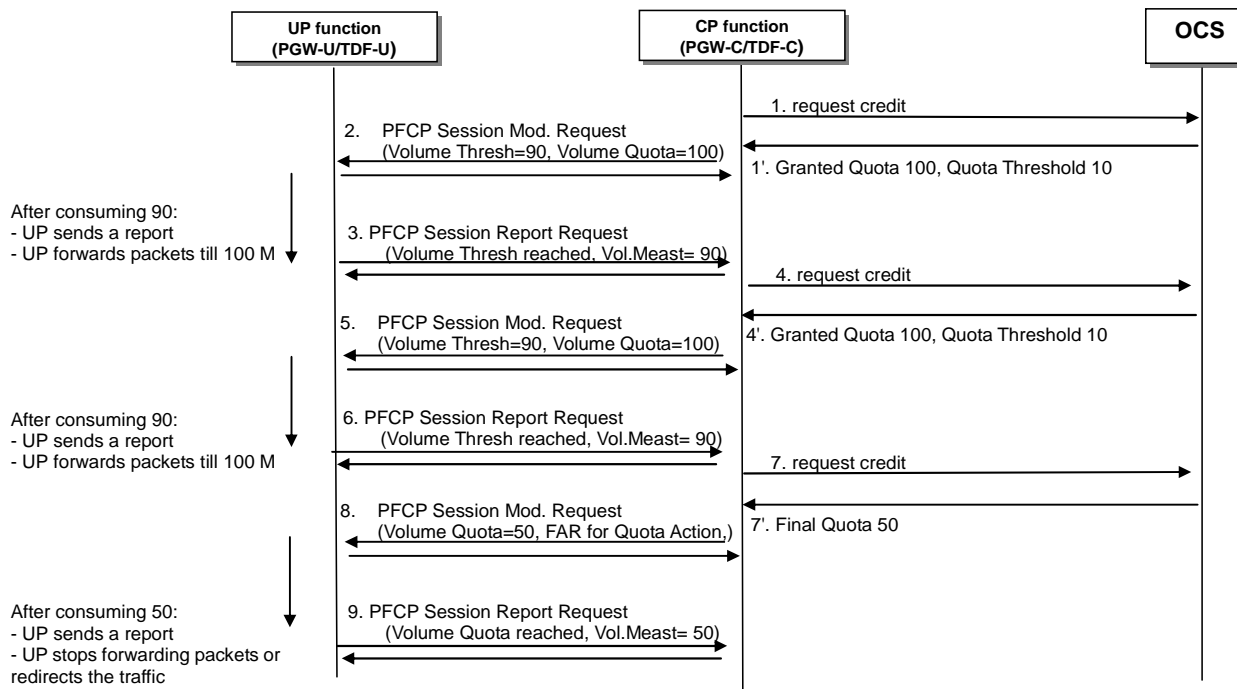

Figure C.2.1.1-2: Online charging with Quota Action provisioned in the UP function

1 to 7'. Same as for figure C.2.1.1-1.

8. The CP function sends an PFCP Session Modification Request to the UP function with a Create FAR IE provisioning the action the UP function shall apply when reaching the quota, and with an Update URR IE including the Volume Quota IE set to 50 Mbytes and the FAR ID for Quota Action IE set to the new FAR ID). If the UP function had forwarded e.g. 5 Mbytes of traffic since the last usage report, the UP function knows that it shall send the next usage report upon passing on an extra 45 Mbytes of traffic.
9. Upon reaching the Volume Quota (i.e. 50 Mbytes), the UP function sends an PFCP Session Report Request to the CP function with a Usage Report IE including the Usage Report Trigger set to "Volume Quota" and the Volume Measurement set to 50 Mbytes.
10. The UP function applies the quota action provisioned at step 8, i.e. it stops forwarding packets or it redirects the traffic towards a redirect destination, according to the FAR identified in the FAR ID for Quota Action.

C.2.1.2 Online Charging Call Flow with Credit Pooling

C.2.1.2.1 General

Figure C.2.1.2-1 illustrates a signalling flow over the Sxb and Gy reference points when applying online charging, and when the CP function (i.e. PGW-C) is instructed by the OCS to handle a Credit Pool for a given Gy Session.

C.2.1.2.2 Example Call Flow 1

In this example, the PGW-C is instructed by the OCS to handle a credit pool for two Rating Groups, RG1 and RG2. The PGW-C provisions two URRs, URR1 and URR2, for the two RGs respectively, and a URR3 for the Credit Pool. The PGW-C provisions the URR1 and URR2 with the quota received from the OCS respectively for RG1 and RG2 (like if there was no credit pooling).

This reflects one possible implementation option, whereby each quota remains managed independently from the others. This approach can result in extra usage reports being sent over Sxb for RG1 or RG2 before the credit pool is exhausted.

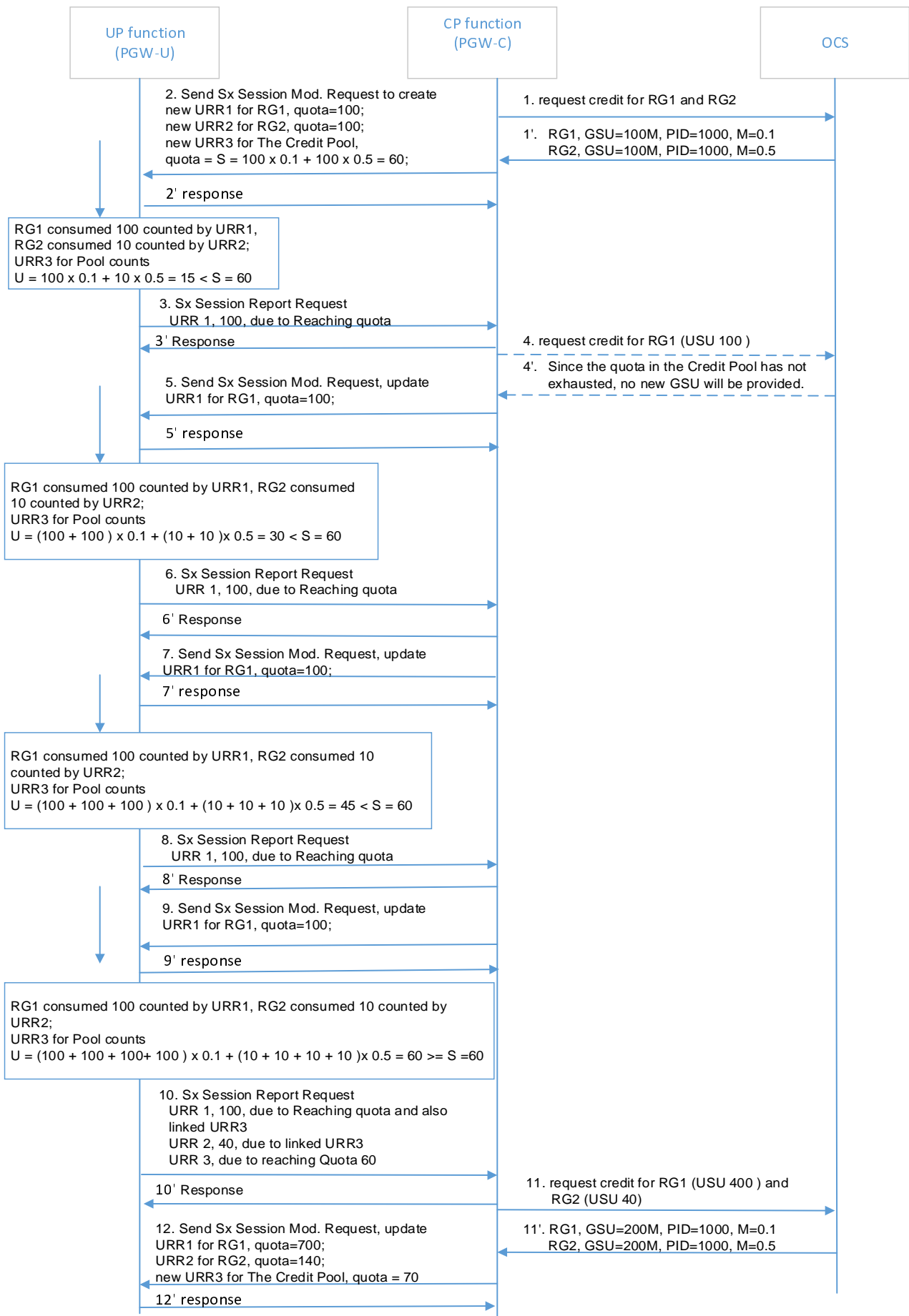

Figure C.2.2.2-1: Online charging with Credit Pooling (alt 1)

1. Upon the request from the CP function for RG1 and RG2, the OCS grants:

RG1: quota 100 Mbytes, together with a G-S-U-Pool-Reference AVP included within the Multiple Services Credit Control (for RG1), where the G-S-U-Pool-Identifier AVP indicating the identifier (e.g. 1000) of the Credit Pool to which the RG1 pertains, the CC-Unit-Type AVP specifies the type of units for which credit is (e.g. total octets), the Unit-Value AVP specifies the multiplier (e.g. 0.1);

RG2: quotas 100 Mbytes, together with a G-S-U-Pool-Reference AVP included within the Multiple Services Credit Control (for RG2), where the G-S-U-Pool-Identifier AVP indicating the identifier (e.g. 1000) of the Credit Pool to which the RG2 pertains, the CC-Unit-Type AVP specifies the type of units for which credit is (e.g. total octets), the Unit-Value AVP specifies the multiplier (e.g. 0.5);

2. The CP function sends an PFCP Session Modification Request to the UP function, to create:

A new URR1 for RG1, quota=100, Linked URR = URR3;

A new URR2 for RG2, quota=100, Linked URR = URR3;

A new URR3 for Pool, quota = $S = 100 \times 0.1 + 100 \times 0.5 = 60$, Aggregated URRs: URR1 with Multiplier 0.1 and URR2 with Multiplier 0.5.

The UP function accepts the request.

3. The RG1 has consumed 100 counted by URR1, RG2 consumed 10 counted by URR2; the URR3 for the Credit Pool counts $U = 100 \times 0.1 + 10 \times 0.5 = 15 < S$. The URR1 triggers sending a usage report towards the CP function due to reaching the Quota 100. So the UP function sends an PFCP Session Report Request, including the Usage Reports for the URR1. The CP function sends the response message.
4. Based on operator's policies, the CP function reports used quota for the RG1 to the OCS. The OCS does not grant any quota since the quota for the Credit Pool has not been consumed yet.

NOTE: This step is skipped in the rest flow.

5. The CP function sends an PFCP Session Modification Request to the UP function with the modified URR1, with new quota 100.

Step 6, 7, 8 and 9 repeats step 3 and 5.

10. The RG1 has consumed another 100 counted by URR1, RG2 consumed another 10 counted by URR2; the URR3 for the Credit Pool counts $U = (100 + 100 + 100 + 100) \times 0.1 + (10 + 10 + 10 + 10) \times 0.5 = 60 \geq S = 60$. So the UP function sends an PFCP Session Report Request, including the Usage Reports for:

- the URR3, generated due to reaching quota (60),

- for the URR1, generated due to that it is linked to the URR3 and it has reached the quota 100, and

- for the URR2 generated due to that it is linked to the URR3.

The CP function sends the response message.

11. The CP function requests new Quota for RG1 and RG2 to the OCS. The OCS grants 200M for RG1 and 100M for RG2, with the same pool ID and Multipliers.

12. The CP function sends an PFCP Session Modification Request to the UP function with the modified URRs, for URR1, URR2 and URR3.

C.2.1.2.3 Example Call Flow 2

In this example, the PGW-C is instructed by the OCS to handle a credit pool for two Rating Groups, RG1 and RG2. The PGW-C provisions two URRs, URR1 and URR2, for the two RGs respectively, and a URR3 for the Credit Pool. The PGW-C provisions the quotas for URR1 and URR2 taking into account the credit pool quota and the multipliers of the RGs.

This reflects another possible implementation option. This approach avoids extra usage reports being sent over Sxb for RG1 or RG2 before the credit pool is exhausted, and thus reduces Sxb signalling.

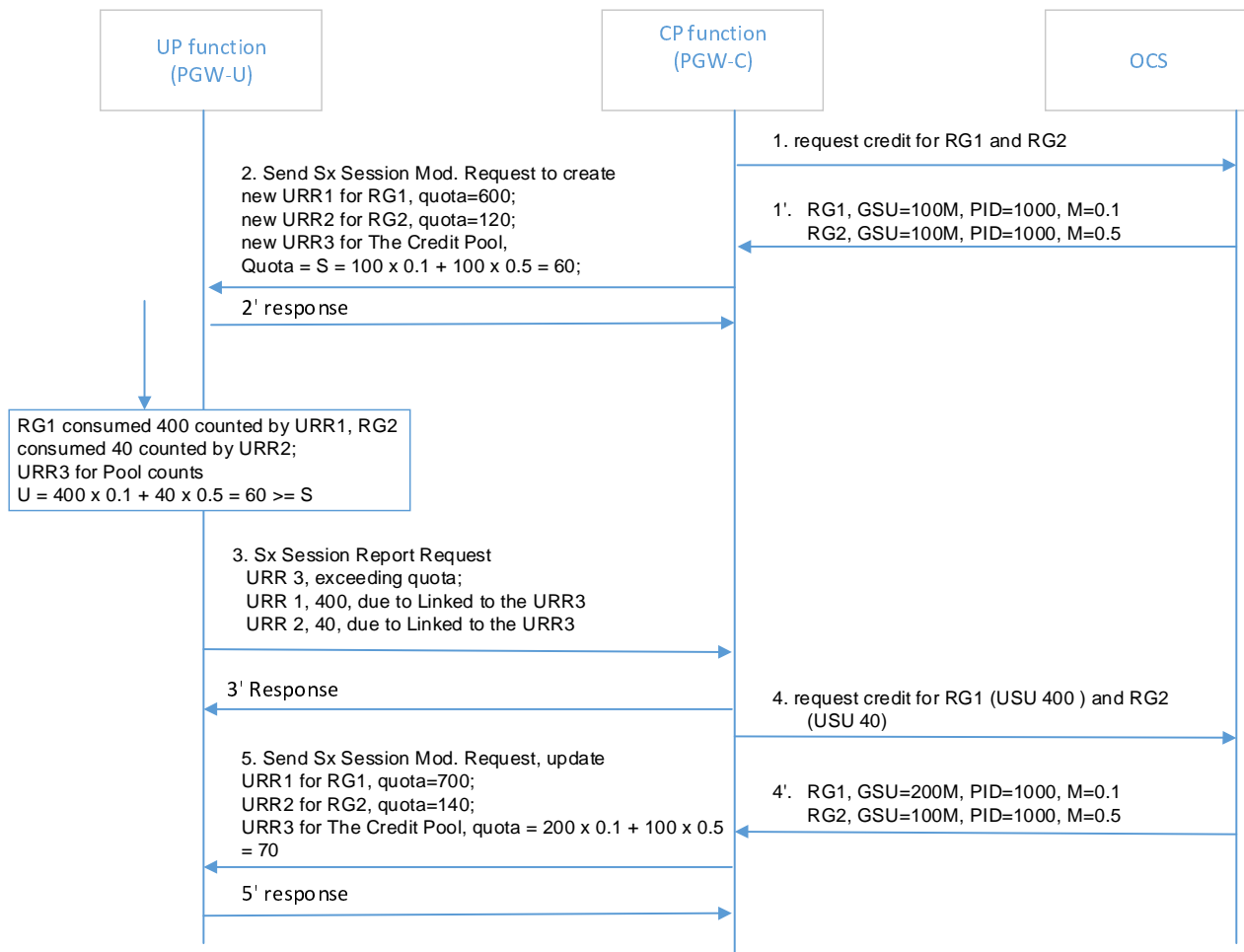

Figure C.2.2.3-2: Online charging with Credit Pooling (alt 2)

1. Upon the request from the CP function for RG1 and RG2, the OCS grants:

RG1: quota 100 Mbytes, together with a G-S-U-Pool-Reference AVP included within the Multiple Services Credit Control (for RG1), where the G-S-U-Pool-Identifier AVP indicating the identifier (e.g. 1000) of the Credit Pool to which the RG1 pertains, the CC-Unit-Type AVP specifies the type of units for which credit is (e.g. total octets), the Unit-Value AVP specifies the multiplier (e.g. 0.1);

RG2: quotas 100 Mbytes, together with a G-S-U-Pool-Reference AVP included within the Multiple Services Credit Control (for RG2), where the G-S-U-Pool-Identifier AVP indicating the identifier (e.g. 1000) of the Credit Pool to which the RG2 pertains, the CC-Unit-Type AVP specifies the type of units for which credit is (e.g. total octets), the Unit-Value AVP specifies the multiplier (e.g. 0.5);

2. The CP function sends an PFCP Session Modification Request to the UP function, to create:

A new URR1 for RG1, quota=600, Linked URR = URR3;
 A new URR2 for RG2, quota=120, Linked URR = URR3;
 And new URR3 for Pool, quota = S = 100 x 0.1 + 100 x 0.5 = 60, Aggregated URRs: URR1 with Multiplier 0.1 and URR2 with Multiplier 0.5.

The UP function accepts the request.

NOTE 1: To avoid receiving usage report upon exceeding the original Quota for RG1 or RG2, the quota can be set to $60 / 0.1 = 600$ for RG1, assuming RG1 consumes the complete Quota for the pool; similarly, for RG2, the quota can be set to $60 / 0.5 = 120$;

3. The URR3 always first reaches the Quota, e.g. when the URR1 has counted 400, and URR2 has counted 40, this results the counted usage for the Credit Pool $U=400 \times 0.1 + 40 \times 0.5 = 60$. So the UP function sends an PFCP Session Report Request, including the Usage Reports:

- for the URR3, generated due to that it has reached quota (60),
- for the URR1, generated due to that it is linked to the URR3 and
- for the URR2, generated due to that it is linked to the URR3.

The CP function sends the response message.

4. The CP function requests new Quota for RG1 and RG2 to the OCS. The OCS grants 200M for RG1 and 100M for RG2, with the same pool ID and Multipliers.
5. The CP function sends an PFCP Session Modification Request to the UP function with the modified URRs, for URR1, URR2 and URR3.

URR1 for RG1, $\text{quota} = 70 / 0.1 = 700$; 

URR2 for RG2, $\text{quota} = 70 / 0.5 = 140$; 

URR3 for The Credit Pool, $\text{quota} = 200 \times 0.1 + 100 \times 0.5 = 70$.

Annex D (Informative): Change history

Date	TSG #	TSG Doc.	CR	Rev	Subject/Comment	New
2016-07	CT4#74	C4-164286			First version after CT4#74	0.1.0
2016-10	CT4#74bis	C4-165318			Version after CT4#74bis	0.2.0
2016-11	CT4#75	C4-166347			Version after CT4#75	0.3.0
2017-01	CT4#75bis	C4-170124			Version after CT4#75bis	0.4.0
2017-02	CT4#76	C4-171423			Version after CT4#76	0.5.0
2017-03	CT#75	CP-170016			This version was sent for information	1.0.0
2017-04	C4#77	C4-172285			Version after CT4#77	1.1.0
2017-05	C4#78	C4-173360			Version after CT4#78	1.2.0
2017-06	CT#76	CP-171047			This version was sent for approval	2.0.0
2017-06	CT#76	CP-171183			Editorial correction	2.0.1
2017-06	CT#76	CP-171183			Approved in CT#76	14.0.0
2017-09	CT#77	CP-172020	0001	-	PDN Instance over Sx	14.1.0
2017-09	CT#77	CP-172020	0002	1	Transport Level Marking & DL Flow Level Marking	14.1.0
2017-09	CT#77	CP-172020	0003	2	Clarifications and corrections to Usage Reporting	14.1.0
2017-09	CT#77	CP-172020	0004	-	PDN Type over Sx	14.1.0
2017-09	CT#77	CP-172020	0005	1	Creating multiple PDRs in one Sx message with F-TEID allocation in UP function	14.1.0
2017-09	CT#77	CP-172020	0006	1	Message with a rejection cause	14.1.0
2017-09	CT#77	CP-172020	0007	-	Corrections to the number of Fixed Octets	14.1.0
2017-09	CT#77	CP-172020	0008	1	QER correlation ID	14.1.0
2017-09	CT#77	CP-172020	0009	3	Sx Protocol extension to support Envelope Reporting	14.1.0
2017-09	CT#77	CP-172020	0010	1	OCI Flags	14.1.0
2017-09	CT#77	CP-172020	0011	2	IP Address(es) and TEIDs of a UP function	14.1.0
2017-09	CT#77	CP-172020	0012	1	Clarification on bearer of a PDN connection and description on UP function feature	14.1.0
2017-09	CT#77	CP-172020	0013	2	Clarification on Rule IDs	14.1.0
2017-09	CT#77	CP-172020	0014	1	Clarification on creating rules	14.1.0
2017-09	CT#77	CP-172020	0018	2	URR and QER handling	14.1.0
2017-12	CT#78	CP-173023	0026	4	Reporting User Plane Inactivity	14.2.0
2017-12	CT#78	CP-173023	0027	-	Reporting of Usage Reports to the CP function	14.2.0
2017-12	CT#78	CP-173023	0028	-	Suspend and Resume Notification procedures	14.2.0
2017-12	CT#78	CP-173023	0029	-	Network Instance parameter	14.2.0
2017-12	CT#78	CP-173023	0030	1	User Plane traffic handling upon reaching quotas based on operator policies	14.2.0
2017-12	CT#78	CP-173023	0031	-	Reduced Application Detection Information for Envelope Reporting	14.2.0
2017-12	CT#78	CP-173023	0034	3	Sx protocol extension to support Credit Pool	14.2.0
2017-12	CT#78	CP-173023	0035	-	Clarification on the Setting of Precedence	14.2.0
2017-12	CT#78	CP-173023	0036	1	Presence of UP F-SEID in Sx Session Establishment Response	14.2.0
2017-12	CT#78	CP-173023	0042	1	Change the Title of the TS	14.2.0
2017-12	CT#78	CP-173023	0043	1	Clarification on Create PDR and Create FAR IEs in Sx Session Establishment Request	14.2.0
2017-12	CT#78	CP-173023	0047	1	Outer Header Creation	14.2.0
2017-12	CT#78	CP-173023	0048	1	Clarification on presence of Activate Predefined Rule Name	14.2.0
2017-12	CT#78	CP-173023	0056	-	Correction on Load Control Information IE Type value	14.2.0
2017-12	CT#78	CP-173023	0058	2	Provisioning of Subsequent Time Quota and Subsequent Volume Quota	14.2.0
2017-12	CT#78	CP-173027	0032		Quota Action to apply upon reaching quotas	15.0.0
2017-12	CT#78	CP-173036	0033	2	SGW/PGW selection for NR	15.0.0
2017-12	CT#78	CP-173034	0037	2	Update of the TS to prepare it for 5GC/N4	15.0.0
2017-12	CT#78	CP-173034	0038	1	Update introduction clause to 5GC	15.0.0
2017-12	CT#78	CP-173034	0039	2	Update on general procedures for N4	15.0.0
2017-12	CT#78	CP-173034	0040	1	Node related Messages supported on N4 interface	15.0.0
2017-12	CT#78	CP-173034	0041	1	User plane reporting	15.0.0
2017-12	CT#78	CP-173034	0049	2	Session establishment on N4	15.0.0
2017-12	CT#78	CP-173034	0050	2	Session Modification on N4	15.0.0
2017-12	CT#78	CP-173034	0051	1	Session deletion on N4	15.0.0
2017-12	CT#78	CP-173034	0052	2	Session Reporting on N4	15.0.0
2017-12	CT#78	CP-173034	0053	2	Load-overload control on N4	15.0.0
2017-12	CT#78	CP-173034	0054	2	QOS enhancements on N4 for 5G	15.0.0
2018-03	CT#79	CP-180018	0062	1	PDR with multiple SDFs	15.1.0
2018-03	CT#79	CP-180018	0064	1	Bidirectional SDF Filters	15.1.0

2018-03	CT#79	CP-180018	0066	-	Source and Destination Interface setting for Indirect Data Forwarding	15.1.0
2018-03	CT#79	CP-180018	0068	2	Correlating additional usage reports with the query URR request	15.1.0
2018-03	CT#79	CP-180019	0071	5	PDI optimisation	15.1.0
2018-03	CT#79	CP-180018	0078		Corrections to the Association Setup, Update and Release Procedures	15.1.0
2018-03	CT#79	CP-180018	0087	1	Error correction for Cause IE and Online-Charging Call Flow Alternative 2 example	15.1.0
2018-03	CT#79	CP-180019	0075	1	Missing Feature Description on Transport Level Marking	15.1.0
2018-03	CT#79	CP-180026	0055	6	Support of Ethernet frames on N4	15.1.0
2018-03	CT#79	CP-180026	0059	4	N4 alignment	15.1.0
2018-03	CT#79	CP-180026	0060	-	Reporting User Plane Inactivity on N4	15.1.0
2018-03	CT#79	CP-180026	0079	1	Adding QFIs to the Packet Detection Information	15.1.0
2018-03	CT#79	CP-180020	0069	1	Condition correction for SGW-U/PGW-U selection based on DCNR	15.1.0
2018-03	CT#79	CP-180020	0076	2	Selection of SGW-C/PGW-C for Dual Connectivity with NR	15.1.0
2018-06	CT#80	CP-181119	0093	2	Clarification of volume-based measurement report from UP to CP	15.2.0
2018-06	CT#80	CP-181119	0095	-	Usage reports queried by the CP function	15.2.0
2018-06	CT#80	CP-181119	0103	1	Linked URR	15.2.0
2018-06	CT#80	CP-181119	0106	1	Duplicating the user plane packets to multiple destinations	15.2.0
2018-06	CT#80	CP-181119	0108	2	The Source Interface in the User Plane IP Resource Information	15.2.0
2018-06	CT#80	CP-181125	0097	2	Quota Action Buffering	15.2.0
2018-06	CT#80	CP-181125	0100	1	Quota Action to apply upon reaching quotas	15.2.0
2018-06	CT#80	CP-181125	0104	1	The report and update of a URR	15.2.0
2018-06	CT#80	CP-181132	0089	1	User ID	15.2.0
2018-06	CT#80	CP-181132	0090	1	PDN Type of ethernet	15.2.0
2018-06	CT#80	CP-181132	0091	1	Update attributes in QER	15.2.0
2018-06	CT#80	CP-181132	0101	-	Ethernet traffic	15.2.0
2018-06	CT#80	CP-181132	0111	1	Resolve editor's notes	15.2.0
2018-06	CT#80	CP-181132	0112	1	PDR for Ethernet PDU session	15.2.0
2018-06	CT#80	CP-181132	0113	1	Reporting of UE MAC addresses to the SMF	15.2.0
2018-09	CT#81	CP-182079	0118	2	Essential correction on UE IP address	15.3.0
2018-09	CT#81	CP-182079	0120	1	Essential correction on Monitoring Time	15.3.0
2018-09	CT#81	CP-182079	0122	1	Essential clarification on the CHOOSE bit in F-TEID IE	15.3.0
2018-09	CT#81	CP-182079	0124	2	Essential correction on the Forward Policy	15.3.0
2018-09	CT#81	CP-182079	0128	2	Usage Report Trigger IMMEDIATE	15.3.0
2018-09	CT#81	CP-182079	0132	1	Essential clarification on the zero quota	15.3.0
2018-09	CT#81	CP-182079	0134	1	Essential clarification on the provision of several SDF filters in a PDI	15.3.0
2018-09	CT#81	CP-182079	0142	3	Event reporting	15.3.0
2018-09	CT#81	CP-182079	0154	2	Application detection report when the PFDs are removed	15.3.0
2018-09	CT#81	CP-182079	0158	1	Essential correction on reporting the usage	15.3.0
2018-09	CT#81	CP-182079	0160	1	Essential clarification on the provision of SDF filter	15.3.0
2018-09	CT#81	CP-182079	0162	2	Essential correction on the Dropped DL Traffic Threshold	15.3.0
2018-09	CT#81	CP-182068	0136	1	Add support for 5G Trace	15.3.0
2018-09	CT#81	CP-182084	0137	-	QFI in Downlink Data Report	15.3.0
2018-09	CT#81	CP-182084	0138	1	User ID extensions	15.3.0
2018-09	CT#81	CP-182084	0139	2	Framed Routing	15.3.0
2018-09	CT#81	CP-182084	0143	-	5GS restoration procedures	15.3.0
2018-09	CT#81	CP-182084	0144	1	Uplink Classifier and Branching Point functionalities	15.3.0
2018-09	CT#81	CP-182084	0145	1	Pause of charging.	15.3.0
2018-09	CT#81	CP-182084	0146	2	Data forwarding	15.3.0
2018-09	CT#81	CP-182084	0147	1	Sending of endmarker packets in 5GC	15.3.0
2018-09	CT#81	CP-182084	0148	1	Predefined Rules PCC/ADC Rules	15.3.0
2018-09	CT#81	CP-182084	0149	1	Downlink Data Notification Delay	15.3.0
2018-09	CT#81	CP-182084	0150	1	Clarification on Editor's notes and cleanup of the specification.	15.3.0
2018-09	CT#81	CP-182076	0152	3	Linked usage report	15.3.0
2018-12	CT#82	CP-183103	0166	1	Clarification on UL/DL MBR	15.4.0
2018-12	CT#82	CP-183103	0171	2	Forwarding End Marker	15.4.0
2018-12	CT#82	CP-183103	0173	1	Reapplying Thresholds	15.4.0
2018-12	CT#82	CP-183103	0175	1	Support of event based reporting for charging	15.4.0
2018-12	CT#82	CP-183103	0177	1	Usage Report Sequence Number Starting Value	15.4.0
2018-12	CT#82	CP-183103	0179	1	Transport Level Marking	15.4.0
2018-12	CT#82	CP-183103	0181	2	Correction on the support of PGW Pause of Charging	15.4.0
2018-12	CT#82	CP-183103	0183	1	Network Instance in relation to IP Address	15.4.0
2018-12	CT#82	CP-183103	0185	-	Time of First (Last) Packet	15.4.0
2018-12	CT#82	CP-183103	0187	1	Outer Header Removal for IPv4v6 GTP-U tunnel	15.4.0
2018-12	CT#82	CP-183103	0203	1	Essential correction on the start point of time based measurement	15.4.0
2018-12	CT#82	CP-183103	0205	2	FAR for HTTP Redirection	15.4.0
2018-12	CT#82	CP-183092	0163	1	Cleanup and Alignment	15.4.0
2018-12	CT#82	CP-183092	0169	6	VLAN Tag support in outer header creation	15.4.0
2018-12	CT#82	CP-183092	0191	1	The VIDs handling in N4 aligned with 23.501	15.4.0
2018-12	CT#82	CP-183092	0193	-	QFI Correction	15.4.0
2018-12	CT#82	CP-183092	0194	1	Clarification to ARP / IPv6 ND Proxying	15.4.0
2018-12	CT#82	CP-183092	0195	6	Adding Averaging Window parameter on N4	15.4.0

2018-12	CT#82	CP-183092	0196	4	Adding 5G Session-AMBR	15.4.0
2018-12	CT#82	CP-183092	0197	1	Paging Policy Differentiation in 5GC	15.4.0
2018-12	CT#82	CP-183092	0198	3	Clarification on forwarding user plane data via a shared Sx-u tunnel	15.4.0
2018-12	CT#82	CP-183092	0199	1	5G UPF Introduction	15.4.0
2018-12	CT#82	CP-183092	0206	2	PFD Procedure	15.4.0
2018-12	CT#82	CP-183092	0209	1	Traffic steering control with AF provided N6 traffic routing information	15.4.0
2018-12	CT#82	CP-183092	0210	2	Data forwarding between 5GS and EPS	15.4.0
2018-12	CT#82	CP-183099	0188	-	Corrections for wrong references	15.4.0
2018-12	CT#82	CP-183099	0200	2	Interpretation of predefined Rules	15.4.0
2019-03	CT#83	CP-190040	0215	1	Clarifications to CP/UP function, Node, PFCP entity and PFCP Association concepts	15.5.0
2019-03	CT#83	CP-190032	0211	1	(Un)solicited Application Reporting	15.5.0
2019-03	CT#83	CP-190032	0212	2	Policy and Charging Control	15.5.0
2019-03	CT#83	CP-190032	0213	1	Legal Interception support for 5GC SMF/UPF	15.5.0
2019-03	CT#83	CP-190032	0216	1	PFD Contents and Management	15.5.0
2019-03	CT#83	CP-190032	222	1	Clarification on ARP Proxy	15.5.0
2019-03	CT#83	CP-190032	0230	1	Inactivity timer for Always-on PDU session	15.5.0
2019-03	CT#83	CP-190032	0231	1	SMF Derivation of DSCP on N4	15.5.0
2019-03	CT#83	CP-190039	0217	2	Clarification on the use of Graceful Release Period	15.5.0
2019-03	CT#83	CP-190039	0219	2	PFCP Association Release Procedure	15.5.0
2019-03	CT#83	CP-190039	0221	3	URR triggered packets dropping or redirection	15.5.0
2019-03	CT#83	CP-190039	0232	1	IE Name Corrections	15.5.0
2019-06	CT#84	CP-191021	0248	1	Correct the length of redirection server address	15.6.0
2019-06	CT#84	CP-191021	0257	-	Correct the length of Multiplier	15.6.0
2019-06	CT#84	CP-191024	0235	1	Release of F-TEID by the UP Function upon removal of PDR	15.6.0
2019-06	CT#84	CP-191024	0242	1	Essential correction on report of user plane path failure	15.6.0
2019-06	CT#84	CP-191024	0244	2	Parameters for Performance Measurement	15.6.0
2019-06	CT#84	CP-191024	0243	3	Accurate Interface Type for Supporting Performance Measurement	15.6.0
2019-06	CT#84	CP-191024	0245	3	Update the redirection server address to support dual stack UE	15.6.0
2019-06	CT#84	CP-191024	0262	1	Framed-Route and Framed-IPv6-Route in a PDR	15.6.0
2019-06	CT#84	CP-191024	0258	1	Corrections to the Recovery Time Stamp	15.6.0
2019-06	CT#84	CP-191024	0251	1	Matching a PFD	15.6.0
2019-06	CT#84	CP-191058	0233	-	Correction to Framed Routing	15.6.0
2019-06	CT#84	CP-191058	0260	-	Reverting N4 requirements for Lawful Interception support in 5GC	15.6.0
2019-09	CT#85	CP-192096	0279	-	Essential Correction on Heartbeat procedure	15.7.0
2019-12	CT#86	CP-193023	0307	1	Correct Terminology of Sx Session to PFCP Session	15.8.0
2020-06	CT#88	CP-201029	0416	1	Restoring deleted statement	15.9.0
2020-06	CT#88	CP-201029	0440	1	DL Data Notification for the subsequent DL data pertaining to a different QoS flow	15.9.0

History

Document history		
V15.2.0	July 2018	Publication
V15.3.0	October 2018	Publication
V15.4.0	April 2019	Publication
V15.5.0	July 2019	Publication
V15.6.0	July 2019	Publication
V15.7.0	September 2019	Publication
V15.8.0	January 2020	Publication
V15.9.0	July 2020	Publication