

ETSI TS 129 274 V8.3.0 (2009-10)

Technical Specification

**Universal Mobile Telecommunications System (UMTS);
LTE;
3GPP Evolved Packet System (EPS);
Evolved General Packet Radio Service (GPRS)
Tunnelling Protocol for Control plane (GTPv2-C);
Stage 3
(3GPP TS 29.274 version 8.3.0 Release 8)**



Reference

RTS/TSGC-0429274v830

Keywords

LTE, UMTS

ETSI

650 Route des Lucioles
F-06921 Sophia Antipolis Cedex - FRANCE

Tel.: +33 4 92 94 42 00 Fax: +33 4 93 65 47 16

Siret N° 348 623 562 00017 - NAF 742 C
Association à but non lucratif enregistrée à la
Sous-Préfecture de Grasse (06) N° 7803/88

Important notice

Individual copies of the present document can be downloaded from:

<http://www.etsi.org>

The present document may be made available in more than one electronic version or in print. In any case of existing or perceived difference in contents between such versions, the reference version is the Portable Document Format (PDF). In case of dispute, the reference shall be the printing on ETSI printers of the PDF version kept on a specific network drive within ETSI Secretariat.

Users of the present document should be aware that the document may be subject to revision or change of status. Information on the current status of this and other ETSI documents is available at

<http://portal.etsi.org/tb/status/status.asp>

If you find errors in the present document, please send your comment to one of the following services:

http://portal.etsi.org/chaicor/ETSI_support.asp

Copyright Notification

No part may be reproduced except as authorized by written permission.
The copyright and the foregoing restriction extend to reproduction in all media.

© European Telecommunications Standards Institute 2009.
All rights reserved.

DECTTM, **PLUGTESTS**TM, **UMTS**TM, **TIPHON**TM, the TIPHON logo and the ETSI logo are Trade Marks of ETSI registered for the benefit of its Members.

3GPPTM is a Trade Mark of ETSI registered for the benefit of its Members and of the 3GPP Organizational Partners.

LTETM is a Trade Mark of ETSI currently being registered

for the benefit of its Members and of the 3GPP Organizational Partners.

GSM[®] and the GSM logo are Trade Marks registered and owned by the GSM Association.

Intellectual Property Rights

IPRs essential or potentially essential to the present document may have been declared to ETSI. The information pertaining to these essential IPRs, if any, is publicly available for **ETSI members and non-members**, and can be found in ETSI SR 000 314: *"Intellectual Property Rights (IPRs); Essential, or potentially Essential, IPRs notified to ETSI in respect of ETSI standards"*, which is available from the ETSI Secretariat. Latest updates are available on the ETSI Web server (<http://webapp.etsi.org/IPR/home.asp>).

Pursuant to the ETSI IPR Policy, no investigation, including IPR searches, has been carried out by ETSI. No guarantee can be given as to the existence of other IPRs not referenced in ETSI SR 000 314 (or the updates on the ETSI Web server) which are, or may be, or may become, essential to the present document.

Foreword

This Technical Specification (TS) has been produced by ETSI 3rd Generation Partnership Project (3GPP).

The present document may refer to technical specifications or reports using their 3GPP identities, UMTS identities or GSM identities. These should be interpreted as being references to the corresponding ETSI deliverables.

The cross reference between GSM, UMTS, 3GPP and ETSI identities can be found under <http://webapp.etsi.org/key/queryform.asp>.

Contents

Intellectual Property Rights	2
Foreword.....	2
Foreword.....	7
1 Scope	8
2 References	8
3 Definitions, symbols and abbreviations	9
3.1 Definitions	9
3.2 Symbols.....	10
3.3 Abbreviations	10
4 General	12
4.1 GTP Tunnel	12
4.2 Protocol stack	12
4.2.0 General.....	12
4.2.1 UDP header and port numbers.....	13
4.2.1.0 General	13
4.2.1.1 Initial Messages.....	14
4.2.1.2 Triggered Messages	14
4.2.1.3 Piggybacked Messages.....	14
4.2.2 IP header and IP addresses.....	14
4.2.2.1 Initial Messages.....	14
4.2.2.2 Triggered Messages	14
4.2.2.3 Piggybacked Messages.....	15
4.2.3 Layer 2	15
4.2.4 Layer 1	15
4.2.5 Messages with GTPv2 defined replies: Classification of Initial and Triggered Messages	15
4.3 Transmission Order and Bit Definitions.....	15
5 GTP Header for Control Plane	16
5.1 General format.....	16
5.2 Control Plane GTP Extension Header	16
5.3 GTP-C header for Echo and Version Not Supported messages	16
5.4 EPC specific GTP-C header	17
5.5 Usage of the GTPv2-C Header.....	17
5.6 Format of the GTPv2-C Message.....	18
6 GTP-C Message Types and Message Formats	19
6.1 Message Format and Type values	19
6.1.1 Presence requirements of Information Elements	21
6.1.2 Grouped Information Elements.....	22
6.1.3 Information Element instance	22
6.2 Message Granularity.....	23
7.1 Path Management Messages.....	23
7.1.0 General.....	23
7.1.1 Echo Request	23
7.1.2 Echo Response.....	24
7.2 Tunnel Management Messages	24
7.2.1 Create Session Request	24
7.2.2 Create Session Response	30
7.2.3 Create Bearer Request	33
7.2.4 Create Bearer Response	34
7.2.5 Bearer Resource Command	36
7.2.6 Bearer Resource Failure Indication	37
7.2.7 Modify Bearer Request	38
7.2.8 Modify Bearer Response	42

7.2.9	Delete Session Request and Delete Bearer Request	45
7.2.9.1	Delete Session Request	45
7.2.9.2	Delete Bearer Request.....	47
7.2.10	Delete Session Response and Delete Bearer Response.....	49
7.2.10.1	Delete Session Response.....	49
7.2.10.2	Delete Bearer Response	50
7.2.11	Downlink Data Notification messages.....	51
7.2.11.1	Downlink Data Notification	51
7.2.11.2	Downlink Data Notification Acknowledge.....	52
7.2.11.3	Downlink Data Notification Failure Indication.....	52
7.2.12	Delete Indirect Data Forwarding Tunnel Request	53
7.2.13	Delete Indirect Data Forwarding Tunnel Response	53
7.2.14	Modify Bearer Command and Failure Indication	54
7.2.14.1	Modify Bearer Command	54
7.2.14.2	Modify Bearer Failure Indication.....	54
7.2.15	Update Bearer Request	55
7.2.16	Update Bearer Response	56
7.2.17	Delete Bearer Command and Failure Indication.....	58
7.2.17.1	Delete Bearer Command	58
7.2.17.2	Delete Bearer Failure Indication	58
7.2.18	Create Indirect Data Forwarding Tunnel Request	59
7.2.19	Create Indirect Data Forwarding Tunnel Response	60
7.2.20	Void	61
7.2.21	Release Access Bearers Request.....	61
7.2.22	Release Access Bearers Response	62
7.2.23	Stop Paging Indication.....	62
7.3	Mobility Management Messages.....	63
7.3.1	Forward Relocation Request.....	63
7.3.2	Forward Relocation Response	66
7.3.3	Forward Relocation Complete Notification.....	68
7.3.4	Forward Relocation Complete Acknowledge	68
7.3.5	Context Request.....	69
7.3.6	Context Response	70
7.3.7	Context Acknowledge.....	72
7.3.8	Identification Request.....	73
7.3.9	Identification Response.....	74
7.3.10	Forward Access Context Notification.....	75
7.3.11	Forward Access Context Acknowledge.....	76
7.3.12	Detach Notification.....	76
7.3.13	Detach Acknowledge.....	76
7.3.14	Change Notification Request	77
7.3.15	Change Notification Response.....	77
7.3.16	Relocation Cancel Request	78
7.3.17	Relocation Cancel Response.....	78
7.3.18	Configuration Transfer Tunnel	79
7.3.19	RAN Information Relay.....	79
7.4	CS Fallback related messages	80
7.4.1	Suspend Notification.....	80
7.4.2	Suspend Acknowledge.....	80
7.4.3	Resume Notification	81
7.4.4	Resume Acknowledge	81
7.4.5	CS Paging Indication	81
7.5	Non-3GPP access related messages	82
7.5.1	Create Forwarding Tunnel Request	82
7.5.2	Create Forwarding Tunnel Response	82
7.6	Reliable Delivery of Signalling Messages.....	83
7.7	Error Handling.....	84
7.7.0	Handling Piggybacked Messages	84
7.7.1	Protocol Errors.....	84
7.7.2	Different GTP Versions	85
7.7.3	GTP Message of Invalid Length.....	85
7.7.4	Unknown GTP Message	85

7.7.5	Unexpected GTP Message	85
7.7.6	Missing Information Elements.....	85
7.7.7	Invalid Length Information Element	86
7.7.8	Semantically incorrect Information Element	86
7.7.9	Unknown or unexpected Information Element	87
7.7.10	Repeated Information Elements.....	87
7.8	Path Failure	87
7.9	Restoration and Recovery	87
7.9.1	Delete PDN Connection Set Request.....	87
7.9.2	Delete PDN Connection Set Response	88
7.9.3	Update PDN Connection Set Request.....	88
7.9.4	Update PDN Connection Set Response	89
7.10	Fallback to GTPv1 mechanism	89
7.11	Fallback to GTPv0.....	89
7.12	Trace Management Messages.....	90
7.12.1	Trace Session Activation	90
7.12.2	Trace Session Deactivation.....	90
8	GTP-C Information Elements	90
8.1	Information Element Types	90
8.2	Information Element Format	93
8.3	International Mobile Subscriber Identity (IMSI).....	93
8.4	Cause	93
8.5	Recovery (Restart Counter).....	96
8.6	Access Point Name (APN)	96
8.7	Aggregate Maximum Bit Rate (AMBR)	96
8.8	EPS Bearer ID (EBI)	96
8.9	IP Address	97
8.10	Mobile Equipment Identity (MEI).....	97
8.11	MSISDN.....	97
8.12	Indication.....	98
8.13	Protocol Configuration Options (PCO)	99
8.14	PDN Address Allocation (PAA)	99
8.15	Bearer Quality of Service (Bearer QoS).....	100
8.16	Flow Quality of Service (Flow QoS).....	101
8.17	RAT Type.....	101
8.18	Serving Network	102
8.19	EPS Bearer Level Traffic Flow Template (Bearer TFT).....	102
8.20	Traffic Aggregate Description (TAD).....	102
8.21	User Location Information (ULI)	102
8.21.1	CGI field	103
8.21.2	SAI field	103
8.21.3	RAI field	104
8.21.4	TAI field	104
8.21.5	ECGI field.....	104
8.22	Fully Qualified TEID (F-TEID)	105
8.23	TMSI	106
8.24	Global CN-Id.....	106
8.25	S103 PDN Data Forwarding Info (S103PDF)	107
8.26	S1-U Data Forwarding (S1UDF).....	107
8.27	Delay Value	107
8.28	Bearer Context.....	108
8.29	Charging ID	108
8.30	Charging Characteristics	109
8.31	Trace Information.....	109
8.32	Bearer Flags.....	109
8.33	Void.....	110
8.34	PDN Type.....	110
8.35	Procedure Transaction ID (PTI)	110
8.36	DRX Parameter	110
8.37	UE Network Capability	111
8.38	MM Context	111

8.39	PDN Connection	118
8.40	PDU Numbers	120
8.41	Packet TMSI (P-TMSI).....	120
8.42	P-TMSI Signature.....	120
8.43	Hop Counter	121
8.44	UE Time Zone	121
8.45	Trace Reference.....	121
8.46	Complete Request Message.....	122
8.47	GUTI	122
8.48	Fully Qualified Container (F-Container).....	123
8.49	Fully Qualified Cause (F-Cause).....	123
8.50	Selected PLMN ID	124
8.51	Target Identification	124
8.52	NSAPI	125
8.53	Packet Flow ID	125
8.54	RAB Context	125
8.55	Source RNC PDCP context info.....	126
8.56	UDP Source Port Number	126
8.57	APN Restriction	126
8.58	Selection Mode.....	127
8.59	Source Identification	127
8.60	Void.....	128
8.61	Change Reporting Action.....	128
8.62	Fully qualified PDN Connection Set Identifier (FQ-CSID)	129
8.63	Channel needed	130
8.64	eMLPP Priority	130
8.65	Node Type	130
8.66	Fully Qualified Domain Name (FQDN).....	130
8.67	Private Extension.....	131
8.68	Transaction Identifier (TI).....	131
9	Security.....	131
10	IP - The Networking Technology used by GTP.....	132
10.1	IP Version.....	132
10.2	IP Fragmentation	132
Annex A (Informative): Backward Compatibility Guidelines for Information Elements		133
Annex B (informative): Change History		134
History		138

Foreword

This Technical Specification has been produced by the 3rd Generation Partnership Project (3GPP).

The contents of the present document are subject to continuing work within the TSG and may change following formal TSG approval. Should the TSG modify the contents of the present document, it will be re-released by the TSG with an identifying change of release date and an increase in version number as follows:

Version x.y.z

where:

- x the first digit:
 - 1 presented to TSG for information;
 - 2 presented to TSG for approval;
 - 3 or greater indicates TSG approved document under change control.
- y the second digit is incremented for all changes of substance, i.e. technical enhancements, corrections, updates, etc.
- z the third digit is incremented when editorial only changes have been incorporated in the document.

1 Scope

The present document specifies the stage 3 of the control plane of the GPRS Tunnelling Protocol, Version 2 for Evolved Packet System interfaces (GTPv2-C).

In this document, unless otherwise specified the S5 interface refers always to "GTP-based S5" and S8 interface refers always to "GTP-based S8" interface.

GTPv2-C shall be used across the following EPC signalling interfaces: S3, S4, S5, S8, S10, S11 and S16.

GTPv2-C based protocols shall also be used across Sv (3GPP TS 29.280 [15]) and S101 (3GPP TS 29.276 [14]) interfaces.

2 References

The following documents contain provisions which, through reference in this text, constitute provisions of the present document.

- References are either specific (identified by date of publication, edition number, version number, etc.) or non-specific.
- For a specific reference, subsequent revisions do not apply.
- For a non-specific reference, the latest version applies. In the case of a reference to a 3GPP document (including a GSM document), a non-specific reference implicitly refers to the latest version of that document *in the same Release as the present document*.

- [1] 3GPP TR 21.905: "Vocabulary for 3GPP Specifications".
- [2] 3GPP TS 23.003: "Numbering, addressing and identification".
- [3] 3GPP TS 23.401: "General Packet Radio Service (GPRS) enhancements for Evolved Universal Terrestrial Radio Access Network (E-UTRAN) access".
- [4] 3GPP TS 29.060: "General Packet Radio Service (GPRS); GPRS Tunnelling Protocol (GTP) across the Gn and Gp interface".
- [5] 3GPP TS 24.008: "Mobile radio interface Layer 3 specification; Core network protocols; Stage 3".
- [6] IETF RFC 791 (STD 0005): "Internet Protocol", J. Postel.
- [7] IETF RFC 768 (STD 0006): "User Datagram Protocol", J. Postel.
- [8] 3GPP TS 32.251: "Telecommunication Management; Charging Management; Packet Switched (PS) domain charging".
- [9] 3GPP TS 32.298: "Telecommunication Management; Charging Management; Charging Data Record (CDR) parameter classification".
- [10] 3GPP TS 36.413: "Evolved Universal Terrestrial Radio Access Network (E-UTRAN); S1 Application Protocol (S1AP)".
- [11] 3GPP TS 33.102: "3G security; Security architecture".
- [12] 3GPP TS 33.401: "3GPP System Architecture Evolution (SAE); Security architecture".
- [13] 3GPP TS 29.281: "GPRS Tunnelling Protocol User Plane (GTPv1-U)".
- [14] 3GPP TS 29.276: "Optimized Handover Procedures and Protocols between E-UTRAN Access and cdma2000 HRPD Access – Stage 3".
- [15] 3GPP TS 29.280: "3GPP EPS Sv interface (MME to MSC) for SRVCC".

- [16] IETF RFC 2460: "Internet Protocol, Version 6 (IPv6) Specification".
- [17] 3GPP TS 23.007: "Restoration procedures".
- [18] 3GPP TS 32.422: "Telecommunication management; Subscriber and equipment trace; Trace control and configuration management".
- [19] 3GPP TS 36.300: "Evolved Universal Terrestrial Radio Access (E-UTRA) and Evolved Universal Terrestrial Radio Access Network (E-UTRAN); Overall description; Stage 2".
- [20] 3GPP TS 36.414: "Evolved Universal Terrestrial Radio Access Network (E-UTRAN); S1 data transport".
- [21] 3GPP TS 23.272: "Circuit switched fallback in Evolved Packet System; Stage 2".
- [22] 3GPP TS 29.118: "Mobility Management Entity (MME) - Visitor Location Register (VLR) SGs interface specification".
- [23] 3GPP TS 24.301: "Non-Access-Stratum (NAS) protocol for Evolved Packet".
- [24] void
- [25] ITU-T Recommendation E.164: "The international public telecommunication numbering plan".
- [26] 3GPP TS 29.275: "Proxy Mobile IPv6 (PMIPv6) based Mobility and Tunnelling protocols; Stage 3".
- [27] 3GPP TS 44.018: "Mobile radio interface layer 3 specification; Radio Resource Control Protocol".
- [28] 3GPP TS 48.008: "Mobile-services Switching Centre - Base Station System (MSC-BSS) interface; Layer 3 specification".
- [29] 3GPP TS 29.212: "Policy and charging control over Gx reference point".
- [30] 3GPP TS 24.007: "Mobile radio interface signalling layer 3; General aspects".
- [31] IETF RFC 1035: "Domain Names - Implementation and Specification".
- [32] 3GPP TS 29.303: "Domain Name System Procedures; Stage 3".
- [33] 3GPP TS 25.413: "UTRAN Iu Interface RANAP Signalling".
- [34] 3GPP TS 48.018: "General Packet Radio Service (GPRS); Base Station System (BSS) - Serving GPRS Support Node (SGSN); BSS GPRS Protocol (BSSGP)".
- [35] 3GPP TS 23.060: "General Packet Radio Service (GPRS); Service description; Stage 2".
- [36] 3GPP TS 32.295: "Charging management; Charging Data Record (CDR) transfer".

3 Definitions, symbols and abbreviations

3.1 Definitions

For the purposes of the present document, the terms and definitions given in TR 21.905 [1] and the following apply. A term defined in the present document takes precedence over the definition of the same term, if any, in TR 21.905 [1].

GTP-PDU: GTP Protocol Data Unit is either a GTP-C Message or a GTP-U Message. GTP-U Message may be either a signalling message across the user plane tunnel, or a G-PDU (see clause 6).

- **Signalling Message:** any GTP-PDU (GTP-C or GTP-U) except the G-PDU.
- **G-PDU:** GTP user plane message, which carries the original packet (payload). G-PDU consists of GTP-U header and a T-PDU.

- **T-PDU:** original packet, for example an IP datagram, from an UE or a network node in an external packet data network. A T-PDU is the payload that is tunnelled in the GTP-U tunnel.
- **GTP-C Message:** GTP control plane message type of a GTP-PDU. GTP-C message consists of GTP-C header, which is followed by zero or more information elements.
- **GTP-U Message:** GTP user plane message. The user plane messages are used to carry user data packets, and also signalling messages e.g. for path management and error indication. Therefore, GTP-U message consists of GTP-U header, which is followed by either a T-PDU, or zero or more information elements.

GTP Tunnel: FFS (see also subclause 4.1 "GTP Tunnel").

Tunnel Endpoint: A tunnel endpoint is identified with a TEID, an IP address and a UDP port number (see subclause 4.1 "GTP Tunnel").

Tunnel Endpoint Identifier (TEID): unambiguously identifies a tunnel endpoint in scope of a path (see subclause 4.1 "GTP Tunnel").

3.2 Symbols

For the purposes of the present document, the following symbols apply:

S1-U	Interface between SGW and eNodeB
X2	Interface between eNodeBs

3.3 Abbreviations

For the purposes of the present document, the abbreviations given in TR 21.905 [1] and the following apply. An abbreviation defined in the present document takes precedence over the definition of the same abbreviation, if any, in TR 21.905 [1].

AMBR	Aggregate Maximum Bit Rate
APN	Access Point Name
APN-NI	Access Point Name Network Identifier
APN-OI	Access Point Name Operator Identifier
EBI	EPS Bearer ID
eNodeB	Evolved Node B
EPC	Evolved Packet Core
EPS	Evolved Packet System
F-TEID	Fully Qualified Tunnel Endpoint Identifier
G-PDU	GTP-U non-signalling PDU
GPRS	General Packet Radio Service
GTP	GPRS Tunnelling Protocol
GTP-PDU	GTP-C PDU or GTP-U PDU
GTPv2-C	GTP version 2, control plane
GTPv2-U	GTP version 2, user plane
IMSI	International Mobile Subscriber Identity
IP	Internet Protocol
LBI	Linked Bearer identity
L1	Layer 1
L2	Layer 2
MEI	Mobile Equipment Identity
MSISDN	Mobile Subscriber ISDN Number
PAA	PDN Address Allocation
PCO	Protocol Configuration Options
PDU	Protocol Data Unit
PDN	Packet Data Network or Public Data Network
PGW	PDN Gateway
PTI	Procedure Transaction Id
QoS	Quality of Service
RAT	Radio Access Type
RIM	RAN Information Management

SGW	Serving Gateway
TEID	Tunnel Endpoint Identifier
TEID-C	Tunnel Endpoint Identifier, control plane
TEID-U	Tunnel Endpoint Identifier, user plane
TFT	Traffic Flow Template
TLIV	Type Length Instance Value
UDP	User Datagram Protocol
ULI	User Location Information

4 General

4.1 GTP Tunnel

GTP tunnels are used between two nodes communicating over a GTP based interface, to separate traffic into different communication flows.

A GTP tunnel is identified in each node with a TEID, an IP address and a UDP port number. The receiving end side of a GTP tunnel locally assigns the TEID value the transmitting side has to use. The TEID values are exchanged between tunnel endpoints using GTP-C or S1-MME messages.

The criteria defining when the same or different GTP tunnels shall be used between the two nodes differs between the control and the user plane, and also between interfaces.

For the control plane, for each end-point of a GTP-C tunnel:

- The TEID-C shall be unique per PDN-Connection on GTP based S5 and S8 interfaces. The same tunnel shall be shared for the control messages related to all bearers associated to the PDN-Connection. A TEID-C on the S5/S8 interface shall be released after all its associated EPS bearers are deleted.
- There shall be only one pair of TEID-Cs per UE on each of the S3, S10 and the S16 interfaces. The same tunnel shall be shared for the control messages related to the same UE operation. A TEID-C on the S3/S10/S16 interface shall be released after its associated UE context is removed or the UE is detached.
- There shall be only one pair of TEID-C per UE over the S11 and the S4 interfaces. The same tunnel shall be shared for the control messages related to the same UE operation. A TEID-C on the S11/S4 interface shall be released after all its associated EPS bearers are deleted.

For GTP-U, a TEID-U is used according to 3GPP TS 29.281 [13].

NOTE: GTP-U is based on GTP version 1 (GTPv1).

4.2 Protocol stack

4.2.0 General

The protocol stack for GTPv2 shall be as depicted in Figure 4.2.0-1.

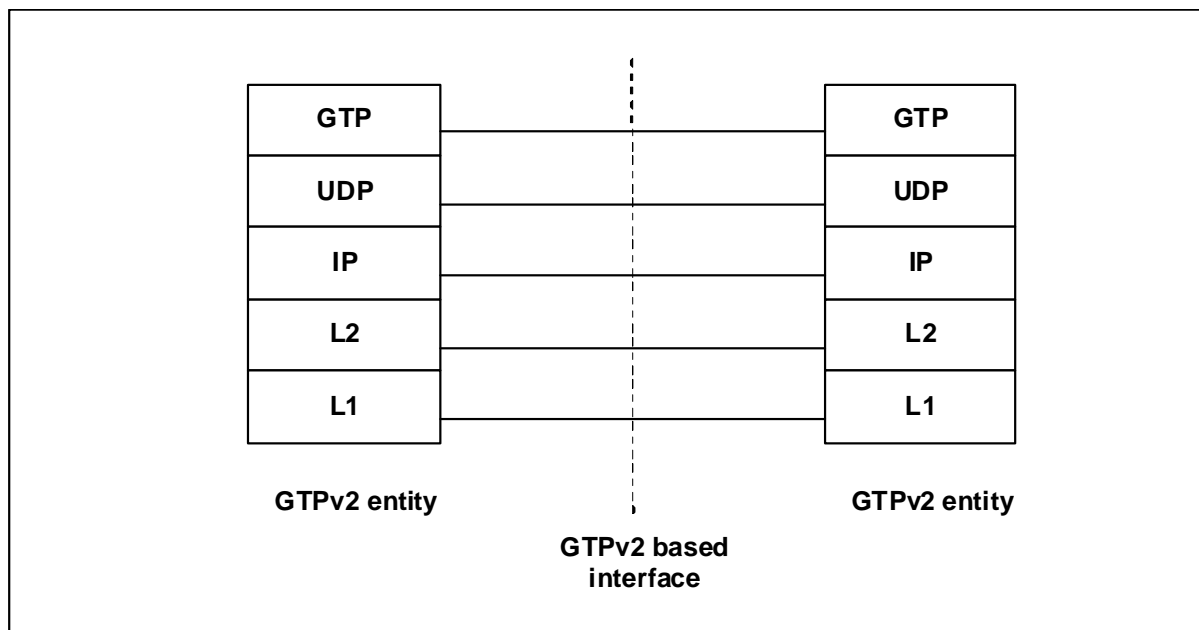

Figure 4.2.0-1: GTPv2 stack

The GTPv2 headers are specified in the respective clauses of this specification.

The source and destination IP addresses and UDP ports used for each GTP-C message depend on the role that the message plays in a message exchange. A message can be an Initial message, or a Triggered message, or a Triggered Reply message to Triggered message. An Initial message is sent to a peer GTP entity with a sequence number chosen by the sending entity (see subclause 7.6). A Triggered message is sent in response to an Initial message. Triggered Reply message may be sent in response to a Triggered message. See subclause 7.6 for the sequence number usage.

Typically, a Request message is an Initial message, but a Request message may be a Triggered messages in certain procedures where they are triggered by an Initial Command message. See subclause 4.2.5 for classification of the Initial messages and their possible Triggered messages, as well as cases where there are Triggered Reply messages to the Triggered messages.

Piggybacking is an optional feature. If the feature is supported, then the piggybacking of the initial messages on triggered response messages for EUTRAN Initial Attach and UE-requested PDN Connectivity procedures shall be implemented as per Annex F of 3GPP TS 23.401 [3]. When piggybacking is used, a common IP header and a common UDP header shall be used for the triggered response message and the piggybacked initial message as depicted in Figure 4.2.0-1. Immediately following the triggered response message is the piggybacked initial message, following which no additional information shall be present. The subclause 5.5 specifies the usage of piggybacking-specific fields in the GTP-C header.

IP header	UDP header	Triggered response message (P=1)	Piggybacked initial message (P=0)
-----------	------------	-------------------------------------	--------------------------------------

Figure 4.2.0-1: Packet Format for the Piggybacking of messages

4.2.1 UDP header and port numbers

4.2.1.0 General

A User Datagram Protocol (UDP) compliant with IETF RFC 768 [7] shall be used.

4.2.1.1 Initial Messages

The UDP Destination Port number for GTPv2 Initial messages shall be 2123. It is the registered port number for GTP-C.

The UDP Source Port for a GTPv2 Initial message is a locally allocated port number at the sending GTP entity.

If GTPv2 and GTP' v2 modules are using the same IP address for sending messages, the implementation shall ensure that while some source port number is used by GTPv2 messages, the same source port number shall not be used by GTP' v2 messages. Otherwise, the IP interface may have difficulty to delivering a response message to the right protocol entity.

4.2.1.2 Triggered Messages

The UDP Destination Port value of a GTPv2 Triggered message and for a Triggered Reply message shall be the value of the UDP Source Port of the corresponding message to which this GTPv2 entity is replying, except in the case of the SGSN pool scenario.

The UDP Source Port of a GTPv2 Triggered message and for a Triggered Reply message shall be the value from the UDP Destination Port of the corresponding message to which this GTPv2 entity is replying, except in the case of the SGSN pool scenario.

In the SGSN pool scenario, if the Identification Request or the Context Request messages have been forwarded by another SGSN in the pool, the UDP Destination Port for the Identification Response or the Context Response message shall be determined in the following way. The value from the information element "UDP Source Port Number", which was sent in the corresponding forwarded request, shall be copied into the UDP Destination Port field. The UDP Source Port for the Identification Response or the Context Response message may be a locally allocated port number at the sending GTP entity.

4.2.1.3 Piggybacked Messages

A piggybacked initial message is carried as a concatenation after a triggered response message and they share a common UDP header (see Figure 4.2.0-1).

The UDP Destination port for the IP packet containing both the triggered response message and the piggybacked initial message shall be the same as the port number used for the triggered response message.

The UDP Source port for the IP packet containing both the triggered response message and the piggybacked initial message shall be the same as the port number used for the triggered response message.

4.2.2 IP header and IP addresses

4.2.2.1 Initial Messages

The IP Destination Address of a GTPv2 Initial message shall be an IP address of the destination GTPv2 entity.

The IP Source Address of a GTPv2 Initial message shall be an IP address of the source GTPv2 entity from which the Initial message is originating.

4.2.2.2 Triggered Messages

The IP Destination Address of a GTPv2 Triggered message and for a Triggered Reply message shall be copied from the IP Source Address of the message to which this GTPv2 entity is replying, except in the case of the SGSN pool scenario.

The IP Source Address of a GTPv2 Triggered message and for a Triggered Reply message shall be copied from the IP destination address of the message to which this GTPv2 entity is replying, except in the case of SGSN pool scenario.

In the SGSN pool scenario, if the Identification Request or the Context Request messages have been forwarded by another SGSN in the pool, the IP Source address for the Identification Response or the Context Response messages shall be locally allocated by the sending GTP entity. The IP Destination Address for the Identification Response or Context Response messages shall be determined in the following way. The value from the information element

"Address for Control Plane", which was sent in the corresponding Identification Request message; or the value from the information element "S3/S16/S10 Address and TEID for Control Plane", which was sent in the corresponding Context Request message, shall be copied into the IP Destination Address field.

4.2.2.3 Piggybacked Messages

A piggybacked initial message is carried as a concatenation after a triggered response message and they share a common IP header (see Figure 4.2.0-1).

The IP Source Address for the IP packet containing both the triggered response message and the piggybacked initial message shall be the same as the IP Address used for the triggered response message.

The IP Destination Address for the IP packet containing both the triggered response message and the piggybacked initial message shall be the same as the IP Address used for the triggered response message.

4.2.3 Layer 2

Typically Ethernet should be used as a Layer 2 protocol, but operators may use any other technology.

4.2.4 Layer 1

Operators may use any appropriate Layer 1 technology.

4.2.5 Messages with GTPv2 defined replies: Classification of Initial and Triggered Messages

NOTE: Other clauses of this specification and Stage 2 documents define in detail when a reply message is expected in an end-to-end procedure. Reply messages are triggered messages.

The expected reply to a Request message is a Triggered message and the reply has the same message name as the Request but with "Response" replacing "Request". If a Request message is a reply to a Command message, then the Request message is a Triggered message; otherwise the Request message is an Initial message. Responses do not have replies except when a "Context Acknowledge" is required as a reply to "Context Response" message as specified in relevant Stage 2 procedures. Context Acknowledge is always triggered message and does not have a reply.

A message whose name ends in "Command" is always an initial message. If a "Command" message fails, the name of the reply message is constructed by replacing "Command" with "Failure Indication". Apart from "Downlink Data Notification Failure Indication" message, a "Failure Indication" is a Triggered message. The "Failure Indication" message does not have a reply. If a "Command" message is successful, its reply will be a Request as specified in relevant Stage 2 procedures.

A message whose name ends in "Notification" is always an Initial message, The expected Triggered message in reply has the same message name but with "Acknowledge" replacing "Notification", except for the case of the message "Downlink Data Notification" which has the reply "Downlink Data Notification Acknowledge". An "Acknowledge" message does not have a reply.

CS Paging Indication, Stop Paging Indication, RAN Information Relay, Configuration Transfer Tunnel, Trace Session Activation, Trace Session Deactivation, and Downlink Data Notification Failure Indication messages are Initial messages that do not have a reply.

A Version Not Supported Indication message is a Triggered message.

4.3 Transmission Order and Bit Definitions

The messages in this document shall be transmitted in network octet order starting with octet 1 with the Most Significant Bit sent first.

The most significant bit of an octet in a GTP message is bit 8. If a value in a GTP message spans several octets and nothing else is stated, the most significant bit is bit 8 of the octet with the lowest number.

5 GTP Header for Control Plane

5.1 General format

Control Plane GTP uses a variable length header. Control Plane GTP header length shall be a multiple of 4 octets. Figure 5.1-1 illustrates the format of the GTPv2-C Header.

Octets	Bits							
	8	7	6	5	4	3	2	1
1	Version		P	T	Spare	Spare	Spare	
2	Message Type							
3	Message Length (1 st Octet)							
4	Message Length (2 nd Octet)							
m to k(m+3)	If T flag is set to 1, then TEID shall be placed into octets 5-8. Otherwise, TEID field is not present at all.							
n to (n+2)	Sequence Number							
(n+3)	Spare							

Figure 5.1-1: General format of GTPv2 Header for Control Plane

Where:

- if T = 0, TEID field is not present, k = 0, m = 0 and n = 5;
- if T = 1, TEID field is present, k = 1, m = 5 and n = 9.

The usage of GTPv2-C header across the EPC specific interfaces is defined in the subclause 5.5 "Usage of the GTPv2-C Header". Octet 1 bits shall be coded as follows:

- Bits 6-8 represent the Version field.
- Bit 5 represents the Piggybacking flag (P).
- Bit 4 represents the TEID flag (T).
- Bits 3-1 are spare, the sender shall set them to "0" and the receiving entity shall ignore them.

5.2 Control Plane GTP Extension Header

The legacy Extension Header mechanism is not used for the GTP version 2 control plane (GTPv2-C). Future extensions will be implemented by adding Information Elements in the message body if new parameters are needed.

5.3 GTP-C header for Echo and Version Not Supported messages

The GTPv2-C message header for the Echo Request, Echo Response and Version Not Supported Indication messages shall not contain the TEID field, but shall contain the Sequence Number fields, followed by one spare octet as depicted in figure 5.3-1. The spare bits shall be set to zero by the sender and ignored by the receiver.

Octets	Bits							
	8	7	6	5	4	3	2	1
1	Version		P	T=0	Spare	Spare	Spare	
2	Message Type							
3	Message Length (1 st Octet)							
4	Message Length (2 nd Octet)							
5	Sequence Number (1 st Octet)							
6	Sequence Number (2 nd Octet)							
7	Sequence Number (3 rd Octet)							
8	Spare							

Figure 5.3-1: The format of Echo and Version Not Supported messages Header

5.4 EPC specific GTP-C header

Apart from the Echo Request, Echo Response and Version Not Supported Indication messages, the GTP-C message header shall contain the TEID and Sequence Number fields followed by one spare octet. A typical GTP-C header is depicted in figure 5.4-1. The spare bits shall be set to zero by the sender and ignored by the receiver.

Octets	Bits							
	8	7	6	5	4	3	2	1
1	Version			P	T=1	Spare	Spare	Spare
2	Message Type							
3	Message Length (1 st Octet)							
4	Message Length (2 nd Octet)							
5	Tunnel Endpoint Identifier (1 st Octet)							
6	Tunnel Endpoint Identifier (2 nd Octet)							
7	Tunnel Endpoint Identifier (3 rd Octet)							
8	Tunnel Endpoint Identifier (4 th Octet)							
9	Sequence Number (1 st Octet)							
10	Sequence Number (2 nd Octet)							
11	Sequence Number (3 rd Octet)							
12	Spare							

Figure 5.4-1: The format of EPC specific GTPv2 Control Plane message Header

5.5 Usage of the GTPv2-C Header

The format of the GTPv2-C header is specified in subclause 5.1 "General format". The usage of the GTP-C header across e.g. S101 (3GPP TS 29.276 [14]) and Sv (3GPP TS 29.280 [15]) interfaces are defined in their respective specifications.

The usage of the GTPv2-C header for EPC specific interfaces shall be as defined below.

The first octet of the header shall be used in the following way:

- Bits 8 to 6, which represent the GTP-C version, shall be set to decimal 2 ("010").
- Bit 5 represents a "P" flag. If the "P" flag is set to "0", no piggybacked message shall be present. If the "P" flag is set to "1", then another GTPv2-C message with its own header and body shall be present at the end of the current message.

When present, a piggybacked message shall have its "P" flag set to "0" in its own header. If Create Session Response message (as part of EUTRAN initial attach or UE-requested PDN connectivity procedure) has the "P" flag set to "1", then a Create Bearer Request message shall be present as the piggybacked message. As a response to the Create Bearer Request message, if the Create Bearer Response has the "P" flag set to "1", then a Modify Bearer Request (as part of EUTRAN initial attach or UE-requested PDN connectivity procedure) shall be present as the piggybacked message. A Create Bearer Response with "P" flag set to "1" shall not be sent unless a Create Session Response with "P" flag set to "1" has been received for the same procedure. Apart from Create Session Response and Create Bearer Response messages, all the EPC specific messages shall have the "P" flag set to "0".

- Bit 4 represents a "T" flag, which indicates if TEID field is present in the GTP-C header or not. If the "T" flag is set to 0, then the TEID field shall not be present in the GTP-C header. If the "T" flag is set to 1, then the TEID field shall immediately follow the Length field, in octets 5 to 8. Apart from the Echo Request, Echo Response and Version Not Supported Indication messages, in all EPC specific messages the value of the "T" flag shall be set to "1".
- Bit 3 is a spare bit. The sending entity shall set it to "0" and the receiving entity shall ignore it.
- Bit 2 is a spare bit. The sending entity shall set it to "0" and the receiving entity shall ignore it.
- Bit 1 is a spare bit. The sending entity shall set it to "0" and the receiving entity shall ignore it.

The usage of the fields in octets 2 - n of the header shall be as specified below.

- Octet 2 represents the Message type field, which shall be set to the unique value for each type of control plane message. Message type values are specified in Table 6.1-1 "Message types for GTPv2".
- Octets 3 to 4 represent the Length field. This field shall indicate the length of the message in octets excluding the mandatory part of the GTP-C header (the first 4 octets). The TEID (if present) and the Sequence Number shall be included in the length count. The format of the Length field is specified in subclause 8.2 "Information Element Format".
- A piggybacked initial message and the preceeding triggered response message present in the common IP/UDP packet shall have their own length and sequence number in their respective GTP-C headers. The overall length of the IP/UDP packet shall indicate the total length of the two GTP-C messages.
- For EPC specific interfaces, T=1, and therefore octets 5 to 8 represent the Tunnel Endpoint Identifier (TEID) field. This field shall unambiguously identify a tunnel endpoint in the receiving GTP-C entity. The Tunnel Endpoint Identifier is set by the sending entity to the value provided by the corresponding receiving entity. When a peer's TEID is not available, as in the following cases, the TEID field shall be present in a GTPv2-C header, but its value shall be set to "0":
 - Create Session Request message on S5/S8
 - Create Session Request message on S4/S11, if for a given UE, the SGSN/MME has not yet obtained the Control TEID of the SGW.
 - Create Indirect Data Forwarding Tunnel Request message on S4/S11, if the SGW selected by the MME/S4-SGSN for indirect data forwarding is different from the SGW used as anchor.
 - Identification Request/Response messages.
 - Change Notification Request/Response messages.
 - Forward Relocation Request message.
 - Context Request message.
 - Relocation Cancel Request message except for the case where the old SGSN/MME has already been assigned the Tunnel Endpoint Identifier Control Plane of the new SGSN/MME.
 - Delete PDN Connection Set Request/Response messages.
 - Configuration Transfer Tunnel message.
 - RAN Information Relay message.
 - If a node receives a message for which it has no context, it shall respond with "Context not found" Cause in the corresponding response message to the sender. The TEID used in the GTPv2-C header in the response message shall be set to zero.
- Octets 9 to 11 represent GTP Sequence Number field.

5.6 Format of the GTPv2-C Message

The GTP-C header may be followed by subsequent information elements dependent on the type of control plane message.

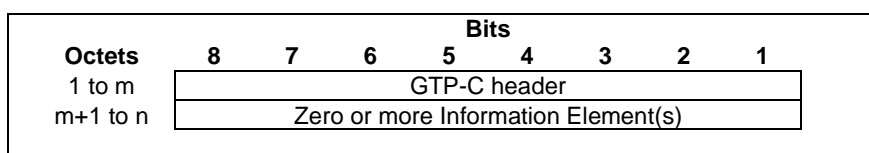

Figure 5.6-1: GTP-C Header followed by subsequent Information Elements

6 GTP-C Message Types and Message Formats

A GTP-C message is sent across a GTP control plane tunnel. In a message, the GTP-C header is followed by zero or more information elements. The GTP-C messages are used for the control plane path management, for the control plane tunnel management and for mobility management.

A T-PDU is an original packet, for example an IP datagram, from an UE, or from a network node in an external packet data network.

6.1 Message Format and Type values

GTP defines a set of messages between two associated EPC network elements. The messages to be used shall be as defined in Table 6.1-1.

Table 6.1-1: Message types for GTPv2

Message Type value (Decimal)	Message	Reference	GTP-C	GTP-U
0	Reserved			
1	Echo Request		X	X
2	Echo Response		X	X
3	Version Not Supported Indication		X	
4 to 24	Reserved for S101 interface	TS 29.276 [14]		
25 to 31	Reserved for Sv interface	TS 29.280 [15]		
	SGSN/MME to PGW (S4/S11, S5/S8)			
32	Create Session Request		X	
33	Create Session Response		X	
34	Modify Bearer Request		X	
35	Modify Bearer Response		X	
36	Delete Session Request		X	
37	Delete Session Response		X	
	SGSN to PGW (S4, S5/S8)			
38	Change Notification Request		X	
39	Change Notification Response		X	
40 to 63	For future use			
	Messages without explicit response			
64	Modify Bearer Command (MME/SGSN to PGW – S11/S4, S5/S8)		X	
65	Modify Bearer Failure Indication (PGW to MME/SGSN – S5/S8, S11/S4)		X	
66	Delete Bearer Command (MME/SGSN to PGW – S11/S4, S5/S8)		X	
67	Delete Bearer Failure Indication (PGW to MME/SGSN – S5/S8, S11/S4))		X	
68	Bearer Resource Command (MME/SGSN to PGW – S11/S4, S5/S8)		X	
69	Bearer Resource Failure Indication (PGW to MME/SGSN – S5/S8, S11/S4)		X	
70	Downlink Data Notification Failure Indication (SGSN/MME to SGW – S4/S11)		X	
71	Trace Session Activation		X	
72	Trace Session Deactivation		X	
73	Stop Paging Indication		X	
74 to 94	For future use			
	PGW to SGSN/MME (S5/S8, S4/S11)			
95	Create Bearer Request		X	
96	Create Bearer Response		X	
97	Update Bearer Request		X	
98	Update Bearer Response		X	
99	Delete Bearer Request		X	
100	Delete Bearer Response		X	
	PGW to MME, MME to PGW, SGW to PGW, SGW to MME (S5/S8, S11)			
101	Delete PDN Connection Set Request		X	
102	Delete PDN Connection Set Response		X	
103 to 127	For future use			
	MME to MME, SGSN to MME, MME to SGSN, SGSN to SGSN (S3/S10/S16)			
128	Identification Request		X	
129	Identification Response		X	
130	Context Request		X	
131	Context Response		X	
132	Context Acknowledge		X	
133	Forward Relocation Request		X	
134	Forward Relocation Response		X	
135	Forward Relocation Complete Notification		X	
136	Forward Relocation Complete Acknowledge		X	
137	Forward Access Context Notification		X	
138	Forward Access Context Acknowledge		X	
139	Relocation Cancel Request		X	

Message Type value (Decimal)	Message	Reference	GTP-C	GTP-U
140	Relocation Cancel Response		X	
141	Configuration Transfer Tunnel		X	
142 to 148	For future use			
152	RAN Information Relay		X	
	SGSN to MME, MME to SGSN (S3)			
149	Detach Notification		X	
150	Detach Acknowledge		X	
151	CS Paging Indication		X	
152	See above			
153 to 159	For future use			
	SGSN/MME to SGW (S4/S11)			
160	Create Forwarding Tunnel Request		X	
161	Create Forwarding Tunnel Response		X	
162	Suspend Notification		X	
163	Suspend Acknowledge		X	
164	Resume Notification		X	
165	Resume Acknowledge		X	
166	Create Indirect Data Forwarding Tunnel Request		X	
167	Create Indirect Data Forwarding Tunnel Response		X	
168	Delete Indirect Data Forwarding Tunnel Request		X	
169	Delete Indirect Data Forwarding Tunnel Response		X	
170	Release Access Bearers Request		X	
171	Release Access Bearers Response		X	
172 to 175	For future use			
	SGW to SGSN/MME (S4/S11)			
176	Downlink Data Notification		X	
177	Downlink Data Notification Acknowledge		X	
	SGW to SGSN (S4)			
178	Reserved			
179 to 199	For future use			
	SGW to PGW, PGW to SGW (S5/S8)			
200	Update PDN Connection Set Request		X	
201	Update PDN Connection Set Response		X	
	Other			
202 to 255	For future use			

6.1.1 Presence requirements of Information Elements

There are four different presence requirements (Mandatory, Conditional, Optional, or Conditional-Optional) for an IE within a given GTP-PDU:

- Mandatory means that the IE shall be included by the sending side, and that the receiver diagnoses a "Mandatory IE missing" error, when detecting that the IE is not present. A response including a "Mandatory IE missing" cause, shall include the type of the missing IE.
- Conditional means:
 - that the IE shall be included by sending entity if the conditions specified in the relevant protocol specification are met;
 - the receiver shall check the conditions as specified in the corresponding message type description, based on the parameter combination in the message and/or on the state of the receiving node, to infer if a conditional IE shall be expected. Only if a receiver has sufficient information the following applies. A conditional IE, which is absolutely necessary for the receiving entity to complete the procedure, is missing, then the receiver shall abort the procedure.
- Conditional-Optional means:
 - that the IE shall be included by the up-to-date sending entity, if the conditions specified in the relevant protocol specification are met. An entity, which is at an earlier version of the protocol and therefore is not up-to-date, obviously cannot send such new IE.

- the receiver need not check the presence of the IE in the message. If the receiver checks the presence of the Conditional-Optional IE, then the IE's absence shall not trigger any of the error handling procedures. The handling of an absence or erroneous such IEs shall be treated as Optional IEs as specified in subclause 7.7 "Error Handling".
- Optional means that the IE shall be included as a service option. Therefore, the IE may be included or not in a message. The handling of an absent optional IE, or an erroneous optional IE is specified in subclause 7.7 "Error Handling".

For conditional IEs, the clause describing the GTP-PDU explicitly defines the conditions under which the inclusion of each IE becomes mandatory or optional for that particular GTP-PDU. These conditions shall be defined so that the presence of a conditional IE only becomes mandatory if it is critical for the receiving entity. The definition might reference other protocol specifications for final terms used as part of the condition.

For grouped IEs, the presence requirement of the emdedded IE shall follow the rules:

- The grouped IE is Mandatory: if the emdedded IE in the grouped IE is Mandatory, this embedded IE is viewed as Mandatory IE by the receiver. If the embedded IE in the grouped IE is Conditional, this embedded IE is viewed as Conditional IE by the receiver. If the embedded IE in the grouped IE is Optional, this embedded IE is viewed as Optional IE by the receiver.
- The grouped IE is Conditional: if the embedded IE in the grouped IE is Mandatory or Conditional, this embedded IE is viewed as Conditional IE by the receiver. If the embedded IE in the grouped IE is Optional, this embedded IE is viewed as Optional IE by the receiver.
- The grouped IE is Optional: the embedded IE in the grouped IE is viewed as Optional IE by the receiver.

Only the Cause information element shall be included in the response if the Cause contains a value that indicates that the request is not accepted. Optionally, the Protocol Configuration Options and the Recovery information element may be included. Failure Indication type messages do not have "Accept" types of cause values, therefore the proceeding rules do not apply. For Failure Indication type of messages, some of the Mandatory information elements may not be included if they are not available.

6.1.2 Grouped Information Elements

Information elements can contain other IEs. This type of IE is called "Grouped IEs".

Grouped IEs have a length value in the TLIV encoding, which includes the added length of all the embedded IEs. Overall coding of a grouped information element with 4 octets long IE header is defined in subclause 8.2 "Information Element Format". Each information element within a grouped IE also shall also contain 4 octets long IE header.

Grouped IEs are not marked by any flag or limited to a specific range of IE type values. The clause describing an IE in this specification shall explicitly state if it is grouped.

NOTE 1: Each entry into each Grouped IE creates a new scope level. Exit from the grouped IE closes the scope level. The GTPv2 message level is the top most scope. This is analogous to the local scope of a subroutine/function.

If more than one grouped information elements of the same type, but for a different purpose are sent with a message, these IEs shall have different Instance values.

If more than one grouped information elements of the same type and for the same purpose are sent with a message, these IEs shall have exactly the same Instance value to represent a list.

NOTE 2: For instance, all "Bearer Contexts Modified" IEs of the type "Bearer Context" in a "Modify Bearer Response" message shall have the Instance value of 0, while all "Bearer Contexts Marked for Removal" IEs of the type "Bearer Context" in the same message shall have the Instance value of 1.

6.1.3 Information Element instance

Every GTPv2 message and grouped IE within a message in this specification has a column documenting the instance value of each IE.

When a GTPv2 message is encoded for use the instance value of each included IE is encoded in the Instance field of the IE for the message scope. See clause 7 and subclause 8.2 for details of that encoding.

An Information Element in an encoded GTPv2 message or encoded grouped IE is identified by the pair of IE Type and Instance values and described by a specific row in the corresponding tables in subclauses of 7 in the present document.

If several Information Elements with the same Type and Instance values are included in an encoded GTPv2 message, they represent a list for the corresponding IE name and row identified in the message grammar in subclauses of clause 7.

If several Information Elements with the same Type and Instance values are included in an encoded grouped IE, they represent a list for the corresponding IE name and row identified in the grouped IE grammar in subclauses of clause 7.

In tables in this document the instance value for "Private Extension" is marked as VS (Vendor Specific). While an instance value must be encoded by the sender the value can be Vendor and even Private Extension specific.

The same IE name might be used in different messages (on the top level or within grouped IEs) in this specification. The instance value and name of an IE is only meaningful within the scope of the message definition. The combination of Type value and Instance value uniquely identifies a specific row in a message description table.

6.2 Message Granularity

The GTPv2-C messages shall be sent per UE on the S3, S10 and S16 interfaces.

The GTPv2-C messages shall be sent per PDN-Connection on the S4 and S11 interfaces apart from the following exclusion.

The following GTPv2-C messages are sent per UE on the S4 and S11 interfaces:

- Downlink Data Notification / Acknowledge / Failure Indication.
- Stop Paging Indication.
- Delete Indirect Data Forwarding Tunnel Request/Response.
- Delete Session Request during TAU/RAU/Handover procedure with SGW change.
- Release Access Bearers Request/Response.
- Create Indirect Data Forwarding Tunnel Request/Response.
- Trace Session Activation.
- Trace Session Deactivation.

7.1 Path Management Messages

7.1.0 General

Three path management messages are specified for GTP-C: Echo Request, Echo Response and Version Not Supported Indication.

The usage of Echo Request / Response procedure is specified in 3GPP TS 23.007 [17].

7.1.1 Echo Request

Table 7.1.1-1 specifies the information elements included in the Echo Request message.

The Recovery information element contains the local Restart Counter, which is specified in 3GPP TS 23.007 [17])

The optional Private Extension contains vendor or operator specific information.

Table 7.1.1-1: Information Elements in Echo Request

Information elements	P	Condition / Comment	IE Type	Ins.
Recovery	M		Recovery	0
Private Extension	O		Private Extension	VS

7.1.2 Echo Response

Table 7.1.2-1 specifies the information elements included in the Echo Response message.

The Recovery information element contains the local Restart Counter, which is specified in 3GPP TS 23.007 [17])

The optional Private Extension contains vendor or operator specific information.

Possible Cause values are:

- "System failure"
- "Mandatory IE incorrect"
- "Mandatory IE missing"
- "Invalid Message format"

Table 7.1.2-1: Information Elements in Echo Response

Information elements	P	Condition / Comment	IE Type	Ins.
Recovery	M		Recovery	0
Cause	O	IE may be included if recovery IE in the Echo Request or the message itself is malformed.	Cause	0
Private Extension	O		Private Extension	VS

NOTE: If the Cause value is not a successful value this does not indicate the node sending the Echo Response is unable to accept GTPv2 messages. 7.1.3 Version Not Supported Indication

This message contains only the GTPv2 header and indicates the latest GTP version that the sending entity supports.

7.2 Tunnel Management Messages

A node shall include the Recovery information element if it is in contact with the peer for the first time or the node has restarted recently and the new Restart Counter value has not yet been indicated to the peer. The peer receiving the Recovery information element shall handle it as when an Echo Response message is received but shall consider the rest of the message in accordance with the message semantics and parameters.

7.2.1 Create Session Request

The direction of this message shall be from MME/S4-SGSN to SGW and from SGW to PGW (see Table 6.1-1).

The Create Session Request message shall be sent on the S11 interface by the MME to the SGW, and on the S5/S8 interface by the SGW to the PGW as part of the procedures:

- E-UTRAN Initial Attach
- UE requested PDN connectivity

The message shall also be sent on S4 interface by the SGSN to the SGW, and on the S5/S8 interface by the SGW to the PGW as part of the procedures:

- PDP Context Activation

The message shall also be sent on the S11 interface by the MME to the SGW as part of the procedures:

- Tracking Area Update procedure with Serving GW change
- S1/X2-based handover with SGW change
- UTRAN Iu mode to E-UTRAN Inter RAT handover with SGW change
- GERAN A/Gb mode to E-UTRAN Inter RAT handover with SGW change
- 3G Gn/Gp SGSN to MME combined hard handover and SRNS relocation procedure
- Gn/Gp SGSN to MME Tracking Area Update procedure

and on the S4 interface by the SGSN to the SGW as part of the procedures:

- Routing Area Update with MME interaction and with SGW change
- Gn/Gp SGSN to S4 SGSN Routing Area Update
- E-UTRAN to UTRAN Iu mode Inter RAT handover with SGW change
- E-UTRAN to GERAN A/Gb mode Inter RAT handover with SGW change
- Serving RNS relocation
- Combined hard handover and SRNS relocation
- Combined Cell / URA update and SRNS relocation
- Enhanced serving RNS relocation with SGW relocation

Table 7.2.1-1: Information Elements in a Create Session Request

Information elements	P	Condition / Comment	IE Type	Ins.
IMSI	M		IMSI	0
MSISDN	C	For an E-UTRAN Initial Attach the IE shall be included when used on the S11 interface, if provided in the subscription data from the HSS and it shall be included when used on the S5/S8 interfaces if provided by the MME/SGSN. For a PDP Context Activation procedure the IE shall be included when used on the S4 interface, if provided in the subscription data from the HSS. The IE shall be included for the case of a UE Requested PDN Connectivity, it shall be included if the MME has it stored for that UE.	MSISDN	0
ME Identity (MEI)	C	The MME shall include the ME Identity (MEI) IE, if it is available.	MEI	0
User Location Information (ULI)	C	This IE shall be included for E-UTRAN Initial Attach and UE-requested PDN Connectivity procedures. It shall include ECGI&TAI. The MME/SGSN shall also include it for TAU/RAU/X2-Handover procedure if the PGW has requested location information change reporting and MME/SGSN support location information change reporting. The SGW shall include this IE on S5/S8 if it receives the ULI from MME/SGSN.	ULI	0
Serving Network	C	This IE shall be included on S4/S11 and S5/S8 interfaces for an E-UTRAN initial attach, a PDP Context Activation and for a UE requested PDN connectivity. This IE shall be included on S4/S11 for RAU/TAU/Handover with SGW relocation procedures, the receiving node need not check the presence for this condition.	Serving Network	0
RAT Type	M		RAT Type	0
Indication Flags	C	Applicable flags are: <ul style="list-style-type: none"> - S5/S8 Protocol Type: This flag shall be used on the S11/S4 interfaces and set according to the protocol chosen to be used on the S5/S8 interfaces. - Dual Address Bearer Flag: This flag shall be set to 1 when the UE requests a PDN type IPv4v6 and all SGSNs which the UE may be handed over to support dual addressing. This shall be determined based on node pre-configuration by the operator. - Handover Indication: If the UE comes from non-3GPP access, this flag shall be set in an E-UTRAN Initial Attach or in a UE Requested PDN Connectivity. - Operation Indication: This flag shall be set for a TAU/RAU procedure with SGW relocation, and X2-based handovers with SGW relocation. - Direct Tunnel Flag: This flag shall be used on the S4 interface and set to 1 if Direct Tunnel is used. - Piggybacking Supported: This flag shall be set to 1 only if the MME/SGW supports the piggybacking feature as described in Annex F of 3GPP TS 23.401 [3]. This flag shall be set to 1 on S5/S8 only when both the MME and the SGW support piggybacking. - Change Reporting support Indication: shall be used on S4/S11, S5/S8 and set if the SGSN/MME 	Indication	0

		supports location Info Change Reporting.		
--	--	--	--	--

Sender F-TEID for Control Plane	M		F-TEID	0
PGW S5/S8 Address for Control Plane or PMIP	C	This IE shall be sent on the S11 / S4 interfaces. The TEID or GRE Key is set to "0" in the E-UTRAN initial attach, the PDP Context Activation and the UE requested PDN connectivity procedures.	F-TEID	1
Access Point Name (APN)	M		APN	0
Selection Mode	C	This IE shall be included for an E-UTRAN initial attach, a PDP Context Activation and a UE requested PDN connectivity. This IE shall be sent by the MME/SGSN on S11/S4 interface during TAU/RAU/HO with SGW relocation; the receiving node need not check the presence for this condition. It shall indicate whether a subscribed APN or a non subscribed APN chosen by the MME/SGSN was selected.	Selection Mode	0
PDN Type	C	This IE shall be included for an E-UTRAN initial attach, a PDP Context Activation and a UE requested PDN connectivity. This IE shall be set to IPv4, IPv6 or IPv4v6. This is based on the UE request and the subscription record retrieved from the HSS (for MME see 3GPP TS 23.401 [3], clause 5.3.1.1, and for SGSN see 3GPP TS 23.060 [35], clause 9.2.1).	PDN Type	0
PDN Address Allocation (PAA)	C	This IE shall be included for an E-UTRAN initial attach, a PDP Context Activation and a UE requested PDN connectivity. For PMIP-based S5/S8, this IE shall also be included for TAU/RAU/Handover cases involving SGW relocation. The PDN type field in the PAA shall be set to IPv4, or IPv6 or IPv4v6 by MME, based on the UE request and the subscription record retrieved from the HSS. For static IP address assignment (for MME see 3GPP TS 23.401 [3], clause 5.3.1.1, and for SGSN see 3GPP TS 23.060 [35], clause 9.2.1), the MME/SGSN shall set the IPv4 address and/or IPv6 prefix length and IPv6 prefix and Interface Identifier based on the subscribed values received from HSS, if available. The value of PDN Type field shall be consistent with the value of the PDN Type IE, if present in this message. If static IP address assignment is not used, the IPv4 address shall be set to 0.0.0.0, and/or the IPv6 Prefix Length and IPv6 prefix and Interface Identifier shall all be set to zero. This IE shall be sent by the MME/SGSN on S11/S4 interface during TAU/RAU/HO with SGW relocation; the receiving node need not check the presence for this condition.	PAA	0
Maximum APN Restriction	M	This IE denotes the most stringent restriction as required by any already active bearer context. If there are no already active bearer contexts, this value is set to the least restrictive type.	APN Restriction	0
Aggregate Maximum Bit Rate (APN-AMBR)	C	This IE represents the APN-AMBR. It shall be included for an E-UTRAN initial attach, UE requested PDN connectivity, the PDP Context Activation procedure using S4 and the PS mobility from the Gn/Gp SGSN to the S4 SGSN/MME procedures.	AMBR	0
Linked EPS Bearer ID	C	This IE shall be included on S4/S11 in RAU/TAU/HO except in the Gn/Gp SGSN to MME/S4-SGSN RAU/TAU/HO procedures with SGW change to identify the default bearer of the PDN Connection	EBI	0
Protocol Configuration Options (PCO)	C	This IE is not applicable to TAU/RAU/Handover. If MME receives PCO from UE (during the attach procedures), the MME shall forward the PCO IE to SGW. The SGW shall also forward it to PGW.	PCO	0
Bearer Contexts to be created	M	Several IEs with the same type and instance value shall be included as necessary to represent a list of Bearers.	Bearer Context	0

		One bearer shall be included for an "eUTRAN Initial Attach", a "PDP Context Activation" or a "UE requested PDN Connectivity". One or more bearers shall be included for a Handover/TAU/RAU with an SGW change.		
Bearer Contexts to be removed	C	This IE shall be included on the S4/S11 interfaces for the TAU/RAU/Handover cases where any of the bearers existing before the TAU/RAU/Handover procedure will be deactivated as consequence of the TAU/RAU/Handover procedure. For each of those bearers, an IE with the same type and instance value shall be included.	Bearer Context	1
Trace Information	C	This IE shall be included if an SGW and/or a PGW is activated. See 3GPP TS 32.422 [18].	Trace Information	0
Recovery	C	This IE shall be included if contacting the peer node for the first time.	Recovery	0
MME-FQ-CSID	C	This IE shall be included by the MME on the S11 interface and shall be forwarded by an SGW on the S5/S8 interfaces according to the requirements in 3GPP TS 23.007 [17].	FQ-CSID	0
SGW-FQ-CSID	C	This IE shall be included by the SGW on the S5/S8 interfaces according to the requirements in 3GPP TS 23.007 [17].	FQ-CSID	1
UE Time Zone	O	This IE may be included by the MME on the S11 interface, or by the SGSN on the S4 interface.	UE Time Zone	0
	C	If SGW receives this IE, SGW shall forward it to PGW across S5/S8 interface.		
Charging Characteristics	C	This IE shall be included according to 3GPP TS 32.251 [8]	Charging Characteristics	0
Private Extension	O		Private Extension	VS

Table 7.2.1-2: Bearer Context to be created within Create Session Request

Octet 1	Bearer Context IE Type = 93 (decimal)			
Octets 2 and 3	Length = n			
Octet 4	Spare and Instance fields			
Information elements	P	Condition / Comment	IE Type	Ins.
EPS Bearer ID	M		EBI	0
TFT	O		Bearer TFT	0
S1-U eNodeB F-TEID	C	This IE shall be included on the S11 interface for X2-based handover with SGW relocation.	F-TEID	0
S4-U SGSN F-TEID	C	This IE shall be included on the S4 interface if the S4-U interface is used.	F-TEID	1
S5/S8-U SGW F-TEID	C	This IE shall be included on the S5/S8 interface for an "eUTRAN Initial Attach", a "PDP Context Activation" or a "UE Requested PDN Connectivity".	F-TEID	2
S5/S8-U PGW F-TEID	C	This IE shall be included on the S4 and S11 interfaces for the TAU/RAU/Handover cases when the GTP-based S5/S8 is used.	F-TEID	3
Bearer Level QoS	M		Bearer QoS	0
Bearer Flags	O	Applicable flags are: - PPC (Prohibit Payload Compression)	Bearer Flags	0

Table 7.2.1-3: Bearer Context to be removed within Create Session Request

Octet 1	Bearer Context IE Type = 93 (decimal)			
Octets 2 and 3	Length = n			
Octet 4	Spare and Instance fields			
Information elements	P	Condition / Comment	IE Type	Ins.
EPS Bearer ID	M		EBI	0
S4-U SGSN F-TEID	C	This IE shall be sent on the S4 interface if the S4-U interface is used.	F-TEID	0

7.2.2 Create Session Response

The Create Session Response message shall be sent on the S11 interface by the SGW to the MME, and on the S5/S8 interface by the PGW to the SGW as part of the procedures:

- E-UTRAN Initial Attach
- UE requested PDN connectivity

The message shall also be sent on S4 interface by the SGSN to the SGW, and on the S5/S8 interface by the SGW to the PGW as part of the procedures:

- PDP Context Activation

The message shall also be sent on the S11 interface by the SGW to the MME as part of the procedures:

- Tracking Area Update procedure with SGW change
- S1/X2-based handover with SGW change
- UTRAN Iu mode to E-UTRAN Inter RAT handover with SGW change
- GERAN A/Gb mode to E-UTRAN Inter RAT handover with SGW change
- 3G Gn/Gp SGSN to MME combined hard handover and SRNS relocation procedure
- Gn/Gp SGSN to MME Tracking Area Update procedure

and on the S4 interface by the SGW to the SGSN as part of the procedures:

- Routing Area Update with MME interaction and with SGW change
- Gn/Gp SGSN to S4 SGSN Routing Area Update
- E-UTRAN to UTRAN Iu mode Inter RAT handover with SGW change
- E-UTRAN to GERAN A/Gb mode Inter RAT handover with SGW change
- Serving RNS relocation
- Combined hard handover and SRNS relocation
- Combined Cell / URA update and SRNS relocation
- Enhanced serving RNS relocation with SGW relocation

If handling of default bearer fails, then cause at the message level shall be a failure cause.

Possible Cause values are:

- "Request accepted".
- "Request accepted partially".
- "New PDN type due to network preference".
- "New PDN type due to single address bearer only".
- "Request rejected".
- "Missing or unknown APN".
- "GRE key not found".
- "Preferred PDN type not supported".
- "All dynamic addresses are occupied".

- "UE context without TFT already activated".
- "No memory available".
- "PGW not responding".
- "Mandatory IE incorrect".
- "Mandatory IE missing".
- "Conditional IE missing".
- "System failure".
- "Semantic error in the TFT operation".
- "Syntactic error in the TFT operation".
- "Semantic errors in packet filter(s)".
- "Syntactic errors in packet filter(s)".
- "Invalid message format".
- "Unexpected repeated IE".
- "No resources available".
- "APN access denied – no subscription".
- "APN Restriction type incompatibility with currently active PDN Connection".
- "Version not supported by next peer".
- "Invalid length".
- "Denied in RAT".
- "Protocol type not supported".

Table 7.2.2-1: Information Elements in a Create Session Response

Information elements	P	Condition / Comment	IE Type	Ins.
Cause	M		Cause	0
Change Reporting Action	C	This IE shall be included with the appropriate Action field if the location Change Reporting mechanism is to be started or stopped for this subscriber in the SGSN/MME.	Change Reporting Action	0
Sender F-TEID for Control Plane	C	This IE shall be sent on the S11/S4 interfaces. For the S5/S8 interfaces it is not needed because its content would be identical to the IE PGW S5/S8 Address for Control Plane or PMIP.	F-TEID	0
PGW S5/S8 F-TEID for PMIP based interface or for GTP based Control Plane interface	C	This IE shall include the TEID in the GTP based S5/S8 case and the GRE key in the PMIP based S5/S8 case. In PMIP based S5/S8 case, same IP address is used for both control plane and the user plane communication.	F-TEID	1
PDN Address Allocation (PAA)	C	This IE shall be included for the E-UTRAN initial attach, the PDP Context Activation and the UE requested PDN connectivity. The PDN type field in the PAA shall be set to IPv4, or IPv6 or IPv4v6 by the PGW. If the DHCPv4 is used for IPv4 address allocation, the IPv4 address field shall be set to 0.0.0.0.	PAA	0
APN Restriction	M	This IE denotes the restriction on the combination of types of APN for the APN associated with this EPS bearer Context.	APN Restriction	0
Aggregate Maximum Bit Rate (APN-AMBR)	C	This IE represents the APN-AMBR. It shall be included if the received APN-AMBR has been modified by the PCRF.	AMBR	0
Linked EPS Bearer ID	C	This IE shall be sent on S4, S11 interfaces during Gn/Gp SGSN to S4-SGSN/MME RAU/TAU procedure to identify the default bearer the PGW selects for the PDN Connection.	EBI	0
Protocol Configuration Options (PCO)	C	This IE is not applicable for TAU/RAU/Handover. If PGW decides to return PCO to the UE, PSW shall send PCO to SGW. If SGW receives the PCO IE, it shall forward it to MME.	PCO	0
Bearer Contexts created	M	EPS bearers corresponding to Bearer Contexts sent in request message. Several IEs with the same type and instance value may be included as necessary to represent a list of Bearers. One bearer shall be included for "eUTRAN Initial Attach", "PDP Context Activation" or "UE Requested PDN Connectivity". One or more created bearers shall be included for a Handover/TAU/RAU with an SGW change.	Bearer Context	0
Bearer Contexts marked for removal	C	EPS bearers corresponding to Bearer Contexts to be removed that were sent in the Create Session Request message. For each of those bearers an IE with the same type and instance value shall be included.	Bearer Context	1
Recovery	C	This IE shall be included if contacting the peer for the first time	Recovery	0
Charging Gateway Name	C	When Charging Gateway Function (CGF) Address is configured, the PGW shall include this IE on the S5 interface. The supporting SGW shall forward the received IE or the locally applied IE on the S4 interface. See NOTE 1.	FQDN	0
Charging Gateway Address	C	When Charging Gateway Function (CGF) Address is configured, the PGW shall include this IE on the S5 interface. The supporting SGW shall forward the received IE or the locally applied IE on the S4 interface. See NOTE 1.	IP Address	0
PGW-FQ-CSID	C	This IE shall be included by the PGW on the S5/S8 interfaces and shall be forwarded by the SGW on the S11 interface according to the requirements in 3GPP TS 23.007 [17].	FQ-CSID	0
SGW-FQ-CSID	C	This IE shall be included by the SGW on the S11 interface	FQ-CSID	1

		according to the requirements in 3GPP TS 23.007 [17].		
Private Extension	O		Private Extension	VS
NOTE 1: Both Charging Gateway Name and Charging Gateway Address shall not be included at the same time. When both are available, the operator configures a preferred value.				

Table 7.2.2-2: Bearer Context Created within Create Session Response

Octets 1	Bearer Context IE Type = 93 (decimal)			
Octets 2 and 3	Length = n			
Octets 4	Spare and Instance fields			
Information elements	P	Condition / Comment	IE Type	Ins.
EPS Bearer ID	M		EBI	0
Cause	M	This IE shall indicate if the bearer handling was successful, and if not, it gives information on the reason.	Cause	0
TFT	O		Bearer TFT	0
S1-U SGW F-TEID	C	This IE shall be included on the S11 interface if the S1-U interface is used.	F-TEID	0
S4-U SGW F-TEID	C	This IE shall be included on the S4 interface if the S4-U interface is used.	F-TEID	1
S5/S8-U PGW F-TEID	C	For GTP-based S5/S8, this User Plane IE shall be included on S11 interface and also on S5/S8 interfaces during the "eUTRAN Initial Attach", a "PDP Context Activation" or a "UE Requested PDN Connectivity".	F-TEID	2
S12 SGW F-TEID	C	This IE shall be included on the S4 interface if the S12 interface is used.	F-TEID	3
Bearer Level QoS	C	This IE shall be included if the received QoS parameters have been modified.	Bearer QoS	0
Charging Id	C	This IE shall be included for an E-UTRAN initial attach, a PDP Context Activation and a UE requested PDN connectivity on the S5/S8 interface.	Charging Id	0
Bearer Flags	O	Applicable flags are: - PPC (Prohibit Payload Compression)	Bearer Flags	0

Table 7.2.2-3: Bearer Context marked for removal within a Create Session Response

Octet 1	Bearer Context IE Type = 93 (decimal)			
Octets 2 and 3	Length = n			
Octet 4	Spare and Instance fields			
Information elements	P	Condition / Comment	IE Type	Ins.
EPS Bearer ID	M		EBI	0
Cause	M	This IE shall indicate if the bearer handling was successful, and if not, gives the information on the reason.	Cause	0

7.2.3 Create Bearer Request

The direction of this message shall be from PGW to SGW and from SGW to MME/S4-SGSN (see Table 6.1-1).

The Create Bearer Request message shall be sent on the S5/S8 interface by the PGW to the SGW and on the S11 interface by the SGW to the MME as part of the Dedicated Bearer Activation procedure.

The message shall also be sent on the S5/S8 interface by the PGW to the SGW and on the S4 interface by the SGW to the SGSN as part of the Secondary PDP Context Activation procedure or the Network Requested Secondary PDP Context Activation procedure.

Table 7.2.3-1: Information Elements in a Create Bearer Request

Information elements	P	Condition / Comment	IE Type	Ins.
Procedure Transaction Id (PTI)	C	This IE shall be sent when the procedure was initiated by a UE Requested Bearer Resource Modification Procedure or Secondary PDP Context Activation Procedure. The PTI shall be the same as the one used in the corresponding Bearer Resource Command.	PTI	0
Linked Bearer Identity (LBI)	M	This IE shall be included to indicate the default bearer associated with the PDN connection.	EBI	0
Protocol Configuration Options (PCO)	O		PCO	0
Bearer Contexts	M	Several IEs with this type and instance values shall be included as necessary to represent a list of Bearers.	Bearer Context	0
PGW-FQ-CSID	C	This IE shall be included by the PGW on the S5/S8 interfaces and shall be forwarded by the SGW on the S11 interface according to the requirements in 3GPP TS 23.007 [17].	FQ-CSID	0
SGW-FQ-CSID	C	This IE shall be included by the SGW on the S11 interface according to the requirements in 3GPP TS 23.007 [17].	FQ-CSID	1
Change Reporting Action	C	This IE shall be included with the appropriate Action field if the location Change Reporting mechanism is to be started or stopped for this subscriber in the SGSN/MME.	Change Reporting Action	0
Private Extension	O		Private Extension	VS

NOTE: In the case that the procedure was initiated by a UE Requested Bearer Resource Modification Procedure or Secondary PDP Context Activation Procedure, then there will be only one instance of the Bearer Contexts IE in the Create Bearer Request.

Table 7.2.3-2: Bearer Context within Create Bearer Request

Information elements	P	Condition / Comment	IE Type	Ins.
Octets 1	Bearer Context IE Type = 93 (decimal)			
Octets 2 and 3	Length = n			
Octets 4	Spare and Instance fields			
EPS Bearer ID	M	This IE shall be set to 0.	EBI	0
TFT	M	This IE can contain both uplink and downlink packet filters to be sent to the UE. Downlink packet filters are also used by SGW for PMIP based S5/8 interfaces.	Bearer TFT	0
S1-U SGW F-TEID	C	This IE shall be sent on the S11 interface if the S1-U interface is used.	F-TEID	0
S5/8-U PGW F-TEID	C	This IE shall be sent on the S4, S5/S8 and S11 interfaces.	F-TEID	1
S12 SGW F-TEID	C	This IE shall be sent on the S4 interface if the S12 interface is used.	F-TEID	2
S4-U SGW F-TEID	C	This IE shall be sent on the S4 interface if the S4-U interface is used.	F-TEID	3
Bearer Level QoS	M		Bearer QoS	0
Charging Id	C	This IE shall be sent on the S5/S8 interface.	Charging Id	0
Bearer Flags	O	Applicable flags are: - PPC (Prohibit Payload Compression)	Bearer Flags	0

7.2.4 Create Bearer Response

The Create Bearer Response message shall be sent on the S5/S8 interface by the SGW to the PGW, and on the S11 interface by the MME to the SGW as part of the Dedicated Bearer Activation procedure.

The message shall also be sent on the S5/S8 interface by the SGW to the PGW and on the S4 interface by the SGSN to the SGW as part of Secondary PDP Context Activation procedure or the Network Requested Secondary PDP Context Activation procedure.

Possible Cause values are:

- "Request accepted".
- "Request accepted partially".
- "Request rejected".
- "Context not found".
- "Mandatory IE incorrect".
- "Mandatory IE missing".
- "Conditional IE missing".
- "System failure".
- "No memory available".
- "Semantic error in the TFT operation".
- "Syntactic error in the TFT operation".
- "Semantic errors in packet filter(s)".
- "Syntactic errors in packet filter(s)".
- "Invalid message format".
- "Unexpected repeated IE".
- "No resources available".
- "Service not supported".
- "Unable to page UE".
- "UE not responding".
- "Unable to page UE due to Suspension".
- "UE refuses".
- "Invalid length".
- "Denied in RAT".
- "UE context without TFT already activated".

Table 7.2.4-1: Information Elements in a Create Bearer Response

Information elements	P	Condition / Comment	IE Type	Ins.
Cause	M		Cause	0
Bearer Contexts	M	Several IEs with this type and instance value shall be included as necessary to represent a list of Bearers.	Bearer Context	0
Recovery	C	This IE shall be included if contacting the peer for the first time	Recovery	0
MME-FQ-CSID	C	This IE shall be included by the MME on the S11 interface and shall be forwarded by the SGW on the S5/S8 interfaces according to the requirements in 3GPP TS 23.007 [17].	FQ-CSID	0
SGW-FQ-CSID	C	This IE shall be included by the MME on the S11 interface and shall be forwarded by the SGW on the S5/S8 interfaces according to the requirements in 3GPP TS 23.007 [17].	FQ-CSID	1
Protocol Configuration Options (PCO)	C	If the UE includes the PCO IE, then the MME/SGSN shall copy the content of this IE transparently from the PCO IE included by the UE. If the SGW receives PCO from MME/SGSN, SGW shall forward it to the PGW.	PCO	0
Private Extension	O		Private Extension	VS

Table 7.2.4-2: Bearer Context within Create Bearer Response

Information elements	P	Condition / Comment	IE Type	Ins.
Octet 1	Bearer Context IE Type = 93 (decimal)			
Octets 2 and 3	Length = n			
Octet 4	Spare and Instance fields			
EPS Bearer ID	M		EBI	0
Cause	M	This IE shall indicate if the bearer handling was successful, and if not, it gives information on the reason.	Cause	0
S1-U eNodeB F-TEID	C	This IE shall be sent on the S11 interface if the S1-U interface is used.	F-TEID	0
S1-U SGW F-TEID	C	This IE shall be sent on the S11 interface. It shall be used to correlate the bearers with those in the Create Bearer Request.	F-TEID	1
S5/8-U SGW F-TEID	C	This IE shall be sent on the S5/S8 interfaces.	F-TEID	2
S5/8-U PGW F-TEID	C	This IE shall be sent on the S5/S8 interfaces. It shall be used to correlate the bearers with those in the Create Bearer Request.	F-TEID	3
S12 RNC F-TEID	C	This IE shall be sent on the S4 interface if the S12 interface is used.	F-TEID	4
S12 SGW F-TEID	C	This IE shall be sent on the S4 interface. It shall be used to correlate the bearers with those in the Create Bearer Request.	F-TEID	5
S4-U SGSN F-TEID	C	This IE shall be sent on the S4 interface if the S4-U interface is used.	F-TEID	6
S4-U SGW F-TEID	C	This IE shall be sent on the S4 interface. It shall be used to correlate the bearers with those in the Create Bearer Request.	F-TEID	7

7.2.5 Bearer Resource Command

A Bearer Resource Command message shall be sent from a MME to a SGW and forwarded to PGW as a part of the UE requested bearer resource allocation procedure or UE requested bearer resource modification procedure.

The message shall also be sent on the S4 interface by a SGSN to a SGW and on the S5/S8 interface by a SGW to a PGW as part of the MS initiated PDP Context modification procedure, or secondary PDP context activation procedure.

Table 7.2.5-1 specifies the presence of the IEs in the message.

Table 7.2.5-1: Information Elements in a Bearer Resource Command

Information elements	P	Condition / Comment	IE Type	Ins.
Linked EPS Bearer ID (LBI)	M		EBI	0
Procedure Transaction Id (PTI)	M		PTI	0
Flow Quality of Service (Flow QoS)	C	This IE shall be included, except for a Bearer resource release.	Flow QoS	0
Traffic Aggregate Description (TAD)	M	The TAD consists of the description of the packet filter(s) for a traffic flow aggregate.	TAD	0
RAT Type	C	This IE shall be included for MS initiated PDP Context modification procedure and Secondary PDP context activation procedure.	RAT Type	0
Serving Network	O	This IE may be included in the MS initiated PDP Context modification procedure.	Serving Network	0
User Location Information (ULI)	O	This IE may be included in the MS initiated PDP Context modification procedure.	ULI	0
EPS Bearer ID	C	This IE indicates the EPS Bearer that needs to be modified. It shall be included for MS initiated PDP Context modification procedure. For EUTRAN this IE shall be present if it is triggered by the NAS Bearer Resource Modification Request message and its value shall be set to the value of the "EPS bearer identity for packet filter" IE received in that NAS message.	EBI	1
Indication Flags	O	Applicable flags: <ul style="list-style-type: none"> - Change Reporting Support Indication: this flag may be included in the MS initiated PDP Context modification procedure. - Direct Tunnel Flag: this flag may be included in the MS initiated PDP Context procedure. 	Indication	0
S4-U SGSN F-TEID	C	This IE shall be included on the S4 interface when direct tunnel is not established in the MS initiated PDP Context modification procedure	F-TEID	0
S12 RNC F-TEID	C	This IE shall be included on the S4 interface when direct tunnel flag is set to 1 in the MS initiated PDP Context modification procedure.	F-TEID	1
Protocol Configuration Options (PCO)	O		PCO	0
Private Extension	O		Private Extension	VS

NOTE: Depending on the protocol type on the S5/S8 interface, the SGW or the PGW will determine if the UE is requesting an Allocation/Modification operation of bearer resources for a traffic flow aggregate based on the TFT operation code and the packet filter ID value in the Traffic Aggregate (TAD) IE and/or the presence of the EPS Bearer ID IE.

7.2.6 Bearer Resource Failure Indication

A Bearer Resource Failure Indication shall be sent by the PGW to an SGW and forwarded to the MME to indicate failure of the UE requested bearer resource allocation procedure or UE requested bearer resource modification procedure.

The message shall also be sent by a PGW to an SGW and forwarded to an SGSN as part of the failure of an MS initiated PDP Context modification procedure or secondary PDP context activation procedure.

Table 7.2.6-1 specifies the presence of the IEs in the message.

Possible Cause values are:

- "No resources available".

- "No memory available".
- "User authentication failed".
- "System failure".
- "Semantic error in the TAD operation".
- "Syntactic error in the TAD operation".
- "Semantic errors in packet filter(s)".
- "Syntactic errors in packet filter(s)".
- "Mandatory IE incorrect".
- "Mandatory IE missing".
- "Conditional IE missing".
- "Invalid message format".
- "Collision with network initiated request".
- "Invalid length".
- "Service denied".

Table 7.2.6-1: Information Elements in a Bearer Resource Failure Indication

Information elements	P	Condition / Comment	IE Type	Ins.
Cause	M		Cause	0
Linked EPS Bearer ID	M		EBI	0
Procedure Transaction ID (PTI)	M		PTI	0
Recovery	O		Recovery	0
Private Extension	O		Private Extension	VS

7.2.7 Modify Bearer Request

The direction of this message shall be from MME/S4-SGSN to SGW and/or from SGW to PGW (see Table 6.1-1).

The Modify Bearer Request message shall only be sent on the S11 interface by the MME to the SGW and on the S5/S8 interfaces by the SGW to the PGW as part of the procedures:

- E-UTRAN Tracking Area Update without SGW Change
- UE triggered Service Request
- S1-based Handover
- UTRAN Iu mode to E-UTRAN Inter RAT handover
- GERAN A/Gb mode to E-UTRAN Inter RAT handover
- E-UTRAN Initial Attach
- UE requested PDN connectivity
- 3G SGSN to MME combined hard handover and SRNS relocation procedure

It shall also only be sent on the S4 interface by the SGSN to the SGW and on the S5/S8 interfaces by the SGW to the PGW as part of the procedures:

- Routing Area Update with MME interaction and without SGW change

- Routing Area Update with MME interaction and with SGW change
- E-UTRAN to UTRAN Iu mode Inter RAT handover
- E-UTRAN to GERAN A/Gb mode Inter RAT handover
- Inter SGSN Routing Area Update Procedure and Combined Inter SGSN RA / LA Update to S4 SGSNs
- Combined RA / LA Update in the Case of Inter SGSN RA Update Procedure
- Iu mode RA Update Procedure
- Serving RNS Relocation Procedure
- Combined Hard Handover and SRNS Relocation Procedure
- Combined Cell / URA Update and SRNS Relocation Procedure
- Enhanced Serving RNS Relocation without SGW relocation
- UE Initiated Service Request Procedure
- Iu mode to A/Gb mode Intra SGSN Change
- A/Gb mode to Iu mode Intra SGSN Change
- Iu mode to A/Gb mode Inter-SGSN Change
- A/Gb mode to Iu mode Inter-SGSN Change
- Paging Response with no established user plane on S4
- PDP Context Activation Procedure

only on the S4 interface by the SGSN to the SGW as part of the procedures:

- READY to STANDBY transition within the network
- RAB Assignment Procedure

on the S11 interface by the MME to the SGW as part of:

- X2-based handover without SGW relocation

and only on the S5/S8 interfaces by the SGW to the PGW as part of the procedures:

- Tracking Area Update procedure with SGW change
- Gn/Gp SGSN to S4 SGSN Routing Area Update
- X2 based handover with SGW relocation
- Gn/Gp SGSN to MME Tracking Area Update
- Enhanced Serving RNS Relocation with SGW relocation

Table 7.2.7-1: Information Elements in a Modify Bearer Request

Information elements	P	Condition / Comment	IE Type	Ins.
ME Identity (MEI)	C	This IE shall be sent on the S5/S8 interfaces for the Gn/Gp SGSN to MME TAU.	MEI	0
User Location Information (ULI)	C	The MME/SGSN shall include this IE for TAU/RAU/Handover procedures and UE-initiated Service Request procedure if the PGW has requested location information change reporting and MME/SGSN support location information change reporting. The SGW shall include this IE on S5/S8 if it receives the ULI from MME/SGSN.	ULI	0
Serving Network	C	This IE shall be sent on S5/S8 for a TAU with an associated MME change and the SGW change. This IE shall be included on S5/S8 for a RAU/Handover with an associated SGSN/MME change and SGW change, the receiving node need not check the presence for this condition.	Serving Network	0
RAT Type	C	This IE shall be sent on the S11 interface for a TAU with an SGSN interaction, UE triggered Service Request or an I-RAT Handover. This IE shall be sent on the S5/S8 interface for a change of RAT type. This IE shall be sent on the S4 interface for a RAU with MME interaction, a RAU with an SGSN change, a UE Initiated Service Request or an I-RAT Handover.	RAT Type	0
Indication Flags	C	Applicable flags are: <ul style="list-style-type: none"> - ISRAI: This flag shall be set when used on the S11 interface for a TAU with an S4 SGSN interaction and for an IRAT handover. This flag shall be used on the S4 interface for a RAU with an MME interaction and an Inter RAT Handover. - Handover Indication: This flag shall be set for an E-UTRAN Initial Attach or for a UE Requested PDN Connectivity, if the UE comes from a non-3GPP access. - Direct Tunnel Flag: This flag shall be used on the S4 interface and set to 1 if Direct Tunnel is used. - Change Reporting support Indication: shall be used on S4/S11, S5/S8 and set if the SGSN/MME supports location Info Change Reporting. - Change F-TEID support Indication: This flag shall be used on S4/S11 for an IDLE state UE initiated TAU/RAU procedure and set to 1 to allow the SGW changing the GTP-U F-TEID. 	Indication	0
Sender F-TEID for Control Plane	C	This IE shall be sent on the S11 and S4 interfaces for a TAU/RAU/ Handover with MME/SGSN change and without any SGW change. This IE shall be sent on the S5 and S8 interfaces for a TAU/RAU/Handover with a SGW change.	F-TEID	0
Aggregate Maximum Bit Rate (APN-AMBR)	C	The APN-AMBR shall be sent for the PS mobility from the Gn/Gp SGSN to the S4 SGSN/MME procedures..	AMBR	0
Delay Downlink Packet Notification Request	C	This IE shall be sent on the S11 interface for a UE triggered Service Request.	Delay Value	0
Bearer Contexts to be modified	C	This IE shall not be sent on the S5/S8 interface for a UE triggered Service Request. Several IEs with the same type and instance value may be included as necessary to represent a list of Bearers to be modified.	Bearer Context	0
Bearer Contexts to be	C	This IE shall be included on the S4 and S11 interfaces for	Bearer Context	1

removed		the TAU/RAU/Handover and Service Request procedures where any of the bearers existing before the TAU/RAU/Handover procedure and Service Request procedures will be deactivated as consequence of the TAU/RAU/Handover procedure and Service Request procedures. For each of those bearers, an IE with the same type and instance value, shall be included.		
Recovery	C	This IE shall be included if contacting the peer for the first time	Recovery	0
UE Time Zone	O	This IE may be included by the MME on the S11 interface or by the SGSN on the S4 interface.	UE Time Zone	0
	C	If SGW receives this IE, SGW shall forward it to PGW across S5/S8 interface.		
MME-FQ-CSID	C	This IE shall be included by MME on S11 and shall be forwarded by SGW on S5/S8 according to the requirements in 3GPP TS 23.007 [17].	FQ-CSID	0
SGW-FQ-CSID	C	This IE shall be included by SGW on S5/S8 according to the requirements in 3GPP TS 23.007 [17].	FQ-CSID	1
Charging Characteristics	C	This IE shall be included according to 3GPP TS 32.251 [8]	Charging Characteristics	0
Private Extension	O		Private Extension	VS

Table 7.2.7-2: Bearer Context to be modified within Modify Bearer Request

Octets 1	Bearer Context IE Type = 93 (decimal)			
Octets 2 and 3	Length = n			
Octets 4	Spare and Instance fields			
Information elements	P	Condition / Comment	IE Type	Ins.
EPS Bearer ID	M		EBI	0
S1 eNodeB F-TEID	C	This IE shall be sent on the S11 interface if the S1-U is being used: <ul style="list-style-type: none"> - for an eUTRAN initial attach - a UE triggered Service Request - in all TAU/handover cases, except during TAU without the active flag (see 3GPP TS 24.301 [23]) being set. <p>If an MME is aware that the eNodeB supports both IP address types, the MME shall send both IP addresses within an F-TEID IE. If only one IP address is included, then the SGW shall assume that the eNodeB does not support the other IP address type.</p>	F-TEID	0
S5/8-U SGW F-TEID	C	This IE shall be sent on the S5/S8 interfaces for a Handover or a TAU/RAU with a SGW change.	F-TEID	1
S12 RNC F-TEID	C	This IE shall be included if the message is sent on the S4 interface if S12 interface is being used. If an S4-SGSN is aware that the RNC supports both IP address types, the S4-SGSN shall send both IP addresses within an F-TEID IE. If only one IP address is included, then the SGW shall assume that the RNC does not support the other IP address type.	F-TEID	2
S4-U SGSN F-TEID	C	This IE shall be included if the message is sent on the S4 interface, if S4-U is being used. If an S4-SGSN supports both IP address types, the S4-SGSN shall send both IP addresses within an F-TEID IE. If only one IP address is included, then the SGW shall assume that the S4-SGSN does not support the other IP address type.	F-TEID	3
Bearer Level QoS	C	This IE shall be included if the message is sent on the S11 interface for a TAU without any SGW change, if QoS information needs to be updated	Bearer QoS	0

Table 7.2.7-3: Bearer Context to be removed within Modify Bearer Request

Octets 1	Bearer Context IE Type = 93 (decimal)			
Octets 2 and 3	Length = n			
Octets 4	Spare and Instance fields			
Information elements	P	Condition / Comment	IE Type	Ins.
EPS Bearer ID	M		EBI	0

7.2.8 Modify Bearer Response

The Modify Bearer Response message shall be sent on the S11 interface by the SGW to the MME and on the S5/S8 interfaces by the PGW to the SGW as part of the procedures:

- E-UTRAN Tracking Area Update without SGW Change
- UE triggered Service Request
- S1-based Handover
- UTRAN Iu mode to E-UTRAN Inter RAT handover
- GERAN A/Gb mode to E-UTRAN Inter RAT handover
- E-UTRAN Initial Attach
- UE requested PDN connectivity
- 3G SGSN to MME combined hard handover and SRNS relocation procedure
- X2-based handover without SGW relocation

It shall also be sent on the S4 interface by the SGW to the SGSN and on the S5/S8 interfaces by the PGW to the SGW as part of the procedures:

- Routing Area Update with MME interaction and without SGW change
- Routing Area Update with MME interaction and with SGW change
- E-UTRAN to UTRAN Iu mode Inter RAT handover
- E-UTRAN to GERAN A/Gb mode Inter RAT handover
- Inter SGSN Routing Area Update Procedure and Combined Inter SGSN RA / LA Update to S4 SGSNs
- Combined RA / LA Update in the Case of Inter SGSN RA Update Procedure
- Iu mode RA Update Procedure
- Serving RNS Relocation Procedure
- Combined Hard Handover and SRNS Relocation Procedure
- Combined Cell / URA Update and SRNS Relocation Procedure
- Enhanced Serving RNS Relocation without SGW relocation
- UE Initiated Service Request Procedure
- Iu mode to A/Gb mode Intra SGSN Change
- A/Gb mode to Iu mode Intra SGSN Change
- Iu mode to A/Gb mode Inter-SGSN Change
- A/Gb mode to Iu mode Inter-SGSN Change

- Paging Response with no established user plane on S4
- PDP Context Activation Procedure

on the S4 interface by the SGSN to the SGW as part of:

- READY to STANDBY transition within the network
- RAB Assignment Procedure

and on the S5/S8 interfaces by the PGW to the SGW as part of:

- Tracking Area Update procedure with SGW change
- Gn/Gp SGSN to S4 SGSN Routing Area Update
- X2 based handover with SGW relocation
- Gn/Gp SGSN to MME Tracking Area Update
- Enhanced Serving RNS Relocation with SGW relocation

If handling of default bearer fails, then Cause at the message level shall be a failure cause.

Possible Cause values are:

- "Request accepted".
- "Request accepted partially".
- "Request rejected".
- "Context not found".
- "Mandatory IE incorrect".
- "Mandatory IE missing".
- "Conditional IE missing".
- "System failure".
- "No memory available"
- "Invalid message format".
- "Unexpected repeated IE".
- "Service not supported".

Table 7.2.8-1: Information Elements in a Modify Bearer Response

Information elements	P	Condition / Comment	IE Type	Ins.
Cause	M		Cause	0
MSISDN	C	This IE shall be included on S5/S8 interfaces by the PGW if it is stored in its UE context and if this message is triggered due to TAU/RAU/HO with SGW relocation.	MSISDN	0
Linked EPS Bearer ID	C	This IE shall be sent on S5/S8 when the UE moves from a Gn/Gp SGSN to the S4 SGSN or MME to identify the default bearer the PGW selects for the PDN Connection. This IE shall also be sent by SGW on S11, S4 during Gn/Gp SGSN to S4-SGSN/MME HO procedures to identify the default bearer the PGW selects for the PDN Connection.	EBI	0
Aggregate Maximum Bit Rate (APN-AMBR)	C	This IE shall be included in the PS mobility from Gn/Gp SGSN to the S4 SGSN/MME procedures if the received APN-AMBR has been modified by the PCRF.	AMBR	0
APN Restriction	C	This IE denotes the restriction on the combination of types of APN for the APN associated with this EPS bearer Context. This IE shall be included over S5/S8 interfaces, and shall be forwarded over S11/S4 interfaces during Gn/Gp SGSN to MME/S4-SGSN handover procedures. The target MME or SGSN determines the Maximum APN Restriction using the APN Restriction.	APN Restriction	0
Protocol Configuration Options (PCO)	C	This IE shall be used for an Inter RAT handover from the UTRAN or GERAN to the E-UTRAN.	PCO	0
Bearer Contexts modified	C	EPS bearers corresponding to Bearer Contexts to be modified that were sent in Modify Bearer Request message. Several IEs with the same type and instance value may be included as necessary to represent a list of the Bearers which are modified.	Bearer Context	0
Bearer Contexts marked for removal	C	EPS bearers corresponding to Bearer Contexts to be removed sent in the Modify Bearer Request message. Shall be included if request message contained Bearer Contexts to be removed. For each of those bearers an IE with the same type and instance value shall be included.	Bearer Context	1
Change Reporting Action	C	This IE shall be included with the appropriate Action field If the location Change Reporting mechanism is to be started or stopped for this subscriber in the SGSN/MME.	Change Reporting Action	0
Charging Gateway Name	C	When Charging Gateway Function (CGF) Address is configured, the PGW shall include this IE on the S5 interface during SGW relocation and when the UE moves from Gn/Gp SGSN to S4-SGSN/MME. The supporting SGW shall forward the received IE or the locally applied IE on the S4 interface. See NOTE 1.	FQDN	0
Charging Gateway Address	C	When Charging Gateway Function (CGF) Address is configured, the PGW shall include this IE on the S5 interface during SGW relocation and when the UE moves from Gn/Gp SGSN to S4-SGSN/MME. The supporting SGW shall forward the received IE or the locally applied IE on the S4 interface. See NOTE 1.	IP Address	0
PGW-FQ-CSID	C	This IE shall be included by PGW on S5/S8 and shall be forwarded by SGW on S11 according to the requirements in 3GPP TS 23.007 [17].	FQ-CSID	0
SGW-FQ-CSID	C	This IE shall be included by SGW on S11 according to the requirements in 3GPP TS 23.007 [17].	FQ-CSID	1
Recovery	C	This IE shall be included if contacting the peer for the first time.	Recovery	0
Private Extension	O		Private Extension	VS
NOTE 1: Both Charging Gateway Name and Charging Gateway Address shall not be included at the same time. When both are available, the operator configures a preferred value.				

Table 7.2.8-2: Bearer Context modified within Modify Bearer Response

Octets 1	Bearer Context IE Type = 93 (decimal)			
Octets 2 and 3	Length = n			
Octets 4	Spare and Instance fields			
Information elements	P	Condition / Comment	IE Type	Ins.
EPS Bearer ID	M		EBI	0
Cause	M	This IE shall indicate if the bearer handling was successful, and if not, gives information on the reason.	Cause	0
S1 SGW F-TEID	C	This IE shall be used on the S11 interface, if the S1 interface is used. See NOTE 1	F-TEID	0
S12 SGW F-TEID	C	This IE shall be included on the S4 interface if the S12 interface is being used. See NOTE 1	F-TEID	1
S4-U SGW F-TEID	C	This IE shall be present if used on the S4 interface if the S4-U interface is being used. See NOTE 1	F-TEID	2
Charging ID	C	This IE shall be present on the S5/S8 interface if this message is triggered due to one of the following procedures: <ul style="list-style-type: none"> - TAU/RAU/HO with SGW relocation - TAU/RAU/HO from Gn/Gp SGSN to MME/S4-SGSN 	Charging ID	0

NOTE 1: The SGW shall not change its F-TEID for a given interface during the Handover, Service Request, E-UTRAN Initial Attach, UE Requested PDN connectivity and PDP Context Activation procedures. The SGW F-TEID shall be same for S1-U, S4-U and S12.
During Handover and Service Request the target eNodeB/RNC/SGSN may use a different IP type than the one used by the source eNodeB/RNC/SGSN. In order to support such a scenario, the SGW F-TEID should contain both an IPv4 address and an IPv6 address (see also subclause 8.22 "F-TEID").

Table 7.2.8-3: Bearer Context marked for removal within Modify Bearer Response

Octet 1	Bearer Context IE Type = 93 (decimal)			
Octets 2 and 3	Length = n			
Octet 4	Spare and Instance fields			
Information elements	P	Condition / Comment	IE Type	Ins.
EPS Bearer ID	M		EBI	0
Cause	M	This IE shall indicate if the bearer handling was successful, and if not, gives information on the reason.	Cause	0

7.2.9 Delete Session Request and Delete Bearer Request

7.2.9.1 Delete Session Request

The direction of this message shall be from MME/S4-SGSN to SGW and from SGW to PGW (see Table 6.1-1).

A Delete Session Request message shall be sent on the S11 interface by the MME to the SGW and on the S5/S8 interface by the SGW to the PGW as part of the procedures:

- EUTRAN Initial Attach
- UE, HSS or MME Initiated Detach
- UE or MME Requested PDN Disconnection

It shall also be sent on the S4 interface by the SGSN to the SGW, and on the S5/S8 interface by the SGW to the PGW as part of

- MS, HLR or SGSN initiated detach procedure
- Combined GPRS/IMSI Attach

- MS and SGSN Initiated PDN connection Deactivation Procedure using S4

On the S11 interface by the MME to the SGW as part of the procedures:

- Tracking Area Update with SGW Change
- S1 Based Handover with SGW Change
- X2 Based Handover with SGW Relocation
- E-UTRAN to UTRAN Iu mode Inter RAT handover with SGW change
- E-UTRAN to GERAN A/Gb mode Inter RAT handover with SGW change
- Inter RAT with SGW change handover cancel
- MME to 3G Gn/Gp SGSN combined hard handover and SRNS relocation procedure
- MME to SGSN Routing Area Update
- E-UTRAN to Gn/Gp SGSN Inter RAT handover

And on the S4 interface by the SGSN to the SGW as part of

- Enhanced Serving RNS Relocation with SGW relocation using S4
- Routing Area Update with SGW change
- SGSN to MME Tracking Area Update
- SRNS Relocation Cancel Procedure Using S4
- Serving RNS relocation with SGW change
- UTRAN Iu mode to E-UTRAN Inter RAT handover with SGW change
- GERAN A/Gb mode to E-UTRAN Inter RAT handover with SGW change

If there are any procedure collisions, the Delete Session Request shall have precedence over any other Tunnel Management message.

Possible Cause values are:

- "ISR deactivation".

Table 7.2.9.1-1 specifies the presence of the IEs in the message.

Table 7.2.9.1-1: Information Elements in a Delete Session Request

Information elements	P	Condition / Comment	IE Type	Ins.
Cause	C	If ISR is being de-activated, the Cause IE shall be included and its value shall indicate that the SGW shall delete the bearer resources by sending Delete Bearer Request to the MME/SGSN on which ISR was activated with Cause value "ISR deactivation".	Cause	0
Linked EPS Bearer ID (LBI)	C	This IE shall be included to indicate the default bearer associated with the PDN being disconnected unless in the handover/TAU/RAU with SGW relocation procedures.	EBI	0
User Location Information (ULI)	C	The MME/SGSN shall include this IE for the Detach procedure if the PGW has requested location information change reporting and MME/SGSN support location information change reporting. The SGW shall include this IE on S5/S8 if it receives the ULI from MME/SGSN.	ULI	0
Indication Flags	C	Applicable flags: <ul style="list-style-type: none"> - Operation Indication: This flag shall be set over S4/S11 interface if the SGW needs to forward the Delete Session Request message to the PGW. This flag shall not be set if the ISR associated GTP entity sends this message to the SGW in the Detach procedure. - Scope Indication: if request corresponds to TAU/RAU/Handover procedure with SGW change, then this bit is set. 	Indication	0
Protocol Configuration Options (PCO)	C	If the UE includes the PCO IE, then the MME shall copy the content of this IE transparently from the PCO IE included by the UE.	PCO	0
Originating Node	C	This IE shall be included if the ISR associated GTP entity sends this message to SGW in Detach procedure to denote the type of the node originating the message. If this IE is included in the Delete Session Request message, the SGW in ISR activated state deactivates ISR, releases the Originating Node related EPS Bearer contexts information and shall not forward this message to the PGW.	Node Type	0
Private Extension	O	None	Private Extension	VS

7.2.9.2 Delete Bearer Request

The direction of this message shall be from PGW to SGW and from SGW to MME/S4-SGSN (see Table 6.1-1).

A Delete Bearer Request message shall be sent as part of the following procedures:

- PGW or MME initiated bearer deactivation procedures,
- UE requested Bearer Resource Modification,
- MS and SGSN Initiated Bearer Deactivation procedure using S4 or
- PGW initiated bearer deactivation procedure using S4.

In the above cases, this Request is sent by the PGW to the SGW and shall be forwarded to the MME or S4-SGSN.

It shall also be sent on the S4/S11 interface by the SGW to the SGSN/MME to delete the bearer resources on the other ISR associated CN node in the TAU/RAU/Handover procedures if the ISR related Cause IE is included in the Delete Session Request message.

Possible Cause values are:

- "RAT changed from 3GPP to Non-3GPP",

- "ISR deactivation".

Table 7.2.9.2-1 specifies the presence of IEs in this message.

Table 7.2.9.2-1: Information Elements in a Delete Bearer Request

Information elements	P	Condition / Comment	IE Type	Ins.
Linked EPS Bearer ID (LBI)	C	If the request corresponds to the bearer deactivation procedure in case all bearers belonging to a PDN connection shall be released, then this IE shall be included to indicate the default bearer associated with the PDN being disconnected. This IE shall be included only when the EPS Bearer ID is not present in the message.	EBI	0
EPS Bearer IDs	C	This IE shall be used for bearers different from the default one, i.e., for dedicated bearers. In this case at least one dedicated bearer shall be included. Several IEs with this type and instance values shall be included as necessary to represent a list of Bearers.	EBI	1
Failed Bearer Contexts	O	This IE may be included if the request corresponds to MME initiated bearer deactivation procedure. This IE shall contain the list of failed bearers if partial Bearer Contexts included in the Delete Bearer Command message could not be deleted. The receiving node need not check the presence of the IE.	Bearer Context	0
Procedure Transaction Id (PTI)	C	If the request corresponds to UE requested bearer resource modification procedure for an E-UTRAN, this IE shall be included.	PTI	0
Protocol Configuration Options (PCO)	C	PGW shall include Protocol Configuration Options (PCO) IE, if available.	PCO	0
PGW-FQ-CSID	C	This IE shall be included by the PGW on the S5/S8 interface and shall be forwarded by the SGW on the S11 interface according to the requirements in 3GPP TS 23.007 [17].	FQ-CSID	0
SGW-FQ-CSID	C	This IE shall be included by the SGW on the S11 interface according to the requirements in 3GPP TS 23.007 [17].	FQ-CSID	1
Cause	C	This IE shall be sent on S11/S4 and S5/S8 interfaces if the message is caused by handover without optimization occurs from 3GPP to non-3GPP. In this case the Cause value shall be set to "RAT changed from 3GPP to Non-3GPP". This IE shall also be sent on S11/S4 interfaces when the SGW requests to delete all bearer contexts in an MME or S4-SGSN due to ISR deactivation, and its Cause value shall then be set to "ISR deactivation".	Cause	0
Private Extension	O		Private Extension	VS

NOTE: In the case that the procedure was initiated by a UE Requested Bearer Resource Modification Procedure for an E-UTRAN, then there will be only one instance of the EPS Bearer IDs IE in the Delete Bearer Request.

Table 7.2.9.2-2: Bearer Context within Delete Bearer Request

Octet 1	Bearer Context IE Type = 93 (decimal)			
Octets 2 and 3	Length = n			
Octet 4	Spare and Instance fields			
Information elements	P	Condition / Comment	IE Type	Ins.
EPS Bearer ID	M		EBI	0
Cause	M	This IE shall indicate the reason of the unsuccessful handling of the bearer.	Cause	0

7.2.10 Delete Session Response and Delete Bearer Response

7.2.10.1 Delete Session Response

A Delete Session Response message shall be sent on the S11 interface by the SGW to the MME and on the S5/S8 interface by the PGW to the SGW as part of the following procedures:

- EUTRAN Initial Attach
- UE, HSS or MME Initiated Detach
- UE or MME Requested PDN Disconnection

It shall also be sent on the S4 interface by the SGW to the SGSN and on the S5/S8 interface by the PGW to the SGW as part of the procedures:

- MS, HLR or SGSN initiated detach procedure
- Combined GPRS/IMSI Attach
- MS and SGSN Initiated Default Bearer Deactivation Procedure using S4

On the S11 interface by the SGW to the MME as part of the procedures:

- Tracking Area Update with SGW Change
- S1 Based Handover with SGW Change
- X2 Based Handover with SGW Relocation
- E-UTRAN to UTRAN Iu mode Inter RAT handover with SGW change
- E-UTRAN to GERAN A/Gb mode Inter RAT handover with SGW change
- Inter RAT with SGW change handover cancel
- MME to 3G Gn/Gp SGSN combined hard handover and SRNS relocation procedure
- MME to SGSN Routing Area Update
- E-UTRAN to Gn/Gp SGSN Inter RAT handover

And on the S4 interface by the SGW to the SGSN as part of the procedures:

- Enhanced Serving RNS Relocation with SGW relocation using S4
- Routing Area Update with SGW change
- SGSN to MME Tracking Area Update
- Serving RNS relocation with SGW change
- UTRAN Iu mode to E-UTRAN Inter RAT handover with SGW change
- GERAN A/Gb mode to E-UTRAN Inter RAT handover with SGW change

The sending entity shall include Cause IE in the Delete Session Response message. The IE indicates if the peer has deleted the bearer, or not.

Possible Cause values are:

- "Request accepted".
- "Context not found".
- "Mandatory IE incorrect".

- "Conditional IE missing".
- "Invalid message format".
- "Unexpected repeated IE"

Table 7.2.10.1-1 specifies the presence of the IEs in the message.

Table 7.2.10.1-1: Information Elements in a Delete Session Response

Information elements	P	Condition / Comment	IE Type	Ins.
Cause	M		Cause	0
Recovery	C	This IE shall be included If contacting the peer for the first time	Recovery	0
Protocol Configuration Options (PCO)	C	PGW shall include Protocol Configuration Options (PCO) IE, if available.	PCO	0
Private Extension	O		Private Extension	VS

7.2.10.2 Delete Bearer Response

The Delete Bearer Response shall be sent as a response of Delete Bearer Request.

Possible Cause values are:

- "Request accepted".
- "Request accepted partially".
- "Request rejected".
- "Context not found".
- "Mandatory IE incorrect".
- "Conditional IE missing".
- "System failure".
- "Invalid message format".
- "Unexpected repeated IE".

Table 7.2.10.2-1: Information Elements in Delete Bearer Response

Information elements	P	Condition / Comment	IE Type	Ins.
Cause	M		Cause	0
Linked EPS Bearer ID (LBI)	C	If the response corresponds to the bearer deactivation procedure in case all the bearers associated with the default bearer of a PDN connection shall be released, this IE shall be included to indicate the default bearer associated with the PDN being disconnected.	EBI	0
Bearer Contexts	C	It shall be used for bearers different from default one. In this case at least one bearer shall be included. Several IEs with this type and instance values shall be included as necessary to represent a list of Bearers. Used for dedicated bearers. When used, at least one dedicated bearer shall be present.	Bearer Context	0
Recovery	C	This IE shall be included if contacting the peer for the first time	Recovery	0
MME-FQ-CSID	C	This IE shall be included by MME the on S11 interface and shall be forwarded by the SGW on S5/S8 interface according to the requirements in 3GPP TS 23.007 [17].	FQ-CSID	0
SGW-FQ-CSID	C	This IE shall be included by the SGW on the S5/S8 interface according to the requirements in 3GPP TS 23.007 [17].	FQ-CSID	1
Protocol Configuration Options (PCO)	C	If the UE includes the PCO IE, then the MME/SGSN shall copy the content of this IE transparently from the PCO IE included by the UE. If the SGW receives PCO from the MME/SGSN, SGW shall forward it to the PGW.	PCO	0
Private Extension	O		Private Extension	VS

Table 7.2.10.2-2: Bearer Context within Delete Bearer Response

Octet 1	Bearer Context IE Type = 93 (decimal)			
Octets 2 and 3	Length = n			
Octet 4	Spare and Instance fields			
Information elements	P	Condition / Comment	IE Type	Ins.
EPS Bearer ID	M		EBI	0
Cause	M	This IE shall indicate if the bearer handling was successful, and if not, gives information on the reason.	Cause	0

7.2.11 Downlink Data Notification messages

7.2.11.1 Downlink Data Notification

A Downlink Data Notification message shall be sent:

- on the S11 interface by the SGW to the MME as a part of the network triggered service request procedure;
- on the S4 interface by the SGW to the SGSN as part of Paging with no established user plane on S4, SGW triggered paging with S4;
- on S11/S4 interface by SGW to MME/S4-SGSN if the SGW has received an Error Indication (see 3GPP TS 29.281 [13]) from eNodeB/RNC across S1-U/S12 interface. Respective SGW and MME/S4-SGSN functionality is specified in 3GPP TS 23.007 [17].

Table 7.2.11.1-1 specifies the presence of the IEs in the message.

Table 7.2.11.1-1: Information Elements in a Downlink Data Notification

Information elements	P	Condition / Comment	IE Type	Ins.
Cause	O	If SGW receives an Error Indication from eNodeB/RNC, the SGW may send the Cause IE with value "Error Indication received from RNC/eNodeB" to MME/S4-SGSN as specified in 3GPP TS 23.007 [17].	Cause	0
Private Extension	O		Private Extension	VS

7.2.11.2 Downlink Data Notification Acknowledge

A Downlink Data Notification Acknowledge shall be sent from a MME/SGSN to a SGW in response to Downlink Data Notification with an indication of success, or failure when MME/SGSN has reachability or abnormal conditions.

Possible Cause values are:

- "Request accepted".
- "Unable to page UE".
- "Invalid message format".
- "Context not found".
- "Unable to page UE due to Suspension".

Table 7.2.11.2-1 specifies the presence of the IEs in the message.

Table 7.2.11.2-1: Information Elements in a Downlink Data Notification Acknowledge

Information elements	P	Condition / Comment	IE Type	Ins.
Cause	M		Cause	0
Data Notification Delay	C	The MME/SGSN shall include an adaptive delay indication to the SGW to delay the number of Data Notification indications, if the rate of Downlink Data Notification event occurrence in the MME/SGSN becomes significant (as configured by the operator) and the MME/SGSN's load exceeds an operator configured value.	Delay Value	0
Recovery	C	This IE shall be included if contacting the peer for the first time	Recovery	0
Private Extension	O		Private Extension	VS

7.2.11.3 Downlink Data Notification Failure Indication

A Downlink Data Notification Failure indication shall be sent from an MME/SGSN to a SGW indicating that the UE did not respond to paging. It shall also be sent in the case that the UE responded to the page with a Service Request but that the MME has rejected the request by sending a Service Reject to the UE. It may happen, for example, because the requested service is not supported or there is a bearer context mismatch.

Possible Cause values are:

- "UE not responding".
- "Service denied".

Table 7.2.11.3-1 specifies the presence of the IEs in the message.

Table 7.2.11.3-1: Information Elements in a Downlink Data Notification Failure Indication

Information elements	P	Condition / Comment	IE Type	Ins.
Cause	M		Cause	0
Private Extension	O		Private Extension	VS

7.2.12 Delete Indirect Data Forwarding Tunnel Request

The Delete Indirect Data Forwarding Tunnel Request message is sent on the S11 interface by the MME to the SGW as part of the following procedures:

- S1-based handover
- UTRAN Iu mode to E-UTRAN Inter RAT handover
- GERAN A/Gb mode to E-UTRAN Inter RAT handover

This message is also sent on the S4 interface by the SGSN to the SGW as part of the procedure:

- E-UTRAN to UTRAN Iu mode Inter RAT handover
- E-UTRAN to GERAN A/Gb mode Inter RAT handover

Table 7.2.12-1: Information Element in Delete Indirect Data Forwarding Tunnel Request

Information elements	P	Condition / Comment	IE Type	Ins.
Private Extension	O	Vendor or operator specific information	Private Extension	VS

7.2.13 Delete Indirect Data Forwarding Tunnel Response

The Delete Indirect Data Forwarding Tunnel Response message is sent on the S11 interface by the SGW to the MME as part of the following procedures:

- S1-based handover
- UTRAN Iu mode to E-UTRAN Inter RAT handover
- GERAN A/Gb mode to E-UTRAN Inter RAT handover

This message is also sent on the S4 interface by the SGW to the SGSN as part of the procedure:

- E-UTRAN to UTRAN Iu mode Inter RAT handover
- E-UTRAN to GERAN A/Gb mode Inter RAT handover

Possible Cause values are:

- "Request accepted".
- "Request accepted partially"
- "Request rejected"
- "No memory available"
- "System failure".
- "Invalid message format".

Table 7.2.13-1: Information Element in Delete Indirect Data Forwarding Tunnel Response

Information elements	P	Condition / Comment	IE Type	Ins.
Cause	M	This IE shall indicate if the deletion of indirect tunnel establishment is successful, and if not, gives information on the reason.	Cause	0
Recovery	C	This IE shall be included if contacting the peer for the first time.	Recovery	0
Private Extension	O		Private Extension	VS

7.2.14 Modify Bearer Command and Failure Indication

7.2.14.1 Modify Bearer Command

The Modify Bearer Command shall be sent on the S11 interface by the MME to the SGW and on the S5/S8 interface by the SGW to the PGW as part of the HSS Initiated Subscribed QoS Modification procedure.

It shall also be sent on the S4 interface by the SGSN to the SGW and on the S5/S8 interface by the SGW to the PGW as part of the HSS Initiated subscribed QoS modification.

Table 7.2.14.1-1: Information Elements in a Modify Bearer Command

Information elements	P	Condition / Comment	IE Type	Ins.
APN-Aggregate Maximum Bit Rate (APN-AMBR)	M	This IE shall contain the modified APN-AMBR value received by the MME/SGSN from the HSS.	AMBR	0
Bearer Context	M	Only one IE with this type and instance value shall be included and this shall represent the Default Bearer.	Bearer Context	0
Private Extension	O		Private Extension	VS

Table 7.2.14.1-2: Bearer Context within Modify Bearer Command

Octet 1	Bearer Context IE Type = 93 (decimal)			
Octets 2 and 3	Length = n			
Octet 4	Spare and Instance fields			
Information elements	P	Condition / Comment	IE Type	Ins.
EPS Bearer ID	M	This IE shall contain the bearer that has been modified.	EBI	0
Bearer Level QoS	C	Mandatory if other parameters than the APN-AMBR have been changed	Bearer QoS	0

7.2.14.2 Modify Bearer Failure Indication

The Modify Bearer Failure Indication shall be sent on the S5/S8 interface by the PGW to the SGW and on the S11 interface by the SGW to the MME as part of failure of HSS Initiated Subscribed QoS Modification procedure.

It shall also be sent on the S5/S8 interface by the PGW to the SGW and on the S4 interface by the SGW to the SGSN as part of failure of HSS Initiated subscribed QoS modification.

Cause IE indicates that an EPS bearer has not been updated in the PGW.

Possible Cause values are:

- "Context not found"
- "No resources available".
- "No memory available".

- "System failure".
- "Mandatory IE incorrect".
- "Mandatory IE missing".
- "Conditional IE missing".
- "Invalid message format".
- "Unexpected repeated IE".
- "Invalid length".
- "Service denied".

Table 7.2.14.2-1: Information Elements in a Modify Bearer Failure Indication

Information elements	P	Condition / Comment	IE Type	Ins.
Cause	M		Cause	0
Recovery	C	This IE shall be included if contacting the peer for the first time	Recovery	0
Private Extension	O		Private Extension	VS

7.2.15 Update Bearer Request

The direction of this message shall be from PGW to SGW and/or from SGW to MME/S4-SGSN (see Table 6.1-1).

For GTP based S5/S8, the Update Bearer Request shall be sent by the PGW to the SGW and forwarded to the MME as part of the following procedures:

- PGW Initiated Bearer Modification with Bearer QoS Update
- HSS Initiated Subscribed QoS Modification
- PGW Initiated Bearer Modification without Bearer QoS Update
- UE Request Bearer Resource Modification procedure

The message shall also be sent on the S5/S8 interface by the PGW to the SGW and on the S4 interface by the SGW to the SGSN as part of the following procedures:

- PGW Initiated EPS Bearer Modification
- Execution part of MS-Initiated EPS Bearer Modification
- SGSN-Initiated EPS Bearer Modification Procedure using S4

For PMIP based S5/S8, the Update Bearer Request shall be sent on the S11 interface by the SGW to the MME and on the S4 interface by the SGW to the SGSN.

Table 7.2.15-1 specifies the presence requirements and the conditions of the IEs in the message.

Table 7.2.15-1: Information Elements in an Update Bearer Request

Information elements	P	Condition / Comment	IE Type	Ins.
Bearer Contexts	M	This IE shall contain contexts related to bearers that need QoS/TFT modification. Several IEs with this type and instance values shall be included as necessary to represent a list of Bearers.	Bearer Context	0
Procedure Transaction Id (PTI)	C	If the request corresponds to UE requested bearer resource modification procedure for an E-UTRAN or MS initiated EPS bearer modification procedure, this IE shall be included. PTI shall be the same as the one used in the corresponding Bearer Resource Command	PTI	0
Protocol Configuration Options (PCO)	C	PGW shall include Protocol Configuration Options (PCO) IE, if available.	PCO	0
Aggregate Maximum Bit Rate (APN-AMBR)	M	APN-AMBR	AMBR	0
Change Reporting Action	C	This IE shall be included with the appropriate Action field If the location Change Reporting mechanism is to be started or stopped for this subscriber in the SGSN/MME.	Change Reporting Action	0
PGW-FQ-CSID	C	This IE shall be by PGW on S5/S8 and shall be forwarded by SGW on S11 according to the requirements in 3GPP TS 23.007 [17].	FQ-CSID	0
SGW-FQ-CSID	C	This IE shall be included by SGW on S11 according to the requirements in 3GPP TS 23.007 [17].	FQ-CSID	1
Private Extension	O		Private Extension	VS

NOTE: In the case that the procedure was initiated by a UE Requested Bearer Resource Modification Procedure for an E-UTRAN or MS initiated EPS bearer modification procedure, then there will be only one instance of the Bearer Contexts IE in the Update Bearer Request.

Table 7.2.15-2: Bearer Context within Update Bearer Request

Information elements	P	Condition / Comment	IE Type	Ins.
Octet 1	Bearer Context IE Type = 93 (decimal)			
Octets 2 and 3	Length = n			
Octet 4	Spare and Instance fields			
EPS Bearer ID	M		EBI	0
TFT	C	This IE shall be included if message relates to Bearer Modification and TFT change.	Bearer TFT	0
Bearer Level QoS	C	This IE shall be included if QoS modification is requested	Bearer QoS	0
Bearer Flags	O	Applicable flags: PPC (Prohibit Payload Compression)	Bearer Flags	0

7.2.16 Update Bearer Response

An Update Bearer Response shall be sent from a MME/SGSN to a SGW and forwarded to the PGW as a response to an Update Bearer Request message.

Table 7.2.16-1 specifies the presence requirements and the conditions of the IEs in the message.

Cause IE indicates if an EPS bearer has been modified in the MME/SGSN or not. The EPS Bearer has not been modified in the MME if the Cause IE value differs from "Request accepted" or "Request accepted partially". Possible Cause values are:

- "Request accepted".
- "Request accepted partially"
- "Request rejected"

- "Context not found"
- "Mandatory IE incorrect".
- "Mandatory IE missing".
- "Conditional IE missing".
- "System failure".
- "Semantic error in the TFT operation".
- "Syntactic error in the TFT operation".
- "Semantic errors in packet filter(s)".
- "Syntactic errors in packet filter(s)".
- "Invalid message format".
- "Unexpected repeated IE".
- "Invalid length".
- "Denied in RAT".
- "UE refuses".
- "UE context without TFT already activated".
- "No resources available".
- "Unable to page UE".
- "UE not responding".
- "Unable to page UE due to Suspension".

Table 7.2.16-1: Information Elements in an Update Bearer Response

Information elements	P	Condition / Comment	IE Type	Ins.
Cause	M		Cause	0
Bearer Contexts	M	This IE shall contain contexts related to bearers for which QoS/TFT modification was requested. Several IEs with this type and instance values shall be included as necessary to represent a list of Bearers	Bearer Context	0
Protocol Configuration Options (PCO)	C	MME/SGSN shall include PCO IE if such information was received from the PGW. This IE shall be included if the Cause IE contains the value "Request accepted".	PCO	0
Recovery	C	This IE shall be included if contacting the peer for the first time	Recovery	0
MME-FQ-CSID	C	This IE shall be included by MME on S11 and shall be forwarded by SGW on S5/S8 according to the requirements in 3GPP TS 23.007 [17].	FQ-CSID	0
SGW-FQ-CSID	C	This IE shall be included by SGW on S11 according to the requirements in 3GPP TS 23.007 [17].	FQ-CSID	1
Indication Flags	O	Applicable flags: Direct Tunnel Flag: this flag may be included if the Direct Tunnel is used.	Indication	0
Private Extension	O		Private Extension	VS

Table 7.2.16-2: Bearer Context within Update Bearer Response

Octet 1	Bearer Context IE Type = 93 (decimal)			
Octets 2 and 3	Length = n			
Octet 4	Spare and Instance fields			
Information elements	P	Condition / Comment	IE Type	Ins.
EPS Bearer ID	M		EBI	0
Cause	M	This IE Indicates if the bearer handling was successful, and if not, gives information on the reason.	Cause	0
S4-U SGSN F-TEID	C	This IE shall be included on the S4 interface when direct tunnel is not established.	F-TEID	0
S12 RNC F-TEID	C	This IE shall be included on the S4 interface when direct tunnel flag is set to 1.	F-TEID	1

7.2.17 Delete Bearer Command and Failure Indication

7.2.17.1 Delete Bearer Command

A Delete Bearer Command message shall be sent on the S11 interface by the MME to the SGW and on the S5/S8 interface by the SGW to the PGW as a part of the eNodeB requested bearer release or MME-Initiated Dedicated Bearer Deactivation procedure.

The message shall also be sent on the S4 interface by the SGSN to the SGW and on the S5/S8 interface by the SGW to the PGW as part of the MS and SGSN Initiated Bearer Deactivation procedure using S4.

Table 7.2.17.1-1: Information Elements in Delete Bearer Command

Information elements	P	Condition / Comment	IE Type	Ins.
Bearer Contexts	M	This IE shall be used to indicate dedicated bearers. When used, at least one dedicated bearer shall be present. Several IEs with this type and instance values shall be included as necessary to represent a list of Bearers	Bearer Context	0
Private Extension	O		Private Extension	VS

Table 7.2.17.1-2: Bearer Context within Delete Bearer Command

Octet 1	Bearer Context IE Type = 93 (decimal)			
Octets 2 and 3	Length = n			
Octet 4	Spare and Instance fields			
Information elements	P	Condition / Comment	IE Type	Ins.
EPS Bearer ID	M		EBI	0

7.2.17.2 Delete Bearer Failure Indication

A Delete Bearer Failure Indication shall be sent on the S5/S8 interface by the PGW to the SGW and on the S11 interface by the SGW to the MME as part of failure of eNodeB requested bearer release or MME Initiated Dedicated Bearer Deactivation procedure.

The message shall also be sent on the S5/S8 interface by the PGW to the SGW and on the S4 interface by the SGW to the SGSN as part of the MS and SGSN Initiated Bearer Deactivation procedure using S4.

This message shall be sent back if all the bearers included in the Delete Bearer Command message could not be deleted.

Cause IE indicates that an EPS bearer has not been deleted in the PGW.

Possible Cause values are:

- "Context not found"

- "Mandatory IE incorrect".
- "Mandatory IE missing".
- "System failure".
- "Invalid message format".
- "Unexpected repeated IE"

Table 7.2.17.2-1: Information Elements in a Delete Bearer Failure Indication

Information elements	P	Condition / Comment	IE Type	Ins.
Cause	M		Cause	0
Bearer Context	M	This IE shall contain the list of failed bearers.	Bearer Context	0
Recovery	C	This IE shall be included If contacting the peer for the first time.	Recovery	0
Private Extension	O		Private Extension	VS

Table 7.2.17.2-2: Bearer Context within Delete Bearer Failure Indication

Octet 1	Bearer Context IE Type = 93 (decimal)			
Octets 2 and 3	Length = n			
Octet 4	Spare and Instance fields			
Information elements	P	Condition / Comment	IE Type	Ins.
EPS Bearer ID	M		EBI	0
Cause	M	This IE shall indicate the reason of the unsuccessful handling of the bearer.	Cause	0

7.2.18 Create Indirect Data Forwarding Tunnel Request

The Create Indirect Data Forwarding Tunnel Request message shall be sent on the S11/S4 interface by the MME/SGSN to the SGW as part of the Handover procedures.

NOTE: The SGW that the MME/SGSN selects for indirect data forwarding and sends Create Indirect Data Forwarding Tunnel Request message to may be different from the SGW used as the anchor point for the UE.

Table 7.2.18-1 specifies the presence requirements and the conditions of the IEs in the message.

Table 7.2.18-1: Information Elements in a Create Indirect Data Forwarding Tunnel Request

Information elements	P	Condition / Comment	IE Type	Ins.
IMSI	C	This IE shall be included if the SGW that the MME/SGSN selects for indirect data forwarding is different from the SGW used as the anchor point.	IMSI	0
Sender F-TEID for Control Plane	C	This IE shall be included if the SGW that the MME/SGSN selects for indirect data forwarding is different from the SGW used as the anchor point.	F-TEID	0
Bearer Contexts	M	Several IEs with this type and instance value may be included as necessary to represent a list of Bearers	Bearer Context	0
Private Extension	O		Private Extension	VS

Table 7.2.18-2: Bearer Context within Create Indirect Data Forwarding Tunnel Request

Information elements	P	Condition / Comment	IE Type	Ins.
Octet 1	Bearer Context IE Type = 93 (decimal)			
Octets 2 and 3	Length = n			
Octet 4	Spare and Instance fields			
EPS Bearer ID	M		EBI	0
eNodeB F-TEID for data forwarding	C	Target eNodeB F-TEID. This IE shall be present in the message sent from the target MME to the target SGW, or shall be included in the message sent from the source SGSN/MME to the source SGW if the eNodeB F-TEID for data forwarding is included in the Forward Relocation Response message.	F-TEID	0
SGW F-TEID for data forwarding	C	Target SGW F-TEID This IE shall be present in the message sent from the source MME/SGSN to the source SGW if SGW F-TEID for data forwarding is included in the Forward Relocation Response message. This F-TEID is assigned by the SGW that the target MME/SGSN selects for indirect data forwarding.	F-TEID	1
SGSN F-TEID for data forwarding	C	Target SGSN F-TEID This IE shall be present in the message sent from the target SGSN to the target SGW in E-UTRAN to GERAN/UTRAN inter RAT handover with SGW relocation procedure, or shall be included in the message sent from the source MME to the source SGW if the SGSN F-TEID for data forwarding is included in the Forwarding Relocation Response message.	F-TEID	2
RNC F-TEID for data forwarding	C	Target RNC F-TEID This IE shall be present in the message sent from the target SGSN to the target SGW in E-UTRAN to UTRAN inter RAT handover with SGW relocation procedure, or shall be included in the message sent from the source MME to the source SGW if the RNC F-TEID for data forwarding is included in the Forwarding Relocation Response message.	F-TEID	3

7.2.19 Create Indirect Data Forwarding Tunnel Response

A Create Indirect Data Forwarding Tunnel Response message shall be sent by the SGW to the MME/SGSN as a response to a Create Indirect Data Forwarding Tunnel Request message.

Table 7.2.19-1 specifies the presence requirements and the conditions of the IEs in the message.

The Cause value indicates if the Indirect Data Forwarding Tunnels has been created in the SGW or not. Indirect Data Forwarding Tunnels have not been created in the SGW if the Cause differs from "Request accepted". Possible Cause values are:

- "Request accepted".
- "Request accepted partially".
- "Data forwarding not supported".
- "No resources available".
- "System failure".
- "Mandatory IE incorrect".
- "Mandatory IE missing".
- "Conditional IE missing".
- "Invalid message format".

Only the Cause IE shall be included in the response if the Cause IE contains another value than "Request accepted".

Table 7.2.19-1: Information Elements in a Create Indirect Data Forwarding Tunnel Response

Information elements	P	Condition / Comment	IE Type	Ins.
Cause	M		Cause	0
Sender F-TEID for Control Plane	C	This IE shall be included if the SGW that the MME/SGSN selects for indirect data forwarding is different from the SGW used as the anchor point.	F-TEID	0
Bearer Contexts	M	Several IEs with this type and instance value may be included as necessary to represent a list of Bearers	Bearer Context	0
Private Extension	O		Private Extension	VS

Table 7.2.19-2: Bearer Context within Create Indirect Data Forwarding Tunnel Response

Information elements	P	Condition / Comment	IE Type	Ins.
Octet 1		Bearer Context IE Type = 93 (decimal)		
Octets 2 and 3		Length = n		
Octet 4		Spare and Instance fields		
EPS Bearer ID	M		EBI	0
Cause	M	This IE shall indicate if the tunnel setup was successful, and if not, gives information on the reason.	Cause	0
S1-U SGW F-TEID	C	This IE shall be included in the response sent from the source SGW to the source MME.	F-TEID	0
S12 SGW F-TEID	C	S12 usage only. This IE shall be included in the response sent from the source SGW to the source SGSN.	F-TEID	1
S4-U SGW F-TEID	C	S4-U usage only. This IE shall be included in the response sent from the source SGW to the source SGSN.	F-TEID	2
SGW F-TEID for data forwarding	C	This IE shall be included in the response message sent from the target SGW to the target MME/SGSN.	F-TEID	3

7.2.20 Void

7.2.21 Release Access Bearers Request

The Release Access Bearers Request message shall be sent on the S11 interface by the MME to the SGW as part of the S1 release procedure.

The message shall also be sent on the S4 interface by the SGSN to the SGW as part of the procedures:

- RAB release using S4
- Iu Release using S4

Table 7.2.21-1: Information Element in Release Access Bearers Request

Information elements	P	Condition / Comment	IE Type	Ins.
User Location Information (ULI)	C	The MME/SGSN shall include this IE for S1/S4 release procedure if the PGW has requested location information change reporting and MME/SGSN support location information change reporting. The SGW shall include this IE on S5/S8 if it receives the ULI from MME/SGSN.	ULI	0
List of RABs	C	Shall be present on S4 interface when this message is used to release a subset of all active RABs according to the RAB release procedure. Several IEs with this type and instance values shall be included as necessary to represent a list of RABs to be released.	EBI	0
Private Extension	O	Vendor or operator specific information	Private Extension	VS

7.2.22 Release Access Bearers Response

The Release Access Bearers Response message is sent on the S11 interface by the SGW to the MME as part of the S1 release procedure.

The message shall also be sent on the S4 interface by the SGW to the SGSN as part of the procedures:

- RAB release using S4
- Iu Release using S4

Possible Cause values are:

- "Request accepted".
- "Request accepted partially".
- "Request rejected".
- "Context not found".
- "System failure".
- "Invalid message format".
- "Unexpected repeated IE".
- "Mandatory IE incorrect".
- "Conditional IE missing".

Table 7.2.22-1: Information Element in Release Access Bearers Response

Information elements	P	Condition / Comment	IE Type	Ins.
Cause	M	None	Cause	0
Recovery	O	This IE shall be included if contacting the peer for the first time	Recovery	0
Private Extension	O	Vendor or operator specific information	Private Extension	VS

7.2.23 Stop Paging Indication

A Stop Paging Indication message shall be sent on the S11/S4 interface by the SGW to the MME/SGSN as a part of the network triggered service request procedure.

Table 7.2.23-1 specifies the presence of the IEs in the message.

Table 7.2.23-1: Information Elements in a Stop Paging Indication

Information elements	P	Condition / Comment	IE Type	Ins.
Private Extension	O		Private Extension	VS

7.3 Mobility Management Messages

7.3.1 Forward Relocation Request

A Forward Relocation Request message shall be sent from the source MME to the target MME over S10 interface as part of S1-based handover relocation procedure from the source MME to the target SGSN, or from the source SGSN to the target MME over S3 interface as part of Inter RAT handover and combined hard handover and SRNS relocation procedures, or from source SGSN to the target SGSN over S16 interface as part of SRNS Relocation and PS handover procedures.

Forward Relocation procedure across S10 interface (when K_{ASME} is taken into use) shall be performed according to the Rules on Concurrent Running of Security Procedures, which are specified in 3GPP TS 33.401 [12].

Table 7.3.1-1 specifies the presence requirements and conditions of the IEs in the message.

Table 7.3.1-1: Information Elements in a Forward Relocation Request

Information elements	P	Condition / Comment	IE Type	Ins.
IMSI	M		IMSI	0
Sender's F-TEID for Control Plane	M	This IE specifies the address and the TEID for control plane message which is chosen by the source MME/SGSN. This information shall be used by the target MME/SGSN to the source MME/SGSN when sending Forward Relocation Response message and Forward Relocation Complete Notification message.	F-TEID	0
MME/SGSN UE EPS PDN Connections	M	Several IEs with this type and instance values shall be included as necessary to represent a list of PDN Connections	PDN Connection	0
SGW S11/S4 IP Address and TEID for Control Plane	M		F-TEID	1
SGW node name	C	This IE shall be included if the source MME or SGSN has the source SGW FQDN.	FQDN	0
MME/SGSN UE MM Context	M		MM Context	0
Indication Flags	C	This IE shall be included if any of the flags are set to 1. - Direct Forwarding Indication: This flag shall be set to 1 if direct forwarding is supported. This flag shall not be set to 1 if the message is used for SRNS relocation procedure. Idle mode Signalling Reduction Supported Indication flag: - This flag shall be set to 1 if the source MME/SGSN is capable to establish ISR for the UE.	Indication	0
E-UTRAN Transparent Container	C	This IE shall be included if the message is used for UTRAN/GERAN to E-UTRAN inter RAT handover procedure, intra RAT handover procedure and 3G SGSN to MME combined hard handover and SRNS relocation procedure.	F-Container	0
UTRAN Transparent Container	C	This IE shall be included if the message is used for PS handover to UTRAN Iu mode procedures, SRNS relocation procedure and E-UTRAN to UTRAN inter RAT handover procedure.	F-Container	1
Target Identification	C	This IE shall be included if the message is used for SRNS relocation procedure and handover to UTRAN/E-UTRAN procedures.	Target Identification	0
HRPD access node S101 IP address	C	This IE shall be included only if the HRPD pre registration was performed at the source MME	IP-Address	0
1xIWS S102 IP address	C	This IE shall be included only if the 1xRTT CS fallback pre registration was performed at the source MME	IP-Address	1
RAN Cause	C	This IE is the information from the source eNodeB, the source MME shall include this IE in the message.	F-Cause	0
RANAP Cause	C	This IE is the information from the source RNC, the source SGSN shall include this IE in the message.	F-Cause	1
BSS Container	C	This IE shall be included if the message is used for PS handover to GERAN A/Gb mode and E-UTRAN to GERAN A/Gb mode inter RAT handover procedure.	F-Container	2
Source Identification	C	This IE shall be included if the message is used for PS handover to GERAN A/Gb mode and E-UTRAN to GERAN A/Gb mode inter RAT handover procedure.	Source Identification	0
BSSGP Cause	C	This IE is the information from source BSS, the source SGSN shall include this IE in the message.	F-Cause	2
Selected PLMN ID	C	The old SGSN shall include this IE if the selected PLMN identity is available. The Selected PLMN ID IE indicates the core network operator selected for the UE in a shared network.	Selected PLMN ID	0
Recovery	C	If contacting the peer for the first time	Recovery	0
Trace Information	C	This IE shall be included when session trace is active for this IMSI/IMEI.	Trace Information	0

Private Extension	O		Private Extension	VS
-------------------	---	--	-------------------	----

The PDN Connection grouped IE shall be coded as depicted in Table 7.3.1-2.

Table 7.3.1-2: MME/SGSN UE EPS PDN Connections within Forward Relocation Request

Octet 1	PDN Connection IE Type = 109 (decimal)			
Octets 2 and 3	Length = n			
Octet 4	Spare and Instance fields			
Information elements	P	Condition / Comment	IE Type	Ins.
APN	M		APN	0
APN Restriction	C	This IE denotes the restriction on the combination of types of APN for the APN associated with this EPS bearer Context. The target MME or SGSN determines the Maximum APN Restriction using the APN Restriction. If available, the source MME/S4SGSN shall include this IE.	APN Restriction	0
IPv4 Address	C	This IE shall not be included if no IPv4 Address is assigned.	IP Address	0
IPv6 Address	C	This IE shall not be included if no IPv6 Address is assigned.	IP Address	1
Linked EPS Bearer ID	M	This IE identifies the default bearer of the PDN Connection.	EBI	0
PGW S5/S8 IP Address for Control Plane or PMIP	M	This IE shall include the TEID in the GTP based S5/S8 case and the GRE key in the PMIP based S5/S8 case.	F-TEID	0
PGW node name	C	This IE shall be included if the source MME or SGSN has the PGW FQDN.	FQDN	0
Bearer Contexts	C	Several IEs with this type and instance values may be included as necessary to represent a list of Bearers.	Bearer Context	0
Aggregate Maximum Bit Rate (APN-AMBR)	M		AMBR	0
Charging characteristics	C	This IE shall be present if charging characteristics was supplied by the HSS to the MME/SGSN as a part of subscription information.	Charging characteristics	0
Change Reporting Action	C	This IE shall be included whenever available at the source MME/SGSN.	Change Reporting Action	0

The Bearer Context grouped IE shall be coded as depicted in Table 7.3.1-3.

Table 7.3.1-3: Bearer Context within MME/SGSN UE EPS PDN Connections within Forward Relocation Request

Octet 1	Bearer Context IE Type = 93 (decimal)			
Octets 2 and 3	Length = n			
Octet 4	Spare and Instance fields			
Information elements	P	Condition / Comment	IE Type	Ins.
EPS Bearer ID	M		EBI	0
TFT	C	This IE shall be present if a TFT is defined for this bearer.	Bearer TFT	0
SGW S1/S4/S12 IP Address and TEID for user plane	M		F-TEID	0
PGW S5/S8 IP Address and TEID for user plane	C	This IE shall be present for GTP based S5/S8	F-TEID	1
Bearer Level QoS	M		Bearer Level QoS	0
BSS Container	O	Packet Flow ID, Radio Priority, SAPI, PS Handover XID Parameters may be included	F-Container	0
Transaction Identifier	C	This IE shall be sent over S3/S10/S16 if the UE supports A/Gb and/or lu mode.	TI	0

7.3.2 Forward Relocation Response

A Forward Relocation Response message shall be sent as a response to Forward Relocation Request during S1-based handover procedure, Inter RAT handover procedures, SRNS Relocation procedure and PS handover procedures.

Table 7.3.2-1 specifies the presence requirements and conditions of the IEs in the message.

Cause IE indicates if the relocation has been accepted, or not. The relocation has not been accepted by the target MME/SGSN if the Cause IE value differs from "Request accepted". Possible Cause values are:

- "Request accepted".
- "System failure".
- "Mandatory IE incorrect".
- "Mandatory IE missing".
- "Conditional IE missing".
- "No resources available".
- "Invalid message format".
- "Relocation failure".

Table 7.3.2-1: Information Elements in a Forward Relocation Response

Information elements	P	Condition / Comment	IE Type	Ins.
Cause	M		Cause	0
Sender's F-TEID for Control Plane	C	If the Cause IE contains the value "Request accepted", the target MME/SGSN shall include this IE in Forward Relocation Response message. This information shall be used by the source MME/SGSN to the target MME/SGSN when sending Forward Relocation Complete Acknowledge message.	F-TEID	0
Indication Flags	C	This IE shall be included if any of the flags are set to 1. SGW Change Indication: - This flag shall be set to 1 if the target MME/SGSN has selected a new SGW.	Indication	0
List of Set-up Bearers	C	The list of set-up Bearers IE contains the EPS bearer Identifiers of the Bearers that were successfully allocated in the target system during a handover procedure. This IE shall be included if the Cause IE contains the value "Request accepted". Several IEs with this type and instance values shall be included as necessary to represent a list of Bearers.	Bearer Context	0
List of Set-up RABs	C	The list of set-up RABs IE contains the RAB Identifiers of the RABs that were successfully allocated in the target system. This IE shall be included if the Cause IE contains the value "Request accepted". Several IEs with this type and instance values shall be included as necessary to represent a list of Bearers.	Bearer Context	1
List of Set-up PFCs	O	The list of set-up PFCs IE contains the Packet Flow Identifies of the PFCs that were successfully allocated in the target system during a PS handover to/from GERAN or inter RAT handover to/from GERAN. If the Cause IE contains the value "Request accepted", this IE may be included.	Bearer Context	2
eNodeB Cause	C	If the Cause IE contains the value "Request accepted", this IE is mandatory if cause value is contained in S1-AP message.	F-Cause	0
RANAP Cause	C	If the Cause IE contains the value "Request accepted", this IE is mandatory if cause value is contained in RANAP message.	F-Cause	1
E-UTRAN Transparent Container	C	This IE is conditionally included only during a handover to E-UTRAN and contains the radio-related and core network information. If the Cause IE contains the value "Request accepted", this IE shall be included.	F-Container	0
UTRAN Transparent Container	C	This IE is conditionally included only during a handover to UTRAN and contains the radio-related and core network information. If the Cause IE contains the value "Request accepted", this IE shall be included.	F-Container	1
BSS Container	C	This IE is conditionally included only during a handover to GERAN and contains the radio-related and core network information. If the Cause IE contains the value "Request accepted", this IE shall be included.	F-Container	2
BSSGP Cause	C	For handover to GERAN, if a cause value is received from the Target BSC, the BSSGP Cause IE shall be included and shall be sent to the cause value received from the target BSC.	F-Cause	2
Private Extension	O		Private Extension	VS

Bearer Context IE in this message is specified in Table 7.3.2-2, the source system shall use this IE for data forwarding in handover.

Table 7.3.2-2: Bearer Context

Information elements	P	Condition / Comment	IE Type	Ins.
Octet 1 Bearer Context IE Type = 93 (decimal)				
Octets 2 and 3 Length = n				
Octet 4 Spare and Instance fields				
EPS Bearer ID	C	This IE shall be included if the message is used for S1-Based handover procedure. This IE shall be included if the message is used for SRNS relocation procedure and Inter RAT handover to/from lu mode procedures.	EBI	0
Packet Flow ID	C	This IE shall be included if the message is used for PS handover and Inter RAT handover to/from A/Gb mode procedures.	Packet Flow ID	0
eNodeB F-TEID for DL data forwarding	C	This IE shall be included for the message sent from the target MME, if the DL Transport Layer Address and DL GTP TEID are included in the "SAE Bearers Admitted List" of the S1AP: HANDOVER REQUEST ACKNOWLEDGE and direct forwarding or indirect forwarding without SGW change is applied.	F-TEID	0
eNodeB F-TEID for UL data forwarding	C	This IE shall be included for the message sent from the target MME, if the UL Transport Layer Address and UL GTP TEID are included in the "SAE Bearers Admitted List" of the S1AP: HANDOVER REQUEST ACKNOWLEDGE and direct forwarding or indirect forwarding without SGW change is applied.	F-TEID	1
SGW F-TEID for data forwarding	C	This SGW F-TEID shall be included for indirect data forwarding.	F-TEID	2
RNC F-TEID for data forwarding	C	This RNC F-TEID shall be included in the message sent from SGSN, if the target system decides using RNC F-TEID for data forwarding.	F-TEID	3
SGSN F-TEID for data forwarding	C	This SGSN F-TEID shall be included in the message sent from SGSN, if the target system decides using SGSN F-TEID for data forwarding.	F-TEID	4

7.3.3 Forward Relocation Complete Notification

A Forward Relocation Complete Notification message shall be sent to the source MME/SGSN to indicate the handover has been successfully finished.

Table 7.3.3-1 specifies the presence requirements and conditions of the IEs in the message.

Table 7.3.3-1: Information Elements in a Forward Relocation Complete Notification

Information elements	P	Condition / Comment	IE Type	Ins.
Indication Flags	C	This IE shall be included if any of the flags are set to 1. Idle mode Signalling Reduction Supported Indication: This flag shall be set to 1 if the message is used for inter RAT handover and the UE has ISR capability. This flag is set to indicate to the source MME/SGSN whether it shall maintain the UE's context and whether it shall activate ISR.	Indication	0
Private Extension	O		Private Extension	VS

7.3.4 Forward Relocation Complete Acknowledge

A Forward Relocation Complete Acknowledge message shall be sent as a response to Forward Relocation Complete Notification during inter eNodeB handover with MME relocation procedure, SRNS Relocation with SGSN change procedures using S4 or Inter RAT Handover with MME/S4 SGSN interaction procedures.

Table 7.3.4-1 specifies the presence requirements and conditions of the IEs in the message.

Possible Cause values are:

- "Request accepted".
- "Request rejected"
- "System failure".
- "Invalid message format".
- "Unexpected repeated IE".
- "Mandatory IE incorrect".
- "Conditional IE missing".

Table 7.3.4-1: Information Elements in a Forward Relocation Complete Acknowledge

Information elements	P	Condition / Comment	IE Type	Ins.
Cause	M		Cause	0
Recovery	O		Recovery	0
Private Extension	O		Private Extension	VS

7.3.5 Context Request

The new MME/SGSN shall send the Context Request message to the old MME/SGSN on S3/S16/S10 interface as a part of TAU/RAU procedure to get the MM and EPS bearer Contexts for the UE.

If the sending node is a MME, it shall include in the Context Request message:

- the GUTI IE and Complete TAU Request Message IE if the GUTI received from UE indicates the old node is a MME.
- the RAI IE, P-TMSI IE and P-TMSI Signature IE if the GUTI received from UE indicates the old node is an SGSN.

If the sending node is an SGSN, it shall include RAI IE, P-TMSI IE and P-TMSI Signature IE in the Context Request message.

The new MME differentiates the type of the old node from the most significant bit of the MME group id in GUTI. The value 0 indicates that the old node is an SGSN, the GUTI shall be mapped to RAI and P-TMSI by the new MME; and the value 1 indicates the old node is a MME, the new MME include GUTI IE and Complete TAU Request Message IE in the Context Request message. The Mapping between temporary and area identities is defined in 3GPP TS 23.003 [2].

The Target PLMN ID IE shall be used in old SGSN/MME in order to decide whether un-used authentication vectors to be distributed to new SGSN/MME or not. Distribution and use of authentication vectors between different serving network domains are specified in 3GPP TS 33.401 [12].

Table 7.3.5-1 specifies the presence requirements and conditions of the IEs in the message.

Table 7.3.5-1: Information Elements in a Context Request

Information elements	P	Condition / Comment	IE Type	Ins.
IMSI	C	IMSI shall be included if the UE has been successfully authenticated.	IMSI	0
GUTI	C	The New MME shall include this IE over S10 interface.	GUTI	0
Routing Area Identity(RAI)	C	This IE shall be included over S3/S16 interface, if the GUTI indicates the old node is an SGSN, the new MME maps this IE from GUTI.	ULI for RAI	0
Packet TMSI(P-TMSI)	C	This IE shall be included over S3/S16 interface, if the GUTI indicates the old node is an SGSN, the new MME maps this IE from GUTI.	P-TMSI	0
P-TMSI Signature	C	This IE shall be included over S3/S16 interface, if the GUTI indicates the old node is an SGSN, the new MME maps this IE from GUTI.	P-TMSI Signature	0
Complete TAU request message	C	The new MME shall include this IE, and the old MME may use this IE for integrity check.	Complete Request Message	0
S3/S16/S10 Address and TEID for Control Plane	C	This IE specifies the address and the TEID for control plane message which is chosen by the new MME/SGSN. In case of SGSN pool, the IPv4 or the IPv6 address field shall be set to the same value of the Source IP address of the IP packet carrying this message, and the relaying SGSN shall not change the content of this IE when sending it to the old SGSN.	F-TEID	0
UDP Source Port Number	C	If an SGSN within the same SGSN pool as the old SGSN receives this message, the SGSN shall include the UDP Source Port number of the received message in this parameter if this IE is not present and relay the message to the old SGSN. The old SGSN shall use this UDP port as the UDP destination port of the Context Response message.	Port Number	0
RAT Type	C	The RAT Type indicates the Radio Access Technology which is used in the new system.	RAT Type	0
Indication	O	Applicable Flags are: - The MS Validated indicates that the new system has successfully authenticated the UE, or the new system has validated the integrity protection of the TAU request message.	Indication	0
Hop Counter	O	If an SGSN within the same SGSN pool with the old SGSN receives this message, the SGSN shall decrement the Hop Counter if this IE is present in the received message; otherwise, the SGSN may include a Hop Counter with a value of max-1, and may relay the message to the old SGSN.	Hop Counter	0
Target PLMN ID	CO	If available, this IE shall be included in order to allow old MME/SGSN to make a judgment whether un-used authentication vectors to be distributed or not.	Serving Network	0
Private Extension	O		Private Extension	VS

7.3.6 Context Response

A Context Response message shall be sent as a response to a previous Context Request message during TAU/RAU procedure.

Possible Cause values are:

- "Request Accepted"
- "IMSI not known"
- "System failure"
- "Mandatory IE incorrect"

- "Conditional IE missing".
- "Invalid message format"
- "P-TMSI Signature mismatch"
- "User authentication failed"

Table 7.3.6-1 specifies the presence requirements and conditions of the IEs in the message.

Table 7.3.6-1: Information Elements in a Context Response

Information elements	P	Condition / Comment	IE Type	Ins.
Cause	M		Cause	0
IMSI	C		IMSI	0
MME/SGSN UE MM Context	C		MM Context	0
MME/SGSN UE EPS PDN Connections	C	This IE shall be included if there is at least a PDN connection for this UE on the sending MME/SGSN. Several IEs with this type and instance values shall be included as necessary to represent a list of PDN Connections.	PDN Connection	0
Sender F-TEID for Control Plane	C	This IE specifies the address and the TEID for control plane message which is chosen by the old MME/SGSN.	F-TEID	0
SGW S11/S4 IP Address and TEID for Control Plane	C	This IE shall be included if a SGW is being used by the UE.	F-TEID	1
SGW node name	C	This IE shall be included if the source MME or SGSN has the source SGW FQDN.	FQDN	0
Indication Flags	C	This IE shall be included if any of the flags are set to 1. Idle mode Signalling Reduction Supported Indication: <ul style="list-style-type: none"> - This flag shall be set to 1 if the Cause IE value indicates "Request accepted" and the old system has the ISR capability. 	Indication	0
Trace Information	C	This IE shall be included when session trace is active for this IMSI/IMEI.	Trace Information	0
HRPD access node S101 IP address	C	This IE shall be included only if the HRPD pre registration was performed at the old MME	IP-Address	0
1xIWS S102 IP address	C	This IE shall be included only if the 1xRTT CS fallback pre registration was performed at the old MME	IP-Address	1
Private Extension	O		Private Extension	VS

Table 7.3.6-2: MME/SGSN UE EPS PDN Connections within Context Response

Information elements	P	Condition / Comment	IE Type	Ins.
APN	M		APN	0
APN Restriction	C	This IE denotes the restriction on the combination of types of APN for the APN associated with this EPS bearer Context. The target MME or SGSN determines the Maximum APN Restriction using the APN Restriction. If available, the source MME/S4 SGSN shall include this IE.	APN Restriction	0
IPv4 Address	C	This IE shall not be included if no IPv4 Address is assigned.	IP Address	0
IPv6 Address	C	This IE shall not be included if no IPv6 Address is assigned.	IP Address	1
Linked EPS Bearer ID	M	This IE identifies the default bearer of the PDN Connection.	EBI	0
PGW S5/S8 IP Address for Control Plane or PMIP	M	This IE shall include the TEID in the GTP based S5/S8 case and the GRE key in the PMIP based S5/S8 case.	F-TEID	0
PGW node name	C	This IE shall be included if the source MME or SGSN has the PGW FQDN.	FQDN	0
Bearer Contexts	M	Several IEs with this type and instance values may be included as necessary to represent a list of Bearers.	Bearer Context	0
Aggregate Maximum Bit Rate (APN-AMBR)	M		AMBR	0
Charging characteristics	C	This IE shall be present if charging characteristics was supplied by the HSS to the MME/SGSN as a part of subscription information.	Charging characteristics	0
Change Reporting Action	C	This IE shall be included whenever available at the source MME/SGSN.	Change Reporting Action	0

The Bearer Context shall be coded as depicted in Table 7.3.6-3.

Table 7.3.6-3: Bearer Context within MME/SGSN UE EPS PDN Connections within Context Response

Information elements	P	Condition / Comment	IE Type	Ins.
EPS Bearer ID	M		EBI	0
TFT	C	This IE shall be present if a TFT is defined for this bearer.	Bearer TFT	0
SGW S1/S4/S12 IP Address and TEID for user plane	M		F-TEID	0
PGW S5/S8 IP Address and TEID for user plane	C	This IE shall only be included for GTP based S5/S8.	F-TEID	1
Bearer Level QoS	M		Bearer Level QoS	0
BSS Container	O	Packet Flow ID , Radio Priority, SAPI, PS Handover XID Parameters may be included as necessary.	F-Container	0
Transaction Identifier	C	This IE shall be sent over S3/S10/S16 if the UE supports A/Gb and/or lu mode.	TI	0

7.3.7 Context Acknowledge

A Context Acknowledge message shall be sent as a response to a previous Context Response message.

Possible cause values are:

- "Request accepted".
- "System failure".
- "Mandatory IE incorrect".
- "Mandatory IE missing".
- "Conditional IE missing".
- "No resources available".
- "Invalid message format".
- "User authentication failed".

Table 7.3.7-1 specifies the presence requirements and conditions of the IEs in the message.

Table 7.3.7-1: Information Elements in a Context Acknowledge

Information elements	P	Condition / Comment	IE Type	Ins.
Cause	M	None	Cause	0
Indication flags	C	Applicable Flags are: SGWCI: <ul style="list-style-type: none"> - SGW change indication indicates a new SGW has been selected. The old MME/old SGSN marks in its context that the information in the GWs and the HSS are invalid. ISRAI: <ul style="list-style-type: none"> - This flag indicates to the old system that it shall maintain the UE's contexts. This IE shall be included if the Cause IE value indicates "Request accepted". 	Indication	0
Private Extension	O	None	Private Extension	VS

7.3.8 Identification Request

If the UE identifies itself with temporary identity and it has changed SGSN/MME since detach in Attach procedure, the new MME/SGSN shall send an Identification Request message to the old SGSN/MME over S3, S16 or S10 interface to request IMSI.

Table 7.3.8-1 specifies the presence requirements and conditions of the IEs in the message.

If the sending node is a MME, it shall include in the Identification Request message:

- the GUTI IE and Complete Attach Request Message IE if the GUTI received from UE indicates the old node is a MME.
- the RAI IE, P-TMSI IE and P-TMSI Signature IE if the GUTI received from UE indicates the old node is an SGSN.

If the sending node is an SGSN, it shall include RAI IE, P-TMSI IE and P-TMSI Signature IE in the Identification Request message.

The new MME differentiates the type of the old node from the most significant bit of the MME group id in GUTI. The value 0 indicates that the old node is an SGSN, the GUTI shall be mapped to RAI and P-TMSI by the new MME; and the value 1 indicates the old node is a MME, the new MME include GUTI IE and Complete Attach Request Message IE in the Identification Request message. The Mapping between temporary and area identities is defined in 3GPP TS 23.003 [2].

The GUTI IE shall not coexist with any of the RAI IE, P-TMSI IE and P-TMSI Signature IE in an Identification Request message. If this occurs, the receiving node shall return a corresponding cause value in the response message.

The Target PLMN ID IE shall be used in old SGSN/MME in order to decide whether un-used authentication vectors to be distributed to new SGSN/MME or not. Distribution and use of authentication vectors between different serving network domains are specified in 3GPP TS 33.401 [12].

Table 7.3.8-1: Information Elements in an Identification Request

Information elements	P	Condition / Comment	IE Type	Ins.
GUTI	C	The new MME shall include this IE over S10 interface.	GUTI	0
Routeing Area Identity(RAI)	C	This IE shall be included over S3/S16 interface, if the GUTI received from the UE indicates the old node is an SGSN, the new MME maps this IE from GUTI.	ULI for RAI	0
Packet TMSI(P-TMSI)	C	This IE shall be included over S3/S16 interface, if the GUTI received from the UE indicates the old node is an SGSN, the new MME maps this IE from GUTI.	P-TMSI	0
P-TMSI Signature	C	This IE shall be included over S3/S16 interface, if the GUTI received from the UE indicates the old node is an SGSN, the new MME maps this IE from GUTI.	P-TMSI Signature	0
Complete Attach Request Message	C	The new MME shall include this IE over S10 interface, and the old MME may use this IE for integrity check.	Complete Request Message	0
Address for Control Plane	O	If an SGSN within the same SGSN pool with the old SGSN receives this message, the SGSN shall include the old IP address of the received message in this optional parameter if this IE is not present and relay the message to the old SGSN.	IP Address	0
UDP Source Port Number	C	If an SGSN within the same SGSN pool as the old SGSN receives this message, the SGSN shall include the UDP Source Port number of the received message in this parameter if this IE is not present and relay the message to the old SGSN. The old SGSN shall use this UDP port as the UDP destination port of the Identification Response message.	Port Number	0
Hop Counter	O	If an SGSN within the same SGSN pool with the old SGSN receives this message, the SGSN shall decrement the Hop Counter if this IE is present in the received message; otherwise, the SGSN may include a Hop Counter with a value of max-1, and may relay the message to the old SGSN.	Hop Counter	0
Target PLMN ID	CO	If available, this IE shall be included in order to allow old MME/SGSN to make a judgment whether un-used authentication vectors to be distributed or not.	Serving Network	0
Private Extension	O	None	Private Extension	VS

7.3.9 Identification Response

The old SGSN/MME shall send an Identification Response message to the new MME/SGSN as a response to a previous Identification Request message over S3/S10/S16 interface.

Table 7.3.9-1 specifies the presence requirements and conditions of the IEs in the message.

For Intra Domain Connection of RAN Nodes to Multiple CN Nodes, if an old SGSN within an SGSN pool receives an Identification Request message that contains the optional parameter Address for Control Plane, the old SGSN shall use this address as destination IP address of the Identification Response message.

Possible Cause values are:

- "Request accepted"
- "System failure"
- "Mandatory IE incorrect"
- "Conditional IE missing".
- "Invalid Message format"

- "P-TMSI Signature mismatch"
- "User authentication failed"

Only the Cause information element shall be included in the response if the Cause contains another value than "Request accepted".

Table 7.3.9-1: Information Elements in an Identification Response

Information elements	P	Condition / Comment	IE Type	Ins.
Cause	M		Cause	0
IMSI	C	This IE shall be included if the Cause contains the value "Request accepted".	IMSI	0
MME/SGSN UE MM Context	C	This IE shall be included if Attach Request is integrity protected	MM Context	0
Private Extension	O		Private Extension	VS

7.3.10 Forward Access Context Notification

A Forward Access Context Notification message shall be sent from the Old SGSN to the New SGSN over the S16 interface to forward the RNC contexts to the target system, or sent from the Old MME to the New MME over the S10 interface to forward the RNC/eNodeB contexts to the target system.

When the old SGSN receives the RANAP message Forward SRNS Context, the old SGSN shall send a Forward Access Context Notification message to the new SGSN. The new SGSN shall forward the message to the target RNC using the corresponding RANAP message.

When the old SGSN receives a BSSGP message PS handover Required and the acknowledged peer-to-peer LLC operation is used for the Bearer Context or when "delivery order" is set in the Bearer Context QoS profile, the old SGSN shall send a Forward Access Context Notification message with the PDU Number IE to the new SGSN. The new SGSN shall forward the message to the target RNC/ target BSS using the corresponding RANAP message only for PS handover to Iu mode.

When the old SGSN receives a BSSGP message PS handover Required from source BSS/RNC for PS handover to A/Gb mode, the value part of RAB Context IE shall be empty according to its defined minimum length.

Table 7.3.10-1 specifies the presence requirements and conditions of the IEs in the message.

Table 7.3.10-1: Information Elements in a Forward Access Context Notification

Information elements	P	Condition / Comment	IE Type	Ins.
RAB Contexts	C	This IE shall be included for S16 only. Several IEs with this type and instance values shall be included as necessary to represent a list of Bearers. For each RAB context in the received RANAP message, the old SGSN shall include this IE in the message.	RAB Context	0
Source RNC PDCP context Info	C	If available, the old SGSN shall include an Source RNC PDCP context info in the message.	Source RNC PDCP context Info	0
PDU Numbers	C	This IE only applies to S16. The old SGSN shall include this IE in the message if the acknowledged peer-to-peer LLC operation is used for the Bearer Context or when "delivery order" is set in the Bearer Context QoS profile in A/Gb mode to Iu/A/Gb mode PS handover.	PDU Numbers	0
E-UTRAN Transparent Container	C	This IE shall be included over S10 to contain the eNodeB Status Transfer Transparent Container IE specified in S1-AP.	F-Container	0
Private Extension	O		Private Extension	VS

7.3.11 Forward Access Context Acknowledge

A Forward Access Context Acknowledge message shall be sent to the old SGSN as a response to Forward SRNS Context Notification.

Possible Cause values are:

- "Request Accepted".
- "Mandatory IE incorrect".
- "Conditional IE missing".
- "Invalid message format".

Table 7.3.11-1 specifies the presence requirements and conditions of the IEs in the message.

Table 7.3.11-1: Information Elements in a Forward Access Context Acknowledge

Information elements	P	Condition / Comment	IE Type	Ins.
Cause	M		Cause	0
Private Extension	O		Private Extension	VS

7.3.12 Detach Notification

A Detach Notification message shall be sent from an MME to the associated SGSN, or from an SGSN to the associated MME as a part of Detach procedure if the ISR is activated between the MME and SGSN for the UE.

Possible Cause values are:

- "Local Detach".
- "Complete Detach".

"Local Detach" indicates that this detach is local to the MME/SGSN and so the associated SGSN/MME registration where the ISR is activated shall not be detached. The MME/SGSN that receives this message including this Cause value of "Local Detach" only deactivates the ISR. This Cause value shall be included in the procedures:

- MME/SGSN-initiated Detach Procedure in case of implicit detach.

"Complete Detach" indicates both the MME registration and the SGSN registration that the ISR is activated for, shall be detached. This "Complete Detach" Cause value shall be included in the procedures:

- UE-initiated Detach Procedure.
- MME/SGSN-initiated Detach Procedure in case of explicit detach.

Table 7.3.12-1 specifies the presence of the IEs in the message.

Table 7.3.12-1: Information Elements in a Detach Notification

Information elements	P	Condition / Comment	IE Type	Ins.
Cause	M		Cause	0
Private Extension	O		Private Extension	VS

7.3.13 Detach Acknowledge

A Detach Acknowledge message shall be sent as a response to a Detach Notification message during Detach procedure.

Possible Cause values are:

- "Request accepted".
- "System failure".
- "Mandatory IE incorrect".
- "Mandatory IE missing".
- "Invalid Message format"

Table 7.3.13-1 specifies the presence of the IEs in the message.

Table 7.3.13-1: Information Elements in a Detach Acknowledge

Information elements	P	Condition / Comment	IE Type	Ins.
Cause	M		Cause	0
Recovery	O		Recovery	0
Private Extension	O		Private Extension	VS

7.3.14 Change Notification Request

The Change Notification Request message is sent on the S4 interface by the SGSN to the SGW and on the S5/S8 interface by the SGW to the PGW as part of location dependent charging related procedures.

The TEID value used in this message shall be zero.

Table 7.3.14-1: Information Element in Change Notification Request

Information elements	P	Condition / Comment	IE Type	Ins.
IMSI	M	None	IMSI	0
RAT Type	M	None	RAT Type	0
User Location Information (ULI)	C	The SGSN shall include the User Location Information IE if the MS is located in a RAT Type of GERAN, UTRAN or GAN and shall include the CGI, SAI or RAI in the "Geographic Location" field depending on whether the MS is in a cell, a service or a routing area respectively.	ULI	0
PGW S5/S8 GTP-C IP Address	C	This IE shall be sent on S4.	IP Address	0
Private Extension	O	Vendor or operator specific information	Private Extension	VS

7.3.15 Change Notification Response

The Change Notification Request message is sent on the S4 interface by the SGW to the SGSN and on the S5/S8 interface by the PGW to the SGW as part of location dependent charging related procedures to acknowledge the receipt of a Change Notification Request.

The Cause value indicates whether or not the Change Notification Request was received correctly. Possible Cause values are:

- "Request accepted".
- "Request accepted partially".
- "Request rejected".
- "Invalid message format".
- "IMSI not known".
- "Mandatory IE incorrect".

- "Mandatory IE missing".
- "Conditional IE missing".
- "System failure".

The TEID value used in this message shall be zero.

If the IMSI is unknown for the receiving GTP-C entity, then the message shall be silently discarded and no further processing of the IEs shall continue.

If the received Change Notification Response contains a Cause value of "IMSI not known", then the Change Reporting mechanism shall be stopped in the receiving SGSN for all Bearers associated with the IMSI received and the PGW from which the "IMSI not known" was occurred. The SGSN shall then initiate PDN disconnection for all of these PDN Connections associated with the PGW.

If the location Change Reporting mechanism is to be stopped for this subscriber in the SGSN, then the PGW shall include the Change Reporting Action IE in the message and shall set the value of the Action field appropriately.

Table 7.3.15-1: Information Element in Change Notification Response

Information elements	P	Condition / Comment	IE Type	Ins.
IMSI	M		IMSI	0
Cause	M		Cause	0
Change Reporting Action	C	This IE shall be included with the appropriate Action field If the location Change Reporting mechanism is to be started or stopped for this subscriber in the SGSN/MME.	Change Reporting Action	0
Private Extension	O		Private Extension	VS

7.3.16 Relocation Cancel Request

A Relocation Cancel Request message shall be sent from the source MME/SGSN to the target MME/SGSN on S3/S10/S16 interface as part of the Inter RAT handover Cancel procedure and on the S16 interface as part of the SRNS Relocation Cancel Procedure. Table 7.3.16-1 specifies the presence of the IEs in the message.

Table 7.3.16-1: Information Elements in Relocation Cancel Request

Information elements	P	Condition / Comment	IE Type	Ins.
IMSI	M		IMSI	0
RANAP Cause	C	This IE shall be present in the case of SRNS relocation cancel procedure. It shall contain the cause value received from the source RNC in the Relocation Cancel message received over the lu interface.	F-Cause	0
Private Extension	O		Private Extension	VS

7.3.17 Relocation Cancel Response

A Relocation Cancel Response message shall be sent as a response to a previous Relocation Cancel Request message during the Inter RAT handover Cancel procedure or the SRNS Relocation Cancel Procedure.

Possible Cause values are:

- "Request Accepted".
- "IMSI not known".
- "System failure".
- "Mandatory IE incorrect".
- "Mandatory IE missing".

- "Conditional IE missing".
- "Invalid message format".

Table 7.3.17-1 specifies the presence of the IEs in the message.

Table 7.3.17-1: Information Elements in Relocation Cancel Response

Information elements	P	Condition / Comment	IE Type	Ins.
Cause	M		Cause	0
Private Extension	O		Private Extension	VS

7.3.18 Configuration Transfer Tunnel

A Configuration Transfer Tunnel message shall be used to tunnel eNodeB Configuration Transfer messages from a source MME to a target MME over the S10 interface. The purpose of the eNodeB Direct Configuration Transfer is to transfer information from an eNodeB to another eNodeB in unacknowledged mode (see 3GPP TS 36.413 [10]).

Table 7.3.18-1 specifies the presence requirements and conditions of the IEs in the message.

Table 7.3.18-1: Information Elements in a Configuration Transfer Tunnel Message

Information elements	P	Condition / Comment	IE Type	Ins.
E-UTRAN Transparent Container	M	This IE shall contain the SON transfer IE.	F-Container	0
Target eNodeB ID	M	This IE shall contain the ID of the target eNodeB	Target Identification	0

7.3.19 RAN Information Relay

The RAN Information Relay message shall be sent on S3 interface between SGSN and MME to transfer the RAN information received by an SGSN from BSS or RNS (GERAN Iu mode) or by an MME from eNodeB. The procedures are specified in 3GPP TS 23.401 [3].

This message shall also be sent on S16 interface to transfer the RAN information between GERAN or GERAN Iu mode and UTRAN.

For handling of protocol errors the RAN Information Relay message is treated as a Response message.

Table 7.3.19-1 specifies the presence requirements and conditions of the IEs in the message.

Table 7.3.19-1: Information Elements in a RAN Information Relay

Information elements	P	Condition / Comment	IE Type	Ins.
BSS Container	M	All information elements from the RIM messages, starting from and including the BSSGP "PDU type", shall be contained within the BSS Container and forwarded to the destination MME/SGSN in the RAN Information Relay message.	F-Container	0
RIM Routing Address	C	This IE shall be included if the RIM Routing Address information is included in the message sent from the source RAN node This IE identifies the destination RAN node where the RAN Information needs to be relayed to. It contains the destination RNC Identity when the source is E-UTRAN/UTRAN and the target is GERAN lu mode or the destination Cell Identity when the source is E-UTRAN/UTRAN and the target is GERAN or the destination global eNodeB ID when the source is GERAN and the target is E-UTRAN.	Target Identification	0
Private Extension	O	None	Private Extension	VS

7.4 CS Fallback related messages

7.4.1 Suspend Notification

The Suspend Notification message shall be sent on the S11 interface by the MME to the SGW as part of the CS fallback from E-UTRAN access to UTRAN/GERAN CS domain access related procedures and also for 1xRTT CS fallback procedures.

Table 7.4.1-1 specifies the presence requirements and conditions of the IEs in the message.

Table 7.4.1-1: Information Element in Suspend Notification

Information elements	P	Condition / Comment	IE Type	Ins.
IMSI	M		IMSI	0
Private Extension	O		Private Extension	VS

7.4.2 Suspend Acknowledge

The Suspend Acknowledge message shall be sent on the S11 interface by the SGW to the MME as part of the CS fallback from E-UTRAN access to UTRAN/GERAN CS domain access related procedures and also for 1xRTT CS fallback procedures.

Possible Cause values are:

- "Request Accepted".
- "Mandatory IE incorrect".
- "Mandatory IE missing".
- "Optional IE incorrect".
- "Invalid message format".

Table 7.4.2-1 specifies the presence requirements and conditions of the IEs in the message.

Table 7.4.2-1: Information Element in Suspend Acknowledge

Information elements	P	Condition / Comment	IE Type	Ins.
Cause	M		Cause	0
Private Extension	O		Private Extension	VS

7.4.3 Resume Notification

The Resume Notification message shall be sent on the S11 interface by the MME to the SGW as part of the resume procedure returning from CS fallback to E-UTRAN.

Table 7.4.3-1 specifies the presence requirements and conditions of the IEs in the message.

Table 7.4.3-1: Information Element in Resume Notification

Information elements	P	Condition / Comment	IE Type	Ins.
IMSI	M		IMSI	0
Private Extension	O		Private Extension	VS

7.4.4 Resume Acknowledge

The Resume Acknowledge message shall be sent on the S11 interface by the SGW to the MME as part of the resume procedure returning from CS fallback to E-UTRAN.

Possible Cause values are:

- "Request Accepted".
- "Mandatory IE incorrect".
- "Mandatory IE missing".
- "Optional IE incorrect".
- "Invalid message format".

Table 7.4.4-1 specifies the presence requirements and conditions of the IEs in the message.

Table 7.4.4-1: Information Element in Resume Acknowledge

Information elements	P	Condition / Comment	IE Type	Ins.
Cause	M		Cause	0
Private Extension	O		Private Extension	VS

7.4.5 CS Paging Indication

The CS Paging Indication shall be sent on the S3 interface by the MME to the associated SGSN when ISR is activated as part of mobile terminated CS services. The MME gets the related information from SGsAP-PAGING-REQUEST message as specified in 3GPP TS29.118 [21]. Table 7.4.5-1 specifies the presence requirements and the conditions of the IEs in the message.

Table 7.4.5-1: Information Element in CS Paging Indication

Information elements	P	Condition / Comment	IE Type	Ins.
IMSI	M		IMSI	0
VLR Name	M		FQDN	0
TMSI	O		TMSI	0
Location area identifier	O		ULI	0
Global CN-Id	O		Global CN-Id	0
Channel needed	O		Channel needed	0
eMLPP Priority	O		eMLPP Priority	0
Private Extension	O		Private Extension	VS

7.5 Non-3GPP access related messages

7.5.1 Create Forwarding Tunnel Request

A Create Forwarding Tunnel Request message shall be sent by a MME to a Serving GW as a part of the MME configures resources for indirect data forwarding during active handover procedure from E-UTRAN to CDMA 2000 HRPD access.

Table 7.5.1-1 specifies the presence requirements and the conditions of the IEs in the message.

Table 7.5.1-1: Information Elements in a Create Forwarding Tunnel Request

Information elements	P	Condition / Comment	IE Type	Ins.
S103 PDN Data Forwarding Info	M	The MME shall include the forwarding Information for all PDN connections of the UE requesting data forwarding towards the HSGW in the message as S103 PDN Data Forwarding Info information elements. The Serving GW shall forward downlink data to the HSGW via the GRE tunnel identified by the HSGW Address and HSGW GRE Key included in this information element when it receives downlink data forwarded from the eNodeB belonging to the corresponding EPS bearers of the PDN connection.	S103PDF	0
Private Extension	O		Private Extension	VS

7.5.2 Create Forwarding Tunnel Response

A Create Forwarding Tunnel Response message shall be sent by a Serving GW to a MME as a response to a Create Forwarding Tunnel Request message.

Table 7.5.2-1 specifies the presence requirements and the conditions of the IEs in the message.

The Cause value indicates if Data Forwarding Resources has been created in the Serving GW or not. Data Forwarding Resources have not been created in the Serving GW if the Cause differs from "Request accepted". Possible Cause values are:

- "Request Accepted".
- "No resources available".
- "System failure".
- "Mandatory IE incorrect".
- "Mandatory IE missing".
- "Invalid message format".

Only the Cause IE shall be included in the response if the Cause IE contains another value than "Request accepted".

Table 7.5.2-1: Information Elements in a Create Forwarding Tunnel Response

Information elements	P	Condition / Comment	IE Type	Ins.
Cause	M	None	Cause	0
S1-U Data Forwarding Info	C	S1-U Data Forwarding Info shall be included in the message if the Cause contains the value "Request accepted". For each EPS bearer requesting data forwarding which is included in the S103 PDN Data Forwarding Info fields of corresponding Create Forwarding Tunnel Request message, the Serving GW shall assign a Serving GW S1-U Address and Serving GW S1-U TEID pair and included it in the response message as S1-U Data Forwarding Info information element. The eNodeB shall forward downlink data of the EPS bearer to the Serving GW via the GTP-U tunnel identified by the Serving GW S1-U Address and Serving GW S1-U TEID.	S1UDF	0
Private Extension	O		Private Extension	VS

7.6 Reliable Delivery of Signalling Messages

Retransmission requirements in the current subclause do not apply to the Initial messages that do not have Triggered messages.

Reliable delivery in GTPv2 messages is accomplished by retransmission of these messages. A message shall be retransmitted if and only if a reply is expected for that message and the reply has not yet been received. There may be limits placed on the total number of retransmissions to avoid network overload.

Initial messages and their Triggered messages, as well as Triggered messages and their Triggered Reply messages are matched based on the Sequence Number and the IP address and port rules in subclause 4.2 "Protocol stack". Therefore, an Initial message and its Triggered message, as well as a Triggered message and its Triggered Reply message shall have the same sequence Number. A retransmitted GTPv2 message (an Initial or a Triggered) has the exact same GTPv2 message content, including the GTP header, UDP ports, source and destination IP addresses as the originally transmitted GTPv2 message.

For each triplet of local IP address, local UDP port and remote peer's IP address a GTP entity maintains a sending queue with signalling messages to be sent to that peer. The message at the front of the queue shall be sent with a Sequence Number, and if the message has an expected reply, it shall be held in a list until a reply is received or until the GTP entity has ceased retransmission of that message. The Sequence Number shall be unique for each outstanding Initial message sourced from the same IP/UDP endpoint. A node running GTP may have several outstanding messages waiting for replies. Not counting retransmissions, a single GTP message with an expected reply shall be answered with a single GTP reply, regardless whether it is per UE, per APN, or per bearer

A piggybacked initial message (such as a Create Bearer Request message or Modify Bearer Request message) shall contain a Sequence Number that is assigned by sending GTP entity and the message shall be held in a list until a response is received. The response message to a piggybacked initial message may arrive without piggybacking (e.g., Create Bearer Response at PGW).

The Sequence Number in the GTP header of the triggered response message shall be copied from the respective request message.

If a request message (e.g., Create Session Request) triggers piggybacking (i.e., Create Bearer Request piggybacked on Create Session Response), re-transmission of the request message shall also trigger piggybacking. A Sequence Number used for a Command message and its Triggered messages, as well as respective Triggered Reply message shall be the same as in the Command message and shall have the most significant bit set to 1. This setting of the most significant bit of the Sequence Number is done to avoid potential clashes between the Sequence Number selected for a Command message, and the Sequence Number selected by a GTPv2 peer for a Request message, which was not triggered by a Command message.

A Sequence Number used for a Request message, which was not triggered by a Command message shall have the most significant bit set to 0.

A timer, denoted T3-RESPONSE, shall be started when a signalling message (for which a reply is expected) is sent. A signalling message or the triggered message has probably been lost if a reply has not been received before the T3-RESPONSE timer expires.

Once the T3-RESPONSE timer expires, the message corresponding to the T3-RESPONSE timer is then retransmitted if the total number of retry attempts is less than N3-REQUESTS times. The expiry of the timer for piggybacked request messages shall result in re-transmission of the original IP/UDP packet containing both the triggered response message and the piggybacked initial message. T3-RESPONSE timer and N3-REQUESTS counter setting is implementation dependent. That is, the timers and counters may be configurable per procedure. Multileg communications (e.g. Create Session Requests and Responses) however require longer timer values and possibly a higher number of retransmission attempts compared to single leg communication.

All received GTPv2 messages with an expected reply shall be replied to and all reply messages associated with a certain message shall always include the same information. Duplicated reply messages shall be discarded by the receiver unless the reply needs a reply. A received reply message without a matching outstanding message that is waiting for a reply should be discarded.

If a GTPv2 node is not successful with the transfer of a non-Echo signalling message, e.g. a Create Bearer Context Request message, it shall inform the upper layer of the unsuccessful transfer so that the controlling upper entity may take the necessary measures.

7.7 Error Handling

7.7.0 Handling Piggybacked Messages

For piggybacked initial messages, the following general rule shall apply: the triggered response message carrying the piggybacked message shall be processed first, according to the following sections. Subsequently, the piggybacked initial message shall be processed independently. If the processing of dedicated bearer activation message results in an error, this shall not affect the default bearer establishment. If the default bearer establishment fails, the dedicated bearer activation related message shall be discarded.

7.7.1 Protocol Errors

A protocol error is defined as a message or an Information Element received from a peer entity with unknown type, or if it is unexpected, or if it has an erroneous content.

The term silently discarded is used in the following subclauses to mean that the receiving GTP entity's implementation shall discard such a message without further processing, or that the receiving GTP entity discards such an IE and continues processing the message. The conditions for the receiving GTP entity to silently discard an IE are specified in the subsequent subclauses.

The handling of unknown, unexpected or erroneous GTP messages and IEs shall provide for the forward compatibility of GTP. Therefore, the sending GTP entity shall be able to safely include in a message a new conditional-optional or an optional IE. Such an IE may also have a new type value. Any legacy receiving GTP entity shall, however, silently discard such an IE and continue processing the message.

If a protocol error is detected by the receiving GTP entity, it should log the event including the erroneous message and should include the error in a statistical counter.

An information element with "Mandatory" in the "Presence requirement" column of a message definition shall always be present in that message.

An information element with "Conditional" in the "Presence requirement" column of a message definition shall be sent when the conditions detailed in the "Presence requirement" are met.

The Version Not Supported Indication message shall be considered as a Triggered message as specified in subclause 4.2.5 "Messages with GTPv2 defined replies: Classification of Initial and Triggered Messages".

The receiving GTP entity shall apply the error handling specified in the subsequent subclauses in decreasing priority.

If the received erroneous message is a reply to an outstanding GTP message, the GTP transaction layer shall stop retransmissions and notify the GTP application layer of the error even if the reply is silently discarded.

7.7.2 Different GTP Versions

If a GTP entity receives a message of an unsupported GTP version, it shall return a Version Not Supported Indication message and discard the received message.

7.7.3 GTP Message of Invalid Length

If a GTP entity receives a message, which is too short to contain the respective GTPv2 header, the GTP-PDU shall be silently discarded.

Apart from a piggybacked GTP message, if a GTP entity receives a Request message within an IP/UDP packet of a length that is inconsistent with the value specified in the Length field of the GTP header, then the receiving GTP entity should log the error and shall send the Response message with Cause IE value set to "Invalid Length".

Apart from a piggybacked GTP message, if a GTP entity receives a Response message within an IP/UDP packet of a length that is inconsistent with the value specified in the Length field of the GTP header, then the receiving GTP entity should log the error and shall silently discard the message.

If a GTP entity receives two GTP messages (triggered response message and a piggybacked initial message) within an IP/UDP packet of a length that is inconsistent with the total length of the two concatenated messages as indicated by Length fields of the GTP headers, then the receiving GTP entity should log the error and return an appropriate Response message with Cause IE value set to "Invalid overall length of the triggered response message and a piggybacked initial message". That is:

- for a Create Session Response message together with a piggybacked Create Bearer Request message, a Create Bearer Response message should be returned with the above Cause value.
- for a Create Bearer Response message together with a piggybacked Modify Bearer Request message, a Modify Bearer Response message should be returned with the above Cause value.

7.7.4 Unknown GTP Message

If a GTP entity receives a message with an unknown Message Type value, it shall silently discard the message.

7.7.5 Unexpected GTP Message

If a GTP entity receives an unexpected initial message (see subclause 4.3 "Protocol stack"), it shall be silently discard the message and shall log an error.

If a GTP entity receives an unexpected triggered message (see subclause 4.3 "Protocol stack"), it shall discard the message and may log an error.

7.7.6 Missing Information Elements

A GTP entity shall check if all mandatory IEs are present in the received Request message. If one or more mandatory information elements are missing, the GTP entity should log the error and shall send a Response message with Cause IE value set to "Mandatory IE missing" together with the type and instance of the missing mandatory IE.

If a GTP entity receives a Response message with Cause IE value set to "Mandatory IE missing", it shall notify its upper layer.

A GTP entity shall check if all mandatory IEs are present in the received Response message. If one or more mandatory information elements are missing, the GTP entity shall notify the upper layer and should log the error.

A GTP entity shall check if conditional information elements are present in the received message, if possible (i.e. if the receiving entity has sufficient information available to check if the respective conditions were met).

When possible, a GTP entity shall check if all conditional IEs are present in the received Request message. If one or more conditional information elements are missing, GTP entity should log the error and shall send a Response message with Cause IE value set to "Conditional IE missing" together with the type and instance of the missing conditional IE.

When possible, a GTP entity shall check if all conditional IEs are present in the received Response message. If one or more conditional information elements are missing, GTP entity shall notify the upper layer and should log the error.

Absence of an optional information element shall not trigger any of the error handling processes.

7.7.7 Invalid Length Information Element

An information element has invalid length when the actual length of the IE is different from the value of the Length field in the IE header.

If a GTP message contains more than one information elements and one or more of them have invalid length, the receiving GTP entity can detect which of the IEs have invalid length only in the following cases:

- If the Length value in the IE header is greater than the overall length of the message;
- If the invalid length IE is the last one in the message.

If a receiving GTP entity detects information element with invalid length in a Request message, it shall send an appropriate error response with Cause IE value set to "Invalid length" together with the type and instance of the offending IE.

Other Length field handling cases are specified below:

- If the received value of the Length field and the actual length of the fixed length IE are consistent, but the length is greater than that expected by the fixed number of octets, then the extra octets shall be discarded.
- If the received value of the Length field and the actual length of the fixed length IE are consistent, but the length is less than that expected by the fixed number of octets, this shall be considered an error, IE shall be discarded and if the IE was received as a Mandatory IE or a verifiable Conditional IE in a Request message, an appropriate error response with Cause IE value set to "Invalid length" together with the type and instance of the offending IE shall be returned to the sender.
- If the received value of the Length field and the actual length of the extendable length IE are consistent, but the length is greater than that expected by the fixed number of octets preceding the extended field(s), then the extra unknown octets shall be discarded.
- If the received value of the Length field and the actual length of the extendable length IE are consistent, but the length is less than that expected by the fixed number of octets preceding the extended field(s), this shall be considered an error, IE shall be discarded and if the IE was received as a Mandatory IE or a verifiable Conditional IE in a Request message, an appropriate error response with Cause IE value set to "Invalid length" together with the type and instance of the offending IE shall be returned to the sender.

7.7.8 Semantically incorrect Information Element

The receiver of a GTP signalling message Request including a mandatory or a verifiable conditional information element with a semantically invalid Value shall discard the request, should log the error, and shall send a response with Cause set to "Mandatory IE incorrect" together with a type and instance of the offending IE.

The receiver of a GTP signalling message Response including a mandatory or a verifiable conditional information element with a semantically invalid Value shall notify the upper layer that a message with this sequence number has been received and should log the error.

If a GTP entity receives an information element with a value which is shown as reserved, it shall treat that information element as invalid and should log the error. If the invalid IE is received in a Request, and it is a mandatory IE or a verifiable conditional IE, the GTP entity shall send a response with Cause set to "Mandatory IE incorrect" together with a type and instance of the offending IE.

The principle is: the use of reserved values invokes error handling; the use of spare values can be silently discarded and so in the case of IEs with spare values used, processing shall be continued ignoring the spare values.

The receiver of a GTP signalling message including an optional information element with a Value that is not in the range defined for this information element value shall discard this IE, but shall treat the rest of the message as if this IE was absent and continue processing. The receiver shall not check the content of an information element field that is defined as 'spare'.

All semantically incorrect optional information elements in a GTP signalling message shall be treated as not present in the message.

7.7.9 Unknown or unexpected Information Element

The receiver of a GTP message including an unexpected information element with known Type value, but with the instance value that is not defined for this message shall discard the IE and log an error. The receiver shall process the message.

An information element with a Type value which is defined in section 8.1 of the present specification but whose Instance Value is not expected in the received GTP signalling message according to the grammar defined in section 7.1 to 7.5 and 7.9 of the present specification shall be silently discarded (skipped) and the rest of the message processed as if this information element was not present.

NOTE: An Information Element in an encoded GTPv2 message or grouped IE is identified by the pair of IE Type and Instance value.

7.7.10 Repeated Information Elements

An Information Element is repeated if there is more than one IE with the same IE Type and Instance in the scope of the GTP message (scope of the grouped IE). Such an IE is a member in a list.

If an information element is repeated in a GTP signalling message in which repetition of the information element is not specified, only the contents of the information element appearing first shall be handled and all subsequent repetitions of the information element shall be ignored. When repetition of information elements is specified, only the contents of specified repeated information elements shall be handled and all subsequent repetitions of the information element shall be ignored.

7.8 Path Failure

Restoration and Recovery procedures are specified generally in 3GPP TS 23.007 [17] and a path failure may initiate recovery procedures.

Path failure is detected only by using Echo Request / Response messages in the following way. A peer's IP address specific counter shall be reset each time an Echo Response message is received from that peer's IP address and incremented when the T3-RESPONSE timer expires for an Echo Request message sent to that peer's IP address. The path shall be considered to be down if the counter exceeds N3-REQUESTS. In this case, the GTP entity may notify the Operation and Maintenance network element. GTP shall also notify the upper layer of the path failure, so that PDN connections or PDP contexts associated with this peer's IP address may be deleted.

7.9 Restoration and Recovery

Restoration and Recovery procedures are specified in 3GPP TS 23.007 [17].

7.9.1 Delete PDN Connection Set Request

This message may be sent on S5, S8, or S11 interfaces as specified in 3GPP TS 23.007 [17].

Table 7.9.1-1: Information Elements in a Delete PDN Connection Set Request

Information elements	P	Condition / Comment	IE Type	Ins.
MME-FQ-CSID	C	This IE shall be included when a MME reports a partial fault according to the requirements in 3GPP TS 23.007 [17]. More than one FQ-CSID may appear.	FQ-CSID	0
SGW-FQ-CSID	C	This IE shall be included when a SGW reports a partial fault according to the requirements in 3GPP TS 23.007 [17]. More than one FQ-CSID may appear.	FQ-CSID	1
PGW-FQ-CSID	C	Shall be included when a PGW reports a partial fault. More than one FQ-CSID may appear	FQ-CSID	2
Private Extension	O	None	Private Extension	VS

TEID of 0 shall be used for the Delete PDN Connection Set Request.

Only one type of FQ-CSID shall be included in each Delete PDN Connection Set Request. A mix of different types, such as SGW-FQ-CSID and PGW-FQ-CSID shall not be used. A combined node, such as a collocated PGW/SGW, shall send separate Delete PDN Connection Set Request for the PGW role and one for the SGW role if a partial fault impacts more than one role.

7.9.2 Delete PDN Connection Set Response

This message is sent as a response to the Delete PDN Connection Set Request.

Table 7.9.2: Information Elements in a Delete PDN Connection Set Response

Information elements	P	Condition / Comment	IE Type	Ins.
Cause	M		Cause	0
Private Extension	O	None	Private Extension	VS

TEID of 0 shall be used for the Delete PDN Connection Set Response.

The following Cause values are defined:

- "Request Accepted"
- "Request rejected"
- "System failure".
- "Mandatory IE incorrect".
- "Conditional IE missing".
- "Invalid message format".

"Request Accepted" indicates the receiving node was capable of storing a CSID value for each PDN connection for the type of node (MME,SGW or PGW) in the Delete PDN Connection Set Request and has marked, or will mark immediately, the PDN connections for deletion as per 3GPP TS 23.007 [17]. "Request Accepted" shall be returned even if there are no PDN connections that match.

"Request rejected" shall be used when the receiver of the Delete PDN Connection Set Request is not capable of storing at least one CSID value per PDN connection for the type of node (MME, SGW or PGW) received in the Delete PDN Connection Set Request.

The SGW shall respond to the Delete PDN Connection Set Request independently, i.e. without waiting for replies.

7.9.3 Update PDN Connection Set Request

The SGW shall send this message to the PGW on S5/S8 according to the requirements in TS 23.007 [17].

Table 7.9.x-1: Information Elements in a Update PDN Connection Set Request

Information elements	P	Condition / Comment	IE Type	Ins.
MME-FQ-CSID	C	This IE shall be included for MME relocation without SGW relocation per 3GPP TS 23.007 [17].	FQ-CSID	0
SGW-FQ-CSID	C	This IE shall be included for MME relocation without SGW relocation per 3GPP TS 23.007 [17].	FQ-CSID	1
Private Extension	O	None	Private Extension	VS

7.9.4 Update PDN Connection Set Response

This message is sent by the PGW to the SGW on S5/S8 in response to the Update PDN Connection Set Request message.

Table 7.9.y: Information Elements in a Update PDN Connection Set Response

Information elements	P	Condition / Comment	IE Type	Ins.
Cause	M		Cause	0
PGW-FQ-CSID	C	This IE shall be included for MME relocation without SGW relocation per 3GPP TS 23.007 [17].	FQ-CSID	0
Private Extension	O	None	Private Extension	VS

The following Cause values are defined:

- "Request accepted"
- "Request rejected"
- "System failure".
- "Mandatory IE missing".
- "Invalid message format".

7.10 Fallback to GTPv1 mechanism

An EPC entity shall assume that each GTP processing node that it is about to communicate with is GTPv2 capable, i.e. before the first GTP tunnel is setup for a given UE/node, the EPC node shall always send a version 2 (GTPv2) message to a peer node.

A GTPv2 entity shall fallback to GTPv1 only if:

- a "Version Not Supported" message in GTPv1 format as specified in 3GPP TS 29.060 [4] is received from the peer node;
- Fallback to GTPv1 shall not occur on already established GTP tunnels without change of the peer nodes of the communication bearer.

If a GTPv2 entity does not support GTPv1 and receives a GTPv1 message, it shall silently discard the message.

7.11 Fallback to GTPv0

Fallback from GTPv2 to GTPv0 shall not be supported. Therefore, GTPv2 entity should not listen to the well-known GTPv0 port 3386. If GTPv2 entity listens to the GTPv0 port, the entity shall silently discard any received GTPv0 message.

7.12 Trace Management Messages

7.12.1 Trace Session Activation

The Trace Session Activation message shall be sent on S11/S4 by the MME/SGSN to the SGW, and on S5/S8 by the SGW to the PGW when session trace is activated for a particular IMSI or IMEI for a UE that is attached and active or attached and idle.

Table 7.12.1-1 specifies the presence of the IEs in the message.

Table 7.12.1-1: Information Elements in a Trace Session Activation

Information elements	P	Condition / Comment	IE Type	Ins.
IMSI	M		IMSI	0
Trace Information	M		Trace Information	0
ME Identity (MEI)	C	The MME shall include the ME Identity (MEI) IE, if available.	MEI	0

7.12.2 Trace Session Deactivation

The Trace Session Deactivation message shall be sent on S11/S4 by the MME/SGSN to the SGW, and on S5/S8 by the SGW to the PGW when session trace is deactivated for a particular IMSI or IMEI for a UE that is attached and active or attached and idle.

Table 7.12.2-1 specifies the presence of the IEs in the message.

Table 7.12.2-1: Information Elements in a Trace Session Deactivation

Information elements	P	Condition / Comment	IE Type	Ins.
Trace Reference	M		Trace Reference	0

8 GTP-C Information Elements

8.1 Information Element Types

A GTP control plane (signalling) message may contain several information elements. In order to have forward compatible type definitions for the GTPv2 information elements, all of them shall be TLIV (Type, Length, Instance, Value) coded. GTPv2 information element type values are specified in the Table 8.1-1. The last column of this table indicates whether the information element is:

- Fixed Length: the IE has a fixed set of fields, and a fixed number of octets.
- Variable Length: the IE has a fixed set of fields, and has a variable number of octets.
For example, the last octets may be numbered similar to "5 to (n+4)". In this example, if the value of the length field, n, is 0, then the last field is not present.
- Extendable: the IE has a variable number of fields, and has a variable number of octets.
The last fields are typically specified with the statement: "These octet(s) is/are present only if explicitly specified". The legacy receiving entity shall ignore the unknown octets.

In order to improve the efficiency of troubleshooting, it is recommended that the information elements should be arranged in the signalling messages as well as in the grouped IEs, according to the order the information elements are listed in the message definition table or grouped IE definition table in section 7. However the receiving entity shall be prepared to handle the messages with information elements in any order.

Within information elements, certain fields may be described as spare. These bits shall be transmitted with the value set to 0. To allow for future features, the receiver shall not evaluate these bits. GTPv2-C information elements that have similar semantics in GTPv1-C shall be converted into GTPv1-C format, as specified in TS 29.060 [4], before sending them to a pre-R8 GSN.

Table 8.1-1: Information Element types for GTPv2

IE Type value (Decimal)	Information elements	Comment / Reference
0	Reserved	
1	International Mobile Subscriber Identity (IMSI)	Variable Length / 8.3
2	Cause	Variable Length / 8.4
3	Recovery (Restart Counter)	Variable Length / 8.5
4 to 50	Reserved for S101 interface	Extendable / See 3GPP TS 29.276 [14]
51 to 70	Reserved for Sv interface	Extendable / See 3GPP TS 29.280 [15]
71	Access Point Name (APN)	Variable Length / 8.6
72	Aggregate Maximum Bit Rate (AMBR)	Fixed Length / 8.7
73	EPS Bearer ID (EBI)	Extendable / 8.8
74	IP Address	Variable Length / 8.9
75	Mobile Equipment Identity (MEI)	Variable Length / 8.10
76	MSISDN	Variable Length / 8.11
77	Indication	Extendable / 8.12
78	Protocol Configuration Options (PCO)	Variable Length / 8.13
79	PDN Address Allocation (PAA)	Variable Length / 8.14
80	Bearer Level Quality of Service (Bearer QoS)	Variable Length / 8.15
81	Flow Quality of Service (Flow QoS)	Extendable / 8.16
82	RAT Type	Extendable / 8.17
83	Serving Network	Extendable / 8.18
84	EPS Bearer Level Traffic Flow Template (Bearer TFT)	Variable Length / 8.19
85	Traffic Aggregation Description (TAD)	Variable Length / 8.20
86	User Location Information (ULI)	Variable Length / 8.21
87	Fully Qualified Tunnel Endpoint Identifier (F-TEID)	Extendable / 8.22
88	TMSI	Variable Length / 8.23
89	Global CN-Id	Variable Length / 8.24
90	S103 PDN Data Forwarding Info (S103PDF)	Variable Length / 8.25
91	S1-U Data Forwarding Info (S1UDF)	Variable Length / 8.26
92	Delay Value	Extendable / 8.27
93	Bearer Context	Extendable / 8.28
94	Charging ID	Extendable / 8.29
95	Charging Characteristics	Extendable / 8.30
96	Trace Information	Extendable / 8.31
97	Bearer Flags	Extendable / 8.32
98	Reserved	
99	PDN Type	Extendable / 8.34
100	Procedure Transaction ID	Extendable / 8.35
101	DRX Parameter	Variable Length / 8.36
102	UE Network Capability	Variable Length / 8.37
103	MM Context (GSM Key and Triplets)	Extendable / 8.38
104	MM Context (UMTS Key, Used Cipher and Quintuplets)	Extendable / 8.38
105	MM Context (GSM Key, Used Cipher and Quintuplets)	Extendable / 8.38
106	MM Context (UMTS Key and Quintuplets)	Extendable / 8.38
107	MM Context (EPS Security Context, Quadruplets and Quintuplets)	Extendable / 8.38
108	MM Context (UMTS Key, Quadruplets and Quintuplets)	Variable Length / 8.38
109	PDN Connection	Extendable / 8.39
110	PDU Numbers	Extendable / 8.40
111	P-TMSI	Variable Length / 8.41
112	P-TMSI Signature	Variable Length / 8.42
113	Hop Counter	Extendable / 8.43
114	UE Time Zone	Variable Length / 8.44
115	Trace Reference	Fixed Length / 8.45
116	Complete Request Message	Variable Length / 8.46
117	GUTI	Variable Length / 8.47
118	F-Container	Variable Length / 8.48
119	F-Cause	Variable Length / 8.49
120	Selected PLMN ID	Variable Length / 8.50
121	Target Identification	Variable Length / 8.51
122	NSAPI	Extendable / 8.52
123	Packet Flow ID	Variable Length / 8.53
124	RAB Context	Fixed Length / 8.54
125	Source RNC PDCP Context Info	Variable Length / 8.55
126	UDP Source Port Number	Extendable / 8.56
127	APN Restriction	Extendable / 8.57
128	Selection Mode	Extendable / 8.58
129	Source Identification	Variable Length / 8.59
130	Reserved	
131	Change Reporting Action	Variable Length / 8.61
132	Fully Qualified PDN Connection Set Identifier (FQ-CSID)	Variable Length / 8.62
133	Channel needed	Extendable / 8.63

IE Type value (Decimal)	Information elements	Comment / Reference
134	eMLPP Priority	Extendable / 8.64
135	Node Type	Extendable / 8.65
136	Fully Qualified Domain Name (FQDN)	Variable Length / 8.66
137	Transaction Identifier (TI)	Variable Length / 8.68
138 to 254	Spare. For future use.	FFS
255	Private Extension	Variable Length / 8.67

8.2 Information Element Format

Figure 8.2-1 depicts the format of an information element.

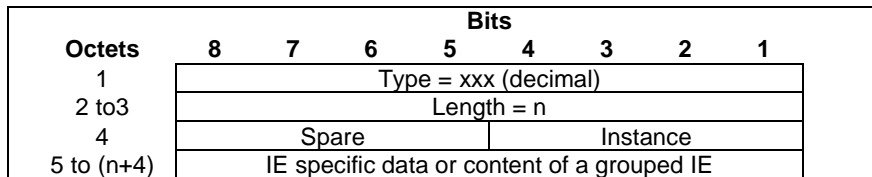

Figure 8.2-1: Information Element Format

An IE has the following mandatory fields:

- Type field: This field indicates the type of Information Element. The valid values of the IE type are defined in clause 8.1.
- Length: This field contains the length of the information element excluding the first four octets, which are common for all information elements (Type, Length and the contents of octet 4) and is denoted "n" in Figure 8.2-1. For all the length fields, bit 8 of the lowest numbered octet is the most significant bit and bit 1 of the highest numbered octet is the least significant bit.
- Instance: This field shall be used to differentiate amongst different parameters in one specific message which use the same information element type (see also subclause 6.1.3 "Information Element Instance").

An IE is said to be TLIV (Type, Length, Instance, Value) encoded.

8.3 International Mobile Subscriber Identity (IMSI)

International Mobile Subscriber Identity (IMSI) is transferred via GTP tunnels. The sending entity copies the value part of the IMSI into the Value field of the IMSI IE. IMSI is defined in 3GPP TS 23.003 [2].

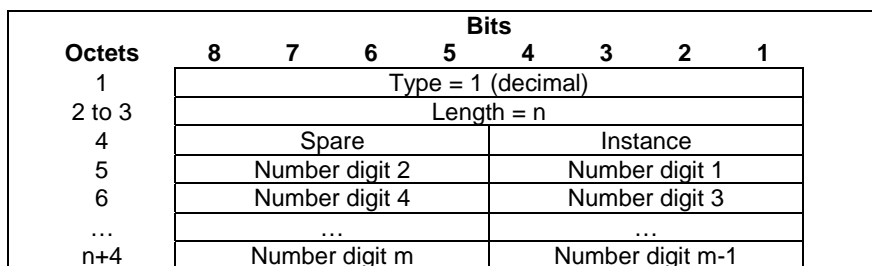

Figure 8.3-1: IMSI

Octets 5 to (n+4) represent the IMSI value in international number format as described in ITU-T Rec E.164 [25], encoded as TBCD digits, i.e. digits from 0 through 9 are encoded "0000" to "1001". When there is an odd number of digits, bits 8 to 5 of the last octet are encoded with the filler "1111". The maximum number of digits is 15.

8.4 Cause

Cause IE is coded as depicted in Figure 8.4-1.

Octets	Bits							
	8	7	6	5	4	3	2	1
1	Type = 2 (decimal)							
2 to 3	Length = n							
4	Spare				Instance			
5	Cause value							
6	Spare							CS
7	Type of the offending IE							
8-9	Length							
10	Spare				Instance			

Figure 8.4-1: Cause

The following bits within Octet 6 indicate:

- Bits 8 to 2: Spare, for future use and set to zero
- Bit 1 – CS (Cause Source): If this bit is set to 1, it indicates that the corresponding error cause is originated by the remote node (i.e., the MME to a PGW, or the PGW to a MME). This bit is set to 0 to denote that the corresponding error cause is originated by the node sending the message. The CS should be set to 1 by the SGW when the SGW relay a response message with cause value from the MME to the PGW or from the PGW to the MME. For PMIP based S5/S8, the SGW shall include the PMIP cause and set the CS bit to 1 when the SGW relay a response message with the cause value from the PGW to the MME.

The Cause value shall be included in the response message. In a response message, the Cause value indicates the acceptance or the rejection of the corresponding request message. The Cause value shall indicate the explicit reason for the rejection.

If the rejection is due to a mandatory IE or a verifiable conditional IE is faulty or missing, the offending IE shall be included within an additional field, as Type and Instance of the offending IE that caused the rejection. The length in the Octet 8-9 and spare bits in the Octet 10 shall be set to "0". In this case, the value of "n" shall be "6". Otherwise, the value of "n" is equal to "2".

The Cause may also be included in the request message. In a request message, the Cause value indicates the reason for the request.

"Request accepted" is returned when the GTPv2 entity has accepted a control plane request.

The listed cause values for rejection response message descriptions in clause 7 are not meant to be exhaustive lists. Therefore a GTPv2 node shall use the most appropriate matching rejection response cause value that is listed in Table 8.4-1.

Table 8.4-1: Cause values

Message Type	Cause value (decimal)	Meaning
	0	Reserved. Shall not be sent and if received the Cause shall be treated as an invalid IE
Request	1	Reserved
	2	Local Detach
	3	Complete Detach
	4	RAT changed from 3GPP to Non-3GPP
	5	ISR deactivation
	6	Error Indication received from RNC/eNodeB
	7 to 15	Spare. This value range is reserved for Cause values in a request message
Acceptance Response	16	Request accepted
	17	Request accepted partially
	18	New PDN type due to network preference
	19	New PDN type due to single address bearer only
	20 to -63	Spare. This value range is reserved for Cause values in acceptance response message
Rejection Response	64	Context Not Found
	65	Invalid Message Format
	66	Version not supported by next peer
	67	Invalid length
	68	Service not supported
	69	Mandatory IE incorrect
	70	Mandatory IE missing
	71	Reserved
	72	System failure
	73	No resources available
	74	Semantic error in the TFT operation
	75	Syntactic error in the TFT operation
	76	Semantic errors in packet filter(s)
	77	Syntactic errors in packet filter(s)
	78	Missing or unknown APN
	79	Unexpected repeated IE
	80	GRE key not found
	81	Relocation failure
	82	Denied in RAT
	83	Preferred PDN type not supported
	84	All dynamic addresses are occupied
	85	UE context without TFT already activated
	86	Protocol type not supported
	87	UE not responding
	88	UE refuses
	89	Service denied
	90	Unable to page UE
	91	No memory available
	92	User authentication failed
	93	APN access denied – no subscription
	94	Request rejected
	95	P-TMSI Signature mismatch
	96	IMSI not known
97	Semantic error in the TAD operation	
98	Syntactic error in the TAD operation	
99	Reserved Message Value Received	
100	Remote peer not responding	
101	Collision with network initiated request	
102	Unable to page UE due to Suspension	
103	Conditional IE missing	
104	APN Restriction type Incompatible with currently active PDN connection	
105	Invalid overall length of the triggered response message and a piggybacked initial message	
106	Data forwarding not supported	
107 to 219	Spare. This value range is reserved for Cause values in rejection response message	
220 to 255	Reserved for 3GPP Specific PMIPv6 Error Codes as defined in 3GPP TS 29.275	

		[26]	
--	--	------	--

8.5 Recovery (Restart Counter)

Recovery IE is coded as depicted in Figure 8.5-1.

In the first release of GTPv2 spec n = 1. That is, the overall length of the IE is 5 octets. In future releases of the spec additional octets may be specified.

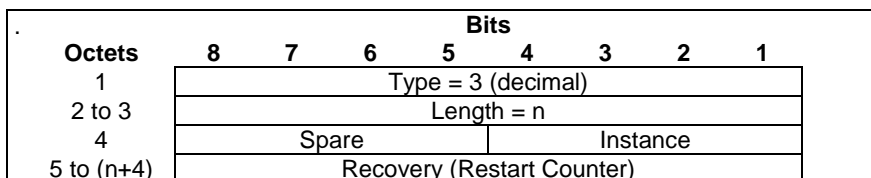

Figure 8.5-1: Recovery (Restart Counter)

8.6 Access Point Name (APN)

Access Point Name (APN) is transferred via GTP tunnels. The sending entity copies the value part of the APN into the Value field of the APN IE.

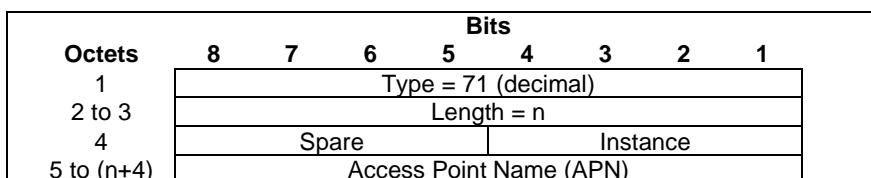

Figure 8.6-1: Access Point Name (APN)

The encoding the APN field follows 3GPP TS 23.003 [2] subclause 9.1 and is also the encoding of a FQDN within a DNS message of section 3.1 of IETF RFC 1035 [31] but excluding the trailing zero byte. The content of the APN field shall be the full APN with both the APN Network Identifier and default APN Operator Identifier being present as specified in 3GPP TS 23.003 [2] subclauses 9.1.1 and 9.1.2.

NOTE: The APN field is not encoded as a dotted string as commonly used in documentation.

8.7 Aggregate Maximum Bit Rate (AMBR)

Aggregate Maximum Bit Rate (AMBR) is transferred via GTP tunnels. The sending entity copies the value part of the AMBR into the Value field of the AMBR (APN-AMBR) IE.

AMBR is defined in clause 9.9.4.2 of 3GPP TS 24.301 [23], but shall be formatted as shown in Figure 8.7-1 as Unsigned32 binary integer values in kbps (1000 bits per second).

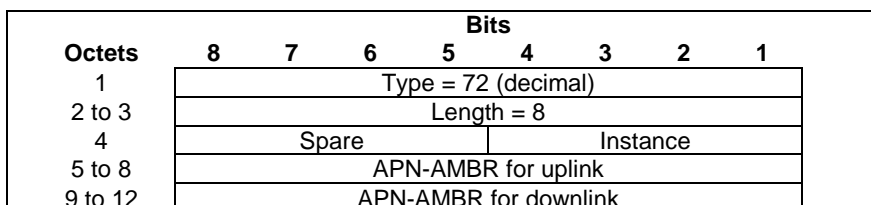

Figure 8.7-1: Aggregate Maximum Bit Rate (AMBR)

8.8 EPS Bearer ID (EBI)

EPS Bearer ID (EBI) is coded as depicted in Figure 8.8-1.

In the first release of GTPv2 spec n = 1. That is, the overall length of the IE is 5 octets. In future releases of the spec additional octets may be specified and new semantic for the spare bits may be defined.

Octets	Bits							
	8	7	6	5	4	3	2	1
1	Type = 73 (decimal)							
2 to 3	Length = n							
4	Spare				Instance			
5	Spare (all bits set to 0)				EPS Bearer ID (EBI)			
6 to (n+4)	These octet(s) is/are present only if explicitly specified							

Figure 8.8-1: EPS Bearer ID (EBI)

8.9 IP Address

IP Address is coded as depicted in Figure 8.9-1. The Length field may have only two values (4 or 16) that determine if the Value field contains IPv4 or IPv6 address.

Octets	Bits							
	8	7	6	5	4	3	2	1
1	Type = 74 (decimal)							
2 to 3	Length = n							
4	Spare				Instance			
5 to (n+4)	IPv4 or IPv6 Address							

Figure 8.9-1: IP address

8.10 Mobile Equipment Identity (MEI)

Mobile Equipment Identity (MEI) is coded as depicted in Figure 8.10-1.. MEI is defined in clause 6.2 of 3GPP TS 23.003 [2].

Octets	Bits							
	8	7	6	5	4	3	2	1
1	Type = 75 (decimal)							
2 to 3	Length = n							
4	Spare				Instance			
5 to (n+4)	Mobile Equipment (ME) Identity							

Figure 8.10-1: Mobile Equipment (ME) Identity (MEI)

The ME Identity field contains either the IMEI or the IMEISV as defined in clause 6.2 of 3GPP TS 23.003 [2]. It is encoded as specified in clause 7.7.53 of 3GPP TS 29.060 [4], beginning with octet 4 of Figure 7.7.53.1.

The IMEI(SV) digits are encoded using BCD coding where IMEI is 15 BCD digits and IMEISV is 16 BCD digits. For IMEI, bits 5 to 8 of the last octet shall be filled with an end mark coded as '1111'.

8.11 MSISDN

MSISDN is transferred via GTP tunnels. The sending entity copies the value part of the MSISDN into the Value field of the MSISDN IE. MSISDN is defined in 3GPP TS 23.003 [2].

Octets	Bits							
	8	7	6	5	4	3	2	1
1	Type = 76 (decimal)							
2 to 3	Length = n							
4	Spare				Instance			
5	Number digit 2				Number digit 1			
6	Number digit 4				Number digit 3			
...			
n+4	Number digit m				Number digit m-1			

Figure 8.11-1: MSISDN

Octets 5 to (n+4) represent the MSISDN value is in international number format as described in ITU-T Rec E.164 [25], encoded as TBCD digits, i.e. digits from 0 through 9 are encoded "0000" to "1001". When there is an odd number of digits, bits 8 to 5 of the last octet are encoded with the filler "1111".

8.12 Indication

Indication is coded as depicted in Figure 8.12-1.

Octets	Bits							
	8	7	6	5	4	3	2	1
1	Type = 77 (decimal)							
2 to 3	Length = n							
4	Spare				Instance			
5	DAF	DTF	HI	DFI	OI	ISRSI	ISRAI	SGW CI
6	Spare	Spare	CFSI	CRSI	P	PT	SI	MSV
7 to (n+4)	These octet(s) is/are present only if explicitly specified							

Figure 8.12-1: Indication

The following bits within Octet 5 shall indicate:

- Bit 8 – DAF (Dual Address Bearer Flag): This bit shall be set when the UE requests PDN type IPv4v6 and all SGSNs which the UE may be handed over to are Release 8 or above supporting dual addressing, which is determined based on node pre-configuration by the operator..
- Bit 7 – DTF (Direct Tunnel Flag): This bit shall be set when the UE is in UTRAN/GERAN network and Direct Tunnel is selected
- Bit 6 – HI (Handover Indication): If this bit is set to 1, it shall indicate that a UE handover from a non-3GPP access to a 3GPP access system. This bit is applicable during the E-UTRAN Initial Attach procedure or during the UE requested PDN connectivity procedure.
- Bit 5 – DFI (Direct Forwarding Indication): If this bit is set to 1, it shall indicate that the direct forwarding between the source eNodeB/RNC and the target eNodeB/RNC during the handover procedure is applied.
- Bit 4 – OI (Operation Indication):
 - If this bit is set to 1, it shall denote that the receiving SGW of a "Create Session Request" shall send a Modify Bearer Request immediately to the PGW. This allows the SGW to differentiate if the "Create Session Request" received on S4/S11 interface belongs to a TAU/RAU with an SGW relocation (OI = 1), or X2-based handover with SGW relocation (OI = 1) or S1-based handover with SGW relocation (OI = 0).
 - It shall be set to 1 on S4/S11 interface if the SGW needs to forward the Delete Session Request message to PGW.
- Bit 3 – ISRSI (Idle mode Signalling Reduction Supported Indication): If this is set to 1, it shall indicate that the old/source SGSN/MME is capable to activate ISR.
- Bit 2 – ISRAI (Idle mode Signalling Reduction Activation Indication): If this bit is set to 1, it shall indicate that the ISR is established between the MME and the S4 SGSN during a TAU/RAU without an SGW change procedure or during an Inter RAT handover without an SGW change procedure. The SGW shall retain the

resources for the other CN node that has its bearer resources on the SGW reserved. The old/source SGSN/MME shall maintain the UE's contexts and activate ISR.

- Bit 1 – SGWCI (SGW Change Indication): If this bit is set to 1, it shall indicate that the target MME/SGSN has selected a new SGW during a TAU/RAU or handover with an SGW change procedure.

The following bits within Octet 6 shall indicate:

- Bit 8 to 7 – Spare, for future use and set to zero.
- Bit 6 – CFSI (Change F-TEID support indication): if this bit is set to 1, it indicates that the SGW can change the assigned GTP-U F-TEID in the current procedure. The MME/SGSN shall include this flag in the Modify Bearer Request message sent to the SGW in the Idle state UE initiated TAU/RAU procedure. The SGW shall include the new F-TEID in the Modify Bearer Response message if the CFSI flag is received in the corresponding Request message and the SGW needs to modify the GTP-U F-TEID.
- Bit 5 – CRSI (Change Reporting support indication): if this bit is set to 1, it indicates that the MME/S4 SGSN supporting Location Change Reporting mechanism.
- Bit 4 – PS (Piggybacking Supported). This bit denotes whether the MME/SGW support piggybacking feature as described in Annex F of 3GPP TS 23.401 [3]. If set to 1, it indicates that the node is capable of processing two different GTP-C messages appearing back to back in a single UDP payload.
- Bit 3 – PT (Protocol Type) If this bit set to 1, it shall indicate that the protocol type for the S5/S8 interface is PMIP; this bit is set to 0 to indicate that the protocol type for the S5/S8 interface is GTP.
- Bit 2 – SI (Scope Indication): If this bit is set to 1, it indicates that all bearer resources of the UE shall be released by the SGW. This flag is set in messages during TAU/RAU/Handover procedure with SGW change.
- Bit 1 – MSV (MS Validated): If this bit is set to 1, it shall indicate that the new MME/SGSN has successfully authenticated the UE.

8.13 Protocol Configuration Options (PCO)

Protocol Configuration Options (PCO) is transferred via GTP tunnels. The sending entity copies the value part of the PCO into the Value field of the PCO IE. The detailed coding of the PCO field from octets 5 to (n+4) shall be specified as per clause 10.5.6.3 of 3GPP TS 24.008 [5], starting with octet 3.

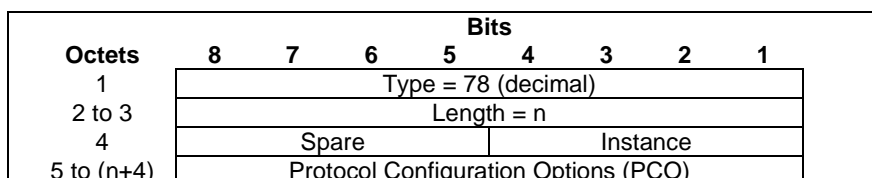

Figure 8.13-1: Protocol Configuration Options (PCO)

8.14 PDN Address Allocation (PAA)

The PDN Address Allocation is coded as depicted in Figure 8.14-1.

NOTE: In Rel 8, Prefix length has a fixed value of /64.

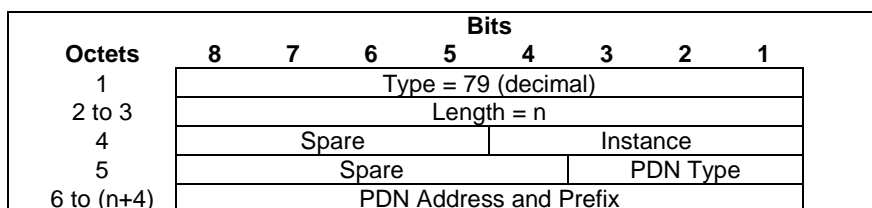

Figure 8.14-1: PDN Address Allocation (PAA)

Table 8.14-1: PDN Address Allocation

PDN type value (octet 5)			
Bits			
3	2	1	
0	0	1	IPv4
0	1	0	IPv6
0	1	1	IPv4v6
Bits 8-4 of octet 5 are spare and shall be coded as zero.			
PDN Address and Prefix (octet 6 to n+4)			
If PDN type value indicates IPv4, an IPv4 address is present in the PDN Address and Prefix from octet 6 to octet 9. Bit 8 of octet 6 represents the most significant bit of the IPv4 address and bit 1 of octet 9 the least significant bit.			
If PDN type value indicates IPv6, octet 6 contains the IPv6 Prefix Length. Octets 7 through 22 contain an IPv6 Prefix and Interface Identifier. Bit 8 of octet 7 represents the most significant bit of the IPv6 Prefix and Interface Identifier and bit 1 of octet 22 the least significant bit.			
If PDN type value indicates IPv4v6, octet 6 contains the IPv6 Prefix Length. Octets 7 through 22 contain an IPv6 Prefix and Interface Identifier. Bit 8 of octet 7 represents the most significant bit of the IPv6 Prefix and Interface Identifier and bit 1 of octet 22 the least significant bit. Octets 23 through 26 contain an IPv4 address. Bit 8 of octet 23 represents the most significant bit of the IPv4 address and bit 1 of octet 26 the least significant bit.			

8.15 Bearer Quality of Service (Bearer QoS)

Bearer Quality of Service (Bearer QoS) is transferred via GTP tunnels. The sending entity copies the value part of the Bearer QoS into the Value field of the Bearer QoS IE.

Octets	Bits							
	8	7	6	5	4	3	2	1
1	Type = 80 (decimal)							
2-3	Length = n							
4	Spare				Instance			
5	Spare	PCI	PL			Spare	PVI	
6	Label (QCI)							
7 to 11	Maximum bit rate for uplink							
12 to 16	Maximum bit rate for downlink							
17 to 21	Guaranteed bit rate for uplink							
22 to 26	Guaranteed bit rate for downlink							
27 to (n+4)	These octet(s) is/are present only if explicitly specified							

Figure 8.15-1: Bearer Level Quality of Service (Bearer QoS)

Octet 5 represents the Allocation/Retention Priority (ARP) parameter. The meaning and value range of the parameters within the ARP are defined in 3GPP TS 29.212 [29]. The bits within the ARP octet are:

- Bit 1 – PVI (Pre-emption Vulnerability): See 3GPP TS 29.212[29], clause 5.3.47 Pre-emption-Vulnerability AVP.
- Bit 2 – spare
- Bits 3 to 6 – PL (Priority Level): See 3GPP TS 29.212[29], clause 5.3.45 ARP-Value AVP. PL encodes each priority level defined for the ARP-Value AVP as the binary value of the priority level.
- Bit 7 – PCI (Pre-emption Capability): See 3GPP TS 29.212[29], clause 5.3.46 Pre-emption-Capability AVP.
- Bit 8 – spare.

QCI, Maximum bit rate for uplink, Maximum bit rate for downlink, Guaranteed bit rate for uplink and Guaranteed bit rate for downlink are specified in 3GPP TS 36.413 [10]

The MBR and GBR are encoded as kilobits per second (1 kbps = 1000 bps). For non-GBR bearers, both the UL/DL MBR and GBR should be set to zero.

NOTE: The encoding in 3GPP TS 24.301 [23] is different from the encoding here.

8.16 Flow Quality of Service (Flow QoS)

Flow Quality of Service (Flow QoS) is transferred via GTP tunnels. The sending entity copies the value part of the Flow QoS into the Value field of the Flow QoS IE.

Octets	Bits							
	8	7	6	5	4	3	2	1
1	Type = 81 (decimal)							
2 to 3	Length = n							
4	Spare				Instance			
5	Label (QCI)							
6 to 10	Maximum bit rate for uplink							
11 to 15	Maximum bit rate for downlink							
16 to 20	Guaranteed bit rate for uplink							
21 to 25	Guaranteed bit rate for downlink							
26 to (n+4)	These octet(s) is/are present only if explicitly specified							

Figure 8.16-1: Flow Quality of Service (Flow QoS)

QCI, Maximum bit rate for uplink, Maximum bit rate for downlink, Guaranteed bit rate for uplink and Guaranteed bit rate for downlink are specified in 3GPP TS 36.413 [10].

The MBR and GBR are encoded as kilobits per second (1 kbps = 1000 bps). For non-GBR bearers, both the UL/DL MBR and GBR should be set to zero.

NOTE: The encoding in 3GPP TS 24.301 [23] is different from the encoding here.

8.17 RAT Type

RAT Type is coded as depicted in Figure 8.17-1.

Octets	Bits							
	8	7	6	5	4	3	2	1
1	Type = 82 (decimal)							
2 to 3	Length = 1							
4	Spare				Instance			
5	RAT Type							
6 to (n+4)	These octet(s) is/are present only if explicitly specified							

Figure 8.17-1: RAT Type

Table 8.17-1: RAT Type values

RAT Types	Values (Decimal)
<reserved>	0
UTRAN	1
GERAN	2
WLAN	3
GAN	4
HSPA Evolution	5
EUTRAN	6
<spare>	7-255

8.18 Serving Network

Serving Network is coded as depicted in Figure 8.18-1.

Octets	Bits							
	8	7	6	5	4	3	2	1
1	Type = 83 (decimal)							
2 to 3	Length = n							
4	Spare				Instance			
5	MNC digit 2				MCC digit 1			
6	MNC digit 3				MCC digit 3			
7	MNC digit 2				MNC digit 1			
8 to (n+4)	These octet(s) is/are present only if explicitly specified							

Figure 8.18-1: Serving Network

If an Administration decides to include only two digits in the MNC, then bits 5 to 8 of octet 6 are coded as "1111".

8.19 EPS Bearer Level Traffic Flow Template (Bearer TFT)

EPS Bearer Level Traffic Flow Template (Bearer TFT) is transferred via GTP tunnels. The sending entity copies the value part of the EPS Bearer Level TFT into the Value field of the EPS Bearer Level TFT IE. The detailed coding of the EPS Bearer Level TFT IE is specified in 3GPP TS 24.008 [5], clause 10.5.6.12, beginning with octet 3.

Octets	Bits							
	8	7	6	5	4	3	2	1
1	Type = 84 (decimal)							
2 to 3	Length = n							
4	Spare				Instance			
5 to (n+4)	EPS Bearer Level Traffic Flow Template (TFT)							

Figure 8.19-1: EPS Bearer Level Traffic Flow Template (Bearer TFT)

8.20 Traffic Aggregate Description (TAD)

The Traffic Aggregate Description IE is coded as depicted in Figure 8.20-1. The detailed coding of Traffic Aggregate Description is specified in 3GPP TS 24.008 [5], clause 10.5.6.12, beginning with octet 3..

Octets	Bits							
	8	7	6	5	4	3	2	1
1	Type = 85 (Decimal)							
2 to 3	Length = n							
4	Spare				Instance			
5 to (n+4)	Traffic Aggregate Description							

Figure 8.20-1 Traffic Aggregate Description

8.21 User Location Information (ULI)

User Location Information (ULI) is a variable length IE that is coded as depicted in Figure 8.21-1. The CGI, SAI, RAI, TAI and ECGI identity types are defined in 3GPP TS 23.003 [2].

Octets	Bits							
	8	7	6	5	4	3	2	1
1	Type = 86 (decimal)							
2 to 3	Length = n							
4	Spare			Instance				
5	Spare		ECGI	TAI	RAI	SAI	CGI	
a to a+6	CGI							
b to b+6	SAI							
c to c+6	RAI							
d to d+4	TAI							
e to e+6	ECGI							
f to (n+4)	These octet(s) is/are present only if explicitly specified							

Figure 8.21-1: User Location Information

The ULI IE shall contain only one identity of the same type (e.g. more than one CGI cannot be included), but ULI IE may contain more than one identity of a different type (e.g. ECGI and TAI). The flags ECGI, TAI, RAI, SAI and CGI in octet 5 indicate if the corresponding type shall be present in a respective field or not. If one of these flags is set to "0", the corresponding field shall not be present at all. If more than one identity of different type is present, then they shall be sorted in the following order: CGI, SAI, RAI, TAI, ECGI.

The following subclauses specify the coding of the fields representing different identities.

For each identity, if an Administration decides to include only two digits in the MNC, then "MNC digit 3" field of corresponding location shall be coded as "1111".

8.21.1 CGI field

The coding of CGI (Cell Global Identifier) is depicted in Figure 8.21.1-1. Only zero or one CGI field shall be present in ULI IE.

Octets	Bits						
	8	7	6	5	4	3	2
a	MCC digit 2			MCC digit 1			
a+1	MNC digit 3			MCC digit 3			
a+2	MNC digit 2			MNC digit 1			
a+3 to a+4	Location Area Code (LAC)						
a+5 to a+6	Cell Identity (CI)						

Figure 8.21.1-1: CGI field

The Location Area Code (LAC) consists of 2 octets. Bit 8 of Octet a+3 is the most significant bit and bit 1 of Octet a+4 the least significant bit. The coding of the location area code is the responsibility of each administration. Coding using full hexadecimal representation shall be used.

The Cell Identity (CI) consists of 2 octets. Bit 8 of Octet a+5 is the most significant bit and bit 1 of Octet a+6 the least significant bit. The coding of the cell identity is the responsibility of each administration. Coding using full hexadecimal representation shall be used.

8.21.2 SAI field

The coding of SAI (Service Area Identifier) is depicted in Figure 8.21.2-1. Only zero or one SAI field shall be present in ULI IE.

Octets	Bits						
	8	7	6	5	4	3	2
b	MCC digit 2			MCC digit 1			
b+1	MNC digit 3			MCC digit 3			
b+2	MNC digit 2			MNC digit 1			
b+3 to b+4	Location Area Code (LAC)						
b+5 to b+6	Service Area Code (SAC)						

Figure 8.21.2-1: SAI field

The Location Area Code (LAC) consists of 2 octets. Bit 8 of Octet b+3 is the most significant bit and bit 1 of Octet b+4 the least significant bit. The coding of the location area code is the responsibility of each administration. Coding using full hexadecimal representation shall be used.

The Service Area Code (SAC) consists of 2 octets. Bit 8 of Octet b+5 is the most significant bit and bit 1 of Octet b+6 the least significant bit. The SAC is defined by the operator. See 3GPP TS 23.003 [2] section 12.5 for more information.

8.21.3 RAI field

The coding of RAI (Routing Area Identity) is depicted in Figure 8.21.3-1. Only zero or one RAI field shall be present in ULI IE.

Octets	Bits							
	8	7	6	5	4	3	2	1
c	MCC digit 2				MCC digit 1			
c+1	MNC digit 3				MCC digit 3			
c+2	MNC digit 2				MNC digit 1			
c+3 to c+4	Location Area Code (LAC)							
c+5 to c+6	Routing Area Code (RAC)							

Figure 8.21.3-1: RAI field

The Location Area Code (LAC) consists of 2 octets. Bit 8 of Octet c+3 is the most significant bit and bit 1 of Octet c+4 the least significant bit. The coding of the location area code is the responsibility of each administration. Coding using full hexadecimal representation shall be used.

The Routing Area Code (RAC) consists of 2 octets. Only Octet c+5 contains the RAC. Octet c+6 is coded as all 1's (11111111). The RAC is defined by the operator.

8.21.4 TAI field

The coding of TAI (Tracking Area Identity) is depicted in Figure 8.21.4-1. Only zero or one TAI field shall be present in ULI IE.

Octets	Bits							
	8	7	6	5	4	3	2	1
d	MCC digit 2				MCC digit 1			
d+1	MNC digit 3				MCC digit 3			
d+2	MNC digit 2				MNC digit 1			
d+3 to d+4	Tracking Area Code (TAC)							

Figure 8.21.4-1: TAI

The Tracking Area Code (TAC) consists of 2 octets. Bit 8 of Octet d+3 is the most significant bit and bit 1 of Octet d+4 the least significant bit. The coding of the tracking area code is the responsibility of each administration. Coding using full hexadecimal representation shall be used.

8.21.5 ECGI field

The coding of ECGI (E-UTRAN Cell Global Identifier) is depicted in Figure 8.21.5-1. Only zero or one ECGI field shall be present in ULI IE.

Octets	Bits							
	8	7	6	5	4	3	2	1
e	MCC digit 2				MCC digit 1			
e+1	MNC digit 3				MCC digit 3			
e+2	MNC digit 2				MNC digit 1			
e+3	Spare				ECI			
e+4 to e+6	ECI (E-UTRAN Cell Identifier)							

Figure 8.21.5-1: ECGI field

The E-UTRAN Cell Identifier (ECI) consists of 28 bits. The ECI field shall start with Bit 4 of octet e+3, which is the most significant bit. Bit 1 of Octet e+6 is the least significant bit. The coding of the E-UTRAN cell identifier is the responsibility of each administration. Coding using full hexadecimal representation shall be used.

8.22 Fully Qualified TEID (F-TEID)

Fully Qualified Tunnel Endpoint Identifier (F-TEID) is coded as depicted in Figure 8.22-1.

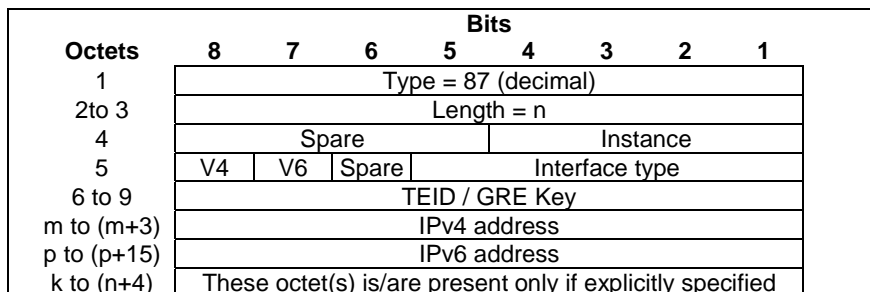

Figure 8.22-1: Fully Qualified Tunnel Endpoint Identifier (F-TEID)

The following flags are coded within Octet 5:

- Bit 8 – V4: If this bit is set to "1", then IPv4 address field exists in the F-TEID, otherwise the IPv4 address field is not present at all.
- Bit 7 – V6: If this bit is set to "1", then IPv6 address field exists in the F-TEID, otherwise the IPv6 address field is not present at all.

At least one of V4 and V6 shall be set to "1", and both may be set to "1".

- Bit 6 – Spare, shall be set to zero by the sender and ignored by the receiver.
- Bit 5 to Bit 1 – Interface Type: This 5 bit wide integer can take the following values representing interface type and endpoint:
 - 0: S1-U eNodeB GTP-U interface
 - 1: S1-U SGW GTP-U interface
 - 2: S12 RNC GTP-U interface
 - 3: S12 SGW GTP-U interface
 - 4: S5/S8 SGW GTP-U interface
 - 5: S5/S8 PGW GTP-U interface
 - 6: S5/S8 SGW GTP-C interface
 - 7: S5/S8 PGW GTP-C interface
 - 8: S5/S8 SGW PMIPv6 interface (the 32 bit GRE key is encoded in 32 bit TEID field and since alternate CoA is not used the control plane and user plane addresses are the same for PMIPv6)
 - 9: S5/S8 PGW PMIPv6 interface (the 32 bit GRE key is encoded in 32 bit TEID field and the control plane and user plane addresses are the same for PMIPv6)
 - 10: S11 MME GTP-C interface
 - 11: S11/S4 SGW GTP-C interface
 - 12: S10 MME GTP-C interface
 - 13: S3 MME GTP-C interface

- 14: S3 SGSN GTP-C interface
- 15: S4 SGSN GTP-U interface
- 16: S4 SGW GTP-U interface
- 17: S4 SGSN GTP-C interface
- 18: S16 SGSN GTP-C interface
- 19: eNodeB GTP-U interface for DL data forwarding
- 20: eNodeB GTP-U interface for UL data forwarding
- 21: RNC GTP-U interface for data forwarding
- 22: SGSN GTP-U interface for data forwarding
- 23: SGW GTP-U interface for data forwarding

Other values of "Interface Type" are spare and reserved for future use.

Octet 6 to 9 (TEID/GRE field) represent either a TEID or a GRE key. If both IPv4 and IPv6 addresses are present in F-TEID IE, then the TEID value shall be shared by both addresses.

Octets "m to (m+3)" and/or "p to (p+15)" (IPv4 address / IPv6 address fields), if present, contain respective address values.

8.23 TMSI

The TMSI, unambiguously associated with a given UE and Location area, is given by:

Octets	8	7	6	5	4	3	2	1
1	Type = 88 (decimal)							
2 to 3	Length = n							
4	Spare				Instance			
5 to (n+4)	TMSI							
The TMSI is defined in 3GPP TS 23.003 [2].								

Figure 8.23-1: TMSI

8.24 Global CN-Id

The Global CN-Id is coded as depicted in Figure 8.24-1.

Octets	8	7	6	5	4	3	2	1
1	Type = 89 (decimal)							
2 to 3	Length = n							
4	Spare				Instance			
5	MCC digit 2				MCC digit 1			
6	MNC digit 3				MCC digit 3			
7	MNC digit 2				MNC digit 1			
8 to (n+4)	CN-Id							
The CN-Id is defined in 3GPP TS 23.003 [2].								

Figure 8.24-1: Global CN-Id

If an Administration decides to include only two digits in the MNC, then bits 5 to 8 of octet 6 are coded as "1111".

8.25 S103 PDN Data Forwarding Info (S103PDF)

The HSGW Address and GRE Key identify a GRE Tunnel towards a HSGW over S103 interface for a specific PDN connection of the UE. The EPS Bearer IDs specify the EPS Bearers which require data forwarding that belonging to this PDN connection. The number of EPS bearer Ids included is specified by the value of EPS Bearer ID Number.

The spare bits indicate unused bits, which shall be set to 0 by the sending side and which shall not be evaluated by the receiving side.

Octets	Bits							
	8	7	6	5	4	3	2	1
1	Type = 90 (decimal)							
2 to 3	Length = n							
4	Spare				Instance			
5	HSGW Address for forwarding Length = m							
6 to (m+5)	HSGW Address for forwarding [4..16]							
(m+6)- to (m+9)	GRE Key							
(m+10)	EPS Bearer ID Number = k							
(m+11) to (m+10+k)	Spare				EPS Bearer ID			

Figure 8.25-1: S103 PDN Data Forwarding Info

8.26 S1-U Data Forwarding (S1UDF)

The Serving GW Address and Serving GW S1-U TEID consist the S1-U Tunnel information allocated by the Serving GW for an EPS Bearer identified by the EPS Bearer ID which requires data forwarding during active handover from E-UTRAN Access to cdma2000 HRPD Access.

The spare bits indicate unused bits, which shall be set to 0 by the sending side and which shall not be evaluated by the receiving side.

Octets	Bits							
	8	7	6	5	4	3	2	1
1	Type = 91 (decimal)							
2 to 3	Length = n							
4	Spare				Instance			
5	Spare				EPS Bearer ID			
6	Serving GW Address Length = m							
7 to (m+6)	These octet(s) is/are present only if explicitly specified							
(m+7) to (m+10)	Serving GW S1-U TEID							

Figure 8.26-1: S1-U Data Forwarding Info

8.27 Delay Value

Delay Value is coded as depicted in Figure 8.27-1.

Octets	Bits							
	8	7	6	5	4	3	2	1
1	Type = 92 (decimal)							
2 to 3	Length = n							
4	Spare				Instance			
5	Delay Value in integer multiples of 50 milliseconds, or zero							
6 to (n+4)	These octet(s) is/are present only if explicitly specified							

Figure 8.27-1: Delay Value

Delay Value is set to zero in order to clear a previously set delay condition.

8.28 Bearer Context

Bearer Context is a grouped IE containing a number of other IEs. Which of those IEs are mandatory, optional or conditional and the conditions that apply are GTP message specific, and described in the corresponding subclause under clause 7.

Bearer Context may be repeated within a message with exactly the same Type and Instance values to represent a list of Bearer Contexts.

Bearer Context is coded as depicted in Table 8.28-1.

Table 8.28-1: Bearer Context Grouped Type

Octet 1	Bearer Context IE Type = 93 (decimal)			
Octets 2 and 3	Length = n			
Octet 4	Spare and Instance fields			
Information elements	P	Condition / Comment	IE Type	Ins.
EPS Bearer ID			EBI	
Cause		This IE shall be used only in response messages. It shall indicate if the bearer handling was successful, and if not, shall give information on the reason.	Cause	
NSAPI		This IE is sent in for a 3G SGSN to MME combined handover or an SRNS relocation procedure.	NSAPI	
TFT		This IE shall be used only in request messages. The downlink packet filters in this IE shall be used by the SGW only for PMIP.	Bearer TFT	
S1 eNodeB F-TEID			F-TEID	
S1 SGW F-TEID			F-TEID	
S4-U SGSN F-TEID		This IE shall only be applicable for the S4 interface.	F-TEID	
S4-U SGW F-TEID		This IE shall only be applicable for the S4 interface.	F-TEID	
S5/8-U SGW F-TEID			F-TEID	
S5/8-U PGW F-TEID			F-TEID	
S12 RNC F-TEID		This IE shall only be applicable for the S12 interface.	F-TEID	
S12 SGW F-TEID		This IE shall only be applicable for the S12 interface.	F-TEID	
Bearer Level QoS			Bearer QoS	
Charging Id		This IE shall be used only in the direction of the PGW -> SGW.	Charging Id	
Bearer Flags		This IE shall be used only in the direction of the PGW -> SGW -> MME. Applicable flags are: <ul style="list-style-type: none"> • PPC (Prohibit Payload Compression) 	Bearer Flags	
Transaction Identifier		This IE shall be sent over S3/S10/S16 if the UE supports A/Gb and/or Iu mode.	TI	
NOTE: This table uses a 5-column format in order to match the format used in subclauses of clause 7, where the usage of this IE is further detailed for each specific GTP message including it. In this subclause, the columns "P" and "Instance" are meaningless. The column "Condition / Comment" is only used in some cases to provide useful descriptions on how some fields are used but for each specific usage of this IE, the only "Condition / Comments" applicable are those in the corresponding subclause of clause 7.				

8.29 Charging ID

The Charging ID is a unique four-octet value generated by the PGW when a bearer is activated. A Charging ID is generated for each bearer. The Charging ID value 0 is reserved and shall not be assigned by the PGW.

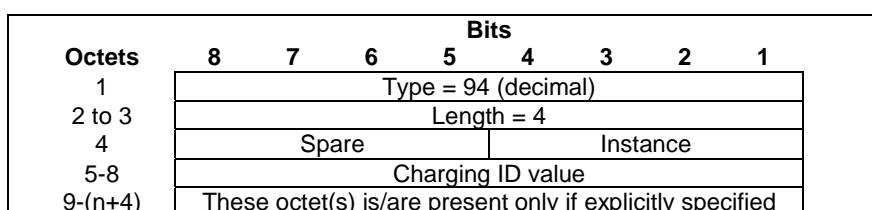

Figure 8.29-1: Charging ID

8.30 Charging Characteristics

The charging characteristics information element is defined in 3GPP TS 32.251 [8] and is a way of informing both the SGW and PGW of the rules for producing charging information based on operator configured triggers. For the encoding of this information element see 3GPP TS 32.298 [9].

Octets	Bits							
	8	7	6	5	4	3	2	1
1	Type = 95 (decimal)							
2 to 3	Length = n							
4	Spare				Instance			
5 to 6	Charging Characteristics value							
7 to (n+4)	These octet(s) is/are present only if explicitly specified							

Figure 8.30-1: Charging Characteristics

8.31 Trace Information

Trace Information is coded as depicted in Figure 8.31-1. See 3GPP TS 32.422 [18] for details on trace related information.

Octets	Bits							
	8	7	6	5	4	3	2	1
1	Type = 96(decimal)							
2 to 3	Length = n							
4	Spare				Instance			
5	MCC digit 2				MCC digit 1			
6	MNC digit 3				MCC digit 3			
7	MNC digit 2				MNC digit 1			
8 to 10	Trace ID							
11 to 19	Triggering Events							
20 to 21	List of NE Types							
22	Session Trace Depth							
23 to 34	List of Interfaces							
35 to (n+4)	IP Address of Trace Collection Entity							

Figure 8.31-1: Trace Information

Octets 5 to 10 represent the Trace Reference parameter as defined in 3GPP TS 32.422 [18], clause 5.6.

Triggering Events, List of NE Types, Session Trace Depth and List of Interfaces are specified in 3GPP TS 32.422 [18]

See 3GPP TS 24.008 [5], clause 10.5.1.4, Mobile Identity, for the coding of MCC and MNC, whose values are obtained from the serving PLMN that the EM/NM is managing. If MNC is 2 digits long, bits 5 to 8 of octet 6 are coded as "1111".

8.32 Bearer Flags

Bearer Flags is coded as depicted in Figure 8.32-1.

Octets	Bits							
	8	7	6	5	4	3	2	1
1	Type = 97 (decimal)							
2 to 3	Length = n							
4	Spare				Instance			
5	Spare							PPC
6-(n+4)	These octet(s) is/are present only if explicitly specified							

Figure 8.32-1: Bearer Flags

The following bits within Octet 5 indicate:

- Bit 1 – PPC (Prohibit Payload Compression): This flag is used to determine whether an SGSN should attempt to compress the payload of user data when the users asks for it to be compressed (PPC = 0), or not (PPC = 1).

8.33 Void

8.34 PDN Type

The PDN Type is coded as depicted in Figure 8.34-1.

Octets	Bits							
	8	7	6	5	4	3	2	1
1	Type = 99 (decimal)							
2 to 3	Length = n							
4	Spare				Instance			
5	Spare				PDN Type			
6 to n+4)	These octet(s) is/are present only if explicitly specified							

Figure 8.34-1: PDN Type

Table 8.34-1: PDN Type

PDN type value (octet 5)			
Bits			
3	2	1	
0	0	1	IPv4
0	1	0	IPv6
0	1	1	IPv4/IPv6
Bits 8-4 of octet 5 are spare and shall be coded as zero.			

8.35 Procedure Transaction ID (PTI)

Procedure Transaction Id is coded as depicted in Figure 8.35-1. It is defined in 3GPP TS 24.301 [23], clause 9.4 and is coded as specified in 3GPP TS 24.007 [30], clause 11.2.3.1a Procedure transaction identity.

Octets	Bits							
	8	7	6	5	4	3	2	1
1	Type = 100 (decimal)							
2 to 3	Length = n							
4	Spare				Instance			
5	Procedure Transaction ID							
6 to (n+4)	These octet(s) is/are present only if explicitly specified							

Figure 8.35-1: Procedure Transaction ID

8.36 DRX Parameter

DRX Parameter indicates whether the UE use DRX mode or not, this parameter is coded as depicted in Figure 839-1.

Octets	Bits							
	8	7	6	5	4	3	2	1
1	Type = 101 (decimal)							
2 to 3	Length = n							
4	Spare				Instance			
5 to (n+4)	DRX Parameter							

Figure 8.36-1: DRX Parameter

8.37 UE Network Capability

UE Network Capability is coded as depicted in Figure 8.37-1. Actual coding of the UE Network Capability field is defined in 3GPP TS 24.301 [23].

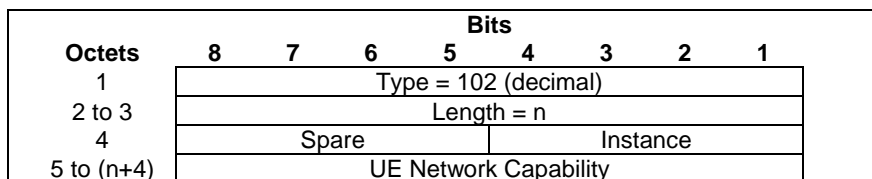

Figure 8.37-1: UE Network Capability

8.38 MM Context

The MM Context information element contains the Mobility Management, UE security parameters that are necessary to transfer over S3/S16/S10 interface.

All Spare bits are set to zeros by the sender and ignored by the receiver. Spare bits in MM Context IE shall be set to 1's before sending MM Context IE to pre-R8 SGSN.

Security Mode indicates the type of security keys (GSM/UMTS/EPS) and Authentication Vectors (quadruplets/quintuplets/triplets) that are passed to the new MME/SGSN.

The DRX parameter coding is specified in clause 9.9.3.34 of 3GPP TS 24.008 [5]. If DRXI (DRX Indicator), bit 4 of octet 5, is set to "1", then the DRX parameter field is present, otherwise its octets are not present.

Uplink/downlink Subscribed UE AMBR (Aggregate Maximum Bit Rate) is coded as Unsigned32 integer values in kbps (1000 bps) for all non-GBR bearers according to the subscription of the user. If SAMBRI (Subscribed UE AMBR Indicator), bit 1 of octet 6, is set to "1", then the Uplink/downlink Subscribed UE AMBR parameter field is present, otherwise these parameters are not present.

Uplink/downlink Used UE AMBR (Aggregate Maximum Bit Rate) is coded as Unsigned32 integer values in kbps (1000 bps) for all non-GBR bearers currently being used by the UE. If UAMBRI (Used UE AMBR Indicator), bit 2 of octet 6, is set to "1", then the Uplink/downlink Used UE AMBR parameter field is present, otherwise these parameters are not present.

The encoding of Mobile Equipment Identity (MEI) field shall be same as specified in clause 8.10 of this specification. If Length of Mobile Equipment Identity is zero, then the Mobile Equipment Identity parameter shall not be present.

The UE Network Capability coding is specified in clause 9.9.3.34 of 3GPP TS 24.301 [23]. If Length of UE Network Capability is zero, then the UE Network Capability parameter shall not be present.

The MS Network Capability coding is specified in clause 10.5.5.12 of 3GPP TS 24.008 [5]. If Length of MS Network Capability is zero, then the MS Network Capability parameter shall not be present.

Used Cipher indicates the GSM ciphering algorithm that is in use.

Used NAS Cipher indicates the EPS ciphering algorithm that is in use.

The Access restriction data is composed of UNA(UTRAN Not Allowed), GENA(GERAN Not Allowed), GANA(GAN Not Allowed), INA(I-HSPA-Evolution Not Allowed), ENA(E-UTRAN Not Allowed) and HNNA(HO-To-Non-3GPP-Access Not Allowed).

As depicted in Figure 8.38-1, the GSM Key, Used Cipher and Authentication Triplets that are unused in the old SGSN shall be transmitted to the new SGSN for the GSM subscribers.

The Authentication Triplet coding is specified in Figure 8.38-7.

Octets	Bits							
	8	7	6	5	4	3	2	1
1	Type = 103 (decimal)							
2 to 3	Length = n							
4	Spare				Instance			
5	Security Mode		Spare		DRXI	CKSN		
6	Number of Triplet			Spare			UAMB RI	SAMB RI
7	Spare				Used Cipher			
8 to 15	Kc							
16 to h	Authentication Triplet [0..4]							
(h+1) to (h+2)	DRX parameter							
j to (j+3)	Uplink Subscribed UE AMBR							
(j+4) to (j+7)	Downlink Subscribed UE AMBR							
(j+7) to (j+10)	Uplink Used UE AMBR							
(j+11) to (j+14)	Downlink Used UE AMBR							
j+15	Length of UE Network Capability							
(j+16) to k	UE Network Capability							
k+1	Length of MS Network Capability							
(k+2) to m	MS Network Capability							
m+1	Length of Mobile Equipment Identity (MEI)							
(m+2) to r	Mobile Equipment Identity (MEI)							
r+1	Spare	HNNA	ENA	INA	GANA	GENA	UNA	
(r+2) to (n+4)	These octet(s) is/are present only if explicitly specified							

Figure 8.38-1: GSM Key and Triplets

As depicted in Figure 8.38-2, the UMTS Key, Used Cipher and Authentication Quintuplets that are unused in the old SGSN shall be transmitted to the new SGSN when the UMTS subscriber is attached to a GSM BSS in the old system, in case the user has a ME capable of UMTS AKA.

The Authentication Quintuplet coding is specified in Figure 8.38-8.

Octets	Bits							
	8	7	6	5	4	3	2	1
1	Type = 104 (decimal)							
2 to 3	Length = n							
4	Spare				Instance			
5	Security Mode		Spare		DRXI	CKSN/KSI		
6	Number of Quintuplets		Spare			UAMB RI	SAMB RI	
7	Spare				Used Cipher			
8 to 23	CK							
24 to 39	IK							
40 to h	Authentication Quintuplet [0..4]							
(h+1) to (h+2)	DRX parameter							
j to (j+3)	Uplink Subscribed UE AMBR							
(j+4) to (j+7)	Downlink Subscribed UE AMBR							
(j+7) to (j+10)	Uplink Used UE AMBR							
(j+11) to (j+14)	Downlink Used UE AMBR							
j+15	Length of UE Network Capability							
(j+16) to k	UE Network Capability							
k+1	Length of MS Network Capability							
(k+2) to m	MS Network Capability							
m+1	Length of Mobile Equipment Identity (MEI)							
(m+2) to r	Mobile Equipment Identity (MEI)							
r+1	Spare	HNNA	ENA	INA	GANA	GENA	UNA	
(r+2) to (n+4)	These octet(s) is/are present only if explicitly specified							

Figure 8.38-2: UMTS Key, Used Cipher and Quintuplets

As depicted in Figure 8.38-3, the GSM Key, Used Cipher and Authentication Quintuplets that are unused in the old SGSN shall be transmitted to the new SGSN when the UMTS subscriber is attached to a GSM BSS in the old system, in case the user has a ME no capable of UMTS AKA.

The Authentication Quintuplet coding is specified in Figure 8.38-8.

Octets	Bits							
	8	7	6	5	4	3	2	1
1	Type = 105 (decimal)							
2 to 3	Length = n							
4	Spare				Instance			
5	Security Mode		Spare	DRXI	CKSN/KSI			
6	Number of Quintuplets			Spare			UAMB RI	SAMB RI
7	Spare				Used Cipher			
8 to 15	Kc							
16 to h	Authentication Quintuplets [0..4]							
(h+1) to (h+2)	DRX parameter							
j to (j+3)	Uplink Subscribed UE AMBR							
(j+4) to (j+7)	Downlink Subscribed UE AMBR							
(j+7) to (j+10)	Uplink Used UE AMBR							
(j+11) to (j+14)	Downlink Used UE AMBR							
j+15	Length of UE Network Capability							
(j+16) to k	UE Network Capability							
k+1	Length of MS Network Capability							
(k+2) to m	MS Network Capability							
m+1	Length of Mobile Equipment Identity (MEI)							
(m+2) to r	Mobile Equipment Identity (MEI)							
r+1	Spare	HNNA	ENA	INA	GANA	GENA	UNA	
(r+2) to (n+4)	These octet(s) is/are present only if explicitly specified							

Figure 8.38-3: GSM Key, Used Cipher and Quintuplets

As depicted in Figure 8.38-4, the UMTS Key, KSI and unused Authentication Quintuplets in the old SGSN shall be transmitted to the new SGSN/MME when the UMTS subscriber is attached to UTRAN/GERAN in the old system. The MME may forward the UMTS Key, KSI and unused Authentication Quintuplets which were previously stored back to the same SGSN, for further details, refer to 3GPP TS 33.401 [12].

The Authentication Quintuplet coding is specified in Figure 8.38-8.

Octets	Bits						
	8	7	6	5	4	3	2
1	Type = 106 (decimal)						
2 to 3	Length = n						
4	Spare			Instance			
5	Security Mode		Spare	DRXI	KSI		
6	Number of Quintuplets		Spare		UAMB RI	SAMB RI	
7	Spare						
8 to 23	CK						
24 to 39	IK						
40 to h	Authentication Quintuplet [0..4]						
(h+1) to (h+2)	DRX parameter						
j to (j+3)	Uplink Subscribed UE AMBR						
(j+4) to (j+7)	Downlink Subscribed UE AMBR						
(j+7) to (j+10)	Uplink Used UE AMBR						
(j+11) to (j+14)	Downlink Used UE AMBR						
j+15	Length of UE Network Capability						
(j+16) to k	UE Network Capability						
k+1	Length of MS Network Capability						
(k+2) to m	MS Network Capability						
m+1	Length of Mobile Equipment Identity (MEI)						
(m+2) to r	Mobile Equipment Identity (MEI)						
r+1	Spare	HNNA	ENA	INA	GANA	GENA	UNA
(r+2) to (n+4)	These octet(s) is/are present only if explicitly specified						

Figure 8.38-4: UMTS Key and Quintuplets

As depicted in Figure 8.38-5, the EPS Security Context, unused Authentication Quadruplets in the old MME shall be transmitted to the new MME. And the Authentication Quintuplets may also be transmitted to the new MME if the old MME has the Authentication Quintuplets for this UE.

The Authentication Quintuplet and Authentication Quadruplet codings are specified in Figure 8.38-8 and Figure 8.38-9 respectively.

In Figure 8.38-5, the fields for the Old EPS Security Context (i.e. octets from s to s+64) may be present only in S10 Forward Relocation Request message according to the Rules on Concurrent Running of Security Procedures, which are specified in 3GPP TS 33.401 [12]. The octets for Old EPS Security Context shall be present if the OSCI (Old Security Context Indicator), bit 1 of octet 6) is set to "1"; otherwise they shall not be present.

If NHI_old (Next Hop Indicator for old EPS Security Context), bit 1 of octet s, is set to "1", then the parameters old NH (Next Hop) and old NCC (Next Hop Chaining Count) shall be present; otherwise the octets for old NH parameter shall not be present and the value of old NCC parameter shall be ignored by the receiver.

Octets	Bits						
	8	7	6	5	4	3	2
1	Type = 107 (decimal)						
2 to 3	Length = n						
4	Spare			Instance			
5	Security Mode		NHI	DRXI	KSI _{ASME}		
6	Number of Quintuplets		Number of Quadruplet		UAMB RI	OSCI	
7	SAMB RI	Used NAS integrity protection algorithm		Used NAS Cipher			
8 to 10	NAS Downlink Count						
11 to 13	NAS Uplink Count						
14 to 45	K _{ASME}						
46 to g	Authentication Quadruplet [0..4]						
(g+1) to h	Authentication Quintuplet [0..4]						
(h+1) to (h+2)	DRX parameter						
p to (p+31)	NH						
p+32	Spare			NCC			
j to (j+3)	Uplink Subscribed UE AMBR						
(j+4) to (j+7)	Downlink Subscribed UE AMBR						
(j+7) to (j+10)	Uplink Used UE AMBR						
(j+11) to (j+14)	Downlink Used UE AMBR						
j+15	Length of UE Network Capability						
(j+16) to k	UE Network Capability						
k+1	Length of MS Network Capability						
(k+2) to m	MS Network Capability						
m+1	Length of Mobile Equipment Identity (MEI)						
(m+2) to r	Mobile Equipment Identity (MEI)						
r+1	Spare	HNNA	ENA	INA	GANNA	GENA	UNA
s	NHI_o Id	Spare	old KSI _{ASME}		old NCC		
(s+1) to (s+32)	old K _{ASME}						
(s+33) to (s+64)	old NH						
t to (n+4)	These octet(s) is/are present only if explicitly specified						

Figure 8.38-5: EPS Security Context, Quadruplets and Quintuplets

If NHI (Next Hop Indicator), bit 5 of octet 5, is set to "1", then the optional parameters NH (Next Hop) and NCC (Next Hop Chaining Count) are both present, otherwise their octets are not present.

NAS integrity protection algorithm shall be specified in 3GPP TS 24.301 [23].

As depicted in Figure 8.38-6, if the old MME has Authentication Quintuplets for this UE, the old MME will derive CK" and IK" from K_{ASME} and transmit the CK", IK", KSI_{ASME} and Authentication Quintuplets to the new SGSN, the Authentication Quadruplets may also be transmitted to the new SGSN.

The Authentication Quintuplet and Authentication Quadruplet codings are specified in Figure 8.38-8 and Figure 8.38-9 respectively.

The old SGSN/MME may deliver both Authentication Quadruplets and Authentication Quintuplets it holds to the peer combo node to optimize the procedure.

Octets	Bits							
	8	7	6	5	4	3	2	1
1	Type = 108 (decimal)							
2 to 3	Length = n							
4	Spare				Instance			
5	Security Mode		Spare	DRXI	KSI _{ASME}			
6	Number of Quintuplets		Number of Quadruplet		UAMB RI	SAMB RI		
7	Spare							
8 to 23	CK							
24 to 39	IK							
40 to g	Authentication Quadruplet [0..4]							
(g+1) to h	Authentication Quintuplet [0..4]							
(h+1) to (h+2)	DRX parameter							
j to (j+3)	Uplink Subscribed UE AMBR							
(j+4) to (j+7)	Downlink Subscribed UE AMBR							
(j+7) to (j+10)	Uplink Used UE AMBR							
(j+11) to (j+14)	Downlink Used UE AMBR							
j+15	Length of UE Network Capability							
(j+16) to k	UE Network Capability							
k+1	Length of MS Network Capability							
(k+2) to m	MS Network Capability							
m+1	Length of Mobile Equipment Identity (MEI)							
(m+2) to r	Mobile Equipment Identity (MEI)							
r+1	Spare	HNNA	ENA	INA	GANA	GENA	UNA	
(r+2) to (n+4)	These octet(s) is/are present only if explicitly specified							

Figure 8.38-6: UMTS Key, Quadruplets and Quintuplets

Octets	Bits							
	8	7	6	5	4	3	2	1
1 to 16	RAND							
17 to 20	SRES							
21 to 28	Kc							

Figure 8.38-7: Authentication Triplet

Octets	Bits							
	8	7	6	5	4	3	2	1
1 to 16	RAND							
17	XRES Length							
18 to m	XRES							
(m+1) to (m+16)	CK							
(m+17) to (m+32)	IK							
m+33	AUTN Length							
(m+34) to n	AUTN							

Figure 8.38-8: Authentication Quintuplet

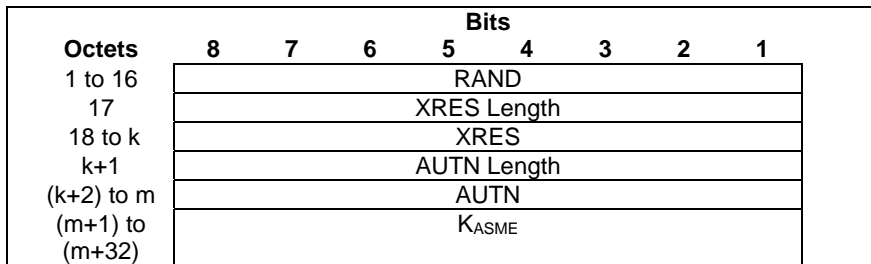

Figure 8.38-9: Authentication Quadruplet Table 8.38-1: Security Mode Values

Security Type	Value (Decimal)
GSM Key and Triplets	0
UMTS Key, Used Cipher and Quintuplets	1
GSM Key, Used Cipher and Quintuplets	2
UMTS Key and Quintuplets	3
EPS Security Context, Quadruplets and Quintuplets	4
UMTS Key, Quadruplets and Quintuplets	5

Table 8.38-2: Used NAS Cipher Values

Cipher Algorithm	Value (Decimal)
No ciphering	0
128-EEA1	1
128-EEA2	2

Table 8.38-3: Used Cipher Values

Cipher Algorithm	Value (Decimal)
No ciphering	0
GEA/1	1
GEA/2	2
GEA/3	3
GEA/4	4
GEA/5	5
GEA/6	6
GEA/7	7

8.39 PDN Connection

The PDN connection is a grouped IE containing a number of other IEs and shall be coded as depicted in Table 8.39-1. The APN IE directly follows octet 4.

The PDN Connection IE may be repeated within a message when more than one PDN Connection is required to be sent. If so, the repeated IEs shall have exactly the same Instance values to represent a list of grouped IEs.

Table 8.39-1: PDN Connection Grouped Type

Octet 1	PDN Connection IE Type = 109 (decimal)			
Octets 2 and 3	Length = n			
Octet 4	Spare and Instance fields			
Information elements	P	Condition / Comment	IE Type	Ins.
APN			APN	
IPv4 Address		This IE shall not be present if an IPv4 Address is not assigned.	IP Address	
IPv6 Address		This IE shall not be present if an IPv6 Address is not assigned	IP Address	
Linked EPS Bearer ID		This IE shall be included to identify the default bearer of the PDN Connection	EBI	
PGW S5/S8 IP Address for Control Plane or PMIP		. This IE shall include the TEID in the GTP based S5/S8 case and the GRE key in the PMIP based S5/S8 case.	F-TEID	
PGW node name		Includes the PGW FQDN	FQDN	
Bearer Contexts		Several IEs with these type and instance values may be included as necessary to represent a list of Bearers.	Bearer Context	
Aggregate Maximum Bit Rate (APN-AMBR)		Includes the APN-AMBR.	AMBR	
Charging characteristics			Charging characteristics	
APN Restriction		This IE shall be included by the source MME/S4 SGSN for the associated PDN connection	APN Restriction	
NOTE: This table uses a 5-column format in order to match the format used in subclauses of clause 7, where the usage of this IE is further detailed for each specific GTP message including it. In this subclause, the columns "P" and "Instance" are meaningless. The column "Condition / Comment" is only used in some cases to provide useful descriptions on how some fields are used but for each specific usage of this IE, the only "Condition / Comments" applicable are those in the corresponding subclause of clause 7.				

The Bearer Context shall be coded as depicted in Table 8.39-2.

Table 8.39-2: Bearer Context in PDN Connection Grouped Type

Octet 1	Bearer Context IE Type = 93 (decimal)			
Octets 2 and 3	Length = n			
Octet 4	Spare and Instance fields			
Information elements	P	Condition / Comment	IE Type	Ins.
EPS Bearer ID			EBI	
TFT			Bearer TFT	
SGW S1/S4/S12 IP Address and TEID for user plane			F-TEID	
PGW S5/S8 IP Address and TEID for user plane		This IE shall only be included for GTP based S5/S8 interfaces.	F-TEID	
Bearer Level QoS			Bearer QoS	
Container		The Packet Flow ID , Radio Priority, SAPI, PS Handover XID Parameters may be included as necessary.	F-Container	
Transaction Identifier		This IE shall be sent over S3/S10/S16 if the UE supports A/Gb and/or lu mode.	TI	
NOTE: This table uses a 5-column format in order to match the format used in subclauses of clause 7, where the usage of this IE is further detailed for each specific GTP message including it. In this subclause, the columns "P" and "Instance" are meaningless. The column "Condition / Comment" is only used in some cases to provide useful descriptions on how some fields are used but for each specific usage of this IE, the only "Condition / Comments" applicable are those in the corresponding subclause of clause 7.				

8.40 PDU Numbers

The PDU Numbers information element contains the sequence number status corresponding to a Bearer context in the old SGSN. This information element shall be sent only when acknowledged peer-to-peer LLC operation is used for the Bearer context or when the "delivery order" QoS attribute is set in the Bearer context QoS profile.

NSAPI identifies the Bearer context for which the PDU Number IE is intended.

DL GTP-U Sequence Number is the number for the next downlink GTP-U T-PDU to be sent to the UE when "delivery order" is set.

UL GTP-U Sequence Number is the number for the next uplink GTP-U T-PDU to be tunnelled to the S-GW when "delivery order" is set.

The Send N-PDU Number is used only when acknowledged peer-to-peer LLC operation is used for the Bearer context. Send N-PDU Number is the N-PDU number to be assigned by SNDSCP to the next down link N-PDU received from the S-GW.

The Receive N-PDU Number is used only when acknowledged peer-to-peer LLC operation is used for the Bearer context. The Receive N-PDU Number is the N-PDU number expected by SNDSCP from the next up link N-PDU to be received from the UE.

The PDU Number IE will be repeated for each Bearer Context for which this IE is required.

PDU Numbers IE is coded as depicted in Figure 8.40-1.

Octets	Bits							
	8	7	6	5	4	3	2	1
1	Type = 110 (decimal)							
2 to 3	Length = n							
4	Spare				Instance			
5	Spare(0 0 0 0)				NSAPI			
6-7	DL GTP-U Sequence Number							
8-9	UL GTP-U Sequence Number							
10-11	Send N-PDU Number							
12-13	Receive N-PDU Number							
14 to (n+4)	These octet(s) is/are present only if explicitly specified							

Figure 8.40-1: PDU Numbers

8.41 Packet TMSI (P-TMSI)

The P-TMSI, unambiguously associated with a given UE and routing area, is given by:

Octets	Bits							
	8	7	6	5	4	3	2	1
1	Type = 111 (decimal)							
2 to 3	Length = n							
4	Spare				Instance			
5 to (n+4)	Packet TMSI (P-TMSI) The P-TMSI is defined in 3GPP TS 23.003 [2].							

Figure 8.41-1: Packet TMSI (P-TMSI)

8.42 P-TMSI Signature

The P-TMSI Signature information element is provided by the UE in the Routing Area Update Request and Attach Request messages to the SGSN, or is provided by the MME that is mapped from GUTI in the Identification Request and Context Request messages to the old SGSN for identification checking purposes. The content and the coding of the P-TMSI Signature information element are defined in 3GPP TS 24.008 [5].

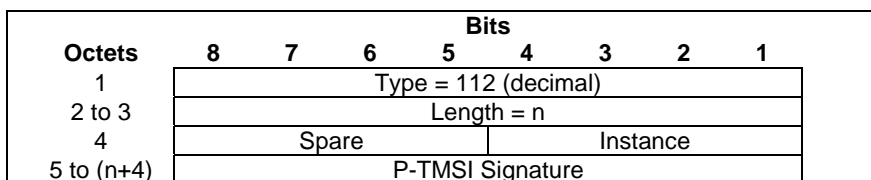

Figure 8.42-1: P-TMSI Signature

8.43 Hop Counter

Where Intra Domain Connection of RAN Nodes to Multiple CN Node is applied, the Hop Counter may be used to prevent endless loops when relaying Identification Request messages and Context Request messages. The maximum value is operator specific and shall not be lower than 1.

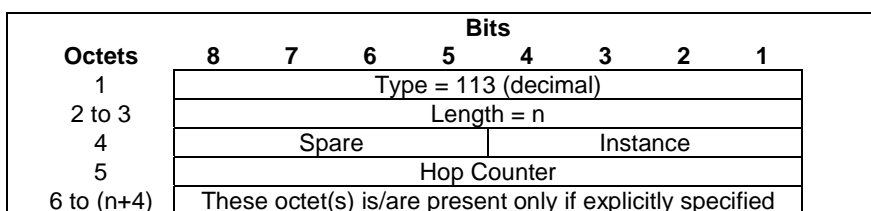

Figure 8.43-1: Hop Counter

8.44 UE Time Zone

UE Time Zone is used to indicate the offset between universal time and local time in steps of 15 minutes of where the UE currently resides. The "Time Zone" field uses the same format as the "Time Zone" IE in 3GPP TS 24.008 [5].

UE Time Zone is coded as this is depicted in Figure 8.44-1.

The spare bits indicate unused bits, which shall be set to 0 by the sending side and which shall not be evaluated by the receiving side.

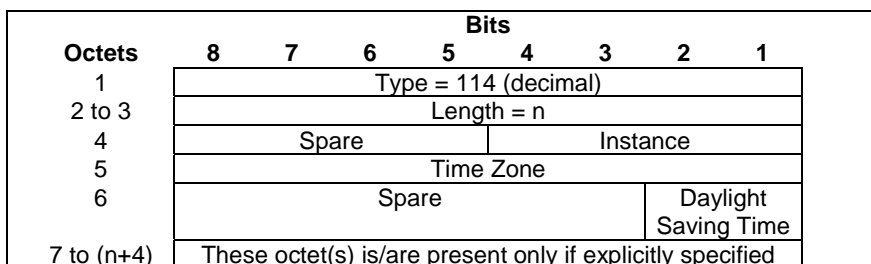

Figure 8.44-1: UE Time Zone

Table 8.44-2 Possible values for the "Daylight Saving Time" field and their meanings.

Daylight Saving Time	Value (binary)	
	Bit 2	Bit 1
No adjustment for Daylight Saving Time	0	0
+1 hour adjustment for Daylight Saving Time	0	1
+2 hours adjustment for Daylight Saving Time	1	0
Spare	1	1

8.45 Trace Reference

Trace Reference shall be coded as depicted in Figure 8.45-1. See 3GPP TS 32.422 [18], clause 5.6, for the definition of Trace Reference.

See 3GPP TS 24.008 [5], clause 10.5.1.4, Mobile Identity, for the coding of MCC and MNC, whose values are obtained from the serving PLMN that the EM/NM is managing. If MNC is 2 digits long, bits 5 to 8 of octet 6 are coded as "1111".

Octets	Bits							
	8	7	6	5	4	3	2	1
1	Type = 115 (decimal)							
2 to 3	Length = 6							
4	Spare				Instance			
5	MCC digit 2				MCC digit 1			
6	MNC digit 3				MCC digit 3			
7	MNC digit 2				MNC digit 1			
8 to 10	Trace ID							

Figure 8.45-1: Trace Reference

8.46 Complete Request Message

The Complete Request Message is coded as depicted in Figure 8.46-1.

Octets	Bits							
	8	7	6	5	4	3	2	1
1	Type = 116 (decimal)							
2 to 3	Length = n							
4	Spare				Instance			
5	Complete Request Message Type							
6- to (n+4)	Complete Request Message							

Figure 8.46-1: Complete Request Message

Complete Request Message type values are specified in Table 8.46-1.

Table 8.46-1: Complete Request Message type values and their meanings

Location Types	Values (Decimal)
Complete Attach Request Message	0
Complete TAU Request Message	1
<spare>	2-255

8.47 GUTI

The GUTI is coded as depicted in Figure 8.47-1.

Octets	Bits							
	8	7	6	5	4	3	2	1
1	Type = 117 (decimal)							
2 to 3	Length = n							
4	Spare				Instance			
5	MCC digit 2				MCC digit 1			
6	MNC digit 3				MCC digit 3			
7	MNC digit 2				MNC digit 1			
8 to 9	MME Group ID							
10	MME Code							
11 to (n+4)	M-TMSI							

Figure 8.47-1: GUTI

If an Administration decides to include only two digits in the MNC, then bits 5 to 8 of octet 6 are coded as "1111".

8.48 Fully Qualified Container (F-Container)

Fully Qualified Container (F-TEID) is coded as depicted in Figure 8.48-1.

All Spare bits are set to zeros by the sender and ignored by the receiver. If the F-Container field is constructed from the received container in the message on the Iu-PS or S1-AP interface, the F-Container field shall be encoded as the content part (excluding IE-ID, criticality, pad and length part) of corresponding parameter.

Octets	Bits							
	8	7	6	5	4	3	2	1
1	Type = 118 (decimal)							
2 to 3	Length = n							
4	Spare				Instance			
5	Spare				Container Type			
6 to (n+4)	F-Container field							

Figure 8.48-1: Full Qualified Container (F-Container)

The Container Type is coded as below:

- If this field is set to 1, then the F-Container field present the UTRAN transparent container.
- If this field is set to 2, then the F-Container field present the BSS container.
- If this field is set to 3, then the F-Container field present the E-UTRAN transparent container.

8.49 Fully Qualified Cause (F-Cause)

Fully Qualified Cause (F-Cause) is coded as depicted in Figure 8.49-1.

Octets	Bits							
	8	7	6	5	4	3	2	1
1	Type = 119 (decimal)							
2 to 3	Length = n							
4	Spare				Instance			
5	Spare				Cause Type			
6 to (n+4)	F-Cause field							

Figure 8.49-1: Full Qualified Cause (F-Cause)

The value of Instance field of the F-Cause IE in a GTPv2 message shall indicate whether the F-Cause field contains RANAP Cause, BSSGP Cause or RAN Cause. If the F-Cause field contains RAN Cause, the Cause Type field shall contain the RAN cause subcategory as specified in 3GPP TS 36.413 [10] and it shall be encoded as in Table 8.49-1. If the F-Cause field contains BSSGP Cause or RANAP Cause, the Cause Type field shall be ignored by the receiver.

All spare bits shall be set to zeros by the sender and ignored by the receiver.

F-Cause field is coded as follows:

- For RANAP Cause, the F-Cause field contains the cause as defined in 3GPP TS 25.413 [33]. The value of F-Cause field (which has a range of 1..512) is transferred over the Iu interface and encoded into two octet as binary integer.
- For BSSGP Cause, the F-Cause field contains the cause as defined in 3GPP TS 48.018 [34]. The value of F-Cause field (which has a range of 1..255) is transferred over the Gb interface and encoded into one octet as binary integer.
- For RAN Cause, the F-Cause field contains the cause as defined in clause 9.2.1.3 in 3GPP TS 36.413 [10]. The value of F-Cause field (and the associated RAN cause subcategory) is transferred over the S1-AP interface and encoded into one octet as binary integer.

Table 8.49-1: Cause Type values and their meanings

Cause Type	Values (Decimal)
Radio Network Layer	0
Transport Layer	1
NAS	2
Protocol	3
Miscellaneous	4
<spare>	5 to 15

8.50 Selected PLMN ID

The Selected PLMN ID IE contains the core network operator selected for the UE in a shared network. Octets 5-7 shall be encoded as the content part of the "Selected PLMN Identity" parameter in 3GPP TS 36.413 [10].

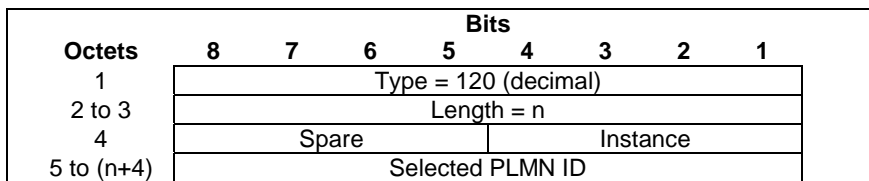

Figure 8.50-1: Selected PLMN ID

8.51 Target Identification

The Target Identification information element is coded as depicted in Figure 8.51-1.

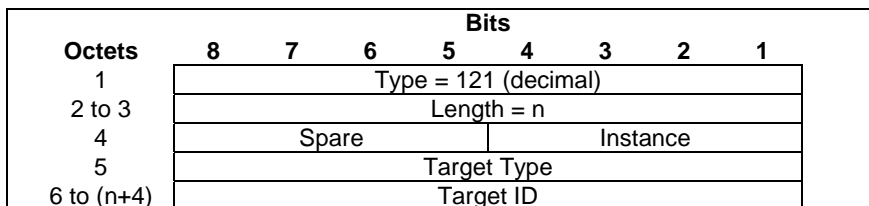

Figure 8.51-1: Target Identification

Target Type values are specified in Table 8.51-1.

The Target Type is RNC ID for SRNS relocation procedure and handover to UTRAN. In this case the Target ID field shall be encoded as the Target RNC-ID part of the "Target ID" parameter in 3GPP TS 25.413 [33].

The Target Type is eNodeB ID for handover to E-UTRAN. In this case the coding of the Target ID field shall be coded as depicted in Figure 8.51-2.

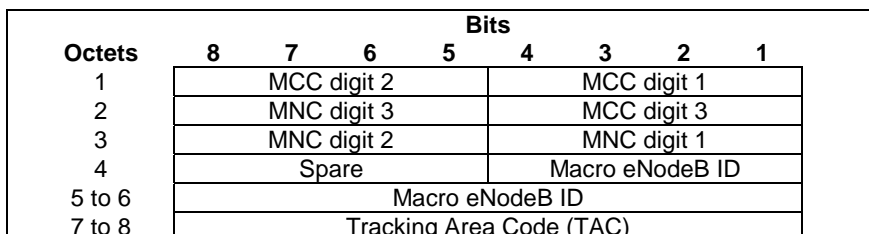

Figure 8.51-2: Target ID for Type eNodeB

The Macro eNodeB ID consists of 20 bits. Bit 4 of Octet 4 is the most significant bit and bit 1 of Octet 6 is the least significant bit. The coding of the Macro eNodeB ID is the responsibility of each administration. Coding using full hexadecimal representation shall be used.

NOTE: If Target Type is eNodeB ID, in Rel-9 version or later, the coding of Target ID field may be extended to represent the Global eNB ID with Home eNB ID as described in 3GPP TS 36.413 [10].

The Target Type is Cell Identifier for handover to GERAN. In this case the coding of the Target ID field shall be same as the Octets 3 to 10 of the Cell Identifier IEI in 3GPP TS 48.018 [34].

Table 8.51-1: Target Type values and their meanings

Target Types	Values (Decimal)
RNC ID	0
eNodeB ID	1
Cell Identifier	2
<spare>	3 to 255

8.52 NSAPI

The NSAPI information element contains an NSAPI identifying a PDP Context.

All Spare bits are set to zeros by the sender and ignored by the receiver.

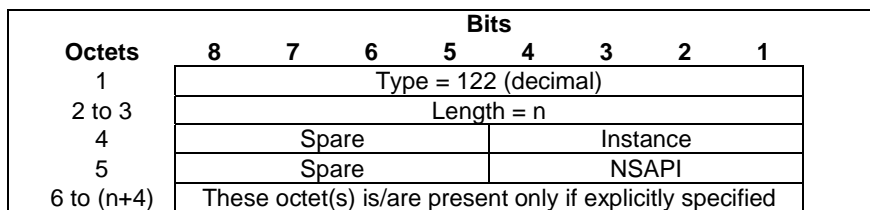

Figure 8.52-1: NSAPI

8.53 Packet Flow ID

The Packet Flow Id information element contains the packet flow identifier assigned to a PDP context as identified by NSAPI.

The spare bits 8 to 5 in octet 5 indicate unused bits, which shall be set to 0 by the sending side and which shall not be evaluated by the receiving side.

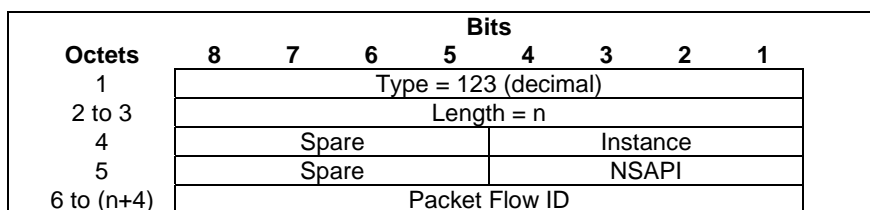

Figure 8.53-1: Packet Flow ID

8.54 RAB Context

The RAB Context shall be coded as is depicted in Figure 8.54-1.

Octets	Bits							
	8	7	6	5	4	3	2	1
1	Type = 124 (decimal)							
2 to 3	Length = 8							
4	Spare				Instance			
5	Spare				NSAPI			
6 to 7	DL GTP-U Sequence Number							
8 to 9	UL GTP-U Sequence Number							
9 to 10	DL PDCP Sequence Number							
11 to 12	UL PDCP Sequence Number							

Figure 8.54-1: RAB Context

The RAB Context IE may be repeated within a message with exactly the same Type and Instance to represent a list.

The RAB context information element contains sequence number status for one RAB in RNC, which corresponds to one PDP context. The RAB contexts are transferred between the RNCs via the SGSNs at inter SGSN hard handover.

NSAPI identifies the PDP context and the associated RAB for which the RAB context IE is intended.

DL GTP-U Sequence Number is the number for the next downlink GTP-U T-PDU to be sent to the UE.

UL GTP-U Sequence Number is the number for the next uplink GTP-U T-PDU to be tunnelled to the SGW.

DL PDCP Sequence Number is the number for the next downlink PDCP-PDU to be sent to the UE.

UL PDCP Sequence Number is the number for the next uplink PDCP-PDU to be received from the UE.

8.55 Source RNC PDCP context info

The purpose of the Source RNC PDCP context info IE is to transfer RNC PDCP context information from a source RNC to a target RNC during an SRNS relocation.

Octets	Bits							
	8	7	6	5	4	3	2	1
1	Type = 125 (decimal)							
2 to 3	Length = n							
4	Spare				Instance			
5 to (n+4)	RRC Container							

Figure 8.55-1: Source RNC PDCP context info

8.56 UDP Source Port Number

UDP Source Port Number is coded as depicted in Figure 8.56-1.

Octets	Bits							
	8	7	6	5	4	3	2	1
1	Type = 126 (decimal)							
2 to 3	Length = 2							
4	Spare				Instance			
5 to 6	UDP Source Port Number							
7 to (n+4)	These octet(s) is/are present only if explicitly specified							

Figure 8.56-1: UDP Source Port Number

8.57 APN Restriction

The APN Restriction information element contains an unsigned integer value indicating the level of restriction imposed on EPS Bearer Contexts created to the associated APN.

The APN Restriction IE is coded as depicted in Figure 8.57-1:

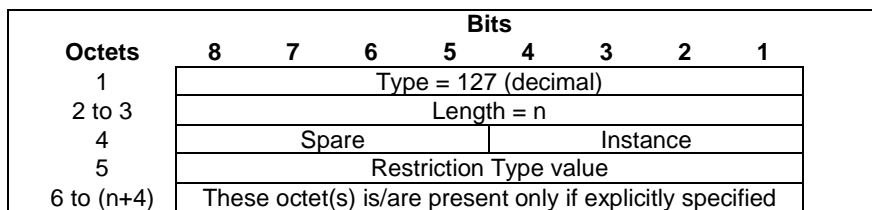

Figure 8.57-1: APN Restriction Type Information Element

An APN Restriction value may be configured for each APN in the PGW. It is used to determine, on a per UE basis, whether it is allowed to establish EPS bearers to other APNs.

Table 8.57-1: Valid Combinations of APN Restriction

Maximum APN Restriction Value	Type of APN	Application Example	APN Restriction Value allowed to be established
0	No Existing Contexts or Restriction		All
1	Public-1	MMS	1, 2, 3
2	Public-2	Internet	1, 2
3	Private-1	Corporate (e.g. who use MMS)	1
4	Private-2	Corporate (e.g. who do not use MMS)	None

8.58 Selection Mode

The Selection mode information element indicates the origin of the APN in the message.

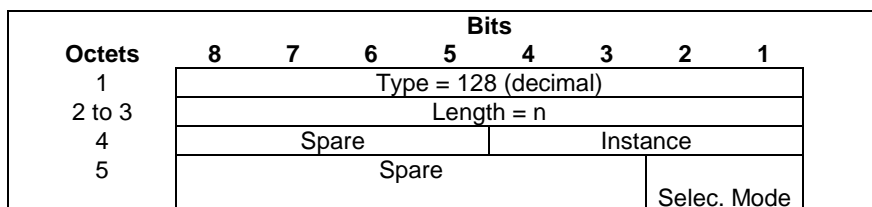

Figure 8.58-1: Selection Mode Information Element

Table 8.58-1: Selection Mode Values

Selection mode value	Value (Decimal)
MS or network provided APN, subscribed verified	0
MS provided APN, subscription not verified	1
Network provided APN, subscription not verified	2
For future use. Shall not be sent. If received, shall be interpreted as the value "2".	3

8.59 Source Identification

The Source Identification information element is coded as depicted in Figure 8.59-1.

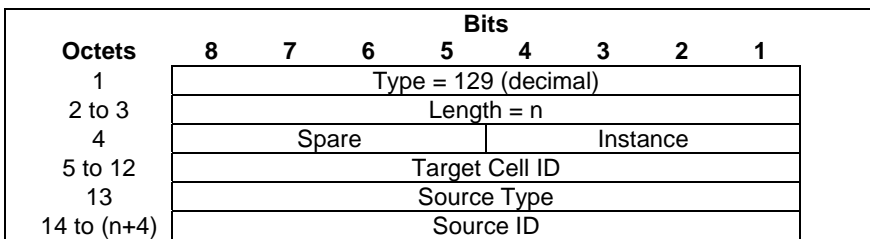

Figure 8.59-1: Source Identification

The Target Cell ID shall be same as the Octets 3 to 10 of the Cell Identifier IEI in 3GPP TS 48.018 [34].

Source Type values are specified in Table 8.59-1.

The Source Type is Cell ID for PS handover from GERAN A/Gb mode. In this case the coding of the Source ID field shall be same as the Octets 3 to 10 of the Cell Identifier IEI in 3GPP TS 48.018 [34].

The Source Type is RNC ID for PS handover from GERAN Iu mode or for inter-RAT handover from UTRAN. In this case the Source ID field shall be encoded as as the Source RNC-ID part of the "Source ID" parameter in 3GPP TS 25.413 [33].

The Source Type is eNodeB ID handover from E-UTRAN to GERAN A/Gb mode. In this case the coding of the Source ID field shall be coded as depicted in Figure 8.59-2.

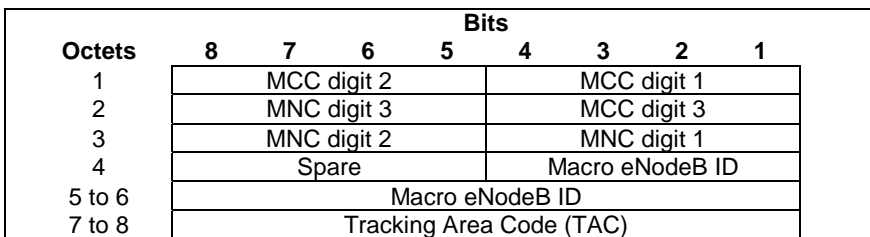

Figure 8.59-2: Source ID for Type eNodeB

The Macro eNodeB ID consists of 20 bits. Bit 4 of Octet 4 is the most significant bit and bit 1 of Octet 6 is the least significant bit. The coding of the Macro eNodeB ID is the responsibility of each administration. Coding using full hexadecimal representation shall be used.

NOTE: If Source Type is eNodeB ID, in Rel-9 version or later, the coding of Source ID field may be extended to represent the Global eNB ID with Home eNB ID as described in 3GPP TS 36.413 [10].

Table 8.59-1: Source Type values and their meanings

Source Types	Values (Decimal)
Cell ID	0
RNC ID	1
eNodeB ID	2
<spare>	3-255

8.60 Void

8.61 Change Reporting Action

Change Reporting Action IE is coded as depicted in Figure 8.61-1.

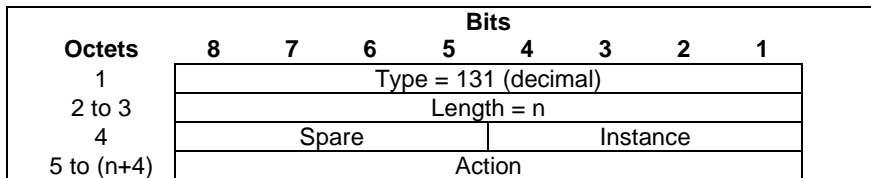

Figure 8.61-1: Change Reporting Action

Table 8.61-1: Action values

Action	Value (Decimal)
Stop Reporting	0
Start Reporting CGI/SAI	1
Start Reporting RAI	2
Start Reporting TAI	3
Start Reporting ECGI	4
<spare>	5-255

8.62 Fully qualified PDN Connection Set Identifier (FQ-CSID)

A fully qualified PDN Connection Set Identifier (FQ-CSID) identifies a set of PDN connections belonging to an arbitrary number of UEs on a MME, SGW or PGW. The FQ-CSID is used on S5, S8 and S11 interfaces.

The size of CSID is two octets. The FQ-CSID is coded as follows:

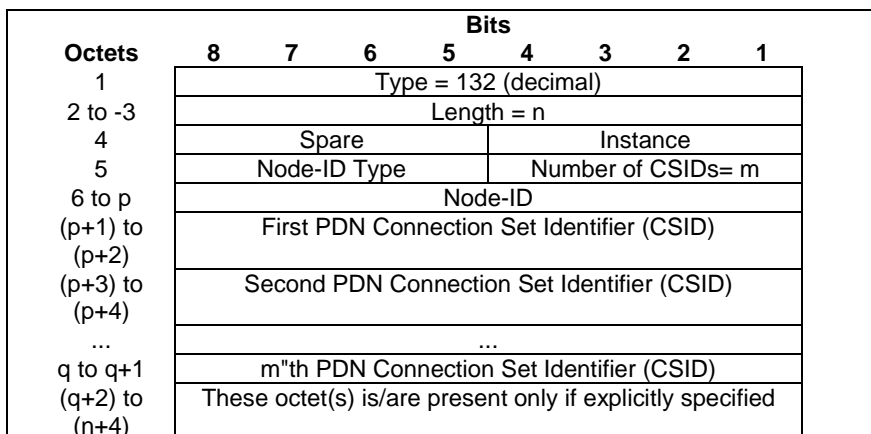

Figure 8.62-1: FQ-CSID

Where Node-ID Type values are:

- 0 indicates that Node-ID is a global unicast IPv4 address and p = 9.
- 1 indicates that Node-ID is a global unicast IPv6 address and p = 21.
- 2 indicates that Node-ID is a 4 octets long field with a 32 bit value stored in network order, and p= 9. The coding of the field is specified below:
 - Most significant 20 bits are the binary encoded value of (MCC * 1000 + MNC).
 - Least significant 12 bits is a 12 bit integer assigned by an operator to an MME, SGW or PGW. Other values of Node-ID Type are reserved.

Values of Number of CSID other than 1 are only employed in the Delete PDN Connection Set Request and Response.

The node that creates the FQ-CSID, (i.e. MME for MME FQ-CSID, SGW for SGW FQ-CSID, and PGW for PGW FQ-CSID), is responsible for making sure the Node-ID is globally unique and the CSID value is unique within that node.

When a FQ-CSID is stored by a receiving node, it is stored on a PDN basis even for messages impacting only one bearer (i.e. Create Bearer Request). See 3GPP TS 23.007 [17] for further details on the CSID and what specific requirements are placed on the PGW, SGW and MME.

8.63 Channel needed

The Channel needed shall be coded as depicted in Figure 8.63-1. Channel needed is coded as the IEI part and the value part of the Channel Needed IE defined in 3GPP TS 44.018[28]

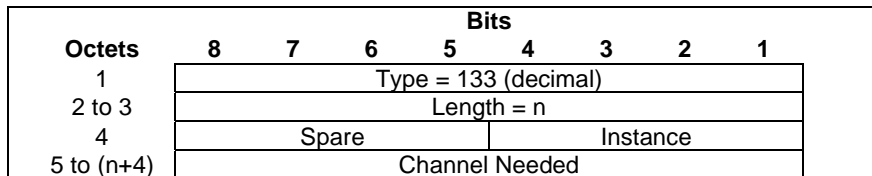

Figure 8.63-1: Channel needed

8.64 eMLPP Priority

The eMLPP-Priority shall be coded as depicted in Figure 8.64-1. The eMLPP Priority is coded as the value part of the eMLPP-Priority IE defined in 3GPP TS 48.008 [29] (not including 3GPP TS 48.008 IEI and 3GPP TS 48.008 [29] length indicator).

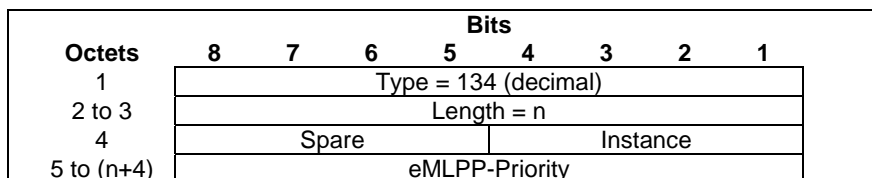

Figure 8.64-1: eMLPP Priority

8.65 Node Type

Node Type is coded as this is depicted in Figure 8.65-1.

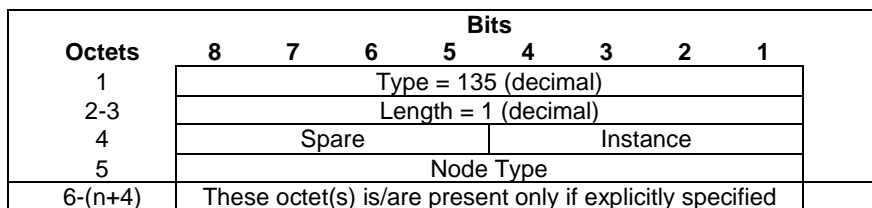

Figure 8.65-1: Node Type

Node type values are specified in Table 8.65-1.

Table 8. 65-1: Node Type values

Node Types	Values (Decimal)
MME	0
SGSN	1
<spare>	2-255

8.66 Fully Qualified Domain Name (FQDN)

Fully Qualified Domain Name (FQDN) is coded as depicted in Figure 8.66-1.

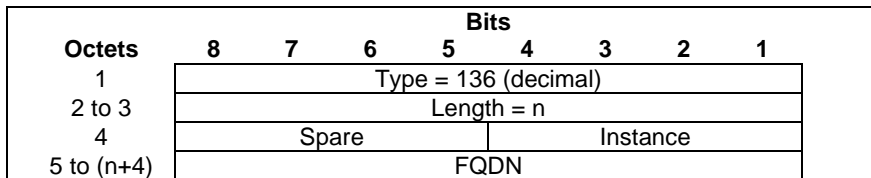

Figure 8.66-1: Fully Qualified Domain Name (FQDN)

The FQDN field encoding shall be identical to the encoding of a FQDN within a DNS message of section 3.1 of IETF RFC 1035 [31] but excluding the trailing zero byte.

NOTE 1: The FQDN field in the IE is not encoded as a dotted string as commonly used in DNS master zone files.

A "PGW node name" IE in S3/S10/S16 GTP messages shall be a PGW host name as per subclause 4.3.2 of 3GPP TS 29.303 [32] when the PGW FQDN IE is populated from 3GPP TS 29.303 [32] procedures. Specifically, the first DNS label is either "topon" or "topoff", and the canonical node name of the PGW starts at the third label. The same rules apply to "SGW node name" IE on S3/S10/S16.

NOTE 2: The constraint of subclause 4.3.2 of 3GPP TS 29.303 format is on populating the IE by 3GPP nodes for 3GPP nodes, the receiver shall not reject an IE that is otherwise correctly formatted since the IE might be populated for a non-3GPP node.

8.67 Private Extension

Private Extension is coded as depicted in Figure 8.67-1.

Enterprise ID can be found at IANA web site (<http://www.iana.org/assignments/enterprise-numbers>).

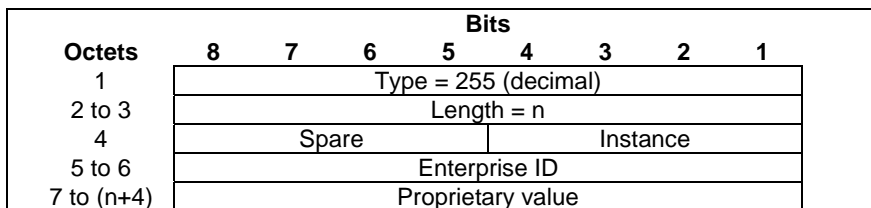

Figure 8.67-1. Private Extension

8.68 Transaction Identifier (TI)

Transaction Identifier is coded as depicted in Figure 8.68-1. It is defined in 3GPP TS 24.301 [23], clause 9.9.4.17 and is coded as specified in 3GPP TS 24.007 [30], clause 11.2.3.1.3 Transaction identifier.

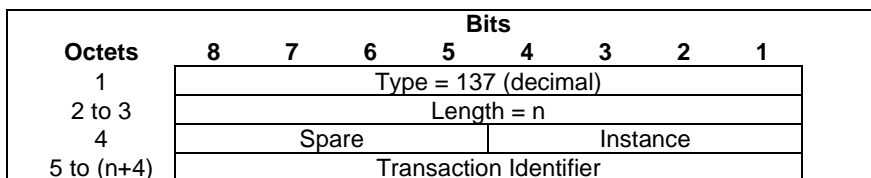

Figure 8.68-1: Transaction Identifier

9 Security

GTPv2-C communications shall be protected according to security mechanisms defined in 3GPP TS 33.401 [12].

10 IP - The Networking Technology used by GTP

10.1 IP Version

GTPv2 entities shall support both versions of the Internet Protocol, version 4 (IPv4) as defined by IETF RFC 791 [6], and version 6 (IPv6) as defined by IETF RFC 2460 [16].

10.2 IP Fragmentation

It is specified here how the fragmentation mechanism shall work with GTP-C.

Fragmentation should be avoided if possible. Examples of fragmentation drawbacks are:

- Fragmentation is inefficient, since the complete IP header is duplicated in each fragment.
- If one fragment is lost, the complete packet has to be discarded. The reason is that no selective retransmission of fragments is possible.

Path MTU discovery should be used, especially if GTPv2-C message is encapsulated with IPv6 header. The application should find out the path MTU, and thereby utilise more efficient fragmentation mechanisms.

Annex A (Informative): Backward Compatibility Guidelines for Information Elements

In order to preserve backward compatibility, the following rules should apply when adding or modifying information elements for existing messages.

- No new mandatory (M) information elements should be added.
- No new conditional (C) information elements should be added.
- Any new IEs should be either:
 - optional (O), having no conditions on their presence, or
 - conditional-optional (CO), having conditions that should apply only to the sender and not to the receiver.

Such conditions should be worded generally as follows: "This IE shall be sent over the xxx interface <condition>. The receiving entity need not check the IE's presence."

- If any new conditions are added to a previously specified conditional (C) information element, these new conditions should apply only to the sender and not to the receiver.

Such additional conditions should be worded generally as follows: "This IE shall be sent over the xxx interface <condition>. For this optional condition, the receiving entity need not check the IE's presence."

Existing conditions for such conditional (C) IEs should be treated as before, and the presence of the IEs should remain conditional (C).

Annex B (informative): Change History

Date	TSG #	TSG Doc	CT4 Doc	CR	Rev	Cat	Subject/Comment	Old	New
2008-12	CT#42	CP-080717					V2.0.0 approved in CT#42	2.0.0	8.0.0
2009-03	CT#43	CP-090050	C4-090922	0001	2	C	Delete Indirect Data Forwarding Tunnel Request/Response	8.0.0	8.1.0
2009-03	CT#43	CP-090050	C4-090520	0003	1	C	Relocation Cancel Req/Res	8.0.0	8.1.0
2009-03	CT#43	CP-090050	C4-090834	0004	2	C	Path Failure	8.0.0	8.1.0
2009-03	CT#43	CP-090050	C4-090878	0005	4	F	Sections 1 through 6 Editorial Clean-up	8.0.0	8.1.0
2009-03	CT#43	CP-090050	C4-090879	0006	2	C	Delete Session and Delete Bearer messages	8.0.0	8.1.0
2009-03	CT#43	CP-090050	C4-090902	0008	2	C	Update User Plane messages	8.0.0	8.1.0
2009-03	CT#43	CP-090050	C4-090880	0017	2	B	Cleanup in path management and bearer command messages	8.0.0	8.1.0
2009-03	CT#43	CP-090050	C4-090526	0018	1	C	Create Session/Bearer Messages	8.0.0	8.1.0
2009-03	CT#43	CP-090050	C4-090901	0019	2	C	Modify Bearer messages	8.0.0	8.1.0
2009-03	CT#43	CP-090050	C4-090991	0020	2	C	IEs in CSFB related messages	8.0.0	8.1.0
2009-03	CT#43	CP-090050	C4-090570	0021	1	C	Command Messages	8.0.0	8.1.0
2009-03	CT#43	CP-090050	C4-090939	0022	3	C	Data Forwarding Info	8.0.0	8.1.0
2009-03	CT#43	CP-090050	C4-090970	0023	3	C	Delete Bearer messages	8.0.0	8.1.0
2009-03	CT#43	CP-090050	C4-090941	0024	2	C	Delete Session messages	8.0.0	8.1.0
2009-03	CT#43	CP-090050	C4-090574	0025	1	F	Downlink Data Notification	8.0.0	8.1.0
2009-03	CT#43	CP-090050	C4-090942	0026	2	F	Update Bearer messages	8.0.0	8.1.0
2009-03	CT#43	CP-090050	C4-090952	0027	2	C	Secondary PDP Activation	8.0.0	8.1.0
2009-03	CT#43	CP-090050	C4-090874	0028	2	C	Stop Paging	8.0.0	8.1.0
2009-03	CT#43	CP-090050	C4-090577	0030	1	F	EPS Bearer Contexts Prioritization	8.0.0	8.1.0
2009-03	CT#43	CP-090050	C4-090875	0032	2	F	Linked EPS Bearer ID	8.0.0	8.1.0
2009-03	CT#43	CP-090050	C4-090578	0034	1	F	AMBR IE encoding	8.0.0	8.1.0
2009-03	CT#43	CP-090050	C4-090157	0035	-	F	Authentication Failure Cause Code	8.0.0	8.1.0
2009-03	CT#43	CP-090050	C4-090580	0040	1	F	Forward SRNS Context Notification	8.0.0	8.1.0
2009-03	CT#43	CP-090050	C4-090581	0041	1	F	F-TEID IE clarification	8.0.0	8.1.0
2009-03	CT#43	CP-090214	-	0043	4	F	SGW Selection during TAU and corrections to Grouped IEs	8.0.0	8.1.0
2009-03	CT#43	CP-090050	C4-090583	0043	1	F	Identification Response algorithm information	8.0.0	8.1.0
2009-03	CT#43	CP-090050	C4-090798	0044	2	F	IE Type ordering	8.0.0	8.1.0
2009-03	CT#43	CP-090050	C4-090945	0045	2	F	Indication IE corrections	8.0.0	8.1.0
2009-03	CT#43	CP-090050	C4-090588	0048	1	F	MM Context enhancements	8.0.0	8.1.0
2009-03	CT#43	CP-090050	C4-090590	0050	1	F	Removal of Bearer ID List IE	8.0.0	8.1.0
2009-03	CT#43	CP-090050	C4-090591	0051	1	F	Remove unused IP Address IEs	8.0.0	8.1.0
2009-03	CT#43	CP-090050	C4-090592	0052	1	F	Selection Mode bits	8.0.0	8.1.0
2009-03	CT#43	CP-090050	C4-090593	0053	1	F	Corrections to Trace Information IE	8.0.0	8.1.0
2009-03	CT#43	CP-090050	C4-090946	0054	2	F	Trace Information IE to be included in S11 and S5/S8 messages	8.0.0	8.1.0
2009-03	CT#43	CP-090050	C4-090947	0055	3	F	Trace Session Activation/Deactivation when UE is attached	8.0.0	8.1.0
2009-03	CT#43	CP-090050	C4-090691	0059	1	B	New UE Time Zone IE Type	8.0.0	8.1.0
2009-03	CT#43	CP-090050	C4-090692	0060	1	C	Release Access Bearers Request/Response	8.0.0	8.1.0
2009-03	CT#43	CP-090256	C4-090935	0061	3	B	Piggybacking of Dedicated Bearer Messages	8.0.0	8.1.0
2009-03	CT#43	CP-090050	C4-090933	0063	4	C	Finalizing GTPv2 Error Handling clause	8.0.0	8.1.0
2009-03	CT#43	CP-090050	C4-090598	0064	1	F	GTPv2 clause 9 and 10 cleanup	8.0.0	8.1.0
2009-03	CT#43	CP-090050	C4-090977	0066	4	B	RAN Information Relay message	8.0.0	8.1.0
2009-03	CT#43	CP-090050	C4-090975	0067	2	F	Bearer QoS encoding	8.0.0	8.1.0
2009-03	CT#43	CP-090050	C4-090694	0068	1	F	Modify Bearer Response	8.0.0	8.1.0
2009-03	CT#43	CP-090050	C4-090932	0075	3	C	Location Change Reporting	8.0.0	8.1.0
2009-03	CT#43	CP-090050	C4-090976	0077	2	F	Cleanup on Cause Values	8.0.0	8.1.0
2009-03	CT#43	CP-090050	C4-090811	0080	1	F	Non-3GPP Requests in GTPv2	8.0.0	8.1.0
2009-03	CT#43	CP-090050	C4-090938	0082	3	F	Support of IP address retrieval for ANRF	8.0.0	8.1.0
2009-03	CT#43	CP-090050	C4-090814	0083	1	F	Support for error response for conflicting resource request	8.0.0	8.1.0
2009-03	CT#43	CP-090050	C4-090817	0085	1	F	Clarification of Target ID vs Cell ID	8.0.0	8.1.0
2009-03	CT#43	CP-090050	C4-090936	0089	2	F	TEID Value of the GTP header	8.0.0	8.1.0
2009-03	CT#43	CP-090050	C4-090826	0093	3	B	Header for the Format of the GTPv2-C message	8.0.0	8.1.0
2009-03	CT#43	CP-090050	C4-090871	0094	3	C	Finalization of Partial fault handling in GTPv2	8.0.0	8.1.0
2009-03	CT#43	CP-090050	C4-090822	0095	1	F	MSISDN encoding	8.0.0	8.1.0
2009-03	CT#43	CP-090050	C4-090823	0096	1	F	IMSI encoding	8.0.0	8.1.0
2009-03	CT#43	CP-090050	C4-090829	0097	1	C	PMIP error code reservation	8.0.0	8.1.0
2009-03	CT#43	CP-090050	C4-090549	0098	-	F	Removal of Comprehension Required from messages 7.3.1 to 7.3.13	8.0.0	8.1.0

Date	TSG #	TSG Doc	CT4 Doc	CR	Rev	Cat	Subject/Comment	Old	New
2009-03	CT#43	CP-090050	C4-090550	0099	-	F	Cause value for PGW not responding	8.0.0	8.1.0
2009-03	CT#43	CP-090050	C4-090551	0100	-	F	Traffic Aggregate Description IE encoding	8.0.0	8.1.0
2009-03	CT#43	CP-090050	C4-090980	0101	3	F	Protocol Stack	8.0.0	8.1.0
2009-03	CT#43	CP-090050	C4-090831	0102	1	C	Reliable delivery for EPC	8.0.0	8.1.0
2009-03	CT#43	CP-090050	C4-090915	0104	-	F	Removal of reservation for message types of GTP-U	8.0.0	8.1.0
2009-03	CT#43	CP-090239	-	0105	1	F	Essential correction to grouped IE type coding	8.0.0	8.1.0
2009-03	-	-	-	-	-	-	Some of the table formats corrected	8.1.0	8.1.1
2009-06	CT#44	CP-090288	C4-091020	0107	-	F	Suspend and Resume are also used for 1xRTT CS Fallback	8.1.1	8.2.0
2009-06	CT#44	CP-090288	C4-091459	0108	1	F	Support for new cause code of "Unable to page UE due to CSFB" in Downlink Data Notification Acknowledgement.	8.1.1	8.2.0
2009-06	CT#44	CP-090288	C4-091460	0109	1	F	Corrections on GTPv2 for 1x IWS IP address	8.1.1	8.2.0
2009-06	CT#44	CP-090288	C4-091461	0110	1	F	Clarification of Operation Indication (OI)	8.1.1	8.2.0
2009-06	CT#44	CP-090288	C4-091463	0111	1	F	Usage of User Location Information (ULI) IE	8.1.1	8.2.0
2009-06	CT#44	CP-090288	C4-091465	0112	1	F	PGW S5/S8 IP Address in Context Response message	8.1.1	8.2.0
2009-06	CT#44	CP-090288	C4-091471	0114	1	F	Delete Indirect Data Forwarding Tunnel Response	8.1.1	8.2.0
2009-06	CT#44	CP-090288	C4-091537	0115	2	F	Error_Handling. Withdrawn	8.1.1	8.2.0
2009-06	CT#44	CP-090288	C4-091473	0117	1	F	PCO Extensions added to messages	8.1.1	8.2.0
2009-06	CT#44	CP-090288	C4-091474	0118	1	F	Clarifications to message directions	8.1.1	8.2.0
2009-06	CT#44	CP-090288	C4-091103	0119	-	F	Removal of specification drafting hints	8.1.1	8.2.0
2009-06	CT#44	CP-090288	C4-091475	0120	1	F	ISR related alignments	8.1.1	8.2.0
2009-06	CT#44	CP-090288	C4-091476	0122	1	F	Clarifications to grouped IE usage	8.1.1	8.2.0
2009-06	CT#44	CP-090288	C4-091586	0125	2	F	Clarification to Recovery IE type	8.1.1	8.2.0
2009-06	CT#44	CP-090288	C4-091478	0127	1	F	Missing conditions	8.1.1	8.2.0
2009-06	CT#44	CP-090288	C4-091480	0128	1	F	Clarification of ARP encoding	8.1.1	8.2.0
2009-06	CT#44	CP-090288	C4-091115	0129	-	F	Units for APN-AMBR	8.1.1	8.2.0
2009-06	CT#44	CP-090288	C4-091481	0131	2	F	Clarification of Mobile Equipment Identity IE encoding	8.1.1	8.2.0
2009-06	CT#44	CP-090288	C4-091120	0134	-	F	EPS Bearer Level TFT encoding	8.1.1	8.2.0
2009-06	CT#44	CP-090288	C4-091587	0136	2	F	UE-initiated procedures with one bearer only	8.1.1	8.2.0
2009-06	CT#44	CP-090288	C4-091510	0137	2	F	Combine UL and DL TFT IEs	8.1.1	8.2.0
2009-06	CT#44	CP-090288	C4-091512	0142	1	F	PGW S5/S8 IP Address and TEID for user plane	8.1.1	8.2.0
2009-06	CT#44	CP-090288	C4-091513	0143	1	F	Transaction Identifier information element	8.1.1	8.2.0
2009-06	CT#44	CP-090288	C4-091515	0147	1	F	Delete Bearer Request	8.1.1	8.2.0
2009-06	CT#44	CP-090288	C4-091516	0149	2	F	Modify Bearer Request for TAU without MME or SGW change	8.1.1	8.2.0
2009-06	CT#44	CP-090288	C4-091538	0150	2	F	Use of APN, PAA in Create Session Request, and S5/S8-U PGW F-TEID in Create Session Response	8.1.1	8.2.0
2009-06	CT#44	CP-090288	C4-091540	0151	1	F	Message table corrections	8.1.1	8.2.0
2009-06	CT#44	CP-090288	C4-091162	0153	-	F	Presence requirement for IEs in response	8.1.1	8.2.0
2009-06	CT#44	CP-090288	C4-091537	0154	2	F	Offending IE in the Cause IE	8.1.1	8.2.0
2009-06	CT#44	CP-090288	C4-091541	0156	1	F	Minor corrections	8.1.1	8.2.0
2009-06	CT#44	CP-090288	C4-091542	0157	1	F	FQ-CSID corrections	8.1.1	8.2.0
2009-06	CT#44	CP-090288	C4-091167	0158	-	F	APN and FQDN encoding clarifications	8.1.1	8.2.0
2009-06	CT#44	CP-090288	C4-091168	0159	-	F	Removal of Trace Information IE from Update Bearer Request	8.1.1	8.2.0
2009-06	CT#44	CP-090288	C4-091467	0160	1	F	Corrections in PDN Connection group IE	8.1.1	8.2.0
2009-06	CT#44	CP-090288	C4-091543	0161	1	F	Missing IEs in "Update Bearer Response"	8.1.1	8.2.0
2009-06	CT#44	CP-090288	C4-091548	0164	2	F	PDN Type	8.1.1	8.2.0
2009-06	CT#44	CP-090288	C4-091549	0168	1	F	IE corrections in Modify Bearer signalling	8.1.1	8.2.0
2009-06	CT#44	CP-090288	C4-091550	0169	2	F	Create Session Request Clarification	8.1.1	8.2.0
2009-06	CT#44	CP-090288	C4-091202	0175	-	F	TEID in Detach Notification/ACK	8.1.1	8.2.0
2009-06	CT#44	CP-090288	C4-091203	0176	-	F	Condition of bearer context in Modify Bearer messages	8.1.1	8.2.0
2009-06	CT#44	CP-090288	C4-091544	0177	1	F	Delete Session Request granularity	8.1.1	8.2.0
2009-06	CT#44	CP-090288	C4-091205	0178	-	F	Deletion of IMSI in the Update Bearer Request	8.1.1	8.2.0
2009-06	CT#44	CP-090288	C4-091546	0180	1	F	Delete Session Request/Response and Delete Bearer Request	8.1.1	8.2.0
2009-06	CT#44	CP-090288	C4-091551	0181	1	F	Detach Notification	8.1.1	8.2.0
2009-06	CT#44	CP-090288	C4-091234	0183	-	F	SGSN Info for Data Forwarding	8.1.1	8.2.0
2009-06	CT#44	CP-090288	C4-091462	0184	1	F	Delete Session Request	8.1.1	8.2.0
2009-06	CT#44	CP-090288	C4-091561	0185	1	F	APN AMBR clarification	8.1.1	8.2.0
2009-06	CT#44	CP-090288	C4-091552	0186	1	F	Delete Bearer Request when ISR activated	8.1.1	8.2.0
2009-06	CT#44	CP-090288	C4-091553	0187	1	F	Clarify the usage of the MS validated IE	8.1.1	8.2.0
2009-06	CT#44	CP-090288	C4-091557	0189	1	F	UDP Source port and IP Source Address	8.1.1	8.2.0

Date	TSG #	TSG Doc	CT4 Doc	CR	Rev	Cat	Subject/Comment	Old	New
2009-06	CT#44	CP-090288	C4-091241	0190	-	F	Recovery IE	8.1.1	8.2.0
2009-06	CT#44	CP-090288	C4-091539	0192	1	F	APN Information	8.1.1	8.2.0
2009-06	CT#44	CP-090500	-	0193	3	F	Cause value	8.1.1	8.2.0
2009-06	CT#44	CP-090288	C4-091547	0195	1	F	Cleanup indication	8.1.1	8.2.0
2009-06	CT#44	CP-090288	C4-091556	0196	1	F	Cleanup the usage of some messages	8.1.1	8.2.0
2009-06	CT#44	CP-090288	C4-091545	0198	1	F	Linked EPS Bearer ID	8.1.1	8.2.0
2009-06	CT#44	CP-090288	C4-091514	0199	1	F	PCO parameter	8.1.1	8.2.0
2009-06	CT#44	CP-090288	C4-091558	0200	1	F	PDP Context Activation	8.1.1	8.2.0
2009-06	CT#44	CP-090288	C4-091464	0201	1	F	User Location Info	8.1.1	8.2.0
2009-06	CT#44	CP-090288	C4-091559	0202	2	F	F-Cause IE correction	8.1.1	8.2.0
2009-06	CT#44	CP-090288	C4-091560	0206	1	F	Message granularity	8.1.1	8.2.0
2009-06	CT#44	CP-090321	-	0209	-	F	Bearer Context in the Modify Bearer Command	8.1.1	8.2.0
2009-06	CT#44	CP-090493	-	0210	1	F	Sequence Number Extension	8.1.1	8.2.0
2009-06	CT#44	CP-090355	-	0212	-	F	Bearer Resource Command clarification	8.1.1	8.2.0
2009-06	CT#44	CP-090485	-	0213	1	F	Piggybacked message clarifications	8.1.1	8.2.0
2009-06	CT#44	CP-090472	-	0214	1	F	Corrections on handling Charging ID IE and Charging Characteristics IE	8.1.1	8.2.0
2009-09	CT#45	CP-090533	C4-091625	0215	-	F	Usage of GTPv2-C Header	8.2.0	8.3.0
2009-09	CT#45	CP-090533	C4-092004	0216	1	F	Create Session Request and Response	8.2.0	8.3.0
2009-09	CT#45	CP-090533	C4-092005	0217	1	F	Cleanup Editors Note	8.2.0	8.3.0
2009-09	CT#45	CP-090533	C4-092008	0218	1	F	Message format and Type values	8.2.0	8.3.0
2009-09	CT#45	CP-090533	C4-091630	0220	-	F	S16 Influence	8.2.0	8.3.0
2009-09	CT#45	CP-090533	C4-092012	0222	1	F	MM Context	8.2.0	8.3.0
2009-09	CT#45	CP-090533	C4-091633	0223	-	F	F-Container	8.2.0	8.3.0
2009-09	CT#45	CP-090533	C4-091635	0225	-	F	Change Reporting Action	8.2.0	8.3.0
2009-09	CT#45	CP-090533	C4-092013	0226	1	F	Procedure names	8.2.0	8.3.0
2009-09	CT#45	CP-090533	C4-092134	0228	3	F	Changes to Create-Session-Request and Create-Session-Response messages	8.2.0	8.3.0
2009-09	CT#45	CP-090533	C4-092017	0229	1	F	Changes to Modify-Bearer-Response	8.2.0	8.3.0
2009-09	CT#45	CP-090533	C4-092014	0232	2	F	Piggybacking Clarifications	8.2.0	8.3.0
2009-09	CT#45	CP-090533	C4-092018	0236	1	F	Delete Bearer Request Cause value for ISR deactivation	8.2.0	8.3.0
2009-09	CT#45	CP-090533	C4-092019	0237	2	F	Modify Bearer Request Bearer Level QoS	8.2.0	8.3.0
2009-09	CT#45	CP-090533	C4-092020	0239	1	F	Possible reject response Cause values in GTPv2 message descriptions	8.2.0	8.3.0
2009-09	CT#45	CP-090533	C4-092002	0241	1	F	SGW F-TEID for S1-U, S12 and S4 for User Plane	8.2.0	8.3.0
2009-09	CT#45	CP-090533	C4-092103	0243	2	F	Clarification on the usage of Version Not Supported Indication	8.2.0	8.3.0
2009-09	CT#45	CP-090533	C4-092074	0244	1	F	Clarifications on Sender-F-TEID for CP and S3/S10/S16 CP IP Addr and TEID IEs	8.2.0	8.3.0
2009-09	CT#45	CP-090533	C4-092076	0245	1	F	Cause Value in Echo Response	8.2.0	8.3.0
2009-09	CT#45	CP-090533	C4-091722	0246	-	F	Corrections in ULI IE and PDN Connection IE definitions	8.2.0	8.3.0
2009-09	CT#45	CP-090533	C4-092656	0247	3	F	GTPv2 Initial and Triggered Message definition and Sequence Number handling	8.2.0	8.3.0
2009-09	CT#45	CP-090533	C4-092078	0249	1	F	Missing Cause values in some message descriptions	8.2.0	8.3.0
2009-09	CT#45	CP-090533	C4-092711	0250	4	F	Add TAC to Target Identification IE	8.2.0	8.3.0
2009-09	CT#45	CP-090533	C4-092081	0256	1	F	IMSI and Sender F-TEID in Create Indirect Data Forwarding Tunnel Messages	8.2.0	8.3.0
2009-09	CT#45	CP-090534	C4-092009	0258	1	F	Indication in Forward Relocation messages	8.2.0	8.3.0
2009-09	CT#45	CP-090534	C4-092082	0259	1	F	Paging cause	8.2.0	8.3.0
2009-09	CT#45	CP-090534	C4-091784	0260	-	F	Correlate the bearers in the Create Bearer Response	8.2.0	8.3.0
2009-09	CT#45	CP-090534	C4-092651	0261	3	F	Cleanup cause values	8.2.0	8.3.0
2009-09	CT#45	CP-090534	C4-092104	0262	2	F	Delete Bearer Failure Indication	8.2.0	8.3.0
2009-09	CT#45	CP-090534	C4-092083	0263	1	F	Cleanup Modify Bearer Request	8.2.0	8.3.0
2009-09	CT#45	CP-090534	C4-092085	0264	2	F	IEs in Response	8.2.0	8.3.0
2009-09	CT#45	CP-090534	C4-091790	0266	-	F	CS Paging Indication	8.2.0	8.3.0
2009-09	CT#45	CP-090534	C4-092086	0267	2	F	Serving Network	8.2.0	8.3.0
2009-09	CT#45	CP-090534	C4-092636	0268	3	F	Service Handover support	8.2.0	8.3.0
2009-09	CT#45	CP-090534	C4-092105	0269	3	F	Fix incorrect interface name, incorrect reference and other misreading texts	8.2.0	8.3.0
2009-09	CT#45	CP-090534	C4-092106	0270	1	F	Clarification on cause value for Downlink Data Notification Failure Indication	8.2.0	8.3.0
2009-09	CT#45	CP-090534	C4-092710	0271	2	F	Clarification on the Authentication Vector handling	8.2.0	8.3.0
2009-09	CT#45	CP-090534	C4-092043	0276	1	F	Clarification on Authentication Vector encoding	8.2.0	8.3.0

Date	TSG #	TSG Doc	CT4 Doc	CR	Rev	Cat	Subject/Comment	Old	New
2009-09	CT#45	CP-090535	C4-092751	0278	5	F	Clarification on Error indication for EPC and DT	8.2.0	8.3.0
2009-09	CT#45	CP-090534	C4-092112	0279	3	F	Aligning MBR units to kbps	8.2.0	8.3.0
2009-09	CT#45	CP-090534	C4-092108	0281	1	F	Clarification to the PGW's UP address in Create Session Response	8.2.0	8.3.0
2009-09	CT#45	CP-090534	C4-092686	0282	4	F	Modify Bearer procedure for X2 and S1 based handovers	8.2.0	8.3.0
2009-09	CT#45	CP-090534	C4-092109	0290	1	F	Add necessary cause value to the Update Bearer Response	8.2.0	8.3.0
2009-09	CT#45	CP-090534	C4-092000	0292	-	F	Update on Concurrent Running of Security Procedures	8.2.0	8.3.0
2009-09	CT#45	CP-090534	C4-092642	0295	2	F	APN Restriction IE	8.2.0	8.3.0
2009-09	CT#45	CP-090534	C4-092644	0296	1	F	Change Reporting IE	8.2.0	8.3.0
2009-09	CT#45	CP-090534	C4-092646	0297	1	F	ULI Clarification	8.2.0	8.3.0
2009-09	CT#45	CP-090534	C4-092189	0301	-	F	Charging ID	8.2.0	8.3.0
2009-09	CT#45	CP-090534	C4-092647	0302	1	F	Delete Indirect Data Forwarding Tunnel Request/Response	8.2.0	8.3.0
2009-09	CT#45	CP-090535	C4-092648	0303	1	F	SGW F-TEID	8.2.0	8.3.0
2009-09	CT#45	CP-090535	C4-092649	0304	1	F	BCM	8.2.0	8.3.0
2009-09	CT#45	CP-090535	C4-092652	0307	3	F	Charging Gateway Address	8.2.0	8.3.0
2009-09	CT#45	CP-090535	C4-092653	0308	1	F	LBI Clarifications for Gn/Gp Handovers	8.2.0	8.3.0
2009-09	CT#45	CP-090535	C4-092654	0309	1	F	Trace management messages and IE related clarifications	8.2.0	8.3.0
2009-09	CT#45	CP-090535	C4-092655	0310	1	F	Indirect Data Forwarding Tunnel clarifications	8.2.0	8.3.0
2009-09	CT#45	CP-090535	C4-092635	0311	2	F	Concurrent Running of Security Procedures	8.2.0	8.3.0
2009-09	CT#45	CP-090535	C4-092657	0315	1	F	Cause value corrections	8.2.0	8.3.0
2009-09	CT#45	CP-090535	C4-092659	0316	1	F	Identification Response	8.2.0	8.3.0
2009-09	CT#45	CP-090535	C4-092677	0317	1	F	NSAPI and EBI in Forward Relocation Response	8.2.0	8.3.0
2009-09	CT#45	CP-090535	C4-092678	0318	1	F	Cause in the CSFB related messages	8.2.0	8.3.0
2009-09	CT#45	CP-090535	C4-092650	0320	1	F	Update Bearer Complete	8.2.0	8.3.0
2009-09	CT#45	CP-090535	C4-092679	0321	1	F	PCO IE	8.2.0	8.3.0
2009-09	CT#45	CP-090535	C4-092368	0322	-	F	Cleanup Trace Management messages	8.2.0	8.3.0
2009-09	CT#45	CP-090535	C4-092369	0323	-	F	Cleanup section 5.3 and 8.12	8.2.0	8.3.0
2009-09	CT#45	CP-090535	C4-092680	0324	1	F	APN AMBR in the Create Bearer Request	8.2.0	8.3.0
2009-09	CT#45	CP-090535	C4-092681	0325	1	F	UDP Source Port Number	8.2.0	8.3.0
2009-09	CT#45	CP-090535	C4-092372	0326	-	F	Presence Requirments for grouped IE	8.2.0	8.3.0
2009-09	CT#45	CP-090535	C4-092709	0330	1	F	Making PCO conditional for the Attach procedure	8.2.0	8.3.0
2009-09	CT#45	CP-090535	C4-092388	0332	-	F	Echo usage alignment with stage 2	8.2.0	8.3.0
2009-09	CT#45	CP-090535	C4-092397	0334	-	F	Trace Depth per session	8.2.0	8.3.0
2009-09	CT#45	CP-090535	C4-092740	0335	4	F	Backward compatibility requirements for presence	8.2.0	8.3.0
2009-09	CT#45	CP-090535	C4-092712	0338	1	F	ECGI encoding correction	8.2.0	8.3.0
2009-09	CT#45	CP-090535	C4-092713	0339	1	F	Consistant PDN type setting	8.2.0	8.3.0
2009-09	CT#45	CP-090535	C4-092714	0340	1	F	GTP Cause value usage	8.2.0	8.3.0
2009-09	CT#45	CP-090729	C4-092626	0341	1	F	Partial failure handling alignment with stage 2	8.2.0	8.3.0
2009-09	CT#45	CP-090729	C4-092738	0342	2	F	Partial failure handling for MME relocation w/o SGW relocation	8.2.0	8.3.0
2009-09	CT#45	CP-090535	C4-092634	0346	1	F	Security Specification for GTPV2-C	8.2.0	8.3.0
2009-09	CT#45	CP-090535	C4-092715	0349	1	F	Avoiding Source Port Overlap between GTPv2-C and GTPv2-C'	8.2.0	8.3.0
2009-09	CT#45	CP-090535	C4-092478	0350	-	F	Delete Bearer Command PCO removal	8.2.0	8.3.0

History

Document history		
V8.0.0	January 2009	Publication
V8.1.1	April 2009	Publication
V8.2.0	June 2009	Publication
V8.3.0	October 2009	Publication