

# ETSI TS 129 275 V11.6.0 (2013-04)



**Universal Mobile Telecommunications System (UMTS);  
LTE;  
Proxy Mobile IPv6 (PMIPv6)  
based Mobility and Tunnelling protocols;  
Stage 3  
(3GPP TS 29.275 version 11.6.0 Release 11)**



---

**Reference**

RTS/TSGC-0429275vb60

---

**Keywords**

LTE,UMTS

**ETSI**

650 Route des Lucioles  
F-06921 Sophia Antipolis Cedex - FRANCE

---

Tel.: +33 4 92 94 42 00 Fax: +33 4 93 65 47 16

Siret N° 348 623 562 00017 - NAF 742 C  
Association à but non lucratif enregistrée à la  
Sous-Préfecture de Grasse (06) N° 7803/88

---

**Important notice**

---

Individual copies of the present document can be downloaded from:

<http://www.etsi.org>

The present document may be made available in more than one electronic version or in print. In any case of existing or perceived difference in contents between such versions, the reference version is the Portable Document Format (PDF). In case of dispute, the reference shall be the printing on ETSI printers of the PDF version kept on a specific network drive within ETSI Secretariat.

Users of the present document should be aware that the document may be subject to revision or change of status. Information on the current status of this and other ETSI documents is available at

<http://portal.etsi.org/tb/status/status.asp>

If you find errors in the present document, please send your comment to one of the following services:

[http://portal.etsi.org/chaicor/ETSI\\_support.asp](http://portal.etsi.org/chaicor/ETSI_support.asp)

---

**Copyright Notification**

---

No part may be reproduced except as authorized by written permission.  
The copyright and the foregoing restriction extend to reproduction in all media.

© European Telecommunications Standards Institute 2013.  
All rights reserved.

**DECT™**, **PLUGTESTS™**, **UMTS™** and the ETSI logo are Trade Marks of ETSI registered for the benefit of its Members.  
**3GPP™** and **LTE™** are Trade Marks of ETSI registered for the benefit of its Members and of the 3GPP Organizational Partners.  
**GSM®** and the GSM logo are Trade Marks registered and owned by the GSM Association.

---

## Intellectual Property Rights

IPRs essential or potentially essential to the present document may have been declared to ETSI. The information pertaining to these essential IPRs, if any, is publicly available for **ETSI members and non-members**, and can be found in ETSI SR 000 314: *"Intellectual Property Rights (IPRs); Essential, or potentially Essential, IPRs notified to ETSI in respect of ETSI standards"*, which is available from the ETSI Secretariat. Latest updates are available on the ETSI Web server (<http://ipr.etsi.org>).

Pursuant to the ETSI IPR Policy, no investigation, including IPR searches, has been carried out by ETSI. No guarantee can be given as to the existence of other IPRs not referenced in ETSI SR 000 314 (or the updates on the ETSI Web server) which are, or may be, or may become, essential to the present document.

---

## Foreword

This Technical Specification (TS) has been produced by ETSI 3rd Generation Partnership Project (3GPP).

The present document may refer to technical specifications or reports using their 3GPP identities, UMTS identities or GSM identities. These should be interpreted as being references to the corresponding ETSI deliverables.

The cross reference between GSM, UMTS, 3GPP and ETSI identities can be found under <http://webapp.etsi.org/key/queryform.asp>.

# Contents

Intellectual Property Rights .....	2
Foreword.....	2
Foreword.....	9
1 Scope .....	10
2 References .....	10
3 Definitions and abbreviations.....	11
3.1 Definitions .....	11
3.2 Abbreviations .....	12
4 General .....	12
4.1 PDN connection .....	12
4.2 PMIPv6 protocol stacks.....	13
5 Mobility Management procedures.....	14
5.1 Proxy Mobile IPv6 PDN Connection Creation procedure.....	14
5.1.1 General.....	14
5.1.1.1 Proxy Binding Update.....	14
5.1.1.2 Proxy Binding Acknowledgement .....	17
5.1.2 MAG procedures .....	19
5.1.3 LMA procedures.....	19
5.2 Proxy Mobile IPv6 PDN Connection Lifetime Extension procedure.....	20
5.2.1 General.....	20
5.2.1.1 Proxy Binding Update.....	20
5.2.1.2 Proxy Binding Acknowledgement .....	22
5.2.2 MAG procedures .....	23
5.2.3 LMA procedures.....	23
5.3 Proxy Mobile IPv6 PDN Connection Handover procedure.....	25
5.3.1 General.....	25
5.3.1.1 Proxy Binding Update.....	25
5.3.1.2 Proxy Binding Acknowledgement .....	27
5.3.2 MAG procedures .....	30
5.3.3 LMA procedures.....	30
5.4 Proxy Mobile IPv6 MAG Initiated PDN Connection Deletion procedure .....	31
5.4.1 General.....	31
5.4.1.1 Proxy Binding Update.....	31
5.4.1.2 Proxy Binding Acknowledgement .....	32
5.4.2 MAG procedures .....	33
5.4.3 LMA procedures.....	34
5.5 Proxy Mobile IPv6 LMA Initiated PDN Connection Deletion procedure .....	34
5.5.1 General.....	34
5.5.1.1 Binding Revocation Indication.....	34
5.5.1.2 Binding Revocation Acknowledgment .....	35
5.5.2 MAG procedures .....	36
5.5.3 LMA procedures.....	36
5.6 Proxy Mobile IPv6 PDN Connection IPv4 address allocation procedure .....	36
5.6.1 General.....	36
5.6.1.1 Proxy Binding Update.....	37
5.6.1.2 Proxy Binding Acknowledgement .....	38
5.6.2 MAG procedures .....	39
5.6.3 LMA procedures.....	40
5.7 Proxy Mobile IPv6 LMA Initiated IPv4 Address Release procedure.....	40
5.7.1 General.....	40
5.7.1.1 Binding Revocation Indication.....	40
5.7.1.2 Binding Revocation Acknowledgment .....	41
5.7.2 MAG procedures .....	42

5.7.3	LMA procedures .....	42
5.8	Proxy Mobile IPv6 Multiple PDN Extensions .....	42
5.8.1	General .....	42
5.8.2	Extensions to PMIPv6 Data Structure .....	42
5.8.3	Extensions to PMIPv6 BULE and BCE Lookups .....	43
5.8.3.1	General .....	43
5.8.3.2	Extensions to PMIPv6 BCE Lookups .....	43
5.8.3.3	Extensions to PMIPv6 BULE Lookups .....	43
5.8.4	Extensions to PMIPv6 Procedure .....	44
5.8.4.1	General .....	44
5.8.4.2	MAG procedure .....	44
5.8.4.3	LMA procedure .....	44
5.9	Serving GW Procedure at Chaining Case .....	44
5.9.1	General .....	44
5.9.2	Signalling procedures .....	44
5.9.2.1	PMIP-based S8 Serving GW procedures .....	44
5.9.3	Payload packets at chained case .....	45
5.10	Proxy Mobile IPv6 MAG Initiated IPv4 Address Release procedure .....	45
5.10.1	General .....	45
5.10.1.1	Proxy Binding Update .....	45
5.10.1.2	Proxy Binding Acknowledgement .....	46
5.10.2	MAG procedures .....	47
5.10.3	LMA procedures .....	47
5.11	Proxy Mobile IPv6 LMA Initiated Update Notification procedure .....	48
5.11.1	General .....	48
5.11.1.1	Update Notification .....	48
5.11.1.2	Update Notification Acknowledgement .....	48
5.11.2	LMA procedures .....	49
5.11.3	MAG procedures .....	49
6	Tunnel Management procedures .....	50
6.1	General .....	50
6.2	MAG procedure .....	50
6.3	LMA procedure .....	50
6.4	Data Structures .....	51
6.4.1	Binding Update List Entry .....	51
6.4.2	Binding Cache Entry .....	51
6.5	Security .....	52
7	Path Management procedures .....	53
7.1	General .....	53
7.2	Heartbeat Mechanism .....	53
7.2.1	General .....	53
7.2.2	Heartbeat Message .....	53
7.2.2.1	Heartbeat Request .....	53
7.2.2.2	Heartbeat Response .....	53
7.3	Void .....	54
7.4	Void .....	54
7.5	Void .....	54
7.6	UE-specific Error Handling .....	54
7.6.1	General .....	54
7.6.2	MAG and LMA procedure .....	54
7.7	Void .....	54
7.8	Partial node failure requiring the removal of a subset of sessions .....	54
7.8.1	General .....	54
7.8.2	Binding Revocation Indication message .....	54
7.8.3	Binding Revocation Acknowledgement message .....	55
7.8.4	MAG procedures .....	55
7.8.5	LMA procedures .....	55
8	PMIP-based S5 and PMIP-based S8 description .....	56
8.1	Initial Attach procedures .....	56
8.1.1	General .....	56

8.1.2	Serving GW procedures .....	56
8.1.3	PDN GW procedures .....	56
8.2	Serving GW Initiated PDN Connection Lifetime Extension procedures .....	56
8.2.1	General.....	56
8.2.2	Serving GW procedures.....	56
8.2.3	PDN GW procedures .....	56
8.3	UE, MME or HSS initiated Detach procedures.....	56
8.3.1	General.....	56
8.3.2	Serving GW procedures.....	56
8.3.3	PDN GW procedures .....	56
8.4	PDN GW Initiated PDN Disconnection procedures.....	57
8.4.1	General.....	57
8.4.2	Serving GW procedures.....	57
8.4.3	PDN GW procedures .....	57
8.5	UE Requested Additional PDN Connectivity procedures .....	57
8.5.1	General.....	57
8.5.2	Serving GW procedures.....	57
8.5.3	PDN GW procedures .....	57
8.6	Handover procedures.....	57
8.6.1	Intra-LTE TAU and Inter-eNodeB Handover with Serving GW Relocation procedures .....	57
8.6.1.1	General .....	57
8.6.1.2	Serving GW procedures .....	57
8.6.1.3	PDN GW procedures.....	57
8.6.2	TAU/RAU or Handover between GERAN A/Gb Mode or UTRAN Iu Mode and E-UTRAN procedures.....	58
8.6.2.1	General.....	58
8.6.2.2	Serving GW procedures .....	58
8.6.2.3	PDN GW procedures.....	58
8.6.3	Handover from Trusted or Untrusted Non-3GPP IP Access over S2a/S2b to 3GPP Access Handover E-UTRAN over PMIP based S5/S8 without optimization procedures .....	58
8.6.3.1	General .....	58
8.6.3.2	Serving GW procedures .....	58
8.6.3.3	PDN GW procedures.....	58
8.6.4	Handover from Trusted or Untrusted Non-3GPP IP Access over S2a/S2b to 3GPP Access UTRAN/GERAN over PMIP based S5/S8 without optimization.....	58
8.6.4.1	General.....	58
8.6.4.2	Serving GW procedures .....	58
8.6.4.3	PDN GW procedures.....	58
8.6.5	Handover from Trusted or Untrusted Non-3GPP IP Access over S2c to 3GPP Access over PMIP based S5/S8 without optimization .....	59
8.6.5.1	General .....	59
8.6.5.2	Serving GW procedures .....	59
8.6.5.3	PDN GW procedures.....	59
8.6.6	Optimised Active Handover: cdma2000 eHRPD Access to EUTRAN .....	59
8.6.6.1	General .....	59
8.6.6.2	Serving GW procedures .....	59
8.6.6.3	PDN GW procedures.....	59
8.6.7	Optimized Idle Mode Mobility: cdma2000 eHRPD Access to E-UTRAN Access .....	59
8.6.7.1	General .....	59
8.6.7.2	Serving GW procedures .....	59
8.6.7.3	PDN GW procedures.....	59
8.7	UE Requested PDN Disconnection procedures.....	59
8.7.1	General.....	59
8.7.2	Serving GW procedures.....	59
8.7.3	PDN GW procedures .....	60
8.8	IPv4 Address Allocation using DHCP .....	60
8.8.1	General.....	60
8.8.2	Serving GW procedures.....	60
8.8.3	PDN GW procedures .....	60
8.9	PDN-GW Initiated IPv4 Address Delete Procedure.....	60
8.9.1	General.....	60
8.9.2	Serving GW procedures.....	60

8.9.3	PDN GW procedures .....	60
9	Trusted Non-3GPP Access over S2a Description .....	60
9.0	General .....	60
9.1	Initial Attach procedures .....	60
9.1.1	General.....	60
9.1.2	Trusted Non-3GPP Access procedures .....	60
9.1.3	PDN GW procedures .....	61
9.2	Trusted Non-3GPP Access Initiated PDN Connection Lifetime Extension procedures.....	61
9.2.1	General.....	61
9.2.2	Trusted Non-3GPP Access procedures .....	61
9.2.3	PDN GW procedures .....	61
9.3	UE / Trusted Non-3GPP Access Initiated Detach and UE Requested PDN Disconnection procedures .....	61
9.3.1	General.....	61
9.3.2	Trusted Non-3GPP Access procedures .....	61
9.3.3	PDN GW procedures .....	61
9.4	HSS / AAA Initiated Detach procedures .....	61
9.4.1	General.....	61
9.4.2	Trusted Non-3GPP Access procedures .....	61
9.4.3	PDN GW procedures .....	61
9.5	UE Initiated Connectivity to Additional PDN procedures .....	62
9.5.1	General.....	62
9.5.2	Trusted Non-3GPP Access procedures .....	62
9.5.3	PDN GW procedures .....	62
9.6	3GPP Access to Trusted Non-3GPP IP Access with PMIPv6 on S2a Handover procedures without optimization.....	62
9.6.1	General.....	62
9.6.2	Trusted Non-3GPP Access procedures .....	62
9.6.3	PDN GW procedures .....	62
9.7	PDN GW Initiated Resource Allocation Deactivation procedures.....	62
9.7.1	General.....	62
9.7.2	Trusted Non-3GPP Access procedures .....	62
9.7.3	PDN GW procedures .....	62
9.8	IPv4 Address Allocation using DHCP .....	63
9.8.1	General.....	63
9.8.2	Trusted Non-3GPP Access procedures .....	63
9.8.3	PDN GW procedures .....	63
9.9	PDN-GW Initiated IPv4 Address Delete Procedure.....	63
9.9.1	General.....	63
9.9.2	Trusted Non-3GPP Access procedures .....	63
9.9.3	PDN GW procedures .....	63
9.10	Optimized E-UTRAN to CDMA2000 eHRPD Handover procedure.....	63
9.10.1	General.....	63
9.10.2	CDMA2000 HRPD access procedure.....	63
9.10.3	PDN GW procedures .....	63
9.11	Optimized Idle Mode Mobility: E-UTRAN Access to cdma2000 eHRPD Access procedure.....	64
9.11.1	General.....	64
9.11.2	CDMA2000 eHRPD access procedure.....	64
9.11.3	PDN GW procedures .....	64
10	Untrusted Non-3GPP Access over S2b Description .....	64
10.1	Initial Attach procedures .....	64
10.1.1	General.....	64
10.1.2	ePDG procedures .....	64
10.1.3	PDN GW procedures .....	64
10.2	ePDG Initiated PDN Connection Lifetime Extension procedures.....	65
10.2.1	General.....	65
10.2.2	ePDG procedures .....	65
10.2.3	PDN GW procedures .....	65
10.3	UE / ePDG Initiated Detach and UE Requested PDN Disconnection procedures .....	65
10.3.1	General.....	65
10.3.2	ePDG procedures .....	65
10.3.3	PDN GW procedures .....	65

10.4	HSS / AAA Initiated Detach procedures .....	65
10.4.1	General.....	65
10.4.2	ePDG procedures .....	65
10.4.3	PDN GW procedures .....	65
10.5	UE Initiated Connectivity to Additional PDN procedures .....	66
10.5.1	General.....	66
10.5.2	ePDG procedures .....	66
10.5.3	PDN GW procedures .....	66
10.6	3GPP Access to Untrusted Non-3GPP IP Access with PMIPv6 on S2b Handover procedures without optimization.....	66
10.6.1	General.....	66
10.6.2	ePDG procedures .....	66
10.6.3	PDN GW procedures .....	66
10.7	PDN GW Initiated Resource Allocation Deactivation procedures.....	67
10.7.1	General.....	67
10.7.2	ePDG procedures .....	67
10.7.3	PDN GW procedures .....	67
10.8	PDN-GW Initiated IPv4 Address Delete Procedure.....	67
10.8.1	General.....	67
10.8.2	ePDG procedures .....	67
10.8.3	PDN GW procedures .....	67
11	S2a and S2b Chaining with PMIP-based S8 Description.....	67
11.1	Initial Attach procedures .....	67
11.1.1	General.....	67
11.1.2	ePDG / Trusted Non-3GPP Access procedures .....	67
11.1.3	Serving GW procedures.....	67
11.2	ePDG / Trusted Non-3GPP Access Initiated PDN Connection Lifetime Extension procedures.....	68
11.2.1	General.....	68
11.2.2	ePDG / Trusted Non-3GPP Access procedures .....	68
11.2.3	Serving GW procedures.....	68
11.3	UE / ePDG / Trusted Non-3GPP Access Initiated Detach procedures .....	68
11.3.1	General.....	68
11.3.2	ePDG / Trusted Non-3GPP Access procedures .....	68
11.3.3	Serving GW procedures.....	68
11.4	HSS / AAA Initiated Detach procedures .....	68
11.4.1	General.....	68
11.4.2	ePDG / Trusted Non-3GPP Access procedures .....	68
11.4.3	Serving GW procedures.....	68
11.5	UE Initiated Connectivity to Additional PDN procedures .....	69
11.5.1	General.....	69
11.5.2	ePDG / Trusted Non-3GPP Access procedures .....	69
11.5.3	Serving GW procedures.....	69
11.6	3GPP Access to Trusted / Untrusted Non-3GPP IP Access Handover procedures without optimization.....	69
11.6.1	General.....	69
11.6.2	ePDG / Trusted Non-3GPP Access procedures .....	69
11.6.3	Serving GW procedures.....	69
11.7	UE Requested PDN Disconnection procedures.....	70
11.7.1	General.....	70
11.7.2	ePDG / Trusted Non-3GPP Access procedures .....	70
11.7.3	Serving GW procedures.....	70
11.8	PDN GW Initiated Resource Allocation Deactivation procedures.....	70
11.8.1	General.....	70
11.8.2	ePDG / Trusted Non-3GPP Access procedures .....	70
11.8.3	Serving GW procedures.....	70
12	Information Elements.....	70
12.1	Additional Proxy Mobile IPv6 Information Elements.....	70
12.1.1	3GPP-Specific PMIPv6 Information Elements.....	70
12.1.1.0	General .....	70
12.1.1.1	3GPP Specific PMIPv6 error code.....	71
12.1.1.2	Fully Qualified PDN Connection Set Identifier (FQ-CSID).....	72
12.1.1.3	PDN Type Indication .....	72



12.1.1.4	PDN GW IP address.....	73
12.1.1.5	DHCPv4 Address Allocation Procedure Indication.....	73
12.1.1.6	Charging ID.....	73
12.1.1.7	Selection Mode .....	73
12.1.1.8	Charging Characteristics .....	74
12.1.1.9	Serving Network .....	74
12.1.1.10	Mobile Equipment Identity .....	74
12.1.1.11	MSISDN .....	75
12.1.1.12	APN Restriction .....	75
12.1.1.13	Maximum APN Restriction.....	75
12.1.1.14	Unauthenticated IMSI .....	75
12.1.1.15	PDN Connection ID .....	76
12.1.1.16	PGW Back-Off Time .....	76
12.1.1.17	Signalling Priority Indication.....	76
12.1.1.18	Static IP Address Allocation Indication.....	76
12.1.1.19	Additional Protocol Configuration Options .....	77
12.1.1.20	MME/SGSN Identifier .....	77
13	Trusted WLAN Access over S2a Description.....	77
13.1	Initial Attach procedures .....	77
13.1.1	General.....	77
13.1.2	TWAN procedures.....	77
13.1.3	PDN GW procedures .....	78
13.2	TWAN Initiated PDN Connection Lifetime Extension procedures .....	78
13.2.1	General.....	78
13.2.2	TWAN procedures.....	78
13.2.3	PDN GW procedures .....	78
13.3	UE / TWAN Initiated Detach and UE/TWAN Requested PDN Disconnection procedures .....	78
13.3.1	General.....	78
13.3.2	TWAN procedures.....	78
13.3.3	PDN GW procedures .....	78
13.4	HSS / AAA Initiated Detach procedures .....	78
13.4.1	General.....	78
13.4.2	TWAN procedures.....	78
13.4.3	PDN GW procedures .....	79
13.5	PDN GW Initiated Resource Allocation Deactivation procedures.....	79
13.5.1	General.....	79
13.5.2	TWAN procedures.....	79
13.5.3	PDN GW procedures .....	79
14	Proxy Mobile IPv6 EPC Restoration Procedure.....	79
14.1	PGW triggered SGW restoration procedure.....	79
14.1.1	General.....	79
14.1.2	Serving GW procedures.....	79
14.1.3	PDN GW procedures .....	79
14.2	Update PDP context/Bearer at P-CSCF failure .....	80
14.2.1	General.....	80
14.2.2	PDN GW procedures .....	80
14.2.3	Serving GW procedures.....	80
14.3	Inform UE about P-CSCF failure .....	80
14.3.1	General.....	80
14.3.2	PDN GW procedures .....	80
14.3.3	Serving GW procedures.....	81
<b>Annex A:</b>	<b>void.....</b>	<b>82</b>
<b>Annex B (Normative):</b>	<b>Definition of the protocol number in pseudo-header.....</b>	<b>83</b>
B.1	General .....	83
B.2	Interworking of different protocol number.....	83
<b>Annex C (informative):</b>	<b>Change History .....</b>	<b>84</b>
History .....		87

---

# Foreword

This Technical Specification has been produced by the 3<sup>rd</sup> Generation Partnership Project (3GPP).

The contents of the present document are subject to continuing work within the TSG and may change following formal TSG approval. Should the TSG modify the contents of the present document, it will be re-released by the TSG with an identifying change of release date and an increase in version number as follows:

Version x.y.z

where:

- x the first digit:
  - 1 presented to TSG for information;
  - 2 presented to TSG for approval;
  - 3 or greater indicates TSG approved document under change control.
- y the second digit is incremented for all changes of substance, i.e. technical enhancements, corrections, updates, etc.
- z the third digit is incremented when editorial only changes have been incorporated in the document.

---

# 1 Scope

The present document specifies the stage 3 of the PMIPv6 Based Mobility and Tunneling Protocols used over the PMIP-based S2a, S2b, S5, and S8 reference points defined in 3GPP TS 23.402 [3], and are thus applicable to the Serving GW, PDN Gateway, ePDG, and Trusted Non-3GPP Access. Protocols specifications are compliant with relevant IETF RFCs. In this specification PMIP refers to PMIPv6 as defined in IETF RFC5213 [4] taking into account the corrections regarding the protocol number definition in IETF RFC6275 [8].

---

# 2 References

The following documents contain provisions which, through reference in this text, constitute provisions of the present document.

- References are either specific (identified by date of publication, edition number, version number, etc.) or non-specific.
- For a specific reference, subsequent revisions do not apply.
- For a non-specific reference, the latest version applies. In the case of a reference to a 3GPP document (including a GSM document), a non-specific reference implicitly refers to the latest version of that document *in the same Release as the present document*.

- [1] 3GPP TR 21.905: "Vocabulary for 3GPP Specifications".
- [2] 3GPP TS 23.401: "GPRS enhancements for E-UTRAN access".
- [3] 3GPP TS 23.402: "Architecture Enhancements for non-3GPP accesses".
- [4] IETF RFC 5213: "Proxy Mobile IPv6".
- [5] IETF RFC 5844: "IPv4 Support for Proxy Mobile IPv6".
- [6] IETF RFC 5846: "Binding Revocation for IPv6 Mobility".
- [7] IETF RFC 5845: "Generic Routing Encapsulation (GRE) Key Option for Proxy Mobile IPv6".
- [8] IETF RFC 6275: "Mobility Support in IPv6".
- [9] IETF RFC 4282: "The Network Access Identifier".
- [10] IETF RFC 4283: "Mobile Node Identifier Option for Mobile IPv6 (MIPv6)".
- [11] IETF RFC 5149: "Service Selection for Mobile Ipv6".
- [12] 3GPP TS 23.003: "Numbering, addressing and identification".
- [13] 3GPP TS 23.007: "Restoration Procedures".
- [14] Void
- [15] Void
- [16] 3GPP TS 24.008: "Mobile radio interface Layer 3 specification; Core network protocols".
- [17] IETF RFC 5847: "Heartbeat Mechanism for Proxy Mobile IPv6".
- [18] IANA Mobile Ipv6 Parameters Registry, <<http://www.iana.org/assignments/mobility-parameters>>.
- [19] 3GPP TS 33.402: "3GPP System Architecture Evolution (SAE); Security aspects of non-3GPP accesses".
- [20] IETF RFC 2784: "Generic Routing Encapsulation (GRE)".

- [21] IETF RFC 2890: "Key and Sequence Number Extensions to GRE".
- [22] 3GPP TS 29.274: "3GPP Evolved Packet System (EPS); Evolved General Packet Radio Service (GPRS) Tunnelling Protocol for Control plane (GTPv2-C); Stage 3".
- [23] 3GPP TS 23.060: "General Packet Radio Service (GPRS); Service description; Stage 2".
- [24] 3GPP TS 29.282: "Mobile IPv6 vendor specific option format and usage within 3GPP".
- [25] 3GPP TS 32.251: "Charging Management; Packet Switched (PS) domain charging".
- [26] 3GPP TS 32.298: "Charging Management; Charging Data Record (CDR) parameter description".
- [27] IETF RFC 4291: "IP Version 6 Addressing Architecture".
- [28] 3GPP TS 29.060: "General Packet Radio Service (GPRS); GPRS Tunnelling Protocol (GTP) across the Gn and Gp interface".
- [29] ITU-T Recommendation E.164: "The international public telecommunication numbering plan".
- [30] 3GPP TS 29.212: "Policy and Charging Control (PCC); Reference points".
- [31] IETF RFC 2473: "Generic Packet Tunneling in IPv6 Specification".
- [32] IANA Registry of Assigned Numbers. Mobile IPv6 parameters, Status Codes: <http://www.iana.org/assignments/mobility-parameters/mobility-parameters.xhtml#mobility-parameters-6>.
- [33] IANA Registry of Assigned Numbers. Mobile IPv6 parameters, Binding Revocation Acknowledgement Status Codes: <http://www.iana.org/assignments/mobility-parameters/mobility-parameters.xhtml#binding-revocation-status-codes>.
- [34] IETF RFC5555: "Mobile IPv6 Support for Dual Stack Hosts and Routers".
- [35] IETF draft-ietf-netext-update-notifications-01: "Update Notifications for Proxy Mobile IPv6".
- Editor's Note:** The above document cannot be formally referenced until it is published as an RFC.
- [36] 3GPP TS 23.380: "IMS Restoration Procedures".
- [37] IETF RFC 6757: "Access Network Identifier Option"..
- [38] IETF RFC 3775, "Mobility Support in IPv6".

---

## 3 Definitions and abbreviations

### 3.1 Definitions

For the purposes of the present document, the terms and definitions given in 3GPP TR 21.905 [1] and the following apply. A term defined in the present document takes precedence over the definition of the same term, if any, in 3GPP TR 21.905 [1].

The following terms used in this Technical Specification are defined in the PMIPv6 specification IETF RFC 5213 [4]: IPv6 Home Network Prefix, Proxy Care-of Address, Local Mobility Anchor Address. The following terms used in this Technical Specification are defined in the IPv4 Support for PMIPv6 specification IETF RFC 5844 [5]: IPv4 Home Address, IPv4 Local Mobility Anchor Address. The following terms used in this Technical Specification are defined in the MIPv6 specification [8] and extended by the PMIPv6 specification IETF RFC 5213 [4]: Binding Cache Entry, Binding Update List Entry. The following terms used in this specification are defined in the Binding Revocation for IPv6 Mobility [6]: Binding Revocation Indication and Binding Revocation Acknowledgement.

**Local Mobility Anchor:** Within EPS the Local Mobility Anchor functionality consists of a PMIPv6 Local Mobility Anchor as described in the PMIPv6 specification IETF RFC 5213 [4] with support of IPv4 Support for PMIPv6 as defined in IETF RFC 5844 [5], Binding Revocation for IPv6 Mobility as defined in IETF RFC 5846 [6], GRE Key

Option for PMIPv6 as defined in IETF RFC 5845 [7], and PMIPv6 Heartbeat Mechanism as defined in IETF RFC 5847 [17].

**Mobile Access Gateway:** Within EPS the Mobility Access Gateway functionality consists of a PMIPv6 Mobility Access Gateway as described in the PMIPv6 specification IETF RFC 5213 [4] with support of IPv4 Support for PMIPv6 as defined in IETF RFC 5844 [5], Binding Revocation for IPv6 Mobility as defined in IETF RFC 5846 [6], GRE Key Option for PMIPv6 as defined in IETF RFC 5845 [7], and PMIPv6 Heartbeat Mechanism as defined in IETF RFC 5847 [17].

**PDN Connection:** The association between a UE represented by one IPv4 Home Address and/or one IPv6 Home Network Prefix, and a PDN represented by an APN. On a PMIPv6 peer (MAG or LMA) there is a one-to-one mapping between a PDN connection and a PMIPv6 binding.

## 3.2 Abbreviations

For the purposes of the present document, the abbreviations given in 3GPP TR 21.905 [1] and the following apply. An abbreviation defined in the present document takes precedence over the definition of the same abbreviation, if any, in 3GPP TR 21.905 [1].

3GSPEC	3GPP Specific PMIPv6 Error Code
BCE	Binding Cache Entry
BRA	Binding Revocation Acknowledgement
BRI	Binding Revocation Indication
BULE	Binding Update List Entry
EPC	Evolved Packet Core
ePDG	Evolved Packet Data Gateway
GRE	Generic Routing Encapsulation
GW	Gateway
IMSI	International Mobile Subscriber Identity
IMEI	International Mobile station Equipment Identity
IPv4-LMAA	IPv4 LMAA
LMA	Local Mobility Anchor
LMAA	LMA Address
MAG	Mobility Access Gateway
MIPv6	Mobile IPv6
NAI	Network Access Identifier
PBA	Proxy Binding Acknowledgment
PBU	Proxy Binding Update
PMIPv6	Proxy MIPv6
Proxy-CoA	Proxy Care-of Address
TWAN	Trusted WLAN Access Network
UPN	Update Notification
UPA	Update Notification Acknowledgment

---

## 4 General

### 4.1 PDN connection

On a PMIPv6 peer (MAG or LMA) there is a one-to-one mapping between a PDN connection and a PMIPv6 binding.

Traffic sent over a given PDN connection is encapsulated with GRE [20] using different, per-interface per-PDN connection, per direction (uplink and downlink) GRE keys [21] to allow multiplexing and demultiplexing of traffic belonging to different PDN connections at MAG and LMA. For the handover between 3GPP access and non-3GPP access, the uplink GRE Key shall be the same.

## 4.2 PMIPv6 protocol stacks

Protocol stacks for PMIPv6 are depicted in Figure 4.2-1. The MAG functions are defined in 3GPP TS 23.402 [3], e. g., relaying DHCPv4/DHCPv6 packets between the UE and the DHCP server, forwarding the payload packets between the UE and the LMA.

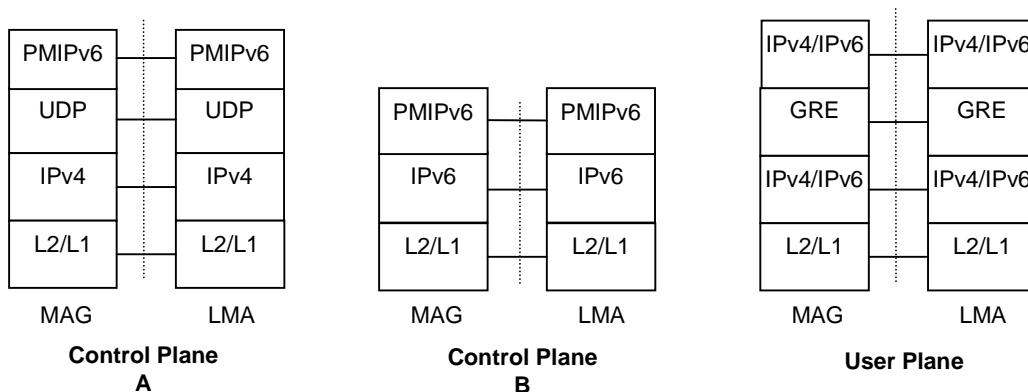

**Figure 4.2-1: Protocols stacks for PMIP**

The Control Plane A shall be used if PMIPv6 messages are transported over IPv4 as described in IETF RFC 5844 [5]. The Control Plane B shall be used if PMIPv6 messages are transported over IPv6 as described in IETF RFC 5213 [4]. User Plane traffic shall be transported with GRE encapsulation as described in IETF RFC 2890 [21] (see also IETF RFC 2784 [20]).

**Figure 4.2-2: Void**

---

## 5 Mobility Management procedures

### 5.1 Proxy Mobile IPv6 PDN Connection Creation procedure

#### 5.1.1 General

The PMIPv6 PDN Connection Creation procedure is initiated by the node acting as a MAG to create a new PDN connection with the node acting as an LMA for an UE that either attaches for the first time to the EPC, or connects to an additional PDN. The procedure starts with the MAG sending a PBU including the APN to the LMA to register with the LMA a binding for the UE's PDN connection. If multiple PDN connections to the same APN function is supported by the MAG, a PDN connection ID shall also be included in the same PBU message. The LMA confirms establishment of the binding by sending a PBA to the MAG. If multiple PDN connections to the same APN function is supported by the LMA, the received PDN connection ID shall also be included in the same PBA message. Establishment of the binding achieves the following:

- **PDN selection:** The LMA select the PDN based on the APN contained in the PBU.
- **IPv6 Home Network Prefix assignment:** The LMA assigns to the UE's PDN connection an IPv6 Home Network Prefix valid in the selected PDN.
- **IPv4 Home Address assignment:** The LMA assigns to the UE's PDN connection an IPv4 Home Address valid in the selected PDN.
- **Downlink and Uplink GRE Key Assignment:** The MAG and LMA will establish downlink and uplink GRE keys to be used for GRE encapsulation of the PDN connection's downlink and uplink traffic, respectively.
- **GRE Tunnel Establishment:** A GRE tunnel is established between the MAG and LMA with the assigned GRE keys to carry uplink and downlink traffic that the UE respectively sends and receives on the PDN connection.
- **BCE Creation:** The LMA creates a BCE for the PDN connection.
- **BULE Creation:** The MAG creates a BULE for the PDN connection.
- **MAG Link Local Address assignment:** The LMA assigns the MAG link local address.
- **UE Interface Identifier (IID) assignment:** The LMA assigns to the UE an IPv6 Interface Identifier to allow formation of an UE Link Local Address from the well-known link local address prefix (fe80::/64).
- **PDN connection ID:** The PDN connection ID is provided by the MAG and accepted by LMA, if multiple PDN connections to the same APN function is supported by both MAG and LMA.

Regarding the usage and support of the protocol number in the pseudo-header see Annex B.

##### 5.1.1.1 Proxy Binding Update

The fields of a PBU message for the PMIPv6 PDN Connection Creation procedure are depicted in Table 5.1.1.1-1.

The Mobility Options in a PBU message for the PMIPv6 PDN Connection Creation procedure are depicted in Table 5.1.1.1-2. When the mobility option is present in the message, only the first instance shall be recognised. If multiple instances are included in the message, the receiver ignores all other instances.

Other flags are not used by this specification.

**Table 5.1.1.1-1: Fields of a PBU message for the PMIPv6 PDN Connection Creation procedure**

<b>Information element</b>	<b>IE Description</b>	<b>Reference</b>
Sequence Number	Set to a locally (i.e. per MAG) monotonically increasing value.	IETF RFC 5213 [4]
Lifetime	Set to the requested number of time units the binding shall remain valid.	IETF RFC 6275 [8]
Acknowledge (A)	Set to "1" to request an acknowledgement message.	IETF RFC 6275 [8]
Proxy Registration Flag (P)	Set to "1" to indicate that the Binding Update message is a proxy registration.	IETF RFC 5213 [4]
Force UDP encapsulation request (F) Flag	Set to "0" to indicate that UDP encapsulation is not used for the user plane.	IETF RFC 5555 [34]



**Table 5.1.1.1-2: Mobility Options in a PBU message for the PMIPv6 PDN Connection Creation procedure**

Information element	Cat.	IE Description	Reference
Mobile Node Identifier option	M	Set to the NAI identifier of the UE as specified in 3GPP TS 23.003 [12]. The format of the NAI is specified in the subclause 19.3 in 3GPP TS 23.003 [12].	3GPP TS 23.003 [12]
IPv6 Home Network Prefix option	C	For dynamic allocation, set the Home Network Prefix to the value "0::0" and Prefix Length to the value "0" to request allocation for the UE's PDN connection of an IPv6 Home Network Prefix in the PDN corresponding the EPS Access Point Name. For static allocation, set the Home Network Prefix to the received static allocated IPv6 Home Network Prefix and Prefix Length to the value "64". NOTE 1.	IETF RFC 5213 [4]
Link-local Address	C	Present when IPv6 Home Network Prefix option is present. Link-local address of the MAG. Set to ALL_ZERO (all bits set to 0), indicating that the MAG requests a link-local address to be used on the access link shared with the UE.	IETF RFC 5213 [4]
Handoff Indicator option	M	Set to the value "1" to indicate attachment over a new interface.	IETF RFC 5213 [4]
Access Technology Type option	M	Set to the 3GPP access type, i.e. GERAN, UTRAN or E-UTRAN, or to the value matching the characteristics of the non-3GPP access (e.g., HRPD) the UE is using to attach to the EPS as defined in the Access Technology Type Option type values registry of the IANA Mobile IPv6 Parameters Registry [18]. The ePDG may use the access technology type of the untrusted non-3GPP access network if it is able to acquire it; otherwise it shall indicate Virtual as the access technology. The TWAN shall set the Access Technology Type Option value to 4 i.e. "IEEE 802.11a/b/g" on the S2a interface. NOTE 2. NOTE 3.	IETF RFC 5213 [4]
Timestamp option	M	Set to the current time	IETF RFC 5213 [4]
GRE key option	M	Set to the downlink GRE key to be used for downlink GRE encapsulated packets sent over the PDN connection.	IETF RFC 5845 [7]
IPv4 Home Address Request option	C	For dynamic allocation, set the IPv4 Home Address to the value "0.0.0.0" and Prefix-len to the value "0" or "32" to request allocation for the UE's PDN connection of an IPv4 Home Address in the PDN corresponding to the EPS Access Point Name. For static allocation, set the IPv4 Home Address to the received static allocated IPv4 Home Address and Prefix-len to the value "32". NOTE 1.	IETF RFC 5844 [5]
Service Selection Mobility Option	M	Set to the EPS Access Point Name to which the UE attaches the new PDN connection. The encoding the APN field follows 3GPP TS 23.003 [12] subclause 9.1 but excluding the trailing zero byte. The content of the APN field shall be the full APN with both the APN Network Identifier and default APN Operator Identifier being present as specified in 3GPP TS 23.003 [12] subclauses 9.1.1 and 9.1.2. NOTE 4.	IETF RFC 5149 [11]
Protocol Configuration Options	O	Contain Protocol Configuration Options.	Subclause 12.1.1.0
PDN GW IP Address	O	Contain PDN GW IP address (on S2a or S2b when used for chained S2a/S2b-PMIP based S8).	Subclause 12.1.1.4
MAG Fully Qualified PDN Connection Set Identifier	O	Contain a Fully Qualified PDN Connection Set Identifier if generated by the MAG on the S5/S8, S2a (for Trusted WLAN Access) and S2b interfaces as specified in 3GPP TS 23.007 [13].	Subclause 12.1.1.2
MME Fully Qualified	O	Contain a Fully Qualified PDN Connection Set Identifier	Subclause 12.1.1.2

PDN Connection Set Identifier		if generated by the MME, and included by the MAG on the S5/S8 interfaces as specified in 3GPP TS 23.007 [13].	
Selection Mode	O	Contains APN selection mode (on S5/S8).	Subclause 12.1.1.7
Charging Characteristics	O	Contains the Charging Characteristics to be applied for EPC charging	Subclause 12.1.1.8
Serving Network	C	This IE shall be included on S2a (for TWAN access), S5 and S8 interfaces to identify the Serving Network	Subclause 12.1.1.9
Mobile Equipment Identity	O	Contains the MEI of the UE (on S5/S8)	Subclause 12.1.1.10
MSISDN	O	This IE shall contain the MSISDN and shall be present, if available, on the S5, S8, S2a or S2b interfaces.	Subclause 12.1.1.11
Maximum APN Restriction	O	Contains the most stringent restriction of already active PDN connections (on S5/S8).	Subclause 12.1.1.13
Unauthenticated IMSI	O	Contains the Unauthenticated IMSI	Subclause 12.1.1.14
PDN connection ID	O	Contains the PDN connection ID	Subclause 12.1.1.15
Signalling Priority Indication	O	The SGW shall forward this IE on the S5/S8 interfaces if received from the MME/SGSN.	Subclause 12.1.1.17
Additional Protocol Configuration Options	O	Contains Additional Protocol Configuration Options.	Subclause 12.1.1.19
MME/SGSN Identifier	O	The SGW shall include the MME/SGSN Identifier on the S5 interface if the SGW supports the PGW triggered SGW restoration procedure and this information is received from the MME/SGSN as specified in 3GPP TS 23.007 [13].	Subclause 12.1.1.20
Access Network Identifier Option	O	Contains the access network identifier (on S2a when TWAN access is used)	IETF RFC 6757 [37]
NOTE 1: At least one of the two options, namely, the IPv6 Home Network Prefix option or the IPv4 Home Address Request option shall be present. If both an IPv6 Home Network Prefix and an IPv4 Home Address are requested, both options shall be included in the same PBU message.			
NOTE 2: The methods that the ePDG may use to acquire the access technology type of the untrusted non-3GPP IP access network are not specified in this release.			
NOTE 3: The PDN-GW can be informed about the type of access network used by the UE over several reference points, see 3GPP TS 29.212 [30] for the mapping between the code values for the different access network types.			
NOTE 4: The APN field is not encoded as a dotted string as commonly used in documentation.			

### 5.1.1.2 Proxy Binding Acknowledgement

The fields of a PBA message for the PMIPv6 PDN Connection Creation procedure are depicted in Table 5.1.1.2-1.

The Mobility Options in a PBA message for the PMIPv6 PDN Connection Creation procedure are depicted in Table 5.1.1.2-2. When the mobility option is present in the message, only the first instance shall be recognised. If multiple instances are included in the message, the receiver ignores all other instances.

Other flags are not used by this specification.

Only the message fields and mobility options used for acceptance cases are present in the following tables.

**Table 5.1.1.2-1: Fields of a PBA message for the PMIPv6 PDN Connection Creation procedure**

Information element	IE Description	Reference
Status	Set to indicate the result.	IETF RFC 6275 [8]
Proxy Registration Flag (P)	Set to "1" to indicate that the Binding Update message is a proxy registration.	IETF RFC 5213 [4]
Sequence Number	Set to the value received in the corresponding PBU.	IETF RFC 5213 [4]
Lifetime	Set to the granted number of time units the binding shall remain valid.	IETF RFC 6275 [8]

**Table 5.1.1.2-2: Mobility Options in a PBA message for the PMIPv6 PDN Connection Creation procedure**

Information element	Cat.	IE Description	Reference
Mobile Node Identifier option	M	Copied from corresponding field of PBU.	IETF RFC 5213 [4]
IPv6 Home Network Prefix option	C	Present if IPv6 Home Network Prefix is allocated. When it's present, set the Home Network Prefix to the IPv6 Home Network Prefix Allocated for the UE's PDN connection based on the selected PDN corresponding to the EPS Access Point Name for dynamic allocation, or set to the static IPv6 Home Network Prefix received in the PBU for static allocation. The Prefix Length is set to the value "64". In addition, the Interface Identifier (IID) allocated for the UE is encoded in the low order 64 bits of this option, i.e., the IPv6 Home Network Prefix option.	IETF RFC 5213 [4]
Link-local Address	C	Present when IPv6 Home Network Prefix option is present. Link-local address to be used by the MAG on the access link shared with the UE.	IETF RFC 5213 [4]
Handoff Indicator option	M	Copied from corresponding field of PBU.	IETF RFC 5213 [4]
Access Technology Type option	M	Copied from corresponding field of PBU.	IETF RFC 5213 [4]
Timestamp option	M	Copied from corresponding field of PBU, or set to the current time of LMA in case of timestamp error.	IETF RFC 5213 [4]
GRE key option	M	Set to the uplink GRE key to be used for uplink GRE encapsulated packets sent over the PDN connection.	IETF RFC 5845 [7]
IPv4 Home Address Reply Option	C	Present if IPv4 address is allocated. When it's present, set the IPv4 Home Address to the IPv4 Home Address allocated for the UE's PDN connection based on the selected PDN corresponding to the EPS Access Point Name for dynamic allocation, or set to the static IPv4 Home Address received in the PBU for static allocation. The Prefix-len is set to a non-zero value. NOTE 1	IETF RFC 5844 [5]
IPv4 Default Router Address Option	C	This option shall be present if and only if IPv4 Home Address Reply Option is present. The LMA sets the value of the UE's IPv4 default router address which belongs to the same subnet as the IPv4 Home Address allocated to the UE.	IETF RFC 5844 [5]
Service Selection Mobility Option	M	Copied from the corresponding field in the PBU message, formatted as defined in 3GPP TS 23.003 [12]	IETF RFC 5149[11]
PDN Type Indication	C	This option shall be present if and only if PDN type is changed in the PDN GW compared to what was requested in the PBU.	Subclause 12.1.1.3
DHCPv4 Address Allocation Procedure Indication	C	This option shall be present if and only if DHCPv4 is to be used to allocate the IPv4 address to the UE.	Subclause 12.1.1.5
Protocol Configuration Options	O	Contain Protocol Configuration Options.	Subclause 12.1.1.0
3GPP Specific PMIPv6 Error Code	O	Contain 3GPP Specific PMIPv6 Error Code (on S5/S8)	Subclause 12.1.1.1
LMA Fully Qualified PDN Connection Set Identifier	O	Contain a Fully Qualified PDN Connection Set Identifier if generated by the LMA on the S5/S8 interfaces as specified in 3GPP TS 23.007 [13].	Subclause 12.1.1.2
Charging ID	M	Contain the Charging ID information	Subclause 12.1.1.6
APN Restriction	O	Contains the restriction of this PDN connection (on S5/S8).	Subclause 12.1.1.12
PDN connection ID	O	Contains the PDN connection ID received in PBU	Subclause 12.1.1.15
PGW Back-Off Time	O	This IE may be included on the S5/S8 interfaces when the PDN GW rejects the Proxy Binding Update with the 3GSPEC set to "APN congestion".	Subclause 12.1.1.16
Additional Protocol Configuration Options	O	Contains Additional Protocol Configuration Options.	Subclause 12.1.1.19
NOTE 1: If the PDN type is IPv4v6 and DHCPv4 is to be used to allocate the IPv4 address to the UE, the			

IPv4 Home Address Reply Option shall not be included.

## 5.1.2 MAG procedures

A MAG initiating the PMIPv6 PDN Connection Creation procedure shall follow the "Mobile Node Attachment and Initial Binding Registration" procedure described in the PMIPv6 IETF RFC 5213 [4] taking into account the corrections regarding the protocol number definition in IETF RFC6275 [8] and interworking solution specified in Annex B and IPv4 support for PMIPv6 IETF RFC 5844 [5] specifications with the following additional requirements:

1. Generate a downlink GRE key that is not already in use locally for the PDN connection's downlink traffic to that UE, as specified in the GRE Key Option for PMIPv6 specification IETF RFC 5845 [7].
2. For IP address allocation, the IPv6 Home Network Prefix option and/or the IPv4 Home Address Request option shall be present according to the UE request and the user subscription for non-3GPP access, or according to the PDN Type received from the MME/SGSN for 3GPP access.
3. If the static IPv4 Home Address and/or IPv6 Home Network Prefix are available at the MAG, set them in the IPv4 home address Request option and/or the IPv6 home prefix option in the PBU.
4. Optionally, assign a Fully Qualified PDN Connection Set Identifier that identifies a set of PDN connections belonging to an arbitrary number of UEs.
5. Provide a PDN connection ID, if multiple PDN connections to the same APN function is supported by the MAG.
6. Set other parameters in the PBU as specified by the PBU parameters section for this procedure.

## 5.1.3 LMA procedures

On reception of a PBU, the LMA shall initiate the "Initial Binding Registration (New Mobility session)" and "Processing Binding Registrations" procedures described in the PMIPv6 IETF RFC 5213 [4] taking into account the corrections regarding the protocol number definition in IETF RFC6275 [8] and interworking solution specified in Annex B and IPv4 support for PMIPv6 IETF RFC 5844 [5] specifications with the following additional requirements:

1. Select the PDN for the UE's PDN connection based on the APN present in the PBU.
2. Check if the received IPv6 Home prefix and/or IPv4 Home address are topologically correct.
3. If no static IPv6 Home Network Prefix and/or IPv4 Home Address were received in the PBU, allocate the IPv6 Home Network Prefix and/or an IPv4 Home Address for the selected PDN.
4. If a PCO with value IPv4 Address Allocation via DHCPv4 is present in the PBU,
  - if the LMA allocates an IPv4 address, it shall include the IPv4 Home Address Reply Option in the PBA message
  - if the LMA allocates an IPv6 prefix, the LMA shall not allocate an IPv4 address and shall not include the IPv4 Home Address Reply Option in the PBA message
5. Generate a uplink GRE key that is not already in use locally for the PDN connection's uplink traffic from that UE, as specified in the GRE Key Option for PMIPv6 specification IETF RFC 5845 [7].
6. Assign to the UE an IPv6 Interface Identifier to allow formation of an UE Link Local Address from the well-known link local address prefix (fe80::/64).
7. Optionally, assign a Fully Qualified PDN Connection Set Identifier that identifies a set of PDN connections belonging to an arbitrary number of UEs.
8. If PDN connection ID was received in the PBU message,
  - the LMA includes the received a PDN connection ID in the PBA message, if the multiple PDN connections to the same APN function is supported by the LMA; or

- the LMA ignores the received PDN connection ID and does not include it in the PBA message, if the multiple PDN connections to the same APN function is not supported by the LMA.
9. Set parameters in the PBA as specified by the PBA parameters section for this procedure.

## 5.2 Proxy Mobile IPv6 PDN Connection Lifetime Extension procedure

### 5.2.1 General

The PMIPv6 PDN Connection Lifetime Extension procedure is initiated by the node acting as a MAG to prolong the lifetime of an existing PDN connection with the node acting as an LMA for a UE that is already attached. This procedure may also be used when the MME is relocated and the MAG remains unchanged (see 3GPP TS 23.007 [13]). The procedure starts with the MAG sending a PBU to the LMA to extend the binding lifetime for the UE's PDN connection. The LMA confirms that the binding lifetime is extended by sending a PBA to the MAG.

#### 5.2.1.1 Proxy Binding Update

The fields of a PBU message for the PMIPv6 PDN Connection Lifetime Extension procedure are depicted in Table 5.2.1.1-1.

The Mobility Options in a PBU message for the PMIPv6 PDN Connection Lifetime Extension procedure are depicted in Table 5.2.1.1-2. When the mobility option is present in the message, only the first instance shall be recognised. If multiple instances are included in the message, the receiver ignores all other instances.

Other flags are not used by this specification.

**Table 5.2.1.1-1: Fields of a PBU message for the PMIPv6 PDN Connection Lifetime Extension procedure**

Information element	IE Description	Reference
Sequence Number	Set to a locally (i.e. per MAG) monotonically increasing value.	IETF RFC 5213 [4]
Lifetime	Set to the requested number of time units the binding shall remain valid.	IETF RFC 6275 [8]
Acknowledge (A)	Set to "1" to request an acknowledgement message.	IETF RFC 6275 [8]
Proxy Registration Flag (P)	Set to "1" to indicate that the Binding Update message is a proxy registration.	IETF RFC 5213 [4]
Force UDP encapsulation request (F) Flag	Set to "0" to indicate that UDP encapsulation is not used for the user plane.	IETF RFC 5555 [34]

**Table 5.2.1.1-2: Mobility Options in a PBU message for the PMIPv6 PDN Connection Lifetime Extension procedure**

Information element	Cat.	IE Description	Reference
Mobile Node Identifier option	M	Set to the UE NAI that is derived from the UE IMSI if an authenticated IMSI is available, or from the UE IMEI if IMSI is not available or the IMSI is not authenticated by the network. The NAI format is specified in 3GPP TS 23.003 [12].	IETF RFC 5213 [4], 3GPP TS 23.003 [12]
IPv6 Home Network Prefix option	C	Set the Home Network Prefix to the IPv6 Home Network Prefix allocated to the UE's PDN connection based on the selected PDN and Prefix Length to the value "64". NOTE 1.	IETF RFC 5213 [4]
Link-local Address	C	Present when IPv6 Home Network Prefix option is present. Set to the link-local address already allocated to the MAG (in the previous initial binding registration) for use on the access link shared with the UE.	IETF RFC 5213 [4]
Handoff Indicator option	M	Set to the value "5" to indicate handoff state not changed (Re-registration).	IETF RFC 5213 [4]
Access Technology Type option	M	Set to the 3GPP access type, i.e. GERAN, UTRAN or E-UTRAN, or to the value matching the characteristics of the non-3GPP access (e.g., HRPD) the UE is using to attach to the EPS as defined in the Access Technology Type Option type values registry of the IANA Mobile IPv6 Parameters Registry [18]. The ePDG may use the access technology type of the untrusted non-3GPP access network if it is able to acquire it; otherwise it shall indicate Virtual as the access technology. NOTE 2 NOTE 3	IETF RFC 5213 [4]
Timestamp option	M	Set to the current time	IETF RFC 5213 [4]
GRE Key option	M	Set to the previously exchanged downlink GRE key to be used for downlink GRE encapsulated packets sent over the PDN connection.	IETF RFC 5845 [7]
IPv4 Home Address Request option	C	Set the IPv4 Home Address to the IPv4 Home Address allocated for the UE's PDN connection based on the selected PDN and Prefix-len to the non-zero value received from LMA. NOTE 1.	IETF RFC 5844 [5]
Service Selection Mobility Option	M	Set to the EPS Access Point Name to which the UE's PDN connection is attached. The encoding the APN field follows 3GPP TS 23.003 [12] subclause 9.1 but excluding the trailing zero byte. The content of the APN field shall be the full APN with both the APN Network Identifier and default APN Operator Identifier being present as specified in 3GPP TS 23.003 [12] subclauses 9.1.1 and 9.1.2. NOTE 4.	IETF RFC 5149[11]
MME Fully Qualified PDN Connection Set Identifier	O	Contain a Fully Qualified PDN Connection Set Identifier if generated by the MME, and included by the MAG on the S5/S8 interfaces as specified in 3GPP TS 23.007 [13].	Subclause 12.1.1.2
MAG Fully Qualified PDN Connection Set Identifier	O	Contain a Fully Qualified PDN Connection Set Identifier if generated by the MAG on the S5/S8, S2a (for Trusted WLAN Access) and S2b interfaces as specified in 3GPP TS 23.007 [13].	Subclause 12.1.1.2
PDN connection ID	C	Contains the PDN connection ID if the BULE contains the PDN Connection ID.	Subclause 12.1.1.15
NOTE 1: At least one of the two options, namely, the IPv6 Home Network Prefix option or the IPv4 Home Address Request option shall be present. If the UE has both IPv4 home address and IPv6 home network prefix registered, both the IPv6 Home Network Prefix option and IPv4 Home Address Request option shall be included in the same PBU message.			
NOTE 2: The methods that the ePDG may use to acquire the access technology type of the untrusted non-3GPP IP access network are not specified in this release.			
NOTE 3: The PDN-GW can be informed about the type of access network used by the UE over several reference points, see 3GPP TS 29.212 [30] for the mapping between the code values for the			

different access network types.  
 NOTE 4: The APN field is not encoded as a dotted string as commonly used in documentation.

### 5.2.1.2 Proxy Binding Acknowledgement

The fields of a PBA message for the PMIPv6 PDN Connection Lifetime Extension procedure are depicted in Table 5.2.1.2-1.

The Mobility Options in a PBA message for the PMIPv6 PDN Connection Lifetime Extension procedure are depicted in Table 5.2.1.2-2. When the mobility option is present in the message, only the first instance shall be recognised. If multiple instances are included in the message, the receiver ignores all other instances.

Other flags are not used by this specification.

Only the message fields and mobility options used for acceptance cases are present in the following tables.

**Table 5.2.1.2-1: Fields of a PBA message for the PMIPv6 PDN Connection Lifetime Extension procedure**

Information element	IE Description	Reference
Status	Set to indicate the result.	IETF RFC 6275 [8]
Proxy Registration Flag (P)	Set to "1" to indicate that the Binding Update message is a proxy registration.	IETF RFC 5213 [4]
Sequence Number	Set to the value received in the corresponding PBU.	IETF RFC 5213 [4]
Lifetime	Set to the granted number of time units the binding shall remain valid.	IETF RFC 6275 [8]

**Table 5.2.1.2-2: Mobility Options in a PBA message for the PMIPv6 PDN Connection Lifetime Extension procedure**

Information element	Cat.	IE Description	Reference
Mobile Node Identifier option	M	Copied from corresponding field of PBU.	IETF RFC 5213 [4]
IPv6 Home Network Prefix option	C	If it is present in the corresponding PBU, set the Home Network Prefix to the IPv6 Home Network Prefix allocated to the UE's PDN connection based on the selected PDN and Prefix Length to the value "64".	IETF RFC 5213 [4]
Link-local Address	C	Present when IPv6 Home Network Prefix option is present. Set to the link-local address already allocated to the MAG (in the previous initial binding registration) for use on the access link shared with the UE.	IETF RFC 5213 [4]
Handoff Indicator option	M	Copied from corresponding field of PBU.	IETF RFC 5213 [4]
Access Technology Type option	M	Copied from corresponding field of PBU.	IETF RFC 5213 [4]
Timestamp option	M	Copied from corresponding field of PBU, or set to the current time of LMA in case of timestamp error.	IETF RFC 5213 [4]
GRE key option	M	Set to the previously exchanged uplink GRE key to be used for uplink GRE encapsulated packets sent over the PDN connection.	IETF RFC 5845 [7]
IPv4 Home Address Reply Option	C	If it is present in the corresponding PBU, set the IPv4 Home Address to the IPv4 Home Address allocated for the UE's PDN connection based on the selected PDN and Prefix-len to the non-zero value present in the corresponding PBU.	IETF RFC 5844 [5]
IPv4 Default Router Address Option	C	This option shall be present if and only if IPv4 Home Address Reply Option is present and PBU is accepted. The LMA sets the value of the UE's IPv4 default router address which belongs to the same subnet as the IPv4 Home Address allocated to the UE.	IETF RFC 5844 [5]
Service Selection Mobility Option	M	Copied from the corresponding field in the PBU message. The encoding the APN field follows 3GPP TS 23.003 [12] subclause 9.1 but excluding the trailing zero byte. The content of the APN field shall be the full APN with both the APN Network Identifier and default APN Operator Identifier being present as specified in 3GPP TS 23.003 [12] subclauses 9.1.1 and 9.1.2. NOTE 1.	IETF RFC 5149[11]
3GPP Specific PMIPv6 Error Code	O	Contain 3GPP Specific PMIPv6 Error Code (on S5/S8).	Subclause 12.1.1.1
LMA Fully Qualified PDN Connection Set Identifier	O	Contain a Fully Qualified PDN Connection Set Identifier if generated by the LMA on the S5/S8 interfaces as specified in 3GPP TS 23.007 [13].	Subclause 12.1.1.2
PDN connection ID	C	Contains the PDN connection ID received in PBU	Subclause 12.1.1.15

NOTE 1: The APN field is not encoded as a dotted string as commonly used in documentation.

## 5.2.2 MAG procedures

A MAG initiating the PMIPv6 PDN Connection Lifetime Extension procedure shall follow the "Extending Binding Lifetime" procedure described in the PMIPv6 [4] and IPv4 support for PMIPv6 [5] specifications, while parameters in the PBU are set as specified by the PBU parameters section for this procedure. When an MME FQ-CSID is received by the MAG during MME relocation, if the MAG supports the feature according to 3GPP TS 23.007 [13], it shall store the Node ID and CSID from the MME FQ-CSID for the PDN connection and forward the MME FQ-CSID to the LMA in the PBU.

## 5.2.3 LMA procedures

On reception of a PBU, the LMA shall initiate the "Binding Lifetime Extension without Handover" procedure as described in the PMIPv6 [4] and IPv4 support for PMIPv6 [5] specifications, while parameters in the PBA are set as



specified by the PBA parameters section for this procedure. When an MME FQ-CSID is received by the LMA, if the LMA supports the feature according to 3GPP TS 23.007 [13], it shall store the Node-ID and CSID from the MME FQ-CSID in place of those previously stored for the PDN connection.

## 5.3 Proxy Mobile IPv6 PDN Connection Handover procedure

### 5.3.1 General

The PMIPv6 PDN Connection Handover procedure is initiated by the node acting as a new MAG for the UE to update an existing PDN connection for an UE that is already attached to the EPC. The procedure starts with the new MAG sending a PBU including the APN to the LMA to update the binding for the UE's PDN connection. If multiple PDN connections to the same APN function is supported by the new MAG, a PDN connection ID shall also be included in the same PBU message. The LMA confirms update of the binding by sending a PBA to the MAG. If multiple PDN connections to the same APN function is supported by the LMA, the received PDN connection ID shall also be included in the same PBA message. Update of the binding achieves the following:

- **IPv6 Home Network Prefix re-assignment:** The LMA re-assigns to the UE's PDN connection the IPv6 Home Network Prefix valid in the selected PDN.
- **IPv4 Home Address re-assignment:** The LMA re-assigns to the UE's PDN connection the IPv4 Home Address valid in the selected PDN.
- **Downlink and Uplink GRE Key Assignment:** The MAG and LMA will establish downlink and uplink GRE keys to be used for GRE encapsulation of downlink and uplink traffic, respectively on the PDN connection.
- **GRE Tunnel Establishment:** A GRE tunnel is established between the MAG and LMA with the assigned GRE keys to carry uplink and downlink traffic that UE respectively sends and receives on the PDN connection.
- **BCE Update:** The LMA updates or creates the BCE for the PDN connection.
- **BULE Creation: The new MAG creates a BULE for the PDN connection.**
- **IP address(es) preservation:** the IP addresses allocated in the previous initial attachment are reused if IP address(es) preservation decision is made.
- **MAG Link Local Address re-assignment:** The LMA re-assigns the same MAG link local address.
- **UE Interface Identifier (IID) re-assignment:** The LMA re-assigns to the UE the same IPv6 Interface Identifier to allow formation of the same UE Link Local Address from the well-known link local address prefix (fe80::/64).
- **PDN connection ID:** The PDN connection ID is provided by the MAG and accepted by LMA, if multiple PDN connections to the same APN function is supported by both MAG and LMA.

#### 5.3.1.1 Proxy Binding Update

The fields of a PBU message for the PMIPv6 PDN Connection Handover procedure are depicted in Table 5.3.1.1-1.

The Mobility Options in a PBU message for the PMIPv6 PDN Connection Handover procedure are depicted in Table 5.3.1.1-2. When the mobility option is present in the message, only the first instance shall be recognised. If multiple instances are included in the message, the receiver ignores all other instances.

**Table 5.3.1.1-1: Fields of a PBU message for the PDN Connection Handover procedure**

Information element	IE Description	Reference
Sequence Number	Set to a locally (i.e. per MAG) monotonically increasing value.	IETF RFC 5213 [4]
Lifetime	Set to the requested number of time units the binding shall remain valid.	IETF RFC 6275 [8]
Acknowledge (A)	Set to "1" to request an acknowledgement message.	IETF RFC 6275 [8]
Proxy Registration Flag (P)	Set to "1" to indicate that the Binding Update message is a proxy registration.	IETF RFC 5213 [4]
Force UDP encapsulation request (F) Flag	Set to "0" to indicate that UDP encapsulation is not used for the user plane.	IETF RFC 5555 [34]

**Table 5.3.1.1-2: Mobility Options in a PBU message for the PMIPv6 PDN Connection Handover procedure**

Information element	Cat.	IE Description	Reference
Mobile Node Identifier option	M	Set to the UE NAI that is derived from the UE IMSI if an authenticated IMSI is available, or from the UE IMEI if IMSI is not available or the IMSI is not authenticated by the network. The NAI format is specified in 3GPP TS 23.003 [12].	IETF RFC 5213 [4], 3GPP TS 23.003 [12]
IPv6 Home Network Prefix option	C	If available at the MAG, set the Home Network Prefix to the IPv6 Home Network Prefix allocated to the UE's PDN connection and Prefix Length to the value "64". Otherwise, set the Home Network Prefix to the value "0::0" and Prefix Length to the value "0" to request allocation for the UE's PDN connection of an IPv6 Home Network Prefix for the UE in the PDN corresponding to the EPS Access Point Name. NOTE 1.	IETF RFC 5213 [4]
Link-local Address	C	Present when IPv6 Home Network Prefix option is present. If available, set to the link-local address already allocated to the MAG (in the previous initial binding registration) for use on the access link shared with the UE. If not available, set to ALL_ZERO (all bits set to 0), indicating that the MAG requests a link-local address.	IETF RFC 5213 [4]
Handoff Indicator option	M	Set to the value "2" (Handoff between two different interfaces) in case the handover is an inter access handover (i.e. from 3GPP to non-3GPP, from non-3GPP to 3GPP, or between two non-3GPP accesses) and IP address(es) preservation decision is taken; or Set to the value "3" (Handoff between mobile access gateways for the same interface) in case the handover is an intra access (i.e. between two 3GPP accesses) handover; or Set to the value "4" (Handoff state unknown) in case the handover is an inter access handover (i.e. from 3GPP to non-3GPP, from non-3GPP to 3GPP, or between two non-3GPP accesses) and IP address(es) preservation decision is negative or unknown.	IETF RFC 5213 [4]
Access Technology Type option	M	Set to the 3GPP access type, i.e., to GERAN, UTRAN or E-UTRAN, or to the value matching the characteristics of the non-3GPP access (e.g., HRPD) the UE is using to attach to the EPS as defined in the Access Technology Type Option type values registry of the IANA Mobile IPv6 Parameters Registry [18]. The ePDG may use the access technology type of the untrusted non-3GPP access network if it is able to acquire it; otherwise it shall indicate Virtual as the access technology. NOTE 2 NOTE 3	IETF RFC 5213 [4]
Timestamp option	M	Set to the current time	IETF RFC 5213 [4]
GRE key option	M	Set to the downlink GRE key to be used for downlink GRE encapsulated packets sent over the PDN connection.	IETF RFC 5845 [7]
IPv4 Home Address Request option	C	If available at the MAG, set the IPv4 Home Address to the IPv4 Address allocated to the UE's PDN connection and Prefix-len to the value "32". Otherwise, set the IPv4 Home Address to the value "0.0.0.0" and Prefix-len to the value "0" or "32" to request allocation for the UE's PDN connection of an IPv4 Home Address in the PDN corresponding to the EPS Access Point Name. NOTE 1.	IETF RFC 5844 [5]
Service Selection Mobility Option	M	Set to the EPS Access Point Name to which the UE's PDN connection is attached. The encoding the APN field follows 3GPP TS 23.003 [12] subclause 9.1 but excluding the trailing zero byte.	IETF RFC 5149[11]

		The content of the APN field shall be the full APN with both the APN Network Identifier and default APN Operator Identifier being present as specified in 3GPP TS 23.003 [12] subclauses 9.1.1 and 9.1.2. NOTE 4.	
Protocol Configuration Options	O	Contain Protocol Configuration Options.	Subclause 12.1.1.0
PDN GW IP Address	O	Contain PDN GW IP address (on S2a or S2b when used for chained S2a/S2b-PMIP based S8)..	Subclause 12.1.1.4
MAG Fully Qualified PDN Connection Set Identifier	O	Contain a Fully Qualified PDN Connection Set Identifier if generated by the MAG on the S5/S8 interfaces as specified in 3GPP TS 23.007 [13].	Subclause 12.1.1.2
MME Fully Qualified PDN Connection Set Identifier	O	Contain a Fully Qualified PDN Connection Set Identifier if generated by the MME, and included by the MAG on the S5/S8 interfaces as specified in 3GPP TS 23.007 [13].	Subclause 12.1.1.2
Selection Mode	C	Contains APN selection mode (on S5/S8). Shall be present if the PDN connection is initiated by S4 SGSN or MME.	Subclause 12.1.1.7
Charging Characteristics	O	Contains the Charging Characteristics to be applied for EPC charging	Subclause 12.1.1.8
Serving Network	C	This IE shall be included on S5 and S8 interfaces to identify the Serving Network	Subclause 12.1.1.9
Mobile Equipment Identity	O	Contains the MEI of the UE (on S5/S8)	Subclause 12.1.1.10
MSISDN	O	This IE shall contains the MSISDN and shall be present, if available, on the S5, S8, S2a or S2b interfaces.	Subclause 12.1.1.11
Maximum APN Restriction	O	Contains the most stringent restriction of already active PDN connections (on S5/S8).	Subclause 12.1.1.13
PDN connection ID	O	Contains the PDN connection ID	Subclause 12.1.1.15
Signalling Priority Indication	O	The SGW shall forward this IE on the S5/S8 interfaces during the handover from non-3GPP to 3GPP procedure.	Subclause 12.1.1.17
MME/SGSN Identifier	O	The SGW shall include the MME/SGSN Identifier on the S5 interface if the SGW supports the PGW triggered SGW restoration procedure and this information is received from the MME/SGSN as specified in 3GPP TS 23.007 [13].	Subclause 12.1.1.20
NOTE 1: At least one of the two options, namely, the IPv6 Home Network Prefix option or the IPv4 Home Address Request option shall be present. If the MAG knows the UE has both IPv4 home address and IPv6 home network prefix registered, both the IPv6 Home Network Prefix option and IPv4 Home Address Request option shall be included in the same PBU message.			
NOTE 2: The methods that the ePDG may use to acquire the access technology type of the untrusted non-3GPP IP access network are not specified in this release.			
NOTE 3: The PDN-GW can be informed about the type of access network used by the UE over several reference points, see 3GPP TS 29.212 [30] for the mapping between the code values for the different access network types.			
NOTE 4: The APN field is not encoded as a dotted string as commonly used in documentation.			

### 5.3.1.2 Proxy Binding Acknowledgement

The fields of a PBA message for the PMIPv6 PDN Connection Handover procedure are depicted in Table 5.3.1.2-1.

The Mobility Options in a PBA message for the PMIPv6 PDN Connection Handover procedure are depicted in Table 5.3.1.2-2. When the mobility option is present in the message, only the first instance shall be recognised. If multiple instances are included in the message, the receiver ignores all other instances.

Other flags are not used by this specification.

Only the message fields and mobility options used for acceptance cases are present in the following tables.

**Table 5.3.1.2-1: Fields of a PBA message for the PMIPv6 PDN Connection Handover procedure**

<b>Information element</b>	<b>IE Description</b>	<b>Reference</b>
Status	Set to indicate the result.	IETF RFC 6275 [8]
Proxy Registration Flag (P)	Set to "1" to indicate that the Binding Update message is a proxy registration.	IETF RFC 5213 [4]
Sequence Number	Set to the value received in the corresponding PBU.	IETF RFC 5213 [4]
Lifetime	Set to the granted number of time units the binding shall remain valid.	IETF RFC 6275 [8]

**Table 5.3.1.2-2: Mobility Options in a PBA message for the PMIPv6 PDN Connection Handover procedure**

Information element	Cat.	IE Description	Reference
Mobile Node Identifier option	M	Copied from corresponding field of PBU.	IETF RFC 5213 [4]
IPv6 Home Network Prefix option	C	Present if IPv6 Home Network Prefix is allocated. When it's present, set the Home Network Prefix to the IPv6 Home Network Prefix Allocated for the UE's PDN connection based on the selected PDN corresponding to the EPS Access Point Name for dynamic allocation, or set to the static IPv6 Home Network Prefix received in the PBU for static allocation. The Prefix Length is set to the value "64". In addition, the Interface Identifier (IID) allocated for the UE is encoded in the low order 64 bits of this option, i.e., the IPv6 Home Network Prefix option.	IETF RFC 5213 [4]
Link-local Address	C	Present when IPv6 Home Network Prefix option is present. Set to the link-local address already allocated to the MAG (in the previous initial binding registration) for use on the access link shared with the UE.	IETF RFC 5213 [4]
Handoff Indicator option	M	Copied from corresponding field of PBU.	IETF RFC 5213 [4]
Access Technology Type option	M	Copied from corresponding field of PBU.	IETF RFC 5213 [4]
Timestamp option	M	Copied from corresponding field of PBU, or set to the current time of LMA in case of timestamp error.	IETF RFC 5213 [4]
GRE key option	M	Set to the uplink GRE key to be used for uplink GRE encapsulated packets sent over the PDN connection. The same uplink GRE key used for the UE's PDN connection with the previous MAG shall be re-assigned.	IETF RFC 5845 [7]
IPv4 Home Address Reply Option	C	Present if IPv4 address is allocated. When it's present, set the IPv4 Home Address to the IPv4 Home Address allocated for the UE's PDN connection based on the selected PDN corresponding to the EPS Access Point Name for dynamic allocation, or set to the static IPv4 Home Address received in the PBU for static allocation. The Prefix-len is set to a non-zero value.	IETF RFC 5844 [5]
IPv4 Default Router Address Option	C	This option shall be present if and only if IPv4 Home Address Reply Option is present. The LMA sets the value of the UE's IPv4 default router address which belongs to the same subnet as the IPv4 Home Address allocated to the UE.	IETF RFC 5844 [5]
Service Selection Mobility Option	M	Copied from the corresponding field in the PBU message. The encoding the APN field follows 3GPP TS 23.003 [12] subclause 9.1 but excluding the trailing zero byte. The content of the APN field shall be the full APN with both the APN Network Identifier and default APN Operator Identifier being present as specified in 3GPP TS 23.003 [12] subclauses 9.1.1 and 9.1.2. NOTE 1.	IETF RFC 5149 [11]
PDN Type Indication	C	This option shall be present if and only if PDN type is changed in the PDN GW compared to what was requested in the PBU.	Subclause 12.1.1.3
PMIPv6 DHCPv4 Address Allocation Procedure Indication	C	This option shall be present if and only if DHCPv4 is to be used to allocate the IPv4 address to the UE.	Subclause 12.1.1.5
Protocol Configuration Options	O	Contain Protocol Configuration Options.	Subclause 12.1.1.0
3GPP Specific PMIPv6 Error Code	O	Contain 3GPP Specific PMIPv6 Error Code (on S5/S8).	Subclause 12.1.1.1
LMA Fully Qualified PDN Connection Set Identifier List	O	Contain a Fully Qualified PDN Connection Set Identifiers if generated by the LMA on the S5/S8 interfaces as specified in 3GPP TS 23.007 [13].	Subclause 12.1.1.2
Charging ID	M	Contain the Charging ID information	Subclause 12.1.1.6

APN Restriction	O	Contains the restriction of this PDN connection (on S5/S8).	Subclause 12.1.1.12
PDN connection ID	O	Contains the PDN connection ID received in PBU	Subclause 12.1.1.15
Static IP Address Allocation Indication	O	Contains Static IP Address Allocation Indication if the IPv4 address and/or IPv6 Home Network Prefix is statically allocated. See NOTE 2	Subclause 12.1.1.18
NOTE 1: The APN field is not encoded as a dotted string as commonly used in documentation.			
NOTE 2: Static IP Address Allocation Indication is used by MAG to provide dynamic IPv4/v6 address flag information as specified in 3GPP TS 32.251 [25].			

### 5.3.2 MAG procedures

A MAG initiating the PMIPv6 PDN Connection Handover procedure shall follow the "Mobile Node Attachment and Initial Binding Registration" procedure described in the PMIPv6 [4] and IPv4 support for PMIPv6 [5] specifications with the following additional requirements:

1. Generate a downlink GRE key that is not already in use locally for the PDN connection's downlink traffic to that UE, as specified in the GRE Key Option for PMIPv6 specification [7].
2. Provide a PDN connection ID, if multiple PDN connections to the same APN function is supported by the MAG.
3. Set other parameters in the PBU as specified by the PBU parameters section for this procedure.
4. Optionally, assign a Fully Qualified PDN Connection Set Identifier that identifies a set of PDN connections belonging to an arbitrary number of UEs.

### 5.3.3 LMA procedures

On reception of a PBU, the LMA shall initiate the "Binding Lifetime Extension (After handoff)" and "Processing Proxy Binding Updates" procedures described in the PMIPv6 [4] and IPv4 support for PMIPv6 [5] specifications with the following additional requirements:

1. Re-assign the same uplink GRE key that was used by the previous MAG for the PDN connection's uplink traffic from the UE, as specified in the GRE Key Option for PMIPv6 specification [7].
2. Check if the received IPv6 Home prefix and/or IPv4 Home address are topologically correct.
3. Dynamic IP address allocation:
  - a) If Handoff Indicator option is "2" or "3": Re-allocate the IPv6 Home Network Prefix and/or the IPv4 Home Address for the selected PDN which were/was allocated during the previous attachment.
  - b) If Handoff Indicator option is "4": Make the IP address preservation decision as per the PMIPv6 specification [4].
- 3a. Static IP address allocation: If the IPv4 address and/or IPv6 Home Network Prefix is statically allocated, the LMA includes Static IP Address Allocation Indication in the PBA message.
4. Optionally, assign or reuse a Fully Qualified PDN Connection Set Identifier that identifies a set of PDN connections belonging to an arbitrary number of UEs.
5. If PDN connection ID was received in the PBU message,
  - a) the LMA updates PDN connection ID in the BCE accordingly and includes the received a PDN connection ID in the PBA message, if the multiple PDN connections to the same APN function is supported by the LMA; or
  - b) the LMA ignores the received PDN connection ID and does not include the received a PDN connection ID in the PBA message, if the multiple PDN to the same APN function is not supported by the LMA.
6. Set parameters in the PBA as specified by the PBA parameters section for this procedure.

The LMA performs the lookup of BCE as described in subclause 5.8.3. If no existing BCE is found, the LMA shall follow the Proxy Mobile IPv6 PDN Connection Creation procedure as specified in section 5.1.3.

## 5.4 Proxy Mobile IPv6 MAG Initiated PDN Connection Deletion procedure

### 5.4.1 General

The PMIPv6 MAG Initiated PDN Connection Deletion procedure is initiated by the node acting as a MAG to tear down an existing PDN connection with the node acting as an LMA. The procedure starts with the MAG sending a PBU to the LMA to deregister with the LMA a binding for the UE's PDN connection. The LMA confirms deregistration of the binding by sending a PBA to the MAG. Deregistration of the binding achieves the following:

- **IPv6 Home Network Prefix deallocation:** When the PDN connection is released, the LMA returns the IPv6 Home Network Prefix assigned to the UE's PDN connection to the pool of free IPv6 Home Network Prefixes.
- **IPv4 Home Address deallocation:** When the PDN connection is released, the LMA returns the IPv4 Home Address assigned to the UE's PDN connection to the pool of free IPv4 Home Network Addresses.
- **Downlink and Uplink GRE Key de-assignment:** The MAG and LMA will return, respectively, the PDN connection's uplink and downlink GRE keys to their respective pool of free GRE keys.
- **GRE Tunnel Tear-down:** The GRE tunnel between the MAG and LMA is deleted.
- **BCE Deletion:** The LMA deletes the BCE for the PDN connection.
- **BULE Deletion:** The MAG deletes the BULE for the PDN connection.

#### 5.4.1.1 Proxy Binding Update

The fields of a PBU message for the PMIPv6 MAG Initiated PDN Connection Deletion procedure are depicted in Table 5.4.1.1-1.

The Mobility Options in a PBU message for the PMIPv6 MAG Initiated PDN Connection Deletion procedure are depicted in Table 5.4.1.1-2. When the mobility option is present in the message, only the first instance shall be recognised. If multiple instances are included in the message, the receiver ignores all other instances.

Other flags are not used by this specification.

**Table 5.4.1.1-1: Fields of a PBU message for the PMIPv6 MAG Initiated PDN Connection Deletion procedure**

Information element	IE Description	Reference
Sequence Number	Set to a locally (i.e. per MAG) monotonically increasing value.	IETF RFC 5213 [4]
Lifetime	Set to "0" to request deletion of the BCE.	IETF RFC 6275 [8]
Acknowledge (A)	Set to "1" to request an acknowledgement message.	IETF RFC 6275 [8]
Proxy Registration Flag (P)	Set to "1" to indicate that the Binding Update message is a proxy registration.	IETF RFC 5213 [4]
Force UDP encapsulation request (F) Flag	Set to "0" to indicate that UDP encapsulation is not used for the user plane.	IETF RFC 5555 [34]



**Table 5.4.1.1-2: Mobility Options in a PBU message for the PMIPv6 MAG Initiated PDN Connection Deletion procedure**

Information element	Cat.	IE Description	Reference
Mobile Node Identifier option	M	Set to the UE NAI that is derived from the UE IMSI if an authenticated IMSI is available, or from the UE IMEI if IMSI is not available or the IMSI is not authenticated by the network. The NAI format is specified in 3GPP TS 23.003 [12].	IETF RFC 5213 [4], 3GPP TS 23.003 [12]
IPv6 Home Network Prefix option	C	Set the Home Network Prefix to the IPv6 Home Network Prefix allocated to the UE's PDN connection based on the selected PDN and Prefix Length to the value "64". NOTE 1.	IETF RFC 5213 [4]
Handoff Indicator option	M	Set to the value "4" to indicate Handoff state unknown.	IETF RFC 5213 [4]
Access Technology Type option	M	Set to the 3GPP access type, i.e., to GERAN, UTRAN or E-UTRAN, or to the value matching the characteristics of the non-3GPP access (e.g., HRPD) the UE is using to attach to the EPS as defined in the Access Technology Type Option type values registry of the IANA Mobile IPv6 Parameters Registry [18]. The ePDG may use the access technology type of the untrusted non-3GPP access network if it is able to acquire it; otherwise it shall indicate Virtual as the access technology. NOTE 2 NOTE 3	IETF RFC 5213 [4]
Timestamp option	M	Set to the current time	IETF RFC 5213 [4]
IPv4 Home Request Address option	C	Set the IPv4 Home Address to the IPv4 Home Address allocated for the UE's PDN connection based on the selected PDN and Prefix-len to the non-zero value received from the LMA. NOTE 1.	IETF RFC 5844 [5]
Service Selection Mobility Option	M	Set to the EPS Access Point Name to which the UE's PDN connection is attached. The encoding the APN field follows 3GPP TS 23.003 [12] subclause 9.1 but excluding the trailing zero byte. The content of the APN field shall be the full APN with both the APN Network Identifier and default APN Operator Identifier being present as specified in 3GPP TS 23.003 [12] subclauses 9.1.1 and 9.1.2. NOTE 4.	IETF RFC 5149[11]
Protocol Configuration Options	O	Contain Protocol Configuration Options.	Subclause 12.1.1.0
PDN connection ID	C	Contains the PDN connection ID if the BULE contains the PDN Connection ID.	Subclause 12.1.1.15
<p>NOTE 1: At least one of the two options, namely, the IPv6 Home Network Prefix option or the IPv4 Home Address Request option shall be present. If the UE has both IPv4 home address and IPv6 home network prefix registered, both the IPv6 Home Network Prefix option and IPv4 Home Address Request option shall be included in the same PBU message.</p> <p>NOTE 2: The methods that the ePDG may use to acquire the access technology type of the untrusted non-3GPP IP access network are not specified in this release.</p> <p>NOTE 3: The PDN-GW can be informed about the type of access network used by the UE over several reference points, see 3GPP TS 29.212 [30] for the mapping between the code values for the different access network types.</p> <p>NOTE 4: The APN field is not encoded as a dotted string as commonly used in documentation.</p>			

### 5.4.1.2 Proxy Binding Acknowledgement

The fields of a PBA message for the PMIPv6 MAG Initiated PDN Connection Deletion procedure are depicted in Table 5.4.1.2-1.

The Mobility Options in a PBA message for the MAG Initiated PDN Connection Deletion procedure are depicted in Table 5.4.1.2-2. When the mobility option is present in the message, only the first instance shall be recognised. If multiple instances are included in the message, the receiver ignores all other instances.

Other flags are not used by this specification.

Only the message fields and mobility options used for acceptance cases are present in the following tables.

**Table 5.4.1.2-1: Fields of a PBA message for the PMIPv6 MAG Initiated PDN Connection Deletion procedure**

Information element	IE Description	Reference
Status	Set to indicate the result.	IETF RFC 6275 [8]
Proxy Registration Flag (P)	Set to "1" to indicate that the Binding Update message is a proxy registration.	IETF RFC 5213 [4]
Sequence Number	Set to a value received in the corresponding PBU.	IETF RFC 5213 [4]
Lifetime	Set to "0" to request deletion of the binding.	IETF RFC 6275 [8]

**Table 5.4.1.2-2: Mobility Options in a PBA message for the PMIPv6 MAG Initiated PDN Connection Deletion procedure**

Information element	Cat.	IE Description	Reference
Mobile Node Identifier option	M	Copied from corresponding field of PBU.	IETF RFC 5213 [4]
IPv6 Home Network Prefix option	C	If it is present in the corresponding PBU, set to the IPv6 Home Network Prefix allocated to the UE's PDN connection based on the selected PDN.	IETF RFC 5213 [4]
Handoff Indicator option	M	Copied from corresponding field of PBU.	IETF RFC 5213 [4]
Access Technology Type option	M	Copied from corresponding field of PBU.	IETF RFC 5213 [4]
Timestamp option	M	Copied from corresponding field of PBU, or set to the current time of LMA in case of timestamp error.	IETF RFC 5213 [4]
IPv4 Home Address Reply Option	C	If it is present in the corresponding PBU, set the IPv4 Home Address to the IPv4 Home Address allocated for the UE's PDN connection based on the selected PDN and Prefix-len to a non-zero value received in the corresponding PBU.	IETF RFC 5844 [5]
IPv4 Default Router Address Option	C	This option shall be present if and only if IPv4 Home Address Reply Option is present and PBU is accepted. The LMA sets the value of the UE's IPv4 default router address which belongs to the same subnet as the IPv4 Home Address allocated to the UE.	IETF RFC 5844 [5]
Service Selection Mobility Option	M	Copied from the corresponding field in the PBU message. The encoding the APN field follows 3GPP TS 23.003 [12] subclause 9.1 but excluding the trailing zero byte. The content of the APN field shall be the full APN with both the APN Network Identifier and default APN Operator Identifier being present as specified in 3GPP TS 23.003 [12] subclauses 9.1.1 and 9.1.2. NOTE 1.	IETF RFC 5149[11]
Protocol Configuration Options	O	Contain Protocol Configuration Options.	Subclause 12.1.1.0
3GPP Specific PMIPv6 Error Code	O	Contain 3GPP Specific PMIPv6 Error Code	Subclause 12.1.1.1
PDN connection ID	C	Contains the PDN connection ID received in PBU	Subclause 12.1.1.15

NOTE 1: The APN field is not encoded as a dotted string as commonly used in documentation.

## 5.4.2 MAG procedures

A MAG initiating the PMIPv6 Initial MAG Initiated PDN Connection Deletion procedure shall follow the "Mobile Node Detachment and Binding De-Registration" procedure described in the PMIPv6 [4] and IPv4 support for PMIPv6 [5] specifications, while parameters in the PBU are set as specified by the PBU parameters section for this procedure.

### 5.4.3 LMA procedures

On reception of a PBU, the LMA shall initiate the "Binding De-Registration" procedure described in the PMIPv6 [4] and IPv4 support for PMIPv6 [5] specifications, while parameters in the PBA are set as specified by the PBA parameters section for this procedure.

## 5.5 Proxy Mobile IPv6 LMA Initiated PDN Connection Deletion procedure

### 5.5.1 General

In EPC the PMIPv6 LMA Initiated PDN Connection Deletion is initiated by the node acting as a LMA to notify the node acting as a MAG, that the Binding Cache Entry related to the UE is about to be deactivated, so the MAG should remove the resources related to that PDN connection. The procedure starts with the LMA sending a BRI to the MAG to revoke the binding. The MAG confirms the revocation of the binding by sending a BRA to the LMA.

The LMA Initiated PDN Connection Deletion Procedure initiated by the LMA achieves the following:

- **IPv6 Home Network Prefix release:** When the UE's PDN connection is deactivated, the LMA returns the IPv6 Home Network Prefix assigned to the UE's PDN connection to the pool of free IPv6 Home Network Prefixes.
- **IPv4 Home Address release:** When the UE's PDN connection is deactivated, the LMA returns the IPv4 Home Address assigned to the UE's PDN connection to the pool of free IPv4 Home Network Addresses.
- **Downlink and Uplink GRE keys de-assignment:** The MAG and LMA will return, respectively, the PDN connection's uplink and downlink GRE keys to their respective pool of free GRE keys.
- **GRE tunnel Deletion:** The GRE tunnel is removed from the LMA and the MAG.
- **BCE Deletion:** The LMA deletes the BCE for the PDN connection.
- **BULE Deletion:** The MAG deletes the BULE for the PDN connection.

#### 5.5.1.1 Binding Revocation Indication

The fields of a BRI message for the PMIPv6 LMA Initiated PDN Connection Deletion procedure are depicted in Table 5.5.1.1-1.

The Mobility Options in a BRI message for the LMA Initiated PDN Connection Deletion procedure are depicted in Table 5.5.1.1-2. When the mobility option is present in the message, only the first instance shall be recognised. If multiple instances are included in the message, the receiver ignores all other instances.

**Table 5.5.1.1-1: Fields of a BRI message for the PMIPv6**

Information element	IE Description	Reference
Revocation Trigger	Set to a value indicating the event which triggered the revoking node to send the BRI message	IETF RFC 5846 [6]
Sequence Number	A sequence number generated by the LMA, and increased for every BRI sent.	IETF RFC 5846 [6]
Proxy Binding Flag (P)	Set to "1" to indicate that the Binding Revocation Indication is for a proxy MIPv6 binding entry.	IETF RFC 5213 [4]
IPv4 HoA Binding Only (V)	Set to "0" to request for complete binding revocation	IETF RFC 5846 [6]
Global Per-Peer Bindings (G)	Set to 0 to indicate that the request is for a specific PMIPv6 BCE.	IETF RFC 5846 [6]

**Table 5.5.1.1-2: Mobility Options in a BRI message for the PMIPv6 LMA Initiated PDN Connection Deletion**

Information element	Cat.	IE Description	Reference
Mobile Node Identifier option	M	Set to the UE NAI that is derived from the UE IMSI if an authenticated IMSI is available, or from the UE IMEI if IMSI is not available or the IMSI is not authenticated by the network. The NAI format is specified in 3GPP TS 23.003[12].	IETF RFC 5213 [4], 3GPP TS 23.003[12]
IPv6 Home Network Prefix option	C	Set the Home Network Prefix to the Home Network Prefix of the UE's PDN connection. Set the Prefix Length to the value "64". NOTE 1.	IETF RFC 5213 [4]
IPv4 Home Address Request option	C	Set the IPv4 Home Address to the IPv4 home address of the UE's PDN connection. Set the Prefix-len to the non-zero value which was sent to the MAG at PMIPv6 PDN connection creation procedure or Handover procedure.. NOTE 1.	IETF RFC 5844 [5]
Service Selection Mobility Option	M	Set to the EPS Access Point Name to which the UE's PDN connection is attached. The encoding the APN field follows 3GPP TS 23.003 [12] subclause 9.1 but excluding the trailing zero byte. The content of the APN field shall be the full APN with both the APN Network Identifier and default APN Operator Identifier being present as specified in 3GPP TS 23.003 [12] subclauses 9.1.1 and 9.1.2. NOTE 2.	IETF RFC 5149[11]
Protocol Configuration Options	O	Contain Protocol Configuration Options	Subclause 12.1.1.0
PDN connection ID	C	Contains the PDN connection ID if the BCE contains the PDN Connection ID.	Subclause 12.1.1.15
3GPP Specific PMIPv6 Error Code	O	For the S5/S8 interface, contain 3GPP Specific PMIPv6 Error Code	Subclause 12.1.1.1
NOTE 1: At least one of the two options, namely, the IPv6 Home Network Prefix option or the IPv4 Home Address Request option shall be present. If the UE has both IPv4 home address and IPv6 home network prefix registered, both the IPv6 Home Network Prefix option and IPv4 Home Address Request option shall be included in the same BRI message.			
NOTE 2: The APN field is not encoded as a dotted string as commonly used in documentation.			

### 5.5.1.2 Binding Revocation Acknowledgment

The fields of a BRA message for the PMIPv6 LMA Initiated PDN Connection Deletion procedure are depicted in Table 5.5.1.2-1.

The Mobility Options in a BRA message for the LMA Initiated PDN Connection Deletion procedure are depicted in Table 5.5.1.2-2. When the mobility option is present in the message, only the first instance shall be recognised. If multiple instances are included in the message, the receiver ignores all other instances.

Only the message fields and mobility options used for acceptance cases are present in the following tables.

**Table 5.5.1.2-1: Fields of a BRA message for a PMIPv6 LMA Initiated PDN Connection Deletion**

Information element	IE Description	Reference
Status	Indicates the result of the BRI	IETF RFC 5846 [6]
Sequence Number	Set to the value received in the corresponding BRI.	IETF RFC 5846 [6]
Proxy Registration Flag (P)	Set to "1" to indicate that the Binding Revocation Acknowledgment is for a proxy MIPv6 binding entry.	IETF RFC 5213 [4]
IPv4 HoA Binding Only (V)	Set to "0"; the same value as for BRI	IETF RFC 5846 [6]
Global Per-Peer Bindings (G)	Set to "0"; the same value as for the BRI.	IETF RFC 5846 [6]

**Table 5.5.1.2-2: Mobility Options in a BRA message for the PMIPv6 LMA Initiated PDN Connection Deletion**

Information element	Cat.	IE Description	Reference
Mobile Node Identifier option	M	Copied from corresponding field of BRI.	IETF RFC 5213 [4]
IPv6 Home Network Prefix option	C	Set the Home Network Prefix to the IPv6 Home Network Prefix of the UE's PDN connection received in BRI. Set the Prefix Length to the value "64".	IETF RFC 5213 [4]
IPv4 Home Address Reply Option	C	Set the IPv4 Home Address to the IPv4 home address of the UE's PDN connection received in BRI. Set the Prefix-len to the non-zero value received in BRI.	IETF RFC 5844 [5]
Service Selection Mobility Option	M	Copied from the corresponding field in the PBU message. The encoding the APN field follows 3GPP TS 23.003 [12] subclause 9.1 but excluding the trailing zero byte. The content of the APN field shall be the full APN with both the APN Network Identifier and default APN Operator Identifier being present as specified in 3GPP TS 23.003 [12] subclauses 9.1.1 and 9.1.2. NOTE 1.	IETF RFC 5149[11]
Protocol Configuration Options	O	Contain Protocol Configuration Options	Subclause 12.1.1.0
3GPP Specific PMIPv6 Error Code	O	Contain 3GPP Specific PMIPv6 Error Code (on S5/S8).	Subclause 12.1.1.1
PDN connection ID	C	Contains the PDN connection ID received in BRI	Subclause 12.1.1.15

NOTE 1: The APN field is not encoded as a dotted string as commonly used in documentation.

## 5.5.2 MAG procedures

The MAG shall follow the "Local Mobility Anchor Revokes a PMIPv6 Binding" procedure described in the IETF RFC 5846 [6]. The MAG should release the resources associated with the UE's PDN connection referred to in the BRI message.

The MAG shall respond with a BRA.

## 5.5.3 LMA procedures

The LMA shall send a BRI to the MAG as described in the "Local Mobility Anchor Revokes a PMIPv6 binding" procedure described in the IETF RFC 5846 [6]. The LMA shall clear the BCE related to the UE's PDN connection after sending the BRI in case of UE detach.

## 5.6 Proxy Mobile IPv6 PDN Connection IPv4 address allocation procedure

### 5.6.1 General

The IPv4 address allocation procedure is initiated by the node acting as a MAG when DHCPv4 message is received from the UE which requires a new IPv4 address. The MAG sends a PBU to LMA requesting a new IPv4 address for an existing PDN connection. The LMA assigns a new IPv4 address by sending a PBA to the MAG. IPv4 address assignment procedure achieves the following:

- **IPv4 Home Address assignment:** The LMA assigns to the UE's PDN connection an IPv4 Home Address valid in the selected PDN.

### 5.6.1.1 Proxy Binding Update

The fields of a PBU message for the PMIPv6 PDN Connection IPv4 address allocation procedure are depicted in Table 5.6.1.1-1.

The Mobility Options in a PBU message for the PMIPv6 PDN Connection IPv4 address allocation procedure are depicted in Table 5.6.1.1-2. When the mobility option is present in the message, only the first instance shall be recognised. If multiple instances are included in the message, the receiver ignores all other instances.

Other flags are not used by this specification.

**Table 5.6.1.1-1: Fields of a PBU message for the PMIPv6 PDN Connection IPv4 address allocation procedure**

Information element	IE Description	Reference
Sequence Number	Set to a locally (i.e. per MAG) monotonically increasing value.	IETF RFC 5213 [4]
Lifetime	Set to the requested number of time units the binding shall remain valid.	IETF RFC 6275 [8]
Acknowledge (A)	Set to "1" to request an acknowledgement message.	IETF RFC 6275 [8]
Proxy Registration Flag (P)	Set to "1" to indicate that the Binding Update message is a proxy registration.	IETF RFC 5213 [4]
Force UDP encapsulation request (F) Flag	Set to "0" to indicate that UDP encapsulation is not used for the user plane.	IETF RFC 5555 [34]

**Table 5.6.1.1-2: Mobility Options in a PBU message for the PMIPv6 PDN Connection IPv4 address allocation procedure**

Information element	Cat.	IE Description	Reference
Mobile Node Identifier option	M	Set to the UE NAI that is derived from the UE IMSI if an authenticated IMSI is available, or from the UE IMEI if IMSI is not available or the IMSI is not authenticated by the network. The NAI format is specified in 3GPP TS 23.003 [12].	IETF RFC 5213 [4], 3GPP TS 23.003 [12]
IPv6 Home Network Prefix option	M	Set the Home Network Prefix to the IPv6 Home Network Prefix allocated to the UE's PDN connection based on the selected PDN and Prefix Length to the value "64".	IETF RFC 5213 [4]
Link-local Address	M	Set to the link-local address already allocated to the MAG (in the previous initial binding registration) for use on the access link shared with the UE.	IETF RFC 5213 [4]
Handoff Indicator option	M	Set to the value "5" to indicate handoff state not changed (Re-registration).	IETF RFC 5213 [4]
Access Technology Type option	M	Set to the 3GPP access type, i.e., to GERAN, UTRAN or E-UTRAN, or to the value matching the characteristics of the non-3GPP access (e.g., HRPD) the UE is using to attach to the EPS as defined in the Access Technology Type Option type values registry of the IANA Mobile IPv6 Parameters Registry [18]. NOTE 1	IETF RFC 5213 [4]
Timestamp option	M	Set to the current time	IETF RFC 5213 [4]
IPv4 Home Address Request option	M	For dynamic allocation, set the IPv4 Home Address to the value "0.0.0.0" and Prefix-len to the value "0" or "32" to request allocation for the UE's PDN connection of an IPv4 Home Address in the PDN corresponding to the EPS Access Point Name. For static allocation, set the IPv4 Home Address to the received static allocated IPv4 Home Address and Prefix-len to the value "32".	IETF RFC 5844 [5]
Service Selection Mobility Option	M	Set to the EPS Access Point Name to which the UE's PDN connection is attached. The encoding the APN field follows 3GPP TS 23.003 [12] subclause 9.1 but excluding the trailing zero byte. The content of the APN field shall be the full APN with both the APN Network Identifier and default APN Operator Identifier being present as specified in 3GPP TS 23.003 [12] subclauses 9.1.1 and 9.1.2. NOTE 2.	IETF RFC 5149[11]
PDN connection ID	C	Contains the PDN connection ID if the BULE contains the PDN Connection ID.	Subclause 12.1.1.15
NOTE 1: The PDN-GW can be informed about the type of access network used by the UE over several reference points, see 3GPP TS 29.212 [30] for the mapping between the code values for the different access network types.			
NOTE 2: The APN field is not encoded as a dotted string as commonly used in documentation.			

### 5.6.1.2 Proxy Binding Acknowledgement

The fields of a PBA message for the PMIPv6 PDN Connection IPv4 address allocation procedure are depicted in Table 5.6.1.2-1.

The Mobility Options in a PBA message for the PMIPv6 PDN Connection IPv4 address allocation procedure are depicted in Table 5.6.1.2-2. When the mobility option is present in the message, only the first instance shall be recognised. If multiple instances are included in the message, the receiver ignores all other instances.

Other flags are not used by this specification.

Only the message fields and mobility options used for acceptance cases are present in the following tables.

**Table 5.6.1.2-1: Fields of a PBA message for the PMIPv6 PDN Connection IPv4 address allocation procedure**

Information element	IE Description	Reference
Status	Set to indicate the result.	IETF RFC 6275 [8]
Proxy Registration Flag (P)	Set to "1" to indicate that the Binding Update message is a proxy registration.	IETF RFC 5213 [4]
Sequence Number	Set to the value received in the corresponding PBU.	IETF RFC 5213 [4]
Lifetime	Set to the granted number of time units the binding shall remain valid.	IETF RFC 6275 [8]

**Table 5.6.1.2-2: Mobility Options in a PBA message for the PMIPv6 PDN Connection IPv4 address allocation procedure**

Information element	Cat.	IE Description	Reference
Mobile Node Identifier option	M	Copied from corresponding field of PBU.	IETF RFC 5213 [4]
IPv6 Home Network Prefix option	M	Set the Home Network Prefix to the IPv6 Home Network Prefix allocated to the UE's PDN connection based on the selected PDN and Prefix Length to the value "64".	IETF RFC 5213 [4]
Link-local Address	M	Set to the link-local address already allocated to the MAG (in the previous initial binding registration) for use on the access link shared with the UE.	IETF RFC 5213 [4]
Handoff Indicator option	M	Copied from corresponding field of PBU.	IETF RFC 5213 [4]
Access Technology Type option	M	Copied from corresponding field of PBU.	IETF RFC 5213 [4]
Timestamp option	M	Copied from corresponding field of PBU, or set to the current time of LMA in case of timestamp error.	IETF RFC 5213 [4]
IPv4 Home Address Reply option	M	Set the IPv4 Home Address to the IPv4 Home Address allocated for the UE's PDN connection based on the selected PDN corresponding to the EPS Access Point Name for dynamic allocation, or set to the static IPv4 Home Address received in the PBU for static allocation. The Prefix-len is set to a non-zero value.	IETF RFC 5844 [5]
IPv4 Default Router Address Option	M	The LMA sets the value of the UE's IPv4 default router address which belongs to the same subnet as the IPv4 Home Address allocated to the UE.	IETF RFC 5844 [5]
Service Selection Mobility Option	M	Copied from the corresponding field in the PBU message. The encoding the APN field follows 3GPP TS 23.003 [12] subclause 9.1 but excluding the trailing zero byte. The content of the APN field shall be the full APN with both the APN Network Identifier and default APN Operator Identifier being present as specified in 3GPP TS 23.003 [12] subclauses 9.1.1 and 9.1.2. NOTE 1.	IETF RFC 5149[11]
3GPP Specific PMIPv6 Error Code	O	Contain 3GPP Specific PMIPv6 Error Code (on S5/S8).	Subclause 12.1.1.1
PDN connection ID	C	Contains the PDN connection ID received in PBU	Subclause 12.1.1.15

NOTE 1: The APN field is not encoded as a dotted string as commonly used in documentation.

## 5.6.2 MAG procedures

The MAG initiating IPv4 Address Allocation using DHCPv4 procedure shall follow the "Extending Binding Lifetime" procedure described in the PMIPv6 [4] and "DHCP Relay Agent co-located with MAG" or "DHCP Server co-located with MAG" procedure as described in IPv4 support for PMIPv6 [5] specifications, while parameters in the PBU are set as specified by the PBU parameters section for this procedure.

1. If the static IPv4 Home Address is available at the MAG, set it in the IPv4 home address Request option in the PBU.
2. Set other parameters in the PBU as specified by the PBU parameters section for this procedure.



### 5.6.3 LMA procedures

On reception of a PBU, the LMA shall initiate the "Binding Lifetime Extension without Handover" procedures as described in the PMIPv6 [4] and IPv4 support for PMIPv6 [5] specifications with the following additional requirements:

1. Check if the received IPv4 Home address is topologically correct.
2. Allocate an IPv4 Home Address for the selected PDN.
3. Set parameters in the PBA as specified by the PBA parameters section for this procedure.

## 5.7 Proxy Mobile IPv6 LMA Initiated IPv4 Address Release procedure

### 5.7.1 General

In the case when UE is assigned both IPv6 HNP and IPv4 Home Address, if IPv4 Address lease expires or DHCPv4 Release procedure, the node acting as LMA initiates IPv4 Address Release procedure to notify the node acting as MAG about release of IPv4 address of UE for a certain PDN connection. LMA indicates MAG by sending a BRI and MAG confirms by replying with a BRA as described in IETF RFC 5846 [6].

LMA Initiated IPv4 Address Release procedure achieves the following:

- **IPv4 Home Address release:** The LMA returns the IPv4 Home Address assigned to the UE's PDN connection to the pool of free IPv4 Home Network Addresses.

#### 5.7.1.1 Binding Revocation Indication

The fields of a BRI message for the PMIPv6 LMA Initiated PDN Connection Deletion procedure are depicted in Table 5.7.1.1-1.

The Mobility Options in a BRI message for the LMA Initiated PDN Connection Deletion procedure are depicted in Table 5.7.1.1-2. When the mobility option is present in the message, only the first instance shall be recognised. If multiple instances are included in the message, the receiver ignores all other instances.

**Table 5.7.1.1-1: Fields of a BRI message for the LMA Initiated IPv4 Address Release**

Information element	IE Description	Reference
Revocation Trigger	Set to a value indicating the event which triggered the revoking node to send the BRI message.	IETF RFC 5846 [6]
Sequence Number	A sequence number generated by the LMA, and increased for every BRI sent.	IETF RFC 5846 [6]
Proxy Binding Flag (P)	Set to "1" to indicate that the Binding Revocation Indication is for a proxy MIPv6 binding entry.	IETF RFC 5213 [4]
IPv4 HoA Binding Only (V)	Set to "1" to revoke IPv4 address only	IETF RFC 5846 [6]
Global Per-Peer Bindings (G)	Set to 0 to indicate that the request is for a specific PMIPv6 BCE.	IETF RFC 5846 [6]

**Table 5.7.1.1-2: Mobility Options in a BRI message for the LMA Initiated IPv4 Address Release**

Information element	Cat.	IE Description	Reference
Mobile Node Identifier option	M	Set to the UE NAI that is derived from the UE IMSI if an authenticated IMSI is available, or from the UE IMEI if IMSI is not available or the IMSI is not authenticated by the network. The NAI format is specified in 3GPP TS 23.003[12].	IETF RFC 5213 [4], 3GPP TS 23.003[12]
IPv4 Home Address Request option	M	Set the IPv4 Home Address to the IPv4 home address of the UE's PDN connection and Prefix-len to the non-zero value which was sent to the MAG at PMIPv6 PDN connection creation procedure or Handover procedure.	IETF RFC 5844 [5]
Service Selection Mobility Option	M	Set to the EPS Access Point Name to which the UE's PDN connection is attached. The encoding the APN field follows 3GPP TS 23.003 [12] subclause 9.1 but excluding the trailing zero byte. The content of the APN field shall be the full APN with both the APN Network Identifier and default APN Operator Identifier being present as specified in 3GPP TS 23.003 [12] subclauses 9.1.1 and 9.1.2. NOTE 1.	IETF RFC 5149[11]
PDN connection ID	C	Contains the PDN connection ID if the BCE contains the PDN Connection ID.	Subclause 12.1.1.15
NOTE 1: The APN field is not encoded as a dotted string as commonly used in documentation.			

### 5.7.1.2 Binding Revocation Acknowledgment

The fields of a BRA message for the PMIPv6 LMA Initiated PDN Connection Deletion procedure are depicted in Table 5.7.1.2-1.

The Mobility Options in a BRA message for the LMA Initiated PDN Connection Deletion procedure are depicted in Table 5.7.1.2-2. When the mobility option is present in the message, only the first instance shall be recognised. If multiple instances are included in the message, the receiver ignores all other instances.

Only the message fields and mobility options used for acceptance cases are present in the following tables.

**Table 5.7.1.2-1: Fields of a BRA message for a LMA Initiated IPv4 Address Release**

Information element	IE Description	Reference
Status	Indicates the result of the BRI	IETF RFC 5846 [6]
Sequence Number	Set to the value received in the corresponding BRI.	IETF RFC 5846 [6]
Proxy Binding Flag (P)	Set to "1" to indicate that the Binding Revocation Indication is for a proxy MIPv6 binding entry.	IETF RFC 5213 [4]
IPv4 HoA Binding Only (V)	Set to "1"; the same value as for BRI	IETF RFC 5846 [6]
Global Per-Peer Bindings (G)	Set to 0 to indicate that the request is for a specific PMIPv6 BCE.	IETF RFC 5846 [6]

**Table 5.7.1.2-2: Mobility Options in a BRA message for the LMA Initiated IPv4 Address Release**

Information element	Cat.	IE Description	Reference
Mobile Node Identifier option	M	Copied from corresponding field of BRI.	IETF RFC 5213 [4] , 3GPP TS 23.003 [12]
IPv4 Home Address Reply Option	M	Set the IPv4 Home Address to the IPv4 home address of the UE's PDN connection received in BRI. Set the Prefix-len to the non-zero value received in BRI.	IETF RFC 5844 [5]
Service Selection Mobility Option	M	Copied from the corresponding field in the PBU message. The encoding the APN field follows 3GPP TS 23.003 [12] subclause 9.1 but excluding the trailing zero byte. The content of the APN field shall be the full APN with both the APN Network Identifier and default APN Operator Identifier being present as specified in 3GPP TS 23.003 [12] subclauses 9.1.1 and 9.1.2. NOTE 1.	IETF RFC 5149[11]
3GPP Specific PMIPv6 Error Code	O	Contain 3GPP Specific PMIPv6 Error Code (on S5/S8)	Subclause 12.1.1.1
PDN connection ID	C	Contains the PDN connection ID received in BRI	Subclause 12.1.1.15
NOTE 1: The APN field is not encoded as a dotted string as commonly used in documentation.			

## 5.7.2 MAG procedures

The MAG shall follow the procedure for Revocation Trigger in BRI as "IPv4 HoA only" in "Binding Revocation Responder" sub-section of "Mobile Access Gateway" described in the IETF RFC 5846 [6]. The MAG shall respond with a BRA. BRA message parameters are set as per the details in BRA section of the procedure.

## 5.7.3 LMA procedures

The LMA shall send a BRI to the MAG as described for revoking IPv4 address only in the "Binding Revocation Initiator" sub-section of "Local Mobility Anchor" described in the IETF RFC 5846 [6]. The LMA shall delete the IPv4 Address from corresponding BCE related to the UE's PDN connection after receiving the BRA in reply to the BRI sent from LMA. BRI message parameters are set as per the details in BRI section of the procedure.

## 5.8 Proxy Mobile IPv6 Multiple PDN Extensions

### 5.8.1 General

In EPC a UE can connect or disconnect to multiple distinct PDNs in an independent manner. Thus a distinct PMIPv6 BCE and BULE exist for each of the PDN connections of an UE.

Supporting multiple PDN connections to the same APN function is optional for MAG and LMA. A MAG which supports the multiple PDN connections to the same APN function shall include PDN connection ID in the PBU message at initial attach/handover procedure. If the LMA supports the multiple PDN connections to the same APN function, it shall include the received PDN connection ID in the PBA message. If the LMA does not support the multiple PDN connections to the same APN function, it shall ignore the received PDN connection ID and shall not include the PDN connection ID in the PBA message. If the received PBA message does not contain a PDN connection ID, the MAG shall not send any PBU message for additional PDN connectivity request to the same APN for the same UE.

### 5.8.2 Extensions to PMIPv6 Data Structure

There shall be a unique BCE and BULE for each PDN connection. Each PDN connection can be uniquely identified by MN ID, an APN, and optionally a PDN connection ID in the BCE and BULE.

To support Multiple PDNs the MAG and LMA maintains extended data structure compared to the standard PMIPv6 as defined in IETF RFC 5213 [4]. Since multiple PDN connections of a UE can be distinguished based on an APN, both the BCE on the LMA and the BULE on the MAG need to be extended with the following additional field:

- APN of a UE's PDN connection.

Moreover, to support multiple PDN connections to the same APN function, the MAG and LMA shall maintain extended data structure compared to the PMIPv6 data structure described above. This extension is only applicable if multiple PDN connections to the same APN function is supported by both MAG and LMA.

Since the multiple PDN connections with the same APN of a UE shall be distinguished based on MN ID, an APN, and a PDN connection ID, both the BCE on the LMA and the BULE on the MAG need to be extended with the following additional field:

- PDN connection ID of a UE's PDN connection. The PDN connection ID is provided by the MAG to the LMA at PDN Connection Creation procedure or Handover procedure. For S2a/S2b interface, the MAG generates the PDN connection ID which shall be unique per MN-ID per APN. How the MAG generates the PDN Connection ID for the S2a and S2b reference points is out of scope of 3GPP. For S5/S8 interface, the MAG uses the EPS bearer identity of the default bearer as PDN connection ID.

### 5.8.3 Extensions to PMIPv6 BULE and BCE Lookups

#### 5.8.3.1 General

To support Multiple PDNs the MAG and LMA perform extended lookups on the extended data structure compared to the standard PMIPv6 as defined in IETF RFC 5213 [4].

In standard PMIPv6 as defined in IETF RFC 5213 [4], a PMIPv6 BCE/BULE is looked up based on the Mobile Node Identifier (MN-Id), the access technology types (ATT) and if it exist the MN's link-layer identifier (MN-LL-Id).

In EPC the MN-LL-Id is not used and the EPC support handover between different interfaces for handover between non-3GPP and 3GPP accesses.

Distinct PMIPv6 BCE and BULE exist for each of the PDN connections of an UE.

The feature of having multiple PDN connections to the same APN is only supported if both MAG and LMA support it.

#### 5.8.3.2 Extensions to PMIPv6 BCE Lookups

If the multiple PDN connections to the same APN feature is not supported, all PDN connections of a UE can be distinguished based on an APN and there is a one-to-one mapping between a PMIPv6 BCE, a PDN connection, and the (MN-Id, APN) tuple. An UE PDN connection can be uniquely identified by a (MN-Id, APN) tuple, the BCE is accordingly looked up on a per (MN-Id, APN) tuple basis.

If the multiple PDN connections to the same APN feature is supported, the LMA shall store the received PDN connection ID in the BCE. There is a one-to-one mapping between a PMIPv6 BCE, a PDN connection, and the (MN-Id, APN, PDN connection ID) tuple. Thus, an UE PDN connection can be uniquely identified by a (MN-Id, APN, PDN connection ID) tuple. The BCE is accordingly looked up as follows:

- If a PDN connection ID is received in the request message, the PMIPv6 BCE is looked up based on the (MN-Id, APN, PDN connection ID) tuple. If no existing binding is found based on the (MN-Id, APN, PDN connection ID) tuple, the LMA shall re-perform the PMIPv6 BCE lookup based on a per (MN-Id, APN) tuple.
- If a PDN connection ID is not received in the request message, the PMIPv6 BCE lookup is based on a per (MN-Id, APN) tuple.

#### 5.8.3.3 Extensions to PMIPv6 BULE Lookups

If the multiple PDN connections to the same APN feature is not supported, an UE PDN connection can be uniquely identified by a (MN-Id, APN) tuple. In this case the BULE is accordingly looked up on a per (MN-Id, APN) tuple basis.

If the multiple PDN connections to the same APN feature is supported, the MAG shall generate a PDN connection ID per PDN connection and store it in the BULE. Thus, there is a one-to-one mapping between a PMIPv6 BULE, a PDN connection, and the (MN-Id, APN, PDN connection ID) tuple. An UE PDN connection can be uniquely identified by a per (MN-Id, APN, PDN connection ID) tuple. The BULE is accordingly looked up on a per (MN-Id, APN, PDN connection ID) tuple basis.

## 5.8.4 Extensions to PMIPv6 Procedure

### 5.8.4.1 General

The processing rules on the received PMIPv6 message are specified in IETF RFC 5213 [4] and IETF RFC 5844 [5]. This subclause specifies the additional PMIPv6 procedures.

### 5.8.4.2 MAG procedure

If the PMIPv6 PBU retransmission is triggered, a PMIPv6 PBU message with identical mobility options, except the value of the Timestamp option is new, shall be sent.

### 5.8.4.3 LMA procedure

If before responding to a received PMIPv6 PBU message, a new PMIPv6 PBU message with the same MN-ID, APN (and PDN connection ID) mobility options is received, then the LMA may respond to one or all of the received PMIPv6 PBU messages.

If the LMA receives a PMIPv6 PBU message with HI = 1 from the same MAG and an existing BCE with the same MN-ID, APN (and PDN connection ID) is found, the LMA may refresh the BCE or release the old BCE and create a new one based on the received PBU message.

## 5.9 Serving GW Procedure at Chaining Case

### 5.9.1 General

Chained S2a/S2b with GTP-based S8 is not supported in this release.

Chained S2a/S2b with PMIP-based S8 is used when VPLMN has business relationship with Non-3GPP Networks and Serving GW in VPLMN supporting a LMA function as local non-3GPP Anchor.

### 5.9.2 Signalling procedures

When either of the S2a or S2b interfaces is chained with a PMIP-based S8 interface, the Serving GW acts as the signaling endpoint for each interface. On the S2a or S2b interface, the Serving GW acts as an LMA. On the chained PMIP-based S8 interface, the Serving GW acts as MAG. When a procedure is initiated by its peer on a given interface for a given PDN connection, the Serving GW shall trigger an equivalent procedure over the chained interface for the designated PDN connection. The procedure initiated by its peer cannot be completed before the completion of the equivalent procedure initiated over the chained interface.

#### 5.9.2.1 PMIP-based S8 Serving GW procedures

Upon receiving a PMIPv6 message over S8 for an LMA initiated procedure for a given PDN connection, the Serving GW shall initiate the corresponding LMA procedure over S2a or S2b for the designated PDN connection.

Upon receiving a PMIPv6 message over S2a or S2b for a MAG initiated procedure for a given PDN connection, the Serving GW shall initiate the corresponding MAG procedure over PMIP-based S8 for the designated PDN connection.

Table 5.9.2.1-1: procedure, message and IE mapping at PMIPv6 based S8

Initiated procedure	Messages	Initiating interface	Chained interface	Corresponding procedure Chained interface	Corresponding messages
PDN Connection Creation as specified in subclause 5.1	PBU/PBA	S2a or S2b	PMIPv6 based S8	PDN Connection Creation as specified in subclause 5.1	PBU/PBA
PDN Connection Lifetime Extension as specified in subclause 5.2	PBU/PBA	S2a or S2b	PMIPv6 based S8	PDN Connection Lifetime Extension as specified in subclause 5.2	PBU/PBA
PDN Connection Handover as specified in subclause 5.3	PBU/PBA	S2a or S2b	PMIPv6 based S8	PDN Connection Handover as specified in subclause 5.3	PBU/PBA
MAG Initiated PDN Connection Deletion as specified in subclause 5.4	PBU/PBA	S2a or S2b	PMIPv6 based S8	MAG Initiated PDN Connection Deletion as specified in subclause 5.4	PBU/PBA
LMA Initiated PDN Connection Deletion as specified in subclause 5.5	BRI/BRA	PMIPv6 based S8	S2a or S2b	LMA Initiated PDN Connection Deletion as specified in subclause 5.5	BRI/BRA

### 5.9.3 Payload packets at chained case

When the S2a or S2b interfaces is chained with a PMIP-based S8 interface, both uplink and downlink payload packets are forwarded by the Serving GW between the S2a or S2b PMIPv6 GRE tunnel and the S8 PMIPv6 GRE tunnel for a given PDN connection.

## 5.10 Proxy Mobile IPv6 MAG Initiated IPv4 Address Release procedure

### 5.10.1 General

In the case when UE is assigned both IPv6 HNP and IPv4 Home Address, for DHCPv4 Release procedure, the node acting as MAG initiates the selective de-registration of IPv4 home address procedure to notify the node acting as LMA about release of IPv4 address of UE for a certain PDN connection. MAG notifies LMA by sending a PBU and LMA confirms by replying with a PBA as described in IETF RFC 5844 [5]. IPv4 address release procedure achieves the following:

**IPv4 Home Address release:** The LMA releases an IPv4 Home Address of the UE's PDN connection.

#### 5.10.1.1 Proxy Binding Update

The fields of a PBU message for the PMIPv6 MAG Initiated IPv4 Address Release procedure are depicted in Table 5.10.1.1-1.

The Mobility Options in a PBU message for the PMIPv6 MAG Initiated IPv4 Address Release procedure are depicted in Table 5.10.1.1-2. When the mobility option is present in the message, only the first instance shall be recognised. If multiple instances are included in the message, the receiver ignores all other instances.

Other flags are not used by this specification.

**Table 5.10.1.1-1: Fields of a PBU message for the PMIPv6 MAG Initiated IPv4 Address Release procedure**

Information element	IE Description	Reference
Sequence Number	Set to a locally (i.e. per MAG) monotonically increasing value.	IETF RFC 5213 [4]
Lifetime	Set to "0" to request deletion of the IPv4 binding.	IETF RFC 5844 [5]
Acknowledge (A)	Set to "1" to request an acknowledgement message.	IETF RFC 6275 [8]
Proxy Registration Flag (P)	Set to "1" to indicate that the Binding Update message is a proxy registration.	IETF RFC 5213 [4]
Force UDP encapsulation request (F) Flag	Set to "0" to indicate that UDP encapsulation is not used for the user plane.	IETF RFC 5555 [34]

**Table 5.10.1.1-2: Mobility Options in a PBU message for the PMIPv6 MAG Initiated IPv4 Address Release procedure**

Information element	Cat.	IE Description	Reference
Mobile Node Identifier option	M	Set to the NAI identifier of the UE as specified in 3GPP TS 23.003 [12].	3GPP TS 23.003 [12]
Handoff Indicator option	M	Set to the value "4" to indicate Handoff state unknown.	IETF RFC 5213 [4]
Access Technology Type option	M	Set to the value matching the characteristics of the non-3GPP access on S2a (e.g., HRPD) the UE is using to attach to the EPS as defined in the Access Technology Type Option type values registry of the IANA Mobile IPv6 Parameters Registry [18]. NOTE 1	IETF RFC 5213 [4]
Timestamp option	M	Set to the current time	IETF RFC 5213 [4]
IPv4 Home Address Request option	M	Set the IPv4 Home Address to the IPv4 Home Address to be released of the UE's PDN connection and Prefix-len to the non-zero value received from LMA.	IETF RFC 5844 [5]
Service Selection Mobility Option	M	Set to the EPS Access Point Name to which the UE's PDN connection is attached, formatted as defined in 3GPP TS 23.003 [12]	IETF RFC 5149[11]
NOTE 1: The PDN-GW can be informed about the type of access network used by the UE over several reference points, see 3GPP TS 29.212 [30] for the mapping between the code values for the different access network types.			

### 5.10.1.2 Proxy Binding Acknowledgement

The fields of a PBA message for the PMIPv6 MAG Initiated IPv4 Address Release procedure are depicted in Table 5.10.1.2-1.

The Mobility Options in a PBA message for the PMIPv6 MAG Initiated IPv4 Address Release procedure are depicted in Table 5.10.1.2-2. When the mobility option is present in the message, only the first instance shall be recognised. If multiple instances are included in the message, the receiver ignores all other instances.

Other flags are not used by this specification.

Only the message fields and mobility options used for acceptance cases are present in the following tables.

**Table 5.10.1.2-1: Fields of a PBA message for the PMIPv6 MAG Initiated IPv4 Address Release procedure**

Information element	IE Description	Reference
Status	Set to indicate the result.	IETF RFC 6275 [8]
Proxy Registration Flag (P)	Set to "1" to indicate that the Binding Update message is a proxy registration.	IETF RFC 5213 [4]
Sequence Number	Set to the value received in the corresponding PBU.	IETF RFC 5213 [4]
Lifetime	Set to "0" to request deletion of the IPv4 binding.	IETF RFC 5844 [5]

**Table 5.10.1.2-2: Mobility Options in a PBA message for the PMIPv6 MAG Initiated IPv4 Address Release procedure**

Information element	Cat.	IE Description	Reference
Mobile Node Identifier option	M	Copied from corresponding field of PBU.	IETF RFC 5213 [4]
Handoff Indicator option	M	Copied from corresponding field of PBU.	IETF RFC 5213 [4]
Access Technology Type option	M	Copied from corresponding field of PBU.	IETF RFC 5213 [4]
Timestamp option	M	Copied from corresponding field of PBU, or set to the current time of LMA in case of timestamp error.	IETF RFC 5213 [4]
IPv4 Home Address Reply Option	M	Set the IPv4 Home Address to the released IPv4 Home Address of the UE's PDN connection and Prefix-len to the non-zero value received in BRI.	IETF RFC 5844 [5]
IPv4 Default Router Address Option	M	The LMA sets the value of the UE's IPv4 default router address which belongs to the same subnet as the IPv4 Home Address allocated to the UE.	IETF RFC 5844 [5]
Service Selection Mobility Option	M	Copied from the corresponding field in the PBU message, formatted as defined in 3GPP TS 23.003 [12]	IETF RFC 5149[11]
3GPP Specific PMIPv6 Error Code	O	Contain 3GPP Specific PMIPv6 Error Code (on S5/S8).	Subclause 12.1.1.1

## 5.10.2 MAG procedures

The MAG initiating IPv4 Address Release using DHCPv4 procedure shall follow the "Selective De-Registration" procedure and "DHCP Server co-located with MAG" procedure as described in IPv4 support for PMIPv6 [5] specifications, while parameters in the PBU are set as specified by the PBU parameters section for this procedure.

3. Set the IPv4 home address to be released in the IPv4 home address Request option in the PBU.
4. Set other parameters in the PBU as specified by the PBU parameters section for this procedure.

## 5.10.3 LMA procedures

On reception of a PBU, the LMA shall initiate the "Selective De-Registration" procedures as described in the IPv4 support for PMIPv6 [5] specifications with the following additional requirements:

4. Release the IPv4 Home Address corresponding to the IPv4 home address Request option in the PBU message.
5. Set parameters in the PBA as specified by the PBA parameters section for this procedure.



## 5.11 Proxy Mobile IPv6 LMA Initiated Update Notification procedure

### 5.11.1 General

In EPC the PMIPv6 LMA Initiated Update Notification procedure is initiated by the node acting as a LMA to notify the node acting as a MAG, that the Binding Cache Entry related to the UE is about to be updated, so the MAG updates the resources related to that PDN connection. The procedure starts with the LMA sending a PMIPv6 UPN message to the MAG. The MAG confirms by sending a PMIPv6 UPA message to the LMA. This PMIPv6 LMA Initiated Update Notification procedure is based on the PMIPv6 notification procedure as specified in the IETF draft-krishnan-netext-update-notifications-00 [35].

#### 5.11.1.1 Update Notification

The fields of a UPN message for the PMIPv6 LMA Initiated Update Notification procedure are depicted in Table 5.11.1.1-1.

The Mobility Options in a UPN message for the PMIPv6 LMA Initiated Update Notification procedure are depicted in Table 5.11.1.1-2. When the mobility option is present in the message, only the first instance shall be recognised. If multiple instances are included in the message, the receiver shall ignore all other instances.

Other flags are not used by this specification.

**Table 5.11.1.1-1: Fields of a UPN message for the PMIPv6 LMA Initiate Update Notification procedure**

Information element	Description	Reference
Sequence Number	Set to a locally (i.e. per LMA) monotonically increasing value.	IETF RFC 5213 [4]
Notification Reason	Set to the corresponding notification reason	IETF draft-ietf-netext-update-notifications-00 [35]
Acknowledge (A)	Set to "1" to request an acknowledgement message.	IETF draft-ietf-netext-update-notifications-00 [35]

**Table 5.11.1.1-2: Mobility Options in a UPN message for the PMIPv6 LMA Initiated Update Notification procedure**

Information element	Cat.	IE Description	Reference
Mobile Node Identifier option	M	Set to the NAI identifier of the UE as specified in 3GPP TS 23.003 [12].	3GPP TS 23.003 [12]
Service Selection Mobility Option	O	Set to the EPS Access Point Name to which the UE's PDN connection is attached.	IETF RFC 5149 [11]
PDN connection ID	O	Contains the PDN connection ID if the BCE contains the PDN Connection ID.	Subclause 12.1.1.15
MME/SGSN Identifier	O	Contains the MME/S4-SGSN identifier	Subclause 12.1.1.20
Protocol Configuration Option	O	Contains Protocol Configuration Options.	Subclause 12.1.1.0

#### 5.11.1.2 Update Notification Acknowledgement

The fields of a UPA message for the PMIPv6 LMA Initiated Update procedure are depicted in Table 5.11.1.2-1.

The Mobility Options in a UPA message for the PMIPv6 LMA Initiated Update procedure are depicted in Table 5.11.1.2-2. When the mobility option is present in the message, only the first instance shall be recognised. If multiple instances are included in the message, the receiver shall ignore all other instances.

Other flags are not used by this specification.

Only the message fields and mobility options used for acceptance cases are present in the following tables.

**Table 5.11.1.2-1: Fields of a UPA message for the PMIPv6 LMA Initiated Update Notification procedure**

Information element	Description	Reference
Sequence Number	Set to the value received in the corresponding UPN.	IETF RFC 5846[6]
Status	Indicates the result of the UPN	IETF draft-ietf-netext-update-notifications-00 [35]

**Table 5.11.1.2-2: Mobility Options in a UPA message for the PMIPv6 LMA Initiated Update Notification procedure**

Information element	Cat.	IE Description	Reference
Mobile Node Identifier option	M	Copied from the corresponding field in the UPN.	3GPP TS 23.003 [12]
Service Selection Mobility Option	O	Copied from the corresponding field in the UPN message.	IETF RFC 5149 [11]
PDN connection ID	C	Contains the PDN connection ID received in UPN	Subclause 12.1.1.15
3GPP Specific PMIPv6 Error Code	O	Contains a 3GPP Specific PMIPv6 Error Code.	Subclause 12.1.1.1

## 5.11.2 LMA procedures

A LMA initiating the PMIPv6 LMA Initiated Update Notification procedure shall follow the procedure described in IETF draft-ietf-netext-update-notifications-00 [35], while parameters in the UPN message are set as specified by the UPN message parameters section for this procedure.

## 5.11.3 MAG procedures

On reception of a UPN, the MAG shall follow the procedure described in IETF draft-ietf-netext-update-notifications-00 [35], while parameters in the UPA message are set as specified by the UPA message parameters section for this procedure.

---

## 6 Tunnel Management procedures

### 6.1 General

The Mobile Anchor Gateway (MAG) and the Local Mobility Anchor (LMA) establish and maintain a bi-directional tunnel for each PDN connection, which is used for routing the UE's PDN connection user-plane traffic between the MAG and the LMA. This tunnel is based on GRE encapsulation as specified in IETF RFC 2890 [21] (see also IETF RFC 2784 [20]) and is established as a result of exchanging the Proxy Binding Update (PBU) and the Proxy Binding Acknowledgment (PBA) messages between the MAG and LMA. The PBU and PBA messages establish unique Binding Cache Entry (BCE) and Binding Update List Entry (BULE) entries for each PDN connection at the LMA and the MAG respectively. The tunnel end points are the Proxy-CoA and LMAA with GRE encapsulation (for IPv6 transport network) or IPv4-Proxy-CoA and IPv4-LMAA with GRE encapsulation (for IPv4 transport network), as described in IETF RFC 5845 [7]. GRE encapsulation shall always be used; the GRE tunneling negotiation described in IETF RFC 5845 [7] is not applicable and the GRE Key Identifier Option shall always be present in the PBU messages for PMIPv6 PDN Connection Creation and binding registration after handover.

Tear down of GRE tunnels and cleanup of state is done explicitly by MAG Initiated PDN Connection Deletion or LMA Initiated PDN Connection Deletion; additionally, the tunnel is torn down when the binding lifetime expires as described in IETF RFC 5213 [4].

A PMIPv6 node (MAG or LMA), which uses the control plane A protocol stack (see subclause 4.2) shall send signalling messages specified in Section 5 with IPv4-UDP encapsulation in IPv4 transport network as specified in IETF RFC 5844 [5].

A PMIPv6 node (MAG or LMA), which uses the control plane B protocol stack (see subclause 4.2) shall send signalling messages specified in Section 5 natively, without encapsulation in IPv6 transport network as specified in IETF RFC 5213 [4].

The maximum size of an inner IP packet that may be transmitted without fragmentation by the PDN GW or the MS/UE is the same as the maximum N-PDU size that can be transmitted without IP fragmentation as defined in 3GPP TS 23.060 [23].

Recommendations on how to set the default inner MTU size at the PDN GW and UE/MS to avoid IP fragmentation of both inner IP packets (in the PDN GW or UE/MS) and outer IP packets in the backbone are specified in clause 9.3 of 3GPP TS 23.060 [23].

To avoid network overload due to excessive signalling, when sending a PBU message, the requested binding lifetime should be sufficiently large, e.g. greater than 300 seconds. After accepting a PBU request, the binding lifetime may be reset to another value by the LMA based on local configuration.

### 6.2 MAG procedure

When the PDN connectivity is established, the downlink GRE key for the PDN connection downlink traffic is selected by the MAG and sent to LMA in PBU message. This downlink GRE key shall be unique within the MAG for a given LMAA or IPv4-LMAA.

The uplink GRE key is received from LMA in a PBA message, and also from the MME in case Serving GW relocation occurs. The MAG shall be able to send the PDN connection uplink traffic using the received uplink GRE key towards the LMAA or IPv4-LMAA before sending the PBU or before receiving the PBA.

When the PDN connection is released, the downlink GRE key shall be released by the MAG.

### 6.3 LMA procedure

When the PDN connectivity is established, the uplink GRE key for the PDN connection uplink traffic is selected by the LMA and sent to MAG in PBA message. This uplink GRE key shall be unique within the LMA.

The LMA function shall be able to accept the PDN connection uplink packets from any MAG without enforcing that the source IP address of the outer IP header matches the Proxy-CoA in the UE BCE.

If GTP based S5/S8 is used for E-UTRAN access and PMIP based S2a is used for HRPD access, and optimized handover between E-UTRAN and HRPD is supported, when the PGW allocates an uplink TEID for a default bearer of a GTP tunnel, it shall also reserve an uplink GRE key with the same value of the default bearer uplink TEID.

When the PDN connection is released, the uplink GRE key shall be released by the LMA.

## 6.4 Data Structures

### 6.4.1 Binding Update List Entry

MAG maintains a unique Binding Update List Entry for for each PDN connection of a UE. The required elements of BULE as per 3GPP requirements are described in table 6.4.1-1.

**Table 6.4.1-1: Elements of BULE**

Element	Description	Reference
Mobile Node Identifier	Set to the UE NAI that is derived from the UE IMSI if an authenticated IMSI is available, or from the UE IMEI if IMSI is not available or the IMSI is not authenticated by the network. The NAI format is specified in 3GPP TS 23.003 [12].	3GPP TS 23.003 [12], IETF RFC 5213 [4]
Access Point Name	Set to the EPS Access Point Name to which the UE's PDN connection is attached, formatted as defined in 3GPP TS 23.003 [12]	3GPP TS 23.003 [12]
Lifetime	Set to lifetime granted for the binding as received in PBA.	IETF RFC 6275 [8]
Remaining Lifetime	This lifetime is initialized from the lifetime granted for the binding and is decremented until it reaches 0.	IETF RFC 6275 [8]
Sequence Number	The sequence number of the last Proxy Binding Update message sent.	IETF RFC 6275 [8]
Timestamp	Time at which last PBU was sent.	IETF RFC 6275 [8]
Binding Flag	Set to 1 if MAG receives an ICMPv6 parameter problem, code 1, error message in response to a PBU. Set to 0 if MAG continues to send PBU.	IETF RFC 6275 [8]
IPv6 Home Network Prefix	IPv6 Home Network Prefix assigned to the UE's PDN connection.	IETF RFC 5213 [4]
Link-local Address	IPv6 Link-local address to be used by the MAG on the access link shared with the UE.	IETF RFC 5213 [4]
IPv4 Home Address	IPv4 Home Address assigned to UE's PDN connection.	IETF RFC 5213 [4]
IPv4 default-router address	The IPv4 default-router address of the mobile node.	IETF RFC 5844 [5]
LMA IPv6 Address	IPv6 Address of the LMA.	IETF RFC 6275 [8]
LMA IPv4 Address	IPv4 Address of the LMA.	IETF RFC 5844 [5]
Downlink GRE Key	Downlink GRE key for the PDN connection as selected by MAG.	IETF RFC 5845 [7]
Uplink GRE key	Uplink GRE key for the PDN connection selected by LMA as received in GRE Key option of PBA.	IETF RFC 5845 [7]
Chained Binding Cache Entry	Reference to the corresponding BCE used for the binding on the S8 interface. It shall be present only in the Serving GW, in case of S2a/S2b - PMIP based-S8 chaining.	
PDN Connection ID	Set to the PDN Connection ID if multiple PDN connections to the same APN is supported by both MAG and LMA	Subclause 12.1.1.15

### 6.4.2 Binding Cache Entry

LMA maintains a unique Binding Cache Entry for each PDN connection for a UE. The required elements of BCE as per 3GPP requirements are described in table 6.4.1-2.

**Table 6.4.2-1: Elements of BCE**

<b>Element</b>	<b>Element Description</b>	<b>Reference</b>
Mobile Node Identifier	The MN-Id mobility option as received in PBU.	3GPP TS 23.003 [12], IETF RFC 5213 [4]
Access Point Name	The Service Selection Mobility option received in PBU	3GPP TS 23.003 [12]
Lifetime	Lifetime granted for the binding.	IETF RFC 6275 [8]
Sequence Number	Sequence number of last received PBU.	IETF RFC 6275 [8]
IPv6 Home Network Prefix	IPv6 Home Network Prefix assigned to the UE's PDN connection.	IETF RFC 5213 [4]
Link-local Address	The assigned IPv6 link local address to MAG for use on the access link shared with the UE.	IETF RFC 5213 [4]
IPv4 Home Address	IPv4 Home Address assigned to UE's PDN connection.	IETF RFC 5213 [4]
IPv4 default-router address	The IPv4 default-router address of the mobile node.	IETF RFC 5844 [5]
IPv6 Proxy care-of-address	MAG IPv6 Address, i.e. the source address of the IP packet in which PBU was received.	IETF RFC 6275 [8]
IPv4 Proxy care-of-address	MAG IPv4 Address.	IETF RFC 5844 [5]
Access Technology Type	Access Technology Type as received in PBU.	IETF RFC 5213 [4]
Timestamp	Timestamp as received in PBU.	
Binding Flag	'1' as it is proxy registration.	IETF RFC 5213 [4]
Downlink GRE key	Downlink GRE key for the PDN connection selected by MAG as received in GRE key option of PBU.	IETF RFC 5845 [7]
Uplink GRE key	Uplink GRE key for the PDN connection selected by LMA.	IETF RFC 5845 [7]
Chained Binding Update List Entry	Reference to the corresponding BULE used for binding on the S2a / S2b interface. It shall be present only in the Serving GW, in case of S2a/S2b – PMIP-based S8 chaining.	
PDN Connection ID	Set to the PDN Connection ID if multiple PDN connections to the same APN is supported by both MAG and LMA	Subclause 12.1.1.15

## 6.5 Security

Security aspects for PMIPv6 are described in 3GPP TS 33.402 [19].

## 7 Path Management procedures

### 7.1 General

The path management for PMIPv6 is very similar to that of GTP; the main difference is the use of PMIPv6 messages instead of GTP messages.

Path failure handling procedures are specified in 3GPP TS 23.007 [13].

### 7.2 Heartbeat Mechanism

#### 7.2.1 General

A LMA or MAG shall support sending Heartbeat Message to a peer MAG or LMA for Failure Detection and Restart Detection. The Heartbeat Message and procedures of Failure Detection and Restart Detection are defined in IETF RFC 5847 [17]. When and how often a Heartbeat Request message are sent is implementation specific but a periodic Heartbeat Request shall not be sent more often than every 60 s on each path.

#### 7.2.2 Heartbeat Message

##### 7.2.2.1 Heartbeat Request

Table 7.2.2.1-1 specifies the information elements included in the Heartbeat Request message.

**Table 7.2.2.1-1: Fields of a Heartbeat message for the Heartbeat request**

Information element	IE Description	Reference
R flag	Set to 0 for a request message.	IETF RFC 5847 [17]
Sequence Number	Set to a locally monotonically increasing value.	IETF RFC 5847 [17]

##### 7.2.2.2 Heartbeat Response

Table 7.2.2.2-1 and 7.2.2.2-2 specifies the information elements included in the Heartbeat Response message.

**Table 7.2.2.2-1: Fields of a Heartbeat message for the Heartbeat Response**

Information element	IE Description	Reference
R flag	Set to 1 for a response message.	IETF RFC 5847 [17]
U flag	Set to 0 if the heartbeat response is sent as an answer to a heartbeat request. Set to 1 otherwise.	IETF RFC 5847 [17]
Sequence Number	Set to the value received in the corresponding Heartbeat Request message.	IETF RFC 5847 [17]

**Table 7.2.2.2-2: Mobility Options in a Heartbeat message for the Heartbeat Response**

Information element	IE Description	Reference
Restart Counter	indicates the current Restart Counter value	IETF RFC 5847 [17]

## 7.3 Void

## 7.4 Void

## 7.5 Void

## 7.6 UE-specific Error Handling

### 7.6.1 General

A PMIPv6 node (i.e., LMA or MAG) may support the UE-specific error indication such that a PMIPv6 node may send a message to the source PMIPv6 node when no binding exists for a packet received from a GRE tunnel.

### 7.6.2 MAG and LMA procedure

If a PMIPv6 receiving node (i.e. MAG or LMA) verifies that no PMIPv6 binding exists for a received user packet based on GRE Key, the receiving PMIPv6 node shall discard the packet. The PMIPv6 node may report the error to the peer PMIPv6 node, in the form of an ICMP message, as specified in Sections 8.1, 8.2 and 8.3 of IETF RFC2473 [31] for the node unreachable error case.

Handling of the received error in the form of an ICMP message is specified in 3GPP TS 23.007 [13].

## 7.7 Void

## 7.8 Partial node failure requiring the removal of a subset of sessions

### 7.8.1 General

See 3GPP TS 23.007 [13] for the description of this function.

### 7.8.2 Binding Revocation Indication message

The fields of a BRI message to revoke bulk PMIPv6 bindings initiated by the LMA or the MAG are depicted in Table 7.8.2-1.

The Mobility Options in a BRI message to revoke bulk PMIPv6 bindings sent by the LMA or the MAG are depicted in Table 7.8.2-2.

**Table 7.8.2-1: Fields of a BRI message for the PMIPv6**

Information element	IE Description	Reference
Revocation Trigger	Set to a the value of "Revoking Mobility Node Local Policy"	IETF RFC 5846 [6]
Sequence Number	A sequence number generated by the LMA, and increased for every BRI sent.	IETF RFC 5846 [6]
Proxy Binding Flag (P)	Set to "1" to indicate that the Binding Revocation Indication is for a proxy MIPv6 binding entry.	RFC 5213 [4]
IPv4 HoA Binding Only (V)	Set to "0" to request for complete binding revocation	IETF RFC 5846 [6]
Global Per-Peer Bindings (G)	Set to 1	IETF RFC 5846 [6]

**Table 7.8.2-2: Mobility Options in a BRI message for the PMIPv6 LMA or MAG Initiated bulk PDN Connections Deletion for Partial Node failure**

Information element	Cat.	IE Description	Reference
Mobile Node Identifier	C	Set to the IP address of the MAG, only when the BRI message is sent by the MAG.	3GPP TS 23.402[3]
Fully Qualified PDN Connection Set Identifier	M	This IE shall be included by the MAG or LMA on the S5/S8, S2a (for Trusted WLAN Access) and S2b interfaces (see 3GPP TS 23.007 [13]) and contains the Fully Qualified PDN Connection Set Identifier(s) that need to be revoked.	Subclause 12.1.1.2

### 7.8.3 Binding Revocation Acknowledgement message

The fields of a BRA message to revoke bulk PMIPv6 bindings for the PMIPv6 LMA or MAG Initiated PDN Connection Deletion procedure are depicted in Table 7.8.3-1.

**Table 7.8.3-1: Fields of a BRA message for a PMIPv6 for a MAG or LMA Initiated bulk PDN Connections Deletion for Partial Node failure**

Information element	IE Description	Reference
Status	Indicates the result of the BRI.	IETF RFC 5846 [6]
Sequence Number	Set to the value received in the corresponding BRI.	IETF RFC 5846 [6]
Proxy Registration Flag (P)	Set to "1" to indicate that the Binding Revocation Acknowledgment is for a proxy MIPv6 binding entry.	RFC 5213 [4]
IPv4 HoA Binding Only (V)	Set to "0"; the same value as for BRI	IETF RFC 5846 [6]
Global Per-Peer Bindings (G)	Set to 1; the same value as for the BRI.	IETF RFC 5846 [6]

### 7.8.4 MAG procedures

The MAG can be the initiator or the receiver of a BRI message to revoke bulk PMIPv6 bindings.

The MAG shall follow the "Local Mobility Anchor Revokes Bulk PMIPv6 Bindings" procedure described in the IETF RFC 5846 [6] when it receives a Binding Revocation Indication message with G bit set, removing the sessions identified by the Fully Qualified PDN Connection Set Identifier Mobility Option.

The MAG shall follow the "Mobile Access Gateway Revoke Bulk PMIPv6 Bindings" when it sends a Binding Revocation Indication message with G bit set to the LMA, including the Fully Qualified PDN Connection Set Identifier Mobility Option.

### 7.8.5 LMA procedures

The LMA can be the initiator or the receiver of a BRI message to revoke bulk PMIPv6 bindings.

The LMA shall follow the "Mobile Access Gateway Revokes Bulk PMIPv6 Bindings" procedure described in the IETF RFC 5846 [6] when it receives a Binding Revocation Indication message with G bit set, removing the sessions identified by the Fully Qualified PDN Connection Set Identifier Mobility Option.

The LMA shall follow the "Local Mobility Anchor Revoke Bulk PMIPv6 Bindings" when it sends a Binding Revocation Indication message with G bit set to the LMA, including the Fully Qualified PDN Connection Set Identifier Mobility Option.



---

## 8 PMIP-based S5 and PMIP-based S8 description

### 8.1 Initial Attach procedures

#### 8.1.1 General

#### 8.1.2 Serving GW procedures

The Serving GW shall follow the MAG procedure for the PMIPv6 PDN Connection Creation as outlined in subclause 5.1.2.

#### 8.1.3 PDN GW procedures

The PDN GW shall follow the LMA procedure for the PMIPv6 PDN Connection Creation as outlined in subclause 5.1.3

### 8.2 Serving GW Initiated PDN Connection Lifetime Extension procedures

#### 8.2.1 General

#### 8.2.2 Serving GW procedures

The Serving GW shall follow the MAG procedure for the PMIPv6 PDN Connection Lifetime Extension as outlined in subclause 5.2.2.

#### 8.2.3 PDN GW procedures

The PDN GW shall follow the LMA procedure for the PMIPv6 PDN Connection Lifetime Extension as outlined in subclause 5.2.3.

### 8.3 UE, MME or HSS initiated Detach procedures

#### 8.3.1 General

#### 8.3.2 Serving GW procedures

The Serving GW shall follow the MAG procedure for the PMIPv6 MAG Initiated PDN Connection Deletion as outlined in subclause 5.4.2 repeated for each PDN connection of the UE.

#### 8.3.3 PDN GW procedures

The PDN GW shall follow the LMA procedure for the PMIPv6 MAG Initiated PDN Connection Deletion as outlined in subclause 5.4.3.

## 8.4 PDN GW Initiated PDN Disconnection procedures

### 8.4.1 General

### 8.4.2 Serving GW procedures

The Serving GW shall follow the MAG procedure for the PMIPv6 LMA Initiated PDN Connection Deletion as outlined in subclause 5.5.2.

### 8.4.3 PDN GW procedures

The PDN GW shall follow the LMA procedure for the PMIPv6 LMA Initiated PDN Connection Deletion for the selected PDN connection as outlined in subclause 5.5.3.

## 8.5 UE Requested Additional PDN Connectivity procedures

### 8.5.1 General

### 8.5.2 Serving GW procedures

If the Request Type indicates "initial attach", the Serving GW shall follow the MAG procedure for the PMIPv6 PDN Connection Creation as outlined in subclause 5.1.2.

If the Request Type indicates "Handover", the Serving GW shall follow the MAG procedure for the PMIPv6 PDN Connection Handover as outlined in subclause 5.3.2.

### 8.5.3 PDN GW procedures

If the Request Type indicates "initial attach", the PDN GW shall follow the LMA procedure for the PMIPv6 PDN Connection Creation as outlined in subclause 5.1.3.

If the Request Type indicates "Handover", the PDN GW shall follow the LMA procedure for the PMIPv6 PDN Connection Handover as outlined in subclause 5.3.3.

## 8.6 Handover procedures

### 8.6.1 Intra-LTE TAU and Inter-eNodeB Handover with Serving GW Relocation procedures

#### 8.6.1.1 General

#### 8.6.1.2 Serving GW procedures

The Serving GW shall follow the MAG procedure for the PMIPv6 PDN Connection Handover as outlined in subclause 5.3.2 repeated for each PDN connection of the UE.

#### 8.6.1.3 PDN GW procedures

The PDN GW shall follow the LMA procedure for the PMIPv6 PDN Connection Handover as outlined in subclause 5.3.3.

## 8.6.2 TAU/RAU or Handover between GERAN A/Gb Mode or UTRAN Iu Mode and E-UTRAN procedures

### 8.6.2.1 General

### 8.6.2.2 Serving GW procedures

The Serving GW shall follow the MAG procedure for the PMIPv6 PDN Connection Handover as outlined in subclause 5.3.2 repeated for each PDN connection of the UE.

### 8.6.2.3 PDN GW procedures

The PDN GW shall follow the LMA procedure for the PMIPv6 PDN Connection Handover as outlined in subclause 5.3.3.

## 8.6.3 Handover from Trusted or Untrusted Non-3GPP IP Access over S2a/S2b to 3GPP Access Handover E-UTRAN over PMIP based S5/S8 without optimization procedures

### 8.6.3.1 General

### 8.6.3.2 Serving GW procedures

The Serving GW shall follow the MAG procedure for the PMIPv6 PDN Connection Handover as outlined in subclause 5.3.2 repeated for each PDN connection of the UE.

### 8.6.3.3 PDN GW procedures

The PDN GW shall follow the LMA procedure for the PMIPv6 PDN Connection Handover as outlined in subclause 5.3.3.

## 8.6.4 Handover from Trusted or Untrusted Non-3GPP IP Access over S2a/S2b to 3GPP Access UTRAN/GERAN over PMIP based S5/S8 without optimization

### 8.6.4.1 General

### 8.6.4.2 Serving GW procedures

The Serving GW shall follow the MAG procedure for the PMIPv6 PDN Connection Handover as outlined in subclause 5.3.2 repeated for each PDN connection of the UE.

### 8.6.4.3 PDN GW procedures

The PDN GW shall follow the LMA procedure for the PMIPv6 PDN Connection Handover as outlined in subclause 5.3.3.

## 8.6.5 Handover from Trusted or Untrusted Non-3GPP IP Access over S2c to 3GPP Access over PMIP based S5/S8 without optimization

### 8.6.5.1 General

### 8.6.5.2 Serving GW procedures

The Serving GW shall follow the MAG procedure for the PMIPv6 PDN Connection Handover as outlined in subclause 5.3.2 repeated for each PDN connection of the UE.

### 8.6.5.3 PDN GW procedures

The PDN GW shall follow the LMA procedure for the PMIPv6 PDN Connection Handover as outlined in subclause 5.3.3.

## 8.6.6 Optimised Active Handover: cdma2000 eHRPD Access to EUTRAN

### 8.6.6.1 General

### 8.6.6.2 Serving GW procedures

The Serving GW shall follow the MAG procedure for the PMIPv6 PDN Connection Handover as outlined in subclause 5.3.2 repeated for each PDN connection of the UE.

### 8.6.6.3 PDN GW procedures

The PDN GW shall follow the LMA procedure for the PMIPv6 PDN Connection Handover as outlined in subclause 5.3.3.

## 8.6.7 Optimized Idle Mode Mobility: cdma2000 eHRPD Access to E-UTRAN Access

### 8.6.7.1 General

### 8.6.7.2 Serving GW procedures

The Serving GW shall follow the MAG procedure for the PMIPv6 PDN Connection Handover as outlined in subclause 5.3.2 repeated for each PDN connection of the UE.

### 8.6.7.3 PDN GW procedures

The PDN GW shall follow the LMA procedure for the PMIPv6 PDN Connection Handover as outlined in subclause 5.3.3..

## 8.7 UE Requested PDN Disconnection procedures

### 8.7.1 General

### 8.7.2 Serving GW procedures

The Serving GW shall follow the MAG procedure for the PMIPv6 MAG Initiated PDN Connection Deletion, for the selected PDN connection as outlined in subclause 5.4.2.

### 8.7.3 PDN GW procedures

The PDN GW shall follow the LMA procedure for the PMIPv6 MAG Initiated PDN Connection Deletion, for the selected PDN connection as outlined in subclause 5.4.3.

## 8.8 IPv4 Address Allocation using DHCP

### 8.8.1 General

### 8.8.2 Serving GW procedures

The Serving GW shall follow the MAG procedure for the Proxy Mobile IPv6 PDN Connection IPv4 Address Allocation Procedure as defined in sub clause 5.6.2.

### 8.8.3 PDN GW procedures

The PDN GW shall follow the LMA procedure for the Proxy Mobile IPv6 PDN Connection IPv4 Address Allocation Procedure as defined in sub clause 5.6.3.

## 8.9 PDN-GW Initiated IPv4 Address Delete Procedure

### 8.9.1 General

### 8.9.2 Serving GW procedures

If UE is assigned both IPv6 HNP and IPv4 HoA, the Serving GW shall follow the MAG procedure for the LMA Initiated IPv4 Address Release procedure as defined in sub clause 5.7.2.

### 8.9.3 PDN GW procedures

If UE is assigned both IPv6 HNP and IPv4 HoA, the PDN GW shall follow the LMA procedure for the LMA Initiated IPv4 Address Release procedure as defined in sub clause 5.7.3.

If UE is assigned only IPv4 HoA, then PDN-GW initiated PDN Disconnection procedure is initiated.

---

## 9 Trusted Non-3GPP Access over S2a Description

### 9.0 General

Please refer to clause 13 for the description of the Trusted WLAN Access over S2a interface.

### 9.1 Initial Attach procedures

#### 9.1.1 General

#### 9.1.2 Trusted Non-3GPP Access procedures

In PMIPv6 mode, the Trusted Non-3GPP Access shall follow the MAG procedure for the PMIPv6 PDN Connection Creation as outlined in subclause 5.1.2.

### 9.1.3 PDN GW procedures

In PMIPv6 mode, the PDN GW shall follow the MAG procedure for the PMIPv6 PDN Connection Creation as outlined in subclause 5.1.3.

## 9.2 Trusted Non-3GPP Access Initiated PDN Connection Lifetime Extension procedures

### 9.2.1 General

### 9.2.2 Trusted Non-3GPP Access procedures

In PMIPv6 mode, the Trusted Non-3GPP Access shall follow the MAG procedure for the PMIPv6 PDN Connection Lifetime Extension as outlined in subclause 5.2.2.

### 9.2.3 PDN GW procedures

In PMIPv6 mode, the PDN GW shall follow the LMA procedure for the PMIPv6 PDN Connection Lifetime Extension as outlined in subclause 5.2.3.

## 9.3 UE / Trusted Non-3GPP Access Initiated Detach and UE Requested PDN Disconnection procedures

### 9.3.1 General

### 9.3.2 Trusted Non-3GPP Access procedures

In PMIPv6 mode, the Trusted Non-3GPP Access shall follow the MAG procedure for the PMIPv6 MAG Initiated PDN Connection Deletion as outlined in subclause 5.4.2 for PDN Disconnection procedure,.

For Detach the Trusted Non-3GPP Access shall follow the above repeated for each PDN connection of the UE.

### 9.3.3 PDN GW procedures

In PMIPv6 mode, the PDN GW shall follow the LMA procedure for the PMIPv6 MAG Initiated PDN Connection Deletion as outlined in subclause 5.4.3.

## 9.4 HSS / AAA Initiated Detach procedures

### 9.4.1 General

The HSS/AAA may initiate a detach procedure resulting in a PMIPv6 De-Registration.

### 9.4.2 Trusted Non-3GPP Access procedures

In PMIPv6 mode, the Trusted Non-3GPP Access shall follow the MAG procedure for the PMIPv6 MAG Initiated PDN Connection Deletion as outlined in subclause 5.4.2 repeated for each PDN connection of the UE.

### 9.4.3 PDN GW procedures

In PMIPv6 mode, the PDN GW shall follow the LMA procedure for the PMIPv6 MAG Initiated PDN Connection Deletion as outlined in subclause 5.4.3.

## 9.5 UE Initiated Connectivity to Additional PDN procedures

### 9.5.1 General

### 9.5.2 Trusted Non-3GPP Access procedures

In PMIPv6 mode, if the Request Type indicates "initial attach", the Trusted Non-3GPP Access shall follow the MAG procedure for the PMIPv6 PDN Connection Creation as outlined in subclause 5.1.2. If the Request Type indicates "Handover", the Trusted Non-3GPP Access shall follow the MAG procedure for the PMIPv6 PDN Connection Handover as outlined in subclause 5.3.2.

### 9.5.3 PDN GW procedures

In PMIPv6 mode, if the Request Type indicates "initial attach", the PDN GW shall follow the LMA procedure for the PMIPv6 PDN Connection Creation as outlined in subclause 5.1.3. If the Request Type indicates "Handover", the PDN GW shall follow the LMA procedure for the PMIPv6 PDN Connection Handover as outlined in subclause 5.3.3.

## 9.6 3GPP Access to Trusted Non-3GPP IP Access with PMIPv6 on S2a Handover procedures without optimization

### 9.6.1 General

### 9.6.2 Trusted Non-3GPP Access procedures

In PMIPv6 mode, the Trusted Non-3GPP Access shall follow the MAG procedure for the PMIPv6 PDN Connection Handover as outlined in subclause 5.3.2.

### 9.6.3 PDN GW procedures

In PMIPv6 mode, the PDN GW shall follow the LMA procedure for the PMIPv6 PDN Connection Handover as outlined in subclause 5.3.3.

If IPv6 network prefix preservation is supported at a handover from 3GPP Access with a GTP-based S5/S8 to non-3GPP Access, the LMA shall provide to the MAG the link-local address which is used by the PDN GW at the link shared with the UE in the 3GPP Access.

## 9.7 PDN GW Initiated Resource Allocation Deactivation procedures

### 9.7.1 General

### 9.7.2 Trusted Non-3GPP Access procedures

In PMIPv6 mode, the Trusted Non-3GPP Access shall follow the MAG procedure for the PMIPv6 LMA Initiated PDN Connection Deletion as outlined in subclause 5.5.2.

### 9.7.3 PDN GW procedures

In PMIPv6 mode, the PDN GW shall follow the LMA procedure for the PMIPv6 LMA Initiated PDN Connection Deletion as outlined in subclause 5.5.3.

## 9.8 IPv4 Address Allocation using DHCP

### 9.8.1 General

### 9.8.2 Trusted Non-3GPP Access procedures

The Trusted Non-3GPP Access shall follow the MAG procedure for the Proxy Mobile IPv6 PDN Connection IPv4 Address Allocation Procedure as defined in sub clause 5.6.2.

### 9.8.3 PDN GW procedures

The PDN GW shall follow the LMA procedure for the Proxy Mobile IPv6 PDN Connection IPv4 Address Allocation Procedure as defined in sub clause 5.6.3.

## 9.9 PDN-GW Initiated IPv4 Address Delete Procedure

### 9.9.1 General

### 9.9.2 Trusted Non-3GPP Access procedures

If UE is assigned both IPv6 HNP and IPv4 HoA, the Trusted Non-3GPP Access shall follow the MAG procedure for the LMA Initiated IPv4 Address Release procedure as defined in sub clause 5.7.2.

### 9.9.3 PDN GW procedures

If UE is assigned both IPv6 HNP and IPv4 HoA, the PDN GW shall follow the LMA procedure for the LMA Initiated IPv4 Address Release procedure as defined in sub clause 5.7.3.

If UE is assigned only IPv4 HoA, then PDN-GW initiated Resource Allocation Deactivation procedure is initiated.

## 9.10 Optimized E-UTRAN to CDMA2000 eHRPD Handover procedure

### 9.10.1 General

### 9.10.2 CDMA2000 HRPD access procedure

In PMIPv6 mode, the CDMA2000 HRPD access shall follow the MAG procedure for the PMIPv6 PDN Connection Handover procedure as outlined in subclause 5.3.2.

### 9.10.3 PDN GW procedures

In PMIPv6 mode, the PDN GW shall follow the LMA procedure for the PMIPv6 PDN Connection Handover procedure as outlined in subclause 5.3.3.



## 9.11 Optimized Idle Mode Mobility: E-UTRAN Access to cdma2000 eHRPD Access procedure

### 9.11.1 General

### 9.11.2 CDMA2000 eHRPD access procedure

In PMIPv6 mode, the CDMA2000 eHRPD access shall follow the MAG procedure for the PMIPv6 PDN Connection Handover procedure as outlined in subclause 5.3.2.

### 9.11.3 PDN GW procedures

In PMIPv6 mode, the PDN GW shall follow the LMA procedure for the PMIPv6 PDN Connection Handover procedure as outlined in subclause 5.3.3.

---

# 10 Untrusted Non-3GPP Access over S2b Description

## 10.1 Initial Attach procedures

### 10.1.1 General

If multiple authentications are supported by the network both ePDG and PDN GW shall support the corresponding procedures as specified for PAP and CHAP authentication of the UE with external networks in 3GPP TS 33.402 [19]. Multiple authentication is per PDN connection when the UE requested additional PDN connectivity as specified in subclause 10.5.

### 10.1.2 ePDG procedures

In PMIPv6 mode, the ePDG shall follow the MAG procedure for the PMIPv6 PDN Connection Creation as outlined in subclause 5.1.2.

If ePDG supports multiple authentication exchanges with the UE in the IKEv2 protocol, the ePDG shall send the PAP or CHAP additional authentication and authorization information received from the UE in the Additional Protocol Configuration Options IE in the PBU to the PDN-GW as specified 3GPP TS 33.402 [19]. The ePDG shall follow the multiple authentication procedures when receiving PAP or CHAP additional authentication and authorization information in the Additional Protocol Configuration Options IE in the PBA from the PDN-GW and sending the information to the UE as specified in 3GPP TS 33.402 [19].

If the UE requests the DNS IPv4/IPv6 address in the Configuration Payload (CFG\_REQ) during the IPsec tunnel establishment procedure, as specified 3GPP TS 33.402 [19], and if the ePDG supports the Additional Protocol Configuration Options IE, the ePDG may include this IE in the PBU to the PDN-GW and correspondingly set "DNS IPv4/IPv6 Server Address Request" parameter. If the ePDG receives the Additional Protocol Configuration Options IE with "DNS Server IPv4/v6 Address" parameter in the PBA from the PDN-GW, the ePDG shall send this information in the Configuration Payload (CFG\_REPLY) to the UE as specified in 3GPP TS 33.402 [19].

### 10.1.3 PDN GW procedures

In PMIPv6 mode, the PDN GW shall follow the LMA procedure for the PMIPv6 PDN Connection Creation as outlined in subclause 5.1.3.

If PDN GW supports multiple authentications it shall send the PAP or CHAP additional authentication and authorization information received from the ePDG in the Additional Protocol Configuration Options IE in the PBU to the external AAA server and the PDN GW shall send the PAP or CHAP additional authentication and authorization information received from the external AAA server to the ePDG in the Additional Protocol Configuration Options IE in the PBA as specified in 3GPP TS 33.402 [19].

If the PDN-GW supports Additional Protocol Configuration Options IE and if the PDN-GW receives it with the "DNS IPv4/IPv6 Server Address Request" parameter in the PBU from the ePDG, the PGW may include the Additional Protocol Configuration Options IE in the PBA and correspondingly set "DNS IPv4/IPv6 Address" as specified in 3GPP TS 24.008 [16].

## 10.2 ePDG Initiated PDN Connection Lifetime Extension procedures

### 10.2.1 General

### 10.2.2 ePDG procedures

In PMIPv6 mode, the ePDG shall follow the MAG procedure for the PMIPv6 PDN Connection Lifetime Extension as outlined in subclause 5.2.2.

### 10.2.3 PDN GW procedures

In PMIPv6 mode, the PDN GW shall follow the LMA procedure for the PMIPv6 PDN Connection Lifetime Extension as outlined in subclause 5.2.3.

## 10.3 UE / ePDG Initiated Detach and UE Requested PDN Disconnection procedures

### 10.3.1 General

### 10.3.2 ePDG procedures

In PMIPv6 mode, the ePDG shall follow the MAG procedure for the PMIPv6 MAG Initiated PDN Connection Deletion as outlined in subclause 5.4.2 for PDN Disconnection procedure,

For Detach the ePDG shall follow the above repeated for each PDN connection of the UE.

### 10.3.3 PDN GW procedures

In PMIPv6 mode, the PDN GW shall follow the LMA procedure for the PMIPv6 MAG Initiated PDN Connection Deletion as outlined in subclause 5.4.3.

## 10.4 HSS / AAA Initiated Detach procedures

### 10.4.1 General

The HSS/AAA may initiate a detach procedure resulting in a PMIPv6 De-Registration.

### 10.4.2 ePDG procedures

In PMIPv6 mode, the ePDG shall follow the MAG procedure for the PMIPv6 MAG Initiated PDN Connection Deletion as outlined in subclause 5.4.2 repeated for each PDN connection of the UE.

### 10.4.3 PDN GW procedures

In PMIPv6 mode, the PDN GW shall follow the LMA procedure for the PMIPv6 MAG Initiated PDN Connection Deletion as outlined in subclause 5.4.3.

## 10.5 UE Initiated Connectivity to Additional PDN procedures

### 10.5.1 General

### 10.5.2 ePDG procedures

In PMIPv6 mode, if the Request Type indicates "initial attach", the ePDG shall follow the MAG procedure for the PMIPv6 PDN Connection Creation as outlined in subclause 5.1.2. If the Request Type indicates "Handover", the ePDG shall follow the MAG procedure for the PMIPv6 PDN Connection Handover as outlined in subclause 5.3.2.

If the UE requests the DNS IPv4/IPv6 address in the Configuration Payload (CFG\_REQ) during the IPsec tunnel establishment procedure, as specified 3GPP TS 33.402 [19], and if the ePDG supports the Additional Protocol Configuration Options IE, the ePDG may include this IE in the PBU to the PDN-GW and correspondingly set "DNS IPv4/IPv6 Server Address Request" parameter. If the ePDG receives the Additional Protocol Configuration Options IE with "DNS Server IPv4/v6 Address" parameter in the PBA from the PDN-GW, the ePDG shall send this information in the Configuration Payload (CFG\_REPLY) to the UE as specified in 3GPP TS 33.402 [19].

### 10.5.3 PDN GW procedures

In PMIPv6 mode, if the Request Type indicates "initial attach", the PDN GW shall follow the LMA procedure for the PMIPv6 PDN Connection Creation as outlined in subclause 5.1.3. If the Request Type indicates "Handover", the PDN GW shall follow the LMA procedure for the PMIPv6 PDN Connection Handover as outlined in subclause 5.3.3.

If the PDN-GW supports Additional Protocol Configuration Options IE and if the PDN-GW receives it with the "DNS IPv4/IPv6 Server Address Request" parameter in the PBU from the ePDG, the PGW may include the Additional Protocol Configuration Options IE in the PBA and correspondingly set "DNS IPv4/IPv6 Address" as specified in 3GPP TS 24.008 [16].

## 10.6 3GPP Access to Untrusted Non-3GPP IP Access with PMIPv6 on S2b Handover procedures without optimization

### 10.6.1 General

### 10.6.2 ePDG procedures

In PMIPv6 mode, the ePDG shall follow the MAG procedure for the PMIPv6 PDN Connection Handover as outlined in subclause 5.3.2.

### 10.6.3 PDN GW procedures

In PMIPv6 mode, the PDN GW shall follow the LMA procedure for the PMIPv6 PDN Connection Handover as outlined in subclause 5.3.3.

If IPv6 network prefix preservation is supported at a handover from 3GPP Access with a GTP-based S5/S8 to non-3GPP Access, the LMA shall provide to the MAG the link-local address which is used by the PDN GW at the link shared with the UE in the 3GPP Access.

## 10.7 PDN GW Initiated Resource Allocation Deactivation procedures

### 10.7.1 General

### 10.7.2 ePDG procedures

In PMIPv6 mode, the ePDG shall follow the MAG procedure for the PMIPv6 LMA Initiated PDN Connection Deletion as outlined in subclause 5.5.2.

### 10.7.3 PDN GW procedures

In PMIPv6 mode, the PDN GW shall follow the LMA procedure for the PMIPv6 LMA Initiated PDN Connection Deletion as outlined in subclause 5.5.3.

## 10.8 PDN-GW Initiated IPv4 Address Delete Procedure

### 10.8.1 General

### 10.8.2 ePDG procedures

If UE is assigned both IPv6 HNP and IPv4 HoA, the ePDG shall follow the MAG procedure for the LMA Initiated IPv4 Address Release procedure as defined in sub clause 5.7.2.

### 10.8.3 PDN GW procedures

If UE is assigned both IPv6 HNP and IPv4 HoA, the PDN GW shall follow the LMA procedure for the LMA Initiated IPv4 Address Release procedure as defined in sub clause 5.7.3.

If UE is assigned only IPv4 HoA, then PDN-GW initiated Resource Allocation Deactivation procedure is initiated.

---

## 11 S2a and S2b Chaining with PMIP-based S8 Description

### 11.1 Initial Attach procedures

#### 11.1.1 General

#### 11.1.2 ePDG / Trusted Non-3GPP Access procedures

In PMIPv6 mode, the ePDG or Trusted Non-3GPP Access shall follow the MAG procedure for the PMIPv6 PDN Connection Creation. In addition to the general procedure, it shall include the PDN GW IP address received during the authorization procedure into the PBU request, encoding it into a Vendor-Specific Option (refer to clause 12.1.1.4).

#### 11.1.3 Serving GW procedures

In PMIPv6 mode, the Serving GW shall follow:

- the LMA procedure for the PMIPv6 PDN Connection Creation on the S2a/S2b interface. In addition to the general procedure, the Serving GW shall include the PDN GW IP address received in the PBU request into the PBA, using the same encoding (refer to clause 12.1.1.4).

- the MAG procedure for the PMIPv6 PDN Connection Creation on the S8 interface. The Serving GW shall send the PBU request to the PDN GW IP address received on the chained S2a / S2b interface.

## 11.2 ePDG / Trusted Non-3GPP Access Initiated PDN Connection Lifetime Extension procedures

### 11.2.1 General

### 11.2.2 ePDG / Trusted Non-3GPP Access procedures

In PMIPv6 mode, the ePDG or Trusted Non-3GPP Access shall follow the MAG procedure for the PMIPv6 PDN Connection Lifetime Extension.

### 11.2.3 Serving GW procedures

In PMIPv6 mode, the Serving GW shall follow:

- the LMA procedure for the PMIPv6 PDN Connection Lifetime Extension on the S2a/S2b interface.
- the MAG procedure for the PMIPv6 PDN Connection Lifetime Extension on the S8 interface.

## 11.3 UE / ePDG / Trusted Non-3GPP Access Initiated Detach procedures

### 11.3.1 General

### 11.3.2 ePDG / Trusted Non-3GPP Access procedures

In PMIPv6 mode, the ePDG or Trusted Non-3GPP Access shall follow the MAG procedure for the PMIPv6 MAG Initiated PDN Connection Deletion repeated for each PDN connection of the UE.

### 11.3.3 Serving GW procedures

In PMIPv6 mode, the Serving GW shall follow:

- the LMA procedure for the PMIPv6 MAG Initiated PDN Connection Deletion on the S2a/S2b interface.
- the MAG procedure for the PMIPv6 MAG Initiated PDN Connection Deletion on the S8 interface.

## 11.4 HSS / AAA Initiated Detach procedures

### 11.4.1 General

The HSS/AAA may initiate a detach procedure resulting in a PMIPv6 De-Registration.

### 11.4.2 ePDG / Trusted Non-3GPP Access procedures

In PMIPv6 mode, the ePDG or Trusted Non-3GPP Access shall follow the MAG procedure for the PMIPv6 MAG Initiated PDN Connection Deletion repeated for each PDN connection of the UE.

### 11.4.3 Serving GW procedures

In PMIPv6 mode, the Serving GW shall follow:

- the LMA procedure for the PMIPv6 MAG Initiated PDN Connection Deletion on the S2a/S2b interface.
- the MAG procedure for the PMIPv6 MAG Initiated PDN Connection Deletion on the S8 interface.

## 11.5 UE Initiated Connectivity to Additional PDN procedures

### 11.5.1 General

### 11.5.2 ePDG / Trusted Non-3GPP Access procedures

In PMIPv6 mode, the ePDG or Trusted Non-3GPP Access shall follow the MAG procedure for the PMIPv6 PDN Connection Creation if the Request Type indicates "initial attach", or the PMIPv6 PDN Connection Handover if the Request Type indicates "Handover". In addition to the general procedure, it shall include the PDN GW IP address received during the authorization procedure into the PBU request, encoding it to the Vendor-Specific Option (refer to clause 12.1.1.4).

### 11.5.3 Serving GW procedures

In PMIPv6 mode, the Serving GW shall follow:

- the LMA procedure for the PMIPv6 PDN Connection Creation if the Request Type indicates "initial attach", or the PMIPv6 PDN Connection Handover if the Request Type indicates "Handover" on the S2a/S2b interface. In addition to the general procedure, the Serving GW shall include the PDN GW IP address received in the PBU request into the PBA, using the same encoding (refer to clause 12.1.1.4).
- the MAG procedure for the PMIPv6 PDN Connection Creation if the Request Type indicates "initial attach", or the PMIPv6 PDN Connection Handover if the Request Type indicates "Handover" on the S8 interface. The Serving GW shall send the PBU request to the PDN GW IP address received on the chained S2a / S2b interface.

## 11.6 3GPP Access to Trusted / Untrusted Non-3GPP IP Access Handover procedures without optimization

### 11.6.1 General

### 11.6.2 ePDG / Trusted Non-3GPP Access procedures

In PMIPv6 mode, the ePDG or Trusted Non-3GPP Access shall follow the MAG procedure for the PMIPv6 PDN Connection Handover. In addition to the general procedure, it shall include the PDN GW IP address received during the authorization procedure into the PBU request, encoding it to the Vendor-Specific Option (refer to clause 12.1.1.4).

### 11.6.3 Serving GW procedures

In PMIPv6 mode, the Serving GW shall follow:

- the LMA procedure for the PMIPv6 PDN Connection Handover on the S2a/S2b interface. In addition to the general procedure, the Serving GW shall include the PDN GW IP address received in the PBU request into the PBA, using the same encoding (refer to clause 12.1.1.4).
- the MAG procedure for the PMIPv6 PDN Connection Handover on the S8 interface. The Serving GW shall send the PBU request to the PDN GW IP address received on the chained S2a / S2b interface.

## 11.7 UE Requested PDN Disconnection procedures

### 11.7.1 General

### 11.7.2 ePDG / Trusted Non-3GPP Access procedures

In PMIPv6 mode, the ePDG or Trusted Non-3GPP Access shall follow the MAG procedure for the PMIPv6 MAG Initiated PDN Connection Deletion, for the selected PDN connection.

### 11.7.3 Serving GW procedures

In PMIPv6 mode, the Serving GW shall follow:

- the LMA procedure for the PMIPv6 MAG Initiated PDN Connection Deletion, for the selected PDN connection on the S2a/S2b interface.
- the MAG procedure for the PMIPv6 MAG Initiated PDN Connection Deletion, for the selected PDN connection on the S8 interface.

## 11.8 PDN GW Initiated Resource Allocation Deactivation procedures

### 11.8.1 General

### 11.8.2 ePDG / Trusted Non-3GPP Access procedures

In PMIPv6 mode, the ePDG or Trusted Non-3GPP Access shall follow the MAG procedure for the PMIPv6 LMA Initiated PDN Connection Deletion.

### 11.8.3 Serving GW procedures

In PMIPv6 mode, the Serving GW shall follow:

- the MAG procedure for the PMIPv6 LMA Initiated PDN Connection Deletion on the S8 interface.
- the LMA procedure for the PMIPv6 LMA Initiated PDN Connection Deletion on the S2a/S2b interface.

---

## 12 Information Elements

### 12.1 Additional Proxy Mobile IPv6 Information Elements

#### 12.1.1 3GPP-Specific PMIPv6 Information Elements

##### 12.1.1.0 General

This specification requires the encoding of additional 3GPP-specific Information Elements for PMIPv6 with the 3GPP Mobility Option, as defined by 3GPP TS 29. 282 [24]. The 3GPP specific Information Elements defined by this specification are listed in the table 12.1.1.0-1.

**Table 12.1.1.0-1: 3GPP Specific PMIPv6 Information Elements**

<b>3GPP Specific PMIPv6 Information Element</b>	<b>3GPP Specific PMIPv6 Information Element Description</b>
Protocol Configuration Options	3GPP PCO data, in the format from 3GPP TS 24.008 [16] subclause 10.5.6.3, starting with octet 3.
3GPP Specific PMIPv6 error code	3GPP Vendor-Specific PMIPv6 error code, as specified in subclause 12.1.1.1
PDN GW IP address	PDN GW IP address, as specified in subclause 12.1.1.4
DHCPv4 Address Allocation Procedure Indication	DHCPv4 Address Allocation Procedure Indication, as specified in subclause 12.1.1.5.
Fully Qualified PDN Connection Set Identifier	FQ-CSID as specified in subclause 12.1.1.2
PDN Type Indication	PDN type indication as specified in subclause 12.1.1.3
Charging ID	Charging ID as specified in subclause 12.1.1.6
Selection Mode	Selection Mode as specified in subclause 12.1.1.7
Charging Characteristics	Subclause 12.1.1.8
Serving Network	Subclause 12.1.1.9
Mobile Equipment Identity	Subclause 12.1.1.10
MSISDN	Subclause 12.1.1.11
APN Restriction	Subclause 12.1.1.12
Maximum APN Restriction	Subclause 12.1.1.13
Unauthenticated IMSI	Subclause 12.1.1.14
PDN Connection ID	Subclause 12.1.1.15
PGW Back-Off Time	Subclause 12.1.1.16
Signalling Priority Indication	Subclause 12.1.1.17
Static IP Address Allocation Indication	Subclause 12.1.1.18
Additional Protocol Configuration Options	Subclause 12.1.1.19
MME/SGSN Identifier	Subclause 12.1.1.20

Depending on the need for 3GPP-specific information content, there several items of this information element may be added to the PBU, PBA, BRI, or BRA.

The subtype for a 3GPP specific PMIPv6 Information Element is defined in 3GPP TS 29.282 [24]. The data format of the 3GPP specific PMIPv6 Information Element is defined in this specification. If the data format is defined by another specification, that specification shall be referenced in the table above.

### 12.1.1.1 3GPP Specific PMIPv6 error code

Proxy Binding Acknowledgement (PBA) and Binding Revocation Acknowledgment (BRA) contain a mandatory Status information element and also may contain a 3GPP Specific PMIPv6 Error Code (3GSPEC) information element, which is coded within Mobility Options field.

**NOTE:** ETF RFC 5213 [4] and IETF RFC 6275 [8] specify PMIPv6 Status values for a PBA message for indicating the acceptance of a message, or for reporting an error. Up-to-date values for the Status field are specified in the IANA registry of assigned numbers [32]. IETF RFC 5846 [6] specifies PMIPv6 Status values for the BRA message. Up-to-date BRA status values are specified in the IANA registry of assigned numbers [33].



Binding Revocation Indication (BRI) may contain a 3GPP Specific PMIPv6 Error Code (3GSPEC) information element, which is coded within Mobility Options field.

The purpose of the 3GSPEC information element, which is depicted in Figure 12.1.1.1-1 is to carry a GTPv2 Cause value within PMIPv6 messages. 3GPP TS 29.274 [22] specifies GTPv2 Cause values.

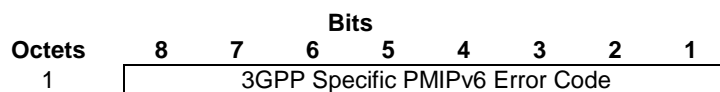

**Figure 12.1.1.1-1: 3GPP Specific PMIPv6 Error Code**

If MAG/SGW receives a 3GSPEC IE in Proxy Binding Acknowledgement message from LMA/PGW, which requires that the MAG/SGW shall send a GTPv2 message to MME/SGSN, then the MAG/SGW shall copy 3GSPEC value into GTPv2 Cause IE. If in such case, the MAG/SGW does not receive 3GSPEC IE with PBA, depending on the overall meaning of the PMIPv6 Status IE the MAG/SGW shall send to MME/SGSN one of the following GTPv2 Cause values with CS bit set to 1:

- "Request Accepted" (decimal 16), if the received PMIPv6 Status indicates PBU acceptance.
- "Request rejected for a PMIP reason" (decimal 112), if the received PMIPv6 Status indicates PBU rejection.

If MAG/SGW receives a 3GSPEC IE in Binding Revocation Indication message from LMA/PGW, which requires that the MAG/SGW shall send a GTPv2 message to MME/SGSN, then the MAG/SGW shall copy 3GSPEC value into GTPv2 Cause IE with CS bit set to 1.

If MAG/SGW receives a Cause IE with a GTPv2 message, which requires sending a Binding Revocation Acknowledgement message to LMA/PGW, the MAG/SGW shall copy the GTPv2 Cause value into the 3GSPEC IE.

### 12.1.1.2 Fully Qualified PDN Connection Set Identifier (FQ-CSID)

A fully qualified PDN Connection Set Identifier (FQ-CSID) identifies a set of PDN connections belonging to an arbitrary number of UEs on a node such as a MME, SGW or PGW. The FQ-CSID is generated by the MAG, the LMA and any other node such as the MME for 3GPP access. It is generated for each new PDN connection, and it is used in case of partial node failure to identify the PDN connections associated with a Connection Set Identifier.

The FQ-CSID is coded as follows:

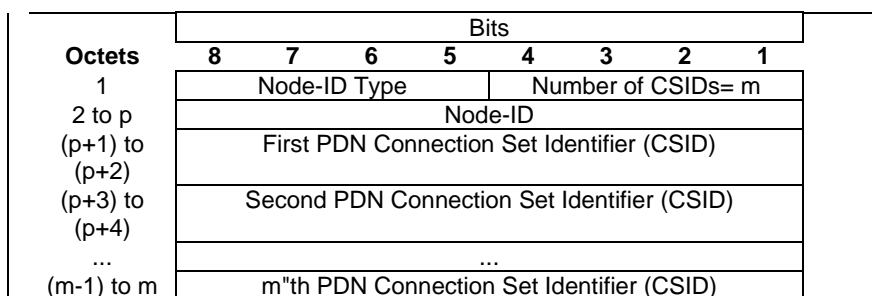

**Figure 12.1.1.2-1: FQ-CSID**

The details of each field and value are specified in 3GPP TS 29.274[22].

### 12.1.1.3 PDN Type Indication

The purpose of the PDN type indication option is to indicate the GW decision to change the PDN type and a cause for the change. This attribute is set by the LMA in the PBA.

The MAG shall set the PDN type accordingly, if this option is present in the PBA.

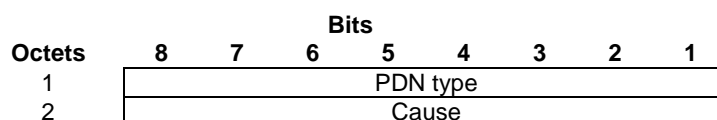

**Figure 12.1.1.3-1: PMIPv6 PDN type indication**

The following defines the value of the PMIPv6 PDN type indication.

PDN type value	
#1:	IPv4
#2:	IPv6
Cause value as defined in 3GPP TS 29.274[13]	
#18:	New PDN type due to network preference;

### 12.1.1.4 PDN GW IP address

The purpose of the PDN GW IP address information element is to carry the IP address of the PDN GW to which the receiving Serving GW shall send a PBU on the chained S8 interface. This information element shall be included only in a PBU for initial attach or handover sent on S2a or S2b interface for S2a/S2b - PMIP based S8 chaining scenario. The content and encoding of the PDN GW IP address is depicted on Figure 12.1.1.4-1.

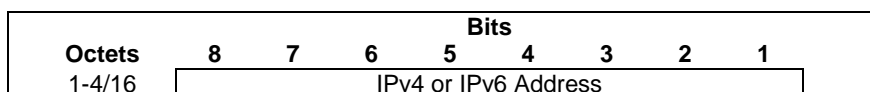

**Figure 12.1.1.4-1: PDN GW IP Address**

### 12.1.1.5 DHCPv4 Address Allocation Procedure Indication

The purpose of the DHCPv4 Address Allocation option is to indicate that DHCPv4 is to be used in allocating the IPv4 address to the UE if the option is present in the PBA message.

### 12.1.1.6 Charging ID

The Charging ID is defined in figure 12.1.1.6-1.

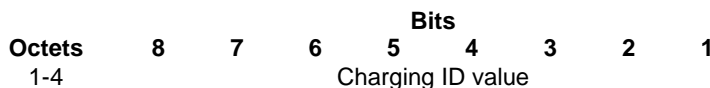

**Figure 12.1.1.6-1: Charging ID**

### 12.1.1.7 Selection Mode

Selection Mode indicates the way the MME or SGSN selected the APN: whether a subscribed APN was selected, or whether a non-subscribed APN sent by a UE or a non-subscribed APN chosen by the SGSN was selected. The Selection Mode is defined in 3GPP TS 23.060 [23]

The encoding of the Selection Mode is shown in Figure 12.1.1.7-1.

Octets	Bits							
	8	7	6	5	4	3	2	1
1	Reserved						Selection Mode	

**Figure 12.1.1.7-1: Selection mode**

The reserved bits shall be set to 1 by the MAG and not processed by the LMA.

The defined Selection Mode values are shown in Table 12.1.1.7-1.

**Table 12.1.1.7-1: Selection Mode**

Value	Selection mode value
0	MS or network provided APN, subscribed verified
1	MS provided APN, subscription not verified
2	Network provided APN, subscription not verified
3	For future use. Shall not be sent. If received, shall be interpreted as the value '2'.

### 12.1.1.8 Charging Characteristics

The Charging Characteristics information element is defined in 3GPP TS 32.251 [25] and is a way of informing both the SGW and PGW of the rules for producing charging information based on operator configured triggers. For the encoding of this information element see 3GPP TS 32.298 [26].

The Charging Characteristics is defined in figure 12.1.1.8-1.

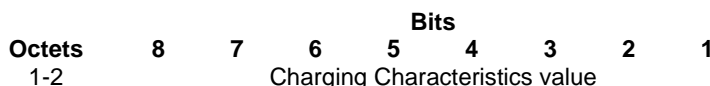

**Figure 12.1.1.8-1: Charging Characteristics**

### 12.1.1.9 Serving Network

Serving Network identifies the serving network the UE is attached to. The format of the Serving Network 3GPP-specific Information Element is defined below.

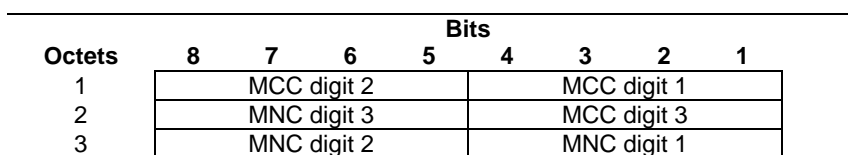
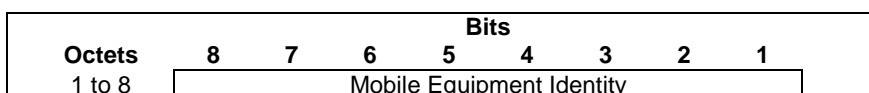

**Figure 12.1.1.9-1**

### 12.1.1.10 Mobile Equipment Identity

The purpose of the Mobile Equipment Identity (MEI) information element is used to convey the UE's terminal identity from the Serving GW to the PDN GW over the S5/S8 interface.

The encoding of the MEI is depicted in Figure 12.1.1.10-1.



**Figure 12.1.1.10-1: Mobile Equipment Identity (MEI)**

The MEI contains either the IMEI or IMEISV in the format defined in subclause 6.2 of 3GPP TS 23.003 [12].

The MEI shall contain the IMEISV if it is available. If only the IMEI is available, then the last semi-octet of octet 8 of MEI shall be set to "1111". Both IMEI and IMEISV are TBCD encoded, where IMEI is 15 BCD digits and IMEISV is 16 BCD digits. Bits 5 to 8 of octet n encodes digit 2n, bits 1 to 4 of octet n encodes digit 2n-1. Digits are packed contiguously with no internal padding.

NOTE: This encoding follows that of the IMEI(SV) field in the International Mobile Equipment Identity (and Software Version) (IMEI(SV)) information element defined in clause 7.7.53 of 3GPP TS 29.060 [28].

### 12.1.1.11 MSISDN

The purpose of the MSISDN information element is used to convey the user's MSISDN from the Serving GW to the PDN GW over the S5/S8 interface, from the trusted non-3GPP access network to the PDN-GW over S2a and from ePDG to the PDN-GW over S2b. MSISDN is defined in 3GPP TS 23.003 [12].

The content and encoding of the MSISDN is depicted on Figure 12.1.1.11-1.

Octets	Bits							
	8	7	6	5	4	3	2	1
1	Number digit 2				Number digit 1			
n	Number digit m				Number digit m-1			

Figure 12.1.1.11-1: MSISDN

Octets 1 to n represent the MSISDN value in international number format as described in ITU-T Rec E.164 [29], encoded as TBCD digits, i.e. digits from 0 through 9 are encoded "0000" to "1001". When there is an odd number of digits, bits 8 to 5 of the last octet are encoded with the filler "1111".

### 12.1.1.12 APN Restriction

The APN Restriction is defined in figure 12.1.1.12-1. The APN Restriction value is specified in 3GPP TS 29.274 [22].

Octets	Bits							
	8	7	6	5	4	3	2	1
1	APN Restriction value							

Figure 12.1.1.12-1: APN Restriction

### 12.1.1.13 Maximum APN Restriction

The Maximum APN Restriction is defined in figure 12.1.1.13-1. The Maximum APN Restriction value is specified in 3GPP TS 29.274 [22].

Octets	Bits							
	8	7	6	5	4	3	2	1
1	Maximum APN Restriction value							

Figure 12.1.1.13-1: Maximum APN Restriction

### 12.1.1.14 Unauthenticated IMSI

The purpose of the Unauthenticated IMSI information element is used to convey the user's IMSI for the emergency attached UE with an IMSI which is not authenticated by the network. The format of IMSI is defined in 3GPP TS 23.003 [12].

The content and encoding of the Unauthenticated IMSI is depicted on Figure 12.1.1.14-1.

Octets	Bits							
	8	7	6	5	4	3	2	1
1	Number digit 2				Number digit 1			
n	Number digit m				Number digit m-1			

Figure 12.1.1.14-1: Unauthenticated IMSI

Octets 1 to n represent the IMSI value in international number format as described in ITU-T Rec E.164 [29], encoded as TBCD digits, i.e. digits from 0 through 9 are encoded "0000" to "1001". When there is an odd number of digits, bits 8 to 5 of the last octet are encoded with the filler "1111". The maximum number of digits is 15.

### 12.1.1.15 PDN Connection ID

The purpose of the PDN Connection ID information element is used to convey the PDN Connection ID.

The content and encoding of the PDN Connection ID is depicted on Figure 12.1.1.15-1.

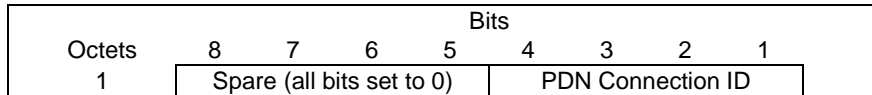
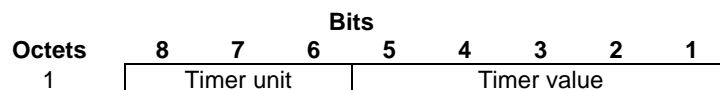

**Figure 12.1.1.15-1: PDN Connection ID**

NOTE: The format of the PDN connection ID is aligned with EPS bearer ID defined for GTPv2 in 3GPP TS 29.274 [22].

### 12.1.1.16 PGW Back-Off Time

The PGW Back-Off Time information element is coded as shown in figure 12.1.1.16-1. The timer unit and timer value are specified in 3GPP TS 29.274 [22].

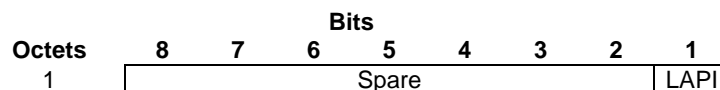

**Figure 12.1.1.16-1: PGW Back-Off Time**

### 12.1.1.17 Signalling Priority Indication

The Signalling Priority Indication information element contains signalling priority indications received from the UE for a specific PDN connection.

The Signalling Priority Indication information element is coded as shown in figure 12.1.1.17-1.



**Figure 12.1.1.17-1: Signalling Priority Indication**

The following bits within Octet 1 shall indicate:

- Bit 8 to 2 – Spare, for future use and set to zero.
- Bit 1 – LAPI (Low Access Priority Indication): This bit defines if the UE indicated low access priority when establishing the PDN connection. It shall be encoded as the Low Priority parameter of the Device Properties IE in 3GPP TS 24.008 [16]. The receiver shall assume the value "0" if the Signalling Priority Indication IE is applicable for a message but not included in that message by the sender. The low access priority indication may be included in charging records.

### 12.1.1.18 Static IP Address Allocation Indication

The Static IP Address Allocation Indication information element contains Static IP Address Allocation Indication for the Handover procedures. These indications are equivalent for the Static IPv4/IPv6 Address Flag defined in 3GPP TS 29.274 [22].

The Static IP Address Allocation Indication information element is coded as shown in figure 12.1.1.18-1.



**Figure 12.1.1.18-1: Static IP Address Allocation Indication**

The following bits within Octet 1 shall indicate:

- Bit 8 to 3 – Spare, for future use and set to zero.
- Bit 2 – S6PI (Static IPv6 Home Network Prefix Indication): if this bit is set to 1, it indicates that IPv6 Home Network Prefix is statically allocated.
- Bit 1 – S4AI (Static IPv4 Address Indication): if this bit is set to 1, it indicates that IPv4 address is statically allocated.

### 12.1.1.19 Additional Protocol Configuration Options

The Additional Protocol Configuration Options IE contains additional 3GPP protocol configuration options information. The IE is in the same format as the PCO IE specified in 3GPP TS 24.008 [16] subclause 10.5.6.3, starting with octet 3.

### 12.1.1.20 MME/SGSN Identifier

The purpose of the MME/SGSN Identifier information element is to carry the IP address of the MME/SGSN. The content and encoding of the MME/SGSN Identifier is depicted on Figure 12.1.1.20-1.

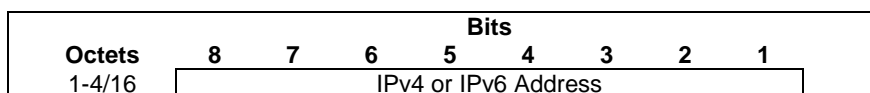

**Figure 12.1.1.20-1: MME/SGSN Identifier**

---

## 13 Trusted WLAN Access over S2a Description

### 13.1 Initial Attach procedures

#### 13.1.1 General

#### 13.1.2 TWAN procedures

In PMIPv6 mode, the TWAN shall follow the MAG procedure for the PMIPv6 PDN Connection Creation as outlined in subclause 5.1.2.

The TWAN may include Additional Protocol Configuration Options IE in PBU to retrieve additional IP configuration parameters from the PGW (e.g. DNS server).

If location information is sent, the TWAN should include Access Network Identifier Option IE with only Network-Identifier sub-option. If present, it should include the BSSID of the access point to which the UE is attached within "Access-Point Name" field of the Network-Identifier sub-option. If present, it shall include the SSID of the access point to which the UE is attached within "Network Name" field of the Network-Identifier sub-option.

The TWAN shall include the Serving Network IE in PBU and set it to the PLMN identity of the selected PLMN used for 3GPP-based access authentication. The selected PLMN is the PLMN of the 3GPP AAA Proxy in roaming case and the PLMN of the 3GPP AAA Server in non-roaming case.

### 13.1.3 PDN GW procedures

In PMIPv6 mode, the PDN GW shall follow the LMA procedure for the PMIPv6 PDN Connection Creation as outlined in subclause 5.1.3.

The PDN GW may include Additional Protocol Configuration Options IE in PBA message to provide the TWAN with additional IP configuration parameters (e.g. DNS server), if a corresponding request was received in the PBU message.

## 13.2 TWAN Initiated PDN Connection Lifetime Extension procedures

### 13.2.1 General

### 13.2.2 TWAN procedures

In PMIPv6 mode, the TWAN shall follow the MAG procedure for the PMIPv6 PDN Connection Lifetime Extension as outlined in subclause 5.2.2.

### 13.2.3 PDN GW procedures

In PMIPv6 mode, the PDN GW shall follow the LMA procedure for the PMIPv6 PDN Connection Lifetime Extension as outlined in subclause 5.2.3.

## 13.3 UE / TWAN Initiated Detach and UE/TWAN Requested PDN Disconnection procedures

### 13.3.1 General

### 13.3.2 TWAN procedures

In PMIPv6 mode, the TWAN shall follow the MAG procedure for the PMIPv6 MAG Initiated PDN Connection Deletion as outlined in subclause 5.4.2 for Detach/PDN Disconnection procedure.

### 13.3.3 PDN GW procedures

In PMIPv6 mode, the PDN GW shall follow the LMA procedure for the PMIPv6 MAG Initiated PDN Connection Deletion as outlined in subclause 5.4.3.

## 13.4 HSS / AAA Initiated Detach procedures

### 13.4.1 General

The HSS/AAA may initiate a detach procedure resulting in a PMIPv6 De-Registration.

### 13.4.2 TWAN procedures

In PMIPv6 mode, the TWAN shall follow the MAG procedure for the PMIPv6 MAG Initiated PDN Connection Deletion as outlined in subclause 5.4.2.

### 13.4.3 PDN GW procedures

In PMIPv6 mode, the PDN GW shall follow the LMA procedure for the PMIPv6 MAG Initiated PDN Connection Deletion as outlined in subclause 5.4.3.

## 13.5 PDN GW Initiated Resource Allocation Deactivation procedures

### 13.5.1 General

### 13.5.2 TWAN procedures

In PMIPv6 mode, the Trusted Non-3GPP Access shall follow the MAG procedure for the PMIPv6 LMA Initiated PDN Connection Deletion as outlined in subclause 5.5.2.

### 13.5.3 PDN GW procedures

In PMIPv6 mode, the PDN GW shall follow the LMA procedure for the PMIPv6 LMA Initiated PDN Connection Deletion as outlined in subclause 5.5.3.

---

## 14 Proxy Mobile IPv6 EPC Restoration Procedure

### 14.1 PGW triggered SGW restoration procedure

#### 14.1.1 General

The PGW triggered SGW restoration procedure is specified in 3GPP TS 23.007 [13]. The Proxy Mobile IPv6 LMA Initiated Update Notification procedure specified in subclause 5.x is used to initiate the PGW triggered SGW restoration procedure.

#### 14.1.2 Serving GW procedures

The Serving GW shall follow the PGW triggered SGW restoration procedure as specified in subclause 27.2.3.3 of 3GPP TS 23.007 [13]. When receiving the Update Notification message with notification reason "PGW Downlink Trigger Notification", the Serving GW shall response with an Update Notification Acknowledgement message specified as the MAG procedure in subclause 5.11.

#### 14.1.3 PDN GW procedures

The PDN GW shall follow the PGW triggered SGW restoration procedure as specified in subclause 27.2.3.4 of 3GPP TS 23.007 [13]. When sending the Update Notification message, the PDN GW shall follow the LMA procedure specified in subclause 5.11 as follows:

1. The notification reason shall be set to "PGW Downlink Trigger Notification".

**Editor's Note: The Notification reason " PGW Downlink Trigger Notification " needs to be registered in IANA.**

2. If the MME/S4-SGSN identifier was received in the last Create Session Request or Modify Bearer Request message as specified in 3GPP TS 23.007 [13], the MME/SGSN Identifier mobility option shall contain the stored MME/S4-SGSN identifier.



## 14.2 Update PDP context/Bearer at P-CSCF failure

### 14.2.1 General

The update PDP context/Bearer at P-CSCF failure procedure is specified in subclause 5.1 of 3GPP TS 23.380 [36]. The Proxy Mobile IPv6 LMA Initiated Update Notification procedure specified in subclause 5.11 is used to inform the SGW at P-CSCF failure.

### 14.2.2 PDN GW procedures

The PDN GW shall follow the update PDP context/Bearer at P-CSCF failure procedure as specified in subclause 5.1 of 3GPP TS 23.380 [36]. When sending the Update Notification message, the PDN GW shall follow the LMA procedure specified in subclause 5.11 as follows:

1. The notification reason shall be set to "PGW triggered P-CSCF restoration using PCO".

**Editor's Note:** The notification reason "PGW triggered P-CSCF restoration using PCO" needs to be registered in IANA.

2. The Service Selection Mobility Option shall be set to the corresponding APN to which the UE PDN connection is attached
3. The PDN connection ID Mobility Option shall contain the PDN connection ID stored in the BCE if multiple PDN connection to a given APN is supported.
4. The PCO Mobility Option shall contain a list of P-CSCF address.

### 14.2.3 Serving GW procedures

The Serving GW shall follow the update PDP context/Bearer at P-CSCF failure procedure as specified in subclause 5.1 of 3GPP TS 23.380 [36]. When receiving the Update Notification message with notification reason "PGW triggered P-CSCF restoration using PCO", the Serving GW shall response with an Update Notification Acknowledgement message specified as the MAG procedure in subclause 5.11.

## 14.3 Inform UE about P-CSCF failure

### 14.3.1 General

The inform UE about P-CSCF failure procedure is specified in subclause 5.2 of 3GPP TS 23.380 [36]. The Proxy Mobile IPv6 LMA Initiated Update Notification procedure specified in subclause 5.11 is used to inform the SGW at P-CSCF failure.

### 14.3.2 PDN GW procedures

The PDN GW shall follow the inform UE about P-CSCF failure procedure as specified in subclause 5.2 of 3GPP TS 23.380 [36]. When sending the Update Notification message, the PDN GW shall follow the LMA procedure specified in subclause 5.11 as follows:

1. The notification reason shall be set to "PGW triggered P-CSCF restoration using DHCP".

**Editor's Note:** The notification reason "PGW triggered P-CSCF restoration using DHCP" needs to be registered in IANA.

2. The Service Selection Mobility Option shall be set to the corresponding APN to which the UE PDN connection is attached
3. The PDN connection ID Mobility Option shall contain the PDN connection ID stored in the BCE if multiple PDN connection to a given APN is supported.
4. The PCO Mobility Option shall contain an indicator that there is P-CSCF failure.

### 14.3.3 Serving GW procedures

The Serving GW shall follow the inform UE about P-CSCF failure procedure as specified in subclause 5.2 of 3GPP TS 23.380 [36]. When receiving the Update Notification message with notification reason "PGW triggered P-CSCF restoration using DHCP", the Serving GW shall response with an Update Notification Acknowledgement message specified as the MAG procedure in subclause 5.11.

## Annex A: void

---

## Annex B (Normative): Definition of the protocol number in pseudo-header

### B.1 General

In this specification PMIP refers to PMIPv6 as defined in IETF RFC5213 [4] and IETF RFC5213 [4] is based on Mobile IPv6 IETF RFC 3775[8]. IETF RFC 3775[38], however, is obsolete by IETF RFC 6275 [8], which specifies protocol number 135 instead of 2 to be used in the checksum pseudo-header. For forward compatibility with future 3GPP releases, the protocol number 135 shall be supported. In addition the protocol number 2 may also be supported.

NOTE: Some nodes complying to an earlier version of this specification can be implemented according to IETF RFC 3775[38] and this could result in the use of different protocol numbers within a network.

To migrate a protocol number 2 based PMIP network into a protocol number 135 based PMIP network, the network migration may be achieved by static configuration or supporting a migration solution as specified in this Annex B. Any other alternatives for a specific development use case are possible.

### B.2 Interworking of different protocol number

If a PMIPv6 node (LMA) supports both protocol numbers (2 and 135), it shall silently discard the received PBU message if the checksum value calculated from the protocol number 2 and 135 are both invalid. If one of the protocol number (2 or 135) is valid in checksum calculation, the node shall use this protocol number in the "pseudo-header" when sending any subsequent PMIPv6 messages with the same peer PMIPv6 node. If the checksum validation is skipped, the LMA shall use the configured protocol number for the subsequent PMIPv6 messages to that peer node.

If a PMIPv6 node (MAG) supports both protocol numbers (2 and 135), it shall construct PBU message using protocol number 135 which takes precedence over protocol number 2. If no response is received from LMA, the MAG sends another PBU message to the peer node using protocol number 2. The MAG shall store the protocol number of the response message and use it for the subsequent message interaction. If the checksum validation is skipped, the MAG shall use the configured protocol number for the subsequent PMIPv6 messages to that peer node.

## Annex C (informative): Change History

Change history							
Date	TSG #	TSG Doc.	CR	Rev	Subject/Comment	Old	New
2008-09	CT#41	CP-080476			V2.0.0 approved in CT#41	2.0.0	8.0.0
2008-12	CT#42	CP-080692	0002		IPv4 Address Acknowledgement option in PBA	8.0.0	8.1.0
		CP-080692	0006	2	IPv4 Address Deletion		
		CP-080692	0007		PDN-GW Initiated Resource Allocation Deactivation		
		CP-080692	0008	2	PDNType-IP Address Option		
		CP-080692	0009	4	PMIP Bulk Revocation Support.		
		CP-080692	0010	1	Link local address		
		CP-080692	0011		Service selection option in the PBA message		
		CP-080692	0012	4	PMIP IPv4 address allocation		
		CP-080692	0019		Interface Id in PBA at HO case		
		CP-080692	0022		Clarification to subclause PMIP6 LMA Initiated PDN Connection Deletion Procedure		
		CP-080692	0023		Update references to latest version of IETF documents		
		CP-080692	0025		Putting back GSM logo on front page		
		CP-080692	0026		PMIPv6 Heartbeat/Path Management Update		
		CP-080692	0031		PMIPv6 clarification		
		CP-080692	0033		Optimized E-UTRAN to CDMA2000 HRPD Handover procedure cleanup		
		CP-080692	0036	1	IPv4-UDP encapsulation option		
		CP-080692	0037	2	S5/S8 procedure corrections		
		CP-080692	0038	1	S2a procedure corrections		
		CP-080692	0039		S2b procedure corrections		
		CP-080692	0040	1	Chaining case procedure corrections		
		CP-080692	0042	1	DHCPv4 Address Allocation 3GPP VSO		
		CP-080692	0043	1	PDN type indicator		
		CP-080692	0044		FFS cleanup		
		CP-080692	0045		HI FFS cleanup		
		CP-080692	0046		Clean up on BULE and BCE		
		CP-080692	0047	2	Clarification on PMIPv6 Protocol Stack		
		CP-080692	0048	3	Modifications for S2a/S2b - PMIP based S8 chaining		
2009-03	CT#43	CP-090052	0054	1	3GPP VSO PDN type cause value	8.1.0	8.2.0
		CP-090052	0055		3GPP VSO DHCPv4 Address Allocation Procedure Indication		
		CP-090052	0056	1	3GPP VSO PMIP error code missing in PBA and BRA		
		CP-090052	0059	1	3GPP VSO PCO in PBU/PBA message		
		CP-090052	0061	1	Old BCE is lost at handover		
		CP-090052	0062	2	Partial Node Failure		
		CP-090052	0064	2	Alignments of cause codes		
		CP-090052	0065	4	UE specific Error Indication		
		CP-090052	0066		Clarification on Heartbeat Request Message		
		CP-090052	0071	2	Link-local Address Option		
		CP-090052	0072	1	IPv4 Deferred Address Allocation and PDN Type		
		CP-090052	0073	3	PMIP VSO Charging ID		
		CP-090052	0074	1	ATT Values for PMIP base S5/S8		
		CP-090052	0077		Detach or PDN Disconnection		
		CP-090052	0079		Status Field update		
		CP-090052	0080	1	Correction to tunnel management		
		CP-090052	0085	2	Carrying APN selection mode in PMIP		
		CP-090271	0086	6	Removing 3GPP Vendor Specific Mobility Option format		
2009-04					Correction to history table	8.2.0	8.2.1
2009-06	CT#44	CP-090290	0090	2	PMIP VSO Charging Characteristics	8.2.1	8.3.0
		CP-090290	0092		PDN Type Cause Value		
		CP-090290	0093	1	UE Requested additional PDN Connectivity Procedure		
		CP-090290	0094	1	IP address allocation Procedure		
		CP-090290	0095	1	FQ-CSID		
		CP-090290	0097	2	Timestamp		
		CP-090290	0098	2	Serving Network VSO in PBU		
		CP-090290	0099		GRE Key usage in PDN Connection Lifetime Extension		
		CP-090290	0101	3	PMIPv6 messages transport over IPv4		
		CP-090290	0102	3	PDN Type for PMIPv6		
		CP-090290	0106	2	Carrying MEI over PMIP based S5/S8		
		CP-090290	0107	2	Carrying MSISDN over PMIP based S5/S8		
		CP-090290	0109	2	Access technology type to be used by ePDG		
		CP-090290	0110	1	Binding Revocation Indication		
2009-09	CT#45	CP-090538	0114	1	APN Restriction for PMIPv6	8.3.0	8.4.0
		CP-090538	0116		The IPv4 address allocation procedure		

		CP-090538	0117	1	Clean up on 3GPP Specific PMIPv6 Error Code		
		CP-090538	0118	1	GRE Key usage in PDN Connection Lifetime Extension		
		CP-090538	0120	1	Defining values for 3GPP specific PMIPv6 error code		
		CP-090538	0121	1	Conditional 3GPP specific PMIPv6 information elements		
		CP-090538	0122	1	Reintroducing specific 3GPP Access Technology Types		
		CP-090538	0124	1	Clarifications for HO 3GPP to non-3GPP		
		CP-090538	0125	2	Default MTU size to avoid IP fragmentation in EPS		
		CP-090538	0126	1	Heartbeat Mechanism condition for path failure detection		
		CP-090538	0127	2	Correct on GRE key assignment		
		CP-090538	0128	1	E-UTRAN to HRPD optimized handover		
		CP-090538	0130	2	The revision of LMA's dynamic IP address allocation in handover procedure		
		CP-090729	0131	1	Partial failure handling alignment with stage 2		
		CP-090729	0132	3	Partial failure handling for S1 based handovers		
2009-12	CT#46	CP-090971	0133	5	UE-specific Error Indication	8.4.0	8.5.0
		CP-090775	0139	1	IPv4 Address Release for PMIPv6 based S2a		
		CP-090775	0140	2	Correct IPv4 Home Address Reply option IE name		
		CP-090775	0142	3	Clarification on Heartbeat Mechanism		
		CP-090775	0143		FFS Cleanup for Service Selection Mobility Option		
		CP-090775	0144	1	IPv4 Default-Router Address option		
		CP-090775	0145	1	Clarifications on the format of Mobile Node Identifier option		
		CP-090775	0146	1	Removing access type mapping table from annex B		
		CP-090775	0152	1	Clarifications on the format of Service Selection Mobility Option		
		CP-090775	0154		Correct fields of revocation message		
2009-12	CT#46	CP-090801	0134		IMEI based NAI	8.5.0	9.0.0
		CP-090801	0135		Unauthenticated IMSI		
		CP-090802	0136	2	Multiple PDN to the Same APN for PMIP-based Interfaces		
		CP-090802	0137	1	BCE extensions for MUPSAP		
2010-03	CT#47	CP-100026	0157	1	Correction of the UE-specific Error Indication	9.0.0	9.1.0
			0159	1	Bulk Binding Revocation Indication		
			0161		FQ-CSID option		
2010-06	CT#48	CP-100265	0167		Cause Mapping	9.1.0	9.2.0
2010-09	CT#49	CP-100444	0171		PMIPv6 Reference Update	9.2.0	9.3.0
2010-12	CT#50	CP-100669	0174	1	Essential correction to the mapping between PMIP 3GSPEC and GTP Cause	9.3.0	9.4.0
2010-12	CT#50	CP-100694	0177	2	IPv4 Default Router Address	9.4.0	10.0.0
2011-03	CT#51	CP-110081	0180	1	Clarification on IE using interfaces	10.0.0	10.1.0
		CP-110072	0189	1	Handling of UE specific Error Indication over the PMIP		
		CP-110072	0190	1	LMA initiated PDN Connection Deletion with Reactivation requested		
		CP-110208	0191		Clarification of PCO decoding		
2011-06	CT#52	CP-110369	0178	2	APN based congestion control	10.1.0	10.2.0
		CP-110369	0179	2	Low access priority indicator		
		CP-110372	0193	1	Incorrect RFC reference for the UE-specific Error Handling		
		CP-110372	0194	1	PDN GW IP address Correction		
2011-09	CT#53	CP-110558	0198	2	PMIP message format	10.2.0	10.3.0
		CP-110567	0201	1	Signalling path failure handling		
2011-09	CT#53	CP-110580	0200		Default inner MTU size	10.3.0	11.0.0
2011-12	CT#54	CP-110785	0211	2	Correction of the protocol stack for PMIP	11.0.0	11.1.0
		CP-110785	0212	2	Migration solution of the PMIP protocol stack issue		
		CP-110791	0220	2	Static IP Address Allocation Indication for Handover procedure		
		CP-110791	0225	1	Learn capability of MUPSAP from PDN connection ID		
		CP-110792	0218	1	Authentication with external networks over PMIP S2b		
2012-03	CT#55	CP-120018	0232	1	PMIP binding lifetime	11.1.0	11.2.0
		CP-120036	0234	2	PGW based provisioning of the DNS server address for the S2b interface		
2012-06	CT#56	CP-120248	0237	2	IPv4 Address Allocation procedure	11.2.0	11.3.0
		CP-120248	0239	1	Clarification for IPv4 Home Address Request option in dynamic IP allocation		
		CP-120248	0240	1	S2a related changes when Trusted WLAN Access is used		
		CP-120248	0241	2	Clarifying the use of Default Router Address Option in case of Trusted WLAN access		
		CP-120248	0238	3	Multiple PDN connections		
		CP-120248	0247	1	GRE key reference correction		
2012-09	CT#57	CP-120477	0249	1	RAT Type for EPC access via TWAN	11.3.0	11.4.0
		CP-120464	0250	2	Extensions to PMIPv6 signalling		
			0251		Correction to references for TS 29.275		
		CP-120656	0252	1	Reference list correction to align with the corrected TS 29.212 title		
2012-12	CT#58	CP-120729	0255	1	Signalling Priority Indication in handover	11.4.0	11.5.0
		CP-120729	0266	-	Static IP Address Allocation Indication		
		CP-120739	0253	3	New PMIP message for EPC Restoration Procedure		
		CP-120739	0254	1	MME/SGSN Id for the PGW triggered SGW restoration procedure		

		CP-120733	0259	1	MSISDN over PMIPv6 S2b/S2a interface		
		CP-120733	0262	2	TWAN operator identification for EPC access charging		
		CP-120733	0268	2	Trusted WLAN AP identity over S2a		
2013-03	CT#59	CP-130019	0272	1	IETF Draft Reference- Update Notifications for Proxy Mobile IPv6	11.5.0	11.6.0
		CP-130024	0273	2	Completion of replacing RFC 3775 with RFC 6275 references		
		CP-130024	0274	4	Protocol number used in pseudo-header Migration RFC 3775 to RFC 6275		
		CP-130027	0275	-	Sending SSID for SaMOG in PMIP		

---

## History

<b>Document history</b>		
V11.4.0	October 2012	Publication
V11.5.0	January 2013	Publication
V11.6.0	April 2013	Publication