

# ETSI TS 129 435 V18.2.0 (2024-09)



**5G;  
Service Enabler Architecture Layer for Verticals (SEAL);  
Network Slice Capability Enablement (NSCE) Server Services  
(3GPP TS 29.435 version 18.2.0 Release 18)**



---

**Reference**

RTS/TSGC-0329435vi20

---

**Keywords**

5G

**ETSI**

650 Route des Lucioles  
F-06921 Sophia Antipolis Cedex - FRANCE

---

Tel.: +33 4 92 94 42 00 Fax: +33 4 93 65 47 16

Siret N° 348 623 562 00017 - APE 7112B  
Association à but non lucratif enregistrée à la  
Sous-Préfecture de Grasse (06) N° w061004871

---

**Important notice**

The present document can be downloaded from:

<https://www.etsi.org/standards-search>

The present document may be made available in electronic versions and/or in print. The content of any electronic and/or print versions of the present document shall not be modified without the prior written authorization of ETSI. In case of any existing or perceived difference in contents between such versions and/or in print, the prevailing version of an ETSI deliverable is the one made publicly available in PDF format at [www.etsi.org/deliver](http://www.etsi.org/deliver).

Users of the present document should be aware that the document may be subject to revision or change of status.

Information on the current status of this and other ETSI documents is available at

<https://portal.etsi.org/TB/ETSIDeliverableStatus.aspx>

If you find errors in the present document, please send your comment to one of the following services:

<https://portal.etsi.org/People/CommitteeSupportStaff.aspx>

If you find a security vulnerability in the present document, please report it through our

Coordinated Vulnerability Disclosure Program:

<https://www.etsi.org/standards/coordinated-vulnerability-disclosure>

---

**Notice of disclaimer & limitation of liability**

The information provided in the present deliverable is directed solely to professionals who have the appropriate degree of experience to understand and interpret its content in accordance with generally accepted engineering or other professional standard and applicable regulations.

No recommendation as to products and services or vendors is made or should be implied.

No representation or warranty is made that this deliverable is technically accurate or sufficient or conforms to any law and/or governmental rule and/or regulation and further, no representation or warranty is made of merchantability or fitness for any particular purpose or against infringement of intellectual property rights.

In no event shall ETSI be held liable for loss of profits or any other incidental or consequential damages.

Any software contained in this deliverable is provided "AS IS" with no warranties, express or implied, including but not limited to, the warranties of merchantability, fitness for a particular purpose and non-infringement of intellectual property rights and ETSI shall not be held liable in any event for any damages whatsoever (including, without limitation, damages for loss of profits, business interruption, loss of information, or any other pecuniary loss) arising out of or related to the use of or inability to use the software.

---

**Copyright Notification**

No part may be reproduced or utilized in any form or by any means, electronic or mechanical, including photocopying and microfilm except as authorized by written permission of ETSI.

The content of the PDF version shall not be modified without the written authorization of ETSI.

The copyright and the foregoing restriction extend to reproduction in all media.

© ETSI 2024.  
All rights reserved.

---

## Intellectual Property Rights

### Essential patents

IPRs essential or potentially essential to normative deliverables may have been declared to ETSI. The declarations pertaining to these essential IPRs, if any, are publicly available for **ETSI members and non-members**, and can be found in ETSI SR 000 314: "*Intellectual Property Rights (IPRs); Essential, or potentially Essential, IPRs notified to ETSI in respect of ETSI standards*", which is available from the ETSI Secretariat. Latest updates are available on the ETSI Web server (<https://ipr.etsi.org/>).

Pursuant to the ETSI Directives including the ETSI IPR Policy, no investigation regarding the essentiality of IPRs, including IPR searches, has been carried out by ETSI. No guarantee can be given as to the existence of other IPRs not referenced in ETSI SR 000 314 (or the updates on the ETSI Web server) which are, or may be, or may become, essential to the present document.

### Trademarks

The present document may include trademarks and/or tradenames which are asserted and/or registered by their owners. ETSI claims no ownership of these except for any which are indicated as being the property of ETSI, and conveys no right to use or reproduce any trademark and/or tradename. Mention of those trademarks in the present document does not constitute an endorsement by ETSI of products, services or organizations associated with those trademarks.

**DECT™**, **PLUGTESTS™**, **UMTS™** and the ETSI logo are trademarks of ETSI registered for the benefit of its Members. **3GPP™** and **LTE™** are trademarks of ETSI registered for the benefit of its Members and of the 3GPP Organizational Partners. **oneM2M™** logo is a trademark of ETSI registered for the benefit of its Members and of the oneM2M Partners. **GSM®** and the GSM logo are trademarks registered and owned by the GSM Association.

---

## Legal Notice

This Technical Specification (TS) has been produced by ETSI 3rd Generation Partnership Project (3GPP).

The present document may refer to technical specifications or reports using their 3GPP identities. These shall be interpreted as being references to the corresponding ETSI deliverables.

The cross reference between 3GPP and ETSI identities can be found under <https://webapp.etsi.org/key/queryform.asp>.

---

## Modal verbs terminology

In the present document "**shall**", "**shall not**", "**should**", "**should not**", "**may**", "**need not**", "**will**", "**will not**", "**can**" and "**cannot**" are to be interpreted as described in clause 3.2 of the [ETSI Drafting Rules](#) (Verbal forms for the expression of provisions).

"**must**" and "**must not**" are **NOT** allowed in ETSI deliverables except when used in direct citation.

# Contents

Intellectual Property Rights .....	2
Legal Notice .....	2
Modal verbs terminology.....	2
Foreword.....	22
Introduction .....	23
1 Scope .....	24
2 References .....	25
3 Definitions, symbols and abbreviations .....	27
3.1 Definitions .....	27
3.2 Symbols.....	27
3.3 Abbreviations .....	27
4 Overview .....	28
5 Services offered by the NSCE Server .....	30
5.1 Introduction .....	30
5.2 NSCE_SliceApiManagement .....	31
5.2.1 Service Description.....	31
5.2.2 Service Operations .....	32
5.2.2.1 Introduction.....	32
5.2.2.2 NSCE_SliceApiManagement_Configure.....	32
5.2.2.2.1 General .....	32
5.2.2.2.2 Slice API Configuration Creation.....	32
5.2.2.2.3 Slice API Configuration Deletion.....	33
5.2.2.3 NSCE_SliceApiManagement_Update .....	33
5.2.2.3.1 General .....	33
5.2.2.3.2 Slice API Configuration Update.....	33
5.2.2.4 NSCE_SliceApiManagement_Notify .....	34
5.2.2.4.1 General .....	34
5.2.2.4.2 Slice API Configuration Notification .....	34
5.2.2.5 NSCE_SliceApiManagement_Invoke.....	35
5.2.2.5.1 General .....	35
5.2.2.5.2 Slice API Invocation Request.....	35
5.3 NSCE_NetSliceLifeCycleMngt .....	35
5.3.1 Service Description.....	35
5.3.2 Service Operations .....	36
5.3.2.1 Introduction.....	36
5.3.2.2 NSCE_NetSliceLifeCycleMngt_Subscribe.....	36
5.3.2.2.1 General .....	36
5.3.2.2.2 Network Slice Lifecycle Management Subscription Creation.....	36
5.3.2.2.3 Network Slice Lifecycle Management Subscription Update.....	37
5.3.2.2.4 Network Slice Lifecycle Management Subscription Deletion.....	37
5.3.2.3 NSCE_NetSliceLifeCycleMngt_Notify.....	38
5.3.2.3.1 General .....	38
5.3.2.3.2 Network Slice Lifecycle Management Notification .....	38
5.3.2.4 NSCE_NetSliceLifeCycleMngt_QoEMetricsSubscribe .....	39
5.3.2.4.1 General .....	39
5.3.2.4.2 QoE Metrics Subscription Notification .....	39
5.3.2.5 NSCE_NetSliceLifeCycleMngt_QoEMetricsNotify .....	39
5.3.2.5.1 General .....	39
5.3.2.5.2 QoE Metrics Notification .....	40
5.3.2.6 NSCE_NetSliceLifeCycleMngt_Recommend .....	40
5.3.2.6.1 General .....	40
5.3.2.6.2 Network Slice LCM Recommendation Notification .....	40

5.4	NSCE_PolicyManagement.....	41
5.4.1	Service Description.....	41
5.4.2	Service Operations.....	41
5.4.2.1	Introduction.....	41
5.4.2.2	NSCE_PolicyManagement_Create.....	42
5.4.2.2.1	General.....	42
5.4.2.2.2	Policy Provisioning.....	42
5.4.2.3	NSCE_PolicyManagement_Update.....	43
5.4.2.3.1	General.....	43
5.4.2.3.2	Policy Update.....	43
5.4.2.4	NSCE_PolicyManagement_Delete.....	44
5.4.2.4.1	General.....	44
5.4.2.4.2	Policy(ies) Deletion.....	44
5.4.2.5	NSCE_PolicyManagement_HarmonizationNotify.....	44
5.4.2.5.1	General.....	44
5.4.2.5.2	Policy Harmonization Notification.....	45
5.4.2.6	NSCE_PolicyManagement_Subscribe.....	45
5.4.2.6.1	General.....	45
5.4.2.6.2	Policy Usage Subscription Creation.....	45
5.4.2.6.3	Policy Usage Subscription Update.....	46
5.4.2.6.4	Policy Usage Subscription Deletion.....	47
5.4.2.7	NSCE_PolicyManagement_Notify.....	47
5.4.2.7.1	General.....	47
5.4.2.7.2	Policy Usage Notification.....	47
5.5	NSCE_NSOptimization.....	48
5.5.1	Service Description.....	48
5.5.2	Service Operations.....	48
5.5.2.1	Introduction.....	48
5.5.2.2	NSCE_NSOptimization_Subscribe.....	49
5.5.2.2.1	General.....	49
5.5.2.2.2	Network Slice Optimization Subscription Creation.....	49
5.5.2.2.3	Network Slice Optimization Subscription Update.....	49
5.5.2.2.4	Network Slice Optimization Subscription Deletion.....	50
5.5.2.3	NSCE_NSOptimization_Notify.....	51
5.5.2.3.1	General.....	51
5.5.2.3.2	Network Slice Optimization Notification.....	51
5.6	NSCE_ManagementServiceDiscovery.....	51
5.6.1	Service Description.....	51
5.6.2	Service Operations.....	52
5.6.2.1	Introduction.....	52
5.6.2.2	NSCE_ManagementServiceDiscovery_Subscribe.....	52
5.6.2.2.1	General.....	52
5.6.2.2.2	Management Discovery Subscription Creation.....	52
5.6.2.2.3	Management Discovery Subscription Update.....	53
5.6.2.2.4	Management Discovery Subscription Deletion.....	53
5.6.2.3	NSCE_ManagementServiceDiscovery_Notify.....	54
5.6.2.3.1	General.....	54
5.6.2.3.2	Management Discovery Notification.....	54
5.7	NSCE_PerfMonitoring.....	54
5.7.1	Service Description.....	54
5.7.2	Service Operations.....	55
5.7.2.1	Introduction.....	55
5.7.2.2	NSCE_PerfMonitoring_Manage.....	55
5.7.2.2.1	General.....	55
5.7.2.2.2	Monitoring Job Creation.....	55
5.7.2.2.3	Monitoring Job Update.....	56
5.7.2.2.4	Monitoring Job Deletion.....	57
5.7.2.3	NSCE_PerfMonitoring_Subscribe.....	57
5.7.2.3.1	General.....	57
5.7.2.3.2	Monitoring Subscription Creation.....	57
5.7.2.3.3	Monitoring Subscription Update.....	58
5.7.2.3.4	Monitoring Subscription Deletion.....	59

5.7.2.4	NSCE_PerfMonitoring_Notify .....	59
5.7.2.4.1	General .....	59
5.7.2.4.2	Monitoring Notification.....	59
5.7.2.5	NSCE_PerfMonitoring_Request.....	60
5.7.2.5.1	General .....	60
5.7.2.5.2	Multiple Slices related Performance and Analytics Consolidated Reporting Request .....	60
5.8	NSCE_InfoCollection .....	61
5.8.1	Service Description.....	61
5.8.2	Service Operations.....	61
5.8.2.1	Introduction.....	61
5.8.2.2	NSCE_InfoCollection_Subscribe.....	61
5.8.2.2.1	General .....	61
5.8.2.2.2	Information Collection Subscription Creation.....	61
5.8.2.2.3	Information Collection Subscription Update.....	62
5.8.2.2.4	Information Collection Subscription Deletion.....	63
5.8.2.3	NSCE_InfoCollection_Notify.....	63
5.8.2.3.1	General .....	63
5.8.2.3.2	Information Collection Notification .....	63
5.9	NSCE_ServiceContinuity.....	64
5.9.1	Service Description.....	64
5.9.2	Service Operations.....	64
5.9.2.1	Introduction.....	64
5.9.2.2	NSCE_ServiceContinuity_Request.....	64
5.9.2.2.1	General .....	64
5.9.2.2.2	Edge service continuity requirement Request .....	65
5.9.2.3	NSCE_ServiceContinuity_Notify .....	65
5.9.2.3.1	General .....	65
5.9.2.3.2	Edge service continuity requirement Notification .....	65
5.9.2.4	NSCE_ServiceContinuity_Negotiate .....	66
5.9.2.4.1	General .....	66
5.9.2.4.2	Edge service continuity negotiation Request.....	66
5.9.2.5	NSCE_ServiceContinuity_NegotiateNotify.....	66
5.9.2.5.1	General .....	66
5.9.2.5.2	Edge service continuity negotiation Notification .....	67
5.10	NSCE_MultiSlicesOptimization .....	67
5.10.1	Service Description.....	67
5.10.2	Service Operations.....	67
5.10.2.1	Introduction.....	67
5.10.2.2	NSCE_MultiSlicesOptimization_Request .....	68
5.10.2.2.1	General .....	68
5.10.2.2.2	Multiple Slices Optimization Request .....	68
5.11	NSCE_NetworkSliceAdaptation .....	68
5.11.1	Service Description.....	68
5.11.2	Service Operations.....	68
5.11.2.1	Introduction.....	68
5.11.2.2	Network_slice_adaptation.....	69
5.11.2.2.1	General .....	69
5.11.2.2.2	Network Slice Adaptation Request.....	69
5.11.2.3	NSCE_NetworkSliceAdaptation_Notify.....	70
5.11.2.3.1	General .....	70
5.11.2.3.2	Network Slice Adaptation Status Notification.....	70
5.12	NSCE_SliceCommService.....	70
5.12.1	Service Description.....	70
5.12.2	Service Operations.....	71
5.12.2.1	Introduction.....	71
5.12.2.2	NSCE_SliceCommService_Create .....	71
5.12.2.2.1	General .....	71
5.12.2.2.2	Slice Related Communication Service Creation.....	71
5.12.2.3	NSCE_SliceCommService_Reconfigure .....	72
5.12.2.3.1	General .....	72
5.12.2.3.2	Slice Related Communication Service Reconfiguration.....	72
5.12.2.4	NSCE_SliceCommService_Disengage .....	73

5.12.2.4.1	General .....	73
5.12.2.4.2	Slice Related Communication Service Disengagement.....	73
5.13	NSCE_InterPLMNContinuity .....	73
5.13.1	Service Description.....	73
5.13.2	Service Operations.....	73
5.13.2.1	Introduction.....	73
5.13.2.2	NSCE_InterPLMNContinuity_Request .....	74
5.13.2.2.1	General .....	74
5.13.2.2.2	Inter-PLMN Application Service Continuity Request.....	74
5.13.2.3	NSCE_InterPLMNContinuity_Notify.....	74
5.13.2.3.1	General .....	74
5.13.2.3.2	Inter-PLMN Service Continuity Notification.....	75
5.14	NSCE_NS.Diagnostics.....	75
5.14.1	Service Description.....	75
5.14.2	Service Operations.....	75
5.14.2.1	Introduction.....	75
5.14.2.2	NSCE_NS.Diagnostics_Request.....	75
5.14.2.2.1	General .....	75
5.14.2.2.2	Network Slice Diagnostics Request.....	76
5.15	NSCE_FaultDiagnosis.....	76
5.15.1	Service Description.....	76
5.15.2	Service Operations.....	76
5.15.2.1	Introduction.....	76
5.15.2.2	NSCE_FaultDiagnosis_Subscribe.....	77
5.15.2.2.1	General .....	77
5.15.2.2.2	Network Slice Fault Diagnosis Subscription Creation .....	77
5.15.2.2.3	Network Slice Fault Diagnosis Subscription Update.....	77
5.15.2.2.4	Network Slice Fault Diagnosis Subscription Deletion .....	78
5.15.2.3	NSCE_FaultDiagnosis_Notify .....	79
5.15.2.3.1	General .....	79
5.15.2.3.2	Network Slice Fault Diagnosis Notification.....	79
5.16	NSCE_SliceReqVerifyAndAlign .....	79
5.16.1	Service Description.....	79
5.16.2	Service Operations.....	80
5.16.2.1	Introduction.....	80
5.16.2.2	NSCE_SliceReqVerifyAndAlign_Subscribe .....	80
5.16.2.2.1	General .....	80
5.16.2.2.2	Network Slice Requirements Verification and Alignment Subscription Creation .....	80
5.16.2.2.3	Network Slice Requirements Verification and Alignment Subscription Update.....	81
5.16.2.2.4	Network Slice Requirements Verification and Alignment Subscription Deletion .....	81
5.16.2.3	NSCE_SliceReqVerifyAndAlign_Notify .....	82
5.16.2.3.1	General .....	82
5.16.2.3.2	Network Slice Requirements Verification and Alignment Notification.....	82
5.17	NSCE_NSInfoDelivery .....	83
5.17.1	Service Description.....	83
5.17.2	Service Operations.....	83
5.17.2.1	Introduction.....	83
5.17.2.2	NSCE_NSInfoDelivery_Request .....	83
5.17.2.2.1	General .....	83
5.17.2.2.2	Network Slice Information Retrieval.....	83
5.17.2.2.3	Network Slice Information Delivery .....	84
5.18	Void.....	85
5.19	NSCE_NSAllocation.....	85
5.19.1	Service Description.....	85
5.19.2	Service Operations.....	85
5.19.2.1	Introduction.....	85
5.19.2.2	NSCE_NSAllocation_Request.....	85
5.19.2.2.1	General .....	85
5.19.2.2.2	Network Slice Allocation Request.....	85
6	API Definitions .....	87
6.1	NSCE_SliceApiManagement API.....	87

6.1.1	Introduction.....	87
6.1.2	Usage of HTTP.....	87
6.1.3	Resources.....	87
6.1.3.1	Overview.....	87
6.1.3.2	Resource: Slice API Configurations.....	88
6.1.3.2.1	Description.....	88
6.1.3.2.2	Resource Definition.....	88
6.1.3.2.3	Resource Standard Methods.....	89
6.1.3.2.3.1	POST.....	89
6.1.3.2.4	Resource Custom Operations.....	89
6.1.3.3	Resource: Individual Slice API Configuration.....	89
6.1.3.3.1	Description.....	89
6.1.3.3.2	Resource Definition.....	89
6.1.3.3.3	Resource Standard Methods.....	90
6.1.3.3.3.1	GET.....	90
6.1.3.3.3.2	DELETE.....	91
6.1.3.3.4	Resource Custom Operations.....	92
6.1.3.3.4.1	Overview.....	92
6.1.3.3.4.2	Operation: Update.....	92
6.1.3.3.4.2.1	Description.....	92
6.1.3.3.4.2.2	Operation Definition.....	92
6.1.4	Custom Operations without associated resources.....	93
6.1.4.1	Overview.....	93
6.1.4.2	Operation: Invoke.....	94
6.1.4.2.1	Description.....	94
6.1.4.2.2	Operation Definition.....	94
6.1.5	Notifications.....	95
6.1.5.1	General.....	95
6.1.5.2	Slice API Configuration Notification.....	95
6.1.5.2.1	Description.....	95
6.1.5.2.2	Target URI.....	95
6.1.5.2.3	Standard Methods.....	95
6.1.6	Data Model.....	96
6.1.6.1	General.....	96
6.1.6.2	Structured data types.....	97
6.1.6.2.1	Introduction.....	97
6.1.6.2.2	Type: SliceAPIConfig.....	97
6.1.6.2.3	Type: AppServReqs.....	98
6.1.6.2.4	Type: UpdateReq.....	98
6.1.6.2.5	Type: UpdateResp.....	98
6.1.6.2.6	Type: SliceAPIInfo.....	99
6.1.6.2.7	Type: InvokeReq.....	99
6.1.6.2.8	Type: SliceAPIConfigNotif.....	99
6.1.6.3	Simple data types and enumerations.....	99
6.1.6.3.1	Introduction.....	99
6.1.6.3.2	Simple data types.....	99
6.1.6.3.3	Enumeration: TriggerEvent.....	99
6.1.6.4	Data types describing alternative data types or combinations of data types.....	100
6.1.6.5	Binary data.....	100
6.1.6.5.1	Binary Data Types.....	100
6.1.7	Error Handling.....	100
6.1.7.1	General.....	100
6.1.7.2	Protocol Errors.....	100
6.1.7.3	Application Errors.....	100
6.1.8	Feature negotiation.....	100
6.1.9	Security.....	101
6.2	NSCE_NetSliceLifeCycleMngt API.....	101
6.2.1	Introduction.....	101
6.2.2	Usage of HTTP.....	101
6.2.3	Resources.....	101
6.2.3.1	Overview.....	101
6.2.3.2	Resource: Network Slice Lifecycle Management Subscriptions.....	102



6.2.3.2.1	Description .....	102
6.2.3.2.2	Resource Definition .....	102
6.2.3.2.3	Resource Standard Methods .....	103
6.2.3.2.3.2	POST .....	103
6.2.3.2.4	Resource Custom Operations .....	103
6.2.3.3	Resource: Individual Network Slice Lifecycle Management Subscription .....	104
6.2.3.3.1	Description .....	104
6.2.3.3.2	Resource Definition .....	104
6.2.3.3.3	Resource Standard Methods .....	104
6.2.3.3.3.1	GET .....	104
6.2.3.3.3.2	PUT .....	105
6.2.3.3.3.3	PATCH .....	106
6.2.3.3.3.4	DELETE .....	107
6.2.3.3.4	Resource Custom Operations .....	108
6.2.3.3.4.1	Overview .....	108
6.2.3.3.4.2	Operation: QoEMetricNotify .....	109
6.2.3.3.4.2.1	Description .....	109
6.2.3.3.4.2.2	Operation Definition .....	109
6.2.4	Custom Operations without associated resources .....	110
6.2.5	Notifications .....	110
6.2.5.1	General .....	110
6.2.5.2	Network Slice Lifecycle Management Notification .....	110
6.2.5.2.1	Description .....	110
6.2.5.2.2	Target URI .....	110
6.2.5.2.3	Standard Methods .....	110
6.2.5.2.3.1	POST .....	110
6.2.5.3	QoE metrics Subscribe Notification .....	111
6.2.5.3.1	Description .....	111
6.2.5.3.2	Target URI .....	111
6.2.5.3.3	Standard Methods .....	112
6.2.5.3.3.1	POST .....	112
6.2.5.4	Network Slice LCM Recommendation Notification .....	113
6.2.5.4.1	Description .....	113
6.2.5.4.2	Target URI .....	113
6.2.5.4.3	Standard Methods .....	113
6.2.5.4.3.1	POST .....	113
6.2.6	Data Model .....	114
6.2.6.1	General .....	114
6.2.6.2	Structured data types .....	115
6.2.6.2.0	Introduction .....	115
6.2.6.2.1	Type: NSLCMSubsc .....	116
6.2.6.2.2	Type: NSLCMSubscPatch .....	116
6.2.6.2.3	Type: NSLCMNotif .....	117
6.2.6.2.4	Type: QoEMetricsSubsc .....	117
6.2.6.2.5	Type: QoEMetricsResp .....	117
6.2.6.2.6	Type: QoEMetricsReport .....	117
6.2.6.2.7	Type: NSLCMRecom .....	118
6.2.6.2.8	Type: CollectInfo .....	118
6.2.6.2.9	Type: TriggerCond .....	118
6.2.6.2.10	Type: QoEMetric .....	119
6.2.6.2.11	Type: QoEMetricsReportNotif .....	119
6.2.6.3	Simple data types and enumerations .....	119
6.2.6.3.1	Introduction .....	119
6.2.6.3.2	Simple data types .....	119
6.2.6.3.3	Enumeration: QoEType .....	120
6.2.6.3.4	Enumeration: TriggerType .....	120
6.2.6.3.5	Enumeration: SliceLCMAction .....	120
6.2.6.4	Data types describing alternative data types or combinations of data types .....	120
6.2.6.5	Binary data .....	120
6.2.6.5.1	Binary Data Types .....	120
6.2.7	Error Handling .....	120
6.2.7.1	General .....	120

6.2.7.2	Protocol Errors .....	121
6.2.7.3	Application Errors .....	121
6.2.8	Feature negotiation .....	121
6.2.9	Security .....	121
6.3	NSCE_PolicyManagement API .....	121
6.3.1	Introduction.....	121
6.3.2	Usage of HTTP.....	122
6.3.3	Resources.....	122
6.3.3.1	Overview.....	122
6.3.3.2	Resource: Policies .....	123
6.3.3.2.1	Description .....	123
6.3.3.2.2	Resource Definition.....	123
6.3.3.2.3	Resource Standard Methods .....	123
6.3.3.2.3.1	POST.....	123
6.3.3.2.4	Resource Custom Operations .....	124
6.3.3.2.4.1	Overview.....	124
6.3.3.2.4.2	Operation: Delete .....	124
6.3.3.2.4.2.1	Description .....	124
6.3.3.2.4.2.2	Operation Definition .....	124
6.3.3.3	Resource: Individual Policy .....	125
6.3.3.3.1	Description .....	125
6.3.3.3.2	Resource Definition.....	125
6.3.3.3.3	Resource Standard Methods .....	126
6.3.3.3.3.1	GET.....	126
6.3.3.3.3.2	PUT.....	127
6.3.3.3.3.3	PATCH .....	128
6.3.3.3.4	Resource Custom Operations .....	129
6.3.3.4	Resource: Policy Usage Subscriptions .....	129
6.3.3.4.1	Description .....	129
6.3.3.4.2	Resource Definition.....	129
6.3.3.4.3	Resource Standard Methods .....	130
6.3.3.4.3.2	POST.....	130
6.3.3.4.4	Resource Custom Operations .....	130
6.3.3.5	Resource: Individual Policy Usage Subscription .....	130
6.3.3.5.1	Description .....	130
6.3.3.5.2	Resource Definition.....	131
6.3.3.5.3	Resource Standard Methods .....	131
6.3.3.5.3.1	GET.....	131
6.3.3.5.3.2	PUT.....	132
6.3.3.5.3.3	PATCH .....	133
6.3.3.5.3.4	DELETE .....	134
6.3.3.5.4	Resource Custom Operations .....	135
6.3.4	Custom Operations without associated resources .....	135
6.3.5	Notifications .....	135
6.3.5.1	General .....	135
6.3.5.2	Policy Usage Notification .....	136
6.3.5.2.1	Description .....	136
6.3.5.2.2	Target URI.....	136
6.3.5.2.3	Standard Methods.....	136
6.3.5.3	Policy Harmonization Notification .....	137
6.3.5.3.1	Description .....	137
6.3.5.3.2	Target URI.....	137
6.3.5.3.3	Standard Methods.....	138
6.3.6	Data Model .....	139
6.3.6.1	General .....	139
6.3.6.2	Structured data types .....	140
6.3.6.2.1	Introduction .....	140
6.3.6.2.2	Type: Policy .....	141
6.3.6.2.3	Type: PolicyPatch.....	143
6.3.6.2.4	Type: PolicyData.....	144
6.3.6.2.5	Type: PolUsageSubsc.....	144
6.3.6.2.6	Type: PolUsageSubscPatch .....	144

6.3.6.2.7	Type: ReqPolRep.....	145
6.3.6.2.8	Type: PolUsageNotif .....	145
6.3.6.2.9	Type: PolRepData .....	145
6.3.6.2.10	Type: PolDeleteReq.....	146
6.3.6.2.11	Type: PolDeleteResp .....	146
6.3.6.2.12	Type: DefaultPolInfo.....	146
6.3.6.2.13	Type: HarmonizationNotif .....	147
6.3.6.2.14	Type: HarmonizationResp.....	147
6.3.6.2.15	Type: NetSliceId.....	147
6.3.6.2.16	Type: PolicyTriggers .....	148
6.3.6.2.17	Type: PolicyActions .....	151
6.3.6.2.18	Type: TimePeriodInfo .....	152
6.3.6.3	Simple data types and enumerations .....	152
6.3.6.3.1	Introduction .....	152
6.3.6.3.2	Simple data types.....	152
6.3.6.3.3	Enumeration: PolicyType .....	152
6.3.6.3.4	Enumeration: QoSAction .....	153
6.3.6.4	Data types describing alternative data types or combinations of data types .....	153
6.3.6.5	Binary data .....	153
6.3.6.5.1	Binary Data Types .....	153
6.3.7	Error Handling .....	153
6.3.7.1	General .....	153
6.3.7.2	Protocol Errors .....	153
6.3.7.3	Application Errors.....	153
6.3.8	Feature negotiation .....	154
6.3.9	Security .....	154
6.4	NSCE_NSOptimization API .....	154
6.4.1	Introduction.....	154
6.4.2	Usage of HTTP.....	155
6.4.3	Resources.....	155
6.4.3.1	Overview.....	155
6.4.3.2	Resource: Network Slice Optimization Subscriptions .....	156
6.4.3.2.1	Description .....	156
6.4.3.2.2	Resource Definition.....	156
6.4.3.2.3	Resource Standard Methods .....	156
6.4.3.2.3.1	POST.....	156
6.4.3.2.4	Resource Custom Operations .....	157
6.4.3.3	Resource: Individual Network Slice Optimization Subscription.....	157
6.4.3.3.1	Description .....	157
6.4.3.3.2	Resource Definition.....	157
6.4.3.3.3	Resource Standard Methods .....	157
6.4.3.3.3.1	GET.....	157
6.4.3.3.3.2	PUT.....	158
6.4.3.3.3.3	PATCH .....	159
6.4.3.3.3.4	DELETE .....	160
6.4.3.3.4	Resource Custom Operations .....	161
6.4.4	Custom Operations without associated resources .....	161
6.4.5	Notifications .....	161
6.4.5.1	General .....	161
6.4.5.2	Network Slice Optimization Notification.....	162
6.4.5.2.1	Description .....	162
6.4.5.2.2	Target URI.....	162
6.4.5.2.3	Standard Methods .....	162
6.4.5.2.3.1	POST.....	162
6.4.6	Data Model .....	163
6.4.6.1	General .....	163
6.4.6.2	Structured data types .....	164
6.4.6.2.1	Introduction .....	164
6.4.6.2.2	Type: NetSliceOptSubsc.....	165
6.4.6.2.3	Type: NetSliceOptSubscPatch.....	166
6.4.6.2.4	Type: NetSliceOptNotif.....	166
6.4.6.3	Simple data types and enumerations .....	167

6.4.6.3.1	Introduction .....	167
6.4.6.3.2	Simple data types.....	167
6.4.6.4	Data types describing alternative data types or combinations of data types .....	167
6.4.6.5	Binary data .....	167
6.4.6.5.1	Binary Data Types .....	167
6.4.7	Error Handling .....	167
6.4.7.1	General .....	167
6.4.7.2	Protocol Errors .....	167
6.4.7.3	Application Errors.....	167
6.4.8	Feature negotiation .....	167
6.4.9	Security .....	168
6.5	NSCE_ManagementServiceDiscovery API .....	168
6.5.1	Introduction.....	168
6.5.2	Usage of HTTP .....	168
6.5.3	Resources.....	168
6.5.3.1	Overview.....	168
6.5.3.2	Resource: Management Discovery Subscription.....	169
6.5.3.2.1	Description .....	169
6.5.3.2.2	Resource Definition.....	169
6.5.3.2.3	Resource Standard Methods .....	170
6.5.3.2.3.2	POST.....	170
6.5.3.2.4	Resource Custom Operations .....	170
6.5.3.3	Resource: Individual Management Discovery Subscription .....	170
6.5.3.3.1	Description .....	170
6.5.3.3.2	Resource Definition.....	170
6.5.3.3.3	Resource Standard Methods .....	171
6.5.3.3.3.1	GET.....	171
6.5.3.3.3.2	PUT.....	172
6.5.3.3.3.3	PATCH.....	173
6.5.3.3.3.4	DELETE .....	174
6.5.3.3.4	Resource Custom Operations .....	175
6.5.4	Custom Operations without associated resources .....	175
6.5.5	Notifications .....	175
6.5.5.1	General .....	175
6.5.5.2	Management discovery Notification .....	176
6.5.5.2.1	Description .....	176
6.5.5.2.2	Target URI.....	176
6.5.5.2.3	Standard Methods.....	176
6.5.6	Data Model .....	177
6.5.6.1	General .....	177
6.5.6.2	Structured data types .....	178
6.5.6.2.1	Introduction .....	178
6.5.6.2.2	Type: MnSDiscSubsc .....	179
6.5.6.2.3	Type: MnSDiscSubscPatch .....	179
6.5.6.2.4	Type: MnSDiscNotif .....	179
6.5.6.2.5	Type: MnSInfo .....	180
6.5.6.2.6	Type: ExpCapReqs.....	180
6.5.6.3	Simple data types and enumerations .....	180
6.5.6.3.1	Introduction .....	180
6.5.6.3.2	Simple data types.....	180
6.5.6.3.3	Enumeration: MnSPermission .....	180
6.5.6.3.4	Enumeration: ExpCapType .....	181
6.5.6.4	Data types describing alternative data types or combinations of data types .....	181
6.5.6.5	Binary data .....	181
6.5.6.5.1	Binary Data Types .....	181
6.5.7	Error Handling .....	181
6.5.7.1	General .....	181
6.5.7.2	Protocol Errors .....	181
6.5.7.3	Application Errors.....	181
6.5.8	Feature negotiation .....	182
6.5.9	Security .....	182
6.6	NSCE_PerfMonitoring API.....	182

6.6.1	Introduction.....	182
6.6.2	Usage of HTTP.....	182
6.6.3	Resources.....	182
6.6.3.1	Overview.....	182
6.6.3.2	Resource: Monitoring Jobs.....	184
6.6.3.2.1	Description.....	184
6.6.3.2.2	Resource Definition.....	184
6.6.3.2.3	Resource Standard Methods.....	184
6.6.3.2.3.1	POST.....	184
6.6.3.2.4	Resource Custom Operations.....	185
6.6.3.3	Resource: Individual Monitoring Job.....	185
6.6.3.3.1	Description.....	185
6.6.3.3.2	Resource Definition.....	185
6.6.3.3.3	Resource Standard Methods.....	185
6.6.3.3.3.1	GET.....	185
6.6.3.3.3.2	PUT.....	186
6.6.3.3.3.3	PATCH.....	187
6.6.3.3.3.4	DELETE.....	188
6.6.3.3.4	Resource Custom Operations.....	189
6.6.3.4	Resource: Monitoring Subscriptions.....	189
6.6.3.4.1	Description.....	189
6.6.3.4.2	Resource Definition.....	189
6.6.3.4.3	Resource Standard Methods.....	190
6.6.3.4.3.2	POST.....	190
6.6.3.4.4	Resource Custom Operations.....	190
6.6.3.5	Resource: Individual Monitoring Subscription.....	191
6.6.3.5.1	Description.....	191
6.6.3.5.2	Resource Definition.....	191
6.6.3.5.3	Resource Standard Methods.....	191
6.6.3.5.3.1	GET.....	191
6.6.3.5.3.2	PUT.....	192
6.6.3.5.3.3	PATCH.....	193
6.6.3.5.3.4	DELETE.....	194
6.6.4	Custom Operations without associated resources.....	195
6.6.4.1	Overview.....	195
6.6.4.2	Operation: Request.....	196
6.6.4.2.1	Description.....	196
6.6.4.2.2	Operation Definition.....	196
6.6.5	Notifications.....	197
6.6.5.1	General.....	197
6.6.5.2	Monitoring Notification.....	197
6.6.5.2.1	Description.....	197
6.6.5.2.2	Target URI.....	198
6.6.5.2.3	Standard Methods.....	198
6.6.5.2.3.1	POST.....	198
6.6.6	Data Model.....	199
6.6.6.1	General.....	199
6.6.6.2	Structured data types.....	200
6.6.6.2.1	Introduction.....	200
6.6.6.2.2	Type: MonitoringJob.....	200
6.6.6.2.3	Type: MonitoringJobPatch.....	200
6.6.6.2.4	Type: MonitoringMetric.....	201
6.6.6.2.5	Type: MonPerfAnalytics.....	201
6.6.6.2.6	Type: MonitoringSubsc.....	202
6.6.6.2.7	Type: MonitoringSubscPatch.....	202
6.6.6.2.8	Type: ReportingInfo.....	203
6.6.6.2.9	Type: MonitoringNotif.....	203
6.6.6.2.10	Type: ReportingData.....	204
6.6.6.2.11	Type: MonPerfAnalyRes.....	204
6.6.6.2.12	Type: MonitoringReq.....	204
6.6.6.2.13	Type: MonitoringResp.....	205
6.6.6.2.14	Type: MonReqMetrics.....	205

6.6.6.2.15	Type: MonRespRepData .....	206
6.6.6.3	Simple data types and enumerations .....	206
6.6.6.3.1	Introduction .....	206
6.6.6.3.2	Simple data types.....	206
6.6.6.3.3	Enumeration: MonPerfMetric.....	206
6.6.6.4	Data types describing alternative data types or combinations of data types .....	207
6.6.6.5	Binary data .....	207
6.6.6.5.1	Binary Data Types .....	207
6.6.7	Error Handling .....	207
6.6.7.1	General .....	207
6.6.7.2	Protocol Errors .....	207
6.6.7.3	Application Errors.....	207
6.6.8	Feature negotiation .....	208
6.6.9	Security .....	208
6.7	NSCE_InfoCollection API .....	208
6.7.1	Introduction.....	208
6.7.2	Usage of HTTP.....	208
6.7.3	Resources .....	208
6.7.3.1	Overview .....	208
6.7.3.2	Resource: Information Collection Subscriptions.....	209
6.7.3.2.1	Description .....	209
6.7.3.2.2	Resource Definition.....	209
6.7.3.2.3	Resource Standard Methods .....	210
6.7.3.2.3.1	POST.....	210
6.7.3.2.4	Resource Custom Operations .....	210
6.7.3.3	Resource: Individual Information Collection Subscription.....	210
6.7.3.3.1	Description .....	210
6.7.3.3.2	Resource Definition.....	210
6.7.3.3.3	Resource Standard Methods .....	211
6.7.3.3.3.1	GET.....	211
6.7.3.3.3.2	PUT.....	212
6.7.3.3.3.3	PATCH .....	213
6.7.3.3.3.4	DELETE .....	214
6.7.3.3.4	Resource Custom Operations .....	215
6.7.4	Custom Operations without associated resources .....	215
6.7.5	Notifications .....	215
6.7.5.1	General .....	215
6.7.5.2	Information Collection Notification.....	216
6.7.5.2.1	Description .....	216
6.7.5.2.2	Target URI.....	216
6.7.5.2.3	Standard Methods .....	216
6.7.5.2.3.1	POST.....	216
6.7.6	Data Model .....	217
6.7.6.1	General .....	217
6.7.6.2	Structured data types .....	218
6.7.6.2.1	Introduction .....	218
6.7.6.2.2	Type: InfoCollectSubsc .....	218
6.7.6.2.3	Type: InfoCollectSubscPatch .....	219
6.7.6.2.4	Type: InfoCollectNotif .....	219
6.7.6.2.5	Type: CollectInfo.....	219
6.7.6.2.6	Type: QoSMetric .....	220
6.7.6.3	Simple data types and enumerations .....	220
6.7.6.3.1	Introduction .....	220
6.7.6.3.2	Simple data types.....	220
6.7.6.3.3	Enumeration: QoSType .....	220
6.7.6.4	Data types describing alternative data types or combinations of data types .....	220
6.7.6.5	Binary data .....	221
6.7.6.5.1	Binary Data Types .....	221
6.7.7	Error Handling .....	221
6.7.7.1	General .....	221
6.7.7.2	Protocol Errors .....	221
6.7.7.3	Application Errors.....	221

6.7.8	Feature negotiation .....	221
6.7.9	Security .....	221
6.8	NSCE_ServiceContinuity API .....	221
6.8.3	Resources .....	222
6.8.4	Custom Operations without associated resources .....	222
6.8.4.1	Overview .....	222
6.8.4.2	Operation: Edge Service Continuity Requirement Request .....	223
6.8.4.2.1	Description .....	223
6.8.4.2.2	Operation Definition .....	223
6.8.4.3	Operation: Edge Service Continuity Negotiation Request .....	224
6.8.4.2.1	Description .....	224
6.8.4.2.2	Operation Definition .....	224
6.8.5	Notifications .....	225
6.8.5.2.3	Standard Methods .....	226
6.8.5.2.3.1	POST .....	226
6.8.5.3.3	Standard Methods .....	227
6.8.5.3.3.1	POST .....	227
6.8.6	Data Model .....	228
6.8.6.1	General .....	228
6.8.6.2	Structured data types .....	229
6.8.6.2.1	Introduction .....	229
6.8.6.2.2	Type: EdgeSCRequirementReq .....	229
6.8.6.2.3	Type: EdgeSCRequirementNotif .....	230
6.8.6.2.4	Type: EdgeSCNegotiationReq .....	230
6.8.6.2.5	Type: EdgeSCNegotiationNotif .....	230
6.8.6.3.3	Enumeration: TriggerAction .....	231
6.8.7	Error Handling .....	231
6.8.7.1	General .....	231
6.8.7.2	Protocol Errors .....	231
6.8.7.3	Application Errors .....	231
6.8.8	Feature negotiation .....	231
6.8.9	Security .....	231
6.9	NSCE_MultiSlicesOptimization API .....	232
6.9.1	Introduction .....	232
6.9.2	Usage of HTTP .....	232
6.9.3	Resources .....	232
6.9.4	Custom Operations without associated resources .....	232
6.9.4.1	Overview .....	232
6.9.4.2	Operation: Request .....	233
6.9.4.2.1	Description .....	233
6.9.4.2.2	Operation Definition .....	233
6.9.5	Notifications .....	234
6.9.6	Data Model .....	234
6.9.6.1	General .....	234
6.9.6.2	Structured data types .....	234
6.9.6.2.1	Introduction .....	234
6.9.6.2.2	Type: MultiSlicesOptReq .....	235
6.9.6.3	Simple data types and enumerations .....	235
6.9.6.3.1	Introduction .....	235
6.9.6.3.2	Simple data types .....	235
6.9.6.4	Data types describing alternative data types or combinations of data types .....	235
6.9.6.5	Binary data .....	235
6.9.6.5.1	Binary Data Types .....	235
6.9.7	Error Handling .....	235
6.9.7.1	General .....	235
6.9.7.2	Protocol Errors .....	236
6.9.7.3	Application Errors .....	236
6.9.8	Feature negotiation .....	236
6.9.9	Security .....	236
6.10	NSCE_NetworkSliceAdaptation API .....	236
6.10.1	Introduction .....	236
6.10.2	Usage of HTTP .....	237

6.10.3	Resources .....	237
6.10.4	Custom Operations without associated resources .....	237
6.10.4.1	Overview .....	237
6.10.4.2	Operation: Request .....	237
6.10.4.2.1	Description .....	237
6.10.4.2.2	Operation Definition .....	237
6.10.5	Notifications .....	238
6.10.5.1	General .....	238
6.10.5.2	Network Slice Adaptation Status Notification .....	239
6.10.5.2.1	Description .....	239
6.10.5.2.2	Target URI .....	239
6.10.5.2.3	Standard Methods .....	239
6.10.6	Data Model .....	240
6.10.6.1	General .....	240
6.10.6.2	Structured data types .....	241
6.10.6.2.1	Introduction .....	241
6.10.6.2.2	Type: NwSliceAdptInfo .....	241
6.10.6.2.3	Type: AdaptThreshold .....	241
6.10.6.2.4	Type: AdaptStatusNotif .....	242
6.10.6.3	Simple data types and enumerations .....	242
6.10.6.3.1	Introduction .....	242
6.10.6.3.2	Simple data types .....	242
6.10.6.4	Data types describing alternative data types or combinations of data types .....	243
6.10.6.4.1	Type: ProblemDetailsSliceAdapt .....	243
6.10.6.5	Binary data .....	243
6.10.6.5.1	Binary Data Types .....	243
6.10.7	Error Handling .....	244
6.10.7.1	General .....	244
6.10.7.2	Protocol Errors .....	244
6.10.7.3	Application Errors .....	244
6.10.8	Feature negotiation .....	244
6.10.9	Security .....	244
6.11	NSCE_SliceCommService API .....	244
6.11.1	Introduction .....	244
6.11.2	Usage of HTTP .....	245
6.11.3	Resources .....	245
6.11.3.1	Overview .....	245
6.11.3.2	Resource: Slice Related Communication Services .....	246
6.11.3.2.1	Description .....	246
6.11.3.2.2	Resource Definition .....	246
6.11.3.2.3	Resource Standard Methods .....	246
6.11.3.2.3.1	POST .....	246
6.11.3.2.4	Resource Custom Operations .....	247
6.11.3.3	Resource: Individual Slice Related Communication Service .....	247
6.11.3.3.1	Description .....	247
6.11.3.3.2	Resource Definition .....	247
6.11.3.3.3	Resource Standard Methods .....	247
6.11.3.3.3.1	GET .....	247
6.11.3.3.3.2	PUT .....	248
6.11.3.3.3.3	PATCH .....	249
6.11.3.3.3.4	DELETE .....	251
6.11.3.3.4	Resource Custom Operations .....	251
6.11.4	Custom Operations without associated resources .....	252
6.11.5	Notifications .....	252
6.11.6	Data Model .....	252
6.11.6.1	General .....	252
6.11.6.2	Structured data types .....	252
6.11.6.2.1	Introduction .....	252
6.11.6.2.2	Type: SliceCommService .....	253
6.11.6.2.3	Type: SliceCommServicePatch .....	253
6.11.6.2.4	Type: ServReq .....	253
6.11.6.2.5	Type: NetSliceInfo .....	254



6.11.6.3	Simple data types and enumerations .....	254
6.11.6.3.1	Introduction .....	254
6.11.6.3.2	Simple data types.....	254
6.11.6.4	Data types describing alternative data types or combinations of data types .....	254
6.11.6.5	Binary data .....	254
6.11.6.5.1	Binary Data Types.....	254
6.11.7	Error Handling .....	254
6.11.7.1	General .....	254
6.11.7.2	Protocol Errors .....	254
6.11.7.3	Application Errors.....	255
6.11.8	Feature negotiation .....	255
6.11.9	Security .....	255
6.12	NSCE_InterPLMNContinuity API.....	255
6.12.1	Introduction.....	255
6.12.2	Usage of HTTP .....	255
6.12.3	Resources.....	256
6.12.4	Custom Operations without associated resources .....	256
6.12.4.1	Overview .....	256
6.12.4.2	Operation: Request.....	256
6.12.4.2.1	Description .....	256
6.12.4.2.2	Operation Definition.....	256
6.12.5	Notifications .....	257
6.12.5.1	General .....	257
6.12.5.2	Monitoring Notification .....	258
6.12.5.2.1	Description .....	258
6.12.5.2.2	Target URI.....	258
6.12.5.2.3	Standard Methods.....	258
6.12.5.2.3.1	POST.....	258
6.12.6	Data Model .....	259
6.12.6.1	General .....	259
6.12.6.2	Structured data types .....	259
6.12.6.2.1	Introduction .....	259
6.12.6.2.2	Type: InterPlmnServContReq .....	260
6.12.6.2.3	Type: AppReqs.....	260
6.12.6.2.4	Type: InterPlmnServContNotif .....	261
6.12.6.3	Simple data types and enumerations .....	261
6.12.6.3.1	Introduction .....	261
6.12.6.3.2	Simple data types.....	261
6.12.6.3.3	Enumeration: ServContReq.....	261
6.12.6.4	Data types describing alternative data types or combinations of data types .....	261
6.12.6.5	Binary data .....	262
6.12.6.5.1	Binary Data Types.....	262
6.12.7	Error Handling .....	262
6.12.7.1	General .....	262
6.12.7.2	Protocol Errors .....	262
6.12.7.3	Application Errors.....	262
6.12.8	Feature negotiation .....	262
6.12.9	Security .....	262
6.13	NSCE_NSDDiagnostics API .....	263
6.13.1	Introduction.....	263
6.13.2	Usage of HTTP .....	263
6.13.3	Resources.....	263
6.13.4	Custom Operations without associated resources .....	263
6.13.4.1	Overview .....	263
6.13.4.2	Operation: Request.....	264
6.13.4.2.1	Description .....	264
6.13.4.2.2	Operation Definition.....	264
6.13.5	Notifications .....	265
6.13.6	Data Model .....	265
6.13.6.1	General .....	265
6.13.6.2	Structured Data Types.....	265
6.13.6.2.1	Introduction .....	265

6.13.6.2.2	Type: NwSliceDiagReq .....	266
6.13.6.2.3	Type: NwSliceDiagResp .....	266
6.13.6.2.4	Type: ServDgradInfo .....	266
6.13.6.2.5	Type: ErrorInfo .....	266
6.13.6.2.6	Type: DataReport .....	267
6.13.6.3	Simple data types and enumerations .....	267
6.13.6.3.1	Introduction .....	267
6.13.6.3.2	Simple data types .....	267
6.13.6.3.3	Enumeration: Error .....	267
6.13.6.3.4	Enumeration: DataType .....	267
6.13.6.4	Data types describing alternative data types or combinations of data types .....	267
6.13.6.5	Binary data .....	268
6.13.6.5.1	Binary Data Types .....	268
6.13.7	Error Handling .....	268
6.13.7.1	General .....	268
6.13.7.2	Protocol Errors .....	268
6.13.7.3	Application Errors .....	268
6.13.8	Feature Negotiation .....	268
6.13.9	Security .....	268
6.14	NSCE_FaultDiagnosis API .....	268
6.14.1	Introduction .....	268
6.14.3	Resources .....	269
6.14.3.1	Overview .....	269
6.14.3.2	Resource: Network Slice Fault Diagnosis Subscriptions .....	270
6.14.3.2.1	Description .....	270
6.14.3.2.2	Resource Definition .....	270
6.14.3.2.3	Resource Standard Methods .....	270
6.14.3.2.3.1	POST .....	270
6.14.3.2.4	Resource Custom Operations .....	271
6.14.3.3	Resource: Individual Network Slice Fault Diagnosis Subscription .....	271
6.14.3.3.1	Description .....	271
6.14.3.3.2	Resource Definition .....	271
6.14.3.3.3	Resource Standard Methods .....	271
6.14.3.3.3.1	GET .....	271
6.14.3.3.3.2	PUT .....	272
6.14.3.3.3.3	PATCH .....	274
6.14.3.3.3.4	DELETE .....	275
6.14.3.3.4	Resource Custom Operations .....	276
6.14.4	Custom Operations without associated resources .....	276
6.14.5	Notifications .....	276
6.14.5.1	General .....	276
6.14.5.2	Network Slice Fault Diagnosis Notification .....	276
6.14.5.2.1	Description .....	276
6.14.5.2.2	Target URI .....	276
6.14.5.2.3	Standard Methods .....	276
6.14.5.2.3.1	POST .....	276
6.14.6	Data Model .....	277
6.14.6.1	General .....	277
6.14.6.2	Structured data types .....	278
6.14.6.2.1	Introduction .....	278
6.14.6.2.2	Type: FaultDiagSubsc .....	278
6.14.6.2.3	Type: FaultDiagSubscPatch .....	279
6.14.6.2.4	Type: FaultDiagNotif .....	279
6.14.6.2.5	Type: FaultReportInfo .....	279
6.14.6.2.6	Type: CorrelatedAlarm .....	279
6.14.6.3	Simple data types and enumerations .....	280
6.14.6.3.1	Introduction .....	280
6.14.6.3.2	Simple data types .....	280
6.14.6.3.3	Enumeration: AlarmType .....	280
6.14.6.3.4	Enumeration: Priority .....	280
6.14.6.4	Data types describing alternative data types or combinations of data types .....	281
6.14.6.5	Binary data .....	281

6.14.6.5.1	Binary Data Types .....	281
6.14.7	Error Handling .....	281
6.14.7.1	General .....	281
6.14.7.2	Protocol Errors .....	281
6.14.7.3	Application Errors .....	281
6.14.8	Feature negotiation .....	281
6.14.9	Security .....	281
6.15	NSCE_SliceReqVerifyAndAlign API .....	282
6.15.1	Introduction .....	282
6.15.2	Usage of HTTP .....	282
6.15.3	Resources .....	282
6.15.3.1	Overview .....	282
6.15.3.2	Resource: Network Slice Requirements Verification and Alignment Subscriptions .....	283
6.15.3.2.1	Description .....	283
6.15.3.2.2	Resource Definition .....	283
6.15.3.2.3	Resource Standard Methods .....	283
6.15.3.2.3.1	POST .....	283
6.15.3.2.4	Resource Custom Operations .....	284
6.15.3.3	Resource: Individual Network Slice Requirements Verification and Alignment Subscription .....	284
6.15.3.3.1	Description .....	284
6.15.3.3.2	Resource Definition .....	284
6.15.3.3.3	Resource Standard Methods .....	285
6.15.3.3.3.1	GET .....	285
6.15.3.3.3.2	PUT .....	286
6.15.3.3.3.3	PATCH .....	287
6.15.3.3.3.4	DELETE .....	288
6.15.3.3.4	Resource Custom Operations .....	289
6.15.4	Custom Operations without associated resources .....	289
6.15.5	Notifications .....	289
6.15.5.1	General .....	289
6.15.5.2	Network Slice Requirements Verification and Alignment Notification .....	289
6.15.5.2.1	Description .....	289
6.15.5.2.2	Target URI .....	289
6.15.5.2.3	Standard Methods .....	290
6.15.5.2.3.1	POST .....	290
6.15.6	Data Model .....	290
6.15.6.1	General .....	290
6.15.6.2	Structured data types .....	291
6.15.6.2.1	Introduction .....	291
6.15.6.2.2	Type: SliceReqVerAlignSubsc .....	291
6.15.6.2.3	Type: SliceReqVerAlignSubscPatch .....	292
6.15.6.2.4	Type: SliceReqVerAlignNotif .....	292
6.15.6.3	Simple data types and enumerations .....	292
6.15.6.3.1	Introduction .....	292
6.15.6.3.2	Simple data types .....	292
6.15.6.4	Data types describing alternative data types or combinations of data types .....	292
6.15.6.5	Binary data .....	293
6.15.6.5.1	Binary Data Types .....	293
6.15.7	Error Handling .....	293
6.15.7.1	General .....	293
6.15.7.2	Protocol Errors .....	293
6.15.7.3	Application Errors .....	293
6.15.8	Feature negotiation .....	293
6.15.9	Security .....	293
6.16	NSCE_NSInfoDelivery API .....	293
6.16.1	Introduction .....	293
6.16.2	Usage of HTTP .....	294
6.16.3	Resources .....	294
6.16.3.1	Overview .....	294
6.16.3.2	Resource: Network Slice Information Sets .....	295
6.16.3.2.1	Description .....	295
6.16.3.2.2	Resource Definition .....	295

6.16.3.2.3	Resource Standard Methods .....	295
6.16.3.2.3.1	GET .....	295
6.16.3.2.4	Resource Custom Operations .....	296
6.16.3.2.4.1	Overview .....	296
6.16.3.2.4.2	Operation: Deliver .....	296
6.16.3.2.4.2.1	Description .....	296
6.16.3.2.4.2.2	Operation Definition .....	297
6.16.4	Custom Operations without associated resources .....	297
6.16.5	Notifications .....	297
6.16.6	Data Model .....	298
6.16.6.1	General .....	298
6.16.6.2	Structured data types .....	298
6.16.6.2.1	Introduction .....	298
6.16.6.2.2	Type: NSInfoRetResp .....	298
6.16.6.2.3	Type: NSInfoDelReq .....	299
6.16.6.2.4	Type: NSInfoSet .....	299
6.16.6.2.5	Type: ServArea .....	299
6.16.6.3	Simple data types and enumerations .....	299
6.16.6.3.1	Introduction .....	299
6.16.6.3.2	Simple data types .....	299
6.16.6.3.3	Enumeration: ReqSliceInfo .....	300
6.16.6.4	Data types describing alternative data types or combinations of data types .....	300
6.16.6.5	Binary data .....	300
6.16.6.5.1	Binary Data Types .....	300
6.16.7	Error Handling .....	300
6.16.7.1	General .....	300
6.16.7.2	Protocol Errors .....	300
6.16.7.3	Application Errors .....	300
6.16.8	Feature negotiation .....	301
6.16.9	Security .....	301
6.17	Void .....	301
6.18	NSCE_NSAllocation API .....	301
6.18.1	Introduction .....	301
6.18.2	Usage of HTTP .....	301
6.18.3	Resources .....	301
6.18.4	Custom Operations without associated resources .....	301
6.18.4.1	Overview .....	301
6.18.4.2	Operation: Request .....	302
6.18.4.2.1	Description .....	302
6.18.4.2.2	Operation Definition .....	302
6.18.5	Notifications .....	303
6.18.6	Data Model .....	303
6.18.6.1	General .....	303
6.18.6.2	Structured Data Types .....	304
6.18.6.2.1	Introduction .....	304
6.18.6.2.2	Type: NwSliceAllocReq .....	304
6.18.6.2.3	Type: NwSliceAllocResp .....	304
6.18.6.3	Simple data types and enumerations .....	304
6.18.6.3.1	Introduction .....	304
6.18.6.3.2	Simple data types .....	304
6.18.6.4	Data types describing alternative data types or combinations of data types .....	305
6.18.6.5	Binary data .....	305
6.18.6.5.1	Binary Data Types .....	305
6.18.7	Error Handling .....	305
6.18.7.1	General .....	305
6.18.7.2	Protocol Errors .....	305
6.18.7.3	Application Errors .....	305
6.18.8	Feature Negotiation .....	305
6.18.9	Security .....	305
7	Using Common API Framework .....	306

<b>Annex A (normative):</b>	<b>OpenAPI specification.....</b>	<b>307</b>
A.1	General .....	307
A.2	NSCE_SliceApiManagement API .....	308
A.3	NSCE_NetSliceLifeCycleMngt API.....	314
A.4	NSCE_PolicyManagement API .....	323
A.5	NSCE_NSOptimization API .....	336
A.6	NSCE_ManagementServiceDiscovery API .....	341
A.7	NSCE_PerfMonitoring API .....	347
A.8	NSCE_InfoCollection API.....	359
A.9	NSCE_ServiceContinuity API .....	365
A.10	NSCE_MultiSlicesOptimization API.....	370
A.11	NSCE_NetworkSliceAdaptation API.....	371
A.12	NSCE_SliceCommService API .....	374
A.13	NSCE_InterPLMNContinuity API.....	379
A.14	NSCE_NS.Diagnostics API .....	382
A.15	NSCE_FaultDiagnosis API .....	386
A.16	NSCE_SliceReqVerifyAndAlign API.....	392
A.17	NSCE_NSInfoDelivery API.....	397
A.18	NSCE_NSAllocation API .....	401
<b>Annex B (informative):</b>	<b>Withdrawn API versions.....</b>	<b>403</b>
B.1	General .....	403
B.2	NSCE_SliceApiManagement API .....	403
B.3	NSCE_NetSliceLifeCycleMngt API.....	403
B.4	NSCE_PolicyManagement API .....	403
B.5	NSCE_NSOptimization API .....	403
B.6	NSCE_ManagementServiceDiscovery API .....	404
B.7	NSCE_PerfMonitoring API .....	404
B.8	NSCE_InfoCollection API.....	404
B.9	NSCE_ServiceContinuity API .....	404
B.10	NSCE_MultiSlicesOptimization API.....	404
B.11	NSCE_NetworkSliceAdaptation API.....	404
B.12	NSCE_SliceCommService API .....	405
B.13	NSCE_InterPLMNContinuity API.....	405
B.14	NSCE_NS.Diagnostics API .....	405
B.15	NSCE_FaultDiagnosis API .....	405
B.16	NSCE_SliceReqVerifyAndAlign API.....	405
B.17	NSCE_NSInfoDelivery API.....	406
B.18	NSCE_NSAllocation API .....	406

**Annex C (informative):**      **Change history** .....407  
History .....408

---

# Foreword

This Technical Specification has been produced by the 3rd Generation Partnership Project (3GPP).

The contents of the present document are subject to continuing work within the TSG and may change following formal TSG approval. Should the TSG modify the contents of the present document, it will be re-released by the TSG with an identifying change of release date and an increase in version number as follows:

Version x.y.z

where:

- x the first digit:
  - 1 presented to TSG for information;
  - 2 presented to TSG for approval;
  - 3 or greater indicates TSG approved document under change control.
- y the second digit is incremented for all changes of substance, i.e. technical enhancements, corrections, updates, etc.
- z the third digit is incremented when editorial only changes have been incorporated in the document.

In the present document, modal verbs have the following meanings:

- shall** indicates a mandatory requirement to do something
- shall not** indicates an interdiction (prohibition) to do something

The constructions "shall" and "shall not" are confined to the context of normative provisions, and do not appear in Technical Reports.

The constructions "must" and "must not" are not used as substitutes for "shall" and "shall not". Their use is avoided insofar as possible, and they are not used in a normative context except in a direct citation from an external, referenced, non-3GPP document, or so as to maintain continuity of style when extending or modifying the provisions of such a referenced document.

- should** indicates a recommendation to do something
- should not** indicates a recommendation not to do something
- may** indicates permission to do something
- need not** indicates permission not to do something

The construction "may not" is ambiguous and is not used in normative elements. The unambiguous constructions "might not" or "shall not" are used instead, depending upon the meaning intended.

- can** indicates that something is possible
- cannot** indicates that something is impossible

The constructions "can" and "cannot" are not substitutes for "may" and "need not".

- will** indicates that something is certain or expected to happen as a result of action taken by an agency the behaviour of which is outside the scope of the present document
- will not** indicates that something is certain or expected not to happen as a result of action taken by an agency the behaviour of which is outside the scope of the present document
- might** indicates a likelihood that something will happen as a result of action taken by some agency the behaviour of which is outside the scope of the present document

**might not** indicates a likelihood that something will not happen as a result of action taken by some agency the behaviour of which is outside the scope of the present document

In addition:

**is** (or any other verb in the indicative mood) indicates a statement of fact

**is not** (or any other negative verb in the indicative mood) indicates a statement of fact

The constructions "is" and "is not" do not indicate requirements.

---

## Introduction

*This clause is optional. If it exists, it is always the second unnumbered clause.*



---

# 1 Scope

The present document specifies the stage 3 protocol and data model for the Network Slice Capability Exposure (NSCE) Server Services, for enabling the support of Network Slice Capability Exposure (NSCE) Server services for vertical applications. It provides stage 3 protocol definitions and message flows, and specifies the API for each service offered by the NSCE Server.

The stage 2 application layer architecture, functional requirements, procedures and information flows necessary for enabling Network Slice Capability Exposure (NSCE) are specified in 3GPP TS 23.435 [14].

The common protocol and interface aspects for API definition are specified in clause 5.2 of 3GPP TS 29.122 [2].

---

## 2 References

The following documents contain provisions which, through reference in this text, constitute provisions of the present document.

- References are either specific (identified by date of publication, edition number, version number, etc.) or non-specific.
- For a specific reference, subsequent revisions do not apply.
- For a non-specific reference, the latest version applies. In the case of a reference to a 3GPP document (including a GSM document), a non-specific reference implicitly refers to the latest version of that document *in the same Release as the present document*.

- [1] 3GPP TR 21.905: "Vocabulary for 3GPP Specifications".
- [2] 3GPP TS 29.122: "T8 reference point for Northbound Application Programming Interfaces (APIs)".
- [3] 3GPP TS 29.501: "5G System; Principles and Guidelines for Services Definition; Stage 3".
- [4] OpenAPI: "OpenAPI Specification Version 3.0.0", <https://spec.openapis.org/oas/v3.0.0>.
- [5] 3GPP TR 21.900: "Technical Specification Group working methods".
- [6] 3GPP TS 23.222: "Common API Framework for 3GPP Northbound APIs; Stage 2".
- [7] 3GPP TS 29.222: "Common API Framework for 3GPP Northbound APIs; Stage 3".
- [8] 3GPP TS 33.122: "Security aspects of Common API Framework (CAPIF) for 3GPP northbound APIs".
- [9] IETF RFC 6749: "The OAuth 2.0 Authorization Framework".
- [10] IETF RFC 9113: "HTTP/2".
- [11] IETF RFC 8259: "The JavaScript Object Notation (JSON) Data Interchange Format".
- [12] IETF RFC 9457: "Problem Details for HTTP APIs".
- [13] 3GPP TS 23.434: "Service Enabler Architecture Layer for Verticals (SEAL); Functional architecture and information flows".
- [14] 3GPP TS 23.435: "Procedures for Network Slice Capability Exposure for Application Layer Enablement Service".
- [15] 3GPP TS 29.549: "Service Enabler Architecture Layer for Verticals (SEAL); Application Programming Interface (API) specification".
- [16] 3GPP TS 29.571: "5G System; Common Data Types for Service Based Interfaces; Stage 3".
- [17] 3GPP TS 29.522: "5G System; Network Exposure Function Northbound APIs; Stage 3".
- [18] 3GPP TS 29.572: "5G System; Location Management Services; Stage 3".
- [19] 3GPP TS 28.541: "Management and orchestration; 5G Network Resource Model (NRM); Stage 2 and stage 3".
- [20] 3GPP TS 29.531: "5G System; Network Slice Selection Services; Stage 3".
- [21] 3GPP TS 33.501: "Security architecture and procedures for 5G System".
- [22] 3GPP TS 28.104: "Management and orchestration; Management Data Analytics (MDA)".
- [23] 3GPP TS 28.552: "Management and orchestration; 5G performance measurements".

- [24] 3GPP TS 28.554: "Management and orchestration; 5G end to end Key Performance Indicators (KPI)".
- [25] 3GPP TS 29.558: " Enabling Edge Applications; Application Programming Interface (API) specification; Stage 3".
- [26] 3GPP TS 29.520: "5G System; Network Data Analytics Services; Stage 3".

---

## 3 Definitions, symbols and abbreviations

### 3.1 Definitions

For the purposes of the present document, the terms and definitions given in 3GPP TR 21.905 [1] and the following apply. A term defined in the present document takes precedence over the definition of the same term, if any, in 3GPP TR 21.905 [1].

For the purpose of the present document, the terms and definitions specified in clause 3.1 of 3GPP TS 23.435 [14] and clause 3.1 of 3GPP TS 29.549 [15] also apply, including the ones referencing other specifications.

### 3.2 Symbols

Void

### 3.3 Abbreviations

For the purposes of the present document, the abbreviations given in 3GPP TR 21.905 [1] and the following apply. An abbreviation defined in the present document takes precedence over the definition of the same abbreviation, if any, in 3GPP TR 21.905 [1].

NSCE	Network Slice Capability Enablement
SEAL	Service Enabler Architecture Layer for Verticals

---

## 4 Overview

The Network Slice Capability Enablement (NSCE) Server forms part of the SEAL Enabler Layer defined in 3GPP TS 23.434 [13] and aims to ensure the efficient use and deployment of network slice capability exposure capabilities to vertical applications. The NSCE Server services expose network slicing capabilities based on the 5GS management system services (e.g., MnS services) and the 5GS network services (e.g., NEF APIs, NWDAF APIs, NSACF APIs). The NSCE Server supports for this purpose, among other functionalities defined in 3GPP TS 23.435 [14], the following functionalities:

- network slice API configuration and translation management;
- network slice lifecycle management;
- network slice policy management;
- network slice optimization management;
- network slice management service discovery management;
- network slice related performance and analytics monitoring management;
- network slice information collection management;
- network slice predictive modification management;
- multiple network slice coordinated resource optimization management;
- network slice adaptation management;
- network slice related communication services management;
- network slice modification in Inter-PLMN continuity management;
- network slice diagnostics management;
- network slice fault management;
- network slice requirements verification and alignment management;
- network slice information retrieval and delivery management; and
- network slice allocation management.

Figure 4-1 shows the reference model of the NSCE Enabler Layer, with a focus on the NSCE Server:

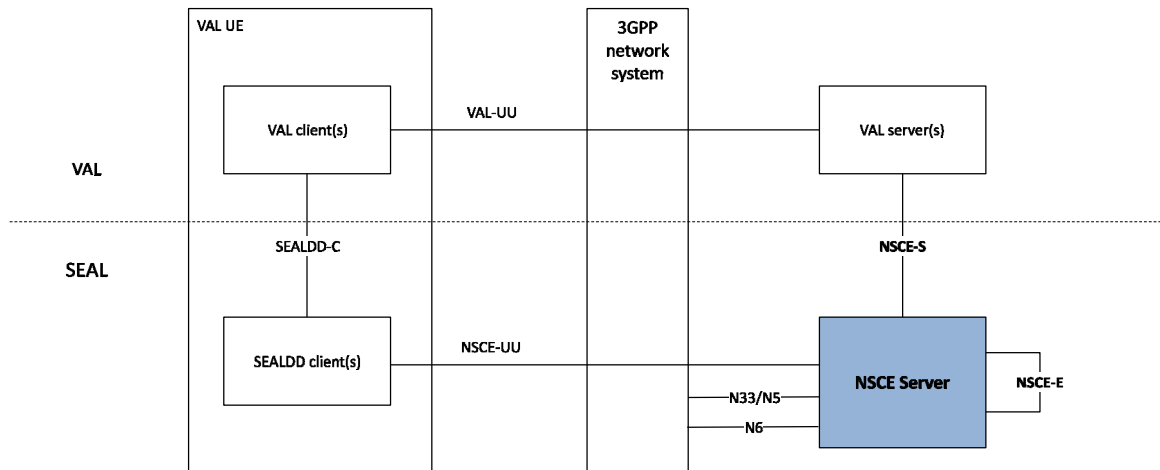

Figure 4-1: NSCE Enabler Layer functional model

---

## 5 Services offered by the NSCE Server

### 5.1 Introduction

The NSCE Server provides the following services:

- NSCE\_SliceApiManagement
- NSCE\_NetSliceLifeCycleMngt
- NSCE\_PolicyManagement
- NSCE\_NSOptimization
- NSCE\_ManagementServiceDiscovery
- NSCE\_PerfMonitoring
- NSCE\_InfoCollection
- NSCE\_ServiceContinuity
- NSCE\_MultiSlicesOptimization
- NSCE\_NetworkSliceAdaptation
- NSCE\_SliceCommService
- NSCE\_InterPLMNContinuity
- NSCE\_NS.Diagnostics
- NSCE\_FaultDiagnosis
- NSCE\_SliceReqVerifyAndAlign
- NSCE\_NSInfoDelivery
- NSCE\_NSAllocation

Table 5.1-1 summarizes the corresponding APIs defined for this specification.

Table 5.1-1: API Descriptions

Service Name	Clause	Description	OpenAPI Specification File	API Name	Annex
NSCE_SliceApiManagement	6.1	NSCE Slice API Management Service	nsce-sam	TS29435_NSCE_SliceApiManagement.yaml	A.2
NSCE_NetSliceLifeCycleMngt	6.2	NSCE Network Slice Lifecycle Management Service	nsce-nslcm	TS29435_NSCE_NetSliceLifeCycleMngt.yaml	A.3
NSCE_PolicyManagement	6.3	NSCE Policy Management Service	nsce-pm	TS29435_NSCE_PolicyManagement.yaml	A.4
NSCE_NSOptimization	6.4	NSCE Network Slice Optimization Service	nsce-nso	TS29435_NSCE_NSOptimization.yaml	A.5
NSCE_ManagementServiceDiscovery	6.5	NSCE Management Service Discovery Service	nsce-msd	TS29435_NSCE_ManagementServiceDiscovery.yaml	A.6
NSCE_PerfMonitoring	6.6	NSCE Network Slice Performance and Analytics Monitoring Service	nsce-pam	TS29435_NSCE_PerfMonitoring.yaml	A.7
NSCE_InfoCollection	6.7	NSCE Information Collection Service	nsce-ic	TS29435_NSCE_InfoCollection.yaml	A.8
NSCE_ServiceContinuity	6.8	NSCE Service Continuity Service	nsce-sc	TS29435_NSCE_ServiceContinuity.yaml	A.9
NSCE_MultiSlicesOptimization	6.9	NSCE Multiple Slices Optimization Service	nsce-mso	TS29435_NSCE_MultiSlicesOptimization.yaml	A.10
NSCE_NetworkSliceAdaptation	6.10	NSCE Network Slice Adaptation Service	ss-nsa	TS29435_NSCE_NetworkSliceAdaptation.yaml	A.11
NSCE_SliceCommService	6.11	NSCE Network Slice Communication Service	nsce-scs	TS29435_NSCE_SliceCommService.yaml	A.12
NSCE_InterPLMNContinuity	6.12	NSCE Inter-PLMN Service Continuity Service	nsce-ipc	TS29435_NSCE_InterPLMNContinuity.yaml	A.13
NSCE_NS.Diagnostics	6.13	NSCE Network Slice Diagnostics Service	nsce-nsd	TS29435_NSCE_NetworkSliceDiagnostics.yaml	A.14
NSCE_FaultDiagnosis	6.14	NSCE Network Slice Fault Diagnosis Service	nsce-fd	TS29435_NSCE_FaultDiagnosis.yaml	A.15
NSCE_SliceReqVerifyAndAlign	6.15	NSCE Network Slice Requirements Verification And Alignment Service	nsce-srva	TS29435_NSCE_SliceReqVerifyAndAlign.yaml	A.16
NSCE_NSInfoDelivery	6.16	NSCE Network Slice Information Delivery Service	nsce-nsid	TS29435_NSCE_NSInfoDelivery.yaml	A.17
NSCE_NSAllocation	6.18	NSCE Network Slice Allocation Service	nsce-nsa	TS29435_NSCE_NSAllocation.yaml	A.18

NOTE: When 3GPP TS 29.122 [2] is referenced for the common protocol and interface aspects for API definition in the clauses under clause 5, the NSCE Server takes the role of the SCEF and the service consumer takes the role of the SCS/AS.

## 5.2 NSCE\_SliceApiManagement

### 5.2.1 Service Description

The NSCE\_SliceApiManagement service exposed by the NSCE Server enables a service consumer to:



- create/delete a Slice API Configuration;
- request the update of an existing slice API configuration;
- receive Slice API Configuration notifications; and
- request slice API invocation.

## 5.2.2 Service Operations

### 5.2.2.1 Introduction

The service operations defined for the NSCE\_SliceApiManagement service are shown in table 5.2.2.1-1.

**Table 5.2.2.1-1: NSCE\_SliceApiManagement Service Operations**

Service Operation Name	Description	Initiated by
NSCE_SliceApiManagement_Configure	This service operation enables a service consumer to create/delete a Slice API Configuration.	e.g., VAL Server
NSCE_SliceApiManagement_Update	This service operation enables a service consumer to request the update of an existing slice API configuration.	e.g., VAL Server
NSCE_SliceApiManagement_Notify	This service operation enables a service consumer to receive Slice API Configuration notifications.	NSCE Server
NSCE_SliceApiManagement_Invoke	This service operation enables a service consumer to request slice API invocation.	e.g., VAL Server

### 5.2.2.2 NSCE\_SliceApiManagement\_Configure

#### 5.2.2.2.1 General

This service operation is used by a service consumer to request the creation/deletion of a Slice API Configuration at the NSCE Server.

The following procedures are supported by the "NSCE\_SliceApiManagement\_Configure" service operation:

- Slice API Configuration Creation.
- Slice API Configuration Deletion.

#### 5.2.2.2.2 Slice API Configuration Creation

Figure 5.2.2.2.2-1 depicts a scenario where a service consumer sends a request to the NSCE Server to request the creation of a Slice API Configuration (see also clause 9.3 of 3GPP°TS°23.435°[14]).

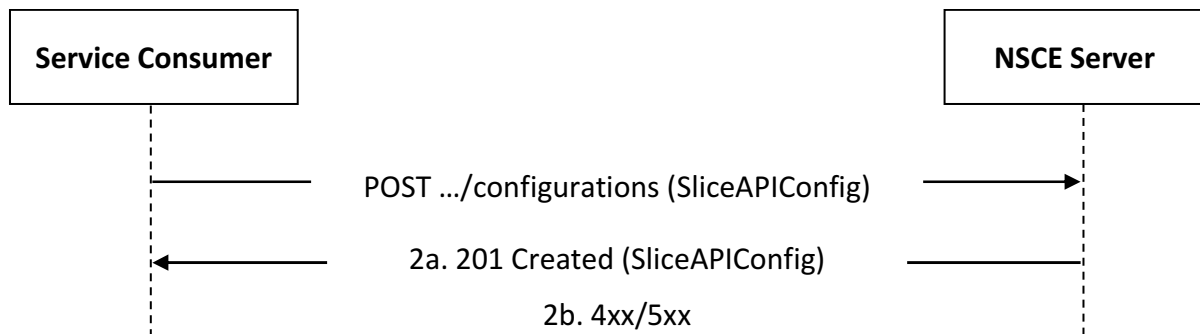
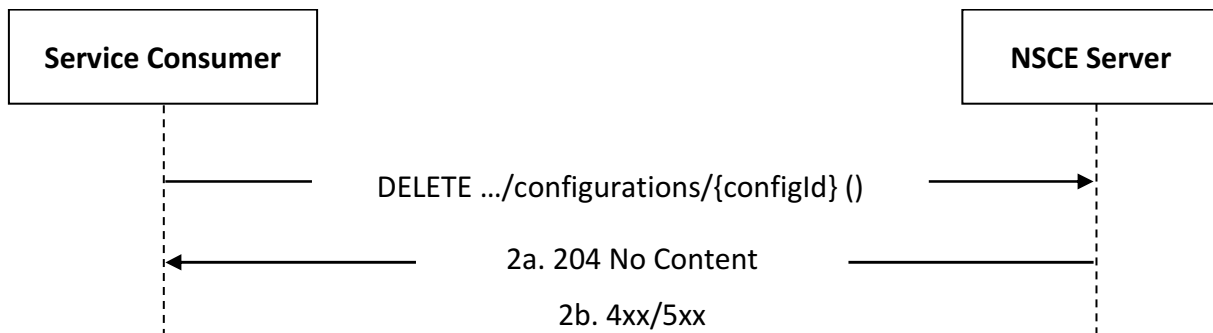

**Figure 5.2.2.2.2-1: Procedure for Slice API Configuration Creation**

1. In order to create a new Slice API Configuration, the service consumer shall send an HTTP POST request to the NSCE Server targeting the URI of the "Slice API Configurations" collection resource, with the request body including the SliceAPIConfig data structure.
- 2a. Upon success, the NSCE Server shall respond with an HTTP "201 Created" status code, with the response body containing the representation of the created "Individual Slice API Configuration" resource within the SliceAPIConfig data structure, and an HTTP "Location" header field containing the URI of the created resource.
- 2b. On failure, the appropriate HTTP status code indicating the error shall be returned and appropriate additional error information should be returned in the HTTP POST response body, as specified in clause 6.1.7.

### 5.2.2.2.3 Slice API Configuration Deletion

Figure 5.2.2.2.3-1 depicts a scenario where a service consumer sends a request to the NSCE Server to request the deletion of an existing Slice API Configuration (see also clause 9.3 of 3GPP TS 23.435 [14]).



**Figure 5.2.2.2.3-1: Procedure for Slice API Configuration Deletion**

1. In order to request the deletion of an existing Slice API Configuration, the service consumer shall send an HTTP DELETE request to the NSCE Server targeting the corresponding "Individual Slice API Configuration" resource.

**NOTE:** An alternative service consumer (i.e. other than the one that requested the creation of the targeted resource) can initiate this request.

- 2a. Upon success, the NSCE Server shall respond with an HTTP "204 No Content" status code.
- 2b. On failure, the appropriate HTTP status code indicating the error shall be returned and appropriate additional error information should be returned in the HTTP DELETE response body, as specified in clause 6.1.7.

## 5.2.2.3 NSCE\_SliceApiManagement\_Update

### 5.2.2.3.1 General

This service operation is used by a service consumer to request the update of an existing slice API configuration at the NSCE Server.

The following procedures are supported by the "NSCE\_SliceApiManagement\_Update" service operation:

- Slice API Configuration Update.

### 5.2.2.3.2 Slice API Configuration Update

Figure 5.2.2.3.2-1 depicts a scenario where a service consumer sends a request to the NSCE Server to request the update of an existing slice API configuration (see also clause 9.3 of 3GPP TS 23.435 [14]).

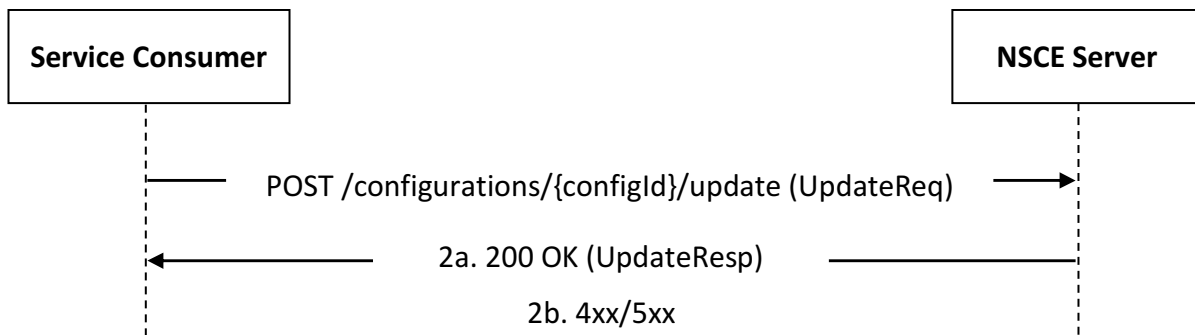

**Figure 5.2.2.3.2-1: Procedure for Slice API Configuration Update**

1. In order to request the update of an existing slice API configuration, the service consumer shall send an HTTP POST request to the NSCE Server targeting the URI of the corresponding resource custom operation (i.e., "Update"), with the request body including the UpdateReq data structure.
- 2a. Upon success, the NSCE Server shall respond with an HTTP "200 OK" status code with the response body containing the updated slice API configuration information within the UpdateResp data structure.
- 2b. On failure, the appropriate HTTP status code indicating the error shall be returned and appropriate additional error information should be returned in the HTTP POST response body, as specified in clause 6.1.7.

## 5.2.2.4 NSCE\_SliceApiManagement\_Notify

### 5.2.2.4.1 General

This service operation is used by the NSCE Server to notify a previously subscribed service consumer on:

- Slice API Configuration event(s).

The following procedures are supported by the "NSCE\_SliceApiManagement\_Notify" service operation:

- Slice API Configuration Notification.

### 5.2.2.4.2 Slice API Configuration Notification

Figure 5.2.2.4.2-1 depicts a scenario where the NSCE Server sends a request to notify a previously subscribed service consumer on Slice API Configuration event(s) (see also clause 9.3 of 3GPP<sup>o</sup>TS<sup>o</sup>23.435<sup>[14]</sup>).

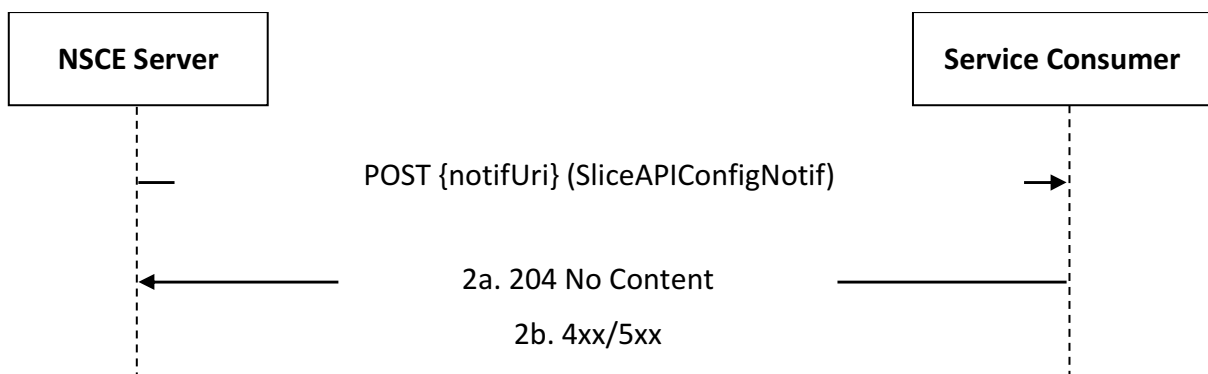

**Figure 5.2.2.4.2-1: Slice API Configuration Notification**

1. In order to notify a previously subscribed service consumer on Slice API Configuration event(s), the NSCE Server shall send an HTTP POST request to the service consumer with the request URI set to "{notifUri}", where the "notifUri" variable is set to the value received from the service consumer during the creation of the corresponding Slice API Configuration using the procedures defined in clause 5.2.2.2.2, and the request body including the SliceAPIConfigNotif data structure.

2a. Upon success, the service consumer shall respond to the NSCE Server with an HTTP "204 No Content" status code to acknowledge the successful reception and processing of the notification.

2b. On failure, the appropriate HTTP status code indicating the error shall be returned and appropriate additional error information should be returned in the HTTP POST response body, as specified in clause 6.1.7.

## 5.2.2.5 NSCE\_SliceApiManagement\_Invoke

### 5.2.2.5.1 General

This service operation is used by a service consumer to request slice API invocation to the NSCE Server.

The following procedures are supported by the "NSCE\_SliceApiManagement\_Invoke" service operation:

- Slice API Invocation Request.

### 5.2.2.5.2 Slice API Invocation Request

Figure 5.2.2.5.2-1 depicts a scenario where a service consumer sends a request to the NSCE Server to request slice API invocation (see also clause 9.3 of 3GPP°TS°23.435°[14]).

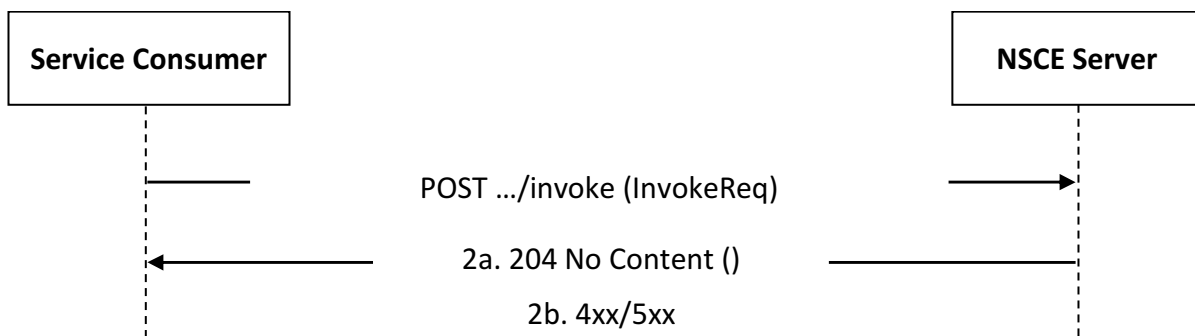

**Figure 5.2.2.5.2-1: Procedure for Slice API Invocation Request**

1. In order to request slice API invocation, the service consumer shall send an HTTP POST request to the NSCE Server targeting the URI of the corresponding custom operation (i.e., "Invoke"), with the request body including the InvokeReq data structure.

2a. Upon success, the NSCE Server shall respond with an HTTP "204 No Content" status code.

2b. On failure, the appropriate HTTP status code indicating the error shall be returned and appropriate additional error information should be returned in the HTTP POST response body, as specified in clause 6.1.7.

## 5.3 NSCE\_NetSliceLifeCycleMngt

### 5.3.1 Service Description

The NSCE\_NetSliceLifeCycleMngt service exposed by the NSCE Server enables a service consumer to:

- create/update/delete a Slice Lifecycle Management Subscription; and
- receive Slice Lifecycle Management related event(s) notifications.

## 5.3.2 Service Operations

### 5.3.2.1 Introduction

The service operations defined for the NSCE\_NetSliceLifeCycleMngt service are shown in table 5.3.2.1-1.

**Table 5.3.2.1-1: NSCE\_NetSliceLifeCycleMngt Service Operations**

Service Operation Name	Description	Initiated by
NSCE_NetSliceLifeCycleMngt_Subscribe	This service operation enables a service consumer to request the creation/update/deletion of an Application layer Network Slice Lifecycle Management Subscription at the NSCE Server.	e.g., VAL Server
NSCE_NetSliceLifeCycleMngt_Notify	This service operation enables a service consumer to receive application layer network slice lifecycle management related notifications.	NSCE Server
NSCE_NetSliceLifeCycleMngt_QoEMetricsSubscribe	This service operation enables the NSCE Server to subscribe to QoE metrics reporting at the service consumer.	NSCE Server
NSCE_NetSliceLifeCycleMngt_QoEMetricsNotify	This service operation enables a service consumer to send QoE metrics report(s) to the NSCE Server.	e.g., VAL Server
NSCE_NetSliceLifeCycleMngt_Recommend	This service operation enables a service consumer to receive network slice LCM recommendation notifications.	NSCE Server

### 5.3.2.2 NSCE\_NetSliceLifeCycleMngt\_Subscribe

#### 5.3.2.2.1 General

This service operation is used by a service consumer to request the creation/update/deletion of an Application layer Network Slice Lifecycle Management Subscription at the NSCE Server.

The following procedures are supported by the "NSCE\_NetSliceLifeCycleMngt\_Subscribe" service operation:

- Network Slice Lifecycle Management Subscription Creation.
- Network Slice Lifecycle Management Subscription Update.
- Network Slice Lifecycle Management Subscription Deletion.

#### 5.3.2.2.2 Network Slice Lifecycle Management Subscription Creation

Figure 5.3.2.2.2-1 depicts a scenario where a service consumer sends a request to the NSCE Server to request the creation of a Network Slice Lifecycle Management Subscription (see also clause 9.4 of 3GPP TS 23.435 [14]).

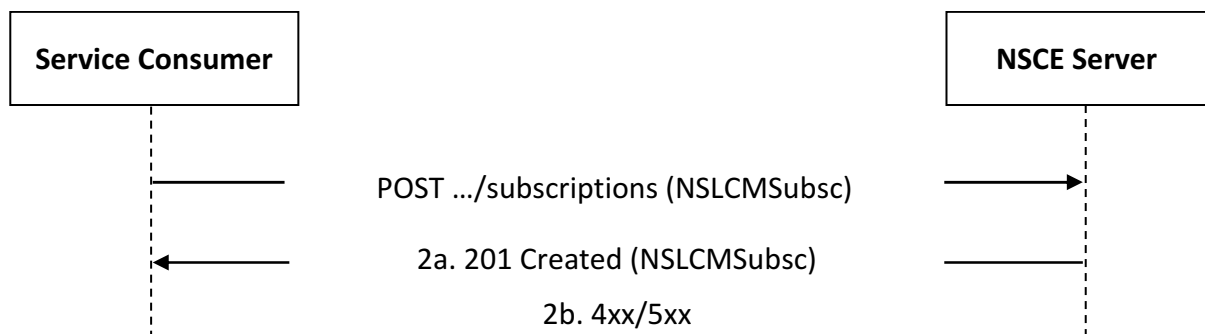

**Figure 5.3.2.2.2-1: Procedure for Network Slice Lifecycle Management Subscription Creation**

1. In order to request the creation of a new Network Slice Lifecycle Management Subscription, the service consumer shall send an HTTP POST request to the NSCE Server targeting the URI of the "Network Slice

Lifecycle Management Subscriptions" collection resource, with the request body including the NSLCMSubsc data structure.

- 2a. Upon success, the NSCE Server shall respond with an HTTP "201 Created" status code, with the response body containing a representation of the created "Individual Network Slice Lifecycle Management Subscription" resource within the NSLCMSubsc data structure, and an HTTP "Location" header field containing the URI of the created resource.
- 2b. On failure, the appropriate HTTP status code indicating the error shall be returned and appropriate additional error information should be returned in the HTTP POST response body, as specified in clause 6.2.7.

### 5.3.2.2.3 Network Slice Lifecycle Management Subscription Update

Figure 5.3.2.2.3-1 depicts a scenario where a service consumer sends a request to the NSCE Server to request the update of an existing Network Slice Lifecycle Management Subscription (see also clause 9.4 of 3GPP°TS°23.435°[14]).

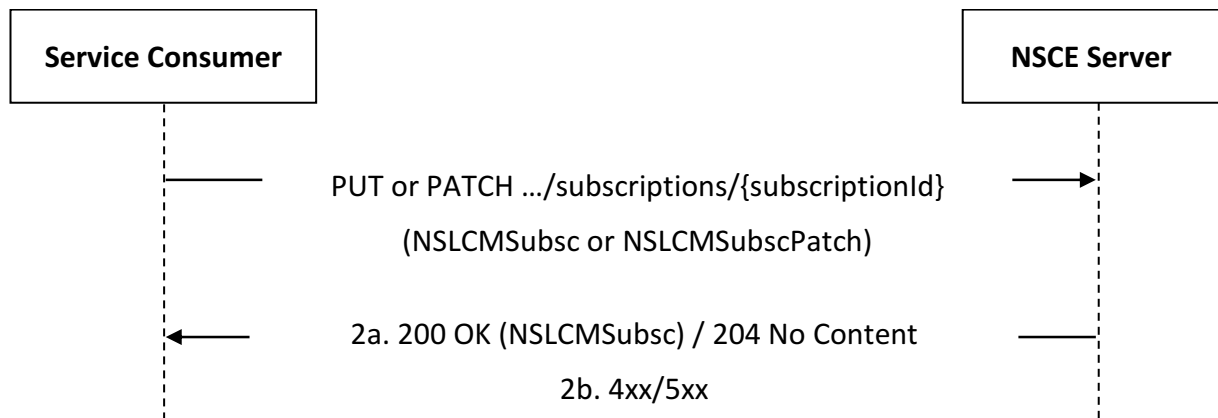
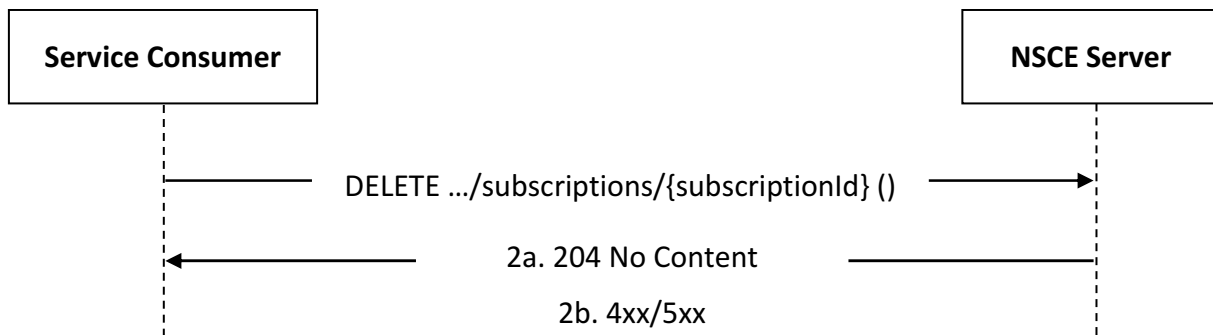

**Figure 5.3.2.2.3-1: Procedure for Network Slice Lifecycle Management Subscription Update**

1. In order to update an existing Network Slice Lifecycle Management Subscription, the service consumer shall send an HTTP PUT/PATCH request to the NSCE Server, targeting the URI of the corresponding "Individual Network Slice Lifecycle Management Subscription" resource, with the request body including either:
  - the updated representation of the resource within the NSLCMSubsc data structure, in case the HTTP PUT method is used; or
  - the requested modifications to the resource within the NSLCMSubscPatch data structure, in case the HTTP PATCH method is used.
- 2a. Upon success, the NSCE Server shall update the targeted "Individual Network Slice Lifecycle Management Subscription" resource accordingly and respond with either:
  - an HTTP "200 OK" status code with the response body containing a representation of the updated "Individual Network Slice Lifecycle Management Subscription" resource within the NSLCMSubsc data structure; or
  - an HTTP "204 No Content" status code.
- 2b. On failure, the appropriate HTTP status code indicating the error shall be returned and appropriate additional error information should be returned in the HTTP PUT/PATCH response body, as specified in clause 6.2.7.

### 5.3.2.2.4 Network Slice Lifecycle Management Subscription Deletion

Figure 5.3.2.2.4-1 depicts a scenario where a service consumer sends a request to the NSCE Server to request the deletion of an existing Network Slice Lifecycle Management Subscription (see also clause 9.4 of 3GPP°TS°23.435°[14]).



**Figure 5.3.2.2.4-1: Procedure for Network Slice Lifecycle Management Subscription Deletion**

1. In order to request the deletion of an existing Network Slice Lifecycle Management Subscription, the service consumer shall send an HTTP DELETE request to the NSCE Server targeting the corresponding "Individual Network Slice Lifecycle Management Subscription" resource.
- 2a. Upon success, the NSCE Server shall respond with an HTTP "204 No Content" status code.
- 2b. On failure, the appropriate HTTP status code indicating the error shall be returned and appropriate additional error information should be returned in the HTTP DELETE response body, as specified in clause 6.2.7.

### 5.3.2.3 NSCE\_NetSliceLifeCycleMngt\_Notify

#### 5.3.2.3.1 General

This service operation is used by the NSCE Server to notify a previously subscribed service consumer on:

- Network Slice Lifecycle Management event(s).

The following procedures are supported by the "NSCE\_NetSliceLifeCycleMngt\_Notify" service operation:

- Network Slice Lifecycle Management Notification.

#### 5.3.2.3.2 Network Slice Lifecycle Management Notification

Figure 5.3.2.3.2-1 depicts a scenario where the NSCE Server sends a request to notify a previously subscribed service consumer on Network Slice Lifecycle Management event(s) (see also clause 9.4 of 3GPP TS 23.435 [14]).

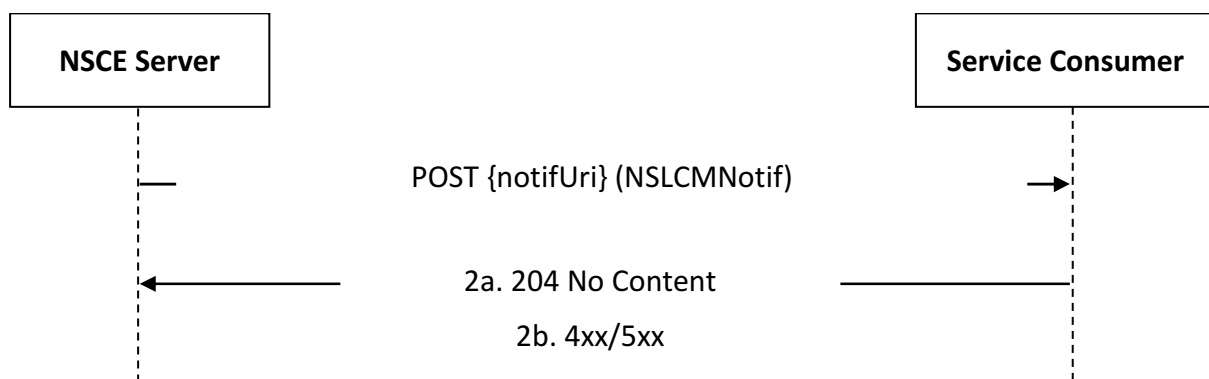

**Figure 5.3.2.3.2-1: Network Slice Lifecycle Management Notification**

1. In order to notify a previously subscribed service consumer on Network Slice Lifecycle Management event(s), the NSCE Server shall send an HTTP POST request to the service consumer with the request URI set to "{notifUri}", where the "notifUri" is set to the value received from the service consumer during the creation/update of the corresponding Network Slice Lifecycle Management Subscription using the procedures defined in clause 5.3.2.2, and the request body including the NSLCMNotif data structure.

2a. Upon success, the service consumer shall respond to the NSCE Server with an HTTP "204 No Content" status code to acknowledge the reception of the notification.

2b. On failure, the appropriate HTTP status code indicating the error shall be returned and appropriate additional error information should be returned in the HTTP POST response body, as specified in clause 6.2.7.

### 5.3.2.4 NSCE\_NetSliceLifeCycleMngt\_QoEMetricsSubscribe

#### 5.3.2.4.1 General

This service operation is used by a NSCE Server to subscribe a previously subscribed service consumer on:

- QoE metrics.

The following procedures are supported by the "NSCE\_NetSliceLifeCycleMngt\_QoEMetricsSubscribe" service operation:

- QoE Metrics Subscription Notification.

#### 5.3.2.4.2 QoE Metrics Subscription Notification

Figure 5.3.2.4.2-1 depicts a scenario where the NSCE Server sends a request to subscribe to QoE metrics reporting at the service consumer (see also clause 9.4 of 3GPP°TS°23.435°[14]).

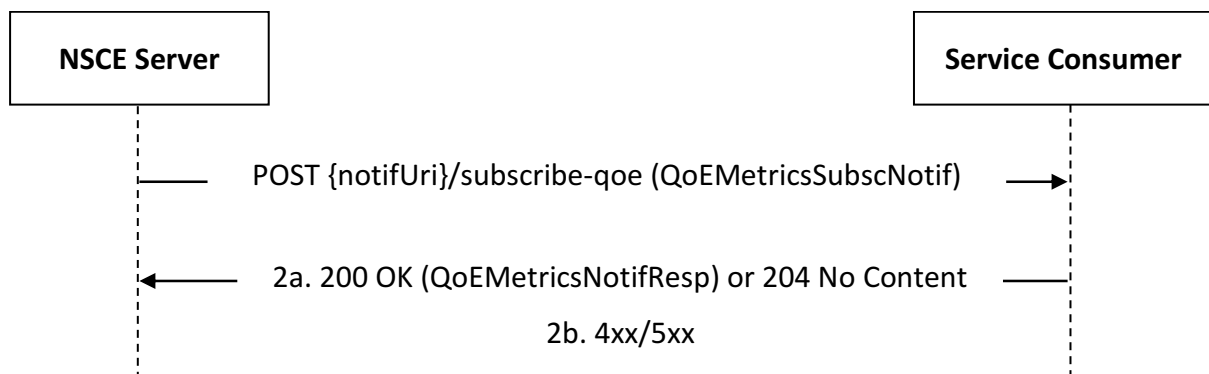

**Figure 5.3.2.4.2-1: QoE Metrics Subscribe Notification**

1. In order to subscribe at the service consumer on QoE metrics reporting, the NSCE Server shall send an HTTP POST request to the service consumer with the request URI set to "`{notifUri}/subscribe-qoe`", where the "notifUri" variable is set to the value received from the service consumer during the creation/update of the corresponding Network Slice Lifecycle Management Subscription using the procedures defined in clause 5.3.2.2, and the request body including the `QoEMetricsSubscNotif` data structure.

2a. Upon success, the service consumer shall respond to the NSCE Server with either:

- an HTTP "200 OK" status code with the response body containing immediate QoE metrics reporting related information within the `QoEMetricsNotifResp` data structure, if immediate reporting was requested.
- an HTTP "204 No Content" status code to acknowledge the reception of the notification and the successful subscription to QoE metrics reporting.

2b. On failure, the appropriate HTTP status code indicating the error shall be returned and appropriate additional error information should be returned in the HTTP POST response body, as specified in clause 6.2.7.

### 5.3.2.5 NSCE\_NetSliceLifeCycleMngt\_QoEMetricsNotify

#### 5.3.2.5.1 General

This service operation is used by a service consumer to notify the NSCE Server on:



- QoE metrics report(s).

The following procedures are supported by the "NSCE\_NetSliceLifeCycleMngt\_QoEMetricsNotify" service operation:

- QoE Metrics Notification.

### 5.3.2.5.2 QoE Metrics Notification

Figure 5.3.2.5.2-1 depicts a scenario where the service consumer sends a request to notify the NSCE Server on QoE metrics report(s) (see also clause 9.4 of 3GPP°TS°23.435°[14]).

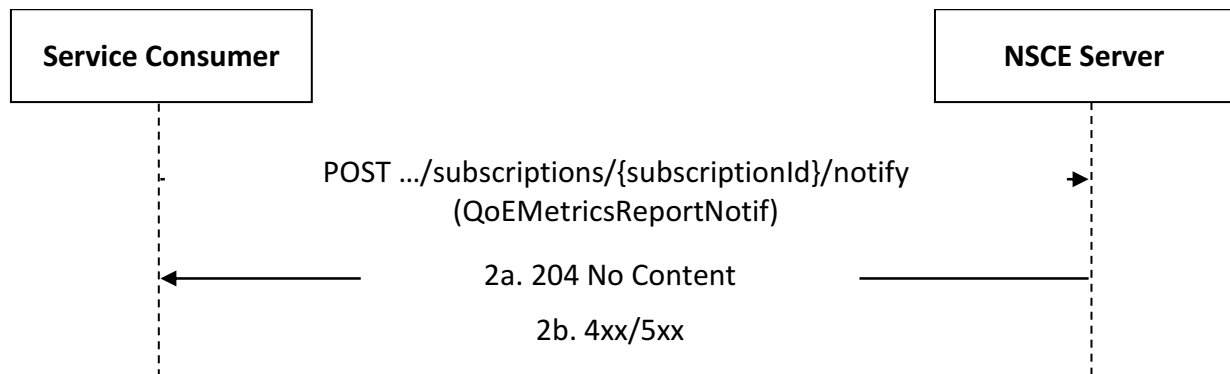

**Figure 5.3.2.5.2-1: QoE Metrics Notification**

1. In order to send a notification on QoE metrics report(s), the service consumer shall send an HTTP POST request targeting the corresponding resource custom operation (i.e., "QoE Metrics Notification") to the NSCE Server, with request body including the QoEMetricsReportNotif data structure.
- 2a. Upon success, the NSCE Server shall respond to the service consumer with an HTTP "204 No Content" status code to acknowledge the reception of the notification.
- 2b. On failure, the appropriate HTTP status code indicating the error shall be returned and appropriate additional error information should be returned in the HTTP POST response body, as specified in clause 6.2.7.

## 5.3.2.6 NSCE\_NetSliceLifeCycleMngt\_Recommend

### 5.3.2.6.1 General

This service operation is used by a NSCE Server to notify a previously subscribed service consumer on:

- network slice LCM recommendation Notification.

The following procedures are supported by the "NSCE\_NetSliceLifeCycleMngt\_Recommend" service operation:

- Network Slice LCM Recommendation Notification.

### 5.3.2.6.2 Network Slice LCM Recommendation Notification

Figure 5.3.2.6.2-1 depicts a scenario where the NSCE Server sends a request to notify a previously subscribed service consumer on network slice LCM recommendation (see also clause 9.4 of 3GPP°TS°23.435°[14]).

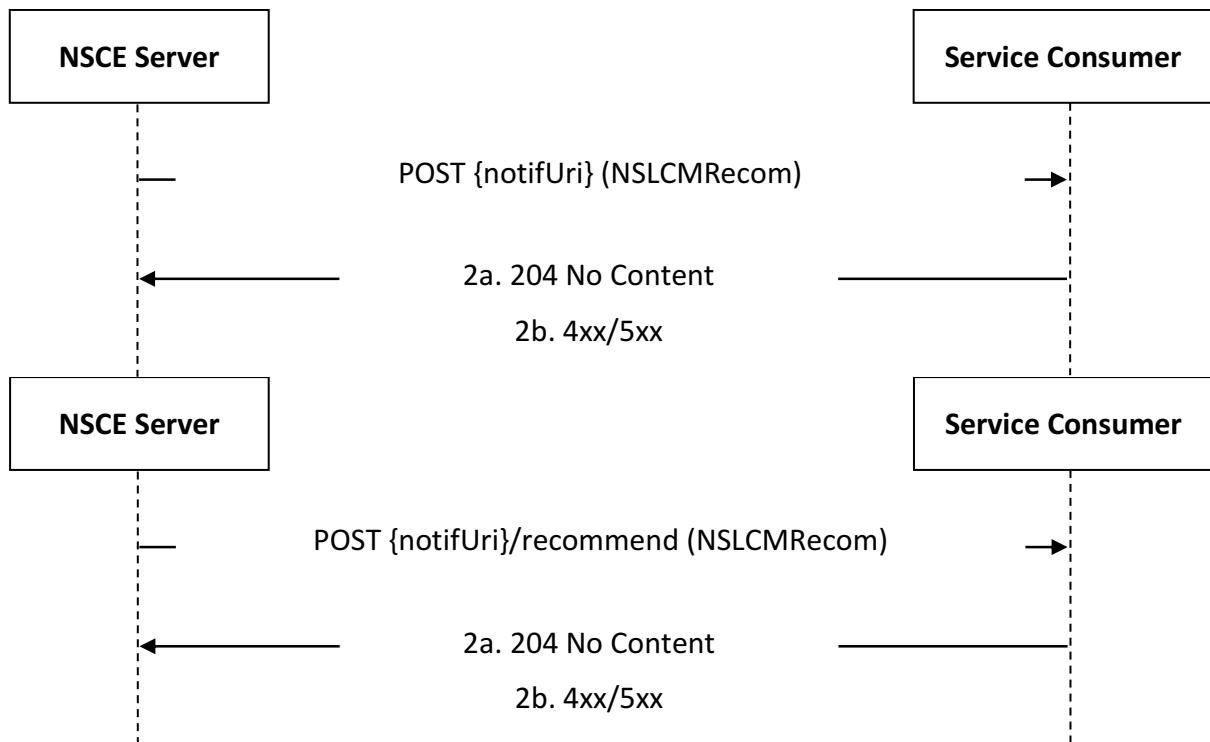

**Figure 5.3.2.6.2-1: Network Slice LCM Recommendation Notification**

1. In order to notify a previously subscribed service consumer on network Slice LCM Recommendation, the NSCE Server shall send an HTTP POST request to the service consumer with the request URI set to "`{notifUri}/recommend`", where the "`notifUri`" variable is set to the value received from the service consumer during the creation/update of the corresponding Network Slice Lifecycle Management Subscription using the procedures defined in clause 5.3.2.2, and the request body including the NSLCMRecom data structure.
- 2a. Upon success, the service consumer shall respond to the NSCE Server with an HTTP "204 No Content" status code to acknowledge the reception of the notification.
- 2b. On failure, the appropriate HTTP status code indicating the error shall be returned and appropriate additional error information should be returned in the HTTP POST response body, as specified in clause 6.2.7.

## 5.4 NSCE\_PolicyManagement

### 5.4.1 Service Description

The NSCE\_PolicyManagement service exposed by the NSCE Server enables a service consumer to:

- provision/update/delete a Policy;
- create/update/delete a Policy Usage Subscription; and
- receive Policy Usage Notifications.

### 5.4.2 Service Operations

#### 5.4.2.1 Introduction

The service operations defined for the NSCE\_PolicyManagement service are shown in table 5.4.2.1-1.

**Table 5.4.2.1-1: NSCE\_PolicyManagement Service Operations**

Service Operation Name	Description	Initiated by
NSCE_PolicyManagement_Create	This service operation enables a service consumer to request the provisioning of a Policy at the NSCE Server.	e.g., VAL Server
NSCE_PolicyManagement_Update	This service operation enables a service consumer to request the update/modification of a Policy at the NSCE Server.	e.g., VAL Server
NSCE_PolicyManagement_Delete	This service operation enables a service consumer to request the deletion of a Policy at the NSCE Server.	e.g., VAL Server
NSCE_PolicyManagement_HarmonizationNotify	This service operation enables a service consumer to receive Policy Harmonization Notifications.	NSCE Server
NSCE_PolicyManagement_Subscribe	This service operation enables a service consumer to request the creation/update/deletion of a Policy Usage Subscription.	e.g., VAL Server
NSCE_PolicyManagement_Notify	This service operation enables a service consumer to receive Policy Usage Notifications.	NSCE Server

### 5.4.2.2 NSCE\_PolicyManagement\_Create

#### 5.4.2.2.1 General

This service operation is used by a service consumer to request the provisioning of a Policy at the NSCE Server.

The following procedures are supported by the "NSCE\_PolicyManagement\_Create" service operation:

- Policy Provisioning.

#### 5.4.2.2.2 Policy Provisioning

Figure 5.4.2.2.2-1 depicts a scenario where a service consumer sends a request to the NSCE Server to request the provisioning of a Policy (see also clause 9.5 of 3GPP TS 29.435 [14]).

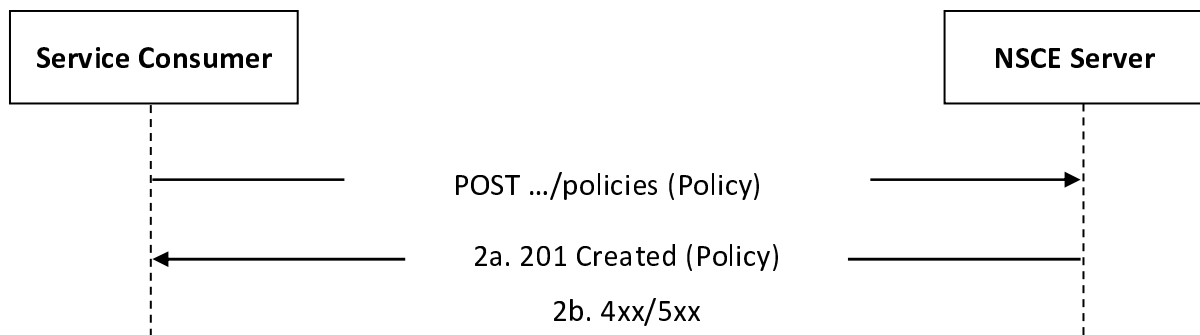

**Figure 5.4.2.2.2-1: Procedure for Policy Provisioning**

1. In order to provision a new Policy, the service consumer shall send an HTTP POST request to the NSCE Server targeting the URI of the "Policies" collection resource, with the request body including the Policy data structure.
- 2a. Upon success, the NSCE Server shall respond with an HTTP "201 Created" status code, with the response body containing a representation of the created "Individual Policy" resource within the Policy data structure, and an HTTP "Location" header field containing the URI of the created resource.
- 2b. On failure, the appropriate HTTP status code indicating the error shall be returned and appropriate additional error information should be returned in the HTTP POST response body, as specified in clause 6.3.7. In particular:
  - if the NSCE Server needs to perform policy harmonization for the policy that is requested to be created and the harmonization process is still ongoing, the NSCE Server may reject the request with an HTTP "403

Forbidden" status code with the response body including the ProblemDetails data structure containing the "cause" attribute set to the "HARMOMIZATION\_ONGOING" application error.

### 5.4.2.3 NSCE\_PolicyManagement\_Update

#### 5.4.2.3.1 General

This service operation is used by a service consumer to request the update of an existing Policy at the NSCE Server.

The following procedures are supported by the "NSCE\_PolicyManagement\_Update" service operation:

- Policy Update.

#### 5.4.2.3.2 Policy Update

Figure 5.4.2.3.2-1 depicts a scenario where a service consumer sends a request to the NSCE Server to request the update of an existing Policy (see also clause 9.5 of 3GPP TS 29.435 [14]).

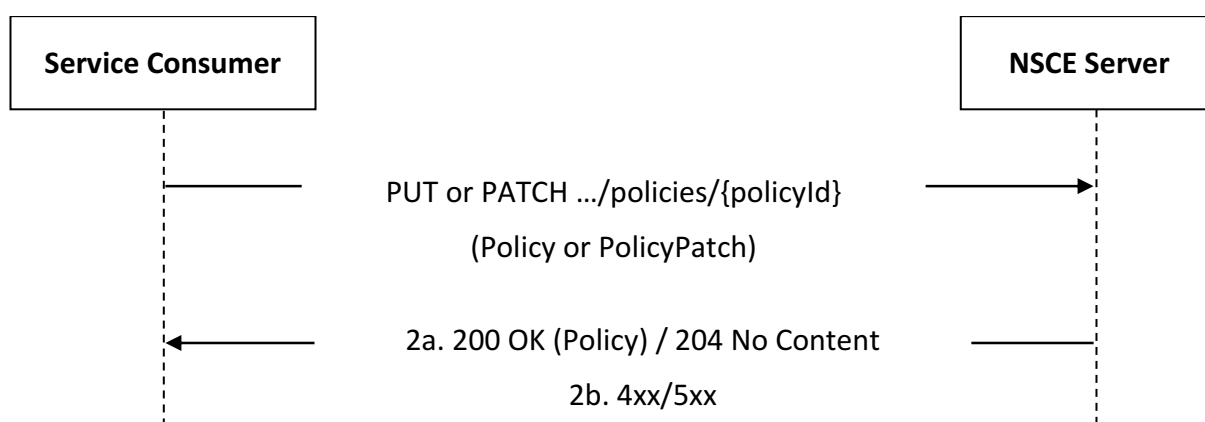

**Figure 5.4.2.3.2-1: Procedure for Policy Update**

1. In order to update an existing Policy, the service consumer shall send an HTTP PUT/PATCH request to the NSCE Server, targeting the URI of the corresponding "Individual Policy" resource, with the request body including either:
  - the updated representation of the resource within the Policy data structure, in case the HTTP PUT method is used; or
  - the requested modifications to the resource within the PolicyPatch data structure, in case the HTTP PATCH method is used.

**NOTE:** An alternative service consumer (i.e., other than the one that requested the creation of the targeted resource) can initiate this request.

- 2a. Upon success, the NSCE Server shall update the targeted "Individual Policy" resource accordingly and respond with either:
  - an HTTP "200 OK" status code with the response body containing a representation of the updated "Individual Policy" resource within the Policy data structure; or
  - an HTTP "204 No Content" status code.
- 2b. On failure, the appropriate HTTP status code indicating the error shall be returned and appropriate additional error information should be returned in the HTTP PUT/PATCH response body, as specified in clause 6.3.7. In particular:
  - if the NSCE Server needs to perform policy harmonization for the policy that is requested to be updated and the harmonization process is still ongoing, the NSCE Server may reject the request with an HTTP "403 Forbidden" status code with the response body including the ProblemDetails data structure containing the "cause" attribute set to the "HARMOMIZATION\_ONGOING" application error.

## 5.4.2.4 NSCE\_PolicyManagement\_Delete

### 5.4.2.4.1 General

This service operation is used by a service consumer to request the deletion of one or several existing Policy(ies) at the NSCE Server.

The following procedures are supported by the "NSCE\_PolicyManagement\_Delete" service operation:

- Policy(ies) Deletion.

### 5.4.2.4.2 Policy(ies) Deletion

Figure 5.4.2.4.2-1 depicts a scenario where a service consumer sends a request to the NSCE Server to request the deletion of one or several existing Policy(ies) (see also clause 9.5 of 3GPP TS 29.435 [14]).

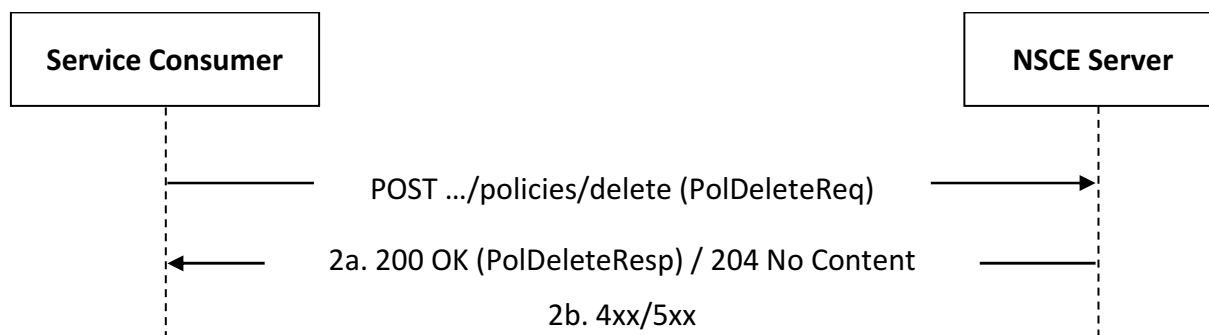

**Figure 5.4.2.4.2-1: Procedure for Policy(ies) Deletion**

1. In order to request the deletion of one or several existing Policy(ies), the service consumer shall send an HTTP POST request to the NSCE Server targeting the URI of the corresponding custom operation (i.e., "Delete"), with the request body including the PolDeleteReq data structure.

**NOTE:** An alternative service consumer (i.e., other than the one that requested the creation/update of the concerned policy(ies)) can initiate this request.

- 2a. Upon success, the NSCE Server shall delete the concerned "Individual Policy" resource(s), update the default policy(ies), accordingly and when relevant, and respond with either:

- an HTTP "200 OK" status code with the response body containing policy(ies) deletion related information within the PolDeleteResp data structure; or
- an HTTP "204 No Content" status code.

- 2b. On failure, the appropriate HTTP status code indicating the error shall be returned and appropriate additional error information should be returned in the HTTP POST response body, as specified in clause 6.3.7.

## 5.4.2.5 NSCE\_PolicyManagement\_HarmonizationNotify

### 5.4.2.5.1 General

This service operation is used by a NSCE Server to notify a previously implicitly subscribed service consumer on:

- Policy Harmonization event(s).

The following procedures are supported by the "NSCE\_PolicyManagement\_HarmonizationNotify" service operation:

- Policy Harmonization Notification.

### 5.4.2.5.2 Policy Harmonization Notification

Figure 5.4.2.5.2-1 depicts a scenario where the NSCE Server sends a request to notify a previously implicitly subscribed service consumer on Policy Harmonization event(s) (see also clause 9.5 of 3GPP°TS°23.435°[14]).

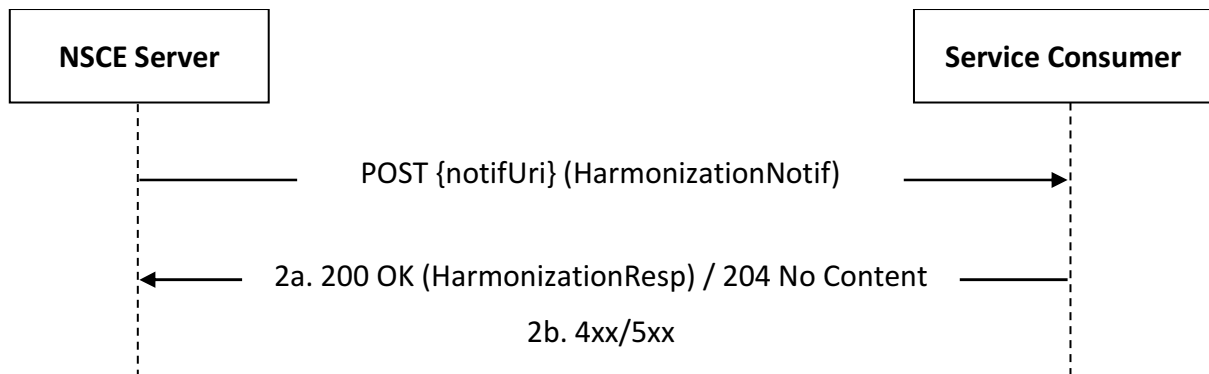

**Figure 5.4.2.5.2-1: Procedure for Policy Harmonization Notification**

1. In order to notify a previously implicitly subscribed service consumer on Policy Harmonization event(s), the NSCE Server shall send an HTTP POST request to the service consumer with the request URI set to "{notifUri}", where the "notifUri" variable is set to the value received from the service consumer during the creation/update of the corresponding Policy, using the procedures defined in clause 5.4.2.2 and 5.4.2.3, and the request body including the HarmonizationNotif data structure.
- 2a. Upon success, the service consumer shall respond to the NSCE Server with either:
  - an HTTP "200 OK" status code to acknowledge the reception of the notification, with the response body containing harmonization related information within the HarmonizationResp data structure; or
  - an HTTP "204 No Content" status code to acknowledge the reception of the notification.
- 2b. On failure, the appropriate HTTP status code indicating the error shall be returned and appropriate additional error information should be returned in the HTTP POST response body, as specified in clause 6.3.7.

## 5.4.2.6 NSCE\_PolicyManagement\_Subscribe

### 5.4.2.6.1 General

This service operation is used by a service consumer to request the creation/update/deletion of a Policy Usage Subscription at the NSCE Server.

The following procedures are supported by the "NSCE\_PolicyManagement\_Subscribe" service operation:

- Policy Usage Subscription Creation.
- Policy Usage Subscription Update.
- Policy Usage Subscription Deletion.

### 5.4.2.6.2 Policy Usage Subscription Creation

Figure 5.4.2.6.2-1 depicts a scenario where a service consumer sends a request to the NSCE Server to request the creation of a Policy Usage Subscription (see also clause 9.5 of 3GPP°TS°23.435°[14]).

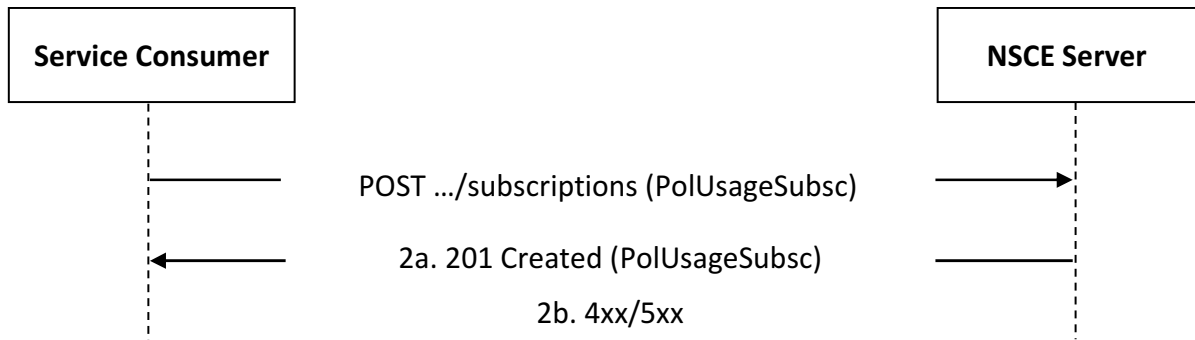
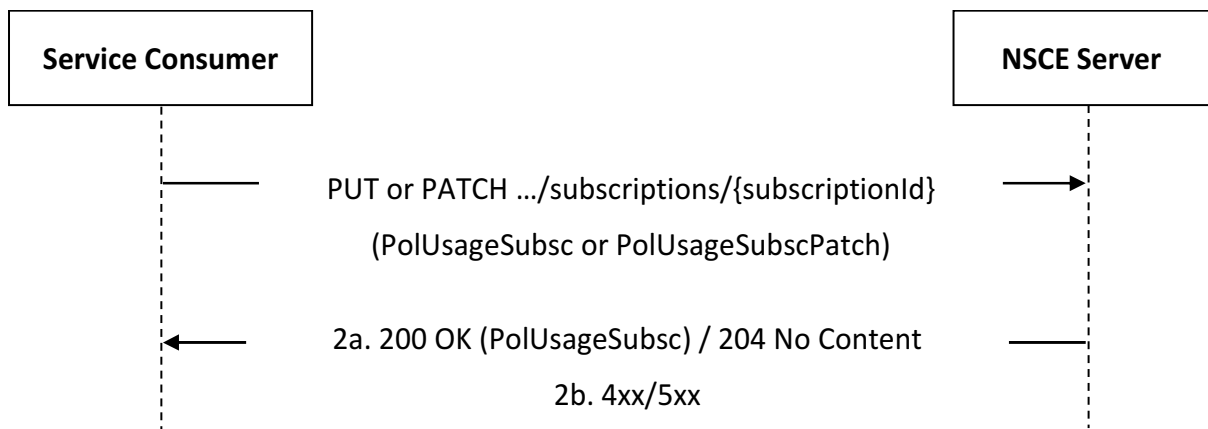

**Figure 5.4.2.6.2-1: Procedure for Policy Usage Subscription Creation**

1. In order to request the creation of a new Policy Usage Subscription, the service consumer shall send an HTTP POST request to the NSCE Server targeting the URI of the "Policy Usage Subscriptions" collection resource, with the request body including the PoUsageSubsc data structure.
- 2a. Upon success, the NSCE Server shall respond with an HTTP "201 Created" status code, with the response body containing a representation of the created "Individual Policy Usage Subscription" resource within the PoUsageSubsc data structure, and an HTTP "Location" header field containing the URI of the created resource.
- 2b. On failure, the appropriate HTTP status code indicating the error shall be returned and appropriate additional error information should be returned in the HTTP POST response body, as specified in clause 6.3.7.

**5.4.2.6.3 Policy Usage Subscription Update**

Figure 5.4.2.6.3-1 depicts a scenario where a service consumer sends a request to the NSCE Server to request the update of an existing Policy Usage Subscription (see also clause 9.5 of 3GPP°TS°23.435°[14]).



**Figure 5.4.2.6.3-1: Procedure for Policy Usage Subscription Update**

1. In order to update an existing Policy Usage Subscription, the service consumer shall send an HTTP PUT/PATCH request to the NSCE Server, targeting the URI of the corresponding "Individual Policy Usage Subscription" resource, with the request body including either:
  - the updated representation of the resource within the PoUsageSubsc data structure, in case the HTTP PUT method is used; or
  - the requested modifications to the resource within the PoUsageSubscPatch data structure, in case the HTTP PATCH method is used.

NOTE: An alternative service consumer (i.e., other than the one that requested the creation of the targeted resource) can initiate this request.

- 2a. Upon success, the NSCE Server shall update the targeted "Individual Policy Usage Subscription" resource accordingly and respond with either:

- an HTTP "200 OK" status code with the response body containing a representation of the updated "Individual Policy Usage Subscription" resource within the PolUsageSubsc data structure; or
- an HTTP "204 No Content" status code.

2b. On failure, the appropriate HTTP status code indicating the error shall be returned and appropriate additional error information should be returned in the HTTP PUT/PATCH response body, as specified in clause 6.3.7.

#### 5.4.2.6.4 Policy Usage Subscription Deletion

Figure 5.4.2.6.4-1 depicts a scenario where a service consumer sends a request to the NSCE Server to request the deletion of an existing Policy Usage Subscription (see also clause 9.5 of 3GPP°TS°23.435°[14]).

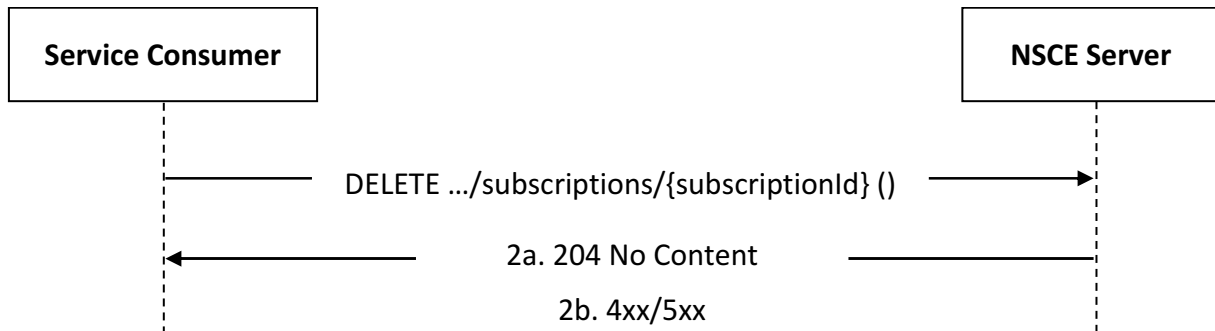

**Figure 5.4.2.6.4-1: Procedure for Policy Usage Subscription Deletion**

1. In order to request the deletion of an existing Policy Usage Subscription, the service consumer shall send an HTTP DELETE request to the NSCE Server targeting the corresponding "Individual Policy Usage Subscription" resource.

NOTE: An alternative service consumer (i.e., other than the one that requested the creation/update of the targeted resource) can initiate this request.

2a. Upon success, the NSCE Server shall respond with an HTTP "204 No Content" status code.

2b. On failure, the appropriate HTTP status code indicating the error shall be returned and appropriate additional error information should be returned in the HTTP DELETE response body, as specified in clause 6.3.7.

#### 5.4.2.7 NSCE\_PolicyManagement\_Notify

##### 5.4.2.7.1 General

This service operation is used by a NSCE Server to notify a previously subscribed service consumer on:

- Policy Usage event(s).

The following procedures are supported by the "NSCE\_PolicyManagement\_Notify" service operation:

- Policy Usage Notification.

##### 5.4.2.7.2 Policy Usage Notification

Figure 5.4.2.7.2-1 depicts a scenario where the NSCE Server sends a request to notify a previously subscribed service consumer on Policy Usage event(s) (see also clause 9.5 of 3GPP°TS°23.435°[14]).



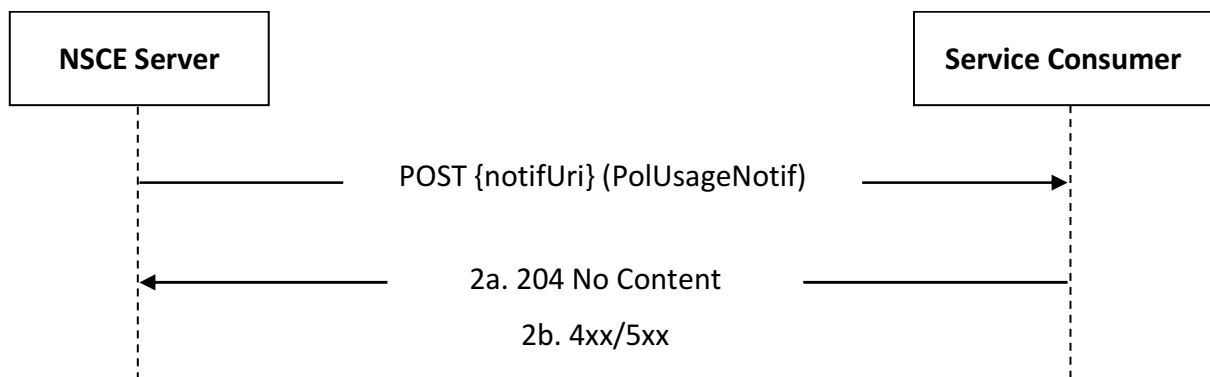

**Figure 5.4.2.7.2-1: Procedure for Policy Usage Notification**

1. In order to notify a previously subscribed service consumer on Policy Usage event(s), the NSCE Server shall send an HTTP POST request to the service consumer with the request URI set to "{notifUri}", where the "notifUri" is set to the value received from the service consumer during the creation/update of the corresponding Policy Usage Subscription, using the procedures defined in clause 5.4.2.6, and the request body including the PolUsageNotif data structure.
- 2a. Upon success, the service consumer shall respond to the NSCE Server with an HTTP "204 No Content" status code to acknowledge the reception of the notification.
- 2b. On failure, the appropriate HTTP status code indicating the error shall be returned and appropriate additional error information should be returned in the HTTP POST response body, as specified in clause 6.3.7.

## 5.5 NSCE\_NSOptimization

### 5.5.1 Service Description

The NSCE\_NSOptimization service exposed by the NSCE Server enables a service consumer to:

- Create/delete a Network Slice Optimization Subscription;
- Receive Network Slice Optimization notifications; and
- Retrieve Network Slice Optimization reports.

### 5.5.2 Service Operations

#### 5.5.2.1 Introduction

The service operations defined for the NSCE\_NSOptimization service are shown in table 5.5.2.1-1.

**Table 5.5.2.1-1: NSCE\_NSOptimization Service Operations**

Service Operation Name	Description	Initiated by
NSCE_NSOptimization_Subscribe	This service operation enables a service consumer to create/update/delete a Network Slice Optimization Subscription.	e.g., VAL Server
NSCE_NSOptimization_Notify	This service operation enables a service consumer to receive Network Slice Optimization notifications.	NSCE Server

## 5.5.2.2 NSCE\_NSOptimization\_Subscribe

### 5.5.2.2.1 General

This service operation is used by a service consumer (e.g. VAL Server) to request the creation/update/deletion of a Network Slice Optimization Subscription at the NSCE Server.

The following procedures are supported by the "NSCE\_NSOptimization\_Subscribe" service operation:

- Network Slice Optimization Subscription Creation;
- Network Slice Optimization Subscription Update;
- Network Slice Optimization Subscription Deletion.

#### 5.5.2.2.2 Network Slice Optimization Subscription Creation

Figure 5.5.2.2.2-1 depicts a scenario where a service consumer sends a request to the NSCE Server to request the creation of a Network Slice Optimization Subscription (as defined in clause 9.5 of 3GPP°TS°23.435°[14]).

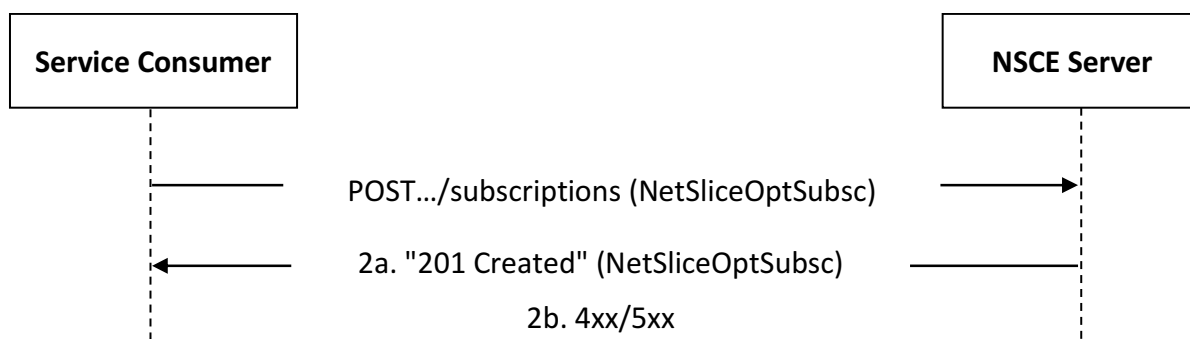
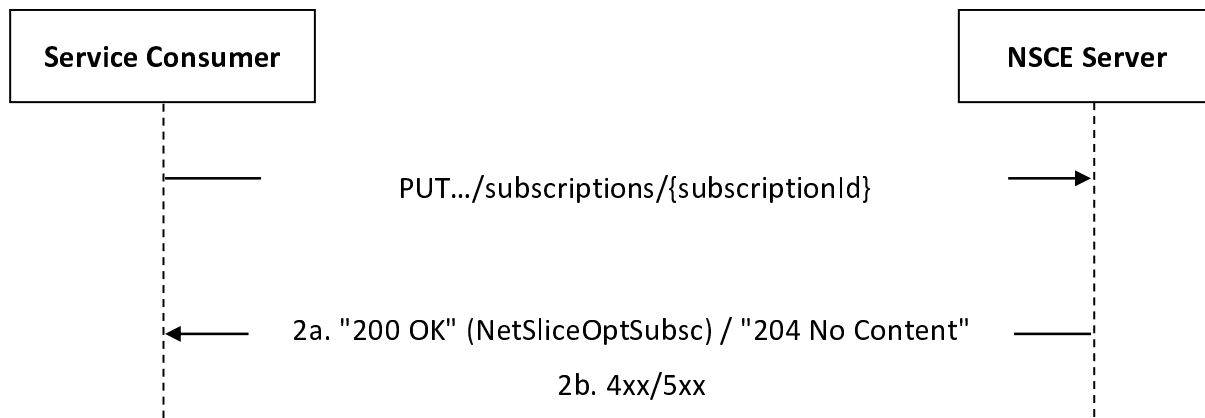

**Figure 5.5.2.2.2-1: Procedure for Network Slice Optimization Subscription Creation**

1. In order to subscribe to network slice optimization reporting, the service consumer shall send an HTTP POST request to the NSCE Server targeting the URI of the "Network Slice Optimization Subscriptions" collection resource, with the request body including the NetSliceOptSubsc data structure.
- 2a. Upon success, the NSCE Server shall respond with an HTTP "201 Created" status code with the response body containing a representation of the created "Individual Network Slice Optimization Subscription" resource within the NetSliceOptSubsc data structure.
- 2b. On failure, the appropriate HTTP status code indicating the error shall be returned and appropriate additional error information should be returned in the HTTP POST response body, as specified in clause 6.4.7.

#### 5.5.2.2.3 Network Slice Optimization Subscription Update

Figure 5.5.2.2.3-1 depicts a scenario where a service consumer sends a request to the NSCE Server to request the update of an existing Network Slice Optimization Subscription (as defined in clause 9.5 of 3GPP°TS°23.435°[14]).



**Figure 5.5.2.2.3-1: Procedure for Network Slice Optimization Subscription Update**

1. In order to update an existing network slice optimization subscription, the service consumer shall send an HTTP PUT/PATCH request to the NSCE Server, targeting the URI of the corresponding "Individual Network Slice Optimization Subscription" resource, with the request body including either:

- the updated representation of the resource within the NetSliceOptSubsc data structure, in case the HTTP PUT method is used.
- the requested modifications to the resource within the NetSliceOptSubscPatch data structure, in case the HTTP PATCH method is used.

NOTE: An alternative service consumer (i.e. other than the one that requested the creation of the targeted resource) can initiate this request.

2a. Upon success, the NSCE Server shall update the targeted "Individual Network Slice Optimization Subscription" resource accordingly and respond with either:

- an HTTP "200 OK" status code with the response body containing a representation of the updated "Individual Network Slice Optimization Subscription" resource within the NetSliceOptSubsc data structure; or
- an HTTP "204 No Content" status code.

2b. On failure, the appropriate HTTP status code indicating the error shall be returned and appropriate additional error information should be returned in the HTTP PUT response body, as specified in clause 6.4.7.

#### 5.5.2.2.4 Network Slice Optimization Subscription Deletion

Figure 5.5.2.2.4-1 depicts a scenario where a service consumer sends a request to the NSCE Server to delete an existing Network Slice Optimization Subscription (as defined in clause 9.5 of 3GPP°TS°23.435°[14]).

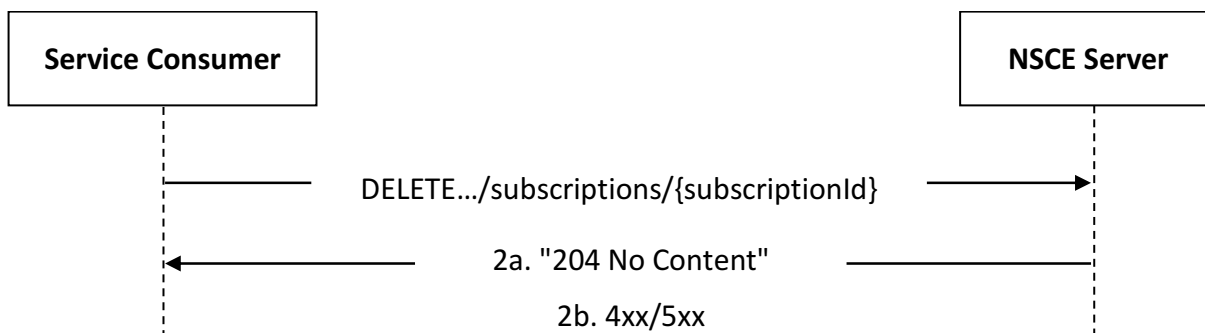

**Figure 5.5.2.2.4-1: Procedure for Network Slice Optimization Subscription Deletion**

1. In order to request the deletion of an existing network slice optimization subscription, the service consumer shall send an HTTP DELETE request to the NSCE Server targeting the corresponding "Individual Network Slice Optimization Subscription" resource.

2a. Upon success, the NSCE Server shall respond with an HTTP "204 No Content" status code.

2b. On failure, the appropriate HTTP status code indicating the error shall be returned and appropriate additional error information should be returned in the HTTP DELETE response body, as specified in clause 6.4.7.

### 5.5.2.3 NSCE\_NSOptimization\_Notify

#### 5.5.2.3.1 General

This service operation is used by a NSCE Server to notify a previously subscribed service consumer on:

- Network Slice Optimization report(s).

The following procedures are supported by the "NSCE\_NSOptimization\_Notify" service operation:

- Network Slice Optimization Notification.

#### 5.5.2.3.2 Network Slice Optimization Notification

Figure 5.5.2.3.2-1 depicts a scenario where the NSCE Server sends a request to notify a previously subscribed service consumer on Network Slice Optimization report(s) (as defined in clause 9.5 of 3GPP TS 23.435 [14]).

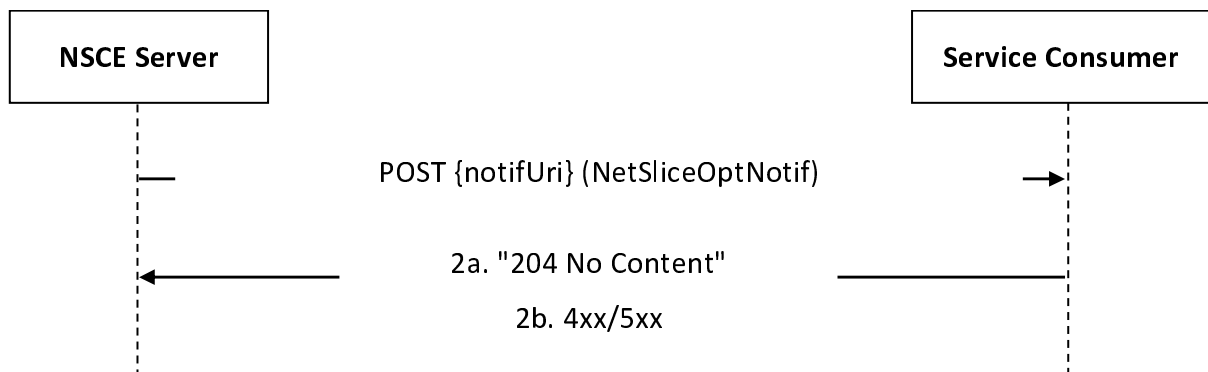

**Figure 5.5.2.3.2-1: Procedure for Network Slice Optimization Notification**

1. In order to notify a previously subscribed service consumer on Network Slice Optimization report(s), the NSCE Server shall send an HTTP POST request to the service consumer with the request URI set to "{notifUri}", where the "notifUri" is set to the value received from the service consumer during the creation/update of the corresponding Network Slice Optimization Subscription using the procedures defined in clause 5.5.2.2, and the request body including the NetSliceOptNotif data structure.

2a. Upon success, the service consumer shall respond to the NSCE Server with an HTTP "204 No Content" status code to acknowledge the reception of the notification.

2b. On failure, the appropriate HTTP status code indicating the error shall be returned and appropriate additional error information should be returned in the HTTP POST response body, as specified in clause 6.4.7.

## 5.6 NSCE\_ManagementServiceDiscovery

### 5.6.1 Service Description

The NSCE\_ManagementServiceDiscovery service exposed by the NSCE Server enables a service consumer to:

- create/update/delete a Management Discovery Subscription; and
- receive Management Discovery Notifications.

## 5.6.2 Service Operations

### 5.6.2.1 Introduction

The service operations defined for the NSCE\_ManagementServiceDiscovery service are shown in table 5.6.2.1-1.

**Table 5.6.2.1-1: NSCE\_ManagementServiceDiscovery Service Operations**

Service Operation Name	Description	Initiated by
NSCE_ManagementServiceDiscovery_Subscribe	This service operation enables a service consumer to request the creation of a Management Discovery Subscription at the NSCE Server.	e.g., VAL Server
NSCE_ManagementServiceDiscovery_Notify	This service operation enables a service consumer to receive Management Discovery Notifications.	NSCE Server

### 5.6.2.2 NSCE\_ManagementServiceDiscovery\_Subscribe

#### 5.6.2.2.1 General

This service operation is used by a service consumer to request the creation/update/deletion of a Management Discovery Subscription at the NSCE Server.

The following procedures are supported by the "NSCE\_ManagementServiceDiscovery\_Subscribe" service operation:

- Management Discovery Subscription Creation.
- Management Discovery Subscription Update.
- Management Discovery Subscription Deletion.

#### 5.6.2.2.2 Management Discovery Subscription Creation

Figure 5.6.2.2.2-1 depicts a scenario where a service consumer sends a request to the NSCE Server to request the creation of a Management Discovery Subscription (see also clause 9.6 of 3GPP TS 29.435 [14]).

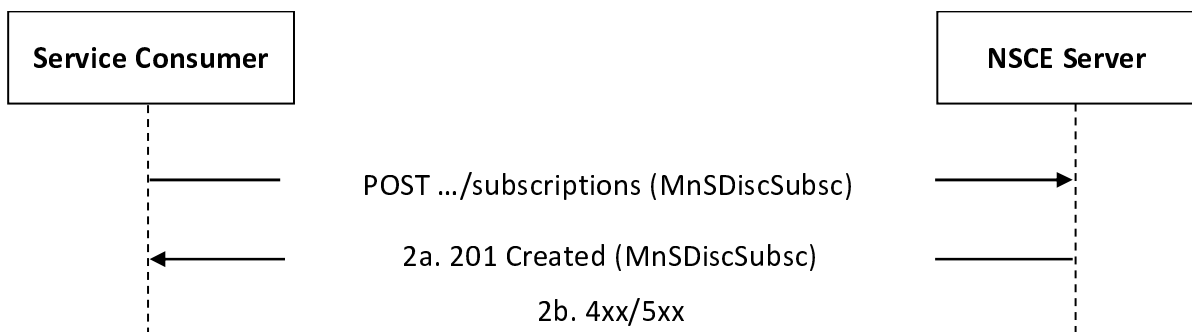
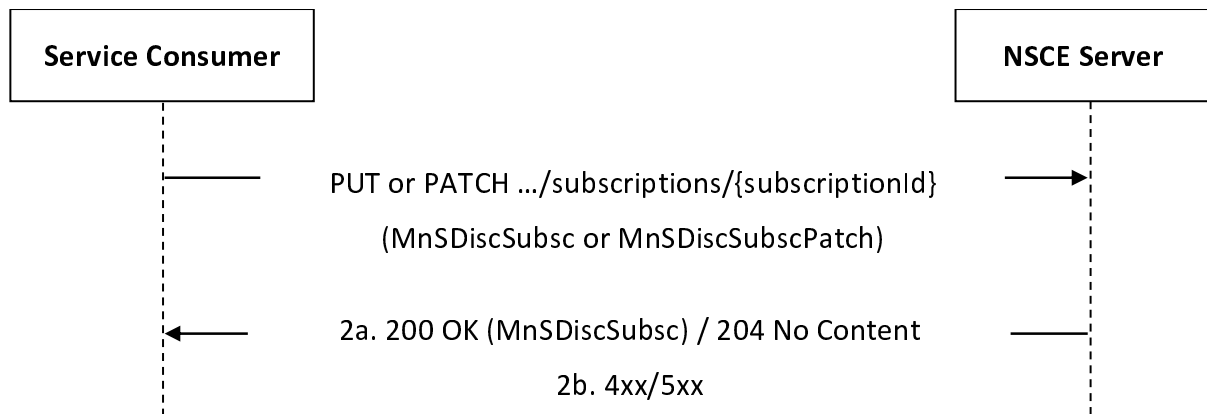

**Figure 5.6.2.2.2-1: Procedure for Management Discovery Subscription Creation**

1. In order to request the creation of a new Management Discovery Subscription, the service consumer shall send an HTTP POST request to the NSCE Server targeting the URI of the "Management Discovery Subscription" collection resource, with the request body including the MnSDiscSubsc data structure.
- 2a. Upon success, the NSCE Server shall respond with an HTTP "201 Created" status code, with the response body containing a representation of the created "Individual Management Discovery Subscription" resource within the MnSDiscSubsc data structure, and an HTTP "Location" header field containing the URI of the created resource.
- 2b. On failure, the appropriate HTTP status code indicating the error shall be returned and appropriate additional error information should be returned in the HTTP POST response body, as specified in clause 6.5.7.

### 5.6.2.2.3 Management Discovery Subscription Update

Figure 5.6.2.2.3-1 depicts a scenario where a service consumer sends a request to the NSCE Server to request the update of an existing Management Discovery Subscription (see also clause 9.6 of 3GPP°TS°23.435°[14]).



**Figure 5.6.2.2.3-1: Procedure for Management Discovery Subscription Update**

1. In order to update an existing Management Discovery Subscription, the service consumer shall send an HTTP PUT/PATCH request to the NSCE Server, targeting the URI of the corresponding "Individual Management Discovery Subscription" resource, with the request body including either:
  - the updated representation of the resource within the MnSDiscSubsc data structure, in case the HTTP PUT method is used; or
  - the requested modifications to the resource within the MnSDiscSubscPatch data structure, in case the HTTP PATCH method is used.

NOTE: An alternative service consumer (i.e. other than the one that requested the creation of the targeted resource) can initiate this request.

- 2a. Upon success, the NSCE Server shall update the targeted "Individual Management Discovery Subscription" resource accordingly and respond with either:
  - an HTTP "200 OK" status code with the response body containing a representation of the updated "Individual Management Discovery Subscription" resource within the MnSDiscSubsc data structure; or
  - an HTTP "204 No Content" status code.
- 2b. On failure, the appropriate HTTP status code indicating the error shall be returned and appropriate additional error information should be returned in the HTTP PUT/PATCH response body, as specified in clause 6.5.7.

### 5.6.2.2.4 Management Discovery Subscription Deletion

Figure 5.6.2.2.4-1 depicts a scenario where a service consumer sends a request to the NSCE Server to request the deletion of an existing Management Discovery Subscription (see also clause 9.6 of 3GPP°TS°23.435°[14]).

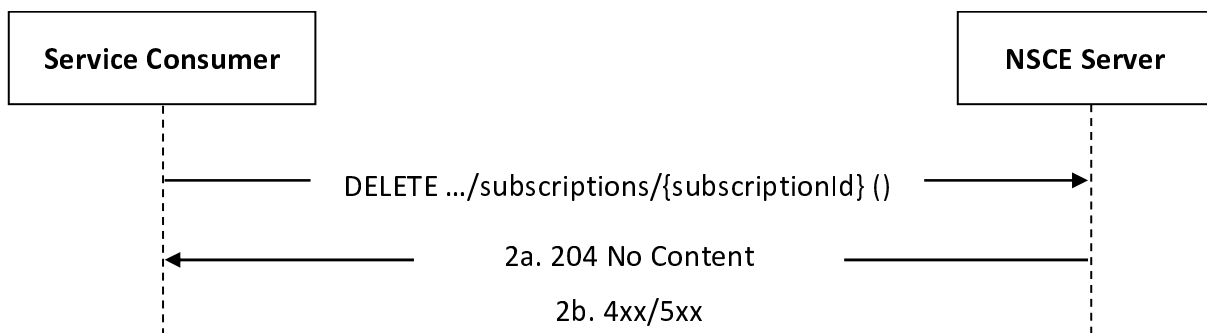

**Figure 5.6.2.2.4-1: Procedure for Management Discovery Subscription Deletion**

1. In order to request the deletion of an existing Management Discovery Subscription, the service consumer shall send an HTTP DELETE request to the NSCE Server targeting the corresponding "Individual Management Discovery Subscription" resource.

NOTE: An alternative service consumer (i.e. other than the one that requested the creation of the targeted resource) can initiate this request.

2a. Upon success, the NSCE Server shall respond with an HTTP "204 No Content" status code.

2b. On failure, the appropriate HTTP status code indicating the error shall be returned and appropriate additional error information should be returned in the HTTP DELETE response body, as specified in clause 6.5.7.

### 5.6.2.3 NSCE\_ManagementServiceDiscovery\_Notify

#### 5.6.2.3.1 General

This service operation is used by a NSCE Server to notify a previously subscribed service consumer on:

- Management Discovery Subscription.

The following procedures are supported by the "NSCE\_ManagementServiceDiscovery\_Notify" service operation:

- MnS discovery Notification.

#### 5.6.2.3.2 Management Discovery Notification

Figure 5.6.2.3.2-1 depicts a scenario where the NSCE Server sends a request to notify a previously subscribed service consumer on Management Discovery event(s) (see also clause 9.6 of 3GPP°TS°23.435°[14]).

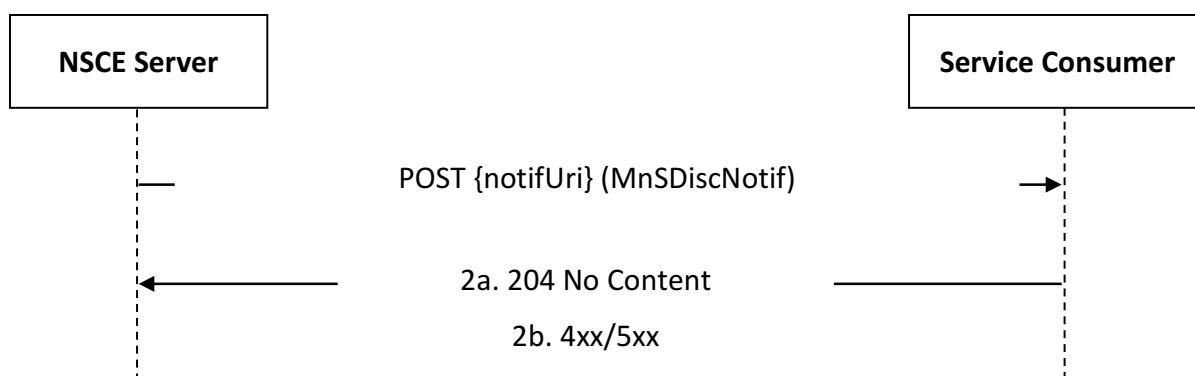

**Figure 5.6.2.3.2-1: MnS discovery Notification**

1. In order to notify a previously subscribed service consumer on Management Discovery event(s), the NSCE Server shall send an HTTP POST request to the service consumer with the request URI set to "{notifUri}", where the "notifUri" variable is set to the value received from the service consumer during the creation/update of the corresponding Management Discovery Subscription using the procedures defined in clause 5.6.2.2, and the request body including the MnSDiscNotif data structure.
- 2a. Upon success, the service consumer shall respond to the NSCE Server with an HTTP "204 No Content" status code to acknowledge the reception of the notification.
- 2b. On failure, the appropriate HTTP status code indicating the error shall be returned and appropriate additional error information should be returned in the HTTP POST response body, as specified in clause 6.5.7.

## 5.7 NSCE\_PerfMonitoring

### 5.7.1 Service Description

The NSCE\_PerfMonitoring service exposed by the NSCE Server enables a service consumer to:

- create/update/delete a network slice related performance and analytics monitoring job;
- create/update/delete a network slice related performance and analytics monitoring subscription;
- receive network slice related performance and analytics monitoring event(s) related notifications; and
- request a multiple slices related performance and analytics consolidated reporting;

## 5.7.2 Service Operations

### 5.7.2.1 Introduction

The service operations defined for the NSCE\_PerfMonitoring service are shown in table 5.7.2.1-1.

**Table 5.7.2.1-1: NSCE\_PerfMonitoring Service Operations**

Service Operation Name	Description	Initiated by
NSCE_PerfMonitoring_Manage	This service operation enables a service consumer to request the creation/update/deletion of a network slice related performance and analytics monitoring job at the NSCE Server.	e.g., VAL Server
NSCE_PerfMonitoring_Subscribe	This service operation enables a service consumer to request the creation/update/deletion of a network slice related performance and analytics monitoring subscription at the NSCE Server.	e.g., VAL Server
NSCE_PerfMonitoring_Notify	This service operation enables a service consumer to receive network slice related performance and analytics monitoring event(s) related notifications from the NSCE Server.	NSCE Server
NSCE_PerfMonitoring_Request	This service operation enables a service consumer to request a multiple slices related performance and analytics consolidated reporting to the NSCE Server.	e.g., VAL Server

### 5.7.2.2 NSCE\_PerfMonitoring\_Manage

#### 5.7.2.2.1 General

This service operation is used by a service consumer to request the creation/update/deletion of a network slice related performance and analytics monitoring job at the NSCE Server.

The following procedures are supported by the "NSCE\_PerfMonitoring\_Manage" service operation:

- Monitoring Job Creation.
- Monitoring Job Update.
- Monitoring Job Deletion.

#### 5.7.2.2.2 Monitoring Job Creation

Figure 5.7.2.2.2-1 depicts a scenario where a service consumer sends a request to the NSCE Server to request the creation of a Monitoring Job (see also clause 9.7 of 3GPP°TS°23.435°[14]).



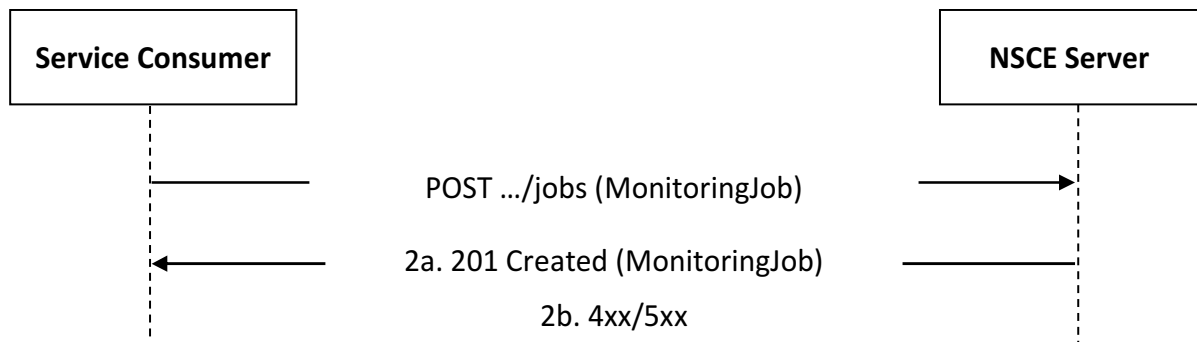
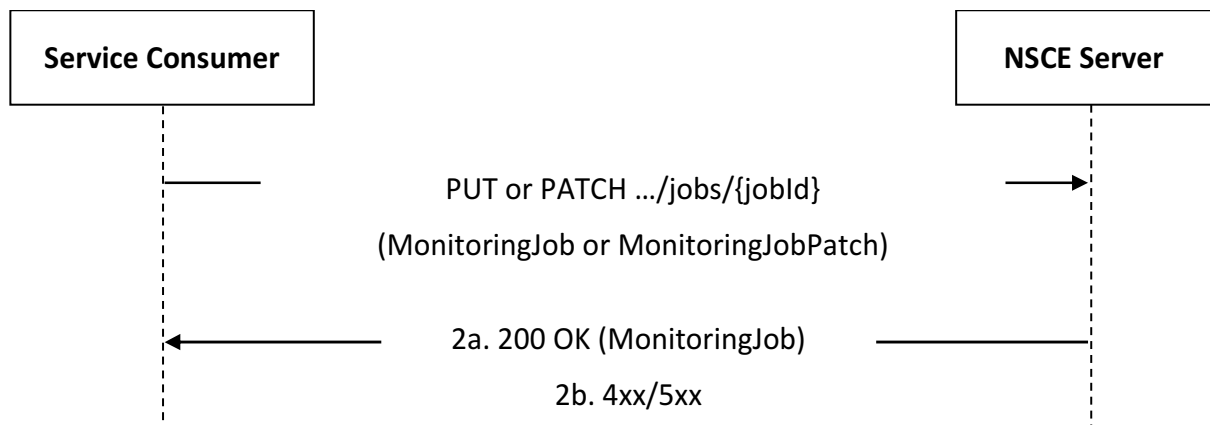

**Figure 5.7.2.2.2-1: Procedure for Monitoring Job Creation**

1. In order to create a new network slice related performance and analytics monitoring job, the service consumer shall send an HTTP POST request to the NSCE Server targeting the URI of the "Monitoring Jobs" collection resource, with the request body including the MonitoringJob data structure.
- 2a. Upon success, the NSCE Server shall respond with an HTTP "201 Created" status code, with the response body containing a representation of the created "Individual Monitoring Job" resource within the MonitoringJob data structure, and an HTTP "Location" header field containing the URI of the created resource.
- 2b. On failure, the appropriate HTTP status code indicating the error shall be returned and appropriate additional error information should be returned in the HTTP POST response body, as specified in clause 6.6.7.

**5.7.2.2.3 Monitoring Job Update**

Figure 5.7.2.2.3-1 depicts a scenario where a service consumer sends a request to the NSCE Server to request the update of an existing Monitoring Job (see also clause 9.7 of 3GPP°TS°23.435°[14]).



**Figure 5.7.2.2.3-1: Procedure for Monitoring Job Update**

1. In order to request the update of an existing network slice related performance and analytics monitoring job, the service consumer shall send an HTTP PUT/PATCH request to the NSCE Server, targeting the URI of the corresponding "Individual Monitoring Job" resource, with the request body including either:
  - the updated representation of the resource within the MonitoringJob data structure, in case the HTTP PUT method is used; or
  - the requested modifications to the resource within the MonitoringJobPatch data structure, in case the HTTP PATCH method is used.

**NOTE:** An alternative service consumer (i.e. other than the one that requested the creation of the targeted resource) can initiate this request.

- 2a. Upon success, the NSCE Server shall update the targeted "Individual Monitoring Job" resource accordingly and respond with either:

- an HTTP "200 OK" status code with the response body containing a representation of the updated "Individual Monitoring Job" resource within the MonitoringJob data structure; or
- an HTTP "204 No Content" status code.

2b. On failure, the appropriate HTTP status code indicating the error shall be returned and appropriate additional error information should be returned in the HTTP PUT/PATCH response body, as specified in clause 6.6.7.

#### 5.7.2.2.4 Monitoring Job Deletion

Figure 5.7.2.2.4-1 depicts a scenario where a service consumer sends a request to the NSCE Server to request the deletion of an existing Monitoring Job (see also clause 9.7 of 3GPP°TS°23.435°[14]).

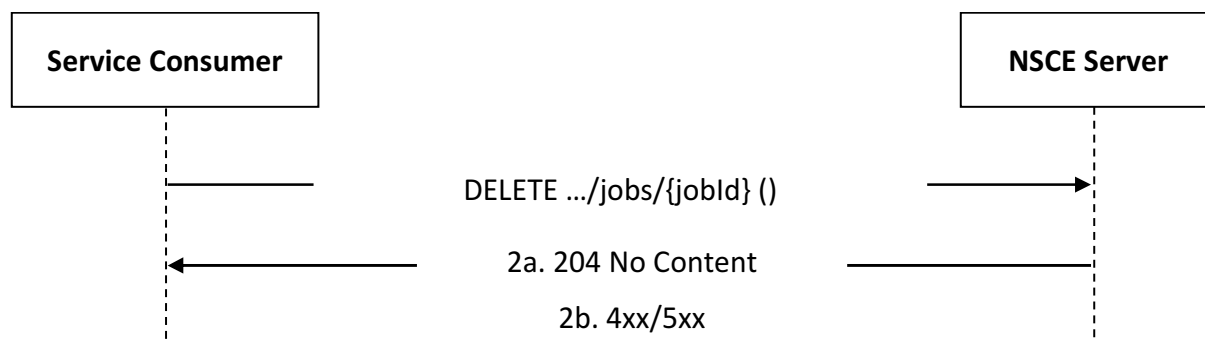

**Figure 5.7.2.2.4-1: Procedure for Monitoring Job Deletion**

1. In order to request the deletion of an existing network slice related performance and analytics monitoring job, the service consumer shall send an HTTP DELETE request to the NSCE Server targeting the corresponding "Individual Monitoring Job" resource.

NOTE: An alternative service consumer (i.e. other than the one that requested the creation/update of the targeted resource) can initiate this request.

2a. Upon success, the NSCE Server shall respond with an HTTP "204 No Content" status code.

2b. On failure, the appropriate HTTP status code indicating the error shall be returned and appropriate additional error information should be returned in the HTTP DELETE response body, as specified in clause 6.6.7.

### 5.7.2.3 NSCE\_PerfMonitoring\_Subscribe

#### 5.7.2.3.1 General

This service operation is used by a service consumer to request the creation/update/deletion of a network slice related performance and analytics monitoring subscription at the NSCE Server.

The following procedures are supported by the "NSCE\_PerfMonitoring\_Subscribe" service operation:

- Monitoring Subscription Creation.
- Monitoring Subscription Update.
- Monitoring Subscription Deletion.

#### 5.7.2.3.2 Monitoring Subscription Creation

Figure 5.7.2.3.2-1 depicts a scenario where a service consumer sends a request to the NSCE Server to request the creation of a Monitoring Subscription (see also clause 9.7 of 3GPP°TS°23.435°[14]).

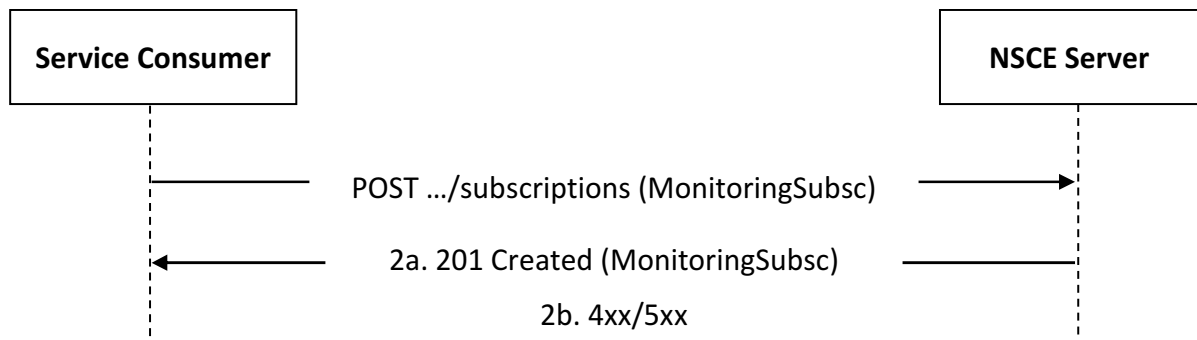
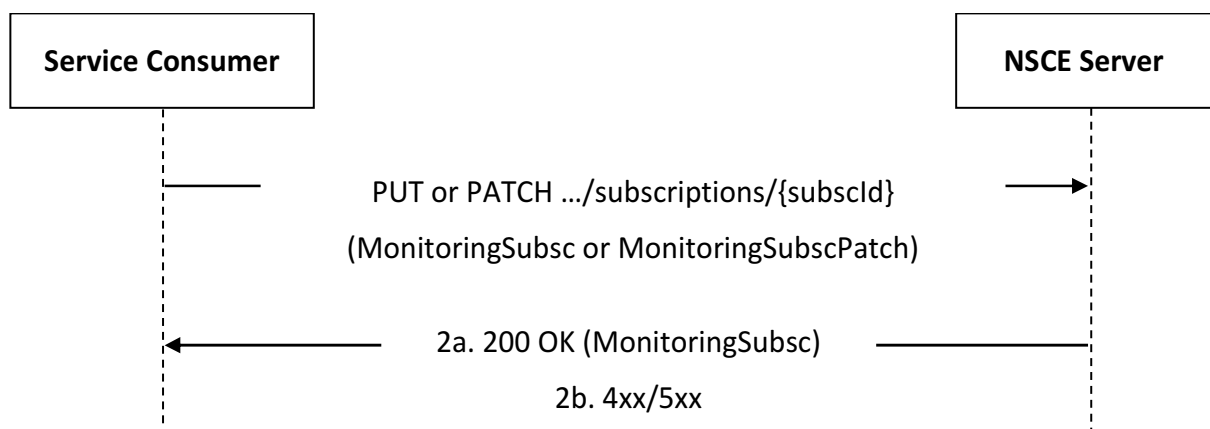

**Figure 5.7.2.3.2-1: Procedure for Monitoring Subscription Creation**

1. In order to create a new network slice related performance and analytics monitoring subscription, the service consumer shall send an HTTP POST request to the NSCE Server targeting the URI of the "Monitoring Subscriptions" collection resource, with the request body including the MonitoringSubsc data structure.
- 2a. Upon success, the NSCE Server shall respond with an HTTP "201 Created" status code, with the response body containing a representation of the created "Individual Monitoring Subscription" resource within the MonitoringSubsc data structure, and an HTTP "Location" header field containing the URI of the created resource.
- 2b. On failure, the appropriate HTTP status code indicating the error shall be returned and appropriate additional error information should be returned in the HTTP POST response body, as specified in clause 6.6.7.

### 5.7.2.3.3 Monitoring Subscription Update

Figure 5.7.2.3.3-1 depicts a scenario where a service consumer sends a request to the NSCE Server to request the update of an existing Monitoring Subscription (see also clause 9.7 of 3GPP°TS°23.435°[14]).



**Figure 5.7.2.3.3-1: Procedure for Monitoring Subscription Update**

1. In order to request the update of an existing network slice related performance and analytics monitoring subscription, the service consumer shall send an HTTP PUT/PATCH request to the NSCE Server, targeting the URI of the corresponding "Individual Monitoring Subscription" resource, with the request body including either:
  - the updated representation of the resource within the MonitoringSubsc data structure, in case the HTTP PUT method is used; or
  - the requested modifications to the resource within the MonitoringSubscPatch data structure, in case the HTTP PATCH method is used.

**NOTE:** An alternative service consumer (i.e. other than the one that requested the creation of the targeted resource) can initiate this request.

- 2a. Upon success, the NSCE Server shall update the targeted "Individual Monitoring Subscription" resource accordingly and respond with either:

- an HTTP "200 OK" status code with the response body containing a representation of the updated "Individual Monitoring Subscription" resource within the MonitoringSubsc data structure; or
- an HTTP "204 No Content" status code.

2b. On failure, the appropriate HTTP status code indicating the error shall be returned and appropriate additional error information should be returned in the HTTP PUT/PATCH response body, as specified in clause 6.6.7.

#### 5.7.2.3.4 Monitoring Subscription Deletion

Figure 5.7.2.3.4-1 depicts a scenario where a service consumer sends a request to the NSCE Server to request the deletion of an existing Monitoring Subscription (see also clause 9.7 of 3GPP°TS°23.435°[14]).

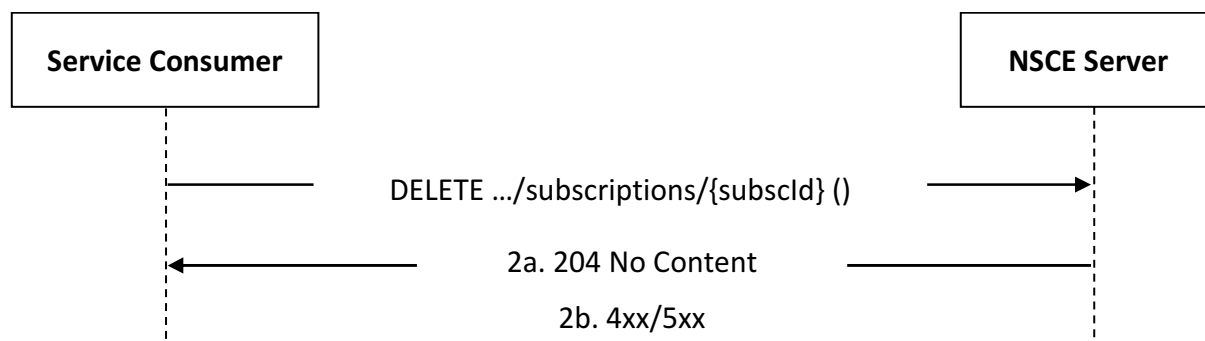

**Figure 5.7.2.3.4-1: Procedure for Monitoring Subscription Deletion**

1. In order to request the deletion of an existing network slice related performance and analytics monitoring subscription, the service consumer shall send an HTTP DELETE request to the NSCE Server targeting the corresponding "Individual Monitoring Subscription" resource.

NOTE: An alternative service consumer (i.e. other than the one that requested the creation/update of the targeted resource) can initiate this request.

2a. Upon success, the NSCE Server shall respond with an HTTP "204 No Content" status code.

2b. On failure, the appropriate HTTP status code indicating the error shall be returned and appropriate additional error information should be returned in the HTTP DELETE response body, as specified in clause 6.6.7.

#### 5.7.2.4 NSCE\_PerfMonitoring\_Notify

##### 5.7.2.4.1 General

This service operation is used by a NSCE Server to notify a previously subscribed service consumer on:

- network slice related performance and analytics monitoring event(s).

The following procedures are supported by the "NSCE\_PerfMonitoring\_Notify" service operation:

- Monitoring Notification.

##### 5.7.2.4.2 Monitoring Notification

Figure 5.7.2.4.2-1 depicts a scenario where the NSCE Server sends a request to notify a previously subscribed service consumer on network slice related performance and analytics monitoring event(s) (see also clause 9.7 of 3GPP°TS°23.435°[14]).

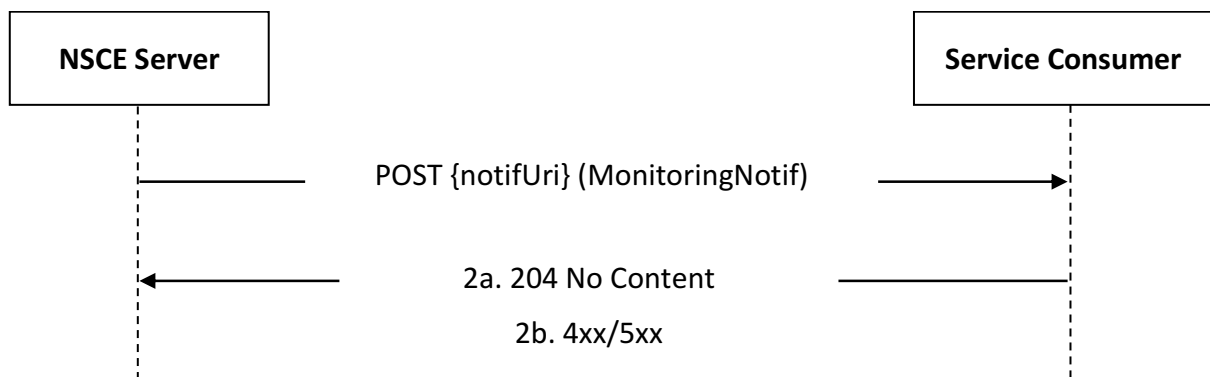

**Figure 5.7.2.4.2-1: Procedure for Monitoring Notification**

1. In order to notify a previously subscribed service consumer on network slice related performance and analytics monitoring event(s), the NSCE Server shall send an HTTP POST request to the service consumer with the request URI set to "{notifUri}", where the "notifUri" variable is set to the value received from the service consumer during the creation/update of the corresponding Monitoring Subscription using the procedures defined in clause 5.7.2.3, and the request body including the MonitoringNotif data structure.
- 2a. Upon success, the service consumer shall respond to the NSCE Server with an HTTP "204 No Content" status code to acknowledge the successful reception and processing of the notification.
- 2b. On failure, the appropriate HTTP status code indicating the error shall be returned and appropriate additional error information should be returned in the HTTP POST response body, as specified in clause 6.6.7.

## 5.7.2.5 NSCE\_PerfMonitoring\_Request

### 5.7.2.5.1 General

This service operation is used by a service consumer to request a multiple slices related performance and analytics consolidated reporting to the NSCE Server.

The following procedures are supported by the "NSCE\_PerfMonitoring\_Request" service operation:

- Multiple Slices related Performance and Analytics Consolidated Reporting Request.

### 5.7.2.5.2 Multiple Slices related Performance and Analytics Consolidated Reporting Request

Figure 5.7.2.5.2-1 depicts a scenario where a service consumer sends a request to the NSCE Server to request a multiple slices related performance and analytics consolidated reporting (see also clause 9.7 of 3GPP°TS°23.435°[14]).

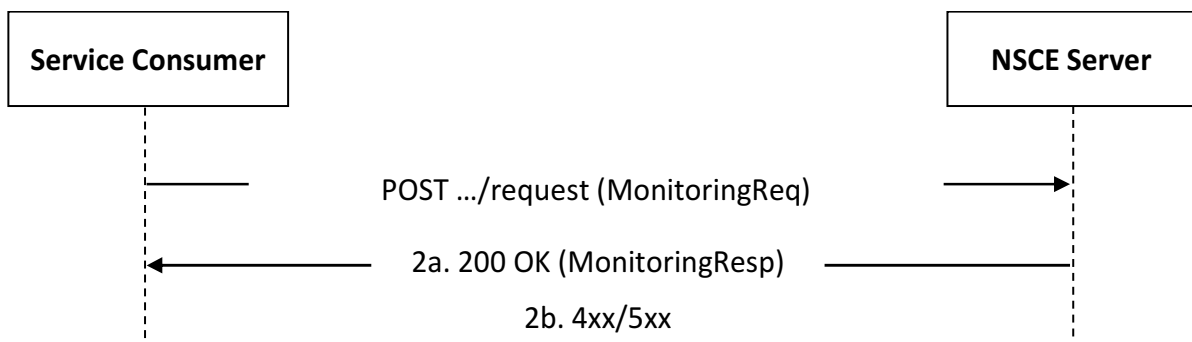

**Figure 5.7.2.5.2-1: Procedure for Multiple Slices related Performance and Analytics Consolidated Reporting Request**

1. In order to request a multiple slices related performance and analytics consolidated reporting, the service consumer shall send an HTTP POST request to the NSCE Server targeting the URI of the corresponding custom operation (i.e., "Request"), with the request body including the MonitoringReq data structure.
- 2a. Upon success, the NSCE Server shall respond with an HTTP "200 OK" status code with the response body containing the requested multiple slices related performance and analytics consolidated report within the MonitoringResp data structure.
- 2b. On failure, the appropriate HTTP status code indicating the error shall be returned and appropriate additional error information should be returned in the HTTP POST response body, as specified in clause 6.6.7.

## 5.8 NSCE\_InfoCollection

### 5.8.1 Service Description

The NSCE\_InfoCollection service exposed by the NSCE Server enables a service consumer to:

- create/update/delete the Information Collection Subscription; and
- receive the Information Collection Notifications.

### 5.8.2 Service Operations

#### 5.8.2.1 Introduction

The service operations defined for the NSCE\_InfoCollection service are shown in table 5.8.2.1-1.

**Table 5.8.2.1-1: NSCE\_InfoCollection Service Operations**

Service Operation Name	Description	Initiated by
NSCE_InfoCollection_Subscribe	This service operation enables a service consumer to create/update/delete an Information Collection Subscription.	e.g., NSCE Server
NSCE_InfoCollection_Notify	This service operation enables a service consumer to receive Information Collection Notifications.	e.g., NSCE Server

#### 5.8.2.2 NSCE\_InfoCollection\_Subscribe

##### 5.8.2.2.1 General

This service operation is used by a service consumer to request the creation/update/deletion of an Information Collection Subscription at the NSCE Server.

The following procedures are supported by the "NSCE\_InfoCollection\_Subscribe" service operation:

- Information Collection Subscription Creation;
- Information Collection Subscription Update;
- Information Collection Subscription Deletion.

##### 5.8.2.2.2 Information Collection Subscription Creation

Figure 5.8.2.2.2-1 depicts a scenario where a service consumer sends a request to the NSCE Server to request the creation of an Information Collection Subscription (as defined in clause 9.8 of 3GPP TS 29.435 [14]).

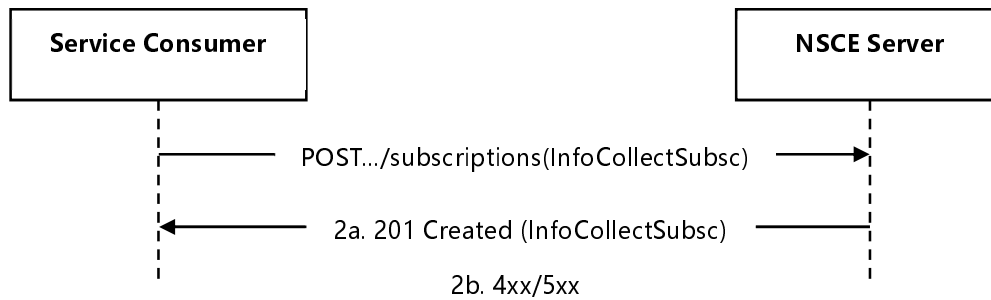
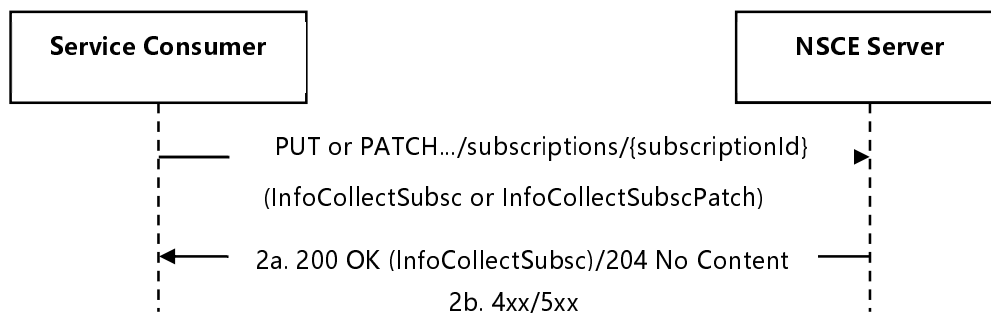

**Figure 5.8.2.2.2-1: Procedure for Information Collection Subscription Creation**

1. In order to request the creation of an Information Collection Subscription, the service consumer shall send an HTTP POST request to the NSCE Server targeting the URI of the "Information Collection Subscriptions" collection resource, with the request body including the InfoCollectSubsc data structure.
- 2a. Upon success, the NSCE Server shall respond with an HTTP "201 Created" status code with the response body containing a representation of the created "Individual Information Collection Subscription" resource within the InfoCollectSubsc data structure.
- 2b. On failure, the appropriate HTTP status code indicating the error shall be returned and appropriate additional error information should be returned in the HTTP POST response body, as specified in clause 6.7.7.

### 5.8.2.2.3 Information Collection Subscription Update

Figure 5.8.2.2.3-1 depicts a scenario where a service consumer sends a request to the NSCE Server to request the update of an existing Information Collection Subscription (as defined in clause 9.8 of 3GPP TS 23.435 [14]).



**Figure 5.8.2.2.3-1: Procedure for Information Collection Subscription Update**

1. In order to update an existing Information Collection Subscription, the service consumer shall send an HTTP PUT/PATCH request to the NSCE Server, targeting the URI of the corresponding "Individual Information Collection Subscription" resource, with the request body including either:
  - the updated representation of the resource within the InfoCollectSubsc data structure, in case the HTTP PUT method is used; or
  - the requested modifications to the resource within the InfoCollectSubscPatch data structure, in case the HTTP PATCH method is used.

**NOTE:** An alternative service consumer (i.e. other than the one that requested the creation of the targeted resource) can initiate this request.

- 2a. Upon success, the NSCE Server shall update the targeted "Individual Information Collection Subscription" resource accordingly and respond with either:
  - an HTTP "200 OK" status code with the response body containing a representation of the updated "Individual Information Collection Subscription" resource within the InfoCollectSubsc data structure; or
  - an HTTP "204 No Content" status code.

2b. On failure, the appropriate HTTP status code indicating the error shall be returned and appropriate additional error information should be returned in the HTTP PUT/PATCH response body, as specified in clause 6.7.7.

### 5.8.2.2.4 Information Collection Subscription Deletion

Figure 5.8.2.2.4-1 depicts a scenario where a service consumer sends a request to the NSCE Server to request the update of an existing Information Collection Subscription (as defined in clause 9.8 of 3GPP°TS°23.435°[14]).

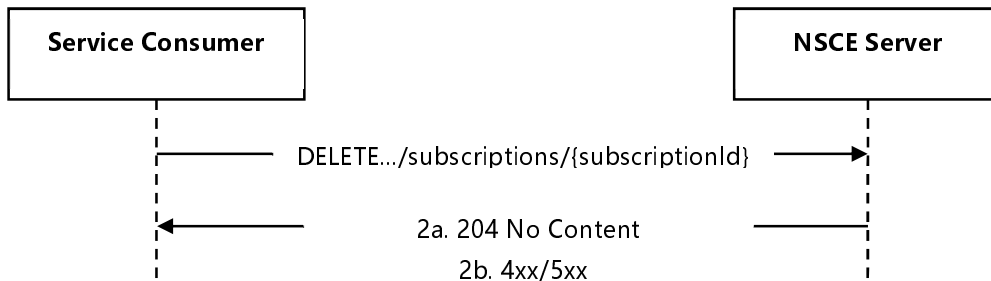

**Figure 5.8.2.2.4-1: Procedure for Information Collection Subscription Deletion**

1. In order to request the deletion of an existing Information Collection Subscription, the service consumer shall send an HTTP DELETE request to the NSCE Server targeting the corresponding "Individual Information Collection Subscription" resource.
- 2a. Upon success, the NSCE Server shall respond with an HTTP "204 No Content" status code.
- 2b. On failure, the appropriate HTTP status code indicating the error shall be returned and appropriate additional error information should be returned in the HTTP DELETE response body, as specified in clause 6.7.7.

### 5.8.2.3 NSCE\_InfoCollection\_Notify

#### 5.8.2.3.1 General

This service operation is used by an NSCE Server to notify a previously subscribed service consumer on:

- information Collection report(s).

The following procedures are supported by the "NSCE\_InfoCollection\_Notify" service operation:

- Information Collection Notification.

#### 5.8.2.3.2 Information Collection Notification

Figure 5.8.2.3.2-1 depicts a scenario where the NSCE Server sends a request to notify a previously subscribed service consumer on Information Collection report(s) (as defined in clause 9.8 of 3GPP°TS°23.435°[14]).

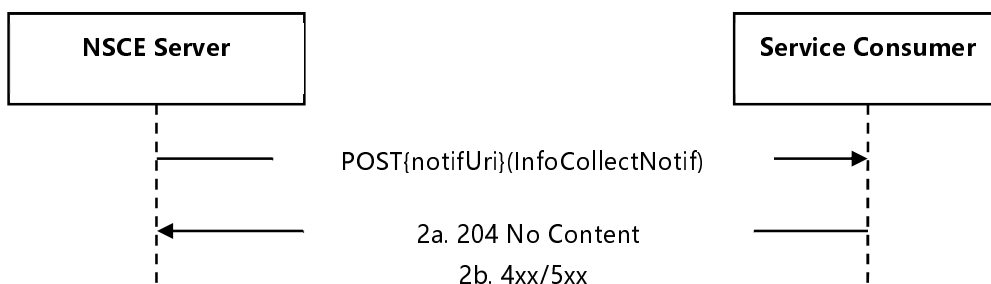

**Figure 5.8.2.3.2-1: Procedure for Information Collection Notification**

1. In order to notify a previously subscribed service consumer on Information Collection report(s), the NSCE Server shall send an HTTP POST request to the service consumer with the request URI set to "{notifUri}", where the "notifUri" variable is set to the value received from the service consumer during the creation/update of



the corresponding Information Collection Subscription using the procedures defined in clause 5.8.2.2, and the request body including the InfoCollectNotif data structure.

- 2a. Upon success, the service consumer shall respond to the NSCE Server with an HTTP "204 No Content" status code to acknowledge the reception of the notification.
- 2b. On failure, the appropriate HTTP status code indicating the error shall be returned and appropriate additional error information should be returned in the HTTP POST response body, as specified in clause 6.7.7.

## 5.9 NSCE\_ServiceContinuity

### 5.9.1 Service Description

The NSCE\_ServiceContinuity service exposed by the NSCE Server enables a service consumer to:

- request edge service continuity requirement; and
- receive edge service continuity requirement related notifications.
- request edge service continuity negotiation; and
- receive edge service continuity negotiation related notifications.

### 5.9.2 Service Operations

#### 5.9.2.1 Introduction

The service operations defined for the NSCE\_ServiceContinuity service are shown in table 5.9.2.1-1.

**Table 5.9.2.1-1: NSCE\_ServiceContinuity Service Operations**

Service Operation Name	Description	Initiated by
NSCE_ServiceContinuity_Request	This service operation enables a service consumer to request edge service continuity requirement to the NSCE Server.	e.g., VAL Server
NSCE_ServiceContinuity_Notify	This service operation enables a service consumer to receive edge service continuity requirement related notifications from the NSCE Server.	NSCE Server
NSCE_ServiceContinuity_Negotiate	This service operation enables a service consumer to request edge service continuity negotiation to the NSCE Server.	NSCE Server
NSCE_ServiceContinuity_NegotiateNotify	This service operation enables a service consumer to receive edge service continuity negotiation related notifications from the NSCE Server.	NSCE Server

#### 5.9.2.2 NSCE\_ServiceContinuity\_Request

##### 5.9.2.2.1 General

This service operation is used by a service consumer to request edge service continuity requirement to the NSCE Server.

The following procedures are supported by the "NSCE\_ServiceContinuity\_Request" service operation:

- Edge service continuity requirement Request.

### 5.9.2.2.2 Edge service continuity requirement Request

Figure 5.9.2.2.2-1 depicts a scenario where a service consumer sends a request to the NSCE Server to request edge service continuity requirement to the NSCE Server (see also clause 9.9 of 3GPP°TS°23.435°[14]).

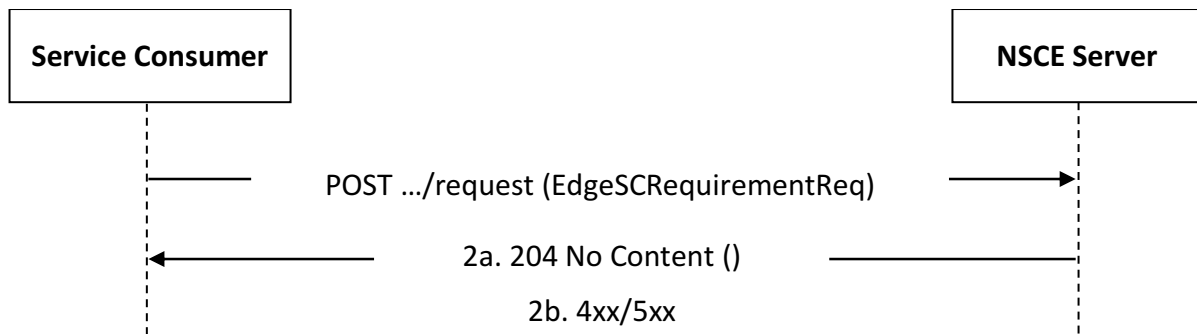

**Figure 5.9.2.2.2-1: Procedure for Edge service continuity requirement Request**

1. In order to request edge service continuity requirement, the service consumer shall send an HTTP POST request to the NSCE Server targeting the URI of the corresponding custom operation (i.e., "Request"), with the request body including the EdgeSCRequirementReq data structure.
- 2a. Upon success, the NSCE Server shall respond with an HTTP "204 No Content" status code to indicate that the edge service continuity requirement request is successfully received, accepted and processed.
- 2b. On failure, the appropriate HTTP status code indicating the error shall be returned and appropriate additional error information should be returned in the HTTP POST response body, as specified in clause 6.8.7.

### 5.9.2.3 NSCE\_ServiceContinuity\_Notify

#### 5.9.2.3.1 General

This service operation is used by a NSCE Server to notify a previously subscribed service consumer on:

- edge service continuity requirement.

The following procedures are supported by the "NSCE\_ServiceContinuity\_Notify" service operation:

- Edge service continuity requirement Notification.

#### 5.9.2.3.2 Edge service continuity requirement Notification

Figure 5.9.2.3.2-1 depicts a scenario where the NSCE Server sends a request to notify a previously requested service consumer on edge service continuity requirement (see also clause 9.9 of 3GPP°TS°23.435°[14]).

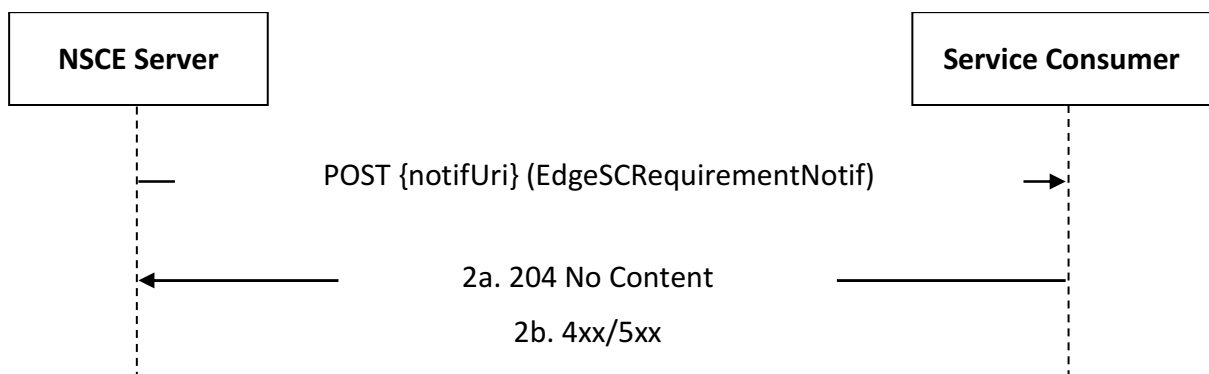

**Figure 5.9.2.3.2-1: Edge service continuity requirement Notification**

1. In order to notify a previously subscribed service consumer on edge service continuity requirement, the NSCE Server shall send an HTTP POST request to the service consumer with the request URI set to "{notifUri}", where the "notifUri" variable is set to the value received from the service consumer using the procedures defined in clause 5.9.2.2, and the request body including the EdgeSCRequirementNotif data structure.
- 2a. Upon success, the service consumer shall respond to the NSCE Server with an HTTP "204 No Content" status code to acknowledge the successful reception and processing of the notification.
- 2b. On failure, the appropriate HTTP status code indicating the error shall be returned and appropriate additional error information should be returned in the HTTP POST response body, as specified in clause 6.8.7.

## 5.9.2.4 NSCE\_ServiceContinuity\_Negotiate

### 5.9.2.4.1 General

This service operation is used by a service consumer to request edge service continuity negotiation to the NSCE Server.

The following procedures are supported by the "NSCE\_ServiceContinuity\_Negotiate" service operation:

- Edge service continuity negotiation Request.

### 5.9.2.4.2 Edge service continuity negotiation Request

Figure 5.9.2.4.2-1 depicts a scenario where a service consumer sends a request to the NSCE Server to request edge service continuity negotiation to the NSCE Server (see also clause 9.9 of 3GPP TS 23.435 [14]).

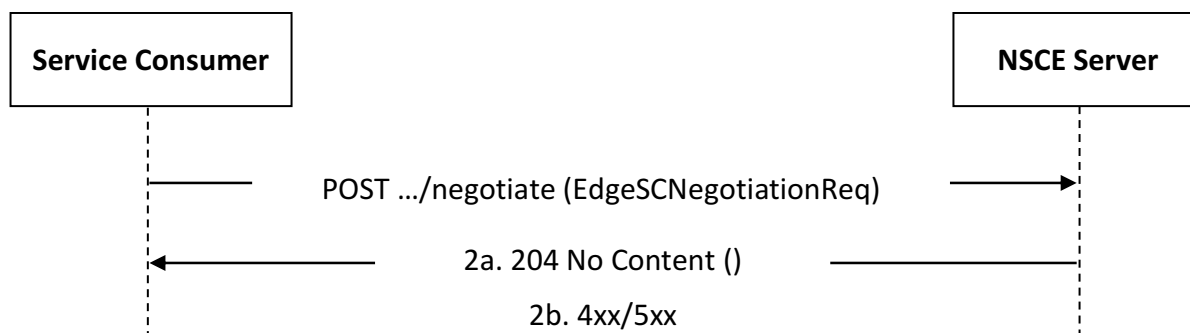

**Figure 5.9.2.4.2-1: Procedure for Edge service continuity negotiation Request**

1. In order to request edge service continuity negotiation, the service consumer shall send an HTTP POST request to the NSCE Server targeting the URI of the corresponding custom operation (i.e., "Request"), with the request body including the EdgeSCNegotiationReq data structure.
- 2a. Upon success, the NSCE Server shall respond with an HTTP "204 No Content" status code to indicate that the edge service continuity negotiation request is successfully received, accepted and processed.
- 2b. On failure, the appropriate HTTP status code indicating the error shall be returned and appropriate additional error information should be returned in the HTTP POST response body, as specified in clause 6.8.7.

## 5.9.2.5 NSCE\_ServiceContinuity\_NegotiateNotify

### 5.9.2.5.1 General

This service operation is used by a NSCE Server to notify a previously subscribed service consumer on:

- edge service continuity negotiation.

The following procedures are supported by the "NSCE\_ServiceContinuity\_NegotiateNotify" service operation:

- Edge service continuity negotiation Notification.

### 5.9.2.5.2 Edge service continuity negotiation Notification

Figure 5.9.2.5.2-1 depicts a scenario where the NSCE Server sends a request to notify a previously requested service consumer on edge service continuity negotiation (see also clause 9.9 of 3GPP°TS°23.435°[14]).

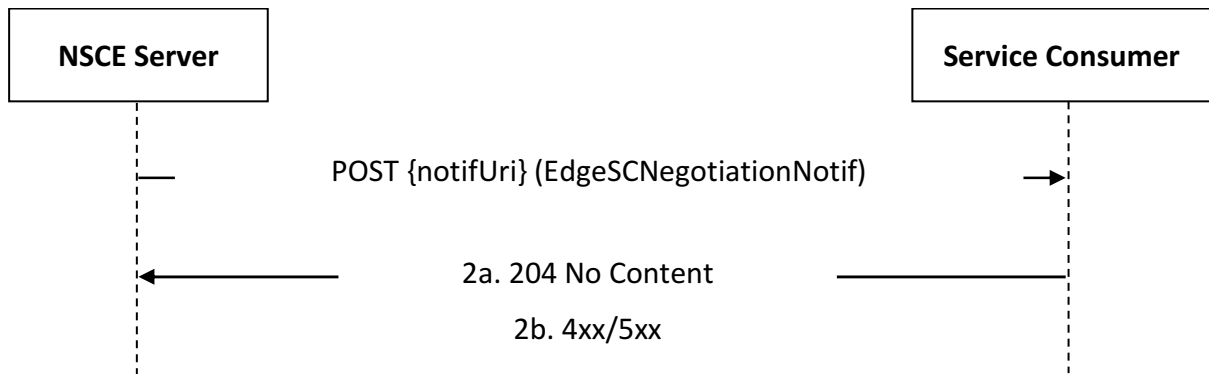

**Figure 5.9.2.5.2-1: Edge service continuity negotiation Notification**

1. In order to notify a previously subscribed service consumer on edge service continuity negotiation, the NSCE Server shall send an HTTP POST request to the service consumer with the request URI set to "{notifUri}", where the "notifUri" variable is set to the value received from the service consumer using the procedures defined in clause 5.9.2.4, and the request body including the EdgeSCNegotiationNotif data structure.
- 2a. Upon success, the service consumer shall respond to the NSCE Server with an HTTP "204 No Content" status code to acknowledge the successful reception and processing of the notification.
- 2b. On failure, the appropriate HTTP status code indicating the error shall be returned and appropriate additional error information should be returned in the HTTP POST response body, as specified in clause 6.8.7.

## 5.10 NSCE\_MultiSlicesOptimization

### 5.10.1 Service Description

The NSCE\_MultiSlicesOptimization service exposed by the NSCE Server enables a service consumer to:

- request Multiple Slices Optimization.

### 5.10.2 Service Operations

#### 5.10.2.1 Introduction

The service operation defined for the NSCE\_MultiSlicesOptimization service is shown in table 5.10.2.1-1.

**Table 5.10.2.1-1: NSCE\_MultiSlicesOptimization Service Operations**

Service Operation Name	Description	Initiated by
NSCE_MultiSlicesOptimization_Request	This service operation enables a service consumer to request multiple slices optimization to the NSCE Server.	e.g., VAL Server

## 5.10.2.2 NSCE\_MultiSlicesOptimization\_Request

### 5.10.2.2.1 General

This service operation is used by a service consumer to request multiple slices optimization to the NSCE Server.

The following procedures are supported by the "NSCE\_MultiSlicesOptimization\_Request" service operation:

- Multiple Slices Optimization Request.

#### 5.10.2.2.2 Multiple Slices Optimization Request

Figure 5.10.2.2.2-1 depicts a scenario where a service consumer sends a request to the NSCE Server to request multiple slices optimization (as defined in clause 9.10 of 3GPP TS 29.435 [14]).

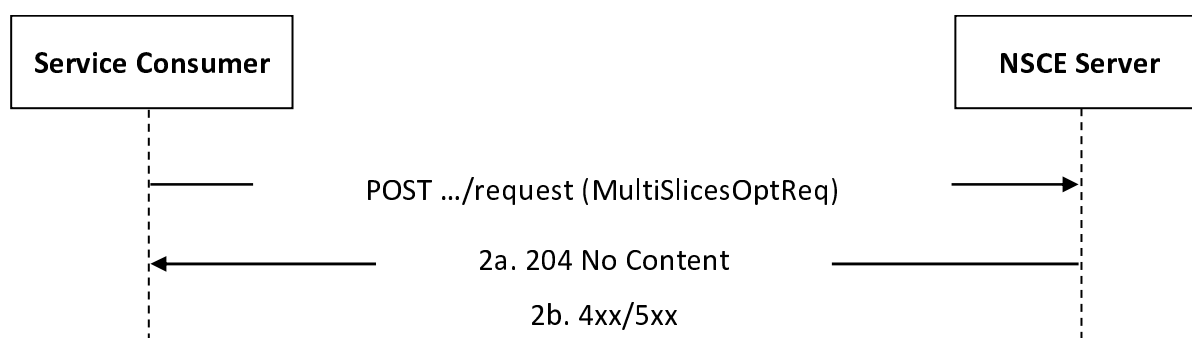

**Figure 5.10.2.2.2-1: Procedure for Multiple Slices Optimization Request**

1. In order to request multiple slices optimization, the service consumer shall send an HTTP POST request to the NSCE Server, with the request body including the MultiSlicesOptReq data structure.
- 2a. Upon success, the NSCE Server shall respond with an HTTP "204 No Content" status code.
- 2b. On failure, the appropriate HTTP status code indicating the error shall be returned and appropriate additional error information should be returned in the HTTP POST response body, as specified in clause 6.9.7.

## 5.11 NSCE\_NetworkSliceAdaptation

### 5.11.1 Service Description

The NSCE\_NetworkSliceAdaptation service exposed by the NSCE Server enables a service consumer to:

- request network slice adaptation;
- receive Network Slice Adaptation Status notifications;

NOTE: The Rel-17 version of this API is documented in clauses 5.8.1.1, 7.7.1, and Annex A.9 of 3GPP TS 29.549 [15]. This API moves to this specification in Rel-18.

### 5.11.2 Service Operations

#### 5.11.2.1 Introduction

The service operations defined for the NSCE\_NetworkSliceAdaptation service are shown in table 5.11.2.1-1.

**Table 5.11.2.1-1: NSCE\_NetworkSliceAdaptation Service Operations**

Service Operation Name	Description	Initiated by
Network_slice_adaptation	This service operation enables a service consumer to request network slice adaptation to the NSCE Server.	e.g., VAL Server
NSCE_NetworkSliceAdaptation_Notify	This service operation enables a service consumer to receive Network Slice Adaptation Status notifications.	NSCE Server

5.11.2.2 Network\_slice\_adaptation

5.11.2.2.1 General

This service operation is used by a service consumer to request network slice adaptation to the NSCE Server.

The following procedures are supported by the "Network\_slice\_adaptation" service operation:

- Network Slice Adaptation Request.

5.11.2.2.2 Network Slice Adaptation Request

Figure 5.11.2.2.2-1 depicts a scenario where a service consumer sends a request to the NSCE Server to request network slice adaptation (see also clause 9.11 of 3GPP TS 23.435 [14]).

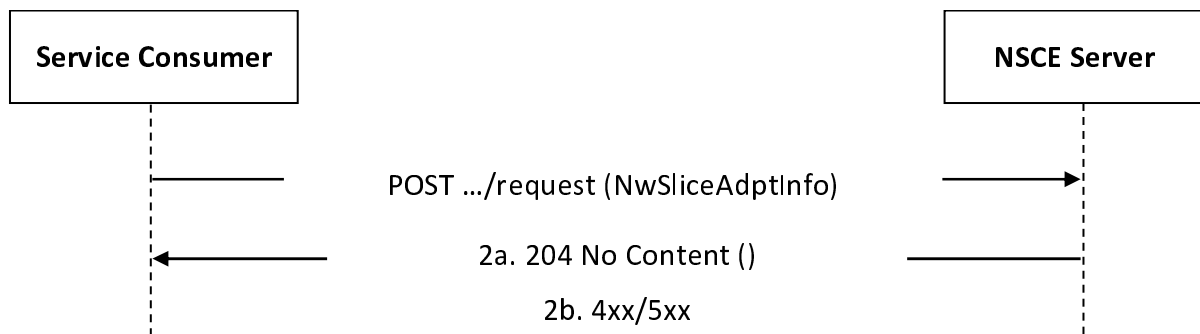

**Figure 5.11.2.2.2-1: Procedure for Network Slice Adaptation Request**

- To request network slice adaptation, the service consumer shall send an HTTP POST request to the NSCE server targeting the URI of the corresponding custom operation (i.e., "Request"), with the request body including the NwSliceAdptInfo data structure.
- Upon reception of the HTTP POST request message, the NSCE server shall:
  - process the request and trigger the network slice configuration per VAL UE within the VAL Application;
  - send guidance information to the PCF via the NEF as part of the AF-driven guidance for URSP determination to the 5G system, using the Nnef\_ServiceParameter API defined in 3GPP TS 29.522 [16]; and
  - after receiving a successful response from the NEF, respond with an HTTP "204 No content" status code to confirm the fulfillment of the network slice adaptation request.
- On failure, the appropriate HTTP status code indicating the error shall be returned and appropriate additional error information should be returned in the HTTP POST response body, as specified in clause 6.10.7. In particular:
  - if the requested network slice adaptation fails or cannot be performed at the NSCE Server, the NSCE Server may reject the request and respond to the AF with an HTTP "403 Forbidden" status code with the response body including the ProblemDetailsSliceAdapt data structure containing:
    - the ProblemDetails data structure with the "cause" attribute set to the "ADAPTATION\_FAILURE" application error; and optionally

- the AdaptFailCause data structure containing the cause of the network slice adaptation failure.

### 5.11.2.3 NSCE\_NetworkSliceAdaptation\_Notify

#### 5.11.2.3.1 General

This service operation is used by a NSCE Server to notify a previously subscribed service consumer on:

- Network Slice Adaptation Status event(s).

The following procedures are supported by the "NSCE\_NetworkSliceAdaptation\_Notify" service operation:

- Network Slice Adaptation Status Notification.

#### 5.11.2.3.2 Network Slice Adaptation Status Notification

Figure 5.11.2.3.2-1 depicts a scenario where the NSCE Server sends a request to notify a previously implicitly subscribed service consumer on Network Slice Adaptation Status event(s) (see also clause 9.11 of 3GPP TS 23.435 [14]).

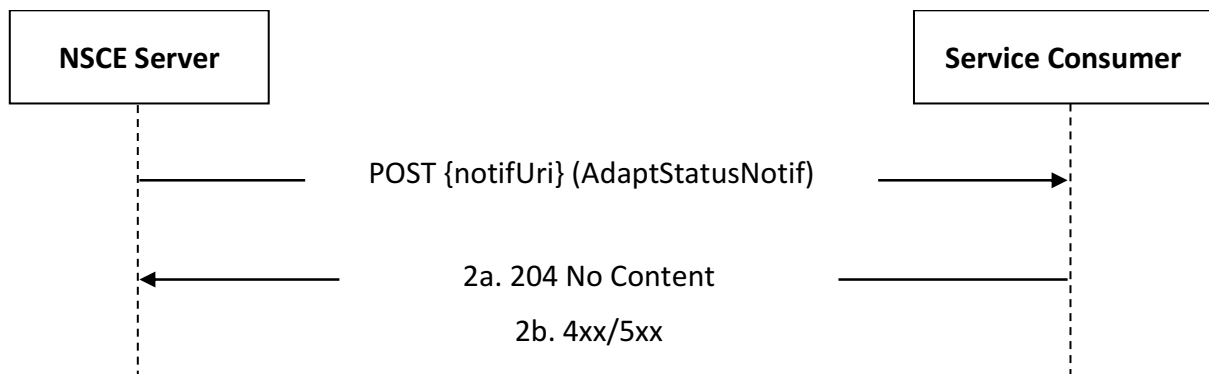

**Figure 5.11.2.3.2-1: Procedure for Network Slice Adaptation Status Notification**

1. In order to notify a previously implicitly subscribed service consumer on Network Slice Adaptation Status event(s), the NSCE Server shall send an HTTP POST request to the service consumer with the request URI set to "{notifUri}", where the "notifUri" variable is set to the value received from the service consumer during the corresponding Network Slice Adaptation Request, using the procedures defined in clause 5.11.2.2, and the request body including the AdaptStatusNotif data structure.
- 2a. Upon success, the service consumer shall respond to the NSCE Server with an HTTP "204 No Content" status code to acknowledge the reception of the notification.
- 2b. On failure, the appropriate HTTP status code indicating the error shall be returned and appropriate additional error information should be returned in the HTTP POST response body, as specified in clause 6.10.7.

## 5.12 NSCE\_SliceCommService

### 5.12.1 Service Description

The NSCE\_SliceCommService service exposed by the NSCE Server enables a service consumer to:

- create/reconfigure/disengage a Slice Related Communication Service.

## 5.12.2 Service Operations

### 5.12.2.1 Introduction

The service operations defined for the NSCE\_SliceCommService service are shown in table 5.12.2.1-1.

**Table 5.12.2.1-1: NSCE\_SliceCommService Service Operations**

Service Operation Name	Description	Initiated by
NSCE_SliceCommService_Create	This service operation enables a service consumer to request the creation of a Slice Related Communication Service at the NSCE Server.	e.g., VAL Server
NSCE_SliceCommService_Reconfigure	This service operation enables a service consumer to request the update/modification (i.e., reconfiguration) of an existing Slice Related Communication Service at the NSCE Server.	e.g., VAL Server
NSCE_SliceCommService_Disengage	This service operation enables a service consumer to request the deletion (disengagement) of an existing Slice Related Communication Service at the NSCE Server.	e.g., VAL Server

### 5.12.2.2 NSCE\_SliceCommService\_Create

#### 5.12.2.2.1 General

This service operation is used by a service consumer to request the creation of a Slice Related Communication Service at the NSCE Server.

The following procedures are supported by the "NSCE\_SliceCommService\_Create" service operation:

- Slice Related Communication Service Creation.

#### 5.12.2.2.2 Slice Related Communication Service Creation

Figure 5.12.2.2.2-1 depicts a scenario where a service consumer sends a request to the NSCE Server to request the creation of a Slice Related Communication Service (see also clause 9.12 of 3GPP°TS°23.435°[14]).

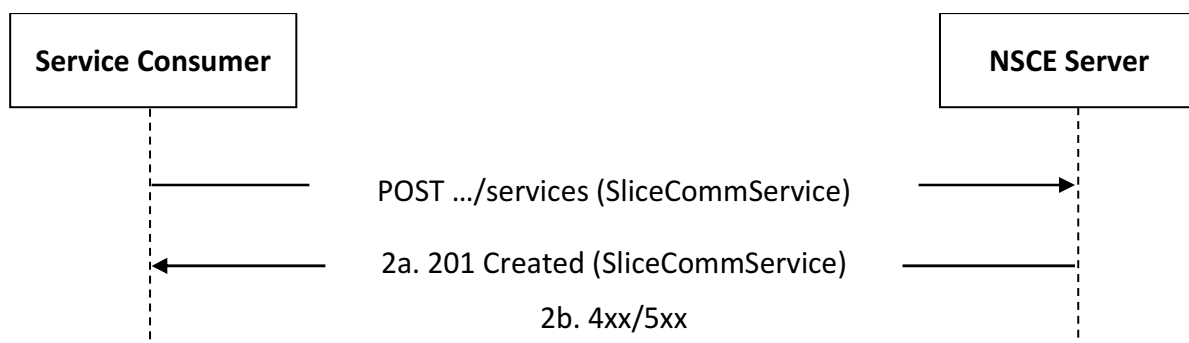

**Figure 5.12.2.2.2-1: Procedure for Slice Related Communication Service Creation**

1. In order to create a new Slice Related Communication Service, the service consumer shall send an HTTP POST request to the NSCE Server targeting the URI of the "Slice Related Communication Services" collection resource, with the request body including the SliceCommService data structure.
- 2a. Upon success, the NSCE Server shall respond with an HTTP "201 Created" status code, with the response body containing a representation of the created "Individual Slice Related Communication Service" resource within the SliceCommService data structure, and an HTTP "Location" header field containing the URI of the created resource.



- 2b. On failure, the appropriate HTTP status code indicating the error shall be returned and appropriate additional error information should be returned in the HTTP POST response body, as specified in clause 6.11.7.

### 5.12.2.3 NSCE\_SliceCommService\_Reconfigure

#### 5.12.2.3.1 General

This service operation is used by a service consumer to request the reconfiguration of an existing Slice Related Communication Service at the NSCE Server.

The following procedures are supported by the "NSCE\_SliceCommService\_Reconfigure" service operation:

- Slice Related Communication Service Reconfiguration.

#### 5.12.2.3.2 Slice Related Communication Service Reconfiguration

Figure 5.12.2.3.2-1 depicts a scenario where a service consumer sends a request to the NSCE Server to request the reconfiguration of an existing Slice Related Communication Service (see also clause 9.12 of 3GPP TS 29.435 [14]).

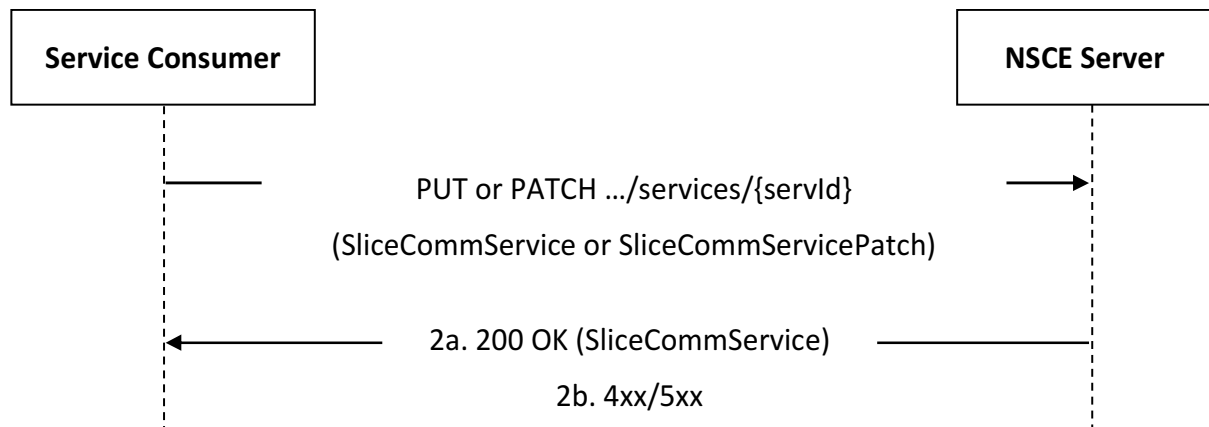

**Figure 5.12.2.3.2-1: Procedure for Slice Related Communication Service Reconfiguration**

1. In order to request the update (i.e., reconfiguration) of an existing Slice Related Communication Service, the service consumer shall send an HTTP PUT/PATCH request to the NSCE Server, targeting the URI of the corresponding "Individual Slice Related Communication Service" resource, with the request body including either:

- the updated representation of the resource within the `SliceCommService` data structure, in case the HTTP PUT method is used; or
- the requested modifications to the resource within the `SliceCommServicePatch` data structure, in case the HTTP PATCH method is used.

NOTE 1: An alternative service consumer (i.e. other than the one that requested the creation of the targeted resource) can initiate this request.

- 2a. Upon success, the NSCE Server shall update the targeted "Individual Slice Related Communication Service" resource accordingly and respond with an HTTP "200 OK" status code with the response body containing a representation of the updated "Individual Slice Related Communication Service" resource within the `SliceCommService` data structure.

NOTE 2: The HTTP "204 No Content" status code is not supported for this case as the response has to always include a response body to convey the information of the network slice determined and assigned to fulfill the received updated application service requirements within the updated resource representation.

- 2b. On failure, the appropriate HTTP status code indicating the error shall be returned and appropriate additional error information should be returned in the HTTP PUT/PATCH response body, as specified in clause 6.11.7.

## 5.12.2.4 NSCE\_SliceCommService\_Disengage

### 5.12.2.4.1 General

This service operation is used by a service consumer to request the disengagement of an existing Slice Related Communication Service at the NSCE Server.

The following procedures are supported by the "NSCE\_SliceCommService\_Disengage" service operation:

- Slice Related Communication Service Disengagement.

### 5.12.2.4.2 Slice Related Communication Service Disengagement

Figure 5.12.2.4.2-1 depicts a scenario where a service consumer sends a request to the NSCE Server to request the disengagement of an existing Slice Related Communication Service (see also clause 9.12 of 3GPP°TS°23.435°[14]).

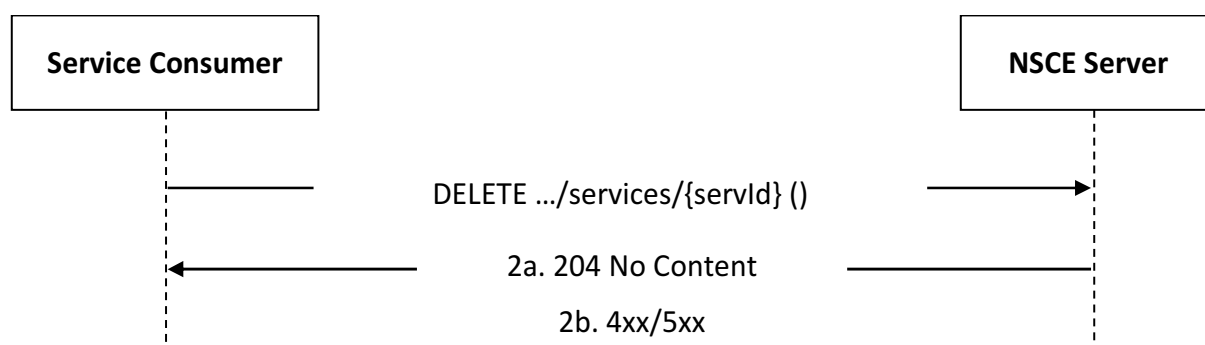

**Figure 5.12.2.4.2-1: Procedure for Slice Related Communication Service Disengagement**

1. In order to request the deletion (i.e., disengagement) of an existing Slice Related Communication Service, the service consumer shall send an HTTP DELETE request to the NSCE Server targeting the corresponding "Individual Slice Related Communication Service" resource.

NOTE: An alternative service consumer (i.e. other than the one that requested the creation/update of the targeted resource) can initiate this request.

2a. Upon success, the NSCE Server shall respond with an HTTP "204 No Content" status code.

2b. On failure, the appropriate HTTP status code indicating the error shall be returned and appropriate additional error information should be returned in the HTTP DELETE response body, as specified in clause 6.11.7.

## 5.13 NSCE\_InterPLMNContinuity

### 5.13.1 Service Description

The NSCE\_InterPLMNContinuity service exposed by the NSCE Server enables a service consumer to:

- request inter-PLMN application service continuity; and
- receive inter-PLMN service continuity event(s) related notifications.

### 5.13.2 Service Operations

#### 5.13.2.1 Introduction

The service operations defined for the NSCE\_InterPLMNContinuity service are shown in table 5.13.2.1-1.

**Table 5.13.2.1-1: NSCE\_InterPLMNContinuity Service Operations**

Service Operation Name	Description	Initiated by
NSCE_InterPLMNContinuity_Request	This service operation enables a service consumer to request inter-PLMN application service continuity to the NSCE Server.	e.g., VAL Server
NSCE_InterPLMNContinuity_Notify	This service operation enables a service consumer to receive inter-PLMN service continuity event(s) related notifications from the NSCE Server.	NSCE Server

5.13.2.2 NSCE\_InterPLMNContinuity\_Request

5.13.2.2.1 General

This service operation is used by a service consumer to request inter-PLMN application service continuity to the NSCE Server.

The following procedures are supported by the "NSCE\_InterPLMNContinuity\_Request" service operation:

- Inter-PLMN Application Service Continuity Request.

5.13.2.2.2 Inter-PLMN Application Service Continuity Request

Figure 5.13.2.2.2-1 depicts a scenario where a service consumer sends a request to the NSCE Server to request inter-PLMN application service continuity (see also clause 9.13 of 3GPP°TS°23.435°[14]).

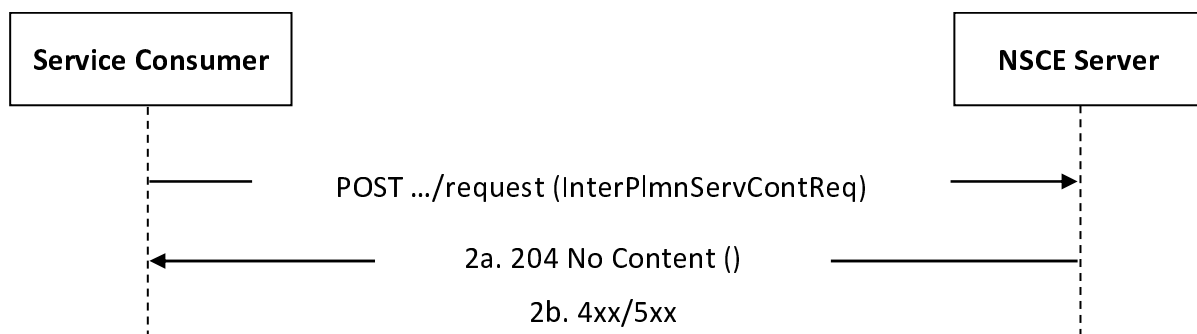

**Figure 5.13.2.2.2-1: Procedure for Inter-PLMN Application Service Continuity Request**

1. In order to request inter-PLMN application service continuity, the service consumer shall send an HTTP POST request to the NSCE Server targeting the URI of the corresponding custom operation (i.e., "Request"), with the request body including the InterPlmnServContReq data structure.
- 2a. Upon success, the NSCE Server shall respond with an HTTP "204 No Content" status code to indicate that the inter-PLMN application service continuity request is successfully received, accepted and processed.
- 2b. On failure, the appropriate HTTP status code indicating the error shall be returned and appropriate additional error information should be returned in the HTTP POST response body, as specified in clause 6.12.7.

5.13.2.3 NSCE\_InterPLMNContinuity\_Notify

5.13.2.3.1 General

This service operation is used by a NSCE Server to notify a previously subscribed service consumer on:

- inter-PLMN service continuity event(s).

The following procedures are supported by the "NSCE\_InterPLMNContinuity\_Notify" service operation:

- Inter-PLMN Service Continuity Notification.

### 5.13.2.3.2 Inter-PLMN Service Continuity Notification

Figure 5.13.2.3.2-1 depicts a scenario where the NSCE Server sends a request to notify a previously subscribed service consumer on inter-PLMN service continuity event(s) (see also clause 9.13 of 3GPP°TS°23.435°[14]).

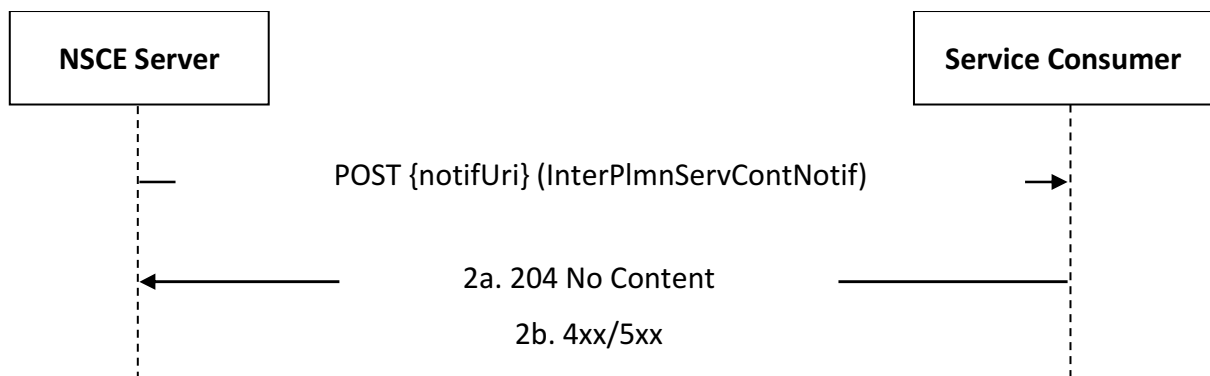

**Figure 5.13.2.3.2-1: Inter-PLMN Service Continuity Notification**

1. In order to notify a previously subscribed service consumer on inter-PLMN service continuity event(s), the NSCE Server shall send an HTTP POST request to the service consumer with the request URI set to "{notifUri}", where the "notifUri" variable is set to the value received from the service consumer using the procedures defined in clause 5.13.2.2, and the request body including the InterPlmnServContNotif data structure.
- 2a. Upon success, the service consumer shall respond to the NSCE Server with an HTTP "204 No Content" status code to acknowledge the successful reception and processing of the notification.
- 2b. On failure, the appropriate HTTP status code indicating the error shall be returned and appropriate additional error information should be returned in the HTTP POST response body, as specified in clause 6.12.7.

## 5.14 NSCE\_NS.Diagnostics

### 5.14.1 Service Description

The NSCE\_NS.Diagnostics service exposed by the NSCE Server enables a service consumer to:

- request network slice diagnostics information.

### 5.14.2 Service Operations

#### 5.14.2.1 Introduction

The service operations defined for NSCE\_NS.Diagnostics service is shown in the table 5.14.2.1-1.

**Table 5.14.2.1-1: NSCE\_NS.Diagnostics API Service Operations**

Service operation name	Description	Initiated by
NSCE_NS.Diagnostics_Request	This service operation is used by a service consumer to request network slice diagnostics from the NSCE Server.	e.g., VAL Server

#### 5.14.2.2 NSCE\_NS.Diagnostics\_Request

##### 5.14.2.2.1 General

This service operation is used by a service consumer to request network slice diagnostics from the NSCE Server.

The following procedures are supported by the "NSCE\_NS.Diagnostics\_Request" service operation:

- Network Slice Diagnostics Request.

### 5.14.2.2.2 Network Slice Diagnostics Request

Figure 5.14.2.2.2-1 depicts a scenario where a service consumer sends a request to the NSCE Server to request the network slice diagnostics (see also clause 9.14 of 3GPP TS 29.435 [14]).

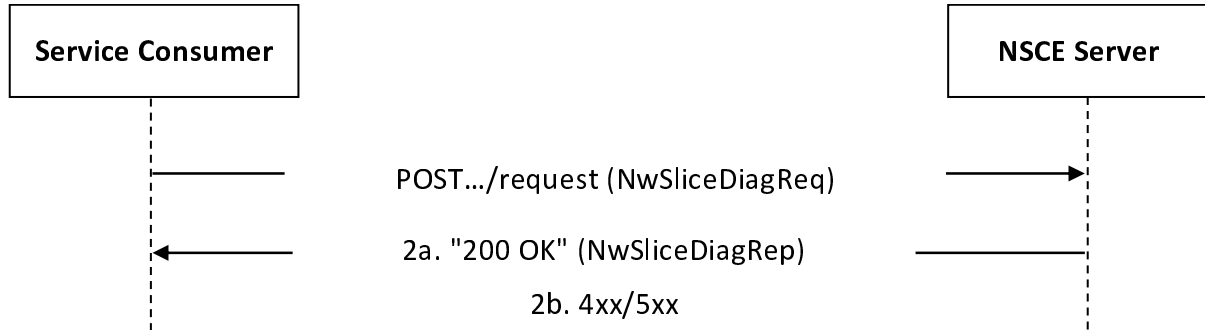

**Figure 5.14.2.2.2-1: Procedure for Network Slice Diagnostics Request**

1. In order to request network slice diagnostics, the service consumer shall send an HTTP POST request (i.e., custom operation "Request") to the NSCE Server, with the request body containing the NwSliceDiagReq data structure.
- 2a. Upon success, the NSCE Server shall respond with an HTTP "200 OK" status code with the response body containing the requested network slice diagnostics within the NwSliceDiagRep data structure.
- 2b. On failure, the appropriate HTTP status code indicating the error shall be returned and appropriate additional error information should be returned in the HTTP POST response body, as specified in clause 6.13.7.

## 5.15 NSCE\_FaultDiagnosis

### 5.15.1 Service Description

The NSCE\_FaultDiagnosis service exposed by the NSCE Server enables a service consumer to:

- create/update/delete a Network Slice Fault Diagnosis Subscription;
- receive Network Slice Fault Diagnosis Notifications; and

### 5.15.2 Service Operations

#### 5.15.2.1 Introduction

The service operations defined for the NSCE\_FaultDiagnosis service are shown in table 5.15.2.1-1.

**Table 5.15.2.1-1: NSCE\_FaultDiagnosis Service Operations**

Service Operation Name	Description	Initiated by
NSCE_FaultDiagnosis_Subscribe	This service operation enables a service consumer to create/update/delete a Network Slice Fault Diagnosis Subscription.	e.g., VAL Server
NSCE_FaultDiagnosis_Notify	This service operation enables a service consumer to receive Network Slice Fault Diagnosis Notifications.	NSCE Server

## 5.15.2.2 NSCE\_FaultDiagnosis\_Subscribe

### 5.15.2.2.1 General

This service operation is used by a service consumer to request the creation/update/deletion of a Network Slice Fault Diagnosis Subscription at the NSCE Server.

The following procedures are supported by the "NSCE\_FaultDiagnosis\_Subscribe" service operation:

- Network Slice Fault Diagnosis Subscription Creation;
- Network Slice Fault Diagnosis Subscription Update;
- Network Slice Fault Diagnosis Subscription Deletion.

#### 5.15.2.2.2 Network Slice Fault Diagnosis Subscription Creation

Figure 5.15.2.2.2-1 depicts a scenario where a service consumer sends a request to the NSCE Server to request the creation of a Network Slice Fault Diagnosis Subscription (see also clause 9.15 of 3GPP°TS°23.435°[14]).

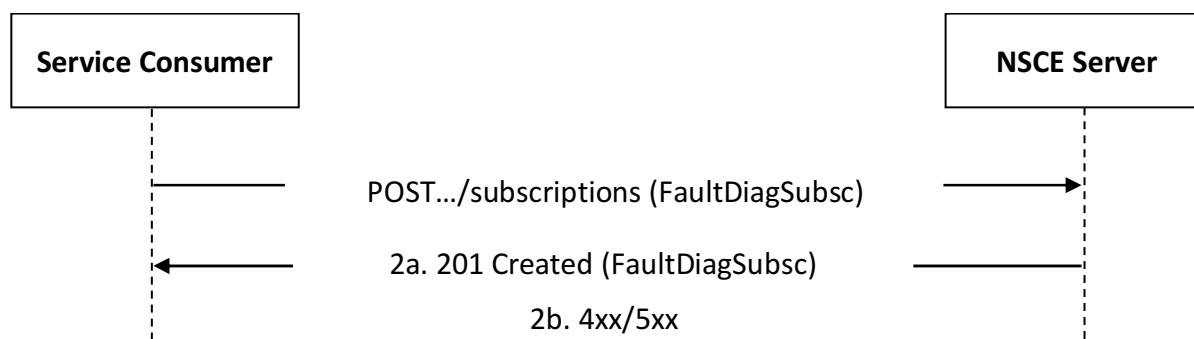
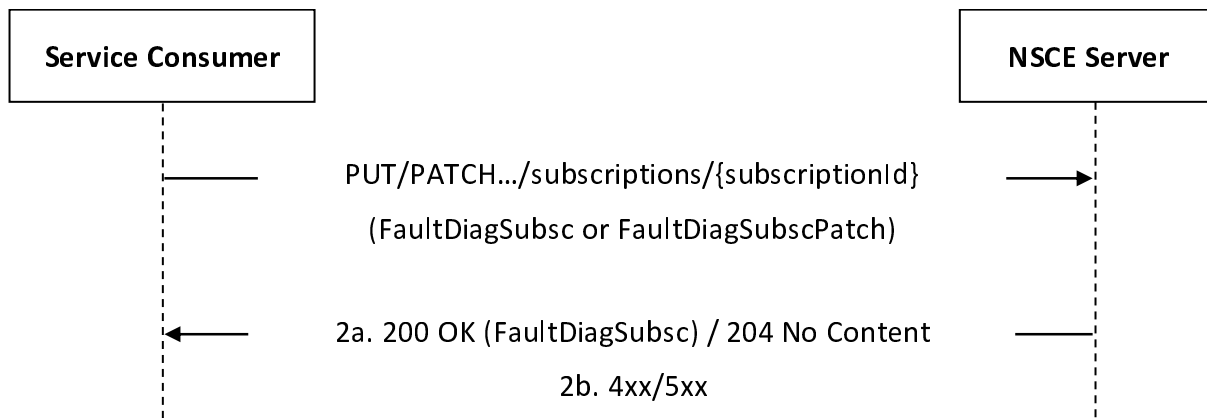

**Figure 5.15.2.2.2-1: Procedure for Network Slice Fault Diagnosis Subscription Creation**

1. In order to subscribe to network slice fault diagnosis reporting, a service consumer shall send an HTTP POST request to the NSCE Server targeting the URI of the "Network Slice Fault Diagnosis Subscriptions" collection resource, with the request body including the FaultDiagSubsc data structure.
- 2a. Upon success, the NSCE Server shall respond with an HTTP "201 Created" status code with the response body containing a representation of the created "Individual Network Slice Fault Diagnosis Subscription" resource within the FaultDiagSubsc data structure.
- 2b. On failure, the appropriate HTTP status code indicating the error shall be returned and appropriate additional error information should be returned in the HTTP POST response body, as specified in clause 6.14.7.

#### 5.15.2.2.3 Network Slice Fault Diagnosis Subscription Update

Figure 5.15.2.2.3-1 depicts a scenario where a service consumer sends a request to the NSCE Server to request the update of an existing Network Slice Fault Diagnosis Subscription (see also clause 9.15 of 3GPP°TS°23.435°[14]).



**Figure 5.15.2.2.3-1: Procedure for Network Slice Fault Diagnosis Subscription Update**

1. In order to update an existing network slice fault diagnosis subscription, the service consumer shall send an HTTP PUT/PATCH request to the NSCE Server, targeting the URI of the corresponding "Individual Network Slice Fault Diagnosis Subscription" resource, with the request body including either:

- the updated representation of the resource within the FaultDiagSubsc data structure, in case the HTTP PUT method is used; or
- the requested modifications to the resource within the FaultDiagSubscPatch data structure, in case the HTTP PATCH method is used.

NOTE: An alternative service consumer (i.e. other than the one that requested the creation of the targeted resource) can initiate this request.

2a. Upon success, the NSCE Server shall update the targeted "Individual Network Slice Fault Diagnosis Subscription" resource accordingly and respond with either:

- an HTTP "200 OK" status code with the response body containing a representation of the updated "Individual Network Slice Fault Diagnosis Subscription" resource within the FaultDiagSubsc data structure; or
- an HTTP "204 No Content" status code.

2b. On failure, the appropriate HTTP status code indicating the error shall be returned and appropriate additional error information should be returned in the HTTP PUT response body, as specified in clause 6.14.7.

#### 5.15.2.2.4 Network Slice Fault Diagnosis Subscription Deletion

Figure 5.15.2.2.4-1 depicts a scenario where a service consumer sends a request to the NSCE Server to delete an existing Network Slice Fault Diagnosis Subscription (see also clause 9.15 of 3GPP°TS°23.435°[14]).

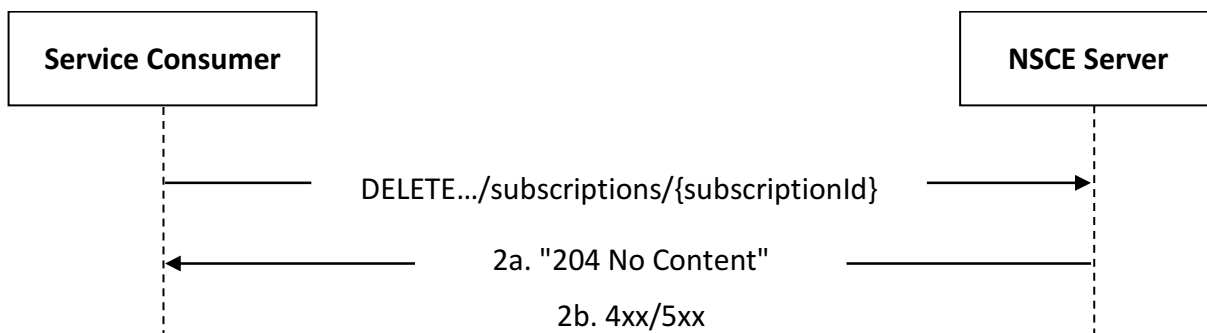

**Figure 5.15.2.2.4-1: Procedure for Network Slice Fault Diagnosis Subscription Deletion**

1. In order to request the deletion of an existing network slice fault diagnosis subscription, the service consumer shall send an HTTP DELETE request to the NSCE Server targeting the corresponding "Individual Network Slice Fault Diagnosis Subscription" resource.

2a. Upon success, the NSCE Server shall respond with an HTTP "204 No Content" status code.

2b. On failure, the appropriate HTTP status code indicating the error shall be returned and appropriate additional error information should be returned in the HTTP DELETE response body, as specified in clause 6.14.7.

### 5.15.2.3 NSCE\_FaultDiagnosis\_Notify

#### 5.15.2.3.1 General

This service operation is used by a NSCE Server to notify a previously subscribed service consumer on:

- Network Slice Fault Diagnosis event(s).

The following procedures are supported by the "NSCE\_FaultDiagnosis\_Notify" service operation:

- Network Slice Fault Diagnosis Notification.

#### 5.15.2.3.2 Network Slice Fault Diagnosis Notification

Figure 5.15.2.3.2-1 depicts a scenario where the NSCE Server sends a request to notify a previously subscribed service consumer on Network Slice Fault Diagnosis event(s) (see also clause 9.15 of 3GPP°TS°23.435°[14]).

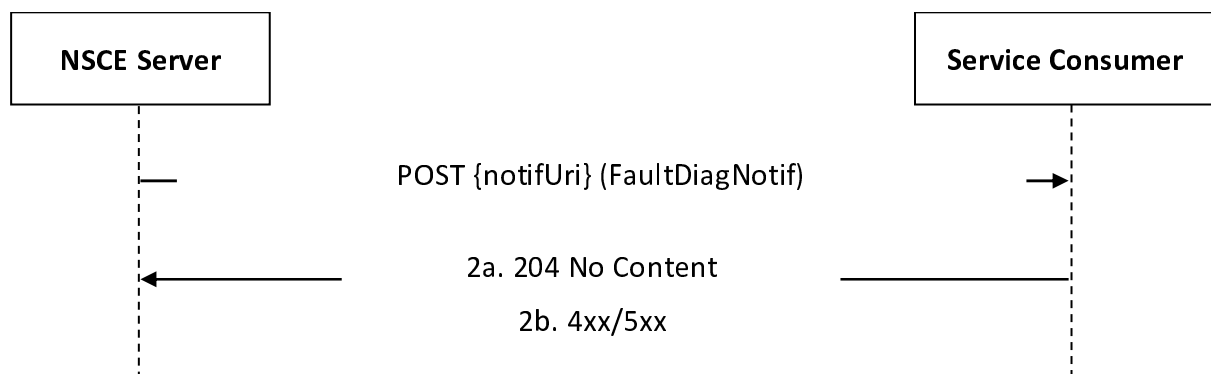

**Figure 5.15.2.3.2-1: Procedure for Network Slice Fault Diagnosis Notification**

1. In order to notify a previously subscribed service consumer on network slice fault diagnosis event(s), the NSCE Server shall send an HTTP POST request to the service consumer with the request URI set to "{notifUri}", where the "notifUri" variable is set to the value received from the service consumer during the creation/update of the corresponding Network Slice Fault Diagnosis Subscription using the procedures defined in clause 5.15.2.2, and the request body including the FaultDiagNotif data structure.
- 2a. Upon success, the service consumer shall respond to the NSCE Server with an HTTP "204 No Content" status code to acknowledge the reception of the notification.
- 2b. On failure, the appropriate HTTP status code indicating the error shall be returned and appropriate additional error information should be returned in the HTTP POST response body, as specified in clause 6.14.7.

## 5.16 NSCE\_SliceReqVerifyAndAlign

### 5.16.1 Service Description

The NSCE\_SliceReqVerifyAndAlign service exposed by the NSCE Server enables a service consumer to:

- create/update/delete a Network Slice Requirements Verification and Alignment Subscription;
- receive Network Slice Requirements Verification and Alignment Notifications.



## 5.16.2 Service Operations

### 5.16.2.1 Introduction

The service operations defined for the NSCE\_SliceReqVerifyAndAlign service are shown in table 5.16.2.1-1.

**Table 5.16.2.1-1: NSCE\_SliceReqVerifyAndAlign Service Operations**

Service Operation Name	Description	Initiated by
NSCE_SliceReqVerifyAndAlign_Subscribe	This service operation enables a service consumer to create/update/delete a Network Slice Requirements Verification and Alignment Subscription.	e.g., VAL Server
NSCE_SliceReqVerifyAndAlign_Noify	This service operation enables a service consumer to receive Network Slice Requirements Verification and Alignment Notifications.	NSCE Server

### 5.16.2.2 NSCE\_SliceReqVerifyAndAlign\_Subscribe

#### 5.16.2.2.1 General

This service operation is used by a service consumer to request the creation/update/deletion of a Network Slice Requirements Verification and Alignment Subscription at the NSCE Server.

The following procedures are supported by the "NSCE\_SliceReqVerifyAndAlign\_Subscribe" service operation:

- Network Slice Requirements Verification and Alignment Subscription Creation;
- Network Slice Requirements Verification and Alignment Subscription Update;
- Network Slice Requirements Verification and Alignment Subscription Deletion.

#### 5.16.2.2.2 Network Slice Requirements Verification and Alignment Subscription Creation

Figure 5.16.2.2.2-1 depicts a scenario where a service consumer sends a request to the NSCE Server to request the creation of a Network Slice Requirements Verification and Alignment Subscription (see also clause 9.16 of 3GPP TS 23.435 [14]).

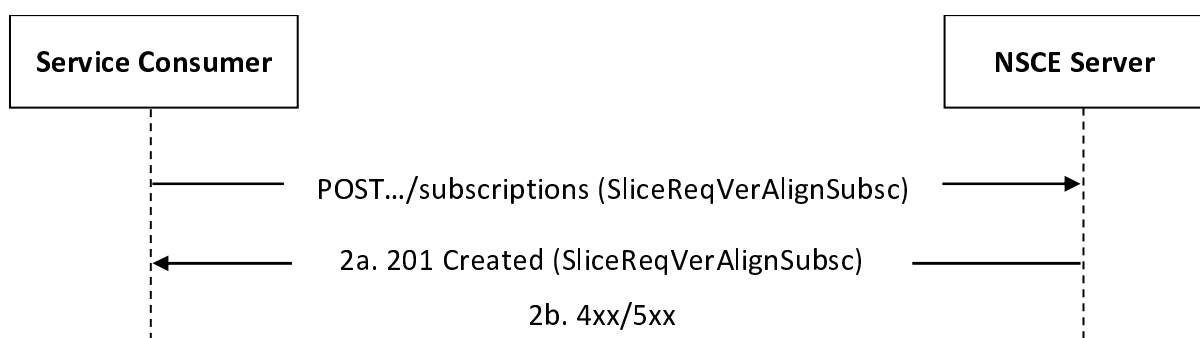

**Figure 5.16.2.2.2-1: Procedure for Network Slice Requirements Verification and Alignment Subscription Creation**

1. In order to subscribe to network slice requirements verification and alignment, a service consumer shall send an HTTP POST request to the NSCE Server targeting the URI of the "Network Slice Requirements Verification and Alignment Subscriptions" collection resource, with the request body including the SliceReqVerAlignSubsc data structure.
- 2a. Upon success, the NSCE Server shall respond with an HTTP "201 Created" status code with the response body containing a representation of the created "Individual Network Slice Requirements Verification and Alignment Subscription" resource within the SliceReqVerAlignSubsc data structure.

- 2b. On failure, the appropriate HTTP status code indicating the error shall be returned and appropriate additional error information should be returned in the HTTP POST response body, as specified in clause 6.15.7.

### 5.16.2.2.3 Network Slice Requirements Verification and Alignment Subscription Update

Figure 5.16.2.2.3-1 depicts a scenario where a service consumer sends a request to the NSCE Server to request the update of an existing Network Slice Requirements Verification and Alignment Subscription (see also clause 9.16 of 3GPP TS 23.435 [14]).

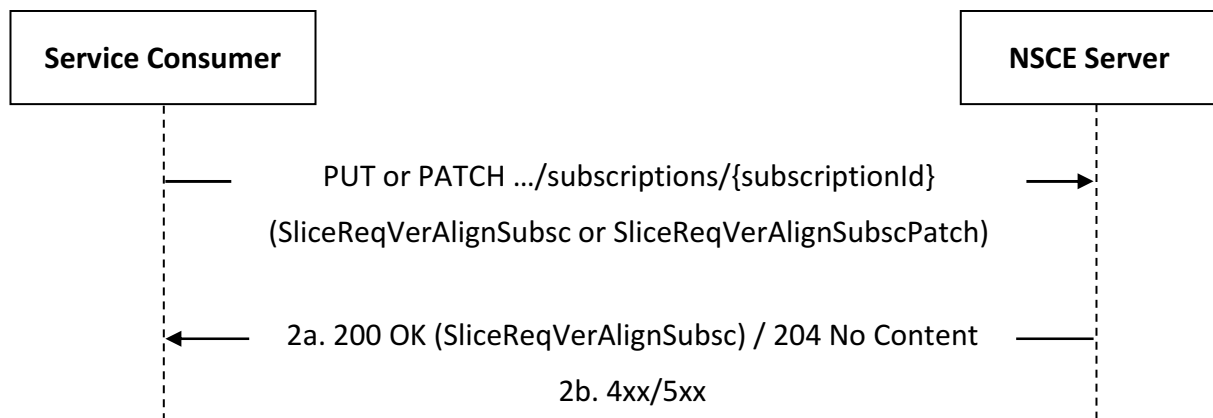

**Figure 5.16.2.2.3-1: Procedure for Network Slice Requirements Verification and Alignment Subscription Update**

1. In order to update an existing network slice requirements verification and alignment subscription, the service consumer shall send an HTTP PUT/PATCH request to the NSCE Server, targeting the URI of the corresponding "Individual Network Slice Requirements Verification and Alignment Subscription" resource, with the request body including either:

- the updated representation of the resource within the SliceReqVerAlignSubsc data structure, in case the HTTP PUT method is used; or
- the requested modifications to the resource within the SliceReqVerAlignSubscPatch data structure, in case the HTTP PATCH method is used.

**NOTE:** An alternative service consumer (i.e. other than the one that requested the creation of the targeted resource) can initiate this request.

- 2a. Upon success, the NSCE Server shall update the targeted "Individual Network Slice Requirements Verification and Alignment Subscription" resource accordingly and respond with either:

- an HTTP "200 OK" status code with the response body containing a representation of the updated "Individual Network Slice Requirements Verification and Alignment Subscription" resource within the SliceReqVerAlignSubsc data structure; or
- an HTTP "204 No Content" status code.

- 2b. On failure, the appropriate HTTP status code indicating the error shall be returned and appropriate additional error information should be returned in the HTTP PUT/PATCH response body, as specified in clause 6.15.7.

### 5.16.2.2.4 Network Slice Requirements Verification and Alignment Subscription Deletion

Figure 5.16.2.2.4-1 depicts a scenario where a service consumer sends a request to the NSCE Server to delete an existing Network Slice Requirements Verification and Alignment Subscription (see also clause 9.16 of 3GPP TS 23.435 [14]).

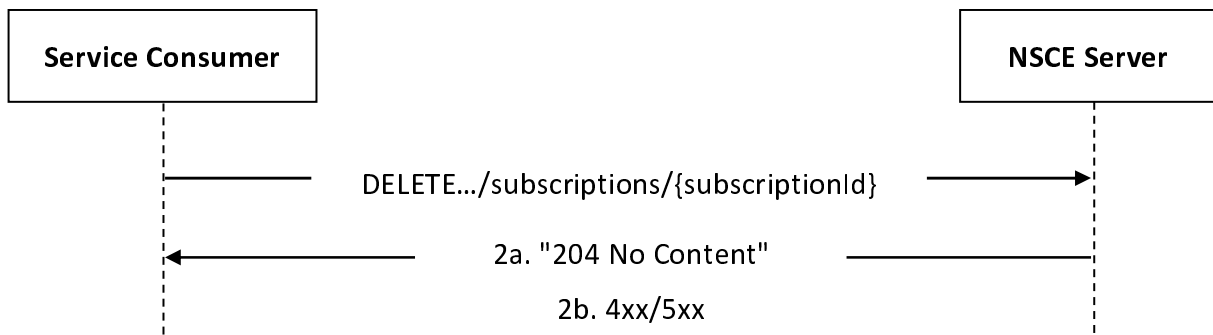

**Figure 5.16.2.2.4-1: Procedure for Network Slice Requirements Verification and Alignment Subscription Deletion**

1. In order to request the deletion of an existing network slice requirements verification and alignment subscription, the service consumer shall send an HTTP DELETE request to the NSCE Server targeting the corresponding "Individual Network Slice Requirements Verification and Alignment Subscription" resource.

NOTE: An alternative service consumer (i.e. other than the one that requested the creation/update of the targeted resource) can initiate this request.

2a. Upon success, the NSCE Server shall respond with an HTTP "204 No Content" status code.

2b. On failure, the appropriate HTTP status code indicating the error shall be returned and appropriate additional error information should be returned in the HTTP DELETE response body, as specified in clause 6.15.7.

### 5.16.2.3 NSCE\_SliceReqVerifyAndAlign\_Notify

#### 5.16.2.3.1 General

This service operation is used by a NSCE Server to notify a previously subscribed service consumer on:

- Network Slice Requirements Verification and Alignment information.

The following procedures are supported by the "NSCE\_SliceReqVerifyAndAlign\_Notify" service operation:

- Network Slice Requirements Verification and Alignment Notification.

#### 5.16.2.3.2 Network Slice Requirements Verification and Alignment Notification

Figure 5.16.2.3.2-1 depicts a scenario where the NSCE Server sends a request to notify a previously subscribed service consumer on Network Slice Requirements Verification and Alignment information (see also clause 9.16 of 3GPP TS 23.435 [14]).

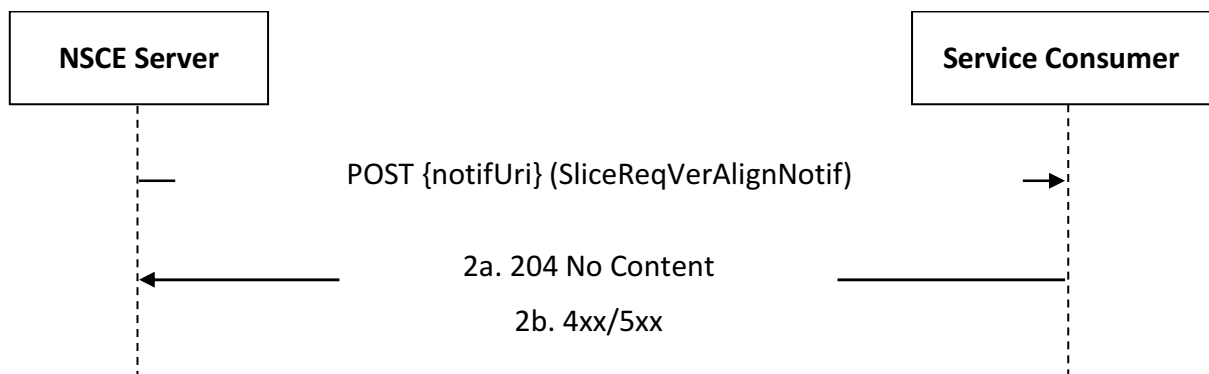

**Figure 5.16.2.3.2-1: Procedure for Network Slice Requirements Verification and Alignment Notification**

1. In order to notify a previously subscribed service consumer on network slice requirements verification and alignment information, the NSCE Server shall send an HTTP POST request to the service consumer with the

request URI set to "{notifUri}", where the "notifUri" variable is set to the value received from the service consumer during the creation/update of the corresponding Network Slice Requirements Verification and Alignment Subscription using the procedures defined in clause 5.16.2.2, and the request body including the SliceReqVerAlignNotif data structure.

- 2a. Upon success, the service consumer shall respond to the NSCE Server with an HTTP "204 No Content" status code to acknowledge the reception of the notification.
- 2b. On failure, the appropriate HTTP status code indicating the error shall be returned and appropriate additional error information should be returned in the HTTP POST response body, as specified in clause 6.15.7.

## 5.17 NSCE\_NSInfoDelivery

### 5.17.1 Service Description

The NSCE\_NSInfoDelivery service exposed by the NSCE Server enables a service consumer to:

- retrieve Network Slice Information; and
- request Network Slice Information delivery to another entity (e.g., NSCE Client).

### 5.17.2 Service Operations

#### 5.17.2.1 Introduction

The service operations defined for the NSCE\_NSInfoDelivery service are shown in table 5.17.2.1-1.

**Table 5.17.2.1-1: NSCE\_NSInfoDelivery Service Operations**

Service Operation Name	Description	Initiated by
NSCE_NSInfoDelivery_Request	This service operation enables a service consumer to either: <ul style="list-style-type: none"> <li>- retrieve Network Slice Information; or</li> <li>- request Network Slice Information delivery to another entity (e.g., NSCE Client).</li> </ul>	e.g., VAL Server

#### 5.17.2.2 NSCE\_NSInfoDelivery\_Request

##### 5.17.2.2.1 General

This service operation is used by a service consumer to request Network Slice Information retrieval or delivery from the NSCE Server.

The following procedures are supported by the "NSCE\_NSInfoDelivery\_Request" service operation:

- Network Slice Information Retrieval.
- Network Slice Information Delivery.

##### 5.17.2.2.2 Network Slice Information Retrieval

Figure 5.17.2.2.2-1 depicts a scenario where a service consumer sends a request to the NSCE Server to request the retrieval of Network Slice Information (see also clause 9.17 of 3GPP TS 23.435 [14]).

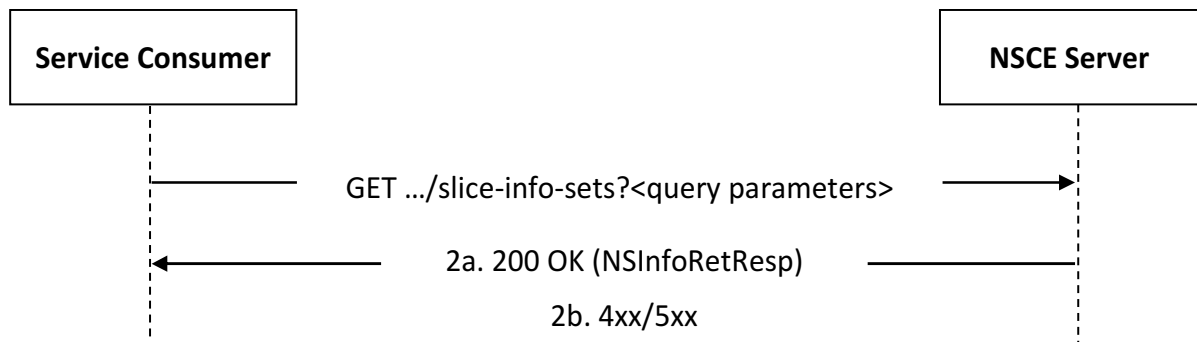
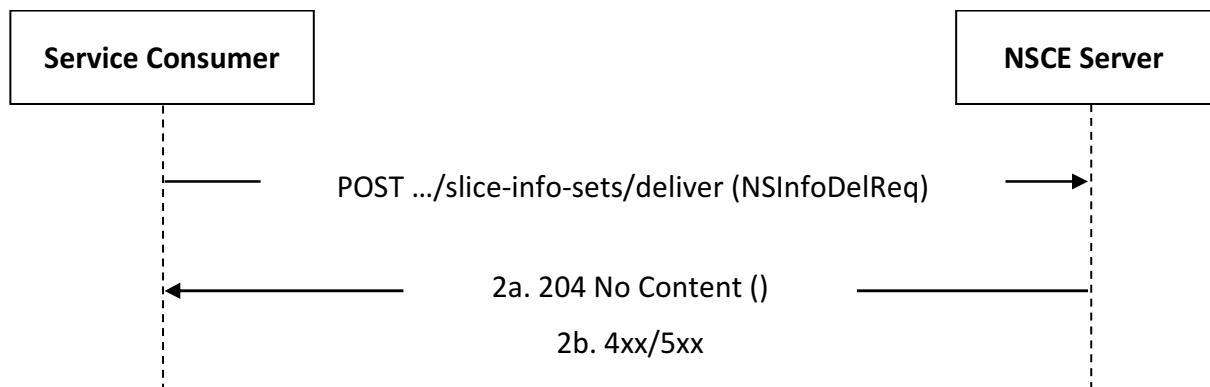

**Figure 5.17.2.2.2-1: Procedure for Network Slice Information Retrieval**

1. In order to request the retrieval of Network Slice Information, the service consumer shall send an HTTP GET request targeting the URI of the "Network Slice Information Sets" collection resource and including query parameter(s) to filter the content of the response from the NSCE Server.
- 2a. Upon success, the NSCE Server shall respond with an HTTP "200 OK" status code with the response body containing the requested Network Slice Information within the NSInfoRetResp data structure.
- 2b. On failure, the appropriate HTTP status code indicating the error shall be returned and appropriate additional error information should be returned in the HTTP GET response body, as specified in clause 6.16.7.

**5.17.2.2.3 Network Slice Information Delivery**

Figure 5.17.2.2.3-1 depicts a scenario where a service consumer sends a request to the NSCE Server to request the delivery of Network Slice Information (see also clause 9.17 of 3GPP TS 23.435 [14]).



**Figure 5.17.2.2.3-1: Procedure for Network Slice Information Delivery**

1. In order to request Network Slice Information delivery, the service consumer shall send an HTTP POST request to the NSCE Server, targeting the URI of the corresponding "Deliver" resource custom operation defined under the "Network Slice Information Sets" collection resource, with the request body including the NSInfoDelReq data structure.
- 2a. Upon success, the NSCE Server shall respond with an HTTP "204 No Content" status code.
- 2b. On failure, the appropriate HTTP status code indicating the error shall be returned and appropriate additional error information should be returned in the HTTP POST response body, as specified in clause 6.16.7.

## 5.18 Void

## 5.19 NSCE\_NSAllocation

### 5.19.1 Service Description

The NSCE\_NSAllocation service exposed by the NSCE Server enables a service consumer to:

- request network slice allocation.

### 5.19.2 Service Operations

#### 5.19.2.1 Introduction

The service operation defined for NSCE\_NSAllocation API is shown in the table 5.19.2.1-1.

**Table 5.19.2.1-1: NSCE\_NSAllocation API Service Operations**

Service operation name	Description	Initiated by
NSAllocation_Request	This service operation is used by a service consumer to request for network slice allocation.	e.g., VAL Server

#### 5.19.2.2 NSCE\_NSAllocation\_Request

##### 5.19.2.2.1 General

This service operation is used by a service consumer to request network slice allocation from the NSCE Server.

The following procedures are supported by the "NSCE\_NSAllocation\_Request" service operation:

- Network Slice Allocation Request.

##### 5.19.2.2.2 Network Slice Allocation Request

Figure 5.19.2.2-1 depicts a scenario where a service consumer sends a request to the NSCE Server to request network slice allocation (see also clause 9.18 of 3GPP TS 23.435 [14]).

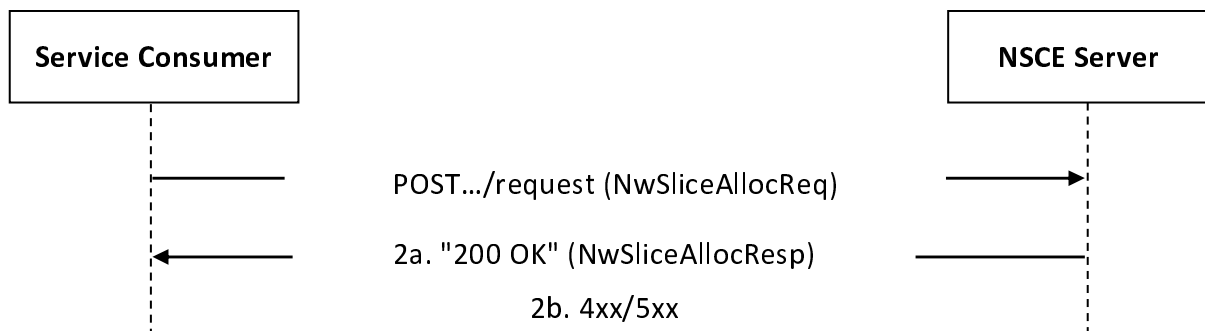

**Figure 5.19.2.2-1: Procedure for Network Slice Allocation Request**

1. In order to request network slice allocation, the service consumer shall send an HTTP POST request (i.e. custom operation "Request") to the NSCE Server, with the request body containing the NwSliceAllocReq data structure.
- 2a. Upon success, the NSCE Server shall respond with an HTTP "200 OK" status code with the response body containing network slice allocation related information within the NwSliceAllocResp data structure.

2b. On failure, the appropriate HTTP status code indicating the error shall be returned and appropriate additional error information should be returned in the HTTP POST response body, as specified in clause 6.18.7.

---

## 6 API Definitions

### 6.1 NSCE\_SliceApiManagement API

#### 6.1.1 Introduction

The NSCE\_SliceApiManagement service shall use the NSCE\_SliceApiManagement API.

The API URI of the NSCE\_SliceApiManagement Service API shall be:

**{apiRoot}/<apiName>/<apiVersion>**

The request URIs used in HTTP requests shall have the Resource URI structure defined in clause 6.5 of 3GPP TS 29.549 [15], i.e.:

**{apiRoot}/<apiName>/<apiVersion>/<apiSpecificSuffixes>**

with the following components:

- The {apiRoot} shall be set as described in clause 6.5 of 3GPP TS 29.549 [15].
- The <apiName> shall be "nsce-sam".
- The <apiVersion> shall be "v1".
- The <apiSpecificSuffixes> shall be set as described in clause 6.5 of 3GPP TS 29.549 [15].

**NOTE:** When 3GPP TS 29.122 [2] is referenced for the common protocol and interface aspects for API definition in the clauses under clause 6.1, the NSCE Server takes the role of the SCEF and the service consumer takes the role of the SCS/AS.

#### 6.1.2 Usage of HTTP

The provisions of clause 6.3 of 3GPP TS 29.549 [15] shall apply for the NSCE\_SliceApiManagement API.

#### 6.1.3 Resources

##### 6.1.3.1 Overview

This clause describes the structure for the Resource URIs and the resources and methods used for the service.

Figure 6.1.3.1-1 depicts the resource URIs structure for the NSCE\_SliceApiManagement API.



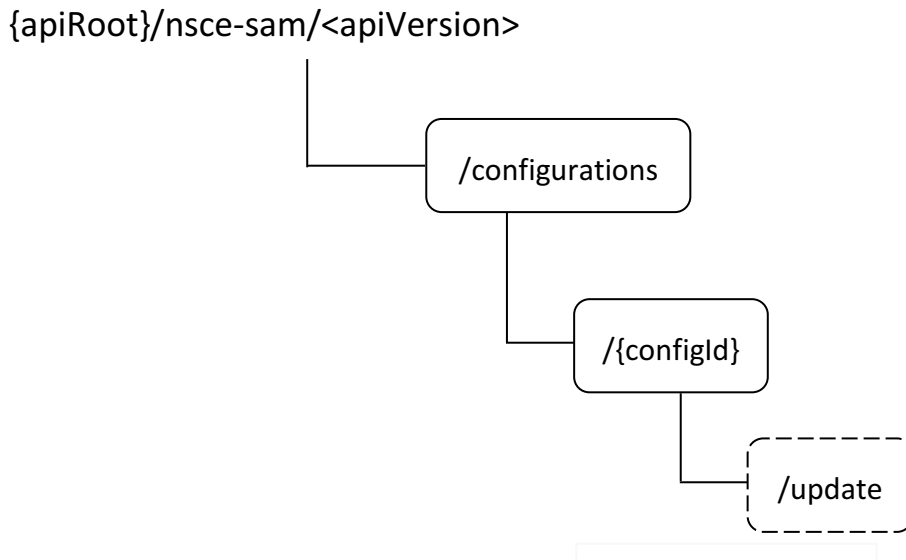

**Figure 6.1.3.1-1: Resource URIs structure of the NSCE\_SliceApiManagement API**

Table 6.1.3.1-1 provides an overview of the resources and applicable HTTP methods for the NSCE\_SliceApiManagement API.

**Table 6.1.3.1-1: Resources and methods overview**

Resource name	Resource URI	HTTP method or custom operation	Description
Slice API Configurations	/configurations	POST	Request the creation of a Slice API Configuration.
Individual Slice API Configuration	/configurations/{configId}	GET	Retrieve an existing "Individual Slice API Configuration" resource.
		DELETE	Request the deletion of an existing "Individual Slice API Configuration" resource.
		Update	Request the update of an existing slice API configuration.

### 6.1.3.2 Resource: Slice API Configurations

#### 6.1.3.2.1 Description

This resource represents the collection of Slice API Configurations managed by the NSCE Server.

#### 6.1.3.2.2 Resource Definition

Resource URI: **{apiRoot}/nsce-sam/<apiVersion>/configurations**

This resource shall support the resource URI variables defined in table 6.1.3.2.2-1.

**Table 6.1.3.2.2-1: Resource URI variables for this resource**

Name	Data type	Definition
apiRoot	string	See clause 6.1.1.

### 6.1.3.2.3 Resource Standard Methods

#### 6.1.3.2.3.1 POST

The HTTP POST method allows a service consumer to request the creation of a Slice API Configuration at the NSCE Server.

This method shall support the URI query parameters specified in table 6.1.3.2.3.1-1.

**Table 6.1.3.2.3.1-1: URI query parameters supported by the POST method on this resource**

Name	Data type	P	Cardinality	Description	Applicability
n/a					

This method shall support the request data structures specified in table 6.1.3.2.3.1-2 and the response data structures and response codes specified in table 6.1.3.2.3.1-3.

**Table 6.1.3.2.3.1-2: Data structures supported by the POST Request Body on this resource**

Data type	P	Cardinality	Description
SliceAPIConfig	M	1	Represents the parameters to request the creation of a Slice API Configuration.

**Table 6.1.3.2.3.1-3: Data structures supported by the POST Response Body on this resource**

Data type	P	Cardinality	Response codes	Description
SliceAPIConfig	M	1	201 Created	Successful case. The Slice API Configuration is successfully created and a representation of the created "Individual Slice API Configuration" resource shall be returned. An HTTP "Location" header that contains the URI of the created resource shall also be included.
NOTE: The mandatory HTTP error status codes for the HTTP POST method listed in table 5.2.6-1 of 3GPP TS 29.122 [2] shall also apply.				

**Table 6.1.3.2.3.1-4: Headers supported by the 201 Response Code on this resource**

Name	Data type	P	Cardinality	Description
Location	string	M	1	Contains the URI of the newly created resource, according to the structure: {apiRoot}/nsce-sam/<apiVersion>/configurations/{configId}

### 6.1.3.2.4 Resource Custom Operations

There are no resource custom operations defined for this resource in this release of the specification.

## 6.1.3.3 Resource: Individual Slice API Configuration

### 6.1.3.3.1 Description

This resource represents a Slice API Configuration managed by the NSCE Server.

### 6.1.3.3.2 Resource Definition

Resource URI: {apiRoot}/nsce-sam/<apiVersion>/configurations/{configId}

This resource shall support the resource URI variables defined in table 6.1.3.3.2-1.

**Table 6.1.3.3.2-1: Resource URI variables for this resource**

Name	Data type	Definition
apiRoot	string	See clause 6.1.1.
configId	string	Represents the identifier of the "Individual Slice API Configuration" resource.

### 6.1.3.3.3 Resource Standard Methods

#### 6.1.3.3.3.1 GET

The HTTP GET method allows a service consumer to retrieve an existing "Individual Slice API Configuration" resource at the NSCE Server.

This method shall support the URI query parameters specified in table 6.1.3.3.3.1-1.

**Table 6.1.3.3.3.1-1: URI query parameters supported by the GET method on this resource**

Name	Data type	P	Cardinality	Description	Applicability
n/a					

This method shall support the request data structures specified in table 6.1.3.3.3.1-2 and the response data structures and response codes specified in table 6.1.3.3.3.1-3.

**Table 6.1.3.3.3.1-2: Data structures supported by the GET Request Body on this resource**

Data type	P	Cardinality	Description
n/a			

**Table 6.1.3.3.3.1-3: Data structures supported by the GET Response Body on this resource**

Data type	P	Cardinality	Response codes	Description
SliceAPIConfig	M	1	200 OK	Successful case. The requested "Individual Slice API Configuration" resource shall be returned.
n/a			307 Temporary Redirect	Temporary redirection. The response shall include a Location header field containing an alternative URI of the resource located in an alternative NSCE Server. Redirection handling is described in clause 5.2.10 of 3GPP TS 29.122 [2].
n/a			308 Permanent Redirect	Permanent redirection. The response shall include a Location header field containing an alternative URI of the resource located in an alternative NSCE Server. Redirection handling is described in clause 5.2.10 of 3GPP TS 29.122 [2].
NOTE: The mandatory HTTP error status codes for the HTTP GET method listed in table 5.2.6-1 of 3GPP TS 29.122 [2] shall also apply.				

**Table 6.1.3.3.3.1-4: Headers supported by the 307 Response Code on this resource**

Name	Data type	P	Cardinality	Description
Location	string	M	1	Contains an alternative URI of the resource located in an alternative NSCE Server.

**Table 6.1.3.3.3.1-5: Headers supported by the 308 Response Code on this resource**

Name	Data type	P	Cardinality	Description
Location	string	M	1	Contains an alternative URI of the resource located in an alternative NSCE Server.

#### 6.1.3.3.3.2 DELETE

The HTTP DELETE method allows a service consumer to request the deletion of an existing "Individual Slice API Configuration" resource at the NSCE Server.

This method shall support the URI query parameters specified in table 6.1.3.3.3.2-1.

**Table 6.1.3.3.3.2-1: URI query parameters supported by the DELETE method on this resource**

Name	Data type	P	Cardinality	Description	Applicability
n/a					

This method shall support the request data structures specified in table 6.1.3.3.3.2-2 and the response data structures and response codes specified in table 6.1.3.3.3.2-3.

**Table 6.1.3.3.3.2-2: Data structures supported by the DELETE Request Body on this resource**

Data type	P	Cardinality	Description
n/a			

**Table 6.1.3.3.3.2-3: Data structures supported by the DELETE Response Body on this resource**

Data type	P	Cardinality	Response codes	Description
n/a			204 No Content	Successful case. The "Individual Slice API Configuration" resource is successfully deleted.
n/a			307 Temporary Redirect	Temporary redirection. The response shall include a Location header field containing an alternative URI of the resource located in an alternative NSCE Server. Redirection handling is described in clause 5.2.10 of 3GPP TS 29.122 [2].
n/a			308 Permanent Redirect	Permanent redirection. The response shall include a Location header field containing an alternative URI of the resource located in an alternative NSCE Server. Redirection handling is described in clause 5.2.10 of 3GPP TS 29.122 [2].
NOTE: The mandatory HTTP error status codes for the HTTP DELETE method listed in table 5.2.6-1 of 3GPP TS 29.122 [2] shall also apply.				

**Table 6.1.3.3.3.2-4: Headers supported by the 307 Response Code on this resource**

Name	Data type	P	Cardinality	Description
Location	string	M	1	Contains an alternative URI of the resource located in an alternative NSCE Server.

**Table 6.1.3.3.2-5: Headers supported by the 308 Response Code on this resource**

Name	Data type	P	Cardinality	Description
Location	string	M	1	Contains an alternative URI of the resource located in an alternative NSCE Server.

#### 6.1.3.3.4 Resource Custom Operations

##### 6.1.3.3.4.1 Overview

Table 6.1.3.3.4.1-1 specifies the custom operations defined on this resource.

**Table 6.1.3.3.4.1-1: Resource Custom Operations**

Operation name	Custom operation URI	Mapped HTTP method	Description
Update	/configurations/{configId}/update	POST	Enables a service consumer to request the update of an existing slice API configuration.

##### 6.1.3.3.4.2 Operation: Update

###### 6.1.3.3.4.2.1 Description

This resource custom operation enables a service consumer to request the update of an existing slice API configuration at the NSCE Server.

###### 6.1.3.3.4.2.2 Operation Definition

This operation shall support the request data structures specified in table 6.1.3.3.4.2.2-1 and the response data structure and response codes specified in table 6.1.3.3.4.2.2-2.

**Table 6.1.3.3.4.2.2-1: Data structures supported by the POST Request Body on this resource**

Data type	P	Cardinality	Description
UpdateReq	M	1	Contains the parameters to request the update of the slice API configuration.

**Table 6.1.3.3.4.2.2-2: Data structures supported by the POST Response Body on this resource**

Data type	P	Cardinality	Response codes	Description
UpdateResp	M	1	200 OK	Successful case. The slice API configuration update request is successfully received and processed, and slice API configuration update related information shall be returned in the response body.
n/a			307 Temporary Redirect	Temporary redirection. The response shall include a Location header field containing an alternative URI of the resource custom operation located in an alternative NSCE Server. Redirection handling is described in clause 5.2.10 of 3GPP TS 29.122 [2].
n/a			308 Permanent Redirect	Permanent redirection. The response shall include a Location header field containing an alternative URI of the resource custom operation located in an alternative NSCE Server. Redirection handling is described in clause 5.2.10 of 3GPP TS 29.122 [2].
NOTE: The mandatory HTTP error status codes for the HTTP POST method listed in table 5.2.6-1 of 3GPP TS 29.122 [2] shall also apply.				

**Table 6.1.3.3.4.2.2-3: Headers supported by the 307 Response Code on this resource custom operation**

Name	Data type	P	Cardinality	Description
Location	string	M	1	Contains an alternative URI of the resource custom operation located in an alternative NSCE Server.

**Table 6.1.3.3.4.2.2-4: Headers supported by the 308 Response Code on this resource custom operation**

Name	Data type	P	Cardinality	Description
Location	string	M	1	Contains an alternative URI of the resource custom operation located in an alternative NSCE Server.

## 6.1.4 Custom Operations without associated resources

### 6.1.4.1 Overview

The structure of the custom operation URIs of the NSCE\_SliceApiManagement API is shown in Figure 6.1.4.1-1.

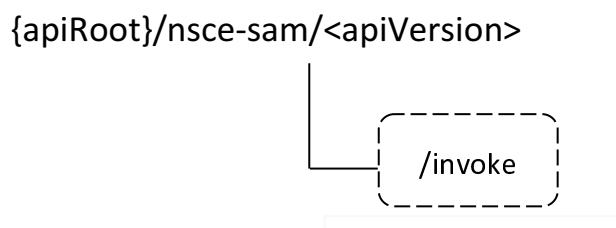

**Figure 6.1.4.1-1: Custom operation URI structure of the NSCE\_SliceApiManagement API**

Table 6.1.4.1-1 provides an overview of the custom operations and applicable HTTP methods defined for the NSCE\_SliceApiManagement API.

**Table 6.1.4.1-1: Custom operations without associated resources**

Custom operation name	Custom operation URI	Mapped HTTP method	Description
Invoke	/invoke	POST	Enables a service consumer to request slice API invocation.

The custom operations shall support the URI variables defined in table 6.1.4.1-2.

**Table 6.1.4.1-2: URI variables for this custom operation**

Name	Data type	Definition
apiRoot	string	See clause 6.1.1.

## 6.1.4.2 Operation: Invoke

### 6.1.4.2.1 Description

The custom operation enables a service consumer to request slice API invocation to the NSCE Server.

### 6.1.4.2.2 Operation Definition

This operation shall support the request data structures specified in table 6.1.4.2.2-1 and the response data structures and response codes specified in table 6.1.4.2.2-2.

**Table 6.1.4.2.2-1: Data structures supported by the POST Request Body on this resource**

Data type	P	Cardinality	Description
InvokeReq	M	1	Contains the parameters to request slice API invocation.

**Table 6.1.4.2.2-2: Data structures supported by the POST Response Body on this resource**

Data type	P	Cardinality	Response codes	Description
n/a			204 No Content	Successful case. The slice API invocation request is successfully received and processed.
n/a			307 Temporary Redirect	Temporary redirection. The response shall include a Location header field containing an alternative target URI located in an alternative NSCE Server. Redirection handling is described in clause 5.2.10 of 3GPP TS 29.122 [2].
n/a			308 Permanent Redirect	Permanent redirection. The response shall include a Location header field containing an alternative target URI located in an alternative NSCE Server. Redirection handling is described in clause 5.2.10 of 3GPP TS 29.122 [2].
NOTE: The mandatory HTTP error status codes for the HTTP POST method listed in table 5.2.6-1 of 3GPP TS 29.122 [2] shall also apply.				

**Table 6.1.4.2.2-3: Headers supported by the 307 Response Code on this resource**

Name	Data type	P	Cardinality	Description
Location	string	M	1	Contains an alternative target URI located in an alternative NSCE Server.

**Table 6.1.4.2.2-4: Headers supported by the 308 Response Code on this resource**

Name	Data type	P	Cardinality	Description
Location	string	M	1	Contains an alternative target URI located in an alternative NSCE Server.

## 6.1.5 Notifications

### 6.1.5.1 General

Notifications shall comply to clause 6.1 of 3GPP TS 29.549 [15].

**Table 6.1.5.1-1: Notifications overview**

Notification	Callback URI	HTTP method or custom operation	Description (service operation)
Slice API Configuration Notification	{notifUri}	POST	Enables a NSCE Server to notify a previously subscribed service consumer on Slice API Configuration event(s).

### 6.1.5.2 Slice API Configuration Notification

#### 6.1.5.2.1 Description

The Slice API Configuration Notification is used by the NSCE Server to notify a previously subscribed service consumer on Slice API Configuration event(s).

#### 6.1.5.2.2 Target URI

The Callback URI "{**notifUri**}" shall be used with the callback URI variables defined in table 6.1.5.2.2-1.

**Table 6.1.5.2.2-1: Callback URI variables**

Name	Definition
notifUri	Represents the callback URI encoded as a string formatted as a URI.

#### 6.1.5.2.3 Standard Methods

##### 6.1.5.2.3.1 POST

This method shall support the request data structures specified in table 6.1.5.2.3.1-1 and the response data structures and response codes specified in table 6.1.5.2.3.1-2.

**Table 6.1.5.2.3.1-1: Data structures supported by the POST Request Body**

Data type	P	Cardinality	Description
SliceAPIConfigNotif	M	1	Represents the Slice API Configuration Notification.



**Table 6.1.5.2.3.1-2: Data structures supported by the POST Response Body**

Data type	P	Cardinality	Response codes	Description
n/a			204 No Content	Successful case. The Slice API Configuration Notification is successfully received and processed.
n/a			307 Temporary Redirect	Temporary redirection.  The response shall include a Location header field containing an alternative URI representing the end point of an alternative service consumer towards which the notification should be sent.  Redirection handling is described in clause 5.2.10 of 3GPP TS 29.122 [2].
n/a			308 Permanent Redirect	Permanent redirection.  The response shall include a Location header field containing an alternative URI representing the end point of an alternative service consumer towards which the notification should be sent.  Redirection handling is described in clause 5.2.10 of 3GPP TS 29.122 [2].
NOTE: The mandatory HTTP error status codes for the HTTP POST method listed in table 5.2.6-1 of 3GPP TS 29.122 [2] shall also apply.				

**Table 6.1.5.2.3.1-3: Headers supported by the 307 Response Code on this resource**

Name	Data type	P	Cardinality	Description
Location	string	M	1	Contains an alternative URI representing the end point of an alternative service consumer towards which the notification should be redirected.

**Table 6.1.5.2.3.1-4: Headers supported by the 308 Response Code on this resource**

Name	Data type	P	Cardinality	Description
Location	string	M	1	Contains an alternative URI representing the end point of an alternative service consumer towards which the notification should be redirected.

## 6.1.6 Data Model

### 6.1.6.1 General

This clause specifies the application data model supported by the API.

Table 6.1.6.1-1 specifies the data types defined for the NSCE\_SliceApiManagement API.

**Table 6.1.6.1-1: NSCE\_SliceApiManagement API specific Data Types**

Data type	Clause defined	Description	Applicability
AppServReqs	6.1.6.2.3	Represents the application service requirements for a network slice.	
InvokeReq	6.1.6.2.7	Represents a slice API invocation request.	
SliceAPIConfigNotif	6.1.6.2.8	Represents a Slice API Configuration Notification.	
SliceAPIInfo	6.1.6.2.6	Represents slice API information.	
SliceAPIConfig	6.1.6.2.2	Represents a Slice API Configuration.	
TriggerEvent	6.1.6.3.3	Represents the triggering event.	
UpdateReq	6.1.6.2.4	Represents the parameters to request the update of a slice API configuration.	
UpdateResp	6.1.6.2.5	Represents the response to a slice API configuration update request.	

Table 6.1.6.1-2 specifies data types re-used by the NSCE\_SliceApiManagement API from other specifications, including a reference to their respective specifications, and when needed, a short description of their use within the NSCE\_SliceApiManagement API.

**Table 6.1.6.1-2: NSCE\_SliceApiManagement API re-used Data Types**

Data type	Reference	Comments	Applicability
AppReqs	Clause 6.12.6.2.3	Represents the application QoS requirements.	
NetSliceId	Clause 6.3.6.2.15	Represents the identification information of a network slice.	
ServArea	Clause 6.16.6.2.5	Represents a network slice service area.	
ServReq	Clause 6.11.6.2.4	Represents a set of application service requirements.	
SupportedFeatures	3GPP TS 29.571 [16]	Represents the list of supported feature(s) and used to negotiate the applicability of the optional features.	
TimeWindow	3GPP TS 29.122 [2]	Represents a time window.	
Uri	3GPP TS 29.122 [2]	Represents a URI.	

## 6.1.6.2 Structured data types

### 6.1.6.2.1 Introduction

This clause defines the structures to be used in resource representations.

### 6.1.6.2.2 Type: SliceAPIConfig

**Table 6.1.6.2.2-1: Definition of type SliceAPIConfig**

Attribute name	Data type	P	Cardinality	Description	Applicability
servReqs	array(AppServReqs)	M	1..N	Contains one or several set(s) of per network slice related application service requirements.	
notifUri	Uri	M	1	Contains the URI via which Slice API Configuration notifications shall be delivered.	
timeValidity	TimeWindow	O	0..1	Contains the time validity of the slice API configuration.	
suppFeat	SupportedFeatures	C	0..1	Contains the list of supported feature(s) among the ones defined in clause 6.1.8. This attribute shall be present only when feature negotiation needs to take place.	

## 6.1.6.2.3 Type: AppServReqs

**Table 6.1.6.2.3-1: Definition of type AppServReqs**

Attribute name	Data type	P	Cardinality	Description	Applicability
valServiceId	string	M	1	Represents the identifier of the VAL service to which the application service requirements are related.	
netSliceId	NetSliceId	M	1	Contains the identifier of the network slice to which the application service requirements are related.	
servKpis	AppReqs	O	0..1	Contains the QoS related application service requirements.	
servReqs	array(ServReq)	O	1..N	Contains the application layer Service Profile representing the network slice related application service requirements.	
areaOfInterest	ServArea	O	0..1	Represents the service area within which the application service requirements shall apply.	

## 6.1.6.2.4 Type: UpdateReq

**Table 6.1.6.2.4-1: Definition of type UpdateReq**

Attribute name	Data type	P	Cardinality	Description	Applicability
triggEvent	TriggerEvent	M	1	Contains the event triggering the need for slice API configuration update.	
netSliceId	NetSliceId	O	0..1	Contains the identifier of the network slice for which the slice API configuration update is requested.  When this attribute is absent, the slice API configuration update request applies to all the network slice(s) of the corresponding Network Slice API Configuration.	
suppFeat	SupportedFeatures	C	0..1	Contains the list of supported feature(s) among the ones defined in clause 6.1.8.  This attribute shall be present only when feature negotiation needs to take place.	

## 6.1.6.2.5 Type: UpdateResp

**Table 6.1.6.2.5-1: Definition of type UpdateResp**

Attribute name	Data type	P	Cardinality	Description	Applicability
sliceAPIInfo	SliceAPIInfo	M	1	Contains the updated slice API information.	
suppFeat	SupportedFeatures	C	0..1	Contains the list of supported feature(s) among the ones defined in clause 6.1.8.  This attribute shall be present only when feature negotiation needs to take place.	

## 6.1.6.2.6 Type: SliceAPIInfo

**Table 6.1.6.2.6-1: Definition of type SliceAPIInfo**

Attribute name	Data type	P	Cardinality	Description	Applicability
apiInfo	string	C	0..1	Contains slice API information. (NOTE)	
NOTE: At least one of these attributes shall be present.					

## 6.1.6.2.7 Type: InvokeReq

**Table 6.1.6.2.7-1: Definition of type InvokeReq**

Attribute name	Data type	P	Cardinality	Description	Applicability
sliceApIdInfo	string	M	1	Contains the identification information of the targeted slice API.	
suppFeat	SupportedFeatures	C	0..1	Contains the list of supported feature(s) among the ones defined in clause 6.1.8. This attribute shall be present only when feature negotiation needs to take place.	

## 6.1.6.2.8 Type: SliceAPIConfigNotif

**Table 6.1.6.2.8-1: Definition of type SliceAPIConfigNotif**

Attribute name	Data type	P	Cardinality	Description	Applicability
sliceAPIInfo	SliceAPIInfo	M	1	Contains the configured slice API information.	

## 6.1.6.3 Simple data types and enumerations

## 6.1.6.3.1 Introduction

This clause defines simple data types and enumerations that can be referenced from data structures defined in the previous clauses.

## 6.1.6.3.2 Simple data types

The simple data types defined in table 6.1.6.3.2-1 shall be supported.

**Table 6.1.6.3.2-1: Simple data types**

Type Name	Type Definition	Description	Applicability

## 6.1.6.3.3 Enumeration: TriggerEvent

The enumeration TriggerEvent represents the triggering event for slice API configuration update. It shall comply with the provisions defined in table 6.1.6.3.3-1.

**Table 6.1.6.3.3-1: Enumeration TriggerEvent**

Enumeration value	Description	Applicability
UE_MOBILITY	Indicates that the triggering event for slice API configuration update is UE mobility to a different service area.	
MIGRATION	Indicates that the triggering event for slice API configuration update is application server migration to a different edge/cloud platform.	
SERV_API_UNAVAILABILITY	Indicates that the triggering event for slice API configuration update is service API unavailability.	
APP_QOS_REQ_CHANGE	Indicates that the triggering event for slice API configuration update is application QoS requirements change.	

#### 6.1.6.4 Data types describing alternative data types or combinations of data types

There are no data types describing alternative data types or combinations of data types defined for this API in this release of the specification.

#### 6.1.6.5 Binary data

##### 6.1.6.5.1 Binary Data Types

**Table 6.1.6.5.1-1: Binary Data Types**

Name	Clause defined	Content type

#### 6.1.7 Error Handling

##### 6.1.7.1 General

For the NSCE\_SliceApiManagement API, error handling shall be supported as specified in clause 6.7 of 3GPP TS 29.549 [15].

In addition, the requirements in the following clauses are applicable for the NSCE\_SliceApiManagement API.

##### 6.1.7.2 Protocol Errors

No specific protocol errors for the NSCE\_SliceApiManagement API are specified.

##### 6.1.7.3 Application Errors

The application errors defined for the NSCE\_SliceApiManagement API are listed in Table 6.1.7.3-1.

**Table 6.1.7.3-1: Application errors**

Application Error	HTTP status code	Description	Applicability

#### 6.1.8 Feature negotiation

The optional features listed in table 6.1.8-1 are defined for the NSCE\_SliceApiManagement API. They shall be negotiated using the extensibility mechanism defined in clause 6.8 of 3GPP TS 29.549 [15].

Table 6.1.8-1: Supported Features

Feature number	Feature Name	Description

## 6.1.9 Security

The provisions of clause 9 of 3GPP TS 29.549 [15] shall apply for the NSCE\_SliceApiManagement API.

## 6.2 NSCE\_NetSliceLifeCycleMngt API

### 6.2.1 Introduction

The NSCE\_NetSliceLifeCycleMngt service shall use the NSCE\_NetSliceLifeCycleMngt API.

The API URI of the NSCE\_NetSliceLifeCycleMngt Service API shall be:

**{apiRoot}/<apiName>/<apiVersion>**

The request URIs used in HTTP requests shall have the Resource URI structure defined in clause 6.5 of 3GPP TS 29.549 [15], i.e.:

**{apiRoot}/<apiName>/<apiVersion>/<apiSpecificSuffixes>**

with the following components:

- The {apiRoot} shall be set as described in clause 6.5 of 3GPP TS 29.549 [15].
- The <apiName> shall be "nsce-nslcm".
- The <apiVersion> shall be "v1".
- The <apiSpecificSuffixes> shall be set as described in clause 6.5 of 3GPP TS 29.549 [15].

NOTE: When 3GPP TS 29.122 [2] is referenced for the common protocol and interface aspects for API definition in the clauses under clause 6.2, the NSCE Server takes the role of the SCEF and the service consumer takes the role of the SCS/AS.

### 6.2.2 Usage of HTTP

The provisions of clause 6.3 of 3GPP TS 29.549 [15] shall apply for the NSCE\_NetSliceLifeCycleMngt API.

### 6.2.3 Resources

#### 6.2.3.1 Overview

This clause describes the structure for the Resource URIs and the resources and methods used for the service.

Figure 6.2.3.1-1 depicts the resource URIs structure for the NSCE\_NetSliceLifeCycleMngt API.

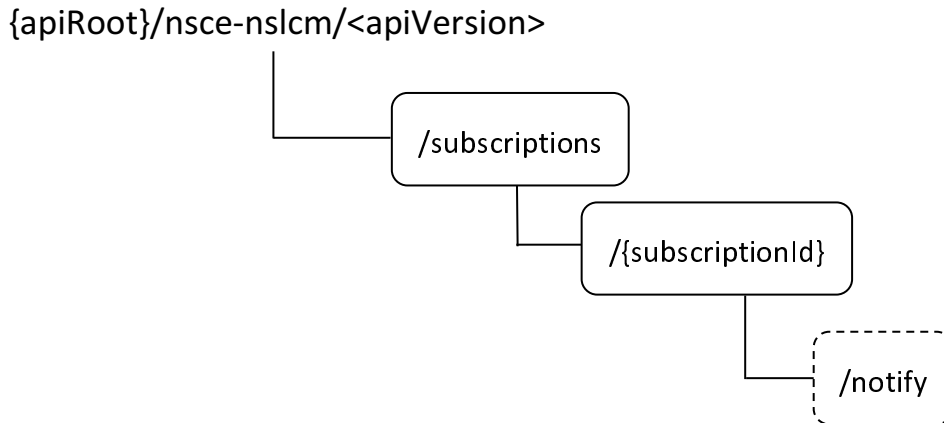

**Figure 6.2.3.1-1: Resource URIs structure of the NSCE\_NetSliceLifeCycleMngt API**

Table 6.2.3.1-1 provides an overview of the resources and applicable HTTP methods for the NSCE\_NetSliceLifeCycleMngt API.

**Table 6.2.3.1-1: Resources and methods overview**

Resource name	Resource URI	HTTP method or custom operation	Description
Network Slice Lifecycle Management Subscriptions	/subscriptions	POST	Request the creation of a Network Slice Lifecycle Management Subscription.
Individual Network Slice Lifecycle Management Subscription	/subscriptions/{subscriptionId}	GET	Retrieve an existing Network Slice Lifecycle Management Subscription.
		PUT	Request the update of an existing Network Slice Lifecycle Management Subscription.
		PATCH	Request the modification of an existing Network Slice Lifecycle Management Subscription.
		DELETE	Request the deletion of an existing Network Slice Lifecycle Management Subscription.
	QoEMetricNotify	Notify on QoE metrics.	
	/subscriptions/{subscriptionId}/notify	POST	Enables to notify the NSCE Server on QoE metrics.

## 6.2.3.2 Resource: Network Slice Lifecycle Management Subscriptions

### 6.2.3.2.1 Description

This resource represents the collection of Network Slice Lifecycle Management Subscriptions managed by the NSCE Server.

### 6.2.3.2.2 Resource Definition

Resource URI: **{apiRoot}/nsce-nslcm/<apiVersion>/subscriptions**

This resource shall support the resource URI variables defined in table 6.2.3.2.2-1.

**Table 6.2.3.2.2-1: Resource URI variables for this resource**

Name	Data type	Definition
apiRoot	string	See clause 6.2.1.

### 6.2.3.2.3 Resource Standard Methods

#### 6.2.3.2.3.2 POST

The HTTP POST method allows a service consumer to request the creation of a Network Slice Lifecycle Management Subscription at the NSCE Server.

This method shall support the URI query parameters specified in table 6.2.3.2.3.2-1.

**Table 6.2.3.2.3.2-1: URI query parameters supported by the POST method on this resource**

Name	Data type	P	Cardinality	Description	Applicability
n/a					

This method shall support the request data structures specified in table 6.2.3.2.3.2-2 and the response data structures and response codes specified in table 6.2.3.2.3.2-3.

**Table 6.2.3.2.3.2-2: Data structures supported by the POST Request Body on this resource**

Data type	P	Cardinality	Description
NSLCMSubsc	M	1	Represents the parameters to request the creation of a Network Slice Lifecycle Management Subscription.

**Table 6.2.3.2.3.2-3: Data structures supported by the POST Response Body on this resource**

Data type	P	Cardinality	Response codes	Description
NSLCMSubsc	M	1	201 Created	Successful case. The Network Slice Lifecycle Management Subscription is successfully created and a representation of the created "Individual Network Slice Lifecycle Management Subscription" resource shall be returned.  An HTTP "Location" header that contains the URI of the created resource shall also be included.
NOTE: The mandatory HTTP error status codes for the HTTP POST method listed in table 5.2.6-1 of 3GPP TS 29.122 [2] shall also apply.				

**Table 6.2.3.2.3.2-4: Headers supported by the 201 Response Code on this resource**

Name	Data type	P	Cardinality	Description
Location	string	M	1	Contains the URI of the newly created resource, according to the structure: {apiRoot}/nsce-nslcm/<apiVersion>/subscriptions/{subscriptionId}

### 6.2.3.2.4 Resource Custom Operations

There are no resource custom operations defined for this resource in this release of the specification.



### 6.2.3.3 Resource: Individual Network Slice Lifecycle Management Subscription

#### 6.2.3.3.1 Description

This resource represents a Network Slice Lifecycle Management Subscription managed by the NSCE Server.

#### 6.2.3.3.2 Resource Definition

Resource URI: **{apiRoot}/nsce-nslcm/<apiVersion>/subscriptions/{subscriptionId}**

This resource shall support the resource URI variables defined in table 6.2.3.3.2-1.

**Table 6.2.3.3.2-1: Resource URI variables for this resource**

Name	Data type	Definition
apiRoot	string	See clause 6.2.1.
subscriptionId	string	Represents the identifier of the "Individual Network Slice Lifecycle Management Subscription" resource.

#### 6.2.3.3.3 Resource Standard Methods

##### 6.2.3.3.3.1 GET

The HTTP GET method allows a service consumer to retrieve an existing "Individual Network Slice Lifecycle Management Subscription" resource at the NSCE Server.

This method shall support the URI query parameters specified in table 6.2.3.3.3.1-1.

**Table 6.2.3.3.3.1-1: URI query parameters supported by the GET method on this resource**

Name	Data type	P	Cardinality	Description	Applicability
n/a					

This method shall support the request data structures specified in table 6.2.3.3.3.1-2 and the response data structures and response codes specified in table 6.2.3.3.3.1-3.

**Table 6.2.3.3.3.1-2: Data structures supported by the GET Request Body on this resource**

Data type	P	Cardinality	Description
n/a			

**Table 6.2.3.3.3.1-3: Data structures supported by the GET Response Body on this resource**

Data type	P	Cardinality	Response codes	Description
NSLCMSubsc	M	1	200 OK	Successful case. The requested "Individual Network Slice Lifecycle Management Subscription" resource shall be returned.
n/a			307 Temporary Redirect	Temporary redirection. The response shall include a Location header field containing an alternative URI of the resource located in an alternative NSCE Server. Redirection handling is described in clause 5.2.10 of 3GPP TS 29.122 [2].
n/a			308 Permanent Redirect	Permanent redirection. The response shall include a Location header field containing an alternative URI of the resource located in an alternative NSCE Server. Redirection handling is described in clause 5.2.10 of 3GPP TS 29.122 [2].
NOTE: The mandatory HTTP error status codes for the HTTP GET method listed in table 5.2.6-1 of 3GPP TS 29.122 [2] shall also apply.				

**Table 6.2.3.3.3.1-4: Headers supported by the 307 Response Code on this resource**

Name	Data type	P	Cardinality	Description
Location	string	M	1	Contains an alternative URI of the resource located in an alternative NSCE Server.

**Table 6.2.3.3.3.1-5: Headers supported by the 308 Response Code on this resource**

Name	Data type	P	Cardinality	Description
Location	string	M	1	Contains an alternative URI of the resource located in an alternative NSCE Server.

#### 6.2.3.3.3.2 PUT

The HTTP PUT method allows a service consumer to request the update of an existing "Individual Network Slice Lifecycle Management Subscription" resource at the NSCE Server.

This method shall support the URI query parameters specified in table 6.2.3.3.3.2-1.

**Table 6.2.3.3.3.2-1: URI query parameters supported by the PUT method on this resource**

Name	Data type	P	Cardinality	Description	Applicability
n/a					

This method shall support the request data structures specified in table 6.2.3.3.3.2-2 and the response data structures and response codes specified in table 6.2.3.3.3.2-3.

**Table 6.2.3.3.3.2-2: Data structures supported by the PUT Request Body on this resource**

Data type	P	Cardinality	Description
NSLCMSubsc	M	1	Represents the updated representation of the "Individual Network Slice Lifecycle Management Subscription" resource.

**Table 6.2.3.3.2-3: Data structures supported by the PUT Response Body on this resource**

Data type	P	Cardinality	Response codes	Description
NSLCMSubsc	M	1	200 OK	Successful case. The "Individual Network Slice Lifecycle Management Subscription" resource is successfully updated and a representation of the updated resource shall be returned in the response body.
n/a			204 No Content	Successful case. The "Individual Network Slice Lifecycle Management Subscription" resource is successfully updated and no content is returned in the response body.
n/a			307 Temporary Redirect	Temporary redirection. The response shall include a Location header field containing an alternative URI of the resource located in an alternative NSCE Server. Redirection handling is described in clause 5.2.10 of 3GPP TS 29.122 [2].
n/a			308 Permanent Redirect	Permanent redirection. The response shall include a Location header field containing an alternative URI of the resource located in an alternative NSCE Server. Redirection handling is described in clause 5.2.10 of 3GPP TS 29.122 [2].
NOTE: The mandatory HTTP error status codes for the HTTP PUT method listed in table 5.2.6-1 of 3GPP TS 29.122 [2] shall also apply.				

**Table 6.2.3.3.2-4: Headers supported by the 307 Response Code on this resource**

Name	Data type	P	Cardinality	Description
Location	string	M	1	Contains an alternative URI of the resource located in an alternative NSCE Server.

**Table 6.2.3.3.2-5: Headers supported by the 308 Response Code on this resource**

Name	Data type	P	Cardinality	Description
Location	string	M	1	Contains an alternative URI of the resource located in an alternative NSCE Server.

6.2.3.3.3 PATCH

The HTTP PATCH method allows a service consumer to request the modification of an existing "Individual Network Slice Lifecycle Management Subscription" resource at the NSCE Server.

This method shall support the URI query parameters specified in table 6.2.3.3.3-1.

**Table 6.2.3.3.3-1: URI query parameters supported by the PATCH method on this resource**

Name	Data type	P	Cardinality	Description	Applicability
n/a					

This method shall support the request data structures specified in table 6.2.3.3.3-2 and the response data structures and response codes specified in table 6.2.3.3.3-3.

**Table 6.2.3.3.3.3-2: Data structures supported by the PATCH Request Body on this resource**

Data type	P	Cardinality	Description
NSLCMSubscPatch	M	1	Represents the parameters to request the modification of the "Individual Network Slice Lifecycle Management Subscription" resource.

**Table 6.2.3.3.3.3-3: Data structures supported by the PATCH Response Body on this resource**

Data type	P	Cardinality	Response codes	Description
NSLCMSubsc	M	1	200 OK	Successful case. The "Individual Network Slice Lifecycle Management Subscription" resource is successfully modified and a representation of the updated resource shall be returned in the response body.
n/a			204 No Content	Successful case. The "Individual Network Slice Lifecycle Management Subscription" resource is successfully modified and no content is returned in the response body.
n/a			307 Temporary Redirect	Temporary redirection. The response shall include a Location header field containing an alternative URI of the resource located in an alternative NSCE Server. Redirection handling is described in clause 5.2.10 of 3GPP TS 29.122 [2].
n/a			308 Permanent Redirect	Permanent redirection. The response shall include a Location header field containing an alternative URI of the resource located in an alternative NSCE Server. Redirection handling is described in clause 5.2.10 of 3GPP TS 29.122 [2].
NOTE: The mandatory HTTP error status codes for the HTTP PATCH method listed in table 5.2.6-1 of 3GPP TS 29.122 [2] shall also apply.				

**Table 6.2.3.3.3.3-4: Headers supported by the 307 Response Code on this resource**

Name	Data type	P	Cardinality	Description
Location	string	M	1	Contains an alternative URI of the resource located in an alternative NSCE Server.

**Table 6.2.3.3.3.3-5: Headers supported by the 308 Response Code on this resource**

Name	Data type	P	Cardinality	Description
Location	string	M	1	Contains an alternative URI of the resource located in an alternative NSCE Server.

#### 6.2.3.3.3.4 DELETE

The HTTP DELETE method allows a service consumer to request the deletion of an existing "Individual Network Slice Lifecycle Management Subscription" resource at the NSCE Server.

This method shall support the URI query parameters specified in table 6.2.3.3.3.4-1.

**Table 6.2.3.3.3.4-1: URI query parameters supported by the DELETE method on this resource**

Name	Data type	P	Cardinality	Description	Applicability
n/a					

This method shall support the request data structures specified in table 6.2.3.3.3.4-2 and the response data structures and response codes specified in table 6.2.3.3.3.4-3.

**Table 6.2.3.3.3.4-2: Data structures supported by the DELETE Request Body on this resource**

Data type	P	Cardinality	Description
n/a			

**Table 6.2.3.3.3.4-3: Data structures supported by the DELETE Response Body on this resource**

Data type	P	Cardinality	Response codes	Description
n/a			204 No Content	Successful case. The "Individual Network Slice Lifecycle Management Subscription" resource is successfully deleted.
n/a			307 Temporary Redirect	Temporary redirection. The response shall include a Location header field containing an alternative URI of the resource located in an alternative NSCE Server. Redirection handling is described in clause 5.2.10 of 3GPP TS 29.122 [2].
n/a			308 Permanent Redirect	Permanent redirection. The response shall include a Location header field containing an alternative URI of the resource located in an alternative NSCE Server. Redirection handling is described in clause 5.2.10 of 3GPP TS 29.122 [2].
NOTE: The mandatory HTTP error status codes for the HTTP DELETE method listed in table 5.2.6-1 of 3GPP TS 29.122 [2] shall also apply.				

**Table 6.2.3.3.3.4-4: Headers supported by the 307 Response Code on this resource**

Name	Data type	P	Cardinality	Description
Location	string	M	1	Contains an alternative URI of the resource located in an alternative NSCE Server.

**Table 6.2.3.3.3.4-5: Headers supported by the 308 Response Code on this resource**

Name	Data type	P	Cardinality	Description
Location	string	M	1	Contains an alternative URI of the resource located in an alternative NSCE Server.

## 6.2.3.3.4 Resource Custom Operations

### 6.2.3.3.4.1 Overview

Table 6.2.3.3.4.1-1 specifies the custom operations defined on this resource.

**Table 6.2.3.3.4.1-1: Resource Custom Operations**

Operation name	Custom operation URI	Mapped HTTP method	Description
QoEMetricNotify	/notify	POST	Enables a service consumer to notify the NSCE Server on QoE metrics.

6.2.3.3.4.2 Operation: QoEMetricNotify

6.2.3.3.4.2.1 Description

This resource custom operation is used by a service consumer to notify the NSCE Server on QoE metrics.

6.2.3.3.4.2.2 Operation Definition

This method shall support the request data structures specified in table 6.2.3.3.4.2.2-1 and the response data structures and response codes specified in table 6.2.3.3.4.2.2-2.

**Table 6.2.3.3.4.2.2-1: Data structures supported by the POST Request Body**

Data type	P	Cardinality	Description
QoEMetricsReportNotification	M	1	Represents the QoE Metrics Notification related information.

**Table 6.2.3.3.4.2.2-2: Data structures supported by the POST Response Body**

Data type	P	Cardinality	Response codes	Description
n/a			204 No Content	Successful case. The QoE Metrics Notification is successfully received and processed, and no content is returned in the response body.
n/a			307 Temporary Redirect	Temporary redirection. The response shall include a Location header field containing an alternative URI of the resource located in an alternative NSCE Server. Redirection handling is described in clause 5.2.10 of 3GPP TS 29.122 [2].
n/a			308 Permanent Redirect	Permanent redirection. The response shall include a Location header field containing an alternative URI of the resource located in an alternative NSCE Server. Redirection handling is described in clause 5.2.10 of 3GPP TS 29.122 [2].
NOTE: The mandatory HTTP error status codes for the HTTP POST method listed in table 5.2.6-1 of 3GPP TS 29.122 [2] shall also apply.				

**Table 6.2.3.3.4.2.2-3: Headers supported by the 307 Response Code on this resource**

Name	Data type	P	Cardinality	Description
Location	string	M	1	Contains an alternative URI of the resource located in an alternative NSCE Server.

**Table 6.2.3.3.4.2.2-4: Headers supported by the 308 Response Code on this resource**

Name	Data type	P	Cardinality	Description
Location	string	M	1	Contains an alternative URI of the resource located in an alternative NSCE Server.

## 6.2.4 Custom Operations without associated resources

There are no custom operations without associated resources defined for this API in this release of the specification.

## 6.2.5 Notifications

### 6.2.5.1 General

Notifications shall comply to clause 6.6 of 3GPP TS 29.549 [15].

**Table 6.2.5.1-1: Notifications overview**

Notification	Callback URI	HTTP method or custom operation	Description (service operation)
Network Slice Lifecycle Management Notification	{notifUri}	POST	Enables the NSCE Server to notify a previously subscribed service consumer on Network Slice Lifecycle Management event(s).
QoE Metrics Subscription Notification	{notifUri}/subscribe-qoe	POST	Enables the NSCE Server to subscribe to QoE metrics reporting at the service consumer.
Network Slice LCM Recommendation Notification	{notifUri}/recommend	POST	Enables the NSCE Server to notify a previously subscribed service consumer on network slice LCM recommendation.

### 6.2.5.2 Network Slice Lifecycle Management Notification

#### 6.2.5.2.1 Description

The Network Slice Lifecycle Management Notification is used by the NSCE Server to notify a previously subscribed service consumer on Network Slice Lifecycle Management event(s).

#### 6.2.5.2.2 Target URI

The Callback URI "{**notifUri**}" shall be used with the callback URI variables defined in table 6.2.5.2.2-1.

**Table 6.2.5.2.2-1: Callback URI variables**

Name	Definition
notifUri	Represents the callback URI encoded as a string formatted as a URI.

#### 6.2.5.2.3 Standard Methods

##### 6.2.5.2.3.1 POST

This method shall support the request data structures specified in table 6.2.5.2.3.1-1 and the response data structures and response codes specified in table 6.2.5.2.3.1-2.

**Table 6.2.5.2.3.1-1: Data structures supported by the POST Request Body**

Data type	P	Cardinality	Description
NSLCMNotif	M	1	Represents the Network Slice Lifecycle Management Notification.

**Table 6.2.5.2.3.1-2: Data structures supported by the POST Response Body**

Data type	P	Cardinality	Response codes	Description
n/a			204 No Content	Successful case. The Network Slice Lifecycle Management Notification is successfully received.
n/a			307 Temporary Redirect	Temporary redirection.  The response shall include a Location header field containing an alternative URI representing the end point of an alternative service consumer towards which the notification should be redirected.  Redirection handling is described in clause 5.2.10 of 3GPP TS 29.122 [2].
n/a			308 Permanent Redirect	Permanent redirection.  The response shall include a Location header field containing an alternative URI representing the end point of an alternative service consumer towards which the notification should be redirected.  Redirection handling is described in clause 5.2.10 of 3GPP TS 29.122 [2].
NOTE: The mandatory HTTP error status codes for the HTTP POST method listed in table 5.2.6-1 of 3GPP TS 29.122 [2] shall also apply.				

**Table 6.2.5.2.3.1-3: Headers supported by the 307 Response Code on this resource**

Name	Data type	P	Cardinality	Description
Location	string	M	1	Contains an alternative URI representing the end point of an alternative service consumer towards which the notification should be redirected.

**Table 6.2.5.2.3.1-4: Headers supported by the 308 Response Code on this resource**

Name	Data type	P	Cardinality	Description
Location	string	M	1	Contains an alternative URI representing the end point of an alternative service consumer towards which the notification should be redirected.

### 6.2.5.3 QoE metrics Subscribe Notification

#### 6.2.5.3.1 Description

The QoE metrics Subscription is used by the NSCE Server to subscribe a previously implicitly subscribed service consumer on QoE Metrics Subscription.

#### 6.2.5.3.2 Target URI

The Callback URI "{notifUri}/subscribe-qoe" shall be used with the callback URI variables defined in table 6.2.5.3.2-1.



**Table 6.2.5.3.2-1: Callback URI variables**

Name	Definition
notifUri	Represents the callback URI encoded as a string formatted as a URI.

### 6.2.5.3.3 Standard Methods

#### 6.2.5.3.3.1 POST

This method shall support the request data structures specified in table 6.2.5.3.3.1-1 and the response data structures and response codes specified in table 6.2.5.3.3.1-2.

**Table 6.2.5.3.3.1-1: Data structures supported by the POST Request Body**

Data type	P	Cardinality	Description
QoEMetricsSubsc	M	1	Represents the QoE metrics Subscription.

**Table 6.2.5.3.3.1-2: Data structures supported by the POST Response Body**

Data type	P	Cardinality	Response codes	Description
QoEMetricsResp	M	1	200 OK	Successful case. The QoE metrics Subscribe Notification is successfully received and processed, and immediate QoE metrics reporting related information shall be returned in the response body.
n/a			204 No Content	Successful case. The QoE metrics Subscription is successfully received and processed, and no content is returned in the response body.
n/a			307 Temporary Redirect	Temporary redirection.  The response shall include a Location header field containing an alternative URI representing the end point of an alternative service consumer where the notification should be sent.  Redirection handling is described in clause 5.2.10 of 3GPP TS 29.122 [2].
n/a			308 Permanent Redirect	Permanent redirection.  The response shall include a Location header field containing an alternative URI representing the end point of an alternative service consumer where the notification should be sent.  Redirection handling is described in clause 5.2.10 of 3GPP TS 29.122 [2].
NOTE: The mandatory HTTP error status codes for the HTTP POST method listed in table 5.2.6-1 of 3GPP TS 29.122 [2] shall also apply.				

**Table 6.2.5.3.3.1-3: Headers supported by the 307 Response Code on this resource**

Name	Data type	P	Cardinality	Description
Location	string	M	1	Contains an alternative URI representing the end point of an alternative service consumer towards which the notification should be redirected.

**Table 6.2.5.3.3.1-4: Headers supported by the 308 Response Code on this resource**

Name	Data type	P	Cardinality	Description
Location	string	M	1	Contains an alternative URI representing the end point of an alternative service consumer towards which the notification should be redirected.

## 6.2.5.4 Network Slice LCM Recommendation Notification

### 6.2.5.4.1 Description

The Network Slice LCM Recommendation is used by the NSCE Server to notify a previously subscribed service consumer on network slice LCM recommendation.

### 6.2.5.4.2 Target URI

The Callback URI "{notifUri}/recommend" shall be used with the callback URI variables defined in table 6.2.5.4.2-1.

**Table 6.2.5.4.2-1: Callback URI variables**

Name	Definition
notifUri	Represents the callback URI encoded as a string formatted as a URI.

### 6.2.5.4.3 Standard Methods

#### 6.2.5.4.3.1 POST

This method shall support the request data structures specified in table 6.2.5.4.3.1-1 and the response data structures and response codes specified in table 6.2.5.4.3.1-2.

**Table 6.2.5.4.3.1-1: Data structures supported by the POST Request Body**

Data type	P	Cardinality	Description
NSLCMRecom	M	1	Represents the Network Slice LCM Recommendation Notification.

**Table 6.2.5.4.3.1-2: Data structures supported by the POST Response Body**

Data type	P	Cardinality	Response codes	Description
n/a			204 No Content	Successful case. The Network Slice LCM Recommendation Notification is successfully received and processed, and no content is returned in the response body.
n/a			307 Temporary Redirect	Temporary redirection.  The response shall include a Location header field containing an alternative URI representing the end point of an alternative service consumer towards which the notification should be redirected.  Redirection handling is described in clause 5.2.10 of 3GPP TS 29.122 [2].
n/a			308 Permanent Redirect	Permanent redirection.  The response shall include a Location header field containing an alternative URI representing the end point of an alternative service consumer towards which the notification should be redirected.  Redirection handling is described in clause 5.2.10 of 3GPP TS 29.122 [2].
NOTE: The mandatory HTTP error status codes for the HTTP POST method listed in table 5.2.6-1 of 3GPP TS 29.122 [2] also apply.				

**Table 6.2.5.4.3.1-3: Headers supported by the 307 Response Code on this resource**

Name	Data type	P	Cardinality	Description
Location	string	M	1	Contains an alternative URI representing the end point of an alternative service consumer towards which the notification should be redirected.

**Table 6.2.5.4.3.1-4: Headers supported by the 308 Response Code on this resource**

Name	Data type	P	Cardinality	Description
Location	string	M	1	Contains an alternative URI representing the end point of an alternative service consumer towards which the notification should be redirected.

## 6.2.6 Data Model

### 6.2.6.1 General

This clause specifies the application data model supported by the API.

Table 6.2.6.1-1 specifies the data types defined for the NSCE\_NetSliceLifeCycleMngt API.

**Table 6.2.6.1-1: NSCE\_NetSliceLifeCycleMngt API specific Data Types**

Data type	Clause defined	Description	Applicability
CollectInfo	6.2.6.2.8	The information collected from the interested network slice.	
NSLCMNotif	6.2.6.2.3	The Network Slice Lifecycle Management Notification.	
NSLCMRecom	6.2.6.2.7	The Network Slice LCM Recommendation.	
NSLCMSubsc	6.2.6.2.1	The parameters to request the creation of a Network Slice Lifecycle Management Subscription resource.	
NSLCMSubscPatch	6.2.6.2.2	The parameters to request the update of a Network Slice Lifecycle Management Subscription resource.	
QoEMetric	6.2.6.2.10	The QoE metric type and the corresponding QoE threshold.	
QoEMetricsResp	6.2.6.2.5	The response of QoE Metrics Subscription.	
QoEMetricsReport	6.2.6.2.6	The QoE Metrics Report.	
QoEMetricsReportNotif	6.2.6.2.11	The QoE metrics notification including the QoE Metrics Report.	
QoEMetricsSubsc	6.2.6.2.4	The subscription to a previously subscribed service consumer on QoE metrics	
QoEType	6.2.6.3.3	The QoE metric type, e.g., latency, throughput, jitter, etc.	
SliceLCMAction	6.2.6.3.5	Recommend network slice LCM action.	
TriggerCond	6.2.6.2.9	The updated monitored parameters and the corresponding thresholds which could trigger the AppLayer-NS-LCM.	
TriggerType	6.2.6.3.4	The monitored parameter type, e.g., Network Slice load, collected Network Slice performance, collected QoE, etc.	

Table 6.2.6.1-2 specifies data types re-used by the NSCE\_NetSliceLifeCycleMngt API from other specifications, including a reference to their respective specifications, and when needed, a short description of their use within the NSCE\_NetSliceLifeCycleMngt API.

**Table 6.2.6.1-2: NSCE\_NetSliceLifeCycleMngt API re-used Data Types**

Data type	Reference	Comments	Applicability
AppServReqs	6.1.6.2.3	Represents the application service requirements for a network slice.	
DateTime	3GPP TS 29.122 [2]	Represents a date and a time.	
NetworkPerfInfo	3GPP TS 29.520 [26]	Represents the network performance information.	
NetSliceId	6.3.6.2.15	Represents the identification information of a network slice.	
NSInfoSet	6.16.6.2.4	Represents a Network Slice Information Set.	
PacketLossRate	3GPP TS 29.571 [16]	Represents the Packet Loss Rate.	

## 6.2.6.2 Structured data types

### 6.2.6.2.0 Introduction

This clause defines the data structures to be used in resource representations.

## 6.2.6.2.1 Type: NSLCMSubsc

Table 6.2.6.2.1-1: Definition of type NSLCMSubsc

Attribute name	Data type	P	Cardinality	Description	Applicability
notifUri	Uri	M	1	Contains the URI via which the Network Slice Lifecycle Management Notifications shall be delivered.	
servReqs	array(AppServReqs)	C	1..N	Contains one or several set(s) of per network slice related application service requirements. This attribute shall be present if available.	
triggerConds	array(TriggerCond)	O	1..N	Contains the monitored parameters and the corresponding thresholds which could trigger the AppLayer-NS-LCM.	
expTime	DateTime	O	0..1	Indicates the time at which the Network Slice Lifecycle Management subscription shall expire.  This attribute may only be present in Network Slice Lifecycle Management subscription creation/update responses.  If this attribute is absent, this means that the Network Slice Lifecycle Management subscription shall not expire, until explicitly deleted by the service consumer.	
suppFeat	SupportedFeatures	C	0..1	Contains the list of supported features among the ones defined in clause 6.2.8.  This attribute shall be present only if feature negotiation needs to take place.	

## 6.2.6.2.2 Type: NSLCMSubscPatch

Table 6.2.6.2.2-1: Definition of type NSLCMSubscPatch

Attribute name	Data type	P	Cardinality	Description	Applicability
notifUri	Uri	O	0..1	Contains the updated URI via which the Network Slice Lifecycle Management Notifications shall be delivered.	
servReqs	array(AppServReqs)	O	1..N	Contains one or several set(s) of per network slice related application service requirements.	
triggerConds	array(TriggerCond)	O	1..N	Contains the updated monitored parameters and the corresponding thresholds which could trigger the AppLayer-NS-LCM.	
expTime	DateTime	O	0..1	Indicates the updated time at which the Network Slice Lifecycle Management subscription shall expire.  This attribute may only be present in Network Slice Lifecycle Management subscription creation/update responses.  If this attribute is absent, this means that the Network Slice Lifecycle Management subscription shall not expire, until explicitly deleted by the service consumer.	

## 6.2.6.2.3 Type: NSLCMNotif

Table 6.2.6.2.3-1: Definition of type NSLCMNotif

Attribute name	Data type	P	Cardinality	Description	Applicability
netSliceld	NetSliceld	M	1	Represents the identifier of the reported network slice.	

## 6.2.6.2.4 Type: QoEMetricsSubsc

Table 6.2.6.2.4-1: Definition of type QoEMetricsSubsc

Attribute name	Data type	P	Cardinality	Description	Applicability
notifCorrld	string	O	0..1	Contains the notification correlation ID for the subscription of QoE Metrics.	
subscriptionId	string	O	0..1	Contains the identifier of the related subscription.	
collectInfos	map(CollectInfo)	M	1..N	Contains the information collected from the interested network slice. The key of the map shall be any unique string encoded value.	
expTime	DateTime	O	0..1	Contains the proposed expiration time of the subscription.	

## 6.2.6.2.5 Type: QoEMetricsResp

Table 6.2.6.2.5-1: Definition of type QoEMetricsResp

Attribute name	Data type	P	Cardinality	Description	Applicability
qoeMetrics	QoEMetricsSubsc	O	0..1	Identifier of the subscription.	
qoeMetricsReports	array(QoEMetricsReport)	O	1..N	Contains the network slice related performance and analytics report(s). Shall only be present if the immediate reporting indication in the "immRepFlag" attribute within the "collectInfos" attribute sets to true in the event subscription, and the reports are available.	

## 6.2.6.2.6 Type: QoEMetricsReport

Table 6.2.6.2.6-1: Definition of type QoEMetricsReport

Attribute name	Data type	P	Cardinality	Description	Applicability
netSliceld	NetSliceld	M	1	Represents the identifier of the targeted network slice.	
qoeMetrics	array(QoEMetric)	M	1..N	Contains the QoE metric type and the corresponding QoE threshold.	

## 6.2.6.2.7 Type: NSLCMRecom

Table 6.2.6.2.7-1: Definition of type NSLCMRecom

Attribute name	Data type	P	Cardinality	Description	Applicability
netSliceId	NetSliceId	M	1	Represents the identifier of the targeted network slice.	
sliceLCMActions	array(SliceLCMAction)	M	1..N	Recommend network slice LCM action.	
sliceInfo	NSInfoSet	O	0..1	Contains the network slice information. (NOTE)	
NOTE: At least the "snssai" attribute within the NSInfoSet shall be provided.					

## 6.2.6.2.8 Type: CollectInfo

Table 6.2.6.2.8-1: Definition of type CollectInfo

Attribute name	Data type	P	Cardinality	Description	Applicability
netSliceId	NetSliceId	M	1	Represents the targeted concerned network slice.	
qoeMetric	array(QoEMetric)	O	1..N	Contains the QoE metric type and the corresponding QoE threshold.	
repPeriod	DurationSec	O	0..1	Contains the reporting period.	
immRepFlag	boolean	O	0..1	Contains the immediate reporting indication. - Set to "true" to indicate that immediate reporting is requested. - Set to "false" to indicate that immediate reporting is not requested. - The default value is "false" if this attribute is omitted.	

## 6.2.6.2.9 Type: TriggerCond

Table 6.2.6.2.9-1: Definition of type TriggerCond

Attribute name	Data type	P	Cardinality	Description	Applicability
triggerType	TriggerType	M	1	Represents the monitored parameter type, e.g., Network Slice load, collected Network Slice performance, collected QoE, etc.	
netSliceId	NetSliceId	O	0..1	Represents the identifier of the targeted network slice.	
loadLevelThreshold	integer	C	0..1	Indicates that the NSCE shall report the corresponding network slice load level to the NF service consumer where the load level of the network slice identified by "netSliceId" exceeds the threshold (expressed as a percentage).  This attribute shall be present only when the subscribed event is "NETWORK_SLICE_LOAD". Minimum = 0. Maximum = 100.	
perfThreshold	integer	O	0..1	Indicates that the NSCE shall report the corresponding network slice performance when the performance exceeds the threshold (expressed as a percentage). Minimum = 0. Maximum = 100.	
qoeMetrics	array(QoEMetric)	O	1..N	Contains the QoE metric type and the corresponding QoE threshold.	

6.2.6.2.10 Type: QoEMetric

**Table 6.2.6.2.10-1: Definition of type QoEMetric**

Attribute name	Data type	P	Cardinality	Description	Applicability
qoeType	QoeType	M	1	Represents the QoE metric type, e.g., latency, throughput, jitter, etc.	
latency	Float	O	0..1	Contains the threshold average latency in milliseconds.  This attribute may be present only if the "qoeType" attribute is set to "LATENCY".	
throughput	BitRate	O	0..1	Contains the threshold average throughput.  This attribute may be present only if the "qoeType" attribute is set to "THROUGHPUT".	
jitter	Uint32	O	0..1	Contains the threshold average jitter.  This attribute may be present only if the "qoeType" attribute is set to "JITTER".	
avgPacketLossRate	PacketLossRate	O	0..1	Contains the threshold average Packet Loss Rate.  This attribute may be present only if the "qoeType" attribute is set to "AVG_PKT_LOSS_RATE".	
maxPacketLossRate	PacketLossRate	O	0..1	Contains the threshold maximum Packet Loss Rate.  This attribute may be present only if the "qoeType" attribute is set to "MAX_PKT_LOSS_RATE".	
NOTE: The attributes "latency", "throughput", "jitter", "avgPacketLossRate" and "maxPacketLossRate" are mutually exclusive. Either one of them may be present.					

6.2.6.2.11 Type: QoEMetricsReportNotif

**Table 6.2.6.2.11-1: Definition of type QoEMetricsReportNotif**

Attribute name	Data type	P	Cardinality	Description	Applicability
notifCorrId	string	M	1	Contains the notification correlation Id for the subscription of QoE Metrics.	
qoEMetricsReport	QoEMetricsReport	M	1	Contains the QoE metric report.	

6.2.6.3 Simple data types and enumerations

6.2.6.3.1 Introduction

This clause defines simple data types and enumerations that can be referenced from data structures defined in the previous clauses.

6.2.6.3.2 Simple data types

The simple data types defined in table 6.2.6.3.2-1 shall be supported.

**Table 6.2.6.3.2-1: Simple data types**

Type Name	Type Definition	Description	Applicability



## 6.2.6.3.3 Enumeration: QoEType

**Table 6.2.6.3.3-1: Enumeration QoEType**

Enumeration value	Description	Applicability
LATENCY	Indicates that the QoE type is latency.	
THROUGHPUT	Indicates that the QoE type is throughput.	
JITTER	Indicates that the QoE type is jitter.	
AVG_PKT_LOSS_RATE	Indicates that the QoE type is average Packet Loss Rate.	
MAX_PKT_LOSS_RATE	Indicates that the QoE type is maximum Packet Loss Rate.	

## 6.2.6.3.4 Enumeration: TriggerType

**Table 6.2.6.3.4-1: Enumeration TriggerType**

Enumeration value	Description	Applicability
NETWORK_SLICE_LOAD	Indicates that the trigger type is Network Slice load.	
NETWORK_SLICE_PERFORMANCE	Indicates that the trigger type is Network Slice performance.	
QOE	Indicates that the trigger type is QoE.	

## 6.2.6.3.5 Enumeration: SliceLCMAction

**Table 6.2.6.3.5-1: Enumeration SliceLCMAction**

Enumeration value	Description	Applicability
MODIFY_CONFIGURATION	Indicates that the recommend action is modifying the configuration.	
ALLOCATE_SLICE	Indicates that the recommend action is allocating a network slice.	

## 6.2.6.4 Data types describing alternative data types or combinations of data types

There are no data types describing alternative data types or combinations of data types defined for this API in this release of the specification.

## 6.2.6.5 Binary data

## 6.2.6.5.1 Binary Data Types

**Table 6.2.6.5.1-1: Binary Data Types**

Name	Clause defined	Content type

## 6.2.7 Error Handling

## 6.2.7.1 General

For the NSCE\_NetSliceLifeCycleMngt API, error handling shall be supported as specified in clause 6.7 of 3GPP TS 29.549 [15].

In addition, the requirements in the following clauses are applicable for the NSCE\_NetSliceLifeCycleMngt API.

### 6.2.7.2 Protocol Errors

No specific protocol errors for the NSCE\_NetSliceLifeCycleMngt API are specified.

### 6.2.7.3 Application Errors

The application errors defined for the NSCE\_NetSliceLifeCycleMngt API are listed in Table 6.2.7.3-1.

**Table 6.2.7.3-1: Application errors**

Application Error	HTTP status code	Description	Applicability

## 6.2.8 Feature negotiation

The optional features listed in table 6.2.8-1 are defined for the NSCE\_NetSliceLifeCycleMngt API. They shall be negotiated using the extensibility mechanism defined in clause 6.8 of 3GPP TS 29.549 [15].

**Table 6.2.8-1: Supported Features**

Feature number	Feature Name	Description

### 6.2.9 Security

The provisions of clause 9 of 3GPP TS 29.549 [15] shall apply for the NSCE\_NetSliceLifeCycleMngt API.

## 6.3 NSCE\_PolicyManagement API

### 6.3.1 Introduction

The NSCE\_PolicyManagement service shall use the NSCE\_PolicyManagement API.

The API URI of the NSCE\_PolicyManagement Service API shall be:

**{apiRoot}/<apiName>/<apiVersion>**

The request URIs used in HTTP requests shall have the Resource URI structure defined in clause 6.5 of 3GPP TS 29.549 [15], i.e.:

**{apiRoot}/<apiName>/<apiVersion>/<apiSpecificSuffixes>**

with the following components:

- The {apiRoot} shall be set as described in clause 6.5 of 3GPP TS 29.549 [15].
- The <apiName> shall be "nsce-pm".
- The <apiVersion> shall be "v1".
- The <apiSpecificSuffixes> shall be set as described in clause 6.5 of 3GPP TS 29.549 [15].

**NOTE:** When 3GPP TS 29.122 [2] is referenced for the common protocol and interface aspects for API definition in the clauses under clause 6.3, the NSCE Server takes the role of the SCEF and the service consumer takes the role of the SCS/AS.

## 6.3.2 Usage of HTTP

The provisions of clause 6.3 of 3GPP TS 29.549 [15] shall apply for the NSCE\_PolicyManagement API.

## 6.3.3 Resources

### 6.3.3.1 Overview

This clause describes the structure for the Resource URIs and the resources and methods used for the service.

Figure 6.3.3.1-1 depicts the resource URIs structure for the NSCE\_PolicyManagement API.

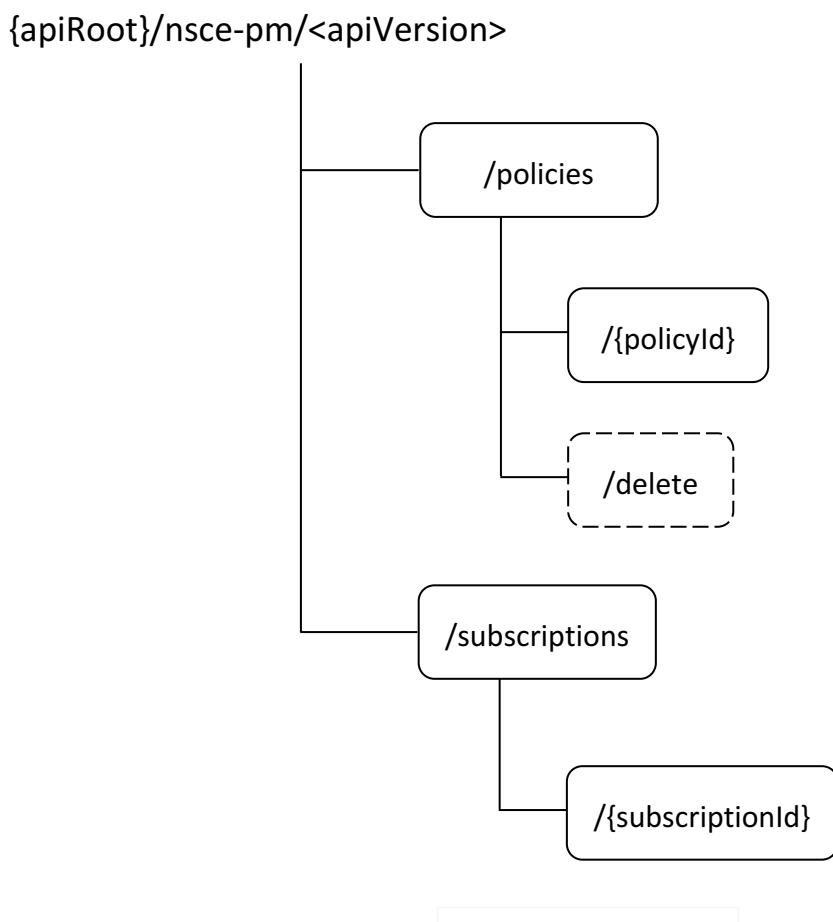

**Figure 6.3.3.1-1: Resource URIs structure of the NSCE\_PolicyManagement API**

Table 6.3.3.1-1 provides an overview of the resources and applicable HTTP methods for the NSCE\_PolicyManagement API.

**Table 6.3.3.1-1: Resources and methods overview**

Resource name	Resource URI	HTTP method or custom operation	Description
Policies	/policies	POST	Request the provisioning of a Policy.
		Delete	Request the deletion of one or several existing Policy(ies).
Individual Policy	/policies/{policyId}	GET	Retrieve an existing Policy.
		PUT	Request the update of an existing Policy.
		PATCH	Request the modification of an existing Policy.
Policy Usage Subscriptions	/subscriptions	POST	Request the creation of a Policy Usage Subscription.
Individual Policy Usage Subscription	/subscriptions/{subscriptionId}	GET	Retrieve an existing Policy Usage Subscription.
		PUT	Request the update of an existing Policy Usage Subscription.
		PATCH	Request the modification of an existing Policy Usage Subscription.
		DELETE	Request the deletion of an existing Policy Usage Subscription.

**6.3.3.2 Resource: Policies**

**6.3.3.2.1 Description**

This resource represents the collection of Policies managed by the NSCE Server.

**6.3.3.2.2 Resource Definition**

Resource URI: {apiRoot}/nsce-pm/<apiVersion>/policies

This resource shall support the resource URI variables defined in table 6.3.3.2.2-1.

**Table 6.3.3.2.2-1: Resource URI variables for this resource**

Name	Data type	Definition
apiRoot	string	See clause 6.3.1.

**6.3.3.2.3 Resource Standard Methods**

**6.3.3.2.3.1 POST**

The HTTP POST method allows a service consumer to request the provisioning of a Policy at the NSCE Server.

This method shall support the URI query parameters specified in table 6.3.3.2.3.1-1.

**Table 6.3.3.2.3.1-1: URI query parameters supported by the POST method on this resource**

Name	Data type	P	Cardinality	Description	Applicability
n/a					

This method shall support the request data structures specified in table 6.3.3.2.3.1-2 and the response data structures and response codes specified in table 6.3.3.2.3.1-3.

**Table 6.3.3.2.3.1-2: Data structures supported by the POST Request Body on this resource**

Data type	P	Cardinality	Description
Policy	M	1	Represents the parameters to request the provisioning of a Policy.

**Table 6.3.3.2.3.1-3: Data structures supported by the POST Response Body on this resource**

Data type	P	Cardinality	Response codes	Description
Policy	M	1	201 Created	Successful case. The Policy is successfully provisioned and a representation of the created "Individual Policy" resource shall be returned.  An HTTP "Location" header that contains the URI of the created resource shall also be included.
ProblemDetails	O	0..1	403 Forbidden	(NOTE 2)
NOTE 1: The mandatory HTTP error status codes for the HTTP POST method listed in table 5.2.6-1 of 3GPP TS 29.122 [2] shall also apply.				
NOTE 2: Failure causes are described in clause 6.3.7.				

**Table 6.3.3.2.3.1-4: Headers supported by the 201 Response Code on this resource**

Name	Data type	P	Cardinality	Description
Location	string	M	1	Contains the URI of the newly created resource, according to the structure: {apiRoot}/nsce-pm/<apiVersion>/policies/{policyId}

## 6.3.3.2.4 Resource Custom Operations

### 6.3.3.2.4.1 Overview

Table 6.3.3.2.4.1-1 specifies the custom operations defined on this resource.

**Table 6.3.3.2.4.1-1: Resource Custom Operations**

Operation name	Custom operation URI	Mapped HTTP method	Description
Delete	/policies/delete	POST	Enables a service consumer to request the deletion of one or several existing Policy(ies).

### 6.3.3.2.4.2 Operation: Delete

#### 6.3.3.2.4.2.1 Description

This resource custom operation enables a service consumer to request the deletion of one or several existing Policy(ies) at the NSCE Server.

#### 6.3.3.2.4.2.2 Operation Definition

This operation shall support the request data structures specified in table 6.3.3.2.4.2.2-1 and the response data structure and response codes specified in table 6.3.3.2.4.2.2-2.

**Table 6.3.3.2.4.2.2-1: Data structures supported by the POST Request Body on this resource**

Data type	P	Cardinality	Description
PolDeleteReq	M	1	Contains the parameters to request the deletion of one or several existing Policy(ies).

**Table 6.3.3.2.4.2.2-2: Data structures supported by the POST Response Body on this resource**

Data type	P	Cardinality	Response codes	Description
PolDeleteResp	M	1	200 OK	Successful case. The Policy(ies) deletion request is successfully received and processed, and deletion related information shall be returned in the response body.
n/a			204 No Content	Successful case. The Policy(ies) deletion request is successfully received and processed, and no content is returned in the response body.
n/a			307 Temporary Redirect	Temporary redirection. The response shall include a Location header field containing an alternative URI of the resource custom operation located in an alternative NSCE Server. Redirection handling is described in clause 5.2.10 of 3GPP TS 29.122 [2].
n/a			308 Permanent Redirect	Permanent redirection. The response shall include a Location header field containing an alternative URI of the resource custom operation located in an alternative NSCE Server. Redirection handling is described in clause 5.2.10 of 3GPP TS 29.122 [2].

NOTE: The mandatory HTTP error status codes for the HTTP POST method listed in table 5.2.6-1 of 3GPP TS 29.122 [2] shall also apply.

**Table 6.3.3.2.4.2.2-3: Headers supported by the 307 Response Code on this resource custom operation**

Name	Data type	P	Cardinality	Description
Location	string	M	1	Contains an alternative URI of the resource custom operation located in an alternative NSCE Server.

**Table 6.3.3.2.4.2.2-4: Headers supported by the 308 Response Code on this resource custom operation**

Name	Data type	P	Cardinality	Description
Location	string	M	1	Contains an alternative URI of the resource custom operation located in an alternative NSCE Server.

### 6.3.3.3 Resource: Individual Policy

#### 6.3.3.3.1 Description

This resource represents a Policy managed by the NSCE Server.

#### 6.3.3.3.2 Resource Definition

Resource URI: **{apiRoot}/nsce-pm/<apiVersion>/policies/{policyId}**

This resource shall support the resource URI variables defined in table 6.3.3.3.2-1.

**Table 6.3.3.3.2-1: Resource URI variables for this resource**

Name	Data type	Definition
apiRoot	string	See clause 6.3.1.
policyId	string	Represents the identifier of the "Individual Policy" resource.

### 6.3.3.3.3 Resource Standard Methods

#### 6.3.3.3.3.1 GET

The HTTP GET method allows a service consumer to retrieve an existing "Individual Policy" resource at the NSCE Server.

This method shall support the URI query parameters specified in table 6.3.3.3.3.1-1.

**Table 6.3.3.3.3.1-1: URI query parameters supported by the GET method on this resource**

Name	Data type	P	Cardinality	Description	Applicability
n/a					

This method shall support the request data structures specified in table 6.3.3.3.3.1-2 and the response data structures and response codes specified in table 6.3.3.3.3.1-3.

**Table 6.3.3.3.3.1-2: Data structures supported by the GET Request Body on this resource**

Data type	P	Cardinality	Description
n/a			

**Table 6.3.3.3.3.1-3: Data structures supported by the GET Response Body on this resource**

Data type	P	Cardinality	Response codes	Description
Policy	M	1	200 OK	Successful case. The requested "Individual Policy" resource shall be returned.
n/a			307 Temporary Redirect	Temporary redirection. The response shall include a Location header field containing an alternative URI of the resource located in an alternative NSCE Server. Redirection handling is described in clause 5.2.10 of 3GPP TS 29.122 [2].
n/a			308 Permanent Redirect	Permanent redirection. The response shall include a Location header field containing an alternative URI of the resource located in an alternative NSCE Server. Redirection handling is described in clause 5.2.10 of 3GPP TS 29.122 [2].
NOTE: The mandatory HTTP error status codes for the HTTP GET method listed in table 5.2.6-1 of 3GPP TS 29.122 [2] shall also apply.				

**Table 6.3.3.3.3.1-4: Headers supported by the 307 Response Code on this resource**

Name	Data type	P	Cardinality	Description
Location	string	M	1	Contains an alternative URI of the resource located in an alternative NSCE Server.

**Table 6.3.3.3.1-5: Headers supported by the 308 Response Code on this resource**

Name	Data type	P	Cardinality	Description
Location	string	M	1	Contains an alternative URI of the resource located in an alternative NSCE Server.

## 6.3.3.3.2 PUT

The HTTP PUT method allows a service consumer to request the update of an existing "Individual Policy" resource at the NSCE Server.

This method shall support the URI query parameters specified in table 6.3.3.3.2-1.

**Table 6.3.3.3.2-1: URI query parameters supported by the PUT method on this resource**

Name	Data type	P	Cardinality	Description	Applicability
n/a					

This method shall support the request data structures specified in table 6.3.3.3.2-2 and the response data structures and response codes specified in table 6.3.3.3.2-3.

**Table 6.3.3.3.2-2: Data structures supported by the PUT Request Body on this resource**

Data type	P	Cardinality	Description
Policy	M	1	Represents the updated representation of the "Individual Policy" resource.

**Table 6.3.3.3.2-3: Data structures supported by the PUT Response Body on this resource**

Data type	P	Cardinality	Response codes	Description
Policy	M	1	200 OK	Successful case. The "Individual Policy" resource is successfully updated and a representation of the updated resource shall be returned in the response body.
n/a			204 No Content	Successful case. The "Individual Policy" resource is successfully updated and no content is returned in the response body.
n/a			307 Temporary Redirect	Temporary redirection. The response shall include a Location header field containing an alternative URI of the resource located in an alternative NSCE Server. Redirection handling is described in clause 5.2.10 of 3GPP TS 29.122 [2].
n/a			308 Permanent Redirect	Permanent redirection. The response shall include a Location header field containing an alternative URI of the resource located in an alternative NSCE Server. Redirection handling is described in clause 5.2.10 of 3GPP TS 29.122 [2].
ProblemDetails	O	0..1	403 Forbidden	(NOTE 2)
NOTE 1: The mandatory HTTP error status codes for the HTTP PUT method listed in table 5.2.6-1 of 3GPP TS 29.122 [2] shall also apply.				
NOTE 2: Failure causes are described in clause 6.3.7.				



**Table 6.3.3.3.2-4: Headers supported by the 307 Response Code on this resource**

Name	Data type	P	Cardinality	Description
Location	string	M	1	Contains an alternative URI of the resource located in an alternative NSCE Server.

**Table 6.3.3.3.2-5: Headers supported by the 308 Response Code on this resource**

Name	Data type	P	Cardinality	Description
Location	string	M	1	Contains an alternative URI of the resource located in an alternative NSCE Server.

### 6.3.3.3.3.3 PATCH

The HTTP PATCH method allows a service consumer to request the modification of an existing "Individual Policy" resource at the NSCE Server.

This method shall support the URI query parameters specified in table 6.3.3.3.3.3-1.

**Table 6.3.3.3.3.3-1: URI query parameters supported by the PATCH method on this resource**

Name	Data type	P	Cardinality	Description	Applicability
n/a					

This method shall support the request data structures specified in table 6.3.3.3.3.3-2 and the response data structures and response codes specified in table 6.3.3.3.3.3-3.

**Table 6.3.3.3.3.3-2: Data structures supported by the PATCH Request Body on this resource**

Data type	P	Cardinality	Description
PolicyPatch	M	1	Represents the parameters to request the modification of the "Individual Policy" resource.

**Table 6.3.3.3.3-3: Data structures supported by the PATCH Response Body on this resource**

Data type	P	Cardinality	Response codes	Description
Policy	M	1	200 OK	Successful case. The "Individual Policy" resource is successfully modified and a representation of the updated resource shall be returned in the response body.
n/a			204 No Content	Successful case. The "Individual Policy" resource is successfully modified and no content is returned in the response body.
n/a			307 Temporary Redirect	Temporary redirection.  The response shall include a Location header field containing an alternative URI of the resource located in an alternative NSCE Server.  Redirection handling is described in clause 5.2.10 of 3GPP TS 29.122 [2].
n/a			308 Permanent Redirect	Permanent redirection.  The response shall include a Location header field containing an alternative URI of the resource located in an alternative NSCE Server.  Redirection handling is described in clause 5.2.10 of 3GPP TS 29.122 [2].
ProblemDetails	O	0..1	403 Forbidden	(NOTE 2)
NOTE 1: The mandatory HTTP error status codes for the HTTP PATCH method listed in table 5.2.6-1 of 3GPP TS 29.122 [2] shall also apply.				
NOTE 2: Failure causes are described in clause 6.3.7.				

**Table 6.3.3.3.3-4: Headers supported by the 307 Response Code on this resource**

Name	Data type	P	Cardinality	Description
Location	string	M	1	Contains an alternative URI of the resource located in an alternative NSCE Server.

**Table 6.3.3.3.3-5: Headers supported by the 308 Response Code on this resource**

Name	Data type	P	Cardinality	Description
Location	string	M	1	Contains an alternative URI of the resource located in an alternative NSCE Server.

#### 6.3.3.3.4 Resource Custom Operations

There are no resource custom operations defined for this resource in this release of the specification.

#### 6.3.3.4 Resource: Policy Usage Subscriptions

##### 6.3.3.4.1 Description

This resource represents the collection of Policy Usage Subscriptions managed by the NSCE Server.

##### 6.3.3.4.2 Resource Definition

Resource URI: **{apiRoot}/nsce-pm/<apiVersion>/subscriptions**

This resource shall support the resource URI variables defined in table 6.3.3.4.2-1.

**Table 6.3.3.4.2-1: Resource URI variables for this resource**

Name	Data type	Definition
apiRoot	string	See clause 6.3.1.

### 6.3.3.4.3 Resource Standard Methods

#### 6.3.3.4.3.2 POST

The HTTP POST method allows a service consumer to request the creation of a Policy Usage Subscription at the NSCE Server.

This method shall support the URI query parameters specified in table 6.3.3.4.3.2-1.

**Table 6.3.3.4.3.2-1: URI query parameters supported by the POST method on this resource**

Name	Data type	P	Cardinality	Description	Applicability
n/a					

This method shall support the request data structures specified in table 6.3.3.4.3.2-2 and the response data structures and response codes specified in table 6.3.3.4.3.2-3.

**Table 6.3.3.4.3.2-2: Data structures supported by the POST Request Body on this resource**

Data type	P	Cardinality	Description
PolUsageSubsc	M	1	Represents the parameters to request the creation of a Policy Usage Subscription resource.

**Table 6.3.3.4.3.2-3: Data structures supported by the POST Response Body on this resource**

Data type	P	Cardinality	Response codes	Description
PolUsageSubsc	M	1	201 Created	Successful case. The Policy Usage Subscription is successfully created and a representation of the created "Individual Policy Usage Subscription" resource shall be returned.  An HTTP "Location" header that contains the resource URI of the created resource shall also be included.
NOTE: The mandatory HTTP error status codes for the HTTP POST method listed in table 5.2.6-1 of 3GPP TS 29.122 [2] shall also apply.				

**Table 6.3.3.4.3.2-4: Headers supported by the 201 Response Code on this resource**

Name	Data type	P	Cardinality	Description
Location	string	M	1	Contains the URI of the newly created resource, according to the structure: {apiRoot}/nsce-pm/<apiVersion>/subscriptions/{subscriptionId}

### 6.3.3.4.4 Resource Custom Operations

There are no resource custom operations defined for this resource in this release of the specification.

## 6.3.3.5 Resource: Individual Policy Usage Subscription

### 6.3.3.5.1 Description

This resource represents a Policy Usage Subscription managed by the NSCE Server.

## 6.3.3.5.2 Resource Definition

Resource URI: {apiRoot}/nsce-pm/<apiVersion>/subscriptions/{subscriptionId}

This resource shall support the resource URI variables defined in table 6.3.3.5.2-1.

**Table 6.3.3.5.2-1: Resource URI variables for this resource**

Name	Data type	Definition
apiRoot	string	See clause 6.3.1.
subscriptionId	string	Represents the identifier of the "Individual Policy Usage Subscription" resource.

## 6.3.3.5.3 Resource Standard Methods

## 6.3.3.5.3.1 GET

The HTTP GET method allows a service consumer to retrieve an existing "Individual Policy Usage Subscription" resource at the NSCE Server.

This method shall support the URI query parameters specified in table 6.3.3.5.3.1-1.

**Table 6.3.3.5.3.1-1: URI query parameters supported by the GET method on this resource**

Name	Data type	P	Cardinality	Description	Applicability
n/a					

This method shall support the request data structures specified in table 6.3.3.5.3.1-2 and the response data structures and response codes specified in table 6.3.3.5.3.1-3.

**Table 6.3.3.5.3.1-2: Data structures supported by the GET Request Body on this resource**

Data type	P	Cardinality	Description
n/a			

**Table 6.3.3.5.3.1-3: Data structures supported by the GET Response Body on this resource**

Data type	P	Cardinality	Response codes	Description
PolUsageSubsc	M	1	200 OK	Successful case. The requested "Individual Policy Usage Subscription" resource shall be returned.
n/a			307 Temporary Redirect	Temporary redirection. The response shall include a Location header field containing an alternative URI of the resource located in an alternative NSCE Server. Redirection handling is described in clause 5.2.10 of 3GPP TS 29.122 [2].
n/a			308 Permanent Redirect	Permanent redirection. The response shall include a Location header field containing an alternative URI of the resource located in an alternative NSCE Server. Redirection handling is described in clause 5.2.10 of 3GPP TS 29.122 [2].
NOTE: The mandatory HTTP error status codes for the HTTP GET method listed in table 5.2.6-1 of 3GPP TS 29.122 [2] shall also apply.				

**Table 6.3.3.5.3.1-4: Headers supported by the 307 Response Code on this resource**

Name	Data type	P	Cardinality	Description
Location	string	M	1	Contains an alternative URI of the resource located in an alternative NSCE Server.

**Table 6.3.3.5.3.1-5: Headers supported by the 308 Response Code on this resource**

Name	Data type	P	Cardinality	Description
Location	string	M	1	Contains an alternative URI of the resource located in an alternative NSCE Server.

#### 6.3.3.5.3.2 PUT

The HTTP PUT method allows a service consumer to request the update of an existing "Individual Policy Usage Subscription" resource at the NSCE Server.

This method shall support the URI query parameters specified in table 6.3.3.5.3.2-1.

**Table 6.3.3.5.3.2-1: URI query parameters supported by the PUT method on this resource**

Name	Data type	P	Cardinality	Description	Applicability
n/a					

This method shall support the request data structures specified in table 6.3.3.5.3.2-2 and the response data structures and response codes specified in table 6.3.3.5.3.2-3.

**Table 6.3.3.5.3.2-2: Data structures supported by the PUT Request Body on this resource**

Data type	P	Cardinality	Description
PolUsageSubsc	M	1	Represents the updated representation of the "Individual Policy Usage Subscription" resource.

**Table 6.3.3.5.3.2-3: Data structures supported by the PUT Response Body on this resource**

Data type	P	Cardinality	Response codes	Description
PolUsageSubsc	M	1	200 OK	Successful case. The "Individual Policy Usage Subscription" resource is successfully updated and a representation of the updated resource shall be returned in the response body.
n/a			204 No Content	Successful case. The "Individual Policy Usage Subscription" resource is successfully updated and no content is returned in the response body.
n/a			307 Temporary Redirect	Temporary redirection.  The response shall include a Location header field containing an alternative URI of the resource located in an alternative NSCE Server.  Redirection handling is described in clause 5.2.10 of 3GPP TS 29.122 [2].
n/a			308 Permanent Redirect	Permanent redirection.  The response shall include a Location header field containing an alternative URI of the resource located in an alternative NSCE Server.  Redirection handling is described in clause 5.2.10 of 3GPP TS 29.122 [2].
NOTE: The mandatory HTTP error status codes for the HTTP PUT method listed in table 5.2.6-1 of 3GPP TS 29.122 [2] shall also apply.				

**Table 6.3.3.5.3.2-4: Headers supported by the 307 Response Code on this resource**

Name	Data type	P	Cardinality	Description
Location	string	M	1	Contains an alternative URI of the resource located in an alternative NSCE Server.

**Table 6.3.3.5.3.2-5: Headers supported by the 308 Response Code on this resource**

Name	Data type	P	Cardinality	Description
Location	string	M	1	Contains an alternative URI of the resource located in an alternative NSCE Server.

6.3.3.5.3.3 PATCH

The HTTP PATCH method allows a service consumer to request the modification of an existing "Individual Policy Usage Subscription" resource at the NSCE Server.

This method shall support the URI query parameters specified in table 6.3.3.5.3.3-1.

**Table 6.3.3.5.3.3-1: URI query parameters supported by the PATCH method on this resource**

Name	Data type	P	Cardinality	Description	Applicability
n/a					

This method shall support the request data structures specified in table 6.3.3.5.3.3-2 and the response data structures and response codes specified in table 6.3.3.5.3.3-3.

**Table 6.3.3.5.3.3-2: Data structures supported by the PATCH Request Body on this resource**

Data type	P	Cardinality	Description
PolUsageSubscPatch	M	1	Represents the parameters to request the modification of the "Individual Policy Usage Subscription" resource.

**Table 6.3.3.5.3.3-3: Data structures supported by the PATCH Response Body on this resource**

Data type	P	Cardinality	Response codes	Description
PolUsageSubsc	M	1	200 OK	Successful case. The "Individual Policy Usage Subscription" resource is successfully modified and a representation of the updated resource shall be returned in the response body.
n/a			204 No Content	Successful case. The "Individual Policy Usage Subscription" resource is successfully modified and no content is returned in the response body.
n/a			307 Temporary Redirect	Temporary redirection. The response shall include a Location header field containing an alternative URI of the resource located in an alternative NSCE Server. Redirection handling is described in clause 5.2.10 of 3GPP TS 29.122 [2].
n/a			308 Permanent Redirect	Permanent redirection. The response shall include a Location header field containing an alternative URI of the resource located in an alternative NSCE Server. Redirection handling is described in clause 5.2.10 of 3GPP TS 29.122 [2].
NOTE: The mandatory HTTP error status codes for the HTTP PATCH method listed in table 5.2.6-1 of 3GPP TS 29.122 [2] shall also apply.				

**Table 6.3.3.5.3.3-4: Headers supported by the 307 Response Code on this resource**

Name	Data type	P	Cardinality	Description
Location	string	M	1	Contains an alternative URI of the resource located in an alternative NSCE Server.

**Table 6.3.3.5.3.3-5: Headers supported by the 308 Response Code on this resource**

Name	Data type	P	Cardinality	Description
Location	string	M	1	Contains an alternative URI of the resource located in an alternative NSCE Server.

#### 6.3.3.5.3.4 DELETE

The HTTP DELETE method allows a service consumer to request the deletion of an existing "Individual Policy Usage Subscription" resource at the NSCE Server.

This method shall support the URI query parameters specified in table 6.3.3.5.3.4-1.

**Table 6.3.3.5.3.4-1: URI query parameters supported by the DELETE method on this resource**

Name	Data type	P	Cardinality	Description	Applicability
n/a					

This method shall support the request data structures specified in table 6.3.3.5.3.4-2 and the response data structures and response codes specified in table 6.3.3.5.3.4-3.

**Table 6.3.3.5.3.4-2: Data structures supported by the DELETE Request Body on this resource**

Data type	P	Cardinality	Description
n/a			

**Table 6.3.3.5.3.4-3: Data structures supported by the DELETE Response Body on this resource**

Data type	P	Cardinality	Response codes	Description
n/a			204 No Content	Successful case. The "Individual Policy Usage Subscription" resource is successfully deleted.
n/a			307 Temporary Redirect	Temporary redirection.  The response shall include a Location header field containing an alternative URI of the resource located in an alternative NSCE Server.  Redirection handling is described in clause 5.2.10 of 3GPP TS 29.122 [2].
n/a			308 Permanent Redirect	Permanent redirection.  The response shall include a Location header field containing an alternative URI of the resource located in an alternative NSCE Server.  Redirection handling is described in clause 5.2.10 of 3GPP TS 29.122 [2].
NOTE: The mandatory HTTP error status codes for the HTTP DELETE method listed in table 5.2.6-1 of 3GPP TS 29.122 [2] shall also apply.				

**Table 6.3.3.5.3.4-4: Headers supported by the 307 Response Code on this resource**

Name	Data type	P	Cardinality	Description
Location	string	M	1	Contains an alternative URI of the resource located in an alternative NSCE Server.

**Table 6.3.3.5.3.4-5: Headers supported by the 308 Response Code on this resource**

Name	Data type	P	Cardinality	Description
Location	string	M	1	Contains an alternative URI of the resource located in an alternative NSCE Server.

#### 6.3.3.5.4 Resource Custom Operations

There are no resource custom operations defined for this resource in this release of the specification.

#### 6.3.4 Custom Operations without associated resources

There are no custom operations without associated resources defined for this API in this release of the specification.

#### 6.3.5 Notifications

##### 6.3.5.1 General

Notifications shall comply to clause 6.6 of 3GPP TS 29.549 [15].



**Table 6.3.5.1-1: Notifications overview**

Notification	Callback URI	HTTP method or custom operation	Description (service operation)
Policy Usage Notification	{notifUri}	POST	This service operation enables the NSCE Server to notify a previously subscribed service consumer on Policy Usage event(s).
Policy Harmonization Notification	{notifUri}	POST	This service operation enables the NSCE Server to notify a previously implicitly subscribed service consumer on Policy Harmonization event(s).

## 6.3.5.2 Policy Usage Notification

### 6.3.5.2.1 Description

The Policy Usage Notification is used by the NSCE Server to notify a previously subscribed service consumer on Policy Usage event(s).

### 6.3.5.2.2 Target URI

The Callback URI "{**notifUri**}" shall be used with the callback URI variables defined in table 6.3.5.2.2-1.

**Table 6.3.5.2.2-1: Callback URI variables**

Name	Definition
notifUri	Represents the callback URI encoded as a string formatted as a URI.

### 6.3.5.2.3 Standard Methods

#### 6.3.5.2.3.1 POST

This method shall support the request data structures specified in table 6.3.5.2.3.1-1 and the response data structures and response codes specified in table 6.3.5.2.3.1-2.

**Table 6.3.5.2.3.1-1: Data structures supported by the POST Request Body**

Data type	P	Cardinality	Description
PolUsageNotif	M	1	Represents the Policy Usage Notification.

**Table 6.3.5.2.3.1-2: Data structures supported by the POST Response Body**

Data type	P	Cardinality	Response codes	Description
n/a			204 No Content	Successful case. The Policy Usage Notification is successfully received.
n/a			307 Temporary Redirect	Temporary redirection.  The response shall include a Location header field containing an alternative URI representing the end point of an alternative service consumer where the notification should be sent.  Redirection handling is described in clause 5.2.10 of 3GPP TS 29.122 [2].
n/a			308 Permanent Redirect	Permanent redirection.  The response shall include a Location header field containing an alternative URI representing the end point of an alternative service consumer where the notification should be sent.  Redirection handling is described in clause 5.2.10 of 3GPP TS 29.122 [2].
NOTE: The mandatory HTTP error status codes for the HTTP POST method listed in table 5.2.6-1 of 3GPP TS 29.122 [2] shall also apply.				

**Table 6.3.5.2.3.1-3: Headers supported by the 307 Response Code on this resource**

Name	Data type	P	Cardinality	Description
Location	string	M	1	Contains an alternative URI representing the end point of an alternative service consumer towards which the notification should be redirected.

**Table 6.3.5.2.3.1-4: Headers supported by the 308 Response Code on this resource**

Name	Data type	P	Cardinality	Description
Location	string	M	1	Contains an alternative URI representing the end point of an alternative service consumer towards which the notification should be redirected.

### 6.3.5.3 Policy Harmonization Notification

#### 6.3.5.3.1 Description

The Policy Harmonization Notification is used by the NSCE Server to notify a previously implicitly subscribed service consumer on Policy Harmonization event(s).

#### 6.3.5.3.2 Target URI

The Callback URI "{notifUri}" shall be used with the callback URI variables defined in table 6.3.5.3.2-1.

**Table 6.3.5.3.2-1: Callback URI variables**

Name	Definition
notifUri	Represents the callback URI encoded as a string formatted as a URI.

## 6.3.5.3.3 Standard Methods

## 6.3.5.3.3.1 POST

This method shall support the request data structures specified in table 6.3.5.3.3.1-1 and the response data structures and response codes specified in table 6.3.5.3.3.1-2.

Table 6.3.5.3.3.1-1: Data structures supported by the POST Request Body

Data type	P	Cardinality	Description
HarmonizationNotif	M	1	Represents the Policy Harmonization Notification.

Table 6.3.5.3.3.1-2: Data structures supported by the POST Response Body

Data type	P	Cardinality	Response codes	Description
HarmonizationResp	M	1	200 OK	Successful case. The Policy Harmonization Notification is successfully received and processed, and policy harmonization related information shall be returned in the response body.
n/a			204 No Content	Successful case. The Policy Harmonization Notification is successfully received and processed, and no content is returned in the response body.
n/a			307 Temporary Redirect	Temporary redirection.  The response shall include a Location header field containing an alternative URI representing the end point of an alternative service consumer where the notification should be sent.  Redirection handling is described in clause 5.2.10 of 3GPP TS 29.122 [2].
n/a			308 Permanent Redirect	Permanent redirection.  The response shall include a Location header field containing an alternative URI representing the end point of an alternative service consumer where the notification should be sent.  Redirection handling is described in clause 5.2.10 of 3GPP TS 29.122 [2].
NOTE: The mandatory HTTP error status codes for the HTTP POST method listed in table 5.2.6-1 of 3GPP TS 29.122 [2] shall also apply.				

Table 6.3.5.3.3.1-3: Headers supported by the 307 Response Code on this resource

Name	Data type	P	Cardinality	Description
Location	string	M	1	Contains an alternative URI representing the end point of an alternative service consumer towards which the notification should be redirected.

Table 6.3.5.3.3.1-4: Headers supported by the 308 Response Code on this resource

Name	Data type	P	Cardinality	Description
Location	string	M	1	Contains an alternative URI representing the end point of an alternative service consumer towards which the notification should be redirected.

## 6.3.6 Data Model

### 6.3.6.1 General

This clause specifies the application data model supported by the API.

Table 6.3.6.1-1 specifies the data types defined for the NSCE\_PolicyManagement API.

**Table 6.3.6.1-1: NSCE\_PolicyManagement API specific Data Types**

Data type	Clause defined	Description	Applicability
DefaultPolInfo	6.3.6.2.12	Represents the default policy related information.	
Ensi	6.3.6.3.2	Represents the External Network Slice Information.	
HarmonizationNotif	6.3.6.2.13	Represents a Policy Harmonization Notification.	
HarmonizationResp	6.3.6.2.14	Represents the response to a Policy Harmonization Notification.	
NetSliceId	6.3.6.2.15	Represents the identification information of a network slice.	
QoSAction	6.3.6.3.4	Represents the QoS related action.	
Policy	6.3.6.2.2	Represents the parameters to request the provisioning of a Policy.	
PolicyActions	6.3.6.2.17	Represents the policy related actions.	
PolicyPatch	6.3.6.2.3	Represents the requested modifications to a Policy.	
PolicyData	6.3.6.2.4	Represents the content of a policy.	
PolicyTriggers	6.3.6.2.16	Represents the policy related triggers.	
PolicyType	6.3.6.3.3	Represents the policy type.	
PolDeleteReq	6.3.6.2.10	Represents the parameters to request the deletion of one or several Policy(ies).	
PolDeleteResp	6.3.6.2.11	Represents the response to the Policy(ies) deletion request.	
PolRepData	6.3.6.2.9	Represents policy usage reporting data.	
PolUsageNotif	6.3.6.2.8	Represents a Policy Usage Notification.	
PolUsageSubsc	6.3.6.2.5	Represents a Policy Usage Subscription.	
PolUsageSubscPatch	6.3.6.2.6	Represents the requested modifications to a Policy Usage Subscription.	
PriorityLevel	6.3.6.3.2	Represents the priority level of a policy.	
ReqPolRep	6.3.6.2.7	Represents the requested policy usage reporting information.	
TimePeriodInfo	6.3.6.2.18	Represents the time period related information.	

Table 6.3.6.1-2 specifies data types re-used by the NSCE\_PolicyManagement API from other specifications, including a reference to their respective specifications, and when needed, a short description of their use within the NSCE\_PolicyManagement API.

**Table 6.3.6.1-2: NSCE\_PolicyManagement API re-used Data Types**

<b>Data type</b>	<b>Reference</b>	<b>Comments</b>	<b>Applicability</b>
DateTime	3GPP TS 29.122 [2]	Represents a date and a time.	
DayOfWeek	3GPP TS 29.122 [2]	Represents a day of the week.	
Dnn	3GPP TS 29.571 [16]	Represents a DNN.	
DurationSec	3GPP TS 29.122 [2]	Represents a time duration in seconds.	
Nsild	3GPP TS 29.531 [20]	Represents the identifier of a network slice instance.	
ProblemDetails	3GPP TS 29.122 [2]	Represents error related information.	
ServArea	Clause 6.16.6.2.5	Represents a service area.	
Snsai	3GPP TS 29.571 [16]	Represents an S-NSSAI.	
SupportedFeatures	3GPP TS 29.571 [16]	Represents the list of supported feature(s) and used to negotiate the applicability of the optional features.	
TimeWindow	3GPP TS 29.122 [2]	Represents a time window with a start time and an end time.	
UInteger	3GPP TS 29.571 [16]	Represents an unsigned integer.	
Uri	3GPP TS 29.122 [2]	Represents a URI.	

## 6.3.6.2 Structured data types

### 6.3.6.2.1 Introduction

This clause defines the data structures to be used in resource representations.

6.3.6.2.2      Type: Policy

**Table 6.3.6.2.2-1: Definition of type Policy**

Attribute name	Data type	P	Cardinality	Description	Applicability
netSliceld	NetSliceld	C	0..1	Contains the identifier of the concerned network slice.  (NOTE 1, NOTE 2)	
reqDnn	Dnn	C	0..1	Contains the requested DNN.  (NOTE 1, NOTE 2)	
polHarmInd	boolean	O	0..1	Contains the policy harmonization indication. It indicates whether policy harmonization is requested or not, i.e.: - "true" means that policy harmonization is requested. - "false" means that policy harmonization is not requested. - The default value when omitted is "false".	
policy	PolicyData	M	0..1	Contains the provisioned policy content data.	
defaultPolInd	boolean	O	0..1	Contains the default policy indication. It indicates whether or not the provisioned policy shall be used as a default policy for the network slices provisioned without any policy for the policy type it belongs to, i.e.: - "true" means that the provisioned policy shall be used as a default policy for the network slices provisioned without any policy for the policy type. - "false" means that the provisioned policy shall not be used as a default policy for the network slices provisioned without any policy for the policy type. - The default value when omitted is "false".  (NOTE 1)	
notifUri	Uri	C	0..1	Contains the URI via which the Policy Harmonization Notifications shall be delivered.  This attribute shall be present only when the "polHarmInd" attribute is present and set to "true".	
harmonizationId	string	O	0..1	Contains the harmonization identifier.  This attribute may only be present in a response to a policy provisioning/update request.  When this attribute is present, it indicates that policy harmonization of the provisioned/updated policy is still ongoing, i.e., the NSCE Server will notify the service consumer once the harmonization process is finalized.	
supFeat	SupportedFeatures	C	0..1	Contains the list of supported features among the ones defined in clause 6.3.8.  This attribute shall be present only when feature negotiation needs to take place.	
<p>NOTE 1: At least one of these attributes shall be present, unless the provisioned policy is a default policy (i.e., the "defaultPolInd" attribute is present and set to "true"), in which case these attributes are both optional.</p> <p>NOTE 2: In case of a default policy provisioning (i.e., when the "defaultPolInd" attribute is present and set to "true"), both the "netSliceld" attribute and the "reqDnn" attribute are optional. When one of them or both of them is/are present, this means that the provisioned default policy applies only to the provided network slice and/or DNN for the policy type it belongs to. Otherwise, when both of them are absent, this means that the provisioned default policy applies to all the network slice(s) and/or DNN(s) that do not have any configured policy for the policy type it belongs to.</p>					

## 6.3.6.2.3 Type: PolicyPatch

Table 6.3.6.2.3-1: Definition of type PolicyPatch

Attribute name	Data type	P	Cardinality	Description	Applicability
netSliceld	NetSliceld	O	0..1	Contains the identifier for the concerned network slice.	
reqDnn	Dnn	O	0..1	Contains the requested DNN.	
polHarmlnd	boolean	O	0..1	Contains the policy harmonization indication. It indicates whether policy harmonization is requested or not, i.e.: <ul style="list-style-type: none"> <li>- "true" means that policy harmonization is requested.</li> <li>- "false" means that policy harmonization is not requested.</li> <li>- The default value when omitted and not previously provisioned is "false".</li> </ul>	
policy	PolicyData	O	0..1	Contains the updated policy content data.	
defaultPolInd	boolean	O	0..1	Contains the default policy indication. It indicates whether or not the provisioned policy shall be used as a default policy for the network slices provisioned without any policy for the policy type it belongs to, i.e.: <ul style="list-style-type: none"> <li>- "true" means that the provisioned policy shall be used as a default policy for the network slices provisioned without any policy for the policy type.</li> <li>- "false" means that the provisioned policy shall not be used as a default policy for the network slices provisioned without any policy for the policy type.</li> <li>- The default value when omitted and not previously provisioned is "false".</li> </ul>	
notifUri	Uri	O	0..1	Contains the updated URI via which the Policy Harmonization Notifications shall be delivered.  This attribute shall be present only if the "polHarmlnd" attribute is provisioned for the first time and set to "true", and may be present only when the "polHarmlnd" attribute is already present and set to "true" within the targeted "Individual Policy" resource representation.	



## 6.3.6.2.4 Type: PolicyData

Table 6.3.6.2.4-1: Definition of type PolicyData

Attribute name	Data type	P	Cardinality	Description	Applicability
policyType	PolicyType	M	1	Represents the policy type.	
areaOfInterest	ServArea	M	1	Represents the service area within which the policy shall apply.	
triggers	PolicyTriggers	M	1	Contains the criteria (e.g., thresholds) to be used to trigger the policy.	
actions	PolicyActions	M	1	Contains the actions to be initiated when the criteria provided within the "triggers" attribute are met.	
lifetime	DurationSec	C	0..1	Indicates the time duration of the policy. (NOTE)	
maxNumTimes	UInteger	C	0..1	Indicates the maximum number of times that the policy can be used/triggered. (NOTE)	
priority	PriorityLevel	O	0..1	Contains the priority of the policy.	
schedule	TimeWindow	O	0..1	Contains the time scheduling information (i.e., start time and end time) of the policy.	
preemption	PriorityLevel	O	0..1	Contains the pre-emption capability of the policy.	
NOTE: These attributes are mutually exclusive. Either one of them shall be present.					

## 6.3.6.2.5 Type: PoUsageSubsc

Table 6.3.6.2.5-1: Definition of type PoUsageSubsc

Attribute name	Data type	P	Cardinality	Description	Applicability
notifUri	Uri	M	1	Contains the URI via which the Policy Usage Notifications shall be delivered.	
netSliceId	NetSliceId	M	1	Contains the identifier for the requested network slice.	
reqPolicyRep	ReqPolRep	M	1	Contains the requested policy usage reporting information.	
repPeriodicity	DurationSec	O	0..1	Contains the reporting periodicity (i.e., reporting interval).	
suppFeat	SupportedFeatures	C	0..1	Contains the list of supported features among the ones defined in clause 6.3.8. This attribute shall be present only when feature negotiation needs to take place.	

## 6.3.6.2.6 Type: PoUsageSubscPatch

Table 6.3.6.2.6-1: Definition of type PoUsageSubscPatch

Attribute name	Data type	P	Cardinality	Description	Applicability
notifUri	Uri	O	0..1	Contains the updated URI via which the Policy Usage Notifications shall be delivered.	
reqPolicyRep	ReqPolRep	O	0..1	Contains the updated requested policy usage reporting information.	
repPeriodicity	DurationSec	O	0..1	Contains the updated reporting periodicity (i.e., reporting interval).	

## 6.3.6.2.7 Type: ReqPolRep

Table 6.3.6.2.7-1: Definition of type ReqPolRep

Attribute name	Data type	P	Cardinality	Description	Applicability
policyId	string	M	1	Contains the identifier of the targeted policy.	
startTime	DateTime	M	1	Contains the start time of the requested policy usage reporting.	
endTime	DateTime	M	1	Contains the end time of the requested policy usage reporting.	

## 6.3.6.2.8 Type: PolUsageNotif

Table 6.3.6.2.8-1: Definition of type PolUsageNotif

Attribute name	Data type	P	Cardinality	Description	Applicability
subscriptionId	string	M	1	Contains the identifier of the subscription to which the Policy Usage Notification is related.	
reports	array(PolRepData)	M	1..N	Contains the reported policy usage data.	

## 6.3.6.2.9 Type: PolRepData

Table 6.3.6.2.9-1: Definition of type PolRepData

Attribute name	Data type	P	Cardinality	Description	Applicability
policyId	string	M	1	Contains the identifier of the policy to which the policy usage report is related.	
count	UInteger	M	1	Contains the number of times the policy identified by the "policyId" attribute is active/used.	
timeSpent	DurationSec	M	1	Contains the usage time duration of the policy identified by the "policyId" attribute.	
preEmptCount	UInteger	O	0..1	Contains the number of times the policy is pre-empted by another policy. (NOTE)	
preEmptPolId	array(string)	O	1..N	Contains the identifier(s) of the policy(s) that are used for pre-emption. (NOTE)	

NOTE: When the "preEmptCount" attribute is present and set to "1", then the "preEmptPolId" attribute, when present, shall not contain more than one array element.

## 6.3.6.2.10 Type: PolDeleteReq

Table 6.3.6.2.10-1: Definition of type PolDeleteReq

Attribute name	Data type	P	Cardinality	Description	Applicability
policyIds	array(string)	M	1..N	Contains the identifier(s) of the Policy(ies) to be deleted.	
defPolicyIds	map(string)	C	1..N	<p>Contains the identifier(s) of the policy(ies) that are to be configured as the new default Policy(ies). Each map entry corresponds to the new default policy for a particular policy type. There shall not be more than one new default policy for the same policy type.</p> <p>This attribute shall be present only when at least one of the deleted policies provided within the "policyIds" is the current default Policy for a policy type.</p> <p>The key of the map shall be the policy type (encoded using the PolicyType enumeration data type defined in clause 6.3.6.3.3) for which the provided new default policy identified by the corresponding map value is related.</p>	
suppFeat	SupportedFeatures	C	0..1	<p>Contains the list of supported features among the ones defined in clause 6.3.8.</p> <p>This attribute shall be present only when feature negotiation needs to take place.</p>	

## 6.3.6.2.11 Type: PolDeleteResp

Table 6.3.6.2.11-1: Definition of type PolDeleteResp

Attribute name	Data type	P	Cardinality	Description	Applicability
defPoliciesInfo	map(DefaultPolInfo)	M	1..N	<p>Contains the new default policy(ies) related information. Each map entry corresponds to the information of the new default policy for a particular policy type.</p> <p>The key of the map shall be set to the value of the "policyType" attribute of the corresponding map entry encoded using the DefaultPolInfo data type.</p>	
suppFeat	SupportedFeatures	C	0..1	<p>Contains the list of supported features among the ones defined in clause 6.3.8.</p> <p>This attribute shall be present only when feature negotiation needs to take place.</p>	

## 6.3.6.2.12 Type: DefaultPolInfo

Table 6.3.6.2.12-1: Definition of type DefaultPolInfo

Attribute name	Data type	P	Cardinality	Description	Applicability
policyType	PolicyType	M	1	Represents the policy type.	
defPolicyId	string	M	1	Contains the identifier of the default policy.	
priority	PriorityLevel	O	0..1	Contains the priority of the default policy.	

## 6.3.6.2.13 Type: HarmonizationNotif

**Table 6.3.6.2.13-1: Definition of type HarmonizationNotif**

Attribute name	Data type	P	Cardinality	Description	Applicability
harmonizationId	string	M	1	Contains the harmonization identifier.	
policy	PolicyData	M	1	Contains the policy content data after harmonization.	

## 6.3.6.2.14 Type: HarmonizationResp

**Table 6.3.6.2.14-1: Definition of type HarmonizationResp**

Attribute name	Data type	P	Cardinality	Description	Applicability
feedback	boolean	M	1	Contains the policy harmonization feedback. It indicates whether the policy harmonization result is accepted or not, i.e.: - "true" means that the policy harmonization result is accepted. - "false" means that the policy harmonization result is not accepted.	

## 6.3.6.2.15 Type: NetSliceId

**Table 6.3.6.2.15-1: Definition of type NetSliceId**

Attribute name	Data type	P	Cardinality	Description	Applicability
snssai	Snssai	C	0..1	Contains the S-NSSAI. (NOTE)	
nsild	Nsild	C	0..1	Contains the identifier of the network slice instance. (NOTE)	
ensi	Ensi	C	0..1	Contains the external network slice identifier. (NOTE)	
NOTE: These attributes are mutually exclusive. Either one of them shall be present.					

6.3.6.2.16 Type: PolicyTriggers

**Table 6.3.6.2.16-1: Definition of type PolicyTriggers**

Attribute name	Data type	P	Cardinality	Description	Applicability
monPercentage	integer	C	0..1	<p>Contains the monitoring percentage to be used to trigger the actions.</p> <p>When used to encode the "triggers" attribute of the PolicyData data structure, this attribute may be presents only when the "policyType" attribute of the PolicyData data structure is set to either:</p> <ul style="list-style-type: none"> <li>- "MAX_NUM_PDU_SESS", to indicate the threshold utilization percentage of the available capacity, i.e., the maximum number of PDU Sessions within the network slice.</li> <li>- "MAX_NUM_UE", to indicate the threshold utilization percentage of the available capacity, i.e., the maximum number of UEs within the network slice.</li> <li>- "SLICE_LOAD_PREDICTION", to indicate the threshold network slice load level.</li> </ul> <p>Minimum value = 0. Maximum value = 100.</p> <p>(NOTE)</p>	
monValue	integer	C	0..1	<p>Contains the monitoring value to be used to trigger the actions.</p> <p>When used to encode the "triggers" attribute of the PolicyData data structure, this attribute may be presents only when the "policyType" attribute of the PolicyData data structure is set to either:</p> <ul style="list-style-type: none"> <li>- "MAX_NUM_PDU_SESS", to indicate the threshold number of PDU Sessions value.</li> <li>- "MAX_NUM_UE", to indicate the threshold number of UE(s) value.</li> <li>- "MAX_NUM_UE", to indicate the threshold number of UE(s) value.</li> </ul> <p>Minimum value = 1.</p> <p>(NOTE)</p>	
monParamsValues	string	C	0..1	<p>Contains the values of the monitoring parameters to be used to trigger the actions.</p> <p>When used to encode the "triggers" attribute of the PolicyData data structure, this attribute shall be presents only when the "policyType" attribute of the PolicyData data structure is set to either:</p> <ul style="list-style-type: none"> <li>- "TIME_PERIOD_AND_AVG_QOS", to indicate the threshold average QoS parameter(s)' value(s).</li> <li>- "TIME_PERIOD_AND_MIN_QOS", to indicate the threshold minimum QoS parameter(s)' value(s).</li> </ul> <p>Minimum value = 1.</p> <p>(NOTE)</p>	

timePeriod	TimePeriodInfo	C	0..1	Contains the time period during which the policy trigger is valid.  This attribute may be present only when the "monParamsValues" is present.	
NOTE: When used to encode the "triggers" attribute of the PolicyData data structure, these attributes are mutually exclusive, i.e., only one of them shall be present.					

6.3.6.2.17 Type: PolicyActions

**Table 6.3.6.2.17-1: Definition of type PolicyActions**

Attribute name	Data type	P	Cardinality	Description	Applicability
stepIncreasePerc	integer	C	0..1	<p>Contains the requested actions in in the form of steps of increase expressed in percentage.</p> <p>This attribute may be presents only when the "policyType" attribute is set to either:</p> <ul style="list-style-type: none"> <li>- "MAX_NUM_PDU_SESS", to indicate the step (expressed in percentage) by which the capacity, i.e., the maximum number of PDU Sessions within the network slice, should be increased when the policy triggers are met.</li> <li>- "MAX_NUM_UE", to indicate the step (expressed in percentage) by which the capacity, i.e., the maximum number of UEs within the network slice, should be increased when the policy triggers are met.</li> <li>- "SLICE_LOAD_PREDICTION", to indicate the step (expressed in percentage) by which the capacity, i.e., network slice load level, should be increased when the policy triggers are met.</li> </ul> <p>Minimum value = 0. Maximum value = 100.</p> <p>(NOTE)</p>	
allowedQoSActions	array(QoSAction)	C	1..N	<p>Indicates the allowed QoS related action(s) to be triggered.</p> <p>This attribute may be presents only when the "policyType" attribute is set to either:</p> <ul style="list-style-type: none"> <li>- "TIME_PERIOD_AND_AVG_QOS", to indicate whether the network slice capacity shall be modified to fulfil the requested period average QoS during the provided time period, if applicable.</li> <li>- "TIME_PERIOD_AND_MIN_QOS", to indicate whether the network slice capacity shall be modified to fulfil the requested minimum QoS during the provided time period, if applicable.</li> </ul> <p>(NOTE)</p>	
<p>NOTE: When used to encode the "actions" attribute of the PolicyData data structure, these attributes are mutually exclusive, i.e., only one of them shall be present.</p>					



6.3.6.2.18 Type: TimePeriodInfo

**Table 6.3.6.2.18-1: Definition of type TimePeriodInfo**

Attribute name	Data type	P	Cardinality	Description	Applicability
startTime	DateTime	C	0..1	Contains the applicable start time. (NOTE 1, NOTE 2, NOTE 3)	
endTime	DateTime	C	0..1	Contains the applicable end time. (NOTE 1, NOTE 2, NOTE 3)	
daysOfWeek	array(DayOfWeek)	C	1..7	Contains the applicable day(s) of the week. (NOTE 1, NOTE 2, NOTE 3)	
NOTE 1: At least one of these attributes shall be present.					
NOTE 2: When the "daysOfWeek" attribute is present, then if the "startTime" attribute is absent, this means that the applicable start time is the start of the day, and/or if the "endTime" attribute is absent, this means that the applicable end time is the end of the day, for each applicable day.					
NOTE 3: When the "daysOfWeek" attribute is absent, then both the "startTime" and "endTime" attributes shall be present.					

6.3.6.3 Simple data types and enumerations

6.3.6.3.1 Introduction

This clause defines simple data types and enumerations that can be referenced from data structures defined in the previous clauses.

6.3.6.3.2 Simple data types

The simple data types defined in table 6.3.6.3.2-1 shall be supported.

**Table 6.3.6.3.2-1: Simple data types**

Type Name	Type Definition	Description	Applicability
PriorityLevel	integer	Represents an unsigned integer, within the range 1 to 255, indicating the priority level of a policy or the pre-emption capability of a policy.  The values are ordered in decreasing order of priority, with 1 being the highest priority and 255 the lowest priority.	
Ensi	string	Represents the External Network Slice Information that is used to identify a network slice, as specified in 3GPP TS 33.501 [21].	

6.3.6.3.3 Enumeration: PolicyType

The enumeration PolicyType represents the policy type. It shall comply with the provisions defined in table 6.3.6.3.3-1.

**Table 6.3.6.3.3-1: Enumeration PolicyType**

Enumeration value	Description	Applicability
MAX_NUM_PDU_SESS	Indicates that the policy type is the maximum number of PDU Sessions.	
MAX_NUM_UE	Indicates that the policy type is the maximum number of UEs Sessions.	
SLICE_LOAD_PREDICTION	Indicates that the policy type is the network slice load prediction.	
TIME_PERIOD_AND_AVG_QOS	Indicates that the policy type is the time period and average QoS per UE.	
TIME_PERIOD_AND_MIN_QOS	Indicates that the policy type is the time period and minimum QoS per UE.	

#### 6.3.6.3.4 Enumeration: QoSAction

The enumeration PolicyType represents the QoS related action. It shall comply with the provisions defined in table 6.3.6.3.3-1.

**Table 6.3.6.3.4-1: Enumeration QoSAction**

Enumeration value	Description	Applicability
MODIFY	Indicates that the QoS related action is to trigger the modification of the network slice capacity to fulfil the requested needs (e.g., average QoS, minimum QoS).	

#### 6.3.6.4 Data types describing alternative data types or combinations of data types

There are no data types describing alternative data types or combinations of data types defined for this API in this release of the specification.

#### 6.3.6.5 Binary data

##### 6.3.6.5.1 Binary Data Types

**Table 6.3.6.5.1-1: Binary Data Types**

Name	Clause defined	Content type

### 6.3.7 Error Handling

#### 6.3.7.1 General

For the NSCE\_PolicyManagement API, error handling shall be supported as specified in clause 6.7 of 3GPP TS 29.549 [15].

In addition, the requirements in the following clauses are applicable for the NSCE\_PolicyManagement API.

#### 6.3.7.2 Protocol Errors

No specific protocol errors for the NSCE\_PolicyManagement API are specified.

#### 6.3.7.3 Application Errors

The application errors defined for the NSCE\_PolicyManagement API are listed in Table 6.3.7.3-1.

**Table 6.3.7.3-1: Application errors**

Application Error	HTTP status code	Description	Applicability
INVALID_POLICY	403 Forbidden	Indicates that the Policy provisioning/update is rejected because the provided policy is not valid.	
POLICY_CONFLICT	403 Forbidden	Indicates that the Policy provisioning/update is rejected because the provided policy conflicts with existing policies.  This application error applies only when policy harmonization was not requested.	
HARMONIZATION_ONGOING	403 Forbidden	Indicates that the Policy provisioning/update is rejected because policy harmonization of the policy to be created/updated is ongoing.  This application error applies only when policy harmonization was requested.	

## 6.3.8 Feature negotiation

The optional features listed in table 6.3.8-1 are defined for the NSCE\_PolicyManagement API. They shall be negotiated using the extensibility mechanism defined in clause 6.8 of 3GPP TS 29.549 [15].

**Table 6.3.8-1: Supported Features**

Feature number	Feature Name	Description

## 6.3.9 Security

The provisions of clause 9 of 3GPP TS 29.549 [15] shall apply for the NSCE\_PolicyManagement API.

## 6.4 NSCE\_NSOptimization API

### 6.4.1 Introduction

The NSCE\_NSOptimization service shall use the NSCE\_NSOptimization API.

The API URI of the NSCE\_NSOptimization Service API shall be:

**{apiRoot}/<apiName>/<apiVersion>**

The request URIs used in HTTP requests shall have the Resource URI structure defined in clause 6.5 of 3GPP TS 29.549 [15], i.e.:

**{apiRoot}/<apiName>/<apiVersion>/<apiSpecificSuffixes>**

with the following components:

- The {apiRoot} shall be set as described in clause 6.5 of 3GPP TS 29.549 [15].
- The <apiName> shall be "nsce-nso".
- The <apiVersion> shall be "v1".
- The <apiSpecificSuffixes> shall be set as described in clause 6.5 of 3GPP TS 29.549 [15].

**NOTE:** When 3GPP TS 29.122 [2] is referenced for the common protocol and interface aspects for API definition in the clauses under clause 6.4, the service producer (i.e. NSCE Server) takes the role of the SCEF and the service consumer (e.g., VAL Server) takes the role of the SCS/AS.

## 6.4.2 Usage of HTTP

The provisions of clause 6.3 of 3GPP TS 29.549 [15] shall apply for the NSCE\_NSOptimization API.

## 6.4.3 Resources

### 6.4.3.1 Overview

This clause describes the structure for the Resource URIs and the resources and methods used for the service.

Figure 6.4.3.1-1 depicts the resource URIs structure for the NSCE\_NSOptimization API.

{apiRoot}/nsce-nso/<apiVersion>

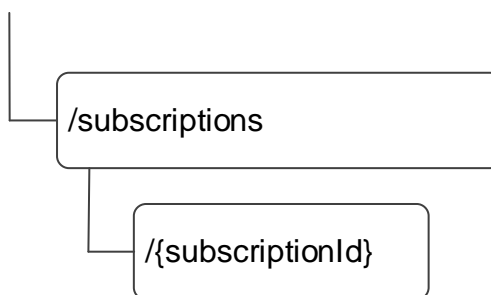

**Figure 6.4.3.1-1: Resource URIs structure of the NSCE\_NSOptimization API**

Table 6.4.3.1-1 provides an overview of the resources and applicable HTTP methods for the NSCE\_NSOptimization API.

**Table 6.4.3.1-1: Resources and methods overview**

Resource name	Resource URI	HTTP method or custom operation	Description
Network Slice Optimization Subscriptions	/subscriptions	POST	Request the creation of a Network Slice Optimization Subscription.
Individual Network Slice Optimization Subscription	/subscriptions/{subscriptionId}	GET	Retrieve an existing "Individual Network Slice Optimization Subscription".
		PUT	Request the fully update of an existing "Individual Network Slice Optimization Subscription".
		PATCH	Request to partially update of an existing "Individual Network Slice Optimization Subscription" resource.
		DELETE	Request the deletion of an existing "Individual Network Slice Optimization Subscription".

## 6.4.3.2 Resource: Network Slice Optimization Subscriptions

### 6.4.3.2.1 Description

This resource represents the collection of Network Slice Optimization Subscriptions managed by the NSCE Server.

### 6.4.3.2.2 Resource Definition

Resource URI: **{apiRoot}/nsce-nso/<apiVersion>/subscriptions**

This resource shall support the resource URI variables defined in the table 6.4.3.2.2-1.

**Table 6.4.3.2.2-1: Resource URI variables for this resource**

Name	Data Type	Definition
apiRoot	string	See clause 6.4.1

### 6.4.3.2.3 Resource Standard Methods

#### 6.4.3.2.3.1 POST

The HTTP POST method allows a service consumer to request the creation of a Network Slice Optimization Subscription at the NSCE Server.

This method shall support the URI query parameters specified in the table 6.4.3.2.3.1-1.

**Table 6.4.3.2.3.1-1: URI query parameters supported by the POST method on this resource**

Name	Data type	P	Cardinality	Description
n/a				

This method shall support the request data structures specified in table 6.4.3.2.3.1-2 and the response data structures and response codes specified in table 6.4.3.2.3.1-3.

**Table 6.4.3.2.3.1-2: Data structures supported by the POST Request Body on this resource**

Data type	P	Cardinality	Description
NetSliceOptSubsc	M	1	Represents the parameters to request the creation of a new network slice optimization subscription.

**Table 6.4.3.2.3.1-3: Data structures supported by the POST Response Body on this resource**

Data type	P	Cardinality	Response codes	Description
NetSliceOptSubsc	M	1	201 Created	Successful case. The Network Slice Optimization Subscription is successfully created and a representation of the created "Individual Network Slice Optimization Subscription" resource shall be returned.  An HTTP "Location" header that contains the resource URI of the created resource shall also be included.
NOTE: The mandatory HTTP error status code for the HTTP POST method listed in Table 5.2.6-1 of 3GPP TS 29.122 [2] shall also apply.				

**Table 6.4.3.2.3.1-4: Headers supported by the 201 response code on this resource**

Name	Data type	P	Cardinality	Description
Location	string	M	1	Contains the URI of the newly created resource, according to the structure: {apiRoot}/nsce-nso/<apiVersion>/subscriptions/{subscriptionId}

#### 6.4.3.2.4 Resource Custom Operations

There are no resource custom operations defined for this resource in this release of the specification.

### 6.4.3.3 Resource: Individual Network Slice Optimization Subscription

#### 6.4.3.3.1 Description

This resource represents a Network Slice Optimization Subscription managed by the NSCE Server.

#### 6.4.3.3.2 Resource Definition

Resource URI: {apiRoot}/nsce-nso/<apiVersion>/subscriptions/{subscriptionId}

This resource shall support the resource URI variables defined in the table 6.4.3.3.2-1.

**Table 6.4.3.3.2-1: Resource URI variables for this resource**

Name	Data Type	Definition
apiRoot	string	See clause 6.4.1
subscriptionId	string	Represents the identifier of the "Individual Network Slice Optimization Subscription" resource.

#### 6.4.3.3.3 Resource Standard Methods

##### 6.4.3.3.3.1 GET

The HTTP GET method allows a service consumer to retrieve an existing "Individual Network Slice Optimization Subscription" resource at the NSCE Server.

This method shall support the URI query parameters specified in the table 6.4.3.3.3.1-1.

**Table 6.4.3.3.3.1-1: URI query parameters supported by the GET method on this resource**

Name	Data type	P	Cardinality	Description
n/a				

This method shall support the request data structures specified in table 6.4.3.3.3.1-2 and the response data structures and response codes specified in table 6.4.3.3.3.1-3.

**Table 6.4.3.3.3.1-2: Data structures supported by the GET Request Body on this resource**

Data type	P	Cardinality	Description
n/a			

**Table 6.4.3.3.3.1-3: Data structures supported by the GET Response Body on this resource**

Data type	P	Cardinality	Response codes	Description
NetSliceOptSubsc	M	1	200 OK	Successful case. The requested "Individual Network Slice Optimization Subscription" resource shall be returned.
n/a			307 Temporary Redirect	Temporary redirection. The response shall include a Location header field containing an alternative URI of the resource located in an alternative NSCE Server.  Redirection handling is described in clause 5.2.10 of 3GPP TS 29.122 [2].
n/a			308 Permanent Redirect	Permanent redirection. The response shall include a Location header field containing an alternative URI of the resource located in an alternative NSCE Server.  Redirection handling is described in clause 5.2.10 of 3GPP TS 29.122 [2].
NOTE: The mandatory HTTP error status codes for the GET method listed in Table 5.2.6-1 of 3GPP TS 29.122 [2] shall also apply.				

**Table 6.4.3.3.3.1-4: Headers supported by the 307 Response Code on this resource**

Name	Data type	P	Cardinality	Description
Location	string	M	1	An alternative URI of the resource located in an alternative NSCE server.

**Table 6.4.3.3.3.1-5: Headers supported by the 308 Response Code on this resource**

Name	Data type	P	Cardinality	Description
Location	string	M	1	An alternative URI of the resource located in an alternative NSCE server.

#### 6.4.3.3.3.2 PUT

The HTTP PUT method allows a service consumer to request the update of an existing "Individual Network Slice Optimization Subscription" resource at the NSCE Server.

This method shall support the URI query parameters specified in the table 6.4.3.3.3.2-1.

**Table 6.4.3.3.3.2-1: URI query parameters supported by the PUT method on this resource**

Name	Data type	P	Cardinality	Description
n/a				

This method shall support the request data structures specified in table 6.4.3.3.3.2-2 and the response data structures and response codes specified in table 6.4.3.3.3.2-3.

**Table 6.4.3.3.3.2-2: Data structures supported by the PUT Request Body on this resource**

Data type	P	Cardinality	Description
NetSliceOptSubsc	M	1	Represents the updated representation of the "Individual Network Slice Optimization Subscription" resource.

**Table 6.4.3.3.2-3: Data structures supported by the PUT Response Body on this resource**

Data type	P	Cardinality	Response codes	Description
NetSliceOptSubsc	M	1	200 OK	Successful case. The "Individual Network Slice Optimization Subscription" resource is successfully updated and a representation of the updated resource shall be returned in the response body.
n/a			204 No Content	Successful case. The "Individual Network Slice Optimization Subscription" resource is successfully updated and no content is returned in the response body.
n/a			307 Temporary Redirect	Temporary redirection. The response shall include a Location header field containing an alternative URI of the resource located in an alternative NSCE Server.  Redirection handling is described in clause 5.2.10 of 3GPP TS 29.122 [2].
n/a			308 Permanent Redirect	Permanent redirection. The response shall include a Location header field containing an alternative URI of the resource located in an alternative NSCE Server.  Redirection handling is described in clause 5.2.10 of 3GPP TS 29.122 [2].
NOTE: The mandatory HTTP error status codes for the PUT method listed in Table 5.2.6-1 of 3GPP TS 29.122 [2] shall also apply.				

**Table 6.4.3.3.2-4: Headers supported by the 307 Response Code on this resource**

Name	Data type	P	Cardinality	Description
Location	string	M	1	An alternative URI of the resource located in an alternative NSCE server.

**Table 6.4.3.3.2-5: Headers supported by the 308 Response Code on this resource**

Name	Data type	P	Cardinality	Description
Location	string	M	1	An alternative URI of the resource located in an alternative NSCE server.

### 6.4.3.3.3 PATCH

The HTTP PATCH method allows a service consumer to request the modification of an existing "Individual Network Slice Optimization Subscription" resource at the NSCE Server.

This method shall support the URI query parameters specified in table 6.4.3.3.3.3-1.

**Table 6.4.3.3.3-1: URI query parameters supported by the PATCH method on this resource**

Name	Data type	P	Cardinality	Description	Applicability
n/a					

This method shall support the request data structures specified in table 6.4.3.3.3.3-2 and the response data structures and response codes specified in table 6.4.3.3.3.3-3.

**Table 6.4.3.3.3-2: Data structures supported by the PATCH Request Body on this resource**

Data type	P	Cardinality	Description
NetSliceOptSubscPatch	M	1	Represents the parameters to request the modification of the "Individual Network Slice Optimization Subscription" resource.



**Table 6.4.3.3.3-3: Data structures supported by the PATCH Response Body on this resource**

Data type	P	Cardinality	Response codes	Description
NetSliceOptSubsc	M	1	200 OK	Successful case. The "Individual Network Slice Optimization Subscription" resource is successfully modified and a representation of the updated resource shall be returned in the response body.
n/a			204 No Content	Successful case. The "Individual Network Slice Optimization Subscription" resource is successfully updated and no content is returned in the response body.
n/a			307 Temporary Redirect	Temporary redirection.  The response shall include a Location header field containing an alternative URI of the resource located in an alternative NSCE Server.  Redirection handling is described in clause 5.2.10 of 3GPP TS 29.122 [2].
n/a			308 Permanent Redirect	Permanent redirection.  The response shall include a Location header field containing an alternative URI of the resource located in an alternative NSCE Server.  Redirection handling is described in clause 5.2.10 of 3GPP TS 29.122 [2].
NOTE: The mandatory HTTP error status codes for the HTTP PATCH method listed in table 5.2.6-1 of 3GPP TS 29.122 [2] shall also apply.				

**Table 6.4.3.3.3-4: Headers supported by the 307 Response Code on this resource**

Name	Data type	P	Cardinality	Description
Location	string	M	1	Contains an alternative URI of the resource located in an alternative NSCE Server.

**Table 6.4.3.3.3-5: Headers supported by the 308 Response Code on this resource**

Name	Data type	P	Cardinality	Description
Location	string	M	1	Contains an alternative URI of the resource located in an alternative NSCE Server.

#### 6.4.3.3.3.4 DELETE

The HTTP DELETE method allows a service consumer to request the deletion of an existing "Individual Network Slice Optimization Subscription" resource at the NSCE Server.

This method shall support the URI query parameters specified in table 6.4.3.3.3.4-1.

**Table 6.4.3.3.3.4-1: URI query parameters supported by the DELETE method on this resource**

Name	Data type	P	Cardinality	Description	Applicability
n/a					

This method shall support the request data structures specified in table 6.4.3.3.3.4-2 and the response data structures and response codes specified in table 6.4.3.3.3.4-3.

**Table 6.4.3.3.4-2: Data structures supported by the DELETE Request Body on this resource**

Data type	P	Cardinality	Description
n/a			

**Table 6.4.3.3.4-3: Data structures supported by the DELETE Response Body on this resource**

Data type	P	Cardinality	Response codes	Description
n/a			204 No Content	Successful case. The "Individual Network Slice Optimization Subscription" resource is successfully deleted.
n/a			307 Temporary Redirect	Temporary redirection. The response shall include a Location header field containing an alternative URI of the resource located in an alternative NSCE Server. Redirection handling is described in clause 5.2.10 of 3GPP TS 29.122 [2].
n/a			308 Permanent Redirect	Permanent redirection. The response shall include a Location header field containing an alternative URI of the resource located in an alternative NSCE Server. Redirection handling is described in clause 5.2.10 of 3GPP TS 29.122 [2].
NOTE: The mandatory HTTP error status code for the HTTP DELETE method listed in table 5.2.6-1 of 3GPP TS 29.122 [2] shall also apply.				

**Table 6.4.3.3.4-4: Headers supported by the 307 Response Code on this resource**

Name	Data type	P	Cardinality	Description
Location	string	M	1	An alternative URI of the resource located in an alternative NSCE Server.

**Table 6.4.3.3.4-5: Headers supported by the 308 Response Code on this resource**

Name	Data type	P	Cardinality	Description
Location	string	M	1	An alternative URI of the resource located in an alternative NSCE Server.

#### 6.4.3.3.4 Resource Custom Operations

There are no resource custom operations defined for this resource in this release of the specification.

#### 6.4.4 Custom Operations without associated resources

There are no custom operations without associated resources defined for this API in this release of the specification.

#### 6.4.5 Notifications

##### 6.4.5.1 General

Notifications shall comply to clause 6.6 of 3GPP TS 29.549 [15].

**Table 6.4.5.1-1: Notifications overview**

Notification	Callback URI	HTTP method or custom operation	Description (service operation)
Network Slice Optimization Notification	{notifUri}	POST	This service operation enables a NSCE Server to notify a previously subscribed service consumer on Network Slice Optimization reports.

## 6.4.5.2 Network Slice Optimization Notification

### 6.4.5.2.1 Description

The Network Slice Optimization Notification is used by a NSCE Server to notify a previously subscribed service consumer on Network Slice Optimization reports.

### 6.4.5.2.2 Target URI

The Callback URI "{notifUri}" shall be used with the callback URI variables defined in table 6.4.5.2.2-1.

**Table 6.4.5.2.2-1: Callback URI variables**

Name	Data type	Definition
notifUri	Uri	String formatted as a URI containing the Callback URI. The notification URI is provided as part of the corresponding Network Slice Optimization Subscription creation/update request.

### 6.4.5.2.3 Standard Methods

#### 6.4.5.2.3.1 POST

This method shall support the request data structures specified in table 6.4.5.2.3.1-1 and the response data structures and response codes specified in table 6.4.5.2.3.1-2.

**Table 6.4.5.2.3.1-1: Data structures supported by the POST Request Body**

Data type	P	Cardinality	Description
NetSliceOptNotif	M	1	Represents a Network Slice Optimization notification.

**Table 6.4.5.2.3.1-2: Data structures supported by the POST Response Body**

Data type	P	Cardinality	Response codes	Description
n/a			204 No Content	Successful case. The Network Slice Optimization Notification is successfully received and acknowledged.
n/a			307 Temporary Redirect	Temporary redirection. The response shall include a Location header field containing an alternative URI representing the end point of an alternative service consumer where the notification should be sent.  Redirection handling is described in clause 5.2.10 of 3GPP TS 29.122 [2].
n/a			308 Permanent Redirect	Permanent redirection. The response shall include a Location header field containing an alternative URI representing the end point of an alternative service consumer where the notification should be sent.  Redirection handling is described in clause 5.2.10 of 3GPP TS 29.122 [2].
NOTE: The mandatory HTTP error status codes for the HTTP POST method listed in table 5.2.6-1 of 3GPP TS 29.122 [2] shall also apply.				

**Table 6.4.5.2.3.1-3: Headers supported by the 307 Response Code on this resource**

Name	Data type	P	Cardinality	Description
Location	string	M	1	An alternative URI representing the end point of an alternative service consumer towards which the notification should be redirected.

**Table 6.4.5.2.3.1-4: Headers supported by the 308 Response Code on this resource**

Name	Data type	P	Cardinality	Description
Location	string	M	1	An alternative URI representing the end point of an alternative service consumer towards which the notification should be redirected.

## 6.4.6 Data Model

### 6.4.6.1 General

This clause specifies the application data model supported by the API.

Table 6.4.6.1-1 specifies the data types defined for the NSCE\_NSOptimization API.

**Table 6.4.6.1-1: NSCE\_NSOptimization API specific Data Types**

Data type	Section defined	Description	Applicability
NetSliceOptNotif	6.4.6.2.4	Represents a Network Slice Optimization notification.	
NetSliceOptSubsc	6.4.6.2.2	Represents a Network Slice Optimization subscription.	
NetSliceOptSubscPatch	6.4.6.2.3	Represents the requested modifications to a Network Slice Optimization subscription.	

Table 6.4.6.1-2 specifies data types re-used by the NSCE\_NSOptimization API from other specifications, including a reference to their respective specifications, and when needed, a short description of their use within the NSCE\_NSOptimization API.

**Table 6.4.6.1-2: NSCE\_NSOptimization API re-used Data Types**

<b>Data type</b>	<b>Reference</b>	<b>Comments</b>	<b>Applicability</b>
DateTime	3GPP TS 29.122 [2]	Represents a date and a time.	
DateTimeRm	3GPP TS 29.122 [2]	Represents the same as the DateTime data type, but with the "nullable: true" property.	
Dnn	3GPP TS 29.571 [16]	Identifies a DNN.	
DurationSec	3GPP TS 29.571 [16]	Identifies a period of time in units of seconds.	
NSInfoSet	6.16.6.2.4	Represents a Network Slice Information Set.	
NetSliceId	6.3.6.2.15	Represents the identification information of a network slice.	
Snssai	3GPP TS 29.571 [16]	Represents an S-NSSAI.	
SupportedFeatures	3GPP TS 29.571 [16]	Used to negotiate the applicability of the optional features.	
Uri	3GPP TS 29.122 [2]	Represents a URI.	

## 6.4.6.2 Structured data types

### 6.4.6.2.1 Introduction

This clause defines the data structures to be used in resource representations.

## 6.4.6.2.2 Type: NetSliceOptSubsc

Table 6.4.6.2.2-1: Definition of type NetSliceOptSubsc

Attribute name	Data type	P	Cardinality	Description	Applicability
notifUri	Uri	M	1	Contains the URI via which notifications shall be provided.	
netSliceld	NetSliceld	O	0..1	Contains the identifier for the network slice. (NOTE)	
dnn	Dnn	O	0..1	Identifies a DNN, a full DNN with both the Network Identifier and Operator Identifier, or a DNN with the Network Identifier only. (NOTE)	
policyId	string	O	0..1	Identifies the VAL server policy. (NOTE)	
expTime	DateTime	O	0..1	Indicates the time at which the network slice optimization subscription shall expire.  This attribute may only be present in Network Slice Optimization subscription creation/update responses.  If this attribute is absent, this means that the Network Slice Optimization subscription shall not expire, until explicitly deleted by the service consumer. (NOTE)	
secPolicId	string	O	0..1	Contains the identifier of the secondary policy for the network slice optimization in the case of a failed network slice optimization. (NOTE)	
suppFeat	SupportedFeatures	C	0..1	Contains the list of supported features among the ones defined in clause 6.4.8.  This attribute shall be provided if feature negotiation shall take place.	
NOTE: At least one of the attributes shall be provided.					

## 6.4.6.2.3 Type: NetSliceOptSubscPatch

Table 6.4.6.2.3-1: Definition of type NetSliceOptSubscPatch

Attribute name	Data type	P	Cardinality	Description	Applicability
notifUri	Uri	M	1	Contains the URI via which notifications shall be provided.	
netSliceld	NetSliceld	O	0..1	Contains the identifier for the network slice. (NOTE)	
dnn	Dnn	O	0..1	Identifies a DNN, a full DNN with both the Network Identifier and Operator Identifier, or a DNN with the Network Identifier only. (NOTE)	
policyId	string	O	0..1	Identifies the VAL server policy. (NOTE)	
expTime	DateTimeRm	O	0..1	Indicates the time at which the network slice optimization subscription shall expire.  This attribute may only be present in Network Slice Optimization subscription creation/update responses.  If this attribute is absent, this means that the Network Slice Optimization subscription shall not expire, until explicitly deleted by the service consumer (e.g. VAL Server). (NOTE)	
secPolicId	string	O	0..1	Contains the identifier of the secondary policy for the network slice optimization in the case of a failed network slice optimization. (NOTE)	
NOTE: At least one of the attributes shall be provided.					

## 6.4.6.2.4 Type: NetSliceOptNotif

Table 6.4.6.2.4-1: Definition of type NetSliceOptNotif

Attribute name	Data type	P	Cardinality	Description	Applicability
subscriptionId	string	M	1	Represents the identifier of the subscription to which the network slice optimization notification is related.	
sliceInfo	NSInfoSet	M	1	Contains the network slice information. (NOTE)	
optTime	DurationSec	O	0..1	Indicates time spent for slice optimization by the NSCE Server.	
enforPolId	string	O	0..1	Indicates the policy used for slice optimization in the case of the failed network slice optimization.	
NOTE: At least the "snssai" attribute within the NSInfoSet shall be provided.					

### 6.4.6.3 Simple data types and enumerations

#### 6.4.6.3.1 Introduction

This clause defines simple data types and enumerations that can be referenced from data structures defined in the previous clauses.

#### 6.4.6.3.2 Simple data types

The simple data types defined in table 6.4.6.3.2-1 shall be supported.

**Table 6.4.6.3.2-1: Simple data types**

Type Name	Type Definition	Description	Applicability

#### 6.4.6.4 Data types describing alternative data types or combinations of data types

There are no data types describing alternative data types or combinations of data types defined for this API in this release of the specification.

#### 6.4.6.5 Binary data

##### 6.4.6.5.1 Binary Data Types

**Table 6.4.6.5.1-1: Binary Data Types**

Name	Clause defined	Content type

### 6.4.7 Error Handling

#### 6.4.7.1 General

For the NSCE\_NSOptimization API, HTTP error responses shall be supported as specified in clause 6.7 of 3GPP TS 29.549 [15].

In addition, the requirements in the following clauses are applicable for the NSCE\_NSOptimization API.

#### 6.4.7.2 Protocol Errors

No specific protocol errors for the NSCE\_NSOptimization API are specified.

#### 6.4.7.3 Application Errors

The application errors defined for the NSCE\_NSOptimization API are listed in Table 6.4.7.3-1.

**Table 6.4.7.3-1: Application errors**

Application Error	HTTP status code	Description	Applicability

### 6.4.8 Feature negotiation

The optional features in table 6.4.8-1 are defined for the NSCE\_NSOptimization API. They shall be negotiated using the extensibility mechanism defined in clause 6.8 of 3GPP TS 29.549 [15].



Table 6.4.8-1: Supported Features

Feature number	Feature Name	Description
n/a		

## 6.4.9 Security

The provisions of clause 9 of 3GPP TS 29.549 [15] shall apply for the NSCE\_NSOptimization API.

## 6.5 NSCE\_ManagementServiceDiscovery API

### 6.5.1 Introduction

The NSCE\_ManagementServiceDiscovery service shall use the NSCE\_ManagementServiceDiscovery API.

The API URI of the NSCE\_ManagementServiceDiscovery API shall be:

**{apiRoot}/<apiName>/<apiVersion>**

The request URIs used in HTTP requests shall have the Resource URI structure defined in clause 6.5 of 3GPP TS 29.549 [15], i.e.:

**{apiRoot}/<apiName>/<apiVersion>/<apiSpecificSuffixes>**

with the following components:

- The {apiRoot} shall be set as described in clause 6.5 of 3GPP TS 29.549 [15].
- The <apiName> shall be "nsce-msd".
- The <apiVersion> shall be "v1".
- The <apiSpecificSuffixes> shall be set as described in clause 6.5 of 3GPP TS 29.549 [15].

NOTE: When 3GPP TS 29.122 [2] is referenced for the common protocol and interface aspects for API definition in the clauses under clause 6, the service producer NSCE server takes the role of the SCEF and the service consumer (i.e. NSCE server) takes the role of the SCS/AS.

### 6.5.2 Usage of HTTP

The provisions of clause 6.3 of 3GPP TS 29.549 [15] shall apply for the NSCE\_ManagementServiceDiscovery API.

### 6.5.3 Resources

#### 6.5.3.1 Overview

This clause describes the structure for the Resource URIs and the resources and methods used for the service.

Figure 6.5.3.1-1 depicts the resource URIs structure for the NSCE\_ManagementServiceDiscovery API.

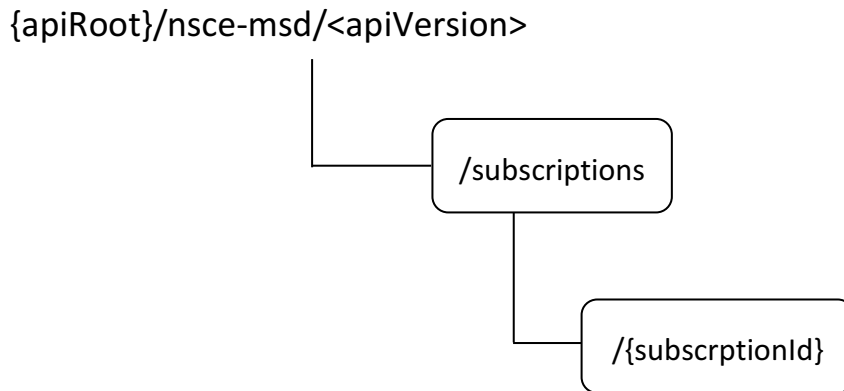

**Figure 6.5.3.1-1: Resource URIs structure of the NSCE\_ManagementServiceDiscovery API**

Table 6.5.3.1-1 provides an overview of the resources and applicable HTTP methods for the NSCE\_ManagementServiceDiscovery API.

**Table 6.5.3.1-1: Resources and methods overview**

Resource name	Resource URI	HTTP method or custom operation	Description
Management Discovery Subscription	/subscriptions	POST	Request the creation of a Management Discovery Subscription.
Individual Management Discovery Subscription	/subscriptions/{subscriptionId}	GET	Retrieve an existing "Individual Management Discovery Subscription" resource.
		PUT	Request the update of an existing "Individual Management Discovery Subscription" resource.
		PATCH	Request the modification of an existing "Individual Management Discovery Subscription" resource.
		DELETE	Request the deletion of an existing "Individual Management Discovery Subscription" resource.

### 6.5.3.2 Resource: Management Discovery Subscription

#### 6.5.3.2.1 Description

This resource represents the collection of Management Discovery Subscription managed by the NSCE Server.

#### 6.5.3.2.2 Resource Definition

Resource URI: **{apiRoot}/nsce-msd/<apiVersion>/subscriptions**

This resource shall support the resource URI variables defined in table 6.5.3.2.2-1.

**Table 6.5.3.2.2-1: Resource URI variables for this resource**

Name	Data type	Definition
apiRoot	string	See clause 6.5.1.

### 6.5.3.2.3 Resource Standard Methods

#### 6.5.3.2.3.2 POST

The HTTP POST method allows a service consumer to request the creation of a Management Discovery Subscription at the NSCE Server.

This method shall support the URI query parameters specified in table 6.5.3.2.3.2-1.

**Table 6.5.3.2.3.2-1: URI query parameters supported by the POST method on this resource**

Name	Data type	P	Cardinality	Description	Applicability
n/a					

This method shall support the request data structures specified in table 6.5.3.2.3.2-2 and the response data structures and response codes specified in table 6.5.3.2.3.2-3.

**Table 6.5.3.2.3.2-2: Data structures supported by the POST Request Body on this resource**

Data type	P	Cardinality	Description
MnSDiscSubsc	M	1	Represents the parameters to request the creation of a Management Discovery Subscription resource.

**Table 6.5.3.2.3.2-3: Data structures supported by the POST Response Body on this resource**

Data type	P	Cardinality	Response codes	Description
MnSDiscSubsc	M	1	201 Created	Successful case. The Management Discovery Subscription is successfully created and a representation of the created "Individual Management Discovery Subscription" resource shall be returned.  An HTTP "Location" header that contains the resource URI of the created resource shall also be included.
NOTE: The mandatory HTTP error status codes for the HTTP POST method listed in table 5.2.6-1 of 3GPP TS 29.122 [2] shall also apply.				

**Table 6.5.3.2.3.2-4: Headers supported by the 201 Response Code on this resource**

Name	Data type	P	Cardinality	Description
Location	string	M	1	Contains the URI of the newly created resource, according to the structure: {apiRoot}/nsce-msd/<apiVersion>/subscriptions/{subscriptionId}

### 6.5.3.2.4 Resource Custom Operations

There are no resource custom operations defined for this resource in this release of the specification.

## 6.5.3.3 Resource: Individual Management Discovery Subscription

### 6.5.3.3.1 Description

This resource represents a Management Discovery Subscription managed by the NSCE Server.

### 6.5.3.3.2 Resource Definition

Resource URI: {apiRoot}/nsce-msd/<apiVersion>/subscriptions/{subscriptionId}

This resource shall support the resource URI variables defined in table 6.5.3.3.2-1.

**Table 6.5.3.3.2-1: Resource URI variables for this resource**

Name	Data type	Definition
apiRoot	string	See clause 6.5.1.
subscriptionId	string	Represents the identifier of the "Individual Management Discovery Subscription" resource.

### 6.5.3.3.3 Resource Standard Methods

#### 6.5.3.3.3.1 GET

The HTTP GET method allows a service consumer to retrieve an existing "Individual Management Discovery Subscription" resource at the NSCE Server.

This method shall support the URI query parameters specified in table 6.5.3.3.3.1-1.

**Table 6.5.3.3.3.1-1: URI query parameters supported by the GET method on this resource**

Name	Data type	P	Cardinality	Description	Applicability
n/a					

This method shall support the request data structures specified in table 6.5.3.3.3.1-2 and the response data structures and response codes specified in table 6.5.3.3.3.1-3.

**Table 6.5.3.3.3.1-2: Data structures supported by the GET Request Body on this resource**

Data type	P	Cardinality	Description
n/a			

**Table 6.5.3.3.3.1-3: Data structures supported by the GET Response Body on this resource**

Data type	P	Cardinality	Response codes	Description
MnSDiscSubsc	M	1	200 OK	Successful case. The requested "Individual Management Discovery Subscription" resource shall be returned.
n/a			307 Temporary Redirect	Temporary redirection. The response shall include a Location header field containing an alternative URI of the resource located in an alternative NSCE Server. Redirection handling is described in clause 5.2.10 of 3GPP TS 29.122 [2].
n/a			308 Permanent Redirect	Permanent redirection. The response shall include a Location header field containing an alternative URI of the resource located in an alternative NSCE Server. Redirection handling is described in clause 5.2.10 of 3GPP TS 29.122 [2].
NOTE: The mandatory HTTP error status codes for the HTTP GET method listed in table 5.2.6-1 of 3GPP TS 29.122 [2] shall also apply.				

**Table 6.5.3.3.3.1-4: Headers supported by the 307 Response Code on this resource**

Name	Data type	P	Cardinality	Description
Location	string	M	1	Contains an alternative URI of the resource located in an alternative NSCE Server.

**Table 6.5.3.3.1-5: Headers supported by the 308 Response Code on this resource**

Name	Data type	P	Cardinality	Description
Location	string	M	1	Contains an alternative URI of the resource located in an alternative NSCE Server.

## 6.5.3.3.3.2 PUT

The HTTP PUT method allows a service consumer to request the update of an existing "Individual Management Discovery Subscription" resource at the NSCE Server.

This method shall support the URI query parameters specified in table 6.5.3.3.2-1.

**Table 6.5.3.3.2-1: URI query parameters supported by the PUT method on this resource**

Name	Data type	P	Cardinality	Description	Applicability
n/a					

This method shall support the request data structures specified in table 6.5.3.3.2-2 and the response data structures and response codes specified in table 6.5.3.3.2-3.

**Table 6.5.3.3.2-2: Data structures supported by the PUT Request Body on this resource**

Data type	P	Cardinality	Description
MnSDiscSubsc	M	1	Represents the updated representation of the "Individual Management Discovery Subscription" resource.

**Table 6.5.3.3.2-3: Data structures supported by the PUT Response Body on this resource**

Data type	P	Cardinality	Response codes	Description
MnSDiscSubsc	M	1	200 OK	Successful case. The "Individual Management Discovery Subscription" resource is successfully updated and a representation of the updated resource shall be returned in the response body.
n/a			204 No Content	Successful case. The "Individual Management Discovery Subscription" resource is successfully updated and no content is returned in the response body.
n/a			307 Temporary Redirect	Temporary redirection. The response shall include a Location header field containing an alternative URI of the resource located in an alternative NSCE Server. Redirection handling is described in clause 5.2.10 of 3GPP TS 29.122 [2].
n/a			308 Permanent Redirect	Permanent redirection. The response shall include a Location header field containing an alternative URI of the resource located in an alternative NSCE Server. Redirection handling is described in clause 5.2.10 of 3GPP TS 29.122 [2].
NOTE: The mandatory HTTP error status codes for the HTTP PUT method listed in table 5.2.6-1 of 3GPP TS 29.122 [2] shall also apply.				

**Table 6.5.3.3.3.2-4: Headers supported by the 307 Response Code on this resource**

Name	Data type	P	Cardinality	Description
Location	string	M	1	Contains an alternative URI of the resource located in an alternative NSCE Server.

**Table 6.5.3.3.3.2-5: Headers supported by the 308 Response Code on this resource**

Name	Data type	P	Cardinality	Description
Location	string	M	1	Contains an alternative URI of the resource located in an alternative NSCE Server.

### 6.5.3.3.3.3 PATCH

The HTTP PATCH method allows a service consumer to request the modification of an existing "Individual Management Discovery Subscription" resource at the NSCE Server.

This method shall support the URI query parameters specified in table 6.5.3.3.3.3-1.

**Table 6.5.3.3.3.3-1: URI query parameters supported by the PATCH method on this resource**

Name	Data type	P	Cardinality	Description	Applicability
n/a					

This method shall support the request data structures specified in table 6.5.3.3.3.3-2 and the response data structures and response codes specified in table 6.5.3.3.3.3-3.

**Table 6.5.3.3.3.3-2: Data structures supported by the PATCH Request Body on this resource**

Data type	P	Cardinality	Description
MnSDiscSubscPatch	M	1	Represents the parameters to request the modification of the "Individual Management Discovery Subscription" resource.

**Table 6.5.3.3.3-3: Data structures supported by the PATCH Response Body on this resource**

Data type	P	Cardinality	Response codes	Description
MnSDiscSubsc	M	1	200 OK	Successful case. The "Individual Management Discovery Subscription" resource is successfully modified and a representation of the updated resource shall be returned in the response body.
n/a			204 No Content	Successful case. The "Individual Management Discovery Subscription" resource is successfully modified and no content is returned in the response body.
n/a			307 Temporary Redirect	Temporary redirection.  The response shall include a Location header field containing an alternative URI of the resource located in an alternative NSCE Server.  Redirection handling is described in clause 5.2.10 of 3GPP TS 29.122 [2].
n/a			308 Permanent Redirect	Permanent redirection.  The response shall include a Location header field containing an alternative URI of the resource located in an alternative NSCE Server.  Redirection handling is described in clause 5.2.10 of 3GPP TS 29.122 [2].
NOTE: The mandatory HTTP error status codes for the HTTP PATCH method listed in table 5.2.6-1 of 3GPP TS 29.122 [2] shall also apply.				

**Table 6.5.3.3.3-4: Headers supported by the 307 Response Code on this resource**

Name	Data type	P	Cardinality	Description
Location	string	M	1	Contains an alternative URI of the resource located in an alternative NSCE Server.

**Table 6.5.3.3.3-5: Headers supported by the 308 Response Code on this resource**

Name	Data type	P	Cardinality	Description
Location	string	M	1	Contains an alternative URI of the resource located in an alternative NSCE Server.

#### 6.5.3.3.3.4 DELETE

The HTTP DELETE method allows a service consumer to request the deletion of an existing "Individual Management Discovery Subscription" resource at the NSCE Server.

This method shall support the URI query parameters specified in table 6.5.3.3.3.4-1.

**Table 6.5.3.3.3.4-1: URI query parameters supported by the DELETE method on this resource**

Name	Data type	P	Cardinality	Description	Applicability
n/a					

This method shall support the request data structures specified in table 6.5.3.3.3.4-2 and the response data structures and response codes specified in table 6.5.3.3.3.4-3.

**Table 6.5.3.3.3.4-2: Data structures supported by the DELETE Request Body on this resource**

Data type	P	Cardinality	Description
n/a			

**Table 6.5.3.3.3.4-3: Data structures supported by the DELETE Response Body on this resource**

Data type	P	Cardinality	Response codes	Description
n/a			204 No Content	Successful case. The "Individual Management Discovery Subscription" resource is successfully deleted.
n/a			307 Temporary Redirect	Temporary redirection.  The response shall include a Location header field containing an alternative URI of the resource located in an alternative NSCE Server.  Redirection handling is described in clause 5.2.10 of 3GPP TS 29.122 [2].
n/a			308 Permanent Redirect	Permanent redirection.  The response shall include a Location header field containing an alternative URI of the resource located in an alternative NSCE Server.  Redirection handling is described in clause 5.2.10 of 3GPP TS 29.122 [2].
NOTE: The mandatory HTTP error status codes for the HTTP DELETE method listed in table 5.2.6-1 of 3GPP TS 29.122 [2] shall also apply.				

**Table 6.5.3.3.3.4-4: Headers supported by the 307 Response Code on this resource**

Name	Data type	P	Cardinality	Description
Location	string	M	1	Contains an alternative URI of the resource located in an alternative NSCE Server.

**Table 6.5.3.3.3.4-5: Headers supported by the 308 Response Code on this resource**

Name	Data type	P	Cardinality	Description
Location	string	M	1	Contains an alternative URI of the resource located in an alternative NSCE Server.

#### 6.5.3.3.4 Resource Custom Operations

There are no resource custom operations defined for this resource in this release of the specification.

### 6.5.4 Custom Operations without associated resources

There are no custom operations without associated resources defined for this API in this release of the specification.

## 6.5.5 Notifications

### 6.5.5.1 General

Notifications shall comply to clause 6.6 of 3GPP TS 29.549 [15].



**Table 6.5.5.1-1: Notifications overview**

Notification	Callback URI	HTTP method or custom operation	Description (service operation)
Management discovery Notification	{notifUri}	POST	This service operation enables a NSCE Server to notify a previously subscribed service consumer on Management Discovery event(s).

## 6.5.5.2 Management discovery Notification

### 6.5.5.2.1 Description

The Management discovery Notification is used by the NSCE Server to notify a previously subscribed service consumer on Management discovery subscriptions.

### 6.5.5.2.2 Target URI

The Callback URI "{notifUri}" shall be used with the callback URI variables defined in table 6.5.5.2.2-1.

**Table 6.5.5.2.2-1: Callback URI variables**

Name	Definition
notifUri	Represents the callback URI encoded as a string formatted as a URI.

### 6.5.5.2.3 Standard Methods

#### 6.5.5.2.3.1 POST

This method shall support the request data structures specified in table 6.5.5.2.3.1-1 and the response data structures and response codes specified in table 6.5.5.2.3.1-2.

**Table 6.5.5.2.3.1-1: Data structures supported by the POST Request Body**

Data type	P	Cardinality	Description
MnSDiscNotif	M	1	Represents the Management Discovery Notification.

**Table 6.5.5.2.3.1-2: Data structures supported by the POST Response Body**

Data type	P	Cardinality	Response codes	Description
n/a			204 No Content	Successful case. The Management Discovery Notification is successfully received.
n/a			307 Temporary Redirect	Temporary redirection.  The response shall include a Location header field containing an alternative URI representing the end point of an alternative service consumer where the notification should be sent.  Redirection handling is described in clause 5.2.10 of 3GPP TS 29.122 [2].
n/a			308 Permanent Redirect	Permanent redirection.  The response shall include a Location header field containing an alternative URI representing the end point of an alternative service consumer where the notification should be sent.  Redirection handling is described in clause 5.2.10 of 3GPP TS 29.122 [2].
NOTE: The mandatory HTTP error status codes for the HTTP POST method listed in table 5.2.6-1 of 3GPP TS 29.122 [2] also apply.				

**Table 6.5.5.2.3.1-3: Headers supported by the 307 Response Code on this resource**

Name	Data type	P	Cardinality	Description
Location	string	M	1	Contains an alternative URI representing the end point of an alternative service consumer towards which the notification should be redirected.

**Table 6.5.5.2.3.1-4: Headers supported by the 308 Response Code on this resource**

Name	Data type	P	Cardinality	Description
Location	string	M	1	Contains an alternative URI representing the end point of an alternative service consumer towards which the notification should be redirected.

## 6.5.6 Data Model

### 6.5.6.1 General

This clause specifies the application data model supported by the API.

Table 6.5.6.1-1 specifies the data types defined for the NSCE\_ManagementServiceDiscovery API.

**Table 6.5.6.1-1: NSCE\_ManagementServiceDiscovery API specific Data Types**

Data type	Clause defined	Description	Applicability
ExpCapReqs	6.5.6.2.6	Represents the exposure capability requirements.	
ExpCapType	6.5.6.3.4	Represents the exposure capability type.	
MnSDiscNotif	6.5.6.2.4	Represents a Management Discovery Notification.	
MnSDiscSubsc	6.5.6.2.2	Represents a Management Discovery Subscription.	
MnSDiscSubscPatch	6.5.6.2.3	Represents the requested modifications to a Management Discovery Subscription.	
MnSInfo	6.5.6.2.5	Represents the Management Services related information.	
MnSPermission	6.5.6.3.3	Represents the permissions for exposing information related to the target slice over the MnS.	

Table 6.5.6.1-2 specifies data types re-used by the NSCE\_ManagementServiceDiscovery API from other specifications, including a reference to their respective specifications, and when needed, a short description of their use within the NSCE\_ManagementServiceDiscovery API.

**Table 6.5.6.1-2: NSCE\_ManagementServiceDiscovery API re-used Data Types**

Data type	Reference	Comments	Applicability
DateTime	3GPP TS 29.122 [2]	Represents a date and a time.	
Dnn	3GPP TS 29.571 [18]	Represents a DNN.	
DurationSec	3GPP TS 29.122 [2]	Represents a time duration in seconds.	
NetSliceId	6.3.6.2.15	Represents the identification information of a network slice.	
ProblemDetails	3GPP TS 29.122 [2]	Represents error related information.	
Snssai	3GPP TS 29.571 [18]	Represents an S-NSSAI.	
SupportedFeatures	3GPP TS 29.571 [18]	Represents the list of supported feature(s) and used to negotiate the applicability of the optional features.	
UInteger	3GPP TS 29.571 [18]	Represents an unsigned integer.	
Uri	3GPP TS 29.122 [2]	Represents a URI.	

## 6.5.6.2 Structured data types

### 6.5.6.2.1 Introduction

This clause defines the data structures to be used in resource representations.

## 6.5.6.2.2 Type: MnSDiscSubsc

**Table 6.5.6.2.2-1: Definition of type MnSDiscSubsc**

Attribute name	Data type	P	Cardinality	Description	Applicability
notifUri	Uri	M	1	Contains the URI via which the Management Discovery Notifications shall be delivered.	
netSliceIds	array(NetSliceId)	O	1..N	Contains the identifier for the requested network slice(s).	
expCapReqs	ExpCapReqs	O	0..1	Contains the exposure capability requirements, i.e., the indication of the requested permissions for exposing information related to the target slice and/or the supported exposure capability type (e.g., via EGMF or directly to MnS producer).	
supFeat	SupportedFeatures	C	0..1	Contains the list of supported features among the ones defined in clause 6.5.8. This attribute shall be present only if feature negotiation needs to take place.	

## 6.5.6.2.3 Type: MnSDiscSubscPatch

**Table 6.5.6.2.3-1: Definition of type MnSDiscSubscPatch**

Attribute name	Data type	P	Cardinality	Description	Applicability
notifUri	Uri	O	0..1	Contains the updated URI via which the Management Discovery Notifications shall be delivered.	
expCapReqs	ExpCapReqs	O	0..1	Contains the updated exposure capability requirements, i.e., the updated indication of the requested permissions for exposing information related to the target slice and/or the updated supported exposure capability type (e.g., via EGMF or directly to MnS producer).	

## 6.5.6.2.4 Type: MnSDiscNotif

**Table 6.5.6.2.4-1: Definition of type MnSDiscNotif**

Attribute name	Data type	P	Cardinality	Description	Applicability
mnSDomainId	string	M	1	Contains the identifier of the management system/domain of interest.	
mnSs	array(MnSInfo)	M	1..N	Contains the list of Management Services.	

6.5.6.2.5 Type: MnSInfo

**Table 6.5.6.2.5-1: Definition of type MnSInfo**

Attribute name	Data type	P	Cardinality	Description	Applicability
mnSIds	array(string)	M	1..N	Contains the list of the identifiers of the needed MnSs / MnS producers	
mnSCap	string	M	1	Contains the capability per needed MnS. Such capability may be related to the managed elements such as considerations for radio, technology, coverage or NFs.	
mnSPerms	array(MnSPermission)	O	1..N	Contains the allowed permissions of the VAL server over the MnS, e.g., whether it is allowed to read, write, delete, and/or update.	
netSliceId	NetSliceId	O	0..1	Contains the identifier of the concerned network slice.	

6.5.6.2.6 Type: ExpCapReqs

**Table 6.5.6.2.6-1: Definition of type ExpCapReqs**

Attribute name	Data type	P	Cardinality	Description	Applicability
reqPerm	array(MnSPermission)	C	1..N	Contains the list of the requested permissions for exposing information related to the target slice.  (NOTE)	
expCapType	array(ExpCapType)	C	1..N	Contains the supported exposure capability type (e.g., via EGMF or directly to MnS producer).  (NOTE)	

NOTE: At least one of these attributes shall be present.

6.5.6.3 Simple data types and enumerations

6.5.6.3.1 Introduction

This clause defines simple data types and enumerations that can be referenced from data structures defined in the previous clauses.

6.5.6.3.2 Simple data types

The simple data types defined in table 6.5.6.3.2-1 shall be supported.

**Table 6.5.6.3.2-1: Simple data types**

Type Name	Type Definition	Description	Applicability

6.5.6.3.3 Enumeration: MnSPermission

The enumeration MnSPermission represents the permissions for exposing information related to the target slice over the MnS. It shall comply with the provisions defined in table 6.5.6.3.3-1.

**Table 6.5.6.3.3-1: Enumeration MnSPermission**

Enumeration value	Description	Applicability
READ	Indicates the allowed permission is to read over the MnS.	
WRITE	Indicates the allowed permission is to write over the MnS.	
DELETE	Indicates the allowed permission is to delete over the MnS.	
UPDATE	Indicates the allowed permission is to update over the MnS.	

6.5.6.3.4 Enumeration: ExpCapType

The enumeration ExpCapType represents the exposure capability type. It shall comply with the provisions defined in table 6.5.6.3.4-1.

**Table 6.5.6.3.4-1: Enumeration ExpCapType**

Enumeration value	Description	Applicability
VIA_EGMF	Indicates the supported exposure capability is via EGMF.	
DIRECT	Indicates the supported exposure capability is directly to MnS producer.	

6.5.6.4 Data types describing alternative data types or combinations of data types

There are no data types describing alternative data types or combinations of data types defined for this API in this release of the specification.

6.5.6.5 Binary data

6.5.6.5.1 Binary Data Types

**Table 6.5.6.5.1-1: Binary Data Types**

Name	Clause defined	Content type

6.5.7 Error Handling

6.5.7.1 General

For the NSCE\_ManagementServiceDiscovery API, error handling shall be supported as specified in clause 6.7 of 3GPP TS 29.549 [15].

In addition, the requirements in the following clauses are applicable for the NSCE\_ManagementServiceDiscovery API.

6.5.7.2 Protocol Errors

No specific protocol errors for the NSCE\_ManagementServiceDiscovery API are specified.

6.5.7.3 Application Errors

The application errors defined for the NSCE\_ManagementServiceDiscovery API are listed in Table 6.5.7.3-1.

**Table 6.5.7.3-1: Application errors**

Application Error	HTTP status code	Description	Applicability

## 6.5.8 Feature negotiation

The optional features listed in table 6.5.8-1 are defined for the NSCE\_ManagementServiceDiscovery API. They shall be negotiated using the extensibility mechanism defined in clause 6.8 of 3GPP TS 29.549 [15].

**Table 6.5.8-1: Supported Features**

Feature number	Feature Name	Description

## 6.5.9 Security

The provisions of clause 9 of 3GPP TS 29.549 [15] shall apply for the NSCE\_ManagementServiceDiscovery API.

## 6.6 NSCE\_PerfMonitoring API

### 6.6.1 Introduction

The NSCE\_PerfMonitoring service shall use the NSCE\_PerfMonitoring API.

The API URI of the NSCE\_PerfMonitoring Service API shall be:

**{apiRoot}/<apiName>/<apiVersion>**

The request URIs used in HTTP requests shall have the Resource URI structure defined in clause 6.5 of 3GPP TS 29.549 [15], i.e.:

**{apiRoot}/<apiName>/<apiVersion>/<apiSpecificSuffixes>**

with the following components:

- The {apiRoot} shall be set as described in clause 6.5 of 3GPP TS 29.549 [15].
- The <apiName> shall be "nsce-pam".
- The <apiVersion> shall be "v1".
- The <apiSpecificSuffixes> shall be set as described in clause 6.5 of 3GPP TS 29.549 [15].

**NOTE:** When 3GPP TS 29.122 [2] is referenced for the common protocol and interface aspects for API definition in the clauses under clause 6.6, the NSCE Server takes the role of the SCEF and the service consumer takes the role of the SCS/AS.

### 6.6.2 Usage of HTTP

The provisions of clause 6.3 of 3GPP TS 29.549 [15] shall apply for the NSCE\_PerfMonitoring API.

### 6.6.3 Resources

#### 6.6.3.1 Overview

This clause describes the structure for the Resource URIs and the resources and methods used for the service.

Figure 6.6.3.1-1 depicts the resource URIs structure for the NSCE\_PerfMonitoring API.

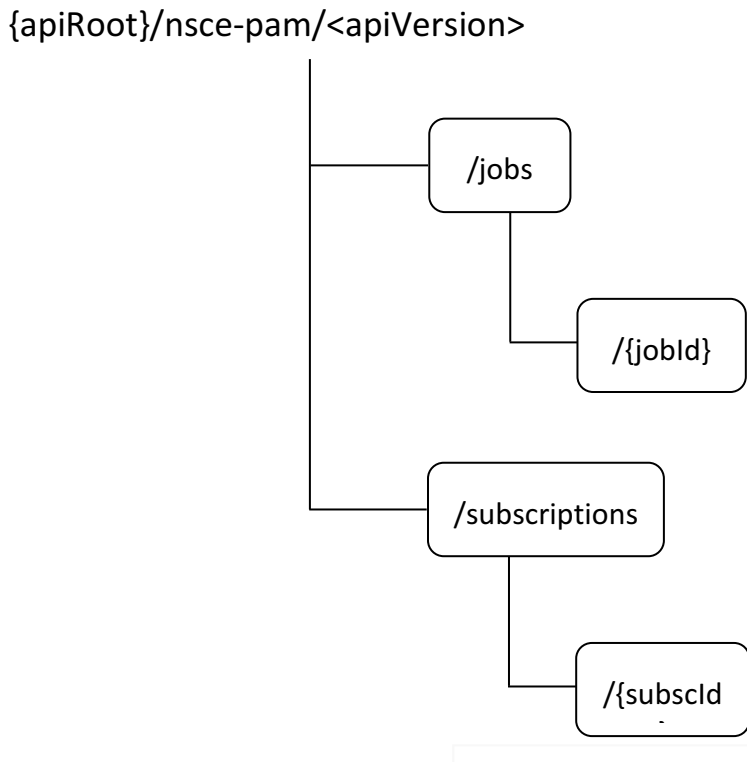

**Figure 6.6.3.1-1: Resource URIs structure of the NSCE\_PerfMonitoring API**

Table 6.6.3.1-1 provides an overview of the resources and applicable HTTP methods for the NSCE\_PerfMonitoring API.

**Table 6.6.3.1-1: Resources and methods overview**

Resource name	Resource URI	HTTP method or custom operation	Description
Monitoring Jobs	/jobs	POST	Request the creation of a Monitoring Job.
Individual Monitoring Job	/jobs/{jobId}	GET	Retrieve an existing "Individual Monitoring Job" resource.
		PUT	Request the update of an existing "Individual Monitoring Job" resource.
		PATCH	Request the modification of an existing "Individual Monitoring Job" resource.
		DELETE	Request the deletion of an existing "Individual Monitoring Job" resource.
Monitoring Subscriptions	/subscriptions	POST	Request the creation of a Monitoring Subscription.
Individual Monitoring Subscription	/subscriptions/{subscId}	GET	Retrieve an existing "Individual Monitoring Subscription" resource.
		PUT	Request the update of an existing "Individual Monitoring Subscription" resource.
		PATCH	Request the modification of an existing "Individual Monitoring Subscription" resource.
		DELETE	Request the deletion of an existing "Individual Monitoring Subscription" resource.



## 6.6.3.2 Resource: Monitoring Jobs

### 6.6.3.2.1 Description

This resource represents the collection of Monitoring Jobs managed by the NSCE Server.

### 6.6.3.2.2 Resource Definition

Resource URI: `{apiRoot}/nsce-pam/<apiVersion>/jobs`

This resource shall support the resource URI variables defined in table 6.6.3.2.2-1.

**Table 6.6.3.2.2-1: Resource URI variables for this resource**

Name	Data type	Definition
apiRoot	string	See clause 6.6.1.

### 6.6.3.2.3 Resource Standard Methods

#### 6.6.3.2.3.1 POST

The HTTP POST method allows a service consumer to request the creation of a Monitoring Job at the NSCE Server.

This method shall support the URI query parameters specified in table 6.6.3.2.3.1-1.

**Table 6.6.3.2.3.1-1: URI query parameters supported by the POST method on this resource**

Name	Data type	P	Cardinality	Description	Applicability
n/a					

This method shall support the request data structures specified in table 6.6.3.2.3.1-2 and the response data structures and response codes specified in table 6.6.3.2.3.1-3.

**Table 6.6.3.2.3.1-2: Data structures supported by the POST Request Body on this resource**

Data type	P	Cardinality	Description
MonitoringJob	M	1	Represents the parameters to request the creation of a Monitoring Job.

**Table 6.6.3.2.3.1-3: Data structures supported by the POST Response Body on this resource**

Data type	P	Cardinality	Response codes	Description
MonitoringJob	M	1	201 Created	Successful case. The Monitoring Job is successfully created and a representation of the created "Individual Monitoring Job" resource shall be returned.  An HTTP "Location" header that contains the URI of the created resource shall also be included.
NOTE: The mandatory HTTP error status codes for the HTTP POST method listed in table 5.2.6-1 of 3GPP TS 29.122 [2] shall also apply.				

**Table 6.6.3.2.3.1-4: Headers supported by the 201 Response Code on this resource**

Name	Data type	P	Cardinality	Description
Location	string	M	1	Contains the URI of the newly created resource, according to the structure: <code>{apiRoot}/nsce-pam/&lt;apiVersion&gt;/jobs/{jobId}</code>

6.6.3.2.4 Resource Custom Operations

There are no resource custom operations defined for this resource in this release of the specification.

6.6.3.3 Resource: Individual Monitoring Job

6.6.3.3.1 Description

This resource represents a Monitoring Job managed by the NSCE Server.

6.6.3.3.2 Resource Definition

Resource URI: {apiRoot}/nsce-pam/<apiVersion>/jobs/{jobId}

This resource shall support the resource URI variables defined in table 6.6.3.3.2-1.

**Table 6.6.3.3.2-1: Resource URI variables for this resource**

Name	Data type	Definition
apiRoot	string	See clause 6.6.1.
jobId	string	Represents the identifier of the "Individual Monitoring Job" resource.

6.6.3.3.3 Resource Standard Methods

6.6.3.3.3.1 GET

The HTTP GET method allows a service consumer to retrieve an existing "Individual Monitoring Job" resource at the NSCE Server.

This method shall support the URI query parameters specified in table 6.6.3.3.3.1-1.

**Table 6.6.3.3.3.1-1: URI query parameters supported by the GET method on this resource**

Name	Data type	P	Cardinality	Description	Applicability
n/a					

This method shall support the request data structures specified in table 6.6.3.3.3.1-2 and the response data structures and response codes specified in table 6.6.3.3.3.1-3.

**Table 6.6.3.3.3.1-2: Data structures supported by the GET Request Body on this resource**

Data type	P	Cardinality	Description
n/a			

**Table 6.6.3.3.1-3: Data structures supported by the GET Response Body on this resource**

Data type	P	Cardinality	Response codes	Description
MonitoringJob	M	1	200 OK	Successful case. The requested "Individual Monitoring Job" resource shall be returned.
n/a			307 Temporary Redirect	Temporary redirection. The response shall include a Location header field containing an alternative URI of the resource located in an alternative NSCE Server. Redirection handling is described in clause 5.2.10 of 3GPP TS 29.122 [2].
n/a			308 Permanent Redirect	Permanent redirection. The response shall include a Location header field containing an alternative URI of the resource located in an alternative NSCE Server. Redirection handling is described in clause 5.2.10 of 3GPP TS 29.122 [2].
NOTE: The mandatory HTTP error status codes for the HTTP GET method listed in table 5.2.6-1 of 3GPP TS 29.122 [2] shall also apply.				

**Table 6.6.3.3.1-4: Headers supported by the 307 Response Code on this resource**

Name	Data type	P	Cardinality	Description
Location	string	M	1	Contains an alternative URI of the resource located in an alternative NSCE Server.

**Table 6.6.3.3.1-5: Headers supported by the 308 Response Code on this resource**

Name	Data type	P	Cardinality	Description
Location	string	M	1	Contains an alternative URI of the resource located in an alternative NSCE Server.

#### 6.6.3.3.3.2 PUT

The HTTP PUT method allows a service consumer to request the update of an existing "Individual Monitoring Job" resource at the NSCE Server.

This method shall support the URI query parameters specified in table 6.6.3.3.2-1.

**Table 6.6.3.3.2-1: URI query parameters supported by the PUT method on this resource**

Name	Data type	P	Cardinality	Description	Applicability
n/a					

This method shall support the request data structures specified in table 6.6.3.3.2-2 and the response data structures and response codes specified in table 6.6.3.3.2-3.

**Table 6.6.3.3.2-2: Data structures supported by the PUT Request Body on this resource**

Data type	P	Cardinality	Description
MonitoringJob	M	1	Represents the updated representation of the "Individual Monitoring Job" resource.

**Table 6.6.3.3.3.2-3: Data structures supported by the PUT Response Body on this resource**

Data type	P	Cardinality	Response codes	Description
MonitoringJob	M	1	200 OK	Successful case. The "Individual Monitoring Job" resource is successfully updated and a representation of the updated resource shall be returned in the response body.
n/a			204 No Content	Successful case. The "Individual Monitoring Job" resource is successfully updated and no content is returned in the response body.
n/a			307 Temporary Redirect	Temporary redirection.  The response shall include a Location header field containing an alternative URI of the resource located in an alternative NSCE Server.  Redirection handling is described in clause 5.2.10 of 3GPP TS 29.122 [2].
n/a			308 Permanent Redirect	Permanent redirection.  The response shall include a Location header field containing an alternative URI of the resource located in an alternative NSCE Server.  Redirection handling is described in clause 5.2.10 of 3GPP TS 29.122 [2].
NOTE: The mandatory HTTP error status codes for the HTTP PUT method listed in table 5.2.6-1 of 3GPP TS 29.122 [2] shall also apply.				

**Table 6.6.3.3.3.2-4: Headers supported by the 307 Response Code on this resource**

Name	Data type	P	Cardinality	Description
Location	string	M	1	Contains an alternative URI of the resource located in an alternative NSCE Server.

**Table 6.6.3.3.3.2-5: Headers supported by the 308 Response Code on this resource**

Name	Data type	P	Cardinality	Description
Location	string	M	1	Contains an alternative URI of the resource located in an alternative NSCE Server.

### 6.6.3.3.3.3 PATCH

The HTTP PATCH method allows a service consumer to request the modification of an existing "Individual Monitoring Job" resource at the NSCE Server.

This method shall support the URI query parameters specified in table 6.6.3.3.3.3-1.

**Table 6.6.3.3.3.3-1: URI query parameters supported by the PATCH method on this resource**

Name	Data type	P	Cardinality	Description	Applicability
n/a					

This method shall support the request data structures specified in table 6.6.3.3.3.3-2 and the response data structures and response codes specified in table 6.6.3.3.3.3-3.

**Table 6.6.3.3.3-2: Data structures supported by the PATCH Request Body on this resource**

Data type	P	Cardinality	Description
MonitoringJobPatch	M	1	Represents the parameters to request the modification of the "Individual Monitoring Job" resource.

**Table 6.6.3.3.3-3: Data structures supported by the PATCH Response Body on this resource**

Data type	P	Cardinality	Response codes	Description
MonitoringJob	M	1	200 OK	Successful case. The "Individual Monitoring Job" resource is successfully modified and a representation of the updated resource shall be returned in the response body.
n/a			204 No Content	Successful case. The "Individual Monitoring Job" resource is successfully modified and no content is returned in the response body.
n/a			307 Temporary Redirect	Temporary redirection. The response shall include a Location header field containing an alternative URI of the resource located in an alternative NSCE Server. Redirection handling is described in clause 5.2.10 of 3GPP TS 29.122 [2].
n/a			308 Permanent Redirect	Permanent redirection. The response shall include a Location header field containing an alternative URI of the resource located in an alternative NSCE Server. Redirection handling is described in clause 5.2.10 of 3GPP TS 29.122 [2].
NOTE: The mandatory HTTP error status codes for the HTTP PATCH method listed in table 5.2.6-1 of 3GPP TS 29.122 [2] shall also apply.				

**Table 6.6.3.3.3-4: Headers supported by the 307 Response Code on this resource**

Name	Data type	P	Cardinality	Description
Location	string	M	1	Contains an alternative URI of the resource located in an alternative NSCE Server.

**Table 6.6.3.3.3-5: Headers supported by the 308 Response Code on this resource**

Name	Data type	P	Cardinality	Description
Location	string	M	1	Contains an alternative URI of the resource located in an alternative NSCE Server.

#### 6.6.3.3.3.4 DELETE

The HTTP DELETE method allows a service consumer to request the deletion of an existing "Individual Monitoring Job" resource at the NSCE Server.

This method shall support the URI query parameters specified in table 6.6.3.3.3.4-1.

**Table 6.6.3.3.3.4-1: URI query parameters supported by the DELETE method on this resource**

Name	Data type	P	Cardinality	Description	Applicability
n/a					

This method shall support the request data structures specified in table 6.6.3.3.3.4-2 and the response data structures and response codes specified in table 6.6.3.3.3.4-3.

**Table 6.6.3.3.3.4-2: Data structures supported by the DELETE Request Body on this resource**

Data type	P	Cardinality	Description
n/a			

**Table 6.6.3.3.3.4-3: Data structures supported by the DELETE Response Body on this resource**

Data type	P	Cardinality	Response codes	Description
n/a			204 No Content	Successful case. The "Individual Monitoring Job" resource is successfully deleted.
n/a			307 Temporary Redirect	Temporary redirection.  The response shall include a Location header field containing an alternative URI of the resource located in an alternative NSCE Server.  Redirection handling is described in clause 5.2.10 of 3GPP TS 29.122 [2].
n/a			308 Permanent Redirect	Permanent redirection.  The response shall include a Location header field containing an alternative URI of the resource located in an alternative NSCE Server.  Redirection handling is described in clause 5.2.10 of 3GPP TS 29.122 [2].
NOTE: The mandatory HTTP error status codes for the HTTP DELETE method listed in table 5.2.6-1 of 3GPP TS 29.122 [2] shall also apply.				

**Table 6.6.3.3.3.4-4: Headers supported by the 307 Response Code on this resource**

Name	Data type	P	Cardinality	Description
Location	string	M	1	Contains an alternative URI of the resource located in an alternative NSCE Server.

**Table 6.6.3.3.3.4-5: Headers supported by the 308 Response Code on this resource**

Name	Data type	P	Cardinality	Description
Location	string	M	1	Contains an alternative URI of the resource located in an alternative NSCE Server.

#### 6.6.3.3.4 Resource Custom Operations

There are no resource custom operations defined for this resource in this release of the specification.

#### 6.6.3.4 Resource: Monitoring Subscriptions

##### 6.6.3.4.1 Description

This resource represents the collection of Monitoring Subscriptions managed by the NSCE Server.

##### 6.6.3.4.2 Resource Definition

Resource URI: {apiRoot}/nsce-pam/<apiVersion>/subscriptions

This resource shall support the resource URI variables defined in table 6.6.3.4.2-1.

**Table 6.6.3.4.2-1: Resource URI variables for this resource**

Name	Data type	Definition
apiRoot	string	See clause 6.6.1.

### 6.6.3.4.3 Resource Standard Methods

#### 6.6.3.4.3.2 POST

The HTTP POST method allows a service consumer to request the creation of a Monitoring Subscription at the NSCE Server.

This method shall support the URI query parameters specified in table 6.6.3.4.3.2-1.

**Table 6.6.3.4.3.2-1: URI query parameters supported by the POST method on this resource**

Name	Data type	P	Cardinality	Description	Applicability
n/a					

This method shall support the request data structures specified in table 6.6.3.4.3.2-2 and the response data structures and response codes specified in table 6.6.3.4.3.2-3.

**Table 6.6.3.4.3.2-2: Data structures supported by the POST Request Body on this resource**

Data type	P	Cardinality	Description
MonitoringSubsc	M	1	Represents the parameters to request the creation of a Monitoring Subscription.

**Table 6.6.3.4.3.2-3: Data structures supported by the POST Response Body on this resource**

Data type	P	Cardinality	Response codes	Description
MonitoringSubsc	M	1	201 Created	Successful case. The Monitoring Subscription is successfully created and a representation of the created "Individual Monitoring Subscription" resource shall be returned.  An HTTP "Location" header that contains the URI of the created resource shall also be included.
NOTE: The mandatory HTTP error status codes for the HTTP POST method listed in table 5.2.6-1 of 3GPP TS 29.122 [2] shall also apply.				

**Table 6.6.3.4.3.2-4: Headers supported by the 201 Response Code on this resource**

Name	Data type	P	Cardinality	Description
Location	string	M	1	Contains the URI of the newly created resource, according to the structure: {apiRoot}/nsce-pam/<apiVersion>/subscriptions/{subscld}

### 6.6.3.4.4 Resource Custom Operations

There are no resource custom operations defined for this resource in this release of the specification.

### 6.6.3.5 Resource: Individual Monitoring Subscription

#### 6.6.3.5.1 Description

This resource represents a Monitoring Subscription managed by the NSCE Server.

#### 6.6.3.5.2 Resource Definition

Resource URI: {apiRoot}/nsce-pam/<apiVersion>/subscriptions/{subscId}

This resource shall support the resource URI variables defined in table 6.6.3.5.2-1.

**Table 6.6.3.5.2-1: Resource URI variables for this resource**

Name	Data type	Definition
apiRoot	string	See clause 6.6.1.
subscId	string	Represents the identifier of the "Individual Monitoring Subscription" resource.

#### 6.6.3.5.3 Resource Standard Methods

##### 6.6.3.5.3.1 GET

The HTTP GET method allows a service consumer to retrieve an existing "Individual Monitoring Subscription" resource at the NSCE Server.

This method shall support the URI query parameters specified in table 6.6.3.5.3.1-1.

**Table 6.6.3.5.3.1-1: URI query parameters supported by the GET method on this resource**

Name	Data type	P	Cardinality	Description	Applicability
n/a					

This method shall support the request data structures specified in table 6.6.3.5.3.1-2 and the response data structures and response codes specified in table 6.6.3.5.3.1-3.

**Table 6.6.3.5.3.1-2: Data structures supported by the GET Request Body on this resource**

Data type	P	Cardinality	Description
n/a			



**Table 6.6.3.5.3.1-3: Data structures supported by the GET Response Body on this resource**

Data type	P	Cardinality	Response codes	Description
MonitoringSubsc	M	1	200 OK	Successful case. The requested "Individual Monitoring Subscription" resource shall be returned.
n/a			307 Temporary Redirect	Temporary redirection. The response shall include a Location header field containing an alternative URI of the resource located in an alternative NSCE Server. Redirection handling is described in clause 5.2.10 of 3GPP TS 29.122 [2].
n/a			308 Permanent Redirect	Permanent redirection. The response shall include a Location header field containing an alternative URI of the resource located in an alternative NSCE Server. Redirection handling is described in clause 5.2.10 of 3GPP TS 29.122 [2].
NOTE: The mandatory HTTP error status codes for the HTTP GET method listed in table 5.2.6-1 of 3GPP TS 29.122 [2] shall also apply.				

**Table 6.6.3.5.3.1-4: Headers supported by the 307 Response Code on this resource**

Name	Data type	P	Cardinality	Description
Location	string	M	1	Contains an alternative URI of the resource located in an alternative NSCE Server.

**Table 6.6.3.5.3.1-5: Headers supported by the 308 Response Code on this resource**

Name	Data type	P	Cardinality	Description
Location	string	M	1	Contains an alternative URI of the resource located in an alternative NSCE Server.

#### 6.6.3.5.3.2 PUT

The HTTP PUT method allows a service consumer to request the update of an existing "Individual Monitoring Subscription" resource at the NSCE Server.

This method shall support the URI query parameters specified in table 6.6.3.5.3.2-1.

**Table 6.6.3.5.3.2-1: URI query parameters supported by the PUT method on this resource**

Name	Data type	P	Cardinality	Description	Applicability
n/a					

This method shall support the request data structures specified in table 6.6.3.5.3.2-2 and the response data structures and response codes specified in table 6.6.3.5.3.2-3.

**Table 6.6.3.5.3.2-2: Data structures supported by the PUT Request Body on this resource**

Data type	P	Cardinality	Description
MonitoringSubsc	M	1	Represents the updated representation of the "Individual Monitoring Subscription" resource.

**Table 6.6.3.5.3.2-3: Data structures supported by the PUT Response Body on this resource**

Data type	P	Cardinality	Response codes	Description
MonitoringSubsc	M	1	200 OK	Successful case. The "Individual Monitoring Subscription" resource is successfully updated and a representation of the updated resource shall be returned in the response body.
n/a			204 No Content	Successful case. The "Individual Monitoring Subscription" resource is successfully updated and no content is returned in the response body.
n/a			307 Temporary Redirect	Temporary redirection.  The response shall include a Location header field containing an alternative URI of the resource located in an alternative NSCE Server.  Redirection handling is described in clause 5.2.10 of 3GPP TS 29.122 [2].
n/a			308 Permanent Redirect	Permanent redirection.  The response shall include a Location header field containing an alternative URI of the resource located in an alternative NSCE Server.  Redirection handling is described in clause 5.2.10 of 3GPP TS 29.122 [2].
NOTE: The mandatory HTTP error status codes for the HTTP PUT method listed in table 5.2.6-1 of 3GPP TS 29.122 [2] shall also apply.				

**Table 6.6.3.5.3.2-4: Headers supported by the 307 Response Code on this resource**

Name	Data type	P	Cardinality	Description
Location	string	M	1	Contains an alternative URI of the resource located in an alternative NSCE Server.

**Table 6.6.3.5.3.2-5: Headers supported by the 308 Response Code on this resource**

Name	Data type	P	Cardinality	Description
Location	string	M	1	Contains an alternative URI of the resource located in an alternative NSCE Server.

### 6.6.3.5.3.3 PATCH

The HTTP PATCH method allows a service consumer to request the modification of an existing "Individual Monitoring Subscription" resource at the NSCE Server.

This method shall support the URI query parameters specified in table 6.6.3.5.3.3-1.

**Table 6.6.3.5.3.3-1: URI query parameters supported by the PATCH method on this resource**

Name	Data type	P	Cardinality	Description	Applicability
n/a					

This method shall support the request data structures specified in table 6.6.3.5.3.3-2 and the response data structures and response codes specified in table 6.6.3.5.3.3-3.

**Table 6.6.3.5.3.3-2: Data structures supported by the PATCH Request Body on this resource**

Data type	P	Cardinality	Description
MonitoringSubscPatch	M	1	Represents the parameters to request the modification of the "Individual Monitoring Subscription" resource.

**Table 6.6.3.5.3.3-3: Data structures supported by the PATCH Response Body on this resource**

Data type	P	Cardinality	Response codes	Description
MonitoringSubsc	M	1	200 OK	Successful case. The "Individual Monitoring Subscription" resource is successfully modified and a representation of the updated resource shall be returned in the response body.
n/a			204 No Content	Successful case. The "Individual Monitoring Subscription" resource is successfully modified and no content is returned in the response body.
n/a			307 Temporary Redirect	Temporary redirection. The response shall include a Location header field containing an alternative URI of the resource located in an alternative NSCE Server. Redirection handling is described in clause 5.2.10 of 3GPP TS 29.122 [2].
n/a			308 Permanent Redirect	Permanent redirection. The response shall include a Location header field containing an alternative URI of the resource located in an alternative NSCE Server. Redirection handling is described in clause 5.2.10 of 3GPP TS 29.122 [2].
NOTE: The mandatory HTTP error status codes for the HTTP PATCH method listed in table 5.2.6-1 of 3GPP TS 29.122 [2] shall also apply.				

**Table 6.6.3.5.3.3-4: Headers supported by the 307 Response Code on this resource**

Name	Data type	P	Cardinality	Description
Location	string	M	1	Contains an alternative URI of the resource located in an alternative NSCE Server.

**Table 6.6.3.5.3.3-5: Headers supported by the 308 Response Code on this resource**

Name	Data type	P	Cardinality	Description
Location	string	M	1	Contains an alternative URI of the resource located in an alternative NSCE Server.

#### 6.6.3.5.3.4 DELETE

The HTTP DELETE method allows a service consumer to request the deletion of an existing "Individual Monitoring Subscription" resource at the NSCE Server.

This method shall support the URI query parameters specified in table 6.6.3.5.3.4-1.

**Table 6.6.3.5.3.4-1: URI query parameters supported by the DELETE method on this resource**

Name	Data type	P	Cardinality	Description	Applicability
n/a					

This method shall support the request data structures specified in table 6.6.3.5.3.4-2 and the response data structures and response codes specified in table 6.6.3.5.3.4-3.

**Table 6.6.3.5.3.4-2: Data structures supported by the DELETE Request Body on this resource**

Data type	P	Cardinality	Description
n/a			

**Table 6.6.3.5.3.4-3: Data structures supported by the DELETE Response Body on this resource**

Data type	P	Cardinality	Response codes	Description
n/a			204 No Content	Successful case. The "Individual Monitoring Subscription" resource is successfully deleted.
n/a			307 Temporary Redirect	Temporary redirection.  The response shall include a Location header field containing an alternative URI of the resource located in an alternative NSCE Server.  Redirection handling is described in clause 5.2.10 of 3GPP TS 29.122 [2].
n/a			308 Permanent Redirect	Permanent redirection.  The response shall include a Location header field containing an alternative URI of the resource located in an alternative NSCE Server.  Redirection handling is described in clause 5.2.10 of 3GPP TS 29.122 [2].
NOTE: The mandatory HTTP error status codes for the HTTP DELETE method listed in table 5.2.6-1 of 3GPP TS 29.122 [2] shall also apply.				

**Table 6.6.3.5.3.4-4: Headers supported by the 307 Response Code on this resource**

Name	Data type	P	Cardinality	Description
Location	string	M	1	Contains an alternative URI of the resource located in an alternative NSCE Server.

**Table 6.6.3.5.3.4-5: Headers supported by the 308 Response Code on this resource**

Name	Data type	P	Cardinality	Description
Location	string	M	1	Contains an alternative URI of the resource located in an alternative NSCE Server.

## 6.6.4 Custom Operations without associated resources

### 6.6.4.1 Overview

The structure of the custom operation URIs of the NSCE\_PerfMonitoring API is shown in Figure 6.6.4.1-1.

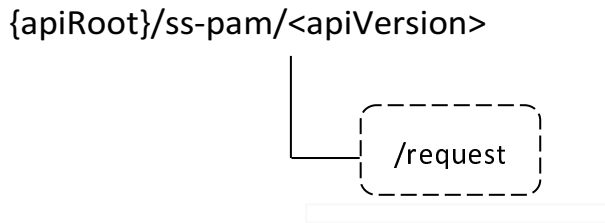

**Figure 6.6.4.1-1: Custom operation URI structure of the NSCE\_PerfMonitoring API**

Table 6.10.4.1-1 provides an overview of the custom operations and applicable HTTP methods defined for the NSCE\_PerfMonitoring API.

**Table 6.6.4.1-1: Custom operations without associated resources**

Custom operation name	Custom operation URI	Mapped HTTP method	Description
Request	/request	POST	Enables a service consumer to request a multiple slices related performance and analytics consolidated reporting.

The custom operations shall support the URI variables defined in table 6.6.4.1-2.

**Table 6.6.4.1-2: URI variables for this custom operation**

Name	Data type	Definition
apiRoot	string	See clause 6.6.1.

## 6.6.4.2 Operation: Request

### 6.6.4.2.1 Description

The custom operation enables a service consumer to request a multiple slices related performance and analytics consolidated reporting to the NSCE Server.

### 6.6.4.2.2 Operation Definition

This operation shall support the request data structures specified in table 6.6.4.2.2-1 and the response data structures and response codes specified in table 6.6.4.2.2-2.

**Table 6.6.4.2.2-1: Data structures supported by the POST Request Body on this resource**

Data type	P	Cardinality	Description
MonitoringReq	M	1	Contains the parameters to request a multiple slices related performance and analytics consolidated report.

**Table 6.6.4.2.2-2: Data structures supported by the POST Response Body on this resource**

Data type	P	Cardinality	Response codes	Description
MonitoringResp	M	1	200 OK	Successful case. The requested multiple slices related performance and analytics consolidated report shall be returned in the response body.
n/a			307 Temporary Redirect	Temporary redirection. The response shall include a Location header field containing an alternative target URI located in an alternative NSCE Server. Redirection handling is described in clause 5.2.10 of 3GPP TS 29.122 [2].
n/a			308 Permanent Redirect	Permanent redirection. The response shall include a Location header field containing an alternative target URI located in an alternative NSCE Server. Redirection handling is described in clause 5.2.10 of 3GPP TS 29.122 [2].
NOTE: The mandatory HTTP error status codes for the HTTP POST method listed in table 5.2.6-1 of 3GPP TS 29.122 [2] shall also apply.				

**Table 6.6.4.2.2-3: Headers supported by the 307 Response Code on this resource**

Name	Data type	P	Cardinality	Description
Location	string	M	1	Contains an alternative target URI located in an alternative NSCE Server.

**Table 6.6.4.2.2-4: Headers supported by the 308 Response Code on this resource**

Name	Data type	P	Cardinality	Description
Location	string	M	1	Contains an alternative target URI located in an alternative NSCE Server.

## 6.6.5 Notifications

### 6.6.5.1 General

Notifications shall comply to clause 6.6 of 3GPP TS 29.549 [15].

**Table 6.6.5.1-1: Notifications overview**

Notification	Callback URI	HTTP method or custom operation	Description (service operation)
Monitoring Notification	{notifUri}	POST	This service operation enables a NSCE Server to notify a previously subscribed service consumer on Monitoring event(s).

### 6.6.5.2 Monitoring Notification

#### 6.6.5.2.1 Description

The Monitoring Notification is used by the NSCE Server to notify a previously subscribed service consumer on Monitoring event(s).

## 6.6.5.2.2 Target URI

The Callback URI "{notifUri}" shall be used with the callback URI variables defined in table 6.6.5.2.2-1.

Table 6.6.5.2.2-1: Callback URI variables

Name	Definition
notifUri	Represents the callback URI encoded as a string formatted as a URI.

## 6.6.5.2.3 Standard Methods

## 6.6.5.2.3.1 POST

This method shall support the request data structures specified in table 6.6.5.2.3.1-1 and the response data structures and response codes specified in table 6.6.5.2.3.1-2.

Table 6.6.5.2.3.1-1: Data structures supported by the POST Request Body

Data type	P	Cardinality	Description
MonitoringNotif	M	1	Represents the Monitoring Notification.

Table 6.6.5.2.3.1-2: Data structures supported by the POST Response Body

Data type	P	Cardinality	Response codes	Description
n/a			204 No Content	Successful case. The Monitoring Notification is successfully received and processed.
n/a			307 Temporary Redirect	Temporary redirection.  The response shall include a Location header field containing an alternative URI representing the end point of an alternative service consumer where the notification should be sent.  Redirection handling is described in clause 5.2.10 of 3GPP TS 29.122 [2].
n/a			308 Permanent Redirect	Permanent redirection.  The response shall include a Location header field containing an alternative URI representing the end point of an alternative service consumer where the notification should be sent.  Redirection handling is described in clause 5.2.10 of 3GPP TS 29.122 [2].

NOTE: The mandatory HTTP error status codes for the HTTP POST method listed in table 5.2.6-1 of 3GPP TS 29.122 [2] shall also apply.

Table 6.6.5.2.3.1-3: Headers supported by the 307 Response Code on this resource

Name	Data type	P	Cardinality	Description
Location	string	M	1	Contains an alternative URI representing the end point of an alternative service consumer towards which the notification should be redirected.

**Table 6.6.5.2.3.1-4: Headers supported by the 308 Response Code on this resource**

Name	Data type	P	Cardinality	Description
Location	string	M	1	Contains an alternative URI representing the end point of an alternative service consumer towards which the notification should be redirected.

## 6.6.6 Data Model

### 6.6.6.1 General

This clause specifies the application data model supported by the API.

Table 6.6.6.1-1 specifies the data types defined for the NSCE\_PerfMonitoring API.

**Table 6.6.6.1-1: NSCE\_PerfMonitoring API specific Data Types**

Data type	Clause defined	Description	Applicability
MonitoringJob	6.6.6.2.2	Represents a Monitoring Job.	
MonitoringJobPatch	6.6.6.2.3	Represents the requested modifications to a Monitoring Job.	
MonitoringMetric	6.6.6.2.4	Represents the parameters of a network slice related performance and analytics monitoring metric.	
MonitoringNotif	6.6.6.2.9	Represents a Monitoring Notification.	
MonitoringReq	6.6.6.2.12	Represents a multiple slices related performance and analytics consolidated reporting request.	
MonitoringResp	6.6.6.2.13	Represents a multiple slices related performance and analytics consolidated reporting response.	
MonitoringSubsc	6.6.6.2.6	Represents a Monitoring Subscription.	
MonitoringSubscPatch	6.6.6.2.7	Represents the requested modifications to a Monitoring Subscription.	
MonPerfAnalyRes	6.6.6.2.11	Represents a monitored performance or analytics result.	
MonPerfAnalytics	6.6.6.2.5	Represents a monitored performance or analytics information.	
MonReqMetrics	6.6.6.2.14	Represents the parameters of a network slice related performance and analytics monitoring metric used within a multiple slices related performance and analytics consolidated reporting request.	
MonRespRepData	6.6.6.2.15	Represents a network slice related performance and analytics monitoring report instance provided as part of a multiple slices related performance and analytics consolidated reporting response.	
ReportingData	6.6.6.2.10	Represents a network slice related performance and analytics monitoring report.	
ReportingInfo	6.6.6.2.8	Represents the network slice related performance and analytics monitoring reporting information.	

Table 6.6.6.1-2 specifies data types re-used by the NSCE\_PerfMonitoring API from other specifications, including a reference to their respective specifications, and when needed, a short description of their use within the NSCE\_PerfMonitoring API.



**Table 6.6.6.1-2: NSCE\_PerfMonitoring API re-used Data Types**

Data type	Reference	Comments	Applicability
Bytes	3GPP TS 29.122 [2]	Represents a sequence of bytes.	
DateTime	3GPP TS 29.122 [2]	Represents a date and a time.	
DurationSec	3GPP TS 29.122 [2]	Represents a time duration.	
NetSliceId	Clause 6.3.6.2.15	Represents the identification information of a network slice.	
SupportedFeatures	3GPP TS 29.571 [18]	Represents the list of supported feature(s) and used to negotiate the applicability of the optional features.	

## 6.6.6.2 Structured data types

### 6.6.6.2.1 Introduction

This clause defines the data structures to be used in resource representations.

### 6.6.6.2.2 Type: MonitoringJob

**Table 6.6.6.2.2-1: Definition of type MonitoringJob**

Attribute name	Data type	P	Cardinality	Description	Applicability
monMetrics	map(MonitoringMetric)	M	1..N	Contains the requested performance and analytics monitoring metric(s). The key of the map shall be any unique string encoded value.	
suppFeat	SupportedFeatures	C	0..1	Contains the list of supported features among the ones defined in clause 6.6.8. This attribute shall be present only when feature negotiation needs to take place.	

### 6.6.6.2.3 Type: MonitoringJobPatch

**Table 6.6.6.2.3-1: Definition of type MonitoringJobPatch**

Attribute name	Data type	P	Cardinality	Description	Applicability
monMetrics	map(MonitoringMetric)	O	1..N	Contains the requested performance and analytics monitoring metric(s). The key of the map shall be any unique string encoded value and shall be set to the same value as the one provided during the creation of the corresponding Monitoring Job.	

## 6.6.6.2.4 Type: MonitoringMetric

Table 6.6.6.2.4-1: Definition of type MonitoringMetric

Attribute name	Data type	P	Cardinality	Description	Applicability
valServId	string	C	0..1	Contains the identifier of the VAL Service to which the performance and analytics monitoring is related.  (NOTE 1)	
netSliceIds	array(NetSliceId)	C	1..N	Contains the identifier(s) of the network slice(s) to which the performance and analytics monitoring is related.  (NOTE 1, NOTE 2)	
perfAnalyList	array(MonPerfAnalytics)	M	1..N	Contains the list of the performance and/or analytics information to be monitored.  (NOTE 2)	
startTime	DateTime	M	1	Contains the start time of the performance and analytics monitoring.	
endTime	DateTime	O	0..1	Contains the end time of the performance and analytics monitoring.  If this attribute is not present, the performance and analytics monitoring shall not stop until explicitly terminated.	
NOTE 1: At least one of these attributes shall be present.					
NOTE 2: When the "netSliceIds" attribute is present and the "monNetSliceIds" attribute of the MonPerfAnalytics data structure is present within an array element of the "perfAnalyList" attribute, then the network slice(s) identified by the "monNetSliceIds" attribute of the MonPerfAnalytics data structure shall be a subset of the network slice(s) identified by the "netSliceIds" attribute.					

## 6.6.6.2.5 Type: MonPerfAnalytics

Table 6.6.6.2.5-1: Definition of type MonPerfAnalytics

Attribute name	Data type	P	Cardinality	Description	Applicability
monNetSliceIds	array(NetSliceId)	O	1..N	Contains the identifier(s) of the network slice(s) for which the monitoring of the metric provided within the "metricName" attribute or the "metricCustName" attribute should be performed.	
metricName	MonPerfMetric	M	1	Contains the name of the performance or analytics metric to be monitored.	
metricCustName	string	C	0..1	Contains the custom name of the performance or analytics metric to be monitored.  This attribute shall be present only when the "metricName" attribute is set to "OTHER".	

## 6.6.6.2.6 Type: MonitoringSubsc

**Table 6.6.6.2.6-1: Definition of type MonitoringSubsc**

Attribute name	Data type	P	Cardinality	Description	Applicability
reqReportingList	map(ReportingInfo)	M	1..N	Contains the requested performance and analytics reporting information. The key of the map shall be any unique string encoded value.	
notifUri	Uri	M	1	Contains the URI via which the network slice related performance and analytics monitoring event(s) notifications shall be delivered.	
suppFeat	SupportedFeatures	C	0..1	Contains the list of supported features among the ones defined in clause 6.6.8. This attribute shall be present only when feature negotiation needs to take place.	

## 6.6.6.2.7 Type: MonitoringSubscPatch

**Table 6.6.6.2.7-1: Definition of type MonitoringSubscPatch**

Attribute name	Data type	P	Cardinality	Description	Applicability
monMetrics	map(MonitoringMetric)	O	1..N	Contains the updated requested performance and analytics reporting information. The key of the map shall be any unique string encoded value and shall be set to the same value as the one provided during the creation of the corresponding Monitoring Subscription.	
notifUri	Uri	O	0..1	Contains the updated URI via which the network slice related performance and analytics monitoring event(s) notifications shall be delivered.	

## 6.6.6.2.8 Type: ReportingInfo

Table 6.6.6.2.8-1: Definition of type ReportingInfo

Attribute name	Data type	P	Cardinality	Description	Applicability
valServId	string	C	0..1	Contains the identifier of the VAL Service to which the performance and analytics monitoring is related.  (NOTE 1, NOTE 2)	
netSliceIds	array(NetSliceId)	C	1..N	Contains the identifier(s) of the network slice(s) to which the performance and analytics monitoring is related.  (NOTE 1, NOTE 2)	
perfAnalyList	array(MonPerfAnalytics)	M	1..N	Contains the list of the performance and/or analytics information to be monitored.  (NOTE 2)	
startTime	DateTime	M	1	Contains the start time of the performance and analytics monitoring.	
endTime	DateTime	M	1	Contains the end time of the performance and analytics monitoring.	
repPeriodicity	DurationSec	O	0..1	Contains the reporting periodicity, i.e., the time interval between consecutive reportings.	
NOTE 1: At least one of these attributes shall be present.					
NOTE 2: When the "netSliceIds" attribute is present and the "monNetSliceIds" attribute of the MonPerfAnalytics data structure is present within an array element of the "perfAnalyList" attribute, then the network slice(s) identified by the "monNetSliceIds" attribute of the MonPerfAnalytics data structure shall be a subset of the network slice(s) identified by the "netSliceIds" attribute.					

## 6.6.6.2.9 Type: MonitoringNotif

Table 6.6.6.2.9-1: Definition of type MonitoringNotif

Attribute name	Data type	P	Cardinality	Description	Applicability
subscId	string	M	1	Contains the identifier of the Monitoring Subscription to which the notification is related.	
reports	array(ReportingData)	M	1..N	Contains the network slice related performance and analytics report(s).	

## 6.6.6.2.10 Type: ReportingData

**Table 6.6.6.2.10-1: Definition of type ReportingData**

Attribute name	Data type	P	Cardinality	Description	Applicability
valServId	string	C	0..1	Contains the identifier of the VAL Service to which the performance and analytics monitoring report is related.  (NOTE 1, NOTE 2)	
netSliceIds	array(NetSliceId)	C	1..N	Contains the identifier(s) of the network slice(s) to which the performance and analytics monitoring report is related.  (NOTE 1, NOTE 2)	
perfResults	array(MonPerfAnalyRes)	M	1..N	Contains the list of the network slice related performance and analytics result(s).  (NOTE 2)	
NOTE 1: At least one of these attributes shall be present. NOTE 2: When the "netSliceIds" attribute is present and the "monNetSliceIds" attribute of the MonPerfAnalyRes data structure is present within an array element of the "perfResults" attribute, then the network slice(s) identified by the "monNetSliceIds" attribute of the MonPerfAnalyRes data structure shall be a subset of the network slice(s) identified by the "netSliceIds" attribute.					

## 6.6.6.2.11 Type: MonPerfAnalyRes

**Table 6.6.6.2.11-1: Definition of type MonPerfAnalyRes**

Attribute name	Data type	P	Cardinality	Description	Applicability
monNetSliceIds	array(NetSliceId)	O	1..N	Contains the identifier of the network slice(s) for which the reported result is related.	
metricName	MonPerfMetric	M	1	Contains the name of the reported performance or analytics metric.	
metricCustName	string	C	0..1	Contains the custom name of the performance or analytics metric to be monitored.  This attribute shall be present only when the "metricName" attribute is set to "OTHER".	
metricValue	Bytes	M	1	Contains the value of the reported performance or analytics information.	

## 6.6.6.2.12 Type: MonitoringReq

**Table 6.6.6.2.12-1: Definition of type MonitoringReq**

Attribute name	Data type	P	Cardinality	Description	Applicability
monMetrics	array(MonReqMetrics)	M	1..N	Contains the requested multiple slices related performance and analytics monitoring metric(s).	
suppFeat	SupportedFeatures	C	0..1	Contains the list of supported features among the ones defined in clause 6.6.8.  This attribute shall be present only when feature negotiation needs to take place.	

## 6.6.6.2.13 Type: MonitoringResp

Table 6.6.6.2.13-1: Definition of type MonitoringResp

Attribute name	Data type	P	Cardinality	Description	Applicability
perfResults	array(MonRespRepData)	M	1..N	Contains the list of the multiple slices related network slice related performance and analytics result(s).	
supFeat	SupportedFeatures	C	0..1	Contains the list of supported features among the ones defined in clause 6.6.8. This attribute shall be present only when feature negotiation needs to take place.	

## 6.6.6.2.14 Type: MonReqMetrics

Table 6.6.6.2.14-1: Definition of type MonReqMetrics

Attribute name	Data type	P	Cardinality	Description	Applicability
valServId	string	C	0..1	Contains the identifier of the VAL Service to which the performance and analytics monitoring is related. (NOTE 1, NOTE 2)	
netSliceIds	array(NetSliceId)	C	1..N	Contains the identifier(s) of the network slice(s) to which the performance and analytics monitoring is related. (NOTE 1, NOTE 2)	
perfAnalyList	array(MonPerfAnalytics)	M	1..N	Contains the list of the performance and/or analytics information to be monitored. (NOTE 2)	
startTime	DateTime	M	1	Contains the start time of the performance and analytics monitoring.	
endTime	DateTime	M	1	Contains the end time of the performance and analytics monitoring.	
NOTE 1: At least one of these attributes shall be present.					
NOTE 2: When the "netSliceIds" attribute is present and the "monNetSliceIds" attribute of the MonPerfAnalytics data structure is present within an array element of the "perfAnalyList" attribute, then the network slice(s) identified by the "monNetSliceIds" attribute of the MonPerfAnalytics data structure shall be a subset of the network slice(s) identified by the "netSliceIds" attribute.					

## 6.6.6.2.15 Type: MonRespRepData

**Table 6.6.6.2.15-1: Definition of type MonRespRepData**

Attribute name	Data type	P	Cardinality	Description	Applicability
valServId	string	C	0..1	Contains the identifier of the VAL Service to which the performance and analytics monitoring report is related.  (NOTE 1, NOTE 2)	
netSliceIds	array(NetSliceId)	C	1..N	Contains the identifier(s) of the network slice(s) to which the performance and analytics monitoring report is related.  (NOTE 1, NOTE 2)	
perfResults	array(MonPerfAnalyRes)	M	1..N	Contains the list of the network slice related performance and analytics result(s).  (NOTE 2)	
startTime	DateTime	M	1	Contains the start time of the reported performance and analytics monitoring.	
endTime	DateTime	M	1	Contains the end time of the reported performance and analytics monitoring.	
NOTE 1: At least one of these attributes shall be present.					
NOTE 2: When the "netSliceIds" attribute is present and the "monNetSliceIds" attribute of the MonPerfAnalyRes data structure is present within an array element of the "perfResults" attribute, then the network slice(s) identified by the "monNetSliceIds" attribute of the MonPerfAnalyRes data structure shall be a subset of the network slice(s) identified by the "netSliceIds" attribute.					

## 6.6.6.3 Simple data types and enumerations

## 6.6.6.3.1 Introduction

This clause defines simple data types and enumerations that can be referenced from data structures defined in the previous clauses.

## 6.6.6.3.2 Simple data types

The simple data types defined in table 6.6.6.3.2-1 shall be supported.

**Table 6.6.6.3.2-1: Simple data types**

Type Name	Type Definition	Description	Applicability

## 6.6.6.3.3 Enumeration: MonPerfMetric

The enumeration MonPerfMetric represents a performance or analytics metric. It shall comply with the provisions defined in table 6.6.6.3.3-1.

**Table 6.6.6.3.3-1: Enumeration MonPerfMetric**

Enumeration value	Description	Applicability
RTT	Indicates that the performance or analytics metric is the round-trip time within the network slice.	
E2E_LATENCY	Indicates that the performance or analytics metric is the E2E Latency within the network slice.	
PACKET_LOSS	Indicates that the performance or analytics metric is the packet loss within the network slice.	
RETRANSMISSIONS	Indicates that the performance or analytics metric is the retransmissions within the network slice.	
THROUGHPUT	Indicates that the performance or analytics metric is the throughput within the network slice.	
NUM_OF_REG_UES	Indicates that the performance or analytics metric is the number of registered UEs within the network slice.	
NUM_OF_EST_PDU_SESS	Indicates that the performance or analytics metric is the number of established PDU Sessions within the network slice.	
RESOURCE_USAGE	Indicates that the performance or analytics metric is the resources usage within the network slice.	
LOAD_LEVEL	Indicates that the performance or analytics metric is the load level within the network slice.	
OTHER	Indicates that the performance or analytics metric is a custom metric.	

#### 6.6.6.4 Data types describing alternative data types or combinations of data types

There are no data types describing alternative data types or combinations of data types defined for this API in this release of the specification.

#### 6.6.6.5 Binary data

##### 6.6.6.5.1 Binary Data Types

**Table 6.6.6.5.1-1: Binary Data Types**

Name	Clause defined	Content type

#### 6.6.7 Error Handling

##### 6.6.7.1 General

For the NSCE\_PerfMonitoring API, error handling shall be supported as specified in clause 6.7 of 3GPP TS 29.549 [15].

In addition, the requirements in the following clauses are applicable for the NSCE\_PerfMonitoring API.

##### 6.6.7.2 Protocol Errors

No specific protocol errors for the NSCE\_PerfMonitoring API are specified.

##### 6.6.7.3 Application Errors

The application errors defined for the NSCE\_PerfMonitoring API are listed in Table 6.6.7.3-1.



**Table 6.6.7.3-1: Application errors**

Application Error	HTTP status code	Description	Applicability

## 6.6.8 Feature negotiation

The optional features listed in table 6.6.8-1 are defined for the NSCE\_PerfMonitoring API. They shall be negotiated using the extensibility mechanism defined in clause 6.8 of 3GPP TS 29.549 [15].

**Table 6.6.8-1: Supported Features**

Feature number	Feature Name	Description

## 6.6.9 Security

The provisions of clause 9 of 3GPP TS 29.549 [15] shall apply for the NSCE\_PerfMonitoring API.

## 6.7 NSCE\_InfoCollection API

### 6.7.1 Introduction

The NSCE\_InfoCollection service shall use the NSCE\_InfoCollection API.

The API URI of the NSCE\_InfoCollection Service API shall be:

**{apiRoot}/<apiName>/<apiVersion>**

The request URIs used in HTTP requests shall have the Resource URI structure defined in clause 6.5 of 3GPP TS 29.549 [15], i.e.:

**{apiRoot}/<apiName>/<apiVersion>/<apiSpecificSuffixes>**

with the following components:

- The {apiRoot} shall be set as described in clause 6.5 of 3GPP TS 29.549 [15].
- The <apiName> shall be "nsce-ic".
- The <apiVersion> shall be "v1".
- The <apiSpecificSuffixes> shall be set as described in clause 6.5 of 3GPP TS 29.549 [15].

**NOTE:** When 3GPP TS 29.122 [2] is referenced for the common protocol and interface aspects for API definition in the clauses under clause 6.7, the NSCE Server takes the role of the SCEF and the service consumer takes the role of the SCS/AS.

### 6.7.2 Usage of HTTP

The provisions of clause 6.3 of 3GPP TS 29.549 [15] shall apply for the NSCE\_InfoCollection API.

### 6.7.3 Resources

#### 6.7.3.1 Overview

This clause describes the structure for the Resource URIs and the resources and methods used for the service.

Figure 6.7.3.1-1 depicts the resource URIs structure for the NSCE\_InfoCollection API.

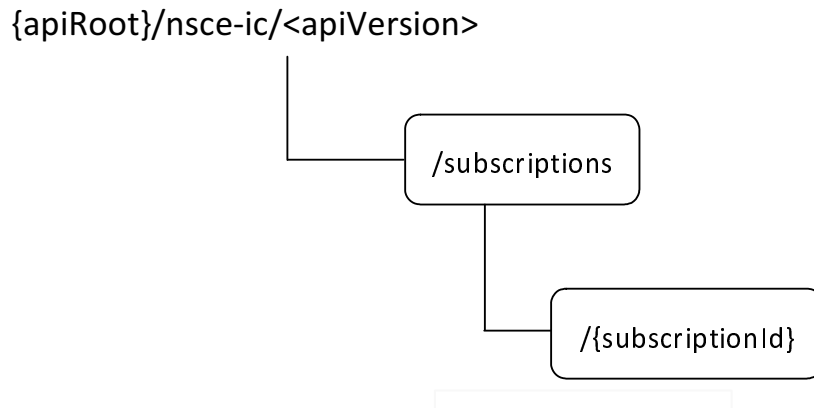

**Figure 6.7.3.1-1: Resource URIs structure of the NSCE\_InfoCollection API**

Table 6.7.3.1-1 provides an overview of the resources and applicable HTTP methods for the NSCE\_InfoCollection API.

**Table 6.7.3.1-1: Resources and methods overview**

Resource name	Resource URI	HTTP method or custom operation	Description
Information Collection Subscriptions	/subscriptions	POST	Request the creation of an Information Collection Subscription.
Individual Information Collection Subscription	/subscriptions/{subscriptionId}	GET	Retrieve an existing "Individual Information Collection Subscription" resource.
		PUT	Request the update of an existing "Individual Information Collection Subscription" resource.
		PATCH	Request the modification of an existing "Individual Information Collection Subscription" resource.
		DELETE	Request the deletion of an existing "Individual Information Collection Subscription" resource.

### 6.7.3.2 Resource: Information Collection Subscriptions

#### 6.7.3.2.1 Description

This resource represents the collection of Information Collection Subscriptions managed by the NSCE Server.

#### 6.7.3.2.2 Resource Definition

Resource URI: **{apiRoot}/nsce-ic/<apiVersion>/subscriptions**

This resource shall support the resource URI variables defined in the table 6.7.3.2.2-1.

**Table 6.7.3.2.2-1: Resource URI variables for this resource**

Name	Data Type	Definition
apiRoot	string	See clause 6.7.1

### 6.7.3.2.3 Resource Standard Methods

#### 6.7.3.2.3.1 POST

The HTTP POST method allows a service consumer to request the creation of an Information Collection Subscription at the NSCE Server.

This method shall support the URI query parameters specified in table 6.7.3.2.3.1-1.

**Table 6.7.3.2.3.1-1: URI query parameters supported by the POST method on this resource**

Name	Data type	P	Cardinality	Description
n/a				

This method shall support the request data structures specified in table 6.7.3.2.3.1-2 and the response data structures and response codes specified in table 6.7.3.2.3.1-3.

**Table 6.7.3.2.3.1-2: Data structures supported by the POST Request Body on this resource**

Data type	P	Cardinality	Description
InfoCollectSubsc	M	1	Represents the parameters to request the creation of an Information Collection Subscription resource.

**Table 6.7.3.2.3.1-3: Data structures supported by the POST Response Body on this resource**

Data type	P	Cardinality	Response Codes	Description
InfoCollectSubsc	M	1	201 Created	Successful case. The Information Collection Subscription is successfully created and a representation of the created "Individual Information Collection Subscription" resource shall be returned.  An HTTP "Location" header that contains the resource URI of the created resource shall also be included.

NOTE: The mandatory HTTP error status codes for the HTTP POST method listed in Table 5.2.6-1 of 3GPP TS 29.122 [2] shall also apply.

**Table 6.7.3.2.3.1-4: Headers supported by the 201 Response code on this resource**

Name	Data type	P	Cardinality	Description
Location	string	M	1	Contains the URI of the newly created resource, according to the structure: {apiRoot}/nsce-ic/<apiVersion>/subscriptions/{subscriptionId}

### 6.7.3.2.4 Resource Custom Operations

There are no resource custom operations defined for this resource in this release of the specification.

## 6.7.3.3 Resource: Individual Information Collection Subscription

### 6.7.3.3.1 Description

This resource represents an Information Collection Subscription managed by the NSCE Server.

### 6.7.3.3.2 Resource Definition

Resource URI: {apiRoot}/nsce-ic/<apiVersion>/subscriptions/{subscriptionId}

This resource shall support the resource URI variables defined in the table 6.7.3.3.2-1.

**Table 6.7.3.3.2-1: Resource URI variables for this resource**

Name	Data Type	Definition
apiRoot	string	See clause 6.7.1
subscriptionId	string	Represents the identifier of the "Individual Information Collection Subscription" resource.

### 6.7.3.3.3 Resource Standard Methods

#### 6.7.3.3.3.1 GET

The HTTP GET method allows a service consumer to retrieve an existing "Individual Information Collection Subscription" resource at the NSCE Server.

This method shall support the URI query parameters specified in the table 6.7.3.3.3.1-1.

**Table 6.7.3.3.3.1-1: URI query parameters supported by the GET method on this resource**

Name	Data type	P	Cardinality	Description
n/a				

This method shall support the request data structures specified in table 6.7.3.3.3.1-2 and the response data structures and response codes specified in table 6.7.3.3.3.1-3.

**Table 6.7.3.3.3.1-2: Data structures supported by the GET Request Body on this resource**

Data type	P	Cardinality	Description
n/a			

**Table 6.7.3.3.3.1-3: Data structures supported by the GET Response Body on this resource**

Data type	P	Cardinality	Response codes	Description
InfoCollectSubsc	M	1	200 OK	Successful case. The requested "Individual Information Collection Subscription" resource shall be returned.
n/a			307 Temporary Redirect	Temporary redirection. The response shall include a Location header field containing an alternative URI of the resource located in an alternative NSCE Server. Redirection handling is described in clause 5.2.10 of 3GPP TS 29.122 [2].
n/a			308 Permanent Redirect	Permanent redirection. The response shall include a Location header field containing an alternative URI of the resource located in an alternative NSCE Server. Redirection handling is described in clause 5.2.10 of 3GPP TS 29.122 [2].

NOTE: The mandatory HTTP error status codes for the HTTP GET method listed in Table 5.2.6-1 of 3GPP TS 29.122 [2] shall also apply.

**Table 6.7.3.3.3.1-4: Headers supported by the 307 Response Code on this resource**

Name	Data type	P	Cardinality	Description
Location	string	M	1	Contains an alternative URI of the resource located in an alternative NSCE Server.

**Table 6.7.3.3.3.1-5: Headers supported by the 308 Response Code on this resource**

Name	Data type	P	Cardinality	Description
Location	string	M	1	Contains an alternative URI of the resource located in an alternative NSCE Server.

## 6.7.3.3.3.2 PUT

The HTTP PUT method allows a service consumer to request the update of an existing "Individual Information Collection Subscription" resource at the NSCE Server.

This method shall support the URI query parameters specified in the table 6.7.3.3.3.2-1.

**Table 6.7.3.3.3.2-1: URI query parameters supported by the PUT method on this resource**

Name	Data type	P	Cardinality	Description
n/a				

This method shall support the request data structures specified in table 6.7.3.3.3.2-2 and the response data structures and response codes specified in table 6.7.3.3.3.2-3.

**Table 6.7.3.3.3.2-2: Data structures supported by the PUT Request Body on this resource**

Data type	P	Cardinality	Description
InfoCollectSubsc	M	1	Represents the updated representation of the "Individual Information Collection Subscription" resource.

**Table 6.7.3.3.3.2-3: Data structures supported by the PUT Response Body on this resource**

Data type	P	Cardinality	Response codes	Description
InfoCollectSubsc	M	1	200 OK	Successful case. The "Individual Information Collection Subscription" resource is successfully updated and a representation of the updated resource shall be returned in the response body.
n/a			204 No Content	Successful case. The "Individual Information Collection Subscription" resource is successfully updated and no content is returned in the response body.
n/a			307 Temporary Redirect	Temporary redirection.  The response shall include a Location header field containing an alternative URI of the resource located in an alternative NSCE Server.  Redirection handling is described in clause 5.2.10 of 3GPP TS 29.122 [2].
n/a			308 Permanent Redirect	Permanent redirection.  The response shall include a Location header field containing an alternative URI of the resource located in an alternative NSCE Server.  Redirection handling is described in clause 5.2.10 of 3GPP TS 29.122 [2].
NOTE: The mandatory HTTP error status codes for the PUT method listed in Table 5.2.6-1 of 3GPP TS 29.122 [2] shall also apply.				

**Table 6.7.3.3.2-4: Headers supported by the 307 Response Code on this resource**

Name	Data type	P	Cardinality	Description
Location	string	M	1	Contains an alternative URI of the resource located in an alternative NSCE Server.

**Table 6.7.3.3.2-5: Headers supported by the 308 Response Code on this resource**

Name	Data type	P	Cardinality	Description
Location	string	M	1	Contains an alternative URI of the resource located in an alternative NSCE Server.

### 6.7.3.3.3.3 PATCH

The HTTP PATCH method allows a service consumer to request the modification of an existing "Individual Information Collection Subscription" resource at the NSCE Server.

This method shall support the URI query parameters specified in table 6.7.3.3.3.3-1.

**Table 6.7.3.3.3.3-1: URI query parameters supported by the PATCH method on this resource**

Name	Data type	P	Cardinality	Description
n/a				

This method shall support the request data structures specified in table 6.7.3.3.3.3-2 and the response data structures and response codes specified in table 6.7.3.3.3.3-3.

**Table 6.7.3.3.3.3-2: Data structures supported by the PATCH Request Body on this resource**

Data type	P	Cardinality	Description
InfoCollectSubscPatch	M	1	Represents the parameters to request the modification of the "Individual Information Collection Subscription" resource.

**Table 6.7.3.3.3-3: Data structures supported by the PATCH Response Body on this resource**

Data type	P	Cardinality	Response codes	Description
InfoCollectSubsc	M	1	200 OK	Successful case. The "Individual Information Collection Subscription" resource is successfully modified and a representation of the updated resource shall be returned in the response body.
n/a			204 No Content	Successful case. The "Individual Information Collection Subscription" resource is successfully modified and no content is returned in the response body.
n/a			307 Temporary Redirect	Temporary redirection.  The response shall include a Location header field containing an alternative URI of the resource located in an alternative NSCE Server.  Redirection handling is described in clause 5.2.10 of 3GPP TS 29.122 [2].
n/a			308 Permanent Redirect	Permanent redirection.  The response shall include a Location header field containing an alternative URI of the resource located in an alternative NSCE Server.  Redirection handling is described in clause 5.2.10 of 3GPP TS 29.122 [2].
NOTE: The mandatory HTTP error status codes for the HTTP PATCH method listed in table 5.2.6-1 of 3GPP TS 29.122 [2] shall also apply.				

**Table 6.7.3.3.3-4: Headers supported by the 307 Response Code on this resource**

Name	Data type	P	Cardinality	Description
Location	string	M	1	Contains an alternative URI of the resource located in an alternative NSCE Server.

**Table 6.7.3.3.3-5: Headers supported by the 308 Response Code on this resource**

Name	Data type	P	Cardinality	Description
Location	string	M	1	Contains an alternative URI of the resource located in an alternative NSCE Server.

#### 6.7.3.3.3.4 DELETE

The HTTP DELETE method allows a service consumer to request the deletion of an existing "Individual Information Collection Subscription" resource at the NSCE Server.

This method shall support the URI query parameters specified in table 6.7.3.3.3.4-1.

**Table 6.7.3.3.3.4-1: URI query parameters supported by the DELETE method on this resource**

Name	Data type	P	Cardinality	Description
n/a				

This method shall support the request data structures specified in table 6.7.3.3.3.4-2 and the response data structures and response codes specified in table 6.7.3.3.3.4-3.

**Table 6.7.3.3.3.4-2: Data structures supported by the DELETE Request Body on this resource**

Data type	P	Cardinality	Description
n/a			

**Table 6.7.3.3.3.4-3: Data structures supported by the DELETE Response Body on this resource**

Data type	P	Cardinality	Response codes	Description
n/a			204 No Content	Successful case. The "Individual Information Collection Subscription" resource is successfully deleted.
n/a			307 Temporary Redirect	Temporary redirection.  The response shall include a Location header field containing an alternative URI of the resource located in an alternative NSCE Server.  Redirection handling is described in clause 5.2.10 of 3GPP TS 29.122 [2].
n/a			308 Permanent Redirect	Permanent redirection.  The response shall include a Location header field containing an alternative URI of the resource located in an alternative NSCE Server.  Redirection handling is described in clause 5.2.10 of 3GPP TS 29.122 [2].
NOTE: The mandatory HTTP error status codes for the HTTP DELETE method listed in table 5.2.6-1 of 3GPP TS 29.122 [2] shall also apply.				

**Table 6.7.3.3.3.4-4: Headers supported by the 307 Response Code on this resource**

Name	Data type	P	Cardinality	Description
Location	string	M	1	Contains an alternative URI of the resource located in an alternative NSCE Server.

**Table 6.7.3.3.3.4-5: Headers supported by the 308 Response Code on this resource**

Name	Data type	P	Cardinality	Description
Location	string	M	1	Contains an alternative URI of the resource located in an alternative NSCE Server.

#### 6.7.3.3.4 Resource Custom Operations

There are no resource custom operations defined for this resource in this release of the specification.

#### 6.7.4 Custom Operations without associated resources

There are no custom operations without associated resources defined for this API in this release of the specification.

#### 6.7.5 Notifications

##### 6.7.5.1 General

Notifications shall comply to clause 6.6 of 3GPP TS 29.549 [15].



**Table 6.7.5.1-1: Notifications overview**

Notification	Callback URI	HTTP method or custom operation	Description (service operation)
Information Collection Notification	{notifUri}	POST	This service operation enables an NSCE Server to notify a previously subscribed service consumer on Information Collection report(s).

## 6.7.5.2 Information Collection Notification

### 6.7.5.2.1 Description

The Information Collection Notification is used by an NSCE Server to notify a previously subscribed service consumer on Information Collection report(s).

### 6.7.5.2.2 Target URI

The Callback URI "{notifUri}" shall be used with the callback URI variables defined in table 6.7.5.2.2-1.

**Table 6.7.5.2.2-1: Callback URI variables**

Name	Data type	Definition
notifUri	Uri	Represents the callback URI encoded as a string formatted as a URI.

### 6.7.5.2.3 Standard Methods

#### 6.7.5.2.3.1 POST

This method shall support the request data structures specified in table 6.7.5.2.3.1-1 and the response data structures and response codes specified in table 6.7.5.2.3.1-2.

**Table 6.7.5.2.3.1-1: Data structures supported by the POST Request Body**

Data type	P	Cardinality	Description
InfoCollectNotif	M	1	Represents an Information Collection Notification.

**Table 6.7.5.2.3.1-2: Data structures supported by the POST Response Body**

Data type	P	Cardinality	Response codes	Description
n/a			204 No Content	Successful case. The Information Collection Notification is successfully received.
n/a			307 Temporary Redirect	Temporary redirection. The response shall include a Location header field containing an alternative URI representing the end point of an alternative service consumer where the notification should be sent. Redirection handling is described in clause 5.2.10 of 3GPP TS 29.122 [2].
n/a			308 Permanent Redirect	Permanent redirection. The response shall include a Location header field containing an alternative URI representing the end point of an alternative service consumer where the notification should be sent. Redirection handling is described in clause 5.2.10 of 3GPP TS 29.122 [2].
NOTE: The mandatory HTTP error status codes for the HTTP POST method listed in table 5.2.6-1 of 3GPP TS 29.122 [2] shall also apply.				

**Table 6.7.5.2.3.1-3: Headers supported by the 307 Response Code on this resource**

Name	Data type	P	Cardinality	Description
Location	string	M	1	Contains an alternative URI representing the end point of an alternative service consumer towards which the notification should be redirected.

**Table 6.7.5.2.3.1-4: Headers supported by the 308 Response Code on this resource**

Name	Data type	P	Cardinality	Description
Location	string	M	1	Contains an alternative URI representing the end point of an alternative service consumer towards which the notification should be redirected.

## 6.7.6 Data Model

### 6.7.6.1 General

**Table 6.7.6.1-1: NSCE\_InfoCollection API specific Data Types**

Data type	Section defined	Description	Applicability
CollectInfo	6.7.6.2.5	Represents the information to be collected.	
InfoCollectSubsc	6.7.6.2.2	Represents an Information Collection subscription.	
InfoCollectSubscPatch	6.7.6.2.3	Represents the requested modifications of an Information Collection subscription.	
InfoCollectNotif	6.7.6.2.4	Represents an Information Collection Notification.	
QoSMetric	6.7.6.2.6	Represents the QoS metric.	
QoSType	6.7.6.3.3	Represents the QoS metric type.	

Table 6.7.6.1-2 specifies data types re-used by the NSCE\_InfoCollection API from other specifications, including a reference to their respective specifications, and when needed, a short description of their use within the NSCE\_InfoCollection API.

**Table 6.7.6.1-2: NSCE\_InfoCollection API re-used Data Types**

Data type	Reference	Comments	Applicability
BitRate	3GPP TS 29.571 [16]	Represents a bit rate.	
DateTime	3GPP TS 29.122 [2]	Represents a date and a time.	
DurationSec	3GPP TS 29.571 [16]	Represents a time duration in seconds.	
Float	3GPP TS 29.571 [16]	Represents a number with format "float" as defined in the OpenAPI Specification [4].	
ReportingData	Clause 6.6.6.2.10	Represents a network slice related performance and analytics monitoring report.	
NetSliceId	6.3.6.2.15	Represents the identification information of a network slice.	
SupportedFeatures	3GPP TS 29.571 [16]	Represents the list of supported feature(s) and used to negotiate the applicability of the optional features.	
UInt32	3GPP TS 29.571 [16]	Represents an unsigned 32-bit integer.	
Uri	3GPP TS 29.122 [2]	Represents a URI.	

## 6.7.6.2 Structured data types

### 6.7.6.2.1 Introduction

This clause defines the data structures to be used in resource representations.

### 6.7.6.2.2 Type: InfoCollectSubsc

**Table 6.7.6.2.2-1: Definition of type InfoCollectSubsc**

Attribute name	Data type	P	Cardinality	Description	Applicability
notifUri	Uri	M	1	Contains the URI via which notifications shall be delivered.	
collectInfo	map(CollectInfo)	M	1..N	Contains the information collected from the interested network slice. The key of the map shall be any unique string encoded value.	
expTime	DateTime	O	0..1	Contains the proposed expiration time of the subscription.	
netSlicePerf	array(ReportingData)	O	1..N	Contains the network slice related performance and analytics report(s). This attribute may be present only in Information Collection Subscription creation/update responses.	
suppFeat	SupportedFeatures	C	0..1	Contains the list of supported features among the ones defined in clause 6.7.8. This attribute shall be present only when feature negotiation needs to take place.	

## 6.7.6.2.3 Type: InfoCollectSubscPatch

Table 6.7.6.2.2-1: Definition of type InfoCollectSubscPatch

Attribute name	Data type	P	Cardinality	Description	Applicability
notifUri	Uri	O	0..1	Contains the updated URI via which notifications shall be provided.	
collectInfo	map(CollectInfo)	O	1..N	Contains the updated information collected from the interested network slice.  The key of the map shall be any unique string encoded value and shall be set to the same value as the as the one provided during the creation of the corresponding Information Collection Subscription.	
expTime	DateTime	O	0..1	Contains the expiration time of the subscription.	

## 6.7.6.2.4 Type: InfoCollectNotif

Table 6.7.6.2.4-1: Definition of type InfoCollectNotif

Attribute name	Data type	P	Cardinality	Description	Applicability
subscriptionId	string	M	1	Contains the identifier of the subscription to which the notification is related.	
netSlicePerf	array(Reporting Data)	M	1..N	Contains the network slice related performance and analytics report(s).	

## 6.7.6.2.5 Type: CollectInfo

Table 6.7.6.2.5-1: Definition of type CollectInfo

Attribute name	Data type	P	Cardinality	Description	Applicability
netSliceId	NetSliceId	M	1	Represents the targeted concerned network slice.	
qosMetrics	array(QoSMetric)	O	1..N	Contains the QoS metric(s) related information with each instance including the QoS metric type and the corresponding QoS threshold.  (NOTE)	
repPeriod	DurationSec	O	0..1	Contains the reporting period.	
immRepFlag	boolean	O	0..1	Contains the immediate reporting indication.  - Set to "true" to indicate that immediate reporting is requested. - Set to "false" to indicate that immediate reporting is not requested. - The default value is "false" if this attribute is omitted.  (NOTE)	
NOTE: If the "immRepFlag" is set to "false" or omitted, the "qosMetrics" attribute indicates the reporting conditions as the average "latency", "throughput", or "jitter" is greater than the threshold.					

6.7.6.2.6 Type: QoSMetric

**Table 6.7.6.2.6-1: Definition of type QoSMetric**

Attribute name	Data type	P	Cardinality	Description	Applicability
qosType	QoSType	M	1	Represents the QoS metric type, e.g., latency, throughput, jitter, etc.	
latency	Float	O	0..1	Contains the threshold average latency in milliseconds.  This attribute may be present only if the "qosType" attribute is set to "LATENCY".	
throughput	BitRate	O	0..1	Contains the threshold average throughput.  This attribute may be present only if the "qosType" attribute is set to "THROUGHPUT".	
jitter	Uint32	O	0..1	Contains the threshold average jitter.  This attribute may be present only if the "qosType" attribute is set to "JITTER".	

NOTE: The attributes "latency", "throughput", and "jitter" are mutually exclusive. Either one of them may be present.

6.7.6.3 Simple data types and enumerations

6.7.6.3.1 Introduction

This clause defines simple data types and enumerations that can be referenced from data structures defined in the previous clauses.

6.7.6.3.2 Simple data types

The simple data types defined in table 6.7.6.3.2-1 shall be supported.

**Table 6.7.6.3.2-1: Simple data types**

Type Name	Type Definition	Description	Applicability

6.7.6.3.3 Enumeration: QoSType

**Table 6.7.6.3.3-1: Enumeration QoSType**

Enumeration value	Description	Applicability
LATENCY	Indicates that the QoS type is latency.	
THROUGHPUT	Indicates that the QoS type is throughput.	
JITTER	Indicates that the QoS type is jitter.	

6.7.6.4 Data types describing alternative data types or combinations of data types

There are no data types describing alternative data types or combinations of data types defined for this API in this release of the specification.

## 6.7.6.5 Binary data

### 6.7.6.5.1 Binary Data Types

**Table 6.7.6.5.1-1: Binary Data Types**

Name	Clause defined	Content type

## 6.7.7 Error Handling

### 6.7.7.1 General

For the NSCE\_InfoCollection API, error handling shall be supported as specified in clause 6.7 of 3GPP TS 29.549 [15]. In addition, the requirements in the following clauses are applicable for the NSCE\_InfoCollection API.

### 6.7.7.2 Protocol Errors

No specific protocol errors for the NSCE\_InfoCollection API are specified.

### 6.7.7.3 Application Errors

The application errors defined for the NSCE\_InfoCollection API are listed in Table 6.7.7.3-1.

**Table 6.7.7.3-1: Application errors**

Application Error	HTTP status code	Description	Applicability

## 6.7.8 Feature negotiation

The optional features in table 6.7.8-1 are defined for the NSCE\_InfoCollection API. They shall be negotiated using the extensibility mechanism defined in clause 6.8 of 3GPP TS 29.549 [15].

**Table 6.7.8-1: Supported Features**

Feature number	Feature Name	Description
n/a		

## 6.7.9 Security

The provisions of clause 9 of 3GPP TS 29.549 [15] shall apply for the NSCE\_InfoCollection API.

## 6.8 NSCE\_ServiceContinuity API

### 6.8.1 Introduction

The NSCE\_ServiceContinuity service shall use the NSCE\_ServiceContinuity API.

The API URI of the NSCE\_ServiceContinuity Service API shall be:

**{apiRoot}/<apiName>/<apiVersion>**

The request URIs used in HTTP requests shall have the Resource URI structure defined in clause 6.5 of 3GPP TS 29.549 [15], i.e.:

**{apiRoot}/<apiName>/<apiVersion>/<apiSpecificSuffixes>**

with the following components:

- The {apiRoot} shall be set as described in clause 6.5 of 3GPP TS 29.549 [15].
- The <apiName> shall be "nsce-esc".
- The <apiVersion> shall be "v1".
- The <apiSpecificSuffixes> shall be set as described in clause 6.5 of 3GPP TS 29.549 [15].

NOTE: When 3GPP TS 29.122 [2] is referenced for the common protocol and interface aspects for API definition in the clauses under clause 6.18, the NSCE Server takes the role of the SCEF and the service consumer takes the role of the SCS/AS.

## 6.8.2 Usage of HTTP

The provisions of clause 6.3 of 3GPP TS 29.549 [15] shall apply for the NSCE\_ServiceContinuity API.

## 6.8.3 Resources

There are no resources defined for this API in this release of the specification.

## 6.8.4 Custom Operations without associated resources

### 6.8.4.1 Overview

The structure of the custom operation URIs of the NSCE\_ServiceContinuity API is shown in Figure 6.8.4.1-1.

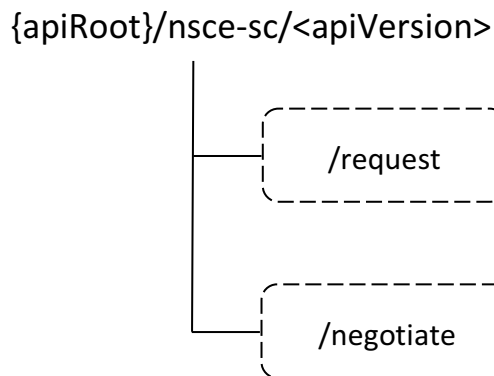

**Figure 6.8.4.1-1: Custom operation URI structure of the NSCE\_ServiceContinuity API**

Table 6.8.4.1-1 provides an overview of the custom operations and applicable HTTP methods defined for the NSCE\_ServiceContinuity API.

**Table 6.8.4.1-1: Custom operations without associated resources**

Custom operation name	Custom operation URI	Mapped HTTP method	Description
Edge Service Continuity Requirement Request	/request	POST	Enables a service consumer to request Edge service continuity requirement.
Edge Service Continuity Negotiation Request	/negotiate	POST	Enables a service consumer to request Edge service continuity negotiation.

The custom operations shall support the URI variables defined in table 6.8.4.1-2.

**Table 6.8.4.1-2: URI variables for this custom operation**

Name	Data type	Definition
apiRoot	string	See clause 6.8.1.

## 6.8.4.2 Operation: Edge Service Continuity Requirement Request

### 6.8.4.2.1 Description

The custom operation enables a service consumer to request Edge service continuity requirement to the NSCE Server.

### 6.8.4.2.2 Operation Definition

This operation shall support the request data structures specified in table 6.8.4.2.2-1 and the response data structures and response codes specified in table 6.8.4.2.2-2.

**Table 6.8.4.2.2-1: Data structures supported by the POST Request Body on this resource**

Data type	P	Cardinality	Description
EdgeSCRequirementReq	M	1	Contains the parameters to request Edge service continuity requirement.



**Table 6.8.4.2.2-2: Data structures supported by the POST Response Body on this resource**

Data type	P	Cardinality	Response codes	Description
n/a			204 No Content	The Edge Service Continuity Requirement request is successfully received and processed.
n/a			307 Temporary Redirect	Temporary redirection. The response shall include a Location header field containing an alternative target URI located in an alternative NSCE Server. Redirection handling is described in clause 5.2.10 of 3GPP TS 29.122 [2].
n/a			308 Permanent Redirect	Permanent redirection. The response shall include a Location header field containing an alternative target URI located in an alternative NSCE Server. Redirection handling is described in clause 5.2.10 of 3GPP TS 29.122 [2]
ProblemDetails	O	0..1	403 Forbidden	(NOTE 2)
NOTE 1: The mandatory HTTP error status codes for the HTTP POST method listed in table 5.2.6-1 of 3GPP TS 29.122 [2] shall also apply.				
NOTE 2: Failure causes are described in clause 6.12.7.				

**Table 6.8.4.2.2-3: Headers supported by the 307 Response Code on this resource**

Name	Data type	P	Cardinality	Description
Location	string	M	1	Contains an alternative target URI located in an alternative NSCE Server.

**Table 6.8.4.2.2-4: Headers supported by the 308 Response Code on this resource**

Name	Data type	P	Cardinality	Description
Location	string	M	1	Contains an alternative target URI located in an alternative NSCE Server.

### 6.8.4.3 Operation: Edge Service Continuity Negotiation Request

#### 6.8.4.2.1 Description

The custom operation enables a service consumer to request Edge service continuity negotiation to the NSCE Server.

#### 6.8.4.2.2 Operation Definition

This operation shall support the request data structures specified in table 6.8.4.2.2-1 and the response data structures and response codes specified in table 6.8.4.2.2-2.

**Table 6.8.4.2.2-1: Data structures supported by the POST Request Body on this resource**

Data type	P	Cardinality	Description
EdgeSCNegotiationReq	M	1	Contains the parameters to request Edge service continuity negotiation.

**Table 6.8.4.2.2-2: Data structures supported by the POST Response Body on this resource**

Data type	P	Cardinality	Response codes	Description
n/a			204 No Content	The Edge Service Continuity Negotiation request is successfully received and processed.
n/a			307 Temporary Redirect	Temporary redirection. The response shall include a Location header field containing an alternative target URI located in an alternative NSCE Server. Redirection handling is described in clause 5.2.10 of 3GPP TS 29.122 [2].
n/a			308 Permanent Redirect	Permanent redirection. The response shall include a Location header field containing an alternative target URI located in an alternative NSCE Server. Redirection handling is described in clause 5.2.10 of 3GPP TS 29.122 [2]
ProblemDetails	O	0..1	403 Forbidden	(NOTE 2)
NOTE 1: The mandatory HTTP error status codes for the HTTP POST method listed in table 5.2.6-1 of 3GPP TS 29.122 [2] shall also apply.				
NOTE 2: Failure causes are described in clause 6.12.7.				

**Table 6.8.4.2.2-3: Headers supported by the 307 Response Code on this resource**

Name	Data type	P	Cardinality	Description
Location	string	M	1	Contains an alternative target URI located in an alternative NSCE Server.

**Table 6.8.4.2.2-4: Headers supported by the 308 Response Code on this resource**

Name	Data type	P	Cardinality	Description
Location	string	M	1	Contains an alternative target URI located in an alternative NSCE Server.

## 6.8.5 Notifications

### 6.8.5.1 General

Notifications shall comply to clause 6.6 of 3GPP TS 29.549 [15].

**Table 6.8.5.1-1: Notifications overview**

Notification	Callback URI	HTTP method or custom operation	Description (service operation)
Edge Service Continuity Requirement Notification	{notifUri}	POST	This service operation enables the NSCE Server to notify a previously subscribed service consumer on Edge Service Continuity Requirement.
Edge Service Continuity Negotiation Notification	{notifUri}	POST	This service operation enables the NSCE Server to notify a previously subscribed service consumer on Edge Service Continuity Negotiation.

## 6.8.5.2 Edge Service Continuity Requirement Notification

### 6.8.5.2.1 Description

The Edge Service Continuity Requirement Notification is used by the NSCE Server to notify a previously subscribed service consumer on Edge Service Continuity Requirement Subscription.

### 6.8.5.2.2 Target URI

The Callback URI "{notifUri}" shall be used with the callback URI variables defined in table 6.8.5.2.2-1.

**Table 6.8.5.2.2-1: Callback URI variables**

Name	Definition
notifUri	Represents the callback URI encoded as a string formatted as a URI.

### 6.8.5.2.3 Standard Methods

#### 6.8.5.2.3.1 POST

This method shall support the request data structures specified in table 6.8.5.2.3.1-1 and the response data structures and response codes specified in table 6.8.5.2.3.1-2.

**Table 6.8.5.2.3.1-1: Data structures supported by the POST Request Body**

Data type	P	Cardinality	Description
EdgeSCRequirementNotif	M	1	Represents the Edge Service Continuity Requirement Notification.

**Table 6.8.5.2.3.1-2: Data structures supported by the POST Response Body**

Data type	P	Cardinality	Response codes	Description
n/a			204 No Content	Successful case. The Edge Service Continuity Requirement Notification is successfully received.
n/a			307 Temporary Redirect	Temporary redirection.  The response shall include a Location header field containing an alternative URI representing the end point of an alternative service consumer where the notification should be sent.  Redirection handling is described in clause 5.2.10 of 3GPP TS 29.122 [3].
n/a			308 Permanent Redirect	Permanent redirection.  The response shall include a Location header field containing an alternative URI representing the end point of an alternative service consumer where the notification should be sent.  Redirection handling is described in clause 5.2.10 of 3GPP TS 29.122 [3].
NOTE: The mandatory HTTP error status codes for the HTTP POST method listed in table 5.2.6-1 of 3GPP TS 29.122 [2] also apply.				

**Table 6.8.5.2.3.1-3: Headers supported by the 307 Response Code on this resource**

Name	Data type	P	Cardinality	Description
Location	string	M	1	Contains an alternative URI representing the end point of an alternative service consumer towards which the notification should be redirected.

**Table 6.8.5.2.3.1-4: Headers supported by the 308 Response Code on this resource**

Name	Data type	P	Cardinality	Description
Location	string	M	1	Contains an alternative URI representing the end point of an alternative service consumer towards which the notification should be redirected.

### 6.8.5.3 Edge Service Continuity Negotiation Notification

#### 6.8.5.3.1 Description

The Edge Service Continuity Negotiation Notification is used by the NSCE Server to notify a previously subscribed service consumer on Edge Service Continuity Negotiation.

#### 6.8.5.3.2 Target URI

The Callback URI "{notifUri}" shall be used with the callback URI variables defined in table 6.8.5.3.2-1.

**Table 6.8.5.3.2-1: Callback URI variables**

Name	Definition
notifUri	Represents the callback URI encoded as a string formatted as a URI.

#### 6.8.5.3.3 Standard Methods

##### 6.8.5.3.3.1 POST

This method shall support the request data structures specified in table 6.8.5.3.3.1-1 and the response data structures and response codes specified in table 6.8.5.3.3.1-2.

**Table 6.8.5.3.3.1-1: Data structures supported by the POST Request Body**

Data type	P	Cardinality	Description
EdgeSCNegotiationNotif	M	1	Represents the Edge Service Continuity Negotiation Notification.

**Table 6.8.5.3.3.1-2: Data structures supported by the POST Response Body**

Data type	P	Cardinality	Response codes	Description
n/a			204 No Content	Successful case. The Edge Service Continuity Negotiation Notification is successfully received.
n/a			307 Temporary Redirect	Temporary redirection.  The response shall include a Location header field containing an alternative URI representing the end point of an alternative service consumer where the notification should be sent.  Redirection handling is described in clause 5.2.10 of 3GPP TS 29.122 [3].
n/a			308 Permanent Redirect	Permanent redirection.  The response shall include a Location header field containing an alternative URI representing the end point of an alternative service consumer where the notification should be sent.  Redirection handling is described in clause 5.2.10 of 3GPP TS 29.122 [3].
NOTE: The mandatory HTTP error status codes for the HTTP POST method listed in table 5.2.6-1 of 3GPP TS 29.122 [2] also apply.				

**Table 6.8.5.3.3.1-3: Headers supported by the 307 Response Code on this resource**

Name	Data type	P	Cardinality	Description
Location	string	M	1	Contains an alternative URI representing the end point of an alternative service consumer towards which the notification should be redirected.

**Table 6.8.5.3.3.1-4: Headers supported by the 308 Response Code on this resource**

Name	Data type	P	Cardinality	Description
Location	string	M	1	Contains an alternative URI representing the end point of an alternative service consumer towards which the notification should be redirected.

## 6.8.6 Data Model

### 6.8.6.1 General

This clause specifies the application data model supported by the API.

Table 6.8.6.1-1 specifies the data types defined for the NSCE\_ServiceContinuity API.

**Table 6.8.6.1-1: NSCE\_ServiceContinuity API specific Data Types**

Data type	Clause defined	Description	Applicability
EdgeSCNegotiationNotif	6.8.6.2.5	Represents a Edge Service Continuity Negotiation Notification.	
EdgeSCNegotiationReq	6.8.6.2.4	Represents the parameters to request Edge Service Continuity Negotiation.	
EdgeSCRequirementNotif	6.8.6.2.3	Represents a Edge Service Continuity Requirement Notification.	
EdgeSCRequirementReq	6.8.6.2.2	Represents the parameters to request Edge Service Continuity Requirement.	
TriggerAction	6.8.6.3.3	Represents the trigger action.	

Table 6.8.6.1-2 specifies data types re-used by the NSCE\_ServiceContinuity API from other specifications, including a reference to their respective specifications, and when needed, a short description of their use within the NSCE\_ServiceContinuity API.

**Table 6.8.6.1-2: NSCE\_ServiceContinuity API re-used Data Types**

Data type	Reference	Comments	Applicability
AppReqs	6.12.6.2.3	Represents the application QoS requirements.	
EndPoint	3GPP TS 29.558 [25]	Represents endpoint information.	
NetSliceld	6.3.6.2.15	Identifies the S-NSSAI.	
ServArea	Clause 6.16.6.2.5	Represents a service area.	
ServContReq	6.12.6.3.3	Represents the service continuity requirement.	
SupportedFeatures	3GPP TS 29.571 [16]	Represents the list of supported feature(s) and used to negotiate the applicability of the optional features.	
Uri	3GPP TS 29.122 [2]	Represents a URI.	

## 6.8.6.2 Structured data types

### 6.8.6.2.1 Introduction

This clause defines the structures to be used in resource representations.

### 6.8.6.2.2 Type: EdgeSCRequirementReq

**Table 6.8.6.2.2-1: Definition of type EdgeSCRequirementReq**

Attribute name	Data type	P	Cardinality	Description	Applicability
notifUri	Uri	M	1	Contains the URI via which the Edge Service Continuity Requirement Notifications shall be delivered.	
valServId	string	M	1	The identifier of the VAL service for which the requirement request applies.	
valUelds	array(string)	O	1..N	The list of VAL UE IDs for which the requirement request applies.	
netSliceld	NetSliceld	O	0..1	Identifier of the network slice for which is mapped to the VAL application.	
servContReq	ServContReq	M	1	Contains the requested service continuity requirement information.	
targetServArea	ServArea	O	0..1	Contains the target service area.	
suppFeat	SupportedFeatures	C	0..1	Contains the list of supported features among the ones defined in clause 6.8.8. This attribute shall be present only when feature negotiation needs to take place.	

## 6.8.6.2.3 Type: EdgeSCRequirementNotif

**Table 6.8.6.2.3-1: Definition of type EdgeSCRequirementNotif**

Attribute name	Data type	P	Cardinality	Description	Applicability
valServId	string	M	1	The identifier of the VAL service for which the requirement request applies	
valUeIds	array(string)	O	1..N	The list of VAL UE IDs for which the requirement request applies	
netSliceId	NetSliceId	M	1	Identifier of the network slice for which is mapped to the VAL application.	
tgtNsceServId	string	M	1	Contains the identifier of the target NSCE Server.	
tgtNsceAddr	EndPoint	M	1	Contains the addressing information of the target NSCE Server.	
targetServArea	ServArea	M	1	Contains the target service area.	

## 6.8.6.2.4 Type: EdgeSCNegotiationReq

**Table 6.8.6.2.4-1: Definition of type EdgeSCNegotiationReq**

Attribute name	Data type	P	Cardinality	Description	Applicability
notifUri	Uri	M	1	Contains the URI via which the Edge Service Continuity Negotiation Notifications shall be delivered.	
valServId	string	M	1	The identifier of the VAL service for which the Negotiation request applies	
valUeIds	array(string)	O	1..N	The list of VAL UE IDs for which the negotiation request applies	
netSliceId	NetSliceId	M	1	Identifier of the network slice for which is mapped to the VAL application.	
servContReq	ServContReq	M	1	Contains the requested service continuity requirement information.	
appQoSReqs	AppReqs	O	0..1	Represents the requested application QoS requirements.	
triggerAction	TriggerAction	O	0..1	Represents the requested proposed trigger action.	
suppFeat	SupportedFeatures	C	0..1	Contains the list of supported features among the ones defined in clause 6.8.8.  This attribute shall be present only when feature negotiation needs to take place.	

## 6.8.6.2.5 Type: EdgeSCNegotiationNotif

**Table 6.8.6.2.5-1: Definition of type EdgeSCNegotiationNotif**

Attribute name	Data type	P	Cardinality	Description	Applicability
valServId	string	M	1	Represents the identifier of the VAL service to which the notification is related.	
triggerAction	TriggerAction	M	1	Represents the determined trigger action.	

## 6.8.6.3 Simple data types and enumerations

## 6.8.6.3.1 Introduction

This clause defines simple data types and enumerations that can be referenced from data structures defined in the previous clauses.

### 6.8.6.3.2 Simple data types

The simple data types defined in table 6.8.6.3.2-1 shall be supported.

**Table 6.8.6.3.2-1: Simple data types**

Type Name	Type Definition	Description	Applicability

### 6.8.6.3.3 Enumeration: TriggerAction

**Table 6.8.6.3.3-1: Enumeration TriggerAction**

Enumeration value	Description	Applicability
SLICE_LIFECYCLE_CHG	Indicates that the trigger action is slice lifecycle change.	

## 6.8.7 Error Handling

### 6.8.7.1 General

For the NSCE\_ServiceContinuity API, error handling shall be supported as specified in clause 6.7 of 3GPP TS 29.549 [15].

In addition, the requirements in the following clauses are applicable for the NSCE\_ServiceContinuity API.

### 6.8.7.2 Protocol Errors

No specific procedures for the NSCE\_ServiceContinuity API are specified.

### 6.8.7.3 Application Errors

The application errors defined for the NSCE\_ServiceContinuity API are listed in Table 6.8.7.3-1.

**Table 6.8.7.3-1: Application errors**

Application Error	HTTP status code	Description	Applicability

## 6.8.8 Feature negotiation

The optional features in table 6.1.8-1 are defined for the NSCE\_ServiceContinuity API. They shall be negotiated using the extensibility mechanism defined in clause 6.8 of 3GPP TS 29.549 [15].

**Table 6.8.8-1: Supported Features**

Feature number	Feature Name	Description

## 6.8.9 Security

The provisions of clause 9 of 3GPP TS 29.549 [15] shall apply for the NSCE\_ServiceContinuity API.



## 6.9 NSCE\_MultiSlicesOptimization API

### 6.9.1 Introduction

The NSCE\_MultiSlicesOptimization service shall use the NSCE\_MultiSlicesOptimization API.

The API URI of the NSCE\_MultiSlicesOptimization Service API shall be:

**{apiRoot}/<apiName>/<apiVersion>**

The request URIs used in HTTP requests shall have the Resource URI structure defined in clause 6.5 of 3GPP TS 29.549 [15], i.e.:

**{apiRoot}/<apiName>/<apiVersion>/<apiSpecificSuffixes>**

with the following components:

- The {apiRoot} shall be set as described in clause 6.5 of 3GPP TS 29.549 [15].
- The <apiName> shall be "nsce-mso".
- The <apiVersion> shall be "v1".
- The <apiSpecificSuffixes> shall be set as described in clause 6.5 of 3GPP TS 29.549 [15].

**NOTE:** When 3GPP TS 29.122 [2] is referenced for the common protocol and interface aspects for API definition in the clauses under clause 6.9, the NSCE Server takes the role of the SCEF and the service consumer takes the role of the SCS/AS.

### 6.9.2 Usage of HTTP

The provisions of clause 6.3 of 3GPP TS 29.549 [15] shall apply for the NSCE\_MultiSlicesOptimization API.

### 6.9.3 Resources

There are no resources defined for this API in this release of the specification.

### 6.9.4 Custom Operations without associated resources

#### 6.9.4.1 Overview

The structure of the custom operation URIs of the NSCE\_MultiSlicesOptimization API is shown in Figure 6.9.4.1-1.

{apiRoot}/nsce-mso/<apiVersion>

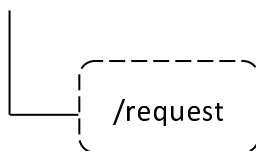

**Figure 6.9.4.1-1: Custom operation URI structure of the NSCE\_MultiSlicesOptimization API**

Table 6.9.4.1-1 provides an overview of the custom operation and applicable HTTP methods defined for the NSCE\_MultiSlicesOptimization API.

**Table 6.9.4.1-1: Custom operations without associated resources**

Operation name	Custom operation URI	Mapped HTTP method	Description
Request	/request	POST	Enables a service consumer to request multiple slices optimization.

The custom operations shall support the URI variables defined in table 6.9.4.1-2.

**Table 6.9.4.1-2: URI variables for this custom operation**

Name	Data type	Definition
apiRoot	string	See clause 6.9.1.

## 6.9.4.2 Operation: Request

### 6.9.4.2.1 Description

The custom operation enables a service consumer to request multiple slices optimization to the NSCE Server.

### 6.9.4.2.2 Operation Definition

This operation shall support the request data structures specified in table 6.9.4.2.2-1 and the response data structures and response codes specified in table 6.9.4.2.2-2.

**Table 6.9.4.2.2-1: Data structures supported by the POST Request Body for this operation**

Data type	P	Cardinality	Description
MultiSlicesOptReq	M	1	Contains the parameters to request multiple slices optimization.

**Table 6.9.4.2.2-2: Data structures supported by the POST Response Body for this operation**

Data type	P	Cardinality	Response codes	Description
n/a			204 No Content	Successful case. The multiple slices optimization request is successfully received and processed.
n/a			307 Temporary Redirect	Temporary redirection. The response shall include a Location header field containing an alternative target URI located in an alternative NSCE Server. Redirection handling is described in clause 5.2.10 of 3GPP TS 29.122 [2].
n/a			308 Permanent Redirect	Permanent redirection. The response shall include a Location header field containing an alternative target URI located in an alternative NSCE Server. Redirection handling is described in clause 5.2.10 of 3GPP TS 29.122 [2].
NOTE: The mandatory HTTP error status codes for the HTTP POST method listed in table 5.2.6-1 of 3GPP TS 29.122 [2] shall also apply.				

**Table 6.9.4.2.2-3: Headers supported by 307 Response Code for this operation**

Name	Data type	P	Cardinality	Description
Location	string	M	1	Contains an alternative target URI located in an alternative NSCE Server.

**Table 6.9.4.2.2-4: Headers supported by 308 Response Code for this operation**

Name	Data type	P	Cardinality	Description
Location	string	M	1	Contains an alternative target URI located in an alternative NSCE Server.

## 6.9.5 Notifications

There are no notifications defined for this API in this release of the specification.

## 6.9.6 Data Model

### 6.9.6.1 General

This clause specifies the application data model supported by the API.

Table 6.9.6.1-1 specifies the data types defined specifically for the NSCE\_MultiSlicesOptimization API.

**Table 6.9.6.1-1: NSCE\_MultiSlicesOptimization API specific Data Types**

Data type	Section defined	Description	Applicability
MultiSlicesOptReq	6.9.6.2.2	Represents a multiple slices optimization request.	

Table 6.9.6.1-2 specifies data types re-used by the NSCE\_MultiSlicesOptimization API from other specifications, including a reference to their respective specifications, and when needed, a short description of their use within the NSCE\_MultiSlicesOptimization API.

**Table 6.9.6.1-2: NSCE\_MultiSlicesOptimization API re-used Data Types**

Data type	Reference	Comments	Applicability
Snssai	3GPP TS 29.571 [16]	Identifies an S-NSSAI.	
SupportedFeatures	3GPP TS 29.571 [16]	Represents the list of supported feature(s) and used to negotiate the applicability of the optional features.	
ServArea	Clause 6.16.6.2.5	Represent network slice coverage area.	

### 6.9.6.2 Structured data types

#### 6.9.6.2.1 Introduction

This clause defines the data structures to be used in resource representations.

## 6.9.6.2.2 Type: MultiSlicesOptReq

**Table 6.9.6.2.2-1: Definition of type MultiSlicesOptReq**

Attribute name	Data type	P	Cardinality	Description	Applicability
valServId	string	M	1	Represents the identifier of the targeted VAL service.	
optZone	ServArea	O	0..1	Contains the preferred optimization zone, i.e., the preferred location where the performance monitoring and optimization should be performed.	
snssais	array(Snssai)	O	1..N	Contains the targeted S-NSSAI(s).	
suppFeat	SupportedFeatures	C	0..1	Contains the list of supported features among the ones defined in clause 6.9.8. This attribute shall be present only when feature negotiation needs to take place.	

## 6.9.6.3 Simple data types and enumerations

## 6.9.6.3.1 Introduction

This clause defines simple data types and enumerations that can be referenced from data structures defined in the previous clauses.

## 6.9.6.3.2 Simple data types

The simple data types defined in table 6.9.6.3.2-1 shall be supported.

**Table 6.9.6.3.2-1: Simple data types**

Type Name	Type Definition	Description	Applicability

## 6.9.6.4 Data types describing alternative data types or combinations of data types

There are no data types describing alternative data types or combinations of data types defined for this API in this release of the specification.

## 6.9.6.5 Binary data

## 6.9.6.5.1 Binary Data Types

**Table 6.9.6.5.1-1: Binary Data Types**

Name	Clause defined	Content type

## 6.9.7 Error Handling

## 6.9.7.1 General

For the NSCE\_MultiSlicesOptimization API, error handling shall be supported as specified in clause 6.7 of 3GPP TS 29.549 [15].

In addition, the requirements in the following clauses are applicable for the NSCE\_MultiSlicesOptimization API.

### 6.9.7.2 Protocol Errors

No specific protocol errors for the NSCE\_MultiSlicesOptimization API are specified.

### 6.9.7.3 Application Errors

The application errors defined for the NSCE\_MultiSlicesOptimization API are listed in Table 6.9.7.3-1.

**Table 6.9.7.3-1: Application errors**

Application Error	HTTP status code	Description	Applicability

## 6.9.8 Feature negotiation

The optional features in table 6.9.8-1 are defined for the NSCE\_MultiSlicesOptimization API. They shall be negotiated using the extensibility mechanism defined in clause 6.8 of 3GPP TS 29.549 [15].

**Table 6.9.8-1: Supported Features**

Feature number	Feature Name	Description
n/a		

## 6.9.9 Security

The provisions of clause 9 of 3GPP TS 29.549 [15] shall apply for the NSCE\_MultiSlicesOptimization API.

## 6.10 NSCE\_NetworkSliceAdaptation API

### 6.10.1 Introduction

The NSCE\_NetworkSliceAdaptation service shall use the NSCE\_NetworkSliceAdaptation API.

The API URI of the NSCE\_NetworkSliceAdaptation Service API shall be:

**{apiRoot}/<apiName>/<apiVersion>**

The request URIs used in HTTP requests shall have the Resource URI structure defined in clause 6.5 of 3GPP TS 29.549 [15], i.e.:

**{apiRoot}/<apiName>/<apiVersion>/<apiSpecificSuffixes>**

with the following components:

- The {apiRoot} shall be set as described in clause 6.5 of 3GPP TS 29.549 [15].
- The <apiName> shall be "ss-nsa".
- The <apiVersion> shall be "v1".
- The <apiSpecificSuffixes> shall be set as described in clause 6.5 of 3GPP TS 29.549 [15].

**NOTE:** When 3GPP TS 29.122 [2] is referenced for the common protocol and interface aspects for API definition in the clauses under clause 6.10, the NSCE Server takes the role of the SCEF and the service consumer takes the role of the SCS/AS.

## 6.10.2 Usage of HTTP

The provisions of clause 6.3 of 3GPP TS 29.549 [15] shall apply for the NSCE\_NetworkSliceAdaptation API.

## 6.10.3 Resources

There are no resources defined for this API in this release of the specification.

## 6.10.4 Custom Operations without associated resources

### 6.10.4.1 Overview

The structure of the custom operation URIs of the NSCE\_NetworkSliceAdaptation API is shown in Figure 6.10.4.1-1.

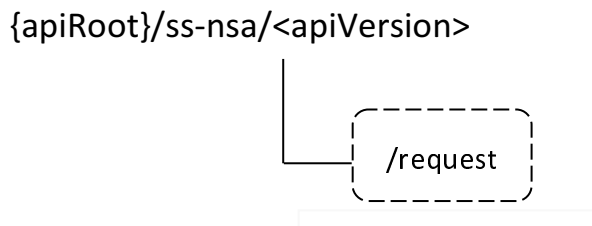

**Figure 6.10.4.1-1: Custom operation URI structure of the NSCE\_NetworkSliceAdaptation API**

Table 6.10.4.1-1 provides an overview of the custom operations and applicable HTTP methods defined for the NSCE\_NetworkSliceAdaptation API.

**Table 6.10.4.1-1: Custom operations without associated resources**

Custom operation name	Custom operation URI	Mapped HTTP method	Description
Request	/request	POST	Enables a service consumer to request network slice adaptation.

The custom operations shall support the URI variables defined in table 6.10.4.1-2.

**Table 6.10.4.1-2: URI variables for this custom operation**

Name	Data type	Definition
apiRoot	string	See clause 6.10.1.

### 6.10.4.2 Operation: Request

#### 6.10.4.2.1 Description

The custom operation enables a service consumer to request network slice adaptation to the NSCE Server.

#### 6.10.4.2.2 Operation Definition

This operation shall support the request data structures specified in table 6.10.4.2.2-1 and the response data structures and response codes specified in table 6.10.4.2.2-2.

**Table 6.10.4.2.2-1: Data structures supported by the POST Request Body on this resource**

Data type	P	Cardinality	Description
NwSliceAdptInfo	M	1	Represents the parameters to request network slice adaptation.

**Table 6.10.4.2.2-2: Data structures supported by the POST Response Body on this resource**

Data type	P	Cardinality	Response codes	Description
n/a			204 No Content	Successful case. The network slice adaptation request is successfully received and processed.
n/a			307 Temporary Redirect	Temporary redirection. The response shall include a Location header field containing an alternative target URI located in an alternative NSCE Server. Redirection handling is described in clause 5.2.10 of 3GPP TS 29.122 [2].
n/a			308 Permanent Redirect	Permanent redirection. The response shall include a Location header field containing an alternative target URI located in an alternative NSCE Server. Redirection handling is described in clause 5.2.10 of 3GPP TS 29.122 [2].
ProblemDetailsSliceAdapt	O	0..1	403 Forbidden	(NOTE 2)

NOTE 1: The mandatory HTTP error status codes for the HTTP POST method listed in table 5.2.6-1 of 3GPP TS 29.122 [2] shall also apply.

NOTE 2: Failure causes are described in clause 6.10.7.

**Table 6.10.4.2.2-3: Headers supported by the 307 Response Code on this resource**

Name	Data type	P	Cardinality	Description
Location	string	M	1	Contains an alternative target URI located in an alternative NSCE Server.

**Table 6.10.4.2.2-4: Headers supported by the 308 Response Code on this resource**

Name	Data type	P	Cardinality	Description
Location	string	M	1	Contains an alternative target URI located in an alternative NSCE Server.

## 6.10.5 Notifications

### 6.10.5.1 General

Notifications shall comply to clause 6.6 of 3GPP TS 29.549 [15].

**Table 6.10.5.1-1: Notifications overview**

Notification	Callback URI	HTTP method or custom operation	Description (service operation)
Network Slice Adaptation Status Notification	{notifUri}	POST	This service operation enables the NSCE Server to notify a previously implicitly subscribed service consumer on Network Slice Adaptation Status event(s).

## 6.10.5.2 Network Slice Adaptation Status Notification

### 6.10.5.2.1 Description

The Network Slice Adaptation Status Notification is used by the NSCE Server to notify a previously implicitly subscribed service consumer on Network Slice Adaptation Status event(s).

### 6.10.5.2.2 Target URI

The Callback URI "{notifUri}" shall be used with the callback URI variables defined in table 6.10.5.2.2-1.

**Table 6.10.5.2.2-1: Callback URI variables**

Name	Definition
notifUri	Represents the callback URI encoded as a string formatted as a URI.

### 6.10.5.2.3 Standard Methods

#### 6.10.5.2.3.1 POST

This method shall support the request data structures specified in table 6.10.5.2.3.1-1 and the response data structures and response codes specified in table 6.10.5.2.3.1-2.

**Table 6.10.5.2.3.1-1: Data structures supported by the POST Request Body**

Data type	P	Cardinality	Description
AdaptStatusNotif	M	1	Represents the Network Slice Adaptation Status Notification.

**Table 6.10.5.2.3.1-2: Data structures supported by the POST Response Body**

Data type	P	Cardinality	Response codes	Description
n/a			204 No Content	Successful case. The Network Slice Adaptation Status Notification is successfully received and processed.
n/a			307 Temporary Redirect	<p>Temporary redirection.</p> <p>The response shall include a Location header field containing an alternative URI representing the end point of an alternative service consumer where the notification should be sent.</p> <p>Redirection handling is described in clause 5.2.10 of 3GPP TS 29.122 [2].</p>
n/a			308 Permanent Redirect	<p>Permanent redirection.</p> <p>The response shall include a Location header field containing an alternative URI representing the end point of an alternative service consumer where the notification should be sent.</p> <p>Redirection handling is described in clause 5.2.10 of 3GPP TS 29.122 [2].</p>
NOTE: The mandatory HTTP error status codes for the HTTP POST method listed in table 5.2.6-1 of 3GPP TS 29.122 [2] shall also apply.				



**Table 6.10.5.2.3.1-3: Headers supported by the 307 Response Code on this resource**

Name	Data type	P	Cardinality	Description
Location	string	M	1	Contains an alternative URI representing the end point of an alternative service consumer towards which the notification should be redirected.

**Table 6.10.5.2.3.1-4: Headers supported by the 308 Response Code on this resource**

Name	Data type	P	Cardinality	Description
Location	string	M	1	Contains an alternative URI representing the end point of an alternative service consumer towards which the notification should be redirected.

## 6.10.6 Data Model

### 6.10.6.1 General

This clause specifies the application data model supported by the API.

Table 6.10.6.1-1 specifies the data types defined for the NSCE\_NetworkSliceAdaptation API.

**Table 6.10.6.1-1: NSCE\_NetworkSliceAdaptation API specific Data Types**

Data type	Clause defined	Description	Applicability
AdaptFailCause	6.10.6.3.2	Represents the network slice adaptation failure cause.	
AdaptStatusNotif	6.10.6.2.4	Represents a Network Slice Adaptation Status Notification.	
AdaptThresholdName	6.10.6.3.2	Represents the name of the adaptation threshold.	NetSliceAdapt_Ext1
AdaptThreshold	6.10.6.2.3	Represents the network slice adaptation threshold.	NetSliceAdapt_Ext1
AdaptThresholdValue	6.10.6.3.2	Represents the value of the adaptation threshold.	NetSliceAdapt_Ext1
NwSliceAdptInfo	6.10.6.2.2	Represents the information associated with requested network slice adaptation with the underlying network.	
ProblemDetailsSliceAdapt	6.10.6.4.1	Represents an extension to the ProblemDetails data structure with potentially additional error information related to network slice adaptation failure.	

Table 6.10.6.1-2 specifies data types re-used by the NSCE\_NetworkSliceAdaptation API from other specifications, including a reference to their respective specifications, and when needed, a short description of their use within the NSCE\_NetworkSliceAdaptation API.

**Table 6.10.6.1-2: NSCE\_NetworkSliceAdaptation API re-used Data Types**

Data type	Reference	Comments	Applicability
Dnn	3GPP TS 29.571 [16]	Represents a DNN.	
NetSliceId	6.3.6.2.15	Represents the identification information of a network slice.	
ProblemDetails	3GPP TS 29.122 [2]	Represents error related information.	
Snssai	3GPP TS 29.571 [16]	Represents an S-NSSAI.	
SupportedFeatures	3GPP TS 29.571 [16]	Represents the list of supported feature(s) and used to negotiate the applicability of the optional features.	
Uri	3GPP TS 29.122 [2]	Represents a URI.	

6.10.6.2 Structured data types

6.10.6.2.1 Introduction

This clause defines the data structures to be used in resource representations.

6.10.6.2.2 Type: NwSliceAdptInfo

**Table 6.10.6.2.2-1: Definition of type NwSliceAdptInfo**

Attribute name	Data type	P	Cardinality	Description	Applicability
valServiceId	string	M	1	Contains the VAL service ID of the VAL application for which the network slice adaptation may corresponds to.	
valTgtUeIds	array(string)	M	1..N	Contains the list of the identifier(s) the VAL UE(s) within the VAL service to which the slice adaptation request relates.	
snssai	Snssai	O	0..1	Contains the new S-NSSAI that is requested.  (NOTE)	
netSliceId	NetSliceId	O	0..1	Contains the identifier(s) of the requested network slice.  (NOTE)	NetSliceAdapt_Ext1
monNetSliceIds	array(NetSliceId)	O	1..N	Contains the identifier(s) of the network slice(s) that are provisioned for the VAL UE(s) (identified by the "valTgtUeIds" attribute) and are to be monitored.	NetSliceAdapt_Ext1
dnn	Dnn	O	0..1	Contains the requested DNN.	
reqAdaptThres	array(AdaptThres hold)	O	1..N	Contains the requested network slice adaptation threshold(s).	NetSliceAdapt_Ext1
notifUri	Uri	C	0..1	Contains the URI via which the Network Slice Adaptation Status Notifications shall be delivered.  This attribute shall be present when Network Slice Adaptation Status event(s) reporting is required.	NetSliceAdapt_Ext1
suppFeat	SupportedFeatures	O	0..1	This parameter shall be supplied by VAL server in the POST request that requests the network slice adaptation and shall be supplied in the reply of corresponding request.	
NOTE: When the "NetSliceAdapt_Ext1" feature is supported, these attributes are mutually exclusive. Either one of them may be present.					

\*\*\* Next changes \*\*\*

6.10.6.2.3 Type: AdaptThreshold

**Table 6.10.6.2.3-1: Definition of type AdaptThreshold**

Attribute name	Data type	P	Cardinality	Description	Applicability
threshName	AdaptThresholdName	M	1	Contains the name of the adaptation threshold.	
threshValue	AdaptThresholdValue	M	1	Contains the value of the adaptation threshold identified by the "threshName" attribute.	

\*\*\* Next changes \*\*\*

## 6.10.6.2.4 Type: AdaptStatusNotif

Table 6.10.6.2.4-1: Definition of type AdaptStatusNotif

Attribute name	Data type	P	Cardinality	Description	Applicability
status	boolean	M	1	Contains the network slice adaptation status. It indicates whether the network slice adaptation was successful or not, i.e.: - "true" means that the network slice adaptation was successful. - "false" means that the network slice adaptation failed.	
failureCause	AdaptFailCause	C	0..1	Contains the network slice adaptation failure cause.  This attribute shall be present only when the "status" attribute is set to "false" (i.e., the network slice adaptation failed).	

## 6.10.6.3 Simple data types and enumerations

## 6.10.6.3.1 Introduction

This clause defines simple data types and enumerations that can be referenced from data structures defined in the previous clauses.

## 6.10.6.3.2 Simple data types

The simple data types defined in table 6.10.6.3.2-1 shall be supported.

**Table 6.10.6.3.2-1: Simple data types**

Type Name	Type Definition	Description	Applicability
AdaptFailCause	string	Represents the network slice adaptation failure cause (e.g., insufficient resources at the target network slice and/or DNN, policy conflict, billing related issues, etc.).	
AdaptThresholdName	string	Represents the name of the metric to be used as an adaptation threshold, which shall be either: <ul style="list-style-type: none"> <li>- one of the packet delay performance metrics (e.g., "Average delay DL air-interface", "Average delay UL on over-the-air interface") defined in clause 5.1.1.1 of 3GPP TS 28.552 [23].</li> <li>- one of the radio resource utilization performance metrics (e.g., "DL Total PRB Usage", "UL Total PRB Usage") defined in clause 5.1.1.2 of 3GPP TS 28.552 [23].</li> <li>- one of the UE throughput performance metrics (e.g., "Average DL UE throughput in gNB", "Average UL UE throughput in gNB") defined in clause 5.1.1.3 of 3GPP TS 28.552 [23].</li> <li>- one of the integrity KPIs (e.g., "Downlink latency in gNB-DU", "Downlink delay in NG-RAN for a sub-network") defined in clause 6.3 of 3GPP TS 28.554 [24].</li> <li>- one of the E2E latency analysis metrics (e.g., "Average e2e UL/DL delay for a network slice") defined in clause 8.4.2.4 of 3GPP TS 28.104 [22].</li> <li>- one of the network slice load analysis metrics (e.g., "Number of PDU sessions of network slice") defined in clause 8.4.2.5 of 3GPP TS 28.104 [22].</li> </ul> The title of the clause or table cell defining the metric shall be used as the value of this data type, as indicated by the above examples.	
AdaptThresholdValue	string	Represents the name of the metric to be used as an adaptation threshold, which shall be encoded as specified in the corresponding metric definition in clause 5.1.1.1, 5.1.1.2 or 5.1.1.3 of 3GPP TS 28.552 [23], clause 6.3 of 3GPP TS 28.554 [24] or clause 8.4.2.4 or 8.4.2.5 of 3GPP TS 28.104 [22].	

6.10.6.4 Data types describing alternative data types or combinations of data types

6.10.6.4.1 Type: ProblemDetailsSliceAdapt

**Table 6.10.6.4.1-1: Definition of type ProblemDetailsSliceAdapt as a list of to be combined data types**

Data type	Cardinality	Description	Applicability
ProblemDetails	1	Contains the details of the encountered problem, as defined in 3GPP TS 29.571 [15].	
AdaptFailCause	0..1	Contains the network slice adaptation failure cause.	

6.10.6.5 Binary data

6.10.6.5.1 Binary Data Types

**Table 6.10.6.5.1-1: Binary Data Types**

Name	Clause defined	Content type

## 6.10.7 Error Handling

### 6.10.7.1 General

For the NSCE\_NetworkSliceAdaptation API, error handling shall be supported as specified in clause 6.7 of 3GPP TS 29.549 [15].

In addition, the requirements in the following clauses are applicable for the NSCE\_NetworkSliceAdaptation API.

### 6.10.7.2 Protocol Errors

No specific protocol errors for the NSCE\_NetworkSliceAdaptation API are specified.

### 6.10.7.3 Application Errors

The application errors defined for the NSCE\_NetworkSliceAdaptation API are listed in Table 6.10.7.3-1.

**Table 6.10.7.3-1: Application errors**

Application Error	HTTP status code	Description	Applicability
ADAPTATION_FAILURE	403 Forbidden	Indicates that the requested network slice adaptation failed.	

## 6.10.8 Feature negotiation

The optional features listed in table 6.10.8-1 are defined for the NSCE\_NetworkSliceAdaptation API. They shall be negotiated using the extensibility mechanism defined in clause 6.8 of 3GPP TS 29.549 [15].

**Table 6.10.8-1: Supported Features**

Feature number	Feature Name	Description
1	NetSliceAdapt_Ext1	<p>This feature indicates the support of the enhancements to the Network Slice Adaptation functionality as part of the definition of the Network Slice Capability Exposure for Application Layer Enablement.</p> <p>The following functionalities are supported:</p> <ul style="list-style-type: none"> <li>- Support that network slice adaptation is triggered only for a list of monitored network slice(s) and/or based on network slice adaptation thresholds.</li> </ul>

## 6.10.9 Security

The provisions of clause 9 of 3GPP TS 29.549 [15] shall apply for the NSCE\_NetworkSliceAdaptation API.

## 6.11 NSCE\_SliceCommService API

### 6.11.1 Introduction

The NSCE\_SliceCommService service shall use the NSCE\_SliceCommService API.

The API URI of the NSCE\_SliceCommService Service API shall be:

**{apiRoot}/<apiName>/<apiVersion>**

The request URIs used in HTTP requests shall have the Resource URI structure defined in clause 6.5 of 3GPP TS 29.549 [15], i.e.:

**{apiRoot}/<apiName>/<apiVersion>/<apiSpecificSuffixes>**

with the following components:

- The {apiRoot} shall be set as described in clause 6.5 of 3GPP TS 29.549 [15].
- The <apiName> shall be "nsce-scs".
- The <apiVersion> shall be "v1".
- The <apiSpecificSuffixes> shall be set as described in clause 6.5 of 3GPP TS 29.549 [15].

**NOTE:** When 3GPP TS 29.122 [2] is referenced for the common protocol and interface aspects for API definition in the clauses under clause 6.11, the NSCE Server takes the role of the SCEF and the service consumer takes the role of the SCS/AS.

## 6.11.2 Usage of HTTP

The provisions of clause 6.3 of 3GPP TS 29.549 [15] shall apply for the NSCE\_SliceCommService API.

## 6.11.3 Resources

### 6.11.3.1 Overview

This clause describes the structure for the Resource URIs and the resources and methods used for the service.

Figure 6.11.3.1-1 depicts the resource URIs structure for the NSCE\_SliceCommService API.

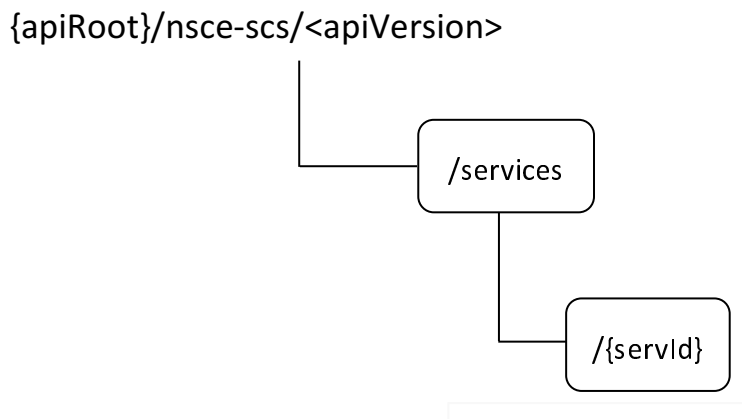

**Figure 6.11.3.1-1: Resource URIs structure of the NSCE\_SliceCommService API**

Table 6.11.3.1-1 provides an overview of the resources and applicable HTTP methods for the NSCE\_SliceCommService API.

**Table 6.11.3.1-1: Resources and methods overview**

Resource name	Resource URI	HTTP method or custom operation	Description
Slice Related Communication Services	/services	POST	Request the creation of a Slice Related Communication Service.
Individual Slice Related Communication Service	/services/{servId}	GET	Retrieve an existing "Individual Slice Related Communication Service" resource.
		PUT	Request the update of an existing "Individual Slice Related Communication Service" resource.
		PATCH	Request the modification of an existing "Individual Slice Related Communication Service" resource.
		DELETE	Request the deletion of an existing "Individual Slice Related Communication Service" resource.

### 6.11.3.2 Resource: Slice Related Communication Services

#### 6.11.3.2.1 Description

This resource represents the collection of Slice Related Communication Services managed by the NSCE Server.

#### 6.11.3.2.2 Resource Definition

Resource URI: **{apiRoot}/nsce-scs/<apiVersion>/services**

This resource shall support the resource URI variables defined in table 6.11.3.2.2-1.

**Table 6.11.3.2.2-1: Resource URI variables for this resource**

Name	Data type	Definition
apiRoot	string	See clause 6.11.1.

### 6.11.3.2.3 Resource Standard Methods

#### 6.11.3.2.3.1 POST

The HTTP POST method allows a service consumer to request the creation of a Slice Related Communication Service at the NSCE Server.

This method shall support the URI query parameters specified in table 6.11.3.2.3.1-1.

**Table 6.11.3.2.3.1-1: URI query parameters supported by the POST method on this resource**

Name	Data type	P	Cardinality	Description	Applicability
n/a					

This method shall support the request data structures specified in table 6.11.3.2.3.1-2 and the response data structures and response codes specified in table 6.11.3.2.3.1-3.

**Table 6.11.3.2.3.1-2: Data structures supported by the POST Request Body on this resource**

Data type	P	Cardinality	Description
SliceCommService	M	1	Represents the parameters to request the creation of a Slice Related Communication Service.

**Table 6.11.3.2.3.1-3: Data structures supported by the POST Response Body on this resource**

Data type	P	Cardinality	Response codes	Description
SliceCommService	M	1	201 Created	Successful case. The Slice Related Communication Service is successfully created and a representation of the created "Individual Slice Related Communication Service" resource shall be returned.  An HTTP "Location" header that contains the URI of the created resource shall also be included.
ProblemDetails	O	0..1	403 Forbidden	(NOTE 2)
NOTE 1: The mandatory HTTP error status codes for the HTTP POST method listed in table 5.2.6-1 of 3GPP TS 29.122 [2] shall also apply.				
NOTE 2: Failure causes are described in clause 6.11.7.				

**Table 6.11.3.2.3.1-4: Headers supported by the 201 Response Code on this resource**

Name	Data type	P	Cardinality	Description
Location	string	M	1	Contains the URI of the newly created resource, according to the structure: {apiRoot}/nsce-scs/<apiVersion>/services/{servId}

#### 6.11.3.2.4 Resource Custom Operations

There are no resource custom operations defined for this resource in this release of the specification.

### 6.11.3.3 Resource: Individual Slice Related Communication Service

#### 6.11.3.3.1 Description

This resource represents a Slice Related Communication Service managed by the NSCE Server.

#### 6.11.3.3.2 Resource Definition

Resource URI: {apiRoot}/nsce-scs/<apiVersion>/services/{servId}

This resource shall support the resource URI variables defined in table 6.11.3.3.2-1.

**Table 6.11.3.3.2-1: Resource URI variables for this resource**

Name	Data type	Definition
apiRoot	string	See clause 6.11.1.
servId	string	Represents the identifier of the "Individual Slice Related Communication Service" resource.

#### 6.11.3.3.3 Resource Standard Methods

##### 6.11.3.3.3.1 GET

The HTTP GET method allows a service consumer to retrieve an existing "Individual Slice Related Communication Service" resource at the NSCE Server.



This method shall support the URI query parameters specified in table 6.11.3.3.3.1-1.

**Table 6.11.3.3.3.1-1: URI query parameters supported by the GET method on this resource**

Name	Data type	P	Cardinality	Description	Applicability
n/a					

This method shall support the request data structures specified in table 6.11.3.3.3.1-2 and the response data structures and response codes specified in table 6.11.3.3.3.1-3.

**Table 6.11.3.3.3.1-2: Data structures supported by the GET Request Body on this resource**

Data type	P	Cardinality	Description
n/a			

**Table 6.11.3.3.3.1-3: Data structures supported by the GET Response Body on this resource**

Data type	P	Cardinality	Response codes	Description
SliceCommService	M	1	200 OK	Successful case. The requested "Individual Slice Related Communication Service" resource shall be returned.
n/a			307 Temporary Redirect	Temporary redirection. The response shall include a Location header field containing an alternative URI of the resource located in an alternative NSCE Server. Redirection handling is described in clause 5.2.10 of 3GPP TS 29.122 [2].
n/a			308 Permanent Redirect	Permanent redirection. The response shall include a Location header field containing an alternative URI of the resource located in an alternative NSCE Server. Redirection handling is described in clause 5.2.10 of 3GPP TS 29.122 [2].
NOTE: The mandatory HTTP error status codes for the HTTP GET method listed in table 5.2.6-1 of 3GPP TS 29.122 [2] shall also apply.				

**Table 6.11.3.3.3.1-4: Headers supported by the 307 Response Code on this resource**

Name	Data type	P	Cardinality	Description
Location	string	M	1	Contains an alternative URI of the resource located in an alternative NSCE Server.

**Table 6.11.3.3.3.1-5: Headers supported by the 308 Response Code on this resource**

Name	Data type	P	Cardinality	Description
Location	string	M	1	Contains an alternative URI of the resource located in an alternative NSCE Server.

#### 6.11.3.3.3.2 PUT

The HTTP PUT method allows a service consumer to request the update of an existing "Individual Slice Related Communication Service" resource at the NSCE Server.

This method shall support the URI query parameters specified in table 6.11.3.3.3.2-1.

**Table 6.11.3.3.2-1: URI query parameters supported by the PUT method on this resource**

Name	Data type	P	Cardinality	Description	Applicability
n/a					

This method shall support the request data structures specified in table 6.11.3.3.2-2 and the response data structures and response codes specified in table 6.11.3.3.2-3.

**Table 6.11.3.3.2-2: Data structures supported by the PUT Request Body on this resource**

Data type	P	Cardinality	Description
SliceCommService	M	1	Represents the updated representation of the "Individual Slice Related Communication Service" resource.

**Table 6.11.3.3.2-3: Data structures supported by the PUT Response Body on this resource**

Data type	P	Cardinality	Response codes	Description
SliceCommService	M	1	200 OK	Successful case. The "Individual Slice Related Communication Service" resource is successfully updated and a representation of the updated resource shall be returned in the response body.
n/a			307 Temporary Redirect	Temporary redirection. The response shall include a Location header field containing an alternative URI of the resource located in an alternative NSCE Server. Redirection handling is described in clause 5.2.10 of 3GPP TS 29.122 [2].
n/a			308 Permanent Redirect	Permanent redirection. The response shall include a Location header field containing an alternative URI of the resource located in an alternative NSCE Server. Redirection handling is described in clause 5.2.10 of 3GPP TS 29.122 [2].
ProblemDetails	O	0..1	403 Forbidden	(NOTE 2)
NOTE 1: The mandatory HTTP error status codes for the HTTP PUT method listed in table 5.2.6-1 of 3GPP TS 29.122 [2] shall also apply.				
NOTE 2: Failure causes are described in clause 6.11.7.				

**Table 6.11.3.3.2-4: Headers supported by the 307 Response Code on this resource**

Name	Data type	P	Cardinality	Description
Location	string	M	1	Contains an alternative URI of the resource located in an alternative NSCE Server.

**Table 6.11.3.3.2-5: Headers supported by the 308 Response Code on this resource**

Name	Data type	P	Cardinality	Description
Location	string	M	1	Contains an alternative URI of the resource located in an alternative NSCE Server.

### 6.11.3.3.3.3 PATCH

The HTTP PATCH method allows a service consumer to request the modification of an existing "Individual Slice Related Communication Service" resource at the NSCE Server.

This method shall support the URI query parameters specified in table 6.11.3.3.3.3-1.

**Table 6.11.3.3.3.3-1: URI query parameters supported by the PATCH method on this resource**

Name	Data type	P	Cardinality	Description	Applicability
n/a					

This method shall support the request data structures specified in table 6.11.3.3.3.3-2 and the response data structures and response codes specified in table 6.11.3.3.3.3-3.

**Table 6.11.3.3.3.3-2: Data structures supported by the PATCH Request Body on this resource**

Data type	P	Cardinality	Description
SliceCommServicePatch	M	1	Represents the parameters to request the modification of the "Individual Slice Related Communication Service" resource.

**Table 6.11.3.3.3.3-3: Data structures supported by the PATCH Response Body on this resource**

Data type	P	Cardinality	Response codes	Description
SliceCommService	M	1	200 OK	Successful case. The "Individual Slice Related Communication Service" resource is successfully modified and a representation of the updated resource shall be returned in the response body.
n/a			307 Temporary Redirect	Temporary redirection. The response shall include a Location header field containing an alternative URI of the resource located in an alternative NSCE Server. Redirection handling is described in clause 5.2.10 of 3GPP TS 29.122 [2].
n/a			308 Permanent Redirect	Permanent redirection. The response shall include a Location header field containing an alternative URI of the resource located in an alternative NSCE Server. Redirection handling is described in clause 5.2.10 of 3GPP TS 29.122 [2].
ProblemDetails	O	0..1	403 Forbidden	(NOTE 2)
NOTE 1: The mandatory HTTP error status codes for the HTTP PATCH method listed in table 5.2.6-1 of 3GPP TS 29.122 [2] shall also apply.				
NOTE 2: Failure causes are described in clause 6.11.7.				

**Table 6.11.3.3.3.3-4: Headers supported by the 307 Response Code on this resource**

Name	Data type	P	Cardinality	Description
Location	string	M	1	Contains an alternative URI of the resource located in an alternative NSCE Server.

**Table 6.11.3.3.3.3-5: Headers supported by the 308 Response Code on this resource**

Name	Data type	P	Cardinality	Description
Location	string	M	1	Contains an alternative URI of the resource located in an alternative NSCE Server.

## 6.11.3.3.4 DELETE

The HTTP DELETE method allows a service consumer to request the deletion of an existing "Individual Slice Related Communication Service" resource at the NSCE Server.

This method shall support the URI query parameters specified in table 6.11.3.3.4-1.

**Table 6.11.3.3.4-1: URI query parameters supported by the DELETE method on this resource**

Name	Data type	P	Cardinality	Description	Applicability
n/a					

This method shall support the request data structures specified in table 6.11.3.3.4-2 and the response data structures and response codes specified in table 6.11.3.3.4-3.

**Table 6.11.3.3.4-2: Data structures supported by the DELETE Request Body on this resource**

Data type	P	Cardinality	Description
n/a			

**Table 6.11.3.3.4-3: Data structures supported by the DELETE Response Body on this resource**

Data type	P	Cardinality	Response codes	Description
n/a			204 No Content	Successful case. The "Individual Slice Related Communication Service" resource is successfully deleted.
n/a			307 Temporary Redirect	Temporary redirection. The response shall include a Location header field containing an alternative URI of the resource located in an alternative NSCE Server. Redirection handling is described in clause 5.2.10 of 3GPP TS 29.122 [2].
n/a			308 Permanent Redirect	Permanent redirection. The response shall include a Location header field containing an alternative URI of the resource located in an alternative NSCE Server. Redirection handling is described in clause 5.2.10 of 3GPP TS 29.122 [2].
NOTE: The mandatory HTTP error status codes for the HTTP DELETE method listed in table 5.2.6-1 of 3GPP TS 29.122 [2] shall also apply.				

**Table 6.11.3.3.4-4: Headers supported by the 307 Response Code on this resource**

Name	Data type	P	Cardinality	Description
Location	string	M	1	Contains an alternative URI of the resource located in an alternative NSCE Server.

**Table 6.11.3.3.4-5: Headers supported by the 308 Response Code on this resource**

Name	Data type	P	Cardinality	Description
Location	string	M	1	Contains an alternative URI of the resource located in an alternative NSCE Server.

## 6.11.3.3.4 Resource Custom Operations

There are no resource custom operations defined for this resource in this release of the specification.

## 6.11.4 Custom Operations without associated resources

There are no custom operations without associated resources defined for this API in this release of the specification.

## 6.11.5 Notifications

There are no notifications defined for this API in this release of the specification.

## 6.11.6 Data Model

### 6.11.6.1 General

This clause specifies the application data model supported by the API.

Table 6.11.6.1-1 specifies the data types defined for the NSCE\_SliceCommService API.

**Table 6.11.6.1-1: NSCE\_SliceCommService API specific Data Types**

Data type	Clause defined	Description	Applicability
NetSliceInfo	6.11.6.2.5	Represents network slice related information.	
ServReq	6.11.6.2.4	Represents a set of application service requirements.	
SliceCommService	6.11.6.2.2	Represents a Slice Related Communication Service.	
SliceCommServicePatch	6.11.6.2.3	Represents the requested modifications to a Slice Related Communication Service.	

Table 6.11.6.1-2 specifies data types re-used by the NSCE\_SliceCommService API from other specifications, including a reference to their respective specifications, and when needed, a short description of their use within the NSCE\_SliceCommService API.

**Table 6.11.6.1-2: NSCE\_SliceCommService API re-used Data Types**

Data type	Reference	Comments	Applicability
ProblemDetails	3GPP TS 29.122 [2]	Represents error related information.	
ServiceProfile	3GPP TS 28.541 [19]	Represents the service profile containing the properties of the network slice related requirements.	
ServArea	Clause 6.16.6.2.5	Represents a network slice service area.	
Snsai	3GPP TS 29.571 [18]	Represents an S-NSSAI.	
SupportedFeatures	3GPP TS 29.571 [18]	Represents the list of supported feature(s) and used to negotiate the applicability of the optional features.	

### 6.11.6.2 Structured data types

#### 6.11.6.2.1 Introduction

This clause defines the data structures to be used in resource representations.

## 6.11.6.2.2 Type: SliceCommService

**Table 6.11.6.2.2-1: Definition of type SliceCommService**

Attribute name	Data type	P	Cardinality	Description	Applicability
valServName	string	M	1	Contains the name of the target VAL service.	
valServId	string	M	1	Contains the identifier of the targeted VAL service.	
areaOfInterest	ServArea	M	1	Contains the service area within which the requested VAL service profile applies.	
servProfile	map(ServReq)	M	1..N	Represents the requested VAL service profile containing the application requirements of the VAL service to be supported.  The key of the map shall be any unique string encoded value.	
sliceInfo	NetSliceInfo	C	1..N	Contains the information of the network slice determined and assigned to fulfill the received application service requirements.  This attribute shall be present only in a response to a Slice Related Communication Service Creation or Reconfiguration request.	
suppFeat	SupportedFeatures	C	0..1	Contains the list of supported features among the ones defined in clause 6.11.8.  This attribute shall be present only when feature negotiation needs to take place.	

## 6.11.6.2.3 Type: SliceCommServicePatch

**Table 6.11.6.2.3-1: Definition of type SliceCommServicePatch**

Attribute name	Data type	P	Cardinality	Description	Applicability
areaOfInterest	ServArea	O	0..1	Contains the updated service area within which the requested VAL service profile applies.	
servProfile	map(ServReq)	O	1..N	Represents the updated requested VAL service profile containing the application requirements of the VAL service to be supported.  The key of the map shall be any unique string encoded value and shall be set to the same value as the one provided during the creation of the corresponding Slice Related Communication Service.	

## 6.11.6.2.4 Type: ServReq

**Table 6.11.6.2.4-1: Definition of type ServReq**

Attribute name	Data type	P	Cardinality	Description	Applicability
reqName	string	M	1	Contains the requirement name.	
reqValue	string	M	1	Contains the requirement value.	

## 6.11.6.2.5 Type: NetSliceInfo

**Table 6.11.6.2.5-1: Definition of type NetSliceInfo**

Attribute name	Data type	P	Cardinality	Description	Applicability
snssai	Snssai	C	0..1	Contains the S-NSSAI of the network slice. (NOTE)	
attributes	ServiceProfile	C	0..1	Contains the attributes (i.e., parameters and characteristics) of the network slice. (NOTE)	
NOTE: At least one of these attributes shall be present.					

## 6.11.6.3 Simple data types and enumerations

## 6.11.6.3.1 Introduction

This clause defines simple data types and enumerations that can be referenced from data structures defined in the previous clauses.

## 6.11.6.3.2 Simple data types

The simple data types defined in table 6.11.6.3.2-1 shall be supported.

**Table 6.11.6.3.2-1: Simple data types**

Type Name	Type Definition	Description	Applicability

## 6.11.6.4 Data types describing alternative data types or combinations of data types

There are no data types describing alternative data types or combinations of data types defined for this API in this release of the specification.

## 6.11.6.5 Binary data

## 6.11.6.5.1 Binary Data Types

**Table 6.11.6.5.1-1: Binary Data Types**

Name	Clause defined	Content type

## 6.11.7 Error Handling

## 6.11.7.1 General

For the NSCE\_SliceCommService API, error handling shall be supported as specified in clause 6.7 of 3GPP TS 29.549 [15].

In addition, the requirements in the following clauses are applicable for the NSCE\_SliceCommService API.

## 6.11.7.2 Protocol Errors

No specific protocol errors for the NSCE\_SliceCommService API are specified.

### 6.11.7.3 Application Errors

The application errors defined for the NSCE\_SliceCommService API are listed in Table 6.11.7.3-1.

**Table 6.11.7.3-1: Application errors**

Application Error	HTTP status code	Description	Applicability
INSUFFICIENT_RESOURCES	403 Forbidden	Indicates that the requested Slice Related Communication Service creation/reconfiguration is rejected because it exceeds the existing available network slice resources within the network.	

### 6.11.8 Feature negotiation

The optional features listed in table 6.11.8-1 are defined for the NSCE\_SliceCommService API. They shall be negotiated using the extensibility mechanism defined in clause 6.8 of 3GPP TS 29.549 [15].

**Table 6.11.8-1: Supported Features**

Feature number	Feature Name	Description

### 6.11.9 Security

The provisions of clause 9 of 3GPP TS 29.549 [15] shall apply for the NSCE\_SliceCommService API.

## 6.12 NSCE\_InterPLMNContinuity API

### 6.12.1 Introduction

The NSCE\_InterPLMNContinuity service shall use the NSCE\_InterPLMNContinuity API.

The API URI of the NSCE\_InterPLMNContinuity Service API shall be:

**{apiRoot}/<apiName>/<apiVersion>**

The request URIs used in HTTP requests shall have the Resource URI structure defined in clause 6.5 of 3GPP TS 29.549 [15], i.e.:

**{apiRoot}/<apiName>/<apiVersion>/<apiSpecificSuffixes>**

with the following components:

- The {apiRoot} shall be set as described in clause 6.5 of 3GPP TS 29.549 [15].
- The <apiName> shall be "nsce-ipc".
- The <apiVersion> shall be "v1".
- The <apiSpecificSuffixes> shall be set as described in clause 6.5 of 3GPP TS 29.549 [15].

**NOTE:** When 3GPP TS 29.122 [2] is referenced for the common protocol and interface aspects for API definition in the clauses under clause 6.12, the NSCE Server takes the role of the SCEF and the service consumer takes the role of the SCS/AS.

### 6.12.2 Usage of HTTP

The provisions of clause 6.3 of 3GPP TS 29.549 [15] shall apply for the NSCE\_InterPLMNContinuity API.



## 6.12.3 Resources

There are no resources defined for this API in this release of the specification.

## 6.12.4 Custom Operations without associated resources

### 6.12.4.1 Overview

The structure of the custom operation URIs of the NSCE\_InterPLMNContinuity API is shown in Figure 6.12.4.1-1.

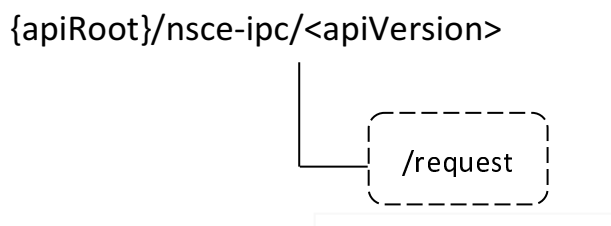

**Figure 6.12.4.1-1: Custom operation URI structure of the NSCE\_InterPLMNContinuity API**

Table 6.12.4.1-1 provides an overview of the custom operations and applicable HTTP methods defined for the NSCE\_InterPLMNContinuity API.

**Table 6.12.4.1-1: Custom operations without associated resources**

Custom operation name	Custom operation URI	Mapped HTTP method	Description
Request	/request	POST	Enables a service consumer to request inter-PLMN application service continuity.

The custom operations shall support the URI variables defined in table 6.12.4.1-2.

**Table 6.12.4.1-2: URI variables for this custom operation**

Name	Data type	Definition
apiRoot	string	See clause 6.12.1.

### 6.12.4.2 Operation: Request

#### 6.12.4.2.1 Description

The custom operation enables a service consumer to request inter-PLMN application service continuity to the NSCE Server.

#### 6.12.4.2.2 Operation Definition

This operation shall support the request data structures specified in table 6.12.4.2.2-1 and the response data structures and response codes specified in table 6.12.4.2.2-2.

**Table 6.12.4.2.2-1: Data structures supported by the POST Request Body on this resource**

Data type	P	Cardinality	Description
InterPlmnServCo ntReq	M	1	Contains the parameters to request inter-PLMN application service continuity.

**Table 6.12.4.2.2-2: Data structures supported by the POST Response Body on this resource**

Data type	P	Cardinality	Response codes	Description
n/a			204 No Content	The inter-PLMN application service continuity request is successfully received and processed.
n/a			307 Temporary Redirect	Temporary redirection. The response shall include a Location header field containing an alternative target URI located in an alternative NSCE Server. Redirection handling is described in clause 5.2.10 of 3GPP TS 29.122 [2].
n/a			308 Permanent Redirect	Permanent redirection. The response shall include a Location header field containing an alternative target URI located in an alternative NSCE Server. Redirection handling is described in clause 5.2.10 of 3GPP TS 29.122 [2]
ProblemDetails	O	0..1	403 Forbidden	(NOTE 2)
NOTE 1: The mandatory HTTP error status codes for the HTTP POST method listed in table 5.2.6-1 of 3GPP TS 29.122 [2] shall also apply.				
NOTE 2: Failure causes are described in clause 6.12.7.				

**Table 6.12.4.2.2-3: Headers supported by the 307 Response Code on this resource**

Name	Data type	P	Cardinality	Description
Location	string	M	1	Contains an alternative target URI located in an alternative NSCE Server.

**Table 6.12.4.2.2-4: Headers supported by the 308 Response Code on this resource**

Name	Data type	P	Cardinality	Description
Location	string	M	1	Contains an alternative target URI located in an alternative NSCE Server.

## 6.12.5 Notifications

### 6.12.5.1 General

Notifications shall comply to clause 6.6 of 3GPP TS 29.549 [15].

**Table 6.12.5.1-1: Notifications overview**

Notification	Callback URI	HTTP method or custom operation	Description (service operation)
Inter-PLMN Service Continuity Notification	{notifUri}	POST	This service operation enables a NSCE Server to notify a previously subscribed service consumer on inter-PLMN application service continuity event(s).

## 6.12.5.2 Monitoring Notification

### 6.12.5.2.1 Description

The Inter-PLMN Service Continuity Notification is used by the NSCE Server to notify a previously subscribed service consumer on inter-PLMN application service continuity event(s).

### 6.12.5.2.2 Target URI

The Callback URI "{**notifUri**}" shall be used with the callback URI variables defined in table 6.12.5.2.2-1.

**Table 6.12.5.2.2-1: Callback URI variables**

Name	Definition
notifUri	Represents the callback URI encoded as a string formatted as a URI.

### 6.12.5.2.3 Standard Methods

#### 6.12.5.2.3.1 POST

This method shall support the request data structures specified in table 6.12.5.2.3.1-1 and the response data structures and response codes specified in table 6.12.5.2.3.1-2.

**Table 6.12.5.2.3.1-1: Data structures supported by the POST Request Body**

Data type	P	Cardinality	Description
InterPlmnServContNotif	M	1	Represents the Inter-PLMN Service Continuity Notification.

**Table 6.12.5.2.3.1-2: Data structures supported by the POST Response Body**

Data type	P	Cardinality	Response codes	Description
n/a			204 No Content	Successful case. The Inter-PLMN Service Continuity Notification is successfully received and processed.
n/a			307 Temporary Redirect	Temporary redirection.  The response shall include a Location header field containing an alternative URI representing the end point of an alternative service consumer where the notification should be sent.  Redirection handling is described in clause 5.2.10 of 3GPP TS 29.122 [2].
n/a			308 Permanent Redirect	Permanent redirection.  The response shall include a Location header field containing an alternative URI representing the end point of an alternative service consumer where the notification should be sent.  Redirection handling is described in clause 5.2.10 of 3GPP TS 29.122 [2].
NOTE: The mandatory HTTP error status codes for the HTTP POST method listed in table 5.2.6-1 of 3GPP TS 29.122 [2] shall also apply.				

**Table 6.12.5.2.3.1-3: Headers supported by the 307 Response Code on this resource**

Name	Data type	P	Cardinality	Description
Location	string	M	1	Contains an alternative URI representing the end point of an alternative service consumer towards which the notification should be redirected.

**Table 6.12.5.2.3.1-4: Headers supported by the 308 Response Code on this resource**

Name	Data type	P	Cardinality	Description
Location	string	M	1	Contains an alternative URI representing the end point of an alternative service consumer towards which the notification should be redirected.

## 6.12.6 Data Model

### 6.12.6.1 General

This clause specifies the application data model supported by the API.

Table 6.12.6.1-1 specifies the data types defined for the NSCE\_InterPLMNContinuity API.

**Table 6.12.6.1-1: NSCE\_InterPLMNContinuity API specific Data Types**

Data type	Clause defined	Description	Applicability
AppReqs	6.12.6.2.3	Represents the application QoS requirements.	
InterPlmnServContNotif	6.12.6.2.4	Represents an Inter-PLMN Service Continuity Notification.	
InterPlmnServContReq	6.12.6.2.2	Represents the parameters to request inter-PLMN application service continuity.	
ServContReq	6.12.6.3.3	Represents the service continuity requirement.	

Table 6.12.6.1-2 specifies data types re-used by the NSCE\_InterPLMNContinuity API from other specifications, including a reference to their respective specifications, and when needed, a short description of their use within the NSCE\_InterPLMNContinuity API.

**Table 6.12.6.1-2: NSCE\_InterPLMNContinuity API re-used Data Types**

Data type	Reference	Comments	Applicability
EndPoint	3GPP TS 29.558 [25]	Represents endpoint information.	
Float	3GPP TS 29.571 [16]	Represents a float number.	
GeographicArea	3GPP TS 29.572 [18]	Represents a geographic area.	
NetSliceId	6.3.6.2.15	Represents the identification information of a network slice.	
PlmnId	3GPP TS 29.571 [16]	Represents the identifier of a PLMN.	
SupportedFeatures	3GPP TS 29.571 [16]	Represents the list of supported feature(s) and used to negotiate the applicability of the optional features.	
UInt32	3GPP TS 29.571 [16]	Represents an unsigned integer 32-bit integer.	

### 6.12.6.2 Structured data types

#### 6.12.6.2.1 Introduction

This clause defines the data structures to be used in resource representations.

## 6.12.6.2.2 Type: InterPlmnServContReq

Table 6.12.6.2.2-1: Definition of type InterPlmnServContReq

Attribute name	Data type	P	Cardinality	Description	Applicability
valServId	string	M	1	Represents the identifier of the targeted VAL service.	
uelds	array(string)	O	1..N	Contains the list of the identifier(s) of the targeted VAL UE(s).	
servContReq	ServContReq	M	1	Contains the requested service continuity requirement information.	
targetPlmnId	PlmnId	M	1	Contains the identifier of the target PLMN.	
netSliceld	NetSliceld	M	1	Represents the identifier of the targeted network slice.	
targetServArea	array(Geographic Area)	O	1..N	Contains the target service area.	
appQoSReqs	AppReqs	O	0..1	Represents the application QoS requirements.	
notifUri	Uri	M	1	Contains the URI via which inter-PLMN application service continuity notifications shall be delivered.	
suppFeat	SupportedFeatures	C	0..1	Contains the list of supported features among the ones defined in clause 6.12.8.  This attribute shall be present only when feature negotiation needs to take place.	

## 6.12.6.2.3 Type: AppReqs

Table 6.12.6.2.3-1: Definition of type AppReqs

Attribute name	Data type	P	Cardinality	Description	Applicability
reliability	Float	O	0..1	Represents the reliability expressed as a percentage.  Minimum = 0. Maximum = 100.  (NOTE)	
delay	integer	O	0..1	Represents the delay in milliseconds.  Minimum = 1.  (NOTE)	
jitter	UInt32	O	0..1	Represents the jitter in nanoseconds.  (NOTE)	
NOTE: At least one of these attributes shall be present.					

## 6.12.6.2.4 Type: InterPlmnServContNotif

**Table 6.12.6.2.4-1: Definition of type InterPlmnServContNotif**

Attribute name	Data type	P	Cardinality	Description	Applicability
valServId	string	M	1	Represents the identifier of the VAL service to which the notification is related.	
uelds	array(string)	O	1..N	Contains the list of the identifier(s) of the impacted VAL UE(s).	
netSliceld	NetSliceld	M	1	Represents the identifier of the network slice to which the notification is related.	
plmnId	PlmnId	M	1	Contains the identifier of the PLMN to which the notification is related.	
targetServArea	array(Geographic Area)	M	1..N	Contains the target service area.	

## 6.12.6.3 Simple data types and enumerations

## 6.12.6.3.1 Introduction

This clause defines simple data types and enumerations that can be referenced from data structures defined in the previous clauses.

## 6.12.6.3.2 Simple data types

The simple data types defined in table 6.12.6.3.2-1 shall be supported.

**Table 6.12.6.3.2-1: Simple data types**

Type Name	Type Definition	Description	Applicability

## 6.12.6.3.3 Enumeration: ServContReq

The enumeration ServContReq represents a service continuity requirement. It shall comply with the provisions defined in table 6.12.6.3.3-1.

**Table 6.12.6.3.3-1: Enumeration ServContReq**

Enumeration value	Description	Applicability
EXPECTED_MIGRATION	Indicates that the service continuity requirement is the expected migration of the VAL application (or a list of VAL UE(s) of the VAL application) to a target area.	
PREDICTED_MIGRATION	Indicates that the service continuity requirement is the predicted migration of the VAL application (or a list of VAL UE(s) of the VAL application) to a target area.	

## 6.12.6.4 Data types describing alternative data types or combinations of data types

There are no data types describing alternative data types or combinations of data types defined for this API in this release of the specification.

## 6.12.6.5 Binary data

### 6.12.6.5.1 Binary Data Types

**Table 6.12.6.5.1-1: Binary Data Types**

Name	Clause defined	Content type

## 6.12.7 Error Handling

### 6.12.7.1 General

For the NSCE\_InterPLMNContinuity API, error handling shall be supported as specified in clause 6.7 of 3GPP TS 29.549 [15].

In addition, the requirements in the following clauses are applicable for the NSCE\_InterPLMNContinuity API.

### 6.12.7.2 Protocol Errors

No specific protocol errors for the NSCE\_InterPLMNContinuity API are specified.

### 6.12.7.3 Application Errors

The application errors defined for the NSCE\_InterPLMNContinuity API are listed in Table 6.12.7.3-1.

**Table 6.12.7.3-1: Application errors**

Application Error	HTTP status code	Description	Applicability
SERVICE_NOT_SUPPORTED	403 Forbidden	Indicates that the inter-PLMN application service continuity request is rejected because the NSCE Server does not support the requested inter-PLMN service continuity (e.g., the targeted PLMN is not supported).	

## 6.12.8 Feature negotiation

The optional features listed in table 6.12.8-1 are defined for the NSCE\_InterPLMNContinuity API. They shall be negotiated using the extensibility mechanism defined in clause 6.8 of 3GPP TS 29.549 [15].

**Table 6.12.8-1: Supported Features**

Feature number	Feature Name	Description

## 6.12.9 Security

The provisions of clause 9 of 3GPP TS 29.549 [15] shall apply for the NSCE\_InterPLMNContinuity API.

## 6.13 NSCE\_NS.Diagnostics API

### 6.13.1 Introduction

The NSCE\_NS.Diagnostics service shall use the NSCE\_NS.Diagnostics API.

The API URI of the NSCE\_NS.Diagnostics Service API shall be:

**{apiRoot}/<apiName>/<apiVersion>**

The request URIs used in HTTP requests shall have the Resource URI structure defined in clause 6.5 of 3GPP TS 29.549 [15], i.e.:

**{apiRoot}/<apiName>/<apiVersion>/<apiSpecificSuffixes>**

with the following components:

- The {apiRoot} shall be set as described in clause 6.5 of 3GPP TS 29.549 [15].
- The <apiName> shall be "nsce-nsd".
- The <apiVersion> shall be "v1".
- The <apiSpecificSuffixes> shall be set as described in clause 6.5 of 3GPP TS 29.549 [15].

**NOTE:** When 3GPP TS 29.122 [2] is referenced for the common protocol and interface aspects for API definition in the clauses under clause 6.13, the NSCE Server takes the role of the SCEF and the service consumer takes the role of the SCS/AS.

### 6.13.2 Usage of HTTP

The provisions of clause 6.3 of 3GPP TS 29.549 [15] shall apply for the NSCE\_NS.Diagnostics API.

### 6.13.3 Resources

There are no resources defined for this API in this release of the specification.

### 6.13.4 Custom Operations without associated resources

#### 6.13.4.1 Overview

The structure of the custom operation URIs of the NSCE\_NS.Diagnostics API is shown in Figure 6.13.4.1-1.

{apiRoot}/nsce-nsd/<apiVersion>

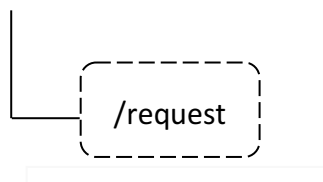

**Figure 6.13.4.1-1: Custom operation URI structure of the NSCE\_NS.Diagnostics API**

Table 6.13.4.1-1 provides an overview of the custom operation and applicable HTTP methods defined for the NSCE\_NS.Diagnostics API.



**Table 6.13.4.1-1: Custom operations without associated resources**

Operation name	Custom operation URI	Mapped HTTP method	Description
Request	/request	POST	Enables a service consumer to request network slice diagnostics information.

The custom operations shall support the URI variables defined in table 6.13.4.1-2.

**Table 6.13.4.1-2: URI variables for this custom operation**

Name	Data type	Definition
apiRoot	string	See clause 6.13.1.

## 6.13.4.2 Operation: Request

### 6.13.4.2.1 Description

The custom operation allows a service consumer to request network slice diagnostics information to the NSCE Server.

### 6.13.4.2.2 Operation Definition

This operation shall support the request data structures specified in table 6.13.4.2.2-1 and the response data structures and response codes specified in table 6.13.4.2.2-2.

**Table 6.13.4.2.2-1: Data structures supported by the POST Request Body for this operation**

Data type	P	Cardinality	Description
NwSliceDiagReq	M	1	Contains the parameters to request network slice diagnostics information.

**Table 6.13.4.2.2-2: Data structures supported by the POST Response Body for this operation**

Data type	P	Cardinality	Response codes	Description
NwSliceDiagResp	M	1	200 OK	The successful response to the request, including the network slice diagnostics report
n/a			307 Temporary Redirect	Temporary redirection. The response shall include a Location header field containing an alternative URI representing an alternative NSCE server to which the request should be sent. Redirection handling is described in clause 5.2.10 of 3GPP TS 29.122 [2].
n/a			308 Permanent Redirect	Permanent redirection. The response shall include a Location header field containing an alternative URI representing an alternative NSCE server to which the request should be sent. Redirection handling is described in clause 5.2.10 of 3GPP TS 29.122 [2].

NOTE: The mandatory HTTP error status codes for the HTTP POST method listed in table 5.2.6-1 of 3GPP TS 29.122 [2] shall also apply.

**Table 6.13.4.2.2-3: Headers supported by 307 Response Code for this operation**

Name	Data type	P	Cardinality	Description
Location	string	M	1	An alternative URI representing an alternative NSCE server to which the request should be redirected.

**Table 6.13.4.2.2-4: Headers supported by 308 Response Code for this operation**

Name	Data type	P	Cardinality	Description
Location	string	M	1	An alternative URI representing an alternative NSCE server to which the request should be redirected.

## 6.13.5 Notifications

There are no notifications defined for this API in this release of the specification.

## 6.13.6 Data Model

### 6.13.6.1 General

This clause specifies the application data model supported by the API.

Table 6.13.6.1-1 specifies the data types defined specifically for the NSCE\_NS.Diagnostics API.

**Table 6.13.6.1-1: NSCE\_NS.Diagnostics API specific Data Types**

Data type	Section defined	Description	Applicability
DataType	6.13.6.3.4	Represents the reported data type.	
Error	6.13.6.3.3	Represents the service degradation related error.	
ErrorInfo	6.13.6.2.5	Represents error related information.	
NwSliceDiagReq	6.13.6.2.2	Represents the information associated with requested network slice diagnostics.	
NwSliceDiagResp	6.13.6.2.3	Represents the network slice diagnostics report.	
ServDgradInfo	6.13.6.2.4	Represents the service degraded information.	
DataReport	6.13.6.2.6	Represents the reported data.	

Table 6.13.6.1-2 specifies data types re-used by the NSCE\_NS.Diagnostics API from other specifications, including a reference to their respective specifications, and when needed, a short description of their use within the NSCE\_NS.Diagnostics API.

**Table 6.13.6.1-2: NSCE\_NS.Diagnostics API re-used Data Types**

Data type	Reference	Comments	Applicability
Bytes	3GPP TS 29.122 [2]	Represents a sequence of bytes.	
DateTime	3GPP TS 29.122 [2]	Represents a date and a time.	
NetSliceId	6.3.6.2.15	Represents the identification information of a network slice.	
ServArea	Clause 6.16.6.2.5	Represents a network slice service area.	
SupportedFeatures	3GPP TS 29.571 [16]	Used to negotiate the applicability of the optional features.	

### 6.13.6.2 Structured Data Types

#### 6.13.6.2.1 Introduction

This clause defines the data structures to be used in resource representations.

## 6.13.6.2.2 Type: NwSliceDiagReq

**Table 6.13.6.2.2-1: Definition of type NwSliceDiagReq**

Attribute name	Data type	P	Cardinality	Description	Applicability
servDgradInfos	ServDgradInfo	M	1	Represents the requested service degraded information.	
suppFeat	SupportedFeatures	C	0..1	Contains the list of supported features among the ones defined in clause 6.13.8.  This attribute shall be present only when feature negotiation needs to take place.	

## 6.13.6.2.3 Type: NwSliceDiagResp

**Table 6.13.6.2.3-1: Definition of type NwSliceDiagResp**

Attribute name	Data type	P	Cardinality	Description	Applicability
startTime	DateTime	M	1	Represents the start time of the reported network slice diagnostics data.	
endTime	DateTime	M	1	Represents the end time of the reported network slice diagnostics data.	
dataReport	array(DataReport)	M	1..N	Represents the reported data related to network slice diagnostics.	
suppFeat	SupportedFeatures	C	0..1	Contains the list of supported features among the ones defined in clause 6.13.8.  This attribute shall be present only when feature negotiation needs to take place.	

## 6.13.6.2.4 Type: ServDgradInfo

**Table 6.13.6.2.4-1: Definition of type ServDgradInfo**

Attribute name	Data type	P	Cardinality	Description	Applicability
valServiceId	string	M	1	Represents the identifier of the targeted VAL service.	
reqErrors	array(ErrorInfo)	M	1..N	Contains the list of requested errors causing service degradation and the related information.	

## 6.13.6.2.5 Type: ErrorInfo

**Table 6.13.6.2.5-1: Definition of type ErrorInfo**

Attribute name	Data type	P	Cardinality	Description	Applicability
errorName	Error	M	1	Contains the name of the error.	
netSliceId	NetSliceId	M	1	Represents the identifier of the targeted network slice.	
ueIds	array(string)	O	1..N	Contains the list of the identifier(s) of the targeted VAL UE(s).	
areaOfInterest	ServArea	O	0..1	Contains the area within which the requested service degradation applies.	
startTime	DateTime	M	1	Represents the start time of the requested service degradation.	
endTime	DateTime	M	1	Represents the end time of the requested service degradation.	

## 6.13.6.2.6 Type: DataReport

**Table 6.13.6.2.6-1: Definition of type DataReport**

Attribute name	Data type	P	Cardinality	Description	Applicability
errorName	Error	M	1	Represents the error to which the report is related.	
dataType	DataType	M	1	Represents the data type of the reported data.	
dataOutput	Bytes	M	1	Represents the diagnostics data based.	

## 6.13.6.3 Simple data types and enumerations

## 6.13.6.3.1 Introduction

This clause defines simple data types and enumerations that can be referenced from data structures defined in the previous clauses.

## 6.13.6.3.2 Simple data types

The simple data types defined in table 6.13.6.3.2-1 shall be supported.

**Table 6.13.6.3.2-1: Simple data types**

Type Name	Type Definition	Description	Applicability

## 6.13.6.3.3 Enumeration: Error

The enumeration Error represents the service degradation related error. It shall comply with the provisions defined in table 6.13.6.3.3-1.

**Table 6.13.6.3.3-1: Enumeration Error**

Enumeration value	Description	Applicability
COMMUNICATION_ERROR	Indicates that the service degradation is due to a detected communication error.	
RTT_ABOVE_LIMIT	Indicates that the service degradation is due to the packet round trip time exceeding an upper threshold limit.	
QOS_DOWNGRADE	Indicates that the service degradation is due to QoS being downgraded.	

## 6.13.6.3.4 Enumeration: DataType

The enumeration DataType represents the reported data type. It shall comply with the provisions defined in table 6.13.6.3.4-1.

**Table 6.13.6.3.4-1: Enumeration DataType**

Enumeration value	Description	Applicability
UE_DATA	Indicates that the reported data type is UE data.	
NETWORK_DATA	Indicates that the reported data type is network data.	
APPLICATION_DATA	Indicates that the reported data type is application data.	

## 6.13.6.4 Data types describing alternative data types or combinations of data types

There are no data types describing alternative data types or combinations of data types defined for this API in this release of the specification.

## 6.13.6.5 Binary data

### 6.13.6.5.1 Binary Data Types

**Table 6.13.6.5.1-1: Binary Data Types**

Name	Clause defined	Content type

## 6.13.7 Error Handling

### 6.13.7.1 General

For the NSCE\_NS.Diagnostics API, error handling shall be supported as specified in clause 6.7 of 3GPP TS 29.549 [15].

In addition, the requirements in the following clauses are applicable for the NSCE\_NS.Diagnostics API.

### 6.13.7.2 Protocol Errors

No specific protocol errors for the NSCE\_NS.Diagnostics API are specified.

### 6.13.7.3 Application Errors

The application errors defined for NSCE\_NS.Diagnostics API are listed in table 6.13.7.3-1.

**Table 6.13.7.3-1: Application errors**

Application Error	HTTP status code	Description	Applicability

## 6.13.8 Feature Negotiation

The optional features listed in table 6.13.8-1 are defined for the NSCE\_NS.Diagnostics API. They shall be negotiated using the extensibility mechanism defined in clause 6.8 of 3GPP TS 29.549 [15].

**Table 6.13.8-1: Supported Features**

Feature number	Feature Name	Description

## 6.13.9 Security

The provisions of clause 9 of 3GPP TS 29.549 [15] shall apply for the NSCE\_NS.Diagnostics API.

## 6.14 NSCE\_FaultDiagnosis API

### 6.14.1 Introduction

The NSCE\_FaultDiagnosis service shall use the NSCE\_FaultDiagnosis API.

The API URI of the NSCE\_FaultDiagnosis Service API shall be:

**{apiRoot}/<apiName>/<apiVersion>**

The request URIs used in HTTP requests shall have the Resource URI structure defined in clause 6.5 of 3GPP TS 29.549 [15], i.e.:

**{apiRoot}/<apiName>/<apiVersion>/<apiSpecificSuffixes>**

with the following components:

- The {apiRoot} shall be set as described in clause 6.5 of 3GPP TS 29.549 [15].
- The <apiName> shall be "nsce-fd".
- The <apiVersion> shall be "v1".
- The <apiSpecificSuffixes> shall be set as described in clause 6.5 of 3GPP TS 29.549 [15].

NOTE: When 3GPP TS 29.122 [2] is referenced for the common protocol and interface aspects for API definition in the clauses under clause 6.14, the service producer takes the role of the SCEF and the service consumer takes the role of the SCS/AS.

## 6.14.2 Usage of HTTP

The provisions of clause 6.3 of 3GPP TS 29.549 [15] shall apply for the NSCE\_FaultDiagnosis API.

## 6.14.3 Resources

### 6.14.3.1 Overview

This clause describes the structure for the Resource URIs and the resources and methods used for the service.

Figure 6.14.3.1-1 depicts the resource URIs structure for the NSCE\_FaultDiagnosis API.

{apiRoot}/nsce-fd/<apiVersion>

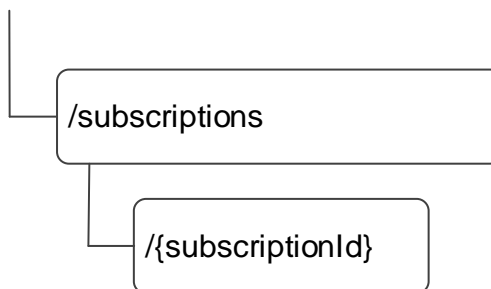

**Figure 6.14.3.1-1: Resource URIs structure of the NSCE\_FaultDiagnosis API**

Table 6.14.3.1-1 provides an overview of the resources and applicable HTTP methods for the NSCE\_FaultDiagnosis API.

**Table 6.14.3.1-1: Resources and methods overview**

Resource name	Resource URI	HTTP method or custom operation	Description
Network Slice Fault Diagnosis Subscriptions	/subscriptions	POST	Request the creation of a Network Slice Fault Diagnosis Subscription.
Individual Network Slice Fault Diagnosis Subscription	/subscriptions/{subscriptionId}	GET	Retrieve an existing "Individual Network Slice Fault Diagnosis Subscription" resource.
		PUT	Request the update of an existing "Individual Network Slice Fault Diagnosis Subscription" resource.
		PATCH	Request the modification of an existing "Individual Network Slice Fault Diagnosis Subscription" resource.
		DELETE	Request the deletion of an existing "Individual Network Slice Fault Diagnosis Subscription" resource.

6.14.3.2 Resource: Network Slice Fault Diagnosis Subscriptions

6.14.3.2.1 Description

This resource represents the collection of Network Slice Fault Diagnosis Subscriptions managed by the NSCE Server.

6.14.3.2.2 Resource Definition

Resource URI: {apiRoot}/nsce-fd/<apiVersion>/subscriptions

This resource shall support the resource URI variables defined in the table 6.14.3.2.2-1.

**Table 6.14.3.2.2-1: Resource URI variables for this resource**

Name	Data Type	Definition
apiRoot	string	See clause 6.14.1

6.14.3.2.3 Resource Standard Methods

6.14.3.2.3.1 POST

The HTTP POST method allows a service consumer to request the creation of a Network Slice Fault Diagnosis Subscription at the NSCE Server.

This method shall support the URI query parameters specified in the table 6.14.3.2.3.1-1.

**Table 6.14.3.2.3.1-1: URI query parameters supported by the POST method on this resource**

Name	Data type	P	Cardinality	Description
n/a				

This method shall support the request data structures specified in table 6.14.3.2.3.1-2 and the response data structures and response codes specified in table 6.14.3.2.3.1-3.

**Table 6.14.3.2.3.1-2: Data structures supported by the POST Request Body on this resource**

Data type	P	Cardinality	Description
FaultDiagSubsc	M	1	Represents the parameters to request the creation of a new Network Slice Fault Diagnosis Subscription.

**Table 6.14.3.2.3.1-3: Data structures supported by the POST Response Body on this resource**

Data type	P	Cardinality	Response codes	Description
FaultDiagSubsc	M	1	201 Created	Successful case. The Network Slice Fault Diagnosis Subscription is successfully created and a representation of the created "Individual Network Slice Fault Diagnosis Subscription" resource shall be returned.  An HTTP "Location" header that contains the URI of the created resource shall also be included.

NOTE: The mandatory HTTP error status codes for the HTTP POST method listed in Table 5.2.6-1 of 3GPP TS 29.122 [2] shall also apply.

**Table 6.14.3.2.3.1-4: Headers supported by the 201 response code on this resource**

Name	Data type	P	Cardinality	Description
Location	string	M	1	Contains the URI of the newly created resource, according to the structure: {apiRoot}/nsce-fd/<apiVersion>/subscriptions/{subscriptionId}

#### 6.14.3.2.4 Resource Custom Operations

There are no resource custom operations defined for this resource in this release of the specification.

### 6.14.3.3 Resource: Individual Network Slice Fault Diagnosis Subscription

#### 6.14.3.3.1 Description

This resource represents a Network Slice Fault Diagnosis Subscription managed by the NSCE Server.

#### 6.14.3.3.2 Resource Definition

Resource URI: {apiRoot}/nsce-fd/<apiVersion>/subscriptions/{subscriptionId}

This resource shall support the resource URI variables defined in the table 6.14.3.3.2-1.

**Table 6.14.3.3.2-1: Resource URI variables for this resource**

Name	Data Type	Definition
apiRoot	string	See clause 6.14.1
subscriptionId	string	Represents the identifier of the "Individual Network Slice Fault Diagnosis Subscription" resource.

#### 6.14.3.3.3 Resource Standard Methods

##### 6.14.3.3.3.1 GET

The HTTP GET method allows a service consumer to retrieve an existing "Individual Network Slice Fault Diagnosis Subscription" resource at the NSCE Server.



This method shall support the URI query parameters specified in table 6.14.3.3.3.1-1.

**Table 6.14.3.3.3.1-1: URI query parameters supported by the GET method on this resource**

Name	Data type	P	Cardinality	Description	Applicability
n/a					

This method shall support the request data structures specified in table 6.14.3.3.3.1-2 and the response data structures and response codes specified in table 6.14.3.3.3.1-3.

**Table 6.14.3.3.3.1-2: Data structures supported by the GET Request Body on this resource**

Data type	P	Cardinality	Description
n/a			

**Table 6.14.3.3.3.1-3: Data structures supported by the GET Response Body on this resource**

Data type	P	Cardinality	Response codes	Description
FaultDiagSubsc	M	1	200 OK	Successful case. The requested "Individual Network Slice Fault Diagnosis Subscription" resource shall be returned.
n/a			307 Temporary Redirect	Temporary redirection. The response shall include a Location header field containing an alternative URI of the resource located in an alternative NSCE Server. Redirection handling is described in clause 5.2.10 of 3GPP TS 29.122 [2].
n/a			308 Permanent Redirect	Permanent redirection. The response shall include a Location header field containing an alternative URI of the resource located in an alternative NSCE Server. Redirection handling is described in clause 5.2.10 of 3GPP TS 29.122 [2].
NOTE: The mandatory HTTP error status codes for the HTTP GET method listed in table 5.2.6-1 of 3GPP TS 29.122 [2] shall also apply.				

**Table 6.14.3.3.3.1-4: Headers supported by the 307 Response Code on this resource**

Name	Data type	P	Cardinality	Description
Location	string	M	1	Contains an alternative URI of the resource located in an alternative NSCE Server.

**Table 6.14.3.3.3.1-5: Headers supported by the 308 Response Code on this resource**

Name	Data type	P	Cardinality	Description
Location	string	M	1	Contains an alternative URI of the resource located in an alternative NSCE Server.

#### 6.14.3.3.3.2 PUT

The HTTP PUT method allows a service consumer to request the update of an existing "Individual Network Slice Fault Diagnosis Subscription" resource at the NSCE Server.

This method shall support the URI query parameters specified in the table 6.14.3.3.3.2-1.

**Table 6.14.3.3.3.2-1: URI query parameters supported by the PUT method on this resource**

Name	Data type	P	Cardinality	Description
n/a				

This method shall support the request data structures specified in table 6.14.3.3.3.2-2 and the response data structures and response codes specified in table 6.14.3.3.3.2-3.

**Table 6.14.3.3.3.2-2: Data structures supported by the PUT Request Body on this resource**

Data type	P	Cardinality	Description
FaultDiagSubsc	M	1	Represents the updated representation of the "Individual Network Slice Fault Diagnosis Subscription" resource.

**Table 6.14.3.3.3.2-3: Data structures supported by the PUT Response Body on this resource**

Data type	P	Cardinality	Response codes	Description
FaultDiagSubsc	M	1	200 OK	Successful case. The "Individual Network Slice Fault Diagnosis Subscription" resource is successfully updated and a representation of the updated resource shall be returned in the response body.
n/a			204 No Content	Successful case. The "Individual Network Slice Fault Diagnosis Subscription" resource is successfully updated and no content is returned in the response body.
n/a			307 Temporary Redirect	Temporary redirection. The response shall include a Location header field containing an alternative URI of the resource located in an alternative NSCE Server. Redirection handling is described in clause 5.2.10 of 3GPP TS 29.122 [2].
n/a			308 Permanent Redirect	Permanent redirection. The response shall include a Location header field containing an alternative URI of the resource located in an alternative NSCE Server. Redirection handling is described in clause 5.2.10 of 3GPP TS 29.122 [2].

NOTE: The mandatory HTTP error status codes for the PUT method listed in Table 5.2.6-1 of 3GPP TS 29.122 [2] shall also apply.

**Table 6.14.3.3.3.2-4: Headers supported by the 307 Response Code on this resource**

Name	Data type	P	Cardinality	Description
Location	string	M	1	Contains an alternative URI of the resource located in an alternative NSCE server.

**Table 6.14.3.3.3.2-5: Headers supported by the 308 Response Code on this resource**

Name	Data type	P	Cardinality	Description
Location	string	M	1	Contains an alternative URI of the resource located in an alternative NSCE server.

## 6.14.3.3.3.3 PATCH

The HTTP PATCH method allows a service consumer to request the modification of an existing "Individual Network Slice Fault Diagnosis Subscription" resource at the NSCE Server.

This method shall support the URI query parameters specified in table 6.14.3.3.3.3-1.

**Table 6.14.3.3.3.3-1: URI query parameters supported by the PATCH method on this resource**

Name	Data type	P	Cardinality	Description	Applicability
n/a					

This method shall support the request data structures specified in table 6.14.3.3.3.3-2 and the response data structures and response codes specified in table 6.14.3.3.3.3-3.

**Table 6.14.3.3.3.3-2: Data structures supported by the PATCH Request Body on this resource**

Data type	P	Cardinality	Description
FaultDiagSubscPatch	M	1	Represents the parameters to request the modification of the "Individual Network Slice Fault Diagnosis Subscription" resource.

**Table 6.14.3.3.3.3-3: Data structures supported by the PATCH Response Body on this resource**

Data type	P	Cardinality	Response codes	Description
FaultDiagSubsc	M	1	200 OK	Successful case. The "Individual Network Slice Fault Diagnosis Subscription" resource is successfully modified and a representation of the updated resource shall be returned in the response body.
n/a			204 No Content	Successful case. The "Individual Network Slice Fault Diagnosis Subscription" resource is successfully updated and no content is returned in the response body.
n/a			307 Temporary Redirect	Temporary redirection. The response shall include a Location header field containing an alternative URI of the resource located in an alternative NSCE Server. Redirection handling is described in clause 5.2.10 of 3GPP TS 29.122 [2].
n/a			308 Permanent Redirect	Permanent redirection. The response shall include a Location header field containing an alternative URI of the resource located in an alternative NSCE Server. Redirection handling is described in clause 5.2.10 of 3GPP TS 29.122 [2].
NOTE: The mandatory HTTP error status codes for the HTTP PATCH method listed in table 5.2.6-1 of 3GPP TS 29.122 [2] shall also apply.				

**Table 6.14.3.3.3.3-4: Headers supported by the 307 Response Code on this resource**

Name	Data type	P	Cardinality	Description
Location	string	M	1	Contains an alternative URI of the resource located in an alternative NSCE Server.

**Table 6.14.3.3.3-5: Headers supported by the 308 Response Code on this resource**

Name	Data type	P	Cardinality	Description
Location	string	M	1	Contains an alternative URI of the resource located in an alternative NSCE Server.

#### 6.14.3.3.3.4 DELETE

The HTTP DELETE method allows a service consumer to request the deletion of an existing "Individual Network Slice Fault Diagnosis Subscription" resource at the NSCE Server.

This method shall support the URI query parameters specified in table 6.14.3.3.3.4-1.

**Table 6.14.3.3.3.4-1: URI query parameters supported by the DELETE method on this resource**

Name	Data type	P	Cardinality	Description	Applicability
n/a					

This method shall support the request data structures specified in table 6.14.3.3.3.4-2 and the response data structures and response codes specified in table 6.14.3.3.3.4-3.

**Table 6.14.3.3.3.4-2: Data structures supported by the DELETE Request Body on this resource**

Data type	P	Cardinality	Description
n/a			

**Table 6.14.3.3.3.4-3: Data structures supported by the DELETE Response Body on this resource**

Data type	P	Cardinality	Response codes	Description
n/a			204 No Content	Successful case. The targeted "Individual Network Slice Fault Diagnosis Subscription" resource is successfully deleted.
n/a			307 Temporary Redirect	Temporary redirection. The response shall include a Location header field containing an alternative URI of the resource located in an alternative NSCE Server. Redirection handling is described in clause 5.2.10 of 3GPP TS 29.122 [2].
n/a			308 Permanent Redirect	Permanent redirection. The response shall include a Location header field containing an alternative URI of the resource located in an alternative NSCE Server. Redirection handling is described in clause 5.2.10 of 3GPP TS 29.122 [2].
NOTE: The mandatory HTTP error status codes for the HTTP DELETE method listed in table 5.2.6-1 of 3GPP TS 29.122 [2] shall also apply.				

**Table 6.14.3.3.3.4-4: Headers supported by the 307 Response Code on this resource**

Name	Data type	P	Cardinality	Description
Location	string	M	1	Contains an alternative URI of the resource located in an alternative NSCE Server.

**Table 6.14.3.3.4-5: Headers supported by the 308 Response Code on this resource**

Name	Data type	P	Cardinality	Description
Location	string	M	1	Contains an alternative URI of the resource located in an alternative NSCE Server.

#### 6.14.3.3.4 Resource Custom Operations

There are no resource custom operations defined for this resource in this release of the specification.

### 6.14.4 Custom Operations without associated resources

There are no custom operations without associated resources defined for this API in this release of the specification.

### 6.14.5 Notifications

#### 6.14.5.1 General

Notifications shall comply to clause 6.6 of 3GPP TS 29.549 [15].

**Table 6.14.5.1-1: Notifications overview**

Notification	Callback URI	HTTP method or custom operation	Description (service operation)
Network Slice Fault Diagnosis Notification	{notifUri}	POST	This service operation enables to notify a previously subscribed service consumer on Network Slice Fault Diagnosis event(s).

#### 6.14.5.2 Network Slice Fault Diagnosis Notification

##### 6.14.5.2.1 Description

The Network Slice Fault Diagnosis Notification is used by a NSCE Server to notify a previously subscribed service consumer on Network Slice Fault Diagnosis event(s).

##### 6.14.5.2.2 Target URI

The Callback URI "{**notifUri**}" shall be used with the callback URI variables defined in table 6.14.5.2.2-1.

**Table 6.14.5.2.2-1: Callback URI variables**

Name	Data type	Definition
notifUri	Uri	Represents the callback URI encoded as a string formatted as a URI.

##### 6.14.5.2.3 Standard Methods

###### 6.14.5.2.3.1 POST

This method shall support the request data structures specified in table 6.14.5.2.3.1-1 and the response data structures and response codes specified in table 6.14.5.2.3.1-2.

**Table 6.14.5.2.3.1-1: Data structures supported by the POST Request Body**

Data type	P	Cardinality	Description
FaultDiagNotif	M	1	Represents a Network Slice Fault Diagnosis Notification.

**Table 6.14.5.2.3.1-2: Data structures supported by the POST Response Body**

Data type	P	Cardinality	Response codes	Description
n/a			204 No Content	Successful case. The Network Slice Fault Diagnosis Notification is successfully received and acknowledged.
n/a			307 Temporary Redirect	Temporary redirection. The response shall include a Location header field containing an alternative URI representing the end point of an alternative service consumer where the notification should be sent. Redirection handling is described in clause 5.2.10 of 3GPP TS 29.122 [2].
n/a			308 Permanent Redirect	Permanent redirection. The response shall include a Location header field containing an alternative URI representing the end point of an alternative service consumer where the notification should be sent. Redirection handling is described in clause 5.2.10 of 3GPP TS 29.122 [2].
NOTE: The mandatory HTTP error status codes for the HTTP POST method listed in table 5.2.6-1 of 3GPP TS 29.122 [2] shall also apply.				

**Table 6.14.5.2.3.1-3: Headers supported by the 307 Response Code on this resource**

Name	Data type	P	Cardinality	Description
Location	string	M	1	Contains an alternative URI representing the end point of an alternative service consumer towards which the notification should be redirected.

**Table 6.14.5.2.3.1-4: Headers supported by the 308 Response Code on this resource**

Name	Data type	P	Cardinality	Description
Location	string	M	1	Contains an alternative URI representing the end point of an alternative service consumer towards which the notification should be redirected.

## 6.14.6 Data Model

### 6.14.6.1 General

This clause specifies the application data model supported by the API.

Table 6.14.6.1-1 specifies the data types defined for the NSCE\_FaultDiagnosis API.

**Table 6.14.6.1-1: NSCE\_FaultDiagnosis API specific Data Types**

Data type	Section defined	Description	Applicability
AlarmType	6.14.6.3.3	Represents the alarm type(s).	
CorrelatedAlarm	6.14.6.2.6	Represents the correlated alarm information.	
FaultDiagInformation	6.14.6.2.7	Represents the fault diagnosis information.	
FaultDiagNotif	6.14.6.2.4	Represents a Network Slice Fault Diagnosis notification.	
FaultDiagSubsc	6.14.6.2.2	Represents a Network Slice Fault Diagnosis subscription.	
FaultDiagSubscPatch	6.14.6.2.3	Represents the requested modifications to a Network Slice Fault Diagnosis subscription.	
FaultReportInfo	6.14.6.2.5	Represents the report of the fault diagnosis information.	
Priority	6.14.6.3.4	Represents the prioritization of the fault associated with the correlated alarm.	

Table 6.14.6.1-2 specifies data types re-used by the NSCE\_FaultDiagnosis API from other specifications, including a reference to their respective specifications, and when needed, a short description of their use within the NSCE\_FaultDiagnosis API.

**Table 6.14.6.1-2: NSCE\_FaultDiagnosis API re-used Data Types**

Data type	Reference	Comments	Applicability
NetSliceId	6.3.6.2.15	Represents the identification information of a network slice.	
SupportedFeatures	3GPP TS 29.571 [16]	Represents the list of supported feature(s) and used to negotiate the applicability of the optional features.	
TimeWindow	3GPP TS 29.122 [2]	Represents a time window with a start time and an end time.	
Uri	3GPP TS 29.122 [2]	Represents a URI.	

## 6.14.6.2 Structured data types

### 6.14.6.2.1 Introduction

This clause defines the data structures to be used in resource representations.

### 6.14.6.2.2 Type: FaultDiagSubsc

**Table 6.14.6.2.2-1: Definition of type FaultDiagSubsc**

Attribute name	Data type	P	Cardinality	Description	Applicability
notifUri	Uri	M	1	Contains the URI via which notifications shall be delivered.	
valServId	string	M	1	Contains the identifier of the VAL Service to which the fault diagnosis is related.	
valUeIds	array(string)	O	1..N	Contains the list of the identifier(s) of the VAL UE(s) to which the subscription is related.	
faultDiagInfo	array(FaultDiagInformation)	O	1..N	Contains the fault diagnosis information to which the subscription is related.	
netSliceIds	array(NetSliceId)	O	1..N	Contains the identifier(s) of the network slice(s) to be monitored.	
supFeat	SupportedFeatures	C	0..1	Contains the list of supported features among the ones defined in clause 6.14.8. This attribute shall be present only when feature negotiation needs to take place.	

## 6.14.6.2.3 Type: FaultDiagSubscPatch

Table 6.14.6.2.3-1: Definition of type FaultDiagSubscPatch

Attribute name	Data type	P	Cardinality	Description	Applicability
notifUri	Uri	O	0..1	Contains the updated URI via which notifications shall be delivered.	
faultDiagInfo	array(FaultDiagInformation)	O	1..N	Contains the updated fault diagnosis information to which the subscription is related.	
valUelds	array(string)	O	1..N	Contains the updated list of the identifier(s) of the VAL UE(s) to which the subscription is related.	
netSlicelds	array(NetSliced)	O	1..N	Contains the updated identifier(s) of the network slice to be monitored.	

## 6.14.6.2.4 Type: FaultDiagNotif

Table 6.14.6.2.4-1: Definition of type FaultDiagNotif

Attribute name	Data type	P	Cardinality	Description	Applicability
subscriptionId	string	M	1	Contains the identifier of the subscription to which the Network Slice Fault Diagnosis Notification is related.	
faultRep	FaultReportInfo	M	1	Contains the report of the fault diagnosis.	

## 6.14.6.2.5 Type: FaultReportInfo

Table 6.14.6.2.5-1: Definition of type FaultReportInfo

Attribute name	Data type	P	Cardinality	Description	Applicability
corelAlarm	array(CorrelatedAlarm)	M	1..N	Contains the list of the correlated alarms.	

NOTE: At least one of the CorrelatedAlarm shall provide rootCause attribute.

## 6.14.6.2.6 Type: CorrelatedAlarm

Table 6.14.6.2.6-1: Definition of type CorrelatedAlarm

Attribute name	Data type	P	Cardinality	Description	Applicability
alarmType	AlarmType	M	1	Contains the correlated alarm type.	
priority	Priority	O	0..1	Indicates the prioritization of the fault associated with the correlated alarm.	
rootCause	boolean	O	0..1	Indicates whether the event is the root cause of the events.  When set to "true", it indicates that the event is the root cause of the events. When set to "false", it indicates that the event is not the root cause of the events.  The default value when omitted is "false".	



## 6.14.6.2.7 Type: FaultDiagInformation

**Table 6.14.6.2.7-1: Definition of type FaultDiagInformation**

Attribute name	Data type	P	Cardinality	Description	Applicability
monitorTime	TimeWindow	O	0..1	Contains the monitoring time window of the subscription.	
alarmType	AlarmType	O	0..1	Contains the correlated alarm type to which the subscription is related.	

## 6.14.6.3 Simple data types and enumerations

## 6.14.6.3.1 Introduction

This clause defines simple data types and enumerations that can be referenced from data structures defined in the previous clauses.

## 6.14.6.3.2 Simple data types

The simple data types defined in table 6.14.6.3.2-1 shall be supported.

**Table 6.14.6.3.2-1: Simple data types**

Type Name	Type Definition	Description	Applicability

## 6.14.6.3.3 Enumeration: AlarmType

The enumeration AlarmType represents the alarm types. It shall comply with the provisions defined in table 6.14.6.3.3-1.

**Table 6.14.6.3.3-1: Enumeration AlarmType**

Enumeration value	Description	Applicability
COMMUNICATIONS_ALARM	An alarm associated with the procedures and/or processes required to convey information from one point to another.	
PROCESSING_ERROR_ALARM	An alarm associated with a software or processing fault.	
ENVIRONMENTAL_ALARM	An alarm associated with a condition relating to an enclosure in which the equipment resides.	
QUALITY_OF_SERVICE_ALARM	An alarm associated with a degradation in the quality of a service.	
EQUIPMENT_ALARM	An alarm associated with an equipment fault.	
INTEGRITY_VIOLATION	An indication that information may have been illegally modified, inserted or deleted.	

## 6.14.6.3.4 Enumeration: Priority

The enumeration Priority represents the prioritization. It shall comply with the provisions defined in table 6.14.6.3.4-1.

**Table 6.14.6.3.4-1: Enumeration Priority**

Enumeration value	Description	Applicability
CRITICAL	Indicates the prioritization of the fault is "critical".	
MAJOR	Indicates the prioritization of the fault is "major".	
MINOR	Indicates the prioritization of the fault is "minor".	
IGNORE	Indicates the prioritization of the fault is "ignore".	

#### 6.14.6.4 Data types describing alternative data types or combinations of data types

There are no data types describing alternative data types or combinations of data types defined for this API in this release of the specification.

#### 6.14.6.5 Binary data

##### 6.14.6.5.1 Binary Data Types

**Table 6.14.6.5.1-1: Binary Data Types**

Name	Clause defined	Content type

#### 6.14.7 Error Handling

##### 6.14.7.1 General

For the NSCE\_FaultDiagnosis API, HTTP error responses shall be supported as specified in clause 6.7 of 3GPP TS 29.549 [15].

In addition, the requirements in the following clauses are applicable for the NSCE\_FaultDiagnosis API.

##### 6.14.7.2 Protocol Errors

No specific protocol errors for the NSCE\_FaultDiagnosis API are specified.

##### 6.14.7.3 Application Errors

The application errors defined for the NSCE\_FaultDiagnosis API are listed in Table 6.14.7.3-1.

**Table 6.14.7.3-1: Application errors**

Application Error	HTTP status code	Description	Applicability

#### 6.14.8 Feature negotiation

The optional features in table 6.14.8-1 are defined for the NSCE\_FaultDiagnosis API. They shall be negotiated using the extensibility mechanism defined in clause 6.8 of 3GPP TS 29.549 [15].

**Table 6.14.8-1: Supported Features**

Feature number	Feature Name	Description
n/a		

#### 6.14.9 Security

The provisions of clause 9 of 3GPP TS 29.549 [15] shall apply for the NSCE\_FaultDiagnosis API.

## 6.15 NSCE\_SliceReqVerifyAndAlign API

### 6.15.1 Introduction

The NSCE\_SliceReqVerifyAndAlign service shall use the NSCE\_SliceReqVerifyAndAlign API.

The API URI of the NSCE\_SliceReqVerifyAndAlign Service API shall be:

**{apiRoot}/<apiName>/<apiVersion>**

The request URIs used in HTTP requests shall have the Resource URI structure defined in clause 6.5 of 3GPP TS 29.549 [15], i.e.:

**{apiRoot}/<apiName>/<apiVersion>/<apiSpecificSuffixes>**

with the following components:

- The {apiRoot} shall be set as described in clause 6.5 of 3GPP TS 29.549 [15].
- The <apiName> shall be "nsce-srva".
- The <apiVersion> shall be "v1".
- The <apiSpecificSuffixes> shall be set as described in clause 6.5 of 3GPP TS 29.549 [15].

**NOTE:** When 3GPP TS 29.122 [2] is referenced for the common protocol and interface aspects for API definition in the clauses under clause 6.15, the service producer takes the role of the SCEF and the service consumer takes the role of the SCS/AS.

### 6.15.2 Usage of HTTP

The provisions of clause 6.3 of 3GPP TS 29.549 [15] shall apply for the NSCE\_SliceReqVerifyAndAlign API.

### 6.15.3 Resources

#### 6.15.3.1 Overview

This clause describes the structure for the Resource URIs and the resources and methods used for the service.

Figure 6.15.3.1-1 depicts the resource URIs structure for the NSCE\_SliceReqVerifyAndAlign API.

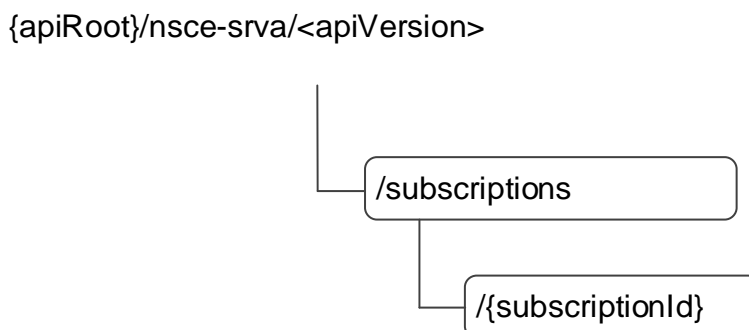

**Figure 6.15.3.1-1: Resource URIs structure of the NSCE\_SliceReqVerifyAndAlign API**

Table 6.15.3.1-1 provides an overview of the resources and applicable HTTP methods for the NSCE\_SliceReqVerifyAndAlign API.

**Table 6.15.3.1-1: Resources and methods overview**

Resource name	Resource URI	HTTP method or custom operation	Description
Network Slice Requirements Verification and Alignment Subscriptions	/subscriptions	POST	Request the creation of a Network Slice Requirements Verification and Alignment Subscription.
Individual Network Slice Requirements Verification and Alignment Subscriptions	/subscriptions/{subscriptionId}	GET	Retrieve an existing "Individual Network Slice Requirements Verification and Alignment Subscription" resource.
		PUT	Request the update of an existing "Individual Network Slice Requirements Verification and Alignment Subscription" resource.
		PATCH	Request the modification of an existing "Individual Network Slice Requirements Verification and Alignment Subscription" resource.
		DELETE	Request the deletion of an existing "Individual Network Requirements Verification and Alignment Subscription" resource.

### 6.15.3.2 Resource: Network Slice Requirements Verification and Alignment Subscriptions

#### 6.15.3.2.1 Description

This resource represents the collection of Network Slice Requirements Verification and Alignment Subscriptions managed by the NSCE Server.

#### 6.15.3.2.2 Resource Definition

Resource URI: {apiRoot}/nsce-srva/<apiVersion>/subscriptions

This resource shall support the resource URI variables defined in the table 6.15.3.2.2-1.

**Table 6.15.3.2.2-1: Resource URI variables for this resource**

Name	Data Type	Definition
apiRoot	string	See clause 6.15.1

#### 6.15.3.2.3 Resource Standard Methods

##### 6.15.3.2.3.1 POST

The HTTP POST method allows a service consumer to request the creation of a Network Slice Requirements Verification and Alignment Subscription at the NSCE Server.

This method shall support the URI query parameters specified in the table 6.15.3.2.3.1-1.

**Table 6.15.3.2.3.1-1: URI query parameters supported by the POST method on this resource**

Name	Data type	P	Cardinality	Description
n/a				

This method shall support the request data structures specified in table 6.15.3.2.3.1-2 and the response data structures and response codes specified in table 6.15.3.2.3.1-3.

**Table 6.15.3.2.3.1-2: Data structures supported by the POST Request Body on this resource**

Data type	P	Cardinality	Description
SliceReqVerAlignSubsc	M	1	Represents the parameters to request the creation of a new Network Slice Requirements Verification and Alignment Subscription.

**Table 6.15.3.2.3.1-3: Data structures supported by the POST Response Body on this resource**

Data type	P	Cardinality	Response codes	Description
SliceReqVerAlignSubsc	M	1	201 Created	Successful case. The Network Slice Requirements Verification and Alignment Subscription is successfully created and a representation of the created "Individual Network Slice Requirements Verification and Alignment Subscription" resource shall be returned.  An HTTP "Location" header that contains the URI of the created resource shall also be included.
NOTE: The mandatory HTTP error status codes for the HTTP POST method listed in Table 5.2.6-1 of 3GPP TS 29.122 [2] shall also apply.				

**Table 6.15.3.2.3.1-4: Headers supported by the 201 response code on this resource**

Name	Data type	P	Cardinality	Description
Location	string	M	1	Contains the URI of the newly created resource, according to the structure: {apiRoot}/nsce-srva/<apiVersion>/subscriptions/{subscriptionId}

#### 6.15.3.2.4 Resource Custom Operations

There are no resource custom operations defined for this resource in this release of the specification.

### 6.15.3.3 Resource: Individual Network Slice Requirements Verification and Alignment Subscription

#### 6.15.3.3.1 Description

This resource represents a Network Slice Requirements Verification and Alignment Subscription managed by the NSCE Server.

#### 6.15.3.3.2 Resource Definition

Resource URI: {apiRoot}/nsce-srva/<apiVersion>/subscriptions/{subscriptionId}

This resource shall support the resource URI variables defined in the table 6.15.3.3.2-1.

**Table 6.15.3.3.2-1: Resource URI variables for this resource**

Name	Data Type	Definition
apiRoot	string	See clause 6.15.1
subscriptionId	string	Represents the identifier of the "Individual Network Slice Requirements Verification and Alignment Subscription" resource.

## 6.15.3.3.3 Resource Standard Methods

## 6.15.3.3.3.1 GET

The HTTP GET method allows a service consumer to retrieve an existing "Individual Network Requirements Verification and Alignment Subscription" resource at the NSCE Server.

This method shall support the URI query parameters specified in table 6.15.3.3.3.1-1.

**Table 6.15.3.3.3.1-1: URI query parameters supported by the GET method on this resource**

Name	Data type	P	Cardinality	Description	Applicability
n/a					

This method shall support the request data structures specified in table 6.15.3.3.3.1-2 and the response data structures and response codes specified in table 6.15.3.3.3.1-3.

**Table 6.15.3.3.3.1-2: Data structures supported by the GET Request Body on this resource**

Data type	P	Cardinality	Description
n/a			

**Table 6.15.3.3.3.1-3: Data structures supported by the GET Response Body on this resource**

Data type	P	Cardinality	Response codes	Description
SliceReqVerAlignSubsc	M	1	200 OK	Successful case. The requested "Individual Network Slice Requirements Verification and Alignment Subscription" resource shall be returned.
n/a			307 Temporary Redirect	Temporary redirection. The response shall include a Location header field containing an alternative URI of the resource located in an alternative NSCE Server. Redirection handling is described in clause 5.2.10 of 3GPP TS 29.122 [2].
n/a			308 Permanent Redirect	Permanent redirection. The response shall include a Location header field containing an alternative URI of the resource located in an alternative NSCE Server. Redirection handling is described in clause 5.2.10 of 3GPP TS 29.122 [2].
NOTE: The mandatory HTTP error status codes for the HTTP GET method listed in table 5.2.6-1 of 3GPP TS 29.122 [2] shall also apply.				

**Table 6.15.3.3.3.1-4: Headers supported by the 307 Response Code on this resource**

Name	Data type	P	Cardinality	Description
Location	string	M	1	Contains an alternative URI of the resource located in an alternative NSCE Server.

**Table 6.15.3.3.3.1-5: Headers supported by the 308 Response Code on this resource**

Name	Data type	P	Cardinality	Description
Location	string	M	1	Contains an alternative URI of the resource located in an alternative NSCE Server.

## 6.15.3.3.3.2 PUT

The HTTP PUT method allows a service consumer to request the update of an existing "Individual Network Slice Requirements Verification and Alignment Subscription" resource at the NSCE Server.

This method shall support the URI query parameters specified in the table 6.15.3.3.3.2-1.

**Table 6.15.3.3.3.2-1: URI query parameters supported by the PUT method on this resource**

Name	Data type	P	Cardinality	Description
n/a				

This method shall support the request data structures specified in table 6.15.3.3.3.2-2 and the response data structures and response codes specified in table 6.15.3.3.3.2-3.

**Table 6.15.3.3.3.2-2: Data structures supported by the PUT Request Body on this resource**

Data type	P	Cardinality	Description
SliceReqVerAlignSubsc	M	1	Represents the updated representation of the "Individual Network Slice Requirements Verification and Alignment Subscription" resource.

**Table 6.15.3.3.3.2-3: Data structures supported by the PUT Response Body on this resource**

Data type	P	Cardinality	Response codes	Description
SliceReqVerAlignSubsc	M	1	200 OK	Successful case. The "Individual Network Slice Requirements Verification and Alignment Subscription" resource is successfully updated and a representation of the updated resource shall be returned in the response body.
n/a			204 No Content	Successful case. The "Individual Network Slice Requirements Verification and Alignment Subscription" resource is successfully updated and no content is returned in the response body.
n/a			307 Temporary Redirect	Temporary redirection. The response shall include a Location header field containing an alternative URI of the resource located in an alternative NSCE Server. Redirection handling is described in clause 5.2.10 of 3GPP TS 29.122 [2].
n/a			308 Permanent Redirect	Permanent redirection. The response shall include a Location header field containing an alternative URI of the resource located in an alternative NSCE Server. Redirection handling is described in clause 5.2.10 of 3GPP TS 29.122 [2].

NOTE: The mandatory HTTP error status codes for the PUT method listed in Table 5.2.6-1 of 3GPP TS 29.122 [2] shall also apply.

**Table 6.15.3.3.3.2-4: Headers supported by the 307 Response Code on this resource**

Name	Data type	P	Cardinality	Description
Location	string	M	1	Contains an alternative URI of the resource located in an alternative NSCE server.

**Table 6.15.3.3.3.2-5: Headers supported by the 308 Response Code on this resource**

Name	Data type	P	Cardinality	Description
Location	string	M	1	Contains an alternative URI of the resource located in an alternative NSCE server.

## 6.15.3.3.3.3 PATCH

The HTTP PATCH method allows a service consumer to request the modification of an existing "Individual Network Slice Requirements Verification and Alignment Subscription" resource at the NSCE Server.

This method shall support the URI query parameters specified in table 6.15.3.3.3.3-1.

**Table 6.15.3.3.3.3-1: URI query parameters supported by the PATCH method on this resource**

Name	Data type	P	Cardinality	Description	Applicability
n/a					

This method shall support the request data structures specified in table 6.15.3.3.3.3-2 and the response data structures and response codes specified in table 6.15.3.3.3.3-3.

**Table 6.15.3.3.3.3-2: Data structures supported by the PATCH Request Body on this resource**

Data type	P	Cardinality	Description
SliceReqVerAlignSubsc Patch	M	1	Represents the parameters to request the modification of the "Individual Network Slice Requirements Verification and Alignment Subscription" resource.

**Table 6.15.3.3.3.3-3: Data structures supported by the PATCH Response Body on this resource**

Data type	P	Cardinality	Response codes	Description
SliceReqVerAlignSubsc	M	1	200 OK	Successful case. The "Individual Network Slice Requirements Verification and Alignment Subscription" resource is successfully modified and a representation of the updated resource shall be returned in the response body.
n/a			204 No Content	Successful case. The "Individual Network Slice Requirements Verification and Alignment Subscription" resource is successfully updated and no content is returned in the response body.
n/a			307 Temporary Redirect	Temporary redirection. The response shall include a Location header field containing an alternative URI of the resource located in an alternative NSCE Server. Redirection handling is described in clause 5.2.10 of 3GPP TS 29.122 [2].
n/a			308 Permanent Redirect	Permanent redirection. The response shall include a Location header field containing an alternative URI of the resource located in an alternative NSCE Server. Redirection handling is described in clause 5.2.10 of 3GPP TS 29.122 [2].
NOTE: The mandatory HTTP error status codes for the HTTP PATCH method listed in table 5.2.6-1 of 3GPP TS 29.122 [2] shall also apply.				



**Table 6.15.3.3.3.4: Headers supported by the 307 Response Code on this resource**

Name	Data type	P	Cardinality	Description
Location	string	M	1	Contains an alternative URI of the resource located in an alternative NSCE Server.

**Table 6.15.3.3.3.5: Headers supported by the 308 Response Code on this resource**

Name	Data type	P	Cardinality	Description
Location	string	M	1	Contains an alternative URI of the resource located in an alternative NSCE Server.

#### 6.15.3.3.4 DELETE

The HTTP DELETE method allows a service consumer to request the deletion of an existing "Individual Network Slice Requirements Verification and Alignment Subscription" resource at the NSCE Server.

This method shall support the URI query parameters specified in table 6.15.3.3.3.4-1.

**Table 6.15.3.3.3.4-1: URI query parameters supported by the DELETE method on this resource**

Name	Data type	P	Cardinality	Description	Applicability
n/a					

This method shall support the request data structures specified in table 6.15.3.3.3.4-2 and the response data structures and response codes specified in table 6.15.3.3.3.4-3.

**Table 6.15.3.3.3.4-2: Data structures supported by the DELETE Request Body on this resource**

Data type	P	Cardinality	Description
n/a			

**Table 6.15.3.3.3.4-3: Data structures supported by the DELETE Response Body on this resource**

Data type	P	Cardinality	Response codes	Description
n/a			204 No Content	Successful case. The targeted "Individual Network Slice Requirements Verification and Alignment Subscription" resource is successfully deleted.
n/a			307 Temporary Redirect	Temporary redirection. The response shall include a Location header field containing an alternative URI of the resource located in an alternative NSCE Server. Redirection handling is described in clause 5.2.10 of 3GPP TS 29.122 [2].
n/a			308 Permanent Redirect	Permanent redirection. The response shall include a Location header field containing an alternative URI of the resource located in an alternative NSCE Server. Redirection handling is described in clause 5.2.10 of 3GPP TS 29.122 [2].

NOTE: The mandatory HTTP error status codes for the HTTP DELETE method listed in table 5.2.6-1 of 3GPP TS 29.122 [2] shall also apply.

**Table 6.15.3.3.3.4-4: Headers supported by the 307 Response Code on this resource**

Name	Data type	P	Cardinality	Description
Location	string	M	1	Contains an alternative URI of the resource located in an alternative NSCE Server.

**Table 6.15.3.3.3.4-5: Headers supported by the 308 Response Code on this resource**

Name	Data type	P	Cardinality	Description
Location	string	M	1	Contains an alternative URI of the resource located in an alternative NSCE Server.

#### 6.15.3.3.4 Resource Custom Operations

There are no resource custom operations defined for this resource in this release of the specification.

#### 6.15.4 Custom Operations without associated resources

There are no custom operations without associated resources defined for this API in this release of the specification.

#### 6.15.5 Notifications

##### 6.15.5.1 General

Notifications shall comply to clause 6.6 of 3GPP TS 29.549 [15].

**Table 6.15.5.1-1: Notifications overview**

Notification	Callback URI	HTTP method or custom operation	Description (service operation)
Network Slice Requirements Verification and Alignment Notification	{notifUri}	POST	This service operation enables to notify a previously subscribed service consumer on Network Slice Requirements Verification and Alignment information.

##### 6.15.5.2 Network Slice Requirements Verification and Alignment Notification

###### 6.15.5.2.1 Description

The Network Slice Requirements Verification and Alignment Notification is used by a NSCE Server to notify a previously subscribed service consumer on Network Slice Requirements Verification and Alignment information.

###### 6.15.5.2.2 Target URI

The Callback URI "{**notifUri**}" shall be used with the callback URI variables defined in table 6.15.5.2.2-1.

**Table 6.15.5.2.2-1: Callback URI variables**

Name	Data type	Definition
notifUri	Uri	Represents the callback URI encoded as a string formatted as a URI.

## 6.15.5.2.3 Standard Methods

## 6.15.5.2.3.1 POST

This method shall support the request data structures specified in table 6.15.5.2.3.1-1 and the response data structures and response codes specified in table 6.15.5.2.3.1-2.

**Table 6.15.5.2.3.1-1: Data structures supported by the POST Request Body**

Data type	P	Cardinality	Description
SliceReqVerAlignNotif	M	1	Represents a Network Slice Requirements Verification and Alignment Notification.

**Table 6.15.5.2.3.1-2: Data structures supported by the POST Response Body**

Data type	P	Cardinality	Response codes	Description
n/a			204 No Content	Successful case. The Network Slice Requirements Verification and Alignment Notification is successfully received and acknowledged.
n/a			307 Temporary Redirect	Temporary redirection. The response shall include a Location header field containing an alternative URI representing the end point of an alternative service consumer where the notification should be sent. Redirection handling is described in clause 5.2.10 of 3GPP TS 29.122 [2].
n/a			308 Permanent Redirect	Permanent redirection. The response shall include a Location header field containing an alternative URI representing the end point of an alternative service consumer where the notification should be sent. Redirection handling is described in clause 5.2.10 of 3GPP TS 29.122 [2].
NOTE: The mandatory HTTP error status codes for the HTTP POST method listed in table 5.2.6-1 of 3GPP TS 29.122 [2] shall also apply.				

**Table 6.15.5.2.3.1-3: Headers supported by the 307 Response Code on this resource**

Name	Data type	P	Cardinality	Description
Location	string	M	1	Contains an alternative URI representing the end point of an alternative service consumer towards which the notification should be redirected.

**Table 6.15.5.2.3.1-4: Headers supported by the 308 Response Code on this resource**

Name	Data type	P	Cardinality	Description
Location	string	M	1	Contains an alternative URI representing the end point of an alternative service consumer towards which the notification should be redirected.

## 6.15.6 Data Model

## 6.15.6.1 General

This clause specifies the application data model supported by the API.

Table 6.15.6.1-1 specifies the data types defined for the NSCE\_SliceReqVerifyAndAlign API.

**Table 6.15.6.1-1: NSCE\_SliceReqVerifyAndAlign API specific Data Types**

Data type	Section defined	Description	Applicability
SliceReqVerAlignNotif	6.15.6.2.4	Represents a Network Slice Requirements Verification and Alignment notification.	
SliceReqVerAlignSubsc	6.15.6.2.2	Represents a Network Slice Requirements Verification and Alignment subscription.	
SliceReqVerAlignSubscPatch	6.15.6.2.3	Represents the requested modifications to a Network Slice Requirements Verification and Alignment subscription.	

Table 6.15.6.1-2 specifies data types re-used by the NSCE\_SliceReqVerifyAndAlign API from other specifications, including a reference to their respective specifications, and when needed, a short description of their use within the NSCE\_SliceReqVerifyAndAlign API.

**Table 6.15.6.1-2: NSCE\_SliceReqVerifyAndAlign API re-used Data Types**

Data type	Reference	Comments	Applicability
NetSliceId	6.3.6.2.15	Represents the identification information of a network slice.	
ServiceProfile	3GPP TS 28.541 [19]	Represents the service profile containing the properties of the network slice related requirements.	
SupportedFeatures	3GPP TS 29.571 [16]	Represents the list of supported feature(s) and used to negotiate the applicability of the optional features.	
Uri	3GPP TS 29.122 [2]	Represents a URI.	

## 6.15.6.2 Structured data types

### 6.15.6.2.1 Introduction

This clause defines the data structures to be used in resource representations.

### 6.15.6.2.2 Type: SliceReqVerAlignSubsc

**Table 6.15.6.2.2-1: Definition of type SliceReqVerAlignSubsc**

Attribute name	Data type	P	Cardinality	Description	Applicability
notifUri	Uri	M	1	Contains the URI via which notifications shall be delivered.	
valServId	string	M	1	Contains the identifier of the VAL Service to which the subscription is related.	
valUeIds	array(string)	O	1..N	Contains the list of the identifier(s) of the VAL UE(s) to which the subscription is related.	
sliceReq	array(ServiceProfile)	M	1..N	Contains the list of the slice requirements (i.e., parameters and characteristics) which need to be verified and aligned.	
netSliceId	NetSliceId	M	1	Contains the identifier of the network slice to which the subscription is related.	
suppFeat	SupportedFeatures	C	0..1	Contains the list of supported features among the ones defined in clause 6.15.8. This attribute shall be present only when feature negotiation needs to take place.	

## 6.15.6.2.3 Type: SliceReqVerAlignSubscPatch

**Table 6.15.6.2.3-1: Definition of type SliceReqVerAlignSubscPatch**

Attribute name	Data type	P	Cardinality	Description	Applicability
notifUri	Uri	O	0..1	Contains the updated URI via which notifications shall be delivered.	
valUelds	array(string)	O	1..N	Contains the updated list of the identifier(s) of the VAL UE(s) to which the subscription is related.	
sliceReq	array(ServiceProfile)	O	1..N	Contains the updated slice requirements (i.e., parameters and characteristics) which need to be verified and aligned.	
netSliceId	NetSliceId	O	0..1	Contains the updated identifier of the network slice to be monitored.	

## 6.15.6.2.4 Type: SliceReqVerAlignNotif

**Table 6.15.6.2.4-1: Definition of type SliceReqVerAlignNotif**

Attribute name	Data type	P	Cardinality	Description	Applicability
subscriptionId	string	M	1	Contains the identifier of the subscription to which the Network Slice Requirements Verification and Alignment Notification is related.	
sliceReqInfo	array(ServiceProfile)	M	1..N	Contains the information of the updated slice requirements (i.e., parameters and characteristics).	

## 6.15.6.3 Simple data types and enumerations

## 6.15.6.3.1 Introduction

This clause defines simple data types and enumerations that can be referenced from data structures defined in the previous clauses.

## 6.15.6.3.2 Simple data types

The simple data types defined in table 6.15.6.3.2-1 shall be supported.

**Table 6.15.6.3.2-1: Simple data types**

Type Name	Type Definition	Description	Applicability

## 6.15.6.4 Data types describing alternative data types or combinations of data types

There are no data types describing alternative data types or combinations of data types defined for this API in this release of the specification.

## 6.15.6.5 Binary data

### 6.15.6.5.1 Binary Data Types

**Table 6.15.6.5.1-1: Binary Data Types**

Name	Clause defined	Content type

## 6.15.7 Error Handling

### 6.15.7.1 General

For the NSCE\_SliceReqVerifyAndAlign API, HTTP error responses shall be supported as specified in clause 6.7 of 3GPP TS 29.549 [15].

In addition, the requirements in the following clauses are applicable for the NSCE\_SliceReqVerifyAndAlign API.

### 6.15.7.2 Protocol Errors

No specific protocol errors for the NSCE\_SliceReqVerifyAndAlign API are specified.

### 6.15.7.3 Application Errors

The application errors defined for the NSCE\_SliceReqVerifyAndAlign API are listed in Table 6.15.7.3-1.

**Table 6.15.7.3-1: Application errors**

Application Error	HTTP status code	Description	Applicability

## 6.15.8 Feature negotiation

The optional features in table 6.15.8-1 are defined for the NSCE\_SliceReqVerifyAndAlign API. They shall be negotiated using the extensibility mechanism defined in clause 6.8 of 3GPP TS 29.549 [15].

**Table 6.15.8-1: Supported Features**

Feature number	Feature Name	Description

## 6.15.9 Security

The provisions of clause 9 of 3GPP TS 29.549 [15] shall apply for the NSCE\_SliceReqVerifyAndAlign API.

## 6.16 NSCE\_NSInfoDelivery API

### 6.16.1 Introduction

The NSCE\_NSInfoDelivery service shall use the NSCE\_NSInfoDelivery API.

The API URI of the NSCE\_NSInfoDelivery Service API shall be:

**{apiRoot}/<apiName>/<apiVersion>**

The request URIs used in HTTP requests shall have the Resource URI structure defined in clause 6.5 of 3GPP TS 29.549 [15], i.e.:

**{apiRoot}/<apiName>/<apiVersion>/<apiSpecificSuffixes>**

with the following components:

- The {apiRoot} shall be set as described in clause 6.5 of 3GPP TS 29.549 [15].
- The <apiName> shall be "nsce-nsid".
- The <apiVersion> shall be "v1".
- The <apiSpecificSuffixes> shall be set as described in clause 6.5 of 3GPP TS 29.549 [15].

NOTE: When 3GPP TS 29.122 [2] is referenced for the common protocol and interface aspects for API definition in the clauses under clause 6.16, the NSCE Server takes the role of the SCEF and the service consumer takes the role of the SCS/AS.

## 6.16.2 Usage of HTTP

The provisions of clause 6.3 of 3GPP TS 29.549 [15] shall apply for the NSCE\_NSInfoDelivery API.

## 6.16.3 Resources

### 6.16.3.1 Overview

This clause describes the structure for the Resource URIs and the resources and methods used for the service.

Figure 6.16.3.1-1 depicts the resource URIs structure for the NSCE\_NSInfoDelivery API.

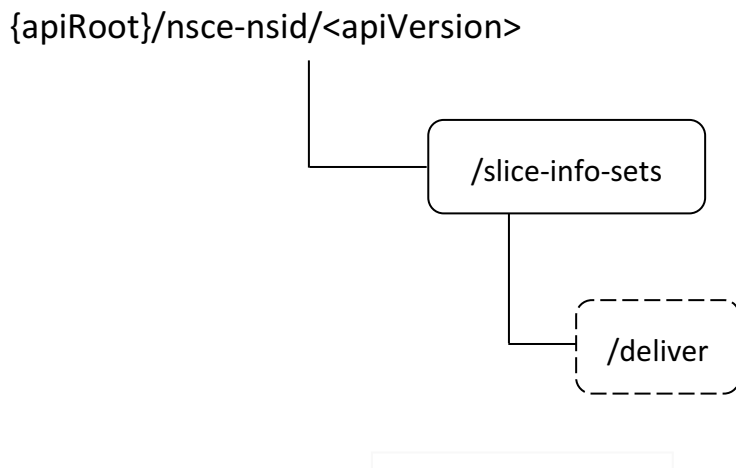

**Figure 6.16.3.1-1: Resource URIs structure of the NSCE\_NSInfoDelivery API**

Table 6.16.3.1-1 provides an overview of the resources and applicable HTTP methods or custom operations for the NSCE\_NSInfoDelivery API.

**Table 6.16.3.1-1: Resources and methods overview**

Resource name	Resource URI	HTTP method or custom operation	Description
Network Slice Information Sets	/slice-info-sets	GET	Request Network Slice Information retrieval.
		Deliver	Request Network Slice Information delivery.

### 6.16.3.2 Resource: Network Slice Information Sets

#### 6.16.3.2.1 Description

This resource represents the collection of Network Slice Information Sets managed by the NSCE Server.

#### 6.16.3.2.2 Resource Definition

Resource URI: {apiRoot}/nsce-nsid/<apiVersion>/slice-info-sets

This resource shall support the resource URI variables defined in table 6.16.3.2.2-1.

**Table 6.16.3.2.2-1: Resource URI variables for this resource**

Name	Data type	Definition
apiRoot	string	See clause 6.16.1.

#### 6.16.3.2.3 Resource Standard Methods

##### 6.16.3.2.3.1 GET

The HTTP GET method allows a service consumer to request Network Slice Information retrieval at the NSCE Server.

This method shall support the URI query parameters specified in table 6.16.3.2.3.1-1.

**Table 6.16.3.2.3.1-1: URI query parameters supported by the GET method on this resource**

Name	Data type	P	Cardinality	Description	Applicability
val-serv-id	string	M	1	Contains the identifier of the targeted VAL service.	
req-slice-info	array(ReqSliceInfo)	O	1..N	Contains the requested Network Slice Information type(s).	
supp-feats	SupportedFeatures	C	0..1	Contains the list of supported features among the ones defined in clause 6.16.8. This query parameter shall be present only when feature negotiation needs to take place.	

This method shall support the request data structures specified in table 6.16.3.2.3.1-2 and the response data structures and response codes specified in table 6.16.3.2.3.1-3.

**Table 6.16.3.2.3.1-2: Data structures supported by the GET Request Body on this resource**

Data type	P	Cardinality	Description
n/a			



**Table 6.16.3.2.3.1-3: Data structures supported by the GET Response Body on this resource**

Data type	P	Cardinality	Response codes	Description
NSInfoRetResp	M	1	200 OK	Successful case. The representation of the "Individual Network Slice Information Set" resource corresponding to the requested Network Slice Information shall be returned.
n/a			307 Temporary Redirect	Temporary redirection. The response shall include a Location header field containing an alternative URI of the resource located in an alternative NSCE Server. Redirection handling is described in clause 5.2.10 of 3GPP TS 29.122 [2].
n/a			308 Permanent Redirect	Permanent redirection. The response shall include a Location header field containing an alternative URI of the resource located in an alternative NSCE Server. Redirection handling is described in clause 5.2.10 of 3GPP TS 29.122 [2].
NOTE: The mandatory HTTP error status codes for the HTTP GET method listed in table 5.2.6-1 of 3GPP TS 29.122 [2] shall also apply.				

**Table 6.16.3.2.3.1-4: Headers supported by the 307 Response Code on this resource**

Name	Data type	P	Cardinality	Description
Location	string	M	1	Contains an alternative URI of the resource located in an alternative NSCE Server.

**Table 6.16.3.2.3.1-5: Headers supported by the 308 Response Code on this resource**

Name	Data type	P	Cardinality	Description
Location	string	M	1	Contains an alternative URI of the resource located in an alternative NSCE Server.

#### 6.16.3.2.4 Resource Custom Operations

##### 6.16.3.2.4.1 Overview

Table 6.16.3.2.4.1-1 specifies the custom operations defined on this resource.

**Table 6.16.3.2.4.1-1: Resource Custom Operations**

Operation name	Custom operation URI	Mapped HTTP method	Description
Deliver	/slice-info-sets/deliver	POST	Enables a service consumer to request Network Slice Information delivery.

##### 6.16.3.2.4.2 Operation: Deliver

###### 6.16.3.2.4.2.1 Description

This resource custom operation enables a service consumer to request Network Slice Information delivery at the NSCE Server.

## 6.16.3.2.4.2.2 Operation Definition

This operation shall support the request data structures specified in table 6.16.3.2.4.2.2-1 and the response data structure and response codes specified in table 6.16.3.2.4.2.2-2.

**Table 6.16.3.2.4.2.2-1: Data structures supported by the POST Request Body on this resource**

Data type	P	Cardinality	Description
NSInfoDelReq	M	1	Contains the parameters to request Network Slice Information delivery.

**Table 6.16.3.2.4.2.2-2: Data structures supported by the POST Response Body on this resource**

Data type	P	Cardinality	Response codes	Description
n/a			204 No Content	Successful case. The Network Slice Information delivery request is successfully received, processed and completed.
n/a			307 Temporary Redirect	Temporary redirection. The response shall include a Location header field containing an alternative target URI for the resource custom operation located in an alternative NSCE Server. Redirection handling is described in clause 5.2.10 of 3GPP TS 29.122 [2].
n/a			308 Permanent Redirect	Permanent redirection. The response shall include a Location header field containing an alternative target URI for the resource custom operation located in an alternative NSCE Server. Redirection handling is described in clause 5.2.10 of 3GPP TS 29.122 [2].
NOTE: The mandatory HTTP error status codes for the HTTP POST method listed in table 5.2.6-1 of 3GPP TS 29.122 [2] shall also apply.				

**Table 6.16.3.2.4.2.2-3: Headers supported by the 307 Response Code on this resource custom operation**

Name	Data type	P	Cardinality	Description
Location	string	M	1	Contains an alternative target URI for the resource custom operation located in an alternative NSCE Server.

**Table 6.16.3.2.4.2.2-4: Headers supported by the 308 Response Code on this resource custom operation**

Name	Data type	P	Cardinality	Description
Location	string	M	1	Contains an alternative target URI for the resource custom operation located in an alternative NSCE Server.

## 6.16.4 Custom Operations without associated resources

There are no custom operations without associated resources defined for this API in this release of the specification.

## 6.16.5 Notifications

There are no notifications defined for this API in this release of the specification.

## 6.16.6 Data Model

### 6.16.6.1 General

This clause specifies the application data model supported by the API.

Table 6.16.6.1-1 specifies the data types defined for the NSCE\_NSInfoDelivery API.

**Table 6.16.6.1-1: NSCE\_NSInfoDelivery API specific Data Types**

Data type	Clause defined	Description	Applicability
NSInfoDelReq	6.16.6.2.2	Represents a Network Slice Information Delivery request.	
NSInfoRetResp	6.16.6.2.3	Represents a Network Slice Information Retrieval response.	
NSInfoSet	6.16.6.2.4	Represents a Network Slice Information Set.	
ReqSliceInfo	6.16.6.3.3	Represents the requested Network Slice Information type.	
ServArea	6.16.6.2.5	Represents the network Slice Coverage Area.	

Table 6.16.6.1-2 specifies data types re-used by the NSCE\_NSInfoDelivery API from other specifications, including a reference to their respective specifications, and when needed, a short description of their use within the NSCE\_NSInfoDelivery API.

**Table 6.16.6.1-2: NSCE\_NSInfoDelivery API re-used Data Types**

Data type	Reference	Comments	Applicability
GeographicArea	3GPP TS 29.572 [18]	Represents a geographic area.	
Snsai	3GPP TS 29.571 [16]	Represents an S-NSSAI.	
SupportedFeatures	3GPP TS 29.571 [16]	Represents the list of supported feature(s) and used to negotiate the applicability of the optional features.	
Tai	3GPP TS 29.571 [16]	Represents a TAI.	
UInteger	3GPP TS 29.571 [16]	Represents an unsigned integer.	

### 6.16.6.2 Structured data types

#### 6.16.6.2.1 Introduction

This clause defines the data structures to be used in resource representations.

#### 6.16.6.2.2 Type: NSInfoRetResp

**Table 6.16.6.2.2-1: Definition of type NSInfoRetResp**

Attribute name	Data type	P	Cardinality	Description	Applicability
sliceInfo	NSInfoSet	M	1	Contains the requested Network Slice Information.	

## 6.16.6.2.3 Type: NSInfoDelReq

**Table 6.16.6.2.3-1: Definition of type NSInfoDelReq**

Attribute name	Data type	P	Cardinality	Description	Applicability
valServId	string	M	1	Contains the identifier of the targeted VAL service.	
valUelds	array(string)	M	1..N	Contains the identifiers of the targeted VAL UE(s).	
reqSliceInfo	array(ReqSliceInfo)	O	1..N	Contains the Network Slice Information requested to be delivered.	
suppFeat	SupportedFeatures	C	0..1	Contains the list of supported features among the ones defined in clause 6.16.8. This attribute shall be present only when feature negotiation needs to take place.	

## 6.16.6.2.4 Type: NSInfoSet

**Table 6.16.6.2.4-1: Definition of type NSInfoSet**

Attribute name	Data type	P	Cardinality	Description	Applicability
snssai	Snssai	C	0..1	Represents the S-NSSAI. (NOTE)	
sst	UInteger	C	0..1	Contains the SST. (NOTE)	
sliceCovArea	ServArea	C	0..1	Contains the network Slice Coverage Area. (NOTE)	
NOTE: At least one of these attributes shall be present.					

## 6.16.6.2.5 Type: ServArea

**Table 6.16.6.2.5-1: Definition of type ServArea**

Attribute name	Data type	P	Cardinality	Description	Applicability
tais	array(Tai)	C	1..N	Represents the identifier(s) or the TA(s) where the network slice is available. (NOTE)	
geoAreas	array(GeographicArea)	C	1..N	Contains the geographical area(s) where the network slice is available. (NOTE)	
NOTE: At least one of these attributes shall be present.					

## 6.16.6.3 Simple data types and enumerations

## 6.16.6.3.1 Introduction

This clause defines simple data types and enumerations that can be referenced from data structures defined in the previous clauses.

## 6.16.6.3.2 Simple data types

The simple data types defined in table 6.16.6.3.2-1 shall be supported.

**Table 6.16.6.3.2-1: Simple data types**

Type Name	Type Definition	Description	Applicability

**6.16.6.3.3 Enumeration: ReqSliceInfo**

The enumeration ReqSliceInfo represents the requested Network Slice Information type. It shall comply with the provisions defined in table 6.16.6.3.3-1.

**Table 6.16.6.3.3-1: Enumeration ReqSliceInfo**

Enumeration value	Description	Applicability
SNSSAI	Indicates that the requested Network Slice Information is the S-NSSAI.	
SST	Indicates that the requested Network Slice Information is the SST.	
SLICE_COV_AREA	Indicates that the requested Network Slice Information is the Slice Coverage Area.	

**6.16.6.4 Data types describing alternative data types or combinations of data types**

There are no data types describing alternative data types or combinations of data types defined for this API in this release of the specification.

**6.16.6.5 Binary data**

**6.16.6.5.1 Binary Data Types**

**Table 6.16.6.5.1-1: Binary Data Types**

Name	Clause defined	Content type

**6.16.7 Error Handling**

**6.16.7.1 General**

For the NSCE\_NSInfoDelivery API, error handling shall be supported as specified in clause 6.7 of 3GPP TS 29.549 [15].

In addition, the requirements in the following clauses are applicable for the NSCE\_NSInfoDelivery API.

**6.16.7.2 Protocol Errors**

No specific protocol errors for the NSCE\_NSInfoDelivery API are specified.

**6.16.7.3 Application Errors**

The application errors defined for the NSCE\_NSInfoDelivery API are listed in Table 6.16.7.3-1.

**Table 6.16.7.3-1: Application errors**

Application Error	HTTP status code	Description	Applicability

## 6.16.8 Feature negotiation

The optional features listed in table 6.16.8-1 are defined for the NSCE\_NSInfoDelivery API. They shall be negotiated using the extensibility mechanism defined in clause 6.8 of 3GPP TS 29.549 [15].

**Table 6.16.8-1: Supported Features**

Feature number	Feature Name	Description

## 6.16.9 Security

The provisions of clause 9 of 3GPP TS 29.549 [15] shall apply for the NSCE\_NSInfoDelivery API.

## 6.17 Void

## 6.18 NSCE\_NSAllocation API

### 6.18.1 Introduction

The NSCE\_NSAllocation service shall use the NSCE\_NSAllocation API.

The API URI of the NSCE\_NSAllocation Service API shall be:

**{apiRoot}/<apiName>/<apiVersion>**

The request URIs used in HTTP requests shall have the Resource URI structure defined in clause 6.5 of 3GPP TS 29.549 [15], i.e.:

**{apiRoot}/<apiName>/<apiVersion>/<apiSpecificSuffixes>**

with the following components:

- The {apiRoot} shall be set as described in clause 6.5 of 3GPP TS 29.549 [15].
- The <apiName> shall be "nsce-nsa".
- The <apiVersion> shall be "v1".
- The <apiSpecificSuffixes> shall be set as described in clause 6.5 of 3GPP TS 29.549 [15].

NOTE: When 3GPP TS 29.122 [2] is referenced for the common protocol and interface aspects for API definition in the clauses under clause 6.18, the NSCE Server takes the role of the SCEF and the service consumer takes the role of the SCS/AS.

### 6.18.2 Usage of HTTP

The provisions of clause 6.3 of 3GPP TS 29.549 [15] shall apply for the NSCE\_NSAllocation API.

### 6.18.3 Resources

There are no resources defined for this API in this release of the specification.

### 6.18.4 Custom Operations without associated resources

#### 6.18.4.1 Overview

The structure of the custom operation URIs of the NSCE\_NSAllocation API is shown in Figure 6.18.4.1-1.

{apiRoot}/nsce-nsa/<apiVersion>

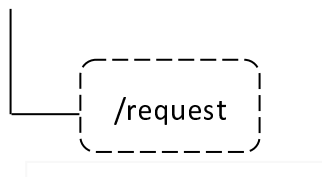

**Figure 6.18.4.1-1: Custom operation URI structure of the NSCE\_NSAllocation API**

Table 6.18.4.1-1 provides an overview of the custom operation and applicable HTTP methods defined for the NSCE\_NSAllocation API.

**Table 6.18.4.1-1: Custom operations without associated resources**

Operation name	Custom operation URI	Mapped HTTP method	Description
Request	/request	POST	Enables a service consumer to request network slice allocation.

### 6.18.4.2 Operation: Request

#### 6.18.4.2.1 Description

The custom operation allows a service consumer to request network slice allocation to the NSCE Server.

#### 6.18.4.2.2 Operation Definition

This operation shall support the request data structures specified in table 6.18.4.2.2-1 and the response data structures and response codes specified in table 6.18.4.2.2-2.

**Table 6.18.4.2.2-1: Data structures supported by the POST Request Body for this operation**

Data type	P	Cardinality	Description
NwSliceAllocReq	M	1	Contains the parameters to request network slice allocation.

**Table 6.18.4.2.2-2: Data structures supported by the POST Response Body for this operation**

Data type	P	Cardinality	Response codes	Description
NwSliceAllocResp	M	1	200 OK	The successful response to the request, including the network slice allocation information.
n/a			307 Temporary Redirect	Temporary redirection. The response shall include a Location header field containing an alternative URI representing an alternative NSCE server to which the request should be sent. Redirection handling is described in clause 5.2.10 of 3GPP TS 29.122 [2].
n/a			308 Permanent Redirect	Permanent redirection. The response shall include a Location header field containing an alternative URI representing an alternative NSCE server to which the request should be sent. Redirection handling is described in clause 5.2.10 of 3GPP TS 29.122 [2].
NOTE: The mandatory HTTP error status codes for the HTTP POST method listed in table 5.2.6-1 of 3GPP TS 29.122 [2] shall also apply.				

**Table 6.18.4.2.2-3: Headers supported by 307 Response Code for this operation**

Name	Data type	P	Cardinality	Description
Location	string	M	1	An alternative URI representing an alternative NSCE server to which the request should be redirected.

**Table 6.18.4.2.2-4: Headers supported by 308 Response Code for this operation**

Name	Data type	P	Cardinality	Description
Location	string	M	1	An alternative URI representing an alternative NSCE server to which the request should be redirected.

## 6.18.5 Notifications

There are no notifications defined for this API in this release of the specification.

## 6.18.6 Data Model

### 6.18.6.1 General

This clause specifies the application data model supported by the API.

Table 6.18.6.1-1 specifies the data types defined specifically for the NSCE\_NSAllocation API service.

**Table 6.18.6.1-1: NSCE\_NSAllocation API specific Data Types**

Data type	Clause defined	Description	Applicability
NwSliceAllocReq	6.18.6.2.2	Represents the network slice allocation request.	
NwSliceAllocResp	6.18.6.2.3	Represents the network slice allocation information.	

Table 6.18.6.1-2 specifies data types re-used by the NSCE\_NSAllocation API from other specifications, including a reference to their respective specifications, and when needed, a short description of their use within the NSCE\_NSAllocation API.



**Table 6.18.6.1-2: NSCE\_NSAllocation API re-used Data Types**

Data type	Reference	Comments	Applicability
NetSliceId	6.3.6.2.15	Represents the identification information of a network slice.	
ServArea	Clause 6.16.6.2.5	Represents a network slice service area.	
ServiceProfile	3GPP TS 28.541 [19]	Represents the network slice service profile.	
Snsai	3GPP TS 29.571 [16]	Represents the S-NSSAI.	
SupportedFeatures	3GPP TS 29.571 [16]	Represents the list of supported feature(s) and used to negotiate the applicability of the optional features.	

## 6.18.6.2 Structured Data Types

### 6.18.6.2.1 Introduction

This clause defines the data structures to be used in resource representations.

#### 6.18.6.2.2 Type: NwSliceAllocReq

**Table 6.18.6.2.2-1: Definition of type NwSliceAllocReq**

Attribute name	Data type	P	Cardinality	Description	Applicability
valServiceId	string	M	1	Represents the VAL service identifier.	
valUeIds	array(string)	O	1..N	Represents the list of VAL UEs ID.	
locArea	ServArea	M	1	Identification of location area to which the request applies.	
sliceId	NetSliceId	O	0..1	Represents the requested slice identifier.	
nwSliceServProf	ServiceProfile	O	0..1	Represents the requested Network slice service requirements.	
suppFeat	SupportedFeatures	C	0..1	Contains the list of supported features among the ones defined in clause 6.18.8. This attribute shall be present only when feature negotiation needs to take place.	

#### 6.18.6.2.3 Type: NwSliceAllocResp

**Table 6.18.6.2.3-1: Definition of type NwSliceAllocResp**

Attribute name	Data type	P	Cardinality	Description	Applicability
snsai	Snsai	M	1	Represents the identifier of the allocated network slice.	
nwSliceServProf	ServiceProfile	M	1	Represents the allocated network slice attributes.	
suppFeat	SupportedFeatures	C	0..1	Contains the list of supported features among the ones defined in clause 6.18.8. This attribute shall be present only when feature negotiation needs to take place.	

## 6.18.6.3 Simple data types and enumerations

### 6.18.6.3.1 Introduction

This clause defines simple data types and enumerations that can be referenced from data structures defined in the previous clauses.

#### 6.18.6.3.2 Simple data types

The simple data types defined in table 6.18.6.3.2-1 shall be supported.

**Table 6.18.6.3.2-1: Simple data types**

Type Name	Type Definition	Description	Applicability

#### 6.18.6.4 Data types describing alternative data types or combinations of data types

There are no data types describing alternative data types or combinations of data types defined for this API in this release of the specification.

#### 6.18.6.5 Binary data

##### 6.18.6.5.1 Binary Data Types

**Table 6.18.6.5.1-1: Binary Data Types**

Name	Clause defined	Content type

### 6.18.7 Error Handling

#### 6.18.7.1 General

For the NSCE\_NSAllocation API, error handling shall be supported as specified in clause 6.7 of 3GPP TS 29.549 [15].

In addition, the requirements in the following clauses are applicable for the NSCE\_NSAllocation API.

#### 6.18.7.2 Protocol Errors

No specific protocol errors for the NSCE\_NSAllocation API are specified.

#### 6.18.7.3 Application Errors

The application errors defined for NSCE\_NSAllocation API are listed in table 6.18.1.6.3-1.

**Table 6.18.7.3-1: Application errors**

Application Error	HTTP status code	Description	Applicability

### 6.18.8 Feature Negotiation

The optional features listed in table 6.18.8-1 are defined for the NSCE\_NSAllocation API. They shall be negotiated using the extensibility mechanism defined in clause 6.8 of 3GPP TS 29.549 [15].

**Table 6.18.8-1: Supported Features**

Feature number	Feature Name	Description

### 6.18.9 Security

The provisions of clause 9 of 3GPP TS 29.549 [15] shall apply for the NSCE\_NSAllocation API.

---

## 7 Using Common API Framework

The provisions of clause 8 of 3GPP TS 29.549 [15] shall apply for the NSCE Server APIs defined in this specification.

---

# Annex A (normative): OpenAPI specification

## A.1 General

This Annex specifies the formal definition of the API(s) defined in the present specification. It consists of OpenAPI specifications in YAML format.

This Annex takes precedence when being discrepant to other parts of the specification with respect to the encoding of information elements and methods within the API(s).

NOTE 1: The semantics and procedures, as well as conditions, e.g. for the applicability and allowed combinations of attributes or values, not expressed in the OpenAPI definitions but defined in other parts of the specification also apply.

Informative copies of the OpenAPI specification files contained in this 3GPP Technical Specification are available on a Git-based repository that uses the GitLab software version control system (see clause 5.3.1 of 3GPP TS 29.501 [3] and clause 5B of 3GPP TR 21.900 [5]).

## A.2 NSCE\_SliceApiManagement API

openapi: 3.0.0

info:

```
title: NSCE_Server Slice API Management Service
version: 1.0.0
description: |
  NSCE Server Slice API Management Service.
  © 2024, 3GPP Organizational Partners (ARIB, ATIS, CCSA, ETSI, TSDSI, TTA, TTC).
  All rights reserved.
```

externalDocs:

```
description: >
  3GPP TS 29.435 V18.1.0; Service Enabler Architecture Layer for Verticals (SEAL);
  Network Slice Capability Exposure (NSCE) Server Services; Stage 3.
url: http://www.3gpp.org/ftp/Specs/archive/29_series/29.435/
```

servers:

```
- url: '{apiRoot}/nsce-sam/v1'
  variables:
    apiRoot:
      default: https://example.com
      description: apiRoot as defined in clause 6.5 of 3GPP TS 29.549
```

security:

```
- {}
- oAuth2ClientCredentials: []
```

paths:

```
/configurations:
  post:
    summary: Request the creation of a new Slice API Configuration.
    operationId: CreateSliceAPIConfig
    tags:
      - Slice API Configurations (Collection)
    requestBody:
      required: true
      content:
        application/json:
          schema:
            $ref: '#/components/schemas/SliceAPIConfig'
    responses:
      '201':
        description: >
          Created. The slice API Configuration is successfully created and a representation of
          the created Individual Slice API Configuration shall be returned in the response body.
        content:
          application/json:
            schema:
              $ref: '#/components/schemas/SliceAPIConfig'
        headers:
          Location:
            description: >
              Contains the URI of the created Individual Slice API Configuration resource.
            required: true
            schema:
              type: string
      '400':
        $ref: 'TS29122_CommonData.yaml#/components/responses/400'
      '401':
        $ref: 'TS29122_CommonData.yaml#/components/responses/401'
      '403':
        $ref: 'TS29122_CommonData.yaml#/components/responses/403'
      '404':
        $ref: 'TS29122_CommonData.yaml#/components/responses/404'
      '411':
        $ref: 'TS29122_CommonData.yaml#/components/responses/411'
      '413':
        $ref: 'TS29122_CommonData.yaml#/components/responses/413'
      '415':
        $ref: 'TS29122_CommonData.yaml#/components/responses/415'
      '429':
        $ref: 'TS29122_CommonData.yaml#/components/responses/429'
      '500':
        $ref: 'TS29122_CommonData.yaml#/components/responses/500'
      '503':
```

```

    $ref: 'TS29122_CommonData.yaml#/components/responses/503'
  default:
    $ref: 'TS29122_CommonData.yaml#/components/responses/default'
  callbacks:
    SliceAPIConfigNotif:
      '{$request.body#/notifUri}':
        post:
          requestBody:
            required: true
            content:
              application/json:
                schema:
                  $ref: '#/components/schemas/SliceAPIConfigNotif'
  responses:
    '204':
      description: >
        No Content. The Slice API Configuration Notification is successfully received
        and processed.
    '307':
      $ref: 'TS29122_CommonData.yaml#/components/responses/307'
    '308':
      $ref: 'TS29122_CommonData.yaml#/components/responses/308'
    '400':
      $ref: 'TS29122_CommonData.yaml#/components/responses/400'
    '401':
      $ref: 'TS29122_CommonData.yaml#/components/responses/401'
    '403':
      $ref: 'TS29122_CommonData.yaml#/components/responses/403'
    '404':
      $ref: 'TS29122_CommonData.yaml#/components/responses/404'
    '411':
      $ref: 'TS29122_CommonData.yaml#/components/responses/411'
    '413':
      $ref: 'TS29122_CommonData.yaml#/components/responses/413'
    '415':
      $ref: 'TS29122_CommonData.yaml#/components/responses/415'
    '429':
      $ref: 'TS29122_CommonData.yaml#/components/responses/429'
    '500':
      $ref: 'TS29122_CommonData.yaml#/components/responses/500'
    '503':
      $ref: 'TS29122_CommonData.yaml#/components/responses/503'
  default:
    $ref: 'TS29122_CommonData.yaml#/components/responses/default'

/configurations/{configId}:
  parameters:
    - name: configId
      in: path
      description: >
        Represents the identifier of the Individual Slice API Configuration.
      required: true
      schema:
        type: string

  get:
    summary: Request to retrieve an existing Individual Slice API Configuration.
    operationId: GetIndSliceAPIConfig
    tags:
      - Individual Slice API Configuration (Document)
    responses:
      '200':
        description: >
          OK. The requested Individual Slice API Configuration resource shall be returned in the
          response body.
        content:
          application/json:
            schema:
              $ref: '#/components/schemas/SliceAPIConfig'
      '307':
        $ref: 'TS29122_CommonData.yaml#/components/responses/307'
      '308':
        $ref: 'TS29122_CommonData.yaml#/components/responses/308'
      '400':
        $ref: 'TS29122_CommonData.yaml#/components/responses/400'
      '401':
        $ref: 'TS29122_CommonData.yaml#/components/responses/401'

```

```

'403':
  $ref: 'TS29122_CommonData.yaml#/components/responses/403'
'404':
  $ref: 'TS29122_CommonData.yaml#/components/responses/404'
'406':
  $ref: 'TS29122_CommonData.yaml#/components/responses/406'
'429':
  $ref: 'TS29122_CommonData.yaml#/components/responses/429'
'500':
  $ref: 'TS29122_CommonData.yaml#/components/responses/500'
'503':
  $ref: 'TS29122_CommonData.yaml#/components/responses/503'
default:
  $ref: 'TS29122_CommonData.yaml#/components/responses/default'

delete:
  summary: Request to delete an existing Individual Slice API Configuration.
  operationId: DeleteIndSliceAPIConfig
  tags:
    - Individual Slice API Configuration (Document)
  responses:
    '204':
      description: >
        No Content. The Individual Slice API Configuration resource is successfully deleted.
    '307':
      $ref: 'TS29122_CommonData.yaml#/components/responses/307'
    '308':
      $ref: 'TS29122_CommonData.yaml#/components/responses/308'
    '400':
      $ref: 'TS29122_CommonData.yaml#/components/responses/400'
    '401':
      $ref: 'TS29122_CommonData.yaml#/components/responses/401'
    '403':
      $ref: 'TS29122_CommonData.yaml#/components/responses/403'
    '404':
      $ref: 'TS29122_CommonData.yaml#/components/responses/404'
    '429':
      $ref: 'TS29122_CommonData.yaml#/components/responses/429'
    '500':
      $ref: 'TS29122_CommonData.yaml#/components/responses/500'
    '503':
      $ref: 'TS29122_CommonData.yaml#/components/responses/503'
    default:
      $ref: 'TS29122_CommonData.yaml#/components/responses/default'

/configurations/{configId}/update:
  parameters:
    - name: configId
      in: path
      description: >
        Represents the identifier of the Individual Slice API Configuration.
      required: true
      schema:
        type: string

  post:
    summary: Request the update of an existing slice API configuration.
    operationId: Update
    tags:
      - Slice API Configuration Update
    requestBody:
      required: true
      content:
        application/json:
          schema:
            $ref: '#/components/schemas/UpdateReq'
    responses:
      '200':
        description: >
          OK. The slice API configuration update request is successfully received and processed,
          and slice API configuration update related information shall be returned in the response
          body.
        content:
          application/json:
            schema:
              $ref: '#/components/schemas/UpdateResp'
      '307':

```

```

    $ref: 'TS29122_CommonData.yaml#/components/responses/307'
  '308':
    $ref: 'TS29122_CommonData.yaml#/components/responses/308'
  '400':
    $ref: 'TS29122_CommonData.yaml#/components/responses/400'
  '401':
    $ref: 'TS29122_CommonData.yaml#/components/responses/401'
  '403':
    $ref: 'TS29122_CommonData.yaml#/components/responses/403'
  '404':
    $ref: 'TS29122_CommonData.yaml#/components/responses/404'
  '411':
    $ref: 'TS29122_CommonData.yaml#/components/responses/411'
  '413':
    $ref: 'TS29122_CommonData.yaml#/components/responses/413'
  '415':
    $ref: 'TS29122_CommonData.yaml#/components/responses/415'
  '429':
    $ref: 'TS29122_CommonData.yaml#/components/responses/429'
  '500':
    $ref: 'TS29122_CommonData.yaml#/components/responses/500'
  '503':
    $ref: 'TS29122_CommonData.yaml#/components/responses/503'
  default:
    $ref: 'TS29122_CommonData.yaml#/components/responses/default'

```

/invoke:

post:

summary: Request slice API invocation.

operationId: Invoke

tags:

- Slice API Invocation Request

requestBody:

required: true

content:

application/json:

schema:

\$ref: '#/components/schemas/InvokeReq'

responses:

'204':

description: >

No Content. The slice API invocation request is successfully received and processed.

'307':

\$ref: 'TS29122\_CommonData.yaml#/components/responses/307'

'308':

\$ref: 'TS29122\_CommonData.yaml#/components/responses/308'

'400':

\$ref: 'TS29122\_CommonData.yaml#/components/responses/400'

'401':

\$ref: 'TS29122\_CommonData.yaml#/components/responses/401'

'403':

\$ref: 'TS29122\_CommonData.yaml#/components/responses/403'

'404':

\$ref: 'TS29122\_CommonData.yaml#/components/responses/404'

'411':

\$ref: 'TS29122\_CommonData.yaml#/components/responses/411'

'413':

\$ref: 'TS29122\_CommonData.yaml#/components/responses/413'

'415':

\$ref: 'TS29122\_CommonData.yaml#/components/responses/415'

'429':

\$ref: 'TS29122\_CommonData.yaml#/components/responses/429'

'500':

\$ref: 'TS29122\_CommonData.yaml#/components/responses/500'

'503':

\$ref: 'TS29122\_CommonData.yaml#/components/responses/503'

default:

\$ref: 'TS29122\_CommonData.yaml#/components/responses/default'

components:

securitySchemes:

oAuth2ClientCredentials:

type: oauth2

flows:

clientCredentials:

tokenUrl: '{tokenUrl}'

scopes: {}



schemas:

#  
# STRUCTURED DATA TYPES  
#

```
SliceAPIConfig:
  description: >
    Represents the slice API Configuration.
  type: object
  properties:
    servReqs:
      type: array
      items:
        $ref: '#/components/schemas/AppServReqs'
      minItems: 1
    notifUri:
      $ref: 'TS29122_CommonData.yaml#/components/schemas/Uri'
    timeValidity:
      $ref: 'TS29122_CommonData.yaml#/components/schemas/TimeWindow'
    suppFeat:
      $ref: 'TS29571_CommonData.yaml#/components/schemas/SupportedFeatures'
  required:
    - servReqs
    - notifUri

AppServReqs:
  description: >
    Represents the application service requirements for a network slice.
  type: object
  properties:
    valServiceId:
      type: string
    netSliceId:
      $ref: 'TS29435_NSCE_PolicyManagement.yaml#/components/schemas/NetSliceId'
    servKpis:
      $ref: 'TS29435_NSCE_InterPLMNContinuity.yaml#/components/schemas/AppReqs'
    servReqs:
      type: array
      items:
        $ref: 'TS29435_NSCE_SliceCommService.yaml#/components/schemas/ServReq'
      minItems: 1
    areaOfInterest:
      $ref: 'TS29435_NSCE_NSInfoDelivery.yaml#/components/schemas/ServArea'
  required:
    - valServiceId
    - netSliceId

UpdateReq:
  description: >
    Represents the parameters to request the update of a slice API configuration.
  type: object
  properties:
    triggEvent:
      $ref: '#/components/schemas/TriggerEvent'
    netSliceId:
      $ref: 'TS29435_NSCE_PolicyManagement.yaml#/components/schemas/NetSliceId'
    suppFeat:
      $ref: 'TS29571_CommonData.yaml#/components/schemas/SupportedFeatures'
  required:
    - triggEvent

UpdateResp:
  description: >
    Represents the response to the slice API configuration update request.
  type: object
  properties:
    sliceAPIInfo:
      $ref: '#/components/schemas/SliceAPIInfo'
    suppFeat:
      $ref: 'TS29571_CommonData.yaml#/components/schemas/SupportedFeatures'
  required:
    - sliceAPIInfo

SliceAPIInfo:
  description: >
    Represents slice API information.
  type: object
```

```
properties:
  apiInfo:
    type: string
anyOf:
  - required: [apiInfo]
```

```
InvokeReq:
description: >
  Represents a slice API invocation request.
type: object
properties:
  sliceApiIdInfo:
    type: string
  suppFeat:
    $ref: 'TS29571_CommonData.yaml#/components/schemas/SupportedFeatures'
required:
  - sliceApiIdInfo
```

```
SliceAPIConfigNotif:
description: >
  Represents a Slice API Configuration Notification.
type: object
properties:
  sliceAPIInfo:
    $ref: '#/components/schemas/SliceAPIInfo'
required:
  - sliceAPIInfo
```

```
# SIMPLE DATA TYPES
```

```
#
```

```
#
```

```
# ENUMERATIONS
```

```
#
```

```
TriggerEvent:
anyOf:
  - type: string
  enum:
    - UE_MOBILITY
    - MIGRATION
    - SERV_API_UNAVAILABILITY
    - APP_QOS_REQ_CHANGE
  - type: string
  description: >
    This string provides the triggering event for slice API configuration update.
description: |
  Represents a trigger event.
  Possible values are:
  - UE_MOBILITY: Indicates that the triggering event for slice API configuration update is
    UE mobility to a different service area.
  - MIGRATION: Indicates that the triggering event for slice API configuration update is
    application server migration to a different edge/cloud platform.
  - SERV_API_UNAVAILABILITY: Indicates that the triggering event for slice API configuration
    update is service API unavailability.
  - APP_QOS_REQ_CHANGE: Indicates that the triggering event for slice API configuration update
    is application QoS requirements change.
```

## A.3 NSCE\_NetSliceLifeCycleMngt API

openapi: 3.0.0

info:

```
title: NSCE Server Network Slice LifeCycle Management
version: 1.0.1
description: |
  NSCE Server Network Slice LifeCycle Management.
  © 2024, 3GPP Organizational Partners (ARIB, ATIS, CCSA, ETSI, TSDSI, TTA, TTC).
  All rights reserved.
```

externalDocs:

```
description: >
  3GPP TS 29.435 V18.2.0; Service Enabler Architecture Layer for Verticals (SEAL);
  Network Slice Capability Exposure (NSCE) Server Service(s); Stage 3.
url: http://www.3gpp.org/ftp/Specs/archive/29_series/29.435/
```

servers:

```
- url: '{apiRoot}/nsce-nslcm/v1'
  variables:
    apiRoot:
      default: https://example.com
      description: apiRoot as defined in clause 5.2.4 of 3GPP TS 29.122
```

security:

```
- {}
- oAuth2ClientCredentials: []
```

paths:

```
/subscriptions:
  post:
    summary: Request the creation of a Network Slice Lifecycle Management Subscription.
    operationId: CreateNetSliceLifeCycleMngtSubsc
    tags:
      - Network Slice Lifecycle Management Subscriptions (Collection)
    requestBody:
      required: true
      content:
        application/json:
          schema:
            $ref: '#/components/schemas/NSLCMSubsc'
    responses:
      '201':
        description: >
          Created. The Network Slice Lifecycle Management Subscription is successfully created
          and a representation of the created Individual Network Slice Lifecycle Management
          Subscription resource shall be returned.
        content:
          application/json:
            schema:
              $ref: '#/components/schemas/NSLCMSubsc'
        headers:
          Location:
            description: >
              Contains the URI of the newly created resource.
            required: true
            schema:
              type: string
      '400':
        $ref: '#/components/responses/400'
      '401':
        $ref: '#/components/responses/401'
      '403':
        $ref: '#/components/responses/403'
      '404':
        $ref: '#/components/responses/404'
      '411':
        $ref: '#/components/responses/411'
      '413':
        $ref: '#/components/responses/413'
      '415':
        $ref: '#/components/responses/415'
      '429':
        $ref: '#/components/responses/429'
      '500':
```

```

    $ref: 'TS29122_CommonData.yaml#/components/responses/500'
  '503':
    $ref: 'TS29122_CommonData.yaml#/components/responses/503'
  default:
    $ref: 'TS29122_CommonData.yaml#/components/responses/default'
callbacks:
  NetSliceLifeCycleMngtNotif:
    '{$request.body#/notifUri}':
      post:
        requestBody:
          required: true
          content:
            application/json:
              schema:
                $ref: '#/components/schemas/NSLCMNotif'
        responses:
          '204':
            description: >
              No Content. The Network Slice Lifecycle Management Notification is successfully
              received and processed.
          '307':
            $ref: 'TS29122_CommonData.yaml#/components/responses/307'
          '308':
            $ref: 'TS29122_CommonData.yaml#/components/responses/308'
          '400':
            $ref: 'TS29122_CommonData.yaml#/components/responses/400'
          '401':
            $ref: 'TS29122_CommonData.yaml#/components/responses/401'
          '403':
            $ref: 'TS29122_CommonData.yaml#/components/responses/403'
          '404':
            $ref: 'TS29122_CommonData.yaml#/components/responses/404'
          '411':
            $ref: 'TS29122_CommonData.yaml#/components/responses/411'
          '413':
            $ref: 'TS29122_CommonData.yaml#/components/responses/413'
          '415':
            $ref: 'TS29122_CommonData.yaml#/components/responses/415'
          '429':
            $ref: 'TS29122_CommonData.yaml#/components/responses/429'
          '500':
            $ref: 'TS29122_CommonData.yaml#/components/responses/500'
          '503':
            $ref: 'TS29122_CommonData.yaml#/components/responses/503'
          default:
            $ref: 'TS29122_CommonData.yaml#/components/responses/default'
  QoEMetricsSubsNotif:
    '{$request.body#/notifUri}/subscribe-qoe':
      post:
        requestBody:
          required: true
          content:
            application/json:
              schema:
                $ref: '#/components/schemas/QoEMetricsSubsc'
        responses:
          '200':
            description: >
              OK. The QoE metrics Subscription is successfully received
              and processed, and immediate QoE metrics reporting related information
              shall be returned in the response body.
            content:
              application/json:
                schema:
                  $ref: '#/components/schemas/QoEMetricsResp'
          '204':
            description: >
              No Content. The QoE metrics Subscription is successfully received and
              processed, and no content is returned in the response body.
          '307':
            $ref: 'TS29122_CommonData.yaml#/components/responses/307'
          '308':
            $ref: 'TS29122_CommonData.yaml#/components/responses/308'
          '400':
            $ref: 'TS29122_CommonData.yaml#/components/responses/400'
          '401':
            $ref: 'TS29122_CommonData.yaml#/components/responses/401'
          '403':
            $ref: 'TS29122_CommonData.yaml#/components/responses/401'

```

```

    $ref: 'TS29122_CommonData.yaml#/components/responses/403'
  '404':
    $ref: 'TS29122_CommonData.yaml#/components/responses/404'
  '411':
    $ref: 'TS29122_CommonData.yaml#/components/responses/411'
  '413':
    $ref: 'TS29122_CommonData.yaml#/components/responses/413'
  '415':
    $ref: 'TS29122_CommonData.yaml#/components/responses/415'
  '429':
    $ref: 'TS29122_CommonData.yaml#/components/responses/429'
  '500':
    $ref: 'TS29122_CommonData.yaml#/components/responses/500'
  '503':
    $ref: 'TS29122_CommonData.yaml#/components/responses/503'
  default:
    $ref: 'TS29122_CommonData.yaml#/components/responses/default'
NetSliceLCMRecomNotif:
  '{$request.body#/notifUri}/recommend':
    post:
      requestBody:
        required: true
        content:
          application/json:
            schema:
              $ref: '#/components/schemas/NSLCMRecom'
      responses:
        '204':
          description: >
            No Content. The Network Slice LCM Recommendation Notification
            is successfully received and processed, and no content is
            returned in the response body.
        '307':
          $ref: 'TS29122_CommonData.yaml#/components/responses/307'
        '308':
          $ref: 'TS29122_CommonData.yaml#/components/responses/308'
        '400':
          $ref: 'TS29122_CommonData.yaml#/components/responses/400'
        '401':
          $ref: 'TS29122_CommonData.yaml#/components/responses/401'
        '403':
          $ref: 'TS29122_CommonData.yaml#/components/responses/403'
        '404':
          $ref: 'TS29122_CommonData.yaml#/components/responses/404'
        '411':
          $ref: 'TS29122_CommonData.yaml#/components/responses/411'
        '413':
          $ref: 'TS29122_CommonData.yaml#/components/responses/413'
        '415':
          $ref: 'TS29122_CommonData.yaml#/components/responses/415'
        '429':
          $ref: 'TS29122_CommonData.yaml#/components/responses/429'
        '500':
          $ref: 'TS29122_CommonData.yaml#/components/responses/500'
        '503':
          $ref: 'TS29122_CommonData.yaml#/components/responses/503'
        default:
          $ref: 'TS29122_CommonData.yaml#/components/responses/default'

/subscriptions/{subscriptionId}:
  parameters:
    - name: subscriptionId
      in: path
      description: >
        Represents the identifier of the Individual Network Slice Lifecycle Management
        Subscription resource.
      required: true
      schema:
        type: string

  get:
    summary: Retrieve an existing Individual Network Slice Lifecycle Management Subscription"
resource at the NSCE Server.
  operationId: GetIndNetSliceLifeCycleMngtSubsc
  tags:
    - Individual Network Slice Lifecycle Management Subscription (Document)
  responses:

```

```

'200':
  description: >
    OK. The requested Individual Network Slice Lifecycle Management Subscription
    resource shall be returned.
  content:
    application/json:
      schema:
        $ref: '#/components/schemas/NSLCMSubsc'
'307':
  $ref: 'TS29122_CommonData.yaml#/components/responses/307'
'308':
  $ref: 'TS29122_CommonData.yaml#/components/responses/308'
'400':
  $ref: 'TS29122_CommonData.yaml#/components/responses/400'
'401':
  $ref: 'TS29122_CommonData.yaml#/components/responses/401'
'403':
  $ref: 'TS29122_CommonData.yaml#/components/responses/403'
'404':
  $ref: 'TS29122_CommonData.yaml#/components/responses/404'
'406':
  $ref: 'TS29122_CommonData.yaml#/components/responses/406'
'429':
  $ref: 'TS29122_CommonData.yaml#/components/responses/429'
'500':
  $ref: 'TS29122_CommonData.yaml#/components/responses/500'
'503':
  $ref: 'TS29122_CommonData.yaml#/components/responses/503'
default:
  $ref: 'TS29122_CommonData.yaml#/components/responses/default'

put:
  summary: Request the update of an existing Individual Network Slice Lifecycle Management
Subscription resource at the NSCE Server.
  operationId: UpdateIndNetSliceLifeCycleMngtSubc
  tags:
    - Individual Network Slice Lifecycle Management Subscription (Document)
  requestBody:
    required: true
    content:
      application/json:
        schema:
          $ref: '#/components/schemas/NSLCMSubsc'
  responses:
    '200':
      description: >
        OK. The Individual Management Discovery Subscription resource is successfully updated
        and a representation of the updated resource shall be returned in the response body.
      content:
        application/json:
          schema:
            $ref: '#/components/schemas/NSLCMSubsc'
    '204':
      description: >
        No Content. The Individual Network Slice Lifecycle Management Subscription resource
        is successfully updated and no content is returned in the response body.
    '307':
      $ref: 'TS29122_CommonData.yaml#/components/responses/307'
    '308':
      $ref: 'TS29122_CommonData.yaml#/components/responses/308'
    '400':
      $ref: 'TS29122_CommonData.yaml#/components/responses/400'
    '401':
      $ref: 'TS29122_CommonData.yaml#/components/responses/401'
    '403':
      $ref: 'TS29122_CommonData.yaml#/components/responses/403'
    '404':
      $ref: 'TS29122_CommonData.yaml#/components/responses/404'
    '411':
      $ref: 'TS29122_CommonData.yaml#/components/responses/411'
    '413':
      $ref: 'TS29122_CommonData.yaml#/components/responses/413'
    '415':
      $ref: 'TS29122_CommonData.yaml#/components/responses/415'
    '429':
      $ref: 'TS29122_CommonData.yaml#/components/responses/429'
    '500':
      $ref: 'TS29122_CommonData.yaml#/components/responses/500'

```

```

'503':
  $ref: 'TS29122_CommonData.yaml#/components/responses/503'
default:
  $ref: 'TS29122_CommonData.yaml#/components/responses/default'

patch:
  summary: Request the modification of an existing Individual Network Slice Lifecycle Management
Subscription resource at the NSCE Server.
  operationId: ModifyIndNetSliceLifeCycleMngtSubsc
  tags:
    - Individual Network Slice Lifecycle Management Subscription (Document)
  requestBody:
    required: true
    content:
      application/merge-patch+json:
        schema:
          $ref: '#/components/schemas/NSLCMSubscPatch'
  responses:
    '200':
      description: >
        OK. The Individual Network Slice Lifecycle Management Subscription resource is
        successfully modified and a representation of the updated resource shall
        be returned in the response body.
      content:
        application/json:
          schema:
            $ref: '#/components/schemas/NSLCMSubsc'
    '204':
      description: >
        No Content. The Individual Network Slice Lifecycle Management Subscription resource
        is successfully modified and no content is returned in the response body.
    '307':
      $ref: 'TS29122_CommonData.yaml#/components/responses/307'
    '308':
      $ref: 'TS29122_CommonData.yaml#/components/responses/308'
    '400':
      $ref: 'TS29122_CommonData.yaml#/components/responses/400'
    '401':
      $ref: 'TS29122_CommonData.yaml#/components/responses/401'
    '403':
      $ref: 'TS29122_CommonData.yaml#/components/responses/403'
    '404':
      $ref: 'TS29122_CommonData.yaml#/components/responses/404'
    '411':
      $ref: 'TS29122_CommonData.yaml#/components/responses/411'
    '413':
      $ref: 'TS29122_CommonData.yaml#/components/responses/413'
    '415':
      $ref: 'TS29122_CommonData.yaml#/components/responses/415'
    '429':
      $ref: 'TS29122_CommonData.yaml#/components/responses/429'
    '500':
      $ref: 'TS29122_CommonData.yaml#/components/responses/500'
    '503':
      $ref: 'TS29122_CommonData.yaml#/components/responses/503'
default:
  $ref: 'TS29122_CommonData.yaml#/components/responses/default'

delete:
  summary: Request the deletion of an existing Individual Network Slice Lifecycle Management
Subscription resource.
  operationId: DeleteIndNetSliceLifeCycleMngtSubsc
  tags:
    - Individual Network Slice Lifecycle Management Subscription (Document)
  responses:
    '204':
      description: >
        No Content. The Individual Network Slice Lifecycle Management Subscription
        resource is successfully deleted.
    '307':
      $ref: 'TS29122_CommonData.yaml#/components/responses/307'
    '308':
      $ref: 'TS29122_CommonData.yaml#/components/responses/308'
    '400':
      $ref: 'TS29122_CommonData.yaml#/components/responses/400'
    '401':
      $ref: 'TS29122_CommonData.yaml#/components/responses/401'
    '403':

```

```

    $ref: 'TS29122_CommonData.yaml#/components/responses/403'
  '404':
    $ref: 'TS29122_CommonData.yaml#/components/responses/404'
  '429':
    $ref: 'TS29122_CommonData.yaml#/components/responses/429'
  '500':
    $ref: 'TS29122_CommonData.yaml#/components/responses/500'
  '503':
    $ref: 'TS29122_CommonData.yaml#/components/responses/503'
  default:
    $ref: 'TS29122_CommonData.yaml#/components/responses/default'

```

```

/subscriptions/{subscriptionId}/notify:

```

```

  parameters:

```

```

    - name: subscriptionId
      in: path
      description: >
        Represents the identifier of the Individual Network Slice Lifecycle Management
        Subscription resource.
      required: true
      schema:
        type: string

```

```

  post:

```

```

    summary: Enables the service consumer to send a notification to the NSCE Server on QoE
    metrics.

```

```

    operationId: QoEMetricNotify

```

```

    tags:

```

```

      - QoE metrics Notification

```

```

    requestBody:

```

```

      required: true

```

```

      content:

```

```

        application/json:

```

```

          schema:

```

```

            $ref: '#/components/schemas/QoEMetricsReportNotif'

```

```

    responses:

```

```

      '204':

```

```

        description: >

```

```

          No Content. The QoE metrics notification is successfully received and processed,
          and no content is returned in the response body.

```

```

      '307':

```

```

        $ref: 'TS29122_CommonData.yaml#/components/responses/307'

```

```

      '308':

```

```

        $ref: 'TS29122_CommonData.yaml#/components/responses/308'

```

```

      '400':

```

```

        $ref: 'TS29122_CommonData.yaml#/components/responses/400'

```

```

      '401':

```

```

        $ref: 'TS29122_CommonData.yaml#/components/responses/401'

```

```

      '403':

```

```

        $ref: 'TS29122_CommonData.yaml#/components/responses/403'

```

```

      '404':

```

```

        $ref: 'TS29122_CommonData.yaml#/components/responses/404'

```

```

      '411':

```

```

        $ref: 'TS29122_CommonData.yaml#/components/responses/411'

```

```

      '413':

```

```

        $ref: 'TS29122_CommonData.yaml#/components/responses/413'

```

```

      '415':

```

```

        $ref: 'TS29122_CommonData.yaml#/components/responses/415'

```

```

      '429':

```

```

        $ref: 'TS29122_CommonData.yaml#/components/responses/429'

```

```

      '500':

```

```

        $ref: 'TS29122_CommonData.yaml#/components/responses/500'

```

```

      '503':

```

```

        $ref: 'TS29122_CommonData.yaml#/components/responses/503'

```

```

      default:

```

```

        $ref: 'TS29122_CommonData.yaml#/components/responses/default'

```

```

components:

```

```

  securitySchemes:

```

```

    oAuth2ClientCredentials:

```

```

      type: oauth2

```

```

      flows:

```

```

        clientCredentials:

```

```

          tokenUrl: '{tokenUrl}'

```

```

          scopes: {}

```



```
schemas:
  NSLCMSubsc:
    description: Represents a Network Slice Life Cycle Management Subscription.
    type: object
    properties:
      notifUri:
        $ref: 'TS29122_CommonData.yaml#/components/schemas/Uri'
      servReqs:
        type: array
        items:
          $ref: 'TS29435_NSCE_SliceApiManagement.yaml#/components/schemas/AppServReqs'
        minItems: 1
      triggerConds:
        type: array
        items:
          $ref: '#/components/schemas/TriggerCond'
        minItems: 1
      expTime:
        $ref: 'TS29122_CommonData.yaml#/components/schemas/DateTime'
      suppFeat:
        $ref: 'TS29571_CommonData.yaml#/components/schemas/SupportedFeatures'
    required:
      - notifUri

  NSLCMSubscPatch:
    description: >
      Represents the requested modifications to a Network Slice Life Cycle
      Management Subscription.
    type: object
    properties:
      notifUri:
        $ref: 'TS29122_CommonData.yaml#/components/schemas/Uri'
      servReqs:
        type: array
        items:
          $ref: 'TS29435_NSCE_SliceApiManagement.yaml#/components/schemas/AppServReqs'
        minItems: 1
      triggerConds:
        type: array
        items:
          $ref: '#/components/schemas/TriggerCond'
        minItems: 1
      expTime:
        $ref: 'TS29122_CommonData.yaml#/components/schemas/DateTime'

  NSLCMNotif:
    description: Represents a Network Slice Life Cycle Management Notification.
    type: object
    properties:
      netSliceId:
        $ref: 'TS29435_NSCE_PolicyManagement.yaml#/components/schemas/NetSliceId'
    required:
      - netSliceId

  QoEMetricsSubsc:
    description: Represents a QoE Metrics Subscription.
    type: object
    properties:
      notifCorrId:
        type: string
      subscriptionId:
        type: string
      collectInfos:
        type: object
        additionalProperties:
          $ref: '#/components/schemas/CollectInfo'
        minProperties: 1
      description: >
        Contains the information collected from the interested network slice.
        The key of the map shall be any unique string encoded value.
      expTime:
        $ref: 'TS29122_CommonData.yaml#/components/schemas/DateTime'
    required:
      - collectInfos

  QoEMetricsResp:
    description: Represents the response to a QoE Metrics Subscription.
    type: object
```

```
properties:
  qoeMetrics:
    $ref: '#/components/schemas/QoEMetricsSubsc'
  qoeMetricsReports:
    type: array
    items:
      $ref: '#/components/schemas/QoEMetricsReport'
    minItems: 1

QoEMetricsReport:
  description: Represents the report of QoE Metrics.
  type: object
  properties:
    netSliceId:
      $ref: 'TS29435_NSCE_PolicyManagement.yaml#/components/schemas/NetSliceId'
    qoeMetrics:
      type: array
      items:
        $ref: '#/components/schemas/QoEMetric'
      minItems: 1
  required:
    - netSliceId
    - qoeMetrics

NSLCMRecom:
  description: Represents the Network Slice LCM Recommendation.
  type: object
  properties:
    netSliceId:
      $ref: 'TS29435_NSCE_PolicyManagement.yaml#/components/schemas/NetSliceId'
    sliceLCMActions:
      type: array
      items:
        $ref: '#/components/schemas/SliceLCMAction'
      minItems: 1
    sliceInfo:
      $ref: 'TS29435_NSCE_NSInfoDelivery.yaml#/components/schemas/NSInfoSet'
  required:
    - netSliceId
    - sliceLCMActions

CollectInfo:
  description: Represents the information collected from the interested network slice.
  type: object
  properties:
    netSliceId:
      $ref: 'TS29435_NSCE_PolicyManagement.yaml#/components/schemas/NetSliceId'
    qoeMetrics:
      type: array
      items:
        $ref: '#/components/schemas/QoEMetric'
      minItems: 1
    repPeriod:
      $ref: 'TS29122_CommonData.yaml#/components/schemas/DurationSec'
    immRepFlag:
      type: boolean
      description: >
        Contains the immediate reporting indication.
        true means that immediate reporting is requested.
        false means that immediate reporting is not requested.
        The default value is false if this attribute is omitted.
  required:
    - netSliceId

TriggerCond:
  description: >
    Represents the updated monitored parameters and the corresponding thresholds
    which could trigger the AppLayer-NS-LCM.
  type: object
  properties:
    triggerType:
      $ref: '#/components/schemas/TriggerType'
    netSliceId:
      $ref: 'TS29435_NSCE_PolicyManagement.yaml#/components/schemas/NetSliceId'
    loadLevelThreshold:
      type: integer
      minimum: 0
      maximum: 100
```

```
perfThreshold:
  type: integer
  minimum: 0
  maximum: 100
qoeMetrics:
  type: array
  items:
    $ref: '#/components/schemas/QoEMetric'
  minItems: 1
required:
- triggerType

QoEMetric:
description: >
  Represents the QoE metric type and the corresponding QoE threshold.
type: object
properties:
  qoeType:
    $ref: '#/components/schemas/QoEType'
  latency:
    $ref: 'TS29571_CommonData.yaml#/components/schemas/Float'
  throughput:
    $ref: 'TS29571_CommonData.yaml#/components/schemas/BitRate'
  jitter:
    $ref: 'TS29571_CommonData.yaml#/components/schemas/Uint32'
  avgPacketLossRate:
    $ref: 'TS29571_CommonData.yaml#/components/schemas/PacketLossRate'
  maxPacketLossRate:
    $ref: 'TS29571_CommonData.yaml#/components/schemas/PacketLossRate'
required:
- qoeType

QoEMetricsReportNotif:
description: >
  Represents the QoE metrics notification including the QoE Metrics Report.
type: object
properties:
  notifCorrId:
    type: string
  qoEMetricsReport:
    $ref: '#/components/schemas/QoEMetricsReport'
required:
- notifCorrId
- qoEMetricsReport

#
# ENUMERATIONS DATA TYPES
#

QoEType:
  anyOf:
  - type: string
    enum:
      - LATENCY
      - THROUGHPUT
      - JITTER
      - AVG_PKT_LOSS_RATE
      - MAX_PKT_LOSS_RATE
  - type: string
    description: >
      This string provides forward-compatibility with future
      extensions to the enumeration and is not used to encode
      content defined in the present version of this API.
description: |
  Represents the QoE metric type, e.g., latency, throughput, jitter, etc.
  Possible values are:
  - LATENCY: Indicates that the QoE type is latency.
  - THROUGHPUT: Indicates that the QoE type is throughput.
  - JITTER: Indicates that the QoE type is jitter.
  - AVG_PKT_LOSS_RATE: Indicates that the QoE type is the average Packet Loss Rate.
  - MAX_PKT_LOSS_RATE: Indicates that the QoE type is the maximum Packet Loss Rate.

TriggerType:
  anyOf:
  - type: string
    enum:
      - NETWORK_SLICE_LOAD
```

```

- NETWORK_SLICE_PERFORMANCE
- QOE
- type: string
description: >
  This string provides forward-compatibility with future
  extensions to the enumeration and is not used to encode
  content defined in the present version of this API.
description: |
  Represents the monitored parameter type, e.g., Network Slice load,
  collected Network Slice performance, collected QoE, etc.
  Possible values are:
- NETWORK_SLICE_LOAD: Indicates that the trigger type is Network Slice Load.
- NETWORK_SLICE_PERFORMANCE: Indicates that the trigger type is Network Slice Performance.
- QOE: Indicates that the trigger type is QoE.

SliceLCMAction:
anyOf:
- type: string
enum:
- MODIFY_CONFIGURATION
- ALLOCATE_SLICE
- type: string
description: >
  This string provides forward-compatibility with future
  extensions to the enumeration and is not used to encode
  content defined in the present version of this API.
description: |
  Represents the recommended slice LCM action.
  Possible values are:
- MODIFY_CONFIGURATION: Indicates that the recommended action is modifying the
  configuration.
- ALLOCATE_SLICE: Indicates that the recommended action is allocating a network slice.

```

---

## A.4 NSCE\_PolicyManagement API

openapi: 3.0.0

```

info:
  title: NSCE Server Policy Management Service
  version: 1.0.0
  description: |
    NSCE Server Policy Management Service.
    © 2024, 3GPP Organizational Partners (ARIB, ATIS, CCSA, ETSI, TSDSI, TTA, TTC).
    All rights reserved.

externalDocs:
  description: >
    3GPP TS 29.435 V18.1.0; Service Enabler Architecture Layer for Verticals (SEAL);
    Network Slice Capability Enablement (NSCE) Server Service(s); Stage 3.
  url: https://www.3gpp.org/ftp/Specs/archive/29_series/29.435/

servers:
- url: '{apiRoot}/nsce-pm/v1'
  variables:
    apiRoot:
      default: https://example.com
      description: apiRoot as defined in clause 6.5 of 3GPP TS 29.549

security:
- {}
- oAuth2ClientCredentials: []

paths:
  /policies:
    post:
      summary: Request the provisioning of a Policy.
      operationId: CreatePolicy
      tags:
        - Policies (Collection)
      requestBody:
        required: true
        content:
          application/json:

```

```

    schema:
      $ref: '#/components/schemas/Policy'
responses:
  '201':
    description: >
      Created. The Policy is successfully created and a representation of the created
      Individual Policy resource shall be returned.
    content:
      application/json:
        schema:
          $ref: '#/components/schemas/Policy'
    headers:
      Location:
        description: >
          Contains the URI of the created Individual Policy resource.
        required: true
        schema:
          type: string
  '400':
    $ref: 'TS29122_CommonData.yaml#/components/responses/400'
  '401':
    $ref: 'TS29122_CommonData.yaml#/components/responses/401'
  '403':
    $ref: 'TS29122_CommonData.yaml#/components/responses/403'
  '404':
    $ref: 'TS29122_CommonData.yaml#/components/responses/404'
  '411':
    $ref: 'TS29122_CommonData.yaml#/components/responses/411'
  '413':
    $ref: 'TS29122_CommonData.yaml#/components/responses/413'
  '415':
    $ref: 'TS29122_CommonData.yaml#/components/responses/415'
  '429':
    $ref: 'TS29122_CommonData.yaml#/components/responses/429'
  '500':
    $ref: 'TS29122_CommonData.yaml#/components/responses/500'
  '503':
    $ref: 'TS29122_CommonData.yaml#/components/responses/503'
default:
  $ref: 'TS29122_CommonData.yaml#/components/responses/default'
callbacks:
  HarmonizationNotif:
    '{$request.body#/notifUri}':
      post:
        requestBody:
          required: true
          content:
            application/json:
              schema:
                $ref: '#/components/schemas/HarmonizationNotif'
        responses:
          '200':
            description: >
              OK. The Policy Harmonization Notification is successfully received and
              processed, and policy harmonization related information shall be returned in the
              response body.
            content:
              application/json:
                schema:
                  $ref: '#/components/schemas/HarmonizationResp'
          '204':
            description: >
              No Content. The Policy Harmonization Notification is successfully received and
              processed, and no content is returned in the response body.
          '307':
            $ref: 'TS29122_CommonData.yaml#/components/responses/307'
          '308':
            $ref: 'TS29122_CommonData.yaml#/components/responses/308'
          '400':
            $ref: 'TS29122_CommonData.yaml#/components/responses/400'
          '401':
            $ref: 'TS29122_CommonData.yaml#/components/responses/401'
          '403':
            $ref: 'TS29122_CommonData.yaml#/components/responses/403'
          '404':
            $ref: 'TS29122_CommonData.yaml#/components/responses/404'
          '411':
            $ref: 'TS29122_CommonData.yaml#/components/responses/411'

```

```

    '413':
      $ref: 'TS29122_CommonData.yaml#/components/responses/413'
    '415':
      $ref: 'TS29122_CommonData.yaml#/components/responses/415'
    '429':
      $ref: 'TS29122_CommonData.yaml#/components/responses/429'
    '500':
      $ref: 'TS29122_CommonData.yaml#/components/responses/500'
    '503':
      $ref: 'TS29122_CommonData.yaml#/components/responses/503'
  default:
    $ref: 'TS29122_CommonData.yaml#/components/responses/default'

/policies/delete:
  post:
    summary: Enables to request the deletion of one or several existing Policy(ies).
    operationId: DeletePolicies
    tags:
      - Policy(ies) Deletion Request
    requestBody:
      required: true
      content:
        application/json:
          schema:
            $ref: '#/components/schemas/PolDeleteReq'
    responses:
      '200':
        description: >
          OK. The Policy(ies) deletion request is successfully received and processed, and
          deletion related information shall be returned in the response body.
        content:
          application/json:
            schema:
              $ref: '#/components/schemas/PolDeleteResp'
      '204':
        description: >
          No Content. The Policy(ies) deletion request is successfully received and processed, and
          no content is returned in the response body.
      '307':
        $ref: 'TS29122_CommonData.yaml#/components/responses/307'
      '308':
        $ref: 'TS29122_CommonData.yaml#/components/responses/308'
      '400':
        $ref: 'TS29122_CommonData.yaml#/components/responses/400'
      '401':
        $ref: 'TS29122_CommonData.yaml#/components/responses/401'
      '403':
        $ref: 'TS29122_CommonData.yaml#/components/responses/403'
      '404':
        $ref: 'TS29122_CommonData.yaml#/components/responses/404'
      '411':
        $ref: 'TS29122_CommonData.yaml#/components/responses/411'
      '413':
        $ref: 'TS29122_CommonData.yaml#/components/responses/413'
      '415':
        $ref: 'TS29122_CommonData.yaml#/components/responses/415'
      '429':
        $ref: 'TS29122_CommonData.yaml#/components/responses/429'
      '500':
        $ref: 'TS29122_CommonData.yaml#/components/responses/500'
      '503':
        $ref: 'TS29122_CommonData.yaml#/components/responses/503'
  default:
    $ref: 'TS29122_CommonData.yaml#/components/responses/default'

/policies/{policyId}:
  parameters:
    - name: policyId
      in: path
      description: >
        Represents the identifier of the Individual Policy resource.
      required: true
      schema:
        type: string
  get:
    summary: Retrieve an existing Individual Policy resource.
    operationId: GetIndPolicy

```

```

tags:
- Individual Policy (Document)
responses:
'200':
  description: >
    OK. The requested Individual Policy resource shall be returned.
  content:
    application/json:
      schema:
        $ref: '#/components/schemas/Policy'
'307':
  $ref: 'TS29122_CommonData.yaml#/components/responses/307'
'308':
  $ref: 'TS29122_CommonData.yaml#/components/responses/308'
'400':
  $ref: 'TS29122_CommonData.yaml#/components/responses/400'
'401':
  $ref: 'TS29122_CommonData.yaml#/components/responses/401'
'403':
  $ref: 'TS29122_CommonData.yaml#/components/responses/403'
'404':
  $ref: 'TS29122_CommonData.yaml#/components/responses/404'
'406':
  $ref: 'TS29122_CommonData.yaml#/components/responses/406'
'429':
  $ref: 'TS29122_CommonData.yaml#/components/responses/429'
'500':
  $ref: 'TS29122_CommonData.yaml#/components/responses/500'
'503':
  $ref: 'TS29122_CommonData.yaml#/components/responses/503'
default:
  $ref: 'TS29122_CommonData.yaml#/components/responses/default'

put:
summary: Request the update of an existing Individual Policy resource.
operationId: UpdateIndDPolicy
tags:
- Individual Policy (Document)
requestBody:
  required: true
  content:
    application/json:
      schema:
        $ref: '#/components/schemas/Policy'
responses:
'200':
  description: >
    OK. The Individual Policy resource is successfully updated and a representation
    of the updated resource shall be returned in the response body.
  content:
    application/json:
      schema:
        $ref: '#/components/schemas/Policy'
'204':
  description: >
    No Content. The Individual Policy resource is successfully updated and no
    content is returned in the response body.
'307':
  $ref: 'TS29122_CommonData.yaml#/components/responses/307'
'308':
  $ref: 'TS29122_CommonData.yaml#/components/responses/308'
'400':
  $ref: 'TS29122_CommonData.yaml#/components/responses/400'
'401':
  $ref: 'TS29122_CommonData.yaml#/components/responses/401'
'403':
  $ref: 'TS29122_CommonData.yaml#/components/responses/403'
'404':
  $ref: 'TS29122_CommonData.yaml#/components/responses/404'
'411':
  $ref: 'TS29122_CommonData.yaml#/components/responses/411'
'413':
  $ref: 'TS29122_CommonData.yaml#/components/responses/413'
'415':
  $ref: 'TS29122_CommonData.yaml#/components/responses/415'
'429':
  $ref: 'TS29122_CommonData.yaml#/components/responses/429'
'500':

```

```

    $ref: 'TS29122_CommonData.yaml#/components/responses/500'
  '503':
    $ref: 'TS29122_CommonData.yaml#/components/responses/503'
  default:
    $ref: 'TS29122_CommonData.yaml#/components/responses/default'

```

patch:

```

summary: Request the modification of an existing Individual Policy resource.
operationId: ModifyIndPolicy
tags:
  - Individual Policy (Document)
requestBody:
  required: true
  content:
    application/merge-patch+json:
      schema:
        $ref: '#/components/schemas/PolicyPatch'
responses:
  '200':
    description: >
      OK. The Individual Policy resource is successfully modified and a representation
      of the updated resource shall be returned in the response body.
    content:
      application/json:
        schema:
          $ref: '#/components/schemas/Policy'
  '204':
    description: >
      No Content. The Individual Policy resource is successfully modified and no
      content is returned in the response body.
  '307':
    $ref: 'TS29122_CommonData.yaml#/components/responses/307'
  '308':
    $ref: 'TS29122_CommonData.yaml#/components/responses/308'
  '400':
    $ref: 'TS29122_CommonData.yaml#/components/responses/400'
  '401':
    $ref: 'TS29122_CommonData.yaml#/components/responses/401'
  '403':
    $ref: 'TS29122_CommonData.yaml#/components/responses/403'
  '404':
    $ref: 'TS29122_CommonData.yaml#/components/responses/404'
  '411':
    $ref: 'TS29122_CommonData.yaml#/components/responses/411'
  '413':
    $ref: 'TS29122_CommonData.yaml#/components/responses/413'
  '415':
    $ref: 'TS29122_CommonData.yaml#/components/responses/415'
  '429':
    $ref: 'TS29122_CommonData.yaml#/components/responses/429'
  '500':
    $ref: 'TS29122_CommonData.yaml#/components/responses/500'
  '503':
    $ref: 'TS29122_CommonData.yaml#/components/responses/503'
  default:
    $ref: 'TS29122_CommonData.yaml#/components/responses/default'

```

/subscriptions:

```

post:
  summary: Request the creation of a Policy Usage Subscription.
  operationId: CreatePolUsageSubsc
  tags:
    - Policy Usage Subscriptions (Collection)
  requestBody:
    required: true
    content:
      application/json:
        schema:
          $ref: '#/components/schemas/PolUsageSubsc'
  responses:
    '201':
      description: >
        Created. The Policy Usage Subscription is successfully created and a representation
        of the created Individual Policy Usage Subscription resource shall be returned.
      content:
        application/json:
          schema:
            $ref: '#/components/schemas/PolUsageSubsc'

```



```
headers:
  Location:
    description: >
      Contains the URI of the created Individual Policy Usage Subscription resource.
    required: true
    schema:
      type: string
'400':
  $ref: 'TS29122_CommonData.yaml#/components/responses/400'
'401':
  $ref: 'TS29122_CommonData.yaml#/components/responses/401'
'403':
  $ref: 'TS29122_CommonData.yaml#/components/responses/403'
'404':
  $ref: 'TS29122_CommonData.yaml#/components/responses/404'
'411':
  $ref: 'TS29122_CommonData.yaml#/components/responses/411'
'413':
  $ref: 'TS29122_CommonData.yaml#/components/responses/413'
'415':
  $ref: 'TS29122_CommonData.yaml#/components/responses/415'
'429':
  $ref: 'TS29122_CommonData.yaml#/components/responses/429'
'500':
  $ref: 'TS29122_CommonData.yaml#/components/responses/500'
'503':
  $ref: 'TS29122_CommonData.yaml#/components/responses/503'
default:
  $ref: 'TS29122_CommonData.yaml#/components/responses/default'
callbacks:
  PolUsageNotif:
    '{$request.body#/notifUri}':
      post:
        requestBody:
          required: true
          content:
            application/json:
              schema:
                $ref: '#/components/schemas/PolUsageNotif'
        responses:
          '204':
            description: >
              No Content. The Policy Usage Notification is successfully received and
              acknowledged.
          '307':
            $ref: 'TS29122_CommonData.yaml#/components/responses/307'
          '308':
            $ref: 'TS29122_CommonData.yaml#/components/responses/308'
          '400':
            $ref: 'TS29122_CommonData.yaml#/components/responses/400'
          '401':
            $ref: 'TS29122_CommonData.yaml#/components/responses/401'
          '403':
            $ref: 'TS29122_CommonData.yaml#/components/responses/403'
          '404':
            $ref: 'TS29122_CommonData.yaml#/components/responses/404'
          '411':
            $ref: 'TS29122_CommonData.yaml#/components/responses/411'
          '413':
            $ref: 'TS29122_CommonData.yaml#/components/responses/413'
          '415':
            $ref: 'TS29122_CommonData.yaml#/components/responses/415'
          '429':
            $ref: 'TS29122_CommonData.yaml#/components/responses/429'
          '500':
            $ref: 'TS29122_CommonData.yaml#/components/responses/500'
          '503':
            $ref: 'TS29122_CommonData.yaml#/components/responses/503'
          default:
            $ref: 'TS29122_CommonData.yaml#/components/responses/default'

/subscriptions/{subscriptionId}:
  parameters:
    - name: subscriptionId
      in: path
      description: >
        Represents the identifier of the Individual Policy Usage Subscription resource.
      required: true
```

```
    schema:
      type: string

get:
  summary: Retrieve an existing Individual Policy Usage Subscription resource.
  operationId: GetIndPolUsageSubsc
  tags:
    - Individual Policy Usage Subscription (Document)
  responses:
    '200':
      description: >
        OK. The requested Individual Policy Usage Subscription resource shall be returned.
      content:
        application/json:
          schema:
            $ref: '#/components/schemas/PolUsageSubsc'
    '307':
      $ref: 'TS29122_CommonData.yaml#/components/responses/307'
    '308':
      $ref: 'TS29122_CommonData.yaml#/components/responses/308'
    '400':
      $ref: 'TS29122_CommonData.yaml#/components/responses/400'
    '401':
      $ref: 'TS29122_CommonData.yaml#/components/responses/401'
    '403':
      $ref: 'TS29122_CommonData.yaml#/components/responses/403'
    '404':
      $ref: 'TS29122_CommonData.yaml#/components/responses/404'
    '406':
      $ref: 'TS29122_CommonData.yaml#/components/responses/406'
    '429':
      $ref: 'TS29122_CommonData.yaml#/components/responses/429'
    '500':
      $ref: 'TS29122_CommonData.yaml#/components/responses/500'
    '503':
      $ref: 'TS29122_CommonData.yaml#/components/responses/503'
    default:
      $ref: 'TS29122_CommonData.yaml#/components/responses/default'

put:
  summary: Request the update of an existing Individual Policy Usage Subscription resource.
  operationId: UpdateIndPolUsageSubsc
  tags:
    - Individual Policy Usage Subscription (Document)
  requestBody:
    required: true
    content:
      application/json:
        schema:
          $ref: '#/components/schemas/PolUsageSubsc'
  responses:
    '200':
      description: >
        OK. The Individual Policy Usage Subscription resource is successfully updated and a
        representation of the updated resource shall be returned in the response body.
      content:
        application/json:
          schema:
            $ref: '#/components/schemas/PolUsageSubsc'
    '204':
      description: >
        No Content. The Individual Policy Usage Subscription resource is successfully updated
        and no content is returned in the response body.
    '307':
      $ref: 'TS29122_CommonData.yaml#/components/responses/307'
    '308':
      $ref: 'TS29122_CommonData.yaml#/components/responses/308'
    '400':
      $ref: 'TS29122_CommonData.yaml#/components/responses/400'
    '401':
      $ref: 'TS29122_CommonData.yaml#/components/responses/401'
    '403':
      $ref: 'TS29122_CommonData.yaml#/components/responses/403'
    '404':
      $ref: 'TS29122_CommonData.yaml#/components/responses/404'
    '411':
      $ref: 'TS29122_CommonData.yaml#/components/responses/411'
    '413':
```

```

    $ref: 'TS29122_CommonData.yaml#/components/responses/413'
  '415':
    $ref: 'TS29122_CommonData.yaml#/components/responses/415'
  '429':
    $ref: 'TS29122_CommonData.yaml#/components/responses/429'
  '500':
    $ref: 'TS29122_CommonData.yaml#/components/responses/500'
  '503':
    $ref: 'TS29122_CommonData.yaml#/components/responses/503'
  default:
    $ref: 'TS29122_CommonData.yaml#/components/responses/default'

```

patch:

```

  summary: Request the modification of an existing Individual Policy Usage Subscription
  resource.
  operationId: ModifyIndPolUsageSubsc
  tags:
    - Individual Policy Usage Subscription (Document)
  requestBody:
    required: true
    content:
      application/merge-patch+json:
        schema:
          $ref: '#/components/schemas/PolUsageSubscPatch'
  responses:
    '200':
      description: >
        OK. The Individual Policy Usage Subscription resource is successfully modified and a
        representation of the updated resource shall be returned in the response body.
      content:
        application/json:
          schema:
            $ref: '#/components/schemas/PolUsageSubsc'
    '204':
      description: >
        No Content. The Individual Policy Usage Subscription resource is successfully modified
        and no content is returned in the response body.
    '307':
      $ref: 'TS29122_CommonData.yaml#/components/responses/307'
    '308':
      $ref: 'TS29122_CommonData.yaml#/components/responses/308'
    '400':
      $ref: 'TS29122_CommonData.yaml#/components/responses/400'
    '401':
      $ref: 'TS29122_CommonData.yaml#/components/responses/401'
    '403':
      $ref: 'TS29122_CommonData.yaml#/components/responses/403'
    '404':
      $ref: 'TS29122_CommonData.yaml#/components/responses/404'
    '411':
      $ref: 'TS29122_CommonData.yaml#/components/responses/411'
    '413':
      $ref: 'TS29122_CommonData.yaml#/components/responses/413'
    '415':
      $ref: 'TS29122_CommonData.yaml#/components/responses/415'
    '429':
      $ref: 'TS29122_CommonData.yaml#/components/responses/429'
    '500':
      $ref: 'TS29122_CommonData.yaml#/components/responses/500'
    '503':
      $ref: 'TS29122_CommonData.yaml#/components/responses/503'
  default:
    $ref: 'TS29122_CommonData.yaml#/components/responses/default'

```

delete:

```

  summary: Request the deletion of an existing Individual Policy Usage Subscription resource.
  operationId: DeleteIndPolUsageSubsc
  tags:
    - Individual Policy Usage Subscription (Document)
  responses:
    '204':
      description: >
        No Content. The Individual Policy Usage Subscription resource is successfully deleted.
    '307':
      $ref: 'TS29122_CommonData.yaml#/components/responses/307'
    '308':
      $ref: 'TS29122_CommonData.yaml#/components/responses/308'
    '400':

```

```

    $ref: 'TS29122_CommonData.yaml#/components/responses/400'
  '401':
    $ref: 'TS29122_CommonData.yaml#/components/responses/401'
  '403':
    $ref: 'TS29122_CommonData.yaml#/components/responses/403'
  '404':
    $ref: 'TS29122_CommonData.yaml#/components/responses/404'
  '429':
    $ref: 'TS29122_CommonData.yaml#/components/responses/429'
  '500':
    $ref: 'TS29122_CommonData.yaml#/components/responses/500'
  '503':
    $ref: 'TS29122_CommonData.yaml#/components/responses/503'
  default:
    $ref: 'TS29122_CommonData.yaml#/components/responses/default'

```

```

components:
  securitySchemes:
    oAuth2ClientCredentials:
      type: oauth2
      flows:
        clientCredentials:
          tokenUrl: '{tokenUrl}'
          scopes: {}

```

```
schemas:
```

```

#
# STRUCTURED DATA TYPES
#

```

```

Policy:
  description: >
    Represents a Policy.
  type: object
  properties:
    netSliceId:
      $ref: '#/components/schemas/NetSliceId'
    reqDnn:
      $ref: 'TS29571_CommonData.yaml#/components/schemas/Dnn'
    polHarmInd:
      type: boolean
      default: false
      description: >
        Contains the policy harmonization indication. It indicates whether policy harmonization
        is requested or not.
        true means that policy harmonization is requested.
        false means that policy harmonization is not requested.
        The default value when omitted is false.
    policy:
      $ref: '#/components/schemas/PolicyData'
    defaultPolInd:
      type: boolean
      default: false
      description: >
        Contains the default policy indication. It indicates whether or not the provisioned
        policy shall be used as a default policy for the network slices provisioned without any
        policy for the policy type it belongs to.
        true means that the provisioned policy shall be used as a default policy for the network
        slices provisioned without any policy for the policy type.
        false means that the provisioned policy shall not be used as a default policy for the
        network slices provisioned without any policy for the policy type.
        The default value when omitted is false.
    notifUri:
      $ref: 'TS29122_CommonData.yaml#/components/schemas/Uri'
    harmonizationId:
      type: string
    suppFeat:
      $ref: 'TS29571_CommonData.yaml#/components/schemas/SupportedFeatures'
  required:
    - policy

```

```

PolicyPatch:
  description: >
    Represents the requested modifications to a Policy.
  type: object
  properties:

```

```

netSliceId:
  $ref: '#/components/schemas/NetSliceId'
reqDnn:
  $ref: 'TS29571_CommonData.yaml#/components/schemas/Dnn'
polHarmInd:
  type: boolean
  description: >
    Contains the policy harmonization indication. It indicates whether policy harmonization
    is requested or not.
    true means that policy harmonization is requested.
    false means that policy harmonization is not requested.
    The default value when omitted and not previously provisioned is false.
policy:
  $ref: '#/components/schemas/PolicyData'
defaultPolInd:
  type: boolean
  description: >
    Contains the default policy indication. It indicates whether or not the provisioned
    policy shall be used as a default policy for the network slices provisioned without any
    policy.
    true means that the provisioned policy shall be used as a default policy for the network
    slices provisioned without any policy.
    false means that the provisioned policy shall not be used as a default policy for the
    network slices provisioned without any policy.
    The default value when omitted and not previously provisioned is false.
notifUri:
  $ref: 'TS29122_CommonData.yaml#/components/schemas/Uri'

PolicyData:
  description: >
    Represents the content of a policy.
  type: object
  properties:
    policyType:
      $ref: '#/components/schemas/PolicyType'
    areaOfInterest:
      $ref: 'TS29435_NSCE_NSInfoDelivery.yaml#/components/schemas/ServArea'
    triggers:
      $ref: '#/components/schemas/PolicyTriggers'
    actions:
      $ref: '#/components/schemas/PolicyActions'
    lifetime:
      $ref: 'TS29122_CommonData.yaml#/components/schemas/DurationSec'
    maxNumTimes:
      $ref: 'TS29571_CommonData.yaml#/components/schemas/Uinteger'
    priority:
      $ref: '#/components/schemas/PriorityLevel'
    schedule:
      $ref: 'TS29122_CommonData.yaml#/components/schemas/TimeWindow'
    preemption:
      $ref: '#/components/schemas/PriorityLevel'
  required:
    - policyType
    - areaOfInterest
    - triggers
    - actions
  oneOf:
    - required: [lifetime]
    - required: [maxNumTimes]

PolUsageSubsc:
  description: >
    Represents a Policy Usage Subscription.
  type: object
  properties:
    notifUri:
      $ref: 'TS29122_CommonData.yaml#/components/schemas/Uri'
    netSliceId:
      $ref: '#/components/schemas/NetSliceId'
    reqPolicyRep:
      $ref: '#/components/schemas/ReqPolRep'
    repPeriodicity:
      $ref: 'TS29122_CommonData.yaml#/components/schemas/DurationSec'
    suppFeat:
      $ref: 'TS29571_CommonData.yaml#/components/schemas/SupportedFeatures'
  required:
    - notifUri
    - netSliceId

```

```
- reqPolicyRep

PolUsageSubscPatch:
  description: >
    Represents the requested modifications to a Policy Usage Subscription.
  type: object
  properties:
    notifUri:
      $ref: 'TS29122_CommonData.yaml#/components/schemas/Uri'
    reqPolicyRep:
      $ref: '#/components/schemas/ReqPolRep'
    repPeriodicity:
      $ref: 'TS29122_CommonData.yaml#/components/schemas/DurationSec'

ReqPolRep:
  description: >
    Represents the requested policy usage reporting information.
  type: object
  properties:
    policyId:
      type: string
    startTime:
      $ref: 'TS29122_CommonData.yaml#/components/schemas/DateTime'
    endTime:
      $ref: 'TS29122_CommonData.yaml#/components/schemas/DateTime'
  required:
    - policyId
    - startTime
    - endTime

PolUsageNotif:
  description: >
    Represents a Policy Usage Notification.
  type: object
  properties:
    subscriptionId:
      type: string
    reports:
      type: array
      items:
        $ref: '#/components/schemas/PolRepData'
      minItems: 1
  required:
    - subscriptionId
    - reports

PolRepData:
  description: >
    Represents policy usage reporting data.
  type: object
  properties:
    policyId:
      type: string
    count:
      $ref: 'TS29571_CommonData.yaml#/components/schemas/UInteger'
    timeSpent:
      $ref: 'TS29122_CommonData.yaml#/components/schemas/DurationSec'
    preEmptCount:
      $ref: 'TS29571_CommonData.yaml#/components/schemas/UInteger'
    preEmptPolId:
      type: array
      items:
        type: string
      minItems: 1
  required:
    - policyId
    - count
    - timeSpent

PolDeleteReq:
  description: >
    Represents the parameters to request the deletion of one or several Policy(ies).
  type: object
  properties:
    policyIds:
      type: array
      items:
        type: string
```

```
    minItems: 1
  defPolicyIds:
    type: object
    additionalProperties:
      type: string
    minProperties: 1
    description: >
      Contains the identifier(s) of the policy(ies) that are to be the new default
      Policy(ies). Each map entry corresponds to the new default policy for a particular
      policy type. There shall not be more than one default policy for the same policy type.
      The key of the map shall be the policy type (encoded using the PolicyType enumeration
      data type defined in clause 6.3.6.3.3) for which the provided new default policy
      identified by the corresponding map value is related.
  suppFeat:
    $ref: 'TS29571_CommonData.yaml#/components/schemas/SupportedFeatures'
  required:
    - policyIds

PolDeleteResp:
  description: >
    Represents the response to the Policy(ies) deletion request.
  type: object
  properties:
    defPoliciesInfo:
      type: object
      additionalProperties:
        $ref: '#/components/schemas/DefaultPolInfo'
      minProperties: 1
      description: >
        Contains the new default policy(ies) related information. Each map entry corresponds to
        the information of the new default policy for a particular policy type.
        The key of the map shall be set to the value of the policyType attribute of the
        corresponding map entry encoded using the DefaultPolInfo data type.
      suppFeat:
        $ref: 'TS29571_CommonData.yaml#/components/schemas/SupportedFeatures'
      required:
        - defPoliciesInfo

DefaultPolInfo:
  description: >
    Represents the default policy related information.
  type: object
  properties:
    policyType:
      $ref: '#/components/schemas/PolicyType'
    defPolicyId:
      type: string
    priority:
      $ref: '#/components/schemas/PriorityLevel'
  required:
    - policyType
    - defPolicyId

HarmonizationNotif:
  description: >
    Represents a Policy Harmonization Notification.
  type: object
  properties:
    harmonizationId:
      type: string
    policy:
      $ref: '#/components/schemas/PolicyData'
  required:
    - harmonizationId
    - policy

HarmonizationResp:
  description: >
    Represents the response to a Policy Harmonization Notification.
  type: object
  properties:
    feedback:
      type: boolean
      description: >
        Contains the policy harmonization feedback. It indicates whether the policy
        harmonization result is accepted or not.
        true means that the policy harmonization result is accepted.
        false means that the policy harmonization result is not accepted.
```

```
required:
  - feedback

NetSliceId:
  description: >
    Represents the network slice identification information.
  type: object
  properties:
    snssai:
      $ref: 'TS29571_CommonData.yaml#/components/schemas/Snssai'
    nsiId:
      $ref: 'TS29531_Nnssf_NSSelection.yaml#/components/schemas/NsiId'
    ensi:
      $ref: '#/components/schemas/Ensi'
  oneOf:
    - required: [snssai]
    - required: [nsiId]
    - required: [ensi]

PolicyTriggers:
  description: >
    Represents the policy related triggers.
  type: object
  properties:
    monPercentage:
      type: integer
      minimum: 0
      maximum: 100
    monValue:
      type: integer
      minimum: 1
      description: Contains an unsigned Integer with only the values 1 and above permitted.
    monParamsValues:
      type: string
    timePeriod:
      $ref: '#/components/schemas/TimePeriodInfo'

PolicyActions:
  description: >
    Represents the policy related actions.
  type: object
  properties:
    stepIncreasePerc:
      type: integer
      minimum: 0
      maximum: 100
    allowedQoSActions:
      type: array
      items:
        $ref: '#/components/schemas/QoSAction'
      minItems: 1

TimePeriodInfo:
  description: >
    Represents the time period related information.
  type: object
  properties:
    startTime:
      $ref: 'TS29122_CommonData.yaml#/components/schemas/DateTime'
    endTime:
      $ref: 'TS29122_CommonData.yaml#/components/schemas/DateTime'
    daysOfWeek:
      type: array
      items:
        $ref: 'TS29122_CommonData.yaml#/components/schemas/DayOfWeek'
      minItems: 1
      maxItems: 7
  anyOf:
    - required: [startTime]
    - required: [endTime]
    - required: [daysOfWeek]

# SIMPLE DATA TYPES
#

PriorityLevel:
  description: >
```



Represents an unsigned integer, within the range 1 to 255, indicating the priority level of a policy or the pre-emption capability of a policy.

type: integer  
 minimum: 1  
 maximum: 255

Ensi:

description: >

Represents the External Network Slice Information that is used to identify a network slice, as specified in 3GPP TS 33.501.

type: string

#  
 # ENUMERATIONS  
 #

PolicyType:

anyOf:

- type: string

enum:

- MAX\_NUM\_PDU\_SESS
- MAX\_NUM\_UE
- SLICE\_LOAD\_PREDICTION
- TIME\_PERIOD\_AND\_AVG\_QOS
- TIME\_PERIOD\_AND\_MIN\_QOS

- type: string

description: >

This string provides forward-compatibility with future extensions to the enumeration and is not used to encode content defined in the present version of this API.

description: |

Represents policy type.

Possible values are:

- MAX\_NUM\_PDU\_SESS: Indicates that the policy type is the maximum number of PDU Sessions.
- MAX\_NUM\_UE: Indicates that the policy type is the maximum number of UEs Sessions.
- SLICE\_LOAD\_PREDICTION: Indicates that the policy type is the network slice load prediction.
- TIME\_PERIOD\_AND\_AVG\_QOS: Indicates that the policy type is the time period and average QoS per UE.
- TIME\_PERIOD\_AND\_MIN\_QOS: Indicates that the policy type is the time period and minimum QoS per UE.

QoSAction:

anyOf:

- type: string

enum:

- MODIFY

- type: string

description: >

This string provides forward-compatibility with future extensions to the enumeration and is not used to encode content defined in the present version of this API.

description: |

Represents the QoS related action.

Possible values are:

- MODIFY: Indicates that the QoS related action is to trigger the modification of the network slice capacity to fulfil the requested needs (e.g., average QoS, minimum QoS).

---

## A.5 NSCE\_NSOptimization API

openapi: 3.0.0

info:

title: NSCE Server Network Slice Optimization Service

version: 1.0.0

description: |

NSCE Server Network Slice Optimization Service.

© 2024, 3GPP Organizational Partners (ARIB, ATIS, CCSA, ETSI, TSDSI, TTA, TTC).

All rights reserved.

externalDocs:

description: >

3GPP TS 29.435 V18.1.0; Service Enabler Architecture Layer for Verticals (SEAL);

Network Slice Capability Enablement (NSCE) Server Service(s); Stage 3.

url: [https://www.3gpp.org/ftp/Specs/archive/29\\_series/29.435/](https://www.3gpp.org/ftp/Specs/archive/29_series/29.435/)

```

servers:
- url: '{apiRoot}/nsce-nso/v1'
  variables:
    apiRoot:
      default: https://example.com
      description: apiRoot as defined in clause 6.5 of 3GPP TS 29.549.

security:
- {}
- oAuth2ClientCredentials: []

paths:
  /subscriptions:
    post:
      summary: Request the creation of a Network Slice Optimization Subscription.
      operationId: CreateNetSliceOptSubsc
      tags:
        - Network Slice Optimization Subscriptions (Collection)
      requestBody:
        required: true
        content:
          application/json:
            schema:
              $ref: '#/components/schemas/NetSliceOptSubsc'
      responses:
        '201':
          description: >
            Created. The Network Slice Optimization Subscription is successfully created and
            a representation of the created Individual Network Slice Optimization
            Subscription resource shall be returned.
          content:
            application/json:
              schema:
                $ref: '#/components/schemas/NetSliceOptSubsc'
          headers:
            Location:
              description: >
                Contains the URI of the created Individual Network Slice Optimization
                Subscription resource.
              required: true
              schema:
                type: string
        '400':
          $ref: 'TS29122_CommonData.yaml#/components/responses/400'
        '401':
          $ref: 'TS29122_CommonData.yaml#/components/responses/401'
        '403':
          $ref: 'TS29122_CommonData.yaml#/components/responses/403'
        '404':
          $ref: 'TS29122_CommonData.yaml#/components/responses/404'
        '411':
          $ref: 'TS29122_CommonData.yaml#/components/responses/411'
        '413':
          $ref: 'TS29122_CommonData.yaml#/components/responses/413'
        '415':
          $ref: 'TS29122_CommonData.yaml#/components/responses/415'
        '429':
          $ref: 'TS29122_CommonData.yaml#/components/responses/429'
        '500':
          $ref: 'TS29122_CommonData.yaml#/components/responses/500'
        '503':
          $ref: 'TS29122_CommonData.yaml#/components/responses/503'
        default:
          $ref: 'TS29122_CommonData.yaml#/components/responses/default'
      callbacks:
        NetSliceOptNotif:
          '{$request.body#/notifUri}':
            post:
              requestBody:
                required: true
                content:
                  application/json:
                    schema:
                      $ref: '#/components/schemas/NetSliceOptNotif'
            responses:
              '204':
                description: >
                  No Content. The Network Slice Optimization Notification is successfully

```

```

        received and acknowledged.
    '307':
        $ref: 'TS29122_CommonData.yaml#/components/responses/307'
    '308':
        $ref: 'TS29122_CommonData.yaml#/components/responses/308'
    '400':
        $ref: 'TS29122_CommonData.yaml#/components/responses/400'
    '401':
        $ref: 'TS29122_CommonData.yaml#/components/responses/401'
    '403':
        $ref: 'TS29122_CommonData.yaml#/components/responses/403'
    '404':
        $ref: 'TS29122_CommonData.yaml#/components/responses/404'
    '411':
        $ref: 'TS29122_CommonData.yaml#/components/responses/411'
    '413':
        $ref: 'TS29122_CommonData.yaml#/components/responses/413'
    '415':
        $ref: 'TS29122_CommonData.yaml#/components/responses/415'
    '429':
        $ref: 'TS29122_CommonData.yaml#/components/responses/429'
    '500':
        $ref: 'TS29122_CommonData.yaml#/components/responses/500'
    '503':
        $ref: 'TS29122_CommonData.yaml#/components/responses/503'
    default:
        $ref: 'TS29122_CommonData.yaml#/components/responses/default'

/subscriptions/{subscriptionId}:
  parameters:
    - name: subscriptionId
      in: path
      description: >
        Represents the identifier of the Individual Network Slice Optimization
        Subscription resource.
      required: true
      schema:
        type: string

  get:
    summary: Retrieve an existing Individual Network Slice Optimization Subscription resource.
    operationId: GetIndNetSliceOptSubsc
    tags:
      - Individual Network Slice Optimization Subscription (Document)
    responses:
      '200':
        description: >
          OK. The requested Individual Network Slice Optimization Subscription resource shall
          be returned.
        content:
          application/json:
            schema:
              $ref: '#/components/schemas/NetSliceOptSubsc'
      '307':
        $ref: 'TS29122_CommonData.yaml#/components/responses/307'
      '308':
        $ref: 'TS29122_CommonData.yaml#/components/responses/308'
      '400':
        $ref: 'TS29122_CommonData.yaml#/components/responses/400'
      '401':
        $ref: 'TS29122_CommonData.yaml#/components/responses/401'
      '403':
        $ref: 'TS29122_CommonData.yaml#/components/responses/403'
      '404':
        $ref: 'TS29122_CommonData.yaml#/components/responses/404'
      '406':
        $ref: 'TS29122_CommonData.yaml#/components/responses/406'
      '429':
        $ref: 'TS29122_CommonData.yaml#/components/responses/429'
      '500':
        $ref: 'TS29122_CommonData.yaml#/components/responses/500'
      '503':
        $ref: 'TS29122_CommonData.yaml#/components/responses/503'
      default:
        $ref: 'TS29122_CommonData.yaml#/components/responses/default'

  put:

```

```

summary: Request the fully update of an existing Individual Network Slice Optimization
Subscription resource.
operationId: UpdateIndNetSliceOptSubsc
tags:
  - Individual Network Slice Optimization Subscription (Document)
requestBody:
  required: true
  content:
    application/json:
      schema:
        $ref: '#/components/schemas/NetSliceOptSubsc'
responses:
  '200':
    description: >
      OK. The Individual Network Slice Optimization Subscription resource is
      successfully updated and a representation of the updated resource shall be returned
      in the response body.
    content:
      application/json:
        schema:
          $ref: '#/components/schemas/NetSliceOptSubsc'
  '204':
    description: >
      No Content. The Individual Network Slice Optimization Subscription resource is
      successfully updated and no content is returned in the response body.
  '307':
    $ref: 'TS29122_CommonData.yaml#/components/responses/307'
  '308':
    $ref: 'TS29122_CommonData.yaml#/components/responses/308'
  '400':
    $ref: 'TS29122_CommonData.yaml#/components/responses/400'
  '401':
    $ref: 'TS29122_CommonData.yaml#/components/responses/401'
  '403':
    $ref: 'TS29122_CommonData.yaml#/components/responses/403'
  '404':
    $ref: 'TS29122_CommonData.yaml#/components/responses/404'
  '411':
    $ref: 'TS29122_CommonData.yaml#/components/responses/411'
  '413':
    $ref: 'TS29122_CommonData.yaml#/components/responses/413'
  '415':
    $ref: 'TS29122_CommonData.yaml#/components/responses/415'
  '429':
    $ref: 'TS29122_CommonData.yaml#/components/responses/429'
  '500':
    $ref: 'TS29122_CommonData.yaml#/components/responses/500'
  '503':
    $ref: 'TS29122_CommonData.yaml#/components/responses/503'
  default:
    $ref: 'TS29122_CommonData.yaml#/components/responses/default'

patch:
summary: Request the partially update of an existing Individual Network Slice Optimization
Subscription resource.
operationId: ModifyIndNetSliceOptSubsc
tags:
  - Individual Network Slice Optimization Subscription (Document)
requestBody:
  required: true
  content:
    application/merge-patch+json:
      schema:
        $ref: '#/components/schemas/NetSliceOptSubscPatch'
responses:
  '200':
    description: >
      OK. The Individual Network Slice Optimization Subscription resource is
      successfully modified and a representation of the updated resource shall be returned
      in the response body.
    content:
      application/json:
        schema:
          $ref: '#/components/schemas/NetSliceOptSubsc'
  '204':
    description: >
      No Content. The Individual Network Slice Optimization Subscription resource is
      successfully modified and no content is returned in the response body.

```

```

'307':
  $ref: 'TS29122_CommonData.yaml#/components/responses/307'
'308':
  $ref: 'TS29122_CommonData.yaml#/components/responses/308'
'400':
  $ref: 'TS29122_CommonData.yaml#/components/responses/400'
'401':
  $ref: 'TS29122_CommonData.yaml#/components/responses/401'
'403':
  $ref: 'TS29122_CommonData.yaml#/components/responses/403'
'404':
  $ref: 'TS29122_CommonData.yaml#/components/responses/404'
'411':
  $ref: 'TS29122_CommonData.yaml#/components/responses/411'
'413':
  $ref: 'TS29122_CommonData.yaml#/components/responses/413'
'415':
  $ref: 'TS29122_CommonData.yaml#/components/responses/415'
'429':
  $ref: 'TS29122_CommonData.yaml#/components/responses/429'
'500':
  $ref: 'TS29122_CommonData.yaml#/components/responses/500'
'503':
  $ref: 'TS29122_CommonData.yaml#/components/responses/503'
default:
  $ref: 'TS29122_CommonData.yaml#/components/responses/default'

delete:
  summary: Request the deletion of an existing Individual Network Slice Optimization
Subscription resource.
  operationId: DeleteIndNetSliceOptSubsc
  tags:
  - Individual Network Slice Optimization Subscription (Document)
  responses:
    '204':
      description: >
        No Content. The Individual Network Slice Optimization Subscription resource is
        successfully deleted.
    '307':
      $ref: 'TS29122_CommonData.yaml#/components/responses/307'
    '308':
      $ref: 'TS29122_CommonData.yaml#/components/responses/308'
    '400':
      $ref: 'TS29122_CommonData.yaml#/components/responses/400'
    '401':
      $ref: 'TS29122_CommonData.yaml#/components/responses/401'
    '403':
      $ref: 'TS29122_CommonData.yaml#/components/responses/403'
    '404':
      $ref: 'TS29122_CommonData.yaml#/components/responses/404'
    '429':
      $ref: 'TS29122_CommonData.yaml#/components/responses/429'
    '500':
      $ref: 'TS29122_CommonData.yaml#/components/responses/500'
    '503':
      $ref: 'TS29122_CommonData.yaml#/components/responses/503'
    default:
      $ref: 'TS29122_CommonData.yaml#/components/responses/default'

components:
  securitySchemes:
    oAuth2ClientCredentials:
      type: oauth2
      flows:
        clientCredentials:
          tokenUrl: '{tokenUrl}'
          scopes: {}

  schemas:

#
# STRUCTURED DATA TYPES
#

NetSliceOptSubsc:
  type: object
  description: Represents a Network Slice Optimization subscription.

```

```

properties:
  notifUri:
    $ref: 'TS29122_CommonData.yaml#/components/schemas/Uri'
  netSliceId:
    $ref: 'TS29435_NSCE_PolicyManagement.yaml#/components/schemas/NetSliceId'
  dnn:
    $ref: 'TS29571_CommonData.yaml#/components/schemas/Dnn'
  policyId:
    type: string
    description: Identifies the VAL server policy.
  expTime:
    $ref: 'TS29122_CommonData.yaml#/components/schemas/DateTime'
  secPolicId:
    type: string
    description: Identifies the the secondary policy for the network slice optimization.
  suppFeat:
    $ref: 'TS29571_CommonData.yaml#/components/schemas/SupportedFeatures'
required:
- notifUri
anyOf:
- required: [netSliceId]
- required: [dnn]
- required: [policyId]
- required: [expTime]
- required: [secPolicId]

NetSliceOptSubscPatch:
  type: object
  description: >
    Represents the requested modifications to a Network Slice Optimization subscription.
  properties:
    notifUri:
      $ref: 'TS29122_CommonData.yaml#/components/schemas/Uri'
    netSliceId:
      $ref: 'TS29435_NSCE_PolicyManagement.yaml#/components/schemas/NetSliceId'
    dnn:
      $ref: 'TS29571_CommonData.yaml#/components/schemas/Dnn'
    policyId:
      type: string
      description: Identifies the VAL server policy.
    expTime:
      $ref: 'TS29122_CommonData.yaml#/components/schemas/DateTimeRm'
    secPolicId:
      type: string
      description: Identifies the the secondary policy for the network slice optimization.
required:
- notifUri
anyOf:
- required: [netSliceId]
- required: [dnn]
- required: [policyId]
- required: [expTime]
- required: [secPolicId]

NetSliceOptNotif:
  type: object
  description: Represents a Network Slice Optimization notification.
  properties:
    subscriptionId:
      type: string
      description: Identifies the Network slice optimization subscribe event.
    sliceInfo:
      $ref: 'TS29435_NSCE_NSInfoDelivery.yaml#/components/schemas/NSInfoSet'
    optTime:
      $ref: 'TS29571_CommonData.yaml#/components/schemas/DurationSec'
    enforPolId:
      type: string
      description: Indicates the policy used for slice optimization.
required:
- subscriptionId
- sliceInfo

```

---

## A.6 NSCE\_ManagementServiceDiscovery API

openapi: 3.0.0

```
info:
  title: NSCE_ManagementServiceDiscovery
  version: 1.0.0
  description: |
    NSCE_ManagementServiceDiscovery Service.
    © 2024, 3GPP Organizational Partners (ARIB, ATIS, CCSA, ETSI, TSDSI, TTA, TTC).
    All rights reserved.

externalDocs:
  description: >
    3GPP TS 29.435 V18.1.0; Service Enabler Architecture Layer for Verticals (SEAL);
    Network Slice Capability Exposure (NSCE) Server Service(s); Stage 3.
  url: http://www.3gpp.org/ftp/Specs/archive/29_series/29.435/

servers:
- url: '{apiRoot}/nsce-msd/v1'
  variables:
    apiRoot:
      default: https://example.com
      description: apiRoot as defined in clause 6.5 of 3GPP TS 29.549

security:
- {}
- oAuth2ClientCredentials: []

paths:
  /subscriptions:
    post:
      summary: Request the creation of a Management Discovery Subscription.
      operationId: CreateMngtDiscSubsc
      tags:
        - Management Discovery Subscriptions (Collection)
      requestBody:
        required: true
        content:
          application/json:
            schema:
              $ref: '#/components/schemas/MnSDiscSubsc'
      responses:
        '201':
          description: >
            Created. The Management Discovery Subscription is successfully created and a
            representation of the created Individual Management Discovery Subscription resource
            shall be returned.
          content:
            application/json:
              schema:
                $ref: '#/components/schemas/MnSDiscSubsc'
          headers:
            Location:
              description: >
                Contains the URI of the newly created resource.
              required: true
              schema:
                type: string
        '400':
          $ref: 'TS29122_CommonData.yaml#/components/responses/400'
        '401':
          $ref: 'TS29122_CommonData.yaml#/components/responses/401'
        '403':
          $ref: 'TS29122_CommonData.yaml#/components/responses/403'
        '404':
          $ref: 'TS29122_CommonData.yaml#/components/responses/404'
        '411':
          $ref: 'TS29122_CommonData.yaml#/components/responses/411'
        '413':
          $ref: 'TS29122_CommonData.yaml#/components/responses/413'
        '415':
          $ref: 'TS29122_CommonData.yaml#/components/responses/415'
        '429':
          $ref: 'TS29122_CommonData.yaml#/components/responses/429'
        '500':
          $ref: 'TS29122_CommonData.yaml#/components/responses/500'
        '503':
          $ref: 'TS29122_CommonData.yaml#/components/responses/503'
      default:
        $ref: 'TS29122_CommonData.yaml#/components/responses/default'
    callbacks:
```

```

ManagementDiscoveryNotif:
  '{$request.body#/notifUri}':
    post:
      requestBody:
        required: true
        content:
          application/json:
            schema:
              $ref: '#/components/schemas/MnSDiscNotif'
      responses:
        '204':
          description: >
            No Content. The Management Discovery Notification is successfully received and
            processed.
        '307':
          $ref: 'TS29122_CommonData.yaml#/components/responses/307'
        '308':
          $ref: 'TS29122_CommonData.yaml#/components/responses/308'
        '400':
          $ref: 'TS29122_CommonData.yaml#/components/responses/400'
        '401':
          $ref: 'TS29122_CommonData.yaml#/components/responses/401'
        '403':
          $ref: 'TS29122_CommonData.yaml#/components/responses/403'
        '404':
          $ref: 'TS29122_CommonData.yaml#/components/responses/404'
        '411':
          $ref: 'TS29122_CommonData.yaml#/components/responses/411'
        '413':
          $ref: 'TS29122_CommonData.yaml#/components/responses/413'
        '415':
          $ref: 'TS29122_CommonData.yaml#/components/responses/415'
        '429':
          $ref: 'TS29122_CommonData.yaml#/components/responses/429'
        '500':
          $ref: 'TS29122_CommonData.yaml#/components/responses/500'
        '503':
          $ref: 'TS29122_CommonData.yaml#/components/responses/503'
        default:
          $ref: 'TS29122_CommonData.yaml#/components/responses/default'

/subscriptions/{subscriptionId}:
  parameters:
    - name: subscriptionId
      in: path
      description: >
        Represents the identifier of the Individual Management Discovery Subscription resource.
      required: true
      schema:
        type: string

  get:
    summary: Retrieve an existing Individual Management Discovery Subscription resource.
    operationId: GetIndMngtDiscSubsc
    tags:
      - Individual Management Discovery Subscription (Document)
    responses:
      '200':
        description: >
          OK. The requested Individual Management Discovery Subscription resource shall be
          returned.
        content:
          application/json:
            schema:
              $ref: '#/components/schemas/MnSDiscSubsc'
      '307':
        $ref: 'TS29122_CommonData.yaml#/components/responses/307'
      '308':
        $ref: 'TS29122_CommonData.yaml#/components/responses/308'
      '400':
        $ref: 'TS29122_CommonData.yaml#/components/responses/400'
      '401':
        $ref: 'TS29122_CommonData.yaml#/components/responses/401'
      '403':
        $ref: 'TS29122_CommonData.yaml#/components/responses/403'
      '404':
        $ref: 'TS29122_CommonData.yaml#/components/responses/404'
      '406':

```



```

    $ref: 'TS29122_CommonData.yaml#/components/responses/406'
  '429':
    $ref: 'TS29122_CommonData.yaml#/components/responses/429'
  '500':
    $ref: 'TS29122_CommonData.yaml#/components/responses/500'
  '503':
    $ref: 'TS29122_CommonData.yaml#/components/responses/503'
  default:
    $ref: 'TS29122_CommonData.yaml#/components/responses/default'

  put:
    summary: Request the update of an existing Individual Management Discovery Subscription
    resource.
    operationId: UpdateIndMngtDiscSubsc
    tags:
      - Individual Management Discovery Subscription (Document)
    requestBody:
      required: true
      content:
        application/json:
          schema:
            $ref: '#/components/schemas/MnSDiscSubsc'
    responses:
      '200':
        description: >
          OK. The Individual Management Discovery Subscription resource is successfully updated
          and a representation of the updated resource shall be returned in the response body.
        content:
          application/json:
            schema:
              $ref: '#/components/schemas/MnSDiscSubsc'
      '204':
        description: >
          No Content. The Individual Management Discovery Subscription resource is successfully
          updated and no content is returned in the response body.
      '307':
        $ref: 'TS29122_CommonData.yaml#/components/responses/307'
      '308':
        $ref: 'TS29122_CommonData.yaml#/components/responses/308'
      '400':
        $ref: 'TS29122_CommonData.yaml#/components/responses/400'
      '401':
        $ref: 'TS29122_CommonData.yaml#/components/responses/401'
      '403':
        $ref: 'TS29122_CommonData.yaml#/components/responses/403'
      '404':
        $ref: 'TS29122_CommonData.yaml#/components/responses/404'
      '411':
        $ref: 'TS29122_CommonData.yaml#/components/responses/411'
      '413':
        $ref: 'TS29122_CommonData.yaml#/components/responses/413'
      '415':
        $ref: 'TS29122_CommonData.yaml#/components/responses/415'
      '429':
        $ref: 'TS29122_CommonData.yaml#/components/responses/429'
      '500':
        $ref: 'TS29122_CommonData.yaml#/components/responses/500'
      '503':
        $ref: 'TS29122_CommonData.yaml#/components/responses/503'
      default:
        $ref: 'TS29122_CommonData.yaml#/components/responses/default'

  patch:
    summary: Request the modification of an existing Individual Management Discovery Subscription
    resource.
    operationId: ModifyIndMngtDiscSubsc
    tags:
      - Individual Management Discovery Subscription (Document)
    requestBody:
      required: true
      content:
        application/merge-patch+json:
          schema:
            $ref: '#/components/schemas/MnSDiscSubscPatch'
    responses:
      '200':
        description: >
          OK. The Individual Management Discovery Subscription resource is successfully modified

```

and a representation of the updated resource shall be returned in the response body.

content:

application/json:

schema:

\$ref: '#/components/schemas/MnSDiscSubsc'

'204':

description: >

No Content. The Individual Management Discovery Subscription resource is successfully modified and no content is returned in the response body.

'307':

\$ref: 'TS29122\_CommonData.yaml#/components/responses/307'

'308':

\$ref: 'TS29122\_CommonData.yaml#/components/responses/308'

'400':

\$ref: 'TS29122\_CommonData.yaml#/components/responses/400'

'401':

\$ref: 'TS29122\_CommonData.yaml#/components/responses/401'

'403':

\$ref: 'TS29122\_CommonData.yaml#/components/responses/403'

'404':

\$ref: 'TS29122\_CommonData.yaml#/components/responses/404'

'411':

\$ref: 'TS29122\_CommonData.yaml#/components/responses/411'

'413':

\$ref: 'TS29122\_CommonData.yaml#/components/responses/413'

'415':

\$ref: 'TS29122\_CommonData.yaml#/components/responses/415'

'429':

\$ref: 'TS29122\_CommonData.yaml#/components/responses/429'

'500':

\$ref: 'TS29122\_CommonData.yaml#/components/responses/500'

'503':

\$ref: 'TS29122\_CommonData.yaml#/components/responses/503'

default:

\$ref: 'TS29122\_CommonData.yaml#/components/responses/default'

delete:

summary: Request the deletion of an existing Individual Management Discovery Subscription resource.

operationId: DeleteIndMngtDiscSubsc

tags:

- Individual Management Discovery Subscription (Document)

responses:

'204':

description: >

No Content. The Individual Management Discovery Subscription resource is successfully deleted.

'307':

\$ref: 'TS29122\_CommonData.yaml#/components/responses/307'

'308':

\$ref: 'TS29122\_CommonData.yaml#/components/responses/308'

'400':

\$ref: 'TS29122\_CommonData.yaml#/components/responses/400'

'401':

\$ref: 'TS29122\_CommonData.yaml#/components/responses/401'

'403':

\$ref: 'TS29122\_CommonData.yaml#/components/responses/403'

'404':

\$ref: 'TS29122\_CommonData.yaml#/components/responses/404'

'429':

\$ref: 'TS29122\_CommonData.yaml#/components/responses/429'

'500':

\$ref: 'TS29122\_CommonData.yaml#/components/responses/500'

'503':

\$ref: 'TS29122\_CommonData.yaml#/components/responses/503'

default:

\$ref: 'TS29122\_CommonData.yaml#/components/responses/default'

components:

securitySchemes:

oAuth2ClientCredentials:

type: oauth2

flows:

clientCredentials:

tokenUrl: '{tokenUrl}'

scopes: {}

schemas:

```
MnSDiscSubsc:
  description: Represents a Management Discovery Subscription.
  type: object
  properties:
    notifUri:
      $ref: 'TS29122_CommonData.yaml#/components/schemas/Uri'
    netSliceIds:
      type: array
      items:
        $ref: 'TS29435_NSCE_PolicyManagement.yaml#/components/schemas/NetSliceId'
      minItems: 1
    expCapReqs:
      $ref: '#/components/schemas/ExpCapReqs'
    suppFeat:
      $ref: 'TS29571_CommonData.yaml#/components/schemas/SupportedFeatures'
  required:
    - notifUri

MnSDiscSubscPatch:
  description: Represents the requested modifications to a Management Discovery Subscription.
  type: object
  properties:
    notifUri:
      $ref: 'TS29122_CommonData.yaml#/components/schemas/Uri'
    expCapReqs:
      $ref: '#/components/schemas/ExpCapReqs'

MnSDiscNotif:
  description: Represents a Management Discovery Notification.
  type: object
  properties:
    mnSDomainId:
      type: string
    mnSs:
      type: array
      items:
        $ref: '#/components/schemas/MnSInfo'
      minItems: 1
  required:
    - mnSDomainId
    - mnSs

MnSInfo:
  description: Represents the Management Services related information.
  type: object
  properties:
    mnSIds:
      type: array
      items:
        type: string
      minItems: 1
    mnSCap:
      type: string
    mnSPerms:
      type: array
      items:
        $ref: '#/components/schemas/MnSPermission'
      minItems: 1
    netSliceId:
      $ref: 'TS29435_NSCE_PolicyManagement.yaml#/components/schemas/NetSliceId'
  required:
    - mnSIds
    - mnSCap

ExpCapReqs:
  description: Represents the exposure capability requirements.
  type: object
  properties:
    reqPerm:
      type: array
      items:
        $ref: '#/components/schemas/MnSPermission'
      minItems: 1
    expCapType:
      type: array
      items:
        $ref: '#/components/schemas/ExpCapType'
      minItems: 1
```

```

    anyOf:
      - required: [reqPerm]
      - required: [expCapType]

#
# ENUMERATIONS DATA TYPES
#

MnSPermission:
  anyOf:
    - type: string
      enum:
        - READ
        - WRITE
        - DELETE
        - UPDATE
    - type: string
      description: >
        This string provides forward-compatibility with future extensions to the enumeration
        and is not used to encode content defined in the present version of this API.
  description: |
    Represents the permissions for exposing information related to the target slice over the
MnS.
    Possible values are:
    - READ: Indicates the allowed permission of the VAL server to read over the MnS.
    - WRITE: Indicates the allowed permission of the VAL server to write over the MnS.
    - DELETE: Indicates the allowed permission of the VAL server to delete over the MnS.
    - UPDATE: Indicates the allowed permission of the VAL server to update over the MnS.

ExpCapType:
  anyOf:
    - type: string
      enum:
        - VIA_EGMF
        - DIRECT
    - type: string
      description: >
        This string provides forward-compatibility with future extensions to the enumeration
        and is not used to encode content defined in the present version of this API.
  description: |
    Represents the exposure capability type.
    Possible values are:
    - VIA_EGMF: Indicates the supported exposure capability is via EGMF.
    - DIRECT: Indicates the supported exposure capability is directly to MnS producer.

```

---

## A.7 NSCE\_PerfMonitoring API

```

openapi: 3.0.0

info:
  title: NSCE Server Network Slice Performance and Analytics Monitoring Service
  version: 1.0.0
  description: |
    NSCE Server Network Slice Performance and Analytics Monitoring Service.
    © 2024, 3GPP Organizational Partners (ARIB, ATIS, CCSA, ETSI, TSDSI, TTA, TTC).
    All rights reserved.

externalDocs:
  description: >
    3GPP TS 29.435 V18.1.0; Service Enabler Architecture Layer for Verticals (SEAL);
    Network Slice Capability Enablement (NSCE) Server Service(s); Stage 3.
  url: https://www.3gpp.org/ftp/Specs/archive/29_series/29.435/

servers:
  - url: '{apiRoot}/nsce-pam/v1'
    variables:
      apiRoot:
        default: https://example.com
        description: apiRoot as defined in clause 6.5 of 3GPP TS 29.549

security:
  - {}
  - oAuth2ClientCredentials: []

```

```

paths:
  /jobs:
    post:
      summary: Request the creation of a Monitoring Job.
      operationId: CreateMonJob
      tags:
        - Monitoring Jobs (Collection)
      requestBody:
        required: true
        content:
          application/json:
            schema:
              $ref: '#/components/schemas/MonitoringJob'
      responses:
        '201':
          description: >
            Created. The Monitoring Job is successfully created and a representation of the
            created Individual Monitoring Job resource shall be returned.
          content:
            application/json:
              schema:
                $ref: '#/components/schemas/MonitoringJob'
          headers:
            Location:
              description: >
                Contains the URI of the created Individual Monitoring Job resource.
              required: true
              schema:
                type: string
        '400':
          $ref: 'TS29122_CommonData.yaml#/components/responses/400'
        '401':
          $ref: 'TS29122_CommonData.yaml#/components/responses/401'
        '403':
          $ref: 'TS29122_CommonData.yaml#/components/responses/403'
        '404':
          $ref: 'TS29122_CommonData.yaml#/components/responses/404'
        '411':
          $ref: 'TS29122_CommonData.yaml#/components/responses/411'
        '413':
          $ref: 'TS29122_CommonData.yaml#/components/responses/413'
        '415':
          $ref: 'TS29122_CommonData.yaml#/components/responses/415'
        '429':
          $ref: 'TS29122_CommonData.yaml#/components/responses/429'
        '500':
          $ref: 'TS29122_CommonData.yaml#/components/responses/500'
        '503':
          $ref: 'TS29122_CommonData.yaml#/components/responses/503'
        default:
          $ref: 'TS29122_CommonData.yaml#/components/responses/default'

  /jobs/{jobId}:
    parameters:
      - name: jobId
        in: path
        description: >
          Represents the identifier of the Individual Monitoring Job resource.
        required: true
        schema:
          type: string

    get:
      summary: Retrieve an existing Individual Monitoring Job resource.
      operationId: GetIndMonJob
      tags:
        - Individual Monitoring Job (Document)
      responses:
        '200':
          description: >
            OK. The requested Individual Monitoring Job resource shall be returned.
          content:
            application/json:
              schema:
                $ref: '#/components/schemas/MonitoringJob'
        '307':
          $ref: 'TS29122_CommonData.yaml#/components/responses/307'

```

```

'308':
  $ref: 'TS29122_CommonData.yaml#/components/responses/308'
'400':
  $ref: 'TS29122_CommonData.yaml#/components/responses/400'
'401':
  $ref: 'TS29122_CommonData.yaml#/components/responses/401'
'403':
  $ref: 'TS29122_CommonData.yaml#/components/responses/403'
'404':
  $ref: 'TS29122_CommonData.yaml#/components/responses/404'
'406':
  $ref: 'TS29122_CommonData.yaml#/components/responses/406'
'429':
  $ref: 'TS29122_CommonData.yaml#/components/responses/429'
'500':
  $ref: 'TS29122_CommonData.yaml#/components/responses/500'
'503':
  $ref: 'TS29122_CommonData.yaml#/components/responses/503'
default:
  $ref: 'TS29122_CommonData.yaml#/components/responses/default'

```

put:

summary: Request the update of an existing Individual Monitoring Job resource.  
 operationId: UpdateIndMonJob

tags:

- Individual Monitoring Job (Document)

requestBody:

required: true

content:

application/json:

schema:

\$ref: '#/components/schemas/MonitoringJob'

responses:

'200':

description: >

OK. The Individual Monitoring Job resource is successfully updated and a representation of the updated resource shall be returned in the response body.

content:

application/json:

schema:

\$ref: '#/components/schemas/MonitoringJob'

'204':

description: >

No Content. The Individual Monitoring Job resource is successfully updated and no content is returned in the response body.

'307':

\$ref: 'TS29122\_CommonData.yaml#/components/responses/307'

'308':

\$ref: 'TS29122\_CommonData.yaml#/components/responses/308'

'400':

\$ref: 'TS29122\_CommonData.yaml#/components/responses/400'

'401':

\$ref: 'TS29122\_CommonData.yaml#/components/responses/401'

'403':

\$ref: 'TS29122\_CommonData.yaml#/components/responses/403'

'404':

\$ref: 'TS29122\_CommonData.yaml#/components/responses/404'

'411':

\$ref: 'TS29122\_CommonData.yaml#/components/responses/411'

'413':

\$ref: 'TS29122\_CommonData.yaml#/components/responses/413'

'415':

\$ref: 'TS29122\_CommonData.yaml#/components/responses/415'

'429':

\$ref: 'TS29122\_CommonData.yaml#/components/responses/429'

'500':

\$ref: 'TS29122\_CommonData.yaml#/components/responses/500'

'503':

\$ref: 'TS29122\_CommonData.yaml#/components/responses/503'

default:

\$ref: 'TS29122\_CommonData.yaml#/components/responses/default'

patch:

summary: Request the modification of an existing Individual Monitoring Job resource.

operationId: ModifyIndMonJob

tags:

- Individual Monitoring Job (Document)

requestBody:

```
    required: true
    content:
      application/merge-patch+json:
        schema:
          $ref: '#/components/schemas/MonitoringJobPatch'
  responses:
    '200':
      description: >
        OK. The Individual Monitoring Job resource is successfully modified and a representation
        of the updated resource shall be returned in the response body.
      content:
        application/json:
          schema:
            $ref: '#/components/schemas/MonitoringJob'
    '204':
      description: >
        No Content. The Individual Monitoring Job resource is successfully modified and no
        content is returned in the response body.
    '307':
      $ref: 'TS29122_CommonData.yaml#/components/responses/307'
    '308':
      $ref: 'TS29122_CommonData.yaml#/components/responses/308'
    '400':
      $ref: 'TS29122_CommonData.yaml#/components/responses/400'
    '401':
      $ref: 'TS29122_CommonData.yaml#/components/responses/401'
    '403':
      $ref: 'TS29122_CommonData.yaml#/components/responses/403'
    '404':
      $ref: 'TS29122_CommonData.yaml#/components/responses/404'
    '411':
      $ref: 'TS29122_CommonData.yaml#/components/responses/411'
    '413':
      $ref: 'TS29122_CommonData.yaml#/components/responses/413'
    '415':
      $ref: 'TS29122_CommonData.yaml#/components/responses/415'
    '429':
      $ref: 'TS29122_CommonData.yaml#/components/responses/429'
    '500':
      $ref: 'TS29122_CommonData.yaml#/components/responses/500'
    '503':
      $ref: 'TS29122_CommonData.yaml#/components/responses/503'
    default:
      $ref: 'TS29122_CommonData.yaml#/components/responses/default'

delete:
  summary: Request the deletion of an existing Individual Monitoring Job resource.
  operationId: DeleteIndMonJob
  tags:
    - Individual Monitoring Job (Document)
  responses:
    '204':
      description: >
        No Content. The Individual Monitoring Job resource is successfully deleted.
    '307':
      $ref: 'TS29122_CommonData.yaml#/components/responses/307'
    '308':
      $ref: 'TS29122_CommonData.yaml#/components/responses/308'
    '400':
      $ref: 'TS29122_CommonData.yaml#/components/responses/400'
    '401':
      $ref: 'TS29122_CommonData.yaml#/components/responses/401'
    '403':
      $ref: 'TS29122_CommonData.yaml#/components/responses/403'
    '404':
      $ref: 'TS29122_CommonData.yaml#/components/responses/404'
    '429':
      $ref: 'TS29122_CommonData.yaml#/components/responses/429'
    '500':
      $ref: 'TS29122_CommonData.yaml#/components/responses/500'
    '503':
      $ref: 'TS29122_CommonData.yaml#/components/responses/503'
    default:
      $ref: 'TS29122_CommonData.yaml#/components/responses/default'

/subscriptions:
  post:
    summary: Request the creation of a Monitoring Subscription.
```

```

operationId: CreateMonSubsc
tags:
  - Monitoring Subscriptions (Collection)
requestBody:
  required: true
  content:
    application/json:
      schema:
        $ref: '#/components/schemas/MonitoringSubsc'
responses:
  '201':
    description: >
      Created. The Monitoring Subscription is successfully created and a representation of the
      created Individual Monitoring Subscription resource shall be returned.
    content:
      application/json:
        schema:
          $ref: '#/components/schemas/MonitoringSubsc'
    headers:
      Location:
        description: >
          Contains the URI of the created Individual Monitoring Subscription resource.
        required: true
        schema:
          type: string
  '400':
    $ref: 'TS29122_CommonData.yaml#/components/responses/400'
  '401':
    $ref: 'TS29122_CommonData.yaml#/components/responses/401'
  '403':
    $ref: 'TS29122_CommonData.yaml#/components/responses/403'
  '404':
    $ref: 'TS29122_CommonData.yaml#/components/responses/404'
  '411':
    $ref: 'TS29122_CommonData.yaml#/components/responses/411'
  '413':
    $ref: 'TS29122_CommonData.yaml#/components/responses/413'
  '415':
    $ref: 'TS29122_CommonData.yaml#/components/responses/415'
  '429':
    $ref: 'TS29122_CommonData.yaml#/components/responses/429'
  '500':
    $ref: 'TS29122_CommonData.yaml#/components/responses/500'
  '503':
    $ref: 'TS29122_CommonData.yaml#/components/responses/503'
  default:
    $ref: 'TS29122_CommonData.yaml#/components/responses/default'
callbacks:
  MonitoringNotif:
    '{$request.body#/notifUri}':
      post:
        requestBody:
          required: true
          content:
            application/json:
              schema:
                $ref: '#/components/schemas/MonitoringNotif'
        responses:
          '204':
            description: >
              No Content. The Monitoring Notification is successfully received and
              acknowledged.
          '307':
            $ref: 'TS29122_CommonData.yaml#/components/responses/307'
          '308':
            $ref: 'TS29122_CommonData.yaml#/components/responses/308'
          '400':
            $ref: 'TS29122_CommonData.yaml#/components/responses/400'
          '401':
            $ref: 'TS29122_CommonData.yaml#/components/responses/401'
          '403':
            $ref: 'TS29122_CommonData.yaml#/components/responses/403'
          '404':
            $ref: 'TS29122_CommonData.yaml#/components/responses/404'
          '411':
            $ref: 'TS29122_CommonData.yaml#/components/responses/411'
          '413':
            $ref: 'TS29122_CommonData.yaml#/components/responses/413'

```



```

    '415':
      $ref: 'TS29122_CommonData.yaml#/components/responses/415'
    '429':
      $ref: 'TS29122_CommonData.yaml#/components/responses/429'
    '500':
      $ref: 'TS29122_CommonData.yaml#/components/responses/500'
    '503':
      $ref: 'TS29122_CommonData.yaml#/components/responses/503'
    default:
      $ref: 'TS29122_CommonData.yaml#/components/responses/default'

/subscriptions/{subscId}:
  parameters:
    - name: subscId
      in: path
      description: >
        Represents the identifier of the Individual Monitoring Subscription resource.
      required: true
      schema:
        type: string

  get:
    summary: Retrieve an existing Individual Monitoring Subscription resource.
    operationId: GetIndMonSubsc
    tags:
      - Individual Monitoring Subscription (Document)
    responses:
      '200':
        description: >
          OK. The requested Individual Monitoring Subscription resource shall be returned.
        content:
          application/json:
            schema:
              $ref: '#/components/schemas/MonitoringSubsc'
      '307':
        $ref: 'TS29122_CommonData.yaml#/components/responses/307'
      '308':
        $ref: 'TS29122_CommonData.yaml#/components/responses/308'
      '400':
        $ref: 'TS29122_CommonData.yaml#/components/responses/400'
      '401':
        $ref: 'TS29122_CommonData.yaml#/components/responses/401'
      '403':
        $ref: 'TS29122_CommonData.yaml#/components/responses/403'
      '404':
        $ref: 'TS29122_CommonData.yaml#/components/responses/404'
      '406':
        $ref: 'TS29122_CommonData.yaml#/components/responses/406'
      '429':
        $ref: 'TS29122_CommonData.yaml#/components/responses/429'
      '500':
        $ref: 'TS29122_CommonData.yaml#/components/responses/500'
      '503':
        $ref: 'TS29122_CommonData.yaml#/components/responses/503'
      default:
        $ref: 'TS29122_CommonData.yaml#/components/responses/default'

  put:
    summary: Request the update of an existing Individual Monitoring Subscription resource.
    operationId: UpdateIndMonSubsc
    tags:
      - Individual Monitoring Subscription (Document)
    requestBody:
      required: true
      content:
        application/json:
          schema:
            $ref: '#/components/schemas/MonitoringSubsc'
    responses:
      '200':
        description: >
          OK. The Individual Monitoring Subscription resource is successfully updated and a
          representation of the updated resource shall be returned in the response body.
        content:
          application/json:
            schema:
              $ref: '#/components/schemas/MonitoringSubsc'
      '204':

```

```
description: >
  No Content. The Individual Monitoring Subscription resource is successfully updated
  and no content is returned in the response body.
'307':
  $ref: 'TS29122_CommonData.yaml#/components/responses/307'
'308':
  $ref: 'TS29122_CommonData.yaml#/components/responses/308'
'400':
  $ref: 'TS29122_CommonData.yaml#/components/responses/400'
'401':
  $ref: 'TS29122_CommonData.yaml#/components/responses/401'
'403':
  $ref: 'TS29122_CommonData.yaml#/components/responses/403'
'404':
  $ref: 'TS29122_CommonData.yaml#/components/responses/404'
'411':
  $ref: 'TS29122_CommonData.yaml#/components/responses/411'
'413':
  $ref: 'TS29122_CommonData.yaml#/components/responses/413'
'415':
  $ref: 'TS29122_CommonData.yaml#/components/responses/415'
'429':
  $ref: 'TS29122_CommonData.yaml#/components/responses/429'
'500':
  $ref: 'TS29122_CommonData.yaml#/components/responses/500'
'503':
  $ref: 'TS29122_CommonData.yaml#/components/responses/503'
default:
  $ref: 'TS29122_CommonData.yaml#/components/responses/default'
```

**patch:**

```
summary: Request the modification of an existing Individual Monitoring Subscription resource.
operationId: ModifyIndMonSubsc
```

**tags:**

```
- Individual Monitoring Subscription (Document)
```

**requestBody:**

```
required: true
```

**content:**

```
application/merge-patch+json:
```

**schema:**

```
$ref: '#/components/schemas/MonitoringSubscPatch'
```

**responses:**

```
'200':
```

**description: >**

```
OK. The Individual Monitoring Subscription resource is successfully modified and a
representation of the updated resource shall be returned in the response body.
```

**content:**

```
application/json:
```

**schema:**

```
$ref: '#/components/schemas/MonitoringSubsc'
```

```
'204':
```

**description: >**

```
No Content. The Individual Monitoring Subscription resource is successfully modified
and no content is returned in the response body.
```

```
'307':
```

```
$ref: 'TS29122_CommonData.yaml#/components/responses/307'
```

```
'308':
```

```
$ref: 'TS29122_CommonData.yaml#/components/responses/308'
```

```
'400':
```

```
$ref: 'TS29122_CommonData.yaml#/components/responses/400'
```

```
'401':
```

```
$ref: 'TS29122_CommonData.yaml#/components/responses/401'
```

```
'403':
```

```
$ref: 'TS29122_CommonData.yaml#/components/responses/403'
```

```
'404':
```

```
$ref: 'TS29122_CommonData.yaml#/components/responses/404'
```

```
'411':
```

```
$ref: 'TS29122_CommonData.yaml#/components/responses/411'
```

```
'413':
```

```
$ref: 'TS29122_CommonData.yaml#/components/responses/413'
```

```
'415':
```

```
$ref: 'TS29122_CommonData.yaml#/components/responses/415'
```

```
'429':
```

```
$ref: 'TS29122_CommonData.yaml#/components/responses/429'
```

```
'500':
```

```
$ref: 'TS29122_CommonData.yaml#/components/responses/500'
```

```
'503':
```

```
$ref: 'TS29122_CommonData.yaml#/components/responses/503'
```

```
    default:
      $ref: 'TS29122_CommonData.yaml#/components/responses/default'

delete:
  summary: Request the deletion of an existing Individual Monitoring Subscription resource.
  operationId: DeleteIndMonSubsc
  tags:
    - Individual Monitoring Subscription (Document)
  responses:
    '204':
      description: >
        No Content. The Individual Monitoring Subscription resource is successfully deleted.
    '307':
      $ref: 'TS29122_CommonData.yaml#/components/responses/307'
    '308':
      $ref: 'TS29122_CommonData.yaml#/components/responses/308'
    '400':
      $ref: 'TS29122_CommonData.yaml#/components/responses/400'
    '401':
      $ref: 'TS29122_CommonData.yaml#/components/responses/401'
    '403':
      $ref: 'TS29122_CommonData.yaml#/components/responses/403'
    '404':
      $ref: 'TS29122_CommonData.yaml#/components/responses/404'
    '429':
      $ref: 'TS29122_CommonData.yaml#/components/responses/429'
    '500':
      $ref: 'TS29122_CommonData.yaml#/components/responses/500'
    '503':
      $ref: 'TS29122_CommonData.yaml#/components/responses/503'
    default:
      $ref: 'TS29122_CommonData.yaml#/components/responses/default'

/request:
  post:
    summary: Enables to request a multiple slices related performance and analytics consolidated reporting.
    operationId: MultiSlicesMonRepReq
    tags:
      - Multiple Slices related Performance and Analytics Consolidated Reporting Request
    requestBody:
      required: true
      content:
        application/json:
          schema:
            $ref: '#/components/schemas/MonitoringReq'
    responses:
      '200':
        description: >
          OK. The requested multiple slices related performance and analytics consolidated report shall be returned in the response body.
        content:
          application/json:
            schema:
              $ref: '#/components/schemas/MonitoringResp'
      '307':
        $ref: 'TS29122_CommonData.yaml#/components/responses/307'
      '308':
        $ref: 'TS29122_CommonData.yaml#/components/responses/308'
      '400':
        $ref: 'TS29122_CommonData.yaml#/components/responses/400'
      '401':
        $ref: 'TS29122_CommonData.yaml#/components/responses/401'
      '403':
        $ref: 'TS29122_CommonData.yaml#/components/responses/403'
      '404':
        $ref: 'TS29122_CommonData.yaml#/components/responses/404'
      '411':
        $ref: 'TS29122_CommonData.yaml#/components/responses/411'
      '413':
        $ref: 'TS29122_CommonData.yaml#/components/responses/413'
      '415':
        $ref: 'TS29122_CommonData.yaml#/components/responses/415'
      '429':
        $ref: 'TS29122_CommonData.yaml#/components/responses/429'
      '500':
        $ref: 'TS29122_CommonData.yaml#/components/responses/500'
      '503':
```

```
$ref: 'TS29122_CommonData.yaml#/components/responses/503'  
default:  
  $ref: 'TS29122_CommonData.yaml#/components/responses/default'
```

```
components:  
  securitySchemes:  
    oAuth2ClientCredentials:  
      type: oauth2  
      flows:  
        clientCredentials:  
          tokenUrl: '{tokenUrl}'  
          scopes: {}
```

```
  schemas:
```

```
#  
# STRUCTURED DATA TYPES  
#
```

```
MonitoringJob:  
  description: >  
    Represents a Monitoring Job.  
  type: object  
  properties:  
    monMetrics:  
      type: object  
      additionalProperties:  
        $ref: '#/components/schemas/MonitoringMetric'  
      minProperties: 1  
      description: >  
        Contains the requested performance and analytics monitoring metric(s).  
        The key of the map shall be any unique string encoded value.  
      supFeat:  
        $ref: 'TS29571_CommonData.yaml#/components/schemas/SupportedFeatures'  
      required:  
        - monMetrics
```

```
MonitoringJobPatch:  
  description: >  
    Represents the requested modifications to a Monitoring Job.  
  type: object  
  properties:  
    monMetrics:  
      type: object  
      additionalProperties:  
        $ref: '#/components/schemas/MonitoringMetric'  
      minProperties: 1  
      description: >  
        Contains the updated requested performance and analytics monitoring metric(s).  
        The key of the map shall be any unique string encoded value and shall be set to the same  
        value as the one provided during the creation of the corresponding Monitoring Job.
```

```
MonitoringMetric:  
  description: >  
    Represents the parameters of a network slice related performance and analytics monitoring  
    metric.  
  type: object  
  properties:  
    valServId:  
      type: string  
    netSliceIds:  
      type: array  
      items:  
        $ref: 'TS29435_NSCE_PolicyManagement.yaml#/components/schemas/NetSliceId'  
      minItems: 1  
    perfAnalyList:  
      type: array  
      items:  
        $ref: '#/components/schemas/MonPerfAnalytics'  
      minItems: 1  
    startTime:  
      $ref: 'TS29122_CommonData.yaml#/components/schemas/DateTime'  
    endTime:  
      $ref: 'TS29122_CommonData.yaml#/components/schemas/DateTime'  
  required:  
    - perfAnalyList  
    - startTime
```

```
anyOf:
  - required: [valServId]
  - required: [netSliceIds]

MonPerfAnalytics:
  description: >
    Represents a monitored performance or analytics information.
  metric:
  type: object
  properties:
    monNetSliceIds:
      type: array
      items:
        $ref: 'TS29435_NSCE_PolicyManagement.yaml#/components/schemas/NetSliceId'
      minItems: 1
    metricName:
      $ref: '#/components/schemas/MonPerfMetric'
    metricCustName:
      type: string
  required:
    - metricName

MonitoringSubsc:
  description: >
    Represents a Monitoring Subscription.
  type: object
  properties:
    reqReportingList:
      type: object
      additionalProperties:
        $ref: '#/components/schemas/ReportingInfo'
      minProperties: 1
      description: >
        Contains the requested performance and analytics reporting information.
        The key of the map shall be any unique string encoded value.
    notifUri:
      $ref: 'TS29122_CommonData.yaml#/components/schemas/Uri'
    suppFeat:
      $ref: 'TS29571_CommonData.yaml#/components/schemas/SupportedFeatures'
  required:
    - reqReportingList
    - notifUri

MonitoringSubscPatch:
  description: >
    Represents the requested modifications to a Monitoring Subscription.
  type: object
  properties:
    monMetrics:
      type: object
      additionalProperties:
        $ref: '#/components/schemas/ReportingInfo'
      minProperties: 1
      description: >
        Contains the updated requested performance and analytics reporting information.
        The key of the map shall be any unique string encoded value and shall be set to the same
        value as the one provided during the creation of the corresponding Monitoring
        Subscription.
    notifUri:
      $ref: 'TS29122_CommonData.yaml#/components/schemas/Uri'

ReportingInfo:
  description: >
    Represents the network slice related performance and analytics monitoring reporting
    information.
  type: object
  properties:
    valServId:
      type: string
    netSliceIds:
      type: array
      items:
        $ref: 'TS29435_NSCE_PolicyManagement.yaml#/components/schemas/NetSliceId'
      minItems: 1
    perfAnalyList:
      type: array
      items:
        $ref: '#/components/schemas/MonPerfAnalytics'
```

```
    minItems: 1
    startTime:
      $ref: 'TS29122_CommonData.yaml#/components/schemas/DateTime'
    endTime:
      $ref: 'TS29122_CommonData.yaml#/components/schemas/DateTime'
    repPeriodicity:
      $ref: 'TS29122_CommonData.yaml#/components/schemas/DurationSec'
  required:
  - perfAnalyList
  - startTime
  - endTime
  anyOf:
  - required: [valServId]
  - required: [netSliceIds]

MonitoringNotif:
  description: >
    Represents a Monitoring Notification.
  type: object
  properties:
    subscId:
      type: string
    reports:
      type: array
      items:
        $ref: '#/components/schemas/ReportingData'
      minItems: 1
  required:
  - subscId
  - reports

ReportingData:
  description: >
    Represents a network slice related performance and analytics monitoring report.
  type: object
  properties:
    valServId:
      type: string
    netSliceIds:
      type: array
      items:
        $ref: 'TS29435_NSCE_PolicyManagement.yaml#/components/schemas/NetSliceId'
      minItems: 1
    perfResults:
      type: array
      items:
        $ref: '#/components/schemas/MonPerfAnalyRes'
      minItems: 1
  required:
  - perfResults
  anyOf:
  - required: [valServId]
  - required: [netSliceIds]

MonPerfAnalyRes:
  description: >
    Represents a monitored performance or analytics result.
    metric.
  type: object
  properties:
    monNetSliceIds:
      type: array
      items:
        $ref: 'TS29435_NSCE_PolicyManagement.yaml#/components/schemas/NetSliceId'
      minItems: 1
    metricName:
      $ref: '#/components/schemas/MonPerfMetric'
    metricCustName:
      type: string
    metricValue:
      $ref: 'TS29122_CommonData.yaml#/components/schemas/Bytes'
  required:
  - metricName
  - metricValue

MonitoringReq:
  description: >
    Represents a multiple slices related performance and analytics consolidated reporting
```

```
    request.  
    type: object  
    properties:  
      monMetrics:  
        type: array  
        items:  
          $ref: '#/components/schemas/MonReqMetrics'  
        minItems: 1  
      suppFeat:  
        $ref: 'TS29571_CommonData.yaml#/components/schemas/SupportedFeatures'  
    required:  
      - monMetrics  
  
MonitoringResp:  
  description: >  
    Represents a multiple slices related performance and analytics consolidated reporting  
    response.  
  type: object  
  properties:  
    perfResults:  
      type: array  
      items:  
        $ref: '#/components/schemas/MonRespRepData'  
      minItems: 1  
    suppFeat:  
      $ref: 'TS29571_CommonData.yaml#/components/schemas/SupportedFeatures'  
  required:  
    - perfResults  
  
MonReqMetrics:  
  description: >  
    Represents the parameters of a network slice related performance and analytics monitoring  
    metric used within a multiple slices related performance and analytics consolidated  
    reporting request.  
  type: object  
  properties:  
    valServId:  
      type: string  
    netSliceIds:  
      type: array  
      items:  
        $ref: 'TS29435_NSCE_PolicyManagement.yaml#/components/schemas/NetSliceId'  
      minItems: 1  
    perfAnalyList:  
      type: array  
      items:  
        $ref: '#/components/schemas/MonPerfAnalytics'  
      minItems: 1  
    startTime:  
      $ref: 'TS29122_CommonData.yaml#/components/schemas/DateTime'  
    endTime:  
      $ref: 'TS29122_CommonData.yaml#/components/schemas/DateTime'  
  required:  
    - perfAnalyList  
    - startTime  
    - endTime  
  anyOf:  
    - required: [valServId]  
    - required: [netSliceIds]  
  
MonRespRepData:  
  description: >  
    Represents a network slice related performance and analytics monitoring report instance  
    provided as part of a multiple slices related performance and analytics consolidated  
    reporting response.  
  type: object  
  properties:  
    valServId:  
      type: string  
    netSliceIds:  
      type: array  
      items:  
        $ref: 'TS29435_NSCE_PolicyManagement.yaml#/components/schemas/NetSliceId'  
      minItems: 1  
    perfResults:  
      type: array  
      items:  
        $ref: '#/components/schemas/MonPerfAnalyRes'
```

```

    minItems: 1
    startTime:
      $ref: 'TS29122_CommonData.yaml#/components/schemas/DateTime'
    endTime:
      $ref: 'TS29122_CommonData.yaml#/components/schemas/DateTime'
  required:
    - perfResults
    - startTime
    - endTime
  anyOf:
    - required: [valServId]
    - required: [netSliceIds]

# SIMPLE DATA TYPES
#

#
# ENUMERATIONS
#

MonPerfMetric:
  anyOf:
    - type: string
      enum:
        - RTT
        - E2E_LATENCY
        - PACKET_LOSS
        - RETRANSMISSIONS
        - THROUGHPUT
        - NUM_OF_REG_UES
        - NUM_OF_EST_PDU_SESS
        - RESOURCE_USAGE
        - LOAD_LEVEL
        - OTHER
    - type: string
      description: >
        This string provides forward-compatibility with future extensions to the enumeration
        and is not used to encode content defined in the present version of this API.
      description: |
        Represents a performance or analytics metric.
        Possible values are:
        - RTT: Indicates that the performance or analytics metric is the round-trip time within the
          network slice.
        - E2E_LATENCY: Indicates that the performance or analytics metric is the E2E Latency within
          the network slice.
        - PACKET_LOSS: Indicates that the performance or analytics metric is the packet loss within
          the network slice.
        - RETRANSMISSIONS: Indicates that the performance or analytics metric is the retransmissions
          within the network slice.
        - THROUGHPUT: Indicates that the performance or analytics metric is the throughput within
          the network slice.
        - NUM_OF_REG_UES: Indicates that the performance or analytics metric is the number of
          registered UEs within the network slice.
        - NUM_OF_EST_PDU_SESS: Indicates that the performance or analytics metric is the number of
          established PDU Sessions within the network slice.
        - RESOURCE_USAGE: Indicates that the performance or analytics metric is the resources usage
          within the network slice.
        - LOAD_LEVEL: Indicates that the performance or analytics metric is the load level within
          the network slice.
        - OTHER: Indicates that the performance or analytics metric is a custom metric.

```

---

## A.8 NSCE\_InfoCollection API

openapi: 3.0.0

```

info:
  title: NSCE_InfoCollection
  version: 1.0.1
  description: |
    NSCE_InfoCollection Service.
    © <2024>, 3GPP Organizational Partners (ARIB, ATIS, CCSA, ETSI, TSDSI, TTA, TTC).
    All rights reserved.

```

externalDocs:



```
description: >
  3GPP TS 29.435 V18.2.0; Service Enabler Architecture Layer for Verticals (SEAL);
  Network Slice Capability Enablement (NSCE) Server Service(s); Stage 3.
url: http://www.3gpp.org/ftp/Specs/archive/29_series/29.435/

servers:
- url: '{apiRoot}/nsce-ic/v1'
  variables:
    apiRoot:
      default: https://example.com
      description: apiRoot as defined in clause 6.5 of 3GPP TS 29.549

security:
- {}
- oAuth2ClientCredentials: []

paths:
  /subscriptions:
    post:
      summary: Request the creation of an Information Collection Subscription.
      operationId: CreateInfoCollectSubscription
      tags:
        - Information Collection Subscriptions (Collection)
      requestBody:
        required: true
        content:
          application/json:
            schema:
              $ref: '#/components/schemas/InfoCollectSubsc'
      responses:
        '201':
          description: >
            Created. The Information Collection Subscription is successfully created and a
            representation of the created Individual Information Collection Subscription resource
            shall be returned.
          content:
            application/json:
              schema:
                $ref: '#/components/schemas/InfoCollectSubsc'
          headers:
            Location:
              description: >
                Contains the URI of the newly created resource.
              required: true
              schema:
                type: string
        '400':
          $ref: 'TS29122_CommonData.yaml#/components/responses/400'
        '401':
          $ref: 'TS29122_CommonData.yaml#/components/responses/401'
        '403':
          $ref: 'TS29122_CommonData.yaml#/components/responses/403'
        '404':
          $ref: 'TS29122_CommonData.yaml#/components/responses/404'
        '411':
          $ref: 'TS29122_CommonData.yaml#/components/responses/411'
        '413':
          $ref: 'TS29122_CommonData.yaml#/components/responses/413'
        '415':
          $ref: 'TS29122_CommonData.yaml#/components/responses/415'
        '429':
          $ref: 'TS29122_CommonData.yaml#/components/responses/429'
        '500':
          $ref: 'TS29122_CommonData.yaml#/components/responses/500'
        '503':
          $ref: 'TS29122_CommonData.yaml#/components/responses/503'
      default:
        $ref: 'TS29122_CommonData.yaml#/components/responses/default'
    callbacks:
      InfoCollectNotif:
        '{$request.body#/notifUri}':
          post:
            requestBody:
```

```

    required: true
    content:
      application/json:
        schema:
          $ref: '#/components/schemas/InfoCollectNotif'
  responses:
    '204':
      description: >
        No Content. The Information Collection Notification is successfully received.
    '307':
      $ref: 'TS29122_CommonData.yaml#/components/responses/307'
    '308':
      $ref: 'TS29122_CommonData.yaml#/components/responses/308'
    '400':
      $ref: 'TS29122_CommonData.yaml#/components/responses/400'
    '401':
      $ref: 'TS29122_CommonData.yaml#/components/responses/401'
    '403':
      $ref: 'TS29122_CommonData.yaml#/components/responses/403'
    '404':
      $ref: 'TS29122_CommonData.yaml#/components/responses/404'
    '411':
      $ref: 'TS29122_CommonData.yaml#/components/responses/411'
    '413':
      $ref: 'TS29122_CommonData.yaml#/components/responses/413'
    '415':
      $ref: 'TS29122_CommonData.yaml#/components/responses/415'
    '429':
      $ref: 'TS29122_CommonData.yaml#/components/responses/429'
    '500':
      $ref: 'TS29122_CommonData.yaml#/components/responses/500'
    '503':
      $ref: 'TS29122_CommonData.yaml#/components/responses/503'
    default:
      $ref: 'TS29122_CommonData.yaml#/components/responses/default'

/subscriptions/{subscriptionId}:
  parameters:
    - name: subscriptionId
      in: path
      description: >
        Represents the identifier of the Information Collection Subscription resource.
      required: true
      schema:
        type: string

  get:
    summary: Retrieve an existing Individual Information Collection Subscription resource.
    operationId: GetIndInfoCollectSubscription
    tags:
      - Individual Information Collection Subscription (Document)
    responses:
      '200':
        description: >
          OK. The requested Individual Information Collection Subscription resource shall be
          returned.
        content:
          application/json:
            schema:
              $ref: '#/components/schemas/InfoCollectSubsc'
      '307':
        $ref: 'TS29122_CommonData.yaml#/components/responses/307'
      '308':
        $ref: 'TS29122_CommonData.yaml#/components/responses/308'
      '400':
        $ref: 'TS29122_CommonData.yaml#/components/responses/400'
      '401':
        $ref: 'TS29122_CommonData.yaml#/components/responses/401'
      '403':
        $ref: 'TS29122_CommonData.yaml#/components/responses/403'
      '404':

```

```

    $ref: 'TS29122_CommonData.yaml#/components/responses/404'
  '406':
    $ref: 'TS29122_CommonData.yaml#/components/responses/406'
  '429':
    $ref: 'TS29122_CommonData.yaml#/components/responses/429'
  '500':
    $ref: 'TS29122_CommonData.yaml#/components/responses/500'
  '503':
    $ref: 'TS29122_CommonData.yaml#/components/responses/503'
  default:
    $ref: 'TS29122_CommonData.yaml#/components/responses/default'

```

put:

summary: Request the update of an existing Individual Information Collection Subscription resource.

operationId: UpdateIndInfoCollectSubscription

tags:

- Individual Information Collection Subscription (Document)

requestBody:

required: true

content:

application/json:

schema:

\$ref: '#/components/schemas/InfoCollectSubsc'

responses:

'200':

description: >

OK. The Individual Information Collection Subscription resource is successfully updated and a representation of the updated resource shall be returned in the response body.

content:

application/json:

schema:

\$ref: '#/components/schemas/InfoCollectSubsc'

'204':

description: >

OK. The Individual Information Collection Subscription resource is successfully updated and a representation of the updated resource shall be returned in the response body.

'307':

\$ref: 'TS29122\_CommonData.yaml#/components/responses/307'

'308':

\$ref: 'TS29122\_CommonData.yaml#/components/responses/308'

'400':

\$ref: 'TS29122\_CommonData.yaml#/components/responses/400'

'401':

\$ref: 'TS29122\_CommonData.yaml#/components/responses/401'

'403':

\$ref: 'TS29122\_CommonData.yaml#/components/responses/403'

'404':

\$ref: 'TS29122\_CommonData.yaml#/components/responses/404'

'411':

\$ref: 'TS29122\_CommonData.yaml#/components/responses/411'

'413':

\$ref: 'TS29122\_CommonData.yaml#/components/responses/413'

'415':

\$ref: 'TS29122\_CommonData.yaml#/components/responses/415'

'429':

\$ref: 'TS29122\_CommonData.yaml#/components/responses/429'

'500':

\$ref: 'TS29122\_CommonData.yaml#/components/responses/500'

'503':

\$ref: 'TS29122\_CommonData.yaml#/components/responses/503'

default:

\$ref: 'TS29122\_CommonData.yaml#/components/responses/default'

patch:

summary: Request the modification of an existing Individual Information Collection Subscription resource.

operationId: ModifyIndInfoCollectSubscription

tags:

- Individual Information Collection Subscription (Document)

requestBody:

```
required: true
content:
  application/merge-patch+json:
    schema:
      $ref: '#/components/schemas/InfoCollectSubscPatch'
responses:
  '200':
    description: >
      OK. The Individual Information Collection Subscription resource is successfully modified
      and a representation of the updated resource shall be returned in the response body.
    content:
      application/json:
        schema:
          $ref: '#/components/schemas/InfoCollectSubsc'
  '204':
    description: >
      No Content. The Individual Information Collection Subscription resource is successfully
      modified and no content is returned in the response body.
  '307':
    $ref: 'TS29122_CommonData.yaml#/components/responses/307'
  '308':
    $ref: 'TS29122_CommonData.yaml#/components/responses/308'
  '400':
    $ref: 'TS29122_CommonData.yaml#/components/responses/400'
  '401':
    $ref: 'TS29122_CommonData.yaml#/components/responses/401'
  '403':
    $ref: 'TS29122_CommonData.yaml#/components/responses/403'
  '404':
    $ref: 'TS29122_CommonData.yaml#/components/responses/404'
  '411':
    $ref: 'TS29122_CommonData.yaml#/components/responses/411'
  '413':
    $ref: 'TS29122_CommonData.yaml#/components/responses/413'
  '415':
    $ref: 'TS29122_CommonData.yaml#/components/responses/415'
  '429':
    $ref: 'TS29122_CommonData.yaml#/components/responses/429'
  '500':
    $ref: 'TS29122_CommonData.yaml#/components/responses/500'
  '503':
    $ref: 'TS29122_CommonData.yaml#/components/responses/503'
  default:
    $ref: 'TS29122_CommonData.yaml#/components/responses/default'

delete:
  summary: Request the deletion of an existing Individual Information Collection Subscription
  resource.
  operationId: DeleteIndInfoCollectSubscription
  tags:
    - Individual Information Collection Subscription (Document)
  responses:
    '204':
      description: >
        No Content. The Individual Information Collection Subscription resource is successfully
        modified and no content is returned in the response body.
    '307':
      $ref: 'TS29122_CommonData.yaml#/components/responses/307'
    '308':
      $ref: 'TS29122_CommonData.yaml#/components/responses/308'
    '400':
      $ref: 'TS29122_CommonData.yaml#/components/responses/400'
    '401':
      $ref: 'TS29122_CommonData.yaml#/components/responses/401'
    '403':
      $ref: 'TS29122_CommonData.yaml#/components/responses/403'
    '404':
      $ref: 'TS29122_CommonData.yaml#/components/responses/404'
    '429':
      $ref: 'TS29122_CommonData.yaml#/components/responses/429'
    '500':
```

```

    $ref: 'TS29122_CommonData.yaml#/components/responses/500'
  '503':
    $ref: 'TS29122_CommonData.yaml#/components/responses/503'
  default:
    $ref: 'TS29122_CommonData.yaml#/components/responses/default'

```

## components:

## securitySchemes:

```

  oAuth2ClientCredentials:
    type: oauth2
    flows:
      clientCredentials:
        tokenUrl: '{tokenUrl}'
        scopes: {}

```

## schemas:

## InfoCollectSubsc:

```

  description: Represents an Information Collection subscription.
  type: object
  properties:
    notifUri:
      $ref: 'TS29122_CommonData.yaml#/components/schemas/Uri'
    collectInfo:
      type: object
      additionalProperties:
        $ref: '#/components/schemas/CollectInfo'
      minProperties: 1
      description: >
        Contains the information collected from the interested Network slice.
        The key of the map shall be any unique string encoded value.
    expTime:
      $ref: 'TS29122_CommonData.yaml#/components/schemas/DateTime'
    netSlicePerf:
      type: array
      items:
        $ref: 'TS29435_NSCE_PerfMonitoring.yaml#/components/schemas/ReportingData'
      minItems: 1
    suppFeat:
      $ref: 'TS29571_CommonData.yaml#/components/schemas/SupportedFeatures'
  required:
    - notifUri
    - collectInfo

```

## InfoCollectSubscPatch:

```

  description: Represents the requested modifications of an Information Collection subscription.
  type: object
  properties:
    notifUri:
      $ref: 'TS29122_CommonData.yaml#/components/schemas/Uri'
    collectInfo:
      type: object
      additionalProperties:
        $ref: '#/components/schemas/CollectInfo'
      minProperties: 1
      description: >
        Contains the information collected from the interested Network slice.
        The key of the map shall be any unique string encoded value and shall be set to the same
        value as the as the one provided during the creation of the corresponding Information
        Collection Subscription.
    expTime:
      $ref: 'TS29122_CommonData.yaml#/components/schemas/DateTime'

```

## InfoCollectNotif:

```

  description: Represents an Information Collection Notification.
  type: object
  properties:
    subscriptionId:
      type: string
      description: >
        Contains the identifier of the subscription to which the notification is related.
    netSlicePerf:
      type: array
      description: Contains the network slice related performance and analytics report(s).
      items:
        $ref: 'TS29435_NSCE_PerfMonitoring.yaml#/components/schemas/ReportingData'

```

```

    minItems: 1
  required:
  - subscriptionId
  - netSlicePerf

CollectInfo:
  type: object
  properties:
    netSliceId:
      $ref: 'TS29435_NSCE_PolicyManagement.yaml#/components/schemas/NetSliceId'
    qosMetrics:
      type: array
      items:
        $ref: '#/components/schemas/QoSMetric'
      minItems: 1
    repPeriod:
      $ref: 'TS29571_CommonData.yaml#/components/schemas/DurationSec'
    immRepFlag:
      type: boolean
      description: Identifies the request needs immediate reporting or not.
  required:
  - netSliceId

QoSMetric:
  type: object
  properties:
    qosType:
      $ref: '#/components/schemas/QoSType'
    latency:
      $ref: 'TS29571_CommonData.yaml#/components/schemas/Float'
    throughput:
      $ref: 'TS29571_CommonData.yaml#/components/schemas/BitRate'
    jitter:
      $ref: 'TS29571_CommonData.yaml#/components/schemas/Uint32'
  required:
  - qosType

#
# ENUMERATIONS DATA TYPES
#

QoSType:
  anyOf:
  - type: string
    enum:
    - LATENCY
    - THROUGHPUT
    - JITTER
  - type: string
    description: >
      This string provides forward-compatibility with future
      extensions to the enumeration and is not used to encode
      content defined in the present version of this API.
  description: |
    Represents the QoS metric type.
    Possible values are:
    - LATENCY: Indicates that the QoS type is latency.
    - THROUGHPUT: Indicates that the QoS type is throughput.
    - JITTER: Indicates that the QoS type is jitter.

```

---

## A.9 NSCE\_ServiceContinuity API

openapi: 3.0.0

info:

```

title: NSCE Server Edge Service Continuity Service
version: 1.0.1
description: |
  NSCE Server Edge Service Continuity Service.
  © 2024, 3GPP Organizational Partners (ARIB, ATIS, CCSA, ETSI, TSDSI, TTA, TTC).
  All rights reserved.

```

externalDocs:

```
description: >
  3GPP TS 29.435 V18.2.0; Service Enabler Architecture Layer for Verticals (SEAL);
  Network Slice Capability Enablement (NSCE) Server Service(s); Stage 3.
url: https://www.3gpp.org/ftp/Specs/archive/29_series/29.435/

servers:
- url: '{apiRoot}/nsce-esc/v1'
  variables:
    apiRoot:
      default: https://example.com
      description: apiRoot as defined in clause 6.5 of 3GPP TS 29.549.

security:
- {}
- oAuth2ClientCredentials: []

paths:
/request:
  post:
    summary: Enables to request Edge service continuity requirement.
    operationId: EdgeSCRequirementReq
    tags:
      - Edge Service Continuity Requirement Request
    requestBody:
      required: true
      content:
        application/json:
          schema:
            $ref: '#/components/schemas/EdgeSCRequirementReq'
    responses:
      '204':
        description: >
          No Content. The Edge service continuity requirement request is successfully
          received and processed.
      '307':
        $ref: 'TS29122_CommonData.yaml#/components/responses/307'
      '308':
        $ref: 'TS29122_CommonData.yaml#/components/responses/308'
      '400':
        $ref: 'TS29122_CommonData.yaml#/components/responses/400'
      '401':
        $ref: 'TS29122_CommonData.yaml#/components/responses/401'
      '403':
        $ref: 'TS29122_CommonData.yaml#/components/responses/403'
      '404':
        $ref: 'TS29122_CommonData.yaml#/components/responses/404'
      '411':
        $ref: 'TS29122_CommonData.yaml#/components/responses/411'
      '413':
        $ref: 'TS29122_CommonData.yaml#/components/responses/413'
      '415':
        $ref: 'TS29122_CommonData.yaml#/components/responses/415'
      '429':
        $ref: 'TS29122_CommonData.yaml#/components/responses/429'
      '500':
        $ref: 'TS29122_CommonData.yaml#/components/responses/500'
      '503':
        $ref: 'TS29122_CommonData.yaml#/components/responses/503'
      default:
        $ref: 'TS29122_CommonData.yaml#/components/responses/default'
    callbacks:
      EdgeSCRequirementNotif:
        '{$request.body#/notifUri}':
          post:
            requestBody:
              required: true
              content:
                application/json:
                  schema:
                    $ref: '#/components/schemas/EdgeSCRequirementNotif'
      responses:
        '204':
          description: >
            No Content. The Edge Service Continuity requirement Notification
            is successfully received and processed.
        '307':
          $ref: 'TS29122_CommonData.yaml#/components/responses/307'
        '308':
```

```

    $ref: 'TS29122_CommonData.yaml#/components/responses/308'
  '400':
    $ref: 'TS29122_CommonData.yaml#/components/responses/400'
  '401':
    $ref: 'TS29122_CommonData.yaml#/components/responses/401'
  '403':
    $ref: 'TS29122_CommonData.yaml#/components/responses/403'
  '404':
    $ref: 'TS29122_CommonData.yaml#/components/responses/404'
  '411':
    $ref: 'TS29122_CommonData.yaml#/components/responses/411'
  '413':
    $ref: 'TS29122_CommonData.yaml#/components/responses/413'
  '415':
    $ref: 'TS29122_CommonData.yaml#/components/responses/415'
  '429':
    $ref: 'TS29122_CommonData.yaml#/components/responses/429'
  '500':
    $ref: 'TS29122_CommonData.yaml#/components/responses/500'
  '503':
    $ref: 'TS29122_CommonData.yaml#/components/responses/503'
  default:
    $ref: 'TS29122_CommonData.yaml#/components/responses/default'

/negotiate:
  post:
    summary: Enables to request Edge service continuity negotiation.
    operationId: EdgeSCNegotiationReq
    tags:
      - Edge Service Continuity Negotiation Request
    requestBody:
      required: true
      content:
        application/json:
          schema:
            $ref: '#/components/schemas/EdgeSCNegotiationReq'
    responses:
      '204':
        description: >
          No Content. The Edge service continuity Negotiation request is successfully
          received and processed.
      '307':
        $ref: 'TS29122_CommonData.yaml#/components/responses/307'
      '308':
        $ref: 'TS29122_CommonData.yaml#/components/responses/308'
      '400':
        $ref: 'TS29122_CommonData.yaml#/components/responses/400'
      '401':
        $ref: 'TS29122_CommonData.yaml#/components/responses/401'
      '403':
        $ref: 'TS29122_CommonData.yaml#/components/responses/403'
      '404':
        $ref: 'TS29122_CommonData.yaml#/components/responses/404'
      '411':
        $ref: 'TS29122_CommonData.yaml#/components/responses/411'
      '413':
        $ref: 'TS29122_CommonData.yaml#/components/responses/413'
      '415':
        $ref: 'TS29122_CommonData.yaml#/components/responses/415'
      '429':
        $ref: 'TS29122_CommonData.yaml#/components/responses/429'
      '500':
        $ref: 'TS29122_CommonData.yaml#/components/responses/500'
      '503':
        $ref: 'TS29122_CommonData.yaml#/components/responses/503'
      default:
        $ref: 'TS29122_CommonData.yaml#/components/responses/default'
    callbacks:
      EdgeSCNegotiationNotif:
        '{$request.body#/notifUri}':
          post:
            requestBody:
              required: true
              content:
                application/json:
                  schema:
                    $ref: '#/components/schemas/EdgeSCNegotiationNotif'
            responses:

```



```

'204':
  description: >
    No Content. The Edge Service Continuity Negotiation Notification is
    successfully received and processed.
'307':
  $ref: 'TS29122_CommonData.yaml#/components/responses/307'
'308':
  $ref: 'TS29122_CommonData.yaml#/components/responses/308'
'400':
  $ref: 'TS29122_CommonData.yaml#/components/responses/400'
'401':
  $ref: 'TS29122_CommonData.yaml#/components/responses/401'
'403':
  $ref: 'TS29122_CommonData.yaml#/components/responses/403'
'404':
  $ref: 'TS29122_CommonData.yaml#/components/responses/404'
'411':
  $ref: 'TS29122_CommonData.yaml#/components/responses/411'
'413':
  $ref: 'TS29122_CommonData.yaml#/components/responses/413'
'415':
  $ref: 'TS29122_CommonData.yaml#/components/responses/415'
'429':
  $ref: 'TS29122_CommonData.yaml#/components/responses/429'
'500':
  $ref: 'TS29122_CommonData.yaml#/components/responses/500'
'503':
  $ref: 'TS29122_CommonData.yaml#/components/responses/503'
default:
  $ref: 'TS29122_CommonData.yaml#/components/responses/default'

```

```

components:
  securitySchemes:
    oAuth2ClientCredentials:
      type: oauth2
      flows:
        clientCredentials:
          tokenUrl: '{tokenUrl}'
          scopes: {}

```

```
schemas:
```

```
#
# STRUCTURED DATA TYPES
#
```

```

EdgeSCRequirementReq:
  description: >
    Represents the parameters to request Edge Service Continuity Requirement.
  type: object
  properties:
    notifUri:
      $ref: 'TS29122_CommonData.yaml#/components/schemas/Uri'
    valServId:
      type: string
      description: >
        The identifier of the VAL service for which the requirement request applies.
    valUeIds:
      type: array
      items:
        type: string
      minItems: 1
      description: >
        The list of VAL UE IDs for which the requirement request applies.
    netSliceId:
      $ref: 'TS29435_NSCE_PolicyManagement.yaml#/components/schemas/NetSliceId'
    servContReq:
      $ref: 'TS29435_NSCE_InterPLMNContinuity.yaml#/components/schemas/ServContReq'
    targetServArea:
      $ref: 'TS29435_NSCE_NSInfoDelivery.yaml#/components/schemas/ServArea'
    suppFeat:
      $ref: 'TS29571_CommonData.yaml#/components/schemas/SupportedFeatures'
  required:
    - valServId
    - servContReq
    - notifUri

```

```
EdgeSCRequirementNotif:
```

```

description: >
  Represents an Edge Service Continuity Requirement Notification.
type: object
properties:
  valServId:
    type: string
    description: >
      The identifier of the VAL service for which the requirement request applies.
  valUeIds:
    type: array
    items:
      type: string
    minItems: 1
    description: >
      The list of VAL UE IDs for which the requirement request applies.
  netSliceId:
    $ref: 'TS29435_NSCE_PolicyManagement.yaml#/components/schemas/NetSliceId'
  tgtNsceServId:
    type: string
    description: >
      Contains the identifier of the target NSCE Server.
  tgtNsceAddr:
    $ref: 'TS29558_Eees_EASRegistration.yaml#/components/schemas/EndPoint'
  targetServArea:
    $ref: 'TS29435_NSCE_NSInfoDelivery.yaml#/components/schemas/ServArea'
required:
  - valServId
  - netSliceId
  - tgtNsceServId
  - tgtNsceAddr
  - targetServArea

EdgeSCNegotiationReq:
description: >
  Represents the parameters to request Edge Service Continuity Negotiation.
type: object
properties:
  notifUri:
    $ref: 'TS29122_CommonData.yaml#/components/schemas/Uri'
  valServId:
    type: string
    description: >
      The identifier of the VAL service for which the negotiation request applies.
  valUeIds:
    type: array
    items:
      type: string
    minItems: 1
    description: >
      The list of VAL UE IDs for which the Negotiation request applies.
  netSliceId:
    $ref: 'TS29435_NSCE_PolicyManagement.yaml#/components/schemas/NetSliceId'
  servContReq:
    $ref: 'TS29435_NSCE_InterPLMNCContinuity.yaml#/components/schemas/ServContReq'
  appQoSReqs:
    $ref: 'TS29435_NSCE_InterPLMNCContinuity.yaml#/components/schemas/AppReqs'
  triggerAction:
    $ref: '#/components/schemas/TriggerAction'
  suppFeat:
    $ref: 'TS29571_CommonData.yaml#/components/schemas/SupportedFeatures'
required:
  - valServId
  - servContReq
  - netSliceId
  - notifUri

EdgeSCNegotiationNotif:
description: >
  Represents an Edge Service Continuity Negotiation Notification.
type: object
properties:
  valServId:
    type: string
    description: >
      The identifier of the VAL service for which the negotiation request applies.
  triggerAction:
    $ref: '#/components/schemas/TriggerAction'
required:

```

```

    - valServId
    - triggerAction

# SIMPLE DATA TYPES
#

#
# ENUMERATIONS
#

TriggerAction:
  anyOf:
  - type: string
    enum:
      - SLICE_LIFECYCLE_CHG
  - type: string
    description: >
      This string provides forward-compatibility with future extensions to the enumeration
      and is not used to encode content defined in the present version of this API.
  description: |
    Represents the trigger action.
    Possible values are:
    - SLICE_LIFECYCLE_CHG: Indicates that the trigger action is slice lifecycle change.

```

---

## A.10 NSCE\_MultiSlicesOptimization API

openapi: 3.0.0

info:

```

title: NSCE Server Multiple Slices Optimization Service
version: 1.0.0
description: |
  NSCE Server Multiple Slices Optimization Service.
  © 2024, 3GPP Organizational Partners (ARIB, ATIS, CCSA, ETSI, TSDSI, TTA, TTC).
  All rights reserved.

```

externalDocs:

```

description: >
  3GPP TS 29.435 V18.1.0; Service Enabler Architecture Layer for Verticals (SEAL);
  Network Slice Capability Enablement (NSCE) Server Service(s); Stage 3.
url: https://www.3gpp.org/ftp/Specs/archive/29_series/29.435/

```

servers:

```

- url: '{apiRoot}/nsce-mso/v1'
  variables:
    apiRoot:
      default: https://example.com
      description: apiRoot as defined in clause 6.5 of 3GPP TS 29.549

```

security:

```

- {}
- oAuth2ClientCredentials: []

```

paths:

```

/request:
  post:
    summary: Request multiple slices optimization.
    operationId: ReqMultiSlicesOptim
    tags:
      - Multiple Slices Optimization Request
    requestBody:
      required: true
      content:
        application/json:
          schema:
            $ref: '#/components/schemas/MultiSlicesOptReq'
    responses:
      '204':
        description: >
          No Content. The multiple slices optimization request is successfully received and
          processed.
      '307':
        $ref: 'TS29122_CommonData.yaml#/components/responses/307'
      '308':
        $ref: 'TS29122_CommonData.yaml#/components/responses/308'

```

```

'400':
  $ref: 'TS29122_CommonData.yaml#/components/responses/400'
'401':
  $ref: 'TS29122_CommonData.yaml#/components/responses/401'
'403':
  $ref: 'TS29122_CommonData.yaml#/components/responses/403'
'404':
  $ref: 'TS29122_CommonData.yaml#/components/responses/404'
'411':
  $ref: 'TS29122_CommonData.yaml#/components/responses/411'
'413':
  $ref: 'TS29122_CommonData.yaml#/components/responses/413'
'415':
  $ref: 'TS29122_CommonData.yaml#/components/responses/415'
'429':
  $ref: 'TS29122_CommonData.yaml#/components/responses/429'
'500':
  $ref: 'TS29122_CommonData.yaml#/components/responses/500'
'503':
  $ref: 'TS29122_CommonData.yaml#/components/responses/503'
default:
  $ref: 'TS29122_CommonData.yaml#/components/responses/default'

components:
  securitySchemes:
    oAuth2ClientCredentials:
      type: oauth2
      flows:
        clientCredentials:
          tokenUrl: '{tokenUrl}'
          scopes: {}

  schemas:

#
# STRUCTURED DATA TYPES
#

MultiSlicesOptReq:
  description: >
    Represents the multiple slices optimization request.
  type: object
  properties:
    valServId:
      type: string
      description: Represents the identifier of the VAL service.
    optZone:
      $ref: 'TS29435_NSCE_NSInfoDelivery.yaml#/components/schemas/ServArea'
    snssais:
      type: array
      items:
        $ref: 'TS29571_CommonData.yaml#/components/schemas/Snssai'
      minItems: 1
    suppFeat:
      $ref: 'TS29571_CommonData.yaml#/components/schemas/SupportedFeatures'
  required:
    - valServId

```

---

## A.11 NSCE\_NetworkSliceAdaptation API

openapi: 3.0.0

info:

```

title: NSCE Server Network Slice Adaptation Service
version: 1.1.0
description: |
  NSCE Server Network Slice Adaptation Service.
  © 2024, 3GPP Organizational Partners (ARIB, ATIS, CCSA, ETSI, TSDSI, TTA, TTC).
  All rights reserved.

```

externalDocs:

```

description: >
  3GPP TS 29.435 V18.1.0; Service Enabler Architecture Layer for Verticals (SEAL);
  Network Slice Capability Enablement (NSCE) Server Services; Stage 3.
url: https://www.3gpp.org/ftp/Specs/archive/29_series/29.435/

```

```

servers:
- url: '{apiRoot}/ss-nsa/v1'
  variables:
    apiRoot:
      default: https://example.com
      description: apiRoot as defined in clause 6.5 of 3GPP TS 29.549

security:
- {}
- oAuth2ClientCredentials: []

paths:
  /request:
    post:
      summary: Request network slice adaptation.
      operationId: RequestNetworkSliceAdaptation
      tags:
      - Network Slice Adaptation Request
      requestBody:
        required: true
        content:
          application/json:
            schema:
              $ref: '#/components/schemas/NwSliceAdptInfo'
      responses:
        '204':
          description: >
            No Content. The network slice adaptation request is successfully received and processed.
        '307':
          $ref: 'TS29122_CommonData.yaml#/components/responses/307'
        '308':
          $ref: 'TS29122_CommonData.yaml#/components/responses/308'
        '400':
          $ref: 'TS29122_CommonData.yaml#/components/responses/400'
        '401':
          $ref: 'TS29122_CommonData.yaml#/components/responses/401'
        '403':
          description: >
            The request is rejected by the NSCE Server and additional details (along with
            ProblemDetails data structure) may be returned.
          content:
            application/problem+json:
              schema:
                $ref: '#/components/schemas/ProblemDetailsSliceAdapt'
        '404':
          $ref: 'TS29122_CommonData.yaml#/components/responses/404'
        '411':
          $ref: 'TS29122_CommonData.yaml#/components/responses/411'
        '413':
          $ref: 'TS29122_CommonData.yaml#/components/responses/413'
        '415':
          $ref: 'TS29122_CommonData.yaml#/components/responses/415'
        '429':
          $ref: 'TS29122_CommonData.yaml#/components/responses/429'
        '500':
          $ref: 'TS29122_CommonData.yaml#/components/responses/500'
        '503':
          $ref: 'TS29122_CommonData.yaml#/components/responses/503'
      default:
        $ref: 'TS29122_CommonData.yaml#/components/responses/default'
    callbacks:
      AdaptStatusNotif:
        '{$request.body#/notifUri}':
          post:
            requestBody:
              required: true
              content:
                application/json:
                  schema:
                    $ref: '#/components/schemas/AdaptStatusNotif'
      responses:
        '204':
          description: >
            No Content. The Network Slice Adaptation Status Notification is successfully
            received and processed.
        '307':
          $ref: 'TS29122_CommonData.yaml#/components/responses/307'
        '308':

```

```

    $ref: 'TS29122_CommonData.yaml#/components/responses/308'
  '400':
    $ref: 'TS29122_CommonData.yaml#/components/responses/400'
  '401':
    $ref: 'TS29122_CommonData.yaml#/components/responses/401'
  '403':
    $ref: 'TS29122_CommonData.yaml#/components/responses/403'
  '404':
    $ref: 'TS29122_CommonData.yaml#/components/responses/404'
  '411':
    $ref: 'TS29122_CommonData.yaml#/components/responses/411'
  '413':
    $ref: 'TS29122_CommonData.yaml#/components/responses/413'
  '415':
    $ref: 'TS29122_CommonData.yaml#/components/responses/415'
  '429':
    $ref: 'TS29122_CommonData.yaml#/components/responses/429'
  '500':
    $ref: 'TS29122_CommonData.yaml#/components/responses/500'
  '503':
    $ref: 'TS29122_CommonData.yaml#/components/responses/503'
  default:
    $ref: 'TS29122_CommonData.yaml#/components/responses/default'

```

```
components:
```

```

  securitySchemes:
    oAuth2ClientCredentials:
      type: oauth2
      flows:
        clientCredentials:
          tokenUrl: '{tokenUrl}'
          scopes: {}

```

```
schemas:
```

```
#
# STRUCTURED DATA TYPES
#
```

```

NwSliceAdptInfo:
  description: >
    Represents the information associated with requested network slice adaptation
    with the underlying network.
  type: object
  properties:
    valServiceId:
      type: string
    valTgtUeIds:
      type: array
      items:
        type: string
      minItems: 1
    snssai:
      $ref: 'TS29571_CommonData.yaml#/components/schemas/Snssai'
    netSliceId:
      $ref: 'TS29435_NSCE_PolicyManagement.yaml#/components/schemas/NetSliceId'
    monNetSliceIds:
      type: array
      items:
        $ref: 'TS29435_NSCE_PolicyManagement.yaml#/components/schemas/NetSliceId'
      minItems: 1
    dnn:
      $ref: 'TS29571_CommonData.yaml#/components/schemas/Dnn'
    reqAdaptThres:
      type: array
      items:
        $ref: '#/components/schemas/AdaptThreshold'
      minItems: 1
    notifUri:
      $ref: 'TS29122_CommonData.yaml#/components/schemas/Uri'
    suppFeat:
      $ref: 'TS29571_CommonData.yaml#/components/schemas/SupportedFeatures'
  required:
    - valServiceId
    - valTgtUeIds
  not:
    required: [snssai, netSliceId]

```

```

AdaptThreshold:
  description: >
    Represents the network slice adaptation threshold.
  type: object
  properties:
    threshName:
      $ref: '#/components/schemas/AdaptThresholdName'
    threshValue:
      $ref: '#/components/schemas/AdaptThresholdValue'
  required:
    - threshName
    - threshValue

AdaptStatusNotif:
  description: >
    Represents a Network Slice Adaptation Status Notification.
  type: object
  properties:
    status:
      type: boolean
      description: >
        Contains the network slice adaptation status. It indicates whether the network slice
        adaptation was successful or not.
        true means that the network slice adaptation was successful.
        false means that the network slice adaptation failed.
    failureCause:
      $ref: '#/components/schemas/AdaptFailCause'
  required:
    - status

```

```

# SIMPLE DATA TYPES
#

```

```

AdaptFailCause:
  description: >
    Represents the network slice adaptation failure cause.
  type: string

```

```

AdaptThresholdName:
  description: >
    Represents the name of the adaptation threshold.
  type: string

```

```

AdaptThresholdValue:
  description: >
    Represents the value of the adaptation threshold.
  type: string

```

```

#
# ENUMERATIONS
#
#
# Data types describing alternative data types or combinations of data types
#

```

```

ProblemDetailsSliceAdapt:
  description: >
    Represents an extension to the ProblemDetails data structure with potentially additional
    error information related to network slice adaptation failure.
  allOf:
    - $ref: 'TS29122_CommonData.yaml#/components/schemas/ProblemDetails'
    - $ref: '#/components/schemas/AdaptFailCause'

```

---

## A.12 NSCE\_SliceCommService API

openapi: 3.0.0

```

info:
  title: NSCE Server Network Slice Communication Service
  version: 1.0.0
  description: |
    NSCE Server Network Slice Communication Service.
    © 2024, 3GPP Organizational Partners (ARIB, ATIS, CCSA, ETSI, TSDSI, TTA, TTC).

```

All rights reserved.

```

externalDocs:
  description: >
    3GPP TS 29.435 V18.1.0; Service Enabler Architecture Layer for Verticals (SEAL);
    Network Slice Capability Enablement (NSCE) Server Service(s); Stage 3.
  url: https://www.3gpp.org/ftp/Specs/archive/29_series/29.435/

servers:
- url: '{apiRoot}/nsce-scs/v1'
  variables:
    apiRoot:
      default: https://example.com
      description: apiRoot as defined in clause 6.5 of 3GPP TS 29.549

security:
- {}
- oAuth2ClientCredentials: []

paths:
  /services:
    post:
      summary: Request the creation of a Slice Related Communication Service.
      operationId: CreateSliceCommServ
      tags:
        - Slice Related Communication Services (Collection)
      requestBody:
        required: true
        content:
          application/json:
            schema:
              $ref: '#/components/schemas/SliceCommService'
      responses:
        '201':
          description: >
            Created. The Slice Related Communication Service is successfully created and a
            representation of the created Individual Slice Related Communication Service resource
            shall be returned.
          content:
            application/json:
              schema:
                $ref: '#/components/schemas/SliceCommService'
          headers:
            Location:
              description: >
                Contains the URI of the created Individual Slice Related Communication Service
                resource.
              required: true
              schema:
                type: string
        '400':
          $ref: 'TS29122_CommonData.yaml#/components/responses/400'
        '401':
          $ref: 'TS29122_CommonData.yaml#/components/responses/401'
        '403':
          $ref: 'TS29122_CommonData.yaml#/components/responses/403'
        '404':
          $ref: 'TS29122_CommonData.yaml#/components/responses/404'
        '411':
          $ref: 'TS29122_CommonData.yaml#/components/responses/411'
        '413':
          $ref: 'TS29122_CommonData.yaml#/components/responses/413'
        '415':
          $ref: 'TS29122_CommonData.yaml#/components/responses/415'
        '429':
          $ref: 'TS29122_CommonData.yaml#/components/responses/429'
        '500':
          $ref: 'TS29122_CommonData.yaml#/components/responses/500'
        '503':
          $ref: 'TS29122_CommonData.yaml#/components/responses/503'
        default:
          $ref: 'TS29122_CommonData.yaml#/components/responses/default'

  /services/{servId}:
    parameters:
      - name: servId
        in: path
        description: >

```



Represents the identifier of the Individual Slice Related Communication Service resource.  
 required: true  
 schema:  
 type: string

## get:

summary: Retrieve an existing Individual Slice Related Communication Service resource.  
 operationId: GetIndSliceCommServ  
 tags:  
 - Individual Slice Related Communication Service (Document)  
 responses:  
 '200':  
 description: >  
 OK. The requested Individual Slice Related Communication Service resource shall be returned.  
 content:  
 application/json:  
 schema:  
 \$ref: '#/components/schemas/SliceCommService'  
 '307':  
 \$ref: 'TS29122\_CommonData.yaml#/components/responses/307'  
 '308':  
 \$ref: 'TS29122\_CommonData.yaml#/components/responses/308'  
 '400':  
 \$ref: 'TS29122\_CommonData.yaml#/components/responses/400'  
 '401':  
 \$ref: 'TS29122\_CommonData.yaml#/components/responses/401'  
 '403':  
 \$ref: 'TS29122\_CommonData.yaml#/components/responses/403'  
 '404':  
 \$ref: 'TS29122\_CommonData.yaml#/components/responses/404'  
 '406':  
 \$ref: 'TS29122\_CommonData.yaml#/components/responses/406'  
 '429':  
 \$ref: 'TS29122\_CommonData.yaml#/components/responses/429'  
 '500':  
 \$ref: 'TS29122\_CommonData.yaml#/components/responses/500'  
 '503':  
 \$ref: 'TS29122\_CommonData.yaml#/components/responses/503'  
 default:  
 \$ref: 'TS29122\_CommonData.yaml#/components/responses/default'

## put:

summary: Request the update of an existing Individual Slice Related Communication Service resource.  
 operationId: UpdateIndSliceCommServ  
 tags:  
 - Individual Slice Related Communication Service (Document)  
 requestBody:  
 required: true  
 content:  
 application/json:  
 schema:  
 \$ref: '#/components/schemas/SliceCommService'  
 responses:  
 '200':  
 description: >  
 OK. The Individual Slice Related Communication Service resource is successfully updated and a representation of the updated resource shall be returned in the response body.  
 content:  
 application/json:  
 schema:  
 \$ref: '#/components/schemas/SliceCommService'  
 '307':  
 \$ref: 'TS29122\_CommonData.yaml#/components/responses/307'  
 '308':  
 \$ref: 'TS29122\_CommonData.yaml#/components/responses/308'  
 '400':  
 \$ref: 'TS29122\_CommonData.yaml#/components/responses/400'  
 '401':  
 \$ref: 'TS29122\_CommonData.yaml#/components/responses/401'  
 '403':  
 \$ref: 'TS29122\_CommonData.yaml#/components/responses/403'  
 '404':  
 \$ref: 'TS29122\_CommonData.yaml#/components/responses/404'  
 '411':  
 \$ref: 'TS29122\_CommonData.yaml#/components/responses/411'  
 '413':

```

    $ref: 'TS29122_CommonData.yaml#/components/responses/413'
  '415':
    $ref: 'TS29122_CommonData.yaml#/components/responses/415'
  '429':
    $ref: 'TS29122_CommonData.yaml#/components/responses/429'
  '500':
    $ref: 'TS29122_CommonData.yaml#/components/responses/500'
  '503':
    $ref: 'TS29122_CommonData.yaml#/components/responses/503'
  default:
    $ref: 'TS29122_CommonData.yaml#/components/responses/default'

```

patch:

```

  summary: Request the modification of an existing Individual Slice Related Communication
Service resource.
  operationId: ModifyIndSliceCommServ
  tags:
  - Individual Slice Related Communication Service (Document)
  requestBody:
    required: true
    content:
      application/merge-patch+json:
        schema:
          $ref: '#/components/schemas/SliceCommServicePatch'
  responses:
    '200':
      description: >
        OK. The Individual Slice Related Communication Service resource is successfully modified
        and a representation of the updated resource shall be returned in the response body.
      content:
        application/json:
          schema:
            $ref: '#/components/schemas/SliceCommService'
    '307':
      $ref: 'TS29122_CommonData.yaml#/components/responses/307'
    '308':
      $ref: 'TS29122_CommonData.yaml#/components/responses/308'
    '400':
      $ref: 'TS29122_CommonData.yaml#/components/responses/400'
    '401':
      $ref: 'TS29122_CommonData.yaml#/components/responses/401'
    '403':
      $ref: 'TS29122_CommonData.yaml#/components/responses/403'
    '404':
      $ref: 'TS29122_CommonData.yaml#/components/responses/404'
    '411':
      $ref: 'TS29122_CommonData.yaml#/components/responses/411'
    '413':
      $ref: 'TS29122_CommonData.yaml#/components/responses/413'
    '415':
      $ref: 'TS29122_CommonData.yaml#/components/responses/415'
    '429':
      $ref: 'TS29122_CommonData.yaml#/components/responses/429'
    '500':
      $ref: 'TS29122_CommonData.yaml#/components/responses/500'
    '503':
      $ref: 'TS29122_CommonData.yaml#/components/responses/503'
  default:
    $ref: 'TS29122_CommonData.yaml#/components/responses/default'

```

delete:

```

  summary: Request the deletion of an existing Individual Slice Related Communication Service
resource.
  operationId: DeleteIndSliceCommServ
  tags:
  - Individual Slice Related Communication Service (Document)
  responses:
    '204':
      description: >
        No Content. The Individual Slice Related Communication Service resource is successfully
        deleted.
    '307':
      $ref: 'TS29122_CommonData.yaml#/components/responses/307'
    '308':
      $ref: 'TS29122_CommonData.yaml#/components/responses/308'
    '400':
      $ref: 'TS29122_CommonData.yaml#/components/responses/400'
    '401':

```

```

    $ref: 'TS29122_CommonData.yaml#/components/responses/401'
  '403':
    $ref: 'TS29122_CommonData.yaml#/components/responses/403'
  '404':
    $ref: 'TS29122_CommonData.yaml#/components/responses/404'
  '429':
    $ref: 'TS29122_CommonData.yaml#/components/responses/429'
  '500':
    $ref: 'TS29122_CommonData.yaml#/components/responses/500'
  '503':
    $ref: 'TS29122_CommonData.yaml#/components/responses/503'
  default:
    $ref: 'TS29122_CommonData.yaml#/components/responses/default'

```

```

components:
  securitySchemes:
    oAuth2ClientCredentials:
      type: oauth2
      flows:
        clientCredentials:
          tokenUrl: '{tokenUrl}'
          scopes: {}

```

```
schemas:
```

```

#
# STRUCTURED DATA TYPES
#

```

```

SliceCommService:
  description: >
    Represents a Slice Related Communication Service.
  type: object
  properties:
    valServName:
      type: string
    valServId:
      type: string
    areaOfInterest:
      $ref: 'TS29435_NSCE_NSInfoDelivery.yaml#/components/schemas/ServArea'
    servProfile:
      type: object
      additionalProperties:
        $ref: '#/components/schemas/ServReq'
      minProperties: 1
      description: >
        Represents the requested VAL service profile containing the application requirements of
        the VAL service to be supported.
        The key of the map shall be any unique string encoded value.
    sliceInfo:
      $ref: '#/components/schemas/NetSliceInfo'
    suppFeat:
      $ref: 'TS29571_CommonData.yaml#/components/schemas/SupportedFeatures'
  required:
    - valServName
    - valServId
    - areaOfInterest
    - servProfile

```

```

SliceCommServicePatch:
  description: >
    Represents the requested modifications to a Slice Related Communication Service.
  type: object
  properties:
    areaOfInterest:
      $ref: 'TS29435_NSCE_NSInfoDelivery.yaml#/components/schemas/ServArea'
    servProfile:
      type: object
      additionalProperties:
        $ref: '#/components/schemas/ServReq'
      minProperties: 1
      nullable: true
      description: >
        Represents the updated requested VAL service profile containing the application
        requirements of the VAL service to be supported.
        The key of the map shall be any unique string encoded value and shall be set to the same
        value as the one provided during the creation of the corresponding Slice Related

```

Communication Service.

```

ServReq:
  description: >
    Represents a set of application service requirements.
  type: object
  properties:
    reqName:
      type: string
    reqValue:
      type: string
  required:
    - reqName
    - reqValue

NetSliceInfo:
  description: >
    Represents network slice related information.
  type: object
  properties:
    snssai:
      $ref: 'TS29571_CommonData.yaml#/components/schemas/Snssai'
    attributes:
      $ref: 'TS28541_SliceNrm.yaml#/components/schemas/ServiceProfile'
  anyOf:
    - required: [snssai]
    - required: [attributes]

```

# SIMPLE DATA TYPES

#

#

# ENUMERATIONS

#

---

## A.13 NSCE\_InterPLMNContinuity API

openapi: 3.0.0

```

info:
  title: NSCE Server Inter-PLMN Service Continuity Service
  version: 1.0.0
  description: |
    NSCE Server Inter-PLMN Service Continuity Service.
    © 2024, 3GPP Organizational Partners (ARIB, ATIS, CCSA, ETSI, TSDSI, TTA, TTC).
    All rights reserved.

externalDocs:
  description: >
    3GPP TS 29.435 V18.1.0; Service Enabler Architecture Layer for Verticals (SEAL);
    Network Slice Capability Enablement (NSCE) Server Service(s); Stage 3.
  url: https://www.3gpp.org/ftp/Specs/archive/29_series/29.435/

servers:
  - url: '{apiRoot}/nsce-ipc/v1'
    variables:
      apiRoot:
        default: https://example.com
        description: apiRoot as defined in clause 6.5 of 3GPP TS 29.549

security:
  - {}
  - oAuth2ClientCredentials: []

paths:
  /request:
    post:
      summary: Enables to request inter-PLMN application service continuity.
      operationId: InterPlmnServContReq
      tags:
        - Inter-PLMN Application Service Continuity Request
      requestBody:
        required: true
        content:
          application/json:

```

```
    schema:
      $ref: '#/components/schemas/InterPlmnServContReq'
  responses:
    '204':
      description: >
        No Content. The inter-PLMN application service continuity request is successfully
        received and processed.
    '307':
      $ref: 'TS29122_CommonData.yaml#/components/responses/307'
    '308':
      $ref: 'TS29122_CommonData.yaml#/components/responses/308'
    '400':
      $ref: 'TS29122_CommonData.yaml#/components/responses/400'
    '401':
      $ref: 'TS29122_CommonData.yaml#/components/responses/401'
    '403':
      $ref: 'TS29122_CommonData.yaml#/components/responses/403'
    '404':
      $ref: 'TS29122_CommonData.yaml#/components/responses/404'
    '411':
      $ref: 'TS29122_CommonData.yaml#/components/responses/411'
    '413':
      $ref: 'TS29122_CommonData.yaml#/components/responses/413'
    '415':
      $ref: 'TS29122_CommonData.yaml#/components/responses/415'
    '429':
      $ref: 'TS29122_CommonData.yaml#/components/responses/429'
    '500':
      $ref: 'TS29122_CommonData.yaml#/components/responses/500'
    '503':
      $ref: 'TS29122_CommonData.yaml#/components/responses/503'
  default:
    $ref: 'TS29122_CommonData.yaml#/components/responses/default'
  callbacks:
    InterPlmnServContNotif:
      '{$request.body#/notifUri}':
        post:
          requestBody:
            required: true
            content:
              application/json:
                schema:
                  $ref: '#/components/schemas/InterPlmnServContNotif'
          responses:
            '204':
              description: >
                No Content. The Inter-PLMN Service Continuity Notification is successfully
                received and processed.
            '307':
              $ref: 'TS29122_CommonData.yaml#/components/responses/307'
            '308':
              $ref: 'TS29122_CommonData.yaml#/components/responses/308'
            '400':
              $ref: 'TS29122_CommonData.yaml#/components/responses/400'
            '401':
              $ref: 'TS29122_CommonData.yaml#/components/responses/401'
            '403':
              $ref: 'TS29122_CommonData.yaml#/components/responses/403'
            '404':
              $ref: 'TS29122_CommonData.yaml#/components/responses/404'
            '411':
              $ref: 'TS29122_CommonData.yaml#/components/responses/411'
            '413':
              $ref: 'TS29122_CommonData.yaml#/components/responses/413'
            '415':
              $ref: 'TS29122_CommonData.yaml#/components/responses/415'
            '429':
              $ref: 'TS29122_CommonData.yaml#/components/responses/429'
            '500':
              $ref: 'TS29122_CommonData.yaml#/components/responses/500'
            '503':
              $ref: 'TS29122_CommonData.yaml#/components/responses/503'
          default:
            $ref: 'TS29122_CommonData.yaml#/components/responses/default'
```

components:  
securitySchemes:

```
oAuth2ClientCredentials:
  type: oauth2
  flows:
    clientCredentials:
      tokenUrl: '{tokenUrl}'
      scopes: {}
```

```
schemas:
```

```
#
# STRUCTURED DATA TYPES
#
```

```
InterPlmnServContReq:
  description: >
    Represents the parameters to request inter-PLMN application service continuity.
  type: object
  properties:
    valServId:
      type: string
    ueIds:
      type: array
      items:
        type: string
      minItems: 1
    servContReq:
      $ref: '#/components/schemas/ServContReq'
    targetPlmnId:
      $ref: 'TS29571_CommonData.yaml#/components/schemas/PlmnId'
    netSliceId:
      $ref: 'TS29435_NSCE_PolicyManagement.yaml#/components/schemas/NetSliceId'
    targetServArea:
      type: array
      items:
        $ref: 'TS29572_Nlmf_Location.yaml#/components/schemas/GeographicArea'
      minItems: 1
    appQoSReqs:
      $ref: '#/components/schemas/AppReqs'
    notifUri:
      $ref: 'TS29122_CommonData.yaml#/components/schemas/Uri'
    suppFeat:
      $ref: 'TS29571_CommonData.yaml#/components/schemas/SupportedFeatures'
  required:
    - valServId
    - servContReq
    - targetPlmnId
    - netSliceId
    - notifUri
```

```
AppReqs:
  description: >
    Represents application QoS requirements.
  type: object
  properties:
    reliability:
      format: float
      type: number
      minimum: 0
      maximum: 100
    delay:
      type: integer
      minimum: 1
    jitter:
      $ref: 'TS29571_CommonData.yaml#/components/schemas/Uint32'
  anyOf:
    - required: [reliability]
    - required: [delay]
    - required: [jitter]
```

```
InterPlmnServContNotif:
  description: >
    Represents an Inter-PLMN Service Continuity Notification.
  type: object
  properties:
    valServId:
      type: string
    ueIds:
      type: array
```

```

    items:
      type: string
      minItems: 1
    netSliceId:
      $ref: 'TS29435_NSCE_PolicyManagement.yaml#/components/schemas/NetSliceId'
    plmnId:
      $ref: 'TS29571_CommonData.yaml#/components/schemas/PlmnId'
    targetServArea:
      type: array
      items:
        $ref: 'TS29572_Nlmf_Location.yaml#/components/schemas/GeographicArea'
      minItems: 1
  required:
    - valServId
    - netSliceId
    - plmnId
    - targetServArea

# SIMPLE DATA TYPES
#

#
# ENUMERATIONS
#

ServContReq:
  anyOf:
    - type: string
      enum:
        - EXPECTED_MIGRATION
        - PREDICTED_MIGRATION
    - type: string
      description: >
        This string provides forward-compatibility with future extensions to the enumeration
        and is not used to encode content defined in the present version of this API.
      description: |
        Represents a service continuity requirement.
        Possible values are:
        - EXPECTED_MIGRATION: Indicates that the service continuity requirement is the expected
          migration of the VAL application (or a list of VAL UE(s) of the VAL application) to a
          target area.
        - PREDICTED_MIGRATION: Indicates that the service continuity requirement is the predicted
          migration of the VAL application (or a list of VAL UE(s) of the VAL application) to a
          target area.



---



## A.14 NSCE_NSDDiagnostics API



openapi: 3.0.0



info:



```

title: NSCE Server Network Slice Diagnostics Service
version: 1.0.0
description: |
  NSCE Server Network Slice Diagnostics Service.
  © 2024, 3GPP Organizational Partners (ARIB, ATIS, CCSA, ETSI, TSDSI, TTA, TTC).
  All rights reserved.

```



externalDocs:



```

description: >
  3GPP TS 29.435 V18.1.0; Service Enabler Architecture Layer for Verticals (SEAL);
  Network Slice Capability Enablement (NSCE) Server Service(s); Stage 3.
url: https://www.3gpp.org/ftp/Specs/archive/29_series/29.435/

```



servers:



```

- url: '{apiRoot}/nsce-nsd/v1'
  variables:
    apiRoot:
      default: https://example.com
      description: apiRoot as defined in clause 6.5 of 3GPP TS 29.549

```



security:



```

- {}
- oAuth2ClientCredentials: []

```



paths:

```

```

/request:
  post:
    summary: Request network slice diagnostics information.
    operationId: RequestNSDiagnostics
    tags:
      - Network Slice Diagnostics Request
    requestBody:
      required: true
      content:
        application/json:
          schema:
            $ref: '#/components/schemas/NwSliceDiagReq'
    responses:
      '200':
        description: >
          The network slice diagnostics request is successful received and processed
          and the requested network slice diagnostics information shall be returned in the
          response body.
        content:
          application/json:
            schema:
              type: array
              items:
                $ref: '#/components/schemas/NwSliceDiagResp'
              minItems: 1
      '307':
        $ref: 'TS29122_CommonData.yaml#/components/responses/307'
      '308':
        $ref: 'TS29122_CommonData.yaml#/components/responses/308'
      '400':
        $ref: 'TS29122_CommonData.yaml#/components/responses/400'
      '401':
        $ref: 'TS29122_CommonData.yaml#/components/responses/401'
      '403':
        $ref: 'TS29122_CommonData.yaml#/components/responses/403'
      '404':
        $ref: 'TS29122_CommonData.yaml#/components/responses/404'
      '411':
        $ref: 'TS29122_CommonData.yaml#/components/responses/411'
      '413':
        $ref: 'TS29122_CommonData.yaml#/components/responses/413'
      '415':
        $ref: 'TS29122_CommonData.yaml#/components/responses/415'
      '429':
        $ref: 'TS29122_CommonData.yaml#/components/responses/429'
      '500':
        $ref: 'TS29122_CommonData.yaml#/components/responses/500'
      '503':
        $ref: 'TS29122_CommonData.yaml#/components/responses/503'
      default:
        $ref: 'TS29122_CommonData.yaml#/components/responses/default'

```

```

components:
  securitySchemes:
    oAuth2ClientCredentials:
      type: oauth2
      flows:
        clientCredentials:
          tokenUrl: '{tokenUrl}'
          scopes: {}

```

```
schemas:
```

```

#
# STRUCTURED DATA TYPES
#

```

```

NwSliceDiagReq:
  description: >
    Represents the network slice diagnostics request.
  type: object
  properties:
    servDgradInfos:
      $ref: '#/components/schemas/ServDgradInfo'
    suppFeat:
      $ref: 'TS29571_CommonData.yaml#/components/schemas/SupportedFeatures'
  required:
    - servDgradInfos

```



```
NwSliceDiagResp:
  description: >
    Represents the requested network slice diagnostics report.
  type: object
  properties:
    startTime:
      $ref: 'TS29122_CommonData.yaml#/components/schemas/DateTime'
    endTime:
      $ref: 'TS29122_CommonData.yaml#/components/schemas/DateTime'
    dataReport:
      type: array
      items:
        $ref: '#/components/schemas/DataReport'
      minItems: 1
    suppFeat:
      $ref: 'TS29571_CommonData.yaml#/components/schemas/SupportedFeatures'
  required:
    - startTime
    - endTime
    - dataReport

ServDgradInfo:
  description: >
    Represents the degraded service information.
  type: object
  properties:
    valServiceId:
      type: string
    reqErrors:
      type: array
      items:
        $ref: '#/components/schemas/ErrorInfo'
      minItems: 1
  required:
    - valServiceId
    - reqErrors

ErrorInfo:
  description: >
    Represents error related information.
  type: object
  properties:
    errorName:
      $ref: '#/components/schemas/Error'
    netSliceId:
      $ref: 'TS29435_NSCE_PolicyManagement.yaml#/components/schemas/NetSliceId'
    ueIds:
      type: array
      items:
        type: string
      minItems: 1
    areaOfInterest:
      $ref: 'TS29435_NSCE_NSInfoDelivery.yaml#/components/schemas/ServArea'
    startTime:
      $ref: 'TS29122_CommonData.yaml#/components/schemas/DateTime'
    endTime:
      $ref: 'TS29122_CommonData.yaml#/components/schemas/DateTime'
  required:
    - errorName
    - netSliceId
    - startTime
    - endTime

DataReport:
  description: >
    Represents the reported data.
  type: object
  properties:
    errorName:
      $ref: '#/components/schemas/Error'
    dataType:
      $ref: '#/components/schemas/DataType'
    dataOutput:
      $ref: 'TS29122_CommonData.yaml#/components/schemas/Bytes'
  required:
    - errorName
    - dataType
```

- dataOutput

# SIMPLE DATA TYPES  
#

#  
# ENUMERATIONS  
#

Error:

anyOf:

- type: string

enum:

- COMMUNICATION\_ERROR

- RTT\_ABOVE\_LIMIT

- QOS\_DOWNGRADE

- type: string

description: >

This string provides forward-compatibility with future extensions to the enumeration and is not used to encode content defined in the present version of this API.

description: |

Represents the errors causing service degradation.

Possible values are:

- COMMUNICATION\_ERROR: Indicates that the service degradation is due to a detected communication error.

- RTT\_ABOVE\_LIMIT: Indicates that the service degradation is due to the packet round trip time exceeding an upper threshold limit.

- QOS\_DOWNGRADE: Indicates that the service degradation is due to QoS being downgraded.

DataType:

anyOf:

- type: string

enum:

- UE\_DATA

- NETWORK\_DATA

- APPLICATION\_DATA

- type: string

description: >

This string provides forward-compatibility with future extensions to the enumeration and is not used to encode content defined in the present version of this API.

description: |

Represents the reported data type.

Possible values are:

- UE\_DATA: Indicates that the reported data type is UE data.

- NETWORK\_DATA: Indicates that the reported data type is Network data.

- APPLICATION\_DATA: Indicates that the reported data type is Application data.

## A.15 NSCE\_FaultDiagnosis API

openapi: 3.0.0

info:

```
title: NSCE Server Network Slice Fault Diagnosis Service
version: 1.0.0
description: |
  NSCE Server Network Slice Fault Diagnosis Service.
  © 2024, 3GPP Organizational Partners (ARIB, ATIS, CCSA, ETSI, TSDSI, TTA, TTC).
  All rights reserved.
```

externalDocs:

```
description: >
  3GPP TS 29.435 V18.1.0; Service Enabler Architecture Layer for Verticals (SEAL);
  Network Slice Capability Enablement (NSCE) Server Service(s); Stage 3.
url: https://www.3gpp.org/ftp/Specs/archive/29_series/29.435/
```

servers:

```
- url: '{apiRoot}/nsce-fd/v1'
  variables:
    apiRoot:
      default: https://example.com
      description: apiRoot as defined in clause 6.5 of 3GPP TS 29.549.
```

security:

```
- {}
- oAuth2ClientCredentials: []
```

paths:

```
/subscriptions:
  post:
    summary: Request the creation of a Network Slice Fault Diagnosis Subscription.
    operationId: CreateFaultDiagSubsc
    tags:
      - Network Slice Fault Diagnosis Subscriptions (Collection)
    requestBody:
      required: true
      content:
        application/json:
          schema:
            $ref: '#/components/schemas/FaultDiagSubsc'
    responses:
      '201':
        description: >
          Created. The Network Slice Fault Diagnosis Subscription is successfully created
          and a representation of the created Individual Network Slice Fault Diagnosis
          Subscription resource shall be returned.
        content:
          application/json:
            schema:
              $ref: '#/components/schemas/FaultDiagSubsc'
        headers:
          Location:
            description: >
              Contains the URI of the created Individual Network Slice Fault Diagnosis
              Subscription resource.
            required: true
            schema:
              type: string
      '400':
        $ref: 'TS29122_CommonData.yaml#/components/responses/400'
      '401':
        $ref: 'TS29122_CommonData.yaml#/components/responses/401'
      '403':
        $ref: 'TS29122_CommonData.yaml#/components/responses/403'
      '404':
        $ref: 'TS29122_CommonData.yaml#/components/responses/404'
      '411':
        $ref: 'TS29122_CommonData.yaml#/components/responses/411'
      '413':
        $ref: 'TS29122_CommonData.yaml#/components/responses/413'
      '415':
        $ref: 'TS29122_CommonData.yaml#/components/responses/415'
      '429':
        $ref: 'TS29122_CommonData.yaml#/components/responses/429'
      '500':
```

```

    $ref: 'TS29122_CommonData.yaml#/components/responses/500'
  '503':
    $ref: 'TS29122_CommonData.yaml#/components/responses/503'
  default:
    $ref: 'TS29122_CommonData.yaml#/components/responses/default'
callbacks:
  FaultDiagNotif:
    '{$request.body#/notifUri}':
      post:
        requestBody:
          required: true
          content:
            application/json:
              schema:
                $ref: '#/components/schemas/FaultDiagNotif'
        responses:
          '204':
            description: >
              No Content. The Network Slice Fault Diagnosis Notification is successfully
              received and acknowledged.
          '307':
            $ref: 'TS29122_CommonData.yaml#/components/responses/307'
          '308':
            $ref: 'TS29122_CommonData.yaml#/components/responses/308'
          '400':
            $ref: 'TS29122_CommonData.yaml#/components/responses/400'
          '401':
            $ref: 'TS29122_CommonData.yaml#/components/responses/401'
          '403':
            $ref: 'TS29122_CommonData.yaml#/components/responses/403'
          '404':
            $ref: 'TS29122_CommonData.yaml#/components/responses/404'
          '411':
            $ref: 'TS29122_CommonData.yaml#/components/responses/411'
          '413':
            $ref: 'TS29122_CommonData.yaml#/components/responses/413'
          '415':
            $ref: 'TS29122_CommonData.yaml#/components/responses/415'
          '429':
            $ref: 'TS29122_CommonData.yaml#/components/responses/429'
          '500':
            $ref: 'TS29122_CommonData.yaml#/components/responses/500'
          '503':
            $ref: 'TS29122_CommonData.yaml#/components/responses/503'
          default:
            $ref: 'TS29122_CommonData.yaml#/components/responses/default'

/subscriptions/{subscriptionId}:
  parameters:
    - name: subscriptionId
      in: path
      description: >
        Represents the identifier of the Individual Network Slice Fault Diagnosis
        Subscription resource.
      required: true
      schema:
        type: string

  get:
    summary: Retrieve an existing Individual Network Slice Fault Diagnosis Subscription resource.
    operationId: GetIndFaultDiagSubsc
    tags:
      - Individual Network Slice Fault Diagnosis Subscription (Document)
    responses:
      '200':
        description: >
          OK. The requested Individual Network Slice Fault Diagnosis Subscription resource shall
          be returned.
        content:
          application/json:
            schema:
              $ref: '#/components/schemas/FaultDiagSubsc'
      '307':
        $ref: 'TS29122_CommonData.yaml#/components/responses/307'
      '308':
        $ref: 'TS29122_CommonData.yaml#/components/responses/308'
      '400':
        $ref: 'TS29122_CommonData.yaml#/components/responses/400'

```

```
'401':
  $ref: 'TS29122_CommonData.yaml#/components/responses/401'
'403':
  $ref: 'TS29122_CommonData.yaml#/components/responses/403'
'404':
  $ref: 'TS29122_CommonData.yaml#/components/responses/404'
'406':
  $ref: 'TS29122_CommonData.yaml#/components/responses/406'
'429':
  $ref: 'TS29122_CommonData.yaml#/components/responses/429'
'500':
  $ref: 'TS29122_CommonData.yaml#/components/responses/500'
'503':
  $ref: 'TS29122_CommonData.yaml#/components/responses/503'
default:
  $ref: 'TS29122_CommonData.yaml#/components/responses/default'
```

put:

summary: Request the fully update of an existing Individual Network Slice Fault Diagnosis Subscription resource.

operationId: UpdateIndFaultDiagSubsc

tags:

- Individual Network Slice Fault Diagnosis Subscription (Document)

requestBody:

required: true

content:

application/json:

schema:

\$ref: '#/components/schemas/FaultDiagSubsc'

responses:

'200':

description: >

OK. The Individual Network Slice Fault Diagnosis Subscription resource is successfully updated and a representation of the updated resource shall be returned in the response body.

content:

application/json:

schema:

\$ref: '#/components/schemas/FaultDiagSubsc'

'204':

description: >

No Content. The Individual Network Slice Fault Diagnosis Subscription resource is successfully updated and no content is returned in the response body.

'307':

\$ref: 'TS29122\_CommonData.yaml#/components/responses/307'

'308':

\$ref: 'TS29122\_CommonData.yaml#/components/responses/308'

'400':

\$ref: 'TS29122\_CommonData.yaml#/components/responses/400'

'401':

\$ref: 'TS29122\_CommonData.yaml#/components/responses/401'

'403':

\$ref: 'TS29122\_CommonData.yaml#/components/responses/403'

'404':

\$ref: 'TS29122\_CommonData.yaml#/components/responses/404'

'411':

\$ref: 'TS29122\_CommonData.yaml#/components/responses/411'

'413':

\$ref: 'TS29122\_CommonData.yaml#/components/responses/413'

'415':

\$ref: 'TS29122\_CommonData.yaml#/components/responses/415'

'429':

\$ref: 'TS29122\_CommonData.yaml#/components/responses/429'

'500':

\$ref: 'TS29122\_CommonData.yaml#/components/responses/500'

'503':

\$ref: 'TS29122\_CommonData.yaml#/components/responses/503'

default:

\$ref: 'TS29122\_CommonData.yaml#/components/responses/default'

patch:

summary: Request the partially update of an existing Individual Network Slice Fault Diagnosis Subscription resource.

operationId: ModifyIndFaultDiagSubsc

tags:

- Individual Network Slice Fault Diagnosis Subscription (Document)

requestBody:

required: true

```

content:
  application/merge-patch+json:
    schema:
      $ref: '#/components/schemas/FaultDiagSubscPatch'
responses:
  '200':
    description: >
      OK. The Individual Network Slice Fault Diagnosis Subscription resource is
      successfully modified and a representation of the updated resource shall be returned
      in the response body.
    content:
      application/json:
        schema:
          $ref: '#/components/schemas/FaultDiagSubsc'
  '204':
    description: >
      No Content. The Individual Network Slice Fault Diagnosis Subscription resource is
      successfully modified and no content is returned in the response body.
  '307':
    $ref: 'TS29122_CommonData.yaml#/components/responses/307'
  '308':
    $ref: 'TS29122_CommonData.yaml#/components/responses/308'
  '400':
    $ref: 'TS29122_CommonData.yaml#/components/responses/400'
  '401':
    $ref: 'TS29122_CommonData.yaml#/components/responses/401'
  '403':
    $ref: 'TS29122_CommonData.yaml#/components/responses/403'
  '404':
    $ref: 'TS29122_CommonData.yaml#/components/responses/404'
  '411':
    $ref: 'TS29122_CommonData.yaml#/components/responses/411'
  '413':
    $ref: 'TS29122_CommonData.yaml#/components/responses/413'
  '415':
    $ref: 'TS29122_CommonData.yaml#/components/responses/415'
  '429':
    $ref: 'TS29122_CommonData.yaml#/components/responses/429'
  '500':
    $ref: 'TS29122_CommonData.yaml#/components/responses/500'
  '503':
    $ref: 'TS29122_CommonData.yaml#/components/responses/503'
  default:
    $ref: 'TS29122_CommonData.yaml#/components/responses/default'

delete:
  summary: Request the deletion of an existing Individual Network Slice Fault Diagnosis
  Subscription resource.
  operationId: DeleteIndFaultDiagSubsc
  tags:
    - Individual Network Slice Fault Diagnosis Subscription (Document)
  responses:
    '204':
      description: >
        No Content. The Individual Network Slice Fault Diagnosis Subscription resource is
        successfully deleted.
    '307':
      $ref: 'TS29122_CommonData.yaml#/components/responses/307'
    '308':
      $ref: 'TS29122_CommonData.yaml#/components/responses/308'
    '400':
      $ref: 'TS29122_CommonData.yaml#/components/responses/400'
    '401':
      $ref: 'TS29122_CommonData.yaml#/components/responses/401'
    '403':
      $ref: 'TS29122_CommonData.yaml#/components/responses/403'
    '404':
      $ref: 'TS29122_CommonData.yaml#/components/responses/404'
    '429':
      $ref: 'TS29122_CommonData.yaml#/components/responses/429'
    '500':
      $ref: 'TS29122_CommonData.yaml#/components/responses/500'
    '503':
      $ref: 'TS29122_CommonData.yaml#/components/responses/503'
    default:
      $ref: 'TS29122_CommonData.yaml#/components/responses/default'

```

```
components:
  securitySchemes:
    oAuth2ClientCredentials:
      type: oauth2
      flows:
        clientCredentials:
          tokenUrl: '{tokenUrl}'
          scopes: {}

  schemas:

#
# STRUCTURED DATA TYPES
#

FaultDiagSubsc:
  type: object
  description: Represents a Network Slice Fault Diagnosis subscription.
  properties:
    notifUri:
      $ref: 'TS29122_CommonData.yaml#/components/schemas/Uri'
    valServId:
      type: string
      description: >
        Contains the identifier of the VAL Service to which the fault diagnosis is related.
    valUeIds:
      type: array
      items:
        type: string
      description: >
        Contains the list of the identifier(s) of the VAL UE(s) to which the subscription
        is related.
      minItems: 1
    faultDiagInfo:
      type: array
      items:
        $ref: '#/components/schemas/FaultDiagInformation'
      description: Contains the fault diagnosis information.
      minItems: 1
    netSliceIds:
      type: array
      items:
        $ref: 'TS29435_NSCE_PolicyManagement.yaml#/components/schemas/NetSliceId'
      description: Contains the identifier(s) of the network slice to be monitored.
      minItems: 1
    suppFeat:
      $ref: 'TS29571_CommonData.yaml#/components/schemas/SupportedFeatures'
  required:
    - notifUri
    - valServId

FaultDiagSubscPatch:
  type: object
  description: >
    Represents the requested modifications to a Network Slice Fault Diagnosis subscription.
  properties:
    notifUri:
      $ref: 'TS29122_CommonData.yaml#/components/schemas/Uri'
    faultDiagInfo:
      type: array
      items:
        $ref: '#/components/schemas/FaultDiagInformation'
      description: Contains the updated fault diagnosis information.
      minItems: 1
    valUeIds:
      type: array
      items:
        type: string
      description: >
        Contains the list of the identifier(s) of the VAL UE(s) to which the subscription
        is related.
      minItems: 1
    netSliceIds:
      type: array
      items:
        $ref: 'TS29435_NSCE_PolicyManagement.yaml#/components/schemas/NetSliceId'
      description: Contains the updated identifier(s) of the network slice to be monitored.
      minItems: 1
```

```
FaultDiagNotif:
  type: object
  description: Represents a Network Slice Fault Diagnosis notification.
  properties:
    subscriptionId:
      type: string
      description: >
        Contains the identifier of the subscription to which the Network Slice Fault
        Diagnosis Notification is related.
    faultRep:
      $ref: '#/components/schemas/FaultReportInfo'
  required:
    - subscriptionId
    - faultRep

FaultReportInfo:
  type: object
  description: Represents the report of the fault diagnosis.
  properties:
    corelAlarm:
      type: array
      items:
        $ref: '#/components/schemas/CorrelatedAlarm'
      description: >
        Contains the list of the correlated alarms.
      minItems: 1
  required:
    - corelAlarm

CorrelatedAlarm:
  type: object
  description: Represents the correlated alarm information.
  properties:
    alarmType:
      $ref: '#/components/schemas/AlarmType'
    priority:
      $ref: '#/components/schemas/Priority'
    rootCause:
      type: boolean
      description: Indicates whether the event is the root cause of the events.
  required:
    - alarmType

FaultDiagInformation:
  type: object
  description: Represents the fault diagnosis information.
  properties:
    monitorTime:
      $ref: 'TS29122_CommonData.yaml#/components/schemas/TimeWindow'
    alarmType:
      $ref: '#/components/schemas/AlarmType'

#
# ENUMERATIONS
#

AlarmType:
  anyOf:
    - type: string
      enum:
        - COMMUNICATIONS_ALARM
        - PROCESSING_ERROR_ALARM
        - ENVIRONMENTAL_ALARM
        - QUALITY_OF_SERVICE_ALARM
        - EQUIPMENT_ALARM
        - INTEGRITY_VIOLATION
    - type: string
      description: >
        This string provides forward-compatibility with future extensions to the enumeration
        and is not used to encode content defined in the present version of this API.
  description: |
    Represents the alarm type(s).
    Possible values are:
    - COMMUNICATIONS_ALARM: An alarm associated with the procedures and/or processes required
      to convey information from one point to another.
    - PROCESSING_ERROR_ALARM: An alarm associated with a software or processing fault.
    - ENVIRONMENTAL_ALARM: An alarm associated with a condition relating to an enclosure in
```



which the equipment resides.

- QUALITY\_OF\_SERVICE\_ALARM: An alarm associated with a degradation in the quality of a service.
- EQUIPMENT\_ALARM: An alarm associated with an equipment fault.
- INTEGRITY\_VIOLATION: An indication that information may have been illegally modified, inserted or deleted.

Priority:

anyOf:

- type: string
- enum:
  - CRITICAL
  - MAJOR
  - MINOR
  - IGNORE
- type: string

description: >

This string provides forward-compatibility with future extensions to the enumeration and is not used to encode content defined in the present version of this API.

description: |

Represents the prioritization of the fault associated with the correlated alarm. Possible values are:

- CRITICAL: Indicates the prioritization of the fault is critical.
- MAJOR: Indicates the prioritization of the fault is major.
- MINOR: Indicates the prioritization of the fault is minor.
- IGNORE: Indicates the prioritization of the fault is ignore.

---

## A.16 NSCE\_SliceReqVerifyAndAlign API

openapi: 3.0.0

info:

title: NSCE Server Network Slice Requirements Verification and Alignment Service  
 version: 1.0.0  
 description: |  
 NSCE Server Network Slice Requirements Verification and Alignment Service.  
 © 2024, 3GPP Organizational Partners (ARIB, ATIS, CCSA, ETSI, TSDSI, TTA, TTC).  
 All rights reserved.

externalDocs:

description: >  
 3GPP TS 29.435 V18.1.0; Service Enabler Architecture Layer for Verticals (SEAL);  
 Network Slice Capability Enablement (NSCE) Server Service(s); Stage 3.  
 url: [https://www.3gpp.org/ftp/Specs/archive/29\\_series/29.435/](https://www.3gpp.org/ftp/Specs/archive/29_series/29.435/)

servers:

- url: '{apiRoot}/nsce-srva/v1'

variables:

apiRoot:

- default: <https://example.com>
- description: apiRoot as defined in clause 6.5 of 3GPP TS 29.549.

security:

- {}
- oAuth2ClientCredentials: []

paths:

/subscriptions:

post:

summary: Request the creation of a Network Slice Requirements Verification and Alignment Subscription.

operationId: CreateSliceReqVerAlignSubsc

tags:

- Network Slice Requirements Verification and Alignment Subscriptions (Collection)

requestBody:

- required: true
- content:
  - application/json:
    - schema:
      - \$ref: '#/components/schemas/SliceReqVerAlignSubsc'

responses:

'201':

description: >

Created. The Network Slice Requirements Verification and Alignment Subscription

```

    is successfully created and a representation of the created Individual Network
    Slice Requirements Verification and Alignment Subscription resource shall be returned.
  content:
    application/json:
      schema:
        $ref: '#/components/schemas/SliceReqVerAlignSubsc'
  headers:
    Location:
      description: >
        Contains the URI of the created Individual Network Slice Requirements Verification
        and Alignment Subscription resource.
      required: true
      schema:
        type: string
'400':
  $ref: 'TS29122_CommonData.yaml#/components/responses/400'
'401':
  $ref: 'TS29122_CommonData.yaml#/components/responses/401'
'403':
  $ref: 'TS29122_CommonData.yaml#/components/responses/403'
'404':
  $ref: 'TS29122_CommonData.yaml#/components/responses/404'
'411':
  $ref: 'TS29122_CommonData.yaml#/components/responses/411'
'413':
  $ref: 'TS29122_CommonData.yaml#/components/responses/413'
'415':
  $ref: 'TS29122_CommonData.yaml#/components/responses/415'
'429':
  $ref: 'TS29122_CommonData.yaml#/components/responses/429'
'500':
  $ref: 'TS29122_CommonData.yaml#/components/responses/500'
'503':
  $ref: 'TS29122_CommonData.yaml#/components/responses/503'
default:
  $ref: 'TS29122_CommonData.yaml#/components/responses/default'
callbacks:
  SliceReqVerAlignNotif:
    '{$request.body#/notifUri}':
      post:
        requestBody:
          required: true
          content:
            application/json:
              schema:
                $ref: '#/components/schemas/SliceReqVerAlignNotif'
  responses:
    '204':
      description: >
        No Content. The Network Slice Requirements Verification and Alignment
        Notification is successfully received and acknowledged.
    '307':
      $ref: 'TS29122_CommonData.yaml#/components/responses/307'
    '308':
      $ref: 'TS29122_CommonData.yaml#/components/responses/308'
    '400':
      $ref: 'TS29122_CommonData.yaml#/components/responses/400'
    '401':
      $ref: 'TS29122_CommonData.yaml#/components/responses/401'
    '403':
      $ref: 'TS29122_CommonData.yaml#/components/responses/403'
    '404':
      $ref: 'TS29122_CommonData.yaml#/components/responses/404'
    '411':
      $ref: 'TS29122_CommonData.yaml#/components/responses/411'
    '413':
      $ref: 'TS29122_CommonData.yaml#/components/responses/413'
    '415':
      $ref: 'TS29122_CommonData.yaml#/components/responses/415'
    '429':
      $ref: 'TS29122_CommonData.yaml#/components/responses/429'
    '500':
      $ref: 'TS29122_CommonData.yaml#/components/responses/500'
    '503':
      $ref: 'TS29122_CommonData.yaml#/components/responses/503'
    default:
      $ref: 'TS29122_CommonData.yaml#/components/responses/default'

```

```

/subscriptions/{subscriptionId}:
  parameters:
    - name: subscriptionId
      in: path
      description: >
        Represents the identifier of the Individual Network Slice Requirements Verification
        and Alignment Subscription resource.
      required: true
      schema:
        type: string

  get:
    summary: Retrieve an existing Individual Network Slice Requirements Verification and Alignment
    Subscription resource.
    operationId: GetIndSliceReqVerAlignSubsc
    tags:
      - Individual Network Slice Requirements Verification and Alignment Subscription (Document)
    responses:
      '200':
        description: >
          OK. The requested Individual Network Slice Requirements Verification and Alignment
          Subscription resource shall be returned.
        content:
          application/json:
            schema:
              $ref: '#/components/schemas/SliceReqVerAlignSubsc'
      '307':
        $ref: 'TS29122_CommonData.yaml#/components/responses/307'
      '308':
        $ref: 'TS29122_CommonData.yaml#/components/responses/308'
      '400':
        $ref: 'TS29122_CommonData.yaml#/components/responses/400'
      '401':
        $ref: 'TS29122_CommonData.yaml#/components/responses/401'
      '403':
        $ref: 'TS29122_CommonData.yaml#/components/responses/403'
      '404':
        $ref: 'TS29122_CommonData.yaml#/components/responses/404'
      '406':
        $ref: 'TS29122_CommonData.yaml#/components/responses/406'
      '429':
        $ref: 'TS29122_CommonData.yaml#/components/responses/429'
      '500':
        $ref: 'TS29122_CommonData.yaml#/components/responses/500'
      '503':
        $ref: 'TS29122_CommonData.yaml#/components/responses/503'
      default:
        $ref: 'TS29122_CommonData.yaml#/components/responses/default'

  put:
    summary: Request the update of an existing Individual Network Slice Requirements Verification
    and Alignment Subscription resource.
    operationId: UpdateIndSliceReqVerAlignSubsc
    tags:
      - Individual Network Slice Requirements Verification and Alignment Subscription (Document)
    requestBody:
      required: true
      content:
        application/json:
          schema:
            $ref: '#/components/schemas/SliceReqVerAlignSubsc'
    responses:
      '200':
        description: >
          OK. The Individual Network Slice Requirements Verification and Alignment Subscription
          resource is successfully updated and a representation of the updated resource shall
          be returned in the response body.
        content:
          application/json:
            schema:
              $ref: '#/components/schemas/SliceReqVerAlignSubsc'
      '204':
        description: >
          No Content. The Individual Network Slice Requirements Verification and Alignment
          Subscription resource is successfully updated and no content is returned in the
          response body.
      '307':
        $ref: 'TS29122_CommonData.yaml#/components/responses/307'

```

```

'308':
  $ref: 'TS29122_CommonData.yaml#/components/responses/308'
'400':
  $ref: 'TS29122_CommonData.yaml#/components/responses/400'
'401':
  $ref: 'TS29122_CommonData.yaml#/components/responses/401'
'403':
  $ref: 'TS29122_CommonData.yaml#/components/responses/403'
'404':
  $ref: 'TS29122_CommonData.yaml#/components/responses/404'
'411':
  $ref: 'TS29122_CommonData.yaml#/components/responses/411'
'413':
  $ref: 'TS29122_CommonData.yaml#/components/responses/413'
'415':
  $ref: 'TS29122_CommonData.yaml#/components/responses/415'
'429':
  $ref: 'TS29122_CommonData.yaml#/components/responses/429'
'500':
  $ref: 'TS29122_CommonData.yaml#/components/responses/500'
'503':
  $ref: 'TS29122_CommonData.yaml#/components/responses/503'
default:
  $ref: 'TS29122_CommonData.yaml#/components/responses/default'

```

patch:

```

summary: Request the modification of an existing Individual Network Slice Requirements
Verification and Alignment Subscription resource.
operationId: ModifyIndSliceReqVerAlignSubsc
tags:
  - Individual Network Slice Requirements Verification and Alignment Subscription (Document)
requestBody:
  required: true
  content:
    application/merge-patch+json:
      schema:
        $ref: '#/components/schemas/SliceReqVerAlignSubscPatch'
responses:
'200':
  description: >
    OK. The Individual Network Slice Requirements Verification and Alignment Subscription
    resource is successfully modified and a representation of the updated resource shall
    be returned in the response body.
  content:
    application/json:
      schema:
        $ref: '#/components/schemas/SliceReqVerAlignSubsc'
'204':
  description: >
    No Content. The Individual Network Slice Requirements Verification and Alignment
    Subscription resource is successfully modified and no content is returned in the
    response body.
'307':
  $ref: 'TS29122_CommonData.yaml#/components/responses/307'
'308':
  $ref: 'TS29122_CommonData.yaml#/components/responses/308'
'400':
  $ref: 'TS29122_CommonData.yaml#/components/responses/400'
'401':
  $ref: 'TS29122_CommonData.yaml#/components/responses/401'
'403':
  $ref: 'TS29122_CommonData.yaml#/components/responses/403'
'404':
  $ref: 'TS29122_CommonData.yaml#/components/responses/404'
'411':
  $ref: 'TS29122_CommonData.yaml#/components/responses/411'
'413':
  $ref: 'TS29122_CommonData.yaml#/components/responses/413'
'415':
  $ref: 'TS29122_CommonData.yaml#/components/responses/415'
'429':
  $ref: 'TS29122_CommonData.yaml#/components/responses/429'
'500':
  $ref: 'TS29122_CommonData.yaml#/components/responses/500'
'503':
  $ref: 'TS29122_CommonData.yaml#/components/responses/503'
default:
  $ref: 'TS29122_CommonData.yaml#/components/responses/default'

```

```

delete:
  summary: Request the deletion of an existing Individual Network Slice Requirements
Verification and Alignment Subscription resource.
  operationId: DeleteIndSliceReqVerAlignSubsc
  tags:
    - Individual Network Slice Requirements Verification and Alignment Subscription (Document)
  responses:
    '204':
      description: >
        No Content. The Individual Network Slice Requirements Verification and Alignment
        Subscription resource is successfully deleted.
    '307':
      $ref: 'TS29122_CommonData.yaml#/components/responses/307'
    '308':
      $ref: 'TS29122_CommonData.yaml#/components/responses/308'
    '400':
      $ref: 'TS29122_CommonData.yaml#/components/responses/400'
    '401':
      $ref: 'TS29122_CommonData.yaml#/components/responses/401'
    '403':
      $ref: 'TS29122_CommonData.yaml#/components/responses/403'
    '404':
      $ref: 'TS29122_CommonData.yaml#/components/responses/404'
    '429':
      $ref: 'TS29122_CommonData.yaml#/components/responses/429'
    '500':
      $ref: 'TS29122_CommonData.yaml#/components/responses/500'
    '503':
      $ref: 'TS29122_CommonData.yaml#/components/responses/503'
  default:
    $ref: 'TS29122_CommonData.yaml#/components/responses/default'

```

```

components:
  securitySchemes:
    oAuth2ClientCredentials:
      type: oauth2
      flows:
        clientCredentials:
          tokenUrl: '{tokenUrl}'
          scopes: {}

```

```
schemas:
```

```

#
# STRUCTURED DATA TYPES
#

```

```

SliceReqVerAlignSubsc:
  type: object
  description: >
    Represents a Network Slice Requirements Verification and Alignment subscription.
  properties:
    notifUri:
      $ref: 'TS29122_CommonData.yaml#/components/schemas/Uri'
    valServId:
      type: string
      description: >
        Contains the identifier of the VAL Service to which the requirement request is related.
    valUeIds:
      type: array
      items:
        type: string
      description: >
        Contains the list of the identifier(s) of the VAL UE(s) to which the subscription
        is related.
      minItems: 1
    sliceReq:
      type: array
      items:
        $ref: 'TS28541_SliceNrm.yaml#/components/schemas/ServiceProfile'
      description: >
        Contains the list of the slice requirements which need to be verified and aligned.
      minItems: 1
    netSliceId:
      $ref: 'TS29435_NSCE_PolicyManagement.yaml#/components/schemas/NetSliceId'
    suppFeat:

```

```

    $ref: 'TS29571_CommonData.yaml#/components/schemas/SupportedFeatures'
  required:
  - notifUri
  - valServId
  - sliceReq
  - netSliceId

SliceReqVerAlignSubscPatch:
  type: object
  description: >
    Represents the requested modifications to a Network Slice Requirements Verification
    and Alignment subscription.
  properties:
    notifUri:
      $ref: 'TS29122_CommonData.yaml#/components/schemas/Uri'
    valUeIds:
      type: array
      items:
        type: string
      description: >
        Contains the updated list of the identifier(s) of the VAL UE(s) to which the
        subscription is related.
      minItems: 1
    sliceReq:
      type: array
      items:
        $ref: 'TS28541_SliceNrm.yaml#/components/schemas/ServiceProfile'
      minItems: 1
      description: >
        Contains the updated list of the slice requirements which need to be verified and
        aligned.
    netSliceId:
      $ref: 'TS29435_NSCE_PolicyManagement.yaml#/components/schemas/NetSliceId'

SliceReqVerAlignNotif:
  type: object
  description: >
    Represents a Network Slice Requirements Verification and Alignment notification.
  properties:
    subscriptionId:
      type: string
      description: >
        Contains the identifier of the subscription to which the Network Slice Requirements
        Verification and Alignment Notification is related.
    sliceReqInfo:
      type: array
      items:
        $ref: 'TS28541_SliceNrm.yaml#/components/schemas/ServiceProfile'
      minItems: 1
      description: >
        Contains the information of the updated slice requirements (i.e., parameters and
        characteristics).
  required:
  - subscriptionId
  - sliceReqInfo

#
# ENUMERATIONS
#

```

---

## A.17 NSCE\_NSInfoDelivery API

openapi: 3.0.0

info:

```

title: NSCE Server Network Slice Information Delivery Service
version: 1.0.0
description: |
  NSCE Server Network Slice Information Delivery Service.
  © 2024, 3GPP Organizational Partners (ARIB, ATIS, CCSA, ETSI, TSDSI, TTA, TTC).
  All rights reserved.

```

```

externalDocs:
  description: >

```

3GPP TS 29.435 V18.1.0; Service Enabler Architecture Layer for Verticals (SEAL);  
 Network Slice Capability Enablement (NSCE) Server Service(s); Stage 3.  
 url: [https://www.3gpp.org/ftp/Specs/archive/29\\_series/29.435/](https://www.3gpp.org/ftp/Specs/archive/29_series/29.435/)

## servers:

```
- url: '{apiRoot}/nsce-nsid/v1'
  variables:
    apiRoot:
      default: https://example.com
      description: apiRoot as defined in clause 6.5 of 3GPP TS 29.549
```

## security:

```
- {}
- oAuth2ClientCredentials: []
```

## paths:

```
/slice-info-sets:
  get:
    summary: Request the retrieval of Network Slice Information.
    operationId: RetrieveNetSliceInfo
    tags:
      - Network Slice Information Sets (Collection)
    parameters:
      - name: val-serv-id
        in: query
        description: Contains the identifier of the targeted VAL service.
        required: true
        schema:
          type: string
      - name: req-slice-info
        in: query
        description: Contains the requested Network Slice Information type(s).
        required: false
        schema:
          type: array
          items:
            $ref: '#/components/schemas/ReqSliceInfo'
            minItems: 1
      - name: supp-feats
        in: query
        description: >
          Contains the list of supported features among the ones defined in clause 6.16.8.
          This query parameter shall be present only when feature negotiation needs to take
          place.
        required: false
        schema:
          $ref: 'TS29571_CommonData.yaml#/components/schemas/SupportedFeatures'
    responses:
      '200':
        description: >
          OK. The representation(s) of the "Individual Network Slice Information Set" resource(s)
          corresponding to the requested Network Slice Information shall be returned.
        content:
          application/json:
            schema:
              $ref: '#/components/schemas/NSInfoRetResp'
      '307':
        $ref: 'TS29122_CommonData.yaml#/components/responses/307'
      '308':
        $ref: 'TS29122_CommonData.yaml#/components/responses/308'
      '400':
        $ref: 'TS29122_CommonData.yaml#/components/responses/400'
      '401':
        $ref: 'TS29122_CommonData.yaml#/components/responses/401'
      '403':
        $ref: 'TS29122_CommonData.yaml#/components/responses/403'
      '404':
        $ref: 'TS29122_CommonData.yaml#/components/responses/404'
      '406':
        $ref: 'TS29122_CommonData.yaml#/components/responses/406'
      '429':
        $ref: 'TS29122_CommonData.yaml#/components/responses/429'
      '500':
        $ref: 'TS29122_CommonData.yaml#/components/responses/500'
      '503':
        $ref: 'TS29122_CommonData.yaml#/components/responses/503'
    default:
      $ref: 'TS29122_CommonData.yaml#/components/responses/default'
```

```

/slice-info-sets/deliver:
  post:
    summary: Enables to request Network Slice Information delivery to another entity.
    operationId: DeliverNetSliceInfo
    tags:
      - Network Slice Information Delivery
    requestBody:
      required: true
      content:
        application/json:
          schema:
            $ref: '#/components/schemas/NSInfoDelReq'
    responses:
      '204':
        description: >
          No Content. The Network Slice Information delivery request is successfully received,
          processed and completed.
      '307':
        $ref: 'TS29122_CommonData.yaml#/components/responses/307'
      '308':
        $ref: 'TS29122_CommonData.yaml#/components/responses/308'
      '400':
        $ref: 'TS29122_CommonData.yaml#/components/responses/400'
      '401':
        $ref: 'TS29122_CommonData.yaml#/components/responses/401'
      '403':
        $ref: 'TS29122_CommonData.yaml#/components/responses/403'
      '404':
        $ref: 'TS29122_CommonData.yaml#/components/responses/404'
      '411':
        $ref: 'TS29122_CommonData.yaml#/components/responses/411'
      '413':
        $ref: 'TS29122_CommonData.yaml#/components/responses/413'
      '415':
        $ref: 'TS29122_CommonData.yaml#/components/responses/415'
      '429':
        $ref: 'TS29122_CommonData.yaml#/components/responses/429'
      '500':
        $ref: 'TS29122_CommonData.yaml#/components/responses/500'
      '503':
        $ref: 'TS29122_CommonData.yaml#/components/responses/503'
      default:
        $ref: 'TS29122_CommonData.yaml#/components/responses/default'

```

```

components:
  securitySchemes:
    oAuth2ClientCredentials:
      type: oauth2
      flows:
        clientCredentials:
          tokenUrl: '{tokenUrl}'
          scopes: {}

```

```
schemas:
```

```

#
# STRUCTURED DATA TYPES
#

```

```

NSInfoRetResp:
  description: >
    Represents a Network Slice Information Retrieval response.
  type: object
  properties:
    sliceInfo:
      $ref: '#/components/schemas/NSInfoSet'
  required:
    - sliceInfo

```

```

NSInfoDelReq:
  description: >
    Represents a Network Slice Information Delivery request.
  type: object
  properties:
    valServId:
      type: string

```



```

    valUeIds:
      type: array
      items:
        type: string
      minItems: 1
    reqSliceInfo:
      type: array
      items:
        $ref: '#/components/schemas/ReqSliceInfo'
      minItems: 1
    suppFeat:
      $ref: 'TS29571_CommonData.yaml#/components/schemas/SupportedFeatures'
  required:
    - valServId
    - valUeIds

NSInfoSet:
  description: >
    Represents a Network Slice Information Set.
  type: object
  properties:
    snssai:
      $ref: 'TS29571_CommonData.yaml#/components/schemas/Snssai'
    sst:
      $ref: 'TS29571_CommonData.yaml#/components/schemas/Uinteger'
    sliceCovArea:
      $ref: '#/components/schemas/ServArea'
  anyOf:
    - required: [snssai]
    - required: [sst]
    - required: [sliceCovArea]

ServArea:
  description: >
    Represents the network Slice Coverage Area.
  type: object
  properties:
    tais:
      type: array
      items:
        $ref: 'TS29571_CommonData.yaml#/components/schemas/Tai'
      minItems: 1
    geoAreas:
      type: array
      items:
        $ref: 'TS29572_Nlmf_Location.yaml#/components/schemas/GeographicArea'
      minItems: 1
  anyOf:
    - required: [tais]
    - required: [geoAreas]

```

```

# SIMPLE DATA TYPES
#

```

```

#
# ENUMERATIONS
#

```

```

ReqSliceInfo:
  anyOf:
    - type: string
      enum:
        - SNSSAI
        - SST
        - SLICE_COV_AREA
    - type: string
      description: >
        This string provides forward-compatibility with future extensions to the enumeration
        and is not used to encode content defined in the present version of this API.
  description: |
    Represents the requested Network Slice Information type.
    Possible values are:
    - SNSSAI: Indicates that the requested Network Slice Information is the S-NSSAI.
    - SST: Indicates that the requested Network Slice Information is the SST.
    - SLICE_COV_AREA: Indicates that the requested Network Slice Information is the Slice
      Coverage Area.

```

## A.18 NSCE\_NSAllocation API

openapi: 3.0.0

info:

```
title: NSCE Server Network Slice Allocation Service
version: 1.0.0
description: |
  NSCE Server Network Slice Allocation Service.
  © 2024, 3GPP Organizational Partners (ARIB, ATIS, CCSA, ETSI, TSDSI, TTA, TTC).
  All rights reserved.
```

externalDocs:

```
description: >
  3GPP TS 29.435 V18.1.0; Service Enabler Architecture Layer for Verticals (SEAL);
  Network Slice Capability Enablement (NSCE) Server Service(s); Stage 3.
url: https://www.3gpp.org/ftp/Specs/archive/29_series/29.435/
```

servers:

```
- url: '{apiRoot}/nsce-nsa/v1'
  variables:
    apiRoot:
      default: https://example.com
      description: apiRoot as defined in clause 6.5 of 3GPP TS 29.549
```

security:

```
- {}
- oAuth2ClientCredentials: []
```

paths:

```
/request:
  post:
    summary: Request network slice allocation.
    operationId: RequestNSAllocation
    tags:
      - Network Slice Allocation Request
    requestBody:
      required: true
      content:
        application/json:
          schema:
            $ref: '#/components/schemas/NwSliceAllocReq'
    responses:
      '200':
        description: >
          The network slice allocation request is successful received and processed
          and the requested network slice allocation information shall be returned in the
          response body.
        content:
          application/json:
            schema:
              type: array
              items:
                $ref: '#/components/schemas/NwSliceAllocResp'
              minItems: 1
      '307':
        $ref: 'TS29122_CommonData.yaml#/components/responses/307'
      '308':
        $ref: 'TS29122_CommonData.yaml#/components/responses/308'
      '400':
        $ref: 'TS29122_CommonData.yaml#/components/responses/400'
      '401':
        $ref: 'TS29122_CommonData.yaml#/components/responses/401'
      '403':
        $ref: 'TS29122_CommonData.yaml#/components/responses/403'
      '404':
        $ref: 'TS29122_CommonData.yaml#/components/responses/404'
      '411':
        $ref: 'TS29122_CommonData.yaml#/components/responses/411'
      '413':
        $ref: 'TS29122_CommonData.yaml#/components/responses/413'
      '415':
        $ref: 'TS29122_CommonData.yaml#/components/responses/415'
      '429':
        $ref: 'TS29122_CommonData.yaml#/components/responses/429'
      '500':
        $ref: 'TS29122_CommonData.yaml#/components/responses/500'
```

```
'503':
  $ref: 'TS29122_CommonData.yaml#/components/responses/503'
default:
  $ref: 'TS29122_CommonData.yaml#/components/responses/default'

components:
  securitySchemes:
    oAuth2ClientCredentials:
      type: oauth2
      flows:
        clientCredentials:
          tokenUrl: '{tokenUrl}'
          scopes: {}

  schemas:

#
# STRUCTURED DATA TYPES
#

NwSliceAllocReq:
  description: >
    Represents the network slice allocation request.
  type: object
  properties:
    valServiceId:
      type: string
      description: Represents the VAL service identifier.
    valUeIds:
      type: array
      items:
        type: string
      minItems: 1
      description: Represents the list of VAL UEs ID.
    locArea:
      $ref: 'TS29435_NSCE_NSInfoDelivery.yaml#/components/schemas/ServArea'
    sliceId:
      $ref: 'TS29435_NSCE_PolicyManagement.yaml#/components/schemas/NetSliceId'
    nwSliceServProf:
      $ref: 'TS28541_SliceNrm.yaml#/components/schemas/ServiceProfile'
    suppFeat:
      $ref: 'TS29571_CommonData.yaml#/components/schemas/SupportedFeatures'
  required:
    - valServiceId
    - locArea

NwSliceAllocResp:
  description: >
    Represents the network slice allocation information.
  type: object
  properties:
    snssai:
      $ref: 'TS29571_CommonData.yaml#/components/schemas/Snssai'
    nwSliceServProf:
      $ref: 'TS28541_SliceNrm.yaml#/components/schemas/ServiceProfile'
    suppFeat:
      $ref: 'TS29571_CommonData.yaml#/components/schemas/SupportedFeatures'
  required:
    - snssai
    - nwSliceServProf
```

---

## Annex B (informative): Withdrawn API versions

### B.1 General

This Annex lists withdrawn API versions of the APIs defined in the present specification. clause 4.3.1.6 of 3GPP TS 29.501 [3] describes the withdrawal of API versions.

---

### B.2 NSCE\_SliceApiManagement API

The API versions listed in table B.2-1 are withdrawn for the NSCE\_SliceApiManagement API.

**Table B.2-1: Withdrawn API versions of the NSCE\_SliceApiManagement service**

API version number	Remarks

---

### B.3 NSCE\_NetSliceLifeCycleMngt API

The API versions listed in table B.3-1 are withdrawn for the NSCE\_NetSliceLifeCycleMngt API.

**Table B.3-1: Withdrawn API versions of the NSCE\_NetSliceLifeCycleMngt service**

API version number	Remarks

---

### B.4 NSCE\_PolicyManagement API

The API versions listed in table B.4-1 are withdrawn for the NSCE\_PolicyManagement API.

**Table B.4-1: Withdrawn API versions of the NSCE\_PolicyManagement service**

API version number	Remarks

---

### B.5 NSCE\_NSOptimization API

The API versions listed in table B.5-1 are withdrawn for the NSCE\_NSOptimization API.

**Table B.5-1: Withdrawn API versions of the NSCE\_NSOptimization service**

API version number	Remarks

---

## B.6 NSCE\_ManagementServiceDiscovery API

The API versions listed in table B.6-1 are withdrawn for the NSCE\_ManagementServiceDiscovery API.

**Table B.6-1: Withdrawn API versions of the NSCE\_ManagementServiceDiscovery service**

API version number	Remarks

---

## B.7 NSCE\_PerfMonitoring API

The API versions listed in table B.7-1 are withdrawn for the NSCE\_PerfMonitoring API.

**Table B.7-1: Withdrawn API versions of the NSCE\_PerfMonitoring service**

API version number	Remarks

---

## B.8 NSCE\_InfoCollection API

The API versions listed in table B.2-1 are withdrawn for the NSCE\_InfoCollection API.

**Table B.8-1: Withdrawn API versions of the NSCE\_InfoCollection service**

API version number	Remarks

---

## B.9 NSCE\_ServiceContinuity API

The API versions listed in table B.9-1 are withdrawn for the NSCE\_ServiceContinuity API.

**Table B.9-1: Withdrawn API versions of the NSCE\_ServiceContinuity service**

API version number	Remarks

---

## B.10 NSCE\_MultiSlicesOptimization API

The API versions listed in table B.10-1 are withdrawn for the NSCE\_MultiSlicesOptimization API.

**Table B.10-1: Withdrawn API versions of the NSCE\_MultiSlicesOptimization service**

API version number	Remarks

---

## B.11 NSCE\_NetworkSliceAdaptation API

The API versions listed in table B.11-1 are withdrawn for the NSCE\_NetworkSliceAdaptation API.

**Table B.11-1: Withdrawn API versions of the NSCE\_NetworkSliceAdaptation service**

API version number	Remarks

## B.12 NSCE\_SliceCommService API

The API versions listed in table B.12-1 are withdrawn for the NSCE\_SliceCommService API.

**Table B.12-1: Withdrawn API versions of the NSCE\_SliceCommService service**

API version number	Remarks

## B.13 NSCE\_InterPLMNContinuity API

The API versions listed in table B.13-1 are withdrawn for the NSCE\_InterPLMNContinuity API.

**Table B.13-1: Withdrawn API versions of the NSCE\_InterPLMNContinuity service**

API version number	Remarks

## B.14 NSCE\_NSDDiagnostics API

The API versions listed in table B.14-1 are withdrawn for the NSCE\_NSDDiagnostics API.

**Table B.14-1: Withdrawn API versions of the NSCE\_NSDDiagnostics service**

API version number	Remarks

## B.15 NSCE\_FaultDiagnosis API

The API versions listed in table B.15-1 are withdrawn for the NSCE\_FaultDiagnosis API.

**Table B.15-1: Withdrawn API versions of the NSCE\_FaultDiagnosis service**

API version number	Remarks

## B.16 NSCE\_SliceReqVerifyAndAlign API

The API versions listed in table B.16-1 are withdrawn for the NSCE\_SliceReqVerifyAndAlign API.

**Table B.16-1: Withdrawn API versions of the NSCE\_SliceReqVerifyAndAlign service**

API version number	Remarks

---

## B.17 NSCE\_NSInfoDelivery API

The API versions listed in table B.17-1 are withdrawn for the NSCE\_NSInfoDelivery API.

**Table B.17-1: Withdrawn API versions of the NSCE\_NSInfoDelivery service**

API version number	Remarks

---

## B.18 NSCE\_NSAllocation API

The API versions listed in table B.18-1 are withdrawn for the NSCE\_NSAllocation API.

**Table B.18-1: Withdrawn API versions of the NSCE\_NSAllocation service**

API version number	Remarks

## Annex C (informative): Change history

Change history							
Date	Meeting	TDoc	CR	Rev	Cat	Subject/Comment	New version
2023-11	CT3#131	C3-235391				TS Skeleton	0.0.0
2023-12	CT3#131	C3-235577				Version agreed via email approval. Inclusion of C3-235550, C3-235551, C3-235578, C3-235579, C3-235580, C3-235630, C3-235631, C3-235632	0.1.1
2024-01	CT3#132e	C3-240153				Version agreed via email approval. Inclusion of C3-240176, C3-240177, C3-240178, C3-240179, C3-240185, C3-240186, C3-240187, C3-240188, C3-240189, C3-240191, C3-240192, C3-240193, C3-240194, C3-240195, C3-240196, C3-240231, C3-240233, C3-240240, C3-240250, C3-240251.	0.2.0
2024-03	CT3#133	C3-241656				Version agreed via email approval. Inclusion of C3-241229, C3-241230, C3-241231, C3-241232, C3-241325, C3-241327, C3-241329, C3-241535, C3-241536, C3-241693, C3-241694, C3-241722.	0.3.0
2024-03	CT#103	CP-240282				Presentation to TSG CT for approval.	1.0.0
2024-03	CT#103	CP-240282				Approved by TSG CT.	18.0.0
2024-06	CT#104	CP-241089	0009		F	Corrections to NSCE_FaultDiagnosis API	18.1.0
2024-06	CT#104	CP-241089	0010		F	Corrections to NSCE_InfoCollection API	18.1.0
2024-06	CT#104	CP-241089	0011		F	Corrections to NSCE_NSOptimization API	18.1.0
2024-06	CT#104	CP-241089	0012		F	Corrections to NSCE_PerfMonitoring API	18.1.0
2024-06	CT#104	CP-241089	0013		F	Corrections to NSCE_PolicyManagement API	18.1.0
2024-06	CT#104	CP-241089	0014		F	Corrections to NSCE_SliceCommService API	18.1.0
2024-06	CT#104	CP-241089	0015	1	F	Corrections to NSCE_SliceReqVerifyAndAlign API	18.1.0
2024-06	CT#104	CP-241089	0016	1	F	Correction of the full name of NSCE	18.1.0
2024-06	CT#104	CP-241089	0017	1	B	Definition of service operation clause of the NSCE_ServiceContinuity API	18.1.0
2024-06	CT#104	CP-241089	0018	1	B	Definition of the API clause of the NSCE_ServiceContinuity API	18.1.0
2024-06	CT#104	CP-241090	0019	2	F	Definition of the OpenAPI file of the NSCE_ServiceContinuity API	18.1.0
2024-06	CT#104	CP-241089	0020	2	F	Support of Fault diagnosis information	18.1.0
2024-06	CT#104	CP-241089	0021		F	Various corrections	18.1.0
2024-06	CT#104	CP-241089	0022	1	F	Correct the reference number for TS 29.122 in some occurrences in the TS	18.1.0
2024-06	CT#104	CP-241089	0023	2	F	Updates to the definition of the NSCE_NetSliceLifeCycleMngt API	18.1.0
2024-06	CT#104	CP-241089	0024	1	F	Remove duplicated 5.11.2.2.1 and void 6.17	18.1.0
2024-06	CT#104	CP-241089	0025		F	Corrections to Notifications	18.1.0
2024-06	CT#104	CP-241089	0027		F	Correction of service name for NSCE_NetSliceLifeCycleMngt	18.1.0
2024-06	CT#104	CP-241089	0028		F	Correction of service name for NSCE_NSAllocation	18.1.0
2024-06	CT#104	CP-241089	0030		F	Corrections to the data structures in the response body.	18.1.0
2024-06	CT#104	CP-241090	0031		F	EN resolutions within NSCE_NSAllocation API	18.1.0
2024-06	CT#104	CP-241090	0032		F	Corrections to NSCE_InfoCollection data model and open API	18.1.0
2024-06	CT#104	CP-241090	0033	1	F	Corrections to NSCE_InterPLMNContinuity data model and open API	18.1.0
2024-06	CT#104	CP-241090	0034		F	Corrections to NSCE_NetSliceLifeCycleMngt data model	18.1.0
2024-06	CT#104	CP-241090	0035		F	Corrections to NetworkSliceAdaptation data model and open API	18.1.0
2024-06	CT#104	CP-241090	0036		F	Corrections to NSCE_PolicyManagement data model and open API	18.1.0
2024-06	CT#104	CP-241090	0037	1	B	Corrections of Overview and Reference	18.1.0
2024-06	CT#104	CP-241090	0039	1	F	Various essential corrections	18.1.0
2024-06	CT#104	CP-241257	0040	2	B	Update on NSCE_NetSliceLifeCycleMngt API	18.1.0
2024-06	CT#104	CP-241258	0041	2	B	Update on NSCE_ManagementServiceDiscovery API	18.1.0
2024-06	CT#104	CP-241085	0042		F	Update of info and externalDocs fields	18.1.0
2024-07	CT#104					Correction to fix OpenAPI parsing errors	18.1.1
2024-09	CT#105	CP-242130	0044		F	Corrections to the NSCE_PolicyManagement API definition	18.2.0
2024-09	CT#105	CP-242130	0045	1	F	Corrections to the NSCE_InfoCollection API definition	18.2.0
2024-09	CT#105	CP-242130	0046	1	F	Corrections to the NSCE_ServiceContinuity API definition	18.2.0
2024-09	CT#105	CP-242130	0047		F	Corrections to the NSCE_SliceReqVerifyAndAlign API definition	18.2.0
2024-09	CT#105	CP-242130	0048		F	Corrections to the NSCE_NSAllocation API definition	18.2.0
2024-09	CT#105	CP-242130	0049		F	Corrections to the NSCE_NetSliceLifeCycleMngt API definition	18.2.0
2024-09	CT#105	CP-242120	0050		F	Update of info and externalDocs fields	18.2.0



---

# History

<b>Document history</b>		
V18.0.0	May 2024	Publication
V18.1.1	August 2024	Publication
V18.2.0	September 2024	Publication