

ETSI TS 129 468 V18.0.0 (2024-05)



**Universal Mobile Telecommunications System (UMTS);
LTE;
Group Communication System Enablers for LTE (GCSE_LTE);
MB2 reference point;
Stage 3
(3GPP TS 29.468 version 18.0.0 Release 18)**



Reference

RTS/TSGC-0329468v100

Keywords

LTE,UMTS

ETSI

650 Route des Lucioles
F-06921 Sophia Antipolis Cedex - FRANCE

Tel.: +33 4 92 94 42 00 Fax: +33 4 93 65 47 16

Siret N° 348 623 562 00017 - APE 7112B
Association à but non lucratif enregistrée à la
Sous-Préfecture de Grasse (06) N° w061004871

Important notice

The present document can be downloaded from:

<https://www.etsi.org/standards-search>

The present document may be made available in electronic versions and/or in print. The content of any electronic and/or print versions of the present document shall not be modified without the prior written authorization of ETSI. In case of any existing or perceived difference in contents between such versions and/or in print, the prevailing version of an ETSI deliverable is the one made publicly available in PDF format at www.etsi.org/deliver.

Users of the present document should be aware that the document may be subject to revision or change of status.

Information on the current status of this and other ETSI documents is available at

<https://portal.etsi.org/TB/ETSIDeliverableStatus.aspx>

If you find errors in the present document, please send your comment to one of the following services:

<https://portal.etsi.org/People/CommitteeSupportStaff.aspx>

If you find a security vulnerability in the present document, please report it through our
Coordinated Vulnerability Disclosure Program:

<https://www.etsi.org/standards/coordinated-vulnerability-disclosure>

Notice of disclaimer & limitation of liability

The information provided in the present deliverable is directed solely to professionals who have the appropriate degree of experience to understand and interpret its content in accordance with generally accepted engineering or other professional standard and applicable regulations.

No recommendation as to products and services or vendors is made or should be implied.

No representation or warranty is made that this deliverable is technically accurate or sufficient or conforms to any law and/or governmental rule and/or regulation and further, no representation or warranty is made of merchantability or fitness for any particular purpose or against infringement of intellectual property rights.

In no event shall ETSI be held liable for loss of profits or any other incidental or consequential damages.

Any software contained in this deliverable is provided "AS IS" with no warranties, express or implied, including but not limited to, the warranties of merchantability, fitness for a particular purpose and non-infringement of intellectual property rights and ETSI shall not be held liable in any event for any damages whatsoever (including, without limitation, damages for loss of profits, business interruption, loss of information, or any other pecuniary loss) arising out of or related to the use of or inability to use the software.

Copyright Notification

No part may be reproduced or utilized in any form or by any means, electronic or mechanical, including photocopying and microfilm except as authorized by written permission of ETSI.

The content of the PDF version shall not be modified without the written authorization of ETSI.

The copyright and the foregoing restriction extend to reproduction in all media.

© ETSI 2024.
All rights reserved.

Intellectual Property Rights

Essential patents

IPRs essential or potentially essential to normative deliverables may have been declared to ETSI. The declarations pertaining to these essential IPRs, if any, are publicly available for **ETSI members and non-members**, and can be found in ETSI SR 000 314: "*Intellectual Property Rights (IPRs); Essential, or potentially Essential, IPRs notified to ETSI in respect of ETSI standards*", which is available from the ETSI Secretariat. Latest updates are available on the ETSI Web server (<https://ipr.etsi.org/>).

Pursuant to the ETSI Directives including the ETSI IPR Policy, no investigation regarding the essentiality of IPRs, including IPR searches, has been carried out by ETSI. No guarantee can be given as to the existence of other IPRs not referenced in ETSI SR 000 314 (or the updates on the ETSI Web server) which are, or may be, or may become, essential to the present document.

Trademarks

The present document may include trademarks and/or tradenames which are asserted and/or registered by their owners. ETSI claims no ownership of these except for any which are indicated as being the property of ETSI, and conveys no right to use or reproduce any trademark and/or tradename. Mention of those trademarks in the present document does not constitute an endorsement by ETSI of products, services or organizations associated with those trademarks.

DECT™, **PLUGTESTS™**, **UMTS™** and the ETSI logo are trademarks of ETSI registered for the benefit of its Members. **3GPP™** and **LTE™** are trademarks of ETSI registered for the benefit of its Members and of the 3GPP Organizational Partners. **oneM2M™** logo is a trademark of ETSI registered for the benefit of its Members and of the oneM2M Partners. **GSM®** and the GSM logo are trademarks registered and owned by the GSM Association.

Legal Notice

This Technical Specification (TS) has been produced by ETSI 3rd Generation Partnership Project (3GPP).

The present document may refer to technical specifications or reports using their 3GPP identities. These shall be interpreted as being references to the corresponding ETSI deliverables.

The cross reference between 3GPP and ETSI identities can be found under <https://webapp.etsi.org/key/queryform.asp>.

Modal verbs terminology

In the present document "**shall**", "**shall not**", "**should**", "**should not**", "**may**", "**need not**", "**will**", "**will not**", "**can**" and "**cannot**" are to be interpreted as described in clause 3.2 of the [ETSI Drafting Rules](#) (Verbal forms for the expression of provisions).

"**must**" and "**must not**" are **NOT** allowed in ETSI deliverables except when used in direct citation.

Contents

Intellectual Property Rights	2
Legal Notice	2
Modal verbs terminology.....	2
Foreword.....	6
1 Scope	7
2 References	7
3 Definitions, symbols and abbreviations	8
3.1 Definitions	8
3.2 Abbreviations	8
4 Architectural Overview	9
4.1 Reference Model	9
4.2 Functional Elements	9
4.2.1 Group Communication Service Application Server (GCS AS)	9
4.2.2 Broadcast-Multicast Service Centre (BM-SC).....	10
5 Procedures over the MB2 Reference Point	10
5.1 TMGI and Flow ID handling.....	10
5.2 TMGI Management	11
5.2.1 TMGI Allocation Procedure	11
5.2.2 TMGI Deallocation Procedure.....	11
5.2.3 TMGI Expiry Notification Procedure	12
5.3 MBMS Bearer Control Procedures	12
5.3.1 General.....	12
5.3.2 Activate MBMS Bearer Procedure	12
5.3.3 Deactivate MBMS Bearer Procedure.....	13
5.3.4 Modify MBMS Bearer Procedure.....	14
5.3.5 MBMS Bearer Status Indication Procedure.....	14
5.4 BM-SC selection	15
5.5 BM-SC overload control	15
5.6 Restoration Procedures	15
5.6.1 General.....	15
5.6.2 Restart Counter	15
5.6.3 GCS AS initiated Heartbeat Procedure	16
5.6.4 BM-SC initiated Heartbeat Procedure	16
5.6.5 GCS AS procedures after detection of BM-SC Restart	16
5.6.6 BM-SC procedures after detection of GCS AS Restart	16
5.6.7 GCS AS procedures upon detection of MB2-C path failure.....	16
5.6.8 BM-SC procedures upon detection of MB2-C path failure	16
6 MB2-C Protocol	17
6.1 Protocol support	17
6.1.1 Use of Diameter base protocol.....	17
6.1.2 Transport protocol	17
6.1.3 Advertising Application Support	17
6.2 Initialization and maintenance of connection and session.....	17
6.3 Security on the MB2-C interface.....	17
6.4 MB2-C specific AVPs.....	18
6.4.1 General.....	18
6.4.2 BMSC-Address AVP.....	19
6.4.3 BMSC-Port AVP	19
6.4.4 MBMS-Bearer-Event AVP.....	19
6.4.5 MBMS-Bearer-Event-Notification AVP	19
6.4.6 MBMS-Bearer-Request AVP	19
6.4.7 MBMS-Bearer-Response AVP	20

6.4.8	MBMS-Bearer-Result AVP	20
6.4.9	MBMS-Start-Time AVP	21
6.4.10	Radio-Frequency AVP	21
6.4.11	TMGI-Allocation-Request AVP	21
6.4.12	TMGI-Allocation-Response AVP	22
6.4.13	TMGI-Allocation-Result AVP	22
6.4.14	TMGI-Deallocation-Request AVP	22
6.4.15	TMGI-Deallocation-Response AVP	22
6.4.16	TMGI-Deallocation-Result AVP	23
6.4.17	TMGI-Expiry AVP	23
6.4.18	TMGI-Number AVP	23
6.4.19	MB2U-Security AVP	23
6.4.20	Local-M1-Information AVP	24
6.4.21	Local-MB2-U-Information AVP	24
6.4.22	MBMS-eNB-IP-Multicast-Address AVP	24
6.4.23	MBMS-eNB-IPv6-Multicast-Address AVP	24
6.4.24	MBMS-GW-SSM-IP-Address AVP	24
6.4.25	MBMS-GW-SSM-IPv6-Address AVP	24
6.4.26	Common-Tunnel-Endpoint-Identifier AVP	24
6.4.27	FEC-Request AVP	24
6.4.28	ROHC-Request AVP	25
6.4.29	ROHC-Full-Header-Periodicity AVP	25
6.4.30	ROHC-Profile AVP	25
6.4.31	Userplane-Protocol-Result AVP	25
6.4.32	ROHC-Result AVP	25
6.4.33	FEC-Result AVP	26
6.4.34	ROHC-Max-CID AVP	26
6.4.35	MBMS-Bearer-Event-Diagnostic-Info AVP	26
6.5	MB2-C re-used AVPs	27
6.5.1	General	27
6.5.2	Supported-Feature-List AVP	28
6.5.2.1	Use of the Supported-Features AVP	28
6.5.2.2	Supported-Feature-List AVP for the MB2-C application	29
6.6	MB2-C Messages	29
6.6.1	Command-Code Values	29
6.6.2	GCS-Action-Request (GAR) command	30
6.6.3	GCS-Action-Answer (GAA) command	30
6.6.4	GCS-Notification-Request (GNR) command	31
6.6.5	GCS-Notification-Answer (GNA) command	31
7	MB2-U Protocol	32
7.1	Protocol Stack	32
7.2	Procedures	33
Annex A (informative): Call Flows		35
A.1	TMGI Management	35
A.1.1	TMGI Allocation Procedure	35
A.1.2	TMGI Deallocation Procedure	35
A.1.3	TMGI Expiry Notification	36
A.2	MBMS Bearer Control Procedures	37
A.2.1	Activate MBMS Bearer Procedure	37
A.2.2	Deactivate MBMS Bearer Procedure	37
A.2.3	Modify MBMS Bearer Procedure	38
A.2.4	MBMS Bearer Status Indication Procedure	39
A.3	Restoration Procedures	40
A.3.1	GCS AS initiated Heartbeat Procedure	40
A.3.2	BM-SC initiated Heartbeat Procedure	40
Annex B (normative): Diameter message priority mechanism		41
B.1	General	41

B.2	MB2-C interface.....	41
B.2.1	General.....	41
B.2.2	GCS AS behaviour	41
B.2.3	BM-SC behaviour.....	41
C.1	General	42
C.2	GCS AS behaviour	42
C.3	BM-SC behaviour.....	42
Annex D (informative):	Change history	43
History		44

Foreword

This Technical Specification has been produced by the 3rd Generation Partnership Project (3GPP).

The contents of the present document are subject to continuing work within the TSG and may change following formal TSG approval. Should the TSG modify the contents of the present document, it will be re-released by the TSG with an identifying change of release date and an increase in version number as follows:

Version x.y.z

where:

- x the first digit:
 - 1 presented to TSG for information;
 - 2 presented to TSG for approval;
 - 3 or greater indicates TSG approved document under change control.
- Y the second digit is incremented for all changes of substance, i.e. technical enhancements, corrections, updates, etc.
- z the third digit is incremented when editorial only changes have been incorporated in the document.

1 Scope

This document defines the protocol for the MB2 reference point between the Group Communication Service Application Server (GCS AS) and the Broadcast-Multicast Service Centre (BM-SC).

The MB2 reference point and related stage 2 procedures are defined in TS 23.468 [4] as part of the Group Communication System Enablers for LTE. The stage 1 requirements for Group Communication System Enablers are specified in TS 22.468 [2].

2 References

The following documents contain provisions which, through reference in this text, constitute provisions of the present document.

- References are either specific (identified by date of publication, edition number, version number, etc.) or non-specific.
- For a specific reference, subsequent revisions do not apply.
- For a non-specific reference, the latest version applies. In the case of a reference to a 3GPP document (including a GSM document), a non-specific reference implicitly refers to the latest version of that document *in the same Release as the present document*.

- [1] 3GPP TR 21.905: "Vocabulary for 3GPP Specifications".
- [2] 3GPP TS 22.468: "Group Communication System(GCSE)".
- [3] 3GPP TS 23.246: "Multimedia Broadcast/Multicast Service (MBMS); Architecture and functional description".
- [4] 3GPP TS 23.468: "Group Communication System Enablers for LTE (GCSE_LTE); stage 2".
- [5] 3GPP TS 26.346: "Multimedia Broadcast/Multicast Service (MBMS); Protocols and codecs".
- [6] 3GPP TS 29.061: "Interworking between the Public Land Mobile Network (PLMN) supporting packet based services and Packet Data Networks (PDN)".
- [7] 3GPP TS 29.212: "Policy and Charging Control (PCC); Reference points".
- [8] 3GPP TS 29.274: "3GPP Evolved Packet System (EPS); Evolved General Packet Radio Service (GPRS) Tunnelling Protocol for Control plane (GTPv2-C); Stage 3".
- [9] 3GPP TS 29.281: "General Packet Radio System (GPRS) Tunnelling Protocol User Plane (GTPv1-U)".
- [10] 3GPP TS 33.246: "Security of Multimedia Broadcast/Multicast Service (MBMS)".
- [11] IETF RFC 791: "Transmission Control Protocol".
- [12] IETF RFC 768: "User Datagram Protocol".
- [13] IETF RFC 2234: "Augmented BNF for syntax specifications".
- [14] Void
- [15] IETF RFC 4960: "Stream Control Transmission Protocol".
- [16] IETF RFC 5719: "Updated IANA Considerations for Diameter Command Code Allocations".
- [17] IETF RFC 5996: "The Internet Key Exchange (IKE)".
- [18] IETF RFC 3947: "Negotiation of NAT-Traversal in the IKE".
- [19] IETF RFC 3948: "UDP Encapsulation of IPsec ESP Packets".

- [20] IETF RFC 4303: "IP Encapsulating Security Payload (ESP)".
- [21] IETF RFC 6347: "Datagram Transport Layer Security Version 1.2".#
- [22] 3GPP TS 23.007: "Restoration procedures".
- [23] 3GPP TS 29.229: "Cx and Dx interfaces based on the Diameter protocol".
- [24] 3GPP TS 36.300: "E-UTRA and E-UTRAN overall description; Stage 2".
- [25] IETF RFC 7944: "Diameter Routing Message Priority".
- [26] IETF RFC 8583: "Diameter Load Information Conveyance".
- [27] IETF RFC 6733: "Diameter Base Protocol".
- [28] 3GPP TS 23.285: "Architecture Enhancements for V2X services".
- [29] IETF RFC 5795: "The Robust Header Compression (ROHC) Framework".
- [30] IETF RFC 3095, "Robust Header Compression (ROHC): Framework and four profiles: RTP, UDP, ESP, and uncompressed"
- [31] IETF RFC 6363: "Forward Error Correction (FEC) Framework,".
- [32] Void.
- [33] 3GPP TS 29.214: " Policy and Charging Control over Rx reference point".

3 Definitions, symbols and abbreviations

3.1 Definitions

For the purposes of the present document, the terms and definitions given in TR 21.905 [1] and the following apply:

MBMS bearer: The service provided by the EPS to deliver the same IP datagrams to multiple receivers in a designated location.

3.2 Abbreviations

For the purposes of the present document, the abbreviations given in TR 21.905 [1] and the following apply. An abbreviation defined in the present document takes precedence over the definition of the same abbreviation, if any, in TR 21.905 [1].

ARP	Allocation and Retention Priority
AVP	Attribute-Value Pair
BM-SC	Broadcast-Multicast Service Centre
DRMP	Diameter Routing Message Priority
DSCP	Differentiated Services Code Point
DTLS	Datagram Transport Layer Security
ESP	Encapsulating Security Payload
FEC	Forward Error Correction
GAA	GCS-Action-Answer
GAR	GCS-Action-Request
GCS	Group Communication Service
GCSE	Group Communication System Enablers
GCS AS	Group Communication Service Application Server
GNA	GCS-Notification-Answer
GNR	GCS-Notification-Request
MBMS-GW	MBMS Gateway

PCRF	Policy and Charging Rules Function
P-GW	PDN Gateway
ROHC	Robust Header Compression
TMGI	Temporary Mobile Group Identity
UDP	User Datagram Protocol
V2X	Vehicle-to-Everything

4 Architectural Overview

4.1 Reference Model

Figure 4.1-1 shows a high level reference model of the architectural elements relevant to understand the MB2 reference point. More complete reference models for GCSE are contained in TS 23.468 [4].

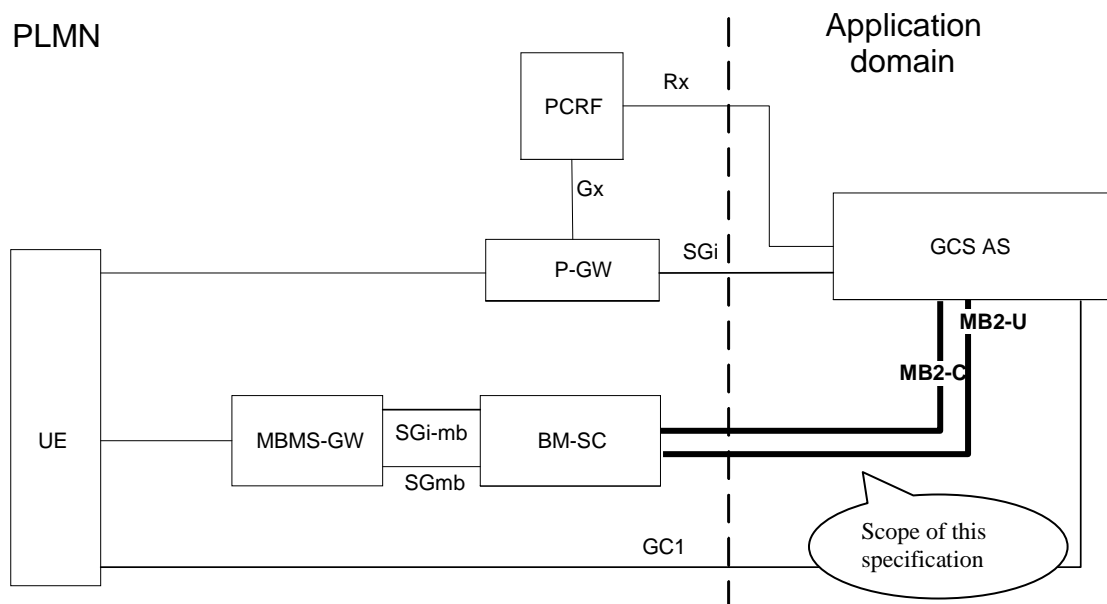

Figure 4.1-1: Reference Model

NOTE: The GC1 reference point between the UE and the GCS AS is unspecified in the present release. Data related to the GC1 reference point are transported via the Sgi reference point between GCS AS and P-GW.

For the V2X Localized User Plane supported feature, the reference model in Annex B.3 of 3GPP TS 23.285 [28] applies.

4.2 Functional Elements

4.2.1 Group Communication Service Application Server (GCS AS)

The GCS AS is defined in TS 23.468 [4] and supports the following functionality:

- Exchanging GC1 signalling with the UE.
- Receiving unicast uplink data from the UE via the SGi reference point.
- Delivery of data to all the UEs belonging to a group using unicast delivery over the SGi reference point and/or MBMS delivery over the MB2 reference point.
- Support for service continuity procedures for a UE to switch between unicast delivery and MBMS delivery.

- For MBMS delivery:
 - MB2-C procedures defined in TS 23.468 [4], for requesting the BM-SC to activate, deactivate, modify an MBMS bearer, allocate/deallocate TMGI.
 - Forwarding of data to be delivered via an MBMS bearer to the BM-SC via the MB2-U reference point.

In addition to the functions defined in 3GPP TS 23.468 [4], an GCS AS which acts as a V2X Application Server may support the following functions:

- For the V2X Localized User Plane supported feature, MB2-C procedures defined in 3GPP TS 23.285 [28] subclause 5.4.2.2 for requesting the BM-SC to activate an MBMS bearer for local MBMS based MBMS data delivery.

In addition to the functions defined in 3GPP TS 23.468 [4], an GCS AS may take further actions based on the MBMS bearer status and diagnostic information notified by the BM-SC in the MB2 reference point.

4.2.2 Broadcast-Multicast Service Centre (BM-SC)

The BM-SC is defined in TS 23.246 [3], with additions related to the MB2 reference point in TS 23.468 [4], and supports the following functionality:

- MBMS Broadcast Mode procedures defined in TS 23.246 [3] (stage 2) and in TS 29.061 [6] (stage 3).
- MB2-C procedures defined in TS 23.468 [4], for activating, deactivating, modifying an MBMS bearer, allocating/deallocating TMGI and notifying the TMGI expiry or the MBMS Bearer condition to GCS AS.
- SGmb procedures for controlling MBMS broadcast bearers defined in TS 29.061 [6].
- Reception of user data from the GCS AS via the MB2-U reference point and forwarding those data via the SGi-mb reference point as described in TS 29.061 [6].

In addition to the functions defined in 3GPP TS 23.468 [4], the BM-SC may support the following functions for V2X services:

- For the V2X Localized User Plane supported feature, MB2-C procedures defined in 3GPP TS 23.285 [28] subclause 5.4.2.2 for receiving Local MBMS information defined in 3GPP TS 23.285 [28] from an GCS AS which acts as a V2X Application Server.

In addition to the functions defined in 3GPP TS 23.468 [4], the BM-SC may notify the MBMS bearer status and diagnostic information to the GCS AS.

5 Procedures over the MB2 Reference Point

5.1 TMGI and Flow ID handling

The combination of TMGI and Flow Identifier shall uniquely identify an MBMS bearer. TMGI and Flow Identifier are defined in TS 23.246 [3].

A TMGI shall be assigned by the BM-SC upon request of the GCS AS. The BM-SC shall provide an expiration time for each assigned TMGI or group of TMGIs to the GCS AS. The BM-SC shall assign a TMGI, which is different from any other TMGI, which the BM-SC has previously assigned and for which the timer has not yet expired and there is no active MBMS broadcast bearer. The GCS AS may request the BM-SC to refresh the expiration timer for a TMGI. The BM-SC and GCS AS shall store the TMGI until the timer expires.

NOTE: As defined in TS 23.246 [3], TMGIs need to be globally unique. It is assumed that the BM-SC uses a configured range of TMGI values.

The BM-SC shall assign Flow Identifier values, which shall be unique for the corresponding TMGI. For each assigned TMGI, both BM-SC and GCS AS shall store all assigned Flow Identifiers until the expiry of the timer of the TMGI, or until GCS AS requests the deallocation of the TMGI.

5.2 TMGI Management

5.2.1 TMGI Allocation Procedure

The TMGI Allocation procedure may be used by the GCS AS to request a set of TMGIs, or to request the renewal of the expiration time for already allocated TMGIs.

To apply this procedure, the GCS AS shall send a GCS-Action-Request (GAR) command including the TMGI-Allocation-Request AVP. Within the TMGI-Allocation-Request AVP, the GCS AS shall indicate the number of requested new TMGIs, excluding any TMGIs for which only an expiration timer renewal is requested, in the TMGI-Number AVP, and may include within TMGI AVPs TMGIs that are already allocated to the GCS AS, and for which the GCS AS wishes to obtain a later expiration time. The number of TMGIs requested may be zero, if this procedure is used only to renew the expiration time for already allocated TMGIs.

Upon reception of a GCS-Action-Request (GAR) command including the TMGI-Allocation-Request AVP, the BM-SC shall determine whether the GCS AS is authorized to receive the requested TMGIs. If no Route-Record AVP(s) are present, the BM-SC shall derive the identity of the GCS AS from the Origin-Host AVP. If Route-Record AVP(s) are present, the BM-SC shall authorize the request if the identity within the first Route-Record AVP matches the GCS AS authorized to use the TMGIs. If the renewal of TMGIs has been requested, the BM-SC shall also determine whether the TMGIs are allocated to the requesting GCS AS and if yes, whether the renewal of TMGI expiration times is possible. The BM-SC shall also determine an expiration time, which shall be applicable for all new TMGIs and all TMGIs for which the timer was renewed.

NOTE 1: During the TMGI Allocation Procedure, the BM-SC does not activate MBMS. However TMGIs, for which the expiration time is renewed, may already have active MBMS bearers.

The BM-SC shall then send the GCS-Action-Answer (GAA) command including the TMGI-Allocation-Response AVP. For a successful TMGI allocation, the TMGI-Allocation-Response AVP shall include TMGI AVPs and the MBMS-Session-Duration AVP. The TMGI AVPs shall contain all successfully allocated or refreshed TMGIs and the MBMS-Session-Duration AVP shall indicate their common new expiration time. For an unsuccessful TMGI allocation request, the TMGI-Allocation-Response AVP shall include the TMGI-Allocation-Result AVP. For a partial success (i.e. if some, but not all of the requested TMGIs are allocated or timers refreshed), the TMGI-Allocation-Response AVP shall include the TMGI AVPs, the MBMS-Session-Duration AVP and the TMGI-Allocation-Result AVP. The TMGI AVPs shall contain all successfully allocated or refreshed TMGIs and the MBMS-Session-Duration AVP shall indicate their common new expiration time. The TMGI-Allocation-Result AVP shall indicate both success and the reason(s) why the allocation or refresh failed for some TMGIs.

5.2.2 TMGI Deallocation Procedure

The TMGI Deallocation procedure may be used by the GCS AS to immediately release a set of TMGIs, irrespective of their expiration times.

To apply this procedure, the GCS AS shall send a GCS-Action-Request (GAR) command including the TMGI-Deallocation-Request AVP. If the GCS AS desires to deallocate some, but not all currently allocated TMGIs, it shall include TMGI AVPs for all TMGIs that are to be deallocated within the TMGI-Deallocation-Request AVP. If the GCS AS desires to deallocate all currently allocated TMGIs, it shall not include TMGI AVPs within the TMGI-Deallocation-Request AVP.

Upon reception of a GCS-Action-Request (GAR) command including the TMGI-Deallocation-Request AVP, the BM-SC shall determine whether the GCS AS is authorized to deallocate the TMGIs. If no Route-Record AVP(s) are present, the BM-SC shall derive the identity of the GCS AS from the Origin-Host AVP. If Route-Record AVP(s) are present, the BM-SC shall authorize the request if the identity within the first Route-Record AVP matches the GCS AS authorized to use the TMGIs.

The BM-SC shall then send the GCS-Action-Answer (GAA) command and shall include a TMGI-Deallocation-Response AVP for each TMGI contained in the TMGI-Deallocation-Request AVP. Each

TMGI-Deallocation-Response AVP shall include the affected TMGI in the TMGI AVP. For an unsuccessful TMGI deallocation, the TMGI-Deallocation-Response AVP shall also include the TMGI-Deallocation-Result AVP.

When the GCS AS requests the deallocation of a TMGI with some related active MBMS bearers, the BM-SC shall terminate those bearer(s).

5.2.3 TMGI Expiry Notification Procedure

At timer expiry for a TMGI, the BM-SC shall notify the GCS AS by sending a GCS-Notification-Request (GNR) command including one TMGI-Expiry AVP.

If there are active MBMS bearer(s) related to an expiring TMGI, the BM-SC shall terminate those bearer(s) and shall notify the GCS AS about the bearer termination by including MBMS-Bearer-Event-Notification AVP(s) in the GNR in accordance with the MBMS Bearer Status Indication Procedure in clause 5.3.5.

5.3 MBMS Bearer Control Procedures

5.3.1 General

The GAR command described in subclauses 5.3.2, 5.3.3 and 5.3.4 may contain more than one MBMS-Bearer-Request AVPs requesting the activation, modification or deactivation of different MBMS bearers.

5.3.2 Activate MBMS Bearer Procedure

The Activate MBMS Bearer procedure may be used by the GCS AS to cause allocation of resources for MBMS bearer(s).

To apply this procedure, the GCS AS shall send a GCS-Action-Request (GAR) command including one MBMS-Bearer-Request AVP for each bearer that is to be activated. Within the MBMS-Bearer-Request AVP, the GCS AS shall include the MBMS-StartStop-Indication AVP set to "START" and the QoS-Information AVP, and the GCS AS may include the TMGI AVP, the MBMS-Start-Time AVP and the MB2U-Security AVP. If the MBMS Cell List feature is supported, the GCS AS shall also include the MBMS-Cell-List AVP, or the MBMS-Service-Area AVP, or both. If the MBMS Cell List feature is not supported, the GCS AS shall also include the MBMS-Service-Area AVP. If the GCS AS does not yet know whether the BM-SC supports the MBMS Cell List feature and includes the MBMS-Cell-List AVP, it shall also include the MBMS-Service-Area AVP.

If the V2X Localized User Plane feature is supported, the GCS AS may include the Local-M1-Information AVP and the Local-MB2-U-Information AVP within the MBMS-Bearer-Request AVP.

NOTE: The GCS AS can find out whether the BM-SC supports the MBMS Cell List feature and the V2X Localized User Plane feature prior to applying the Activate MBMS Bearer Procedure the first time by using the TMGI Allocation Procedure in advance.

If the GCS AS includes both the MBMS-Cell-List AVP and the MBMS-Service-Area AVP in the MBMS-Bearer-Request AVP, then the provided service areas shall be a complete set of the service areas that contains all the provided cells.

If the FEC feature is supported, the GCS AS may include the FEC-Request AVP in the MBMS-Bearer-Request AVP to request that BM-SC applies FEC (see IETF RFC 6363 [31]) to the downlink media streams within the MBMS bearer that are described by the FEC-Request AVP.

If the ROHC feature is supported, the GCS AS may include ROHC-Request AVP(s) together with ROHC-Max-CID AVP in the MBMS-Bearer-Request AVP to request that BM-SC applies ROHC (see IETF RFC 5795 [29] and IETF RFC 3095 [30]) to the downlink media streams within the MBMS bearer that are described by the ROHC-Request AVP(s).

Upon reception of a GCS-Action-Request (GAR) command including the MBMS-Bearer-Request AVP with the MBMS-StartStop-Indication AVP set to "START", the BM-SC shall determine whether the GCS AS is authorized to use the TMGI. If no Route-Record AVP(s) are present, the BM SC shall derive the identity of the GCS AS from the Origin Host AVP. If Route-Record AVP(s) are present, the BM SC shall authorize the request if the identity within the first Route-Record AVP matches the GCS AS authorized to use the TMGI. If the GCS AS is authorized to use the

TMGI, the BM-SC shall allocate MBMS resources to support content delivery of the MBMS bearer to the requested MBMS broadcast area (as described via the MBMS-Cell-List AVP and/or MBMS Service Area AVP) using the Session Start procedure defined in 3GPP TS 23.246 [3]. If an MBMS-Cell-List AVP but no MBMS Service Area AVP is included in the MBMS-Bearer-Request AVP, the BM-SC shall derive MBMS service areas from the cells in the MBMS-Cell-List AVP based on operator policy. If both an MBMS-Cell-List AVP and an MBMS-Service-Area AVP are included, the BM-SC shall either derive MBMS service areas from the cells in the MBMS-Cell-List AVP based on operator policy and ignore the information in the MBMS-Service-Area AVP, or directly provide the information received within the MBMS-Service-Area AVP in the Session Start procedure defined in 3GPP TS 23.246 [3]. If no TMGI AVP is included in the MBMS-Bearer-Request AVP, the BM-SC shall allocate a new TMGI. The BM-SC shall allocate a new Flow Identifier. The BM-SC shall decide whether to use MB2-U Security, and shall take into account related requests of the GCS AS, as received within the MB2U-Security AVP in the MBMS-Bearer-Request AVP.

If the new MBMS service area overlaps with the service area of any active bearer with the same TMGI, the BM-SC should reject the activation request with the result code "Overlapping-MBMS-Service-Area".

The BM-SC shall then send GCS-Action-Answer (GAA) command including an MBMS-Bearer-Response AVP. The BM-SC shall include an MBMS-Bearer-Response AVP for each MBMS-Bearer-Request AVP that was included in the GAR. The MBMS-Bearer-Response AVP shall be included in the same position in the GAA that the corresponding MBMS-Bearer-Request AVP had in the GAR.

For a successful MBMS bearer activation, the MBMS-Bearer-Response AVP shall include the TMGI AVP, the MBMS-Flow-Identifier AVP, the MBMS-Session-Duration AVP, the BMSC-Address AVP and BMSC-Port AVP, and may include Radio-Frequency AVP(s) as MBMS bearer related service description. If MB2-U Security is applied, the MBMS-Bearer-Response AVP shall also include the MB2U-Security AVP. If FEC and/or ROHC was requested the MBMS-Bearer-Response AVP shall also include Userplane-Protocol-Result AVP(s) indicating the success or failure of the FEC and/or RHC activation. If the BM-SC is configured to receive a delayed session start response from the MBMS GW as defined in 3GPP TS 29.061 [6], the BM-SC shall indicate that the bearer activation procedure is still in progress in the MBMS-Bearer-Result AVP. If the IPv4v6 feature is supported, the BM-SC IPv4 address and BM-SC IPv6 address may be both provided as the BMSC-Address AVP, otherwise only one BM-SC IP address may be provided as the BMSC-Address AVP.

If the V2X Localized User Plane feature is supported, and the Local-M1-Information AVP and Local-MB2-U-Information AVP are received from the GCS AS, and the BM-SC determines to use the local MBMS information, the BM-SC shall include the BMSC-Address AVP and the BMSC-Port with the IP address and port included in the received Local-MB2-U-Information AVP in the MBMS-Bearer-Response AVP. Otherwise, the BM-SC shall include the BMSC-Address AVP and the BMSC-Port with the IP address and port allocated by the BM-SC in the MBMS-Bearer-Response AVP. If the IPv4v6 feature is supported, the BM-SC IPv4 address and BM-SC IPv6 address may be both provided as the BMSC-Address AVP, otherwise only one BM-SC IP address may be provided as the BMSC-Address AVP.

5.3.3 Deactivate MBMS Bearer Procedure

The Deactivate MBMS Bearer procedure may be used by the GCS AS to cause deallocation of resources for MBMS bearer(s).

To apply this procedure, the GCS AS shall send a GCS-Action-Request (GAR) command including one MBMS-Bearer-Request AVP for each bearer that is to be deactivated. Within the MBMS-Bearer-Request AVP, the GCS AS shall include the MBMS-StartStop-Indication AVP set to "STOP", the TMGI AVP and the MBMS-Flow-Identifier AVP to designate the bearer to be deactivated.

Upon reception of a GCS-Action-Request (GAR) command including the MBMS-Bearer-Request AVP with MBMS-StartStop-Indication AVP set to "STOP", the BM-SC shall determine whether the GCS AS is authorized to use the TMGI. If no Route-Record AVP(s) are present, the BM-SC shall derive the identity of the GCS AS from the Origin-Host AVP. If Route-Record AVP(s) are present, the BM-SC shall authorize the request if the identity within the first Route-Record AVP matches the GCS AS authorized to use the TMGI. If the GCS AS is authorized to use the TMGI, the BM-SC shall stop the broadcast to the MBMS bearer identified by the TMGI AVP and the MBMS-Flow-Identifier AVP and shall deallocate MBMS resources used for the MBMS bearer using the Session Stop procedure defined in TS 23.246 [3].

The BM-SC shall then send GCS-Action-Answer (GAA) command including an MBMS-Bearer-Response AVP. The BM-SC shall include an MBMS-Bearer-Response AVP for each MBMS-Bearer-Request AVP that was included in the GAR. The MBMS-Bearer-Response AVP shall be included in the same position in the GAA that the corresponding

MBMS-Bearer-Request AVP had in the GAR. For a successful MBMS bearer deactivation, the MBMS-Bearer-Response AVP shall include the TMGI AVP and the MBMS-Flow-Identifier AVP.

5.3.4 Modify MBMS Bearer Procedure

The Modify MBMS Bearer procedure may be used by the GCS AS to cause modification of the priority and pre-emption values for an MBMS bearer, the MBMS broadcast area, or both.

To apply this procedure, the GCS AS shall send a GCS-Action-Request (GAR) command including one MBMS-Bearer-Request AVP for each bearer that is to be modified. Within the MBMS-Bearer-Request AVP, the GCS AS shall include The MBMS-StartStop-Indication AVP set to "UPDATE", the TMGI AVP and the MBMS-Flow-Identifier AVP to designate the bearer to be modified. The GCS AS may include the MBMS-Service-Area AVP, the QoS-Information AVP and/ or, if the MBMS Cell List feature is supported, the MBMS-Cell-List AVP. However, at least one of the MBMS-Service-Area AVP, the MBMS-Cell-List AVP and the QoS-Information AVP shall be included. The QoS-Information AVP shall only be used to modify the Allocation and Retention Priority (ARP), and shall otherwise indicate the same values that were supplied when the activation of the MBMS bearer was requested. If the GCS AS includes both the MBMS-Cell-List AVP and the MBMS Service Area AVP in the MBMS Bearer Request AVP, the provided service areas shall be a complete set of the service areas that contains all the provided cells.

If the FEC feature is supported, the GCS AS may include the FEC-Request AVP in the MBMS-Bearer-Request AVP to request that BM-SC applies FEC (see IETF RFC 6363 [31]) to the downlink media streams within the MBMS bearer that are described by the FEC-Request AVP.

If the ROHC feature is supported, the GCS AS may include ROHC-Request AVP(s) together with ROHC-Max-CID AVP in the MBMS-Bearer-Request AVP to request that BM-SC applies ROHC (see IETF RFC 5795 [29] and IETF RFC 3095 [30]) to the downlink media streams within the MBMS bearer that are described by the ROHC-Request AVP(s).

Upon reception of a GCS-Action-Request (GAR) command including the MBMS-Bearer-Request AVP with MBMS-StartStop-Indication AVP set to "UPDATE", the BM-SC shall determine whether the GCS AS is authorized to use the TMGI. If no Route-Record AVP(s) are present, the BM-SC shall derive the identity of the GCS AS from the Origin-Host AVP. If Route-Record AVP(s) are present, the BM-SC shall authorize the request if the identity within the first Route-Record AVP matches the GCS AS authorized to use the TMGI. If the GCS AS is authorized to use the TMGI, the BM-SC shall modify the characteristics of the MBMS bearer using the Session Update procedure defined in 3GPP TS 23.246 [3]. If an MBMS-Cell-List AVP but no MBMS Service Area AVP is included in the MBMS-Bearer-Request AVP, the BM-SC shall derive MBMS service areas from the cells in the MBMS-Cell-List AVP based on operator policy. If both an MBMS-Cell-List AVP and an MBMS-Service-Area AVP are included, the BM-SC shall either derive MBMS service areas from the cells in the MBMS-Cell-List AVP based on operator policy and ignore the information in the MBMS-Service-Area AVP, or directly provide the information received within the MBMS-Service-Area AVP in the Session Update procedure defined in 3GPP TS 23.246 [3].

If the MBMS broadcast area is being modified, the BM-SC shall ensure that the new MBMS broadcast area is not overlapping with the MBMS broadcast area of any other existing MBMS bearer(s) with the same TMGI, in accordance with TS 23.246 [3]. Otherwise, the BM-SC should reject the modification request with the result code Overlapping-MBMS-Service-Area.

The BM-SC shall then send the GCS-Action-Answer (GAA) command including an MBMS-Bearer-Response AVP. The BM-SC shall include an MBMS-Bearer-Response AVP for each MBMS-Bearer-Request AVP that was included in the GAR. The MBMS-Bearer-Response AVP shall be included in the same position in the GAA that the corresponding MBMS-Bearer-Request AVP had in the GAR. For a successful MBMS bearer modification, the MBMS-Bearer-Response AVP shall include the TMGI AVP and the MBMS-Flow-Identifier AVP, and may include Radio-Frequency AVP(s). If FEC and/or ROHC was requested the MBMS-Bearer-Response AVP shall also include Userplane-Protocol-Result AVP(s) indicating the success or failure of the FEC and/or RHC activation.

5.3.5 MBMS Bearer Status Indication Procedure

The BM-SC may use the MBMS Bearer Status Indication Procedure to notify the GCS AS of conditions affecting the delivery of services that use MBMS Delivery, for instance the termination of an MBMS bearer e.g. due to TMGI expiry or MBMS-GW error, MBMS bearer activation failure due to no established MBMS-GW, MBMS-GW transient error or SGmb path failure.

To apply this procedure, the BM-SC shall send a GCS-Notification-Request (GNR) command including one MBMS-Bearer-Event-Notification AVP for each bearer with an event to be notified. Within the MBMS-Bearer-Event-Notification AVP, the BM-SC shall indicate the bearer event using the MBMS-Bearer-Event AVP and shall include the TMGI AVP and the MBMS-Flow-Identifier AVP to designate the affected bearer, may also include the MBMS-Bearer-Event-Diagnostic-Info AVP to indicate the diagnostics reason of the event. If FEC and/or ROHC is applied the MBMS-Bearer-Event-Notification AVP may also include Userplane-Protocol-Result AVP(s) indicating the success or failure of the FEC and/or ROHC execution.

Upon reception of a GCS-Notification-Request (GNR), the GCS AS shall reply with a GCS-Notification-Answer (GNA) command and may take further actions for the affected bearer based on the notified different event and diagnostic information.

5.4 BM-SC selection

To discover the BM-SC with which to establish the MB2-C session, the GCS AS may use:

- a pre-configured BM-SC identity
- Diameter routing

5.5 BM-SC overload control

Upon receiving a request from the GCS AS, if the BM-SC is in an overload condition, the BM-SC may respond to the GCS AS with a GCS-Action-Answer command containing the Result-Code AVP with the value set to DIAMETER_TOO_BUSY, see IETF RFC 6733 [27].

The GCS AS may implement a back off timer. When this timer is running, the GCS AS does not initiate MB2-C requests. Once the timer expires, the GCS AS may re-attempt to use the BM-SC. The algorithm the BM-SC uses for the back off timer is out of scope of this 3GPP specification.

5.6 Restoration Procedures

5.6.1 General

The restoration procedures enable the BM-SC and GCS AS to detect an MB2-C path failure or the restart of the peer node, as specified in TS 23.007 [22].

The BM-SC and GCS AS shall detect an MB2-C path failure or the restart of the peer node as specified in TS 23.007 [22], i.e. either making use of mechanisms of the Diameter base protocol, or of the Heartbeat procedures and procedures related to the Restart-Counter AVP defined in clause 5.6. 2, 5.6.3 and 5.6.4. The Heartbeat procedure and the procedures related to the Restart-Counter AVP are optional to support for both BM-SC and GCS AS.

NOTE: In deployments with a Diameter Agent between the GCS AS and the BM-SC, the restoration mechanisms of the Diameter base protocol cannot be used.

The use of the Heartbeat procedure and the Restart-Counter AVP shall be negotiated between the BM-SC and GCS AS using the Supported-Features AVP upon contacting the peer node for the first time.

5.6.2 Restart Counter

The BM-SC shall maintain a local restart counter which shall be incremented monotonically whenever the BM-SC restarts with loss of previous states. After the BM-SC starts (or restarts with loss of previous states), it shall include the Restart-Counter AVP indicating the local value of its restart counter in the first message it sends to any peer GCS AS.

The GCS AS shall store the received restart counter value for each peer BM-SC it communicates with. If the new received restart counter value for a peer BM-SC is incremented, the BM-SC has restarted.

The GCS AS shall also maintain a local restart counter which shall be incremented monotonically whenever the GCS AS restarts with loss of previous states. After the GCS AS starts (or restarts with loss of previous states), it shall

include the Restart-Counter AVP indicating the local value of its restart counter in the first message it sends to any peer BM-SC.

The BM-SC shall store the received restart counter value for each peer GCS AS it communicates with. If the new received restart counter value for a peer GCS AS is incremented, the GCS AS has restarted

5.6.3 GCS AS initiated Heartbeat Procedure

To detect an MB2-C path failure or the outage or restart of a peer BM-SC, the GCS AS shall send GARs including the Restart-Counter AVP indicating the local value of its restart counter periodically to each peer BM-SC when no other signalling is exchanged between those two nodes. The GCS AS shall repeat sending the GAR one or more times if no GAA is received. The GCS AS shall consider the MB2-C path to be down if it does not receive a GAA to a configured number of consecutive GARs

If the BM-SC receives a GAR including the Restart-Counter AVP, it shall reply with a GAA including the Restart-Counter AVP indicating the local value of its restart counter.

5.6.4 BM-SC initiated Heartbeat Procedure

To detect an MB2-C path failure or the outage or restart of a peer GCS AS, the BM-SC shall send GNRs including the Restart-Counter AVP indicating the local value of its restart counter periodically to each peer GCS AS when no other signalling is exchanged between those two nodes. The BM-SC shall repeat sending the GNR one or more times if no GNA is received. The BM-SC shall consider the MB2-C path to be down if it does not receive a GNA to a configured number of consecutive GNRs .

If the GCS AS receives a GNR including the Restart-Counter AVP, it shall reply with a GNA including the Restart-Counter AVP indicating the local value of its restart counter.

5.6.5 GCS AS procedures after detection of BM-SC Restart

When the GCS AS detects that the the BM-SC has restarted, the GCS AS:

- shall assume that all the TMGIs that had been assigned by the restarted BM-SC have been de-allocated and that all the related MBMS bearers have been deactivated; and
- may restore the MBMS delivery.

5.6.6 BM-SC procedures after detection of GCS AS Restart

When the BM-SC detects that the GCS AS has restarted, the BM-SC:

- shall deallocate (locally) all the TMGIs that had been assigned to the GCS AS; and
- shall stop all the related MBMS bearers.

5.6.7 GCS AS procedures upon detection of MB2-C path failure

Upon detecting a non-transient MB2-C path failure, the GCS AS:

- shall assume that all the TMGIs that had been assigned by the BM-SC have been de-allocated and that all the related MBMS bearers have been deactivated; and
- may restore the MBMS delivery.

5.6.8 BM-SC procedures upon detection of MB2-C path failure

Upon detecting a non-transient MB2-C path failure, the BM-SC shall:

- deallocate (locally) all the TMGIs that had been assigned to the GCS AS; and
- stop all the related MBMS bearers.

6 MB2-C Protocol

6.1 Protocol support

6.1.1 Use of Diameter base protocol

The Diameter Base Protocol as specified in IETF RFC 6733 [27] shall apply except as modified by the defined support of the methods and the defined support of the commands and AVPs, result and error codes as specified in this specification. Unless otherwise specified, the procedures specified in IETF RFC 6733 [27] (including error handling and unrecognised information handling) shall be used unmodified. Only commands related to peer-to-peer connection are re-used from the Diameter Base Protocol, i.e. Capabilities-Exchange-Request (CER), Capabilities-Exchange-Answer (CEA), Disconnect-Peer-Request (DPR), Disconnect-Peer-Answer (DPA), Device-Watchdog-Request (DWR) and Device-Watchdog-Answer (DWA).

With regards to the Diameter protocol defined over the MB2-C interface, the BM-SC shall act as the Diameter server, in the sense that it is the network element that handles action requests and sends notifications. The GCS AS shall act as the Diameter client, in the sense that it is the network element requesting actions and handles notification from the BM-SC.

A Diameter routing table entry can have a different destination based on the application identifier of the command. The application identifier stored in the command header must match the value of any application identifier AVPs in the command body. Diameter agents (relay, proxy, redirection, translation agents) should use the application identifier in the command header to route to a suitable destination.

6.1.2 Transport protocol

Diameter messages over the MB2-C interface shall make use of SCTP (see IETF RFC 4960 [15]) or TCP (see IETF RFC 791 [11]).

6.1.3 Advertising Application Support

The Diameter application identifier assigned to the MB2-C interface application is 16777335.

The GCS AS and BM-SC shall advertise support of the Diameter MB2-C application by including the value of the MB2-C application identifier in the Auth-Application-Id AVP within the Vendor-Specific-Application-Id grouped AVP of the CER and CEA commands.

The vendor identifier value of 3GPP (10415) shall be included in the Supported-Vendor-Id AVP of the CER and CEA commands, and in the Vendor-Id AVP within the Vendor-Specific-Application-Id grouped AVP of the CER and CEA commands.

The Vendor-Id AVP included in CER and CEA commands that is not included in the Vendor-Specific-Application-Id AVPs as described above shall indicate the manufacturer of the Diameter node as per IETF RFC 6733 [27].

6.2 Initialization and maintenance of connection and session

A peer-to-peer connection is a connection between GCS AS and BM-SC. It has no associated meaning beyond this link. A MB2-C peer-to-peer connection may carry commands associated with multiple TMGIs and/or MBMS bearers.

A MB2-C Diameter session shall consist of a single request and answer pair. The MB2-C Diameter session is terminated after each request and answer pair interaction. In order to indicate that the session state is not to be maintained, the Diameter client and server shall include the Auth-Session-State AVP with the value set to NO_STATE_MAINTAINED (1), in the request and in the answer messages (see IETF RFC 6733 [27]).

6.3 Security on the MB2-C interface

The security mechanism in Annex N of TS 33.246 [10] shall apply.

6.4 MB2-C specific AVPs

6.4.1 General

Table 6.4.1-1 describes the Diameter AVPs defined for the MB2-C reference point, their AVP Code values, types and possible flag values. The Vendor-Id header of all AVPs defined in the present document shall be set to 3GPP (10415).

Table 6.4.1-1: MB2-C specific Diameter AVPs

Attribute Name	AVP Code	Clause defined	Value Type	AVP Flag rules (Note 1)				Applicability (Note 2)
				Must	May	Should not	Must not	
BMSC-Address	3500	6.4.2	Address	M,V	P			
BMSC-Port	3501	6.4.3	Unsigned32	M,V	P			
Common-Tunnel-Endpoint-Identifier	3524	6.4.26	OctetString	V	P		M	V2X Localized User Plane
FEC-Request	3525	6.4.27	OctetString	V	P		M	FEC
FEC-Result	3531	6.4.33	Unsigned32	V	P		M	FEC
Local-M1-Information	3518	6.4.20	Grouped	V	P		M	V2X Localized User Plane
Local-MB2-U-Information	3519	6.4.21	Grouped	V	P		M	V2X Localized User Plane
MB2U-Security	3517	6.4.19	Unsigned32	M,V	P			
MBMS-Bearer-Event	3502	6.4.4	Unsigned32	M,V	P			
MBMS-Bearer-Event-Diagnostic-Info	3533	6.4.35	Unsigned32	V	P		M	
MBMS-Bearer-Event-Notification	3503	6.4.5	Grouped	M,V	P			
MBMS-Bearer-Request	3504	6.4.6	Grouped	M,V	P			
MBMS-Bearer-Response	3505	6.4.7	Grouped	M,V	P			
MBMS-Bearer-Result	3506	6.4.8	Unsigned32	M,V	P			
MBMS-eNB-IP-Multicast-Address	3520	6.4.22	Address	V	P		M	V2X Localized User Plane
MBMS-eNB-IPv6-Multicast-Address	3521	6.4.23	Address	V	P		M	V2X Localized User Plane
MBMS-GW-SSM-IP-Address	3522	6.4.24	Address	V	P		M	V2X Localized User Plane
MBMS-GW-SSM-IPv6-Address	3523	6.4.25	Address	V	P		M	V2X Localized User Plane
MBMS-Start-Time	3507	6.4.9	Time	M,V	P			
Radio-Frequency	3508	6.4.10	Unsigned32	M,V	P			
ROHC-Full-Header-Periodicity	3527	6.4.29	Float32	V	P		M	ROHC
ROHC-Max-CID	3532	6.4.34	Unsigned32	V	P		M	ROHC
ROHC-Profile	3528	6.4.30	Unsigned32	V	P		M	ROHC
ROHC-Request	3526	6.4.28	Grouped	V	P		M	ROHC
ROHC-Result	3530	6.4.32	Unsigned32	V	P		M	ROHC
TMGI-Allocation-Request	3509	6.4.11	Grouped	M,V	P			
TMGI-Allocation-Response	3510	6.4.12	Grouped	M,V	P			
TMGI-Allocation-Result	3511	6.4.13	Unsigned32	M,V	P			
TMGI-Deallocation-Request	3512	6.4.14	Grouped	M,V	P			
TMGI-Deallocation-Response	3513	6.4.15	Grouped	M,V	P			
TMGI-Deallocation-Result	3514	6.4.16	Unsigned32	M,V	P			
TMGI-Expiry	3515	6.4.17	Grouped	M,V	P			
TMGI-Number	3516	6.4.18	Unsigned32	M,V	P			
Userplane-Protocol-Result	3529	6.4.31	Grouped	V	P		M	ROHC, FEC

NOTE 1: The AVP header bit denoted as 'M', indicates whether support of the AVP is required. The AVP header bit denoted as 'V', indicates whether the optional Vendor-ID field is present in the AVP header. For further details, see IETF RFC 6733 [27].

NOTE 2: AVPs marked with a supported feature are applicable as described in clause 6.5.2.

For all AVPs which contain bit masks and are of the type Unsigned32 or Unsigned64, bit 0 shall be the least significant bit. For example, to get the value of bit 0, a bit mask of 0x0001 should be used.

Every AVP of type Grouped is defined by means of the ABNF syntax in IETF RFC 2234 [13] and according to the rules in IETF RFC 6733 [27].

6.4.2 BMSC-Address AVP

The BMSC-Address AVP (AVP code 3500) is of type Address and indicates the IP address where the BM-SC wants to receive user data via the MB2-U interface.

6.4.3 BMSC-Port AVP

The BMSC-Port AVP (AVP code 3501) is of type Unsigned32 and indicates the port where the BM-SC wants to receive user data via the MB2-U interface.

6.4.4 MBMS-Bearer-Event AVP

The MBMS-Bearer-Event AVP (AVP code 3502) is of type Unsigned32 and it shall contain a bit mask with values as defined table 6.4.4-1. Several bits may be set in combination except for bit 0 and bit 1.

Table 6.4.4-1: MBMS-Bearer-Event AVP

Bit	Name	Description
0	Bearer Terminated	The MBMS bearer was terminated.
1	Bearer Activated	The MBMS bearer was activated.
2	Userplane Event	The userplane event is reported, and the result is further indicated in the Userplane-Protocol-Result AVP.
3	Bearer Activation Failure	The MBMS bearer is not activated successfully based on the MBMS-Start-Time.

6.4.5 MBMS-Bearer-Event-Notification AVP

The MBMS-Bearer-Event-Notification AVP (AVP code 3503) is of type Grouped. It is used by the BM-SC to notify the GCS AS about an MBMS bearer event.

AVP Format:

```

MBMS-Bearer-Event-Notification ::=
    < AVP Header: 3503 >
    { TMGI }
    { MBMS-Flow-Identifier }
    { MBMS-Bearer-Event }
    [ MBMS-Bearer-Event-Diagnostic-Info ]
    *[ Userplane-Protocol-Result ]
    *[ AVP ]

```

6.4.6 MBMS-Bearer-Request AVP

The MBMS-Bearer-Request AVP (AVP code 3504) is of type Grouped. It is used by the GCS AS to request the activation, modification, or deactivation of an MBMS bearer.

The MBMS-StartStop-Indication AVP shall indicate if an activation, modification, or deactivation of an MBMS bearer is requested.

For the activation of an MBMS bearer, the TMGI AVP, the MBMS-Start-Time AVP and the MB2U-Security AVP may be included, and the QoS-Information AVP shall be included. If the MBMS Cell List feature is supported, the GCS AS shall also include the MBMS-Cell-List AVP or the MBMS-Service-Area AVP, or both. If the MBMS Cell List feature is not supported, the GCS AS shall also include the MBMS-Service-Area AVP. If the V2X Localized User Plane feature is supported, the GCS AS may also include the Local-M1-Information AVP and the Local-MB2-U-Information AVP. If the FEC feature is supported, the GCS AS may include the FEC-Request AVP. If the ROHC feature is supported, the GCS AS may include the ROHC-Request AVP together with the ROHC-Max-CID AVP.

For the modification of an MBMS bearer, the TMGI AVP, and the MBMS-Flow-Identifier AVP shall be included and the MBMS-Service-Area AVP, the QoS-Information AVP and / or, if the MBMS Cell List feature is supported, the

MBMS-Cell-List may be included. However, at least one of the MBMS-Service-Area AVP, the MBMS-Cell-List AVP and the QoS-Information AVP shall be included. The QoS-Information AVP shall only be used to modify the priority and pre-emption characteristics, and shall otherwise indicate the same values that were supplied when the activation of the MBMS bearer was requested. If the FEC feature is supported, the GCS AS may include the FEC-Request AVP. If the ROHC feature is supported, the GCS AS may include the ROHC-Request AVP together with the ROHC-Max-CID AVP.

For the deactivation of an MBMS bearer, the TMGI AVP and the MBMS-Flow-Identifier AVP shall be included.

AVP Format:

```

MBMS-Bearer-Request ::=
    < AVP Header: 3504 >
    { MBMS-StartStop-Indication }
    [ TMGI ]
    [ MBMS-Flow-Identifier ]
    [ QoS-Information ]
    [ MBMS-Service-Area ]
    [ MBMS-Start-Time ]
    [ MB2U-Security ]
    [ MBMS-Cell-List ]
    [ Local-M1-Information ]
    [ Local-MB2-U-Information ]
    [ FEC-Request ]
    *[ ROHC-Request ]
    [ ROHC-Max-CID ]
    *[ AVP ]

```

6.4.7 MBMS-Bearer-Response AVP

The MBMS-Bearer-Response AVP (AVP code 3505) is of type Grouped. It is used by the BM-SC to inform the GCS AS about the result of a MBMS bearer request.

For a successful MBMS bearer activation, the TMGI AVP, the MBMS-Flow-Identifier AVP, the MBMS-Session-Duration AVP, the BMSC-Address AVP and the BMSC-Port AVP shall be included, and Radio-Frequency AVP(s) and the MB2U-Security AVP may be included.

For a successful MBMS bearer modification, the TMGI AVP and the MBMS-Flow-Identifier AVP shall be included, and the Radio-Frequency AVP(s) may be included.

For a successful MBMS bearer deactivation, the TMGI AVP and the MBMS-Flow-Identifier AVP shall be included.

For an unsuccessful MBMS bearer request, the MBMS-Bearer-Result AVP shall be included.

If the IPv4v6 feature is supported, the BM-SC IPv4 address and BM-SC IPv6 address may be both provided as the BMSC-Address AVP, otherwise only one BM-SC IP address may be provided as the BMSC-Address AVP.

AVP Format:

```

MBMS-Bearer-Response ::=
    < AVP Header: 3505 >
    [ TMGI ]
    [ MBMS-Flow-Identifier ]
    [ MBMS-Session-Duration ]
    [ MBMS-Bearer-Result ]
    0*2[ BMSC-Address ]
    [ BMSC-Port ]
    [ MB2U-Security ]
    *[ Radio-Frequency ]
    *[ Userplane-Protocol-Result ]
    *[ AVP ]

```

6.4.8 MBMS-Bearer-Result AVP

The MBMS-Bearer-Result AVP (AVP code 3506) is of type Unsigned32 and it shall contain a bit mask with values as defined table 6.4.8-1. Several bits indicating errors may be set in combination. Bit 0 and Bit 13 may be set together to indicate that the request for bearer activation was successfully handled but the actual bearer activation is still ongoing.

Table 6.4.8-1: MBMS- Bearer-Result AVP

Bit	Name	Description
0	Success	The requested bearer activation, modification or deactivation was successful; or the request for bearer activation was successfully handled if bit 13 is set.
1	Authorization rejected	The requested bearer activation, modification or deactivation failed because the BM-SC did not authorize it.
2	Resources exceeded	The requested bearer activation, modification or deactivation failed because the BM-SC could not provide sufficient resources.
3	Unknown TMGI	The requested bearer activation, modification or deactivation failed because the BM-SC did not know the requested TMGI or the TMGI expired.
4	TMGI not in use	The requested bearer modification or deactivation failed because the requested TMGI was not related to an active MBMS bearer.
5	Overlapping MBMS-Service-Area	The requested bearer modification failed because the requested Service area was overlapping with a service area already in use for the requested TMGI.
6	Unknown Flow Identifier	The requested bearer modification or deactivation failed because the BM-SC did not know the requested Flow Identifier.
7	QoS Authorization Rejected	The requested bearer activation or modification failed because the BM-SC did not authorize the requested QoS.
8	Unknown MBMS-Service-Area	The requested bearer activation or modification failed because the BM-SC did not know the requested MBMS-Service-Area
9	MBMS-Service-Area Authorization Rejected	The requested bearer activation or modification failed because the BM-SC did not authorize the requested MBMS-Service-Area
10	MBMS-Start-Time	The requested bearer activation failed because the MBMS-Start-Time contained an inappropriate value.
11	Invalid AVP combination	The requested bearer activation, modification or deactivation failed because the provided AVP combination within the corresponding MBMS-Bearer-Request AVP was not allowed (e.g. because some mandatory AVPs for a given MBMS-StartStop-Indication value were missing).
12	System error	The requested procedure (e.g. bearer activation/modification) failed due to internal system error in the BM-SC.
13	Activation ongoing	The requested bearer activation is still ongoing.

6.4.9 MBMS-Start-Time AVP

The MBMS-Start-Time AVP (AVP code 3507) is of type Time and indicates the requested time when an MBMS bearer shall be allocated.

6.4.10 Radio-Frequency AVP

The Radio-Frequency AVP (AVP code 3508) is of type Unsigned32. It is used by the BM-SC to indicate radio frequencies, as defined in TS 26.346 [5], as MBMS bearer related configuration information to the GCS AS. The coding of this AVP shall be the same as defined for the *radiofrequency* child element of the *infoBinding* in TS 26.346 [5].

6.4.11 TMGI-Allocation-Request AVP

The TMGI-Allocation-Request AVP (AVP code 3509) is of type Grouped. It is used by the GCS AS to request the allocation, or timer refresh of TMGIs.

The TMGI-Number shall indicate the number of newly requested TMGI, excluding any TMGI where a timer refresh is requested. Any TMGIs where a timer refresh is requested shall be included in TMGI AVPs.

AVP Format:

```
TMGI-Allocation-Request ::=
    < AVP Header: 3509 >
    { TMGI-Number }
    * [ TMGI ]
    * [ AVP ]
```

6.4.12 TMGI-Allocation-Response AVP

The TMGI-Allocation-Response AVP (AVP code 3510) is of type Grouped. It is used by the BM-SC to inform the GCS AS about the result of a TMGI allocation request.

For a successful TMGI allocation, TMGI AVPs and the MBMS-Session-Duration AVP shall be included. The TMGI AVPs shall contain all successfully allocated or refreshed TMGIs and the MBMS-Session-Duration AVP shall indicate their common new expiration time.

For an unsuccessful TMGI allocation request, the TMGI-Allocation-Result AVP shall be included.

For a partial success, if some, but not all of the requested TMGIs are allocated or timers refreshed, TMGI AVPs, the MBMS-Session-Duration AVP and the TMGI-Allocation-Result AVP shall be included. The TMGI AVPs shall contain all successfully allocated or refreshed TMGIs and the MBMS-Session-Duration AVP shall indicate their common new expiration time. The TMGI-Allocation-Result AVP shall indicate both success and the reason(s) why the allocation or refresh failed for some TMGIs.

AVP Format:

```
TMGI-Allocation-Response ::= < AVP Header: 3510 >
                               * [ TMGI ]
                               [ MBMS-Session-Duration ]
                               [ TMGI-Allocation-Result ]
                               * [ AVP ]
```

6.4.13 TMGI-Allocation-Result AVP

The TMGI-Allocation-Result AVP (AVP code 3511) is of type Unsigned32 and it shall contain a bit mask with values as defined table 6.4.13-1. Several bits indicating errors may be set in combination.

Table 6.4.13-1: TMGI-Allocation-Result AVP

Bit	Name	Description
0	Success	The requested TMGI allocation was successful.
1	Authorization rejected	The requested TMGI allocation failed because the BM-SC did not authorize it.
2	Resources exceeded	The requested TMGI allocation failed because the BM-SC could not provide sufficient resources.
3	Unknown TMGI	The requested TMGI timer refresh failed because the BM-SC did not know the requested TMGI, e.g. because the TMGI already expired.
4	Too many TMGIs requested	The requested TMGI allocation or timer refresh failed because the maximum number of allowed TMGIs for the GCS AS was exceeded.
5	System error	The requested TMGI allocation failed due to internal system error in the BM-SC.

6.4.14 TMGI-Deallocation-Request AVP

The TMGI-Deallocation-Request AVP (AVP code 3512) is of type Grouped. It is used by the GCS AS to request the deallocation of TMGIs.

AVP Format:

```
TMGI-Deallocation-Request ::= < AVP Header: 3512 >
                               * [ TMGI ]
                               * [ AVP ]
```

6.4.15 TMGI-Deallocation-Response AVP

The TMGI-Deallocation-Response AVP (AVP code 3513) is of type Grouped. It is used by the BM-SC to inform the GCS AS about the results of a TMGI deallocation request for a given TMGI.

The TMGI AVP shall indicate the TMGI.

For an unsuccessful TMGI deallocation request, the TMGI-Deallocation-Result AVP shall be included.

AVP Format:

```
TMGI-Deallocation-Response ::= < AVP Header: 3513 >
                               { TMGI }
                               [ TMGI-Deallocation-Result ]
                               *[ AVP ]
```

6.4.16 TMGI-Deallocation-Result AVP

The TMGI-Deallocation-Result AVP (AVP code 3514) is of type Unsigned32 and it shall contain a bit mask with values as defined table 6.4.16-1. Several bits indicating errors may be set in combination for error cases.

Table 6.4.16-1: TMGI-Deallocation-Result AVP

Bit	Name	Description
0	Success	The requested TMGI deallocation was successful.
1	Authorization rejected	The requested TMGI deallocation failed because the BM-SC did not authorize it.
2	Unknown TMGI	The requested TMGI deallocation failed because the BM-SC did not know the requested TMGI, e.g. because the TMGI already expired.
3	System error	The requested TMGI deallocation failed due to internal system error in the BM-SC.

6.4.17 TMGI-Expiry AVP

The TMGI-Expiry AVP (AVP code 3515) is of type Grouped. It is used by the BM-SC to notify the GCS AS about the expiry of TMGIs.

The TMGI AVPs shall include all TMGIs that have expired.

AVP Format:

```
TMGI-Expiry ::= < AVP Header: 3515 >
                *{ TMGI }
                *[ AVP ]
```

6.4.18 TMGI-Number AVP

The TMGI-Number AVP (AVP code 3516) is of type Unsigned32 and it indicates a number of requested TMGIs.

6.4.19 MB2U-Security AVP

The MB2U-Security AVP (AVP code 3517) is of type Unsigned32. It is used to indicate whether the usage of a security protocol for the MB2-U interface is requested (when send by the GCS AS) or decided (when send by the BM-SC).

The following values are defined in this specification:

0 (No security):

This value shall be used to indicate that the usage of no security protocol for the MB2-U interface is requested or decided. "0" is the default value that shall be used if the AVP is omitted.

1 (Security):

This value shall be used to indicate that the usage of a security protocol for the MB2 U interface is requested or decided.

6.4.20 Local-M1-Information AVP

The Local-M1-Information AVP (AVP code 3518) is of type Grouped. It is used to indicate the M1 interface information between the eNB and MBMS GW for local MBMS based MBMS data delivery.

AVP Format:

```
Local-M1-Information ::= < AVP Header: 3518 >
                        [ MBMS-eNB-IP-Multicast-Address ]
                        [ MBMS-eNB-IPv6-Multicast-Address ]
                        [ MBMS-GW-SSM-IP-Address ]
                        [ MBMS-GW-SSM-IPv6-Address ]
                        [ Common-Tunnel-Endpoint-Identifier ]
```

6.4.21 Local-MB2-U-Information AVP

The Local-MB2-U-Information AVP (AVP code 3519) is of type Grouped. It is used to indicate the MB2-U interface information for local MBMS based MBMS data delivery.

If the IPv4v6 feature is supported, the BM-SC IPv4 address and BM-SC IPv6 address may be both provided as the BMSC-Address AVP, otherwise only one BM-SC IP address may be provided as the BMSC-Address AVP.

AVP Format:

```
Local-MB2-U-Information ::= < AVP Header: 3519 >
                            0*2 [ BMSC-Address ]
                            [ BMSC-Port ]
```

6.4.22 MBMS-eNB-IP-Multicast-Address AVP

The MBMS-eNB-IP-Multicast-Address AVP (AVP code 3520) is of type Address and contains the M1 (transport) plane IPv4 destination multicast address used by MBMS-GW for IP multicast encapsulation of user plane IP multicast datagrams.

6.4.23 MBMS-eNB-IPv6-Multicast-Address AVP

The MBMS-eNB-IPv6-Multicast-Address AVP (AVP code 3521) is of type Address and contains the M1 (transport) plane IPv6 prefix of destination multicast address used by MBMS-GW for IP multicast encapsulation of user plane IP multicast datagrams.

6.4.24 MBMS-GW-SSM-IP-Address AVP

The MBMS-GW-SSM-IP-Address AVP (AVP code 3522) is of type Address and contains the IPv4 address of the MBMS-GW for Source Specific Multicasting. This AVP is used for an IPv4 only or dual stack MBMS-GW.

6.4.25 MBMS-GW-SSM-IPv6-Address AVP

The MBMS-GW-SSM-IPv6-Address AVP (AVP code 3523) is of type Address and contains the IPv6 address of the MBMS-GW for Source Specific Multicasting. This AVP is used for a dual stack MBMS-GW.

6.4.26 Common-Tunnel-Endpoint-Identifier AVP

The Common-Tunnel-Endpoint-Identifier AVP (AVP code 3524) is of type OctetString, and it indicates the common tunnel endpoint identifier of the MBMS GW for the user plane.

6.4.27 FEC-Request AVP

The FEC-Request AVP (AVP code 3525) is of type OctetString.

It is used by the GCS AS to request that the BM-SC applies FEC (see IETF RFC 6363 [31]).

The FEC-Request AVP shall include an SDP description of FEC framework configuration information (see subclause 5.5 of IETF RFC 6363 [31]) formatted according to subclause 8A.5 of 3GPP TS 26.346 [5] . The description shall relate to the IP layer and higher protocols within the "User Plane Data" as depicted in Figure 7.1-1.

6.4.28 ROHC-Request AVP

The ROHC-Request AVP (AVP code 3526) is of type Grouped.

It is used by the GCS AS to request that the BM-SC applies ROHC (see IETF RFC 5795 [29] and IETF RFC 3095 [30]) for the indicated downlink media stream(s),

The Flow-Description AVP(s) shall describe the downlink media streams for which ROHC applies. The description shall relate to the IP layer and higher protocols within the "User Plane Data" as depicted in Figure 7.1-1.

AVP Format:

```
ROHC-Request ::=
    < AVP Header: 3525 >
    1*{ Flow-Description }
    [ ROHC-Full-Header-Periodicity ]
    { ROHC-Profile }
    *[ AVP ]
```

6.4.29 ROHC-Full-Header-Periodicity AVP

The ROHC-Full-Header-Periodicity AVP (AVP code 3527) is of type Float32.

It shall indicate the target periodicity for ROHC (see IETF RFC 5795 [29] and IETF RFC 3095 [30]) full header packets in units of seconds.

6.4.30 ROHC-Profile AVP

The ROHC-Profile AVP (AVP code 3528) is of type Unsigned32.

It shall indicate the applicable ROHC profile (see IETF RFC 5795 [29]) as described in subclause 7.2. The AVP value is restricted to the 0x0001 RTP/UDP/IP profile or the 0x0002 UDP/IP profile.

6.4.31 Userplane-Protocol-Result AVP

The Userplane-Protocol-Result AVP (AVP code 3529) is of type Grouped.

It is used by the BM-SC to report the result of the activation of failures of the execution of user plane protocols,

The Flow-Description AVP(s) shall describe the downlink media streams for which the user plane protocol(s) apply. The description shall relate to the IP layer and higher protocols within the "User Plane Data" as depicted in Figure 7.1-1. Omitting this AVP shall indicate that the reported result applies for all media streams.

AVP Format:

```
Userplane-Protocol-Result ::=
    < AVP Header: 3525 >
    *[ Flow-Description ]
    [ ROHC-Result ]
    [ FEC-Result ]
    *[ AVP ]
```

6.4.32 ROHC-Result AVP

The ROHC-Result AVP (AVP code 3530) is of type Unsigned32 and it shall contain a bit mask with values as defined table 6.4.32-1. Several bits indicating errors may be set in combination.

Table 6.4.32-1: ROHC-Result AVP

Bit	Name	Description
0	Success	The requested ROHC activation was successful.
1	Trying	The requested ROHC activation is still ongoing, The final result will be reported separately.
2	Authorization rejected	The requested ROHC activation failed because the BM-SC did not authorize it.
3	Resources exceeded	The requested ROHC activation or execution failed because the BM-SC could not provide sufficient resources.
4	Unknown Profile	The requested ROHC activation failed because the BM-SC does not support the requested ROHC profile.
5	System error	The requested ROHC activation or execution failed due to some internal system error in the BM-SC.
6	No Traffic	The ROHC execution was terminated because the BM-SC did not detect any user plane traffic for a longer period.

6.4.33 FEC-Result AVP

The FEC-Result AVP (AVP code 3531) is of type Unsigned32 and it shall contain a bit mask with values as defined table 6.4.33-1. Several bits indicating errors may be set in combination.

Table 6.4.33-1: FEC-Result AVP

Bit	Name	Description
0	Success	The requested FEC activation was successful.
1	Trying	The requested FEC activation is still ongoing, The final result will be reported separately.
2	Authorization rejected	The requested FEC activation failed because the BM-SC did not authorize it.
3	Resources exceeded	The requested FEC activation or execution failed because the BM-SC could not provide sufficient resources.
4	Unknown Configuration	The requested FEC activation failed because the BM-SC does not support the requested FEC configuration.
5	Invalid SDP	The requested FEC activation failed because the SDP provided within the FEC-Request AVP was invalid.
6	System error	The requested FEC activation or execution failed due to some internal system error in the BM-SC.
7	No Traffic	The FEC execution was terminated because the BM-SC did not detect any user plane traffic for a longer period.

6.4.34 ROHC-Max-CID AVP

The ROHC-Max-CID AVP (AVP code 3532) is of type Unsigned32.

It shall indicate the MAX_CID parameter for the compressor (see IETF RFC 5795 [29] and IETF RFC 3095 [30]). The value for the LARGE_CIDS parameter (usage of short CID representation or large CID representation) shall be deducted from the MAX_CID parameter as follows:

If MAX_CID > 15 then LARGE_CIDS = TRUE else LARGE_CIDS = FALSE.

6.4.35 MBMS-Bearer-Event-Diagnostic-Info AVP

The MBMS-Bearer-Event-Diagnostic-Info AVP (AVP code 3533) is of type Enumerated. It indicates the diagnostic reason of an event notified. The following values are supported:

TMGI-Expiry (0)

The MBMS bearer was terminated due to the expiry of TMGI.

MBMS-GW-Not-Establishment (1)

The MBMS bearer was activated failure due to MBMS-GW is not established.

SGmb-Transient-Path-Failure (2)

The MBMS bearer was activated failure due to SGmb transient path failure.

SGmb-Non-Transient-Path-Failure (3)

The MBMS bearer was terminated due to SGmb non-transient path failure.

MBMS-GW-User-Plane-Failure (4)

The MBMS bearer was terminated due to User Plane Failure detected by the MBMS-GW.

MBMS-GW-Permanent-Error (5)

The MBMS bearer was terminated due to MBMS-GW Permanent Error response.

MBMS-GW-Transient-Error (6)

The MBMS bearer was activated failure due to MBMS-GW Transient Error response.

6.5 MB2-C re-used AVPs

6.5.1 General

Table 6.5.1-1 lists the Diameter AVPs re-used by the MB2-C reference point from existing Diameter Applications, reference to their respective specifications and a short description of their usage within the MB2-C reference point. Other AVPs from existing Diameter Applications, except for the AVPs from Diameter base protocol, do not need to be supported. The AVPs from Diameter base protocol are not included in table 6.5.1-1, but they are re-used for the MB2-C reference point. Unless otherwise stated, re-used AVPs shall maintain their 'M', 'P' and 'V' flag settings.

Table 6.5.1-1: MB2-C re-used Diameter AVPs

Attribute Name	Reference	Description	Applicability (Note 2)
DRMP	IETF RFC 7944 [25]	Allows the BM-SC and GCS AS to indicate the relative priority of Diameter messages.	
Flow-Description	TS 29.214 [33]	A description of IP flows.	FEC, ROHC
Load	IETF RFC 8583 [26]	The AVP used to convey load information between Diameter nodes. This AVP and all AVPs within this grouped AVP shall have the 'M' bit cleared.	
MBMS-Flow-Identifier	TS 29.061 [6]	Represents a location dependent subflow of an MBMS bearer service.	
MBMS-Session-Duration	TS 29.061 [6]	Indicates the duration of the TMGI expiration time. (NOTE 1)	
TMGI	TS 29.061 [6]	Contains the Temporary Mobile Group Identity allocated to a particular MBMS bearer service	
MBMS-Service-Area	TS 29.061 [6]	Indicates the area over which the MBMS bearer service has to be distributed.	
MBMS-StartStop-Indication	TS 29.061 [6]	Indicates if the allocation, deallocation or modification of an MBMS bearer is requested.	
QoS-Information	TS 29.212 [7]	Contains the QoS that is required for the MBMS bearer. Only the QoS-Class-Identifier AVP, Max-Requested-Bandwidth-DL, Guaranteed-Bitrate-DL AVP and Allocation-Retention-Priority AVP within the QoS-Information AVP are applicable.	
Supported-Features	TS 29.229 [23]	If present, this AVP informs the destination host about the features that the origin host requires to successfully complete this command exchange.	
Restart-Counter	TS 29.061 [6]	This AVP contains a monotonically increasing value that is advanced whenever the sending entity restarts with loss of previous state, for example upon restart. The Restart-Counter AVP may be included in any Diameter message over the MB2-C reference point, including CER/CEA defined in IETF RFC 6733 [27].	Heartbeat
MBMS-Cell-List	TS 29.061 [6]	This AVP contains the list of cells used by E-UTRAN to determine the set of radio resources to be used for the broadcast.	MBMS Cell List
NOTE 1: This re-used AVP has a different meaning as compared to the meaning in SGmb interface.			
NOTE 2: AVPs marked with a supported feature are applicable as described in clause 6.5.2.			

6.5.2 Supported-Feature-List AVP

6.5.2.1 Use of the Supported-Features AVP

When new functionality is introduced on the MB2-C reference point, it should be defined as optional. If backwards incompatible changes cannot be avoided, the new functionality shall be introduced as a new feature and support advertised with the Supported-Features AVP. Unless otherwise stated, the use of the Supported-Features AVP on the

MB2-C reference point shall be compliant with the usage of the Supported-Features AVP on the Cx reference point i.e. with the procedures for the dynamic discovery of supported features as defined in clause 7.2 of TS 29.229 [23].

When extending the application by adding new AVPs for a feature, the new AVPs shall have the M bit cleared and the AVP shall not be defined mandatory in the command ABNF.

As defined in TS 29.229 [23], the Supported-Features AVP is of type grouped and contains the Vendor-Id, Feature-List-ID and Feature-List AVPs. On the all reference points as specified in this specification, the Supported-Features AVP is used to identify features that have been defined by 3GPP and hence, for features defined in this document, the Vendor-Id AVP shall contain the vendor ID of 3GPP (10415). If there are multiple feature lists defined for the reference point, the Feature-List-ID AVP shall differentiate those lists from one another. One instance of Supported-Features AVP is needed per Feature-List-ID.

Every GAR shall include the features supported by the GCS AS within Supported-Features AVP(s) with the 'M' bit cleared. Every GAA shall include the features supported by the BM-SC within Supported-Features AVP(s) with the 'M' bit cleared.

The Table 6.5.2.2-1 defines the features applicable to the MB2-C reference point for the feature list with a Feature-List-ID of 1.

6.5.2.2 Supported-Feature-List AVP for the MB2-C application

The syntax of this AVP is defined in TS 29.229 [23].

For the MB2-C application, the meaning of the bits shall be as defined in table 6.5.2.2-1 for the Supported-Feature-List-ID of 1.

Table 6.5.2.2-1: Features of Feature-List-ID 1 used for MB2-C application

Feature bit (NOTE 1)	Feature (NOTE 2)	M/O (NOTE 3)	Description (NOTE 4)
0	Heartbeat	O	This feature indicates the support of the Restoration functionality related Heartbeat procedures and procedures for the Restart-Counter AVP defined in clause 5.6.2, 5.6.3 and 5.6.4.
1	MBMS Cell List	M	This feature indicates the support of providing a MBMS-Cell-List AVP.
2	V2X Localized User Plane	O	This feature indicates the support of local MBMS based MBMS data delivery for V2X services (see 3GPP TS 23.285 [28] subclause 5.4.2.2 and Annex B.3).
3	FEC	O	This feature indicates the support of applying FEC (see IETF RFC 6363 [31]) to downlink packet streams at the BM-SC.
4	ROHC	O	This feature indicates the support of applying ROHC (see IETF RFC 5795 [29] and IETF RFC 3095 [30]) to downlink packet streams at the BM-SC.
5	IPv4v6	O	This feature indicates the support of IPv4v6 dual stack and both BM-SC IPv4 address and BM-SC IPv6 address may be provided as the BMSC-Address AVP.

NOTE 1: Feature bit: The order number of the bit within the Supported-Features AVP, e.g. "0".
NOTE 2: Feature: A short name that can be used to refer to the bit and to the feature, e.g. "".
NOTE 3: M/O: Defines if the implementation of the feature is mandatory ("M") or optional ("O").
NOTE 4: Description: A clear textual description of the feature.

6.6 MB2-C Messages

6.6.1 Command-Code Values

This clause defines the Command-Code values for the MB2-C interface application as allocated by IANA from the vendor-specific namespace defined in IETF RFC 5719 [16]. Every command is defined by means of the ABNF syntax in IETF RFC 2234 [13], and according to the rules in IETF RFC 6733 [27].

The following Command Codes are defined in this specification:

Table 6.6.1-1: Command-Code values for MB2-C

Command-Name	Abbreviation	Code	Section
GCS-Action-Request	GAR	8388662	6.6.2
GCS-Action-Answer	GAA	8388662	6.6.3
GCS-Notification-Request	GNR	8388663	6.6.4
GCS-Notification-Answer	GNA	8388663	6.6.5

For the commands defined in this specification and reused commands, the Application-ID field shall be set to 16777335.

6.6.2 GCS-Action-Request (GAR) command

The GAR command, indicated by the Command-Code field set to 8388662 and the 'R' bit set in the Command Flags field, is sent by the GCS AS to the BM-SC as part of the MBMS bearer activation, modification, or deactivation procedure, or as part of the TMGI allocation or deallocation procedure.

Message Format:

```
<GA-Request> ::= <Diameter Header: 8388662, REQ, PXY >
  < Session-Id >
  [ DRMP ]
  { Auth-Application-Id }
  { Auth-Session-State }
  { Origin-Host }
  { Origin-Realm }
  { Destination-Realm }
  [ Destination-Host ]
  [ Origin-State-Id ]
  *[ Proxy-Info ]
  *[ Route-Record ]
  *{ Supported-Features }
  [ TMGI-Allocation-Request ]
  [ TMGI-Deallocation-Request ]
  *[ MBMS-Bearer-Request ]
  [ Restart-Counter ]
  *[ AVP ]
```

6.6.3 GCS-Action-Answer (GAA) command

The GAA command, indicated by the Command-Code field set to 8388662 and the 'R' bit cleared in the Command Flags field, is sent by the BM-SC to the GCS AS as part of the MBMS bearer activation, modification, or deactivation procedure, or as part of the TMGI allocation or deallocation procedure.

Message Format:

```
<GA-Answer> ::= < Diameter Header: 8388662, PXY >
  < Session-Id >
  [ DRMP ]
```

```

    { Auth-Application-Id }
    { Auth-Session-State }
    { Origin-Host }
    { Origin-Realm }
    [ Result-Code ]
    [ Experimental-Result ]
    [ Error-Message ]
    [ Error-Reporting-Host ]
    [ Failed-AVP ]
    [ Origin-State-Id ]
    *[ Redirect-Host ]
    [ Redirect-Host-Usage ]
    [ Redirect-Max-Cache-Time ]
    *[ Proxy-Info ]
    *{ Supported-Features }
    [ TMGI-Allocation-Response ]
    *{ TMGI-Deallocation-Response }
    *{ MBMS-Bearer-Response }
    [ Restart-Counter ]
    *[ Load ]
    *[ AVP ]

```

6.6.4 GCS-Notification-Request (GNR) command

The GNR command, indicated by the Command-Code field set to 8388663 and the 'R' bit set in the Command Flags field, is sent by the BM-SC to the GCS AS as part of the MBMS Bearer Status Indication procedure.

Message Format:

```

<GN-Request> ::= < Diameter Header: 8388663, REQ, PXY >
    < Session-Id >
    [ DRMP ]
    { Auth-Application-Id }
    { Auth-Session-State }
    { Origin-Host }
    { Origin-Realm }
    { Destination-Realm }
    { Destination-Host }
    [ Origin-State-Id ]
    *[ Proxy-Info ]
    *[ Route-Record ]
    [ TMGI-Expiry ]
    *{ MBMS-Bearer-Event-Notification }
    [ Restart-Counter ]
    *[ AVP ]

```

6.6.5 GCS-Notification-Answer (GNA) command

The GNA command, indicated by the Command-Code field set to 8388663 and the 'R' bit cleared in the Command Flags field, is sent by the GCS AS to the BM-SC as part of the MBMS Bearer Status Indication procedure.

Message Format:

```

<GN-Answer> ::= < Diameter Header: 8388663, PXY >
    < Session-Id >
    [ DRMP ]
    { Auth-Application-Id }
    { Auth-Session-State }
    { Origin-Host }
    { Origin-Realm }
    [ Result-Code ]
    [ Experimental-Result ]
    [ Origin-State-Id ]
    [ Error-Message ]
    [ Error-Reporting-Host ]
    *[ Redirect-Host ]
    [ Redirect-Host-Usage ]
    [ Redirect-Max-Cache-Time ]
    [ Failed-AVP ]
    *[ Proxy-Info ]
    [ Restart-Counter ]
    *[ AVP ]

```

7 MB2-U Protocol

7.1 Protocol Stack

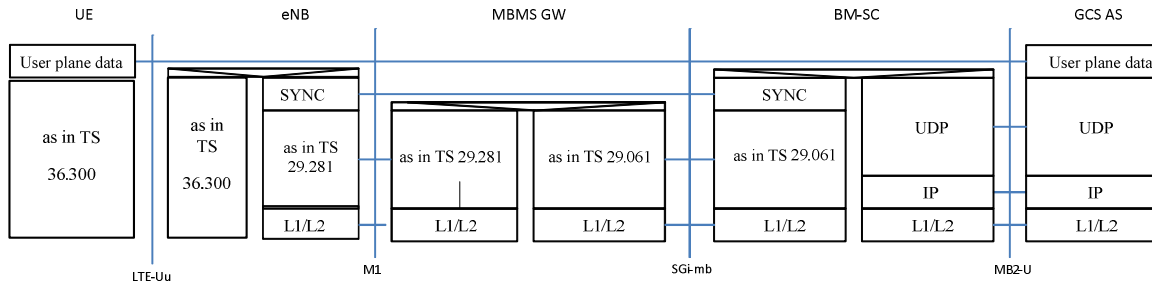

Figure 7.1-1: The user plane protocol stack without security protocols on the MB2-U reference point and in the EPC

Figure 7.1-1 depicts the MB2-U protocol stack without security protocols. The stack shall include:

- User plane data, for instance an IP layer and UDP layer. The user plane data are transparently transported between the GCS AS and the UE unless the BM-SC applies FEC (see IETF RFC 6363 [31]) and/or ROHC (see IETF RFC 5795 [29] and IETF RFC 3095 [30]). The BM-SC shall forward these protocol layers transparently unless the GCS AS instructs the BM-SC to apply FEC and/or ROHC.

NOTE: The user plane data can contain data related to several services, which are transported in the same MBMS bearer. The multiplexing protocol is transparent to the BM-SC.

- UDP according to IETF RFC 768 [12]. UDP shall be terminated at the GCS AS and BM-SC.
- IP transported by lower layers L1 and L2. These layers shall be terminated at the GCS AS and BM-SC.

Figure 7.1-1 also depicts the SGi-mb protocol stack defined in TS 29.061 [6] and the M1 protocol stack as defined in TS 29.274 [8] and TS 29.281 [9] for informational purposes.

The security solutions for the MB2-U reference point in Annex N.3 of TS 33.246 [10] shall apply. The MB2-U protocol stack is augmented depending on the selected security protocol:

- If DTLS (IETF RFC 6347 [21]) is used, it resides in the MB2-U protocol stack between UDP and the user plane data as shown on Figure 7.1-2.
- If IPSec is used without UDP encapsulation for NAT traversal, IKE (IETF RFC 5996 [17]), is transported on top of UDP during the security association establishment, and ESP (IETF RFC 4303 [20]), resides in the MB2-U protocol stack between IP and UDP, as shown on Figure 7.1-3.
- If IPSec is used with possible UDP encapsulation for NAT traversal, IKE (IETF RFC 5996 [17]), is transported on top of UDP during the security association establishment. IKE is used according to IETF RFC 3947 [18] to negotiate if UDP encapsulating of ESP is used for NAT-Traversal. If UDP encapsulating of ESP (IETF RFC 3948 [19]), is used, a lower IP layer, a lower UDP layer and ESP reside in the MB2-U protocol stack between L1/L2 and the IP layer shown in Figure 7.1-1; see Figure 7.1-4. Otherwise, ESP (IETF RFC 4303 [20]), resides in the MB2-U protocol stack between IP and UDP.

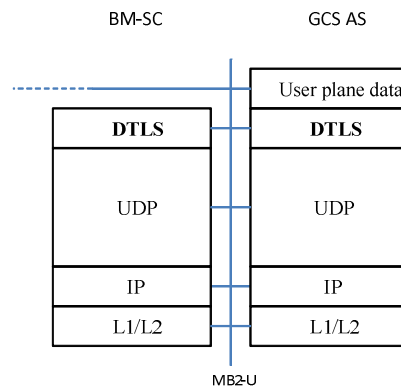

Figure 7.1-2: MB2-U Protocol stack with DTLS Security

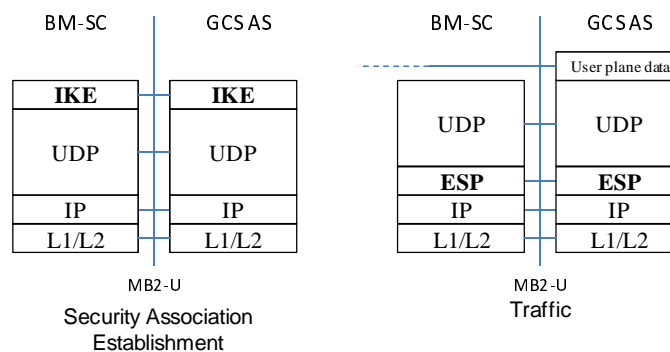

Figure 7.1-3: MB2-U Protocol stack with IPSec Security without UDP encapsulation

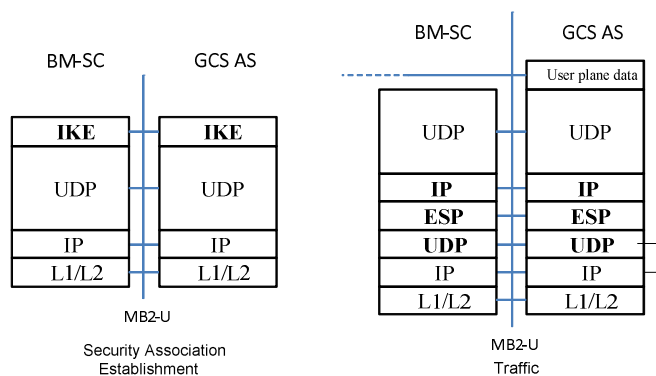

Figure 7.1-4: MB2-U Protocol stack with IPSec Security with UDP encapsulation

7.2 Procedures

When receiving an MBMS bearer allocation request via the MB2-C reference point, the BM-SC shall select an own IP address to receive user plane data from the GCS AS sending the request. The BM-SC shall also allocate a value for the UDP port that is unique on the selected IP address for the MBMS bearer to be activated. The BM-SC shall decide whether to use MB2-U Security. The BM-SC shall send the IP address (within the BMSC-Address AVP), the UDP port value (within the BMSC-Port AVP), and, if MB2-U Security is applied, a request to use user plane security (within the MB2U-Security AVP), in the response to the MBMS bearer allocation request via the MB2-C reference point to the GCS AS.

If security was requested by the BM-SC, the GCS AS shall either establish a new security association or reuse an existing security association towards the BM-SC. The security protocol (DTLS or IKE/IPSec) to be used over MB2-U needs to be configured in the GCS AS, possibly dependent on BM-SC and/or target network.

For IPsec, the IP address shall also apply to the transport of IKE.

NOTE 1: Well-known UDP ports are used for IKE.

For UDP encapsulation of ESP, IETF RFC 3948 [19], the IP address shall apply both to the lower IP layer and the upper IP layer layer shown in Figure 7.1-4. The UDP port shall apply to the upper IP layer layer shown in Figure 7.1-4.

NOTE 2: A well-known UDP port for ESP is used in the lower layer.

The BM-SC shall then transparently forward any user plane data within UDP packets, which are received over the MB2-U reference point at the allocated UDP port on the selected IP address, to the corresponding MBMS bearer at the SGi-mb interface unless the GCS AS instructed the BM-SC to apply FEC (see IETF RFC 6363 [31]) and/or ROHC (see IETF RFC 5795 [29] and IETF RFC 3095 [30]). The BM-SC shall continue forwarding received payload until the corresponding MBMS Bearer is deallocated. If the GCS AS instructed the BM-SC to apply FEC, the BM-SC shall apply the procedures in IETF RFC 6363 [31] to provide forward error protection to downlink IP packets and possibly higher protocol layers within the user plane data.

If the GCS AS instructed the BM-SC to apply ROHC as described in subclause 5.3.2 or subclause 5.3.4 for one MBMS bearer, the BM-SC shall:

1. apply the procedures in IETF RFC 5795 [29] and in IETF RFC 3095 [30] to provide header compression to downlink IP packets and possibly higher protocol layers within the user plane data;
2. use the ROHC profile requested in the ROHC-Profile AVP for downlink packet which belongs to any of the flows listed in the ROHC-Request AVP(s);
3. use the 0x0000 uncompressed profile for any downlink packet which does not belong to any of the flows listed in the ROHC-Request AVP(s); and
4. use the ROHC unidirectional mode (see IETF RFC 3095 [30]) without ROHC segmentation (see IETF RFC 5795 [29]).

When receiving an MBMS bearer allocation response via the MB2-C reference point, the GCS AS shall store the contained IP address and UDP port and may send user plane data for the corresponding MBMS bearer until the MBMS Bearer is deallocated.

NOTE 3: The GCS AS will be informed about the MBMS bearer deallocation by MB2-C procedures defined in clause 6.

To send user plane data towards the MBMS bearer, the GCS AS shall encapsulate them in UDP; it shall use the UDP port signalled by the BM-SC as destination UDP port, and it shall send the resulting packets towards the IP address signalled by the BM-SC.

Annex A (informative): Call Flows

A.1 TMGI Management

A.1.1 TMGI Allocation Procedure

The TMGI allocation procedure is used by the GCS AS to request TMGI(s). This procedure may also be used to renew the expiration time for already allocated TMGI(s).

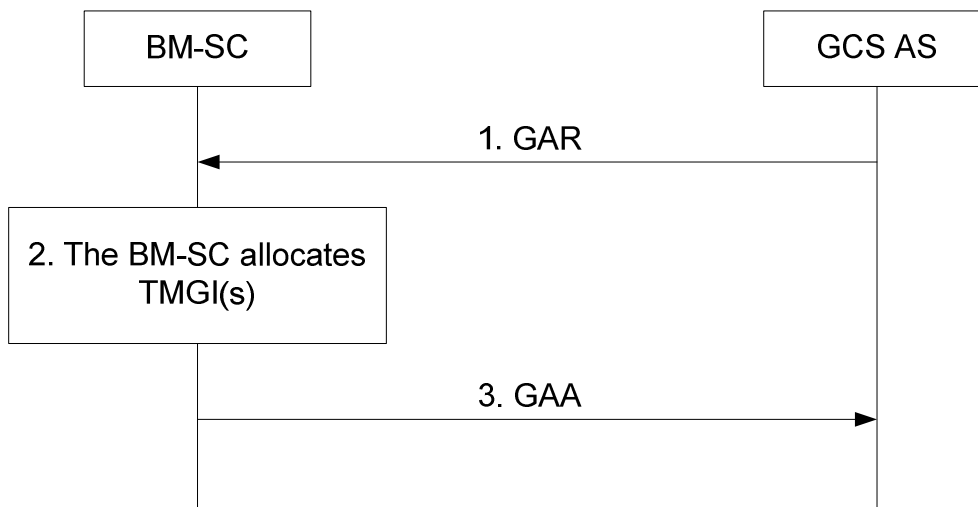

Figure A.1.1-1: TMGI Allocation Procedure

1. If the GCS AS needs to request from the BM-SC the allocation of one or more TMGIs, the GCS AS shall send a Diameter GAR command including the parameters as defined in clause 5.2.1.
2. The BM-SC determines whether the GCS AS is authorized to receive the TMGIs and allocates a set of TMGIs. The BM-SC determines an expiration time for the TMGIs. If a list of TMGIs has been received in the previous Diameter GAR command, the BM-SC also determines whether the TMGIs are allocated to the requesting GCS AS and if yes, whether the expiration time for those TMGIs can be set to the new expiration time.
3. The BM-SC send a Diameter GAA command including the parameters as defined in clause 5.2.1.

A.1.2 TMGI Deallocation Procedure

The TMGI Deallocation procedure is used by the GCS AS to request the BM-SC to immediately release TMGI(s), irrespective of their expiration time(s).

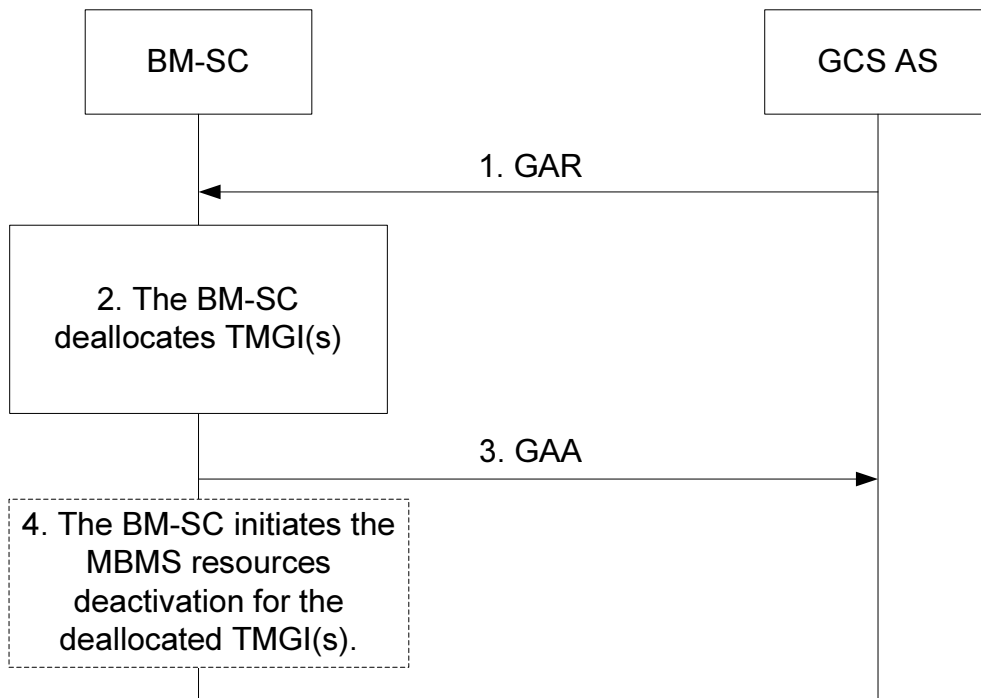

Figure A.1.2-1: TMGI Deallocation Procedure

1. If the GCS AS decides that one or more allocated TMGIs are no longer needed, the GCS AS sends a Diameter GAR command including the parameters as defined in clause 5.2.2.
2. The BM-SC determines if the GCS AS is authorized to deallocate the indicated TMGIs, and then deallocates those TMGIs. If MBMS resources are in use for any of the deallocated TMGIs, those resources are released using the Session Stop procedure defined in TS 23.246 [3].
3. The BM-SC sends a Diameter GAA command including the parameters as defined in clause 5.2.2.
4. If MBMS resources are in use for any of the deallocated TMGIs, the BM-SC initiates the Session Stop procedure defined in sub-clause 20.3.3 of TS 29.061 [6] to release those resources.

A.1.3 TMGI Expiry Notification

The TMGI expiry notification procedure is used by the BM-SC to notify the GCS AS when a timer expires for a TMGI.

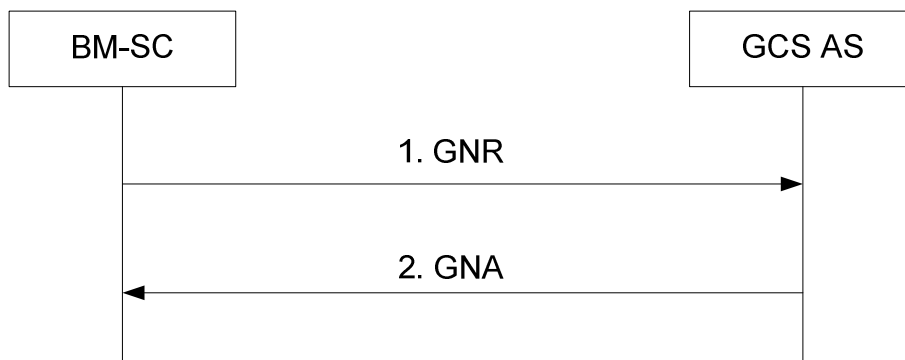

Figure A.1.3-1: TMGI Expiry Notification Procedure

1. If the BM-SC detects a timer expiry for a TMGI, the BM-SC sends a Diameter GNR command to indicate the TMGI expiry to GCS AS including TMGI-Expiry AVP. If there is (are) active MBMS bearer(s) related to this

expiring TMGI, the BM-SC terminates this (these) bearer(s) by applying the Session Stop procedure as defined in clause 20.3.3 of TS 29.061 [6].

2. The GCS AS responds to the BM-SC with a Diameter GNA command. The Diameter session ends after the GNA command.

A.2 MBMS Bearer Control Procedures

A.2.1 Activate MBMS Bearer Procedure

The Activate MBMS Bearer procedure is used by the GCS AS to cause the allocation of resources for an MBMS bearer.

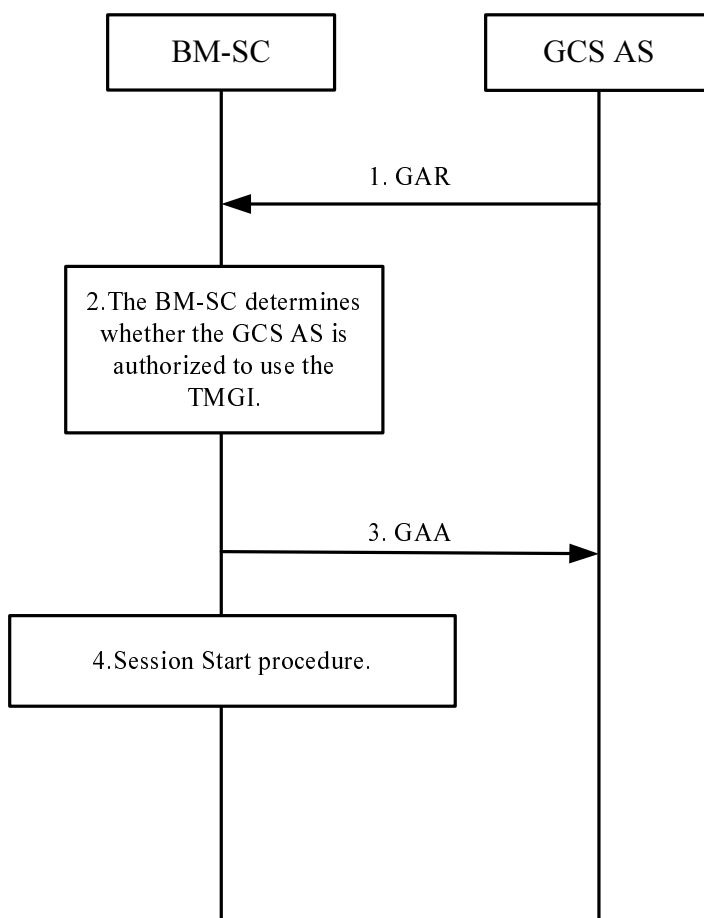

Figure A.2.1.1: Activate MBMS bearer Procedure

1. When the GCS AS wishes to activate an MBMS bearer, the GCS AS sends a GAR command to the BM-SC, including the parameters as defined in clause 5.3.2.
2. The BM-SC determines whether the GCS AS is authorized to use the TMGI.
3. The BM-SC sends a GAA command to the GCS AS including the parameters as defined in clause 5.3.2.
4. If the authorization is successful, the BM-SC applies the Session Start procedure as defined in clause 20.3.1 of 3GPP 29.061 [6].

A.2.2 Deactivate MBMS Bearer Procedure

The Deactivate MBMS Bearer procedure is used by the GCS AS to cause the deallocation of resources for an MBMS bearer.

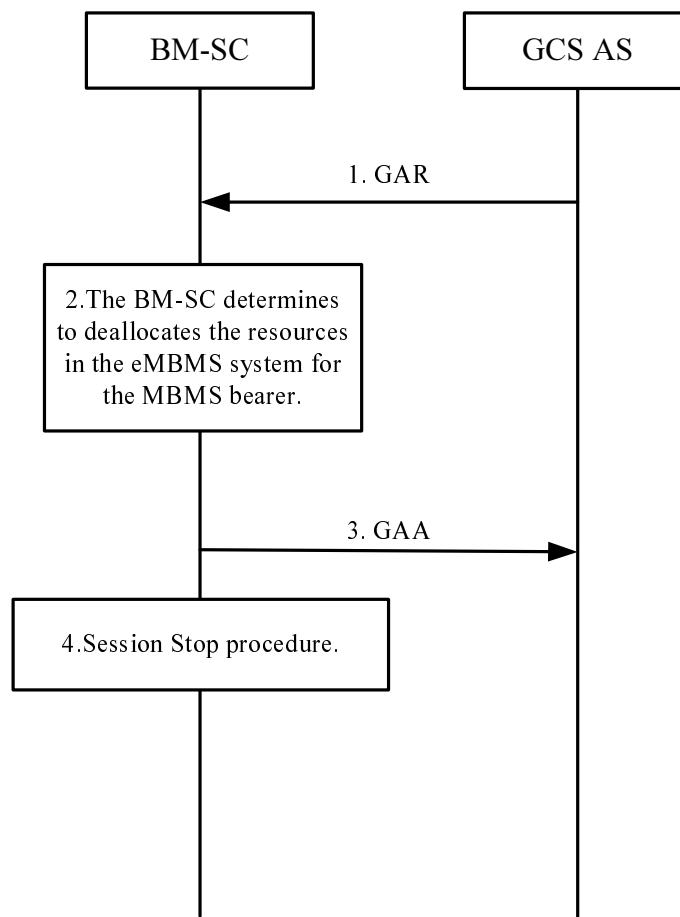

Figure A.2.2.1: Deactivate MBMS bearer Procedure

1. When the GCS AS determines that the MBMS bearer is no longer needed, it sends a GAR command to the BM-SC, including the parameters as defined in clause 5.3.3.
2. The BM-SC determines whether the GCS AS is authorized to use the TMGI and determines to deallocate the resources in the eMBMS system for the MBMS bearer.
3. The BM-SC sends a GAA command to the GCS AS including the parameters as defined in clause 5.3.3.
4. The BM-SC applies the Session Stop procedure as defined in clause 20.3.3 of TS 29.061 [6].

A.2.3 Modify MBMS Bearer Procedure

The Modify MBMS Bearer procedure is used by the GCS AS to cause modification of the priority and pre-emption values for an MBMS bearer, the MBMS broadcast area, or both.

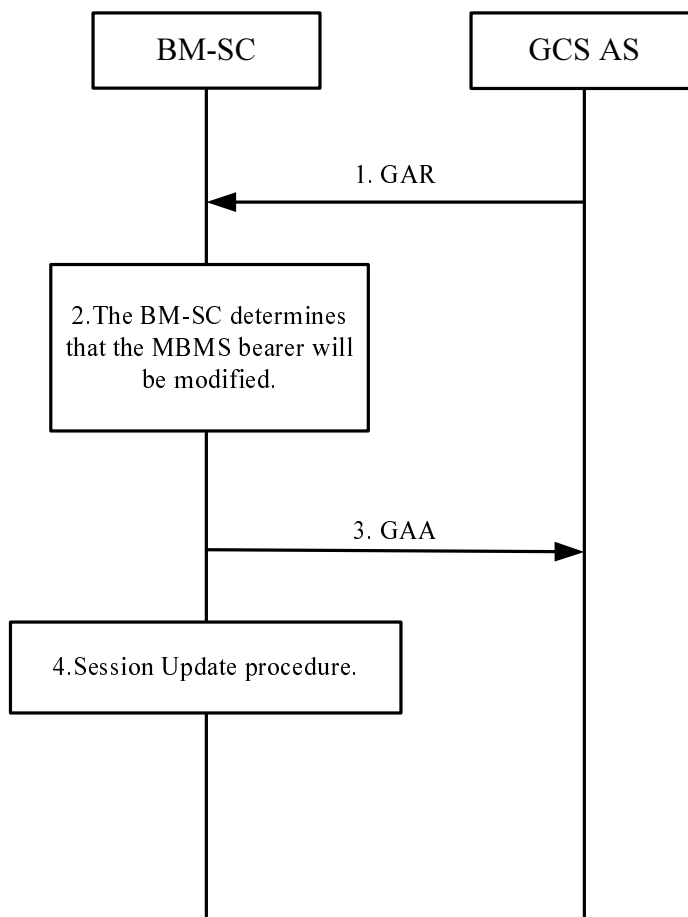

Figure A.2.3.1: Modify MBMS bearer Procedure

1. When the GCS AS determines that an activated MBMS bearer needs to be modified, it sends a GAR command to the BM-SC, including the parameters as defined in clause 5.3.4.
2. The BM-SC determines that the MBMS bearer can be modified.
3. The BM-SC sends a GAA command to the GCS AS including the parameters as defined in clause 5.3.4.
4. The BM-SC applies the Session Update procedure as defined in clause 20.3.2 of TS 29.061 [6].

A.2.4 MBMS Bearer Status Indication Procedure

Figure A.2.4-1 provides the procedure used between the GCS AS and the BM-SC to indicate the change of the MBMS bearer status, e.g. a release of the MBMS bearer.

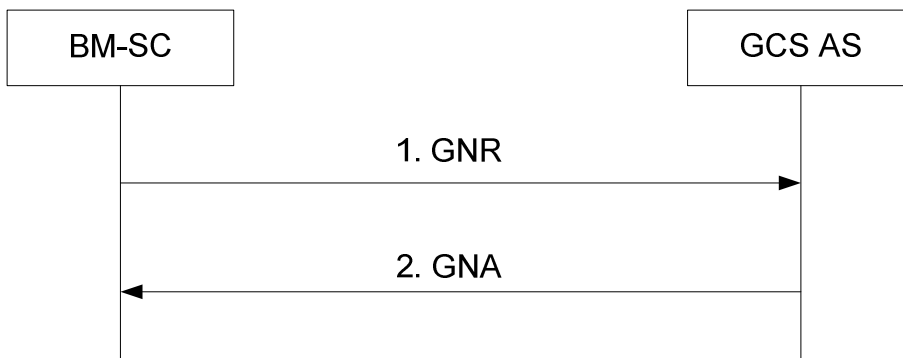

Figure A.2.4-1: MBMS Bearer Status Indication Procedure

1. If the BM-SC receives a MBMS session termination request initiated by the MBMS GW, or if the BM-SC is configured to receive a delayed session start response from the MBMS GW, or if the BM-SC detects the SGmb path failure, the BM-SC sends a Diameter GNR command to indicate the bearer status to the GCS AS including the parameters as defined in clause 5.3.5. Other actions which will trigger the MBMS bearer status indication procedure are not included in this specification.
2. The GCS AS responds to the BM-SC with a Diameter GNA command. The Diameter session ends after the GNA command.

A.3 Restoration Procedures

A.3.1 GCS AS initiated Heartbeat Procedure

The Heartbeat Procedure is used by the GCS AS to detect an MB2-C path failure or the outage or restart of a peer BM-SC.

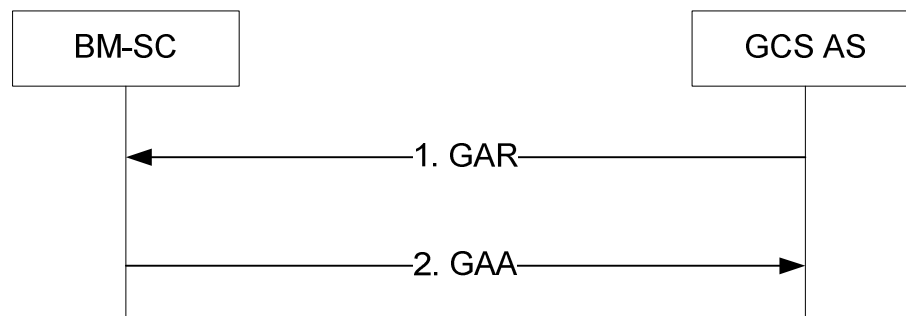

Figure A.3.1-1: GCS AS initiated Heartbeat Procedure

1. The GCS AS periodically sends a GAR including the Restart-Counter AVP to a peer BM-SC when no other signalling is exchanged between those two nodes, as defined in clause 5.6.3.
2. The BM-SC replies with a GAA including the Restart-Counter AVP.

A.3.2 BM-SC initiated Heartbeat Procedure

The Heartbeat Procedure is used by the BM-SC to detect an MB2-C path failure or the outage or restart of a peer GCS AS.

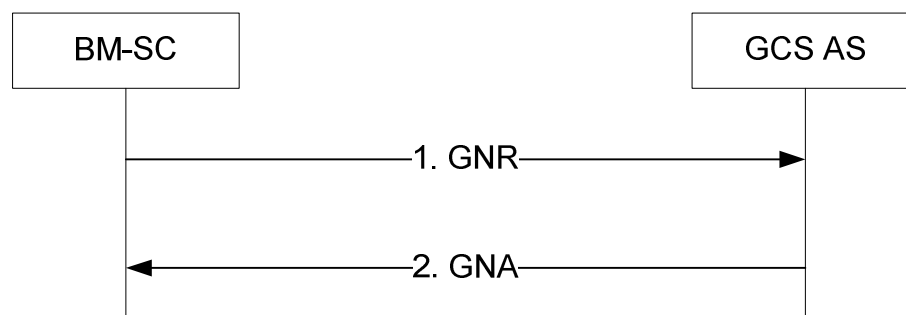

Figure A.3.2-1: BM-SC initiated Heartbeat Procedure

1. The BM-SC periodically sends a GNR including the Restart-Counter AVP to a peer GCS AS when no other signalling is exchanged between those two nodes, as defined in clause 5.6.4.
2. The GCS AS replies with a GNA including the Restart-Counter AVP.

Annex B (normative): Diameter message priority mechanism

B.1 General

IETF RFC 7944 [25] specifies the Diameter message priority mechanism that allows Diameter nodes to indicate the relative priority of Diameter messages. With this information, other Diameter nodes can leverage the relative priority of Diameter messages into routing, resource allocation, and also abatement decisions when overload control is applied.

B.2 MB2-C interface

B.2.1 General

The Diameter message priority mechanism is an optional feature which may apply on the MB2-C interface. It is recommended to make use of IETF RFC 7944 [25] over the MB2-C interface of an operator network.

B.2.2 GCS AS behaviour

When the GCS AS supports the Diameter message priority mechanism, the GCS AS shall comply with IETF RFC 7944 [25].

The GCS AS sending a request shall determine the required priority according to its policies. When priority is required, the GCS AS shall include the DRMP AVP indicating the required priority level in the request it sends, and shall prioritise the request according to the required priority level.

When the GCS AS receives the corresponding response, it shall prioritise the received response according to the priority level received within the DRMP AVP if present in the response, otherwise according to the priority level of the corresponding request.

When the GCS AS receives a request, it shall handle the request according to the received DRMP AVP priority level. For the response, it may modify the priority level received in the DRMP AVP according to its policies and shall handle the response according to the required priority level. If the required priority level is different from the priority level received in the request, it shall include the DRMP AVP in the response.

If:

- the GCS AS supports using the Diameter message priority mechanism for DSCP marking purposes,
- the transport network utilizes DSCP marking, and
- message-dependant DSCP marking is possible for the protocol stack transporting Diameter,

then the GCS AS shall set the DSCP marking for transport of the request or response according to the required priority level.

Diameter requests related to priority traffic shall contain a DRMP AVP with a high priority of which the level value is operator dependent.

When not required according to the procedures above, the decisions of the 3GPP functional entity to include the DRMP AVP and a particular priority level value are implementation specific.

B.2.3 BM-SC behaviour

When the BM-SC supports the Diameter message priority mechanism, the BM-SC shall comply with IETF RFC 7944 [25].

The BM-SC sending a request shall determine the required priority according to its policies. When priority is required, the BM-SC shall include the DRMP AVP indicating the required priority level in the request it sends, and shall prioritise the request according to the required priority level.

When the BM-SC receives the corresponding response, it shall prioritise the received response according to the priority level received within the DRMP AVP if present in the response, otherwise according to the priority level of the corresponding request.

When the BM-SC receives a request, it shall handle the request according to the received DRMP AVP priority level. For the response, it may modify the priority level received in the DRMP AVP according to its policies and shall handle the response according to the required priority level. If the required priority level is different from the priority level received in the request, it shall include the DRMP AVP in the response.

If:

- the BM-SC supports using the Diameter message priority mechanism for DSCP marking purposes,
- the transport network utilizes DSCP marking, and
- message-dependant DSCP marking is possible for the protocol stack transporting Diameter,

then the BM-SC shall set the DSCP marking for transport of the request or response according to the required priority level.

Diameter requests related to priority traffic shall contain a DRMP AVP with a high priority of which the level value is operator dependent.

When not required according to the procedures above, the decisions of the 3GPP functional entity to include the DRMP AVP and a particular priority level value are implementation specific.

Annex C (normative): Diameter load control mechanism

C.1 General

IETF RFC 8583 [26] specifies the Diameter load control mechanism. This includes the definition of Diameter Load AVP and the Diameter load related behaviour.

The Diameter load control mechanism on the MB2-C interface is optional for the GCS AS and the BM-SC.

NOTE: The Diameter Load AVP will simply be ignored by peers not supporting Diameter load control.

If the GCS AS and the BM-SC support the Diameter load control mechanism, they shall apply the procedures in the present Annex.

C.2 GCS AS behaviour

The GCS AS shall act as a reacting node as defined in IETF RFC 8583 [26] and may use the load information in an implementation dependent manner, e.g. when deciding where to route requests for new Diameter sessions.

C.3 BM-SC behaviour

The BM-SC shall act as endpoint reporting node as defined IETF RFC 8583 [26]. The BM-SC shall include load information in the the Load AVP within GCS-Action-Answer messages.

When and in which frequency to include the Load AVP is implementation dependent and based on operator policy.

How the BM-SC determines the specific contents of the Load-Value AVP within the Load AVP is implementation dependent and based on operator policy.

Annex D (informative): Change history

Change history							
Date	TSG #	TSG Doc.	CR	Rev	Subject/Comment	Old	New
09/2014	CT#65	CP-140562			Raised to v.12.0.0 following CT#65 approval	2.0.0	12.0.0
10/2014	-	-	-	-	"Foreword" section added	12.0.0	12.0.1
12/2014	CT#66	CP-140910	0001	1	"Foreword" section added	12.0.1	12.1.0
12/2014	CT#66	CP-140910	0002		TMGI allocation and deallocation by BM-SC	12.0.1	12.1.0
12/2014	CT#66	CP-140910	003		MBMS bearers termination based on TMGI deallocation request from GCS AS	12.0.1	12.1.0
12/2014	CT#66	CP-140910	0004		Protocol Numbers	12.0.1	12.1.0
12/2014	CT#66	CP-140910	0005	3	MB2-U Security	12.0.1	12.1.0
12/2014	CT#66	CP-140910	0006	1	MB2-U User Plane terminated in the UE	12.0.1	12.1.0
12/2014	CT#66	CP-140910	0007	3	Heartbeat procedure	12.0.1	12.1.0
12/2014	CT#66	CP-140910	0008	1	Correction of the MB2 mandatory function	12.0.1	12.1.0
12/2014	CT#66	CP-140910	0009	2	Correction of the TMGI allocation and deallocation procedures	12.0.1	12.1.0
12/2014	CT#66	CP-140910	0010	1	Correction of the TMGI handling	12.0.1	12.1.0
03/2015	CT#67	CP-150119	0012	1	TMGI and Flow ID Handling	12.1.0	12.2.0
03/2015	CT#67	CP-150119	0013	3	Activation of an additional MBMS Bearer for a TMGI with already an active MBMS Bearer	12.1.0	12.2.0
06/2015	CT#68	CP-150352	0015	1	MB2 authorization	12.2.0	12.3.0
12/2015	CT#70	CP-150652	0017	2	Corrections of command codes and corrections of editorial nature	12.3.0	12.4.0
12/2015	CT#70	CP-150658	0016	-	Addition of MBMS Cell List	12.4.0	13.0.0
Change history							
Date	TSG #	TSG Doc.	CR	Rev	Cat	Subject/Comment	New
2016-03	CT#71	CP-160101	0019	2	B	Diameter message priority over MB2	13.1.0
2016-12	CT#74	CP-160614	0020	-	F	Change IETF drmp draft version to official RFC 7944	13.2.0
2016-12	CT#74	CP-160632	0021	4	B	Local MBMS related MBMS data delivery	14.0.0
2016-12	CT#74	CP-160616	0022	1	F	Diameter base protocol specification update	14.0.0
2016-12	CT#74	CP-160615	0023	-	B	Diameter Load Control Mechanism	14.0.0
2017-03	CT#75	CP-170076	0024	-	B	Update instance number for the Failed-AVP in answer commands	14.1.0
2017-06	CT#76	CP-171119	0026	2	F	Reference update for draft-ietf-dime-load	14.2.0
2017-06	CT#76	CP-171133	0031	3	A	Support for signaling transport level packet marking	14.2.0
2017-06	CT#76	CP-171121	0034	-	A	Correction of MBMS Bearer Request AVP	14.2.0
2017-06	CT#76	CP-171118	0035	-	F	Corrections of DRMP procedures	14.2.0
2017-06	CT#76	CP-171136	0029	1	F	Correction of Value for TMGI Deallocation Result AVP	15.0.0
2017-09	CT#77	CP-172052	0036	1	F	Correction for Radio-Frequency AVP in MBMS Bearer-Response AVP	15.1.0
2017-12	CT#78	CP-173093	0039	-	A	Correction for MBMS Bearer Event-Notification AVP	15.2.0
2017-12	CT#78	CP-173093	0042	-	A	Generic error code in MB2 response message	15.2.0
2017-12	CT#78	CP-173105	0043	1	B	Clarification for MBMS bearer activation procedure	15.2.0
2018-06	CT#80	CP-181021	0046	-	F	Correction for TMGI-Deallocation-Request AVP	15.3.0
2018-06	CT#80	CP-181023	0047	3	B	FEC and ROHC for mission critical services over MBMS	15.3.0
2018-09	CT#81	CP-182027	0048	-	F	Removing LTE restriction	15.4.0
2018-09	CT#81	CP-182027	0049	-	F	Correction for FEC and ROHC	15.4.0
2019-03	CT#83	CP-190128	0050	1	F	MB2 Corrections for ROHC usage	15.5.0
2019-06	CT#84	CP-191098	0053	-	A	MBMS bearer activation correction	15.6.0
2019-06	CT#84	CP-191099	0054	1	F	MBMS bearer activation correction	15.6.0
2019-09	CT#85	CP-192154	0056	1	A	draft-ietf-dime-load published as RFC 8583	15.7.0
2019-12	CT#86	CP-193203	0051	2	F	Format for FEC framework configuration information in MB2	15.8.0
2020-07	SA#88e	-	-	-	-	Update to Rel-16 version (MCC)	16.0.0
2021-03	CT#91e	CP-210232	0057	1	B	Support IPv4v6 dual stack BMSC Address	17.0.0
2021-12	CT#94e	CP-213243	0058	1	B	Notification Event enhancement in MB2	17.1.0
2024-03	SA#103	-	-	-	-	Update to Rel-18 version (MCC)	18.0.0

History

Document history		
V18.0.0	May 2024	Publication