

# ETSI TS 129 510 V17.8.0 (2023-01)



**5G;  
5G System;  
Network function repository services;  
Stage 3  
(3GPP TS 29.510 version 17.8.0 Release 17)**



---

**Reference**

RTS/TSGC-0429510vh80

---

**Keywords**

5G

**ETSI**

---

650 Route des Lucioles  
F-06921 Sophia Antipolis Cedex - FRANCE

Tel.: +33 4 92 94 42 00 Fax: +33 4 93 65 47 16

Siret N° 348 623 562 00017 - APE 7112B  
Association à but non lucratif enregistrée à la  
Sous-Préfecture de Grasse (06) N° w061004871

---

**Important notice**The present document can be downloaded from:  
<http://www.etsi.org/standards-search>

The present document may be made available in electronic versions and/or in print. The content of any electronic and/or print versions of the present document shall not be modified without the prior written authorization of ETSI. In case of any existing or perceived difference in contents between such versions and/or in print, the prevailing version of an ETSI deliverable is the one made publicly available in PDF format at [www.etsi.org/deliver](http://www.etsi.org/deliver).

Users of the present document should be aware that the document may be subject to revision or change of status. Information on the current status of this and other ETSI documents is available at <https://portal.etsi.org/TB/ETSIDeliverableStatus.aspx>

If you find errors in the present document, please send your comment to one of the following services:  
<https://portal.etsi.org/People/CommitteeSupportStaff.aspx>

If you find a security vulnerability in the present document, please report it through our Coordinated Vulnerability Disclosure Program:  
<https://www.etsi.org/standards/coordinated-vulnerability-disclosure>

---

**Notice of disclaimer & limitation of liability**

The information provided in the present deliverable is directed solely to professionals who have the appropriate degree of experience to understand and interpret its content in accordance with generally accepted engineering or other professional standard and applicable regulations.

No recommendation as to products and services or vendors is made or should be implied.

No representation or warranty is made that this deliverable is technically accurate or sufficient or conforms to any law and/or governmental rule and/or regulation and further, no representation or warranty is made of merchantability or fitness for any particular purpose or against infringement of intellectual property rights.

In no event shall ETSI be held liable for loss of profits or any other incidental or consequential damages.

Any software contained in this deliverable is provided "AS IS" with no warranties, express or implied, including but not limited to, the warranties of merchantability, fitness for a particular purpose and non-infringement of intellectual property rights and ETSI shall not be held liable in any event for any damages whatsoever (including, without limitation, damages for loss of profits, business interruption, loss of information, or any other pecuniary loss) arising out of or related to the use of or inability to use the software.

---

**Copyright Notification**

No part may be reproduced or utilized in any form or by any means, electronic or mechanical, including photocopying and microfilm except as authorized by written permission of ETSI.

The content of the PDF version shall not be modified without the written authorization of ETSI.  
The copyright and the foregoing restriction extend to reproduction in all media.

© ETSI 2023.  
All rights reserved.

---

# Intellectual Property Rights

## Essential patents

IPRs essential or potentially essential to normative deliverables may have been declared to ETSI. The declarations pertaining to these essential IPRs, if any, are publicly available for **ETSI members and non-members**, and can be found in ETSI SR 000 314: "*Intellectual Property Rights (IPRs); Essential, or potentially Essential, IPRs notified to ETSI in respect of ETSI standards*", which is available from the ETSI Secretariat. Latest updates are available on the ETSI Web server (<https://ipr.etsi.org/>).

Pursuant to the ETSI Directives including the ETSI IPR Policy, no investigation regarding the essentiality of IPRs, including IPR searches, has been carried out by ETSI. No guarantee can be given as to the existence of other IPRs not referenced in ETSI SR 000 314 (or the updates on the ETSI Web server) which are, or may be, or may become, essential to the present document.

## Trademarks

The present document may include trademarks and/or tradenames which are asserted and/or registered by their owners. ETSI claims no ownership of these except for any which are indicated as being the property of ETSI, and conveys no right to use or reproduce any trademark and/or tradename. Mention of those trademarks in the present document does not constitute an endorsement by ETSI of products, services or organizations associated with those trademarks.

**DECT™**, **PLUGTESTS™**, **UMTS™** and the ETSI logo are trademarks of ETSI registered for the benefit of its Members. **3GPP™** and **LTE™** are trademarks of ETSI registered for the benefit of its Members and of the 3GPP Organizational Partners. **oneM2M™** logo is a trademark of ETSI registered for the benefit of its Members and of the oneM2M Partners. **GSM®** and the GSM logo are trademarks registered and owned by the GSM Association.

---

# Legal Notice

This Technical Specification (TS) has been produced by ETSI 3rd Generation Partnership Project (3GPP).

The present document may refer to technical specifications or reports using their 3GPP identities. These shall be interpreted as being references to the corresponding ETSI deliverables.

The cross reference between 3GPP and ETSI identities can be found under <http://webapp.etsi.org/key/queryform.asp>.

---

# Modal verbs terminology

In the present document "**shall**", "**shall not**", "**should**", "**should not**", "**may**", "**need not**", "**will**", "**will not**", "**can**" and "**cannot**" are to be interpreted as described in clause 3.2 of the [ETSI Drafting Rules](#) (Verbal forms for the expression of provisions).

"**must**" and "**must not**" are **NOT** allowed in ETSI deliverables except when used in direct citation.

# Contents

Intellectual Property Rights .....	2
Legal Notice .....	2
Modal verbs terminology.....	2
Foreword.....	10
1 Scope .....	12
2 References .....	12
3 Definitions and abbreviations.....	14
3.1 Definitions .....	14
3.2 Abbreviations .....	14
4 Overview .....	14
5 Services Offered by the NRF .....	15
5.1 Introduction .....	15
5.2 Nnrf_NFManagement Service.....	16
5.2.1 Service Description.....	16
5.2.2 Service Operations .....	17
5.2.2.1 Introduction.....	17
5.2.2.2 NFRegister .....	18
5.2.2.2.1 General .....	18
5.2.2.2.2 NF (other than NRF) registration to NRF.....	18
5.2.2.2.3 NRF registration to another NRF .....	19
5.2.2.3 NFUpdate.....	19
5.2.2.3.1 General .....	19
5.2.2.3.2 NF Heart-Beat .....	21
5.2.2.4 NFDeregister.....	22
5.2.2.4.1 General .....	22
5.2.2.5 NFStatusSubscribe .....	23
5.2.2.5.1 General .....	23
5.2.2.5.2 Subscription to NF Instances in the same PLMN.....	23
5.2.2.5.3 Subscription to NF Instances in a different PLMN .....	24
5.2.2.5.4 Subscription to NF Instances with intermediate forwarding NRF.....	25
5.2.2.5.5 Subscription to NF Instances with intermediate redirecting NRF .....	26
5.2.2.5.6 Update of Subscription to NF Instances .....	27
5.2.2.5.7 Update of Subscription to NF Instances in a different PLMN.....	28
5.2.2.6 NFStatusNotify .....	29
5.2.2.6.1 General .....	29
5.2.2.6.2 Notification from NRF in the same PLMN .....	29
5.2.2.6.3 Notification from NRF in a different PLMN.....	30
5.2.2.6.4 Notification for subscription via intermediate NRF .....	30
5.2.2.7 NFStatusUnSubscribe .....	31
5.2.2.7.1 General .....	31
5.2.2.7.2 Subscription removal in the same PLMN.....	31
5.2.2.7.3 Subscription removal in a different PLMN .....	31
5.2.2.8 NFListRetrieval.....	32
5.2.2.8.1 General .....	32
5.2.2.9 NFProfileRetrieval .....	33
5.2.2.9.1 General .....	33
5.3 Nnrf_NFDiscovery Service .....	33
5.3.1 Service Description.....	33
5.3.2 Service Operations .....	34
5.3.2.1 Introduction.....	34
5.3.2.2 NFDiscover .....	35
5.3.2.2.1 General .....	35
5.3.2.2.2 Service Discovery in the same PLMN.....	35

5.3.2.2.3	Service Discovery in a different PLMN .....	36
5.3.2.2.4	Service Discovery with intermediate redirecting NRF .....	37
5.3.2.2.5	Service Discovery with intermediate forwarding NRF .....	38
5.3.2.2.6	Service Discovery with resolution of the target PLMN .....	39
5.3.2.3	SCPDomainRoutingInfoGet .....	40
5.3.2.4	SCPDomainRoutingInfoSubscribe .....	41
5.3.2.5	SCPDomainRoutingInfoNotify .....	42
5.3.2.6	SCPDomainRoutingInfoUnSubscribe .....	42
5.4	Nnrf_AccessToken Service .....	43
5.4.1	Service Description .....	43
5.4.2	Service Operations .....	43
5.4.2.1	Introduction .....	43
5.4.2.2	Get (Access Token Request) .....	43
5.4.2.2.1	General .....	43
5.4.2.2.2	Access Token request with intermediate forwarding NRF .....	44
5.4.2.2.3	Access Token request with intermediate redirecting NRF .....	45
5.5	Nnrf_Bootstrapping Service .....	46
5.5.1	Service Description .....	46
5.5.2	Service Operations .....	47
5.5.2.1	Introduction .....	47
5.5.2.2	Get .....	47
5.5.2.2.1	General .....	47
6	API Definitions .....	48
6.1	Nnrf_NFManagement Service API .....	48
6.1.1	API URI .....	48
6.1.2	Usage of HTTP .....	48
6.1.2.1	General .....	48
6.1.2.2	HTTP standard headers .....	48
6.1.2.2.1	General .....	48
6.1.2.2.2	Content type .....	48
6.1.2.2.3	Accept-Encoding .....	49
6.1.2.2.4	ETag .....	49
6.1.2.2.5	If-Match .....	49
6.1.2.3	HTTP custom headers .....	49
6.1.2.3.1	General .....	49
6.1.3	Resources .....	49
6.1.3.1	Overview .....	49
6.1.3.2	Resource: nf-instances (Store) .....	51
6.1.3.2.1	Description .....	51
6.1.3.2.2	Resource Definition .....	51
6.1.3.2.3	Resource Standard Methods .....	51
6.1.3.2.4	Resource Custom Operations .....	55
6.1.3.3	Resource: nf-instance (Document) .....	55
6.1.3.3.1	Description .....	55
6.1.3.3.2	Resource Definition .....	56
6.1.3.3.3	Resource Standard Methods .....	56
6.1.3.4	Resource: subscriptions (Collection) .....	62
6.1.3.4.1	Description .....	62
6.1.3.4.2	Resource Definition .....	62
6.1.3.4.3	Resource Standard Methods .....	62
6.1.3.5	Resource: subscription (Document) .....	64
6.1.3.5.1	Description .....	64
6.1.3.5.2	Resource Definition .....	64
6.1.3.5.3	Resource Standard Methods .....	64
6.1.4	Custom Operations without associated resources .....	66
6.1.5	Notifications .....	66
6.1.5.1	General .....	66
6.1.5.2	NF Instance Status Notification .....	67
6.1.5.2.1	Description .....	67
6.1.5.2.2	Notification Definition .....	67
6.1.6	Data Model .....	68

6.1.6.1	General .....	68
6.1.6.2	Structured data types .....	73
6.1.6.2.1	Introduction .....	73
6.1.6.2.2	Type: NFProfile .....	74
6.1.6.2.3	Type: NFSservice .....	84
6.1.6.2.4	Type: DefaultNotificationSubscription .....	91
6.1.6.2.5	Type: IpEndPoint .....	93
6.1.6.2.6	Type: UdrInfo .....	94
6.1.6.2.7	Type: UdmInfo .....	95
6.1.6.2.8	Type: AusfInfo .....	96
6.1.6.2.9	Type: SupiRange .....	96
6.1.6.2.10	Type: IdentityRange .....	97
6.1.6.2.11	Type: AmfInfo .....	97
6.1.6.2.12	Type: SmfInfo .....	99
6.1.6.2.13	Type: UpfInfo .....	102
6.1.6.2.14	Type: SnsaiUpfInfoItem .....	104
6.1.6.2.15	Type: DnnUpfInfoItem .....	105
6.1.6.2.16	Type: SubscriptionData .....	106
6.1.6.2.17	Type: NotificationData .....	111
6.1.6.2.18	Void .....	112
6.1.6.2.19	Type: NFSserviceVersion .....	112
6.1.6.2.20	Type: PcfInfo .....	113
6.1.6.2.21	Type: BsfInfo .....	114
6.1.6.2.22	Type: Ipv4AddressRange .....	114
6.1.6.2.23	Type: Ipv6PrefixRange .....	115
6.1.6.2.24	Type: InterfaceUpfInfoItem .....	115
6.1.6.2.25	Type: UriList .....	115
6.1.6.2.26	Type: N2InterfaceAmfInfo .....	116
6.1.6.2.27	Type: TaiRange .....	116
6.1.6.2.28	Type: TacRange .....	116
6.1.6.2.29	Type: SnsaiSmfInfoItem .....	117
6.1.6.2.30	Type: DnnSmfInfoItem .....	117
6.1.6.2.31	Type: NrfInfo .....	118
6.1.6.2.32	Type: ChfInfo .....	122
6.1.6.2.33	Void .....	123
6.1.6.2.34	Type: PlmnRange .....	123
6.1.6.2.35	Type: SubscrCond .....	124
6.1.6.2.36	Type: NfInstanceIdCond .....	124
6.1.6.2.37	Type: NfTypeCond .....	125
6.1.6.2.38	Type: ServiceNameCond .....	125
6.1.6.2.39	Type: AmfCond .....	125
6.1.6.2.40	Type: GuamiListCond .....	125
6.1.6.2.41	Type: NetworkSliceCond .....	125
6.1.6.2.42	Type: NfGroupCond .....	126
6.1.6.2.43	Type: NotifCondition .....	126
6.1.6.2.44	Type: PlmnSnsai .....	126
6.1.6.2.45	Type: NwdafInfo .....	127
6.1.6.2.46	Type: LmfInfo .....	128
6.1.6.2.47	Type: GmlcInfo .....	129
6.1.6.2.48	Type: NefInfo .....	130
6.1.6.2.49	Type: PfdData .....	130
6.1.6.2.50	Type: AfEventExposureData .....	130
6.1.6.2.51	Type: WAgfInfo .....	131
6.1.6.2.52	Type: TngfInfo .....	131
6.1.6.2.53	Type: PscfInfo .....	131
6.1.6.2.54	Type: NfSetCond .....	132
6.1.6.2.55	Type: NfServiceSetCond .....	132
6.1.6.2.56	Type: NfInfo .....	132
6.1.6.2.57	Type: HssInfo .....	133
6.1.6.2.58	Type: ImsiRange .....	133
6.1.6.2.59	Type: InternalGroupIdRange .....	134
6.1.6.2.60	Type: UpfCond .....	134

6.1.6.2.61	Type: TwifInfo .....	134
6.1.6.2.62	Type: VendorSpecificFeature .....	135
6.1.6.2.63	Type: UdsfInfo .....	135
6.1.6.2.64	Type: NfInstanceIdListCond .....	135
6.1.6.2.65	Type: ScpInfo .....	136
6.1.6.2.66	Type: ScpDomainInfo .....	139
6.1.6.2.67	Type: ScpDomainCond .....	139
6.1.6.2.68	Type: OptionsResponse .....	140
6.1.6.2.69	Type: NwdafCond .....	140
6.1.6.2.70	Type: NefCond .....	141
6.1.6.2.71	Type: SuciInfo .....	141
6.1.6.2.72	Type: SeppInfo .....	142
6.1.6.2.73	Type: AanfInfo .....	142
6.1.6.2.74	Type: 5GDdnmfInfo .....	142
6.1.6.2.75	Type: MfafInfo .....	142
6.1.6.2.76	Type: NwdafCapability .....	143
6.1.6.2.77	Type: EasdfInfo .....	143
6.1.6.2.78	Type: SnssaiEasdfInfoItem .....	143
6.1.6.2.79	Type: DnnEasdfInfoItem .....	144
6.1.6.2.80	Type: DccfInfo .....	144
6.1.6.2.81	Type: NsacfInfo .....	145
6.1.6.2.82	Type: NsacfCapability .....	145
6.1.6.2.83	Type: DccfCond .....	146
6.1.6.2.84	Type: MlAnalyticsInfo .....	146
6.1.6.2.85	Type: MbSmfInfo .....	147
6.1.6.2.86	Type: TmgiRange .....	147
6.1.6.2.87	Type: MbsSession .....	148
6.1.6.2.88	Type: SnssaiMbSmfInfoItem .....	148
6.1.6.2.89	Type: DnnMbSmfInfoItem .....	148
6.1.6.2.90	Void .....	149
6.1.6.2.91	Type: TsctsInfo .....	149
6.1.6.2.92	Type: SnssaiTsctsInfoItem .....	149
6.1.6.2.93	Type: DnnTsctsInfoItem .....	149
6.1.6.2.94	Type: MbUpfInfo .....	150
6.1.6.2.95	Type: UnTrustAfInfo .....	150
6.1.6.2.96	Type: TrustAfInfo .....	151
6.1.6.2.97	Type: SnssaiInfoItem .....	151
6.1.6.2.98	Type: DnnInfoItem .....	151
6.1.6.2.99	Type: CollocatedNfInstance .....	152
6.1.6.2.100	Type: ServiceNameListCond .....	152
6.1.6.2.101	Type: NfGroupListCond .....	152
6.1.6.2.102	Type: PlmnOauth2 .....	152
6.1.6.2.103	Type: V2xCapability .....	153
6.1.6.2.104	Type: NssaafInfo .....	153
6.1.6.2.105	Type: ProSeCapability .....	154
6.1.6.2.106	Type: SharedDataIdRange .....	154
6.1.6.2.107	Type: SubscriptionContext .....	155
6.1.6.2.108	Type: IwmscInfo .....	155
6.1.6.2.109	Type: MnpfInfo .....	155
6.1.6.2.110	Type: DefSubServiceInfo .....	155
6.1.6.3	Simple data types and enumerations .....	156
6.1.6.3.1	Introduction .....	156
6.1.6.3.2	Simple data types .....	156
6.1.6.3.3	Enumeration: NFType .....	156
6.1.6.3.4	Enumeration: NotificationType .....	158
6.1.6.3.5	Enumeration: TransportProtocol .....	161
6.1.6.3.6	Enumeration: NotificationEventType .....	161
6.1.6.3.7	Enumeration: NFStatus .....	161
6.1.6.3.8	Enumeration: DataSetId .....	161
6.1.6.3.9	Enumeration: UPInterfaceType .....	162
6.1.6.3.10	Relation Types .....	162
6.1.6.3.11	Enumeration: ServiceName .....	163

6.1.6.3.12	Enumeration: NFServiceStatus.....	166
6.1.6.3.13	Enumeration: AnNodeType.....	166
6.1.6.3.14	Enumeration: ConditionEventType.....	166
6.1.6.3.15	Enumeration: IpReachability.....	166
6.1.6.3.16	Enumeration: ScpCapability.....	167
6.1.6.3.17	Enumeration: CollocatedNFType.....	167
6.1.7	Error Handling.....	167
6.1.7.1	General.....	167
6.1.7.2	Protocol Errors.....	167
6.1.7.3	Application Errors.....	167
6.1.8	Security.....	167
6.1.9	Features supported by the NFManagement service.....	168
6.2	Nnrf_NFDiscovery Service API.....	168
6.2.1	API URI.....	168
6.2.2	Usage of HTTP.....	169
6.2.2.1	General.....	169
6.2.2.2	HTTP standard headers.....	169
6.2.2.2.1	General.....	169
6.2.2.2.2	Content type.....	169
6.2.2.2.3	Cache-Control.....	169
6.2.2.2.4	ETag.....	169
6.2.2.2.5	If-None-Match.....	169
6.2.2.3	HTTP custom headers.....	169
6.2.2.3.1	General.....	169
6.2.3	Resources.....	169
6.2.3.1	Overview.....	169
6.2.3.2	Resource: nf-instances (Store).....	171
6.2.3.2.1	Description.....	171
6.2.3.2.2	Resource Definition.....	171
6.2.3.2.3	Resource Standard Methods.....	171
6.2.3.2.4	Resource Custom Operations.....	189
6.2.3.3	Resource: Stored Search (Document).....	189
6.2.3.3.1	Description.....	189
6.2.3.3.2	Resource Definition.....	189
6.2.3.4	Resource: Complete Stored Search (Document).....	190
6.2.3.4.1	Description.....	190
6.2.3.4.2	Resource Definition.....	190
6.2.3.5	Resource: SCP Domain Routing Information (Document).....	191
6.2.3.5.1	Description.....	191
6.2.3.5.2	Resource Definition.....	191
6.2.3.6	Resource: SCP Domain Routing Information Subscriptions (Collection).....	192
6.2.3.6.1	Description.....	192
6.2.3.6.2	Resource Definition.....	192
6.2.3.6.3	Resource Standard Methods.....	192
6.2.3.7	Resource: Individual SCP Domain Routing Information Subscription (Document).....	193
6.2.3.7.1	Description.....	193
6.2.3.7.2	Resource Definition.....	193
6.2.3.7.3	Resource Standard Methods.....	193
6.2.4	Custom Operations without associated resources.....	194
6.2.5	Notifications.....	194
6.2.5.1	General.....	194
6.2.5.2	SCP Domain Routing Information Change Notification.....	194
6.2.5.2.1	Description.....	194
6.2.5.2.2	Notification Definition.....	194
6.2.6	Data Model.....	195
6.2.6.1	General.....	195
6.2.6.2	Structured data types.....	198
6.2.6.2.1	Introduction.....	198
6.2.6.2.2	Type: SearchResult.....	199
6.2.6.2.3	Type: NFProfile.....	201
6.2.6.2.4	Type: NFService.....	208
6.2.6.2.5	Type: StoredSearchResult.....	211



6.2.6.2.6	Type: PreferredSearch .....	212
6.2.6.2.7	Type: NfInstanceInfo .....	214
6.2.6.2.8	Type: ScpDomainRoutingInformation .....	215
6.2.6.2.9	Type: ScpDomainConnectivity .....	215
6.2.6.2.10	Type: ScpDomainRoutingInfoSubscription .....	216
6.2.6.2.11	Type: ScpDomainRoutingInfoNotification .....	216
6.2.6.2.12	Type: NfServiceInstance .....	216
6.2.6.2.13	Type: NoProfileMatchInfo .....	217
6.2.6.2.14	Type: QueryParamCombination .....	217
6.2.6.2.15	Type: QueryParameter .....	217
6.2.6.3	Simple data types and enumerations .....	217
6.2.6.3.1	Introduction .....	217
6.2.6.3.2	Simple data types .....	217
6.2.6.3.3	Enumeration: NoProfileMatchReason .....	217
6.2.7	Error Handling .....	218
6.2.7.1	General .....	218
6.2.7.2	Protocol Errors .....	218
6.2.7.3	Application Errors .....	218
6.2.8	Security .....	218
6.2.9	Features supported by the NFDISCOVERY service .....	218
6.3	Nnrf_AccessToken Service API .....	223
6.3.1	General .....	223
6.3.2	API URI .....	223
6.3.3	Usage of HTTP .....	223
6.3.3.1	General .....	223
6.3.3.2	HTTP standard headers .....	224
6.3.3.2.1	General .....	224
6.3.3.2.2	Content type .....	224
6.3.3.3	HTTP custom headers .....	224
6.3.3.3.1	General .....	224
6.3.4	Custom Operations without associated resources .....	224
6.3.4.1	Overview .....	224
6.3.4.2	Operation: Get (Access Token Request) .....	224
6.3.4.2.1	Description .....	224
6.3.4.2.2	Operation Definition .....	224
6.3.5	Data Model .....	226
6.3.5.1	General .....	226
6.3.5.2	Structured data types .....	226
6.3.5.2.1	Introduction .....	226
6.3.5.2.2	Type: AccessTokenReq .....	227
6.3.5.2.3	Type: AccessTokenRsp .....	231
6.3.5.2.4	Type: AccessTokenClaims .....	232
6.3.5.2.5	Type: AccessTokenErr .....	234
6.3.5.3	Simple data types and enumerations .....	234
6.3.5.3.1	Introduction .....	234
6.3.5.3.2	Simple data types .....	235
6.3.5.3.3	Void .....	235
6.3.5.4	Data types describing alternative data types or combinations of data types .....	235
6.3.5.4.1	Type: Audience .....	235
6.3.6	Error Handling .....	235
6.3.6.1	General .....	235
6.3.6.2	Protocol Errors .....	235
6.3.6.3	Application Errors .....	235
6.4	Nnrf_Bootstrapping Service API .....	235
6.4.1	API URI .....	235
6.4.2	Usage of HTTP .....	236
6.4.2.1	General .....	236
6.4.2.2	HTTP standard headers .....	236
6.4.2.2.1	General .....	236
6.4.2.2.2	Content type .....	236
6.4.2.2.3	Cache-Control .....	236
6.4.2.2.4	ETag .....	236

6.4.2.2.5	If-None-Match .....	236
6.4.2.3	HTTP custom headers .....	236
6.4.2.3.1	General .....	236
6.4.3	Resources .....	236
6.4.3.1	Overview .....	236
6.4.3.2	Resource: Bootstrapping (Document) .....	237
6.4.3.2.1	Description .....	237
6.4.3.2.2	Resource Definition .....	237
6.4.3.2.3	Resource Standard Methods .....	237
6.4.4	Custom Operations without associated resources .....	238
6.4.5	Notifications .....	238
6.4.6	Data Model .....	238
6.4.6.1	General .....	238
6.4.6.2	Structured data types .....	239
6.4.6.2.1	Introduction .....	239
6.4.6.2.2	Type: BootstrappingInfo .....	239
6.4.6.3	Simple data types and enumerations .....	239
6.4.6.3.1	Introduction .....	239
6.4.6.3.2	Enumeration: Status .....	240
6.4.6.3.3	Relation Types .....	240
<b>Annex A (normative):    OpenAPI specification .....</b>		<b>241</b>
A.1	General .....	241
A.2	Nnrf_NFManagement API .....	241
A.3	Nnrf_NFDiscovery API .....	299
A.4	Nnrf_AccessToken API (NRF OAuth2 Authorization) .....	325
A.5	Nnrf_Bootstrapping API .....	329
<b>Annex B (normative):    NF Profile changes in NFRegister and NFUpdate (NF Profile Complete Replacement) responses .....</b>		<b>332</b>
B.1	General .....	332
<b>Annex C (informative):    Change history .....</b>		<b>333</b>
History	.....	343

---

# Foreword

This Technical Specification has been produced by the 3rd Generation Partnership Project (3GPP).

The contents of the present document are subject to continuing work within the TSG and may change following formal TSG approval. Should the TSG modify the contents of the present document, it will be re-released by the TSG with an identifying change of release date and an increase in version number as follows:

Version x.y.z

where:

- x the first digit:
  - 1 presented to TSG for information;
  - 2 presented to TSG for approval;
  - 3 or greater indicates TSG approved document under change control.
- y the second digit is incremented for all changes of substance, i.e. technical enhancements, corrections, updates, etc.
- z the third digit is incremented when editorial only changes have been incorporated in the document.

In the present document, modal verbs have the following meanings:

- shall** indicates a mandatory requirement to do something
- shall not** indicates an interdiction (prohibition) to do something

The constructions "shall" and "shall not" are confined to the context of normative provisions, and do not appear in Technical Reports.

The constructions "must" and "must not" are not used as substitutes for "shall" and "shall not". Their use is avoided insofar as possible, and they are not used in a normative context except in a direct citation from an external, referenced, non-3GPP document, or so as to maintain continuity of style when extending or modifying the provisions of such a referenced document.

- should** indicates a recommendation to do something
- should not** indicates a recommendation not to do something
- may** indicates permission to do something
- need not** indicates permission not to do something

The construction "may not" is ambiguous and is not used in normative elements. The unambiguous constructions "might not" or "shall not" are used instead, depending upon the meaning intended.

- can** indicates that something is possible
- cannot** indicates that something is impossible

The constructions "can" and "cannot" are not substitutes for "may" and "need not".

- will** indicates that something is certain or expected to happen as a result of action taken by an agency the behaviour of which is outside the scope of the present document
- will not** indicates that something is certain or expected not to happen as a result of action taken by an agency the behaviour of which is outside the scope of the present document
- might** indicates a likelihood that something will happen as a result of action taken by some agency the behaviour of which is outside the scope of the present document

**might not** indicates a likelihood that something will not happen as a result of action taken by some agency the behaviour of which is outside the scope of the present document

In addition:

**is** (or any other verb in the indicative mood) indicates a statement of fact

**is not** (or any other negative verb in the indicative mood) indicates a statement of fact

The constructions "is" and "is not" do not indicate requirements.

---

# 1 Scope

The present document specifies the stage 3 protocol and data model for the Nnrf Service Based Interface. It provides stage 3 protocol definitions and message flows, and specifies the API for each service offered by the NRF.

The 5G System stage 2 architecture and procedures are specified in 3GPP TS 23.501 [2] and 3GPP TS 23.502 [3].

The Technical Realization of the Service Based Architecture and the Principles and Guidelines for Services Definition are specified in 3GPP TS 29.500 [4] and 3GPP TS 29.501 [5].

---

# 2 References

The following documents contain provisions which, through reference in this text, constitute provisions of the present document.

- References are either specific (identified by date of publication, edition number, version number, etc.) or non-specific.
- For a specific reference, subsequent revisions do not apply.
- For a non-specific reference, the latest version applies. In the case of a reference to a 3GPP document (including a GSM document), a non-specific reference implicitly refers to the latest version of that document *in the same Release as the present document*.

- [1] 3GPP TR 21.905: "Vocabulary for 3GPP Specifications".
- [2] 3GPP TS 23.501: "System Architecture for the 5G System; Stage 2".
- [3] 3GPP TS 23.502: "Procedures for the 5G System; Stage 2".
- [4] 3GPP TS 29.500: "5G System; Technical Realization of Service Based Architecture; Stage 3".
- [5] 3GPP TS 29.501: "5G System; Principles and Guidelines for Services Definition; Stage 3".
- [6] 3GPP TS 29.518: "5G System; Access and Mobility Management Services; Stage 3".
- [7] 3GPP TS 29.571: "5G System; Common Data Types for Service Based Interfaces; Stage 3".
- [8] ECMA-262: "ECMAScript® Language Specification", <https://www.ecma-international.org/ecma-262/5.1/>.
- [9] IETF RFC 7540: "Hypertext Transfer Protocol Version 2 (HTTP/2)".
- [10] OpenAPI Initiative, "OpenAPI Specification Version 3.0.0", <https://spec.openapis.org/oas/v3.0.0>.
- [11] IETF RFC 7807: "Problem Details for HTTP APIs".
- [12] 3GPP TS 23.003: "Numbering, Addressing and Identification".
- [13] IETF RFC 6902: "JavaScript Object Notation (JSON) Patch".
- [14] IETF RFC 6901: "JavaScript Object Notation (JSON) Pointer".
- [15] 3GPP TS 33.501: "Security architecture and procedures for 5G system".
- [16] IETF RFC 6749: "The OAuth 2.0 Authorization Framework".
- [17] IETF RFC 3986: "Uniform Resource Identifier (URI): Generic Syntax".
- [18] IETF RFC 4122: "A Universally Unique Identifier (UUID) URN Namespace".
- [19] IETF RFC 7232: "Hypertext Transfer Protocol (HTTP/1.1): Conditional Requests".
- [20] IETF RFC 7234: "Hypertext Transfer Protocol (HTTP/1.1): Caching".

- [21] 3GPP TS 29.244: "Interface between the Control Plane and the User Plane Nodes; Stage 3".
- [22] IETF RFC 8259: "The JavaScript Object Notation (JSON) Data Interchange Format".
- [23] IETF RFC 2782: "A DNS RR for specifying the location of services (DNS SRV)".
- [24] IETF RFC 7515: "JSON Web Signature (JWS)".
- [25] IETF RFC 7519: "JSON Web Token (JWT)".
- [26] W3C HTML 4.01 Specification, <https://www.w3.org/TR/2018/SPSD-html401-20180327/>.
- [27] 3GPP TS 23.527: "5G System; Restoration Procedures; Stage 2".
- [28] 3GPP TS 29.513: "5G System; Policy and Charging Control signalling flows and QoS parameter mapping; Stage 3".
- [29] 3GPP TS 38.413: "NG-RAN; NG Application Protocol (NGAP)".
- [30] IETF RFC 1952: "GZIP file format specification version 4.3".
- [31] 3GPP TR 21.900: "Technical Specification Group working methods".
- [32] 3GPP TS 29.520: "5G System; Network Data Analytics Services; Stage 3".
- [33] 3GPP TS 29.572: "5G System; Location Management Services; Stage 3".
- [34] 3GPP TS 23.288: "Architecture enhancements for 5G System (5GS) to support network data analytics services".
- [35] 3GPP TS 29.517: "Application Function Event Exposure Service".
- [36] 3GPP TS 29.503: "Unified Data Management Services".
- [37] 3GPP TS 29.336: "Home Subscriber Server (HSS) diameter interfaces for interworking with packet data networks and applications".
- [38] IANA: "SMI Network Management Private Enterprise Codes", <http://www.iana.org/assignments/enterprise-numbers>.
- [39] Semantic Versioning Specification: <https://semver.org>.
- [40] IETF RFC 7231: "Hypertext Transfer Protocol (HTTP/1.1): Semantics and Content".
- [41] IETF RFC 7694: "Hypertext Transfer Protocol (HTTP) Client-Initiated Content-Encoding".
- [42] 3GPP TS 29.531: "5G System; Network Slice Selection Services; Stage 3".
- [43] 3GPP TS 23.247: "Architectural enhancements for 5G multicast-broadcast services".
- [44] ITU-T Recommendation E.164: "The international public telecommunication numbering plan".
- [45] 3GPP TS 23.380: "IMS Restoration Procedures".
- [46] 3GPP TS 32.255: "Telecommunication management; Charging management; 5G data connectivity domain charging; Stage 2".
- [47] 3GPP TS 29.514: "5G System; Policy Authorization Service; Stage 3".
- [48] 3GPP TS 23.540: "5G System; Technical realization of Service Based Short Message Service; Stage 2".

---

## 3 Definitions and abbreviations

### 3.1 Definitions

For the purposes of the present document, the terms and definitions given in 3GPP TR 21.905 [1] and the following apply. A term defined in the present document takes precedence over the definition of the same term, if any, in 3GPP TR 21.905 [1].

### 3.2 Abbreviations

For the purposes of the present document, the abbreviations given in 3GPP TR 21.905 [1] and the following apply. An abbreviation defined in the present document takes precedence over the definition of the same abbreviation, if any, in 3GPP TR 21.905 [1].

5GC	5G Core Network
CEF	Charging Enablement Function
CH	Credentials Holder
CHF	Charging Function
DCS	Default Credentials Server
IPUPS	Inter-PLMN User Plane Security
MBS	Multicast/Broadcast Service
MB-SMF	Multicast/Broadcast Session Management Function
NF	Network Function
NRF	NF Repository Function
NWDAF	Network Data Analytics Function
PFD	Packet Flow Description
SNPN	Stand-alone Non-Public Network
SSM	Source Specific IP Multicast (address)
TNGF	Trusted Non-3GPP Gateway Function
TSCTSF	Time Sensitive Communication and Time Synchronization Function
TWIF	Trusted WLAN Interworking Function
W-AGF	Wireline Access Gateway Function

---

## 4 Overview

The Network Function (NF) Repository Function (NRF) is the network entity in the 5G Core Network (5GC) supporting the following functionality:

- Maintains the NF profile of available NF instances and their supported services;
- Maintains the SCP profile of available SCP instances;
- Maintains the SEPP profile of available SEPP instances;
- Allows other NF or SCP instances to subscribe to, and get notified about, the registration in NRF of new NF instances of a given type or of SEPP instances. It also allows SCP instances to subscribe to, and get notified about, the registration in NRF of new SCP instances;
- Supports service discovery function. It receives NF Discovery Requests from NF or SCP instances, and provides the information of the available NF instances fulfilling certain criteria (e.g., supporting a given service);
- Support SCP discovery function. It receives NF Discovery Requests for SCP profiles from other SCP instances, and provides the information of the available SCP instances fulfilling certain criteria (e.g., serving a given NF set);
- Support SEPP discovery function. It receives NF Discovery Requests for SEPP profiles from other NF or SCP instances, and provides the information of the available SEPP instances fulfilling certain criteria (e.g. supporting connectivity with a remote PLMN).

Figure 4-1 shows the reference architecture for the 5GC, with focus on the NRF:

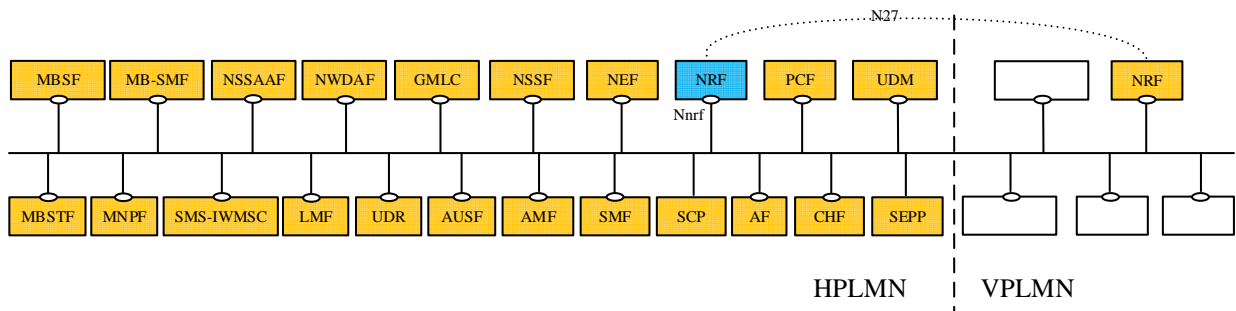

**Figure 4-1: 5G System architecture**

Figure 4-1 illustrates PLMN level scenarios, but this architecture is also applicable to the SNPN scenarios, as explained below.

For the sake of clarity, the NRF is never depicted in reference point representation figures, given that the NRF interacts with every other NF in the 5GC. As an exception, in the roaming case, the reference point between the vNRF and the hNRF is named as N27. The reference point name of N27 is used only for representation purposes, but its functionality is included in the services offered by the Nnrf Service-Based Interface.

In the case of SNPN, the NRF provides services e.g. in the following scenarios:

- For a SNPN for which roaming is not supported (see 3GPP TS 23.501 [2], clause 5.30.2.0);
- For the case of UE access to SNPN using credentials from Credentials Holder (see 3GPP TS 23.501 [2], clause 5.30.2.9);
- For the case of Onboarding of UEs for SNPNS (see 3GPP TS 23.501 [2], clause 5.30.2.10).

## 5 Services Offered by the NRF

### 5.1 Introduction

The NRF offers to other NFs the following services:

- Nnrf\_NFManagement
- Nnrf\_NFDiscovery
- Nnrf\_AccessToken (OAuth2 Authorization)
- Nnrf\_Bootstrapping

Table 5.1-1 summarizes the corresponding APIs defined for this specification.



Table 5.1-1: API Descriptions

Service Name	Clause	Description	OpenAPI Specification File	apiName	Annex
Nnrf_NFManagement	6.1	NRF NFManagement Service	TS29510_Nnrf_NFManagement.yaml	nnrf-nfm	A.2
Nnrf_NFDiscovery	6.2	NRF NFDiscovery Service	TS29510_Nnrf_NFDiscovery.yaml	nnrf-disc	A.3
Nnrf_AccessToken	6.3	NRF OAuth2 Authorization	TS29510_Nnrf_AccessToken.yaml		A.4
Nnrf_Bootstrapping	6.4	NRF Bootstrapping	TS29510_Nnrf_Bootstrapping.yaml		A.5

NRF provides services to the following SNPN scenarios (see clauses 4.17.4a, 4.17.5a, 5.2.7.2 and 5.2.7.3 in 3GPP TS 23.502 [3]):

- In a SNPN where roaming is not supported, which corresponds to the NRF services in the same PLMN;
- In the case of UE access to SNPN using credentials from Credentials Holder with AAA-S, which corresponds to the NRF services in the same PLMN;
- In the case of UE access to SNPN using credentials from Credentials Holder with AUSF and UDM, which corresponds to the NRF services across different PLMNs;
- In the case of Onboarding of UEs for SNPNs without using Default Credentials Server, which corresponds to the NRF services in the same PLMN;
- In the case of Onboarding of UEs for SNPNs using Default Credentials Server with AAA-S, which corresponds to the NRF services in the same PLMN;
- In the case of Onboarding of UEs for SNPNs using Default Credentials Server with AUSF and UDM, which corresponds to the NRF services across different PLMNs.

## 5.2 Nnrf\_NFManagement Service

### 5.2.1 Service Description

The Nnrf\_NFManagement service allows an NF, SCP or SEPP Instance in the serving PLMN to register, update or deregister its profile in the NRF.

The Nnrf\_NFManagement service also allows an NRF Instance to register, update or deregister its profile in another NRF in the same PLMN.

NOTE: Alternatively, other means such as OA&M can also be used to register, update or deregister NRF profile in another NRF.

It also allows an NF or an SCP to subscribe to be notified of registration, deregistration and profile changes of NF Instances, along with their potential NF services, or of SEPP instances. It also enables an SCP to subscribe to be notified of registration, deregistration and profile changes of other SCP instances.

The NF profile consists of general parameters of the NF Instance, and also the parameters of the different NF Service Instances exposed by the NF Instance, if applicable.

The PLMN of the NRF may comprise one or multiple PLMN IDs (i.e. MCC and MNC). An NRF configured with multiple PLMN IDs shall support registering, updating and deregistering the profile of Network Function Instances from any of these PLMN IDs.

The Nnrf\_NFManagement service also allows retrieving a list of NF, SCP or SEPP Instances currently registered in the NRF or the NF Profile of a given NF, SCP or SEPP Instance.

The Nnrf\_NFManagement service also allows checking whether the registered NFs, SCPs and SEPPs are operative.

## 5.2.2 Service Operations

### 5.2.2.1 Introduction

The services operations defined for the Nnrf\_NFManagement service are as follows:

- **NFRegister**: It allows an NF, SCP or SEPP Instance to register its profile in the NRF; it includes the registration of the general parameters of the NF, SCP or SEPP Instance, together with the list of potential services exposed by the NF Instance. This service operation is not allowed to be invoked from an NRF in a different PLMN.
- **NFUpdate**: It allows an NF, SCP or SEPP Instance to replace, or update partially, the parameters of its profile (including the parameters of the associated services, if any) in the NRF; it also allows to add or delete individual services offered by the NF Instance. This service operation is not allowed to be invoked from an NRF in a different PLMN.
- **NFDeregister**: It allows an NF, SCP or SEPP Instance to deregister its profile in the NRF, including the services offered by the NF Instance, if any. This service operation is not allowed to be invoked from an NRF in a different PLMN.
- **NFStatusSubscribe**: It allows an NF or SCP Instance to subscribe to changes on the status of NF or SEPP Instances registered in NRF. It also allows an SCP Instance to subscribe to changes on the status of other SCP Instances registered in NRF. This service operation can be invoked by an NF Instance in a different PLMN (via the local NRF in that PLMN) for changes on the status of NF Instances. It cannot be invoked by an SCP instance in a different PLMN. For changes on the status of SEPP Instance, this operation can only be invoked between the NRF and an NF Instance or SCP in the same PLMN.
- **NFStatusNotify**: It allows the NRF to notify subscribed NF or SCP Instances of changes on the status of NF or SEPP Instances. It also allows the NRF to notify subscribed SCP Instances of changes on the status of SCP Instances. This service operation can be invoked directly between the NRF and an NF Instance in a different PLMN (without involvement of the local NRF in that PLMN) for changes on the status of NF Instances. It cannot be invoked between the NRF and an SCP instance in a different PLMN. For changes on the status of SEPP Instance, this operation can only be invoked between the NRF and an NF Instance or SCP in the same PLMN.
- **NFStatusUnsubscribe**: It allows an NF or SCP Instance to unsubscribe to changes on the status of NF or SEPP Instances registered in NRF. It also allows an SCP Instance to unsubscribe to changes on the status of other SCP Instances registered in NRF. This service operation can be invoked by an NF Instance in a different PLMN (via the local NRF in that PLMN) for changes on the status of NF Instances. It cannot be invoked by an SCP instance in a different PLMN. For changes on the status of SEPP Instance, this operation can only be invoked between the NRF and an NF Instance or SCP in the same PLMN.

NOTE 1: The "change of status" of the NFStatus service operations can imply a request to be notified of newly registered NF, SCP or SEPP Instances in NRF, or to be notified of profile changes of a specific NF, SCP or SEPP Instance, or to be notified of the deregistration of an NF, SCP or SEPP Instance.

NOTE 2: An NRF instance can also use the NFRegister, NFUpdate or NFDeregister service operations or OA&M system to register, update or deregister its profile in another NRF in the same PLMN.

- **NFListRetrieval**: It allows retrieving a list of NFs, SCPs and SEPPs currently registered in the NRF. This service operation is not allowed to be invoked from an NRF in a different PLMN.
- **NFProfileRetrieval**: It allows retrieving the profile of a given NF, SCP or SEPP instance. This service operation is not allowed to be invoked from an NRF in a different PLMN.

The NFStatusSubscribe / NFStatusNotify / NFStatusUnsubscribe operations can be invoked by an NF Service Consumer (i.e., "source NF" or "SCP") requesting to be notified about events (registration, deregistration, profile change) related to an NF instance (i.e., "target NF") located in the same PLMN, or in a different PLMN, or related to a SEPP instance located in the same PLMN. An SCP can also invoke these operations to be notified about events (registration, deregistration, profile change) related to an SCP instance or SEPP instance located in the same PLMN.

In the description of these operations in clauses 5.2.2.5, 5.2.2.6 and 5.2.2.7, when the NF instances are located in the same PLMN, both source NF and target NF are said to be located in the "Serving PLMN" but, in the general case, the functionality is not restricted to the PLMN that is serving a given UE, and it shall be applicable as well to any scenario in which source NF and target NFs belong to the same PLMN.

When source NF and target NF are located in different PLMNs, the source NF is said to be in the "Serving PLMN", and the target NF (and the NRF where such NF is registered) is said to be in the "Home PLMN", similarly to the scenarios described in 3GPP TS 23.502 [3], but the functionality shall be equally applicable to any scenario between any pair of PLMNs (e.g. with the source NF in the Home PLMN and the target NF in the Serving PLMN).

The SCP and SEPP are treated by the Nnrf\_NFManagement service in the same way as NFs. Specifically, the SCP and SEPP are designated with a specific NF type and NF Instance ID. However, the SCP and SEPP do not support services. Accordingly, references to "NF" or "NF Profile" in the description of the service operations in the following clauses also apply to an SCP and SEPP.

## 5.2.2.2 NFRegister

### 5.2.2.2.1 General

This service operation is used:

- to register an NF in the NRF by providing the NF profile of the requesting NF to the NRF, and the NRF marks the requesting NF as available to be discovered by other NFs;
- to register services associated to an existing NF Instance;
- to register NRF information in another NRF, and this information is used for forwarding or redirecting service discovery request.

#### 5.2.2.2.2 NF (other than NRF) registration to NRF

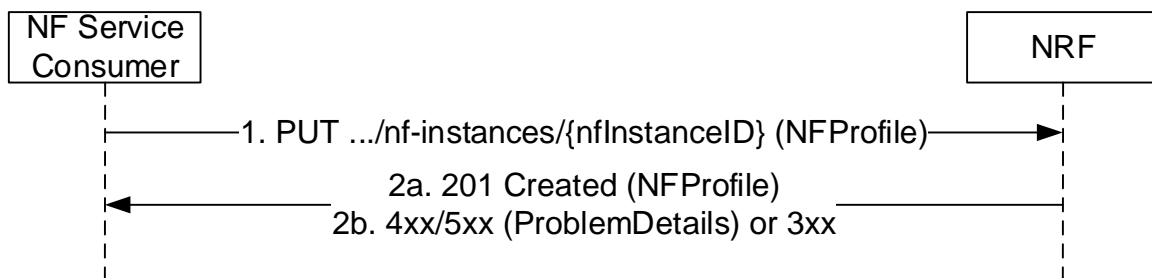

**Figure 5.2.2.2-1: NF Instance Registration**

1. The NF Service Consumer shall send a PUT request to the resource URI representing the NF Instance. The URI is determined by the NF Instance. The variable {nfInstanceId} represents an identifier, provided by the NF Service Consumer that shall be globally unique inside the PLMN of the NRF where the NF is being registered. The format of the NF Instance ID shall be a Universally Unique Identifier (UUID) version 4, as described in IETF RFC 4122 [18].

EXAMPLE: UUID version 4: "4947a69a-f61b-4bc1-b9da-47c9c5d14b64"

The payload body of the PUT request shall contain a representation of the NF Instance to be created.

- 2a. On success, "201 Created" shall be returned, the payload body of the PUT response shall contain the representation of the created resource and the "Location" header shall contain the URI of the created resource. Additionally, the NRF returns a "heart-beat timer" containing the number of seconds expected between two consecutive heart-beat messages from an NF Instance to the NRF (see clause 5.2.2.3.2). The representation of the created resource may be a complete NF Profile or a NF Profile just including the mandatory attributes of the NF Profile and the attributes which the NRF added or changed (see Annex B).

2b. On failure or redirection:

- If the registration of the NF instance fails at the NRF due to errors in the encoding of the NFProfile JSON object, the NRF shall return "400 Bad Request" status code with the ProblemDetails IE providing details of the error.
- If the registration of the NF instance fails at the NRF due to NRF internal errors, the NRF shall return "500 Internal Server Error" status code with the ProblemDetails IE providing details of the error.

- In the case of redirection, the NRF shall return 3xx status code, which shall contain a Location header with an URI pointing to the endpoint of another NRF service instance.

The NRF shall allow the registration of a Network Function instance with any of the NF types described in clause 6.1.6.3.3, and it shall also allow registration of Network Function instances with custom NF types (e.g., NF type values not defined by 3GPP, or NF type values not defined by this API version).

NOTE 1: When registering a custom NF in NRF, it is recommended to use a NF type name that prevents collisions with other custom NF type names, or with NF types defined in the future by 3GPP. E.g., prefixing the custom NF type name with the string "CUSTOM\_".

During the registration of a Network Function instance with a custom NF type, the NF instance may provide NF-specific data (in the "customInfo" attribute), that shall be stored by the NRF as part of the NF profile of the NF instance.

The NRF shall accept the registration of NF Instances containing Vendor-Specific attributes (see 3GPP TS 29.500 [4], clause 6.6.3), and therefore, it shall accept NF Profiles containing attributes whose type may be unknown to the NRF, and those attributes shall be stored as part of the NF's profile data in NRF.

Before an NF Instance registers its NF Profile in NRF, the NF Instance should check the capabilities of the NRF by issuing an OPTIONS request to the "nf-instances" resource (see clause 6.1.3.2.3.2), unless the NF Instance already sent a Bootstrapping Request to the NRF and received the nrfFeatures attribute in the response. The NRF may indicate in the response capabilities such as the support of receiving compressed payloads in the HTTP PUT request used for registration of the NF Profile, or support of specific attributes of the NF Profile.

NOTE 2: A Rel-16 NF needs to register the list of NF Service Instances in the "nfServices" array attribute towards an NRF not supporting the Service-Map feature (i.e. a Rel-15 NRF).

#### 5.2.2.2.3 NRF registration to another NRF

The procedure specified in clause 5.2.2.2.2 applies. Additionally:

- a) the registering NRF shall set the nfType to "NRF" in the nfProfile;
- b) the registering NRF shall set the nfService to contain "nrf-disc", "nrf-nfm" and optionally "nrf-oauth2" in the nfProfile;
- c) the registering NRF may include nrfInfo which contains the information of e.g. udrInfo, udmInfo, ausfInfo, amfInfo, smfInfo, upfInfo, pcfInfo, bsfInfo, nefInfo, chfInfo, pscfInfo, lmfInfo, gmlcInfo, aanfInfo, nfInfo and nsacfInfo in the nfProfile locally configured in the NRF or the NRF received during registration of other NFs, this means the registering NRF is able to provide service for discovery of NFs subject to that information;
- d) if the NRF receives an NF registration with the nfType set to "NRF", the NRF shall use the information contained in the nfProfile to target the registering NRF when forwarding or redirecting NF service discovery request.

### 5.2.2.3 NFUpdate

#### 5.2.2.3.1 General

This service operation updates the profile of a Network Function previously registered in the NRF by providing the updated NF profile of the requesting NF to the NRF. The update operation may apply to the whole profile of the NF (complete replacement of the existing profile by a new profile), or it may apply only to a subset of the parameters of the profile (including adding/deleting/replacing services to the NF profile).

To perform a complete replacement of the NF Profile of a given NF Instance, the NF Service Consumer shall issue an HTTP PUT request, as shown in Figure 5.2.2.3.1-1:

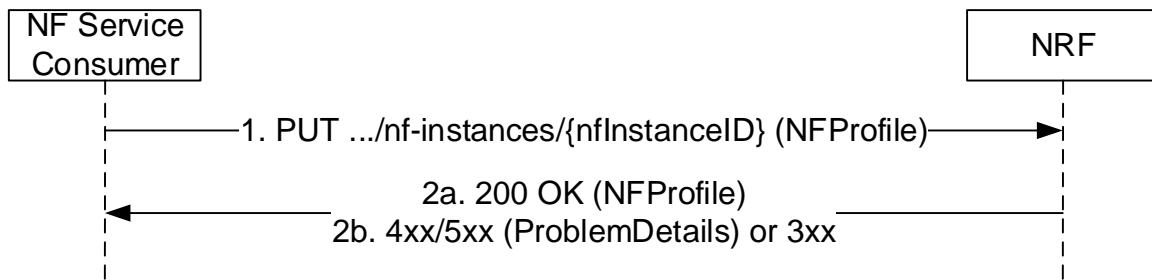

**Figure 5.2.2.3.1-1: NF Profile Complete Replacement**

1. The NF Service Consumer shall send a PUT request to the resource URI representing the NF Instance. The payload body of the PUT request shall contain a representation of the NF Instance to be completely replaced in the NRF.
- 2a. On success, "200 OK" shall be returned, the payload body of the PUT response shall contain the representation of the replaced resource. The representation of the replaced resource may be a complete NF Profile or a NF Profile just including the mandatory attributes of the NF Profile and the attributes which the NRF added or changed (see Annex B).
- 2b. On failure or redirection:
  - If the update of the NF instance fails at the NRF due to errors in the encoding of the NFProfile JSON object, the NRF shall return "400 Bad Request" status code with the ProblemDetails IE providing details of the error.
  - If the update of the NF instance fails at the NRF due to NRF internal errors, the NRF shall return "500 Internal Server Error" status code with the ProblemDetails IE providing details of the error.
  - In the case of redirection, the NRF shall return 3xx status code, which shall contain a Location header with an URI pointing to the endpoint of another NRF service instance.

To perform a partial update of the NF Profile of a given NF Instance, the NF Service Consumer shall issue an HTTP PATCH request, as shown in Figure 5.2.2.3.1-2. This partial update shall be used to add/delete/replace individual parameters of the NF Instance, and also to add/delete/replace any of the services (and their parameters) offered by the NF Instance.

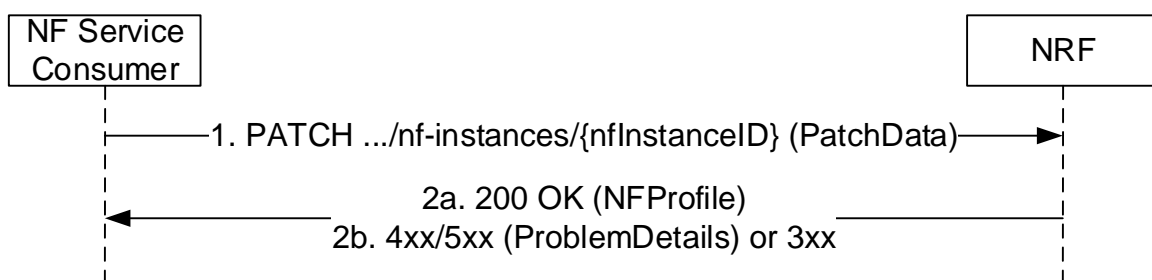

**Figure 5.2.2.3.1-2: NF Profile Partial Update**

1. The NF Service Consumer shall send a PATCH request to the resource URI representing the NF Instance. The payload body of the PATCH request shall contain the list of operations (add/delete/replace) to be applied to the NF Profile of the NF Instance; these operations may be directed to individual parameters of the NF Profile or to the list of services (and their parameters) offered by the NF Instances. In order to leave the NF Profile in a consistent state, all the operations specified by the PATCH request body shall be executed atomically.

The NF Service Consumer should include a "If-Match" HTTP header carrying the latest entity-tag received from NRF for the NF profile to which the PATCH document shall be applied.

- 2a. On success, "200 OK" shall be returned, the payload body of the PATCH response shall contain the representation of the replaced resource.
- 2b. On failure or redirection:

- If the NF Instance, identified by the "nfInstanceID", is not found in the list of registered NF Instances in the NRF's database, the NRF shall return "404 Not Found" status code with the ProblemDetails IE providing details of the error.
- In the case of redirection, the NRF shall return 3xx status code, which shall contain a Location header with an URI pointing to the endpoint of another NRF service instance.
- If "If-Match" header is received with an entity tag different from the entity-tag in NRF for NF profile of the target NF instance, the NRF shall return "412 Precondition Failed" status code with the ProblemDetails IE providing details of the error.
- If no precondition was defined in the request and another confliction has been detected (e.g. to change value of a non-existing IE), the NRF shall return "409 Conflicting" status code with the ProblemDetails IE providing details of the error.

The NRF shall allow updating Vendor-Specific attributes (see 3GPP TS 29.500 [4], clause 6.6.3) that may exist in the NF Profile of a registered NF Instance.

### 5.2.2.3.2 NF Heart-Beat

Each NF that has previously registered in NRF shall contact the NRF periodically (heart-beat), by invoking the NFUpdate service operation, in order to show that the NF is still operative.

The time interval at which the NRF shall be contacted is deployment-specific, and it is returned by the NRF to the NF Service Consumer as a result of a successful registration.

When the NRF detects that a given NF has not updated its profile for a configurable amount of time (longer than the heart-beat interval), the NRF changes the status of the NF to SUSPENDED and considers that the NF and its services can no longer be discovered by other NFs via the NFDiscovery service. The NRF notifies NFs subscribed to receiving notifications of changes of the NF Profile that the NF status has been changed to SUSPENDED.

If the NRF modifies the heart-beat interval value of a given NF instance currently registered (e.g. as a result of an OA&M operation), it shall return the new value to the registered NF in the response of the next periodic heart-beat interaction received from that NF and, until then, the NRF shall apply the heart-beat check procedure according to the original interval value.

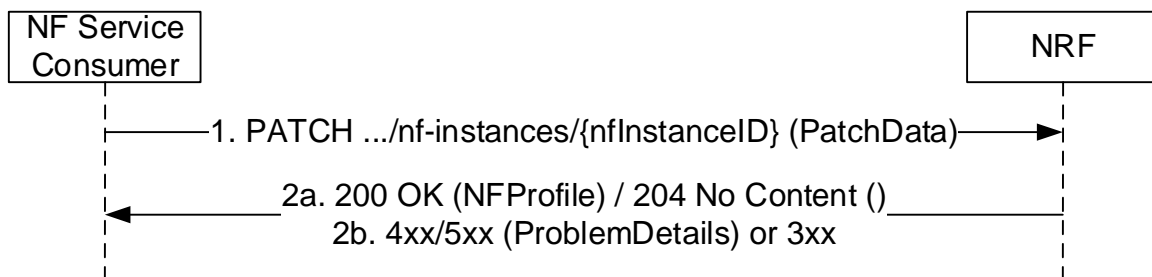

**Figure 5.2.2.3.2-1: NF Heart-Beat**

1. The NF Service Consumer shall send a PATCH request to the resource URI representing the NF Instance. The payload body of the PATCH request shall contain a "replace" operation on the "nfStatus" attribute of the NF Profile of the NF Instance, and set it to the value "REGISTERED" or "UNDISCOVERABLE".

In addition, the NF Service Consumer may also provide the load information of the NF, and/or the load information of the NF associated NF services. The provision of such load information may be limited by this NF via appropriate configuration (e.g. granularity threshold) in order to avoid notifying minor load changes.

The NF Service Consumer shall not include "If-Match" HTTP header in the Heart-Beat request if the request is not modifying any attribute in the NF profile.

- 2a. On success, the NRF should return "204 No Content"; the NRF may also answer with "200 OK" along with the full NF Profile, e.g. in cases where the NRF determines that the NF Profile has changed significantly since the last heart-beat, and wants to send the new profile to the NF Service Consumer (note that this alternative has bigger signalling overhead).

The NRF shall not generate a new entity tag for the NF profile in Heart-Beat operation if no attribute is modified.

2b. On failure or redirection:

- If the NF Instance, identified by the "nfInstanceID", is not found in the list of registered NF Instances in the NRF's database, the NRF shall return "404 Not Found" status code with the ProblemDetails IE providing details of the error.
- In the case of redirection, the NRF shall return 3xx status code, which shall contain a Location header with an URI pointing to the endpoint of another NRF service instance.

EXAMPLE:

```
PATCH .../nf-instances/4947a69a-f61b-4bc1-b9da-47c9c5d14b64
Content-Type: application/json-patch+json

[
  { "op": "replace", "path": "/nfStatus", "value": "REGISTERED" },
  { "op": "replace", "path": "/load", "value": 50 }
]

HTTP/2 204 No Content
Content-Location: .../nf-instances/4947a69a-f61b-4bc1-b9da-47c9c5d14b64
```

## 5.2.2.4 NFDeregister

### 5.2.2.4.1 General

This service operation removes the profile of a Network Function previously registered in the NRF.

It is executed by deleting a given resource identified by a "NF Instance ID". The operation is invoked by issuing a DELETE request on the URI representing the specific NF Instance.

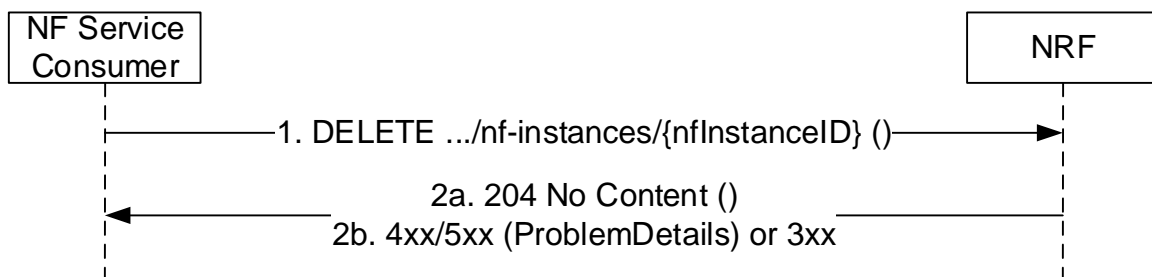

Figure 5.2.2.4.1-1: NF Instance Deregistration

1. The NF Service Consumer shall send a DELETE request to the resource URI representing the NF Instance. The request body shall be empty.
- 2a. On success, "204 No Content" shall be returned. The response body shall be empty.
- 2b. On failure or redirection:
  - If the NF Instance, identified by the "nfInstanceID", is not found in the list of registered NF Instances in the NRF's database, the NRF shall return "404 Not Found" status code with the ProblemDetails IE providing details of the error.
  - In the case of redirection, the NRF shall return 3xx status code, which shall contain a Location header with an URI pointing to the endpoint of another NRF service instance.

## 5.2.2.5 NFStatusSubscribe

### 5.2.2.5.1 General

This service operation is used to:

- create a subscription so an NF Service Consumer can request to be notified when NF Instances of a given set, following certain filter criteria are registered/deregistered in NRF or when their profile is modified;
- create a subscription to a specific NF Instance so an NF Service Consumer can request to be notified when the profile of such NF Instance is modified or when the NF Instance is deregistered from NRF.

#### 5.2.2.5.2 Subscription to NF Instances in the same PLMN

The subscription to notifications on NF Instances is executed creating a new individual resource under the collection resource "subscriptions". The operation is invoked by issuing a POST request on the URI representing the "subscriptions" resource.

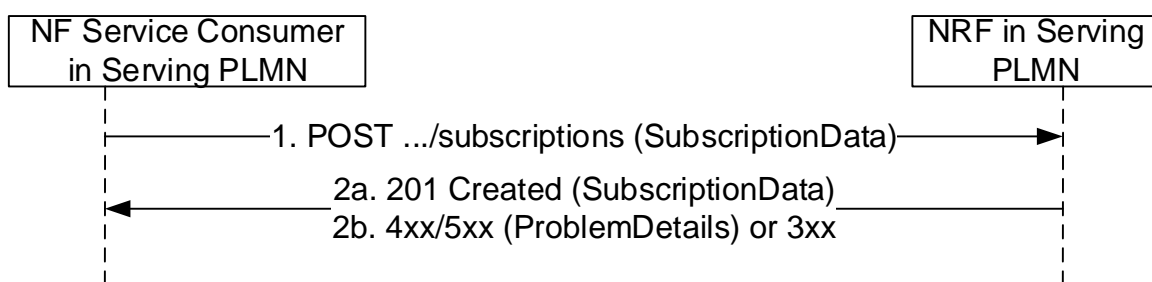

**Figure 5.2.2.5.2-1: Subscription to NF Instances in the same PLMN**

1. The NF Service Consumer shall send a POST request to the resource URI representing the "subscriptions" collection resource. The custom HTTP header "3gpp-Sbi-Notif-Accepted-Encoding", as defined in 3GPP TS 29.500 [4] clause 5.2.3.3.6, may be included to indicate the content-encodings supported by the NF Service Consumer receiving the notification.

The request body shall include the data indicating the type of notifications that the NF Service Consumer is interested in receiving; it also contains a callback URI, where the NF Service Consumer shall be prepared to receive the actual notification from the NRF (see NFStatusNotify operation in 5.2.2.6) and it may contain a validity time, suggested by the NF Service Consumer, representing the time span during which the subscription is desired to be kept active. When the NF Service Consumer creates multiple subscriptions in the NRF, it should use distinct callback URIs for each subscription.

The subscription request may also include additional parameters indicating the list of attributes (including Vendor-Specific attributes, see 3GPP TS 29.500 [4], clause 6.6.3) in the NF Profile to be monitored (or to be excluded from monitoring), in order to determine whether a notification from NRF should be sent, or not, when any of those attributes is changed in the profile.

The NF Service Consumer may request the creation of a subscription to a specific NF Instance, or to a set of NF Instances, where the set is determined according to different criteria specified in the request body, in the "subscrCond" attribute of the "SubscriptionData" object type (see clause 6.1.6.2.16).

The subscription shall be authorized, or rejected, by the NRF by checking the relevant input attributes (e.g. reqNfType, reqNfFqdn, reqSnsais, reqPerPlmnSnsais, reqPlmnList, reqSnpnList, etc.) in the subscription request body (along with the contents of any optional OAuth2 access token provided in the API request) against the list of authorization attributes in the NF Profile of the target NF Instance to be monitored.

When the subscription request is for a set of NFs, the authorization attributes of the NF Instances in the set may differ, resulting in positive authorization of the subscription for only a part of the NF Instances in the set; in that case, the subscription to the set of NFs may be accepted by the NRF, but the NF Instances in the set that are not authorized for the NF Service Consumer that requested the subscription, shall not result in triggering any notification event from the NRF to the NF Service Consumer.



2a. On success, "201 Created" shall be returned. The response shall contain the data related to the created subscription, including the validity time, as determined by the NRF, after which the subscription becomes invalid. Once the subscription expires, if the NF Service Consumer wants to keep receiving status notifications, it shall create a new subscription in the NRF.

2b. On failure or redirection:

- If the creation of the subscription fails at the NRF due to errors in the SubscriptionData JSON object in the request body, the NRF shall return "400 Bad Request" status code with the ProblemDetails IE providing details of the error.
- If the creation of the subscription fails at the NRF due to NRF internal errors, the NRF shall return "500 Internal Server Error" status code with the ProblemDetails IE providing details of the error.
- In the case of redirection, the NRF shall return 3xx status code, which shall contain a Location header with an URI pointing to the endpoint of another NRF service instance.

### 5.2.2.5.3 Subscription to NF Instances in a different PLMN

The subscription to notifications on NF Instances in a different PLMN is done by creating a resource under the collection resource "subscriptions", in the NRF of the Home PLMN.

For that, step 1 in clause 5.2.2.5.2 is executed (send a POST request to the NRF in the Serving PLMN); this request shall include the identity of the PLMN of the home NRF in the SubscriptionData parameter in the request body.

If the NRF in Serving PLMN knows that OAuth2-based authorization is required for accessing the NFManagement service of the NRF in Home PLMN, e.g. by learning this during an earlier Bootstrapping procedure or local configuration, and if the request received at the NRF in Serving PLMN does not include an access token, the NRF in Serving PLMN may reject the request with a 401 Unauthorized as specified in clause 6.7.3 of 3GPP TS 29.500 [4].

Then, steps 1-2 in Figure 5.2.2.5.3-1 are executed, between the NRF in the Serving PLMN and the NRF in the Home PLMN. In this step, the PLMN ID may be present in the SubscriptionData parameter. The NRF in the Home PLMN returns a subscriptionID identifying the created subscription.

Finally, step 2 in clause 5.2.2.5.2 is executed; a new subscriptionID shall be generated by the NRF in the Serving PLMN as indicated in step 2 of Figure 5.2.2.5.3-1, and shall be sent to the NF Service Consumer in the Serving PLMN.

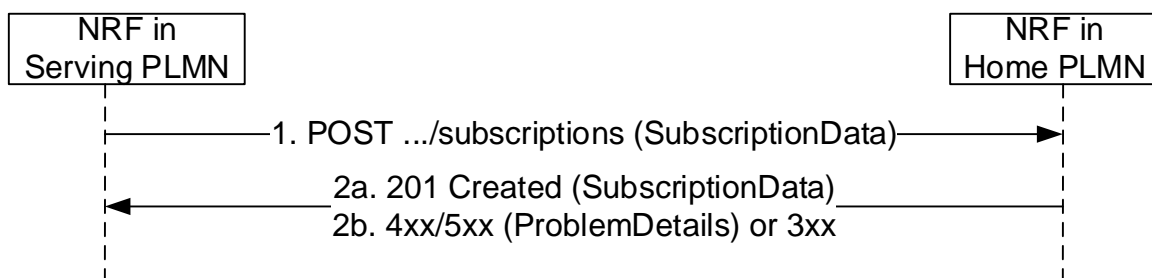

**Figure 5.2.2.5.3-1: Subscription to NF Instances in a different PLMN**

1. The NRF in Serving PLMN shall send a POST request to the resource URI in the NRF in Home PLMN representing the "subscriptions" collection resource. The request body shall include the SubscriptionData as received by the NRF in Serving PLMN from the NF Service Consumer in the Serving PLMN (see 5.2.2.5.2), containing the data about the type of notifications that the NF Service Consumer is interested in receiving and the callback URI where the NF Service Consumer shall be prepared to receive the notifications from the NRF (see NFStatusNotify operation in 5.2.2.6).
- 2a. On success, "201 Created" shall be returned. If the subscription is created in a different NRF in the HPLMN than the NRF in the HPLMN that receives the subscription request, the latter should include information in the subscriptionID (after the first 5 or 6 digits and "-") such as to be able to forward the subsequent subscription modification or deletion request it may receive from the NRF in the serving PLMN towards the NRF in the HPLMN holding the subscription. The information to be included in the subscriptionID is left to implementation.

The NRF in Serving PLMN should not keep state for this created subscription and shall send to the NF Service Consumer in Serving PLMN (step 2 in 5.2.2.5.2) a subscriptionID that shall consist on the following structure:  
 <MCC>+<MNC>+"-"+<OriginalSubscriptionID>

**EXAMPLE:** If the NRF in a Home PLMN (where MCC = 123, and MNC=456) creates a subscription with value "subs987654", the subscriptionID that the NRF in Serving PLMN would send to the NF Service Consumer in Serving PLMN is: "123456-subs987654"

The URI in the Location header that the NRF in Serving PLMN returns to the NF Service Consumer in Serving PLMN shall contain a <subscriptionId> modified as described above and, if it is as an absolute URI, an apiRoot pointing to the address of the NRF in Serving PLMN. The subscriptionId attribute in the message body that the NRF in Serving PLMN returns to the NF Service Consumer in Serving PLMN shall also contain a <subscriptionId> modified as described above.

2b. On failure or redirection:

- If the creation of the subscription fails at the NRF due to errors in the SubscriptionData JSON object in the request body, the NRF shall return "400 Bad Request" status code with the ProblemDetails IE providing details of the error.
- If the creation of the subscription fails at the NRF due to NRF internal errors, the NRF shall return "500 Internal Server Error" status code with the ProblemDetails IE providing details of the error.
- In the case of redirection, the NRF shall return 3xx status code, which shall contain a Location header with an URI pointing to the endpoint of another NRF service instance.

#### 5.2.2.5.4 Subscription to NF Instances with intermediate forwarding NRF

When multiple NRFs are deployed in one PLMN, an NF Instance can subscribe to changes of NF Instances registered in an NRF to which it is not directly interacting. The subscription message is forwarded by an intermediate NRF to which the subscribing NF instance is directly interacting.

For that, step 1 in clause 5.2.2.5.2 is executed (send a POST request to the NRF-1 in the Serving PLMN); this request shall include the SubscriptionData parameter in the request body.

Then, steps 1-4 in Figure 5.2.2.5.4-1 are executed between NF Service Consumer in Serving PLMN, NRF-1 in Serving PLMN and NRF-2 in Serving PLMN. In these steps, NRF-1 sends the subscription request to a pre-configured NRF-2. NRF-2 requests corresponding NRF (e.g. the NF Service Producer registered NRF) and returns a subscriptionID identifying the created subscription and this subscriptionID is sent to the NF Service Consumer via NRF-1.

Finally, step 2 in clause 5.2.2.5.2 is executed; the subscriptionID shall be sent to the NF Service Consumer.

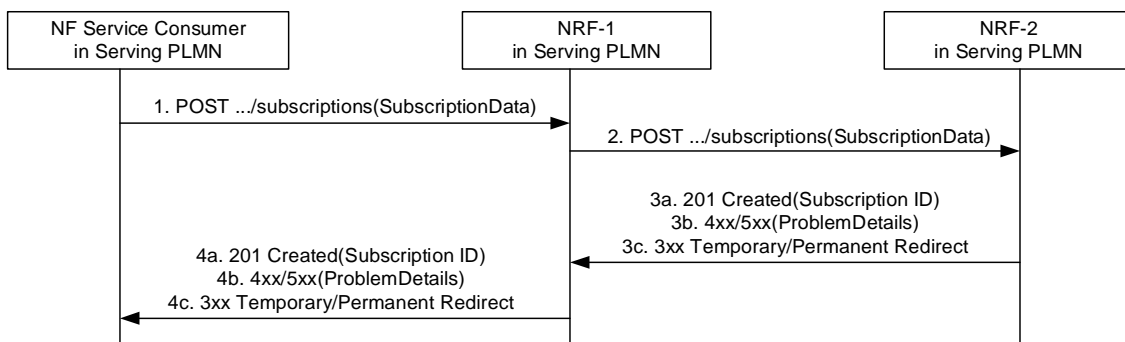

**Figure 5.2.2.5.4-1: Subscription with intermediate forwarding NRF**

1. NRF-1 receives a subscription request and sends the subscription request to a pre-configured NRF-2. This may for example include cases where NRF-1 does not have sufficient information as determined by the operator policy to fulfill the request locally.
2. Upon receiving a subscription request, based on the SubscriptionData contained in the subscription request (e.g. NF type) and locally stored information (see clause 5.2.2.2.3), NRF-2 shall identify the next hop NRF and forward the subscription request to that NRF (i.e. NF Service Producer registered NRF).

- 3a. On success, "201 Created" shall be returned by NRF-2.
- 3b. On failure, i.e. if the creation of the subscription fails, the NRF-2 shall return "4XX/5XX" response.
- 3c. In the case of redirection, the NRF shall return 3xx status code, which shall contain a Location header with an URI pointing to the endpoint of another NRF service instance.
- 4a. NRF-1 forwards the success response to NF Service Consumer. The payload body of the POST response shall contain the representation describing the status of the request and the "Location" header shall be present and shall contain the URI of the created resource. The authority and/or deployment-specific string of the apiRoot of the created resource URI may differ from the authority and/or deployment-specific string of the apiRoot of the request URI received in the POST request.
- 4b. On failure, NRF-1 forwards the error response to NF Service Consumer.
- 4c. In the case of redirection, the NRF shall return 3xx status code, which shall contain a Location header with an URI pointing to the endpoint of another NRF service instance.

### 5.2.2.5.5 Subscription to NF Instances with intermediate redirecting NRF

When multiple NRFs are deployed in one PLMN, an NF Instance can subscribe to changes of NF Instances registered in another NRF. The subscription message is redirected by a third NRF.

For that, step 1 in clause 5.2.2.5.2 is executed (send a POST request to the NRF-1 in the Serving PLMN); this request shall include the SubscriptionData parameter in the request body.

Then, steps 2-5 in Figure 5.2.2.5.5-1 are executed between NRF-1, NRF-2 and NRF-3.

Finally, step 2 in clause 5.2.2.5.2 is executed; the subscriptionID shall be sent to the NF Service Consumer.

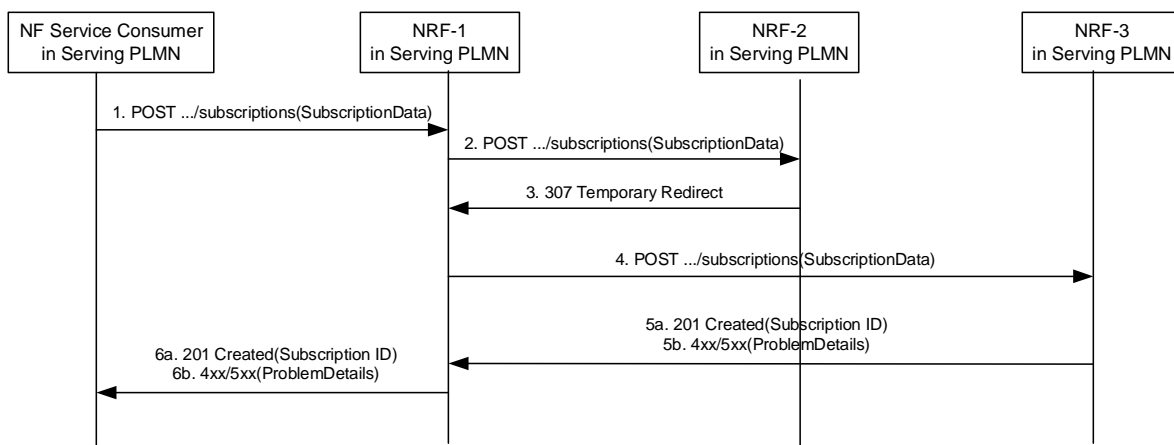

**Figure 5.2.2.5.5-1: Subscription to NF Instances with intermediate redirecting NRF**

1. NF Service Consumer send a subscription request to NRF-1.
2. NRF-1 receives a subscription request but does not have the information to fulfil the request. Then NRF-1 sends the subscription request to a pre-configured NRF-2.
3. Upon receiving a subscription request, based on the SubscriptionData contained in the subscription request (e.g.NF type) and locally stored information (see clause 5.2.2.2.3), NRF-2 shall identify the next hop NRF, and redirect the subscription request by returning HTTP 307 Temporary Redirect response.

The 307 Temporary Redirect response shall contain a Location header field, the host part of the URI in the Location header field represents NRF-3.

4. Upon receiving 307 Temporary Redirect response, NRF-1 sends the subscription request to NRF-3 by using the URI contained in the Location header field of the 307 Temporary Redirect response.
- 5a. On success, "201 Created" shall be returned by NRF-3.

- 5b. On failure, if the creation of the subscription fails at the NRF-3, the NRF-3 shall return "4XX/5XX" response.
- 6a. On success, "201 Created" shall be forwarded to NF Service Consumer via NRF-1. The payload body of the POST response shall contain the representation describing the status of the request and the "Location" header shall be present and shall contain the URI of the created resource. The authority and/or deployment-specific string of the apiRoot of the created resource URI may differ from the authority and/or deployment-specific string of the apiRoot of the request URI received in the POST request.
- 6b. On failure, if the creation of the subscription fails, "4XX/5XX" shall be forwarded to NF Service Consumer via NRF-1.

#### 5.2.2.5.6 Update of Subscription to NF Instances

The subscription to notifications on NF Instances may be updated to refresh the validity time, when this time is about to expire. The NF Service Consumer may request a new validity time to the NRF, and the NRF shall answer with the new assigned validity time, if the operation is successful.

This operation is executed by updating the resource identified by "subscriptionID". It is invoked by issuing an HTTP PATCH request on the URI representing the individual resource received in the Location header field of the "201 Created" response received during a successful subscription (see clause 5.2.2.5).

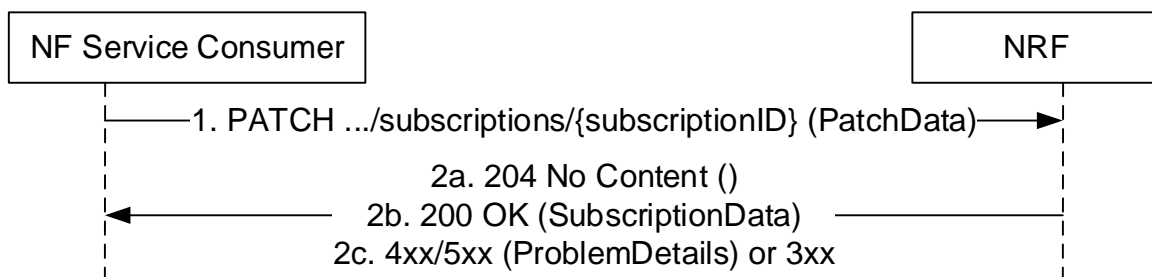

**Figure 5.2.2.5.6-1: Subscription to NF Instances in the same PLMN**

1. The NF Service Consumer shall send a PATCH request to the resource URI identifying the individual subscription resource. The payload body of the PATCH request shall contain a "replace" operation on the "validityTime" attribute of the SubscriptionData structure and shall contain a new suggested value for it; no other attribute of the resource shall be updated as part of this operation.
- 2a. On success, if the NRF accepts the extension of the lifetime of the subscription, and it accepts the requested value for the "validityTime" attribute, a response with status code "204 No Content" shall be returned.
- 2b. On success, if the NRF accepts the extension of the lifetime of the subscription, but it assigns a validity time different than the value suggested by the NF Service Consumer, a "200 OK" response code shall be returned. The response shall contain the new resource representation of the "subscription" resource, which includes the new validity time, as determined by the NRF, after which the subscription becomes invalid.
- 2c. On failure or redirection:
  - If the update of the subscription fails at the NRF due to errors in the JSON Patch object in the request body, the NRF shall return "400 Bad Request" status code with the ProblemDetails IE providing details of the error.
  - If the update of the subscription fails at the NRF due to NRF internal errors, the NRF shall return "500 Internal Server Error" status code with the ProblemDetails IE providing details of the error.
  - In the case of redirection, the NRF shall return 3xx status code, which shall contain a Location header with an URI pointing to the endpoint of another NRF service instance.

#### EXAMPLE:

```
PATCH .../subscriptions/2a58bf47
Content-Type: application/json-patch+json
```

```
[
  { "op": "replace", "path": "/validityTime", "value": "2018-12-30T23:20:50Z" },
]
```

HTTP/2 204 No Content

### 5.2.2.5.7 Update of Subscription to NF Instances in a different PLMN

The update of subscription in a different PLMN is done by updating a subscription resource identified by a "subscriptionID".

For that, step 1 in clause 5.2.2.5.6 is executed (send a PATCH request to the NRF in the Serving PLMN); this request shall include the identity of the PLMN of the home NRF (MCC/MNC values) as a leading prefix of the subscriptionID.

Then, steps 1-2 in Figure 5.2.2.5.7-1 are executed, between the NRF in the Serving PLMN and the NRF in the Home PLMN. In this step, the subscriptionID sent to the NRF in the Home PLMN shall not contain the identity of the PLMN (i.e., it shall be the same subscriptionID value as originally generated by the NRF in the Home PLMN). The NRF in the Home PLMN returns a status code with the result of the operation.

If the subscription was created in a different NRF in the HPLMN than the NRF in the HPLMN that receives the subscription update request, the latter shall forward the request received from the NRF in the serving PLMN towards the NRF in the HPLMN holding the subscription, using the information included in the subscriptionID (see clause 5.2.2.5.3). The subscriptionID value in the request forwarded to the NRF in the HPLMN holding the subscription shall contain the same value as originally generated by the latter.

Finally, step 2 in clause 5.2.2.5.7-2 is executed; a status code is returned to the NF Service Consumer in Serving PLMN in accordance to the result received from NRF in the Home PLMN.

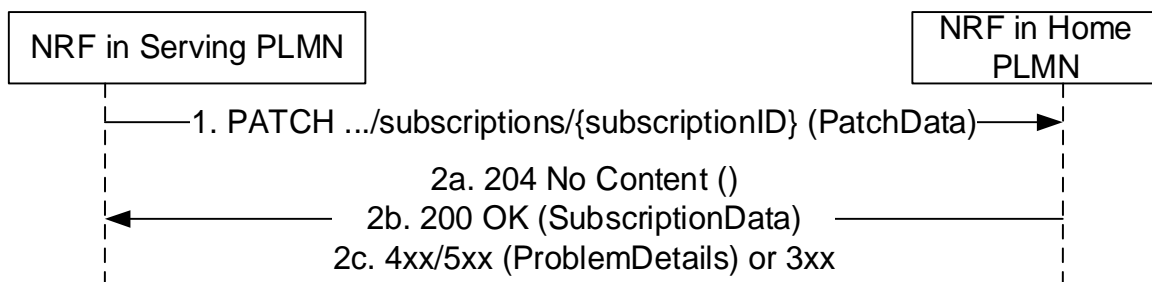

**Figure 5.2.2.5.7-1: Update of Subscription to NF Instances in a different PLMN**

1. The NRF in Serving PLMN shall send a PATCH request to the resource URI representing the individual subscription. The payload body of the PATCH request shall contain a "replace" operation on the "validityTime" attribute of the SubscriptionData structure and shall contain a new suggested value for it;
- 2a. On success, if the NRF in the Home PLMN accepts the extension of the lifetime of the subscription, and it accepts the requested value for the "validityTime" attribute, a response with status code "204 No Content" shall be returned.
- 2b. On success, if the NRF in the Home PLMN accepts the extension of the lifetime of the subscription, but it assigns a validity time different than the value suggested by the NF Service Consumer, a "200 OK" response code shall be returned. The response shall contain the new resource representation of the "subscription" resource, which includes the new validity time, as determined by the NRF in the Home PLMN, after which the subscription becomes invalid.
- 2c. On failure or redirection:
  - If the update of the subscription fails at the NRF due to errors in the JSON Patch object in the request body, the NRF shall return "400 Bad Request" status code with the ProblemDetails IE providing details of the error.
  - If the update of the subscription fails at the NRF due to NRF internal errors, the NRF shall return "500 Internal Server Error" status code with the ProblemDetails IE providing details of the error.
  - In the case of redirection, the NRF shall return 3xx status code, which shall contain a Location header with an URI pointing to the endpoint of another NRF service instance.

## 5.2.2.6 NFStatusNotify

### 5.2.2.6.1 General

This service operation notifies each NF Service Consumer that was previously subscribed to receiving notifications of registration/deregistration of NF Instances, or notifications of changes of the NF profile of a given NF Instance. The notification is sent to a callback URI that each NF Service Consumer provided during the subscription (see NFStatusSubscribe operation in 5.2.2.5).

#### 5.2.2.6.2 Notification from NRF in the same PLMN

The operation is invoked by issuing a POST request to each callback URI of the different subscribed NF Instances.

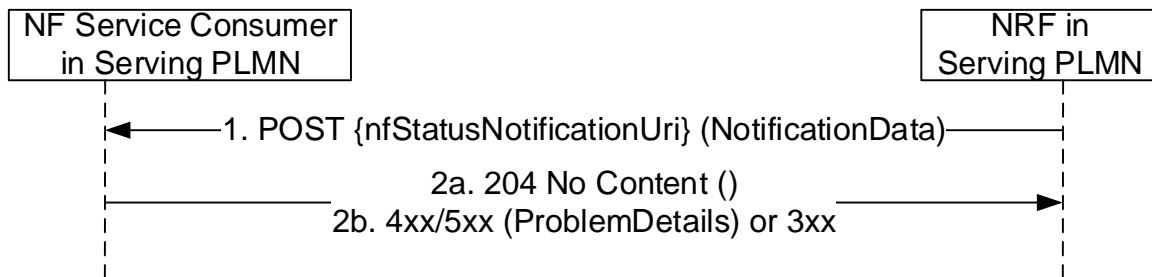

**Figure 5.2.2.6.2-1: Notification from NRF in the same PLMN**

1. The NRF shall send a POST request to the callback URI.

For notifications of newly registered NF Instances, the request body shall include the data associated to the newly registered NF, and its services, according to the criteria indicated by the NF Service Consumer during the subscription operation. These data shall contain the nfInstanceURI of the NF Instance, an indication of the event being notified ("registration"), and the new profile data (including, among others, the services offered by the NF Instance).

For notifications of changes of the profile of a NF Instance, the request body shall include the NFInstanceID of the NF Instance whose profile was changed, an indication of the event being notified ("profile change"), and the new profile data.

For notifications of deregistration of the NF Instance from NRF, the request body shall include the NFInstanceID of the deregistered NF Instance, and an indication of the event being notified ("deregistration").

When an NF Service Consumer subscribes to a set of NFs (using the different subscription conditions specified in clause 6.1.6.2.35), a change in the profile of the monitored NF Instance may result in such NF becoming a part of the NF set, or stops becoming a part of it (e.g., an NF Service Consumer subscribing to all NFs offering a given NF Service, and then, a certain NF Instance changes its profile by adding or removing an NF Service of its NF Profile); in such case, the NRF shall use the "NF\_PROFILE\_CHANGED" event type in the notification. Similarly, a change of the status (i.e. the "nfStatus" attribute of the NF Profile) shall result into the NRF to send notifications to subscribing NFs with event type set to "NF\_PROFILE\_CHANGED".

When an NF Service Consumer subscribes to a set of NFs, using the subscription conditions specified in clause 6.1.6.2.35, in case of a change of profile(s) of NFs potentially related to those subscription conditions, the NRF shall send notification to subscribing NF Service Consumer(s) to those NFs no longer matching the subscription conditions, and to subscribing NF Service Consumer(s) to NFs that start matching the subscription conditions. In that case, the NRF indicates in the notification data whether the notification is due to the NF Instance to newly start or stop matching the subscription condition (i.e. based on the presence of the "conditionEvent" attribute of the NotificationData).

The notification of changes of the profile may be done by the NRF either by sending the entire new NF Profile, or by indicating a number of "delta" changes (see clause 6.1.6.2.17) from an existing NF Profile that might have been previously received by the NF Service Consumer during an NFDISCOVERY search operation (see clause 5.3.2.2). If the NF Service Consumer receives "delta" changes related to an NF Service Instance (other than adding a new NF Service Instance) that had not been previously discovered, those changes shall be ignored by

the NF Service Consumer, but any other "delta" changes related to NF Service Instances previously discovered or adding a new NF Service Instance shall be applied.

Change of authorization attributes (allowedNfTypes, allowedNfDomains, allowedNssais, allowedPlmns etc) shall trigger a "NF\_PROFILE\_CHANGED" notification from NRF, if the change of the NF Profile results in that the NF Instance starts or stops being authorized to be accessed by an NF having subscribed to be notified about NF profile changes. In this case, the NRF indicates in the notification data whether the notification is due to the NF Instance to newly start or stop matching the subscription condition (i.e. based on the presence of the "conditionEvent" attribute of the NotificationData). Otherwise change of authorization attributes shall not trigger notification.

2a. On success, "204 No content" shall be returned by the NF Service Consumer.

2b. On failure or redirection:

- If the NF Service Consumer does not consider the "nfStatusNotificationUri" as a valid notification URI (e.g., because the URI does not belong to any of the existing subscriptions created by the NF Service Consumer in the NRF), the NF Service Consumer shall return "404 Not Found" status code with the ProblemDetails IE providing details of the error.
- In the case of redirection, the NF service consumer shall return 3xx status code, which shall contain a Location header with an URI pointing to the endpoint of another NF service consumer endpoint.

5.2.2.6.3 Notification from NRF in a different PLMN

The operation is invoked by issuing a POST request to each callback URI of the different subscribed NF Instances.

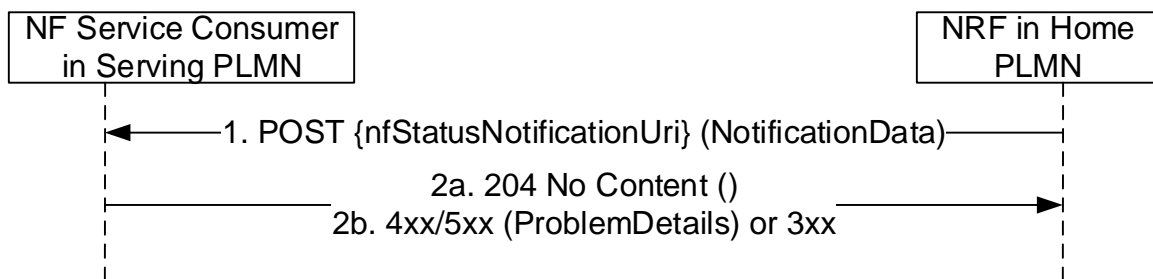

Figure 5.2.2.6.3-1: Notification from NRF in a different PLMN

Steps 1 and 2 are identical to steps 1 and 2 in Figure 5.2.2.6.2-1.

It should be noted that the POST request shall be sent directly from the NRF in Home PLMN to the NF Service Consumer in Serving PLMN, without involvement of the NRF in Serving PLMN.

5.2.2.6.4 Notification for subscription via intermediate NRF

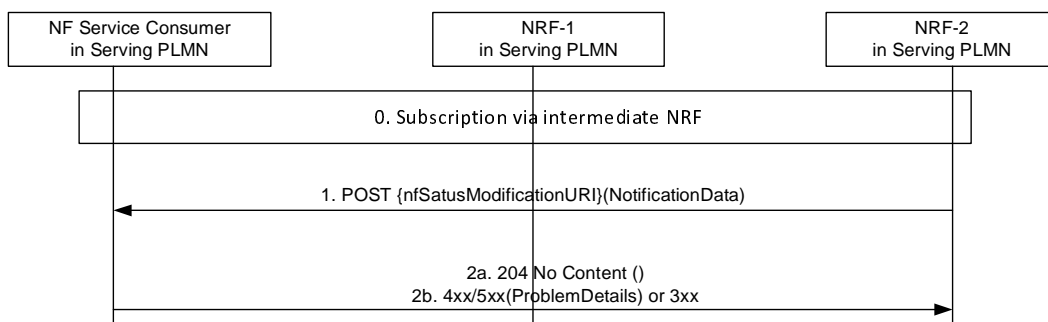

Figure 5.2.2.6.4-1: Notification for subscription via intermediate NRF

Step 0 is the NF Service Consumer creates a subscription to NRF-2 via intermediate NRF.

Steps 1 and 2 are identical to steps 1 and 2 in Figure 5.2.2.6.2-1.

The POST request shall be sent directly from NRF-2 to the NF Service Consumer without involvement of NRF-1.

### 5.2.2.7 NFStatusUnSubscribe

#### 5.2.2.7.1 General

This service operation removes an existing subscription to notifications.

#### 5.2.2.7.2 Subscription removal in the same PLMN

It is executed by deleting a given resource identified by a "subscriptionID". The operation is invoked by issuing a DELETE request on the URI representing the specific subscription received in the Location header field of the "201 Created" response received during a successful subscription (see clause 5.2.2.5).

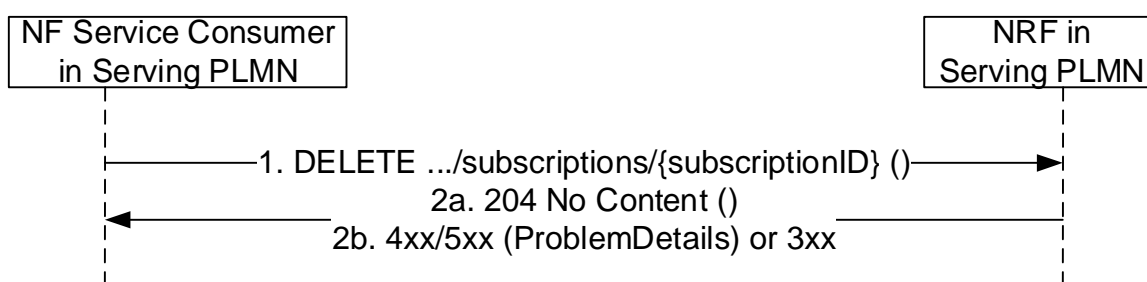

**Figure 5.2.2.7.2-1: Subscription removal in the same PLMN**

1. The NF Service Consumer shall send a DELETE request to the resource URI representing the individual subscription. The request body shall be empty.
- 2a. On success, "204 No Content" shall be returned. The response body shall be empty.
- 2b. On failure or redirection:
  - If the subscription, identified by the "subscriptionID", is not found in the list of active subscriptions in the NRF's database, the NRF shall return "404 Not Found" status code with the ProblemDetails IE providing details of the error.
  - In the case of redirection, the NRF shall return 3xx status code, which shall contain a Location header with an URI pointing to the endpoint of another NRF service instance.

#### 5.2.2.7.3 Subscription removal in a different PLMN

The subscription removal in a different PLMN is done by deleting a resource identified by a "subscriptionID", in the NRF of the Home PLMN.

For that, step 1 in clause 5.2.2.7.2 is executed (send a DELETE request to the NRF in the Serving PLMN); this request shall include the identity of the PLMN of the home NRF (MCC/MNC values) as a leading prefix of the subscriptionID (see clause 5.2.2.5.3).

Then, steps 1-2 in Figure 5.2.2.7.3-1 are executed, between the NRF in the Serving PLMN and the NRF in the Home PLMN. In this step, the subscriptionID sent to the NRF in the Home PLMN shall not contain the identity of the PLMN (i.e., it shall be the same subscriptionID value as originally generated by the NRF in the Home PLMN). The NRF in the Home PLMN returns a status code with the result of the operation.

If the subscription was created in a different NRF in the HPLMN than the NRF in the HPLMN that receives the subscription delete request, the latter shall forward the request received from the NRF in the serving PLMN towards the NRF in the HPLMN holding the subscription, using the information included in the subscriptionID (see clause 5.2.2.5.3). The subscriptionID value in the request forwarded to the NRF in the HPLMN holding the subscription shall contain the same value as originally generated by the latter.

Finally, step 2 in clause 5.2.2.7.2 is executed; a status code is returned from the NRF in serving PLMN to the NF Service Consumer in Serving PLMN in accordance to the result received from NRF in Home PLMN.



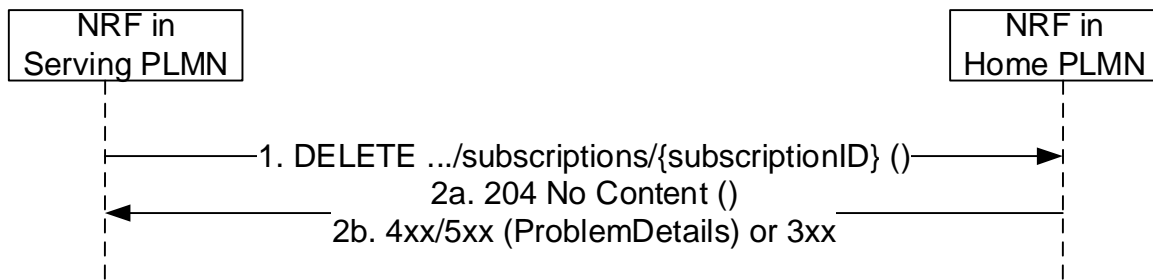

**Figure 5.2.2.7.3-1: Subscription removal in a different PLMN**

1. The NF Service Consumer shall send a DELETE request to the resource URI representing the individual subscription. The request body shall be empty.
- 2a. On success, "204 No Content" shall be returned. The response body shall be empty.
- 2b. On failure or redirection:
  - If the subscription, identified by the "subscriptionID", is not found in the list of active subscriptions in the NRF's database, the NRF shall return "404 Not Found" status code with the ProblemDetails IE providing details of the error.
  - In the case of redirection, the NRF shall return 3xx status code, which shall contain a Location header with an URI pointing to the endpoint of another NRF service instance.

## 5.2.2.8 NFListRetrieval

### 5.2.2.8.1 General

This service operation allows the retrieval of a list of NF Instances that are currently registered in NRF. The operation may apply to the whole set of registered NF instances or only to a subset of the NF instances, based on a given NF type and/or maximum number of NF instances to be returned.

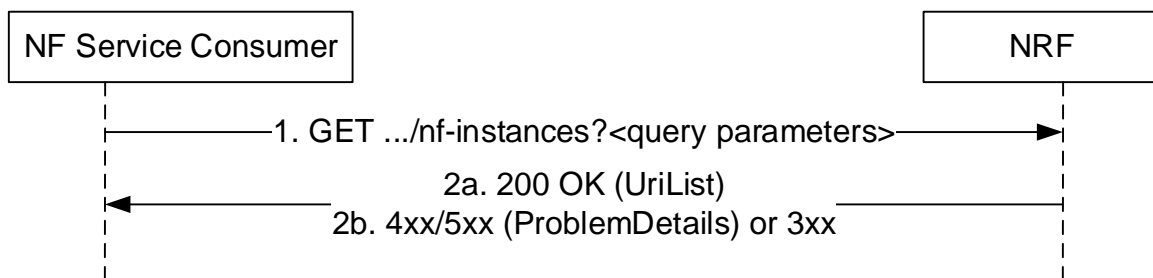

**Figure 5.2.2.8.1-1: NF instance list retrieval**

1. The NF Service Consumer shall send an HTTP GET request to the resource URI "nf-instances" collection resource. The optional input filter criteria (e.g. "nf-type") and pagination parameters for the retrieval request may be included in query parameters.
- 2a. On success, "200 OK" shall be returned. The response body shall contain the URI (conforming to the resource URI structure as described in clause 5.2.2.9.1) of each registered NF in the NRF that satisfy the retrieval filter criteria (e.g., all NF instances of the same NF type), or an empty list if there are no NFs to return in the query result (e.g., because there are no registered NFs in the NRF, or because there are no matching NFs of the type specified in the "nf-type" query parameter, currently registered in the NRF). The total count of items satisfying the filter criteria (e.g. "nf-type") should be returned in the response.
- 2b. On failure or redirection:
  - If the NF Service Consumer is not allowed to retrieve the registered NF instances, the NRF shall return "403 Forbidden" status code.

- If the NF Instance list retrieval fails at the NRF due to errors in the input data in the URI query parameters, the NRF shall return "400 Bad Request" status code with the ProblemDetails IE providing details of the error.
- If the discovery request fails at the NRF due to NRF internal errors, the NRF shall return "500 Internal Server Error" status code with the ProblemDetails IE providing details of the error.
- In the case of redirection, the NRF shall return 3xx status code, which shall contain a Location header with an URI pointing to the endpoint of another NRF service instance.

## 5.2.2.9 NFProfileRetrieval

### 5.2.2.9.1 General

This service operation allows the retrieval of the NF profile of a given NF instance currently registered in NRF.

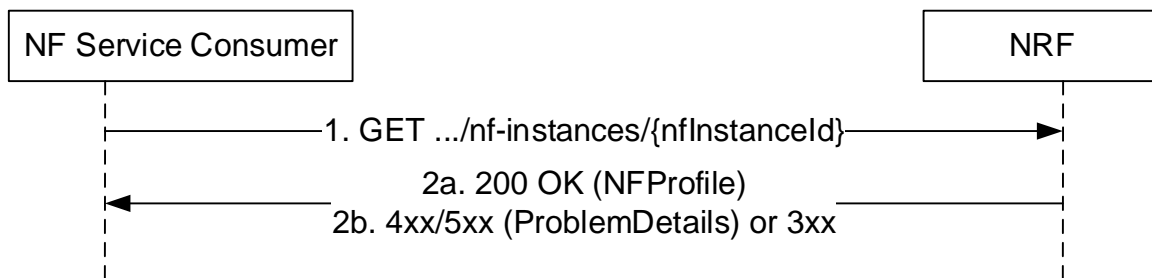

**Figure 5.2.2.9.1-1: NF profile retrieval**

1. The NF Service Consumer shall send an HTTP GET request to the resource URI "nf-instances/{nfInstanceId}".
- 2a. On success, "200 OK" shall be returned. The response body shall contain the NF profile of the NF instance identified in the request.
- 2b. On failure or redirection:
  - If the NF Service Consumer is not allowed to retrieve the NF profile of this specific registered NF instance, the NRF shall return "403 Forbidden" status code.
  - If the NF Profile retrieval fails at the NRF due to NRF internal errors, the NRF shall return "500 Internal Server Error" status code with the ProblemDetails IE providing details of the error.
  - In the case of redirection, the NRF shall return 3xx status code, which shall contain a Location header with an URI pointing to the endpoint of another NRF service instance.

## 5.3 Nnrf\_NFDiscovery Service

### 5.3.1 Service Description

The Nnrf\_NFDiscovery service allows a NF or SCP Instance to discover other NF Instances with the potential services they offer, or to discover SEPP instances in the same PLMN, by querying the local NRF.

The Nnrf\_NFDiscovery service also allows:

- an SCP to discover other SCP instances,
- an NF or SCP to discover the list of NRF instances that are part of the NRF set with, for each NRF instance, its NRF instance ID and addressing information, if the NRF is part of an NRF set.

It also allows an NRF in a PLMN to re-issue a discovery request towards an NRF in another PLMN (e.g., the HPLMN of a certain UE).

## 5.3.2 Service Operations

### 5.3.2.1 Introduction

The service operations defined for the Nnrf\_NFDiscovery service are as follows:

- NFDDiscover: It provides to the NF service consumer or SCP the profile (including IP address(es) or FQDN) of the NF Instance(s) or NF Service(s) or SEPP instances matching certain input criteria. It also provides to the SCP the profile (including IP address(es) or FQDN) of the SCP Instance(s) matching certain input criteria.

The NFDDiscover operation can be invoked by an NF Service Consumer (i.e., "source NF") or SCP requesting to discover NF instances (i.e., "target NFs") located in the same PLMN, or in a different PLMN, or SEPP instances located in the same PLMN. It can also be invoked by an SCP requesting to discover SCP instances located in the same PLMN.

In the description of these operations in clause 5.3.2.2, when the NF instances are located in the same PLMN, both source NF and target NFs are said to be located in the "Serving PLMN" but, in the general case, the functionality is not restricted to the PLMN that is serving a given UE, and it shall be applicable as well to any scenario in which source NF and target NFs belong to the same PLMN.

When source NF and target NFs are located in different PLMNs, the source NF is said to be in the "Serving PLMN", and the target NFs (and the NRF where they are registered) are said to be in the "Home PLMN", similarly to the scenarios described in 3GPP TS 23.502 [3], but the functionality shall be equally applicable to any scenario between any pair of PLMNs (e.g. with the source NF in the Home PLMN and the target NF in the Serving PLMN).

The SCP and SEPP are treated by the Nnrf\_NFDiscovery service in the same way as NFs. Specifically, the SCP and SEPP are designated with a specific NF type and NF Instance ID. However, the SCP and SEPP do not support services. Accordingly, references to "NF" or "NF Profile" in the description of the service operations in the following clauses also apply to an SCP and SEPP.

- SCPDomainRoutingInfoGet: It allows a service consumer (e.g. SCP) to fetch the SCP domain routing information (list of all SCP Domains registered by SCPs and the interconnected SCP domains per SCP domain), if both the SCP and the NRF supports the "SCPDRI" feature. It also allows a service consumer (e.g. NRF) to fetch the local SCP domain routing information (based on SCPs registered in the NRF as service producer), if both the NRF as service consumer and NRF as service producer supports the "SCPDRI" feature.

NOTE: Two SCP domains are considered interconnected when at least one SCP belongs to both SCP domains, i.e. at least one SCP can bridge messages between these two SCP domains.

- SCPDomainRoutingInfoSubscribe: It allows a service consumer (e.g. SCP) to create a subscription for changes of the SCP domain routing information, if both the SCP and the NRF supports the "SCPDRI" feature. It also allows a service consumer (e.g. NRF) to create a subscription for changes of local SCP domain routing information, if both the NRF as service consumer and NRF as service producer supports the "SCPDRI" feature.
- SCPDomainRoutingInfoNotify: It allows the NRF to send notification(s) to a service consumer (e.g. SCP) previously subscribed to the changes of the SCP domain routing information, if both the SCP and the NRF supports the "SCPDRI" feature. It also allows the NRF as service producer to send notification(s) to a service consumer (e.g. NRF) previously subscribed to the changes of the local SCP domain routing information, if both the NRF as service consumer and NRF as service producer supports the "SCPDRI" feature.
- SCPDomainRoutingInfoUnsubscribe: It allows a service consumer (e.g. SCP or NRF) to delete a previously created subscription for changes of the SCP domain routing information, if both the service consumer and the NRF as service producer supports the "SCPDRI" feature.

A NRF may be part of an NRF set, whereby all NRF instances of the NRF Set share the same context data (e.g. registered NF profiles, NF status subscriptions). If so, the NF Service Consumer may be configured with the NRF Set ID or it may discover the same in the NRF Bootstrapping response.

If the NRF is part of an NRF set, the NF Service Consumer may retrieve the NRF Set Information from the NRF via the Nnrf\_NFDiscovery service, which allows to discover the list of NRF instances that are part of the NRF set with, for each NRF instance, its NRF Instance ID and addressing information (i.e. part of NRF profile).

NOTE: As part of the discovery of NRF instances belonging to an NRF Set, not all attributes in the NFProfile and NFService data structures (typically used for NF Consumer – NF Producer interaction) are needed for the NF Consumer to interact with the instances of the NRF Set, so the discovery response from NRF can be simplified and omit certain parameters.

The NF Service Consumer may register with any of the NRF Instance Id within the NRF Set. If the NRF instance where an NF Service Consumer registered is down, the NF Service Consumer need not re-register to any new NRF instance within the NRF Set. The NRF may provide a binding indication to the NF service consumer, e.g. when the NF Service Consumer registers or updates its NF profile in the NRF or when it issues heartbeat requests, to indicate a preferred binding of the NF Service Consumer to one NRF instance within the NRF set, e.g. based on the location or data center of the registering/registered NF Service Consumer.

### 5.3.2.2 NFDISCOVER

#### 5.3.2.2.1 General

This service operation discovers the set of NF Instances (and their associated NF Service Instances), represented by their NF Profile, that are currently registered in NRF and satisfy a number of input query parameters.

Before a service consumer invokes this service operation, it shall consider if it is possible to reuse the results from a previous searching (service discovery).

The service consumer should reuse the previous result if input query parameters in the new service discovery request are the same as used for the previous search and the validity period of the result is not expired.

The service consumer may consider reusing the previous result if the attributes as required for the new query consist of the query attributes from the previous query and additional query attributes. In such case, when the results of a previous query are reused, the service consumer need consider that the previous results will possibly include NF profiles that the new query would not; hence, the service consumer has to complete the filtering itself against the additional filter attributes in the new internal query.

Otherwise, if the query parameters in the new service discovery are different and don't consist of the previous query attributes and additional ones (i.e. the new query parameters, in general, don't have any relationship with those of the previous search), the reuse of cached profiles may still be done.

In these two last cases (i.e. where the query parameters of the new query are not identical to the previous query), re-using data from cached profiles may possibly yield to different results than if a new discovery was performed, and thus may be subject to operator's policy.

NOTE: Certain types of query attributes affect the contents of the NF Profiles returned in the discovery responses (e.g., "preferred-location" typically affects the setting of the "priority" attribute inside the NF Profiles returned by NRF); reusing the results from a previous query, when the new query involves any of such parameters, may not be feasible.

#### 5.3.2.2.2 Service Discovery in the same PLMN

This service operation is executed by querying the "nf-instances" resource. The request is sent to an NRF in the same PLMN of the NF Service Consumer.

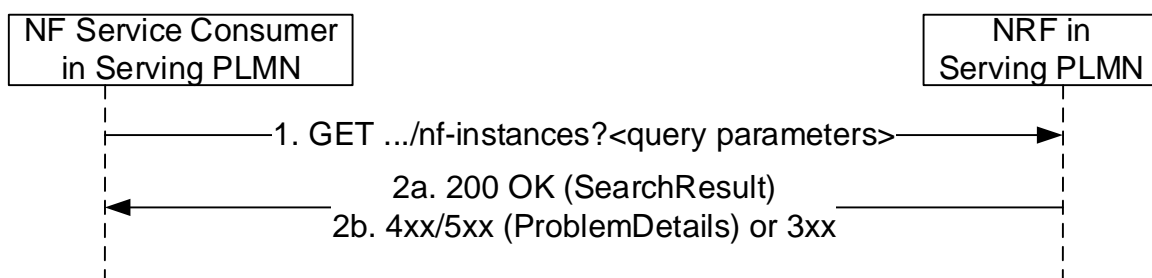

Figure 5.3.2.2-1: Service Discovery Request in the same PLMN

1. The NF Service Consumer shall send an HTTP GET request to the resource URI "nf-instances" collection resource. The input filter criteria for the discovery request shall be included in query parameters.
- 2a. On success, "200 OK" shall be returned. The response body shall contain a validity period, during which the search result can be cached by the NF Service Consumer, and an array of NF Profile objects, and/or a map of NFInstanceInfo objects of NF instances (if the NF service consumer indicated support of the Enh-NF-Discovery feature in the request) that satisfy the search filter criteria (e.g., all NF Instances offering a certain NF Service name in REGISTERED status, or empty array in case search filter criteria do not match a NF Instance in REGISTERED status). In the latter case, the response may include the noProfileMatchInfo attribute to provide the specific reason for not finding any NF instance that can match the search filter criteria.
- 2b. On failure or redirection:
  - If the NF Service Consumer is not allowed to discover the NF services for the requested NF type provided in the query parameters, the NRF shall return "403 Forbidden" response.
  - If the discovery request fails at the NRF due to errors in the input data in the URI query parameters, the NRF shall return "400 Bad Request" status code with the ProblemDetails IE providing details of the error.
  - If the discovery request fails at the NRF due to NRF internal errors, the NRF shall return "500 Internal Server Error" status code with the ProblemDetails IE providing details of the error.
  - In the case of redirection, the NRF shall return 3xx status code, which shall contain a Location header with an URI pointing to the endpoint of another NRF service instance.

The NF Profile objects returned in a successful result shall contain generic data of each NF Instance, applicable to any NF type, and it may also contain NF-specific data, for those NF Instances belonging to a specific type (e.g., the attribute "udrInfo" is typically present in the NF Profile when the type of the NF Instance takes the value "UDR"). In addition, the attribute "customInfo", may be present in the NF Profile for those NF Instances with custom NF types.

For those NF Instances, the "customInfo" attribute shall be returned by NRF, if available, as part of the NF Profiles returned in the discovery response.

The NRF shall also include, in the returned NF Profile objects, the Vendor-Specific attributes (see 3GPP TS 29.500 [4], clause 6.6.3) that may have been provided by the registered NF Instances.

If the response includes a map of NFInstanceInfo objects of NF instances, the NF Service Consumer may retrieve the NF profiles by issuing a service discovery request with the target-nf-instance-id parameter identifying the target NF Instance ID; the service discovery request shall also include the nrf-disc-uri parameter set to the API URI of the Nnrf\_NFDiscovery service of the NRF holding the NF profile, if the nrfDiscApiUri attribute was received in the NFInstanceInfo object and if the service discovery request is addressed to a different NRF than the NRF holding the NF profile.

### 5.3.2.2.3 Service Discovery in a different PLMN

The service discovery in a different PLMN is done by querying the "nf-instances" resource in the NRF of the Home PLMN.

For that, step 1 in clause 5.3.2.2.2 is executed (send a GET request to the NRF in the Serving PLMN); this request shall include the identity of the PLMN of the home NRF in a query parameter of the URI.

If the NRF in Serving PLMN knows that OAuth2-based authorization is required for accessing the NF Discovery service of the NRF in Home PLMN, e.g. by learning this during an earlier Bootstrapping procedure or local configuration, and if the request received at the NRF in Serving PLMN does not include an access token, the NRF in Serving PLMN may reject the request with a 401 Unauthorized as specified in clause 6.7.3 of 3GPP TS 29.500 [4].

Then, steps 1-2 in Figure 5.3.2.2.3-1 are executed, between the NRF in the Serving PLMN and the NRF in the Home PLMN. In this step, the presence of the PLMN ID of the Home NRF in the query parameter of the URI is not required. The NRF in the Home PLMN returns a status code with the result of the operation. The NRF in the Serving PLMN shall be configured with:

- a telescopic FQDN (see 3GPP TS 23.003 [12] and 3GPP TS 29.500 [4]) of the NRF in the Home PLMN, if TLS protection between the NRF and the SEPP in the serving PLMN relies on using telescopic FQDN; or

NOTE: This is required for the NRF in the serving PLMN to route the NF discovery request to the NRF in the HPLMN through a SEPP in the serving PLMN and the SEPP to terminate the TLS connection with a wildcard certificate.

- with the SEPP FQDN (or the FQDN of the SCP if the communication between the NRF and the SEPP goes through an SCP), if TLS protection between the NRF and the SEPP in the serving PLMN relies on using the 3gpp-Sbi-Target-apiRoot header.

See clause 6.1.4.3 of 3GPP TS 29.500 [4].

Finally, step 2 in clause 5.3.2.2.2 is executed; a status code is returned to the NF Service Consumer in Serving PLMN in accordance to the result received from NRF in Home PLMN.

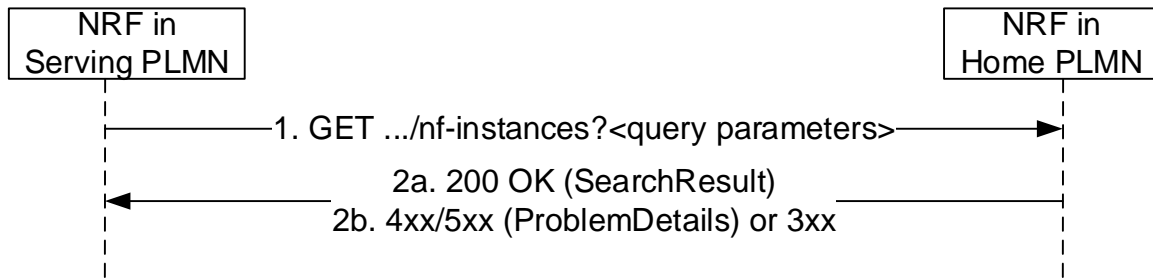

Figure 5.3.2.2.3-1: Service Discovery in a different PLMN

Steps 1 and 2 are similar to steps 1 and 2 in Figure 5.3.2.2.2-1, where the originator of the service invocation is the NRF in Serving PLMN, and the recipient of the service invocation is the NRF in the Home PLMN.

### 5.3.2.2.4 Service Discovery with intermediate redirecting NRF

When multiple NRFs are deployed in one PLMN, one NRF may query the "nf-instances" resource in a different NRF so as to fulfil the service discovery request from a NF service consumer. The query between these two NRFs is redirected by a third NRF.

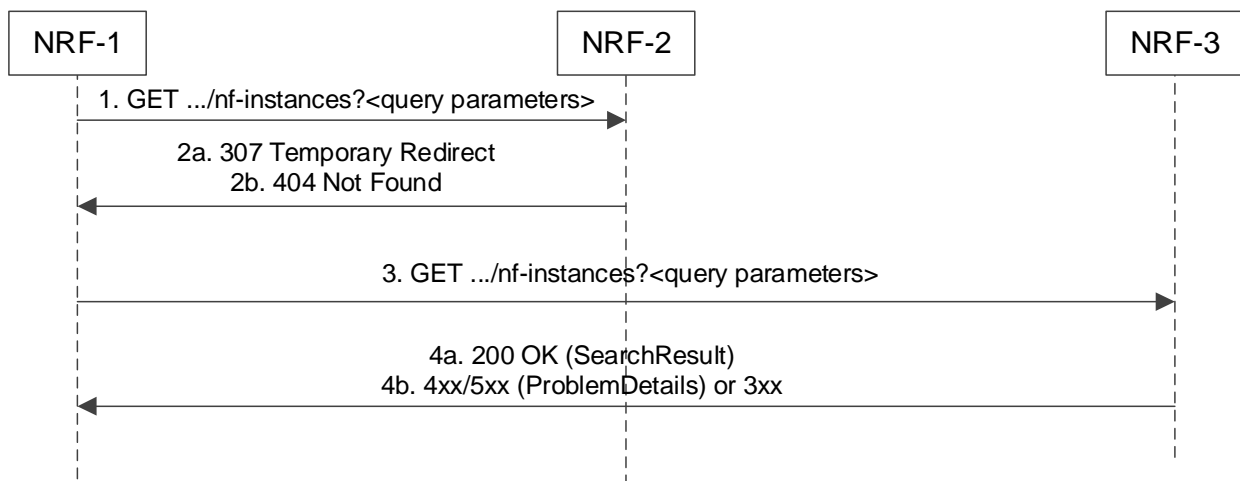

Figure 5.3.2.2.4-1: Service Discovery with intermediate redirecting NRF

1. NRF-1 receives a service discovery request but does not have the information to fulfil the request. Then NRF-1 sends the service discovery request to a pre-configured NRF-2.
- 2a. Upon receiving a service discovery request, based on the information contained in the service discovery request (e.g. the "supi" query parameter in the URI) and locally stored information NRF-2 shall identify the next hop

NRF (see clause 5.2.2.2.3), and redirect the service discovery request by returning HTTP 307 Temporary Redirect response. The locally stored information in NRF-2 may:

- a) be preconfigured; or
- b) registered by other NRFs (see clause 5.2.2.2.3).

The 307 Temporary Redirect response shall contain a Location header field, the host part of the URI in the Location header field represents NRF-3.

- 2b. if NRF-2 does not have enough information to redirect the service discovery request, then it responds with 404 Not Found, and the rest of the steps are omitted.
3. Upon receiving 307 Temporary Redirect response, NRF-1 sends the service discovery request to NRF-3 by using the URI contained in the Location header field of the 307 Temporary Redirect response.
- 4a. Upon success, NRF-3 returns the search result.
- 4b. On failure or redirection:
  - If the NF Service Consumer is not allowed to discover the NF services for the requested NF type provided in the query parameters, the NRF shall return "403 Forbidden" response.
  - If the discovery request fails at the NRF due to errors in the input data in the URI query parameters, the NRF shall return "400 Bad Request" status code with the ProblemDetails IE providing details of the error.
  - If the discovery request fails at the NRF due to NRF internal errors, the NRF shall return "500 Internal Server Error" status code with the ProblemDetails IE providing details of the error.
  - In the case of redirection, the NRF shall return 3xx status code, which shall contain a Location header with an URI pointing to the endpoint of another NRF service instance.

### 5.3.2.2.5 Service Discovery with intermediate forwarding NRF

When multiple NRFs are deployed in one PLMN, one NRF may query the "nf-instances" resource in a different NRF so as to fulfil the service discovery request from a NF service consumer. The query between these two NRFs is forwarded by a third NRF.

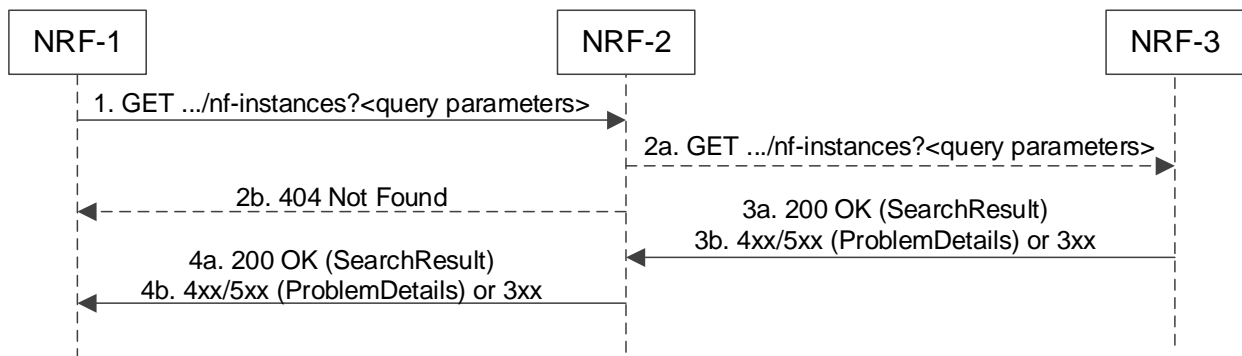

**Figure 5.3.2.2.5-1: Service Discovery with intermediate forwarding NRF**

1. NRF-1 receives a service discovery request and sends the service discovery request to a pre-configured NRF-2. This may for example include cases where NRF-1 does not have sufficient information as determined by the operator policy to fulfill the request locally.
- 2a. Upon receiving a service discovery request, based on the information contained in the service discovery request (e.g. the "supi" query parameter in the URI) and locally stored information, NRF-2 shall identify the next hop NRF (see clause 5.2.2.2.3), and forward the service discovery request to that NRF (i.e. NRF-3 in this example)

similarly to steps 1 and 2 in Figure 5.3.2.2.2-1 where the originator of the service invocation is NRF-2 and the recipient of the service invocation is NRF-3. The locally stored information in NRF-2 may:

a) be preconfigured; or

b) registered by other NRFs (see clause 5.2.2.2.3).

2b. if NRF-2 does not have enough information to forward the service discovery request, then it responds with 404 Not Found, and the rest of the steps are omitted.

3a. Upon success, NRF-3 returns the search result.

3b. On failure or redirection:

- If the NF Service Consumer is not allowed to discover the NF services for the requested NF type provided in the query parameters, the NRF shall return "403 Forbidden" response.
- If the discovery request fails at the NRF due to errors in the input data in the URI query parameters, the NRF shall return "400 Bad Request" status code with the ProblemDetails IE providing details of the error.
- If the discovery request fails at the NRF due to NRF internal errors, the NRF shall return "500 Internal Server Error" status code with the ProblemDetails IE providing details of the error.
- In the case of redirection, the NRF shall return 3xx status code, which shall contain a Location header with an URI pointing to the endpoint of another NRF service instance.

4a. NRF-2 forwards the success response to NRF-1.

4b. On failure or redirection:

- NRF-2 forwards the error response to NRF-1.
- In the case of redirection, the NRF shall return 3xx status code, which shall contain a Location header with an URI pointing to the endpoint of another NRF service instance.

NOTE: It is not assumed that there can only be two NRF hierarchies, i.e. the NRF-3 can go on to forward the service discovery request to another NRF.

### 5.3.2.2.6 Service Discovery with resolution of the target PLMN

This service discovery is done by querying the "nf-instances" resource in the NRF of the target PLMN, similar to the "Service Discovery in a different PLMN", as described in clause 5.3.2.2.3.

The main difference compared with clause 5.3.2.2.3 is that the identity of the target PLMN is not explicitly provided by the NF Service Consumer.

NOTE: This can happen, e.g., when the identity of the UE involved in the service discovery is not based on IMSI, but on GPSI (MSISDN) and, therefore, the MNC/MCC of the target PLMN cannot be derived from the UE identity. It should also be noted that, in these scenarios, the MSISDN may be subject to Mobile Number Portability.



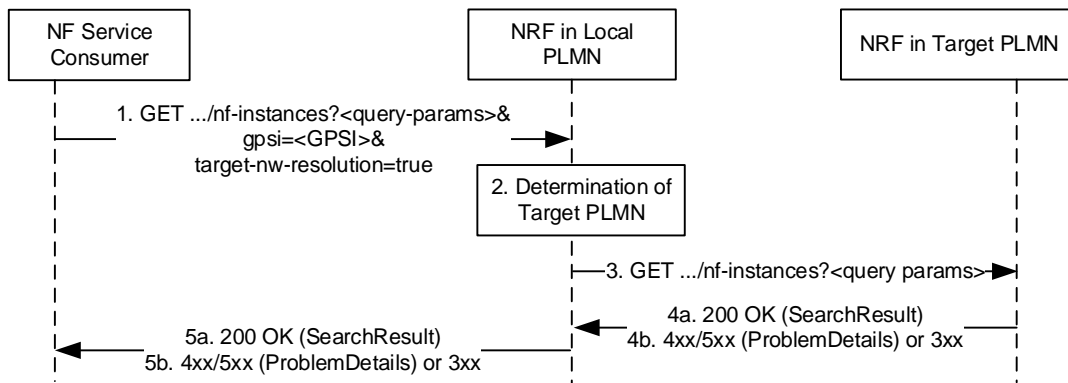
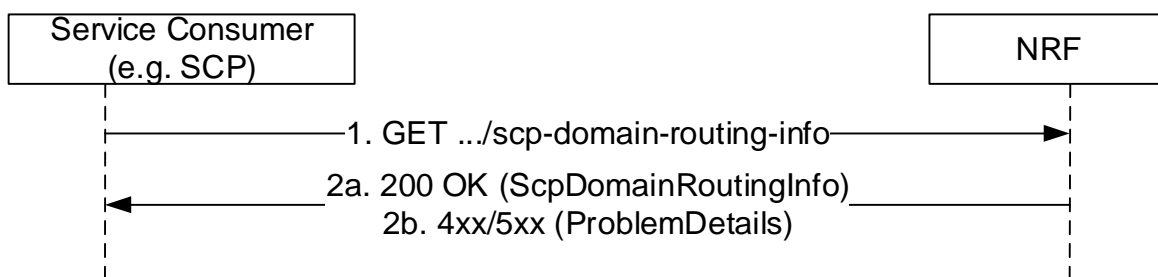

**Figure 5.3.2.2.6-1: Service Discovery with resolution of the target PLMN**

1. The NF Service Consumer (e.g. an SMS-GMSC) sends a GET request to the NRF in the Local PLMN (i.e., the same PLMN where the NF Service Consumer is located); given that the identity of the target PLMN is not known to the NF Service Consumer, this request shall include as query parameters the identity of the target UE for which NF Service Producers need to be discovered (i.e., the "gpsi" query parameter) and also a parameter indicating that the resolution of the target PLMN must be performed (i.e., "target-nw-resolution" set to true).
2. The NRF in the Local PLMN determines the identity of the Target PLMN, as described in 3GPP TS 23.540 [48], and determines the URI of the Nnrf\_NFDiscovery service of the NRF in the Target PLMN.
3. This step is similar to step 1 in Figure 5.3.2.2.3-1, for "Service Discovery in a different PLMN", with the only difference that the "Serving/Home" PLMNs in clause 5.3.2.2.3 are replaced by "Local/Target" PLMNs in the present clause.
4. Steps 4a, 4b are similar to steps 2a, 2b in Figure 5.3.2.2.3-1.
5. Steps 5a, 5b are similar to steps 2a, 2b in Figure 5.3.2.2.2-1.

### 5.3.2.3 SCPDomainRoutingInfoGet

This service operation retrieves the SCP domain routing information, by sending a HTTP GET request to the resource URI representing the "SCP Domain Routing Information" resource.



**Figure 5.3.2.3-1: SCP Domain Routing Information Get**

1. The Service Consumer (i.e. SCP) shall send an HTTP GET request to the resource URI "scp-domain-routing-info" document resource.
- 2a. On success, "200 OK" shall be returned with SCP Domain Routing Information in response body. SCP Domain Routing Information with empty map indicates that no SCP domain is registered in the network.
- 2b. On failure, the NRF shall return "4xx/5xx" response and the response body may contain a ProblemDetails object describing the detailed information of the failure.

When SCPs are registered to multiple NRFs in the network, any NRF providing SCP domain routing information for the whole network shall retrieve the local SCP domain routing information in other NRF(s) and perform aggregation. This service operation retrieves the local SCP domain routing information, e.g. by another NRF, by sending a HTTP GET request to the resource URI representing the "SCP Domain Routing Information" resource with "local" query parameter set to value "true".

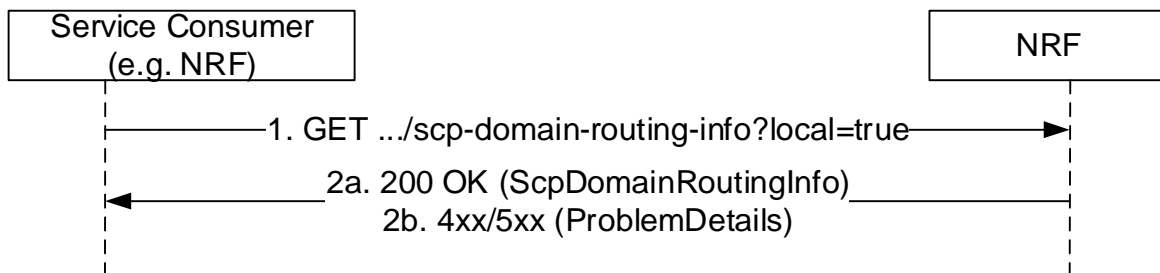

**Figure 5.3.2.3-2: Local SCP Domain Routing Information Get**

1. The Service Consumer (i.e. SCP) shall send an HTTP GET request to the resource URI "scp-domain-routing-info" document resource with "local" query parameter set to value "true".
- 2a. On success, "200 OK" shall be returned with local SCP Domain Routing Information in response body. SCP Domain Routing Information with empty map indicates that no SCP domain is registered in the producer NRF.
- 2b. On failure, the NRF shall return "4xx/5xx" response and the response body may contain a ProblemDetails object describing the detailed information of the failure.

**NOTE:** In deployments where all SCPs in the network can be managed by the same NRF, i.e. all SCPs register to and discover each other with the same NRF, the NRF managing the SCPs can generate the SCP Domain Routing Information accordingly without involvement of other NRFs.

#### 5.3.2.4 SCPDomainRoutingInfoSubscribe

This service operation is used to create a subscription to get notification when SCP Domain Routing Information is changed, e.g. due to a SCP has registered or updated or deregistered in the network, or to get notification when local SCP Domain Routing Information is changed, e.g. due to a SCP has registered or updated or deregistered in the producer NRF. The operation is invoked by issuing a POST request to the resource URI representing the "SCP Domain Routing Info Subscriptions" collection resource.

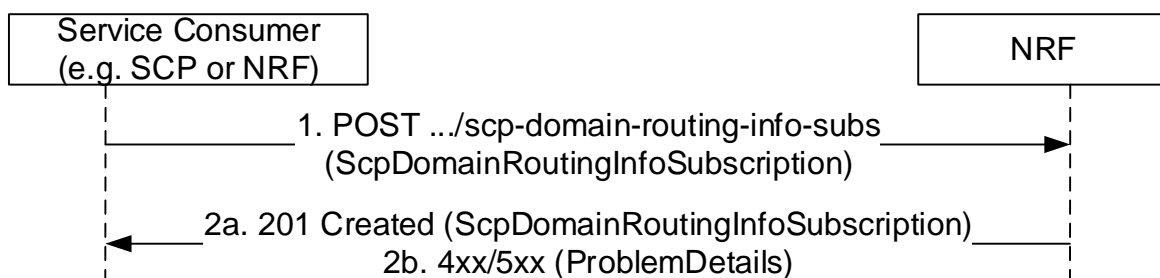

**Figure 5.3.2.4-1: Subscription to SCP Domain Routing Information change**

1. The Service Consumer (i.e. SCP) shall send a POST request to the URI representing the "SCP Domain Routing Info Subscriptions" collection resource. The request body shall contain the callback URI on the Service Consumer to receive the notifications.

To create a subscription for changes of local SCP Domain Routing Information, the request body shall contain the "localInd" with value "true".

- 2a. On success, "201 Created" shall be returned with "Location" header containing the resource URI to the newly created subscription resource. The response shall contain the data related to the created subscription, including the validity time, as determined by the NRF, after which the subscription becomes invalid. Once the subscription expires, if the Service Consumer wants to keep receiving notifications, it shall create a new subscription in the NRF.
- 2b. On failure, the NRF shall return "4xx/5xx" response and the response body may contain a ProblemDetails object describing the detailed information of the failure.

### 5.3.2.5 SCPDomainRoutingInfoNotify

This service operation notifies each subscriber for (local) SCP Domain Routing Information change. The notification is sent to a callback URI that Service Consumer provided during the subscription (see SCPDomainRoutingInfoSubscribe operation in clause 5.3.2.4). The operation is invoked by sending a POST request to the callback URI.

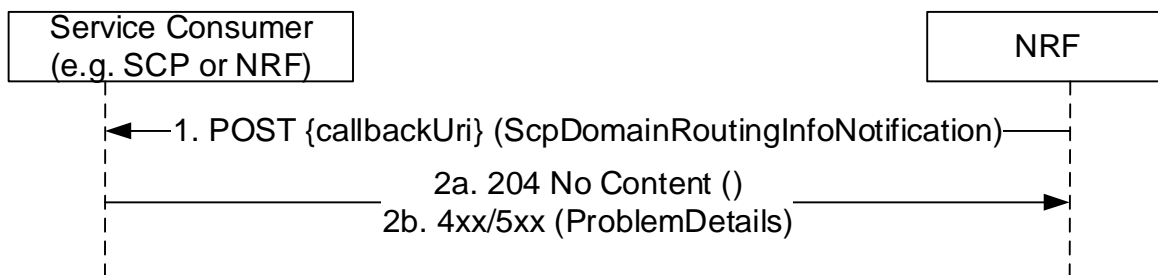
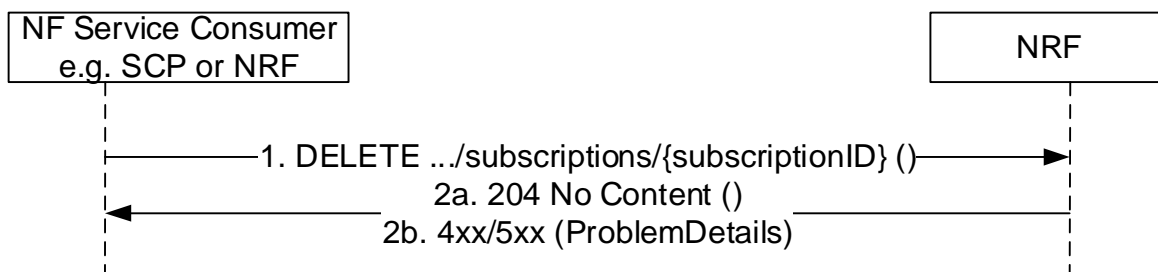

**Figure 5.3.2.5-1: Notification of SCP Domain Routing Info Change**

- 1. The NRF shall send a POST request to the callback URI. The request body shall contain the updated SCP Domain Routing Information. The request body shall contain the "localInd" IE with value "true" if the notification is for a change of local SCP Domain Routing Information. SCP Domain Routing Information with empty map indicates that no SCP domain is registered in the network (or in the producer NRF for local SCP Domain Routing Information) after the change.
- 2a. On success, "204 No content" shall be returned by the NF Service Consumer.
- 2b. On failure, the NRF shall return "4xx/5xx" response and the response body may contain a ProblemDetails object describing the detailed information of the failure.

### 5.3.2.6 SCPDomainRoutingInfoUnSubscribe

This service operation removes an existing subscription to SCP (local) Domain Information Change. The operation is invoked by issuing a DELETE request on the resource URI representing the "Individual SCP Domain Routing Info Subscription", which was received in the Location header field of the "201 Created" response received during a successful subscription (see clause 5.3.2.4).



**Figure 5.3.2.6-1: Unsubscribe to SCP Domain Routing Information Change**

- 1. The Service Consumer (e.g. SCP or NRF) shall send a DELETE request to the resource URI representing the individual subscription. The request body shall be empty.
- 2a. On success, "204 No Content" shall be returned. The response body shall be empty.

- 2b. On failure, the NRF shall return "4xx/5xx" response and the response body may contain a ProblemDetails object describing the detailed information of the failure.

## 5.4 Nnrf\_AccessToken Service

### 5.4.1 Service Description

The NRF offers an Nnrf\_AccessToken service (used for OAuth2 authorization, see IETF RFC 6749 [16]), following the "Client Credentials" authorization grant, as specified in 3GPP TS 33.501 [15]. It exposes a "Token Endpoint" where the Access Token Request service can be requested by NF Service Consumers.

### 5.4.2 Service Operations

#### 5.4.2.1 Introduction

The services operations defined for the Nnrf\_AccessToken service are as follows:

- Access Token Request (i.e. Nnrf\_AccessToken\_Get)

#### 5.4.2.2 Get (Access Token Request)

##### 5.4.2.2.1 General

This service operation is used by an NF Service Consumer to request an OAuth 2.0 access token from the authorization server (NRF).

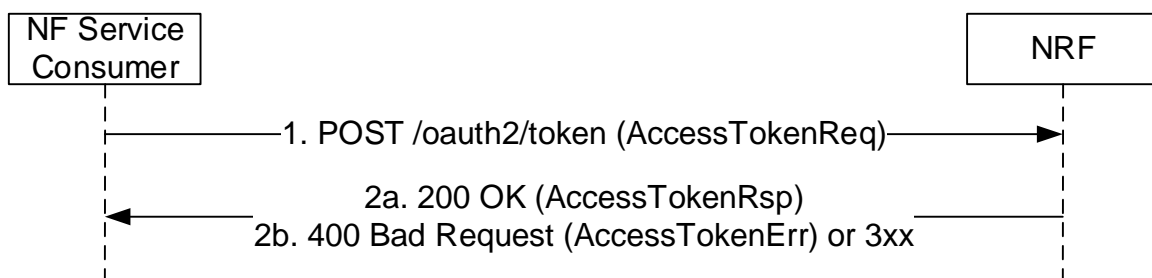

**Figure 5.4.2.2.1-1: Access Token Request**

1. The NF Service Consumer shall send a POST request to the "Token Endpoint", as described in IETF RFC 6749 [16], clause 3.2. The "Token Endpoint" URI shall be:

`{nrfApiRoot}/oauth2/token`

where {nrfApiRoot} represents the concatenation of the "scheme" and "authority" components of the NRF, as defined in IETF RFC 3986 [17].

The OAuth 2.0 Access Token Request includes in the body of the HTTP POST request shall contain:

- An OAuth 2.0 grant type set to "client\_credentials";
- The "scope" parameter indicating the names of the NF Services that the NF Service Consumer is trying to access (i.e., the expected NF service names);
- The NF Instance Id of the the NF Service Consumer requesting the OAuth 2.0 access token;
- NF type of the NF Service Consumer, if this is an access token request not for a specific NF Service Producer;

- NF type of the expected NF Service Producer, if this is an access token request not for a specific NF Service Producer;
- The NF Instance Id of the expected NF Service Producer, if this is an access token request for a specific NF Service Producer;
- Home and Serving PLMN IDs, if this is an access token request for use in roaming scenarios (see clause 13.4.1.2 of 3GPP TS 33.501 [15]).

The request may additionally contain:

- the NF Set ID of the expected NF service producer instances, if this is an access token request not for a specific NF Service Producer.
- the NF Instance Id of the source NF (the NF that requests data), if this is an access token request from the DCCF as NF Service Consumer request data from NF Service Producers on behalf of the source NF.

The NF Service Consumer shall use TLS for mutual authentication with the NRF in order to access this endpoint, if the PLMN uses protection at the transport layer. Otherwise, the NF Service Consumer shall use NDS or physical security to mutually authenticate with the NRF as specified in clause 13.3.1 of 3GPP TS 33.501 [15].

The NRF may verify that the input attributes (e.g. NF type) in the access token request match with the corresponding ones in the public key certificate of the NF service consumer. If the verification is successful, other authorization check shall be performed, otherwise, the request shall be rejected immediately with "400 Bad Request" status code, and "error" attribute set to "invalid\_client".

2a. On success, "200 OK" shall be returned, the payload body of the POST response shall contain the requested access token and the token type set to value "Bearer". The response in addition:

- should contain the expiration time for the token as indicated in IETF RFC 6749 [16] unless the expiration time of the token is made available by other means (e.g. deployment-specific documentation); and
- shall contain the NF service name(s) of the requested NF service producer(s), if it is different from the scope included in the access token request (see IETF RFC 6749 [16]).

The access token shall be a JSON Web Token (JWT) as specified in IETF RFC 7519 [25]. The access token returned by the NRF shall include the claims encoded as a JSON object as specified in clause 6.3.5.2.4 and then digitally signed using JWS as specified in IETF RFC 7515 [24] and in clause 13.4.1 of 3GPP TS 33.501 [15].

The digitally signed access token shall be converted to the JWS Compact Serialization encoding as a string as specified in clause 7.1 of IETF RFC 7515 [24].

2b. On failure or redirection:

- If the access token request fails at the NRF, the NRF shall return "400 Bad Request" status code, including in the response payload a JSON object that provides details about the specific error that occurred.
- In the case of redirection, the NRF shall return 3xx status code, which shall contain a Location header with an URI pointing to the endpoint of another NRF service instance.

#### 5.4.2.2.2 Access Token request with intermediate forwarding NRF

When multiple NRFs are deployed in one PLMN, one NRF may request an OAuth2 access token to a different NRF so as to fulfil the Access Token Request from a NF service consumer. The access token request between these two NRFs is forwarded by a third NRF in this case.

For this, step 1 in clause 5.4.2.2.1 is executed (send a POST request to NRF-1 in the Serving PLMN); this request shall include the OAuth 2.0 Access Token Request in the request body.

Then, steps 1-4 in Figure 5.4.2.2.2-1 hereinafter are executed between NRF-1 in Serving PLMN, NRF-2 in Serving PLMN and NRF-3 in Serving PLMN.

Finally, step 2 in clause 5.4.2.2.1 is executed, the Access Token Response containing the requested access token, the token type and additional attributes shall be sent to the NF Service Consumer.

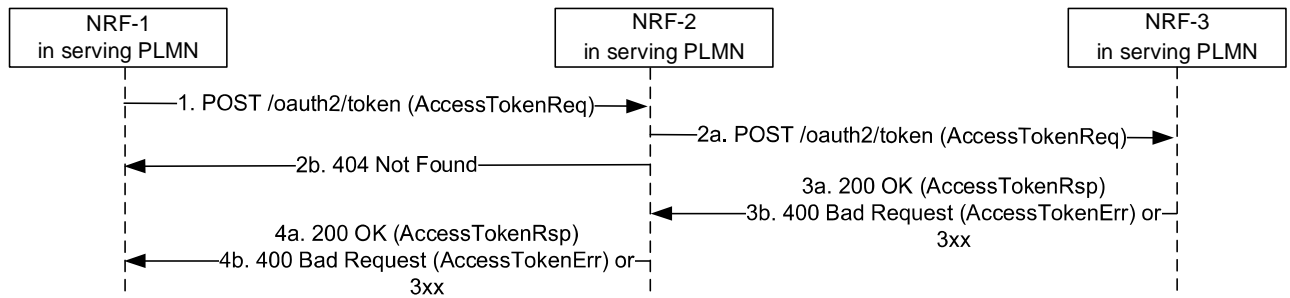

**Figure 5.4.2.2.2-1: Access Token Request with intermediate forwarding NRF**

1. NRF-1 receives an Access token request but does not have the information to fulfil the request. Then NRF-1 sends the Access token request to a pre-configured NRF-2.
- 2a. Upon reception of the Access token request and based on the information contained in the Access token request and locally stored information, NRF-2 shall identify the next hop NRF (see clause 5.2.2.2.3), and forward the Access token request to that NRF (i.e. NRF-3 in this example) by replacing the originator of the service invocation with NRF-2, and the recipient of the service invocation with NRF-3. The locally stored information in NRF-2 may:
  - a) be preconfigured; or
  - b) registered by other NRFs (see clause 5.2.2.2.3).
- 2b. if NRF-2 does not have enough information to forward the Access token request, then it responds with 404 Not Found, and the rest of the steps are omitted.
- 3a. Upon success, NRF-3 shall return a "200 OK" status code, including in the response payload the Access token response containing the requested access token, the token type and additional attributes.
- 3b. Upon failure, NRF-3 shall return "400 Bad Request" status code, including in the response payload a JSON object that provides details about the specific error(s) that occurred.
- 4a. NRF-2 forwards the success response to NRF-1.
- 4b. On failure or redirection:
  - NRF-2 forwards the error response to NRF-1.
  - In the case of redirection, the NRF shall return 3xx status code, which shall contain a Location header with an URI pointing to the endpoint of another NRF service instance.

**NOTE:** It is not assumed that there can only be two NRF hierarchies, i.e. the NRF-3 can go on and forward the Access token request request to another NRF.

### 5.4.2.2.3 Access Token request with intermediate redirecting NRF

When multiple NRFs are deployed in one PLMN, one NRF may request an OAuth2 access token to a different NRF so as to fulfil the Access Token Request from a NF service consumer. The access token request between these two NRFs is redirected by a third NRF in this case.

For this, step 1 in clause 5.4.2.2.1 is executed (send a POST request to NRF-1 in the Serving PLMN); this request shall include the OAuth 2.0 Access Token Request in the request body

Then, steps 1-4 in Figure 5.4.2.2.3-1 hereinafter are executed between NRF-1 in Serving PLMN, NRF-2 in Serving PLMN and NRF-3 in Serving PLMN.

Finally, step 2 in clause 5.4.2.2.1 is executed, the Access token response containing the requested access token, the token type and additional attributes shall be sent to the NF Service Consumer.

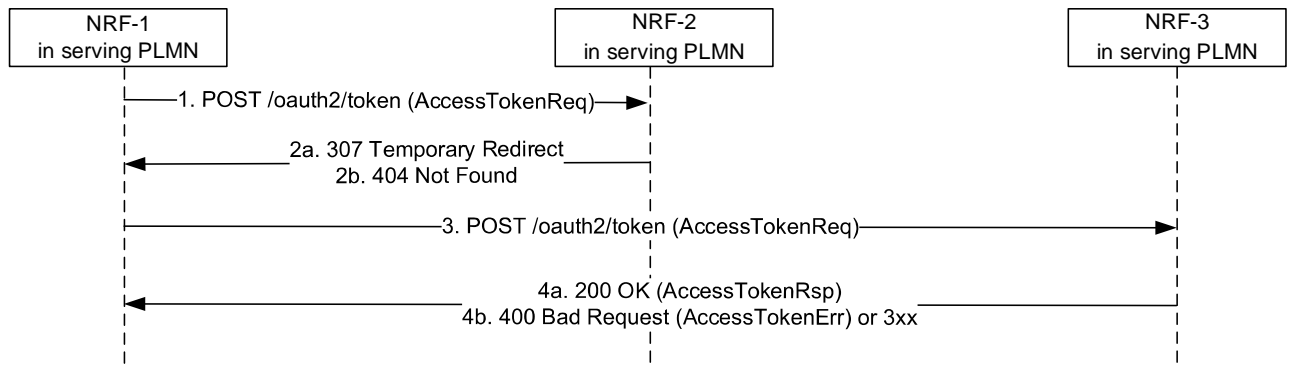

**Figure 5.4.2.2.3-1: Access Token Request with intermediate redirecting NRF**

1. NRF-1 receives an Access token request but does not have the information to fulfil the request. Then NRF-1 sends the Access token request to a pre-configured NRF-2.
- 2a. Upon reception of the Access token request and based on the information contained in the Access token request and locally stored information, NRF-2 shall identify the next hop NRF (see clause 5.2.2.2.3), and redirect the Access token request by returning HTTP "307 Temporary Redirect" response. The locally stored information in NRF-2 may:
  - a) be preconfigured; or
  - b) registered by other NRFs (see clause 5.2.2.2.3).

The "307 Temporary Redirect" response shall contain a Location header field, the host part of the URI in the Location header field represents NRF-3.
- 2b. if NRF-2 does not have enough information to forward the Access token request, then it responds with "404 Not Found", and the rest of the steps are omitted.
3. Upon reception of "307 Temporary Redirect" response, NRF-1 sends the Access token request to NRF-3 by using the URI contained in the Location header field of the "307 Temporary Redirect" response.
- 4a. Upon success, NRF-3 shall return a "200 OK" status code including in the response payload the Access token response containing the requested access token, the token type and additional attributes.
- 4b. On failure or redirection:
  - Upon failure, the NRF-3 shall return "400 Bad Request" status code, including in the response payload a JSON object that provides details about the specific error(s) that occurred.
  - In the case of redirection, the NRF shall return 3xx status code, which shall contain a Location header with an URI pointing to the endpoint of another NRF service instance.

## 5.5 Nnrf\_Bootstrapping Service

### 5.5.1 Service Description

The NRF offers a Nnrf\_Bootstrapping service to let NF Service Consumers of the NRF know about the services endpoints it supports, the NRF Instance ID and NRF Set ID if the NRF is part of an NRF set, by using a version-independent URI endpoint that does not need to be discovered by using a Discovery service.

This service shall be used in inter-PLMN scenarios where the NRF in a PLMN-A needs to invoke services from an NRF in PLMN-B, when there is no pre-configured information indicating the version of the services deployed in PLMN-B.

This service may also be used in intra-PLMN scenarios, to avoid configuring statically in the different NFs information about the service versions deployed in the NRF to be used by those NFs.

## 5.5.2 Service Operations

### 5.5.2.1 Introduction

The services operations defined for the Nnrf\_Bootstrapping service are as follows:

- Nnrf\_Bootstrapping\_Get

### 5.5.2.2 Get

#### 5.5.2.2.1 General

This service operation is used by an NF Service Consumer to request bootstrapping information from the NRF.

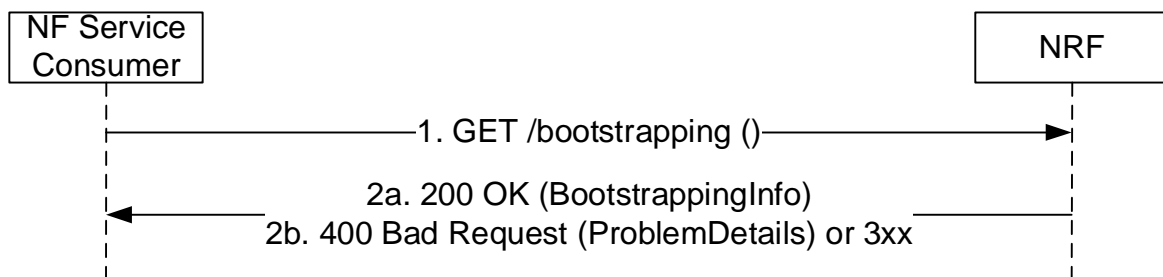

**Figure 5.5.2.2.1-1: Bootstrapping Request**

1. The NF Service Consumer shall send a GET request to the "Bootstrapping Endpoint".

The "Bootstrapping Endpoint" URI shall be constructed as:

{nrfApiRoot}/bootstrapping

where {nrfApiRoot} represents the concatenation of the "scheme" and "authority" components of the NRF, as defined in IETF RFC 3986 [17]; see also the definition of NRF FQDN and NRF URI in 3GPP TS 23.003 [12], clause 28.3.2.3.

- 2a. On success, "200 OK" shall be returned, the payload body of the GET response shall contain the requested bootstrapping information.

EXAMPLE:

```
GET https://nrf.example.com/bootstrapping
Accept: application/3gppHal+json
```

```
HTTP/2 200 OK
Content-Type: application/3gppHal+json
```

```
{
  "status": "OPERATIVE",
  "_links": {
    "self": {
      "href": "https://nrf.example.com/bootstrapping"
    },
    "manage": {
      "href": "https://nrf.example.com/nnrf-nfm/v1/nf-instances"
    },
    "subscribe": {
      "href": "https://nrf.example.com/nnrf-nfm/v1/subscriptions"
    },
    "discover": {
      "href": "https://nrf.example.com/nnrf-disc/v1/nf-instances"
    },
    "authorize": {
      "href": "https://nrf.example.com/oauth2/token"
    }
  }
},
```



```

"nrfFeatures": {
  "nnrf-nfm": "1",
  "nnrf-disc": "D",
  "nnrf-oauth2": "0"
},
"oauth2Required": {
  "nnrf-nfm": true,
  "nnrf-disc": false
},
"nrfSetId": "set12.nrfset.5gc.mnc012.mcc345",
"nrfInstanceId": "4947a69a-f61b-4bc1-b9da-47c9c5d14b67"
}

```

2b. On failure or redirection:

- Upon failure, the NRF shall return "400 Bad Request" status code, including in the response payload a JSON object that provides details about the specific error(s) that occurred.
- In the case of redirection, the NRF shall return 3xx status code, which shall contain a Location header with an URI pointing to the endpoint of another NRF service instance.

---

## 6 API Definitions

### 6.1 Nnrf\_NFManagement Service API

#### 6.1.1 API URI

URIs of this API shall have the following root:

```
{apiRoot}/{apiName}/{apiVersion}
```

where "apiRoot" is defined in clause 4.4.1 of 3GPP TS 29.501 [5], the "apiName" shall be set to "nnrf-nfm" and the "apiVersion" shall be set to "v1" for the current version of this specification.

#### 6.1.2 Usage of HTTP

##### 6.1.2.1 General

HTTP/2, as defined in IETF RFC 7540 [9], shall be used as specified in clause 5 of 3GPP TS 29.500 [4].

HTTP/2 shall be transported as specified in clause 5.3 of 3GPP TS 29.500 [4].

HTTP messages and bodies for the Nnrf\_NFManagement service shall comply with the OpenAPI [10] specification contained in Annex A.

##### 6.1.2.2 HTTP standard headers

###### 6.1.2.2.1 General

The mandatory standard HTTP headers as specified in clause 5.2.2.2 of 3GPP TS 29.500 [4] shall be supported.

###### 6.1.2.2.2 Content type

The following content types shall be supported:

- JSON, as defined in IETF RFC 8259 [22], shall be used as content type of the HTTP bodies specified in the present specification as indicated in clause 5.4 of 3GPP TS 29.500 [4].

- The Problem Details JSON Object (IETF RFC 7807 [11]). The use of the Problem Details JSON object in a HTTP response body shall be signalled by the content type "application/problem+json".
- JSON Patch (IETF RFC 6902 [13]). The use of the JSON Patch format in a HTTP request body shall be signalled by the content type "application/json-patch+json".
- The 3GPP hypermedia format as defined in 3GPP TS 29.501 [5]. The use of the 3GPP hypermedia format in a HTTP response body shall be signalled by the content type "application/3gppHal+json".

#### 6.1.2.2.3 Accept-Encoding

The NRF should support gzip coding (see IETF RFC 1952 [30]) in HTTP requests and responses and indicate so in the Accept-Encoding header, as described in clause 6.9 of 3GPP TS 29.500 [4].

NF Service Consumers of the NFManagement API should support gzip coding in HTTP requests and responses and they should support gzip coding in the reception of notification requests sent by the NRF.

#### 6.1.2.2.4 ETag

An "ETag" (entity-tag) header should be included in HTTP responses for resource creation and resource update, as described in IETF RFC 7232 [19], clause 2.3. It shall contain a server-generated strong validator, that allows further matching of this value (included in subsequent client requests) with a given resource representation stored in the server or in a cache.

An "Etag" (entity-tag) header shall not be included in HTTP responses for Heart-Beat operation.

#### 6.1.2.2.5 If-Match

An NF Service Consumer should issue conditional PATCH request towards NRF, by including an If-Match header in HTTP requests, as described in IETF RFC 7232 [19], clause 3.2, containing an entity tags received in latest response for the same resource.

An NF Service Consumer shall not include If-Match header in HTTP requests for Heart-Beat operation.

### 6.1.2.3 HTTP custom headers

#### 6.1.2.3.1 General

In this release of this specification, no custom headers specific to the Nnrf\_NFManagement service are defined. For 3GPP specific HTTP custom headers used across all service-based interfaces, see clause 5.2.3 of 3GPP TS 29.500 [4].

## 6.1.3 Resources

### 6.1.3.1 Overview

The structure of the Resource URIs of the NFManagement service is shown in figure 6.1.3.1-1.

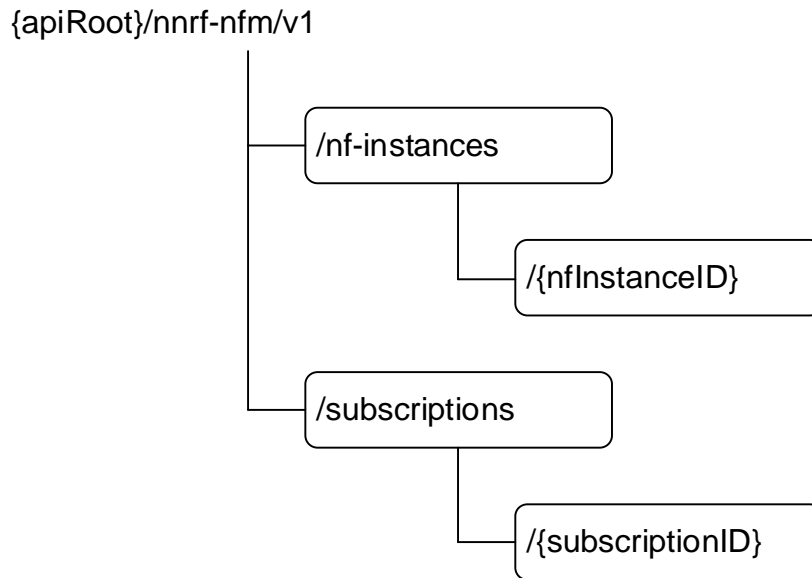

**Figure 6.1.3.1-1: Resource URI structure of the NFManagement API**

Table 6.1.3.1-1 provides an overview of the resources and applicable HTTP methods.

**Table 6.1.3.1-1: Resources and methods overview**

Resource name	Resource URI	HTTP method or custom operation	Description
nf-instances (Store)	/nf-instances	GET	Read a collection of NF Instances.
		OPTIONS	Discover the communication options supported by the NRF for this resource.
nf-instance (Document)	/nf-instances/{nfInstanceID}	GET	Read the profile of a given NF Instance.
		PUT	Register in NRF a new NF Instance, or replace the profile of an existing NF Instance, by providing an NF profile.
		PATCH	Modify the NF profile of an existing NF Instance.
		DELETE	Deregister from NRF a given NF Instance.
subscriptions (Collection)	/subscriptions	POST	Creates a new subscription in NRF to newly registered NF Instances.
subscription (Document)	/subscriptions/{subscriptionID}	PATCH	Updates an existing subscription in NRF.
		DELETE	Deletes an existing subscription from NRF.
Notification Callback	{nfStatusNotificationUri}	POST	Notify about newly created NF Instances, or about changes of the profile of a given NF Instance.

## 6.1.3.2 Resource: nf-instances (Store)

### 6.1.3.2.1 Description

This resource represents a collection of the different NF instances registered in the NRF.

This resource is modelled as the Store resource archetype (see clause C.3 of 3GPP TS 29.501 [5]).

### 6.1.3.2.2 Resource Definition

Resource URI: **{apiRoot}/nnrf-nfm/v1/nf-instances**

This resource shall support the resource URI variables defined in table 6.1.3.2.2-1.

**Table 6.1.3.2.2-1: Resource URI variables for this resource**

Name	Data type	Definition
apiRoot	string	See clause 6.1.1

### 6.1.3.2.3 Resource Standard Methods

#### 6.1.3.2.3.1 GET

This method retrieves a list of all NF instances currently registered in the NRF. This method shall support the URI query parameters specified in table 6.1.3.2.3.1-1.

Table 6.1.3.2.3.1-1: URI query parameters supported by the GET method on this resource

Name	Data type	P	Cardinality	Description
nf-type	NFType	O	0..1	The type of NF to restrict the list of returned NF Instances.
limit	integer	C	0..1	Maximum number of items to be returned in this query; this parameter should only be provided if the "nf-type" parameter is provided. If the "page-number" and "page-size" parameters are present, the "limit" parameter shall be absent.
page-number	integer	C	0..1	This parameter shall be present if the NF Service Consumer requests the retrieval of NF Instance URIs based on <i>pages</i> (i.e. a subset of the total number of items).  If present, it shall contain the page number to retrieve.  The total number of pages available, N, can be determined based on the "totalItemCount" attribute of the response (see clause 6.1.6.2.25) as:  $N = \text{ceiling}(\text{totalItemCount} / \text{page-size})$  The first page shall be identified by "page-number" set to 1.  Minimum: 1  (See NOTE 1, NOTE 2)
page-size	integer	C	0..1	This parameter shall be present if the NF Service Consumer requests the retrieval of NF Instance URIs based on <i>pages</i> .  If present, it shall contain the maximum number of items to be returned per page.  Minimum: 1  (See NOTE 1, NOTE 2)
NOTE 1: The parameters "page-number" and "page-size" shall be either both present, or both absent.				
NOTE 2: If the NRF supports the pagination query parameters, it shall ensure that the response to these requests always return the same set of items for the same query parameters, as long as the ETag of the collection resource is not changed.				

**EXAMPLE:** The NF Service Consumer can retrieve the whole set of NF Instances URIs available in the NRF, using paginated requests, by issuing multiple GET requests, as:

GET .../nnrf-nfm/v1/nf-instances?page-number=1&page-size=100

(returns items from 0 to 99)

GET .../nnrf-nfm/v1/nf-instances?page-number=2&page-size=100

(returns items from 100 to 199)

...

GET .../nnrf-nfm/v1/nf-instances?page-number=N&page-size=100

(returns items from (N-1)\*100 up to totalItemCount-1)

where the first N-1 requests return 100 items each, and the last request (page-number=N) returns between 1 and 100 items.

The NF Service Consumer can also retrieve arbitrary page numbers and page sizes, independently from any prior request previously issued; e.g.

GET .../nnrf-nfm/v1/nf-instances?page-number=4&page-size=50

(returns items from 150 to 199; assuming totalItemCount >= 200)

This method shall support the request data structures specified in table 6.1.3.2.3.1-2 and the response data structures and response codes specified in table 6.1.3.2.3.1-3.

**Table 6.1.3.2.3.1-2: Data structures supported by the GET Request Body on this resource**

Data type	P	Cardinality	Description
n/a			

**Table 6.1.3.2.3.1-3: Data structures supported by the GET Response Body on this resource**

Data type	P	Cardinality	Response codes	Description
UriList	M	1	200 OK	The response body contains a "_links" object containing the URI of each registered NF in the NRF.  If there are no NFs to return in the query result (e.g., because there are no registered NFs in the NRF, or because there are no matching NFs of the type specified in the "nf-type" query parameter, currently registered in the NRF), the "_links" attribute may be absent or, if present, it shall contain only the "self" attribute (i.e. the "item" attribute shall be absent).
RedirectResponse	O	0..1	307 Temporary Redirect	The NRF shall generate a Location header field containing a URI pointing to the endpoint of another NRF service instance to which the request should be sent. If an SCP redirects the message to another SCP then the location header field shall contain the same URI or a different URI pointing to the endpoint of the NF service producer to which the request should be sent.
RedirectResponse	O	0..1	308 Permanent Redirect	The NRF shall generate a Location header field containing a URI pointing to the endpoint of another NRF service instance to which the request should be sent. If an SCP redirects the message to another SCP then the location header field shall contain the same URI or a different URI pointing to the endpoint of the NF service producer to which the request should be sent.
NOTE:	The mandatory HTTP error status codes for the GET method listed in Table 5.2.7.1-1 of 3GPP TS 29.500 [4] other than those specified in the table above also apply, with a ProblemDetails data type (see clause 5.2.7 of 3GPP TS 29.500 [4]).			

**Table 6.1.3.2.3.1-4: Headers supported by the 307 Response Code on this resource**

Name	Data type	P	Cardinality	Description
Location	string	M	1	A URI pointing to the endpoint of the NRF service instance to which the request should be sent

**Table 6.1.3.2.3.1-5: Headers supported by the 308 Response Code on this resource**

Name	Data type	P	Cardinality	Description
Location	string	M	1	A URI pointing to the endpoint of the NRF service instance to which the request should be sent

**Table 6.1.3.2.3.1-6: Headers supported by the 200 Response Code on this resource**

Name	Data type	P	Cardinality	Description
ETag	string	C	0..1	Entity Tag containing a strong validator, described in IETF RFC 7232 [19], clause 2.3. In this resource, this header shall contain a different value if the list of NF instances (regardless of the contents of each NF instance profile) stored in the NRF has changed; i.e. it shall change if there are new instances added to the NRF, or if existing instances are removed from the NRF. If the NF Service Consumer, during the course of successive paginated requests, receives a different ETag value, it shall conclude that the list of NF Instances in the NRF has changed, so it may re-start the paginated NFListRetrieval service operation.

#### 6.1.3.2.3.2 OPTIONS

This method queries the communication options supported by the NRF (see clause 6.9 of 3GPP TS 29.500 [4]). This method shall support the URI query parameters specified in table 6.1.3.2.3.2-1.

**Table 6.1.3.2.3.2-1: URI query parameters supported by the OPTIONS method on this resource**

Name	Data type	P	Cardinality	Description
n/a				

This method shall support the request data structures specified in table 6.1.3.2.3.2-2 and the response data structures and response codes specified in table 6.1.3.2.3.2-3.

**Table 6.1.3.2.3.2-2: Data structures supported by the OPTIONS Request Body on this resource**

Data type	P	Cardinality	Description
n/a			

**Table 6.1.3.2.3.2-3: Data structures supported by the OPTIONS Response Body on this resource**

Data type	P	Cardinality	Response codes	Description
n/a			204 No Content	
OptionsResponse	M	1	200 OK	
RedirectResponse	O	0..1	307 Temporary Redirect	The NRF shall generate a Location header field containing a URI pointing to the endpoint of another NRF service instance to which the request should be sent. If an SCP redirects the message to another SCP then the location header field shall contain the same URI or a different URI pointing to the endpoint of the NF service producer to which the request should be sent.
RedirectResponse	O	0..1	308 Permanent Redirect	The NRF shall generate a Location header field containing a URI pointing to the endpoint of another NRF service instance to which the request should be sent. If an SCP redirects the message to another SCP then the location header field shall contain the same URI or a different URI pointing to the endpoint of the NF service producer to which the request should be sent.
ProblemDetails	O	0..1	405 Method Not Allowed	
ProblemDetails	O	0..1	501 Not Implemented	
NOTE: The mandatory HTTP error status codes for the OPTIONS method listed in Table 5.2.7.1-1 of 3GPP TS 29.500 [4] other than those specified in the table above also apply, with a ProblemDetails data type (see clause 5.2.7 of 3GPP TS 29.500 [4]).				

**Table 6.1.3.2.3.2-4: Headers supported by the 200 Response Code on this resource**

Name	Data type	P	Cardinality	Description
Accept-Encoding	string	O	0..1	Accept-Encoding, described in IETF RFC 7694 [41]

**Table 6.1.3.2.3.2-5: Headers supported by the 307 Response Code on this resource**

Name	Data type	P	Cardinality	Description
Location	string	M	1	A URI pointing to the endpoint of the NRF service instance to which the request should be sent

**Table 6.1.3.2.3.2-6: Headers supported by the 308 Response Code on this resource**

Name	Data type	P	Cardinality	Description
Location	string	M	1	A URI pointing to the endpoint of the NRF service instance to which the request should be sent

#### 6.1.3.2.4 Resource Custom Operations

There are no resource custom operations for the Nnrf\_NFManagement service in this release of the specification.

#### 6.1.3.3 Resource: nf-instance (Document)

##### 6.1.3.3.1 Description

This resource represents a single NF instance.



## 6.1.3.3.2 Resource Definition

Resource URI: {apiRoot}/nrf-nfm/v1/nf-instances/{nfInstanceID}

This resource shall support the resource URI variables defined in table 6.1.3.3.2-1.

**Table 6.1.3.3.2-1: Resource URI variables for this resource**

Name	Data type	Definition
apiRoot	string	See clause 6.1.1
nfInstanceID	NfInstanceID	Represents a specific NF Instance

## 6.1.3.3.3 Resource Standard Methods

## 6.1.3.3.3.1 GET

This method retrieves the NF Profile of a given NF instance.

This method shall support the URI query parameters specified in table 6.1.3.3.3.1-1.

**Table 6.1.3.3.3.1-1: URI query parameters supported by the GET method on this resource**

Name	Data type	P	Cardinality	Description
requester-features	SupportedFeatures	C	0..1	Nrf_NFManagement features supported by the NF Service Consumer that is invoking the Nrf_NFManagement service. See clause 6.1.9.  This IE shall be included if at least one feature is supported by the NF Service Consumer.

This method shall support the request data structures specified in table 6.1.3.3.3.1-2 and the response data structures and response codes specified in table 6.1.3.3.3.1-3.

**Table 6.1.3.3.3.1-2: Data structures supported by the GET Request Body on this resource**

Data type	P	Cardinality	Description
n/a			

**Table 6.1.3.3.3.1-3: Data structures supported by the GET Response Body on this resource**

Data type	P	Cardinality	Response codes	Description
NFProfile	M	1	200 OK	The response body contains the profile of a given NF Instance.
RedirectResponse	O	0..1	307 Temporary Redirect	The NRF shall generate a Location header field containing a URI pointing to the endpoint of another NRF service instance to which the request should be sent. If an SCP redirects the message to another SCP then the location header field shall contain the same URI or a different URI pointing to the endpoint of the NF service producer to which the request should be sent.
RedirectResponse	O	0..1	308 Permanent Redirect	The NRF shall generate a Location header field containing a URI pointing to the endpoint of another NRF service instance to which the request should be sent. If an SCP redirects the message to another SCP then the location header field shall contain the same URI or a different URI pointing to the endpoint of the NF service producer to which the request should be sent.
NOTE: The mandatory HTTP error status codes for the GET method listed in Table 5.2.7.1-1 of 3GPP TS 29.500 [4] other than those specified in the table above also apply, with a ProblemDetails data type (see clause 5.2.7 of 3GPP TS 29.500 [4]).				

**Table 6.1.3.3.3.1-4: Headers supported by the 307 Response Code on this resource**

Name	Data type	P	Cardinality	Description
Location	string	M	1	A URI pointing to the endpoint of the NRF service instance to which the request should be sent

**Table 6.1.3.3.3.1-5: Headers supported by the 308 Response Code on this resource**

Name	Data type	P	Cardinality	Description
Location	string	M	1	A URI pointing to the endpoint of the NRF service instance to which the request should be sent

**Table 6.1.3.3.3.1-6: Headers supported by the 200 Response Code on this resource**

Name	Data type	P	Cardinality	Description
ETag	string	C	0..1	Entity Tag containing a strong validator, described in IETF RFC 7232 [19], clause 2.3

#### 6.1.3.3.3.2 PUT

This method registers a new NF instance in the NRF, or replaces completely an existing NF instance.

This method shall support the URI query parameters specified in table 6.1.3.3.3.2-1.

**Table 6.1.3.3.3.2-1: URI query parameters supported by the PUT method on this resource**

Name	Data type	P	Cardinality	Description
n/a				

This method shall support the request data structures specified in table 6.1.3.3.3.2-2 and the response data structures and response codes specified in table 6.1.3.3.3.2-3.

**Table 6.1.3.3.3.2-2: Data structures supported by the PUT Request Body on this resource**

Data type	P	Cardinality	Description
NFProfile	M	1	Profile of the NF Instance to be registered, or completely replaced, in NRF.

**Table 6.1.3.3.3.2-3: Data structures supported by the PUT Response Body on this resource**

Data type	P	Cardinality	Response codes	Description
NFProfile	M	1	200 OK	This case represents the successful replacement of an existing NF Instance profile.  Upon success, a response body is returned containing the replaced profile of the NF Instance.
NFProfile	M	1	201 Created	This case represents the successful registration of a new NF Instance.  Upon success, a response body is returned containing the newly created NF Instance profile; also, the HTTP response shall include a "Location" HTTP header that contains the resource URI of the created NF Instance.
RedirectResponse	O	0..1	307 Temporary Redirect	The NRF shall generate a Location header field containing a URI pointing to the endpoint of another NRF service instance to which the request should be sent. If an SCP redirects the message to another SCP then the location header field shall contain the same URI or a different URI pointing to the endpoint of the NF service producer to which the request should be sent.
RedirectResponse	O	0..1	308 Permanent Redirect	The NRF shall generate a Location header field containing a URI pointing to the endpoint of another NRF service instance to which the request should be sent. If an SCP redirects the message to another SCP then the location header field shall contain the same URI or a different URI pointing to the endpoint of the NF service producer to which the request should be sent.
NOTE: The mandatory HTTP error status codes for the PUT method listed in Table 5.2.7.1-1 of 3GPP TS 29.500 [4] other than those specified in the table above also apply, with a ProblemDetails data type (see clause 5.2.7 of 3GPP TS 29.500 [4]).				

**Table 6.1.3.3.3.2-4: Headers supported by the PUT method on this resource**

Name	Data type	P	Cardinality	Description
Content-Encoding	string	O	0..1	Content-Encoding, described in IETF RFC 7231 [40]

**Table 6.1.3.3.3.2-5: Headers supported by the 200 Response Code on this resource**

Name	Data type	P	Cardinality	Description
Accept-Encoding	string	O	0..1	Accept-Encoding, described in IETF RFC 7694 [41]
ETag	string	C	0..1	Entity Tag containing a strong validator, described in IETF RFC 7232 [19], clause 2.3

**Table 6.1.3.3.3.2-6: Headers supported by the 201 Response Code on this resource**

Name	Data type	P	Cardinality	Description
Location	string	M	1	Contains the URI of the newly created resource, according to the structure: {apiRoot}/nnrf-nfm/v1/nf-instances/{nfInstanceId}
Accept-Encoding	string	O	0..1	Accept-Encoding, described in IETF RFC 7694 [41]
ETag	string	C	0..1	Entity Tag containing a strong validator, described in IETF RFC 7232 [19], clause 2.3

**Table 6.1.3.3.3.2-7: Headers supported by the 307 Response Code on this resource**

Name	Data type	P	Cardinality	Description
Location	string	M	1	A URI pointing to the endpoint of the NRF service instance to which the request should be sent

**Table 6.1.3.3.3.2-8: Headers supported by the 308 Response Code on this resource**

Name	Data type	P	Cardinality	Description
Location	string	M	1	A URI pointing to the endpoint of the NRF service instance to which the request should be sent

### 6.1.3.3.3.3 PATCH

This method updates partially the profile of a given NF instance.

This method shall support the URI query parameters specified in table 6.1.3.3.3.3-1.

**Table 6.1.3.3.3.3-1: URI query parameters supported by the PATCH method on this resource**

Name	Data type	P	Cardinality	Description
n/a				

This method shall support the request data structures specified in table 6.1.3.3.3.3-2 and the response data structures and response codes specified in table 6.1.3.3.3.3-3.

**Table 6.1.3.3.3.3-2: Data structures supported by the PATCH Request Body on this resource**

Data type	P	Cardinality	Description
array(PatchItem)	M	1	It contains the list of changes to be made to the profile of the NF Instance, according to the JSON PATCH format specified in IETF RFC 6902 [13].

**Table 6.1.3.3.3-3: Data structures supported by the PATCH Response Body on this resource**

Data type	P	Cardinality	Response codes	Description
NFProfile	M	1	200 OK	Upon success, a response body is returned containing the updated profile of the NF Instance.
n/a			204 No Content	Successful response sent when there is no need to provide a full updated profile of the NF Instance (e.g., in the Heart-Beat operation response described in clause 5.2.2.3.2).
RedirectResponse	O	0..1	307 Temporary Redirect	The NRF shall generate a Location header field containing a URI pointing to the endpoint of another NRF service instance to which the request should be sent. If an SCP redirects the message to another SCP then the location header field shall contain the same URI or a different URI pointing to the endpoint of the NF service producer to which the request should be sent.
RedirectResponse	O	0..1	308 Permanent Redirect	The NRF shall generate a Location header field containing a URI pointing to the endpoint of another NRF service instance to which the request should be sent. If an SCP redirects the message to another SCP then the location header field shall contain the same URI or a different URI pointing to the endpoint of the NF service producer to which the request should be sent.
ProblemDetails	O	0..1	412 Precondition Failed	The modification has failed due to the precondition in the request is not fulfilled.
ProblemDetails	O	0..1	409 Conflict	The modification has failed due to confliction (e.g. to change a value of a non-existing IE).
NOTE: The mandatory HTTP error status codes for the PATCH method listed in Table 5.2.7.1-1 of 3GPP TS 29.500 [4] other than those specified in the table above also apply, with a ProblemDetails data type (see clause 5.2.7 of 3GPP TS 29.500 [4]).				

**Table 6.1.3.3.3-4: Headers supported by the 307 Response Code on this resource**

Name	Data type	P	Cardinality	Description
Location	string	M	1	A URI pointing to the endpoint of the NRF service instance to which the request should be sent

**Table 6.1.3.3.3-5: Headers supported by the 308 Response Code on this resource**

Name	Data type	P	Cardinality	Description
Location	string	M	1	A URI pointing to the endpoint of the NRF service instance to which the request should be sent

**Table 6.1.3.3.3-6: Headers supported by the PATCH method on this resource**

Name	Data type	P	Cardinality	Description
If-Match	string	C	0..1	Validator for conditional requests, as described in IETF RFC 7232 [19], clause 3.2.

**Table 6.1.3.3.3-7: Headers supported by the 200 Response Code on this resource**

Name	Data type	P	Cardinality	Description
ETag	string	C	0..1	Entity Tag containing a strong validator, described in IETF RFC 7232 [19], clause 2.3.

## 6.1.3.3.3.4 DELETE

This method deregisters an existing NF instance from the NRF.

This method shall support the URI query parameters specified in table 6.1.3.3.3.4-1.

**Table 6.1.3.3.3.4-1: URI query parameters supported by the DELETE method on this resource**

Name	Data type	P	Cardinality	Description
n/a				

This method shall support the request data structures specified in table 6.1.3.3.3.4-2 and the response data structures and response codes specified in table 6.1.3.3.3.4-3.

**Table 6.1.3.3.3.4-2: Data structures supported by the DELETE Request Body on this resource**

Data type	P	Cardinality	Description
n/a			

**Table 6.1.3.3.3.4-3: Data structures supported by the DELETE Response Body on this resource**

Data type	P	Cardinality	Response codes	Description
n/a			204 No Content	
RedirectResponse	O	0..1	307 Temporary Redirect	The NRF shall generate a Location header field containing a URI pointing to the endpoint of another NRF service instance to which the request should be sent. If an SCP redirects the message to another SCP then the location header field shall contain the same URI or a different URI pointing to the endpoint of the NF service producer to which the request should be sent.
RedirectResponse	O	0..1	308 Permanent Redirect	The NRF shall generate a Location header field containing a URI pointing to the endpoint of another NRF service instance to which the request should be sent. If an SCP redirects the message to another SCP then the location header field shall contain the same URI or a different URI pointing to the endpoint of the NF service producer to which the request should be sent.
NOTE: The mandatory HTTP error status codes for the DELETE method listed in Table 5.2.7.1-1 of 3GPP TS 29.500 [4] other than those specified in the table above also apply, with a ProblemDetails data type (see clause 5.2.7 of 3GPP TS 29.500 [4]).				

**Table 6.1.3.3.3.4-4: Headers supported by the 307 Response Code on this resource**

Name	Data type	P	Cardinality	Description
Location	string	M	1	A URI pointing to the endpoint of the NRF service instance to which the request should be sent

**Table 6.1.3.3.3.4-5: Headers supported by the 308 Response Code on this resource**

Name	Data type	P	Cardinality	Description
Location	string	M	1	A URI pointing to the endpoint of the NRF service instance to which the request should be sent

### 6.1.3.4 Resource: subscriptions (Collection)

#### 6.1.3.4.1 Description

This resource represents a collection of subscriptions of NF Instances to newly registered NF Instances.

#### 6.1.3.4.2 Resource Definition

Resource URI: **{apiRoot}/nnrf-nfm/v1/subscriptions**

This resource shall support the resource URI variables defined in table 6.1.3.4.2-1.

**Table 6.1.3.4.2-1: Resource URI variables for this resource**

Name	Data type	Definition
apiRoot	string	See clause 6.1.1

#### 6.1.3.4.3 Resource Standard Methods

##### 6.1.3.4.3.1 POST

This method creates a new subscription. This method shall support the URI query parameters specified in table 6.1.3.4.3.1-1.

**Table 6.1.3.4.3.1-1: URI query parameters supported by the POST method on this resource**

Name	Data type	P	Cardinality	Description
n/a				

This method shall support the request data structures specified in table 6.1.3.4.3.1-2 and the response data structures and response codes specified in table 6.1.3.4.3.1-3.

**Table 6.1.3.4.3.1-2: Data structures supported by the POST Request Body on this resource**

Data type	P	Cardinality	Description
SubscriptionData	M	1	The request body contains the input parameters for the subscription. These parameters include, e.g.: - Target NF type - Target Service Name - Callback URI of the Requester NF

**Table 6.1.3.4.3.1-3: Data structures supported by the POST Response Body on this resource**

Data type	P	Cardinality	Response codes	Description
SubscriptionData	M	1	201 Created	This case represents the successful creation of a subscription.  Upon success, the HTTP response shall include a "Location" HTTP header that contains the resource URI of the created resource.
RedirectResponse	O	0..1	307 Temporary Redirect	The NRF shall generate a Location header field containing a URI pointing to the endpoint of another NRF service instance to which the request should be sent. If an SCP redirects the message to another SCP then the location header field shall contain the same URI or a different URI pointing to the endpoint of the NF service producer to which the request should be sent.
RedirectResponse	O	0..1	308 Permanent Redirect	The NRF shall generate a Location header field containing a URI pointing to the endpoint of another NRF service instance to which the request should be sent. If an SCP redirects the message to another SCP then the location header field shall contain the same URI or a different URI pointing to the endpoint of the NF service producer to which the request should be sent.
ProblemDetails	O	0..1	403 Forbidden	The "cause" attribute may be used to indicate one of the following application errors: - SUBSCRIPTION_NOT_ALLOWED
ProblemDetails	O	0..1	404 Not Found	The "cause" attribute may be used to indicate one of the following application errors: - NF_NOT_FOUND
NOTE: The mandatory HTTP error status codes for the POST method listed in Table 5.2.7.1-1 of 3GPP TS 29.500 [4] other than those specified in the table above also apply, with a ProblemDetails data type (see clause 5.2.7 of 3GPP TS 29.500 [4]).				

**Table 6.1.3.4.3.1-4: Headers supported by the 201 Response Code on this resource**

Name	Data type	P	Cardinality	Description
Location	string	M	1	Contains the URI of the newly created resource, according to the structure: {apiRoot}/nnrf-nfm/v1/subscriptions/{subscriptionId}

**Table 6.1.3.4.3.1-5: Headers supported by the 307 Response Code on this resource**

Name	Data type	P	Cardinality	Description
Location	string	M	1	A URI pointing to the endpoint of the NRF service instance to which the request should be sent

**Table 6.1.3.4.3.1-6: Headers supported by the 308 Response Code on this resource**

Name	Data type	P	Cardinality	Description
Location	string	M	1	A URI pointing to the endpoint of the NRF service instance to which the request should be sent



### 6.1.3.5 Resource: subscription (Document)

#### 6.1.3.5.1 Description

This resource represents an individual subscription of a given NF Instance to newly registered NF Instances.

#### 6.1.3.5.2 Resource Definition

Resource URI: {apiRoot}/nnrf-nfm/v1/subscriptions/{subscriptionID}

This resource shall support the resource URI variables defined in table 6.1.3.5.2-1.

**Table 6.1.3.5.2-1: Resource URI variables for this resource**

Name	Data type	Definition
apiRoot	string	See clause 6.1.1
subscriptionID	string	Represents a specific subscription

#### 6.1.3.5.3 Resource Standard Methods

##### 6.1.3.5.3.1 DELETE

This method terminates an existing subscription. This method shall support the URI query parameters specified in table 6.1.3.5.3.1-1.

**Table 6.1.3.5.3.1-1: URI query parameters supported by the DELETE method on this resource**

Name	Data type	P	Cardinality	Description
n/a				

This method shall support the request data structures specified in table 6.1.3.5.3.1-2 and the response data structures and response codes specified in table 6.1.3.5.3.1-3.

**Table 6.1.3.5.3.1-2: Data structures supported by the DELETE Request Body on this resource**

Data type	P	Cardinality	Description
n/a			

**Table 6.1.3.5.3.1-3: Data structures supported by the DELETE Response Body on this resource**

Data type	P	Cardinality	Response codes	Description
n/a			204 No Content	
RedirectResponse	O	0..1	307 Temporary Redirect	The NRF shall generate a Location header field containing a URI pointing to the endpoint of another NRF service instance to which the request should be sent. If an SCP redirects the message to another SCP then the location header field shall contain the same URI or a different URI pointing to the endpoint of the NF service producer to which the request should be sent.
RedirectResponse	O	0..1	308 Permanent Redirect	The NRF shall generate a Location header field containing a URI pointing to the endpoint of another NRF service instance to which the request should be sent. If an SCP redirects the message to another SCP then the location header field shall contain the same URI or a different URI pointing to the endpoint of the NF service producer to which the request should be sent.
NOTE: The mandatory HTTP error status codes for the DELETE method listed in Table 5.2.7.1-1 of 3GPP TS 29.500 [4] other than those specified in the table above also apply, with a ProblemDetails data type (see clause 5.2.7 of 3GPP TS 29.500 [4]).				

**Table 6.1.3.5.3.1-4: Headers supported by the 307 Response Code on this resource**

Name	Data type	P	Cardinality	Description
Location	string	M	1	A URI pointing to the endpoint of the NRF service instance to which the request should be sent

**Table 6.1.3.5.3.1-5: Headers supported by the 308 Response Code on this resource**

Name	Data type	P	Cardinality	Description
Location	string	M	1	A URI pointing to the endpoint of the NRF service instance to which the request should be sent

### 6.1.3.5.3.2 PATCH

This method updates an existing subscription. This method shall support the URI query parameters specified in table 6.1.3.5.3.2-1.

**Table 6.1.3.5.3.2-1: URI query parameters supported by the PATCH method on this resource**

Name	Data type	P	Cardinality	Description
n/a				

This method shall support the request data structures specified in table 6.1.3.5.3.2-2 and the response data structures and response codes specified in table 6.1.3.5.3.2-3.

**Table 6.1.3.5.3.2-2: Data structures supported by the PATCH Request Body on this resource**

Data type	P	Cardinality	Description
array(PatchItem)	M	1..N	It contains the list of changes to be made to an individual subscription, according to the JSON PATCH format specified in IETF RFC 6902 [13].

**Table 6.1.3.5.3.2-3: Data structures supported by the PATCH Response Body on this resource**

Data type	P	Cardinality	Response codes	Description
SubscriptionData	M	1	200 OK	
n/a			204 No Content	
RedirectResponse	O	0..1	307 Temporary Redirect	The NRF shall generate a Location header field containing a URI pointing to the endpoint of another NRF service instance to which the request should be sent. If an SCP redirects the message to another SCP then the location header field shall contain the same URI or a different URI pointing to the endpoint of the NF service producer to which the request should be sent.
RedirectResponse	O	0..1	308 Permanent Redirect	The NRF shall generate a Location header field containing a URI pointing to the endpoint of another NRF service instance to which the request should be sent. If an SCP redirects the message to another SCP then the location header field shall contain the same URI or a different URI pointing to the endpoint of the NF service producer to which the request should be sent.
ProblemDetails	O	0..1	404 Not Found	The "cause" attribute may be used to indicate one of the following application errors: - NF_NOT_FOUND

**Table 6.1.3.5.3.2-4: Headers supported by the 307 Response Code on this resource**

Name	Data type	P	Cardinality	Description
Location	string	M	1	A URI pointing to the endpoint of the NRF service instance to which the request should be sent

**Table 6.1.3.5.3.2-5: Headers supported by the 308 Response Code on this resource**

Name	Data type	P	Cardinality	Description
Location	string	M	1	A URI pointing to the endpoint of the NRF service instance to which the request should be sent

## 6.1.4 Custom Operations without associated resources

There are no custom operations defined without any associated resources for the Nnrf\_NFManagement service in this release of the specification.

## 6.1.5 Notifications

### 6.1.5.1 General

This clause specifies the notifications provided by the Nnrf\_NFManagement service.

The delivery of notifications shall be supported as specified in clause 6.2 of 3GPP TS 29.500 [4] for Server-initiated communication.

Table 6.1.5.1-1: Notifications overview

Notification	Resource URI	HTTP method or custom operation	Description (service operation)
NF Instance Status Notification	{nfStatusNotificationUri} (NF Service Consumer provided callback reference)	POST	Notify about registrations / deregistrations or profile changes of NF Instances

## 6.1.5.2 NF Instance Status Notification

### 6.1.5.2.1 Description

The NF Service Consumer provides a callback URI for getting notified about NF Instances status events, the NRF shall notify the NF Service Consumer, when the conditions specified in the subscription are met.

### 6.1.5.2.2 Notification Definition

The POST method shall be used for NF Instance Status notification and the URI shall be the callback reference provided by the NF Service Consumer during the subscription to this notification.

Resource URI: **{nfStatusNotificationUri}**

Support of URI query parameters is specified in table 6.1.5.2.2-1.

Table 6.1.5.2.2-1: URI query parameters supported by the POST method

Name	Data type	P	Cardinality	Description
n/a				

Support of request data structures is specified in table 6.1.5.2.2-2, and support of response data structures and response codes is specified in table 6.1.5.2-3.

Table 6.1.5.2.2-2: Data structures supported by the POST Request Body

Data type	P	Cardinality	Description
NotificationData	M	1	Representation of the NF Instance status notification.

**Table 6.1.5.2.2-3: Data structures supported by the POST Response Body**

Data type	P	Cardinality	Response codes	Description
N/A			204 No Content	This case represents a successful notification of the NF Instance status event.
RedirectResponse	O	0..1	307 Temporary Redirect	The NF service consumer shall generate a Location header field containing a URI pointing to the endpoint of another NF Service Consumer instance to which the notification should be sent. If an SCP redirects the message to another SCP then the location header field shall contain the same URI or a different URI pointing to the endpoint of the NF service consumer to which the notification should be sent.
RedirectResponse	O	0..1	308 Permanent Redirect	The NF service consumer shall generate a Location header field containing a URI pointing to the endpoint of another NF Service Consumer instance to which the notification should be sent. If an SCP redirects the message to another SCP then the location header field shall contain the same URI or a different URI pointing to the endpoint of the NF service consumer to which the notification should be sent.
NOTE: The mandatory HTTP error status codes for the POST method listed in Table 5.2.7.1-1 of 3GPP TS 29.500 [4] other than those specified in the table above also apply, with a ProblemDetails data type (see clause 5.2.7 of 3GPP TS 29.500 [4]).				

**Table 6.1.5.2.2-4: Headers supported by the 307 Response Code on this endpoint**

Name	Data type	P	Cardinality	Description
Location	string	M	1	A URI pointing to the endpoint of the NF service consumer instance to which the request should be sent

**Table 6.1.5.2.2-5: Headers supported by the 308 Response Code on this endpoint**

Name	Data type	P	Cardinality	Description
Location	string	M	1	A URI pointing to the endpoint of the NF service consumer instance to which the request should be sent

## 6.1.6 Data Model

### 6.1.6.1 General

This clause specifies the application data model supported by the API.

Table 6.1.6.1-1 specifies the data types defined for the Nnrf\_NFManagement service-based interface protocol.

**Table 6.1.6.1-1: Nnrf\_NFManagement specific Data Types**

Data type	Clause defined	Description
NFProfile	6.1.6.2.2	Information of an NF Instance registered in the NRF.
NFService	6.1.6.2.3	Information of a given NF Service Instance; it is part of the NFProfile of an NF Instance.
DefaultNotificationSubscription	6.1.6.2.4	Data structure for specifying the notifications the NF service subscribes by default along with callback URI.
IpEndPoint	6.1.6.2.5	IP addressing information of a given NFService; it consists on, e.g. IP address, TCP port, transport protocol...
UdrInfo	6.1.6.2.6	Information of an UDR NF Instance.
UdmInfo	6.1.6.2.7	Information of an UDM NF Instance.
AusfInfo	6.1.6.2.8	Information of an AUSF NF Instance.
SupiRange	6.1.6.2.9	A range of SUPIs (subscriber identities), either based on a numeric range, or based on regular-expression matching.
IdentityRange	6.1.6.2.10	A range of subscriber identities, either based on a numeric range, or based on regular-expression matching.
AmfInfo	6.1.6.2.11	Information of an AMF NF Instance.
SmfInfo	6.1.6.2.12	Information of an SMF NF Instance.
UpfInfo	6.1.6.2.13	Information of an UPF NF Instance.
SnsaiUpfInfoItem	6.1.6.2.14	Set of parameters supported by UPF for a given S-NSSAI.
DnnUpfInfoItem	6.1.6.2.15	Set of parameters supported by UPF for a given DNN.
SubscriptionData	6.1.6.2.16	Information of a subscription to notifications to NRF events, included in subscription requests and responses.
NotificationData	6.1.6.2.17	Data sent in notifications from NRF to subscribed NF Instances.
NFServiceVersion	6.1.6.2.19	Contains the version details of an NF service.
PcfInfo	6.1.6.2.20	Information of a PCF NF Instance.
BsfInfo	6.1.6.2.21	Information of a BSF NF Instance.
Ipv4AddressRange	6.1.6.2.22	Range of IPv4 addresses.
Ipv6PrefixRange	6.1.6.2.23	Range of IPv6 prefixes.
InterfaceUpfInfoItem	6.1.6.2.24	Information of a given IP interface of an UPF.
UriList	6.1.6.2.25	Set of URIs following 3GPP hypermedia format (containing a "_links" attribute).
N2InterfaceAmfInfo	6.1.6.2.26	AMF N2 interface information
TaiRange	6.1.6.2.27	Range of TAIs (Tracking Area Identities).
TacRange	6.1.6.2.28	Range of TACs (Tracking Area Codes).
SnsaiSmfInfoItem	6.1.6.2.29	Set of parameters supported by SMF for a given S-NSSAI.
DnnSmfInfoItem	6.1.6.2.30	Set of parameters supported by SMF for a given DNN.
NrfInfo	6.1.6.2.31	Information of an NRF NF Instance, used in hierarchical NRF deployments.
ChfInfo	6.1.6.2.32	Information of a CHF NF Instance.
PlmnRange	6.1.6.2.34	Range of PLMN IDs.
SubscrCond	6.1.6.2.35	Condition to determine the set of NFs to monitor under a certain subscription in NRF.
NfInstanceIdCond	6.1.6.2.36	Subscription to a given NF Instance Id.
NfTypeCond	6.1.6.2.37	Subscription to a set of NFs based on their NF Type.
ServiceNameCond	6.1.6.2.38	Subscription to a set of NFs based on their support for a given Service Name.
AmfCond	6.1.6.2.39	Subscription to a set of AMFs, based on AMF Set Id and/or AMF Region Id.
GuamiListCond	6.1.6.2.40	Subscription to a set of AMFs, based on their GUAMIs.
NetworkSliceCond	6.1.6.2.41	Subscription to a set of NFs, based on the slices (S-NSSAI and NSI) they support .
NfGroupCond	6.1.6.2.42	Subscription to a set of NFs based on their Group Id.
NotifCondition	6.1.6.2.43	Condition (list of attributes in the NF Profile) to determine whether a notification must be sent by NRF.
PlmnSnsai	6.1.6.2.44	List of network slices (S-NSSAIs) for a given PLMN ID.
NwdafInfo	6.1.6.2.45	Information of a NWDAF NF Instance.
LmfInfo	6.1.6.2.46	Information of an LMF NF Instance.
GmlcInfo	6.1.6.2.47	Information of a GMLC NF Instance.
NefInfo	6.1.6.2.48	Information of an NEF NF Instance.
PfdData	6.1.6.2.49	List of Application IDs and/or AF IDs managed by a given NEF Instance.
AfEventExposureData	6.1.6.2.50	AF Event Exposure data managed by a given NEF Instance.
WAgfInfo	6.1.6.2.51	Information of the W-AGF endpoints.
TngfInfo	6.1.6.2.52	Information of the TNGF endpoints.

PcscfInfo	6.1.6.2.53	Information of a P-CSCF NF Instance.
NfSetCond	6.1.6.2.54	Subscription to a set of NFs based on their Set Id.
NfServiceSetCond	6.1.6.2.55	Subscription to a set of NFs based on their Service Set Id.
NfInfo	6.1.6.2.56	Information of a generic NF Instance.
HssInfo	6.1.6.2.57	Information of an HSS NF Instance.
ImsiRange	6.1.6.2.58	A range of IMSIs (subscriber identities), either based on a numeric range, or based on regular-expression matching.
InternalGroupIdRange	6.1.6.2.59	A range of Group IDs (internal group identities), either based on a numeric range, or based on regular-expression matching.
UpfCond	6.1.6.2.60	Subscription to a set of NF Instances (UPFs), able to serve a certain service area (i.e. SMF serving area or TAI list).
TwifInfo	6.1.6.2.61	Addressing information (IP addresses, FQDN) of the TWIF.
VendorSpecificFeature	6.1.6.2.62	Information about a vendor-specific feature
UdsfInfo	6.1.6.2.63	Information related to UDSF
ScpInfo	6.1.6.2.65	Information of an SCP Instance
ScpDomainInfo	6.1.6.2.66	SCP domain information
ScpDomainCond	6.1.6.2.67	Subscription to an SCP domain
OptionsResponse	6.1.6.2.68	Communication options of the NRF
NwdafCond	6.1.6.2.69	Subscription to a set of NF Instances (NWDAFs), identified by Analytics ID(s), S-NSSAI(s) or NWDAF Serving Area information, i.e. list of TAIs for which the NWDAF can provide analytics.
NefCond	6.1.6.2.70	Subscription to a set of NF Instances (NEFs), identified by Event ID(s) provided by AF, S-NSSAI(s), AF Instance ID, Application Identifier, External Identifier, External Group Identifier, or domain name.
SuciInfo	6.1.6.2.71	SUCI information containing Routing Indicator and Home Network Public Key ID.
SeppInfo	6.1.6.2.72	Information of a SEPP Instance
AanfInfo	6.1.6.2.73	Information of an AANF NF Instance.
5GDDnmfInfo	6.1.6.2.74	Information of a 5G DDNMF NF Instance.
MfafInfo	6.1.6.2.75	Information of the MFAF NF Instance.
NwdafCapability	6.1.6.2.76	Indicates the capability supported by the NWDAF.
DccfInfo	6.1.6.2.80	Information of a DCCF NF Instance.
NsacfInfo	6.1.6.2.81	Information of an NSACF NF Instance.
NsacfCapability	6.1.6.2.82	NSACF service capability.
DccfCond	6.1.6.2.83	Subscription to a set of NF Instances (DCCFs), identified by NF types, NF Set Id(s) or DCCF Serving Area information, i.e. list of TAIs served by the DCCF.
MIAnalyticsInfo	6.1.6.2.84	ML Analytics Filter information supported by the Nnwdaf_MLModelProvision service
MbSmfInfo	6.1.6.2.85	Information of a MB-SMF NF Instance
TmgiRange	6.1.6.2.86	Range of TMGIs
MbsSession	6.1.6.2.87	MBS Session served by an MB-SMF
SnsaiMbSmfInfoltem	6.1.6.2.88	Parameters supported by an MB-SMF for a given S-NSSAI
DnnMbSmfInfoltem	6.1.6.2.89	Parameters supported by an MB-SMF for a given DNN
TsctsInfo	6.1.6.2.91	Information of a TSCTS NF Instance.
SnsaiTsctsInfoltem	6.1.6.2.92	Set of parameters supported by TSCTS for a given S-NSSAI.
DnnTsctsInfoltem	6.1.6.2.93	Set of parameters supported by TSCTS for a given DNN.
MbUpfInfo	6.1.6.2.94	Information of a MB-UPF NF Instance.
UnTrustAfInfo	6.1.6.2.95	Information of a untrusted AF Instance.
TrustAfInfo	6.1.6.2.96	Information of a trusted AF Instance
SnsaiInfoltem	6.1.6.2.97	Set of parameters supported by NF for a given S-NSSAI.
DnnInfoltem	6.1.6.2.98	Set of parameters supported by NF for a given DNN.
CollocatedNfInstance	6.1.6.2.99	Information related to collocated NF type(s) and corresponding NF Instance(s) when the NF is collocated with NFs supporting other NF types.
ServiceNameListCond	6.1.6.2.100	Subscription to a set of NF Instances that offer a service name in the Service Name list.
NfGroupListCond	6.1.6.2.101	Subscription to a set of NF Instances, identified by a NF Group Identity in the NF Group Identity list.
PlmnOauth2	6.1.6.2.102	Per PLMN Oauth2.0 indication.
V2xCapability	6.1.6.2.103	Indicate the supported V2X Capability by the PCF.
NssaafInfo	6.1.6.2.104	Information of a NSSAAF NF Instance.



ProSeCapability	6.1.6.2.105	Indicate the supported ProSe Capability by the PCF.
SharedDataIdRange	6.1.6.2.106	
SubscriptionContext	6.1.6.2.107	Context data related to a created subscription, to be included in notifications sent by NRF.
IwmscInfo	6.1.6.2.108	Information of a SMS-IWMSC NF Instance.
MnpfInfo	6.1.6.2.109	Information of an MNPF Instance.
DefSubServiceInfo	6.1.6.2.110	Service Specific Information for Default Notification Subscription.
NefId	6.1.6.3.2	Identity of the NEF.
VendorId	6.1.6.3.2	Vendor ID of the NF Service instance (Private Enterprise Number assigned by IANA)
WildcardDnai	6.1.6.3.2	Wildcard DNAI
NFType	6.1.6.3.3	NF types known to NRF.
NotificationType	6.1.6.3.4	Types of notifications used in Default Notification URIs in the NF Profile of an NF Instance.
TransportProtocol	6.1.6.3.5	Types of transport protocol used in a given IP endpoint of an NF Service Instance.
NotificationEventType	6.1.6.3.6	Types of events sent in notifications from NRF to subscribed NF Instances.
NFStatus	6.1.6.3.7	Status of a given NF Instance stored in NRF.
DataSetId	6.1.6.3.8	Types of data sets stored in UDR.
UPInterfaceType	6.1.6.3.9	Types of User-Plane interfaces of the UPF.
ServiceName	6.1.6.3.11	Service names known to NRF.
NFServiceStatus	6.1.6.3.12	Status of a given NF Service Instance of an NF Instance stored in NRF.
AnNodeType	6.1.6.3.13	Access Network Node Type (gNB, ng-eNB...).
ConditionEventType	6.1.6.3.14	Indicates whether a notification is due to the NF Instance to start or stop being part of a condition for a subscription to a set of NFs
IpReachability	6.1.6.3.15	Indicates the type(s) of IP addresses reachable via an SCP.
CollocatedNFType	6.1.6.3.17	Possible NF types supported by a collocated NF.

Table 6.1.6.1-2 specifies data types re-used by the Nnrf\_NFManagement service-based interface protocol from other specifications, including a reference to their respective specifications and when needed, a short description of their use within the Nnrf\_NFManagement service-based interface.

Table 6.1.6.1-2: Nnrf\_NFManagement re-used Data Types

Data type	Reference	Comments
N1MessageClass	3GPP TS 29.518 [6]	The N1 message type
N2InformationClass	3GPP TS 29.518 [6]	The N2 information type
IPv4Addr	3GPP TS 29.571 [7]	
IPv6Addr	3GPP TS 29.571 [7]	
IPv6Prefix	3GPP TS 29.571 [7]	
Uri	3GPP TS 29.571 [7]	
Dnn	3GPP TS 29.571 [7]	
SupportedFeatures	3GPP TS 29.571 [7]	
Snsai	3GPP TS 29.571 [7]	
PlmnId	3GPP TS 29.571 [7]	
Guami	3GPP TS 29.571 [7]	
Tai	3GPP TS 29.571 [7]	
NfInstanceId	3GPP TS 29.571 [7]	
LinksValueSchema	3GPP TS 29.571 [7]	3GPP Hypermedia link
UriScheme	3GPP TS 29.571 [7]	
AmfName	3GPP TS 29.571 [7]	
DateTime	3GPP TS 29.571 [7]	
Dnai	3GPP TS 29.571 [7]	
ChangeItem	3GPP TS 29.571 [7]	
DiameterIdentity	3GPP TS 29.571 [7]	
AccessType	3GPP TS 29.571 [7]	
NfGroupId	3GPP TS 29.571 [7]	Network Function Group Id
AmfRegionId	3GPP TS 29.571 [7]	
AmfSetId	3GPP TS 29.571 [7]	
PduSessionType	3GPP TS 29.571 [7]	
AtsssCapability	3GPP TS 29.571 [7]	Capability to support procedures related to Access Traffic Steering, Switching, Splitting.
Nid	3GPP TS 29.571 [7]	
PlmnIdNid	3GPP TS 29.571 [7]	
NfSetId	3GPP TS 29.571 [7]	NF Set ID (see clause 28.12 of 3GPP TS 23.003 [12])
NfServiceSetId	3GPP TS 29.571 [7]	NF Service Set ID (see clause 28.13 of 3GPP TS 23.003 [12])
GroupId	3GPP TS 29.571 [7]	Internal Group Identifier
RatType	3GPP TS 29.571 [7]	RAT Type
DurationSec	3GPP TS 29.571 [7]	
RedirectResponse	3GPP TS 29.571 [7]	Response body of the redirect response message.
ExtSnsai	3GPP TS 29.571 [7]	
AreaSessionId	3GPP TS 29.571 [7]	Area Session Identifier used for an MBS session with location dependent content
MbsSessionId	3GPP TS 29.571 [7]	MBS Session Identifier
MbsServiceArea	3GPP TS 29.571 [7]	MBS Service Area
IpAddr	3GPP TS 29.571 [7]	IP Address
MbsServiceAreaInfo	3GPP TS 29.571 [7]	MBS Service Area Information for Location dependent MBS session
Fqdn	3GPP TS 29.571 [7]	Fully Qualified Domain Name
EventId	3GPP TS 29.520 [32]	Defined in Nnwdaf_AnalyticsInfo API.
NwdafEvent	3GPP TS 29.520 [32]	Defined in Nnwdaf_EventsSubscription API.
ExternalClientType	3GPP TS 29.572 [33]	
LMFIdentification	3GPP TS 29.572 [33]	LMF Identification
AfEvent	3GPP TS 29.517 [35]	Defined in Naf_EventExposure API
SupportedGADShapes	3GPP TS 29.572 [33]	Supported GAD Shapes
NetworkNodeDiameterAddress	3GPP TS 29.503 [36]	Diameter Address of a Network Node
IpIndex	3GPP TS 29.503 [36]	IP Index

## 6.1.6.2 Structured data types

### 6.1.6.2.1 Introduction

This clause defines the structures to be used in resource representations.

6.1.6.2.2 Type: NFProfile

**Table 6.1.6.2.2-1: Definition of type NFProfile**

Attribute name	Data type	P	Cardinality	Description
nfInstanceId	NfInstanceId	M	1	Unique identity of the NF Instance.
nfType	NFType	M	1	Type of Network Function
nfStatus	NFStatus	M	1	Status of the NF Instance (NOTE 5) (NOTE 16)
collocatedNfInstances	array(Collocated NfInstance)	O	1..N	Information related to collocated NF type(s) and corresponding NF Instances when the NF is collocated with NFs supporting other NF types. (NOTE 21)  In this release of the specification, following collocation scenarios are supported (see clause 6.1.6.2.99): - a MB-SMF collocated with a SMF; - a MB-UPF collocated with a UPF.
nfInstanceName	string	O	0..1	Human readable name of the NF Instance
heartBeatTimer	integer	C	0..1	Time in seconds expected between 2 consecutive heart-beat messages from an NF Instance to the NRF. It may be included in the registration request. When present in the request it shall contain the heartbeat time proposed by the NF service consumer. It shall be included in responses from NRF to registration requests (PUT) or in NF profile updates (PUT or PATCH). If the proposed heartbeat time is acceptable by the NRF based on the local configuration, it shall use the same value as in the registration request; otherwise the NRF shall override the value using a preconfigured value.
plmnList	array(PlmnId)	C	1..N	PLMN(s) of the Network Function (NOTE 7). This IE shall be present if this information is available for the NF. If not provided, PLMN ID(s) of the PLMN of the NRF are assumed for the NF.
snpnList	array(PlmnIdNid)	C	1..N	SNPN(s) of the Network Function. This IE shall be present if the NF pertains to one or more SNPNS.
sNssais	array(ExtSnsai)	O	1..N	S-NSSAIs of the Network Function. If not provided, and if the perPlmnSnsaiList attribute is not present, the NF can serve any S-NSSAI. When present this IE represents the list of S-NSSAIs supported in all the PLMNs listed in the plmnList IE. If the sNssais attribute is provided in at least one NF Service, the S-NSSAIs supported by the NF Profile shall be the set or a superset of the S-NSSAIs of the NFService(s).
perPlmnSnsaiList	array(PlmnSnsai)	O	1..N	This IE may be included when the list of S-NSSAIs supported by the NF for each PLMN it is supporting is different. When present, this IE shall include the S-NSSAIs supported by the Network Function for each PLMN supported by the Network Function. When present, this IE shall override sNssais IE. (NOTE 9) If the perPlmnSnsaiList attribute is provided in at least one NF Service, the S-NSSAIs supported per PLMN in the NF Profile shall be the set or a superset of the perPlmnSnsaiList of the NFService(s).
nsiList	array(string)	O	1..N	NSI identities of the Network Function. If not provided, the NF can serve any NSI.
fqdn	Fqdn	C	0..1	FQDN of the Network Function (NOTE 1) (NOTE 2) (NOTE 18). For AMF, the FQDN registered with the NRF shall be that of the AMF Name (see 3GPP TS 23.003 [12] clause 28.3.2.5).

interPlmnFqdn	Fqdn	C	0..1	<p>If the NF needs to be discoverable by other NFs in a different PLMN, then an FQDN that is used for inter-PLMN routing as specified in 3GPP TS 23.003 [12] shall be registered with the NRF (NOTE 8).</p> <p>A change of this attribute shall result in triggering a "NF_PROFILE_CHANGED" notification from NRF towards subscribing NFs located in the same or a different PLMN, but in the latter case the new value shall be notified as a change of the "fqdn" attribute.</p>
ipv4Addresses	array(Ipv4Addr)	C	1..N	IPv4 address(es) of the Network Function (NOTE 1) (NOTE 2) (NOTE 18)
ipv6Addresses	array(Ipv6Addr)	C	1..N	IPv6 address(es) of the Network Function (NOTE 1) (NOTE 2) (NOTE 18)
allowedPlmns	array(PlmnId)	O	1..N	<p>PLMNs allowed to access the NF instance. If not provided, any PLMN is allowed to access the NF.</p> <p>This attribute shall not be included in profile change notifications to subscribed NFs. (NOTE 17)</p>
allowedSnpsns	array(PlmnIdNid)	O	1..N	<p>SNPNs allowed to access the NF instance.</p> <p>If this attribute is present in the NFService and in the NF profile, the attribute from the NFService shall prevail.</p> <p>The absence of this attribute in both the NFService and in the NF profile indicates that no SNPN, other than the SNPN(s) registered in the snpnList attribute of the NF Profile, is allowed to access the service instance.</p> <p>This attribute shall not be included in profile change notifications to subscribed NFs. (NOTE 17)</p>
allowedNfTypes	array(NFType)	O	1..N	<p>Type of the NFs allowed to access the NF instance. If not provided, any NF type is allowed to access the NF.</p> <p>This attribute shall not be included in profile change notifications to subscribed NFs. (NOTE 17)</p>
allowedNfDomains	array(string)	O	1..N	<p>Pattern (regular expression according to the ECMA-262 dialect [8]) representing the NF domain names within the PLMN of the NRF allowed to access the NF instance. If not provided, any NF domain is allowed to access the NF.</p> <p>This attribute shall not be included in profile change notifications to subscribed NFs. (NOTE 17)</p>
allowedNssais	array(ExtSnsai)	O	1..N	<p>S-NSSAI of the allowed slices to access the NF instance. If not provided, any slice is allowed to access the NF.</p> <p>This attribute shall not be included in profile change notifications to subscribed NFs. (NOTE 17)</p>

priority	integer	O	0..1	<p>Priority (relative to other NFs of the same type) within the range 0 to 65535, to be used for NF selection; lower values indicate a higher priority. Priority may or may not be present in the nfServiceList parameters, xxxInfo parameters and in this attribute. Priority in the nfServiceList has precedence over the priority in this attribute (NOTE 4).</p> <p>Priority in xxxInfo parameter shall only be used to determine the relative priority among NF instances with the same priority at NFProfile/NFService.</p> <p>The NRF may overwrite the received priority value when exposing an NFProfile with the Nnrf_NFDiscovery service.</p>
capacity	integer	O	0..1	<p>Static capacity information within the range 0 to 65535, expressed as a weight relative to other NF instances of the same type; if capacity is also present in the nfServiceList parameters, those will have precedence over this value. (NOTE 4).</p>
load	integer	O	0..1	<p>Dynamic load information, within the range 0 to 100, indicates the current load percentage of the NF.</p>
loadTimeStamp	DateTime	O	0..1	<p>It indicates the point in time in which the latest load information (sent by the NF in the "load" attribute of the NF Profile) was generated at the NF Instance.</p> <p>If the NF did not provide a timestamp, the NRF should set it to the instant when the NRF received the message where the NF provided the latest load information.</p>
locality	string	O	0..1	<p>Operator defined information about the location of the NF instance (e.g. geographic location, data center) (NOTE 3)</p>
udrInfo	UdrInfo	O	0..1	<p>Specific data for the UDR (ranges of SUPI, group ID ...)</p>
udrInfoList	map(UdrInfo)	O	1..N	<p>Multiple entries of UdrInfo. This attribute provides additional information to the udrInfo. udrInfoList may be present even if the udrInfo is absent. The key of the map shall be a (unique) valid JSON string per clause 7 of IETF RFC 8259 [22], with a maximum of 32 characters.</p>
udmInfo	UdmInfo	O	0..1	<p>Specific data for the UDM (ranges of SUPI, group ID...)</p>
udmInfoList	map(UdmInfo)	O	1..N	<p>Multiple entries of UdmInfo. This attribute provides additional information to the udmInfo. udmInfoList may be present even if the udmInfo is absent. The key of the map shall be a (unique) valid JSON string per clause 7 of IETF RFC 8259 [22], with a maximum of 32 characters.</p>
ausfInfo	AusfInfo	O	0..1	<p>Specific data for the AUSF (ranges of SUPI, group ID...)</p>
ausfInfoList	map(AusfInfo)	O	1..N	<p>Multiple entries of AusfInfo. This attribute provides additional information to the ausfInfo. ausfInfoList may be present even if the ausfInfo is absent. The key of the map shall be a (unique) valid JSON string per clause 7 of IETF RFC 8259 [22], with a maximum of 32 characters.</p>
amfInfo	AmfInfo	O	0..1	<p>Specific data for the AMF (AMF Set ID, ...)</p>
amfInfoList	map(AmfInfo)	O	1..N	<p>Multiple entries of AmfInfo. This attribute provides additional information to the amfInfo. amfInfoList may be present even if the amfInfo is absent. The key of the map shall be a (unique) valid JSON string per clause 7 of IETF RFC 8259 [22], with a maximum of 32 characters.</p>
smfInfo	SmfInfo	O	0..1	<p>Specific data for the SMF (DNN's, ...). (NOTE 12)</p>

smfInfoList	map(SmfInfo)	O	1..N	Multiple entries of SmfInfo. This attribute provides additional information to the smfInfo. smfInfoList may be present even if the smfInfo is absent. The key of the map shall be a (unique) valid JSON string per clause 7 of IETF RFC 8259 [22], with a maximum of 32 characters. (NOTE 12)
upfInfo	UpfInfo	O	0..1	Specific data for the UPF (S-NSSAI, DNN, SMF serving area, interface...)
upfInfoList	map(UpfInfo)	O	1..N	Multiple entries of UpfInfo. This attribute provides additional information to the upfInfo. upfInfoList may be present even if the upfInfo is absent. The key of the map shall be a (unique) valid JSON string per clause 7 of IETF RFC 8259 [22], with a maximum of 32 characters.
pcfInfo	PcfInfo	O	0..1	Specific data for the PCF.
pcfInfoList	map(PcfInfo)	O	1..N	Multiple entries of PcfInfo. This attribute provides additional information to the pcfInfo. pcfInfoList may be present even if the pcfInfo is absent. The key of the map shall be a (unique) valid JSON string per clause 7 of IETF RFC 8259 [22], with a maximum of 32 characters.
bsfInfo	BsfInfo	O	0..1	Specific data for the BSF.
bsfInfoList	map(BsfInfo)	O	1..N	Multiple entries of BsfInfo. This attribute provides additional information to the bsfInfo. bsfInfoList may be present even if the bsfInfo is absent. The key of the map shall be a (unique) valid JSON string per clause 7 of IETF RFC 8259 [22], with a maximum of 32 characters.
chfInfo	ChfInfo	O	0..1	Specific data for the CHF.
chfInfoList	map(ChfInfo)	O	1..N	Multiple entries of ChfInfo. This attribute provides additional information to the chfInfo. chfInfoList may be present even if the chfInfo is absent. The key of the map shall be a (unique) valid JSON string per clause 7 of IETF RFC 8259 [22], with a maximum of 32 characters.
nefInfo	NefInfo	O	0..1	Specific data for the NEF.
nrfInfo	NrfInfo	O	0..1	Specific data for the NRF.
udsfInfo	UdsfInfo	O	0..1	Specific data for the UDSF.
udsfInfoList	map(UdsfInfo)	O	1..N	Multiple entries of udsfInfo. This attribute provides additional information to the udsfInfo. udsfInfoList may be present even if the udsfInfo is absent. The key of the map shall be a (unique) valid JSON string per clause 7 of IETF RFC 8259 [22], with a maximum of 32 characters.
nwdafInfo	NwdafInfo	O	0..1	Specific data for the NWDAF.
nwdafInfoList	map(NwdafInfo)	O	1..N	Multiple entries of nwdafInfo. This attribute provides additional information to the nwdafInfo. nwdafInfoList may be present even if the nwdafInfo is absent. The key of the map shall be a (unique) valid JSON string per clause 7 of IETF RFC 8259 [22], with a maximum of 32 characters.
pcscfInfoList	map(PcscfInfo)	O	1..N	Specific data for the P-CSCF. The key of the map shall be a (unique) valid JSON string per clause 7 of IETF RFC 8259 [22], with a maximum of 32 characters. (NOTE 11)
hssInfoList	map(HssInfo)	O	1..N	Specific data for the HSS. The key of the map shall be a (unique) valid JSON string per clause 7 of IETF RFC 8259 [22], with a maximum of 32 characters.
customInfo	object	O	0..1	Specific data for custom Network Functions
recoveryTime	DateTime	O	0..1	Timestamp when the NF was (re)started (NOTE 5) (NOTE 6)

nfServicePersistence	boolean	O	0..1	<p>- true: If present, and set to true, it indicates that the different service instances of a same NF Service in this NF instance, supporting a same API version, are capable to persist their resource state in shared storage and therefore these resources are available after a new NF service instance supporting the same API version is selected by a NF Service Consumer (see 3GPP TS 23.527 [27]).</p> <p>- false (default): Otherwise, it indicates that the NF Service Instances of a same NF Service are not capable to share resource state inside the NF Instance.</p>
nfServices	array(NFService)	O	1..N	<p>List of NF Service Instances. It shall include the services produced by the NF that can be discovered by other NFs, if any. (NOTE 15)</p> <p>This attribute is deprecated; the attribute "nfServiceList" should be used instead.</p>
nfServiceList	map(NFService)	O	1..N	<p>Map of NF Service Instances, where the "serviceInstanceId" attribute of the NFService object shall be used as the key of the map. (NOTE 15)</p> <p>It shall include the services produced by the NF that can be discovered by other NFs, if any.</p>
nfProfileChangesSupportInd	boolean	O	0..1	<p>NF Profile Changes Support Indicator. See Annex B.</p> <p>This IE may be present in the NFRegister or NFUpdate (NF Profile Complete Replacement) request and shall be absent in the response.</p> <p>true: the NF Service Consumer supports receiving NF Profile Changes in the response.</p> <p>false (default): the NF Service Consumer does not support receiving NF Profile Changes in the response.</p> <p>Write-Only: true</p>
nfProfileChangesInd	boolean	O	0..1	<p>NF Profile Changes Indicator. See Annex B.</p> <p>This IE shall be absent in the request to the NRF and may be included by the NRF in NFRegister or NFUpdate (NF Profile Complete Replacement) response.</p> <p>true: the NF Profile contains NF Profile changes. false (default): complete NF Profile.</p> <p>Read-Only: true</p>
defaultNotificationSubscriptions	array(DefaultNotificationSubscription)	O	1..N	<p>Notification endpoints for different notification types. (NOTE 10)</p>
lmfInfo	LmfInfo	O	0..1	<p>Specific data for the LMF.</p>
gmlcInfo	GmlcInfo	O	0..1	<p>Specific data for the GMLC.</p>
nfSetIdList	array(NfSetId)	C	1..N	<p>NF Set ID defined in clause 28.12 of 3GPP TS 23.003 [12]. At most one NF Set ID shall be indicated per PLMN-ID or SNPN of the NF. This information shall be present if available. (NOTE 22) (NOTE 23)</p>
servingScope	array(string)	O	1..N	<p>The served area(s) of the NF instance. The absence of this attribute does not imply that the NF instance can serve every area in the PLMN. (NOTE 13)</p>



lcHSupportInd	boolean	O	0..1	This IE indicates whether the NF supports Load Control based on LCI Header (see clause 6.3 of 3GPP TS 29.500 [4]). - true: the NF supports the feature. - false (default): the NF does not support the feature.
olcHSupportInd	boolean	O	0..1	This IE indicates whether the NF supports Overload Control based on OCI Header (see clause 6.4 of 3GPP TS 29.500 [4]). - true: the NF supports the feature. - false (default): the NF does not support the feature.
nfSetRecoveryTimeList	map(DateTime)	O	1..N	Map of recovery time, where the key of the map is the <i>NfSetId</i> of NF Set(s) that the NF instance belongs to.  When present, the value of each entry of the map shall be the recovery time of the NF Set indicated by the key.
serviceSetRecoveryTimeList	map(DateTime)	O	1..N	Map of recovery time, where the key of the map is the <i>NfServiceSetId</i> of the NF Service Set(s) configured in the NF instance.  When present, the value of each entry of the map shall be the recovery time of the NF Service Set indicated by the key.
scpDomains	array(string)	O	1..N	When present, this IE shall carry the list of SCP domains the SCP belongs to, or the SCP domain the NF (other than SCP) or the SEPP belongs to. (NOTE 14)
scplInfo	ScplInfo	O	0..1	Specific data for the SCP.
seppInfo	SeppInfo	O	0..1	Specific data for the SEPP.
vendorId	VendorId	O	0..1	Vendor ID of the NF instance, according to the IANA-assigned "SMI Network Management Private Enterprise Codes" [38].
supportedVendorSpecificFeatures	map(array(VendorSpecificFeature))	O	1..N(1..M)	Map of Vendor-Specific features, where the key of the map is the IANA-assigned "SMI Network Management Private Enterprise Codes" [38]. The string used as key of the map shall contain 6 decimal digits; if the SMI code has less than 6 digits, it shall be padded with leading digits "0" to complete a 6-digit string value. The value of each entry of the map shall be a list (array) of VendorSpecificFeature objects. (NOTE 19)
aanfInfoList	map(AanfInfo)	O	1..N	Multiple entries of AanfInfo. The key of the map shall be a (unique) valid JSON string per clause 7 of IETF RFC 8259 [22], with a maximum of 32 characters.
5gDdnmInfo	5GDdnmInfo	O	0..1	Specific data for the 5G DDNMF (5G DDNMF ID, ...)
mfafInfo	MfafInfo	O	0..1	Specific data for the MFAF
easdfInfoList	map(EasdfInfo)	O	1..N	EASDF specific data. The key of the map shall be a (unique) valid JSON string per clause 7 of IETF RFC 8259 [22], with a maximum of 32 characters. (NOTE 20)
dccfInfo	DccfInfo	O	0..1	Specific data for the DCCF.
nsacfInfoList	map(NsacfInfo)	O	1..N	Specific data for the NSACF. The key of the map shall be a (unique) valid JSON string per clause 7 of IETF RFC 8259 [22], with a maximum of 32 characters.
mbSmfInfoList	map(MbSmfInfo)	O	1..N	MB-SMF specific data. The key of the map shall be a (unique) valid JSON string per clause 7 of IETF RFC 8259 [22], with a maximum of 32 characters.

tsctsflInfoList	map(TsctsflInfo)	O	1..N	Specific data for the TSCTSFl. The key of the map shall be a (unique) valid JSON string per clause 7 of IETF RFC 8259 [22], with a maximum of 32 characters.
mbUpflInfoList	map(MbUpflInfo)	O	1..N	MB-UPF specific data.  The key of the map shall be a (unique) valid JSON string per clause 7 of IETF RFC 8259 [22], with a maximum of 32 characters.
trustAfInfo	TrustAfInfo	O	0..1	Specific data for the trusted AF.
nssaafInfo	NssaafInfo	O	0..1	Specific data for the NSSAAF.
hniList	array(Fqdn)	C	1..N	Identifications of Credentials Holder or Default Credentials Server. This IE shall be present if the NFs are available for the case of access to an SNPN using credentials owned by a Credentials Holder or for the case of SNPN Onboarding using a DCS.
iwmsclInfo	IwmsclInfo	O	0..1	Specific data for the SMS-IWMSC.
mnpflInfo	MnpflInfo	O	0..1	Specific data for the MNPF.

- NOTE 1: At least one of the addressing parameters (fqdn, ipv4address or ipv6address) shall be included in the NF Profile. If the NF supports the NF services with "https" URI scheme (i.e use of TLS is mandatory), then the FQDN shall be provided in the NF Profile or the NF Service profile (see clause 6.1.6.2.3) and it shall be used to construct the target URI (unless overridden by a NFService-specific FQDN). See NOTE 1 of Table 6.1.6.2.3-1 for the use of these parameters. If multiple ipv4 addresses and/or ipv6 addresses are included in the NF Profile, the NF Service Consumer of the discovery service shall select one of these addresses randomly, unless operator defined local policy of IP address selection, in order to avoid overload for a specific ipv4 address and/or ipv6 address.
- NOTE 2: If the type of Network Function is UPF or MB-UPF, the addressing information is for the UPF N4 interface or MB-UPF N4mb interface respectively. If the type of Network Function is a P-CSCF and if no Gm FQDN or IP addresses are registered in the pcsclInfoList attribute, the addressing information is also used for the P-CSCF Gm interface.
- NOTE 3: A requester NF may use this information to select a NF instance (e.g. a NF instance preferably located in the same data center).
- NOTE 4: The capacity and priority parameters, if present, are used for NF selection and load balancing. The priority and capacity attributes shall be used for NF selection in the same way that priority and weight are used for server selection as defined in IETF RFC 2782 [23].
- NOTE 5: The NRF shall notify NFs subscribed to receiving notifications of changes of the NF profile, if the NF recoveryTime or the nfStatus is changed. See clause 6.2 of 3GPP TS 23.527 [27].
- NOTE 6: A requester NF may consider that all the resources created in the NF before the NF recovery time have been lost. This may be used to detect a restart of a NF and to trigger appropriate actions, e.g. release local resources. See clause 6.2 of 3GPP TS 23.527 [27].
- NOTE 7: A NF may register multiple PLMN IDs in its profile within a PLMN comprising multiple PLMN IDs. If so, all the attributes of the NF Profile shall apply to each PLMN ID registered in the plmnList. As an exception, attributes including a PLMN ID, e.g. IMSI-based SUPI ranges, TAIs and GUAMIs, are specific to one PLMN ID and the NF may register in its profile multiple occurrences of such attributes for different PLMN IDs (e.g. the UDM may register in its profile SUPI ranges for different PLMN IDs).
- NOTE 8: Other NFs are in a different PLMN if they belong to none of the PLMN ID(s) configured for the PLMN of the NRF.
- NOTE 9: This is for the use case where an NF (e.g. AMF) supports multiple PLMNs and the slices supported in each PLMN are different. See clause 9.2.6.2 of 3GPP TS 38.413 [29].
- NOTE 10: For notification types that may be associated with a specific service of the NF Instance receiving the notification (see clause 6.1.6.3.4), if notification endpoints are present both in the profile of the NF instance (NFProfile) and in some of its NF Services (NFService) for a same notification type, the notification endpoint(s) of the NF Services shall be used for this notification type. The defaultNotificationSubscriptions attribute may contain multiple default subscriptions for a same notification type; in that case, those default subscriptions are used as alternative notification endpoints so, for each notification event that needs to be sent, the NF Service Consumer shall select one of such subscriptions and use it to send the notification.
- NOTE 11: The absence of the pcsclInfoList attribute in a P-CSCF profile indicates that the P-CSCF can be selected for any DNN and Access Type, and that the P-CSCF Gm addressing information is the same as the addressing information registered in the fqdn, ipv4Addresses and ipv6Addresses attributes of the NF profile.
- NOTE 12: The absence of both the smfInfo and smfInfoList attributes in an SMF profile indicates that the SMF can be selected for any S-NSSAI listed in the sNssais and perPlmnSnsaiList IEs, or for any S-NSSAI if neither the sNssais IE nor the perPlmnSnsaiList IE are present, and for any DNN, TAI and access type.
- NOTE 13: The servingScope attribute may indicate geographical areas, It may be used e.g. to discover and select NFs in centralized Data Centers that are expected to serve users located in specific region(s) or province(s). It may also be used to reduce the large configuration of TAIs in the NF instances.
- NOTE 14: An NF (other than a SCP) can register at most one SCP domain in NF profile, i.e. the NF can belong to only one SCP domain. If an NF (other than a SCP) includes this information in its profile, this indicates that the services produced by this NF should be accessed preferably via an SCP from the SCP domain the NF belongs to.
- NOTE 15: If the NF Service Consumer that issues an NF profile retrieval request indicates support for the "Service-Map" feature, the NRF shall return in the NF profile retrieval response the list of NF Service Instances in the "nfServiceList" map attribute. Otherwise, the NRF shall return the list of NF Service Instances in the "nfServices" array attribute.
- NOTE 16: The nfStatus also indicate the Status of the NF instance as NF Service Consumer for notification delivery. When a notification is to be delivered to the NF instance and the NF Service Producer (or SCP) has been aware that the NF instance is not operative from the nfStatus in its NF profile, the NF Service producer (or SCP) shall reselect another NF Service Consumer as target if possible, e.g. using binding indication or discovery factors previously provided for the notification. When selecting or reselecting an NF Service Consumer for notification delivery, not operative NF instances shall not be selected as target.
- NOTE 17: A change of this attribute shall trigger a "NF\_PROFILE\_CHANGED" notification from NRF, if the change of the NF Profile results in that the NF Instance starts or stops being authorized to be accessed by an NF having subscribed to be notified about NF profile changes.
- NOTE 18: For API URIs constructed with an FQDN, the NF Service Consumer may use the FQDN of the target URI to do a DNS query and obtain the IP address(es) to setup the TCP connection, and ignore the IP addresses that may be present in the NFProfile; alternatively, the NF Service Consumer may use those IP addresses

to setup the TCP connection, if no service-specific FQDN or IP address is provided in the NFService data and if the NF Service Consumer supports to indicate specific IP address(es) to establish an HTTP/2 connection with an FQDN in the target URI.

- NOTE 19: When present, this attribute allows an NF requesting NF Discovery (e.g. an NF Service Consumer) to determine which vendor-specific extensions are supported in a given NF (e.g. an NF Service Producer), so as to select an appropriate NF with specific capability, or to include or not the vendor-specific attributes (see 3GPP TS 29.500 [4] clause 6.6.3) required for a given feature in subsequent messages towards a certain NF. One given vendor-specific feature shall not appear in both NF Profile and NF Service Profile. If one vendor-specific feature is service related, it shall only be included in the NF Service Profile.
- NOTE 20: The absence of the easdfInfoList attribute in an EASDF profile indicates that the EASDF can be selected for any S-NSSAI, DNN, DNAI or PSA UPF N6 IP address.
- NOTE 21: The NF service consumer when invoking NF services offered by collocated NF service producers shall follow the respective service API in the same manner as if they were not collocated with any other NF type. The NF service consumer shall not assume any optimization of signaling between the NF service consumer and the collocated NF service producers.
- NOTE 22: The nfSetIdList attribute shall be present only if all NF service instance(s) of the NF instance are redundant at NF Set level. I.e. any NF service instance shall be redundant (i.e. functionally equivalent, interchangeable and sharing contexts) with equivalent service instance(s) of every other NF instance(s) within the indicated NF Set or, if the NF service instance belongs to an NF service set, it shall be redundant with NF service instance(s) in an equivalent NF service set of every other NF instance(s) within the indicated NF set.
- NOTE 23: The NF Instance shall be removed from an NF set or re-assigned to another NF set ONLY when there is NO ongoing resource/context associated with the NF instance.

6.1.6.2.3 Type: NFService

**Table 6.1.6.2.3-1: Definition of type NFService**

Attribute name	Data type	P	Cardinality	Description
serviceInstanceid	string	M	1	Unique ID of the service instance within a given NF Instance
serviceName	ServiceName	M	1	Name of the service instance (e.g. "nudm-sdm")
versions	array(NFServiceVersion)	M	1..N	The API versions supported by the NF Service and if available, the corresponding retirement date of the NF Service. The different array elements shall have distinct unique values for "apiVersionInUri", and consequently, the values of "apiFullVersion" shall have a unique first digit version number.
scheme	UriScheme	M	1	URI scheme (e.g. "http", "https")
nfServiceStatus	NFServiceStatus	M	1	Status of the NF Service Instance (NOTE 3) (NOTE 12)
fqdn	Fqdn	O	0..1	FQDN of the NF Service Instance (NOTE 1) (NOTE 8) (NOTE 14) The FQDN provided as part of the NFService information has precedence over the FQDN and IP addresses provided as part of the NFProfile information (see clause 6.1.6.2.2).
interPlmnFqdn	Fqdn	O	0..1	If the NF service needs to be discoverable by other NFs in a different PLMN, then an FQDN that is used for inter PLMN routing as specified in 3GPP TS 23.003 [12] may be registered with the NRF (NOTE 1) (NOTE 6).  A change of this attribute shall result in triggering a "NF_PROFILE_CHANGED" notification from NRF towards subscribing NFs located in the same or a different PLMN, but in the latter case the new value shall be notified as a change of the "fqdn" attribute.
ipEndPoints	array(IpEndPoint)	O	1..N	IP address(es) and port information of the Network Function (including IPv4 and/or IPv6 address) where the service is listening for incoming service requests (NOTE 1) (NOTE 7) (NOTE 14). IP addresses provided in ipEndPoints have precedence over IP addresses provided as part of the NFProfile information and, when using the HTTP scheme, over FQDN provided as part of the NFProfile information (see clause 6.1.6.2.2).
apiPrefix	string	O	0..1	Optional path segment(s) used to construct the {apiRoot} variable of the different API URIs, as described in 3GPP TS 29.501 [5], clause 4.4.1
defaultNotificationSubscriptions	array(DefaultNotificationSubscription)	O	1..N	Notification endpoints for different notification types. (See also NOTE 10 in clause 6.1.6.2.2)
allowedPlmns	array(PlmnId)	O	1..N	PLMNs allowed to access the service instance (NOTE 5).  The absence of this attribute indicates that any PLMN is allowed to access the service instance.  When included, the allowedPlmns attribute needs not include the PLMN ID(s) registered in the plmnList attribute of the NF Profile, i.e. the PLMN ID(s) registered in the NF Profile shall be considered to be allowed to access the service instance.  This attribute shall not be included in profile change notifications to subscribed NFs. (NOTE 13)

allowedSnprs	array(PlmnIdNid)	O	1..N	<p>SNPNs allowed to access the service instance.</p> <p>If this attribute is present in the NFService and in the NF profile, the attribute from the NFService shall prevail.</p> <p>The absence of this attribute in both the NFService and in the NF profile indicates that no SNPN, other than the SNPN(s) registered in the snpnList attribute of the NF Profile, is allowed to access the service instance.</p> <p>When included, the allowedSnprs attribute needs not include the PLMN ID/NID(s) registered in the snpnList attribute of the NF Profile, i.e. the SNPNs registered in the NF Profile shall be considered to be allowed to access the service instance.</p> <p>This attribute shall not be included in profile change notifications to subscribed NFs. (NOTE 13)</p>
allowedNfTypes	array(NFType)	O	1..N	<p>Type of the NFs allowed to access the service instance (NOTE 5).</p> <p>The absence of this attribute indicates that any NF type is allowed to access the service instance.</p> <p>This attribute shall not be included in profile change notifications to subscribed NFs. (NOTE 13)</p>
allowedNfDomains	array(string)	O	1..N	<p>Pattern (regular expression according to the ECMA-262 dialect [8]) representing the NF domain names within the PLMN of the NRF allowed to access the service instance (NOTE 5).</p> <p>The absence of this attribute indicates that any NF domain is allowed to access the service instance.</p> <p>This attribute shall not be included in profile change notifications to subscribed NFs. (NOTE 13)</p>
allowedNssais	array(ExtSnsai)	O	1..N	<p>S-NSSAI of the allowed slices to access the service instance (NOTE 5).</p> <p>The absence of this attribute indicates that any slice is allowed to access the service instance.</p> <p>This attribute shall not be included in profile change notifications to subscribed NFs. (NOTE 13)</p>
allowedOperationsPerNfType	map(array(string))	C	1..N(1..M)	<p>Map of allowed operations on resources for each type of NF; the key of the map is the NF Type, and the value is an array of scopes.</p> <p>The scopes shall be any of those defined in the API that defines the current service (identified by the "serviceName" attribute).</p> <p>In an NFRegister (or NFUpdate) procedure, this IE should be present if the NF service instance supports and is configured to use resource/operation specific scope(s) for at least one NF type of NF service consumer.</p> <p>In an NFStatusNotify procedure, this IE should be present, if it is present in the registered NF service instance and if the map contains a key matching the subscriber's NF type. When present, this IE should only contain the key-value pair of the map matching the subscriber's NF type.</p> <p>(NOTE 11)</p>

allowedOperationsPerNfInstance	map(array(string))	C	1..N(1..M)	<p>Map of allowed operations on resources for a given NF Instance; the key of the map is the NF Instance Id, and the value is an array of scopes.</p> <p>The scopes shall be any of those defined in the API that defines the current service (identified by the "serviceName" attribute).</p> <p>In an NFRegister (or NFUpdate) procedure, this IE should be present if the NF service instance supports and is configured to use resource/operation specific scope(s) for at least one NF instance of NF service consumer.</p> <p>In an NFStatusNotify procedure, this IE should be present, if it is present in the registered NF service instance and if the map contains a key matching the subscriber's NF Instance ID. When present, this IE should only contain the key-value pair of the map matching the subscriber's NF Instance ID.</p> <p>(NOTE 11)</p>
priority	integer	O	0..1	<p>Priority (relative to other services of the same type) in the range of 0-65535, to be used for NF Service selection; lower values indicate a higher priority. (NOTE 2).</p> <p>The NRF may overwrite the received priority value when exposing an NFProfile with the Nnrf_NFDiscovery service.</p>
capacity	integer	O	0..1	<p>Static capacity information in the range of 0-65535, expressed as a weight relative to other services of the same type. (NOTE 2).</p>
load	integer	O	0..1	<p>Dynamic load information, ranged from 0 to 100, indicates the current load percentage of the NF Service.</p>
loadTimeStamp	DateTime	O	0..1	<p>It indicates the point in time in which the latest load information (sent by the NF in the "load" attribute of the NF Service) was generated at the NF Service Instance.</p> <p>If the NF did not provide a timestamp, the NRF should set it to the instant when the NRF received the message where the NF provided the latest load information.</p>
recoveryTime	DateTime	O	0..1	<p>Timestamp when the NF service was (re)started (NOTE 3) (NOTE 4)</p>
supportedFeatures	SupportedFeatures	O	0..1	<p>Supported Features of the NF Service instance</p>
nfServiceSetIdList	array(NfServiceSetId)	C	1..N	<p>NF Service Set ID (see clause 28.13 of 3GPP TS 23.003 [12])</p> <p>At most one NF Service Set ID shall be indicated per PLMN-ID or SNPN of the NF.</p> <p>This information shall be present if available. (NOTE 15)</p>
sNssais	array(ExtSnsai)	O	1..N	<p>S-NSSAIs of the NF Service. This may be a subset of the S-NSSAIs supported by the NF (see sNssais attribute in NFProfile).</p> <p>When present, this IE shall represent the list of S-NSSAIs supported by the NF Service in all the PLMNs listed in the plmnList IE and it shall prevail over the list of S-NSSAIs supported by the NF instance.</p>



perPlmnSnssaiList	array(PlmnSnssai)	O	1..N	<p>S-NSSAIs of the NF Service per PLMN. This may be a subset of the S-NSSAIs supported per PLMN by the NF (see perPlmnSnssaiList attribute in NFProfile).</p> <p>This IE may be included when the list of S-NSSAIs supported by the NF Service for each PLMN it is supporting is different. When present, this IE shall include the S-NSSAIs supported by the NF Service for each PLMN and it shall prevail over the list of S-NSSAIs supported per PLMN by the NF instance. When present, this IE shall override the sNssais IE. (NOTE 9)</p>
vendorId	VendorId	O	0..1	<p>Vendor ID of the NF Service instance, according to the IANA-assigned "SMI Network Management Private Enterprise Codes" [38].</p>
supportedVendorSpecificFeatures	map(array(VendorSpecificFeature))	O	1..N(1..M)	<p>Map of Vendor-Specific features, where the key of the map is the IANA-assigned "SMI Network Management Private Enterprise Codes" [38]. The string used as key of the map shall contain 6 decimal digits; if the SMI code has less than 6 digits, it shall be padded with leading digits "0" to complete a 6-digit string value.</p> <p>The value of each entry of the map shall be a list (array) of VendorSpecificFeature objects. (NOTE 10)</p>
oauth2Required	boolean	O	0..1	<p>It indicates whether the NF Service Instance requires OAuth2-based authorization.</p> <p>Absence of this IE means that the NF Service Producer has not provided any indication about its usage of OAuth2 for authorization.</p>
perPlmnOauth2ReqList	PlmnOauth2	O	0..1	<p>When present, this IE shall include the OAuth2-based authorization requirement supported by the NF Service Instance per PLMN of the NF Service Consumer.</p> <p>This IE may be included when the OAuth2.0 authorization requirement supported by the NF Service Instance for different PLMN is different. When the requester PLMN Id is available in perPlmnOauth2ReqList IE, this IE shall override the oauth2Required IE. If the requester PLMN ID is not present in perPlmnOauth2ReqList IE, then the value of oauth2Required IE shall be applicable if available.</p>

- NOTE 1: The NF Service Consumer will construct the API URIs of the service using:
- For intra-PLMN signalling: If TLS is used, the FQDN present in the NF Service Profile, if any; otherwise, the FQDN present in the NF Profile. If TLS is not used, the FQDN should be used if the NF Service Consumer uses Indirect Communication via an SCP; the FQDN or the IP address in the ipEndpoints attribute may be used if the NF Service Consumer uses Direct Communication.
  - For inter-PLMN signalling: the interPlmnFqdn present in the NF Service Profile, if any; otherwise, the interPlmnFqdn present in the NF Profile.
- See Table 6.2.6.2.4-1.
- NOTE 2: The capacity and priority parameters, if present, are used for NF selection and load balancing. The priority and capacity attributes shall be used for NF selection in the same way that priority and weight are used for server selection as defined in IETF RFC 2782 [23].
- NOTE 3: The NRF shall notify NFs subscribed to receiving notifications of changes of the NF profile, if the recoveryTime or the nfServiceStatus is changed. See clause 6.2 of 3GPP TS 23.527 [27].
- NOTE 4: A requester NF subscribed to NF status changes may consider that all the resources created in the NF service before the NF service recovery time have been lost. This may be used to detect a restart of a NF service and to trigger appropriate actions, e.g. release local resources. See clause 6.2 of 3GPP TS 23.527 [27].
- NOTE 5: If this attribute is present in the NFService and in the NF profile, the attribute from the NFService shall prevail. The absence of this attribute in the NFService and in the NFProfile indicates that there is no corresponding restriction to access the service instance. If this attribute is absent in the NF Service, but it is present in the NF Profile, the attribute from the NF Profile shall be applied.
- NOTE 6: Other NFs are in a different PLMN if they belong to none of the PLMN ID(s) configured for the PLMN of the NRF.
- NOTE 7: If multiple ipv4 addresses and/or ipv6 addresses are included in the NF Service, the NF Service Consumer of the discovery service shall select one of these addresses randomly, unless operator defined local policy of IP address selection, in order to avoid overload for a specific ipv4 address and/or ipv6 address.
- NOTE 8: If the URI scheme registered for the NF service is "https" then FQDN shall be provided in the NF Service profile or in NF Profile (see clause 6.1.6.2.2).
- NOTE 9: This is for the use case where an NF (e.g. AMF) supports multiple PLMNs and the slices supported in each PLMN are different. See clause 9.2.6.2 of 3GPP TS 38.413 [29].
- NOTE 10: When present, this attribute allows the NF requesting NF discovery (e.g. an NF Service Consumer) to determine which vendor-specific extensions are supported in a given NF (e.g. an Service Producer) in order to select an appropriate NF, or to include or not include the vendor-specific attributes (see 3GPP TS 29.500 [4] clause 6.6.3) required for a given feature in subsequent service requests towards a certain service instance of the NF Service Producer. One given vendor-specific feature shall not appear in both NF Profile and NF Service Profile. If one vendor-specific feature is service related, it shall only be included in the NF Service Profile.
- NOTE 11: These attributes are used in order to determine whether a given resource/operation-level scope shall be granted to an NF Service Consumer that requested an OAuth2 access token with a specific scope; the NRF shall only grant such scope in the access token, if the scope is present in either "allowedOperationsPerNfType", for the specific NF type of the NF Service Consumer, or in "allowedOperationsPerNfInstance", for the specific NF instance ID of the NF Service Consumer. These attributes need not be registered if the NF service instance only supports (or is configured to only use) the service-level scope for all NF service consumers allowed to access the service. When both these attributes are absent, the NRF should grant access tokens for the service-level scope only. When at least one of these IEs is present, these IEs shall indicate all the NF types or NF instances allowed to access the NF service instance, with all the corresponding scopes (i.e. the service-level scope and resource/operation specific scopes) allowed for each NF type or NF instance, i.e. any NF type or NF instance not listed in these IEs is disallowed to access the NF service instance.
- Example: if an NF service instance is configured to enable an NF type X to access all service operations including resource/operations defined with resource/operation specific scopes and an NF type Y to access only the service operations not requiring resource/operation specific scopes, the allowedOperationsPerNfType IE should be present and set as follows:
- ```

allowedOperationsPerNfType: {
  X: [<service-level scope>, <resource/operation scope 1>, <resource/operation scope 2>],
  Y: [<service-level scope>]
}

```
- NOTE 12: The nfServiceStatus also indicate the Status of the NF service instance as NF Service Consumer for notification delivery. When a notification is to be delivered to the NF service instance and the NF Service Producer (or SCP) has been aware that the NF service instance is not operative from the nfServiceStatus in the NF profile, the NF Service producer (or SCP) shall reselect another NF Service Consumer as target if possible, e.g. using binding indication or discovery factors previously provided for the notification. When selecting or reselecting an NF Service Consumer for notification delivery, not operative NF (service) instances shall not be selected as target.

NOTE 13: A change of this attribute shall trigger a "NF\_PROFILE\_CHANGED" notification from NRF, if the change of the NF Profile results in that the NF Instance starts or stops being authorized to be accessed by an NF having subscribed to be notified about NF profile changes.

NOTE 14: For API URIs constructed with an FQDN, the NF Service Consumer may use the FQDN in the target URI to do a DNS query and obtain the IP address(es) to setup the TCP connection, and ignore the IP addresses that may be present in the ipEndpoints attribute; alternatively, the NF Service Consumer may use those IP addresses to setup the TCP connection, if the NF Service Consumer supports to indicate specific IP address(es) to establish an HTTP/2 connection with an FQDN in the target URI.

NOTE 15: The NF service Instance shall be removed from an NF service set or re-assigned to another NF service set ONLY when there is NO ongoing resource/context associated with the NF service instance.

6.1.6.2.4 Type: DefaultNotificationSubscription

**Table 6.1.6.2.4-1: Definition of type DefaultNotificationSubscription**

| Attribute name     | Data type          | P | Cardinality | Description                                                                                                                                                                                                                                                                                                                                                                                                                                                                                                                            |
|--------------------|--------------------|---|-------------|----------------------------------------------------------------------------------------------------------------------------------------------------------------------------------------------------------------------------------------------------------------------------------------------------------------------------------------------------------------------------------------------------------------------------------------------------------------------------------------------------------------------------------------|
| notificationType   | NotificationType   | M | 1           | Type of notification for which the corresponding callback URI is provided.                                                                                                                                                                                                                                                                                                                                                                                                                                                             |
| callbackUri        | Uri                | M | 1           | This attribute contains a default notification endpoint to be used by a NF Service Producer towards an NF Service Consumer that has not registered explicitly a callback URI in the NF Service Producer (e.g. as a result of an implicit subscription).                                                                                                                                                                                                                                                                                |
| n1MessageClass     | N1MessageClass     | C | 0..1        | If the notification type is N1_MESSAGES, this IE shall be present and shall identify the class of N1 messages to be notified.                                                                                                                                                                                                                                                                                                                                                                                                          |
| n2InformationClass | N2InformationClass | C | 0..1        | If the notification type is N2_INFORMATION, this IE shall be present and shall identify the class of N2 information to be notified.                                                                                                                                                                                                                                                                                                                                                                                                    |
| versions           | array(string)      | O | 1..N        | API versions (e.g. "v1") supported for the default notification type.<br>(NOTE 3)                                                                                                                                                                                                                                                                                                                                                                                                                                                      |
| binding            | string             | O | 0..1        | When present, this IE shall contain the value of the Binding Indication for the default subscription notification (i.e. the value part of "3gpp-Sbi-Binding" header), as specified in clause 6.12.4 of 3GPP TS 29.500 [4]. (NOTE 1)                                                                                                                                                                                                                                                                                                    |
| acceptedEncoding   | string             | O | 0..1        | Content encodings that are accepted by a NF Service Consumer when receiving a notification related to a default notification subscription. The value of this attribute shall be formatted as the value of the Accept-Encoding header defined in IETF RFC 7231 [40] clause 5.3.4 (e.g. acceptedEncoding: "gzip;q=1.0, identity;q=0.5, *;q=0")<br><br>The absence of this IE shall not be interpreted as indicating that no specific encodings are supported, but the NF Service Consumer did not register the encodings it may support. |
| supportedFeatures  | SupportedFeatures  | O | 0..1        | When present, this attribute shall indicate the features of the service corresponding to the subscribed default notification, which are supported by the NF (Service) instance acting as NF service consumer. (NOTE 2, NOTE 3)                                                                                                                                                                                                                                                                                                         |

|                                                                                                                                                                                                                                                                                                                                                                                                                                                                                                                                                                                                                                                                                                                                                                                                                                                                                                                                                                                                                                                                                                                                                                                                                                                                                                                                                                                                                                                                                                                                                                                     |                        |   |      |                                                                                                                                                                                                                                                                                                                                                                                                                                                                                                                                                                                                                                                                                                                                                                                                                                                                                                                                                                                                                          |
|-------------------------------------------------------------------------------------------------------------------------------------------------------------------------------------------------------------------------------------------------------------------------------------------------------------------------------------------------------------------------------------------------------------------------------------------------------------------------------------------------------------------------------------------------------------------------------------------------------------------------------------------------------------------------------------------------------------------------------------------------------------------------------------------------------------------------------------------------------------------------------------------------------------------------------------------------------------------------------------------------------------------------------------------------------------------------------------------------------------------------------------------------------------------------------------------------------------------------------------------------------------------------------------------------------------------------------------------------------------------------------------------------------------------------------------------------------------------------------------------------------------------------------------------------------------------------------------|------------------------|---|------|--------------------------------------------------------------------------------------------------------------------------------------------------------------------------------------------------------------------------------------------------------------------------------------------------------------------------------------------------------------------------------------------------------------------------------------------------------------------------------------------------------------------------------------------------------------------------------------------------------------------------------------------------------------------------------------------------------------------------------------------------------------------------------------------------------------------------------------------------------------------------------------------------------------------------------------------------------------------------------------------------------------------------|
| serviceInfoList                                                                                                                                                                                                                                                                                                                                                                                                                                                                                                                                                                                                                                                                                                                                                                                                                                                                                                                                                                                                                                                                                                                                                                                                                                                                                                                                                                                                                                                                                                                                                                     | map(DefSubServiceInfo) | O | 1..N | <p>This IE may be present when the notification request of the notification type may be generated by multiple services, i.e. notifications from different services may be received by the subscription.</p> <p>When present, this IE shall contain a map of service specific information. The name of the corresponding service (as specified in ServiceName data type, see clause 6.1.6.3.11) is the key of the map and the value of the map is the specific information for the indicated service supported by the NF (Service) instance acting as NF service consumer.</p> <p>For example, when the NF subscribes to default notification of "LOCATION_NOTIFICATION" type which may be sent by Namf_Location service and Nlmf_Location service, the NF may provide service specific information as below:</p> <pre> {   "namf-loc" : {     "versions" : [ "v1" ],     "supportedFeatures" : "AB"   },   "nlmf-loc" : {     "versions" : [ "v1" ],     "supportedFeatures" : "12"   } } </pre> <p>(NOTE 3, NOTE 4)</p> |
| <p>NOTE 1: The binding indication for default subscription may be used by a NF service producer to reselect an alternative NF service consumer instance, when delivering a notification for a default subscription towards a specific NF consumer but the latter is not reachable. E.g. an AMF notifies corresponding uplink LPP/NRPPa messages via default subscription, to the LMF instance who previously sent downlink LPP/NRPPa message during a location procedure, If the original LMF instance is not reachable, the AMF selects an alternative LMF instance using the binding indication and delivers the notification towards the selected LMF instance.</p> <p>NOTE 2: When sending notifications towards the subscribed NF service consumer, the NF service producer shall generate the default notifications according to the supported features indicated in this attribute, e.g. to include the attributes or enumerated values related to particular features only if the corresponding features are supported, as specified in clause 6.6.2 of 3GPP TS 29.500 [4].</p> <p>NOTE 3: When the serviceInfoList IE is present, the versions IE and the supportedFeatures IE shall be absent.</p> <p>NOTE 4: When the serviceInfoList IE is present, the NF producer shall determine whether the service of the default notification is supported, i.e. whether the service is listed in the map keys. If supported, the NF producer shall generate the default notification according to the specific information of the service, i.e. the corresponding map value.</p> |                        |   |      |                                                                                                                                                                                                                                                                                                                                                                                                                                                                                                                                                                                                                                                                                                                                                                                                                                                                                                                                                                                                                          |

6.1.6.2.5 Type: IpEndPoint

Table 6.1.6.2.5-1: Definition of type IpEndPoint

| Attribute name                                                                                                                                                                                                                                                                                                                                                                                  | Data type         | P | Cardinality | Description                                       |
|-------------------------------------------------------------------------------------------------------------------------------------------------------------------------------------------------------------------------------------------------------------------------------------------------------------------------------------------------------------------------------------------------|-------------------|---|-------------|---------------------------------------------------|
| ipv4Address                                                                                                                                                                                                                                                                                                                                                                                     | Ipv4Addr          | C | 0..1        | IPv4 address (NOTE 1)                             |
| ipv6Address                                                                                                                                                                                                                                                                                                                                                                                     | Ipv6Addr          | C | 0..1        | IPv6 address (NOTE 1)                             |
| transport                                                                                                                                                                                                                                                                                                                                                                                       | TransportProtocol | O | 0..1        | Transport protocol                                |
| port                                                                                                                                                                                                                                                                                                                                                                                            | integer           | O | 0..1        | Port number (NOTE 2)<br>Minimum: 0 Maximum: 65535 |
| <p>NOTE 1: At most one occurrence of either ipv4Address or ipv6Address shall be included in this data structure.</p> <p>NOTE 2: If the port number is absent from the ipEndpoints attribute, the NF service consumer shall use the default HTTP port number, i.e. TCP port 80 for "http" URIs or TCP port 443 for "https" URIs as specified in IETF RFC 7540 [9] when invoking the service.</p> |                   |   |             |                                                   |

## 6.1.6.2.6 Type: UdrInfo

Table 6.1.6.2.6-1: Definition of type UdrInfo

| Attribute name                                                                                                                                                                                                                                                                                                                                                                                                                | Data type                | P | Cardinality | Description                                                                                                                                       |
|-------------------------------------------------------------------------------------------------------------------------------------------------------------------------------------------------------------------------------------------------------------------------------------------------------------------------------------------------------------------------------------------------------------------------------|--------------------------|---|-------------|---------------------------------------------------------------------------------------------------------------------------------------------------|
| groupId                                                                                                                                                                                                                                                                                                                                                                                                                       | NfGroupId                | O | 0..1        | Identity of the UDR group that is served by the UDR instance.<br>If not provided, the UDR instance does not pertain to any UDR group.<br>(NOTE 1) |
| supiRanges                                                                                                                                                                                                                                                                                                                                                                                                                    | array(SupiRange)         | O | 1..N        | List of ranges of SUPI's whose profile data is available in the UDR instance (NOTE 1)                                                             |
| gpsiRanges                                                                                                                                                                                                                                                                                                                                                                                                                    | array(IdentityRange)     | O | 1..N        | List of ranges of GPSIs whose profile data is available in the UDR instance (NOTE 1)                                                              |
| externalGroupIdentifiersRanges                                                                                                                                                                                                                                                                                                                                                                                                | array(IdentityRange)     | O | 1..N        | List of ranges of external groups whose profile data is available in the UDR instance (NOTE 1)                                                    |
| supportedDataSets                                                                                                                                                                                                                                                                                                                                                                                                             | array(DataSetId)         | O | 1..N        | List of supported data sets in the UDR instance.<br>If not provided, the UDR supports all data sets.                                              |
| sharedDataIdRanges                                                                                                                                                                                                                                                                                                                                                                                                            | array(SharedDataIdRange) | O | 1..N        | List of ranges of Shared Data IDs that identify shared data available in the UDR instance (NOTE 1)                                                |
| NOTE 1: If none of these parameters are provided, the UDR can serve any external group and any SUPI or GPSI and any SharedData managed by the PLMN of the UDR instance. If "supiRanges", "gpsiRanges" and "externalGroupIdentifiersRanges" attributes are absent, and "groupId" is present, the SUPIs / GPSIs / ExternalGroups served by this UDR instance is determined by the NRF (see 3GPP TS 23.501 [2], clause 6.2.6.2). |                          |   |             |                                                                                                                                                   |

## 6.1.6.2.7 Type: UdmInfo

Table 6.1.6.2.7-1: Definition of type UdmInfo

| Attribute name                                                                                                                                                                                                                                                                                                                                                                                                                                                                                                                                                                                                                                                                                                                                                                                                                                                                                                 | Data type                   | P | Cardinality | Description                                                                                                                                                                                                                        |
|----------------------------------------------------------------------------------------------------------------------------------------------------------------------------------------------------------------------------------------------------------------------------------------------------------------------------------------------------------------------------------------------------------------------------------------------------------------------------------------------------------------------------------------------------------------------------------------------------------------------------------------------------------------------------------------------------------------------------------------------------------------------------------------------------------------------------------------------------------------------------------------------------------------|-----------------------------|---|-------------|------------------------------------------------------------------------------------------------------------------------------------------------------------------------------------------------------------------------------------|
| groupId                                                                                                                                                                                                                                                                                                                                                                                                                                                                                                                                                                                                                                                                                                                                                                                                                                                                                                        | NfGroupId                   | O | 0..1        | Identity of the UDM group that is served by the UDM instance.<br>If not provided, the UDM instance does not pertain to any UDM group.<br>(NOTE 1)                                                                                  |
| supiRanges                                                                                                                                                                                                                                                                                                                                                                                                                                                                                                                                                                                                                                                                                                                                                                                                                                                                                                     | array(SupiRange)            | O | 1..N        | List of ranges of SUPIs whose profile data is available in the UDM instance (NOTE 1)                                                                                                                                               |
| gpsiRanges                                                                                                                                                                                                                                                                                                                                                                                                                                                                                                                                                                                                                                                                                                                                                                                                                                                                                                     | array(IdentityRange)        | O | 1..N        | List of ranges of GPSIs whose profile data is available in the UDM instance (NOTE 1)                                                                                                                                               |
| externalGroupIdentifiers Ranges                                                                                                                                                                                                                                                                                                                                                                                                                                                                                                                                                                                                                                                                                                                                                                                                                                                                                | array(IdentityRange)        | O | 1..N        | List of ranges of external groups whose profile data is available in the UDM instance (NOTE 1)                                                                                                                                     |
| routingIndicators                                                                                                                                                                                                                                                                                                                                                                                                                                                                                                                                                                                                                                                                                                                                                                                                                                                                                              | array(string)               | O | 1..N        | List of Routing Indicator information that allows to route network signalling with SUCI (see 3GPP TS 23.003 [12]) to the UDM instance.<br>If not provided, the UDM can serve any Routing Indicator.<br>Pattern: '^[0-9]{1,4}\$'    |
| internalGroupIdentifiers Ranges                                                                                                                                                                                                                                                                                                                                                                                                                                                                                                                                                                                                                                                                                                                                                                                                                                                                                | array(InternalGroupIdRange) | O | 1..N        | List of ranges of Internal Group Identifiers whose profile data is available in the UDM instance.<br>If not provided, it does not imply that the UDM supports all internal groups.                                                 |
| sucInfos                                                                                                                                                                                                                                                                                                                                                                                                                                                                                                                                                                                                                                                                                                                                                                                                                                                                                                       | array(SucInfo)              | O | 1..N        | List of SucInfo. A SUCI that matches this information can be served by the UDM .<br>(NOTE 2, NOTE 3)<br>A SUCI that matches all attributes of at least one entry in this array shall be considered as a match of this information. |
| <p>NOTE 1: If none of these parameters are provided, the UDM can serve any external group and any SUPI or GPSI managed by the PLMN of the UDM instance. If "supiRanges", "gpsiRanges" and "externalGroupIdentifiersRanges" attributes are absent, and "groupId" is present, the SUPIs / GPSIs / ExternalGroups served by this UDM instance is determined by the NRF (see 3GPP TS 23.501 [2], clause 6.2.6.2).</p> <p>NOTE 2: The combination of SUCI informations, e.g. Routing Indicator and Home Network Public Key Id, may be used as criteria for UDM discovery. In this release, the usage of Home Network Public Key identifier for UDM discovery is limited to the scenario where the UDM NF consumers belong to the same PLMN as UDM.</p> <p>NOTE 3: If the sucInfos attribute is present and contains the routingIndns sub-attribute, then the routingIndicators attribute shall also be present.</p> |                             |   |             |                                                                                                                                                                                                                                    |



## 6.1.6.2.8 Type: AusfInfo

Table 6.1.6.2.8-1: Definition of type AusfInfo

| Attribute name                                                                                                                                                                                                                                                                                                               | Data type        | P | Cardinality | Description                                                                                                                                                                                                                       |
|------------------------------------------------------------------------------------------------------------------------------------------------------------------------------------------------------------------------------------------------------------------------------------------------------------------------------|------------------|---|-------------|-----------------------------------------------------------------------------------------------------------------------------------------------------------------------------------------------------------------------------------|
| groupId                                                                                                                                                                                                                                                                                                                      | NfGroupId        | O | 0..1        | Identity of the AUSF group.<br>If not provided, the AUSF instance does not pertain to any AUSF group.<br>(NOTE 1)                                                                                                                 |
| supiRanges                                                                                                                                                                                                                                                                                                                   | array(SupiRange) | O | 1..N        | List of ranges of SUPIs that can be served by the AUSF instance.<br>(NOTE 1)                                                                                                                                                      |
| routingIndicators                                                                                                                                                                                                                                                                                                            | array(string)    | O | 1..N        | List of Routing Indicator information that allows to route network signalling with SUCI (see 3GPP TS 23.003 [12]) to the AUSF instance.<br>If not provided, the AUSF can serve any Routing Indicator.<br>Pattern: '^[0-9]{1,4}\$' |
| sucInfos                                                                                                                                                                                                                                                                                                                     | array(SucInfo)   | O | 1..N        | List of SucInfo. A SUCI that matches this information can be served by the AUSF. (NOTE 2, NOTE 3)<br>A SUCI that matches all attributes of at least one entry in this array shall be considered as a match of this information.   |
| NOTE 1: If none of these parameters are provided, the AUSF can serve any SUPI managed by the PLMN of the AUSF instance. If "supiRanges" attribute is absent, and "groupId" is present, the SUPIs served by this AUSF instance is determined by the NRF (see 3GPP TS 23.501 [2], clause 6.2.6.2).                             |                  |   |             |                                                                                                                                                                                                                                   |
| NOTE 2: The combination of SUCI informations, e.g. Routing Indicator and Home Network Public Key Id, can be used as criteria for AUSF discovery. In this release, the usage of Home Network Public Key identifier for AUSF discovery is limited to the scenario where the AUSF NF consumers belong to the same PLMN as AUSF. |                  |   |             |                                                                                                                                                                                                                                   |
| NOTE 3: If the sucInfos attribute is present and contains the routingInds sub-attribute, then the routingIndicators attribute shall also be present.                                                                                                                                                                         |                  |   |             |                                                                                                                                                                                                                                   |

## 6.1.6.2.9 Type: SupiRange

Table 6.1.6.2.9-1: Definition of type SupiRange

| Attribute name                                                                         | Data type | P | Cardinality | Description                                                                                                                                                                                                                                  |
|----------------------------------------------------------------------------------------|-----------|---|-------------|----------------------------------------------------------------------------------------------------------------------------------------------------------------------------------------------------------------------------------------------|
| start                                                                                  | string    | O | 0..1        | First value identifying the start of a SUPI range, to be used when the range of SUPI's can be represented as a numeric range (e.g., IMSI ranges). This string shall consist only of digits.<br>Pattern: "^[0-9]+\$"                          |
| end                                                                                    | string    | O | 0..1        | Last value identifying the end of a SUPI range, to be used when the range of SUPI's can be represented as a numeric range (e.g. IMSI ranges). This string shall consist only of digits.<br>Pattern: "^[0-9]+\$"                              |
| pattern                                                                                | string    | O | 0..1        | Pattern (regular expression according to the ECMA-262 dialect [8]) representing the set of SUPI's belonging to this range. A SUPI value is considered part of the range if and only if the SUPI string fully matches the regular expression. |
| NOTE: Either the start and end attributes, or the pattern attribute, shall be present. |           |   |             |                                                                                                                                                                                                                                              |

EXAMPLE 1: IMSI range. From: 123 45 6789040000 To: 123 45 6789059999 (i.e., 20,000 IMSI numbers)  
JSON: { "start": "123456789040000", "end": "123456789059999" }

EXAMPLE 2: IMSI range. From: 123 45 6789040000 To: 123 45 6789049999 (i.e., 10,000 IMSI numbers)  
JSON: { "pattern": "^imsi-12345678904[0-9]{4}\$" }, or  
JSON: { "start": "123456789040000", "end": "123456789049999" }

EXAMPLE 3: NAI range. "smartmeter-{factoryID}@company.com" where "{factoryID}" can be any string.  
 JSON: { "pattern": "^nai-smartmeter-.+@company\\.com\$" }

### 6.1.6.2.10 Type: IdentityRange

**Table 6.1.6.2.10-1: Definition of type IdentityRange**

| Attribute name | Data type | P | Cardinality | Description                                                                                                                                                                                                                                               |
|----------------|-----------|---|-------------|-----------------------------------------------------------------------------------------------------------------------------------------------------------------------------------------------------------------------------------------------------------|
| start          | string    | O | 0..1        | First value identifying the start of an identity range, to be used when the range of identities can be represented as a numeric range (e.g., MSISDN ranges). This string shall consist only of digits. Pattern: "^{0-9}+\$"                               |
| end            | string    | O | 0..1        | Last value identifying the end of an identity range, to be used when the range of identities can be represented as a numeric range (e.g. MSISDN ranges). This string shall consist only of digits. Pattern: "^{0-9}+\$"                                   |
| pattern        | string    | O | 0..1        | Pattern (regular expression according to the ECMA-262 dialect [8]) representing the set of identities belonging to this range. An identity value is considered part of the range if and only if the identity string fully matches the regular expression. |

NOTE: Either the start and end attributes, or the pattern attribute, shall be present.

### 6.1.6.2.11 Type: AmfInfo

**Table 6.1.6.2.11-1: Definition of type AmfInfo**

| Attribute name          | Data type          | P | Cardinality | Description                                                                                                                                                                                                                                                                                                                                 |
|-------------------------|--------------------|---|-------------|---------------------------------------------------------------------------------------------------------------------------------------------------------------------------------------------------------------------------------------------------------------------------------------------------------------------------------------------|
| amfRegionId             | AmfRegionId        | M | 1           | AMF region identifier                                                                                                                                                                                                                                                                                                                       |
| amfSetId                | AmfSetId           | M | 1           | AMF set identifier.                                                                                                                                                                                                                                                                                                                         |
| guamiList               | array(Guami)       | M | 1..N        | List of supported GUAMIs                                                                                                                                                                                                                                                                                                                    |
| taiList                 | array(Tai)         | O | 1..N        | The list of TAIs the AMF can serve. It may contain one or more non-3GPP access TAIs. The absence of this attribute and the taiRangeList attribute indicate that the AMF can be selected for any TAI in the serving network.                                                                                                                 |
| taiRangeList            | array(TaiRange)    | O | 1..N        | The range of TAIs the AMF can serve. It may contain non-3GPP access TAIs. The absence of this attribute and the taiList attribute indicate that the AMF can be selected for any TAI in the serving network.                                                                                                                                 |
| backupInfoAmfFailure    | array(Guami)       | O | 1..N        | List of GUAMIs for which the AMF acts as a backup for AMF failure                                                                                                                                                                                                                                                                           |
| backupInfoAmfRemoval    | array(Guami)       | O | 1..N        | List of GUAMIs for which the AMF acts as a backup for planned AMF removal                                                                                                                                                                                                                                                                   |
| n2InterfaceAmfInfo      | N2InterfaceAmfInfo | O | 0..1        | N2 interface information of the AMF. This information needs not be sent in NF Discovery responses. It may be used by the NRF to update the DNS for AMF discovery by the 5G Access Network. The procedures for updating the DNS are out of scope of this specification.                                                                      |
| amfOnboardingCapability | boolean            | O | 0..1        | When present, this IE indicates the AMF supports SNPN Onboarding capability. This is used for the case of Onboarding of UEs for SNPNs (see 3GPP TS 23.501 [2], clause 5.30.2.10). <ul style="list-style-type: none"> <li>- false (default): AMF does not support SNPN Onboarding;</li> <li>- true: AMF supports SNPN Onboarding.</li> </ul> |

The "backupInfoAmfFailure" attribute and "backupInfoAmfRemoval" attribute indicates the GUAMIs for which the AMF can act as Backup, when the serving AMF has failed or under planned removal.

**EXAMPLE:**

When AMF-A, AMF-B and AMF-C registered their NF profiles for PLMN (e.g. MCC = 234, MNC = 15) as following:

AMF-A NF Profile:

```
{
  "amfInfo": {
    "guamiList": [{ "plmnId": { "mcc": "234", "mnc": "15" }, "amfId": "000001" }],
    "backupInfoAmfFailure": [{ "plmnId": { "mcc": "234", "mnc": "15" }, "amfId": "000003" } ]
  }
}
```

AMF-B NF Profile:

```
{
  "amfInfo": {
    "guamiList": [{ "plmnId": { "mcc": "234", "mnc": "15" }, "amfId": "000002" }],
    "backupInfoAmfRemoval": [{ "plmnId": { "mcc": "234", "mnc": "15" }, "amfId": "000003" } ]
  }
}
```

AMF-C NF Profile:

```
{
  "amfInfo": {
    "guamiList": [{ "plmnId": { "mcc": "234", "mnc": "15" }, "amfId": "000003" } ]
  }
}
```

When one NF consumer queries NRF with a GUAMI served by AMF-C (i.e. { "plmnId": { "mcc": "234", "mnc": "15" }, "amfId": "000003" }), then

- if the NRF detects the AMF-C has failed, e.g. using heartbeat, the NRF shall return AMF-A instance as backup AMF; or
- if the NRF detects AMF-C has entered planned removal, i.e. received a de-registration request from AMF-C, the NRF shall return AMF-B instance as backup AMF.

6.1.6.2.12 Type: SmfInfo

**Table 6.1.6.2.12-1: Definition of type SmfInfo**

| Attribute name    | Data type                | P | Cardinality | Description                                                                                                                                                                                                                                                                                                                                                                                                                                                                            |
|-------------------|--------------------------|---|-------------|----------------------------------------------------------------------------------------------------------------------------------------------------------------------------------------------------------------------------------------------------------------------------------------------------------------------------------------------------------------------------------------------------------------------------------------------------------------------------------------|
| sNssaiSmfInfoList | array(SnssaiSmfInfoItem) | M | 1..N        | List of parameters supported by the SMF per S-NSSAI (NOTE 1).                                                                                                                                                                                                                                                                                                                                                                                                                          |
| tailList          | array(Tai)               | O | 1..N        | The list of TAIs the SMF can serve. It may contain one or more non-3GPP access TAIs. The absence of this attribute and the taiRangeList attribute indicate that the SMF can be selected for any TAI in the serving network.                                                                                                                                                                                                                                                            |
| taiRangeList      | array(TaiRange)          | O | 1..N        | The range of TAIs the SMF can serve. It may contain non-3GPP access TAIs. The absence of this attribute and the tailList attribute indicate that the SMF can be selected for any TAI in the serving network.                                                                                                                                                                                                                                                                           |
| pgwFqdn           | Fqdn                     | O | 0..1        | The FQDN of the PGW if the SMF is a combined SMF/PGW-C.                                                                                                                                                                                                                                                                                                                                                                                                                                |
| pgwIpAddrList     | array(IpAddr)            | O | 1..N        | The PGW IP addresses of the combined SMF/PGW-C.<br><br>This IE allows the NF Service consumer to find the target combined SMF/PGW-C by PGW IP Address, e.g. when only PGW IP Address is available.                                                                                                                                                                                                                                                                                     |
| accessType        | array(AccessType)        | C | 1..2        | If included, this IE shall contain the access type (3GPP_ACCESS and/or NON_3GPP_ACCESS) supported by the SMF.<br>If not included, it shall be assumed the both access types are supported.                                                                                                                                                                                                                                                                                             |
| priority          | integer                  | O | 0..1        | Priority (relative to other NFs of the same type) in the range of 0-65535, to be used for NF selection for a service request matching the attributes of the SmfInfo; lower values indicate a higher priority.<br><br>The NRF may overwrite the received priority value when exposing an NFProfile with the Nnrf_NFDiscovery service.<br><br>Absence of this attribute equals to having the same smfInfo priority as the priority defined at NFProfile/NFService level.<br><br>(NOTE 2) |
| vsmfSupportInd    | boolean                  | O | 0..1        | This IE may be used by an SMF to explicitly indicate the support of V-SMF capability and its preference to be selected as V-SMF.<br><br>When present, this IE shall indicate whether the V-SMF capability are supported by the SMF:<br>- true: V-SMF capability supported by the SMF<br>- false: V-SMF capability not supported by the SMF.<br><br>Absence of this IE indicates the V-SMF capability support of the SMF is not specified.<br>(NOTE 3)                                  |
| ismfSupportInd    | boolean                  | O | 0..1        | This IE may be used by an SMF to explicitly indicate the support of I-SMF capability and its preference to be selected as I-SMF.<br><br>When present, this IE shall indicate whether the I-SMF capability are supported by the SMF:<br>- true: I-SMF capability supported by the SMF<br>- false: I-SMF capability not supported by the SMF.<br><br>Absence of this IE indicates the I-SMF capability support of the SMF is not specified.<br>(NOTE 3)                                  |
| pgwFqdnList       | array(Fqdn)              | O | 1..N        | When present, this attribute provides additional FQDNs to the FQDN indicated in the pgwFqdn attribute. The pgwFqdnList attribute may be present if the pgwFqdn attribute is present.                                                                                                                                                                                                                                                                                                   |

|                                                                                                                                                                                                                                                                                                                                                                                                                                                                                                                                                                                                                                                            |         |   |      |                                                                                                                                                                                                                                                                                                                                                                                                                    |
|------------------------------------------------------------------------------------------------------------------------------------------------------------------------------------------------------------------------------------------------------------------------------------------------------------------------------------------------------------------------------------------------------------------------------------------------------------------------------------------------------------------------------------------------------------------------------------------------------------------------------------------------------------|---------|---|------|--------------------------------------------------------------------------------------------------------------------------------------------------------------------------------------------------------------------------------------------------------------------------------------------------------------------------------------------------------------------------------------------------------------------|
| smfOnboardingCapability                                                                                                                                                                                                                                                                                                                                                                                                                                                                                                                                                                                                                                    | boolean | O | 0..1 | <p>When present, this IE indicates the SMF supports SNPN Onboarding capability and User Plane Remote Provisioning. This is used for the case of Onboarding of UEs for SNPNs (see 3GPP TS 23.501 [2], clauses 5.30.2.10 and 6.2.6.2).</p> <ul style="list-style-type: none"> <li>- false (default): SMF does not support SNPN Onboarding;</li> <li>- true: SMF supports SNPN Onboarding.</li> </ul> <p>(NOTE 4)</p> |
| smfUPRPCapability                                                                                                                                                                                                                                                                                                                                                                                                                                                                                                                                                                                                                                          | boolean | O | 0..1 | <p>When present, this IE indicates the SMF supports User Plane Remote Provisioning (UPRP) capability. This is used for the case of Onboarding of UEs for SNPNs (see 3GPP TS 23.501 [2], clauses 5.30.2.10 and 6.2.6.2).</p> <ul style="list-style-type: none"> <li>- false (default): SMF does not support UPRP;</li> <li>- true: SMF supports UPRP.</li> </ul>                                                    |
| <p>NOTE 1: If this S-NSSAIs is present in the SmfInfo and in the NFprofile, the S-NSSAIs from the SmfInfo shall prevail.</p> <p>NOTE 2: An SMF profile may e.g. contain multiple SmfInfo entries, with each entry containing a different list of TAIs and a different priority, to differentiate the priority to select the SMF based on the user location. The priority in SmfInfo applies between SMFs or SMF Services with the same priority.</p> <p>NOTE 3: The IE should only be registered when the SMF is configured to be preferably selected as V-SMF/I-SMF.</p> <p>NOTE 4: The IE is deprecated and replaced by smfUPRPCapability attribute.</p> |         |   |      |                                                                                                                                                                                                                                                                                                                                                                                                                    |

6.1.6.2.13 Type: UpfInfo

**Table 6.1.6.2.13-1: Definition of type UpfInfo**

| Attribute name        | Data type                    | P | Cardinality | Description                                                                                                                                                                                                                                                                                                                                                                                                                                                                 |
|-----------------------|------------------------------|---|-------------|-----------------------------------------------------------------------------------------------------------------------------------------------------------------------------------------------------------------------------------------------------------------------------------------------------------------------------------------------------------------------------------------------------------------------------------------------------------------------------|
| sNssaiUpflInfoList    | array(SnssaiUpflInfoItem)    | M | 1..N        | List of parameters supported by the UPF per S-NSSAI (NOTE 1)                                                                                                                                                                                                                                                                                                                                                                                                                |
| smfServingArea        | array(string)                | O | 1..N        | The SMF service area(s) the UPF can serve. If not provided, the UPF can serve any SMF service area.                                                                                                                                                                                                                                                                                                                                                                         |
| interfaceUpflInfoList | array(InterfaceUpflInfoItem) | O | 1..N        | List of User Plane interfaces configured on the UPF. When this IE is provided in the NF Discovery response, the NF Service Consumer (e.g. SMF) may use this information for UPF selection.                                                                                                                                                                                                                                                                                  |
| iwkEpsInd             | boolean                      | O | 0..1        | Indicates whether interworking with EPS is supported by the UPF.<br>true: Supported<br>false (default): Not Supported                                                                                                                                                                                                                                                                                                                                                       |
| pduSessionTypes       | array(PduSessionType)        | O | 1..N        | List of PDU session type(s) supported by the UPF. The absence of this attribute indicates that the UPF can be selected for any PDU session type.                                                                                                                                                                                                                                                                                                                            |
| atsssCapability       | AtsssCapability              | C | 0..1        | If present, this IE shall indicate the ATSSS capability of the UPF.<br>If not present, the UPF shall be regarded with no ATSSS capability.                                                                                                                                                                                                                                                                                                                                  |
| uelpAddrInd           | boolean                      | O | 0..1        | Indicates whether the UPF supports allocating UE IP addresses/prefixes.<br>true: supported<br>false (default): not supported                                                                                                                                                                                                                                                                                                                                                |
| taiList               | array(Tai)                   | O | 1..N        | The list of TAIs the UPF can serve. It may contain one or more non-3GPP access TAIs.<br>The absence of this attribute and the taiRangeList attribute indicates that the UPF can serve the whole SMF service area defined by the smfServingArea attribute.                                                                                                                                                                                                                   |
| taiRangeList          | array(TaiRange)              | O | 1..N        | The range of TAIs the UPF can serve. It may contain non-3GPP access TAIs. The absence of this attribute and the taiList attribute indicates that the UPF can serve the whole SMF service area defined by the smfServingArea attribute.<br>(NOTE 6)                                                                                                                                                                                                                          |
| wAgfInfo              | WAgfInfo                     | C | 0..1        | If present, this IE shall indicate that the UPF is collocated with W-AGF.<br>If not present, the UPF is not collocated with W-AGF.                                                                                                                                                                                                                                                                                                                                          |
| tngfInfo              | TngfInfo                     | C | 0..1        | If present, this IE shall indicate that the UPF is collocated with TNGF.<br>If not present, the UPF is not collocated with TNGF.                                                                                                                                                                                                                                                                                                                                            |
| twifInfo              | TwifInfo                     | C | 0..1        | If present, this IE shall indicate that the UPF is collocated with TWIF.<br>If not present, the UPF is not collocated with TWIF.                                                                                                                                                                                                                                                                                                                                            |
| priority              | integer                      | O | 0..1        | Priority (relative to other NFs of the same type) in the range of 0-65535, to be used for NF selection for a service request matching the attributes of the UpflInfo; lower values indicate a higher priority. See the precedence rules in the description of the priority attribute in NFProfile, if Priority is also present in NFProfile.<br>The NRF may overwrite the received priority value when exposing an NFProfile with the Nnrf_NFDiscovery service.<br>(NOTE 2) |
| redundantGtpu         | boolean                      | O | 0..1        | Indicates whether the UPF supports redundant GTP-U path.<br>true: supported<br>false (default): not supported                                                                                                                                                                                                                                                                                                                                                               |
| ipups                 | boolean                      | O | 0..1        | Indicates whether the UPF is configured for IPUPS.<br>(NOTE 3)<br><br>true: the UPF is configured for IPUPS.<br>false (default): the UPF is not configured for IPUPS.                                                                                                                                                                                                                                                                                                       |



|                                                                                                                                                                                                                                                                                                                                                                                                                                                                                                                                                                                                                                                                                                                                                                                                                                                                                                                                                                                                                                                                                                                                                                                                                                                                                                                                                                                                                                                                                                                                                                                                                                                                                                                                                        |         |   |      |                                                                                                                                                                                                                                                                                                                                                                                                                                                                                                                                                                                                                                                                                                           |
|--------------------------------------------------------------------------------------------------------------------------------------------------------------------------------------------------------------------------------------------------------------------------------------------------------------------------------------------------------------------------------------------------------------------------------------------------------------------------------------------------------------------------------------------------------------------------------------------------------------------------------------------------------------------------------------------------------------------------------------------------------------------------------------------------------------------------------------------------------------------------------------------------------------------------------------------------------------------------------------------------------------------------------------------------------------------------------------------------------------------------------------------------------------------------------------------------------------------------------------------------------------------------------------------------------------------------------------------------------------------------------------------------------------------------------------------------------------------------------------------------------------------------------------------------------------------------------------------------------------------------------------------------------------------------------------------------------------------------------------------------------|---------|---|------|-----------------------------------------------------------------------------------------------------------------------------------------------------------------------------------------------------------------------------------------------------------------------------------------------------------------------------------------------------------------------------------------------------------------------------------------------------------------------------------------------------------------------------------------------------------------------------------------------------------------------------------------------------------------------------------------------------------|
| dataForwarding                                                                                                                                                                                                                                                                                                                                                                                                                                                                                                                                                                                                                                                                                                                                                                                                                                                                                                                                                                                                                                                                                                                                                                                                                                                                                                                                                                                                                                                                                                                                                                                                                                                                                                                                         | boolean | O | 0..1 | <p>Indicates whether the UPF is configured for data forwarding. (NOTE 4)</p> <p>When present, this IE shall be set as following:<br/>                     - true: the UPF is configured for data forwarding<br/>                     - false (default): the UPF is not configured for data forwarding</p> <p>If the UPF is configured for data forwarding, it shall support UP network interface with type "DATA_FORWARDING".</p>                                                                                                                                                                                                                                                                         |
| supportedPfcFeatures                                                                                                                                                                                                                                                                                                                                                                                                                                                                                                                                                                                                                                                                                                                                                                                                                                                                                                                                                                                                                                                                                                                                                                                                                                                                                                                                                                                                                                                                                                                                                                                                                                                                                                                                   | string  | O | 0..1 | <p>Supported PFCP Features.</p> <p>A string used to indicate the PFCP features supported by the UPF, which encodes the "UP Function Features" IE as specified in Table 8.2.25-1 of 3GPP TS 29.244 [21] (starting from Octet 5), in hexadecimal representation.</p> <p>Each character in the string shall take a value of "0" to "9", "a" to "f" or "A" to "F" and each two characters shall represent one octet of "UP Function Features" IE (starting from Octet 5, to higher octets). For each two characters representing one octet, the first character representing the 4 most significant bits of the octet and the second character the 4 least significant bits of the octet.</p> <p>(NOTE 5)</p> |
| <p>NOTE 1: If this S-NSSAI is present in the UpfInfo and in the NFprofile, the S-NSSAI from the UpfInfo shall prevail.</p> <p>NOTE 2: An UPF profile may e.g. contain multiple UpfInfo entries, with each entry containing a different list of TAIs and a different priority, to differentiate the priority to select the UPF based on the user location. The priority in UpfInfo has the least precedence, i.e. it applies between UPFs with the same priority.</p> <p>NOTE 3: Any UPF can support the IPUPS functionality. In network deployments where specific UPFs are used to provide IPUPS, UPFs configured for providing IPUPS services shall be selected to provide IPUPS.</p> <p>NOTE 4: Based on operator policies, if dedicated UPFs are preferred to be used for indirect data forwarding during handover scenarios, when setting up the indirect data forwarding tunnel, the SMF should preferably select a UPF configured for data forwarding and use the network instance indicated in the Network Instance ID associated to the DATA_FORWARDING interface type in the interfaceUpfInfoList attribute.</p> <p>NOTE 5: The supportedPfcFeatures shall be provisioned in addition and be consistent with the existing UPF features (atsssCapability, uelpAddrInd, redundantGtpu and ipups) in the upfInfo, e.g. if the uelpAddrInd is set to "true", then the UEIP flag shall also be set to "1" in the supportedPfcFeatures.</p> <p>NOTE 6: This attribute should only be used by the UPF if, based on specific operator's deployment, the NRF and the SMFs intended to interwork with this UPF, have been upgraded to support this feature (i.e. to understand the definition of TAIs in the UPF profile based on ranges of TAIs).</p> |         |   |      |                                                                                                                                                                                                                                                                                                                                                                                                                                                                                                                                                                                                                                                                                                           |

6.1.6.2.14 Type: SnsaiUpfInfoItem

Table 6.1.6.2.14-1: Definition of type SnsaiUpfInfoItem

| Attribute name                                                                                                                                                                        | Data type             | P | Cardinality | Description                                                                                                                                                                             |
|---------------------------------------------------------------------------------------------------------------------------------------------------------------------------------------|-----------------------|---|-------------|-----------------------------------------------------------------------------------------------------------------------------------------------------------------------------------------|
| sNssai                                                                                                                                                                                | ExtSnsai              | M | 1           | Supported S-NSSAI (NOTE)                                                                                                                                                                |
| dnnUpfInfoList                                                                                                                                                                        | array(DnnUpfInfoItem) | M | 1..N        | List of parameters supported by the UPF per DNN                                                                                                                                         |
| redundantTransport                                                                                                                                                                    | boolean               | O | 0..1        | <p>Indicates whether the UPF supports redundant transport path on the transport layer in the corresponding network slice.</p> <p>true: supported<br/>false (default): not supported</p> |
| <p>NOTE: A UPF may register SD ranges or a wildcard SD if the NRF and all consumers of the UPF profile have been upgraded to support SD ranges and wildcard SD in this attribute.</p> |                       |   |             |                                                                                                                                                                                         |

## 6.1.6.2.15 Type: DnnUpflInfoItem

Table 6.1.6.2.15-1: Definition of type DnnUpflInfoItem

| Attribute name                                                                                                                                                                                                  | Data type               | P | Cardinality | Description                                                                                                                                                                                                                                             |
|-----------------------------------------------------------------------------------------------------------------------------------------------------------------------------------------------------------------|-------------------------|---|-------------|---------------------------------------------------------------------------------------------------------------------------------------------------------------------------------------------------------------------------------------------------------|
| dnn                                                                                                                                                                                                             | Dnn                     | M | 1           | Supported DNN. The DNN shall contain the Network Identifier and it may additionally contain an Operator Identifier. If the Operator Identifier is not included, the DNN is supported for all the PLMNs in the plmnList of the NF Profile.               |
| dnaiList                                                                                                                                                                                                        | array(Dnai)             | O | 1..N        | List of Data network access identifiers supported by the UPF for this DNN. The absence of this attribute indicates that the UPF can be selected for this DNN for any DNAI.                                                                              |
| pduSessionTypes                                                                                                                                                                                                 | array(PduSessionType)   | O | 1..N        | List of PDU session type(s) supported by the UPF for a specific DNN. The absence of this attribute indicates that the UPF can be selected for this DNN for any PDU session type supported by the UPF (see clause 6.1.6.2.13).                           |
| ipv4AddressRanges                                                                                                                                                                                               | array(Ipv4AddressRange) | O | 1..N        | List of ranges of IPv4 addresses handled by UPF. (NOTE 1)                                                                                                                                                                                               |
| ipv6PrefixRanges                                                                                                                                                                                                | array(Ipv6PrefixRange)  | O | 1..N        | List of ranges of IPv6 prefixes handled by the UPF. (NOTE 1)                                                                                                                                                                                            |
| ipv4IndexList                                                                                                                                                                                                   | array(IpIndex)          | O | 1..N        | List of Ipv4 Index supported by the UPF. (NOTE 3)                                                                                                                                                                                                       |
| ipv6IndexList                                                                                                                                                                                                   | array(IpIndex)          | O | 1..N        | List of Ipv6 Index supported by the UPF. (NOTE 3)                                                                                                                                                                                                       |
| dnaiNwInstanceList                                                                                                                                                                                              | map(string)             | O | 1..N        | Map of a network instance per DNAI for the DNN, where the key of the map is the DNAI.<br><br>When present, the value of each entry of the map shall contain a N6 network instance that is configured for the DNAI indicated by the key.<br><br>(NOTE 2) |
| NOTE 1: The list of ranges of IPv4/v6 address may be used by the SMF to select a UPF which supports a UE static IP address received in user subscription.                                                       |                         |   |             |                                                                                                                                                                                                                                                         |
| NOTE 2: This IE may be used by the SMF to determine the Network Instance associated to a given S-NSSAI, DNN and DNAI. If this IE is not present, the SMF needs to be configured with corresponding information. |                         |   |             |                                                                                                                                                                                                                                                         |
| NOTE 3: The list of IPv4/v6 Indexes may be used by the SMF to select a UPF which supports a specific IP Index received from UDM or Radius server to allocate an IP address for a UE's PDU session.              |                         |   |             |                                                                                                                                                                                                                                                         |

6.1.6.2.16 Type: SubscriptionData

**Table 6.1.6.2.16-1: Definition of type SubscriptionData**

| Attribute name          | Data type                     | P | Cardinality | Description                                                                                                                                                                                                                                                                                                                                                                                                                                                                                                                                                                                                                                                                                                                                                 |
|-------------------------|-------------------------------|---|-------------|-------------------------------------------------------------------------------------------------------------------------------------------------------------------------------------------------------------------------------------------------------------------------------------------------------------------------------------------------------------------------------------------------------------------------------------------------------------------------------------------------------------------------------------------------------------------------------------------------------------------------------------------------------------------------------------------------------------------------------------------------------------|
| nfStatusNotificationUri | Uri                           | M | 1           | Callback URI where the NF Service Consumer will receive the notifications from NRF.                                                                                                                                                                                                                                                                                                                                                                                                                                                                                                                                                                                                                                                                         |
| reqNfInstanceId         | NfInstanceId                  | O | 0..1        | If present, this IE shall contain the NF instance id of the NF service consumer.                                                                                                                                                                                                                                                                                                                                                                                                                                                                                                                                                                                                                                                                            |
| subscrCond              | SubscrCond                    | O | 0..1        | If present, this attributed shall contain the conditions identifying the set of NF Instances whose status is requested to be monitored. If this attribute is not present, it means that the NF Service Consumer requests a subscription to all NFs in the NRF (NOTE 1).                                                                                                                                                                                                                                                                                                                                                                                                                                                                                     |
| subscriptionId          | string                        | C | 0..1        | Subscription ID for the newly created resource. This parameter shall be absent in the request to the NRF and shall be included by NRF in the response to the subscription creation request.<br>Read-Only: true<br>Pattern: " <code>^[0-9]{5,6}-?[^-]+\$</code> "                                                                                                                                                                                                                                                                                                                                                                                                                                                                                            |
| validityTime            | DateTime                      | C | 0..1        | Time instant after which the subscription becomes invalid. This parameter may be sent by the client, as a hint to the server, but it shall be always sent back by the server (regardless of the presence of the attribute in the request) in the response to the subscription creation request.                                                                                                                                                                                                                                                                                                                                                                                                                                                             |
| reqNotifEvents          | array(Notification EventType) | O | 1..N        | If present, this attribute shall contain the list of event types that the NF Service Consumer is interested in receiving.<br><br>If this attribute is not present, it means that notifications for all event types are requested.                                                                                                                                                                                                                                                                                                                                                                                                                                                                                                                           |
| reqNfType               | NFType                        | C | 0..1        | An NF Service Consumer complying with this version of the specification shall include this IE. If included, this IE shall contain the NF type of the NF Service Consumer that is requesting the creation of the subscription. The NRF shall use it for authorizing the request, in the same way as the "requester-nf-type" is used in the NF Discovery service (see Table 6.2.3.2.3.1-1).<br><br>When the subscription is for a set of NF Instances, the subscription may be accepted by NRF, but it shall only generate notifications from NF Instances whose authorization parameters allow the NF Service Consumer to access their services (NOTE 2).                                                                                                    |
| reqNfFqdn               | Fqdn                          | O | 0..1        | This IE may be present for a subscription request within the same PLMN as the NRF. If included, this IE shall contain the FQDN of the NF Service Consumer that is requesting the creation of the subscription. The NRF shall use it for authorizing the request, in the same way as the "requester-nf-instance-fqdn" is used in the NF Discovery service (see Table 6.2.3.2.3.1-1). This IE shall be ignored by the NRF if it is received from a requester NF belonging to a different PLMN.<br><br>When the subscription is for a set of NF Instances, the subscription may be accepted by NRF, but it shall only generate notifications from NF Instances whose authorization parameters allow the NF Service Consumer to access their services (NOTE 2). |

|                      |                   |   |      |                                                                                                                                                                                                                                                                                                                                                                                                                                                                                                                                                                                                                                                                                                                                                                              |
|----------------------|-------------------|---|------|------------------------------------------------------------------------------------------------------------------------------------------------------------------------------------------------------------------------------------------------------------------------------------------------------------------------------------------------------------------------------------------------------------------------------------------------------------------------------------------------------------------------------------------------------------------------------------------------------------------------------------------------------------------------------------------------------------------------------------------------------------------------------|
| reqSnssais           | array(ExtSnssai)  | O | 0..1 | <p>If included, this IE shall contain the list of S-NSSAIs of the NF Service Consumer that is requesting the creation of the subscription. If this IE is included in a subscription request in a different PLMN, the requester NF shall provide S-NSSAI values of the target PLMN, that correspond to the S-NSSAI values of the requester NF. The NRF shall use it for authorizing the request, in the same way as the "requester-snssais" is used in the NF Discovery service (see Table 6.2.3.2.3.1-1).</p> <p>When the subscription is for a set of NF Instances, the subscription may be accepted by NRF, but it shall only generate notifications from NF Instances whose authorization parameters allow the NF Service Consumer to access their services (NOTE 2).</p> |
| reqPerPlmnSnssais    | array(PlmnSnssai) | O | 1..N | <p>If included, this IE shall indicate the list of S-NSSAIs supported by the NF Service Consumer in each of the PLMNs it supports. The NRF shall use it for authorizing the request, in the same way as the "per-plmn-requester-snssais" is used in the NF Discovery service (see Table 6.2.3.2.3.1-1).</p> <p>When the subscription is for a set of NF Instances, the subscription may be accepted by NRF, but it shall only generate notifications from NF Instances whose authorization parameters allow the NF Service Consumer to access their services (NOTE 2).</p>                                                                                                                                                                                                   |
| plmnId               | PlmnId            | O | 0..1 | <p>If present, this attribute contains the target PLMN ID of the NF Instance(s) whose status is requested to be monitored.<br/>(NOTE 7)</p>                                                                                                                                                                                                                                                                                                                                                                                                                                                                                                                                                                                                                                  |
| nid                  | Nid               | O | 0..1 | <p>If present, this attribute contains the target NID that, together with the plmnId attribute, identifies the SNPN of the NF Instance(s) whose status is requested to be monitored.</p>                                                                                                                                                                                                                                                                                                                                                                                                                                                                                                                                                                                     |
| onboardingCapability | boolean           | O | 0..1 | <p>If present, this attribute indicates the NF Instance(s) whose status is requested to be monitored support SNPN Onboarding capability.</p>                                                                                                                                                                                                                                                                                                                                                                                                                                                                                                                                                                                                                                 |
| notifCondition       | NotifCondition    | O | 0..1 | <p>If present, this attribute contains the conditions that trigger a notification from NRF; this attribute shall only be present if the NF Service Consumer has subscribed to changes on the NF Profile (i.e., reqNotifEvents contains the value "NF_PROFILE_CHANGED", or reqNotifEvents attribute is absent) (NOTE 3).</p> <p>If this attribute is absent, it means that the NF Service Consumer does not indicate any restriction, or condition, on which attributes of the NF Profile shall trigger a notification from NRF.<br/>(NOTE 5).</p>                                                                                                                                                                                                                            |
| reqPlmnList          | array(PlmnId)     | C | 1..N | <p>This IE shall be included when subscribing to NF services in a different PLMN. When included, this IE shall contain the PLMN ID(s) of the requester NF.<br/>(NOTE 2)</p>                                                                                                                                                                                                                                                                                                                                                                                                                                                                                                                                                                                                  |

|                      |                   |   |      |                                                                                                                                                                                                                                                                                                                                                                                                                                                                                       |
|----------------------|-------------------|---|------|---------------------------------------------------------------------------------------------------------------------------------------------------------------------------------------------------------------------------------------------------------------------------------------------------------------------------------------------------------------------------------------------------------------------------------------------------------------------------------------|
| reqSnpnList          | array(PlmnIdNid)  | C | 1..N | <p>This IE shall be included when the subscribing NF belongs to one or several SNPNs and it subscribes to NF services of a specific SNPN. When included, this IE shall contain the SNPN ID(s) of the requester NF.</p> <p>When the subscription is for a set of NF Instances, the subscription may be accepted by NRF, but it shall only generate notifications from NF Instances whose authorization parameters allow the NF Service Consumer to access their services. (NOTE 2)</p> |
| servingScope         | array(string)     | O | 1..N | <p>If present, this attribute indicates the target served area(s) of the NF instance(s) whose status is required to be monitored. (NOTE 4)</p>                                                                                                                                                                                                                                                                                                                                        |
| requesterFeatures    | SupportedFeatures | C | 0..1 | <p>Nnrf_NFManagement features supported by the NF Service Consumer that is invoking the Nnrf_NFManagement service. See clause 6.1.9.</p> <p>This IE shall be included if at least one feature is supported by the NF Service Consumer.</p> <p>Write-Only: true</p> <p>(NOTE 6)</p>                                                                                                                                                                                                    |
| nrfSupportedFeatures | SupportedFeatures | C | 0..1 | <p>Features supported by the NRF in the Nnrf_NFManagement service. See clause 6.1.9.</p> <p>This IE shall be included if at least one feature is supported by the NRF.</p> <p>Read-Only: true</p>                                                                                                                                                                                                                                                                                     |
| hnrfUri              | Uri               | C | 0..1 | <p>If included, this IE shall contain the API URI of the NFManagement Service (see clause 6.1.1) of the home NRF.</p> <p>It shall be included if the NF Service Consumer has previously received such API URI from the NSSF in the home PLMN (see clause 6.1.6.2.11 of 3GPP TS 29.531 [42]).</p>                                                                                                                                                                                      |
| targetHni            | Fqdn              | O | 0..1 | <p>If present, this attribute shall contain the identification of the Default Credentials Server or the identification of the Credentials Holder.</p>                                                                                                                                                                                                                                                                                                                                 |
| preferredLocality    | string            | O | 0..1 | <p>Preferred target NF location (e.g. geographic location, data center).</p> <p>When present, the NRF should set a priority for the monitored NF instance in the notification as specified in the description of the preferred-locality in Table 6.2.3.2.3.1-1.</p>                                                                                                                                                                                                                   |

- NOTE 1: The "subscription to all NFs" may be quite demanding in terms of resources in NRF and also in terms of network traffic of the resulting notifications, so it should be authorized by NRF under very strict policies (e.g. only to a specific requesting NF, as indicated by reqNfType and reqNfQdn attributes).
- NOTE 2: The authorization parameters in NF Profile are those used by NRF to determine whether a given NF Instance / NF Service Instance can be discovered by an NF Service Consumer in order to consume its offered services (e.g. "allowedNfTypes", "allowedNfDomains", etc.). Based on operator's policies, a subscription request not including the requester's information necessary to validate the authorization parameters in NF Profiles may be rejected or may be accepted but with only generating notifications from NF Instances whose authorization parameters allow any NF Service Consumer to access their services.
- NOTE 3: The subscription to load changes may be quite demanding in terms of network traffic of the resulting notifications, thus it may be limited by the NRF via appropriate configuration (e.g. granularity threshold)
- NOTE 4: An NF instance may explicitly indicate the served areas in the NF profile when registered to NRF. When this IE is present, the NRF shall only monitor the NF instance(s) indicating at least one of the served areas in the list. If an NF instance has not indicated any served area in its NF profile, it shall not be monitored.
- NOTE 5: If the attributes to be monitored or excluded from monitoring, included as part of the "notifCondition" attribute, refer to a specific element of an array (e.g. they refer to a specific array index of the "nfServices" attribute of the NFProfile), the NRF shall apply the same condition to all elements of the same array.
- NOTE 6: If the NF Service Consumer that issued the subscription request indicated support for the "Service-Map" feature, the NRF shall send notifications of profile changes (see clause 6.1.6.2.17) affecting the list of NF Service Instances, as modifications of specific attributes of the "nfServiceList" map. Otherwise, the NRF shall send those notifications as a complete replacement of the "nfServices" array attribute.
- NOTE 7: The PLMN ID should be used by the NRF as an additional subscription condition to monitor the change of target NF profile, unless the subscription is specific to one or a list of NF(s) explicitly indicated by their NF Instance ID(s), e.g. using the NfInstanceIdCond or NfInstanceIdListCond, in which case the NRF shall not use the PLMN ID provided in the subscription (if any) as an additional subscription condition to monitor the change of target NF profile.

## 6.1.6.2.17 Type: NotificationData

Table 6.1.6.2.17-1: Definition of type NotificationData

| Attribute name                                                                                                                                                                                                                                                                                                                                                                                                                                                                                                                                                                                                                                                                                                                                                                                                                                                                                                                                                                                                                                        | Data type             | P | Cardinality | Description                                                                                                                                                                                                                                                                                                                                                                                                                          |
|-------------------------------------------------------------------------------------------------------------------------------------------------------------------------------------------------------------------------------------------------------------------------------------------------------------------------------------------------------------------------------------------------------------------------------------------------------------------------------------------------------------------------------------------------------------------------------------------------------------------------------------------------------------------------------------------------------------------------------------------------------------------------------------------------------------------------------------------------------------------------------------------------------------------------------------------------------------------------------------------------------------------------------------------------------|-----------------------|---|-------------|--------------------------------------------------------------------------------------------------------------------------------------------------------------------------------------------------------------------------------------------------------------------------------------------------------------------------------------------------------------------------------------------------------------------------------------|
| event                                                                                                                                                                                                                                                                                                                                                                                                                                                                                                                                                                                                                                                                                                                                                                                                                                                                                                                                                                                                                                                 | NotificationEventType | M | 1           | Notification type. It shall take the values "NF_REGISTERED", "NF_DEREGISTERED" or "NF_PROFILE_CHANGED".                                                                                                                                                                                                                                                                                                                              |
| nfInstanceUri                                                                                                                                                                                                                                                                                                                                                                                                                                                                                                                                                                                                                                                                                                                                                                                                                                                                                                                                                                                                                                         | Uri                   | M | 1           | Uri of the NF Instance (see clause 6.1.3.3.2) associated to the notification event.                                                                                                                                                                                                                                                                                                                                                  |
| nfProfile                                                                                                                                                                                                                                                                                                                                                                                                                                                                                                                                                                                                                                                                                                                                                                                                                                                                                                                                                                                                                                             | NFProfile             | C | 0..1        | New NF Profile or Updated NF Profile; it shall be present when the notification type is "NF_REGISTERED" and it may be present when the notification type is "NF_PROFILE_CHANGED".<br>(NOTE 3)                                                                                                                                                                                                                                        |
| profileChanges                                                                                                                                                                                                                                                                                                                                                                                                                                                                                                                                                                                                                                                                                                                                                                                                                                                                                                                                                                                                                                        | array(Changeltem)     | C | 1..N        | List of changes on the profile of the NF Instance associated to the notification event; it may be present when the notification type is "NF_PROFILE_CHANGED" (see NOTE 1, NOTE 2).                                                                                                                                                                                                                                                   |
| conditionEvent                                                                                                                                                                                                                                                                                                                                                                                                                                                                                                                                                                                                                                                                                                                                                                                                                                                                                                                                                                                                                                        | ConditionEventType    | C | 0..1        | Type of event indicating whether a change of NF Profile results in that the NF Instance starts or stops being part of a given set of NF Instances, as indicated in the subscription condition (see attribute "subscrCond" in clause 6.1.6.2.16).<br><br>It can take the value "NF_ADDED" (if the NF Instance starts being part of a given set) or "NF_REMOVED" (if the NF Instance stops being part of a given set).<br><br>(NOTE 3) |
| subscriptionContext                                                                                                                                                                                                                                                                                                                                                                                                                                                                                                                                                                                                                                                                                                                                                                                                                                                                                                                                                                                                                                   | SubscriptionContext   | C | 0..1        | It shall contain data related to the subscription to which this notification belongs to, such as the subscription ID and the subscription conditions.<br><br>An NRF complying with this release of the specification shall include this attribute, to facilitate to the subscribing entity the identification of the subscription data, or context, that triggered this notification.                                                |
| <p>NOTE 1: If "event" attribute takes the value "NF_PROFILE_CHANGED", then either "nfProfile" or "profileChanges" attributes shall be present, but not both.</p> <p>NOTE 2: The NRF shall notify about NF Profile changes affecting attributes of type "array" only as a complete replacement of the whole array (i.e. it shall not notify about changes of individual array elements).</p> <p>NOTE 3: When a change in an NF Profile results in an NF to start being part of a given set, the NRF shall indicate such condition by including the "conditionEvent" attribute with value "NF_ADDED", and it shall include in the notification the "nfProfile" attribute with the full NF Profile of the NF Instance; the "profileChanges" attribute shall not be included.<br/>When a change in an NF Profile results in an NF to stop being part of a given set, the NRF shall indicate such condition by including the "conditionEvent" attribute with value "NF_REMOVED", and both attributes "nfProfile" and "profileChanges" shall be absent.</p> |                       |   |             |                                                                                                                                                                                                                                                                                                                                                                                                                                      |

**EXAMPLE:** Notification payload sent from NRF when an NF Instance has changed its profile by updating the value of the "recoveryTime" attribute of its NF Profile, and updated any attribute of any of its NF Service Instances:

```
{
  "event": "NF_PROFILE_CHANGED",
  "nfInstanceUri": ".../nf-instances/4947a69a-f61b-4bc1-b9da-47c9c5d14b64",
  "profileChanges": [
    {
      "op": "REPLACE",
      "path": "/recoveryTime",
      "newValue": "2018-12-30T23:20:50Z"
    }
  ],
}
```



```

    "op": "REPLACE",
    "path": "/nfServices",
    "newValue": [ ...new array content... ]
  }
]
}

```

6.1.6.2.18 Void

6.1.6.2.19 Type: NFServiceVersion

**Table 6.1.6.2.19-1: Definition of type NFServiceVersion**

| Attribute name  | Data type | P | Cardinality | Description                                                                                                                               |
|-----------------|-----------|---|-------------|-------------------------------------------------------------------------------------------------------------------------------------------|
| apiVersionInUri | string    | M | 1           | Version of the service instance to be used in the URI for accessing the API (e.g. "v1").                                                  |
| apiFullVersion  | string    | M | 1           | Full version number of the API as specified in clause 4.3.1 of 3GPP TS 29.501 [5].                                                        |
| expiry          | DateTime  | O | 0..1        | Expiry date and time of the NF service. This represents the planned retirement date as specified in clause 4.3.1.5 of 3GPP TS 29.501 [5]. |

## 6.1.6.2.20 Type: PcflInfo

Table 6.1.6.2.20-1: Definition of type PcflInfo

| Attribute name                                                                                                                                                                                                                                                                                                                 | Data type            | P | Cardinality | Description                                                                                                                                                                                                                                                                                          |
|--------------------------------------------------------------------------------------------------------------------------------------------------------------------------------------------------------------------------------------------------------------------------------------------------------------------------------|----------------------|---|-------------|------------------------------------------------------------------------------------------------------------------------------------------------------------------------------------------------------------------------------------------------------------------------------------------------------|
| groupId                                                                                                                                                                                                                                                                                                                        | NfGroupId            | O | 0..1        | Identity of the PCF group that is served by the PCF instance.<br>If not provided, the PCF instance does not pertain to any PCF group.<br>(NOTE)                                                                                                                                                      |
| dnnList                                                                                                                                                                                                                                                                                                                        | array(Dnn)           | O | 1..N        | DNNs supported by the PCF. The DNN shall contain the Network Identifier and it may additionally contain an Operator Identifier. If the Operator Identifier is not included, the DNN is supported for all the PLMNs in the plmnList of the NF Profile.<br>If not provided, the PCF can serve any DNN. |
| supiRanges                                                                                                                                                                                                                                                                                                                     | array(SupiRange)     | O | 1..N        | List of ranges of SUPIs that can be served by the PCF instance.<br>(NOTE)                                                                                                                                                                                                                            |
| gpsiRanges                                                                                                                                                                                                                                                                                                                     | array(IdentityRange) | O | 1..N        | List of ranges of GPSIs that can be served by the PCF instance.<br>(NOTE)                                                                                                                                                                                                                            |
| rxDiamHost                                                                                                                                                                                                                                                                                                                     | DiameterIdentity     | C | 0..1        | This IE shall be present if the PCF supports Rx interface.<br><br>When present, this IE shall indicate the Diameter host of the Rx interface for the PCF.                                                                                                                                            |
| rxDiamRealm                                                                                                                                                                                                                                                                                                                    | DiameterIdentity     | C | 0..1        | This IE shall be present if the PCF supports Rx interface.<br><br>When present, this IE shall indicate the Diameter realm of the Rx interface for the PCF.                                                                                                                                           |
| v2xSupportInd                                                                                                                                                                                                                                                                                                                  | boolean              | O | 0..1        | Indicates whether V2X Policy/Parameter provisioning is supported by the PCF.<br>true: Supported<br>false (default): Not Supported                                                                                                                                                                    |
| proseSupportInd                                                                                                                                                                                                                                                                                                                | boolean              | O | 0..1        | Indicates whether ProSe capability is supported by the PCF.<br>true: Supported<br>false (default): Not Supported                                                                                                                                                                                     |
| proseCapability                                                                                                                                                                                                                                                                                                                | ProseCapability      | C | 0..1        | This IE shall be present if the PCF supports ProSe Capability.<br><br>When present, this IE shall indicate the supported ProSe Capability by the PCF.                                                                                                                                                |
| v2xCapability                                                                                                                                                                                                                                                                                                                  | V2xCapability        | C | 0..1        | This IE shall be present if the PCF supports V2X Capability.<br><br>When present, this IE shall indicate the supported V2X Capability by the PCF.                                                                                                                                                    |
| NOTE: If none of these parameters are provided, the PCF can serve any SUPI or GPSI managed by the PLMN of the PCF instance. If "supiRanges" and "gpsiRanges" attributes are absent, and "groupId" is present, the SUPIs / GPSIs served by this PCF instance is determined by the NRF (see 3GPP TS 23.501 [2], clause 6.2.6.2). |                      |   |             |                                                                                                                                                                                                                                                                                                      |

## 6.1.6.2.21 Type: BsflInfo

Table 6.1.6.2.21-1: Definition of type BsflInfo

| Attribute name                                                                                                                                                                                                                                                                        | Data type               | P | Cardinality | Description                                                                                                                                                                                                                                                                                             |
|---------------------------------------------------------------------------------------------------------------------------------------------------------------------------------------------------------------------------------------------------------------------------------------|-------------------------|---|-------------|---------------------------------------------------------------------------------------------------------------------------------------------------------------------------------------------------------------------------------------------------------------------------------------------------------|
| ipv4AddressRanges                                                                                                                                                                                                                                                                     | array(Ipv4AddressRange) | O | 1..N        | List of ranges of IPv4 addresses handled by BSF. If not provided, the BSF can serve any IPv4 address.                                                                                                                                                                                                   |
| dnnList                                                                                                                                                                                                                                                                               | array(Dnn)              | O | 1..N        | List of DNNs handled by the BSF. The DNN shall contain the Network Identifier and it may additionally contain an Operator Identifier. If the Operator Identifier is not included, the DNN is supported for all the PLMNs in the plmnList of the NF Profile. If not provided, the BSF can serve any DNN. |
| ipDomainList                                                                                                                                                                                                                                                                          | array(string)           | O | 1..N        | List of IPv4 address domains, as described in clause 6.2 of 3GPP TS 29.513 [28], handled by the BSF. If not provided, the BSF can serve any IP domain.                                                                                                                                                  |
| ipv6PrefixRanges                                                                                                                                                                                                                                                                      | array(Ipv6PrefixRange)  | O | 1..N        | List of ranges of IPv6 prefixes handled by the BSF. If not provided, the BSF can serve any IPv6 prefix.                                                                                                                                                                                                 |
| rxDiamHost                                                                                                                                                                                                                                                                            | DiameterIdentity        | C | 0..1        | This IE shall be present if the BSF supports Rx interface.<br><br>When present, this IE shall indicate the Diameter host of the Rx interface for the BSF.                                                                                                                                               |
| rxDiamRealm                                                                                                                                                                                                                                                                           | DiameterIdentity        | C | 0..1        | This IE shall be present if the BSF supports Rx interface.<br><br>When present, this IE shall indicate the Diameter realm of the Rx interface for the BSF.                                                                                                                                              |
| groupId                                                                                                                                                                                                                                                                               | NfGroupId               | O | 0..1        | Identity of the BSF group that is served by the BSF instance.<br>If not provided, the BSF instance does not pertain to any BSF group.<br>(NOTE)                                                                                                                                                         |
| supiRanges                                                                                                                                                                                                                                                                            | array(SupiRange)        | O | 1..N        | List of ranges of SUPI's served by the BSF instance<br>(NOTE)                                                                                                                                                                                                                                           |
| gpsiRanges                                                                                                                                                                                                                                                                            | array(IdentityRange)    | O | 1..N        | List of ranges of GPSIs served by the BSF instance<br>(NOTE)                                                                                                                                                                                                                                            |
| NOTE: If none of these parameters are provided, the BSF can serve any SUPI or GPSI managed by the PLMN of the BSF instance. If "supiRanges" and "gpsiRanges" attributes are absent, and "groupId" is present, the SUPIs / GPSIs served by this BSF instance is determined by the NRF. |                         |   |             |                                                                                                                                                                                                                                                                                                         |

## 6.1.6.2.22 Type: Ipv4AddressRange

Table 6.1.6.2.22-1: Definition of type IPv4AddressRange

| Attribute name | Data type | P | Cardinality | Description                                                |
|----------------|-----------|---|-------------|------------------------------------------------------------|
| start          | Ipv4Addr  | M | 1           | First value identifying the start of an IPv4 address range |
| end            | Ipv4Addr  | M | 1           | Last value identifying the end of an IPv4 address range    |

## 6.1.6.2.23 Type: Ipv6PrefixRange

Table 6.1.6.2.23-1: Definition of type IPv6PrefixRange

| Attribute name | Data type                                                                                                                                                                                                                                                                                                                                                                                                                                                                                                                                                                                 | P | Cardinality | Description                                               |
|----------------|-------------------------------------------------------------------------------------------------------------------------------------------------------------------------------------------------------------------------------------------------------------------------------------------------------------------------------------------------------------------------------------------------------------------------------------------------------------------------------------------------------------------------------------------------------------------------------------------|---|-------------|-----------------------------------------------------------|
| start          | Ipv6Prefix                                                                                                                                                                                                                                                                                                                                                                                                                                                                                                                                                                                | M | 1           | First value identifying the start of an IPv6 prefix range |
| end            | Ipv6Prefix                                                                                                                                                                                                                                                                                                                                                                                                                                                                                                                                                                                | M | 1           | Last value identifying the end of an IPv6 prefix range    |
| NOTE:          | When Ipv6PrefixRange is used to identify a range of IPv6 addresses served by certain NF (e.g. BSF), the range of IPv6 addresses identified by the IPv6PrefixRange shall include the entire IPv6 addresses represented by the "start" and "end" IPv6 prefixes. For example, if the "start" attribute is set to "240e:006a:0000:0000::/32" and the "end" attribute is set to "250e:006a:0000:0000::/32", the Ipv6PrefixRange identifies all the IPv6 addresses from the start IPv6 address "240e:006a:0000:0000::/32" to the end IPv6 address "250e:006a:ffff:ffff:ffff:ffff:ffff:ffff/32". |   |             |                                                           |

## 6.1.6.2.24 Type: InterfaceUpfInfoltem

Table 6.1.6.2.24-1: Definition of type InterfaceUpfInfoltem

| Attribute name        | Data type                                                                                                                                                                                           | P | Cardinality | Description                                                                       |
|-----------------------|-----------------------------------------------------------------------------------------------------------------------------------------------------------------------------------------------------|---|-------------|-----------------------------------------------------------------------------------|
| interfaceType         | UPInterfaceType                                                                                                                                                                                     | M | 1           | User Plane interface type                                                         |
| ipv4EndpointAddresses | array(Ipv4Addr)                                                                                                                                                                                     | C | 1..N        | Available endpoint IPv4 address(es) of the User Plane interface (NOTE 1) (NOTE 2) |
| ipv6EndpointAddresses | array(Ipv6Addr)                                                                                                                                                                                     | C | 1..N        | Available endpoint IPv6 address(es) of the User Plane interface (NOTE 1) (NOTE 2) |
| endpointFqdn          | Fqdn                                                                                                                                                                                                | C | 0..1        | FQDN of available endpoint of the User Plane interface (NOTE 1) (NOTE 2)          |
| networkInstance       | string                                                                                                                                                                                              | O | 0..1        | Network Instance (See 3GPP TS 29.244 [21]) associated to the User Plane interface |
| NOTE 1:               | At least one of the addressing parameters (ipv4address, ipv6address or endpointFqdn) shall be included in the InterfaceUpfInfoltem.                                                                 |   |             |                                                                                   |
| NOTE 2:               | When interfaceType is "DATA_FORWARDING", the SMF shall ignore these IEs. The UPF shall register a dummy FQDN or IP address for interfaceType "DATA_FORWARDING" (for backward compatibility reason). |   |             |                                                                                   |

## 6.1.6.2.25 Type: UriList

Table 6.1.6.2.25-1: Definition of type UriList

| Attribute name | Data type             | P | Cardinality | Description                                                                                                                                                                                                                                                                                                                                                                                                                                                                               |
|----------------|-----------------------|---|-------------|-------------------------------------------------------------------------------------------------------------------------------------------------------------------------------------------------------------------------------------------------------------------------------------------------------------------------------------------------------------------------------------------------------------------------------------------------------------------------------------------|
| _links         | map(LinksValueSchema) | O | 1..N        | See clause 4.9.4 of 3GPP TS 29.501 [5] for the description of the members.<br>In this map, the key "item", if present, shall contain an array of objects, where each object contains an "href" attribute containing the URI of the NF Instance.<br>If the response contains no URIs to return, the "_links" attribute may be absent; if it is included, it shall only contain the "self" key (i.e. the "item" key shall be absent), and the "totalItemCount" attribute shall be set to 0. |
| totalItemCount | integer               | C | 0..1        | This attribute should be included in the response and it shall contain the total number of items matching the input filter criteria of the request (e.g. "nf-type").                                                                                                                                                                                                                                                                                                                      |

## 6.1.6.2.26 Type: N2InterfaceAmfInfo

Table 6.1.6.2.26-1: Definition of type N2InterfaceAmfInfo

| Attribute name      | Data type       | P | Cardinality | Description                                                         |
|---------------------|-----------------|---|-------------|---------------------------------------------------------------------|
| ipv4EndpointAddress | array(Ipv4Addr) | C | 1..N        | Available AMF endpoint IPv4 address(es) for N2 (see NOTE 1)         |
| ipv6EndpointAddress | array(Ipv6Addr) | C | 1..N        | Available AMF endpoint IPv6 address(es) for N2 (see NOTE 1)         |
| amfName             | AmfName         | O | 0..1        | AMF Name FQDN as defined in clause 28.3.2.5 of 3GPP TS 23.003 [12]. |

NOTE 1: At least one of the addressing parameters (ipv4address or ipv6address) shall be included.

## 6.1.6.2.27 Type: TaiRange

Table 6.1.6.2.27-1: Definition of type TaiRange

| Attribute name | Data type       | P | Cardinality | Description                              |
|----------------|-----------------|---|-------------|------------------------------------------|
| plmnId         | PlmnId          | M | 1           | PLMN ID related to the TacRange.         |
| tacRangeList   | array(TacRange) | M | 1..N        | The range of the TACs                    |
| nid            | Nid             | O | 0..1        | NID related to the TacRange, for an SNPN |

## 6.1.6.2.28 Type: TacRange

Table 6.1.6.2.28-1: Definition of type TacRange

| Attribute name | Data type | P | Cardinality | Description                                                                                                                                                                                                                                                                                                                                                                                                                                                                                                                                                                                          |
|----------------|-----------|---|-------------|------------------------------------------------------------------------------------------------------------------------------------------------------------------------------------------------------------------------------------------------------------------------------------------------------------------------------------------------------------------------------------------------------------------------------------------------------------------------------------------------------------------------------------------------------------------------------------------------------|
| start          | string    | O | 0..1        | First value identifying the start of a TAC range, to be used when the range of TAC's can be represented as a hexadecimal range (e.g., TAC ranges). 3-octet string identifying a tracking area code, each character in the string shall take a value of "0" to "9" or "A" to "F" and shall represent 4 bits. The most significant character representing the 4 most significant bits of the TAC shall appear first in the string, and the character representing the 4 least significant bit of the TAC shall appear last in the string.<br>Pattern: " <code>^[A-Fa-f0-9]{4}[A-Fa-f0-9]{6}\$</code> " |
| end            | string    | O | 0..1        | Last value identifying the end of a TAC range, to be used when the range of TAC's can be represented as a hexadecimal range (e.g. TAC ranges). 3-octet string identifying a tracking area code, each character in the string shall take a value of "0" to "9" or "A" to "F" and shall represent 4 bits. The most significant character representing the 4 most significant bits of the TAC shall appear first in the string, and the character representing the 4 least significant bit of the TAC shall appear last in the string.<br>Pattern: " <code>^[A-Fa-f0-9]{4}[A-Fa-f0-9]{6}\$</code> "     |
| pattern        | string    | O | 0..1        | Pattern (regular expression according to the ECMA-262 dialect [8]) representing the set of TAC's belonging to this range. A TAC value is considered part of the range if and only if the TAC string fully matches the regular expression.                                                                                                                                                                                                                                                                                                                                                            |

NOTE: Either the start and end attributes, or the pattern attribute, shall be present.

EXAMPLE 1: TAC range. From: 543000 To: 5433E7 (i.e., 1000 TAC numbers)  
JSON: { "start": "543000", "end": "5433E7" }

EXAMPLE 2: TAC range. From: 54E000 To: 54EFFF (i.e., 4096 TAC numbers)  
 JSON: { "pattern": "^54E[0-9a-fA-F]{3}\$" }, or  
 JSON: { "start": "54E000", "end": "54EFFF" }

#### 6.1.6.2.29 Type: SnsaiSmfInfoItem

**Table 6.1.6.2.29-1: Definition of type SnsaiSmfInfoItem**

| Attribute name                                                                                                                                                                                                                                               | Data type             | P | Cardinality | Description                                     |
|--------------------------------------------------------------------------------------------------------------------------------------------------------------------------------------------------------------------------------------------------------------|-----------------------|---|-------------|-------------------------------------------------|
| sNssai                                                                                                                                                                                                                                                       | ExtSnsai              | M | 1           | Supported S-NSSAI (NOTE)                        |
| dnnSmfInfoList                                                                                                                                                                                                                                               | array(DnnSmfInfoItem) | M | 1..N        | List of parameters supported by the SMF per DNN |
| NOTE: An SMF may register SD ranges or a wildcard SD if the SMF profile is not discoverable from other PLMNs and if the NRF and all consumers of the SMF profile in the same PLMN have been upgraded to support SD ranges and wildcard SD in this attribute. |                       |   |             |                                                 |

#### 6.1.6.2.30 Type: DnnSmfInfoItem

**Table 6.1.6.2.30-1: Definition of type DnnSmfInfoItem**

| Attribute name                                                                                                                                                                                                                                                                                                 | Data type   | P | Cardinality | Description                                                                                                                                                                                                                                                                                                           |
|----------------------------------------------------------------------------------------------------------------------------------------------------------------------------------------------------------------------------------------------------------------------------------------------------------------|-------------|---|-------------|-----------------------------------------------------------------------------------------------------------------------------------------------------------------------------------------------------------------------------------------------------------------------------------------------------------------------|
| dnn                                                                                                                                                                                                                                                                                                            | Dnn         | M | 1           | Supported DNN (NOTE) or Wildcard DNN if the SMF supports all DNNs for the related S-NSSAI. The DNN shall contain the Network Identifier and it may additionally contain an Operator Identifier. If the Operator Identifier is not included, the DNN is supported for all the PLMNs in the plmnList of the NF Profile. |
| dnaiList                                                                                                                                                                                                                                                                                                       | array(Dnai) | O | 1..N        | List of DNAs or Wildcard DNAI supported by the SMF for this DNN.<br>(See NOTE 2)                                                                                                                                                                                                                                      |
| NOTE 1: For a SMF which only supports the I-SMF related functionalities, the dnn attribute may be an invalid DNN according to operator's local policy.                                                                                                                                                         |             |   |             |                                                                                                                                                                                                                                                                                                                       |
| NOTE 2: The Wildcard DNAI included in the "dnaiList" attribute indicates that the SMF can be selected for this DNN for any DNAI. The absence of "dnaiList" attribute does not mean that the SMF (e.g. pre-Rel-17 compliant) does not support any DNAI, but the SMF did not indicate which DNAs it may support. |             |   |             |                                                                                                                                                                                                                                                                                                                       |

6.1.6.2.31 Type: NrfInfo

**Table 6.1.6.2.31-1: Definition of type NrfInfo**

| Attribute name     | Data type          | P | Cardinality | Description                                                                                                                                                                                                  |
|--------------------|--------------------|---|-------------|--------------------------------------------------------------------------------------------------------------------------------------------------------------------------------------------------------------|
| servedUdrInfo      | map(UdrInfo)       | O | 1..N        | This attribute contains all the udrInfo attributes locally configured in the NRF or the NRF received during NF registration. The key of the map is the nfnInstanceid of which the udrInfo belongs to.        |
| servedUdrInfoList  | map(map(UdrInfo))  | O | 1..N(1..M)  | This attribute contains the udrInfoList attribute locally configured in the NRF or that the NRF received during NF registration. The key of the map is the nfnInstanceid to which the map entry belongs to.  |
| servedUdmInfo      | map(UdmInfo)       | O | 1..N        | This attribute contains all the udmInfo attributes locally configured in the NRF or the NRF received during NF registration. The key of the map is the nfnInstanceid of which the udmInfo belongs to.        |
| servedUdmInfoList  | map(map(UdmInfo))  | O | 1..N(1..M)  | This attribute contains the udmInfoList attribute locally configured in the NRF or that the NRF received during NF registration. The key of the map is the nfnInstanceid to which the map entry belongs to.  |
| servedAusfInfo     | map(AusfInfo)      | O | 1..N        | This attribute contains all the ausfInfo attributes locally configured in the NRF or the NRF received during NF registration. The key of the map is the nfnInstanceid of which the ausfInfo belongs to.      |
| servedAusfInfoList | map(map(AusfInfo)) | O | 1..N(1..M)  | This attribute contains the ausfInfoList attribute locally configured in the NRF or that the NRF received during NF registration. The key of the map is the nfnInstanceid to which the map entry belongs to. |
| servedAmfInfo      | map(AmfInfo)       | O | 1..N        | This attribute contains all the amfInfo attributes locally configured in the NRF or the NRF received during NF registration. The key of the map is the nfnInstanceid of which the amfInfo belongs to.        |
| servedAmfInfoList  | map(map(AmfInfo))  | O | 1..N(1..M)  | This attribute contains the amfInfoList attribute locally configured in the NRF or that the NRF received during NF registration. The key of the map is the nfnInstanceid to which the map entry belongs to.  |
| servedSmfInfo      | map(SmfInfo)       | O | 1..N        | This attribute contains all the smfInfo attributes locally configured in the NRF or the NRF received during NF registration. The key of the map is the nfnInstanceid of which the smfInfo belongs to.        |
| servedSmfInfoList  | map(map(SmfInfo))  | O | 1..N(1..M)  | This attribute contains the smfInfoList attribute locally configured in the NRF or that the NRF received during NF registration. The key of the map is the nfnInstanceid to which the map entry belongs to.  |
| servedUpfInfo      | map(UpfInfo)       | O | 1..N        | This attribute contains all the upfInfo attributes locally configured in the NRF or the NRF received during NF registration. The key of the map is the nfnInstanceid of which the upfInfo belongs to.        |
| servedUpfInfoList  | map(map(UpfInfo))  | O | 1..N(1..M)  | This attribute contains the upfInfoList attribute locally configured in the NRF or that the NRF received during NF registration. The key of the map is the nfnInstanceid to which the map entry belongs to.  |
| servedPcfInfo      | map(PcfInfo)       | O | 1..N        | This attribute contains all the pcfInfo attributes locally configured in the NRF or the NRF received during NF registration. The key of the map is the nfnInstanceid of which the pcfInfo belongs to.        |
| servedPcfInfoList  | map(map(PcfInfo))  | O | 1..N(1..M)  | This attribute contains the pcfInfoList attribute locally configured in the NRF or that the NRF received during NF registration. The key of the map is the nfnInstanceid to which the map entry belongs to.  |
| servedBsInfo       | map(BsInfo)        | O | 1..N        | This attribute contains all the bsInfo attributes locally configured in the NRF or the NRF received during NF registration. The key of the map is the nfnInstanceid of which the bsInfo belongs to.          |



|                      |                      |   |            |                                                                                                                                                                                                                                      |
|----------------------|----------------------|---|------------|--------------------------------------------------------------------------------------------------------------------------------------------------------------------------------------------------------------------------------------|
| servedBsflInfoList   | map(map(BsflInfo))   | O | 1..N(1..M) | This attribute contains the bsflInfoList attribute locally configured in the NRF or that the NRF received during NF registration. The key of the map is the nflInstanceld to which the map entry belongs to.                         |
| servedChflInfo       | map(ChflInfo)        | O | 1..N       | This attribute contains all the chflInfo attributes locally configured in the NRF or the NRF received during NF registration. The key of the map is the nflInstanceld of which the chflInfo belongs to.                              |
| servedChflInfoList   | map(map(ChflInfo))   | O | 1..N(1..M) | This attribute contains the chflInfoList attribute locally configured in the NRF or that the NRF received during NF registration. The key of the map is the nflInstanceld to which the map entry belongs to.                         |
| servedNeflInfo       | map(NeflInfo)        | O | 1..N       | This attribute contains all the neflInfo attributes locally configured in the NRF or the NRF received during NF registration. The key of the map is the nflInstanceld of which the neflInfo belongs to.                              |
| servedNwdafInfo      | map(NwdafInfo)       | O | 1..N       | This attribute contains all the nwdafInfo attributes locally configured in the NRF or the NRF received during NF registration. The key of the map is the nflInstanceld of which the nwdafInfo belongs to.                            |
| servedNwdafInfoList  | map(map(NwdafInfo))  | O | 1..N       | This attribute contains all the nwdafInfo attributes locally configured in the NRF or the NRF received during NF registration. The key of the map is the nflInstanceld to which the map entry belongs to.                            |
| servedPcscflInfoList | map(map(PcscflInfo)) | O | 1..N(1..M) | This attribute contains all the pcscflInfo attributes locally configured in the NRF or the NRF received during NF registration. The key of the map is the nflInstanceld to which the map entry belongs to.                           |
| servedGmlcInfo       | map(GmlcInfo)        | O | 1..N       | This attribute contains all the gmlcInfo attributes locally configured in the NRF or the NRF received during NF registration. The key of the map is the nflInstanceld of which the gmlcInfo belongs to.                              |
| servedLmflInfo       | map(LmflInfo)        | O | 1..N       | This attribute contains all the lmflInfo attributes locally configured in the NRF or the NRF received during NF registration. The key of the map is the nflInstanceld of which the lmflInfo belongs to.                              |
| servedNflInfo        | map(NflInfo)         | O | 1..N       | This attribute contains information of other NFs without corresponding NF type specific Info extensions locally configured in the NRF or the NRF received during NF registration. The key of the map is the nflInstanceld of the NF. |
| servedHsslInfoList   | map(map(HsslInfo))   | O | 1..N(1..M) | This attribute contains all the hsslInfo attributes locally configured in the NRF or the NRF received during NF registration. The key of the map is the nflInstanceld to which the map entry belongs to.                             |
| servedUdsflInfo      | map(UdsflInfo)       | O | 1..N       | This attribute contains all the udsflInfo attributes locally configured in the NRF or the NRF received during NF registration. The key of the map is the nflInstanceld to which the map entry belongs to.                            |
| servedUdsflInfoList  | map(map(UdsflInfo))  | O | 1..N(1..M) | This attribute contains the udsflInfoList attribute locally configured in the NRF or that the NRF received during NF registration. The key of the map is the nflInstanceld to which the map entry belongs to.                        |
| servedScplInfoList   | map(ScplInfo)        | O | 1..N       | This attribute contains the scplInfo attribute locally configured in the NRF or that the NRF received during SCP registration. The key of the map is the nflInstanceld to which the scplInfo belongs to.                             |
| servedSeppInfoList   | map(SeppInfo)        | O | 1..N       | This attribute contains the seppInfo attribute locally configured in the NRF or that the NRF received during SEPP registration. The key of the map is the nflInstanceld to which the seppInfo belongs to.                            |
| servedAanfInfoList   | map(map(AanfInfo))   | O | 1..N(1..M) | This attribute contains the aanfInfoList attribute locally configured in the NRF or that the NRF received during NF registration. The key of the map is the nflInstanceld to which the map entry belongs to.                         |

|                                                                                                                                                                                                                                                                                                                                                                                                                                                                                                                                                                                                                                                                                                                                                                                                                                                                                                                                        |                       |   |            |                                                                                                                                                                                                                     |
|----------------------------------------------------------------------------------------------------------------------------------------------------------------------------------------------------------------------------------------------------------------------------------------------------------------------------------------------------------------------------------------------------------------------------------------------------------------------------------------------------------------------------------------------------------------------------------------------------------------------------------------------------------------------------------------------------------------------------------------------------------------------------------------------------------------------------------------------------------------------------------------------------------------------------------------|-----------------------|---|------------|---------------------------------------------------------------------------------------------------------------------------------------------------------------------------------------------------------------------|
| served5gDdnmflInfo                                                                                                                                                                                                                                                                                                                                                                                                                                                                                                                                                                                                                                                                                                                                                                                                                                                                                                                     | map(5GDdnmflInfo)     | O | 1..N       | This attribute contains all the 5GDdnmflInfo attributes locally configured in the NRF or the NRF received during NF registration. The key of the map is the nfnInstanceid of which the 5GDdnmflInfo belongs to.     |
| servedMfafInfoList                                                                                                                                                                                                                                                                                                                                                                                                                                                                                                                                                                                                                                                                                                                                                                                                                                                                                                                     | map(MfafInfo)         | O | 1..N       | This attribute contains the mfafInfo attribute locally configured in the NRF or that the NRF received during MFAF registration. The key of the map is the nfnInstanceid to which the mfafInfo belongs to.           |
| servedEasdfInfoList                                                                                                                                                                                                                                                                                                                                                                                                                                                                                                                                                                                                                                                                                                                                                                                                                                                                                                                    | map(map(EasdfInfo))   | O | 1..N(1..M) | This attribute contains the easdfInfoList attribute locally configured in the NRF or that the NRF received during NF registration. The key of the map is the nfnInstanceid to which the map entry belongs to.       |
| servedDccfInfoList                                                                                                                                                                                                                                                                                                                                                                                                                                                                                                                                                                                                                                                                                                                                                                                                                                                                                                                     | map(DccfInfo)         | O | 1..N       | This attribute contains the dccfInfo attribute locally configured in the NRF or that the NRF received during DCCF registration. The key of the map is the nfnInstanceid to which the dccfInfo belongs to.           |
| servedMbSmfInfoList                                                                                                                                                                                                                                                                                                                                                                                                                                                                                                                                                                                                                                                                                                                                                                                                                                                                                                                    | map(map(MbSmfInfo))   | O | 1..N(1..M) | This attribute contains the mbSmfInfoList attribute locally configured in the NRF or that the NRF received during NF registration. The key of the map is the nfnInstanceid to which the map entry belongs to.       |
| servedTsctsflInfoList                                                                                                                                                                                                                                                                                                                                                                                                                                                                                                                                                                                                                                                                                                                                                                                                                                                                                                                  | map(map(TsctsflInfo)) | O | 1..N(1..M) | This attribute contains the tsctsflInfoList attribute locally configured in the NRF or that the NRF received during TSCTSF registration. The key of the map is the nfnInstanceid to which the map entry belongs to. |
| servedMbUpflInfoList                                                                                                                                                                                                                                                                                                                                                                                                                                                                                                                                                                                                                                                                                                                                                                                                                                                                                                                   | map(map(MbUpflInfo))  | O | 1..N(1..M) | This attribute contains the mbUpflInfoList attribute locally configured in the NRF or that the NRF received during NF registration. The key of the map is the nfnInstanceid to which the map entry belongs to.      |
| servedTrustAfInfo                                                                                                                                                                                                                                                                                                                                                                                                                                                                                                                                                                                                                                                                                                                                                                                                                                                                                                                      | map(TrustAfInfo)      | O | 1..N       | This attribute contains the trustAfInfo attribute locally configured in the NRF or that the NRF received during AF registration. The key of the map is the nfnInstanceid to which the map entry belongs to.         |
| servedNssaafInfo                                                                                                                                                                                                                                                                                                                                                                                                                                                                                                                                                                                                                                                                                                                                                                                                                                                                                                                       | map(NssaafInfo)       | O | 1..N       | This attribute contains all the nssaafInfo attributes locally configured in the NRF or the NRF received during NF registration. The key of the map is the nfnInstanceid of which the nssaafInfo belongs to.         |
| <p>NOTE 1: The absence of these parameters means the NRF is able to serve any NF discovery request.</p> <p>NOTE 2: For any of the servedxxxInfo/servedxxxInfoList attributes (other than servedNflInfo), if the data type definition of the corresponding xxxInfo attribute allows to use an empty JSON object, the registering NRF shall include in the servedxxxInfo/servedxxxInfoList a map entry with an empty JSON object as value, to indicate the registration of an NF Instance that did not include any xxxInfo/xxxInfoList attributes; otherwise, the registering NRF shall check the support of the feature "Empty-Objects-Nrf-Info" (see clause 6.1.9) in the target NRF and, if the feature is not supported, it shall use the generic servedNflInfo attribute (instead of the servedxxxInfo corresponding to its NF type) to signal the registration of such NF instance with absent xxxInfo/xxxInfoList attributes.</p> |                       |   |            |                                                                                                                                                                                                                     |

## 6.1.6.2.32 Type: ChfInfo

Table 6.1.6.2.32-1: Definition of type ChfInfo

| Attribute name                                                                                                                                                                                                                                                                                                                         | Data type            | P | Cardinality | Description                                                                                                                                                                                                                                                                                      |
|----------------------------------------------------------------------------------------------------------------------------------------------------------------------------------------------------------------------------------------------------------------------------------------------------------------------------------------|----------------------|---|-------------|--------------------------------------------------------------------------------------------------------------------------------------------------------------------------------------------------------------------------------------------------------------------------------------------------|
| supiRangeList                                                                                                                                                                                                                                                                                                                          | array(SupiRange)     | O | 1..N        | List of ranges of SUPIs that can be served by the CHF instance.<br>(NOTE 1)                                                                                                                                                                                                                      |
| gpsiRangeList                                                                                                                                                                                                                                                                                                                          | array(IdentityRange) | O | 1..N        | List of ranges of GPSI that can be served by the CHF instance.<br>(NOTE 1)                                                                                                                                                                                                                       |
| plmnRangeList                                                                                                                                                                                                                                                                                                                          | array(PlmnRange)     | O | 1..N        | List of ranges of PLMNs (including the PLMN IDs of the CHF instance) that can be served by the CHF instance. If not provided, the CHF can serve any PLMN.                                                                                                                                        |
| groupId                                                                                                                                                                                                                                                                                                                                | NfGroupId            | O | 0..1        | Identity of the CHF group that is served by the CHF instance.<br>If not provided, the CHF instance does not pertain to any CHF group.<br>(NOTE 1)                                                                                                                                                |
| primaryChfInstance                                                                                                                                                                                                                                                                                                                     | NfInstanceId         | C | 0..1        | This IE shall be present if the CHF instance serves as a secondary CHF instance of another primary CHF instance. When present, it shall be set to the NF Instance Id of the primary CHF instance.<br><br>This IE shall be absent if the secondaryChfInstance is present.<br><br>(NOTE 2, NOTE 3) |
| secondaryChfInstance                                                                                                                                                                                                                                                                                                                   | NfInstanceId         | C | 0..1        | This IE shall be present if the CHF instance serves as a primary CHF instance of another secondary CHF instance. When present, it shall be set to the NF Instance Id of the secondary CHF instance.<br><br>This IE shall be absent if the primaryChfInstance is present.<br><br>(NOTE 2, NOTE 3) |
| NOTE 1: If none of these parameters are provided, the CHF can serve any SUPI or GPSI managed by the PLMN of the CHF instance. If "supiRangeList" and "gpsiRangeList" attributes are absent, and "groupId" is present, the SUPIs / GPSIs served by this CHF instance is determined by the NRF (see 3GPP TS 23.501 [2], clause 6.2.6.2). |                      |   |             |                                                                                                                                                                                                                                                                                                  |
| NOTE 2: The NF Service Consumer of the CHF may use these attributes as primary/secondary redundancy mechanism, or alternatively, it may also rely on the availability of an NF Set (or NF Service Set) of CHF Instances (or CHF Service Instances) for the same purpose.                                                               |                      |   |             |                                                                                                                                                                                                                                                                                                  |
| NOTE 3: If the CHF does not provide NF set ID or NF Service Set ID in NFProfile, it shall provide one of these attributes. These attributes may be present if the CHF registers an NF set ID or NF service set ID.                                                                                                                     |                      |   |             |                                                                                                                                                                                                                                                                                                  |

6.1.6.2.33 Void

6.1.6.2.34 Type: PlmnRange

Table 6.1.6.2.34-1: Definition of type PlmnRange

| Attribute name                                                                         | Data type | P | Cardinality | Description                                                                                                                                                                                                                                                           |
|----------------------------------------------------------------------------------------|-----------|---|-------------|-----------------------------------------------------------------------------------------------------------------------------------------------------------------------------------------------------------------------------------------------------------------------|
| start                                                                                  | string    | O | 0..1        | First value identifying the start of a PLMN range.<br>The string shall be encoded as follows:<br><MCC><MNC><br><br>Pattern: '^([0-9]{3})([0-9]{2,3})\$'                                                                                                               |
| end                                                                                    | string    | O | 0..1        | Last value identifying the end of a PLMN range.<br>The string shall be encoded as follows:<br><MCC><MNC><br><br>Pattern: '^([0-9]{3})([0-9]{2,3})\$'                                                                                                                  |
| pattern                                                                                | string    | O | 0..1        | Pattern (regular expression according to the ECMA-262 dialect [8]) representing the set of PLMNs belonging to this range. A PLMN value is considered part of the range if and only if the PLMN string (formatted as <MCC><MNC>) fully matches the regular expression. |
| NOTE: Either the start and end attributes, or the pattern attribute, shall be present. |           |   |             |                                                                                                                                                                                                                                                                       |

EXAMPLE 1: PLMN range. MCC 123, any MNC  
JSON: { "start": "12300", "end": "123999" }

EXAMPLE 2: PLMN range. MCC 123, MNC within range 45 to 49  
JSON: { "pattern": "^1234[5-9]\$" }, or  
JSON: { "start": "12345", "end": "12349" }

EXAMPLE 3: PLMN range. MCC within range 123 to 257, any MNC  
JSON: { "start": "12300", "end": "257999" }

## 6.1.6.2.35 Type: SubscrCond

**Table 6.1.6.2.35-1: Definition of type SubscrCond as a list of mutually exclusive alternatives**

| Data type           | Cardinality | Description                                                                                                                                                                                                   |
|---------------------|-------------|---------------------------------------------------------------------------------------------------------------------------------------------------------------------------------------------------------------|
| NfInstancelCond     | 1           | Subscription to a given NF Instance                                                                                                                                                                           |
| NfInstancelListCond | 1           | Subscription to a list of NF Instances                                                                                                                                                                        |
| NfTypeCond          | 1           | Subscription to a set of NF Instances, identified by their NF Type                                                                                                                                            |
| ServiceNameCond     | 1           | Subscription to a set of NF Instances that offer a certain service name                                                                                                                                       |
| ServiceNameListCond | 1           | Subscription to a set of NF Instances that offer a service name in the Service Name list.                                                                                                                     |
| AmfCond             | 1           | Subscription to a set of NF Instances (AMFs), belonging to a certain AMF Set and/or belonging to a certain AMF Region.                                                                                        |
| GuamiListCond       | 1           | Subscription to a set of NF Instances (AMFs) identified by their Guamis (i.e. whose guamiList IE in the amfInfo or amfInfoList IE matches at least one of the GUAMI in the guamiList IE of the subscription). |
| NetworkSliceCond    | 1           | Subscription to a set of NF Instances, identified by S-NSSAI(s) and NSI ID(s).                                                                                                                                |
| NfGroupCond         | 1           | Subscription to a set of NF Instances, identified by a NF (UDM, AUSF, PCF, CHF, HSS or UDR) Group Identity.                                                                                                   |
| NfGroupListCond     | 1           | Subscription to a set of NF Instances, identified by a NF Group Identity in the NF Group Identity list.                                                                                                       |
| NfSetCond           | 1           | Subscription to a set of NF Instances belonging to a certain NF Set.                                                                                                                                          |
| NfServiceSetCond    | 1           | Subscription to a set of NF Service Instances, or to a set of equivalent NF Service Instances.                                                                                                                |
| UpfCond             | 1           | Subscription to a set of NF Instances (UPFs), able to serve a certain service area (i.e. SMF serving area or TAI list).                                                                                       |
| ScpDomainCond       | 1           | Subscription to a set of NF, SCP or SEPP instances belonging to certain SCP domains.                                                                                                                          |
| NwdafCond           | 1           | Subscription to a set of NF Instances (NWDAFs), identified by Analytics ID(s), S-NSSAI(s) or NWDAF Serving Area information, i.e. list of TAIs for which the NWDAF can provide analytics.                     |
| NefCond             | 1           | Subscription to a set of NF Instances (NEFs), identified by Event ID(s) provided by AF, S-NSSAI(s), AF Instance ID, Application Identifier, External Identifier, External Group Identifier, or domain name.   |
| DccfCond            | 1           | Subscription to a set of NF Instances (DCCFs), identified by NF types, NF Set Id(s) or DCCF Serving Area information, i.e. list of TAIs served by the DCCF.                                                   |

## 6.1.6.2.36 Type: NfInstancelCond

**Table 6.1.6.2.36-1: Definition of type NfInstancelCond**

| Attribute name | Data type     | P | Cardinality | Description                                                                  |
|----------------|---------------|---|-------------|------------------------------------------------------------------------------|
| nfInstancelId  | NfInstancelId | M | 1           | NF Instance ID of the NF Instance whose status is requested to be monitored. |

## 6.1.6.2.37 Type: NfTypeCond

**Table 6.1.6.2.37-1: Definition of type NfTypeCond**

| Attribute name                                                                                                                          | Data type | P | Cardinality | Description                                                            |
|-----------------------------------------------------------------------------------------------------------------------------------------|-----------|---|-------------|------------------------------------------------------------------------|
| nfType                                                                                                                                  | NFType    | M | 1           | NF type of the NF Instances whose status is requested to be monitored. |
| NOTE: This type shall not contain the attribute "nfGroupId", to avoid that this type has a matching definition with "NfGroupCond" type. |           |   |             |                                                                        |

## 6.1.6.2.38 Type: ServiceNameCond

**Table 6.1.6.2.38-1: Definition of type ServiceNameCond**

| Attribute name | Data type   | P | Cardinality | Description                                                                         |
|----------------|-------------|---|-------------|-------------------------------------------------------------------------------------|
| serviceName    | ServiceName | M | 1           | Service name offered by the NF Instances whose status is requested to be monitored. |

## 6.1.6.2.39 Type: AmfCond

**Table 6.1.6.2.39-1: Definition of type AmfCond**

| Attribute name                                                                                                                                                                                                                                                                              | Data type   | P | Cardinality | Description                                                                        |
|---------------------------------------------------------------------------------------------------------------------------------------------------------------------------------------------------------------------------------------------------------------------------------------------|-------------|---|-------------|------------------------------------------------------------------------------------|
| amfSetId                                                                                                                                                                                                                                                                                    | AmfSetId    | C | 1           | AMF Set ID of the NF Instances (AMF) whose status is requested to be monitored.    |
| amfRegionId                                                                                                                                                                                                                                                                                 | AmfRegionId | C | 1           | AMF Region ID of the NF Instances (AMF) whose status is requested to be monitored. |
| NOTE 1: At least amfSetId or amfRegionId shall be present; if both the amfRegionId and amfSetId attributes are present in the SubscriptionData, this indicates a subscription for notifications satisfying both attributes (i.e. notifications for NFs from that amfRegionId and amfSetId). |             |   |             |                                                                                    |
| NOTE 2: The PLMN ID (or PLMN ID and NID) of the AMF Region and AMF Set of the NF Instances (AMF) whose status is requested to be monitored may be indicated in the plmnId attribute (or plmnid and nid attributes) in the SubscriptionData.                                                 |             |   |             |                                                                                    |

## 6.1.6.2.40 Type: GuamiListCond

**Table 6.1.6.2.40-1: Definition of type GuamiListCond**

| Attribute name | Data type    | P | Cardinality | Description                                                                                                                                                                                                       |
|----------------|--------------|---|-------------|-------------------------------------------------------------------------------------------------------------------------------------------------------------------------------------------------------------------|
| guamiList      | array(Guami) | M | 1..N        | Guamis of the NF Instances (AMFs) whose status is requested to be monitored (i.e. whose guamiList IE in the amfInfo or amfInfoList IE matches at least one of the GUAMI in the guamiList IE of the subscription). |

## 6.1.6.2.41 Type: NetworkSliceCond

**Table 6.1.6.2.41-1: Definition of type NetworkSliceCond**

| Attribute name | Data type     | P | Cardinality | Description                                                              |
|----------------|---------------|---|-------------|--------------------------------------------------------------------------|
| snssaiList     | array(Snssai) | M | 1..N        | S -NSSAIs of the NF Instances whose status is requested to be monitored. |
| nsiList        | array(string) | O | 1..N        | NSI IDs of the NF Instances whose status is requested to be monitored.   |

## 6.1.6.2.42 Type: NfGroupCond

**Table 6.1.6.2.42-1: Definition of type NfGroupCond**

| Attribute name | Data type | P | Cardinality | Description                                                                                              |
|----------------|-----------|---|-------------|----------------------------------------------------------------------------------------------------------|
| nfType         | string    | M | 1           | NF type (UDM, AUSF, PCF, UDR, HSS or CHF) of the NF Instances whose status is requested to be monitored. |
| nfGroupId      | NfGroupId | M | 1           | Group ID of the NF Instances whose status is requested to be monitored.                                  |

## 6.1.6.2.43 Type: NotifCondition

**Table 6.1.6.2.43-1: Definition of type NotifCondition**

| Attribute name                                                                                            | Data type     | P | Cardinality | Description                                                                                                                                                                                                                                         |
|-----------------------------------------------------------------------------------------------------------|---------------|---|-------------|-----------------------------------------------------------------------------------------------------------------------------------------------------------------------------------------------------------------------------------------------------|
| monitoredAttributes                                                                                       | array(string) | C | 1..N        | List of JSON Pointers (as specified in IETF RFC 6901 [14]) of attributes in the NF Profile.<br><br>If this attribute is present, the NRF shall send notification only for changes in the attributes included in this list (see NOTE 1).             |
| unmonitoredAttributes                                                                                     | array(string) | C | 1..N        | List of JSON Pointers (as specified in IETF RFC 6901 [14]) of attributes in the NF Profile.<br><br>If this attribute is present, the NRF shall send notification for changes on any attribute, except for those included in this list (see NOTE 1). |
| NOTE 1: Attributes "monitoredAttributes" and "unmonitoredAttributes" shall not be included simultaneously |               |   |             |                                                                                                                                                                                                                                                     |

EXAMPLE 1: The following JSON object would represent a monitoring condition where the client requests to be notified of all changes on the NF Profile, except "load" attribute.

```
{
  "unmonitoredAttributes": [ "/load" ]
}
```

EXAMPLE 2: The following JSON object would represent a monitoring condition where the client requests to be notified only of changes on attribute "nfStatus":

```
{
  "monitoredAttributes": [ "/nfStatus" ]
}
```

EXAMPLE 3: The following JSON object would represent a monitoring condition where the client requests to be notified only of changes on the first item of "nfServices":

```
{
  "monitoredAttributes": [ "/nfServices/0" ]
}
```

## 6.1.6.2.44 Type: PlmnSnssai

**Table 6.1.6.2.44-1: Definition of type PlmnSnssai**

| Attribute name | Data type        | P | Cardinality | Description                                                        |
|----------------|------------------|---|-------------|--------------------------------------------------------------------|
| plmnId         | PlmnId           | M | 1           | PLMN ID for which list of supported S-NSSAI(s) is provided.        |
| sNssaiList     | array(ExtSnssai) | M | 1..N        | The specific list of S-NSSAIs supported by the given PLMN or SNPN. |
| nid            | Nid              | O | 0..1        | NID for which list of supported S-NSSAI(s) is provided.            |

## 6.1.6.2.45 Type: NwdafInfo

Table 6.1.6.2.45-1: Definition of type NwdafInfo

| Attribute name     | Data type              | P | Cardinality | Description                                                                                                                                                                                                                     |
|--------------------|------------------------|---|-------------|---------------------------------------------------------------------------------------------------------------------------------------------------------------------------------------------------------------------------------|
| eventIds           | array(EventId)         | C | 1..N        | EventId(s) supported by the Nnwdaf_AnalyticsInfo service, if none are provided the NWDAF can serve any eventId.                                                                                                                 |
| nwdafEvents        | array(NwdafEvent)      | C | 1..N        | Event(s) supported by the Nnwdaf_EventsSubscription service, if none are provided the NWDAF can serve any nwdafEvent.                                                                                                           |
| taiList            | array(Tai)             | O | 1..N        | The list of TAIs the NWDAF can serve. It may contain one or more non-3GPP access TAIs. The absence of this attribute and the taiRangeList attribute indicate that the NWDAF can be selected for any TAI in the serving network. |
| taiRangeList       | array(TaiRange)        | O | 1..N        | The range of TAIs the NWDAF can serve. It may contain non-3GPP access TAIs. The absence of this attribute and the taiList attribute indicate that the NWDAF can be selected for any TAI in the serving network.                 |
| nwdafCapability    | NwdafCapability        | O | 0..1        | If present, this IE shall indicate the capability of the NWDAF.<br>If not present, the NWDAF shall be regarded with no capability.                                                                                              |
| analyticsDelay     | DurationSec            | O | 0..1        | Supported Analytics Delay related to the eventIds and nwdafEvents.                                                                                                                                                              |
| servingNfTypeList  | array(NFType)          | O | 1..N        | If present, this IE shall contain the list of NF type(s) from which the NWDAF NF can collect data. The absence of this attribute indicates that the NWDAF can collect data from any NF type.                                    |
| servingNfSetIdList | array(NfSetId)         | O | 1..N        | If present, this IE shall contain the list of NF Set Id(s) from which the NWDAF NF can collect data. The absence of this attribute indicates that the NWDAF can collect data from any NF Set.                                   |
| mlAnalyticsList    | array(MlAnalyticsInfo) | C | 1..N        | ML Analytics Filter information supported by the Nnwdaf_MLModelProvision service.                                                                                                                                               |



## 6.1.6.2.46 Type: LmflInfo

Table 6.1.6.2.46-1: Definition of type LmflInfo

| Attribute name     | Data type                 | P | Cardinality | Description                                                                                                                                                                                                                                                                                                                                                             |
|--------------------|---------------------------|---|-------------|-------------------------------------------------------------------------------------------------------------------------------------------------------------------------------------------------------------------------------------------------------------------------------------------------------------------------------------------------------------------------|
| servingClientTypes | array(ExternalClientType) | C | 1..N        | This IE shall be present if the LMF is dedicated to serve the listed external client type(s), e.g. emergency client. The NRF should only include this LMF instance to NF discovery with "client-type" query parameter indicating one of the external client types in the list.<br><br>Absence of this IE means the LMF is not dedicated to serve specific client types. |
| lmfld              | LMFIdentification         | C | 0..1        | When present, this ID shall indicate the LMF identification.                                                                                                                                                                                                                                                                                                            |
| servingAccessTypes | array(AccessType)         | C | 1..N        | If included, this IE shall contain the access type (i.e. 3GPP_ACCESS and/or NON_3GPP_ACCESS) supported by the LMF.<br><br>If not included, it shall be assumed that all access types are supported.                                                                                                                                                                     |
| servingAnNodeTypes | array(AnNodeType)         | C | 1..N        | If included, this IE shall contain the AN node type (i.e. gNB or NG-eNB) supported by the LMF.<br><br>If not included, it shall be assumed that all AN node types are supported.                                                                                                                                                                                        |
| servingRatTypes    | array(RatType)            | C | 1..N        | If included, this IE shall contain the RAT type (e.g. 5G NR, eLTE or any of the RAT Types specified for NR satellite access) supported by the LMF.<br><br>If not included, it shall be assumed that all RAT types are supported.                                                                                                                                        |
| taiList            | array(Tai)                | O | 1..N        | When present, this IE shall contain TAI list that the LMF can serve. It may contain one or more non-3GPP access TAIs.<br><br>The absence of both this attribute and the taiRangeList attribute indicates that the LMF can be selected for any TAI in the serving network.                                                                                               |
| taiRangeList       | array(TaiRange)           | O | 1..N        | When present, this IE shall contain TAI range list that the LMF can serve. It may contain one or more non-3GPP access TAI ranges. The absence of both this attribute and the taiList attribute indicates that the LMF can be selected for any TAI in the serving network.                                                                                               |
| supportedGADShapes | array(SupportedGADShapes) | O | 1..N        | If included, this IE shall contain the GAD shapes supported by the LMF.<br><br>If not included, it doesn't indicate that the LMF doesn't support any GAD shapes.                                                                                                                                                                                                        |

## 6.1.6.2.47 Type: GmlcInfo

**Table 6.1.6.2.47-1: Definition of type GmlcInfo**

| Attribute name     | Data type                 | P | Cardinality | Description                                                                                                                                                                                                                                                                                                                                                                                      |
|--------------------|---------------------------|---|-------------|--------------------------------------------------------------------------------------------------------------------------------------------------------------------------------------------------------------------------------------------------------------------------------------------------------------------------------------------------------------------------------------------------|
| servingClientTypes | array(ExternalClientType) | C | 1..N        | <p>This IE shall be present if the GMLC is dedicated to serve the listed external client type(s), e.g. emergency client. The NRF should only include this GMLC instance to NF discovery with "client-type" query parameter indicating one of the external client types in the list.</p> <p>Absence of this IE means the GMLC is not dedicated to serve specific client types.</p>                |
| gmlcNumbers        | array(string)             | O | 1..N        | <p>This IE shall be present if the GMLC is configured with a number of GMLC Numbers.</p> <p>When present, each item of the array shall carry an OctetString indicating the ISDN number of the GMLC in international number format as described in ITU-T Rec. E.164 [44] and shall be encoded as a TBCD-string.</p> <p>Pattern for each item of the array: "<math>\wedge[0-9]\{5,15\}</math>"</p> |

## 6.1.6.2.48 Type: NefInfo

Table 6.1.6.2.48-1: Definition of type NefInfo

| Attribute name                  | Data type            | P | Cardinality | Description                                                                                                                                                                                                                                                                                                             |
|---------------------------------|----------------------|---|-------------|-------------------------------------------------------------------------------------------------------------------------------------------------------------------------------------------------------------------------------------------------------------------------------------------------------------------------|
| nefId                           | NefId                | C | 0..1        | This IE shall be present and contain the NEF ID of the NEF if NIDD service is supported.                                                                                                                                                                                                                                |
| pfdData                         | PfdData              | O | 0..1        | PFD data, containing the list of internal application identifiers and/or the list of application function identifiers for which the PFDs can be provided.<br><br>Absence of this attribute indicates that the PFDs for any internal application identifier and for any application function identifier can be provided. |
| afEeData                        | AfEventExposure Data | O | 0..1        | The AF provided event exposure data. The NEF registers such information in the NRF on behalf of the AF.                                                                                                                                                                                                                 |
| gpsiRanges                      | array(IdentityRange) | O | 1..N        | Range(s) of External Identifiers                                                                                                                                                                                                                                                                                        |
| externalGroupIdentifiers Ranges | array(IdentityRange) | O | 1..N        | Range(s) of External Group Identifiers                                                                                                                                                                                                                                                                                  |
| servedFqdnList                  | array(string)        | O | 1..N        | Pattern (regular expression according to the ECMA-262 dialect [8]) representing the Domain names served by the NEF                                                                                                                                                                                                      |
| taiList                         | array(Tai)           | O | 1..N        | The list of TAIs the NEF can serve. It may contain one or more non-3GPP access TAIs. The absence of this attribute and the taiRangeList attribute indicates that the NEF can be selected for any TAI in the serving network.                                                                                            |
| taiRangeList                    | array(TaiRange)      | O | 1..N        | The range of TAIs the NEF can serve. It may contain non-3GPP access TAIs. The absence of this attribute and the taiList attribute indicates that the NEF can be selected for any TAI in the serving network.                                                                                                            |
| dnaiList                        | array(Dnai)          | O | 1..N        | List of Data network access identifiers supported by the NEF. The absence of this attribute indicates that the NEF can be selected for any DNAI.                                                                                                                                                                        |
| unTrustAfInfoList               | array(UnTrustAfInfo) | O | 1..N        | List of information corresponding to the AFs.                                                                                                                                                                                                                                                                           |
| uasNfFunctionalityInd           | boolean              | O | 0..1        | When present, this IE shall indicate whether the NEF supports UAS NF functionality:<br><br>- true: UAS NF functionality is supported by the NEF<br>- false (default): UAS NF functionality is not supported by the NEF.                                                                                                 |

## 6.1.6.2.49 Type: PfdData

Table 6.1.6.2.49-1: Definition of type PfdData

| Attribute name | Data type     | P | Cardinality | Description                                                   |
|----------------|---------------|---|-------------|---------------------------------------------------------------|
| applds         | array(string) | O | 1..N        | List of internal application identifiers of the managed PFDs. |
| aflds          | array(string) | O | 1..N        | List of application function identifiers of the managed PFDs. |

## 6.1.6.2.50 Type: AfEventExposureData

Table 6.1.6.2.50-1: Definition of type AfEventExposureData

| Attribute name | Data type | P | Cardinality | Description |
|----------------|-----------|---|-------------|-------------|
|----------------|-----------|---|-------------|-------------|

|          |                |   |      |                                                                                                                                                                 |
|----------|----------------|---|------|-----------------------------------------------------------------------------------------------------------------------------------------------------------------|
| afEvents | array(AfEvent) | M | 1..N | AF Event(s) exposed by the NEF after registration of the AF(s) at the NEF.                                                                                      |
| aflds    | array(string)  | O | 1..N | Associated AF identifications to the AfEvents. The absence of this attribute indicate that the NEF can be selected for any AF.                                  |
| applds   | array(string)  | O | 1..N | The list of Application ID(s) the AF(s) connected to the NEF supports. The absence of this attribute indicate that the NEF can be selected for any Application. |

## 6.1.6.2.51 Type: WAgfInfo

Table 6.1.6.2.51-1: Definition of type WAgfInfo

| Attribute name        | Data type       | P | Cardinality | Description                                                          |
|-----------------------|-----------------|---|-------------|----------------------------------------------------------------------|
| ipv4EndpointAddresses | array(Ipv4Addr) | C | 1..N        | Available endpoint IPv4 address(es) of the N3 terminations (NOTE 1). |
| ipv6EndpointAddresses | array(Ipv6Addr) | C | 1..N        | Available endpoint IPv6 address(es) of the N3 terminations (NOTE 1). |
| endpointFqdn          | Fqdn            | C | 0..1        | Available endpoint FQDN of the N3 terminations (NOTE 1).             |

NOTE 1: At least one of the addressing parameters (ipv4address, ipv6address or endpointFqdn) shall be included in the WAgfInfo.

## 6.1.6.2.52 Type: TngfInfo

Table 6.1.6.2.52-1: Definition of type TngfInfo

| Attribute name        | Data type       | P | Cardinality | Description                                                          |
|-----------------------|-----------------|---|-------------|----------------------------------------------------------------------|
| ipv4EndpointAddresses | array(Ipv4Addr) | C | 1..N        | Available endpoint IPv4 address(es) of the N3 terminations (NOTE 1). |
| ipv6EndpointAddresses | array(Ipv6Addr) | C | 1..N        | Available endpoint IPv6 address(es) of the N3 terminations (NOTE 1). |
| endpointFqdn          | Fqdn            | C | 0..1        | Available endpoint FQDN of the N3 terminations (NOTE 1).             |

NOTE 1: At least one of the addressing parameters (ipv4address, ipv6address or endpointFqdn) shall be included in the TngfInfo.

## 6.1.6.2.53 Type: PcsclInfo

Table 6.1.6.2.53-1: Definition of type PcsclInfo

| Attribute name  | Data type         | P | Cardinality | Description                                                                                                                                                                                                                                                                                             |
|-----------------|-------------------|---|-------------|---------------------------------------------------------------------------------------------------------------------------------------------------------------------------------------------------------------------------------------------------------------------------------------------------------|
| accessType      | array(AccessType) | C | 1..N        | If included, this IE shall contain the access type (3GPP_ACCESS and/or NON_3GPP_ACCESS) supported by the P-CSCF. If not included, it shall be assumed that all access types are supported.                                                                                                              |
| dnnList         | array(Dnn)        | O | 1..N        | DNNs supported by the P-CSCF. The DNN shall contain the Network Identifier and it may additionally contain an Operator Identifier. If the Operator Identifier is not included, the DNN is supported for all the PLMNs in the plmnList of the NF Profile. If not provided, the P-CSCF can serve any DNN. |
| gmFqdn          | Fqdn              | O | 0..1        | FQDN of the P-CSCF for the Gm interface                                                                                                                                                                                                                                                                 |
| gmIpv4Addresses | array(Ipv4Addr)   | O | 1..N        | IPv4 address(es) of the P-CSCF for the Gm interface                                                                                                                                                                                                                                                     |
| gmIpv6Addresses | array(Ipv6Addr)   | O | 1..N        | IPv6 address(es) of the P-CSCF for the Gm interface                                                                                                                                                                                                                                                     |
| mwFqdn          | Fqdn              | O | 0..1        | FQDN of the P-CSCF for the Mw interface (NOTE)                                                                                                                                                                                                                                                          |

|                                                                                                                                                                                                                                                                                                                                                                                                   |                         |   |      |                                                                                                                                                                       |
|---------------------------------------------------------------------------------------------------------------------------------------------------------------------------------------------------------------------------------------------------------------------------------------------------------------------------------------------------------------------------------------------------|-------------------------|---|------|-----------------------------------------------------------------------------------------------------------------------------------------------------------------------|
| mwlPv4Addresses                                                                                                                                                                                                                                                                                                                                                                                   | array(Ipv4Addr)         | O | 1..N | IPv4 address(es) of the P-CSCF for the Mw interface<br>(NOTE)                                                                                                         |
| mwlPv6Addresses                                                                                                                                                                                                                                                                                                                                                                                   | array(Ipv6Addr)         | O | 1..N | IPv6 address(es) of the P-CSCF for the Mw interface<br>(NOTE)                                                                                                         |
| servedIpv4AddressRanges                                                                                                                                                                                                                                                                                                                                                                           | array(Ipv4AddressRange) | O | 1..N | List of ranges of UE IPv4 addresses used on the Gm interface, served by P-CSCF.<br>The absence of this attribute does not mean the P-CSCF can serve any IPv4 address. |
| servedIpv6PrefixRanges                                                                                                                                                                                                                                                                                                                                                                            | array(Ipv6PrefixRange)  | O | 1..N | List of ranges of UE IPv6 prefixes used on the Gm interface, served by P-CSCF.<br>The absence of this attribute does not mean the P-CSCF can serve any IPv6 prefix.   |
| NOTE: The Mw addressing information of the P-CSCF may be used by other NFs (e.g., SMF) in P-CSCF restoration scenarios (see 3GPP TS 23.380 [45], clause 5.8.4.2 and clause 5.8.5.2), where a mapping between Gm and Mw addresses may be used to determine the updated list of P-CSCFs to be sent to the UE, after excluding those P-CSCF instances that have been deemed as failed by the S-CSCF. |                         |   |      |                                                                                                                                                                       |

## 6.1.6.2.54 Type: NfSetCond

Table 6.1.6.2.54-1: Definition of type NfSetCond

| Attribute name | Data type | P | Cardinality | Description                                                                                                    |
|----------------|-----------|---|-------------|----------------------------------------------------------------------------------------------------------------|
| nfSetId        | NfSetId   | M | 1           | NF Set ID (see clause 28.12 of 3GPP TS 23.003 [12]) of NF Instances whose status is requested to be monitored. |

## 6.1.6.2.55 Type: NfServiceSetCond

Table 6.1.6.2.55-1: Definition of type NfServiceSetCond

| Attribute name | Data type      | P | Cardinality | Description                                                                                                                                                                                                                         |
|----------------|----------------|---|-------------|-------------------------------------------------------------------------------------------------------------------------------------------------------------------------------------------------------------------------------------|
| nfServiceSetId | NfServiceSetId | M | 1           | NF Service Set ID (see clause 28.13 of 3GPP TS 23.003 [12]) of NF service instances whose status is requested to be monitored.                                                                                                      |
| nfSetId        | NfSetId        | C | 0..1        | NF Set ID (see clause 28.12 of 3GPP TS 23.003 [12]).<br><br>This attribute shall be included if the consumer requests to monitor the status of all equivalent NF Service Instances in the provided NF Set ID and NF Service Set ID. |

## 6.1.6.2.56 Type: NfInfo

Table 6.1.6.2.56-1: Definition of type NfInfo

| Attribute name | Data type | P | Cardinality | Description                                |
|----------------|-----------|---|-------------|--------------------------------------------|
| nfType         | NfType    | M | 1           | This IE shall indicate the type of the NF. |

## 6.1.6.2.57 Type: HssInfo

Table 6.1.6.2.57-1: Definition of type HssInfo

| Attribute name                                                                                                                                                                                                                                                                                                                                                                                                                                        | Data type                  | P | Cardinality | Description                                                                                                                                            |
|-------------------------------------------------------------------------------------------------------------------------------------------------------------------------------------------------------------------------------------------------------------------------------------------------------------------------------------------------------------------------------------------------------------------------------------------------------|----------------------------|---|-------------|--------------------------------------------------------------------------------------------------------------------------------------------------------|
| groupid                                                                                                                                                                                                                                                                                                                                                                                                                                               | NfGroupId                  | O | 0..1        | Identity of the HSS group that is served by the HSS instance.<br>If not provided, the HSS instance does not pertain to any HSS group.<br>(NOTE 1)      |
| imsiRanges                                                                                                                                                                                                                                                                                                                                                                                                                                            | array(ImsiRange)           | O | 1..N        | List of ranges of IMSIs whose profile data is available in the HSS instance (NOTE 1)                                                                   |
| imsPrivateIdentityRanges                                                                                                                                                                                                                                                                                                                                                                                                                              | array(IdentityRange)       | O | 1..N        | List of ranges of IMS Private Identities whose profile data is available in the HSS instance (NOTE 1, NOTE 2)                                          |
| imsPublicIdentityRanges                                                                                                                                                                                                                                                                                                                                                                                                                               | array(IdentityRange)       | O | 1..N        | List of ranges of IMS Public Identities whose profile data is available in the HSS instance (NOTE 1)                                                   |
| msisdnsRanges                                                                                                                                                                                                                                                                                                                                                                                                                                         | array(IdentityRange)       | O | 1..N        | List of ranges of MSISDNs whose profile data is available in the HSS instance (NOTE 1)                                                                 |
| externalGroupIdentifiersRanges                                                                                                                                                                                                                                                                                                                                                                                                                        | array(IdentityRange)       | O | 1..N        | List of ranges of external group IDs that can be served by this HSS instance.<br>If not provided, the HSS instance does not serve any external groups. |
| hssDiameterAddress                                                                                                                                                                                                                                                                                                                                                                                                                                    | NetworkNodeDiameterAddress | O | 0..1        | Diameter Address of the HSS                                                                                                                            |
| NOTE 1: If none of these parameters are provided, the HSS can serve any IMSI or IMS Private Identity or IMS Public Identity or MSISDN managed by the PLMN of the HSS instance. If "imsiRanges", "imsPrivateIdentityRanges", "imsPublicIdentityRanges" and "msisdnsRanges" attributes are absent, and "groupid" is present, the IMSIs / IMS Private Identities / IMS Public Identities / MSISDNs served by this HSS instance is determined by the NRF. |                            |   |             |                                                                                                                                                        |
| NOTE 2: In deployments where the users IMPIs are derived from their IMSIs (see 3GPP TS 23.003 [12], clause 13.3, the HSS shall only register imsiRanges in NRF.                                                                                                                                                                                                                                                                                       |                            |   |             |                                                                                                                                                        |

## 6.1.6.2.58 Type: ImsiRange

Table 6.1.6.2.58-1: Definition of type ImsiRange

| Attribute name                                                                         | Data type | P | Cardinality | Description                                                                                                                                                                                                                                  |
|----------------------------------------------------------------------------------------|-----------|---|-------------|----------------------------------------------------------------------------------------------------------------------------------------------------------------------------------------------------------------------------------------------|
| start                                                                                  | string    | O | 0..1        | First value identifying the start of a IMSI range.<br>Pattern: "^{0-9}+\$"                                                                                                                                                                   |
| end                                                                                    | string    | O | 0..1        | Last value identifying the end of a IMSI range.<br>Pattern: "^{0-9}+\$"                                                                                                                                                                      |
| pattern                                                                                | string    | O | 0..1        | Pattern (regular expression according to the ECMA-262 dialect [8]) representing the set of IMSIs belonging to this range. An IMSI value is considered part of the range if and only if the IMSI string fully matches the regular expression. |
| NOTE: Either the start and end attributes, or the pattern attribute, shall be present. |           |   |             |                                                                                                                                                                                                                                              |

## 6.1.6.2.59 Type: InternalGroupIdRange

**Table 6.1.6.2.59-1: Definition of type InternalGroupIdRange**

| Attribute name                                                                         | Data type | P | Cardinality | Description                                                                                                                                                                                                                                               |
|----------------------------------------------------------------------------------------|-----------|---|-------------|-----------------------------------------------------------------------------------------------------------------------------------------------------------------------------------------------------------------------------------------------------------|
| start                                                                                  | GroupId   | O | 0..1        | First value identifying the start of an identity range, to be used when the range of identities can be represented as a consecutive numeric range.                                                                                                        |
| end                                                                                    | GroupId   | O | 0..1        | Last value identifying the end of an identity range, to be used when the range of identities can be represented as a consecutive numeric range.                                                                                                           |
| pattern                                                                                | string    | O | 0..1        | Pattern (regular expression according to the ECMA-262 dialect [8]) representing the set of identities belonging to this range. An identity value is considered part of the range if and only if the identity string fully matches the regular expression. |
| NOTE: Either the start and end attributes, or the pattern attribute, shall be present. |           |   |             |                                                                                                                                                                                                                                                           |

## 6.1.6.2.60 Type: UpfCond

**Table 6.1.6.2.60-1: Definition of type UpfCond**

| Attribute name | Data type     | P | Cardinality | Description                                                                                                                                                                |
|----------------|---------------|---|-------------|----------------------------------------------------------------------------------------------------------------------------------------------------------------------------|
| conditionType  | string        | M | 1           | This attribute serves as discriminator, to make all data types defined in Table 6.1.6.2.35-1 mutually exclusive.<br>In this data type, it shall take the value "UPF_COND". |
| smfServingArea | array(string) | C | 1..N        | SMF service area(s) of the UPF whose status is requested to be monitored.<br>This IE shall be present if the monitored granularity is SMF service area(s).                 |
| taiList        | array(Tai)    | C | 1..N        | TAI(s) of the UPF whose status is requested to be monitored.<br>This IE shall be present if the monitored granularity is TAI list.                                         |

## 6.1.6.2.61 Type: TwifInfo

**Table 6.1.6.2.61-1: Definition of type TwifInfo**

| Attribute name                                                                                                                  | Data type       | P | Cardinality | Description                                                         |
|---------------------------------------------------------------------------------------------------------------------------------|-----------------|---|-------------|---------------------------------------------------------------------|
| ipv4EndpointAddresses                                                                                                           | array(Ipv4Addr) | C | 1..N        | Available endpoint IPv4 address(es) of the N3 terminations (NOTE 1) |
| ipv6EndpointAddresses                                                                                                           | array(Ipv6Addr) | C | 1..N        | Available endpoint IPv6 address(es) of the N3 terminations (NOTE 1) |
| endpointFqdn                                                                                                                    | Fqdn            | C | 0..1        | Available endpoint FQDN of the N3 terminations (NOTE 1)             |
| NOTE 1: At least one of the addressing parameters (ipv4address, ipv6address or endpointFqdn) shall be included in the TwifInfo. |                 |   |             |                                                                     |

## 6.1.6.2.62 Type: VendorSpecificFeature

Table 6.1.6.2.62-1: Definition of type VendorSpecificFeature

| Attribute name | Data type | P | Cardinality | Description                                                                                                                                                                                                                                            |
|----------------|-----------|---|-------------|--------------------------------------------------------------------------------------------------------------------------------------------------------------------------------------------------------------------------------------------------------|
| featureName    | string    | M | 1           | String representing a proprietary feature specific to a given vendor.<br><br>It is recommended that the case convention for these strings is the same as for enumerated data types (i.e. UPPER_WITH_UNDERSCORE; see 3GPP TS 29.501 [5], clause 5.1.1). |
| featureVersion | string    | M | 1           | String representing the version of the feature.<br><br>It is recommended that the versioning system follows the Semantic Versioning Specification [39].                                                                                                |

## 6.1.6.2.63 Type: UdsfInfo

Table 6.1.6.2.63-1: Definition of type UdsfInfo

| Attribute name                                                                     | Data type                 | P | Cardinality | Description                                                                                                                                                                                                                                                                                                                                                                                          |
|------------------------------------------------------------------------------------|---------------------------|---|-------------|------------------------------------------------------------------------------------------------------------------------------------------------------------------------------------------------------------------------------------------------------------------------------------------------------------------------------------------------------------------------------------------------------|
| groupId                                                                            | NfGroupId                 | O | 0..1        | Identity of the UDSF group that is served by the UDSF instance.<br>If not provided, the UDSF instance does not pertain to any UDSF group.                                                                                                                                                                                                                                                            |
| supiRanges                                                                         | array(SupiRange)          | O | 1..N        | List of ranges of SUPIs whose profile data is available in the UDSF instance (NOTE 1)                                                                                                                                                                                                                                                                                                                |
| storageIdRanges                                                                    | map(array(IdentityRange)) | C | 1..N(1..M)  | A map (list of key-value pairs) where realmId serves as key and each value in the map is an array of IdentityRanges. Each IdentityRange is a range of storageIds. A UDSF complying with this version of the specification shall include this IE.<br>Absence indicates that the UDSF's supported realms and storages are determined by the UDSF's consumer by other means such as local provisioning. |
| NOTE 1: If this parameter is not provided, then the UDSF can serve any SUPI range. |                           |   |             |                                                                                                                                                                                                                                                                                                                                                                                                      |

## 6.1.6.2.64 Type: NfInstanceIdListCond

Table 6.1.6.2.64-1: Definition of type NfInstanceIdListCond

| Attribute name   | Data type           | P | Cardinality | Description                                                       |
|------------------|---------------------|---|-------------|-------------------------------------------------------------------|
| nfInstanceIdList | array(NfInstanceId) | C | 1..N        | A list of NF Instances whose status is requested to be monitored. |



6.1.6.2.65      Type: ScplInfo

**Table 6.1.6.2.65-1: Definition of type ScplInfo**

| Attribute name    | Data type               | P | Cardinality | Description                                                                                                                                                                                                                                                                                                                                                                                                                                                                                    |
|-------------------|-------------------------|---|-------------|------------------------------------------------------------------------------------------------------------------------------------------------------------------------------------------------------------------------------------------------------------------------------------------------------------------------------------------------------------------------------------------------------------------------------------------------------------------------------------------------|
| scpDomainInfoList | map(ScpDomainInfo)      | O | 1..N        | SCP domain specific information of the SCP that differs from the common information in NFProfile data type. The key of the map shall be the string identifying an SCP domain.                                                                                                                                                                                                                                                                                                                  |
| scpPrefix         | string                  | O | 0..1        | Optional deployment specific string used to construct the apiRoot of the next hop SCP, as described in clause 6.10 of 3GPP TS 29.500 [4].                                                                                                                                                                                                                                                                                                                                                      |
| scpPorts          | map(integer)            | C | 1..N        | <p>SCP port number(s) for HTTP and/or HTTPS (NOTE 1)</p> <p>This attribute shall be present if the SCP uses non-default HTTP and/or HTTPS ports and if the SCP does not provision port information within ScpDomainInfo for each SCP domain it belongs to.</p> <p>When present, it shall contain the HTTP and/or HTTPS ports.</p> <p>The key of the map shall be "http" or "https". The value shall indicate the port number for HTTP or HTTPS respectively.<br/>Minimum: 0 Maximum: 65535</p> |
| addressDomains    | array(string)           | O | 1..N        | <p>Pattern (regular expression according to the ECMA-262 dialect [8]) representing the address domain names reachable through the SCP.</p> <p>Absence of this IE indicates the SCP can reach any address domain names in the SCP domain(s) it belongs to.</p>                                                                                                                                                                                                                                  |
| ipv4Addresses     | array(Ipv4Addr)         | O | 1..N        | <p>List of IPv4 addresses reachable through the SCP.</p> <p>This IE may be present if IPv4 addresses are reachable via the SCP.</p> <p>If IPv4 addresses are reachable via the SCP, absence of both this IE and ipv4AddrRanges IE indicates the SCP can reach any IPv4 addresses in the SCP domain(s) it belongs to.</p>                                                                                                                                                                       |
| ipv6Prefixes      | array(Ipv6Prefix)       | O | 1..N        | <p>List of IPv6 prefixes reachable through the SCP.</p> <p>This IE may be present if IPv6 addresses are reachable via the SCP.</p> <p>If IPv6 addresses are reachable via the SCP, absence of both this IE and ipv6PrefixRanges IE indicates the SCP can reach any IPv6 prefixes in the SCP domain(s) it belongs to.</p>                                                                                                                                                                       |
| ipv4AddrRanges    | array(Ipv4AddressRange) | O | 1..N        | <p>List of IPv4 addresses ranges reachable through the SCP.</p> <p>This IE may be present if IPv4 addresses are reachable via the SCP.</p> <p>If IPv4 addresses are reachable via the SCP, absence of both this IE and ipv4Addresses IE indicates the SCP can reach any IPv4 addresses in the SCP domain(s) it belongs to.</p>                                                                                                                                                                 |

|                                                                                                                                                                                                                                                                                                                                                                                                                                                                                                                                                                                                                                                                                                                                                                                                                                                                                                                                                                                                                        |                        |   |      |                                                                                                                                                                                                                                                                                                                                                                                                                                                                                                     |
|------------------------------------------------------------------------------------------------------------------------------------------------------------------------------------------------------------------------------------------------------------------------------------------------------------------------------------------------------------------------------------------------------------------------------------------------------------------------------------------------------------------------------------------------------------------------------------------------------------------------------------------------------------------------------------------------------------------------------------------------------------------------------------------------------------------------------------------------------------------------------------------------------------------------------------------------------------------------------------------------------------------------|------------------------|---|------|-----------------------------------------------------------------------------------------------------------------------------------------------------------------------------------------------------------------------------------------------------------------------------------------------------------------------------------------------------------------------------------------------------------------------------------------------------------------------------------------------------|
| ipv6PrefixRanges                                                                                                                                                                                                                                                                                                                                                                                                                                                                                                                                                                                                                                                                                                                                                                                                                                                                                                                                                                                                       | array(Ipv6PrefixRange) | O | 1..N | <p>List of IPv6 prefixes ranges reachable through the SCP.</p> <p>This IE may be present if IPv6 addresses are reachable via the SCP.</p> <p>If IPv6 addresses are reachable via the SCP, absence of both this IE and ipv6Prefixes IE indicates the SCP can reach any IPv6 prefixes in the SCP domain(s) it belongs to.</p>                                                                                                                                                                         |
| servedNfSetIdList                                                                                                                                                                                                                                                                                                                                                                                                                                                                                                                                                                                                                                                                                                                                                                                                                                                                                                                                                                                                      | array(NfSetId)         | O | 1..N | <p>List of NF set ID of NFs served by the SCP.</p> <p>Absence of this IE indicates the SCP can reach any NF set in the SCP domain(s) it belongs to.</p>                                                                                                                                                                                                                                                                                                                                             |
| remotePlmnList                                                                                                                                                                                                                                                                                                                                                                                                                                                                                                                                                                                                                                                                                                                                                                                                                                                                                                                                                                                                         | array(PlmnId)          | O | 1..N | <p>List of remote PLMNs reachable through the SCP.</p> <p>Absence of this IE indicates that no remote PLMN is reachable through the SCP.</p>                                                                                                                                                                                                                                                                                                                                                        |
| remoteSnpnList                                                                                                                                                                                                                                                                                                                                                                                                                                                                                                                                                                                                                                                                                                                                                                                                                                                                                                                                                                                                         | array(PlmnIdNid)       | O | 1..N | <p>List of remote SNPNs reachable through the SCP. The absence of this IE indicates that no remote SNPN is reachable through the SCP.</p>                                                                                                                                                                                                                                                                                                                                                           |
| ipReachability                                                                                                                                                                                                                                                                                                                                                                                                                                                                                                                                                                                                                                                                                                                                                                                                                                                                                                                                                                                                         | IpReachability         | O | 0..1 | <p>This IE may be present to indicate the type(s) of IP addresses reachable via the SCP in the SCP domain(s) it belongs to.</p> <p>Absence of this IE indicates that the SCP can be used to reach both IPv4 addresses and IPv6 addresses in the SCP domain(s) it belongs to.</p>                                                                                                                                                                                                                    |
| scpCapabilities                                                                                                                                                                                                                                                                                                                                                                                                                                                                                                                                                                                                                                                                                                                                                                                                                                                                                                                                                                                                        | array(ScpCapability)   | C | 0..N | <p>List of SCP capabilities supported by the SCP. This IE shall be present if the SCP supports at least one SCP capability. It may be present otherwise, with an empty array, to indicate that the SCP does not support any capability of the ScpCapability data type. The absence of this attribute shall not be interpreted as an SCP that does not support any capability; this only means that the SCP (e.g. pre-Rel-17 SCP) did not register the capabilities it may support.<br/>(NOTE 2)</p> |
| <p>NOTE 1: If no SCP port information is present in ScpInfo or in ScpDomainInfo for a specific SCP domain, the HTTP client shall use the default HTTP port number, i.e. TCP port 80 for "http" URIs or TCP port 443 for "https" URIs as specified in IETF RFC 7540 [9] when sending a request to the SCP within the specific SCP domain.</p> <p>NOTE 2: This IE may be used by another SCP (e.g. SCP-c) to determine whether next hops' SCP(s) (e.g. SCP-p) supports Indirect Communication with Delegated Discovery, e.g. in scenarios with more than one SCP between an NF service consumer and NF service producer. This information is not intended for NF service consumers. This information shall not be used for selecting a next hop SCP. It may only be used by an SCP, once a next hop SCP is selected, to learn the capabilities of the selected SCP, and based on local policy, to determine whether to delegate the selection of the target NF service producer instance to the next hop SCP or not.</p> |                        |   |      |                                                                                                                                                                                                                                                                                                                                                                                                                                                                                                     |

## 6.1.6.2.66 Type: ScpDomainInfo

Table 6.1.6.2.66-1: Definition of type ScpDomainInfo

| Attribute name | Data type                                                                                                                                                                                                                                                                                                                                                                                                       | P | Cardinality | Description                                                                                                                                                                                                                                                                                                                                                                                                                                                                                                                                                                                                                              |
|----------------|-----------------------------------------------------------------------------------------------------------------------------------------------------------------------------------------------------------------------------------------------------------------------------------------------------------------------------------------------------------------------------------------------------------------|---|-------------|------------------------------------------------------------------------------------------------------------------------------------------------------------------------------------------------------------------------------------------------------------------------------------------------------------------------------------------------------------------------------------------------------------------------------------------------------------------------------------------------------------------------------------------------------------------------------------------------------------------------------------------|
| scpFqdn        | Fqdn                                                                                                                                                                                                                                                                                                                                                                                                            | C | 0..1        | FQDN of the SCP (NOTE)                                                                                                                                                                                                                                                                                                                                                                                                                                                                                                                                                                                                                   |
| scplpEndPoints | array(lpEndPoint)                                                                                                                                                                                                                                                                                                                                                                                               | C | 1..N        | IP address(es) and port information of the SCP. If port information is present in this attribute, it applies to any scheme (i.e. HTTP and HTTPS). (NOTE)                                                                                                                                                                                                                                                                                                                                                                                                                                                                                 |
| scpPorts       | map(integer)                                                                                                                                                                                                                                                                                                                                                                                                    | C | 1..N        | SCP port number(s) for HTTP and/or HTTPS.<br><br>This attribute shall be present if the SCP uses different ports for HTTP and HTTPS and at least one port is not the default HTTP or HTTPS port, for this SCP domain. This attribute shall be absent if port information is present in the scplpEndPoints.<br><br>When present, it shall contain the HTTP and/or HTTPS ports.<br><br>The key of the map shall be "http" or "https". The value shall indicate the port number for HTTP or HTTPS respectively.<br>Minimum: 0 Maximum: 65535<br><br>If this attribute is present, it has precedence over the scpPorts attribute of ScpInfo. |
| scpPrefix      | string                                                                                                                                                                                                                                                                                                                                                                                                          | O | 0..1        | Optional deployment specific string used to construct the apiRoot of the next hop SCP, as described in clause 6.10 of 3GPP TS 29.500 [4].<br>If the scpPrefix attribute is present in ScpInfo and in ScpDomainInfo for a specific SCP domain, the attribute in ScpDomainInfo shall prevail for this SCP domain.                                                                                                                                                                                                                                                                                                                          |
| NOTE:          | If any of these attributes is present for a given SCP domain, it shall apply instead of the attributes fqdn, ipv4Addresses and ipv6Addresses within the NFProfile data type for the corresponding SCP Domain. If none of these attributes is present for a given SCP domain, the attributes fqdn, ipv4Addresses, and ipv6Addresses within the NFProfile data type shall apply for the corresponding SCP Domain. |   |             |                                                                                                                                                                                                                                                                                                                                                                                                                                                                                                                                                                                                                                          |

## 6.1.6.2.67 Type: ScpDomainCond

Table 6.1.6.2.67-1: Definition of type ScpDomainCond

| Attribute name | Data type     | P | Cardinality | Description                                                                                                                                                                                                                                                                                                                                                                                                  |
|----------------|---------------|---|-------------|--------------------------------------------------------------------------------------------------------------------------------------------------------------------------------------------------------------------------------------------------------------------------------------------------------------------------------------------------------------------------------------------------------------|
| scpDomains     | array(string) | M | 1..N        | SCP domains of NF, SCP or SEPP instances whose status is requested to be monitored.                                                                                                                                                                                                                                                                                                                          |
| nfTypeList     | array(NFType) | C | 1..N        | This IE shall be present if available.<br>When present, it shall contain the type of the NF Instances or Network Entities (pertaining to any SCP domain in the scpDomains attribute) whose status is requested to be monitored.<br>If not present, it means that the NF Service Consumer requests a subscription to all NF, SCP and SEPP instances pertaining to any SCP domain in the scpDomains attribute. |

## 6.1.6.2.68 Type: OptionsResponse

**Table 6.1.6.2.68-1: Definition of type OptionsResponse**

| Attribute name    | Data type         | P | Cardinality | Description                                                                                                                                                                               |
|-------------------|-------------------|---|-------------|-------------------------------------------------------------------------------------------------------------------------------------------------------------------------------------------|
| supportedFeatures | SupportedFeatures | C | 0..1        | Supported features of the NRF, for the nf-instances store resource. See clause 6.1.9.<br><br>This IE shall be included if at least one Nnrf_NFManagement feature is supported by the NRF. |

## 6.1.6.2.69 Type: NwdafCond

**Table 6.1.6.2.69-1: Definition of type NwdafCond**

| Attribute name     | Data type              | P | Cardinality | Description                                                                                                                                                                  |
|--------------------|------------------------|---|-------------|------------------------------------------------------------------------------------------------------------------------------------------------------------------------------|
| conditionType      | string                 | M | 1           | This attribute serves as discriminator, to make all data types defined in Table 6.1.6.2.35-1 mutually exclusive.<br>In this data type, it shall take the value "NWDAF_COND". |
| analyticsIds       | array(string)          | O | 1..N        | Analytics Id(s) provided by consumers of NWDAF. In this data type, it shall take the value as defined in NwdafEvent IE and EventId IE in nwdafInfo.                          |
| snssaiList         | array(Snssai)          | O | 1..N        | S-NSSAIs of the NWDAF whose status is requested to be monitored.                                                                                                             |
| taiList            | array(Tai)             | O | 1..N        | TAI(s) of the NWDAF whose status is requested to be monitored. It may contain one or more non-3GPP access TAIs.                                                              |
| taiRangeList       | array(TaiRange)        | O | 1..N        | The range of TAIs of the NWDAF whose status is requested to be monitored. It may contain non-3GPP access TAIs.                                                               |
| servingNfTypeList  | array(NFType)          | O | 1..N        | NF type(s) served by the NWDAF whose status is requested to be monitored.                                                                                                    |
| servingNfSetIdList | array(NfSetId)         | O | 1..N        | NF Set Id(s) served by the NWDAF whose status is requested to be monitored.                                                                                                  |
| mlAnalyticsList    | array(MlAnalyticsInfo) | C | 1..N        | The list of ML Analytics Filter information per Analytics ID(s) supported by the NWDAF, whose status is requested to be monitored.                                           |

## 6.1.6.2.70 Type: NefCond

**Table 6.1.6.2.70-1: Definition of type NefCond**

| Attribute name                  | Data type            | P | Cardinality | Description                                                                                                                                                                |
|---------------------------------|----------------------|---|-------------|----------------------------------------------------------------------------------------------------------------------------------------------------------------------------|
| conditionType                   | string               | M | 1           | This attribute serves as discriminator, to make all data types defined in Table 6.1.6.2.35-1 mutually exclusive.<br>In this data type, it shall take the value "NEF_COND". |
| afEvents                        | array(AfEvent)       | O | 1..N        | EventId(s) supported by the AFs.                                                                                                                                           |
| snssaiList                      | array(Snssai)        | O | 1..N        | S-NSSAIs of the NEF whose status is requested to be monitored.                                                                                                             |
| pfdData                         | PfdData              | O | 0..1        | PFD data of the NEF whose status is requested to be monitored.                                                                                                             |
| gpsiRanges                      | array(IdentityRange) | O | 1..N        | Range(s) of External Identifiers of the NEF whose status is requested to be monitored.                                                                                     |
| externalGroupIdentifiers Ranges | array(IdentityRange) | O | 1..N        | Range(s) of External Group Identifiers of the NEF whose status is requested to be monitored.                                                                               |
| servedFqdnList                  | array(string)        | O | 1..N        | Pattern (regular expression according to the ECMA-262 dialect [8]) representing the Domain names of the NEF whose status is requested to be monitored.                     |

## 6.1.6.2.71 Type: SucilInfo

**Table 6.1.6.2.71-1: Definition of type SucilInfo**

| Attribute name                                                                      | Data type      | P | Cardinality | Description                                                                                                                                |
|-------------------------------------------------------------------------------------|----------------|---|-------------|--------------------------------------------------------------------------------------------------------------------------------------------|
| routingInds                                                                         | array(string)  | O | 1..N        | Indicating served Routing Indicator (see 3GPP TS 23.003 [12], clause 2.2B). If not provided, the AUSF/UDM can serve any Routing Indicator. |
| hNwPubKeyIds                                                                        | array(integer) | O | 1..N        | Indicating served Home Network Public Key (see 3GPP TS 23.003 [12], clause 2.2B). If not provided, the AUSF/UDM can serve any public key.  |
| NOTE: Any combination of any routingInds value and any hNwPubKeyIds value is valid. |                |   |             |                                                                                                                                            |

## 6.1.6.2.72 Type: SeppInfo

Table 6.1.6.2.72-1: Definition of type SeppInfo

| Attribute name                                                                                                                                                                                                                                              | Data type         | P | Cardinality | Description                                                                                                                                                                                                                                                                                                                                                            |
|-------------------------------------------------------------------------------------------------------------------------------------------------------------------------------------------------------------------------------------------------------------|-------------------|---|-------------|------------------------------------------------------------------------------------------------------------------------------------------------------------------------------------------------------------------------------------------------------------------------------------------------------------------------------------------------------------------------|
| seppPrefix                                                                                                                                                                                                                                                  | string            | O | 0..1        | Optional deployment specific string used to construct the apiRoot of the next hop SEPP, as described in clause 6.10 of 3GPP TS 29.500 [4].                                                                                                                                                                                                                             |
| seppPorts                                                                                                                                                                                                                                                   | map(integer)      | C | 1..N        | SEPP port number(s) for HTTP and/or HTTPS (NOTE 1)<br>This attribute shall be present if the SEPP uses non-default HTTP and/or HTTPS ports. When present, it shall contain the HTTP and/or HTTPS ports.<br><br>The key of the map shall be "http" or "https".<br>The value shall indicate the port number for HTTP or HTTPS respectively.<br>Minimum: 0 Maximum: 65535 |
| remotePlmnList                                                                                                                                                                                                                                              | array(PlmnlId)    | O | 1..N        | List of remote PLMNs reachable through the SEPP. The absence of this attribute indicates that any PLMN is reachable through the SEPP.                                                                                                                                                                                                                                  |
| remoteSnpnList                                                                                                                                                                                                                                              | array(PlmnlIdNid) | O | 1..N        | List of remote SNPNs reachable through the SEPP. The absence of this attribute indicates that no SNPN is reachable through the SEPP.                                                                                                                                                                                                                                   |
| NOTE 1: If no SEPP port information is present in SeppInfo, the HTTP client shall use the default HTTP port number, i.e. TCP port 80 for "http" URIs or TCP port 443 for "https" URIs as specified in IETF RFC 7540 [9] when sending a request to the SEPP. |                   |   |             |                                                                                                                                                                                                                                                                                                                                                                        |
| NOTE 2: The attributes fqdn, ipv4Addresses and ipv6Addresses within the NFProfile data type shall be used to determine the SEPP address.                                                                                                                    |                   |   |             |                                                                                                                                                                                                                                                                                                                                                                        |

## 6.1.6.2.73 Type: AanfInfo

Table 6.1.6.2.73-1: Definition of type AanfInfo

| Attribute name    | Data type     | P | Cardinality | Description                                                                                                                                         |
|-------------------|---------------|---|-------------|-----------------------------------------------------------------------------------------------------------------------------------------------------|
| routingIndicators | array(string) | O | 1..N        | List of Routing Indicators supported by the AAnf instance. If not provided, the AAnf can serve any Routing Indicator.<br>Pattern: '^([0-9]{1,4})\$' |

## 6.1.6.2.74 Type: 5GDdnmflInfo

Table 6.1.6.2.74-1: Definition of type 5GDdnmflInfo

| Attribute name | Data type | P | Cardinality | Description                                    |
|----------------|-----------|---|-------------|------------------------------------------------|
| plmnlId        | PlmnlId   | M | 1           | PLMN ID of the PLMN which the 5G DDNMF served. |

## 6.1.6.2.75 Type: MfafInfo

Table 6.1.6.2.75-1: Definition of type MfafInfo

| Attribute name     | Data type      | P | Cardinality | Description                                                                                                                                                            |
|--------------------|----------------|---|-------------|------------------------------------------------------------------------------------------------------------------------------------------------------------------------|
| servingNFtypeList  | array(NFType)  | O | 1..N        | If present, this IE shall contain the list of NF type(s) served by MFAF NF. The absence of this attribute indicates that the MFAF can be selected for any NF type      |
| servingNFsetIdList | array(NfSetId) | O | 1..N        | If present, this IE shall contain the list of NF Set Id(s) served by MFAF NF. The absence of this attribute indicates that the MFAF can be selected for any NF Set Id. |

|              |                 |   |      |                                                                                                                                                                                                                                       |
|--------------|-----------------|---|------|---------------------------------------------------------------------------------------------------------------------------------------------------------------------------------------------------------------------------------------|
| taiList      | array(Tai)      | O | 1..N | The list of TAIs the MFAF can serve. It may contain one or more non-3GPP access TAIs. The absence of both this attribute and the taiRangeList attribute indicates that the MFAF can be selected for any TAI in the serving network.   |
| taiRangeList | array(TaiRange) | O | 1..N | The range of TAIs the MFAF can serve. It may contain one or more non-3GPP access TAI ranges. The absence of both this attribute and the taiList attribute indicates that the MFAF can be selected for any TAI in the serving network. |

## 6.1.6.2.76 Type: NwdafCapability

**Table 6.1.6.2.76-1: Definition of type NwdafCapability**

| Attribute name                | Data type | P | Cardinality | Description                                                                                                                                                                                                                                                                      |
|-------------------------------|-----------|---|-------------|----------------------------------------------------------------------------------------------------------------------------------------------------------------------------------------------------------------------------------------------------------------------------------|
| analyticsAggregation          | boolean   | O | 0..1        | When present, this IE shall indicate whether the NWDAF supports analytics aggregation:<br>- true: analytics aggregation capability is supported by the NWDAF<br>- false (default): analytics aggregation capability is not supported by the NWDAF.                               |
| analyticsMetadataProvisioning | boolean   | O | 0..1        | When present, this IE shall indicate whether the NWDAF supports analytics metadata provisioning:<br>- true: analytics metadata provisioning capability is supported by the NWDAF<br>- false (default): analytics metadata provisioning capability is not supported by the NWDAF. |

## 6.1.6.2.77 Type: EasdfInfo

**Table 6.1.6.2.77-1: Definition of type EasdfInfo**

| Attribute name                                                                                                      | Data type                  | P | Cardinality | Description                                                  |
|---------------------------------------------------------------------------------------------------------------------|----------------------------|---|-------------|--------------------------------------------------------------|
| sNssaiEasdfInfoList                                                                                                 | array(SnssaiEasdfInfoItem) | O | 1..N        | List of parameters supported by the EASDF per S-NSSAI (NOTE) |
| easdfN6IpAddressList                                                                                                | array(IpAddr)              | O | 1..N        | N6 IP addresses of the EASDF                                 |
| upfN6IpAddressList                                                                                                  | array(IpAddr)              | O | 1..N        | N6 IP addresses of PSA UPFs                                  |
| NOTE: If S-NSSAIs are present in the EasdfInfo and in the NFprofile, the S-NSSAIs from the EasdfInfo shall prevail. |                            |   |             |                                                              |

## 6.1.6.2.78 Type: SnssaiEasdfInfoItem

**Table 6.1.6.2.78-1: Definition of type SnssaiEasdfInfoItem**

| Attribute name   | Data type               | P | Cardinality | Description                                       |
|------------------|-------------------------|---|-------------|---------------------------------------------------|
| sNssai           | ExtSnssai               | M | 1           | S-NSSAI                                           |
| dnnEasdfInfoList | array(DnnEasdfInfoItem) | M | 1..N        | List of parameters supported by the EASDF per DNN |



## 6.1.6.2.79 Type: DnnEasdfInfoltem

Table 6.1.6.2.79-1: Definition of type DnnEasdfInfoltem

| Attribute name | Data type   | P | Cardinality | Description                                                                                                                                                                                                                                                                                                      |
|----------------|-------------|---|-------------|------------------------------------------------------------------------------------------------------------------------------------------------------------------------------------------------------------------------------------------------------------------------------------------------------------------|
| dnn            | Dnn         | M | 1           | Supported DNN or Wildcard DNN if the EASDF supports all DNNs for the related S-NSSAI. The DNN shall contain the Network Identifier and it may additionally contain an Operator Identifier. If the Operator Identifier is not included, the DNN is supported for all the PLMNs in the plmnList of the NF Profile. |
| dnaiList       | array(Dnai) | O | 1..N        | List of Data network access identifiers supported by the EASDF for this DNN. The absence of this attribute indicates that the EASDF can be selected for this DNN for any DNAI.                                                                                                                                   |

## 6.1.6.2.80 Type: DccfInfo

Table 6.1.6.2.80-1: Definition of type DccfInfo

| Attribute name     | Data type       | P | Cardinality | Description                                                                                                                                                                                                                           |
|--------------------|-----------------|---|-------------|---------------------------------------------------------------------------------------------------------------------------------------------------------------------------------------------------------------------------------------|
| servingNFtypeList  | array(NFType)   | O | 1..N        | If present, this IE shall contain the list of NF type(s) from which the DCCF NF can collect data. The absence of this attribute indicates that the DCCF can collect data from any NF type.                                            |
| servingNFsetIdList | array(NfSetId)  | O | 1..N        | If present, this IE shall contain the list of NF Set Id(s) from which the DCCF NF can collect data. The absence of this attribute indicates that the DCCF can collect data from any NF Set.                                           |
| taiList            | array(Tai)      | O | 1..N        | The list of TAIs the DCCF can serve. It may contain one or more non-3GPP access TAIs. The absence of both this attribute and the taiRangeList attribute indicates that the DCCF can be selected for any TAI in the serving network.   |
| taiRangeList       | array(TaiRange) | O | 1..N        | The range of TAIs the DCCF can serve. It may contain one or more non-3GPP access TAI ranges. The absence of both this attribute and the taiList attribute indicates that the DCCF can be selected for any TAI in the serving network. |

## 6.1.6.2.81 Type: NsacflInfo

Table 6.1.6.2.81-1: Definition of type NsacflInfo

| Attribute name                                                                                                                                                                                                                                                                                                                                                                                                                                      | Data type       | P | Cardinality | Description                                                                                                                                                                                                                                     |
|-----------------------------------------------------------------------------------------------------------------------------------------------------------------------------------------------------------------------------------------------------------------------------------------------------------------------------------------------------------------------------------------------------------------------------------------------------|-----------------|---|-------------|-------------------------------------------------------------------------------------------------------------------------------------------------------------------------------------------------------------------------------------------------|
| nsacfCapability                                                                                                                                                                                                                                                                                                                                                                                                                                     | NsacfCapability | M | 1           | NSACF service capability.                                                                                                                                                                                                                       |
| taiList                                                                                                                                                                                                                                                                                                                                                                                                                                             | array(Tai)      | O | 1..N        | The list of TAIs the NSACF can serve. It may contain one or more non-3GPP access TAIs. The absence of this attribute and the taiRangeList attribute indicate that the NSACF can be selected for any TAI in the serving network.<br><br>(NOTE 1) |
| taiRangeList                                                                                                                                                                                                                                                                                                                                                                                                                                        | array(TaiRange) | O | 1..N        | The range of TAIs the NSACF can serve. It may contain non-3GPP access TAIs. The absence of this attribute and the taiList attribute indicate that the NSACF can be selected for any TAI in the serving network.<br><br>(NOTE 2)                 |
| NOTE 1: When NSACF serving area is configured with TAI list, the serving area of the NSACF should be configured to cover the complete serving area of any of its AMF and SMF consumers, i.e. the TAI list served by NSACF should include all the TAIs served by its AMF and SMF consumers. This can avoid NSACF reselection when the UE moves within the serving area of the NF consumer, e.g. avoid NSACF reselection during intra-AMF UE mobility |                 |   |             |                                                                                                                                                                                                                                                 |
| NOTE 2: Locality of NSACF may be configured to allow the NSACF consumers to discover and select candidate NSACF based on Locality information, instead of using serving TAIs. See NOTE 24 of Table 6.2.3.2.3.1-1.                                                                                                                                                                                                                                   |                 |   |             |                                                                                                                                                                                                                                                 |

## 6.1.6.2.82 Type: NsacfCapability

Table 6.1.6.2.82-1: Definition of type NsacfCapability

| Attribute name | Data type | P | Cardinality | Description                                                                                                                                                                                                                       |
|----------------|-----------|---|-------------|-----------------------------------------------------------------------------------------------------------------------------------------------------------------------------------------------------------------------------------|
| supportUeSAC   | boolean   | C | 0..1        | Indicates the service capability of the NSACF to monitor and control the number of registered UEs per network slice for the network slice that is subject to NSAC.<br>true: Supported<br>false (default): Not Supported           |
| supportPduSAC  | boolean   | C | 0..1        | Indicates the service capability of the NSACF to monitor and control the number of established PDU sessions per network slice for the network slice that is subject to NSAC.<br>true: Supported<br>false (default): Not Supported |

## 6.1.6.2.83 Type: DccfCond

**Table 6.1.6.2.83-1: Definition of type DccfCond**

| Attribute name     | Data type       | P | Cardinality | Description                                                                                                                                                                 |
|--------------------|-----------------|---|-------------|-----------------------------------------------------------------------------------------------------------------------------------------------------------------------------|
| conditionType      | string          | M | 1           | This attribute serves as discriminator, to make all data types defined in Table 6.1.6.2.35-1 mutually exclusive.<br>In this data type, it shall take the value "DCCF_COND". |
| taiList            | array(Tai)      | O | 1..N        | TAI(s) of the DCCF whose status is requested to be monitored. It may contain one or more non-3GPP access TAIs.                                                              |
| taiRangeList       | array(TaiRange) | O | 1..N        | The range of TAIs of the DCCF whose status is requested to be monitored. It may contain non-3GPP access TAIs.                                                               |
| servingNfTypeList  | array(NFType)   | O | 1..N        | The list of NF type(s) served by DCCF whose status is requested to be monitored.                                                                                            |
| servingNfSetIdList | array(NfSetId)  | O | 1..N        | The list of NF Set Id(s) served by DCCF whose status is requested to be monitored.                                                                                          |

## 6.1.6.2.84 Type: MlAnalyticsInfo

**Table 6.1.6.2.84-1: Definition of type MlAnalyticsInfo**

| Attribute name   | Data type         | P | Cardinality | Description                                                                                                                                                                                                           |
|------------------|-------------------|---|-------------|-----------------------------------------------------------------------------------------------------------------------------------------------------------------------------------------------------------------------|
| mlAnalyticsIds   | array(NwdafEvent) | C | 1..N        | Analytics Id(s) supported by the Nnwdaf_MLModelProvision service, if none are provided the NWDAF can serve any mlAnalyticsId.                                                                                         |
| snssaiList       | array(Snssai)     | O | 1..N        | S-NSSAIs of the ML model, if none are provided the ML model for the analytics can apply to any snssai.                                                                                                                |
| trackingAreaList | array(Tai)        | O | 1..N        | Area of Interest of the ML model, if none are provided the ML model for the analytics can apply to any TAIs.<br><br>If present, this IE represents the list of TAIs, it may contain one or more non-3GPP access TAIs. |

## 6.1.6.2.85 Type: MbSmfInfo

Table 6.1.6.2.85-1: Definition of type MbSmfInfo

| Attribute name                                                                                                | Data type                | P | Cardinality | Description                                                                                                                                                                          |
|---------------------------------------------------------------------------------------------------------------|--------------------------|---|-------------|--------------------------------------------------------------------------------------------------------------------------------------------------------------------------------------|
| sNssaiInfoList                                                                                                | map(SnssaiMbSmfInfoItem) | O | 1..N        | S-NSSAIs and DNNs supported by the MB-SMF (NOTE 1)<br>The key of the map shall be a (unique) valid JSON string per clause 7 of IETF RFC 8259 [22], with a maximum of 32 characters.  |
| tmgiRangeList                                                                                                 | map(TmgiRange)           | O | 1..N        | TMGI range(s) supported by the MB-SMF<br>The key of the map shall be a (unique) valid JSON string per clause 7 of IETF RFC 8259 [22], with a maximum of 32 characters.               |
| taiList                                                                                                       | array(Tai)               | O | 1..N        | List of TAIs the MB-SMF can serve.<br>The absence of this attribute and the taiRangeList attribute indicates that the MB-SMF can be selected for any TAI in the serving network.     |
| taiRangeList                                                                                                  | array(TaiRange)          | O | 1..N        | The range of TAIs the MB-SMF can serve.<br>The absence of this attribute and the taiList attribute indicates that the MB-SMF can be selected for any TAI in the serving network.     |
| mbsSessionList                                                                                                | map(MbsSession)          | O | 1..N        | List of MBS sessions currently served by the MB-SMF<br>The key of the map shall be a (unique) valid JSON string per clause 7 of IETF RFC 8259 [22], with a maximum of 32 characters. |
| NOTE 1: If S-NSSAIs are present in MbSmfInfo and in the NFprofile, the S-NSSAIs from MbSmfInfo shall prevail. |                          |   |             |                                                                                                                                                                                      |

## 6.1.6.2.86 Type: TmgiRange

Table 6.1.6.2.86-1: Definition of type TmgiRange

| Attribute name    | Data type | P | Cardinality | Description                                                                                                                                                                                                                   |
|-------------------|-----------|---|-------------|-------------------------------------------------------------------------------------------------------------------------------------------------------------------------------------------------------------------------------|
| mbsServiceIdStart | string    | M | 1           | First MBS Service ID value identifying the start of a TMGI range.<br>The value shall be coded as defined for the mbsServiceId attribute of the Tmgi data type defined in 3GPP TS 29.571 [7].<br>Pattern: '^[\A-Fa-f0-9]{6}\$' |
| mbsServiceIdEnd   | string    | M | 1           | Last MBS Service ID value identifying the end of a TMGI range.<br>The value shall be coded as defined for the mbsServiceId attribute of the Tmgi data type defined in 3GPP TS 29.571 [7].<br>Pattern: '^[\A-Fa-f0-9]{6}\$'    |
| plmnId            | PlmnId    | M | 1           | PLMN ID                                                                                                                                                                                                                       |
| nid               | Nid       | O | 0..1        | Network Identity used for SNPN                                                                                                                                                                                                |

## 6.1.6.2.87 Type: MbsSession

Table 6.1.6.2.87-1: Definition of type MbsSession

| Attribute name  | Data type               | P | Cardinality | Description                                                                                                                                                                                                                                                                                                                                                                                                                                   |
|-----------------|-------------------------|---|-------------|-----------------------------------------------------------------------------------------------------------------------------------------------------------------------------------------------------------------------------------------------------------------------------------------------------------------------------------------------------------------------------------------------------------------------------------------------|
| mbsSessionId    | MbsSessionId            | M | 1           | MBS session identifier                                                                                                                                                                                                                                                                                                                                                                                                                        |
| mbsAreaSessions | map(MbsServiceAreaInfo) | C | 1..N        | Map of Area Session Id and related MBS Service Area information used for MBS session with location dependent content. The Area Session ID together with the mbsSessionId (TMGI) uniquely identifies the MBS session in a specific MBS service area. For an MBS session with location dependent content, one map entry shall be registered for each MBS Service Area served by the MBS session. The key of the map shall be the areaSessionId. |

## 6.1.6.2.88 Type: SnsaiMbSmfInfoItem

Table 6.1.6.2.88-1: Definition of type SnsaiMbSmfInfoItem

| Attribute name | Data type               | P | Cardinality | Description                                        |
|----------------|-------------------------|---|-------------|----------------------------------------------------|
| sNssai         | ExtSnsai                | M | 1           | Supported S-NSSAI                                  |
| dnnInfoList    | array(DnnMbSmfInfoItem) | M | 1..N        | List of parameters supported by the MB-SMF per DNN |

## 6.1.6.2.89 Type: DnnMbSmfInfoItem

Table 6.1.6.2.89-1: Definition of type DnnMbSmfInfoItem

| Attribute name | Data type | P | Cardinality | Description                                                                                                                                                                                                                                                                                                       |
|----------------|-----------|---|-------------|-------------------------------------------------------------------------------------------------------------------------------------------------------------------------------------------------------------------------------------------------------------------------------------------------------------------|
| dnn            | Dnn       | M | 1           | Supported DNN or Wildcard DNN if the MB-SMF supports all DNNs for the related S-NSSAI. The DNN shall contain the Network Identifier and it may additionally contain an Operator Identifier. If the Operator Identifier is not included, the DNN is supported for all the PLMNs in the plmnList of the NF Profile. |

6.1.6.2.90 Void

6.1.6.2.91 Type: TsctsflInfo

**Table 6.1.6.2.91-1: Definition of type TsctsflInfo**

| Attribute name                                                                                                                                                                                                                                                                                   | Data type                      | P | Cardinality | Description                                                                                                                                                                                                                |
|--------------------------------------------------------------------------------------------------------------------------------------------------------------------------------------------------------------------------------------------------------------------------------------------------|--------------------------------|---|-------------|----------------------------------------------------------------------------------------------------------------------------------------------------------------------------------------------------------------------------|
| sNssaiInfoList                                                                                                                                                                                                                                                                                   | map(SnssaiTsctsflInfoItem)     | O | 1..N        | S-NSSAIs and DNNs supported by the TSCTSF (NOTE 1)<br>The key of the map shall be a (unique) valid JSON string per clause 7 of IETF RFC 8259 [22], with a maximum of 32 characters.                                        |
| externalGroupIdentifiers Ranges                                                                                                                                                                                                                                                                  | array(IdentityRange)           | O | 1..N        | Ranges of External Group Identifiers that can be served by the TSCTSF.<br><br>The absence of this IE indicates that the TSCTSF can serve any external group managed by the PLMN (or SNPN) of the TSCTSF instance.          |
| supiRanges                                                                                                                                                                                                                                                                                       | array(SupiRange)               | O | 1..N        | Ranges of SUPIs that can be served by the TSCTSF instance.<br>(NOTE 2)                                                                                                                                                     |
| gpsiRanges                                                                                                                                                                                                                                                                                       | array(IdentityRange)           | O | 1..N        | Ranges of GPSIs that can be served by the TSCTSF instance.<br>(NOTE 2)                                                                                                                                                     |
| internalGroupIdentifiers Ranges                                                                                                                                                                                                                                                                  | array(InternalGroupIdentRange) | O | 1..N        | Ranges of Internal Group Identifiers that can be served by the TSCTSF instance.<br><br>The absence of this IE indicates that the TSCTSF can serve any internal group managed by the PLMN (or SNPN) of the TSCTSF instance. |
| NOTE 1: If S-NSSAIs are present in TsctsflInfo and in the NFprofile, the S-NSSAIs from TsctsflInfo shall prevail. Only one TSCTSF instance, or only the TSCTSF instances belonging to one TSCTSF Set, shall be configured in the PLMN (or SNPN) to serve a specific DNN and S-NSSAI combination. |                                |   |             |                                                                                                                                                                                                                            |
| NOTE 2: If both parameters are not provided, the TSCTSF can serve any SUPI or GPSI managed by the PLMN (or SNPN) of the TSCTSF instance.                                                                                                                                                         |                                |   |             |                                                                                                                                                                                                                            |

6.1.6.2.92 Type: SnssaiTsctsflInfoItem

**Table 6.1.6.2.92-1: Definition of type SnssaiTsctsflInfoItem**

| Attribute name | Data type                 | P | Cardinality | Description                                                                   |
|----------------|---------------------------|---|-------------|-------------------------------------------------------------------------------|
| sNssai         | ExtSnssai                 | M | 1           | Supported S-NSSAI.                                                            |
| dnnInfoList    | array(DnnTsctsflInfoItem) | M | 1..N        | List of parameters supported by the TSCTSF per DNN for the indicated S-NSSAI. |

6.1.6.2.93 Type: DnnTsctsflInfoItem

**Table 6.1.6.2.93-1: Definition of type DnnTsctsflInfoItem**

| Attribute name | Data type | P | Cardinality | Description                                                                                                                                                                                                                                                                                                       |
|----------------|-----------|---|-------------|-------------------------------------------------------------------------------------------------------------------------------------------------------------------------------------------------------------------------------------------------------------------------------------------------------------------|
| dnn            | Dnn       | M | 1           | Supported DNN or Wildcard DNN if the TSCTSF supports all DNNs for the related S-NSSAI. The DNN shall contain the Network Identifier and it may additionally contain an Operator Identifier. If the Operator Identifier is not included, the DNN is supported for all the PLMNs in the plmnList of the NF Profile. |

## 6.1.6.2.94 Type: MbUpfInfo

Table 6.1.6.2.94-1: Definition of type MbUpfInfo

| Attribute name                                                                                                           | Data type                   | P | Cardinality | Description                                                                                                                                                                                                                                                                                                                                                                                                                                                                                                                                                                                                                                                                           |
|--------------------------------------------------------------------------------------------------------------------------|-----------------------------|---|-------------|---------------------------------------------------------------------------------------------------------------------------------------------------------------------------------------------------------------------------------------------------------------------------------------------------------------------------------------------------------------------------------------------------------------------------------------------------------------------------------------------------------------------------------------------------------------------------------------------------------------------------------------------------------------------------------------|
| sNssaiMbUpfInfoList                                                                                                      | array(SnssaiUpfInfoList)    | M | 1..N        | List of parameters supported by the MB-UPF per S-NSSAI. (NOTE)                                                                                                                                                                                                                                                                                                                                                                                                                                                                                                                                                                                                                        |
| mbSmfServingArea                                                                                                         | array(string)               | O | 1..N        | The MB-SMF service area(s) the MB-UPF can serve.<br>If not provided, the MB-UPF can serve any MB-SMF service area.                                                                                                                                                                                                                                                                                                                                                                                                                                                                                                                                                                    |
| interfaceMbUpfInfoList                                                                                                   | array(InterfaceUpfInfoList) | O | 1..N        | List of User Plane interfaces configured on the MB-UPF. When this IE is provided in the NF Discovery response, the NF Service Consumer (e.g. MB-SMF) may use this information for MB-UPF selection.                                                                                                                                                                                                                                                                                                                                                                                                                                                                                   |
| taiList                                                                                                                  | array(Tai)                  | O | 1..N        | The list of TAIs the MB-UPF can serve.<br><br>The absence of this attribute and the taiRangeList attribute indicates that the MB-UPF can serve the whole MB-SMF service area defined by the MbSmfServingArea attribute.                                                                                                                                                                                                                                                                                                                                                                                                                                                               |
| taiRangeList                                                                                                             | array(TaiRange)             | O | 1..N        | The range of TAIs the MB-UPF can serve.<br><br>The absence of this attribute and the taiList attribute indicates that the MB-UPF can serve the whole MB-SMF service area defined by the MbSmfServingArea attribute.                                                                                                                                                                                                                                                                                                                                                                                                                                                                   |
| priority                                                                                                                 | integer                     | O | 0..1        | Priority (relative to other NFs of the same type) in the range of 0-65535, to be used for NF selection for a service request matching the attributes of the MbUpfInfo; lower values indicate a higher priority. See the precedence rules in the description of the priority attribute in NFProfile, if Priority is also present in NFProfile.<br>The NRF may overwrite the received priority value when exposing an NFProfile with the Nnrf_NFDiscovery service.                                                                                                                                                                                                                      |
| supportedPfcFeatures                                                                                                     | string                      | O | 0..1        | Supported PFCP Features.<br><br>A string used to indicate the PFCP features supported by the MB-UPF, which encodes the "UP Function Features" IE as specified in Table 8.2.25-1 of 3GPP TS 29.244 [21] (starting from Octet 5), in hexadecimal representation.<br><br>Each character in the string shall take a value of "0" to "9", "a" to "f" or "A" to "F" and each two characters shall represent one octet of "UP Function Features" IE (starting from Octet 5, to higher octets). For each two characters representing one octet, the first character representing the 4 most significant bits of the octet and the second character the 4 least significant bits of the octet. |
| NOTE : If this S-NSSAIs is present in the MbUpfInfo and in the NFprofile, the S-NSSAIs from the MbUpfInfo shall prevail. |                             |   |             |                                                                                                                                                                                                                                                                                                                                                                                                                                                                                                                                                                                                                                                                                       |

## 6.1.6.2.95 Type: UnTrustAfInfo

Table 6.1.6.2.95-1: Definition of type UnTrustAfInfo

| Attribute name | Data type             | P | Cardinality | Description                            |
|----------------|-----------------------|---|-------------|----------------------------------------|
| afId           | string                | M | 1           | Associated AF id.                      |
| sNssaiInfoList | array(SnssaiInfoList) | O | 1..N        | S-NSSAIs and DNNs supported by the AF. |

|            |         |   |      |                                                                                                                                                                                                                                                                                                       |
|------------|---------|---|------|-------------------------------------------------------------------------------------------------------------------------------------------------------------------------------------------------------------------------------------------------------------------------------------------------------|
| mappingInd | boolean | O | 0..1 | When present, this IE indicates whether the AF supports mapping between UE IP address (IPv4 address or IPv6 prefix) and UE ID (i.e. GPSI).<br><br>true: the AF supports mapping between UE IP address and UE ID;<br>false (default): the AF does not support mapping between UE IP address and UE ID. |
|------------|---------|---|------|-------------------------------------------------------------------------------------------------------------------------------------------------------------------------------------------------------------------------------------------------------------------------------------------------------|

## 6.1.6.2.96 Type: TrustAfInfo

Table 6.1.6.2.96-1: Definition of type TrustAfInfo

| Attribute name  | Data type             | P | Cardinality | Description                                                                                                                                                                                                                                                                                                                   |
|-----------------|-----------------------|---|-------------|-------------------------------------------------------------------------------------------------------------------------------------------------------------------------------------------------------------------------------------------------------------------------------------------------------------------------------|
| sNssaiInfoList  | array(SnssaiInfoItem) | O | 1..N        | S-NSSAIs and DNNs supported by the trusted AF (NOTE 1).                                                                                                                                                                                                                                                                       |
| afEvents        | array(AfEvent)        | O | 1..N        | AF Event(s) supported by the trusted AF.                                                                                                                                                                                                                                                                                      |
| applds          | array(string)         | O | 1..N        | The list of Application ID(s) supported by the trusted AF. The absence of this attribute indicate that the AF can be selected for any Application.                                                                                                                                                                            |
| internalGroupId | array(GroupId)        | O | 1..N        | List of Internal Group Identifiers supported by the trusted AF.<br>If not provided, it does not imply that the AF supports all internal groups.                                                                                                                                                                               |
| mappingInd      | boolean               | O | 0..1        | When present, this IE indicates whether the trusted AF supports mapping between UE IP address (IPv4 address or IPv6 prefix) and UE ID (i.e. SUPI).<br><br>true: the trusted AF supports mapping between UE IP address and UE ID;<br>false (default): the trusted AF does not support mapping between UE IP address and UE ID. |

NOTE 1: If S-NSSAIs are present in TrustAfInfo and in the NFprofile, the S-NSSAIs from TrustAfInfo shall prevail.

## 6.1.6.2.97 Type: SnssaiInfoItem

Table 6.1.6.2.97-1: Definition of type SnssaiInfoItem

| Attribute name | Data type          | P | Cardinality | Description                                    |
|----------------|--------------------|---|-------------|------------------------------------------------|
| sNssai         | ExtSnssai          | M | 1           | Supported S-NSSAI                              |
| dnnInfoList    | array(DnnInfoItem) | M | 1..N        | List of parameters supported by the NF per DNN |

## 6.1.6.2.98 Type: DnnInfoItem

Table 6.1.6.2.98-1: Definition of type DnnInfoItem

| Attribute name | Data type | P | Cardinality | Description                                                                                                                                                                                                                                                                                                   |
|----------------|-----------|---|-------------|---------------------------------------------------------------------------------------------------------------------------------------------------------------------------------------------------------------------------------------------------------------------------------------------------------------|
| dnn            | Dnn       | M | 1           | Supported DNN or Wildcard DNN if the NF supports all DNNs for the related S-NSSAI. The DNN shall contain the Network Identifier and it may additionally contain an Operator Identifier. If the Operator Identifier is not included, the DNN is supported for all the PLMNs in the plmnList of the NF Profile. |



## 6.1.6.2.99 Type: CollocatedNfInstance

**Table 6.1.6.2.99-1: Definition of type CollocatedNfInstance**

| Attribute name                                                                                                                                                                                                                                                                                                                                                                                                                                                                                                                                                                                                                       | Data type        | P | Cardinality | Description                                                      |
|--------------------------------------------------------------------------------------------------------------------------------------------------------------------------------------------------------------------------------------------------------------------------------------------------------------------------------------------------------------------------------------------------------------------------------------------------------------------------------------------------------------------------------------------------------------------------------------------------------------------------------------|------------------|---|-------------|------------------------------------------------------------------|
| nfInstanceId                                                                                                                                                                                                                                                                                                                                                                                                                                                                                                                                                                                                                         | NfInstanceId     | M | 1           | Unique identity of the NF Instance for a collocated NF type.     |
| nfType                                                                                                                                                                                                                                                                                                                                                                                                                                                                                                                                                                                                                               | CollocatedNfType | M | 1           | Possible NF types supported by a collocated NF. (NOTE 1, NOTE 2) |
| NOTE 1: Whether NFs of any NF types are collocated or not, is an implementation and/or deployment issue and needs not be known in general to the NF service consumers and therefore needs not be registered in the NF profile. This data type is only intended for specific scenarios where the discovery and selection of a combined NF service producer by a NF service consumer can allow specific optimizations. In order to retrieve the NFProfile of the collocated NF instance, the NF service consumer shall trigger a separate discovery procedure using the nfType and nfInstanceId in the CollocatedNfInstance data type. |                  |   |             |                                                                  |
| NOTE 2: The supported collocated NF types in this release of the specification may only be one of the following:<br>- a MB-SMF may be collocated with a SMF (N16mb internal interface);<br>- a MB-UPF may be collocated with a UPF (N19mb internal interface).                                                                                                                                                                                                                                                                                                                                                                       |                  |   |             |                                                                  |

## 6.1.6.2.100 Type: ServiceNameListCond

**Table 6.1.6.2.100-1: Definition of type ServiceNameListCond**

| Attribute name  | Data type          | P | Cardinality | Description                                                                                                                                                                              |
|-----------------|--------------------|---|-------------|------------------------------------------------------------------------------------------------------------------------------------------------------------------------------------------|
| conditionType   | string             | M | 1           | This attribute serves as discriminator, to make all data types defined in Table 6.1.6.2.35-1 mutually exclusive.<br>In this data type, it shall take the value "SERVICE_NAME_LIST_COND". |
| serviceNameList | array(ServiceName) | M | 1..N        | Service names offered by the NF Instances whose status is requested to be monitored.                                                                                                     |

## 6.1.6.2.101 Type: NfGroupListCond

**Table 6.1.6.2.101-1: Definition of type NfGroupListCond**

| Attribute name | Data type        | P | Cardinality | Description                                                                                                                                                                          |
|----------------|------------------|---|-------------|--------------------------------------------------------------------------------------------------------------------------------------------------------------------------------------|
| conditionType  | string           | M | 1           | This attribute serves as discriminator, to make all data types defined in Table 6.1.6.2.35-1 mutually exclusive.<br>In this data type, it shall take the value "NF_GROUP_LIST_COND". |
| nfType         | string           | M | 1           | NF type (UDM, AUSF, PCF, UDR, HSS or CHF) of the NF Instances whose status is requested to be monitored.                                                                             |
| nfGroupIdList  | array(NfGroupId) | M | 1..N        | Group IDs of the NF Instances whose status is requested to be monitored.                                                                                                             |

## 6.1.6.2.102 Type: PlmnOauth2

**Table 6.1.6.2.102-1: Definition of type PlmnOauth2**

| Attribute name              | Data type     | P | Cardinality | Description                                                                                                                            |
|-----------------------------|---------------|---|-------------|----------------------------------------------------------------------------------------------------------------------------------------|
| oauth2RequiredPlmnIdList    | array(PlmnId) | O | 1..N        | It shall indicate the consumer PLMN ID list for which NF Service Instance requires Oauth2-based authorization.<br>(See NOTE 1)         |
| oauth2NotRequiredPlmnIdList | array(PlmnId) | O | 1..N        | It shall indicate the consumer PLMN ID list for which NF Service Instance does not require Oauth2-based authorization.<br>(See NOTE 1) |

NOTE 1: The same PLMN Id shall not be present in both oAuth2RequiredPlmnIdList and oAuth2NotRequiredPlmnIdList.

### 6.1.6.2.103 Type: V2xCapability

**Table 6.1.6.2.103-1: Definition of type V2xCapability**

| Attribute name | Data type | P | Cardinality | Description                                                                                                                                                                                                       |
|----------------|-----------|---|-------------|-------------------------------------------------------------------------------------------------------------------------------------------------------------------------------------------------------------------|
| lteV2x         | boolean   | O | 0..1        | When present, this IE shall indicate whether the PCF supports LTE V2X capability:<br><br>- true: LTE V2X capability is supported by the PCF<br>- false (default): LTE V2X capability is not supported by the PCF. |
| nrV2x          | boolean   | O | 0..1        | When present, this IE shall indicate whether the PCF supports NR V2X capability:<br><br>- true: NR V2X capability is supported by the PCF<br>- false (default): NR V2X capability is not supported by the PCF.    |

### 6.1.6.2.104 Type: NssaafInfo

**Table 6.1.6.2.104-1: Definition of type NssaafInfo**

| Attribute name                  | Data type                      | P | Cardinality | Description                                                                                                                                                              |
|---------------------------------|--------------------------------|---|-------------|--------------------------------------------------------------------------------------------------------------------------------------------------------------------------|
| supiRanges                      | array(SupiRange)               | O | 1..N        | List of ranges of SUPIs that can be served by the NSSAAF instance.                                                                                                       |
| internalGroupIdentifiers Ranges | array(InternalGroupIdentRange) | O | 1..N        | List of ranges of Internal Group Identifiers that can be served by the NSSAAF instance. If not provided, it does not imply that the NSSAAF supports all internal groups. |

## 6.1.6.2.105 Type: ProSeCapability

**Table 6.1.6.2.105-1: Definition of type ProSeCapability**

| Attribute name           | Data type | P | Cardinality | Description                                                                                                                                                                                                                                                    |
|--------------------------|-----------|---|-------------|----------------------------------------------------------------------------------------------------------------------------------------------------------------------------------------------------------------------------------------------------------------|
| proseDirectDiscovery     | boolean   | O | 0..1        | When present, this IE shall indicate whether the PCF supports ProSe Direct Discovery:<br><br>- true: ProSe Direct Discovery is supported by the PCF<br>- false (default): ProSe Direct Discovery is not supported by the PCF.                                  |
| proseDirectCommunication | boolean   | O | 0..1        | When present, this IE shall indicate whether the PCF supports ProSe Direct Communication:<br><br>- true: ProSe Direct Communication is supported by the PCF<br>- false (default): ProSe Direct Communication is not supported by the PCF.                      |
| proseL2UetoNetworkRelay  | boolean   | O | 0..1        | When present, this IE shall indicate whether the PCF supports ProSe Layer-2 UE-to-Network Relay:<br><br>- true: ProSe Layer-2 UE-to-Network Relay is supported by the PCF<br>- false (default): ProSe Layer-2 UE-to-Network Relay is not supported by the PCF. |
| proseL3UetoNetworkRelay  | boolean   | O | 0..1        | When present, this IE shall indicate whether the PCF supports ProSe Layer-3 UE-to-Network Relay:<br><br>- true: ProSe Layer-3 UE-to-Network Relay is supported by the PCF<br>- false (default): ProSe Layer-3 UE-to-Network Relay is not supported by the PCF. |
| proseL2RemoteUe          | boolean   | O | 0..1        | When present, this IE shall indicate whether the PCF supports ProSe Layer-2 Remote UE:<br><br>- true: ProSe Layer-2 Remote UE is supported by the PCF<br>- false (default): ProSe Layer-2 Remote UE is not supported by the PCF.                               |
| proseL3RemoteUe          | boolean   | O | 0..1        | When present, this IE shall indicate whether the PCF supports ProSe Layer-3 Remote UE:<br><br>- true: ProSe Layer-3 Remote UE is supported by the PCF<br>- false (default): ProSe Layer-3 Remote UE is not supported by the PCF.                               |

## 6.1.6.2.106 Type: SharedDataIdRange

**Table 6.1.6.2.106-1: Definition of type SharedDataIdRange**

| Attribute name | Data type | P | Cardinality | Description                                                                                                                                                                                                                                                         |
|----------------|-----------|---|-------------|---------------------------------------------------------------------------------------------------------------------------------------------------------------------------------------------------------------------------------------------------------------------|
| pattern        | string    | O | 0..1        | Pattern (regular expression according to the ECMA-262 dialect [8]) representing the set of SharedDataIds belonging to this range. A SharedDataId value is considered part of the range if and only if the SharedDataId string fully matches the regular expression. |

EXAMPLE: SharedDataId range. "123456-sharedAmData{localID}" where "123456" is the HPLMN id (i.e. MCC followed by MNC) and "{localID}" can be any string.  
JSON: { "pattern": "^123456-sharedAmData.+\$" }

## 6.1.6.2.107 Type: SubscriptionContext

Table 6.1.6.2.107-1: Definition of type SubscriptionContext

| Attribute name | Data type  | P | Cardinality | Description                                                                                                                                                                                                 |
|----------------|------------|---|-------------|-------------------------------------------------------------------------------------------------------------------------------------------------------------------------------------------------------------|
| subscriptionId | string     | M | 1           | Subscription ID of the corresponding subscription resource that originated the notification.                                                                                                                |
| subscrCond     | SubscrCond | O | 0..1        | If present, this attribute shall contain the conditions identifying the set of NF Instances whose status was requested to be monitored in the corresponding subscription that originated this notification. |

## 6.1.6.2.108 Type: IwmscInfo

Table 6.1.6.2.108-1: Definition of type IwmscInfo

| Attribute name                                                                         | Data type            | P | Cardinality | Description                                                                                                                                                                                                                                 |
|----------------------------------------------------------------------------------------|----------------------|---|-------------|---------------------------------------------------------------------------------------------------------------------------------------------------------------------------------------------------------------------------------------------|
| msisdnranges                                                                           | array(IdentityRange) | O | 1..N        | List of ranges of MSISDNs supported by the SMS-IWMSC. See NOTE.                                                                                                                                                                             |
| supiRanges                                                                             | array(SupiRange)     | O | 1..N        | List of ranges of SUPIs supported by the SMS-IWMSC. See NOTE.                                                                                                                                                                               |
| taiRangeList                                                                           | array(TaiRange)      | O | 1..N        | The range of TAIs the SMS-IWMSC can serve.<br>The absence of this attribute indicates that the SMS-IWMSC can serve any TA.                                                                                                                  |
| scNumber                                                                               | string               | O | 0..1        | When present, this IE carry an OctetString indicating the ISDN number of the SC in international number format as described in ITU-T Rec. E.164 [44] and shall be encoded as a TBCD-string.<br><br>Pattern: " <code>^[0-9]{5,15}\$</code> " |
| NOTE: If both parameters are not provided, the SMS-IWMSC can serve any SUPI or MSISDN. |                      |   |             |                                                                                                                                                                                                                                             |

## 6.1.6.2.109 Type: MnpfInfo

Table 6.1.6.2.109-1: Definition of type MnpfInfo

| Attribute name | Data type            | P | Cardinality | Description                                                                 |
|----------------|----------------------|---|-------------|-----------------------------------------------------------------------------|
| msisdnranges   | array(IdentityRange) | M | 1..N        | List of ranges of MSISDNs whose portability status is available in the MNPf |

## 6.1.6.2.110 Type: DefSubServiceInfo

Table 6.1.6.2.110-1: Definition of type DefSubServiceInfo

| Attribute name    | Data type         | P | Cardinality | Description                                                                                                                                                                      |
|-------------------|-------------------|---|-------------|----------------------------------------------------------------------------------------------------------------------------------------------------------------------------------|
| versions          | array(string)     | O | 1..N        | When present, this attribute shall indicate the API version (e.g. "v1") of the indicated service which are supported by the NF (Service) instance acting as NF service consumer. |
| supportedFeatures | SupportedFeatures | O | 0..1        | When present, this attribute shall indicate the features of the indicated service which are supported by the NF (Service) instance acting as NF service consumer.                |

### 6.1.6.3 Simple data types and enumerations

#### 6.1.6.3.1 Introduction

This clause defines simple data types and enumerations that can be referenced from data structures defined in the previous clauses.

#### 6.1.6.3.2 Simple data types

The simple data types defined in table 6.1.6.3.2-1 shall be supported.

**Table 6.1.6.3.2-1: Simple data types**

| Type Name    | Type Definition | Description                                                                                                                                                                                                                                |
|--------------|-----------------|--------------------------------------------------------------------------------------------------------------------------------------------------------------------------------------------------------------------------------------------|
| NefId        | string          | The NEF ID as specified in clause 4.25.2 of 3GPP TS 23.502 [3].<br>For combined SCEF+NEF, the NEF ID shall contain the SCEF ID encoded as specified in clause 8.4.5 of 3GPP TS 29.336 [37].                                                |
| VendorId     | string          | Vendor ID, according to the IANA-assigned "SMI Network Management Private Enterprise Codes" [38].<br>It shall be formatted as a fixed 6-digit string, padding with leading digits "0" to complete a 6-digit length.<br>Pattern: "[0-9]{6}" |
| WildcardDnai | string          | String representing the Wildcard DNAI.<br>It shall contain the string "*".<br>Pattern: "[*]"                                                                                                                                               |

#### 6.1.6.3.3 Enumeration: NFType

The enumeration NFType represents the different types of Network Functions or Network Entities that can be found in the 5GC.

Table 6.1.6.3.3-1: Enumeration NFType

| Enumeration value | Description                        |
|-------------------|------------------------------------|
| "NRF"             | Network Function: NRF              |
| "UDM"             | Network Function: UDM              |
| "AMF"             | Network Function: AMF              |
| "SMF"             | Network Function: SMF              |
| "AUSF"            | Network Function: AUSF             |
| "NEF"             | Network Function: NEF              |
| "PCF"             | Network Function: PCF              |
| "SMSF"            | Network Function: SMSF             |
| "NSSF"            | Network Function: NSSF             |
| "UDR"             | Network Function: UDR              |
| "LMF"             | Network Function: LMF              |
| "GMLC"            | Network Function: GMLC             |
| "5G_EIR"          | Network Function: 5G-EIR           |
| "SEPP"            | Network Entity: SEPP               |
| "UPF"             | Network Function: UPF              |
| "N3IWF"           | Network Function and Entity: N3IWF |
| "AF"              | Network Function: AF               |
| "UDSF"            | Network Function: UDSF             |
| "BSF"             | Network Function: BSF              |
| "CHF"             | Network Function: CHF              |
| "NWDAF"           | Network Function: NWDAF            |
| "PCSCF"           | Network Function: P-CSCF           |
| "CBCF"            | Network Function: CBCF             |
| "UCMF"            | Network Function: UCMF             |
| "HSS"             | Network Function: HSS              |
| "SOR_AF"          | Network Function: SOR-AF           |
| "SPAF"            | Network Function: SP-AF            |
| "MME"             | Network Function: MME              |
| "SCSAS"           | Network Function: SCS/AS           |
| "SCEF"            | Network Function: SCEF             |
| "SCP"             | Network Entity: SCP                |
| "NSSAAF"          | Network Function: NSSAAF           |
| "ICSCF"           | Network Function: I-CSCF           |
| "SCSCF"           | Network Function: S-CSCF           |
| "DRA"             | Network Function: DRA              |
| "IMS_AS"          | Network Function: IMS-AS           |
| "AANF"            | Network Function: AANF             |
| "5G_DDNMF"        | Network Function: 5G DDNMF         |
| "NSACF"           | Network Function: NSACF            |
| "MFAF"            | Network Function: MFAF             |
| "EASDF"           | Network Function: EASDF            |
| "DCCF"            | Network Function: DCCF             |
| "MB_SMF"          | Network Function: MB-SMF           |
| "TSCTSF"          | Network Function: TSCTSF           |
| "ADRF"            | Network Function: ADRF             |
| "GBA_BSF"         | Network Function: GBA BSF          |
| "CEF"             | Network Function: CEF              |
| "MB_UPF"          | Network Function: MB-UPF           |
| "NSWOF"           | Network Function: NSWOF            |
| "PKMF"            | Network Function: PKMF             |
| "MNPF"            | Network Function: MNPF             |
| "SMS_GMSC"        | Network Function: SMS-GMSC         |
| "SMS_IWMSC"       | Network Function: SMS-IWMSC        |
| "MBSF"            | Network Function: MBSF             |
| "MBSTF"           | Network Function: MBSTF            |
| "PANF"            | Network Function: PANF             |

6.1.6.3.4 Enumeration: NotificationType

**Table 6.1.6.3.4-1: Enumeration NotificationType**

| Enumeration value           | Description                                                                                                                                                                                                                                                                                                                                                                                                                                                                                                                                                                                                                                |
|-----------------------------|--------------------------------------------------------------------------------------------------------------------------------------------------------------------------------------------------------------------------------------------------------------------------------------------------------------------------------------------------------------------------------------------------------------------------------------------------------------------------------------------------------------------------------------------------------------------------------------------------------------------------------------------|
| "N1_MESSAGES"               | <p>Notification of N1 messages.</p> <p>This notification type may be registered by the NF Instance in a default notification subscription at NFProfile level (see clause 6.1.6.2.2) or as part of a specific service instance.</p> <p>If the AMF registers a default notification subscription with this notification type in an NF Service Instance, it may be associated with the service "namf-comm" or with a custom service.</p> <p>If the LMF registers a default notification subscription with this notification type in an NF Service Instance, it may be associated with the service "nlmf-loc" or with a custom service.</p>    |
| "N2_INFORMATION"            | <p>Notification of N2 information.</p> <p>This notification type may be registered by the NF Instance in a default notification subscription at NFProfile level (see clause 6.1.6.2.2) or as part of a specific service instance.</p> <p>If the AMF registers a default notification subscription with this notification type in an NF Service Instance, it may be associated with the service "namf-comm" or with a custom service.</p> <p>If the LMF registers a default notification subscription with this notification type in an NF Service Instance, it may be associated with the service "nlmf-loc" or with a custom service.</p> |
| "LOCATION_NOTIFICATION"     | <p>Notification of Location Information sent by AMF/LMF towards NF Service Consumers (e.g GMLC).</p> <p>This notification type may be registered by the NF Instance in a default notification subscription at NFProfile level (see clause 6.1.6.2.2) or as part of a specific service instance.</p> <p>If the the GMLC registers a default notification subscription with this notification type in an NF Service Instance, it may be associated with the service "ngmlc-loc" or with a custom service.</p>                                                                                                                                |
| "DATA_REMOVAL_NOTIFICATION" | <p>Notification of Data Removal sent by UDR (e.g., removal of UE registration data upon subscription withdrawal).</p> <p>This notification type shall be registered by the NF Instance in a default notification subscription at NFProfile level (see clause 6.1.6.2.2).</p>                                                                                                                                                                                                                                                                                                                                                               |
| "DATA_CHANGE_NOTIFICATION"  | <p>Notification of Data Changes sent by UDR.</p> <p>This notification type shall be registered by the NF Instance in a default notification subscription at NFProfile level (see clause 6.1.6.2.2).</p>                                                                                                                                                                                                                                                                                                                                                                                                                                    |



|                                 |                                                                                                                                                                                                                                                                                                                                                                                                                                                                                                                                                                                                                                                                                                                                                                    |
|---------------------------------|--------------------------------------------------------------------------------------------------------------------------------------------------------------------------------------------------------------------------------------------------------------------------------------------------------------------------------------------------------------------------------------------------------------------------------------------------------------------------------------------------------------------------------------------------------------------------------------------------------------------------------------------------------------------------------------------------------------------------------------------------------------------|
| "LOCATION_UPDATE_NOTIFICATION"  | <p>Notification of UE Location Information Update sent by GMLC towards NF Service Consumers (e.g. H-GMLC, NEF), during MO_LR procedure.</p> <p>This notification type may be registered by the NF Instance in a default notification subscription at NFProfile level (see clause 6.1.6.2.2) or as part of a specific service instance.</p> <p>If the the GMLC registers a default notification subscription with this notification type in an NF Service Instance, it may be associated with the service "ngmlc-loc" or with a custom service.</p> <p>If the the NEF registers a default notification subscription with this notification type in an NF Service Instance, it may be associated with the service "nnef-eventexposure" or with a custom service.</p> |
| "NSSAA_REAUTH_NOTIFICATION"     | <p>Re-authentication notification for slice-specific authentication and authorization sent by NSSAAF towards NF Service Consumers (e.g. AMF).</p> <p>This notification type should be registered by the NF Instance in a default notification subscription at NFProfile level (see clause 6.1.6.2.2); otherwise, it may be registered in a custom service instance.</p>                                                                                                                                                                                                                                                                                                                                                                                            |
| "NSSAA_REVOC_NOTIFICATION"      | <p>Revocation notification for slice-specific authentication and authorization sent by NSSAAF towards NF Service Consumers (e.g. AMF).</p> <p>This notification type should be registered by the NF Instance in a default notification subscription at NFProfile level (see clause 6.1.6.2.2); otherwise, it may be registered in a custom service instance.</p>                                                                                                                                                                                                                                                                                                                                                                                                   |
| "MATCH_INFO_NOTIFICATION"       | <p>Notification of a matching result, and the information that can be used for charging purpose by 5G DDNMF towards NF Service Consumers (e.g. 5G DDNMF), during Discovery Reporting procedures.</p> <p>This notification type should be registered by the NF Instance in a default notification subscription at NFProfile level (see clause 6.1.6.2.2); otherwise, it may be registered in a custom service instance.</p>                                                                                                                                                                                                                                                                                                                                         |
| "DATA_RESTITUTION_NOTIFICATION" | <p>Notification by UDR to its NF Service Consumers (e.g. UDM, PCF, NEF...) or by UDM to its NF Service Consumers (e.g. AMF, SMF, SMSF...) of a potential data-loss event originated at UDR. The content of the notification shall be as described in 3GPP TS 29.503 [36], clause 5.3.2.12.2 and 6.2.5.4.</p> <p>This notification type should be registered by the NF Instance in a default notification subscription at NFProfile level (see clause 6.1.6.2.2); otherwise, it may be registered in a custom service instance.</p>                                                                                                                                                                                                                                 |
| "TSCTS_NOTIFICATION"            | <p>Notification sent by PCF to TSCTSF of TSC user-plane node information. The content of the notification is described in 3GPP TS 29.514 [47], clause 4.2.5.16.</p> <p>This notification type should be registered by the NF Instance in a default notification subscription at NFProfile level (see clause 6.1.6.2.2); otherwise, it may be registered in a custom service instance.</p>                                                                                                                                                                                                                                                                                                                                                                          |
| "LCS_KEY_DELIVERY_NOTIFICATION" | <p>Notification sent by LMF to AMF to deliver ciphering key information.</p> <p>This notification type should be registered by the NF Instance in a default notification subscription at NFProfile level (see clause 6.1.6.2.2); otherwise, it may be registered in a custom service instance.</p>                                                                                                                                                                                                                                                                                                                                                                                                                                                                 |

## 6.1.6.3.5 Enumeration: TransportProtocol

**Table 6.1.6.3.5-1: Enumeration TransportProtocol**

| Enumeration value | Description             |
|-------------------|-------------------------|
| "TCP"             | Transport protocol: TCP |

## 6.1.6.3.6 Enumeration: NotificationEventType

**Table 6.1.6.3.6-1: Enumeration NotificationEventType**

| Enumeration value    | Description                                      |
|----------------------|--------------------------------------------------|
| "NF_REGISTERED"      | The NF Instance has been registered in NRF       |
| "NF_DEREGISTERED"    | The NF Instance has been deregistered from NRF   |
| "NF_PROFILE_CHANGED" | The profile of the NF Instance has been modified |

## 6.1.6.3.7 Enumeration: NFStatus

**Table 6.1.6.3.7-1: Enumeration NFStatus**

| Enumeration value | Description                                                                                                                                                                                                                                                                                                       |
|-------------------|-------------------------------------------------------------------------------------------------------------------------------------------------------------------------------------------------------------------------------------------------------------------------------------------------------------------|
| "REGISTERED"      | The NF Instance is registered in NRF and can be discovered by other NFs.                                                                                                                                                                                                                                          |
| "SUSPENDED"       | The NF Instance is registered in NRF but it is not operative and cannot be discovered by other NFs.<br>This status may result from a NF Heart-Beat failure (see clause 5.2.2.3.2) or a NF failure and may trigger restoration procedures (see clause 6.2 of 3GPP TS 23.527 [27]).                                 |
| "UNDISCOVERABLE"  | The NF instance is registered in NRF, is operative but cannot be discovered by other NFs.<br>This status may be set by the NF e.g. in shutting down scenarios where the NF is still able to process requests for existing resources or sessions but cannot accept new resource creation or session establishment. |

## 6.1.6.3.8 Enumeration: DataSetId

The enumeration DataSetId represents the different types of data sets supported by an UDR instance.

**Table 6.1.6.3.8-1: Enumeration DataSetId**

| Enumeration value                                                                                                                                                                                                                                                                                                                                                                                                                                                                                                                                                                            | Description                                                |
|----------------------------------------------------------------------------------------------------------------------------------------------------------------------------------------------------------------------------------------------------------------------------------------------------------------------------------------------------------------------------------------------------------------------------------------------------------------------------------------------------------------------------------------------------------------------------------------------|------------------------------------------------------------|
| "SUBSCRIPTION"                                                                                                                                                                                                                                                                                                                                                                                                                                                                                                                                                                               | Data set: Subscription data                                |
| "POLICY"                                                                                                                                                                                                                                                                                                                                                                                                                                                                                                                                                                                     | Data set: Policy data (including all defined subsets)      |
| "EXPOSURE"                                                                                                                                                                                                                                                                                                                                                                                                                                                                                                                                                                                   | Data set: Structured data for exposure                     |
| "APPLICATION"                                                                                                                                                                                                                                                                                                                                                                                                                                                                                                                                                                                | Data set: Application data (including all defined subsets) |
| "A_PFD"                                                                                                                                                                                                                                                                                                                                                                                                                                                                                                                                                                                      | ApplicationData subset: Packet Flow Descriptions           |
| "A_AFTI"                                                                                                                                                                                                                                                                                                                                                                                                                                                                                                                                                                                     | ApplicationData subset: AF Traffic Influence Data          |
| "A_IPTV"                                                                                                                                                                                                                                                                                                                                                                                                                                                                                                                                                                                     | ApplicationData subset: IPTV Config Data                   |
| "A_BDT"                                                                                                                                                                                                                                                                                                                                                                                                                                                                                                                                                                                      | ApplicationData subset: Background Data Transfer           |
| "A_SPD"                                                                                                                                                                                                                                                                                                                                                                                                                                                                                                                                                                                      | ApplicationData subset: Service Parameter Data             |
| "A_EASD"                                                                                                                                                                                                                                                                                                                                                                                                                                                                                                                                                                                     | ApplicationData subset: EAS Deployment Information         |
| "A_AMI"                                                                                                                                                                                                                                                                                                                                                                                                                                                                                                                                                                                      | ApplicationData subset: AM Influence Data                  |
| "P_UE"                                                                                                                                                                                                                                                                                                                                                                                                                                                                                                                                                                                       | PolicyData subset: UE Specific Data                        |
| "P_SCD"                                                                                                                                                                                                                                                                                                                                                                                                                                                                                                                                                                                      | PolicyData subset: Sponsored Connectivity Data             |
| "P_BDT"                                                                                                                                                                                                                                                                                                                                                                                                                                                                                                                                                                                      | PolicyData subset: Background Data Transfer                |
| "P_PLMNUE"                                                                                                                                                                                                                                                                                                                                                                                                                                                                                                                                                                                   | PolicyData subset: PLMN specific UE policy data            |
| "P_NSSCD"                                                                                                                                                                                                                                                                                                                                                                                                                                                                                                                                                                                    | PolicyData subset: Network Slice Specific Control Data     |
| NOTE: Enumeration values identifying an ApplicationData subset or PolicyData subset should not be used in NF discovery requests unless UDR and NRF have been upgraded to support these values. If the UDR registers all defined ApplicationData subset values and/or all defined PolicyData subset values, it shall also register the ApplicationData data set value and/or PolicyData data set value. The UDR that registers the Application Data set value and/or the Policy Data set value shall also register all defined ApplicationData subset values and/or PolicyData subset values. |                                                            |

6.1.6.3.9 Enumeration: UPIInterfaceType

**Table 6.1.6.3.9-1: Enumeration UPIInterfaceType**

| Enumeration value                                                                                          | Description                                                 |
|------------------------------------------------------------------------------------------------------------|-------------------------------------------------------------|
| "N3"                                                                                                       | User Plane Interface: N3                                    |
| "N6"                                                                                                       | User Plane Interface: N6                                    |
| "N9"                                                                                                       | User Plane Interface: N9                                    |
| "DATA_FORWARDING"                                                                                          | User Plane Interface for indirect data forwarding. (NOTE 1) |
| "N6MB"                                                                                                     | User Plane Interface: N6mb                                  |
| "N19MB"                                                                                                    | User Plane Interface: N19mb                                 |
| "N3MB"                                                                                                     | User Plane Interface: N3mb                                  |
| "NMB9"                                                                                                     | User Plane Interface: Nmb9                                  |
| NOTE 1: This interface type may be used when a dedicated network instance is deployed for data forwarding. |                                                             |

6.1.6.3.10 Relation Types

6.1.6.3.10.1 General

This clause describes the possible relation types defined within NRF API. See clause 4.7.5.2 of 3GPP TS 29.501 [5] for the description of the relation types.

**Table 6.1.6.3.10.1-1: supported registered relation types**

| Relation Name |
|---------------|
| self          |
| item          |

6.1.6.3.11 Enumeration: ServiceName

**Table 6.1.6.3.11-1: Enumeration ServiceName**

| Enumeration value                  | Description                                                                                                                             |
|------------------------------------|-----------------------------------------------------------------------------------------------------------------------------------------|
| "nnrf-nfm"                         | Nnrf_NFManagement Service offered by the NRF                                                                                            |
| "nnrf-disc"                        | Nnrf_NFDiscovery Service offered by the NRF                                                                                             |
| "nnrf-oauth2"                      | Nnrf_AccessToken Service offered by the NRF                                                                                             |
| "nudm-sdm"                         | Nudm_SubscriberDataManagement Service offered by the UDM                                                                                |
| "nudm-uecm"                        | Nudm_UEContextManagement Service offered by the UDM                                                                                     |
| "nudm-ueau"                        | Nudm_UEAuthentication Service offered by the UDM                                                                                        |
| "nudm-ee"                          | Nudm_EventExposure Service offered by the UDM                                                                                           |
| "nudm-pp"                          | Nudm_ParameterProvision Service offered by the UDM                                                                                      |
| "nudm-niddau"                      | Nudm_NIDDAuthorization Service offered by the UDM                                                                                       |
| "nudm-mt"                          | Nudm_MT Service offered by the UDM                                                                                                      |
| "nudm-ssau"                        | Nudm_ServiceSpecificAuthorization Service offered by the UDM                                                                            |
| "nudm-rsds"                        | Nudm_ReportSMDeliveryStatus Service offered by the UDM                                                                                  |
| "namf-comm"                        | Namf_Communication Service offered by the AMF                                                                                           |
| "namf-evts"                        | Namf_EventExposure Service offered by the AMF                                                                                           |
| "namf-mt"                          | Namf_MT Service offered by the AMF                                                                                                      |
| "namf-loc"                         | Namf_Location Service offered by the AMF                                                                                                |
| "namf-mbs-comm"                    | Namf_MBSCommunication Service offered by AMF                                                                                            |
| "namf-mbs-bc"                      | Namf_MBSBroadcast Service offered by AMF                                                                                                |
| "nsmf-pdusession"                  | Nsmf_PDUSession Service offered by the SMF                                                                                              |
| "nsmf-event-exposure"              | Nsmf_EventExposure Service offered by the SMF                                                                                           |
| "nsmf-nidd"                        | Nsmf_NIDD Service offered by the SMF                                                                                                    |
| "nausf-auth"                       | Nausf_UEAuthentication Service offered by the AUSF                                                                                      |
| "nausf-sorprotection"              | Nausf_SoRProtection Service offered by the AUSF                                                                                         |
| "nausf-upuprotection"              | Nausf_UPUProtection Service offered by the AUSF                                                                                         |
| "nnef-pfdmanagement"               | Nnef_PFDManagement offered by the NEF                                                                                                   |
| "nnef-smcontext"                   | Nnef_SMContext Service offered by the NEF                                                                                               |
| "nnef-eventexposure"               | Nnef_EventExposure Service offered by the NEF                                                                                           |
| "nnef-eas-deployment-info"         | Nnef_EASDeployment InfoService offered by the NEF. This is the southbound part of the API (e.g. the service operations used by the SMF) |
| "3gpp-cp-parameter-provisioning"   | Nnef_ParameterProvision Service offered by the NEF                                                                                      |
| "3gpp-device-triggering"           | Nnef_Trigger Service offered by the NEF                                                                                                 |
| "3gpp-bdt"                         | Nnef_BDTPNegotiation Service offered by the NEF                                                                                         |
| "3gpp-traffic-influence"           | Nnef_TrafficInfluence Service offered by the NEF                                                                                        |
| "3gpp-chargeable-party"            | Nnef_ChargeableParty Service offered by the NEF                                                                                         |
| "3gpp-as-session-with-qos"         | Nnef_AFsessionWithQoS Service offered by the NEF                                                                                        |
| "3gpp-msisdn-less-mo-sms"          | Nnef_MSISDN-less_MO_SMS Service offered by the NEF                                                                                      |
| "3gpp-service-parameter"           | Nnef_ServiceParameter Service offered by the NEF                                                                                        |
| "3gpp-monitoring-event"            | Nnef_APISupportCapability Service offered by the NEF                                                                                    |
| "3gpp-nidd-configuration-trigger"  | Nnef_NIDDConfiguration Service offered by the NEF                                                                                       |
| "3gpp-nidd"                        | Nnef_NIDD Service offered by the NEF                                                                                                    |
| "3gpp-analyticsexposure"           | Nnef_AnalyticsExposure Service offered by the NEF                                                                                       |
| "3gpp-racs-parameter-provisioning" | Nnef_UCMFProvisioning Service offered by the NEF                                                                                        |
| "3gpp-ecr-control"                 | Nnef_ECRrestriction Service offered by the NEF                                                                                          |
| "3gpp-applying-bdt-policy"         | Nnef_ApplyPolicy Service offered by the NEF                                                                                             |
| "3gpp-mo-lcs-notify"               | Nnef_Location Service offered by the NEF                                                                                                |
| "3gpp-time-sync"                   | Nnef_TimeSynchronization Service offered by the NEF                                                                                     |
| "3gpp-am-influence"                | Nnef_AMInfluence Service offered by the NEF                                                                                             |
| "3gpp-am-policyauthorization"      | Nnef_AMPolicyAuthorization                                                                                                              |
| "3gpp-akma"                        | Nnef_AKMA Service offered by the NEF                                                                                                    |
| "3gpp-eas-deployment"              | Nnef_EASDeployment Service offered by the NEF. This is the northbound part (e.g. the service operations used by the AF).                |
| "3gpp-iptvconfiguration"           | Nnef_IPTV_configuration Service offered by the NEF                                                                                      |
| "3gpp-mbs-tmgi"                    | Nnef_MBSTMGI Service offered by the NEF                                                                                                 |
| "3gpp-mbs-session"                 | Nnef_MBSSession Service offered by the NEF                                                                                              |
| "3gpp-authentication"              | Nnef_Authentication Service offered by the NEF                                                                                          |
| "3gpp-asti"                        | Nnef_ASTI Service offered by the NEF                                                                                                    |
| "npcf-am-policy-control"           | Npcf_AMPolicyControl Service offered by the PCF                                                                                         |
| "npcf-smpolicycontrol"             | Npcf_SMPolicyControl Service offered by the PCF                                                                                         |
| "npcf-policyauthorization"         | Npcf_PolicyAuthorization Service offered by the PCF                                                                                     |
| "npcf-bdtpolicycontrol"            | Npcf_BDTPolicyControl Service offered by the PCF                                                                                        |
| "npcf-eventexposure"               | Npcf_EventExposure Service offered by the PCF                                                                                           |

|                                |                                                              |
|--------------------------------|--------------------------------------------------------------|
| "npcf-ue-policy-control"       | Npcf_UEPolicyControl Service offered by the PCF              |
| "npcf-am-policyauthorization"  | Npcf_AM_PolicyAuthorization Service offered by the PCF       |
| "nsmf-sms"                     | Nsmf_SMSService Service offered by the SMSF                  |
| "nssf-nssselection"            | Nssf_NSSSelection Service offered by the NSSF                |
| "nssf-nssaiavailability"       | Nssf_NSSAIAvailability Service offered by the NSSF           |
| "nudr-dr"                      | Nudr_DataRepository Service offered by the UDR               |
| "nudr-group-id-map"            | Nudr_GroupIDmap Service offered by the UDR                   |
| "nlfm-loc"                     | Nlfm_Location Service offered by the LMF                     |
| "n5g-eir-eic"                  | N5g-eir_EquipmentIdentityCheck Service offered by the 5G-EIR |
| "nbsf-management"              | Nbsf_Management Service offered by the BSF                   |
| "nchf-spendinglimitcontrol"    | Nchf_SpendingLimitControl Service offered by the CHF         |
| "nchf-convergedcharging"       | Nchf_Converged_Charging Service offered by the CHF           |
| "nchf-offlineonlycharging"     | Nchf_OfflineOnlyCharging Service offered by the CHF          |
| "nwdaf-eventssubscription"     | Nwdaf_EventsSubscription Service offered by the NWDAF        |
| "nwdaf-analyticsinfo"          | Nwdaf_AnalyticsInfo Service offered by the NWDAF             |
| "nwdaf-datamanagement"         | Nwdaf_DataManagement Service offered by the NWDAF            |
| "nwdaf-mlmodelprovision"       | Nwdaf_MLModelProvision Service offered by the NWDAF          |
| "ngmlc-loc"                    | Ngmlc_Location Service offered by GMLC                       |
| "nucmf-provisioning"           | Nucmf_Provisioning Service offered by UCMF                   |
| "nucmf-uecapabilitymanagement" | Nucmf_UECapabilityManagement Service offered by UCMF         |
| "nhss-sdm"                     | Nhss_SubscriberDataManagement Service offered by the HSS     |
| "nhss-uecm"                    | Nhss_UEContextManagement Service offered by the HSS          |
| "nhss-ueau"                    | Nhss_UEAuthentication Service offered by the HSS             |
| "nhss-ee"                      | Nhss_EventExposure Service offered by the HSS                |
| "nhss-ims-sdm"                 | Nhss_imsSubscriberDataManagement Service offered by the HSS  |
| "nhss-ims-uecm"                | Nhss_imsUEContextManagement Service offered by the HSS       |
| "nhss-ims-ueau"                | Nhss_imsUEAuthentication Service offered by the HSS          |
| "nhss-gba-sdm"                 | Nhss_gbaSubscriberDataManagement Service offered by the HSS  |
| "nhss-gba-ueau"                | Nhss_gbaUEAuthentication Service offered by the HSS          |
| "nsepp-telescopic"             | Nsepp_Telescopic_FQDN_Mapping Service offered by the SEPP    |
| "nsoraf-sor"                   | Nsoraf_SteeringOfRoaming Service offered by the SOR-AF       |
| "nspaf-secured-packed"         | Nspaf_SecuredPacket Service offered by the SP-AF             |
| "nudsf-d"                      | Nudsf Data Repository service offered by the UDSF.           |
| "nudsf-timer"                  | Nudsf Timer service offered by the UDSF                      |
| "nnsaaf-nssaa"                 | Nnsaaf_NSSAA service offered by the NSSAAF.                  |
| "nnsaaf-aiw"                   | Nnsaaf_AIW service offered by the NSSAAF.                    |
| "naanf-akma"                   | Naanf_AKMA service offered by the AAnF.                      |
| "n5gddnmf-discovery"           | N5g-ddnmf_Discovery service offered by 5G DDNMF              |
| "nmfaf-3dadm"                  | Nmfaf_3daDataManagement service offered by the MFAF.         |
| "nmfaf-3cadm"                  | Nmfaf_3caDataManagement service offered by the MFAF.         |
| "neasdf-dnscontext"            | Neasdf_DNSContext service offered by the EASDF               |
| "neasdf-baselinednspattern"    | Neasdf_BaselineDNSPattern service offered by the EASDF       |
| "ndccf-dm"                     | Ndccf_DataManagement service offered by the DCCF.            |
| "ndccf-cm"                     | Ndccf_ContextManagement service offered by the DCCF.         |
| "nnsacf-nsac"                  | Nnsacf_NSAC service offered by the NSACF.                    |
| "nnsacf-slice-ee"              | Nnsacf_SliceEventExposure service offered by the NSACF.      |
| "nmbmf-tmgi"                   | Nmbmf TMGI service offered by the MB-SMF                     |
| "nmbmf-mbssession"             | Nmbmf MBSSession service offered by the MB-SMF               |
| "nadr-dm"                      | Nadr_DataManagement service offered by the ADRF.             |
| "nbsp-gba"                     | Nbsp_GBA service offered by the GBA BSF.                     |
| "ntsctsf-time-sync"            | Ntsctsf_TimeSynchronization service offered by the TSCTSF    |
| "ntsctsf-qos-tscai"            | Ntsctsf_QoSandTSCAssistance service offered by the TSCTSF    |
| "ntsctsf-asti"                 | Ntsctsf_ASTI service offered by the TSCTSF                   |
| "npkmf-keyrequest"             | Npkmf_PKMFKeyRequest service offered by the PKMF             |
| "nmnpf-npstatus"               | Nmnpf_NPStatus service offered by the MNPF                   |
| "niwmsc-smsservice"            | Niwmsc_SMSService service offered by the SMS-IWMSC           |
| "nmbmf-mbsuserserv"            | Nmbmf_MBSUserService service offered by the MBSF             |
| "nmbmf-mbsuserdataing"         | Nmbmf_MBSUserDataIngestSession service offered by the MBSF   |
| "nmbstf-distsession"           | Nmbstf_MBSDistributionSession service offered by the MBSTF   |
| "npanf-prosekey"               | Npanf_ProseKey service offered by the PANF                   |

NOTE: The services defined in this table are those defined by 3GPP NFs in 5GC; however, in order to support custom services offered by standard and custom NFs, the NRF shall also accept the registration of NF Services with other service names.

### 6.1.6.3.12 Enumeration: NFServiceStatus

**Table 6.1.6.3.12-1: Enumeration NFServiceStatus**

| Enumeration value | Description                                                                                                                                                                                                                                                                                                                    |
|-------------------|--------------------------------------------------------------------------------------------------------------------------------------------------------------------------------------------------------------------------------------------------------------------------------------------------------------------------------|
| "REGISTERED"      | The NF Service Instance is registered in NRF and can be discovered by other NFs.                                                                                                                                                                                                                                               |
| "SUSPENDED"       | The NF Service Instance is registered in NRF but it is not operative and cannot be discovered by other NFs. This status may result from a NF Service failure and may trigger restoration procedures (see clause 6.2 of 3GPP TS 23.527 [27]).                                                                                   |
| "UNDISCOVERABLE"  | The NF Service instance is registered in NRF, is operative but cannot be discovered by other NFs. This status may be set by the NF e.g. in shutting down scenarios where the NF service is still able to process requests for existing resources or sessions but cannot accept new resource creation or session establishment. |
| NOTE:             | An NF service cannot be discovered by other NFs if the NF status is set to "SUSPENDED" or "UNDISCOVERABLE", regardless of the NF service status.                                                                                                                                                                               |

### 6.1.6.3.13 Enumeration: AnNodeType

**Table 6.1.6.3.13-1: Enumeration AnNodeType**

| Enumeration value | Description |
|-------------------|-------------|
| "GNB"             | gNB         |
| "NG_ENB"          | NG-eNB      |

### 6.1.6.3.14 Enumeration: ConditionEventType

**Table 6.1.6.3.14-1: Enumeration ConditionEventType**

| Enumeration value | Description                                                                                          |
|-------------------|------------------------------------------------------------------------------------------------------|
| "NF_ADDED"        | The NF Instance notified by NRF starts being part of a condition for a subscription on a set of NFs. |
| "NF_REMOVED"      | The NF Instance notified by NRF stops being part of a condition for a subscription on a set of NFs.  |

### 6.1.6.3.15 Enumeration: IpReachability

**Table 6.1.6.3.15-1: Enumeration IpReachability**

| Enumeration value | Description                                           |
|-------------------|-------------------------------------------------------|
| "IPV4"            | Only IPv4 addresses are reachable.                    |
| "IPV6"            | Only IPv6 addresses are reachable.                    |
| "IPV4V6"          | Both IPv4 addresses and IPv6 addresses are reachable. |

## 6.1.6.3.16 Enumeration: ScpCapability

**Table 6.1.6.3.16-1: Enumeration ScpCapability**

| Enumeration value              | Description                                               |
|--------------------------------|-----------------------------------------------------------|
| "INDIRECT_COM_WITH_DELEG_DISC" | Indirect communication with delegated discovery supported |

## 6.1.6.3.17 Enumeration: CollocatedNfType

**Table 6.1.6.3.17-1: Enumeration CollocatedNfType**

| Enumeration value | Description              |
|-------------------|--------------------------|
| "UPF"             | Network function: UPF    |
| "SMF"             | Network function: SMF    |
| "MB_UPF"          | Network function: MB-UPF |
| "MB_SMF"          | Network function: MB-SMF |

## 6.1.7 Error Handling

## 6.1.7.1 General

HTTP error handling shall be supported as specified in clause 5.2.4 of 3GPP TS 29.500 [4].

## 6.1.7.2 Protocol Errors

Protocol errors handling shall be supported as specified in clause 5.2.7 of 3GPP TS 29.500 [4].

## 6.1.7.3 Application Errors

The application errors defined for the Nnrf\_NFManagement service are listed in Table 6.1.7.3-1.

**Table 6.1.7.3-1: Application errors**

| Application Error        | HTTP status code | Description                                                                                             |
|--------------------------|------------------|---------------------------------------------------------------------------------------------------------|
| SUBSCRIPTION_NOT_ALLOWED | 403 Forbidden    | It is used when the validation of the authorization parameters in the subscription request has failed.  |
| NF_NOT_FOUND             | 404 Not Found    | It is used when no NFProfile corresponding to the NF Instance Id in NfInstanceIdCond exists in the NRF. |

## 6.1.8 Security

As indicated in clause 13.3 of 3GPP TS 33.501 [15], when static authorization is not used, the access to the Nnrf\_NFManagement API may be authorized by means of the OAuth2 protocol (see IETF RFC 6749 [16]), using the "Client Credentials" authorization grant, where the NRF plays the role of the authorization server.

If OAuth2 authorization is used on the Nnrf\_NFManagement API, an NF Service Consumer, prior to consuming services offered by the Nnrf\_NFManagement API, shall obtain a "token" from the authorization server, by invoking the Access Token Request service, as described in clause 5.4.2.2.

**NOTE:** When multiple NRFs are deployed in a network, the NRF used as authorization server is the same NRF where the Nnrf\_NFManagement service is invoked by the NF Service Producer.

The Nnrf\_NFManagement API defines the following scopes for OAuth2 authorization:



**Table 6.1.8-1: OAuth2 scopes defined in Nnrf\_NFManagement API**

| Scope                        | Description                                                                        |
|------------------------------|------------------------------------------------------------------------------------|
| "nnrf-nfm"                   | Access to the Nnrf_NFManagement API                                                |
| "nnrf-nfm:nf-instances:read" | Access to read the nf-instances resource, or an individual NF Instance ID resource |

## 6.1.9 Features supported by the NFManagement service

The syntax of the supportedFeatures attribute is defined in clause 5.2.2 of 3GPP TS 29.571 [7].

The following features are defined for the Nnrf\_NFManagement service.

**Table 6.1.9-1: Features of supportedFeatures attribute used by Nnrf\_NFManagement service**

| Feature Number                                                                                                                                                                                                                                                                                                                                     | Feature                | M/O | Description                                                                                                                                                                                                                                                                                             |
|----------------------------------------------------------------------------------------------------------------------------------------------------------------------------------------------------------------------------------------------------------------------------------------------------------------------------------------------------|------------------------|-----|---------------------------------------------------------------------------------------------------------------------------------------------------------------------------------------------------------------------------------------------------------------------------------------------------------|
| 1                                                                                                                                                                                                                                                                                                                                                  | Service-Map            | M   | Support of defining in the profile of the NF Instance the list of NF Service Instances based on a map type (i.e. support of the "nfServiceList" attribute in NFProfile).                                                                                                                                |
| 2                                                                                                                                                                                                                                                                                                                                                  | Empty-Objects-Nrf-Info | O   | Support of receiving empty JSON objects as values in the servedxxxInfo/servedxxxInfoList map attributes of the NrfInfo data structure used by an NRF during registration into another NRF (see clause 6.1.6.2.31).<br><br>An NRF that supports registering into another NRF shall support this feature. |
| Feature number: The order number of the feature within the supportedFeatures attribute (starting with 1).<br>Feature: A short name that can be used to refer to the bit and to the feature.<br>M/O: Defines if the implementation of the feature is mandatory ("M") or optional ("O").<br>Description: A clear textual description of the feature. |                        |     |                                                                                                                                                                                                                                                                                                         |

## 6.2 Nnrf\_NFDiscovery Service API

### 6.2.1 API URI

The API URI of the Nnrf\_NFDiscovery API shall be:

**{apiRoot}/<apiName>/<apiVersion>**

The request URIs used in HTTP requests from the NF service consumer towards the NF service producer shall have the Resource URI structure defined in clause 4.4.1 of 3GPP TS 29.501 [5], i.e.:

**{apiRoot}/<apiName>/<apiVersion>/<apiSpecificResourceUriPart>**

where:

- the {apiRoot} shall be set as defined in clause 4.4.1 of 3GPP TS 29.501 [5];
- the <apiName> shall be set to "nnrf-disc";
- the <apiVersion> shall be set to "v1" for the current version of this specification;
- the <apiSpecificResourceUriPart> shall be set as described in clause 6.2.3.

## 6.2.2 Usage of HTTP

### 6.2.2.1 General

HTTP/2, as defined in IETF RFC 7540 [9], shall be used as specified in clause 5 of 3GPP TS 29.500 [4].

HTTP/2 shall be transported as specified in clause 5.3 of 3GPP TS 29.500 [4].

HTTP messages and bodies for the Nnrf\_NFDiscovery service shall comply with the OpenAPI [10] specification contained in Annex A.

### 6.2.2.2 HTTP standard headers

#### 6.2.2.2.1 General

The mandatory standard HTTP headers as specified in clause 5.2.2.2 of 3GPP TS 29.500 [4] shall be supported.

#### 6.2.2.2.2 Content type

The following content types shall be supported:

- The JSON format (IETF RFC 8259 [22]). The use of the JSON format shall be signalled by the content type "application/json". See also clause 5.4 of 3GPP TS 29.500 [4].
- The Problem Details JSON Object (IETF RFC 7807 [11]). The use of the Problem Details JSON object in a HTTP response body shall be signalled by the content type "application/problem+json".

#### 6.2.2.2.3 Cache-Control

A "Cache-Control" header should be included in HTTP responses, as described in IETF RFC 7234 [20], clause 5.2. It shall contain a "max-age" value, indicating the amount of time in seconds after which the received response is considered stale; this value shall be the same as the content of the "validityPeriod" element described in clause 6.2.6.2.2.

#### 6.2.2.2.4 ETag

An "ETag" (entity-tag) header should be included in HTTP responses, as described in IETF RFC 7232 [19], clause 2.3. It shall contain a server-generated strong validator, that allows further matching of this value (included in subsequent client requests) with a given resource representation stored in the server or in a cache.

#### 6.2.2.2.5 If-None-Match

An NF Service Consumer should issue conditional GET request towards NRF, by including an If-None-Match header in HTTP requests, as described in IETF RFC 7232 [19], clause 3.2, containing one or several entity tags received in previous responses for the same resource.

### 6.2.2.3 HTTP custom headers

#### 6.2.2.3.1 General

In this release of this specification, no custom headers specific to the Nnrf\_NFDiscovery service are defined. For 3GPP specific HTTP custom headers used across all service-based interfaces, see clause 5.2.3 of 3GPP TS 29.500 [4].

## 6.2.3 Resources

### 6.2.3.1 Overview

The structure of the Resource URIs of the NFDiscovery service is shown in figure 6.2.3.1-1.

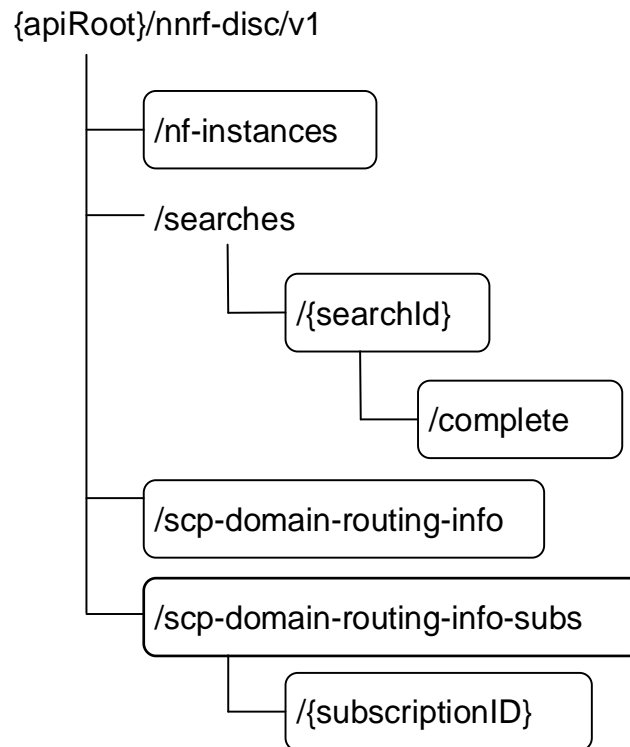

**Figure 6.2.3.1-1: Resource URI structure of the NFDISCOVERY API**

Table 6.2.3.1-1 provides an overview of the resources and applicable HTTP methods.

Table 6.2.3.1-1: Resources and methods overview

| Resource name                                              | Resource URI                                  | HTTP method or custom operation | Description                                                                                                                                                                                                                          |
|------------------------------------------------------------|-----------------------------------------------|---------------------------------|--------------------------------------------------------------------------------------------------------------------------------------------------------------------------------------------------------------------------------------|
| nf-instances (Store)                                       | /nf-instances                                 | GET                             | Retrieve a collection of NF Instances according to certain filter criteria.                                                                                                                                                          |
| Stored Search (Document)                                   | /searches/{searchId}                          | GET                             | Retrieve a collection of NF Instances, previously stored by NRF as a consequence of a prior search result.                                                                                                                           |
| Complete Stored Search (Document)                          | /searches/{searchId}/complete                 | GET                             | Retrieve a collection of NF Instances, previously stored by NRF as a consequence of a prior search result, without applying any client restriction on the number of instances (e.g. "limit" or "max-payload-size" query parameters). |
| SCP Domain Routing Information (Document)                  | /scp-domain-routing-info                      | GET                             | Retrieve the SCP Domain Routing Information.                                                                                                                                                                                         |
| SCP Domain Routing Info Subscriptions (Collection)         | /scp-domain-routing-info-sub                  | POST                            | Subscribe to SCP Domain Routing Information change.                                                                                                                                                                                  |
| Individual SCP Domain Routing Info Subscription (Document) | /scp-domain-routing-info-sub/{subscriptionID} | DELETE                          | Unsubscribe to SCP Domain Routing Information change.                                                                                                                                                                                |

### 6.2.3.2 Resource: nf-instances (Store)

#### 6.2.3.2.1 Description

This resource represents a collection of the different NF instances registered in the NRF.

This resource is modelled as the Store resource archetype (see clause C.3 of 3GPP TS 29.501 [5]).

#### 6.2.3.2.2 Resource Definition

Resource URI: **{apiRoot}/nnrf-disc/v1/nf-instances**

This resource shall support the resource URI variables defined in table 6.2.3.2.2-1.

Table 6.2.3.2.2-1: Resource URI variables for this resource

| Name    | Data type | Definition       |
|---------|-----------|------------------|
| apiRoot | string    | See clause 6.1.1 |

#### 6.2.3.2.3 Resource Standard Methods

##### 6.2.3.2.3.1 GET

This operation retrieves a list of NF Instances, and their offered services, currently registered in the NRF, satisfying a number of filter criteria, such as those NF Instances offering a certain service name, or those NF Instances of a given NF type (e.g., AMF).

**Table 6.2.3.2.3.1-1: URI query parameters supported by the GET method on this resource**

| Name                          | Data type               | P | Cardinality | Description                                                                                                                                                                                                                                                                                                                                                                                                                                                                                                                                                                                                                                                                                                                                                                                                                                                                                                                                      | Applicability           |
|-------------------------------|-------------------------|---|-------------|--------------------------------------------------------------------------------------------------------------------------------------------------------------------------------------------------------------------------------------------------------------------------------------------------------------------------------------------------------------------------------------------------------------------------------------------------------------------------------------------------------------------------------------------------------------------------------------------------------------------------------------------------------------------------------------------------------------------------------------------------------------------------------------------------------------------------------------------------------------------------------------------------------------------------------------------------|-------------------------|
| target-nf-type                | NFType                  | M | 1           | This IE shall contain the NF type of the target NF being discovered.                                                                                                                                                                                                                                                                                                                                                                                                                                                                                                                                                                                                                                                                                                                                                                                                                                                                             |                         |
| requester-nf-type             | NFType                  | M | 1           | This IE shall contain the NF type of the Requester NF that is invoking the Nnrf_NFDiscovery service.                                                                                                                                                                                                                                                                                                                                                                                                                                                                                                                                                                                                                                                                                                                                                                                                                                             |                         |
| preferred-collocated-nf-types | array(CollocatedNFType) | O | 1..N        | The IE may be present to indicate desired collocated NF type(s) when the NF service consumer wants to discover candidate NFs matching the target NF Type that are preferentially collocated with other NF types. (NOTE 19)                                                                                                                                                                                                                                                                                                                                                                                                                                                                                                                                                                                                                                                                                                                       | Collocated-NF-Selection |
| requester-nf-instance-id      | NfInstanceid            | O | 0..1        | If included, this IE shall contain the NF instance id of the Requester NF.                                                                                                                                                                                                                                                                                                                                                                                                                                                                                                                                                                                                                                                                                                                                                                                                                                                                       | Query-Params-Ext2       |
| service-names                 | array(ServiceName)      | O | 1..N        | <p>If included, this IE shall contain an array of service names for which the NRF is queried to provide the list of NF profiles.</p> <p>The NRF shall return the NF profiles that have at least one NF service matching the NF service names in this list.</p> <p>The NF services returned by the NRF (inside the nfServices or nfServiceList attributes) in each matching NFProfile shall be those services whose service name matches one of the service names included in this list.</p> <p>If not included, the NRF shall not filter based on service name.</p> <p>This array shall contain unique items.</p> <p>Example:</p> <pre>NF1 supports services: A, B, C NF2 supports services:      C, D, E NF3 supports services: A,  C,  E NF4 supports services:      B, C, D  Consumer asks for service-names = [A, E]  NRF returns:  NF1 containing service A NF2 containing service E NF3 containing services A, E NF4 is not returned</pre> |                         |
| requester-nf-instance-fqdn    | Fqdn                    | O | 0..1        | <p>This IE may be present for an NF discovery request within the same PLMN as the NRF.</p> <p>If included, this IE shall contain the FQDN of the Requester NF that is invoking the Nnrf_NFDiscovery service.</p> <p>The NRF shall use this to return only those NF profiles that include at least one NF service containing an entry in the "allowedNfDomains" list (see clause 6.1.6.2.3) that matches the domain of the requester NF.</p> <p>This IE shall be ignored by the NRF if it is received from a requester NF belonging to a different PLMN.</p> <p>(NOTE 12)</p>                                                                                                                                                                                                                                                                                                                                                                     |                         |

|                       |                   |   |      |                                                                                                                                                                                                                                                                                                                                                                                                                                                                                                                                                                                                                                                                                                                                                                                                                                                                                                                                                                                                 |                   |
|-----------------------|-------------------|---|------|-------------------------------------------------------------------------------------------------------------------------------------------------------------------------------------------------------------------------------------------------------------------------------------------------------------------------------------------------------------------------------------------------------------------------------------------------------------------------------------------------------------------------------------------------------------------------------------------------------------------------------------------------------------------------------------------------------------------------------------------------------------------------------------------------------------------------------------------------------------------------------------------------------------------------------------------------------------------------------------------------|-------------------|
| target-plmn-list      | array(PlmnlId)    | C | 1..N | <p>This IE shall be included when NF services in a different PLMN, or NF services of specific PLMN ID(s) in a same PLMN comprising multiple PLMN IDs, need to be discovered. When included, this IE shall contain the PLMN ID of the target NF. If more than one PLMN ID is included, NFs from any PLMN ID present in the list matches the query parameter.</p> <p>This IE shall also be included in SNPN scenarios, when the entity owning the subscription, the Credentials Holder (see clause 5.30.2.9 in 3GPP TS 23.501 [2]) is a PLMN.</p> <p>For inter-PLMN service discovery, at most 1 PLMN ID shall be included in the list; it shall be included in the service discovery from the NF in the source PLMN sent to the NRF in the same PLMN, while it may be absent in the service discovery request sent from the source NRF to the target NRF. In such case, if the NRF receives more than 1 PLMN ID, it shall only consider the first element of the array, and ignore the rest.</p> |                   |
| requester-plmn-list   | array(PlmnlId)    | C | 1..N | <p>This IE shall be included when NF services in a different PLMN need to be discovered. It may be present when NF services in the same PLMN need to be discovered. When included, this IE shall contain the PLMN ID(s) of the requester NF. (NOTE 12)</p>                                                                                                                                                                                                                                                                                                                                                                                                                                                                                                                                                                                                                                                                                                                                      |                   |
| requester-snpn-list   | array(PlmnlIdNid) | C | 1..N | <p>This IE shall be included when the Requester NF belongs to one or several SNPNs, and NF services of a specific SNPN need to be discovered. The SNPN scenarios include use cases when CH/DCS is using AAA-S or when CH/DCS is using AUSF/UDM, see clauses 5.30.2.9.2, 5.30.2.9.3 and 5.30.2.10.2.2 in 3GPP TS 23.501 [2]).</p> <p>When present, this IE shall contain the SNPN ID(s) of the requester NF.</p> <p>The NRF shall use this to return only those NF profiles of NF Instances allowing to be discovered from the SNPNs identified by this IE, according to the "allowedSnpns" list in the NF Profile and NF Service (see clauses 6.1.6.2.2 and 6.1.6.2.3).</p>                                                                                                                                                                                                                                                                                                                     | Query-Params-Ext2 |
| target-nf-instance-id | NfInstanceId      | O | 0..1 | Identity of the NF instance being discovered.                                                                                                                                                                                                                                                                                                                                                                                                                                                                                                                                                                                                                                                                                                                                                                                                                                                                                                                                                   |                   |
| target-nf-fqdn        | Fqdn              | O | 0..1 | FQDN of the target NF instance being discovered.                                                                                                                                                                                                                                                                                                                                                                                                                                                                                                                                                                                                                                                                                                                                                                                                                                                                                                                                                |                   |
| hnr-uri               | Uri               | C | 0..1 | If included, this IE shall contain the API URI of the NFDISCOVERY Service (see clause 6.2.1) of the home NRF. It shall be included if the Requester NF has previously received such API URI to be used for service discovery (e.g., from the NSSF in the home PLMN as specified in clause 6.1.6.2.11 of 3GPP TS 29.531 [42]).                                                                                                                                                                                                                                                                                                                                                                                                                                                                                                                                                                                                                                                                   |                   |
| snssais               | array(Snssai)     | O | 1..N | <p>If included, this IE shall contain the list of S-NSSAIs that are served by the NF (Service) Instances being discovered. The NRF shall return those NF profiles/NF services of NF (Service) Instances that have at least one of the S-NSSAIs in this list. The S-NSSAIs included in the NF profiles/NF services of NF (Service) Instances returned by the NRF shall be an interclause of the S-NSSAIs requested and the S-NSSAIs supported by those NF (Service) Instances. (NOTE 10)</p> <p>When the NF Profile of the NF Instances being discovered has defined the list of supported S-NSSAIs in the "perPlmnSnssaiList", the discovered NF Instances shall be those having any of the S-NSSAIs included in this "snssais" parameter in any of the PLMNs included in the "target-plmn-list" attribute, if present; if the "target-plmn-list" is not included, the NRF shall assume that the discovery request is for any of the PLMNs it supports.</p>                                     |                   |

|                                     |                   |   |      |                                                                                                                                                                                                                                                                                                                                                                                                                                                                                                                                                                                                   |                   |
|-------------------------------------|-------------------|---|------|---------------------------------------------------------------------------------------------------------------------------------------------------------------------------------------------------------------------------------------------------------------------------------------------------------------------------------------------------------------------------------------------------------------------------------------------------------------------------------------------------------------------------------------------------------------------------------------------------|-------------------|
| requester-snssais                   | array(ExtSnssai)  | O | 1..N | If included, this IE shall contain the list of S-NSSAI of the requester NF. If this IE is included in a service discovery in a different PLMN, the requester NF shall provide S-NSSAI values of the target PLMN, that correspond to the S-NSSAI values of the requester NF.<br>The NRF shall use this to return only those NF profiles of NF Instances allowing to be discovered from at least one network slice identified by this IE, according to the "allowedNssais" list in the NF Profile and NF Service (see clause 6.1.6.2.2 and 6.1.6.2.3). (NOTE 12)                                    |                   |
| plmn-specific-snssai-list           | array(PlmnSnssai) | O | 1..N | If included, this IE shall contain the list of S-NSSAI that are served by the NF service being discovered for the corresponding PLMN provided. The NRF shall use this to identify the NF services that have registered their support for the S-NSSAIs for the corresponding PLMN given. The NRF shall return the NF profiles that have at least one S-NSSAI supported in any of the PLMNs provided in this list. The per PLMN list of S-NSSAIs included in the NF profile returned by the NRF shall be an interclause of the list requested and the list registered in the NF profile. (NOTE 10). |                   |
| requester-plmn-specific-snssai-list | array(PlmnSnssai) | O | 1..N | If included, this IE shall contain the list of S-NSSAI of the requester NF, for each of the PLMNs it supports. The NRF shall use this to return only those NF profiles of NF Instances allowing to be discovered from at least one network slice identified by this IE, according to the "allowedNssais" and "allowedPlmns" attributes in the NF Profile and NF Service (see clause 6.1.6.2.2 and 6.1.6.2.3). (NOTE 12)                                                                                                                                                                           | Query-Params-Ext3 |
| nsi-list                            | array(string)     | O | 1..N | If included, this IE shall contain the list of NSI IDs that are served by the services being discovered.                                                                                                                                                                                                                                                                                                                                                                                                                                                                                          |                   |
| dnn                                 | Dnn               | O | 0..1 | If included, this IE shall contain the DNN for which NF services serving that DNN is discovered. DNN may be included if the target NF type is e.g. "BSF", "SMF", "PCF", "PCSCF", "UPF", "EASDF", "TSCTSF", "MB-UPF" or "MB-SMF".<br>The DNN shall contain the Network Identifier and it may additionally contain an Operator Identifier. (NOTE 11).<br>If the Snssai(s) are also included, the NF services serving the DNN shall be available in the network slice(s) identified by the Snssai(s).                                                                                                |                   |
| ipv4-index                          | IpIndex           | O | 0..1 | This IE may be included if the target NF type is "UPF" and the dnn IE is included.<br><br>When included, this IE shall indicate the IPv4 index that is supported by the candidate UPF.                                                                                                                                                                                                                                                                                                                                                                                                            | Query-Upf-IpIndex |
| ipv6-index                          | IpIndex           | O | 0..1 | This IE may be included if the target NF type is "UPF" and the dnn IE is included.<br><br>When included, this IE shall indicate the IPv6 index that is supported by the candidate UPF.                                                                                                                                                                                                                                                                                                                                                                                                            | Query-Upf-IpIndex |
| smf-serving-area                    | string            | O | 0..1 | If included, this IE shall contain the serving area of the SMF. It may be included if the target NF type is "UPF".                                                                                                                                                                                                                                                                                                                                                                                                                                                                                |                   |
| mbsmf-serving-area                  | string            | O | 0..1 | If included, this IE shall contain the serving area of the MB-SMF. It may be included if the target NF type is "MB-UPF".                                                                                                                                                                                                                                                                                                                                                                                                                                                                          | Query-MBS         |
| tai                                 | Tai               | O | 0..1 | Tracking Area Identity. (NOTE 22).                                                                                                                                                                                                                                                                                                                                                                                                                                                                                                                                                                |                   |
| amf-region-id                       | AmfRegionId       | O | 0..1 | AMF Region Identity.                                                                                                                                                                                                                                                                                                                                                                                                                                                                                                                                                                              |                   |
| amf-set-id                          | AmfSetId          | O | 0..1 | AMF Set Identity.                                                                                                                                                                                                                                                                                                                                                                                                                                                                                                                                                                                 |                   |
| guami                               | Guami             | O | 0..1 | Guami used to search for an appropriate AMF. (NOTE 1)                                                                                                                                                                                                                                                                                                                                                                                                                                                                                                                                             |                   |
| supi                                | Supi              | O | 0..1 | If included, this IE shall contain the SUPI of the requester UE to search for an appropriate NF. SUPI may be included if the target NF type is e.g. "PCF", "CHF", "AUSF", "BSF", "UDM", "TSCTSF", "NSSAAF" or "UDR".                                                                                                                                                                                                                                                                                                                                                                              |                   |
| ue-ipv4-address                     | Ipv4Addr          | O | 0..1 | The IPv4 address of the UE for which a BSF or P-CSCF needs to be discovered.                                                                                                                                                                                                                                                                                                                                                                                                                                                                                                                      |                   |
| ip-domain                           | string            | O | 0..1 | The IPv4 address domain of the UE for which a BSF needs to be discovered.                                                                                                                                                                                                                                                                                                                                                                                                                                                                                                                         |                   |



|                         |                  |   |      |                                                                                                                                                                                                                                                                                                                                                                                        |                     |
|-------------------------|------------------|---|------|----------------------------------------------------------------------------------------------------------------------------------------------------------------------------------------------------------------------------------------------------------------------------------------------------------------------------------------------------------------------------------------|---------------------|
| ue-ipv6-prefix          | Ipv6Prefix       | O | 0..1 | The IPv6 prefix of the UE for which a BSF or P-CSCF needs to be discovered.                                                                                                                                                                                                                                                                                                            |                     |
| pgw-ind                 | boolean          | O | 0..1 | When present, this IE indicates whether a combined SMF/PGW-C or a standalone SMF needs to be discovered.<br><br>true: A combined SMF/PGW-C is requested to be discovered;<br>false: A standalone SMF is requested to be discovered.<br>(See NOTE 2, NOTE 21)                                                                                                                           |                     |
| preferred-pgw-ind       | boolean          | O | 0..1 | When present, this IE indicates whether combined PGW-C+SMF(s) or standalone SMF(s) are preferred.<br><br>true: Combined PGW-C+SMF(s) are preferred to be discovered;<br>false: Standalone SMF(s) are preferred to be discovered.<br>(See NOTE 2, NOTE 20, NOTE 21)                                                                                                                     | Query-SBIProtocol17 |
| pgw                     | Fqdn             | O | 0..1 | If included, this IE shall contain the PGW FQDN which is used by the AMF to find the combined SMF/PGW-C.                                                                                                                                                                                                                                                                               |                     |
| pgw-ip                  | IpAddr           | O | 0..1 | If included, this IE shall contain the PGW IP Address used by the AMF to find the combined SMF/PGW-C.                                                                                                                                                                                                                                                                                  | Query-SBIProtocol17 |
| gpsi                    | Gpsi             | O | 0..1 | If included, this IE shall contain the GPSI of the requester UE to search for an appropriate NF. GPSI may be included if the target NF type is "CHF", "PCF", "BSF", "UDM", "TSCTSF" or "UDR".                                                                                                                                                                                          |                     |
| external-group-identity | ExtGroupId       | O | 0..1 | If included, this IE shall contain the external group identifier of the requester UE to search for an appropriate NF. This may be included if the target NF type is "UDM", "UDR", "HSS" or "TSCTSF".                                                                                                                                                                                   |                     |
| pfd-data                | PfdData          | O | 0..1 | When present, this IE shall contain the application identifiers and/or application function identifiers in PFD management. This may be included if the target NF type is "NEF".<br>The NRF shall return those NEF instances which can provide the PFDs for at least one of the provided application identifiers, or for at least one of the provided application function identifiers. | Query-Params-Ext2   |
| data-set                | DataSetId        | O | 0..1 | Indicates the data set to be supported by the NF to be discovered. May be included if the target NF type is "UDR".                                                                                                                                                                                                                                                                     |                     |
| routing-indicator       | string           | O | 0..1 | Routing Indicator information that allows to route network signalling with SUCI (see 3GPP TS 23.003 [12]) to an AUSF, AAnF and UDM instance capable to serve the subscriber. May be included if the target NF type is "AUSF", "AANF" or "UDM".<br>Pattern: "^0-9]{1,4}\$"                                                                                                              |                     |
| group-id-list           | array(NfGroupId) | O | 1..N | Identity of the group(s) of the NFs of the target NF type to be discovered. May be included if the target NF type is "UDR", "UDM", "HSS", "PCF", "AUSF", "BSF" or "CHF".                                                                                                                                                                                                               |                     |
| dnai-list               | array(Dnai)      | O | 1..N | If included, this IE shall contain the Data network access identifiers. It may be included if the target NF type is "UPF", "SMF", "EASDF" or "NEF".                                                                                                                                                                                                                                    |                     |
| upf-iwk-eps-ind         | boolean          | O | 0..1 | When present, this IE indicates whether a UPF supporting interworking with EPS needs to be discovered.<br><br>true: A UPF supporting interworking with EPS is requested to be discovered;<br>false: A UPF not supporting interworking with EPS is requested to be discovered.<br>(NOTE 3)                                                                                              |                     |
| chf-supported-plmn      | PlmnId           | O | 0..1 | If included, this IE shall contain the PLMN ID that a CHF supports (i.e., in the PlmnRange of ChfInfo attribute in the NFProfile). This IE may be included when the target NF type is "CHF".<br><br>When an SMF discovers CHF(s) for a PDU session, the SMF shall set the value of this IE as specified in clause 5.1.9.2 of 3GPP TS 32.255 [46].                                      |                     |

|                      |                          |   |      |                                                                                                                                                                                                                                                                                                                                                                                                                                                                                                                                                                                                                                                                                               |                       |
|----------------------|--------------------------|---|------|-----------------------------------------------------------------------------------------------------------------------------------------------------------------------------------------------------------------------------------------------------------------------------------------------------------------------------------------------------------------------------------------------------------------------------------------------------------------------------------------------------------------------------------------------------------------------------------------------------------------------------------------------------------------------------------------------|-----------------------|
| preferred-locality   | string                   | O | 0..1 | Preferred target NF location (e.g. geographic location, data center).<br>When present, the NRF shall prefer NF profiles with a locality attribute that matches the preferred-locality.<br>The NRF may return additional NFs in the response not matching the preferred target NF location, e.g. if no NF profile is found matching the preferred target NF location.<br>The NRF should set a lower priority for any additional NFs on the response not matching the preferred target NF location than those matching the preferred target NF location. In addition, based on operator's policy, the NRF may set different priorities based on the localities of the NFs.<br>(NOTE 6, NOTE 24) |                       |
| access-type          | AccessType               | C | 0..1 | If included, this IE shall contain the Access type which is required to be supported by the target Network Function (i.e. SMF).                                                                                                                                                                                                                                                                                                                                                                                                                                                                                                                                                               |                       |
| supported-features   | SupportedFeatures        | O | 0..1 | List of features required to be supported by the target Network Function.<br>This IE may be present only if the service-names attribute is present and if it contains a single service-name. It shall be ignored by the NRF otherwise.<br>(NOTE 4)                                                                                                                                                                                                                                                                                                                                                                                                                                            |                       |
| required-features    | array(SupportedFeatures) | O | 1..N | List of features required to be supported by the target Network Function, as defined by the supportedFeatures attribute in NFService (see clauses 6.1.6.2.3 and 6.2.6.2.4).<br>This IE may be present only if the service-names attribute is present.<br>When present, the required-features attribute shall contain as many entries as the number of entries in the service-names attribute. The n <sup>th</sup> entry in the required-features attribute shall correspond to the n <sup>th</sup> entry in the service-names attribute. An entry corresponding to a service for which no specific feature is required shall be encoded as "0".                                               | Query-Params-Ext1     |
| complex-query        | ComplexQuery             | O | 0..1 | This query parameter is used to override the default logical relationship of query parameters.                                                                                                                                                                                                                                                                                                                                                                                                                                                                                                                                                                                                | Complex-Query         |
| limit                | integer                  | O | 0..1 | Maximum number of NFProfiles to be returned in the response.<br>Minimum: 1                                                                                                                                                                                                                                                                                                                                                                                                                                                                                                                                                                                                                    | Query-Params-Ext1     |
| max-payload-size     | integer                  | O | 0..1 | Maximum payload size (before compression, if any) of the response, expressed in kilo octets.<br>When present, the NRF shall limit the number of NF profiles returned in the response such as to not exceed the maximum payload size indicated in the request.<br>Default: 124. Maximum: 2000 (i.e. 2 Mo).                                                                                                                                                                                                                                                                                                                                                                                     | Query-Params-Ext1     |
| max-payload-size-ext | integer                  | O | 0..1 | Maximum payload size (before compression, if any) of the response, expressed in kilo octets.<br>When present, the NRF shall limit the number of NF profiles returned in the response such as to not exceed the maximum payload size indicated in the request.<br>This query parameter is used when the consumer supports payload size bigger than 2 million octets.<br>Default: 124                                                                                                                                                                                                                                                                                                           | Query-Params-Ext2     |
| pdu-session-types    | array(PduSessionType)    | O | 1..N | List of the PDU session type (s) requested to be supported by the target Network Function (i.e UPF).                                                                                                                                                                                                                                                                                                                                                                                                                                                                                                                                                                                          | Query-Params-Ext1     |
| event-id-list        | array(EventId)           | O | 1..N | If present, this attribute shall contain the list of events requested to be supported by the Nnwdaf AnalyticsInfo Service, the NRF shall return NF which support all the requested events.                                                                                                                                                                                                                                                                                                                                                                                                                                                                                                    | Query-Param-Analytics |
| nwdaf-event-list     | array(NwdafEvent)        | O | 1..N | If present, this attribute shall contain the list of events requested to be supported by the Nnwdaf_EventsSubscription service, the NRF shall return NF which support all the requested events.                                                                                                                                                                                                                                                                                                                                                                                                                                                                                               | Query-Param-Analytics |
| atsss-capability     | AtsssCapability          | O | 0..1 | When present, this IE indicates the ATSSS capability of the target UPF needs to be supported.                                                                                                                                                                                                                                                                                                                                                                                                                                                                                                                                                                                                 | MAPDU                 |

|                          |                     |   |      |                                                                                                                                                                                                                                                                                                                                                                                       |                   |
|--------------------------|---------------------|---|------|---------------------------------------------------------------------------------------------------------------------------------------------------------------------------------------------------------------------------------------------------------------------------------------------------------------------------------------------------------------------------------------|-------------------|
| upf-ue-ip-addr-ind       | boolean             | O | 0..1 | When present, this IE indicates whether a UPF supporting allocating UE IP addresses/prefixes needs to be discovered.<br><br>true: a UPF supporting UE IP addresses/prefixes allocation is requested to be discovered;<br>false: a UPF not supporting UE IP addresses/prefixes allocation is requested to be discovered.                                                               | Query-Params-Ext2 |
| client-type              | ExternalClientType  | O | 0..1 | When present, this IE indicates that NF(s) dedicatedly serving the specified Client Type needs to be discovered. This IE may be included when target NF Type is "LMF" and "GMLC".<br><br>If no NF profile is found dedicatedly serving the requested client type, the NRF may return NF(s) not dedicatedly serving the request client type in the response.                           | Query-Params-Ext2 |
| lmf-id                   | LMFIdentification   | O | 0..1 | When present, this IE shall contain LMF identification to be discovered. This may be included if the target NF type is "LMF".                                                                                                                                                                                                                                                         | Query-Params-Ext2 |
| an-node-type             | AnNodeType          | O | 0..1 | If included, this IE shall contain the AN Node type which is required to be supported by the target Network Function (i.e. LMF).                                                                                                                                                                                                                                                      | Query-Params-Ext2 |
| rat-type                 | RatType             | O | 0..1 | If included, this IE shall contain the RAT type which is required to be supported by the target Network Function (i.e. LMF).                                                                                                                                                                                                                                                          | Query-Params-Ext2 |
| target-snpn              | PlmnIdNid           | C | 0..1 | This IE shall be included when NF services of a specific SNPN need to be discovered. When included, this IE shall contain the PLMN ID and NID of the target NF.<br>This IE shall also be included in SNPN scenarios, when the entity owning the subscription, the Credentials Holder (see clause 5.30.2.9 in 3GPP TS 23.501 [2]) is an SNPN.                                          | Query-Params-Ext2 |
| af-ee-data               | AfEventExposureData | O | 0..1 | When present, this shall contain the application events, and optionally application function identifiers, application identifiers of the AF(s). This may be included if the target NF type is "NEF".                                                                                                                                                                                  | Query-Params-Ext2 |
| w-agf-info               | WAgfInfo            | O | 0..1 | If included, this IE shall contain the W-AGF identifiers of N3 terminations which is received by the SMF to find the combined W-AGF/UPF.                                                                                                                                                                                                                                              | Query-Params-Ext2 |
| tngf-info                | TngfInfo            | O | 0..1 | If included, this IE shall contain the TNGF identifiers of N3 terminations which is received by the SMF to find the combined TNGF/UPF.                                                                                                                                                                                                                                                | Query-Params-Ext2 |
| twif-info                | TwifInfo            | O | 0..1 | If included, this IE shall contain the TWIF identifiers of N3 terminations which is received by the SMF to find the combined TWIF/UPF.                                                                                                                                                                                                                                                | Query-Params-Ext2 |
| target-nf-set-id         | NfSetId             | O | 0..1 | When present, this IE shall contain the target NF Set ID (as defined in clause 28.12 of 3GPP TS 23.003 [12]) of the NF instances being discovered.                                                                                                                                                                                                                                    | Query-Params-Ext2 |
| target-nf-service-set-id | NfServiceSetId      | O | 0..1 | When present, this IE shall contain the target NF Service Set ID (as defined in clause 28.13 of 3GPP TS 23.003 [12]) of the NF service instances being discovered.<br><br>If this IE is provided together with the target-nf-set-id IE, the NRF shall return service instances of the NF Service Set indicated in the request and should additionally return equivalent ones, if any. | Query-Params-Ext2 |
| preferred-tai            | Tai                 | O | 0..1 | When present, the NRF shall prefer NF profiles that can serve the TAI, or the NRF shall return NF profiles not matching the TAI if no NF profile is found matching the TAI. (NOTE 5)                                                                                                                                                                                                  | Query-Params-Ext2 |
| nef-id                   | NefId               | O | 0..1 | When present, this IE shall contain the NEF ID of the NEF to be discovered. This may be included if the target NF type is "NEF". (NOTE 7)                                                                                                                                                                                                                                             | Query-Params-Ext2 |
| preferred-nf-instances   | array(NfInstanceId) | O | 1..N | When present, this IE shall contain a list of preferred candidate NF instance IDs. (NOTE 8)                                                                                                                                                                                                                                                                                           | Query-Params-Ext2 |

|                         |                    |   |      |                                                                                                                                                                                                                                                                                                                                                                                                                                                                                     |                   |
|-------------------------|--------------------|---|------|-------------------------------------------------------------------------------------------------------------------------------------------------------------------------------------------------------------------------------------------------------------------------------------------------------------------------------------------------------------------------------------------------------------------------------------------------------------------------------------|-------------------|
| notification-type       | NotificationType   | O | 0..1 | If included, this IE shall contain the notification type of default notification subscriptions that shall be registered in the NFProfile or NFService of the NF Instances being discovered. The NF profiles returned by the NRF shall contain all the registered default notification subscriptions, including the one corresponding to the notification-type parameter.<br>(NOTE 9)                                                                                                | Query-Params-Ext2 |
| n1-msg-class            | N1MessageClass     | O | 0..1 | This IE may be included when "notification-type" IE is present with value "N1_MESSAGES".<br><br>When included, this IE shall contain the N1 message class of default notification subscriptions that shall be registered in the NFProfile or NFService of the NF Instances being discovered. The NF profiles returned by the NRF shall contain all the registered default notification subscriptions, including the one corresponding to the n1-msg-class parameter.<br>(NOTE 9)    | Query-Params-Ext3 |
| n2-info-class           | N2InformationClass | O | 0..1 | This IE may be included when "notification-type" IE is present with value "N2_INFORMATION".<br><br>If included, this IE shall contain the notification type of default notification subscriptions that shall be registered in the NFProfile or NFService of the NF Instances being discovered. The NF profiles returned by the NRF shall contain all the registered default notification subscriptions, including the one corresponding to the n2-info-class parameter.<br>(NOTE 9) | Query-Params-Ext3 |
| serving-scope           | array(string)      | O | 1..N | If present, this attribute shall contain the list of areas that can be served by the NF instances to be discovered. The NRF shall return NF profiles of NFs which can serve all the areas requested in this query parameter.<br>(NOTE 18)                                                                                                                                                                                                                                           | Query-Params-Ext2 |
| imsi                    | string             | O | 0..1 | If included, this IE shall contain the IMSI of the requester UE to search for an appropriate NF. IMSI may be included if the target NF type is "HSS".<br>pattern: "[0-9]{5,15}\$"                                                                                                                                                                                                                                                                                                   | Query-Params-Ext2 |
| ims-private-identity    | string             | O | 0..1 | If included, this IE shall contain the IMS Private Identity of the requester UE to search for an appropriate NF. IMS Private Identity may be included if the target NF type is "HSS".                                                                                                                                                                                                                                                                                               | Query-Params-Ext3 |
| ims-public-identity     | string             | O | 0..1 | If included, this IE shall contain the IMS Public Identity of the requester UE to search for an appropriate NF. IMS Public Identity may be included if the target NF type is "HSS".                                                                                                                                                                                                                                                                                                 | Query-Params-Ext3 |
| msisdn                  | string             | O | 0..1 | If included, this IE shall contain the MSISDN of the requester UE to search for an appropriate NF. IMS Public Identity may be included if the target NF type is "HSS".                                                                                                                                                                                                                                                                                                              | Query-Params-Ext3 |
| internal-group-identity | GroupId            | O | 0..1 | If included, this IE shall contain the internal group identifier of the UE to search for an appropriate NF. This may be included if the target NF type is "UDM", "NSSAAF" or "TSCTSF".                                                                                                                                                                                                                                                                                              | Query-Params-Ext2 |

|                        |             |   |      |                                                                                                                                                                                                                                                                                                                                                                                                                                                                                                                                                                                                                                                                                                                                                                                                                                                                                                                                                                                                                                                                                                                                                                                                                                                                                                                                                                                                                                                                                                                                                                                                                                                                                                                                                                                                             |                   |
|------------------------|-------------|---|------|-------------------------------------------------------------------------------------------------------------------------------------------------------------------------------------------------------------------------------------------------------------------------------------------------------------------------------------------------------------------------------------------------------------------------------------------------------------------------------------------------------------------------------------------------------------------------------------------------------------------------------------------------------------------------------------------------------------------------------------------------------------------------------------------------------------------------------------------------------------------------------------------------------------------------------------------------------------------------------------------------------------------------------------------------------------------------------------------------------------------------------------------------------------------------------------------------------------------------------------------------------------------------------------------------------------------------------------------------------------------------------------------------------------------------------------------------------------------------------------------------------------------------------------------------------------------------------------------------------------------------------------------------------------------------------------------------------------------------------------------------------------------------------------------------------------|-------------------|
| preferred-api-versions | map(string) | O | 1..N | <p>When present, this IE indicates the preferred API version of the services that are supported by the target NF instances. The key of the map is the ServiceName (see clause 6.1.6.3.11) for which the preferred API version is indicated. Each element carries the API Version Indication for the service indicated by the key. The NRF may return additional NFs in the response not matching the preferred API versions, e.g. if no NF profile is found matching the preferred-api-versions.</p> <p>An API Version Indication is a string formatted as {operator}+{API Version}.</p> <p>The following operators shall be supported:</p> <p>"=" match a version equals to the version value indicated.<br/> "&gt;" match any version greater than the version value indicated<br/> "&gt;=" match any version greater than or equal to the version value indicated<br/> "&lt;" match any version less than the version value indicated<br/> "&lt;=" match any version less than or equal to the version value indicated<br/> "^" match any version compatible with the version indicated, i.e. any version with the same major version as the version indicated.</p> <p>Precedence between versions is identified by comparing the Major, Minor, and Patch version fields numerically, from left to right.</p> <p>If no operator or an unknown operator is provided in API Version Indication, "=" operator is applied.</p> <p><u>Example of API Version Indication:</u></p> <p>Case1: "=1.2.4.operator-ext" or "1.2.4.operator-ext" means matching the service with API version "1.2.4.operator-ext"<br/> Case2: "&gt;1.2.4" means matching the service with API versions greater than "1.2.4"<br/> Case3: "^2.3.0" or "^2" means matching the service with all API versions with major version "2".</p> | Query-Params-Ext2 |
| v2x-support-ind        | boolean     | O | 0..1 | <p>When present, this IE indicates whether a PCF supporting V2X Policy/Parameter provisioning needs to be discovered.</p> <p>true: a PCF supporting V2X Policy/Parameter provisioning is requested to be discovered;<br/> false: a PCF not supporting V2X Policy/Parameter provisioning is requested to be discovered.</p>                                                                                                                                                                                                                                                                                                                                                                                                                                                                                                                                                                                                                                                                                                                                                                                                                                                                                                                                                                                                                                                                                                                                                                                                                                                                                                                                                                                                                                                                                  | Query-Params-Ext2 |
| redundant-gtpu         | boolean     | O | 0..1 | <p>When present, this IE indicates whether a UPF supporting redundant GTP-U path needs to be discovered.</p> <p>true: a UPF supporting redundant GTP-U path is requested to be discovered;<br/> false: a UPF not supporting redundant GTP-U path is requested to be discovered.</p>                                                                                                                                                                                                                                                                                                                                                                                                                                                                                                                                                                                                                                                                                                                                                                                                                                                                                                                                                                                                                                                                                                                                                                                                                                                                                                                                                                                                                                                                                                                         | Query-Params-Ext2 |
| redundant-transport    | boolean     | O | 0..1 | <p>When present, this IE indicates whether a UPF supporting redundant transport path on the transport layer in the corresponding network slice needs to be discovered.</p> <p>true: a UPF supporting redundant transport path on the transport layer is requested to be discovered;<br/> false: a UPF not supporting redundant transport path on the transport layer is requested to be discovered.</p> <p>If the Snsai(s) are also included, the UPF supporting redundant transport path on the transport layer shall be available in the network slice(s) identified by the Snsai(s).</p>                                                                                                                                                                                                                                                                                                                                                                                                                                                                                                                                                                                                                                                                                                                                                                                                                                                                                                                                                                                                                                                                                                                                                                                                                 | Query-Params-Ext2 |

|                     |                   |   |      |                                                                                                                                                                                                                                                                                                                                                                      |                             |
|---------------------|-------------------|---|------|----------------------------------------------------------------------------------------------------------------------------------------------------------------------------------------------------------------------------------------------------------------------------------------------------------------------------------------------------------------------|-----------------------------|
| ipups               | boolean           | O | 0..1 | When present, this IE indicates whether a UPF which is configured for IPUPS is requested to be discovered.<br><br>true: a UPF which is configured for IPUPS is requested to be discovered;<br>false: a UPF which is not configured for IPUPS is requested to be discovered.                                                                                          | Query-Params-Ext2           |
| scp-domain-list     | array(string)     | O | 1..N | When present, this IE shall contain the SCP domain(s) the target NF, SCP or SEPP belongs to. The NRF shall return NF, SCP or SEPP profiles that belong to all the SCP domains provided in this list.                                                                                                                                                                 | Query-Params-Ext2           |
| address-domain      | Fqdn              | O | 0..1 | If included, this IE shall contain the address domain that shall be reachable through the SCP. This IE may be included when the target NF type is "SCP".                                                                                                                                                                                                             | Query-Params-Ext2           |
| ipv4-addr           | Ipv4Addr          | O | 0..1 | If included, this IE shall contain the IPv4 address that shall be reachable through the SCP. This IE may be included when the target NF type is "SCP".                                                                                                                                                                                                               | Query-Params-Ext2           |
| ipv6-prefix         | Ipv6Prefix        | O | 0..1 | If included, this IE shall contain the IPv6 prefix that shall be reachable through the SCP. This IE may be included when the target NF type is "SCP".                                                                                                                                                                                                                | Query-Params-Ext2           |
| served-nf-set-id    | NfSetId           | O | 0..1 | When present, this IE shall contain the NF Set ID that shall be reachable through the SCP. This IE may be included when the target NF type is "SCP".                                                                                                                                                                                                                 | Query-Params-Ext2           |
| remote-plmn-id      | PlmnId            | O | 0..1 | If included, this IE shall contain the remote PLMN ID that shall be reachable through the SCP or SEPP. This IE may be included when the target NF type is "SCP" or "SEPP".                                                                                                                                                                                           | Query-Params-Ext2           |
| remote-snpn-id      | PlmnIdNid         | O | 0..1 | If included, this IE shall contain the remote SNPN ID that shall be reachable through the SCP or SEPP. This IE may be included when the target NF type is "SCP" or "SEPP".                                                                                                                                                                                           | Query-ENPN                  |
| data-forwarding     | boolean           | O | 0..1 | This may be included if the target NF type is "UPF". (NOTE 13)<br><br>When present, the IE indicates whether UPF(s) configured for data forwarding needs to be discovered.<br><br>true: UPF(s) configured for data forwarding is requested to be discovered;<br>false: UPF(s) not configured for data forwarding is requested to be discovered.                      | Query-Params-Ext2           |
| preferred-full-plmn | boolean           | O | 0..1 | When present, the NRF shall prefer NF profile(s) that can serve the full PLMN (i.e. can serve any TAI in the PLMN), or the NRF shall return other NF profiles if no NF profile serving the full PLMN is found:<br><br>- true: NF instance(s) serving the full PLMN is preferred;<br>- false: NF instance(s) serving the full PLMN is not preferred.<br><br>(NOTE 14) | Query-Params-Ext2           |
| requester-features  | SupportedFeatures | C | 0..1 | Nnrf_NFDiscovery features supported by the Requester NF that is invoking the Nnrf_NFDiscovery service.<br>This IE shall be included if at least one feature is supported by the Requester NF.                                                                                                                                                                        |                             |
| realm-id            | string            | O | 0..1 | May be included if the target NF type is "UDSF". If included, this IE shall contain the realm-id for which a UDSF shall be discovered.                                                                                                                                                                                                                               | Query-Params-Ext4           |
| storage-id          | string            | O | 0..1 | May be included if the target NF type is "UDSF" and realm-id is included. If included, this IE shall contain the storage-id for the realm-id indicated in the realm-id IE for which a UDSF shall be discovered.                                                                                                                                                      | Query-Params-Ext4           |
| vsmf-support-ind    | boolean           | O | 0..1 | If included, this IE shall indicate that target SMF(s) that support V-SMF Capability are preferred.<br><br>This IE may be included when the target NF type is "SMF".<br><br>(NOTE 15)                                                                                                                                                                                | Query-Param-vSmf-Capability |

|                                       |                                        |   |                  |                                                                                                                                                                                                                                                                                                                                                                                                                                                                                                                                                                                                                                                                                                                                                                                                                                                                                                                                                                                                                                                                                                                                                                                                                                                                                                                                                                                       |                             |
|---------------------------------------|----------------------------------------|---|------------------|---------------------------------------------------------------------------------------------------------------------------------------------------------------------------------------------------------------------------------------------------------------------------------------------------------------------------------------------------------------------------------------------------------------------------------------------------------------------------------------------------------------------------------------------------------------------------------------------------------------------------------------------------------------------------------------------------------------------------------------------------------------------------------------------------------------------------------------------------------------------------------------------------------------------------------------------------------------------------------------------------------------------------------------------------------------------------------------------------------------------------------------------------------------------------------------------------------------------------------------------------------------------------------------------------------------------------------------------------------------------------------------|-----------------------------|
| ismf-support-ind                      | boolean                                | O | 0..1             | <p>If included, this IE shall indicate that target SMF(s) that support I-SMF Capability are preferred.</p> <p>This IE may be included when the target NF type is "SMF".</p> <p>(NOTE 15)</p>                                                                                                                                                                                                                                                                                                                                                                                                                                                                                                                                                                                                                                                                                                                                                                                                                                                                                                                                                                                                                                                                                                                                                                                          | Query-Param-iSmf-Capability |
| nrf-disc-uri                          | Uri                                    | C | 0..1             | <p>If included, this IE shall contain the API URI of the NFDISCOVERY Service (see clause 6.2.1) of the NRF holding the NF Profile.</p> <p>It shall be included if:</p> <ul style="list-style-type: none"> <li>- the target-nf-instance-id is present;</li> <li>- the NF Service Consumer has previously received such API URI in an earlier NF service discovery, i.e. if the target NF instance was provided in the nfnInstanceList attribute in SearchResult (see clause 6.2.6.2.2) and the nrfDiscApiUri attribute was present in the NfnInstanceInfo (see clause 6.2.6.2.7); and</li> <li>- the service discovery request is addressed to a different NRF than the NRF holding the NF profile.</li> </ul>                                                                                                                                                                                                                                                                                                                                                                                                                                                                                                                                                                                                                                                                         | Enh-NF-Discovery            |
| preferred-vendor-specific-features    | map(map(array(VendorSpecificFeature))) | O | 1..N(1..M(1..L)) | <p>When present, this IE indicates the list of preferred vendor-specific features supported by the target Network Function, as defined by the supportedVendorSpecificFeatures attribute in NFService (see clauses 6.1.6.2.3 and 6.2.6.2.4). NF profiles that support all the preferred features, or by default, NF profiles that contain at least one service supporting the preferred features, should be preferentially returned in the response; NF profiles in the response may not support the preferred features.</p> <p>The key of the external map is the ServiceName (see clause 6.1.6.3.11) for which the preferred vendor-specific features is indicated. Each element carries the preferred vendor-specific features for the service indicated by the key.</p> <p>The key of the internal map is the IANA-assigned "SMI Network Management Private Enterprise Codes" [38]. The string used as key of the internal map shall contain 6 decimal digits; if the SMI code has less than 6 digits, it shall be padded with leading digits "0" to complete a 6-digit string value.</p> <p>The value of each entry of the map shall be a list (array) of VendorSpecificFeature objects.</p> <p>The NF profiles returned by the NRF shall include the full list of vendor-specific-features and not just the interclause of supported and preferred vendor-specific features.</p> | Query-SBIProtocol17         |
| preferred-vendor-specific-nf-features | map(array(VendorSpecificFeature))      | O | 1..N(1..M)       | <p>When present, this IE indicates the list of preferred vendor-specific features supported by the target Network Function, as defined by the supportedVendorSpecificFeatures attribute in NF profile (see clause 6.1.6.2.2 and 6.2.6.2.3). NF profiles that support all the preferred features should be preferentially returned in the response. NF profiles in the response may not support the preferred features.</p> <p>The key of the map is the IANA-assigned "SMI Network Management Private Enterprise Codes" [38]. The value of each entry of the map shall be a list (array) of VendorSpecificFeature objects.</p> <p>The NF profiles returned by the NRF shall include the full list of vendor-specific features and not just the interclause of supported and preferred vendor-specific features.</p>                                                                                                                                                                                                                                                                                                                                                                                                                                                                                                                                                                   | Query-SBIProtocol17         |
| required-pfcp-features                | string                                 | O | 0..1             | <p>List of features required to be supported by the target UPF or MB-UPF (when selecting a UPF or a MB-UPF), encoded as defined for the supportedPfcPFeatures attribute in UpfInfo (see clause 6.1.6.2.13).</p> <p>(NOTE 16)</p>                                                                                                                                                                                                                                                                                                                                                                                                                                                                                                                                                                                                                                                                                                                                                                                                                                                                                                                                                                                                                                                                                                                                                      | Query-Upf-Pfcp              |

|                             |                        |   |      |                                                                                                                                                                                                                                                                                                                                                                                                                                                                                                                                                                                                                                                                                                                                                                                                                                                                                                                                                                                                                                                                                                                                                                                                                                                                                                                                                                                                                                                                                                                                                                                                                                                                 |                     |
|-----------------------------|------------------------|---|------|-----------------------------------------------------------------------------------------------------------------------------------------------------------------------------------------------------------------------------------------------------------------------------------------------------------------------------------------------------------------------------------------------------------------------------------------------------------------------------------------------------------------------------------------------------------------------------------------------------------------------------------------------------------------------------------------------------------------------------------------------------------------------------------------------------------------------------------------------------------------------------------------------------------------------------------------------------------------------------------------------------------------------------------------------------------------------------------------------------------------------------------------------------------------------------------------------------------------------------------------------------------------------------------------------------------------------------------------------------------------------------------------------------------------------------------------------------------------------------------------------------------------------------------------------------------------------------------------------------------------------------------------------------------------|---------------------|
| home-pub-key-id             | integer                | O | 0..1 | When present, this IE shall indicate the Home Network Public Key ID which shall be able to be served by the NF instance. May be included if the target NF type is "AUSF" or "UDM". This query parameter may only be present if the routing-indicator query parameter is also present.<br>(NOTE 17)                                                                                                                                                                                                                                                                                                                                                                                                                                                                                                                                                                                                                                                                                                                                                                                                                                                                                                                                                                                                                                                                                                                                                                                                                                                                                                                                                              | Query-SBIProtocol17 |
| prose-support-ind           | boolean                | O | 0..1 | When present, this IE indicates whether supporting ProSe capability by PCF needs to be discovered.<br><br>true: a PCF supporting ProSe capability is requested to be discovered;<br>false: a PCF not ProSe capability is requested to be discovered.                                                                                                                                                                                                                                                                                                                                                                                                                                                                                                                                                                                                                                                                                                                                                                                                                                                                                                                                                                                                                                                                                                                                                                                                                                                                                                                                                                                                            | Query-5G-ProSe      |
| analytics-aggregation-ind   | boolean                | O | 0..1 | If included, this IE shall contain the analytics aggregation capability indication of the NF being discovered. This IE may be included when the target NF type is "NWDAF".                                                                                                                                                                                                                                                                                                                                                                                                                                                                                                                                                                                                                                                                                                                                                                                                                                                                                                                                                                                                                                                                                                                                                                                                                                                                                                                                                                                                                                                                                      | Query-eNA-PH2       |
| analytics-metadata-prov-ind | boolean                | O | 0..1 | If included, this IE shall contain the analytics metadata provisioning capability indication of the NF being discovered. This IE may be included when the target NF type is "NWDAF".                                                                                                                                                                                                                                                                                                                                                                                                                                                                                                                                                                                                                                                                                                                                                                                                                                                                                                                                                                                                                                                                                                                                                                                                                                                                                                                                                                                                                                                                            | Query-eNA-PH2       |
| serving-nf-set-id           | NfSetId                | O | 0..1 | When present, this IE shall contain the NF Set ID that is served by the DCCF, NWDAF or MFAF. This IE may be included when the target NF type is "DCCF" or "NWDAF" or "MFAF".                                                                                                                                                                                                                                                                                                                                                                                                                                                                                                                                                                                                                                                                                                                                                                                                                                                                                                                                                                                                                                                                                                                                                                                                                                                                                                                                                                                                                                                                                    | Query-eNA-PH2       |
| serving-nf-type             | NFType                 | O | 0..1 | When present, this IE shall contain the NF type that is served by the DCCF, NWDAF or MFAF. This IE may be included when the target NF type is "DCCF" or "NWDAF" or "MFAF".                                                                                                                                                                                                                                                                                                                                                                                                                                                                                                                                                                                                                                                                                                                                                                                                                                                                                                                                                                                                                                                                                                                                                                                                                                                                                                                                                                                                                                                                                      | Query-eNA-PH2       |
| ml-analytics-info-list      | array(MlAnalyticsInfo) | O | 1..N | If present, this attribute shall contain the list of ML Analytics Filter information per Analytics ID(s) requested to be supported by the Nnwdaf_MLModelProvision Service. The NRF shall return NWDAF profiles that support at least one of the MlAnalyticsInfo in this list.                                                                                                                                                                                                                                                                                                                                                                                                                                                                                                                                                                                                                                                                                                                                                                                                                                                                                                                                                                                                                                                                                                                                                                                                                                                                                                                                                                                   | Query-eNA-PH2       |
| nsacf-capability            | NsacfCapability        | O | 0..1 | When present, this IE indicates the service capability that the target NSACF needs to support.                                                                                                                                                                                                                                                                                                                                                                                                                                                                                                                                                                                                                                                                                                                                                                                                                                                                                                                                                                                                                                                                                                                                                                                                                                                                                                                                                                                                                                                                                                                                                                  | NSAC                |
| mbs-session-id-list         | array(MbsSessionId)    | O | 0..1 | This IE may be present if the target NF type is "MB-SMF".<br>When present, it shall contain the list of MBS Session ID(s) for which MB-SMF(s) are to be discovered.<br>When present, for each mbs-session-id in the list, the NRF shall determine whether an MB-SMF supporting the mbs-session-id and complying with the other query parameters (if any) exists.<br>An MB-SMF shall be considered to support the mbs-session-id if:<br><ul style="list-style-type: none"> <li>- the mbs-session-id contains a TMGI that is part of a TMGI range (see tmgiRangeList attribute in clause 6.1.6.2.85) registered by the MB-SMF and, if the tai query parameter is present:</li> <li style="padding-left: 20px;">- if the TAI indicated in the tai query parameter can be served by the MB-SMF (see taiList and taiRangeList attributes in clause 6.1.6.2.85);</li> </ul> or<br><ul style="list-style-type: none"> <li>- the mbs-session-id contains a TMGI or an SSM address, that is part of the list of MBS sessions currently served by the MB-SMF (see mbsSessionList attribute in clause 6.1.6.2.85) and, if the tai query parameter is present and the MBS session is registered with an MBS Service Area (see mbsServiceArea in clause 6.1.6.2.90):</li> <li style="padding-left: 20px;">- if the TAI indicated in the tai query parameter is supported by the MBS Service Area of the MBS session.</li> </ul> If so, the NRF shall return the profile of this MB-SMF. If no MB-SMF supporting the mbs-session-id and complying with the other query parameters exists, the NRF shall return an empty response.<br>See clause 7.1.2 of 3GPP TS 23.247 [43]. | Query-MBS           |



|                               |                 |   |      |                                                                                                                                                                                                                                                                                                                                                                                                                                                                                                                                                                                                                                                                                                                                                                                                                                                                                                                                     |                     |
|-------------------------------|-----------------|---|------|-------------------------------------------------------------------------------------------------------------------------------------------------------------------------------------------------------------------------------------------------------------------------------------------------------------------------------------------------------------------------------------------------------------------------------------------------------------------------------------------------------------------------------------------------------------------------------------------------------------------------------------------------------------------------------------------------------------------------------------------------------------------------------------------------------------------------------------------------------------------------------------------------------------------------------------|---------------------|
| area-session-id               | AreaSessionId   | O | 0..1 | <p>This IE may be present if the target NF type is "MB-SMF", the mbs-session-id-list IE is present and contains only one MBS Session ID.</p> <p>When present, the IE shall contain the Area Session ID, for the MBS session indicated in the mbs-session-id-list IE, for which an MB-SMF is to be discovered.</p> <p>When this IE is present, the NRF shall return an MB-SMF profile that currently serves the MBS Session ID and Area Session ID (see mbsSessionList attribute in clause 6.1.6.2.85).</p> <p>If no MB-SMF supports the MBS Session ID and Area Session ID, the NRF shall return an empty response.</p> <p>See clause 7.1.2 of 3GPP TS 23.247 [43].</p>                                                                                                                                                                                                                                                             | Query-MBS           |
| gmlc-number                   | string          | O | 0..1 | <p>If included, this IE shall contain the GMLC Number of which should supported by the target GMLC. It may be included if the target NF type is "GMLC".</p> <p>Pattern: "<code>^[0-9]{5,15}\$</code>"</p>                                                                                                                                                                                                                                                                                                                                                                                                                                                                                                                                                                                                                                                                                                                           | Query-eLCS          |
| upf-n6-ip                     | IpAddr          | O | 0..1 | <p>If included, this IE shall contain the N6 IP address of PSA UPF.</p> <p>It may be included if the target NF type is "EASDF".</p>                                                                                                                                                                                                                                                                                                                                                                                                                                                                                                                                                                                                                                                                                                                                                                                                 | Query-eEDGE-5GC     |
| tai-list                      | array(Tai)      | O | 1..N | <p>If included, this IE shall contain the Tracking Area Identities requested to be supported by the NFs being discovered. The NRF shall return NFs which support all the TAIs in the list. It may be included if the target NF type is "NEF".</p>                                                                                                                                                                                                                                                                                                                                                                                                                                                                                                                                                                                                                                                                                   | Query-eEDGE-5GC     |
| preferences-precedence        | array(string)   | O | 2..N | <p>This IE may be present when multiple query parameters expressing a preference are included in the discovery request.</p> <p>When present, this IE shall indicate the relative precedence of these query parameters (from higher precedence to lower precedence). The NRF shall use the indicated precedence to prioritize the candidate NFs in the search result, among the candidate NFs partially matching the different preference query parameters, candidate matching the higher precedence preference query parameter should have higher priority.</p> <p>This IE may include any query parameter named "preferred-xxx" (e.g. preferred-locality, preferred-tai).</p> <p>Example:</p> <p>preferences-precedence=[preferred-tai, preferred-vendor-specific-features]</p> <p>The above value indicates that the "preferred-tai" parameter has higher precedence than the "preferred-vendor-specific-features" parameter.</p> | Query-SBIProtocol17 |
| support-onboarding-capability | boolean         | O | 0..1 | <p>If present, this attribute indicates the target AMF or SMF instances support SNPN Onboarding. If the target is an SMF, this indicates the SMF also supports User Plane Remote Provisioning. This is used for the case of Onboarding of UEs for SNNPs (see 3GPP TS 23.501 [2], clauses 5.30.2.10 and 6.2.6.2).</p>                                                                                                                                                                                                                                                                                                                                                                                                                                                                                                                                                                                                                | Query-ENPN          |
| uas-nf-functionality-ind      | boolean         | O | 0..1 | <p>If included, this IE shall contain the UAS NF functionality indication of the NF being discovered. This IE may be included when the target NF type is "NEF".</p>                                                                                                                                                                                                                                                                                                                                                                                                                                                                                                                                                                                                                                                                                                                                                                 | Query-ID_UAS        |
| v2x-capability                | V2xCapability   | O | 0..1 | <p>When present, this IE indicates the V2X capability that the target PCF needs to support.</p> <p>When the v2x-capability is provided as the query parameter, NRF shall return the PCF instances which support all the V2X capabilities requested.</p>                                                                                                                                                                                                                                                                                                                                                                                                                                                                                                                                                                                                                                                                             | Query-SBIProtocol17 |
| prose-capability              | ProSeCapability | O | 0..1 | <p>When present, this IE indicates the ProSe capability that the target PCF needs to support.</p> <p>When the prose-capability is provided as the query parameter, NRF shall return the PCF instances which support all the ProSe capabilities requested.</p>                                                                                                                                                                                                                                                                                                                                                                                                                                                                                                                                                                                                                                                                       | Query-5G-ProSe      |

|                            |                          |   |      |                                                                                                                                                                                                                                                                                                                                                                                                                                                                                                                                                                                                                                                                                                |                        |
|----------------------------|--------------------------|---|------|------------------------------------------------------------------------------------------------------------------------------------------------------------------------------------------------------------------------------------------------------------------------------------------------------------------------------------------------------------------------------------------------------------------------------------------------------------------------------------------------------------------------------------------------------------------------------------------------------------------------------------------------------------------------------------------------|------------------------|
| shared-data-id             | SharedDataId             | O | 0..1 | Identifies the shared data that is stored in the NF (UDR) to be discovered. May be included if the target NF type is "UDR"                                                                                                                                                                                                                                                                                                                                                                                                                                                                                                                                                                     | Query-SBIProtoc17      |
| target-hni                 | Fqdn                     | O | 0..1 | If included, this IE shall contain the Home Network Identifier. If CH/DCS is using AAA Server or AUSF and UDM for primary authentication and authorization (see clauses 5.30.2.9.2, 5.30.2.9.3 and 5.30.2.10.2.2 in 3GPP TS 23.501 [2]), the sender (AMF or AUSF) populates this IE with CH/DCS ID. See also clauses 4.17.4a and 4.17.5a in TS 23.502 [3].<br>If the target NF is AUSF or NSSAAF and the HNI belongs to a CH/DCS with AAA Server in another domain, i.e. not in this SNPN, the NRF returns back the AUSF or NSSAAF in the same SNPN, based on the NF profile as specified in clause 6.2.6.2 in 3GPP TS 23.501 [2].                                                             | Query-ENPN             |
| target-nw-resolution       | boolean                  | O | 0..1 | If included and set to true, the NRF shall determine the identity of the target PLMN to which the NFDiscovery request shall be directed, based on the MSISDN of the UE included in the "gpsi" query parameter, as described in 3GPP TS 23.540 [48].<br><br>If included and set to false, this IE shall be ignored.                                                                                                                                                                                                                                                                                                                                                                             | Query-Nw-Resolution    |
| exclude-nfinst-list        | array(NfInstanceId)      | O | 1..N | If included, this IE shall indicate the list of NF instances that should not be returned in the NF Discovery response.<br>(NOTE 23)                                                                                                                                                                                                                                                                                                                                                                                                                                                                                                                                                            | Query-SBIProtoc17-Ext1 |
| exclude-nfservinst-list    | array(NfServiceInstance) | O | 1..N | If included, this IE shall indicate the list of NF service instances that should not be returned in the NF Discovery response.<br>(NOTE 23)                                                                                                                                                                                                                                                                                                                                                                                                                                                                                                                                                    | Query-SBIProtoc17-Ext1 |
| exclude-nfserviceset-list  | array(NfServiceSetId)    | O | 1..N | If included, this IE shall indicate the list of NF service sets of NF service instances that should not be returned in the NF Discovery response.<br>(NOTE 23)                                                                                                                                                                                                                                                                                                                                                                                                                                                                                                                                 | Query-SBIProtoc17-Ext1 |
| exclude-nfset-list         | array(NfSetId)           | O | 1..N | If included, this IE shall indicate the list of NF sets of NF instances that should not be returned in the NF Discovery response.<br>(NOTE 23)                                                                                                                                                                                                                                                                                                                                                                                                                                                                                                                                                 | Query-SBIProtoc17-Ext1 |
| preferred-analytics-delays | map(DurationSec)         | O | 1..N | If included, this IE shall contain the preferred Analytics Delay. The key of the map is the EventId or NwdafEvent (as defined in 3GPP TS 29.520 [33]) for which the preferred Analytics Delay is related to. Each element carries the preferred Analytics Delay for the Analytics ID indicated by the key.<br><br>The NRF shall return the NWDAFs supports the Analytics ID with a supported Analytics Delay that is less than or equal to the preferred Analytics Delay, as described in clause 6.3.13 of 3GPP TS 23.501 [2]. The NRF may return NWDAFs in the response not matching the preferred Analytics Delay, e.g. if no NWDAF profile is found matching the preferred Analytics Delay. | Query-eNA-PH2-Ext1     |

- NOTE 1: If this parameter is present and no AMF supporting the requested GUAMI is available due to AMF Failure or planned AMF removal, the NRF shall return in the response AMF instances acting as a backup for AMF failure or planned AMF removal respectively for this GUAMI (see clause 6.1.6.2.11). The NRF can detect if an AMF has failed, using the Heartbeat procedure. The NRF will receive a de-registration request from an AMF performing a planned removal.
- NOTE 2: If the combined SMF/PGW-C is requested to be discovered, the NRF shall return in the response the SMF instances registered with the SmfInfo containing pgwFqdn.
- NOTE 3: If a UPF supporting interworking with EPS is requested to be discovered, the NRF shall return in the response the UPF instances registered with the upfInfo containing iwkEpsInd set to true.
- NOTE 4: This attribute has a different semantic than what is defined in clause 6.6.2 of 3GPP TS 29.500 [4], i.e. it is not used to signal optional features of the Nnrf\_NFDiscovery Service API supported by the requester NF.
- NOTE 5: The AMF may perform the SMF discovery based on the dnn, snssais and preferred-tai during a PDU session establishment procedure, and the NRF shall return the SMF profiles matching all if possible, or the SMF profiles only matching dnn and snssais. If the SMF profiles only matching dnn and snssais are returned, the AMF shall insert an I-SMF. An SMF may also perform a UPF discovery using this parameter.
- NOTE 6: The SMF may select the P-CSCF close to the UPF by setting the preferred-locality to the value of the locality of the UPF.
- NOTE 7: During EPS to 5GS idle mobility procedure, the Requester NF (i.e. SMF) discovers the anchor NEF for NIDD using the SCEF ID received from EPS as the value of the NEF ID, as specified in clause 4.11.1.3.3 of 3GPP TS 23.502 [3].
- NOTE 8: The service consumer may include a list of preferred-nf-instance-ids in the query. If so, the NRF shall first check if the NF profiles of the preferred NF instances match the other query parameters, and if so, then the NRF shall return the corresponding NF profiles; otherwise, the NRF shall return a list of candidate NF profiles matching the query parameters other than the preferred-nf-instance-ids. For example, the target AMF may set this query parameter to the SMF Instance ID and I-SMF Instance ID during an inter AMF mobility procedure to select an I-SMF.
- NOTE 9: This parameter may be used by the SCP (with other query parameters) to discover and select a NF service consumer with a default notification subscription supporting the notification type of a notification request (see clause 6.10.3.3 of 3GPP TS 29.500 [4]).
- NOTE 10: An S-NSSAI value used in discovery request query parameters shall be considered as matching the S-NSSAI value in the NF Profile or NF Service of a given NF Instance if both the SST and SD components are identical (i.e. an S-NSSAI value where SD is absent, shall not be considered as matching an S-NSSAI where SD is present, regardless if SST is equal in both).
- NOTE 11: The dnn query parameter shall be considered as matching a DNN attribute in the NF Profile of a given NF Instance if:
- both contain the same Network Identifier and Operator Identifier;
  - both contain the same Network Identifier and none contains an Operator Identifier;
  - the dnn query parameter contains the Network Identifier only, the DNN value in the NF Profile contains both the Network Identifier and Operator Identifier, and both contain the same Network Identifier; or
  - the dnn query parameter contains both the Network Identifier and Operator Identifier, the DNN value in the NF Profile contains the Network Identifier only, both contain the same Network Identifier and the Operator Identifier matches one PLMN of the NF (i.e. plmnList of the NF Profile).
- NOTE 12: Based on operator's policies, a discovery request not including the requester's information necessary to validate the authorization parameters in NF Profiles may be rejected or accepted but with only returning in the discovery response NF Instances whose authorization parameters allow any NF Service Consumer to access their services. The authorization parameters in NF Profile are those used by NRF to determine whether a given NF Instance / NF Service Instance can be discovered by an NF Service Consumer in order to consume its offered services (e.g. "allowedNfTypes", "allowedNfDomains", etc.).
- NOTE 13: Different UPF instances for data forwarding may be configured in the network e.g. for different serving areas. The SMF may use this query parameter together with others (like SMF Serving Area or TAI) in discovery to select the UPF candidate for data forwarding.
- NOTE 14: For HR roaming, if the V-PLMN requires Deployments Topologies with specific SMF Service Areas (DTSSA) but no H-SMF can be selected supporting V-SMF change, AMF may use this query parameter to select a V-SMF serving the full VPLMN if available.
- NOTE 15: The AMF may perform discovery with this parameter to find V-SMF(s)/I-SMF(s), and the NRF shall return the SMF profiles that explicitly indicated support of V-SMF/I-SMF(s) capability. When performing discovery, the AMF shall use other query parameters together with this IE to ensure the required configurations and/or features are supported by the V-SMF/I-SMF(s), e.g. required Slice for the PDU session, support of DTSSA feature if V-SMF change is required for PDU Session, etc. If no SMF instances that explicitly indicated support of V-SMF/I-SMF(s) capability can be matched for the discovery, the NRF shall return matched SMF instances not indicating support of V-SMF/I-SMF(s) capability explicitly, i.e. the SMF instances not registered vsmfSupportInd/ismfSupportInd IE in the NF profile but matched to the rest query parameters, if available.
- NOTE 16: When required-pfcp-features is used as query parameter, the NRF shall return a list of candidate UPFs supporting all the required PCF features. The NRF may also return UPF profiles not including the "SupportedPfcFeatures" attribute (e.g. pre-Rel-17 UPFs) but matching the other query parameters. The NF Service Consumer, e.g. a SMF, when using required-pfcp-features as query parameter, shall also include the query parameter corresponding to the UPF features (atsss-capability, upf-ue-ip-addr-ind, redundant-

|                                                                                                                                                                                                                                                                                                                                                                                                                                                                                                                                                                                                                                                                                                                                                                                                                                                                                                                                                                                                                                                                                                                                                                                                                                                                                                                                                                                                                                                                                                                                                                                                                                                                                                                                                                                                                                                                                                                                                                                                                                                                                                                                                                                                                                                                                                                                                                                                                                                                                                                                                                                                                                                                                                                                                                                                                                                                                                                                      |
|--------------------------------------------------------------------------------------------------------------------------------------------------------------------------------------------------------------------------------------------------------------------------------------------------------------------------------------------------------------------------------------------------------------------------------------------------------------------------------------------------------------------------------------------------------------------------------------------------------------------------------------------------------------------------------------------------------------------------------------------------------------------------------------------------------------------------------------------------------------------------------------------------------------------------------------------------------------------------------------------------------------------------------------------------------------------------------------------------------------------------------------------------------------------------------------------------------------------------------------------------------------------------------------------------------------------------------------------------------------------------------------------------------------------------------------------------------------------------------------------------------------------------------------------------------------------------------------------------------------------------------------------------------------------------------------------------------------------------------------------------------------------------------------------------------------------------------------------------------------------------------------------------------------------------------------------------------------------------------------------------------------------------------------------------------------------------------------------------------------------------------------------------------------------------------------------------------------------------------------------------------------------------------------------------------------------------------------------------------------------------------------------------------------------------------------------------------------------------------------------------------------------------------------------------------------------------------------------------------------------------------------------------------------------------------------------------------------------------------------------------------------------------------------------------------------------------------------------------------------------------------------------------------------------------------------|
| <p>gtpu) which correspond to the PFCP feature flags MPTCP and ATSSS_LL, UEIP, and RTTL respectively, if the corresponding PFCP feature is required. For example an SMF, that wishes to select a UPF supporting UE IP Address Allocation by the UP function, shall set the UEIP flag to "1" in the required-pfcp-features and also include the upf-ue-ip-addr-ind parameter set to "true".</p> <p>NOTE 17: In this release, the usage of Home Network Public Key identifier for AUSF/UDM discovery is limited to the scenario where the AUSF/UDM NF consumers belong to the same PLMN as AUSF/UDM.</p> <p>NOTE 18: The NF service consumer may derive the serving scope from e.g. the TAI of the UE, using local configuration. This parameter may be used to discover any NF that registers to the NRF, e.g. a 5GC NF or a P-CSCF.</p> <p>NOTE 19: If the NRF supports the "Collocated-NF-Selection" feature and the NF service consumer has included the "preferred-collocated-nf-types" attribute, the NRF shall return a list of candidates NFs (for the target-nf-type) matching the discovery query parameters and preferentially supporting CollocatedNFType(s) as indicated in the preferred-collocated-nf-types.</p> <p>NOTE 20: If the NRF supports this IE and the NF service consumer has included this IE with the value "true" in discovery request, the NRF shall look up and return PGW-C+SMF instances matching the other query parameters. If no matching is found, the NRF shall return a list of standalone SMF instances matching the other query parameters. If the NRF supports this IE and the NF service consumer has included this IE with the value "false" in discovery request, the NRF shall look up and return standalone SMF instances matching the other query parameters. If no matching is found, the NRF shall return a list of PGW-C+SMF instances matching the other query parameters.</p> <p>NOTE 21: Either pgw-ind IE or preferred-pgw-ind IE may be included in the discovery request.</p> <p>NOTE 22: MB-SMF may use an NRF to discover the AMF(s) serving an MBS service area (see clause 7.3.1 in 3GPP TS 23.247 [43]). For this purpose, the MB-SMF may use query parameters specified in this table, e.g. 'tai' and 'service-names', or 'snssais', or any other parameters.</p> <p>NOTE 23: This parameter may be set by an NF service consumer or SCP to filter-out specific NF (service) instances or NF (service) sets from the NF Discovery response, e.g. when the NFc knows that an NF service producer is not responsive or overloaded. See the 3gpp-Sbi-Selection-Info header in clause 5.2.3.3.10 of 3GPP TS 29.500 [4].</p> <p>NOTE 24: When Locality is configured in NSACF(s), an NSACF consumer, e.g. AMF or SMF, may use a locally configured NSACF Locality to discover the candidate NSACF, or otherwise may use its own Locality to discover the candidate NSACF.</p> |
|--------------------------------------------------------------------------------------------------------------------------------------------------------------------------------------------------------------------------------------------------------------------------------------------------------------------------------------------------------------------------------------------------------------------------------------------------------------------------------------------------------------------------------------------------------------------------------------------------------------------------------------------------------------------------------------------------------------------------------------------------------------------------------------------------------------------------------------------------------------------------------------------------------------------------------------------------------------------------------------------------------------------------------------------------------------------------------------------------------------------------------------------------------------------------------------------------------------------------------------------------------------------------------------------------------------------------------------------------------------------------------------------------------------------------------------------------------------------------------------------------------------------------------------------------------------------------------------------------------------------------------------------------------------------------------------------------------------------------------------------------------------------------------------------------------------------------------------------------------------------------------------------------------------------------------------------------------------------------------------------------------------------------------------------------------------------------------------------------------------------------------------------------------------------------------------------------------------------------------------------------------------------------------------------------------------------------------------------------------------------------------------------------------------------------------------------------------------------------------------------------------------------------------------------------------------------------------------------------------------------------------------------------------------------------------------------------------------------------------------------------------------------------------------------------------------------------------------------------------------------------------------------------------------------------------------|

The default logical relationship among the query parameters is logical "AND", i.e. all the provided query parameters shall be matched, with the exception of the "preferred-locality", "preferred-nf-instances", "preferred-tai", "preferred-api-versions", "preferred-full-plmn", "preferred-collocated-nf-types", "preferred-pgw-ind", "preferred-analytics-delays" and "mbs-session-id" query parameters (see Table 6.2.3.2.3.1-1).

The NRF may support the Complex query expression as defined in 3GPP TS 29.501 [5] for the NF Discovery service. If the "complexQuery" query parameter is included, then the logical relationship among the query parameters contained in "complexQuery" query parameter is as defined in 3GPP TS 29.571 [7].

A NRF not supporting Complex query expression shall reject a NF service discovery request including a complexQuery parameter, with a ProblemDetails IE including the cause attribute set to INVALID\_QUERY\_PARAM and the invalidParams attribute indicating the complexQuery parameter.

This method shall support the request data structures specified in table 6.1.3.2.3.1-2 and the response data structures and response codes specified in table 6.1.3.2.3.1-3.

**Table 6.2.3.2.3.1-2: Data structures supported by the GET Request Body on this resource**

| Data type | P | Cardinality | Description |
|-----------|---|-------------|-------------|
| n/a       |   |             |             |

**Table 6.2.3.2.3.1-3: Data structures supported by the GET Response Body on this resource**

| Data type        | P | Cardinality | Response codes            | Description                                                                                                                                                                                                                                                                                                                                                                                                                                                           |
|------------------|---|-------------|---------------------------|-----------------------------------------------------------------------------------------------------------------------------------------------------------------------------------------------------------------------------------------------------------------------------------------------------------------------------------------------------------------------------------------------------------------------------------------------------------------------|
| SearchResult     | M | 1           | 200 OK                    | The response body contains the result of the search over the list of registered NF Instances.                                                                                                                                                                                                                                                                                                                                                                         |
| RedirectResponse | O | 0..1        | 307 Temporary Redirect    | The response shall be used when the intermediate NRF redirects the service discovery request.<br>The NRF shall include in this response a Location header field containing a URI pointing to the resource located on the redirect target NRF.<br>If an SCP redirects the message to another SCP then the location header field shall contain the same URI or a different URI pointing to the endpoint of the NF service producer to which the request should be sent. |
| ProblemDetails   | O | 0..1        | 400 Bad Request           | The response body contains the error reason of the request message.<br><br>If the query parameter used to match the authorization parameter is required but not provided in the NF discovery request, the "cause" attribute shall be set to "MANDATORY_QUERY_PARAM_MISSING", and the missing query parameter shall be indicated.                                                                                                                                      |
| ProblemDetails   | O | 0..1        | 403 Forbidden             | This response shall be returned if the Requester NF is not allowed to discover the NF Service(s) being queried.                                                                                                                                                                                                                                                                                                                                                       |
| ProblemDetails   | O | 0..1        | 404 Not Found             | This response shall be returned if the requested resource URI as defined in clause 6.2.3.2.2 (query parameter not considered) is not found in the server.<br><br>It may also be sent in hierarchical NRF deployments when the NRF needs to forward/redirect the request to another NRF but lacks information in the request to do so; similarly, the NRF shall return this response code when it is received from the upstream NRF.                                   |
| ProblemDetails   | O | 0..1        | 500 Internal Server Error | The response body contains the error reason of the request message.                                                                                                                                                                                                                                                                                                                                                                                                   |

**Table 6.2.3.2.3.1-4: Headers supported by the GET method on this endpoint**

| Name          | Data type | P | Cardinality | Description                                                                        |
|---------------|-----------|---|-------------|------------------------------------------------------------------------------------|
| If-None-Match | string    | C | 0..1        | Validator for conditional requests, as described in IETF RFC 7232 [19], clause 3.2 |

**Table 6.2.3.2.3.1-5: Headers supported by the 200 Response Code on this endpoint**

| Name          | Data type | P | Cardinality | Description                                                                           |
|---------------|-----------|---|-------------|---------------------------------------------------------------------------------------|
| Cache-Control | string    | C | 0..1        | Cache-Control containing max-age, described in IETF RFC 7234 [20], clause 5.2         |
| ETag          | string    | C | 0..1        | Entity Tag containing a strong validator, described in IETF RFC 7232 [19], clause 2.3 |

**Table 6.2.3.2.3.1-6: Headers supported by the 307 Response Code on this endpoint**

| Name     | Data type | P | Cardinality | Description                                                         |
|----------|-----------|---|-------------|---------------------------------------------------------------------|
| Location | string    | M | 1           | The URI pointing to the resource located on the redirect target NRF |

**Table 6.2.3.2.3.1-7: Links supported by the 200 Response Code on this endpoint**

| Name           | Resource name                     | HTTP method or custom operation | Parameters table | Description                                                                                                                                     |
|----------------|-----------------------------------|---------------------------------|------------------|-------------------------------------------------------------------------------------------------------------------------------------------------|
| search         | Stored Search (Document)          | GET                             | 6.2.3.2.3.1-8    | The 'searchId' parameter returned in the response can be used as the 'searchId' parameter in the GET request to '/searches/{searchId}'          |
| completeSearch | Complete Stored Search (Document) | GET                             | 6.2.3.2.3.1-9    | The 'searchId' parameter returned in the response can be used as the 'searchId' parameter in the GET request to '/searches/{searchId}/complete' |

#### 6.2.3.2.4 Resource Custom Operations

There are no resource custom operations for the Nnrf\_NFDDiscovery service in this release of the specification.

### 6.2.3.3 Resource: Stored Search (Document)

#### 6.2.3.3.1 Description

This resource represents a search result (i.e. a number of discovered NF Instances), stored by NRF as a consequence of a prior search result.

This resource is modelled as the Document resource archetype (see clause C.3 of 3GPP TS 29.501 [5]).

#### 6.2.3.3.2 Resource Definition

Resource URI: {apiRoot}/nnrf-disc/v1/searches/{searchId}

This resource shall support the resource URI variables defined in table 6.2.3.3.2-1.

**Table 6.2.3.3.2-1: Resource URI variables for this resource**

| Name     | Data type | Definition                                                                                                                                                  |
|----------|-----------|-------------------------------------------------------------------------------------------------------------------------------------------------------------|
| apiRoot  | string    | See clause 6.1.1                                                                                                                                            |
| searchId | string    | Identifier of a stored search result, returned by NRF to the NF Consumer in the original response to the NF Discovery GET operation (see clause 6.2.6.2.2). |

#### 6.2.3.3.2.1 GET

This method retrieves the NF Instances corresponding to a given stored search result.

This method shall support the URI query parameters specified in table 6.2.3.3.2.1-1.

**Table 6.2.3.3.2.1-1: URI query parameters supported by the GET method on this resource**

| Name | Data type | P | Cardinality | Description |
|------|-----------|---|-------------|-------------|
| n/a  |           |   |             |             |

This method shall support the request data structures specified in table 6.2.3.3.2.1-2 and the response data structures and response codes specified in table 6.2.3.3.2.1-3.

**Table 6.2.3.3.2.1-2: Data structures supported by the GET Request Body on this resource**

| Data type | P | Cardinality | Description |
|-----------|---|-------------|-------------|
| n/a       |   |             |             |

**Table 6.2.3.3.2.1-3: Data structures supported by the GET Response Body on this resource**

| Data type                                                                                                                                                                                                                                          | P | Cardinality | Response codes | Description                                                                                |
|----------------------------------------------------------------------------------------------------------------------------------------------------------------------------------------------------------------------------------------------------|---|-------------|----------------|--------------------------------------------------------------------------------------------|
| StoredSearchResult                                                                                                                                                                                                                                 | M | 1           | 200 OK         | The response body contains the NF Instances corresponding to a given stored search result. |
| NOTE: The mandatory HTTP error status codes for the GET method listed in Table 5.2.7.1-1 of 3GPP TS 29.500 [4] other than those specified in the table above also apply, with a ProblemDetails data type (see clause 5.2.7 of 3GPP TS 29.500 [4]). |   |             |                |                                                                                            |

## 6.2.3.4 Resource: Complete Stored Search (Document)

### 6.2.3.4.1 Description

This resource represents a complete search result (i.e. a number of discovered NF Instances), stored by NRF as a consequence of a prior search result, but without applying any client restrictions in terms of the number of instances to be returned (i.e. "limit" or "max-payload-size" query parameters).

This resource is modelled as the Document resource archetype (see clause C.3 of 3GPP TS 29.501 [5]).

### 6.2.3.4.2 Resource Definition

Resource URI: `{apiRoot}/nnrf-disc/v1/searches/{searchId}/complete`

This resource shall support the resource URI variables defined in table 6.2.3.4.2-1.

**Table 6.2.3.4.2-1: Resource URI variables for this resource**

| Name     | Data type | Definition                                                                                                                                                  |
|----------|-----------|-------------------------------------------------------------------------------------------------------------------------------------------------------------|
| apiRoot  | string    | See clause 6.1.1                                                                                                                                            |
| searchId | string    | Identifier of a stored search result, returned by NRF to the NF Consumer in the original response to the NF Discovery GET operation (see clause 6.2.6.2.2). |

#### 6.2.3.4.2.1 GET

This method retrieves the NF Instances corresponding to a given stored search result.

This method shall support the URI query parameters specified in table 6.2.3.4.2.1-1.

**Table 6.2.3.4.2.1-1: URI query parameters supported by the GET method on this resource**

| Name | Data type | P | Cardinality | Description |
|------|-----------|---|-------------|-------------|
| n/a  |           |   |             |             |

This method shall support the request data structures specified in table 6.2.3.4.2.1-2 and the response data structures and response codes specified in table 6.2.3.4.3.1-3.

**Table 6.2.3.4.2.1-2: Data structures supported by the GET Request Body on this resource**

| Data type | P | Cardinality | Description |
|-----------|---|-------------|-------------|
| n/a       |   |             |             |

**Table 6.2.3.4.2.1-3: Data structures supported by the GET Response Body on this resource**

| Data type                                                                                                                                                                                                                                          | P | Cardinality | Response codes | Description                                                                                                                                                                                                                                       |
|----------------------------------------------------------------------------------------------------------------------------------------------------------------------------------------------------------------------------------------------------|---|-------------|----------------|---------------------------------------------------------------------------------------------------------------------------------------------------------------------------------------------------------------------------------------------------|
| StoredSearchResult                                                                                                                                                                                                                                 | M | 1           | 200 OK         | The response body contains the NF Instances corresponding to a given stored search result, but without applying any client restrictions in terms of the number of instances to be returned (i.e. "limit" or "max-payload-size" query parameters). |
| NOTE: The mandatory HTTP error status codes for the GET method listed in Table 5.2.7.1-1 of 3GPP TS 29.500 [4] other than those specified in the table above also apply, with a ProblemDetails data type (see clause 5.2.7 of 3GPP TS 29.500 [4]). |   |             |                |                                                                                                                                                                                                                                                   |

## 6.2.3.5 Resource: SCP Domain Routing Information (Document)

### 6.2.3.5.1 Description

This resource represents (local) SCP Domain Routing Information, calculated by NRF based on SCPs registered in the network (or in the producer NRF for local SCP Domain Routing Information).

This resource is modelled as the Document resource archetype (see clause C.3 of 3GPP TS 29.501 [5]).

### 6.2.3.5.2 Resource Definition

Resource URI: {apiRoot}/nnrf-disc/v1/scp-domain-routing-info

This resource shall support the resource URI variables defined in table 6.2.3.5.2-1.

**Table 6.2.3.5.2-1: Resource URI variables for this resource**

| Name    | Data type | Definition       |
|---------|-----------|------------------|
| apiRoot | string    | See clause 6.2.1 |

### 6.2.3.5.2.1 GET

This method retrieves the (local) SCP Domain Routing Information.

This method shall support the URI query parameters specified in table 6.2.3.5.2.1-1.

**Table 6.2.3.5.2.1-1: URI query parameters supported by the GET method on this resource**

| Name  | Data type | P | Cardinality | Description                                                                                                                                                                                                                           |
|-------|-----------|---|-------------|---------------------------------------------------------------------------------------------------------------------------------------------------------------------------------------------------------------------------------------|
| local | boolean   | O | 0..1        | When present, this IE shall indicate whether local SCP Domain Routing Information is to be fetched:<br>- true: local SCP Domain Routing Information to be fetched.<br>- false (default): SCP Domain Routing Information to be fetched |

This method shall support the request data structures specified in table 6.2.3.5.2.1-2 and the response data structure and response codes specified in table 6.2.3.5.2.1-3.

**Table 6.2.3.5.2.1-2: Data structures supported by the GET Request Body on this resource**

| Data type | P | Cardinality | Description |
|-----------|---|-------------|-------------|
| n/a       |   |             |             |



**Table 6.2.3.5.2.1-3: Data structures supported by the GET Response Body on this resource**

| Data type                                                                                                                                                                                                                                          | P | Cardinality | Response codes | Description                                                |
|----------------------------------------------------------------------------------------------------------------------------------------------------------------------------------------------------------------------------------------------------|---|-------------|----------------|------------------------------------------------------------|
| ScpDomainRoutingInfo                                                                                                                                                                                                                               | M | 1           | 200 OK         | The response body contains SCP Domain Routing Information. |
| NOTE: The mandatory HTTP error status codes for the GET method listed in Table 5.2.7.1-1 of 3GPP TS 29.500 [4] other than those specified in the table above also apply, with a ProblemDetails data type (see clause 5.2.7 of 3GPP TS 29.500 [4]). |   |             |                |                                                            |

## 6.2.3.6 Resource: SCP Domain Routing Information Subscriptions (Collection)

### 6.2.3.6.1 Description

This resource represents a collection of subscriptions of (local) SCP Domain Routing Information.

### 6.2.3.6.2 Resource Definition

Resource URI: {apiRoot}/nnrf-disc/v1/scp-domain-routing-info subs

This resource shall support the resource URI variables defined in table 6.2.3.6.2-1.

**Table 6.1.3.6.2-1: Resource URI variables for this resource**

| Name    | Data type | Definition       |
|---------|-----------|------------------|
| apiRoot | string    | See clause 6.2.1 |

### 6.2.3.6.3 Resource Standard Methods

#### 6.2.3.6.3.1 POST

This method creates a new subscription. This method shall support the URI query parameters specified in table 6.2.3.6.3.1-1.

**Table 6.2.3.6.3.1-1: URI query parameters supported by the POST method on this resource**

| Name | Data type | P | Cardinality | Description |
|------|-----------|---|-------------|-------------|
| n/a  |           |   |             |             |

This method shall support the request data structures specified in table 6.2.3.6.3.1-2 and the response data structure and response codes specified in table 6.2.3.6.3.1-3.

**Table 6.2.3.6.3.1-2: Data structures supported by the POST Request Body on this resource**

| Data type                        | P | Cardinality | Description                                                          |
|----------------------------------|---|-------------|----------------------------------------------------------------------|
| ScpDomainRoutingInfoSubscription | M | 1           | The request body contains the input parameters for the subscription. |

**Table 6.2.3.6.3.1-3: Data structures supported by the POST Response Body on this resource**

| Data type                                                                                                                                                                                                                                           | P | Cardinality | Response codes | Description                                                                                                                                                                                           |
|-----------------------------------------------------------------------------------------------------------------------------------------------------------------------------------------------------------------------------------------------------|---|-------------|----------------|-------------------------------------------------------------------------------------------------------------------------------------------------------------------------------------------------------|
| ScpDomainRoutingInfoSubscription                                                                                                                                                                                                                    | M | 1           | 201 Created    | This case represents the successful creation of a subscription.<br><br>Upon success, the HTTP response shall include a "Location" HTTP header that contains the resource URI of the created resource. |
| NOTE: The mandatory HTTP error status codes for the POST method listed in Table 5.2.7.1-1 of 3GPP TS 29.500 [4] other than those specified in the table above also apply, with a ProblemDetails data type (see clause 5.2.7 of 3GPP TS 29.500 [4]). |   |             |                |                                                                                                                                                                                                       |

**Table 6.2.3.6.3.1-4: Headers supported by the 201 Response Code on this resource**

| Name     | Data type | P | Cardinality | Description                                                                                                                                      |
|----------|-----------|---|-------------|--------------------------------------------------------------------------------------------------------------------------------------------------|
| Location | string    | M | 1           | Contains the URI of the newly created resource, according to the structure: {apiRoot}/nnrf-disc/v1/scp-domain-routing-info-subs/{subscriptionId} |

### 6.2.3.7 Resource: Individual SCP Domain Routing Information Subscription (Document)

#### 6.2.3.7.1 Description

This resource represents an individual subscription of (local) SCP Domain Routing Information.

#### 6.2.3.7.2 Resource Definition

Resource URI: {apiRoot}/nnrf-disc/v1/scp-domain-routing-info-subs/{subscriptionID}

This resource shall support the resource URI variables defined in table 6.2.3.7.2-1.

**Table 6.2.3.7.2-1: Resource URI variables for this resource**

| Name           | Data type | Definition                         |
|----------------|-----------|------------------------------------|
| apiRoot        | string    | See clause 6.2.1                   |
| subscriptionID | string    | Represents a specific subscription |

#### 6.2.3.7.3 Resource Standard Methods

##### 6.2.3.7.3.1 DELETE

This method terminates an existing subscription. This method shall support the URI query parameters specified in table 6.2.3.7.3.1-1.

**Table 6.2.3.7.3.1-1: URI query parameters supported by the DELETE method on this resource**

| Name | Data type | P | Cardinality | Description |
|------|-----------|---|-------------|-------------|
| n/a  |           |   |             |             |

This method shall support the request data structures specified in table 6.2.3.7.3.1-2 and the response data structure and response codes specified in table 6.2.3.7.3.1-3.

**Table 6.2.3.7.3.1-2: Data structures supported by the DELETE Request Body on this resource**

| Data type | P | Cardinality | Description |
|-----------|---|-------------|-------------|
| n/a       |   |             |             |

**Table 6.2.3.7.3.1-3: Data structures supported by the DELETE Response Body on this resource**

| Data type                                                                                                                                                                                                                                             | P | Cardinality | Response codes | Description |
|-------------------------------------------------------------------------------------------------------------------------------------------------------------------------------------------------------------------------------------------------------|---|-------------|----------------|-------------|
| n/a                                                                                                                                                                                                                                                   |   |             | 204 No Content |             |
| NOTE: The mandatory HTTP error status codes for the DELETE method listed in Table 5.2.7.1-1 of 3GPP TS 29.500 [4] other than those specified in the table above also apply, with a ProblemDetails data type (see clause 5.2.7 of 3GPP TS 29.500 [4]). |   |             |                |             |

## 6.2.4 Custom Operations without associated resources

There are no custom operations defined without any associated resources for the Nnrf\_NFDiscovery service in this release of this specification.

## 6.2.5 Notifications

### 6.2.5.1 General

This clause specifies the notifications provided by the Nnrf\_NFDiscovery service.

The delivery of notifications shall be supported as specified in clause 6.2 of 3GPP TS 29.500 [4] for Server-initiated communication.

**Table 6.2.5.1-1: Notifications overview**

| Notification                                       | Resource URI                                                       | HTTP method or custom operation | Description (service operation)                       |
|----------------------------------------------------|--------------------------------------------------------------------|---------------------------------|-------------------------------------------------------|
| SCP Domain Routing Information Change Notification | {callbackUri}<br>(NF Service Consumer provided callback reference) | POST                            | Notify about change of SCP Domain Routing Information |

### 6.2.5.2 SCP Domain Routing Information Change Notification

#### 6.2.5.2.1 Description

The NF Service Consumer provides a callback URI for getting notified about change of (local) SCP Domain Routing Information, the NRF shall notify the NF Service Consumer, when the (local) SCP Domain Routing Information is updated.

#### 6.2.5.2.2 Notification Definition

The POST method shall be used for SCP Domain Routing Information Change Notification and the URI shall be the callback reference provided by the NF Service Consumer during the subscription to this notification.

Resource URI: {callbackUri}

Support of URI query parameters are specified in table 6.2.5.2.2-1.

**Table 6.2.5.2.2-1: URI query parameters supported by the POST method**

| Name | Data type | P | Cardinality | Description |
|------|-----------|---|-------------|-------------|
| n/a  |           |   |             |             |

Support of request data structures is specified in table 6.2.5.2.2-2, and support of response data structures and response codes is specified in table 6.2.5.2-3.

**Table 6.2.5.2.2-2: Data structures supported by the POST Request Body**

| Data type                        | P | Cardinality | Description                                                               |
|----------------------------------|---|-------------|---------------------------------------------------------------------------|
| ScpDomainRoutingInfoNotification | M | 1           | Representation of the SCP Domain Routing Information Change Notification. |

**Table 6.2.5.2.2-3: Data structures supported by the POST Response Body**

| Data type                                                                                                                                                                                                                                           | P | Cardinality | Response codes | Description                                                                              |
|-----------------------------------------------------------------------------------------------------------------------------------------------------------------------------------------------------------------------------------------------------|---|-------------|----------------|------------------------------------------------------------------------------------------|
| N/A                                                                                                                                                                                                                                                 |   |             | 204 No Content | This case represents a successful notification of SCP Domain Routing Information Change. |
| NOTE: The mandatory HTTP error status codes for the POST method listed in Table 5.2.7.1-1 of 3GPP TS 29.500 [4] other than those specified in the table above also apply, with a ProblemDetails data type (see clause 5.2.7 of 3GPP TS 29.500 [4]). |   |             |                |                                                                                          |

## 6.2.6 Data Model

### 6.2.6.1 General

This clause specifies the application data model supported by the API.

Table 6.2.6.1-1 specifies the data types defined for the Nnrf service based interface protocol.

**Table 6.2.6.1-1: Nnrf\_NFDIScovery specific Data Types**

| Data type                        | Clause defined | Description                                                                                                                            |
|----------------------------------|----------------|----------------------------------------------------------------------------------------------------------------------------------------|
| SearchResult                     | 6.2.6.2.2      | Contains the list of NF Profiles returned in a Discovery response.                                                                     |
| NFProfile                        | 6.2.6.2.3      | Information of an NF Instance discovered by the NRF.                                                                                   |
| NFService                        | 6.2.6.2.4      | Information of a given NF Service Instance; it is part of the NFProfile of an NF Instance discovered by the NRF.                       |
| StoredSearchResult               | 6.2.6.2.5      | Contains a complete search result (i.e. a number of discovered NF Instances), stored by NRF as a consequence of a prior search result. |
| PreferredSearch                  | 6.2.6.2.6      | Contains information on whether the returned NFProfiles match the preferred query parameters.                                          |
| NfInstanceInfo                   | 6.2.6.2.7      | Contains information on an NF profile matching a discovery request.                                                                    |
| ScpDomainRoutingInfo             | 6.2.6.2.8      | SCP Domain Routing Information                                                                                                         |
| ScpDomainConnectivity            | 6.2.6.2.9      | SCP Domain Routing Information                                                                                                         |
| ScpDomainRoutingInfoSubscription | 6.2.6.2.10     | SCP Domain Routing Information Subscription                                                                                            |
| ScpDomainRoutingInfoNotification | 6.2.6.2.11     | Notification for SCP Domain Routing Information Update                                                                                 |
| NfServiceInstance                | 6.2.6.2.12     | NF service instance                                                                                                                    |
| NoProfileMatchInfo               | 6.2.6.2.13     | No Profile Matching information                                                                                                        |
| QueryParameterCombination        | 6.2.6.2.14     | Contains a list of query parameters                                                                                                    |
| QueryParameter                   | 6.2.6.2.15     | Contains name and value of a query parameter                                                                                           |

Table 6.2.6.1-2 specifies data types re-used by the Nnrf\_NFDIScovery service-based interface protocol from other specifications, including a reference to their respective specifications and when needed, a short description of their use within the Nnrf\_NFDIScovery service-based interface.

**Table 6.2.6.1-2: Nnrf\_NFDiscovery re-used Data Types**

| Data type                       | Reference           | Comments                                                                        |
|---------------------------------|---------------------|---------------------------------------------------------------------------------|
| Snssai                          | 3GPP TS 29.571 [7]  |                                                                                 |
| PlmnId                          | 3GPP TS 29.571 [7]  |                                                                                 |
| Dnn                             | 3GPP TS 29.571 [7]  |                                                                                 |
| Tai                             | 3GPP TS 29.571 [7]  |                                                                                 |
| SupportedFeatures               | 3GPP TS 29.571 [7]  |                                                                                 |
| NfInstanceId                    | 3GPP TS 29.571 [7]  |                                                                                 |
| Uri                             | 3GPP TS 29.571 [7]  |                                                                                 |
| Gpsi                            | 3GPP TS 29.571 [7]  |                                                                                 |
| GroupId                         | 3GPP TS 29.571 [7]  |                                                                                 |
| Guami                           | 3GPP TS 29.571 [7]  |                                                                                 |
| IPv4Addr                        | 3GPP TS 29.571 [7]  |                                                                                 |
| IPv6Addr                        | 3GPP TS 29.571 [7]  |                                                                                 |
| UriScheme                       | 3GPP TS 29.571 [7]  |                                                                                 |
| Dnai                            | 3GPP TS 29.571 [7]  |                                                                                 |
| NfGroupId                       | 3GPP TS 29.571 [7]  | Identifier of a NF Group                                                        |
| PduSessionType                  | 3GPP TS 29.571 [7]  |                                                                                 |
| AtsssCapability                 | 3GPP TS 29.571 [7]  |                                                                                 |
| PlmnIdNid                       | 3GPP TS 29.571 [7]  |                                                                                 |
| NfSetId                         | 3GPP TS 29.571 [7]  |                                                                                 |
| NfServiceSetId                  | 3GPP TS 29.571 [7]  |                                                                                 |
| ExtSnssai                       | 3GPP TS 29.571 [7]  |                                                                                 |
| DurationSec                     | 3GPP TS 29.571 [7]  |                                                                                 |
| RedirectResponse                | 3GPP TS 29.571 [7]  | Response body of the redirect response message.                                 |
| MbsSessionId                    | 3GPP TS 29.571 [7]  | MBS Session Identifier                                                          |
| IpAddr                          | 3GPP TS 29.571 [7]  | IP Address                                                                      |
| AreaSessionId                   | 3GPP TS 29.571 [7]  | Area Session Identifier used for an MBS session with location dependent content |
| Fqdn                            | 3GPP TS 29.571 [7]  | Fully Qualified Domain Name                                                     |
| EventId                         | 3GPP TS 29.520 [32] | Defined in Nnwdaf_AnalyticsInfo API.                                            |
| NwdafEvent                      | 3GPP TS 29.520 [32] | Defined in Nnwdaf_EventsSubscription API.                                       |
| ExtGroupId                      | 3GPP TS 29.503 [36] |                                                                                 |
| SharedDataId                    | 3GPP TS 29.503 [36] |                                                                                 |
| ExternalClientType              | 3GPP TS 29.572 [33] |                                                                                 |
| SupportedGADShapes              | 3GPP TS 29.572 [33] | Supported GAD Shapes                                                            |
| DefaultNotificationSubscription | 3GPP TS 29.510      | See clause 6.1.6.2.4                                                            |
| IPEndPoint                      | 3GPP TS 29.510      | See clause 6.1.6.2.5                                                            |
| NFType                          | 3GPP TS 29.510      | See clause 6.1.6.3.3                                                            |
| UdrInfo                         | 3GPP TS 29.510      | See clause 6.1.6.2.6                                                            |
| UdmInfo                         | 3GPP TS 29.510      | See clause 6.1.6.2.7                                                            |
| AusInfo                         | 3GPP TS 29.510      | See clause 6.1.6.2.8                                                            |
| SupiRange                       | 3GPP TS 29.510      | See clause 6.1.6.2.9                                                            |
| AmfInfo                         | 3GPP TS 29.510      | See clause 6.1.6.2.11                                                           |
| SmfInfo                         | 3GPP TS 29.510      | See clause 6.1.6.2.12                                                           |
| UpfInfo                         | 3GPP TS 29.510      | See clause 6.1.6.2.13                                                           |
| PcfInfo                         | 3GPP TS 29.510      | See clause 6.1.6.2.20                                                           |
| BsfInfo                         | 3GPP TS 29.510      | See clause 6.1.6.2.21                                                           |
| ChfInfo                         | 3GPP TS 29.510      | See clause 6.1.6.2.32                                                           |
| NFServiceVersion                | 3GPP TS 29.510      | See clause 6.1.6.2.19                                                           |
| PlmnSnssai                      | 3GPP TS 29.510      | See clause 6.1.6.2.44                                                           |
| NwdafInfo                       | 3GPP TS 29.510      | See clause 6.1.6.2.45                                                           |
| NFStatus                        | 3GPP TS 29.510      | See clause 6.1.6.3.7                                                            |
| DataSetId                       | 3GPP TS 29.510      | See clause 6.1.6.3.8                                                            |
| ServiceName                     | 3GPP TS 29.510      | See clause 6.1.6.3.11                                                           |
| NFServiceStatus                 | 3GPP TS 29.510      | See clause 6.1.6.3.12                                                           |
| LmfInfo                         | 3GPP TS 29.510      | See clause 6.1.6.2.46                                                           |
| GmlcInfo                        | 3GPP TS 29.510      | See clause 6.1.6.2.47                                                           |
| NefInfo                         | 3GPP TS 29.510      | See clause 6.1.6.2.48                                                           |
| PfdData                         | 3GPP TS 29.510      | See clause 6.1.6.2.49                                                           |
| AfEventExposureData             | 3GPP TS 29.510      | See clause 6.1.6.2.50                                                           |
| PcscfInfo                       | 3GPP TS 29.510      | See clause 6.1.6.2.53                                                           |
| HssInfo                         | 3GPP TS 29.510      | See clause 6.1.6.2.57                                                           |
| ImsiRange                       | 3GPP TS 29.510      | See clause 6.1.6.2.58                                                           |
| VendorSpecificFeature           | 3GPP TS 29.510      | See clause 6.1.6.2.62                                                           |
| ScplInfo                        | 3GPP TS 29.510      | See clause 6.1.6.2.65                                                           |

|                      |                |                        |
|----------------------|----------------|------------------------|
| NefId                | 3GPP TS 29.510 | See clause 6.1.6.3     |
| VendorId             | 3GPP TS 29.510 | See clause 6.1.6.3     |
| AnNodeType           | 3GPP TS 29.510 | See clause 6.1.6.3.13  |
| SucInfo              | 3GPP TS 29.510 | See clause 6.1.6.2.71  |
| SeppInfo             | 3GPP TS 29.510 | See clause 6.1.6.2.72  |
| NsacInfo             | 3GPP TS 29.510 | See clause 6.1.6.2.81  |
| NsacCapability       | 3GPP TS 29.510 | See clause 6.1.6.2.82  |
| MiAnalyticsInfo      | 3GPP TS 29.510 | See clause 6.1.6.2.84  |
| MbSmfInfo            | 3GPP TS 29.510 | See clause 6.1.6.2.85  |
| TsctsInfo            | 3GPP TS 29.510 | See clause 6.1.6.2.91  |
| MbUpfInfo            | 3GPP TS 29.510 | See clause 6.1.6.2.94  |
| TrustAfInfo          | 3GPP TS 29.510 | See clause 6.1.6.2.96  |
| CollocatedNfInstance | 3GPP TS 29.510 | See clause 6.1.6.2.99  |
| NssaafInfo           | 3GPP TS 29.510 | See clause 6.1.6.2.104 |
| IwmscInfo            | 3GPP TS 29.510 | See clause 6.1.6.2.108 |
| MnpfInfo             | 3GPP TS 29.510 | See clause 6.1.6.2.109 |

## 6.2.6.2 Structured data types

### 6.2.6.2.1 Introduction

This clause defines the structures to be used in resource representations.

6.2.6.2.2 Type: SearchResult

**Table 6.2.6.2.2-1: Definition of type SearchResult**



| Attribute name                                                                                                                                                                                                                                                                                                                                               | Data type            | P | Cardinality | Description                                                                                                                                                                                                                                                                                                                                                                        |
|--------------------------------------------------------------------------------------------------------------------------------------------------------------------------------------------------------------------------------------------------------------------------------------------------------------------------------------------------------------|----------------------|---|-------------|------------------------------------------------------------------------------------------------------------------------------------------------------------------------------------------------------------------------------------------------------------------------------------------------------------------------------------------------------------------------------------|
| validityPeriod                                                                                                                                                                                                                                                                                                                                               | integer              | M | 1           | It shall contain the time in seconds during which the discovery result is considered valid and can be cached by the NF Service Consumer. This value shall be the same as the value contained in the "max-age" parameter of the "Cache-Control" header field sent in the HTTP response.                                                                                             |
| nflInstances                                                                                                                                                                                                                                                                                                                                                 | array(NFProfile)     | M | 0..N        | It shall contain an array of NF Instance profiles, matching the search criteria indicated by the query parameters of the discovery request. If the nflInstancesList IE is absent, an empty array means there is no NF instance that can match the search criteria.                                                                                                                 |
| searchId                                                                                                                                                                                                                                                                                                                                                     | string               | O | 0..1        | This IE may be present if the NRF stores the result of the current service discovery response in a given URL (server-side caching), to make it available in the future to NF Service Consumers without having to compute the whole search process again.                                                                                                                           |
| numNflInstComplete                                                                                                                                                                                                                                                                                                                                           | Uint32               | O | 0..1        | This IE may be present when the total number of NF Instances found by NRF, as the result of the service discovery process, is higher than the actual number of NF Instances included in the attribute nflInstances of the SearchResult object. This may happen due to the NF Service Consumer including in the discovery request parameters such as "limit" or "max-payload-size". |
| preferredSearch                                                                                                                                                                                                                                                                                                                                              | PreferredSearch      | C | 0..1        | This IE shall be present to indicate whether all the returned NFProfiles match the preferred query parameters, if the discovery request contains any of the query parameter defined in the PreferredSearch data type.                                                                                                                                                              |
| nrfSupportedFeatures                                                                                                                                                                                                                                                                                                                                         | SupportedFeatures    | C | 0..1        | Features supported by the NRF for the NFDISCOVERY service (see clause 6.2.9).<br>This IE should be present if the NRF supports at least one feature.                                                                                                                                                                                                                               |
| nflInstanceList                                                                                                                                                                                                                                                                                                                                              | map(NflInstanceInfo) | O | 1..N        | This IE may be present if the NF Discovery request indicated support of the Enh-NF-Discovery feature. When present, this IE shall contain a map of NflInstanceInfo of NF instance profiles matching the search criteria indicated by the query parameters of the discovery request. The key of the map shall be the NF instance ID.<br>(NOTE 2)                                    |
| alteredPriorityInd                                                                                                                                                                                                                                                                                                                                           | boolean              | O | 0..1        | This IE shall indicate whether the NRF altered the priority values returned in the search result or not.<br>(NOTE 1, NOTE 3)<br><br>When present, this IE shall be set as following:<br>- true: NF instances with NRF altered priority are returned in the search result.<br>- false: the NRF has not altered priority values in any NF instance returned in the search result     |
| noProfileMatchInfo                                                                                                                                                                                                                                                                                                                                           | NoProfileMatchInfo   | O | 0..1        | This IE may be present if an empty array of nflInstances is conveyed and the nflInstancesList IE is absent; otherwise it shall be absent.<br>If present, it shall indicate the specific reason for not finding any NF instance that can match the search criteria.                                                                                                                 |
| NOTE 1: If NRF altered priority values are returned in the search result, when the NF consumer receives a different priority value in a subsequent NF Profile change notification for NF instance(s) returned in the search result, the NF consumer should not overwrite the NRF altered priority in the cached search result.                               |                      |   |             |                                                                                                                                                                                                                                                                                                                                                                                    |
| NOTE 2: If the alteredPriorityInd IE is present and set to true and the nrfAlteredPriorities IE is not included for a certain NF instance of the nflInstanceList, the NF consumer shall apply the priorities retrieved in the corresponding NF profile for this NF instance when selecting a NF service producer for the corresponding NF Discovery request. |                      |   |             |                                                                                                                                                                                                                                                                                                                                                                                    |
| NOTE 3: This IE shall be set if the NRF altered the priority values of one or more NF instances returned in the search result, regardless of whether the NF instances are returned in the nflInstances IE and/or nflInstanceList IE.                                                                                                                         |                      |   |             |                                                                                                                                                                                                                                                                                                                                                                                    |

6.2.6.2.3 Type: NFProfile

**Table 6.2.6.2.3-1: Definition of type NFProfile**

| Attribute name      | Data type                    | P | Cardinality | Description                                                                                                                                                                                                                                                                                                                                                                                                                                                                                                                                                       |
|---------------------|------------------------------|---|-------------|-------------------------------------------------------------------------------------------------------------------------------------------------------------------------------------------------------------------------------------------------------------------------------------------------------------------------------------------------------------------------------------------------------------------------------------------------------------------------------------------------------------------------------------------------------------------|
| nfInstanceId        | NfInstanceId                 | M | 1           | Unique identity of the NF Instance.                                                                                                                                                                                                                                                                                                                                                                                                                                                                                                                               |
| nfType              | NFType                       | M | 1           | Type of Network Function                                                                                                                                                                                                                                                                                                                                                                                                                                                                                                                                          |
| nfStatus            | NFStatus                     | M | 1           | Status of the NF Instance                                                                                                                                                                                                                                                                                                                                                                                                                                                                                                                                         |
| collocatedInstances | array(Collocated NfInstance) | O | 1..N        | Information related collocated NF type(s) and corresponding NF Instance(s) when the NF is collocated with NFs supporting other NF types                                                                                                                                                                                                                                                                                                                                                                                                                           |
| nfInstanceName      | string                       | O | 0..1        | Human readable name of the NF Instance                                                                                                                                                                                                                                                                                                                                                                                                                                                                                                                            |
| plmnList            | array(PlmnId)                | C | 1..N        | PLMN(s) of the Network Function (NOTE 5). This IE shall be present if this information is available for the NF. If this information was not provided by the NF during registration, the NRF should return the list of PLMN ID(s) of the PLMN of the NRF. If this IE is absent in the response, PLMN ID(s) of the PLMN of the NRF are assumed for the NF.                                                                                                                                                                                                          |
| sNssais             | array(ExtSnsai)              | O | 1..N        | S-NSSAIs of the Network Function.<br>If not provided, and if the perPlmnSnsaiList attribute is not present, the NF can serve any S-NSSAI.<br>If the sNssais attribute is provided in at least one NF Service, the sNssais attribute in the NF Profile shall be present and be the set or a superset of the sNssais of the NFService(s).                                                                                                                                                                                                                           |
| perPlmnSnsaiList    | array(PlmnSnsai)             | O | 1..N        | The per-PLMN list of S-NSSAI(s) supported by the Network Function.<br>If the perPlmnSnsaiList attribute is provided in at least one NF Service, the perPlmnSnsaiList attribute in the NF Profile shall be present and be the set or a superset of the perPlmnSnsaiList of the NFService(s).                                                                                                                                                                                                                                                                       |
| nsiList             | array(string)                | O | 1..N        | List of NSIs of the Network Function.<br>If not provided, the NF can serve any NSI.                                                                                                                                                                                                                                                                                                                                                                                                                                                                               |
| fqdn                | Fqdn                         | C | 0..1        | FQDN of the Network Function (NOTE 1, NOTE 3, NOTE 11)                                                                                                                                                                                                                                                                                                                                                                                                                                                                                                            |
| interPlmnFqdn       | Fqdn                         | C | 0..1        | If the requester-plmn-list query parameter is absent in the NF Discovery request, or if is present and the requester's PLMN is the same as the PLMN of the discovered NF, then this attribute shall be included by the NRF and it shall contain the interPlmnFqdn value registered by the NF during NF registration (see clause 6.1.6.2.2), if the interPlmnFqdn attribute was registered in the NF profile.<br>This attribute shall be absent if the requester-plmn in the query parameter is different from the PLMN of the discovered NF.<br>(NOTE 3, NOTE 14) |
| ipv4Addresses       | array(Ipv4Addr)              | C | 1..N        | IPv4 address(es) of the Network Function (NOTE 1, NOTE 11)                                                                                                                                                                                                                                                                                                                                                                                                                                                                                                        |
| ipv6Addresses       | array(Ipv6Addr)              | C | 1..N        | IPv6 address(es) of the Network Function (NOTE 1, NOTE 11)                                                                                                                                                                                                                                                                                                                                                                                                                                                                                                        |
| capacity            | integer                      | O | 0..1        | Static capacity information within the range 0 to 65535, expressed as a weight relative to other NF instances of the same type; if capacity is also present in the nfServiceList parameters, those will have precedence over this value. (See NOTE 2)                                                                                                                                                                                                                                                                                                             |
| load                | integer                      | O | 0..1        | Latest known load information of the NF within the range 0 to 100 in percentage (See NOTE 4)                                                                                                                                                                                                                                                                                                                                                                                                                                                                      |
| loadTimeStamp       | DateTime                     | O | 0..1        | It indicates the point in time in which the latest load information of the NF Instance was sent from the NF to the NRF.                                                                                                                                                                                                                                                                                                                                                                                                                                           |
| locality            | string                       | O | 0..1        | Operator defined information about the location of the NF instance (e.g. geographic location, data center)                                                                                                                                                                                                                                                                                                                                                                                                                                                        |

|              |               |   |      |                                                                                                                                                                                                                                                                                                                                                                                                                                                                                                                                   |
|--------------|---------------|---|------|-----------------------------------------------------------------------------------------------------------------------------------------------------------------------------------------------------------------------------------------------------------------------------------------------------------------------------------------------------------------------------------------------------------------------------------------------------------------------------------------------------------------------------------|
| priority     | integer       | O | 0..1 | <p>Priority (relative to other NFs of the same type) within the range 0 to 65535, to be used for NF selection; lower values indicate a higher priority. Priority may or may not be present in the nfServiceList parameters, xxxInfo parameters and in this attribute. Priority in the nfServiceList has precedence over the priority in this attribute. (NOTE 2)</p> <p>Priority in xxxInfo parameter shall only be used to determine the relative priority among NF instances with the same priority at NFProfile/NFService.</p> |
| udrInfo      | UdrInfo       | O | 0..1 | Specific data for the UDR (ranges of SUPI, ...)                                                                                                                                                                                                                                                                                                                                                                                                                                                                                   |
| udrInfoList  | map(UdrInfo)  | O | 1..N | <p>Multiple entries of UdrInfo. This attribute provides additional information to the udrInfo. udrInfoList may be present even if the udrInfo is absent.</p> <p>The key of the map shall be a (unique) valid JSON string per clause 7 of IETF RFC 8259 [22], with a maximum of 32 characters.</p>                                                                                                                                                                                                                                 |
| udmInfo      | UdmInfo       | O | 0..1 | Specific data for the UDM                                                                                                                                                                                                                                                                                                                                                                                                                                                                                                         |
| udmInfoList  | map(UdmInfo)  | O | 1..N | <p>Multiple entries of UdmInfo. This attribute provides additional information to the udmInfo. udmInfoList may be present even if the udmInfo is absent.</p> <p>The key of the map shall be a (unique) valid JSON string per clause 7 of IETF RFC 8259 [22], with a maximum of 32 characters.</p>                                                                                                                                                                                                                                 |
| ausfInfo     | AusfInfo      | O | 0..1 | Specific data for the AUSF                                                                                                                                                                                                                                                                                                                                                                                                                                                                                                        |
| ausfInfoList | map(AusfInfo) | O | 1..N | <p>Multiple entries of AusfInfo. This attribute provides additional information to the ausfInfo. ausfInfoList may be present even if the ausfInfo is absent.</p> <p>The key of the map shall be a (unique) valid JSON string per clause 7 of IETF RFC 8259 [22], with a maximum of 32 characters.</p>                                                                                                                                                                                                                             |
| amfInfo      | AmfInfo       | O | 0..1 | Specific data for the AMF (AMF Set ID, ...)                                                                                                                                                                                                                                                                                                                                                                                                                                                                                       |
| amfInfoList  | map(AmfInfo)  | O | 1..N | <p>Multiple entries of AmfInfo. This attribute provides additional information to the amfInfo. amfInfoList may be present even if the amfInfo is absent.</p> <p>The key of the map shall be a (unique) valid JSON string per clause 7 of IETF RFC 8259 [22], with a maximum of 32 characters.</p>                                                                                                                                                                                                                                 |
| smfInfo      | SmfInfo       | O | 0..1 | Specific data for the SMF (DNN's, ...). (NOTE 8)                                                                                                                                                                                                                                                                                                                                                                                                                                                                                  |
| smfInfoList  | map(SmfInfo)  | O | 1..N | <p>Multiple entries of SmfInfo. This attribute provides additional information to the smfInfo. smfInfoList may be present even if the smfInfo is absent.</p> <p>The key of the map shall be a (unique) valid JSON string per clause 7 of IETF RFC 8259 [22], with a maximum of 32 characters. (NOTE 8)</p>                                                                                                                                                                                                                        |
| upfInfo      | UpfInfo       | O | 0..1 | Specific data for the UPF (S-NSSAI, DNN, SMF serving area, ...)                                                                                                                                                                                                                                                                                                                                                                                                                                                                   |
| upfInfoList  | map(UpfInfo)  | O | 1..N | <p>Multiple entries of UpfInfo. This attribute provides additional information to the upfInfo. upfInfoList may be present even if the upfInfo is absent.</p> <p>The key of the map shall be a (unique) valid JSON string per clause 7 of IETF RFC 8259 [22], with a maximum of 32 characters.</p>                                                                                                                                                                                                                                 |
| pcfInfo      | PcfInfo       | O | 0..1 | Specific data for the PCF                                                                                                                                                                                                                                                                                                                                                                                                                                                                                                         |
| pcfInfoList  | map(PcfInfo)  | O | 1..N | <p>Multiple entries of PcfInfo. This attribute provides additional information to the pcfInfo. pcfInfoList may be present even if the pcfInfo is absent.</p> <p>The key of the map shall be a (unique) valid JSON string per clause 7 of IETF RFC 8259 [22], with a maximum of 32 characters.</p>                                                                                                                                                                                                                                 |
| bsfInfo      | BsfInfo       | O | 0..1 | Specific data for the BSF                                                                                                                                                                                                                                                                                                                                                                                                                                                                                                         |

|                                  |                                        |   |      |                                                                                                                                                                                                                                                                                                                                                                                                                                                                                                                                                                               |
|----------------------------------|----------------------------------------|---|------|-------------------------------------------------------------------------------------------------------------------------------------------------------------------------------------------------------------------------------------------------------------------------------------------------------------------------------------------------------------------------------------------------------------------------------------------------------------------------------------------------------------------------------------------------------------------------------|
| bsfInfoList                      | map(BsfInfo)                           | O | 1..N | Multiple entries of BsfInfo. This attribute provides additional information to the bsfInfo. bsfInfoList may be present even if the bsfInfo is absent. The key of the map shall be a (unique) valid JSON string per clause 7 of IETF RFC 8259 [22], with a maximum of 32 characters.                                                                                                                                                                                                                                                                                           |
| chfInfo                          | ChfInfo                                | O | 0..1 | Specific data for the CHF                                                                                                                                                                                                                                                                                                                                                                                                                                                                                                                                                     |
| chfInfoList                      | map(ChfInfo)                           | O | 1..N | Multiple entries of ChfInfo. This attribute provides additional information to the chfInfo. chfInfoList may be present even if the chfInfo is absent. The key of the map shall be a (unique) valid JSON string per clause 7 of IETF RFC 8259 [22], with a maximum of 32 characters.                                                                                                                                                                                                                                                                                           |
| udsInfo                          | UdsInfo                                | O | 0..1 | Specific data for the UDSF                                                                                                                                                                                                                                                                                                                                                                                                                                                                                                                                                    |
| udsInfoList                      | map(UdsInfo)                           | O | 1..N | Multiple entries of udsInfo. This attribute provides additional information to the udsInfo. udsInfoList may be present even if the udsInfo is absent. The key of the map shall be a (unique) valid JSON string per clause 7 of IETF RFC 8259 [22], with a maximum of 32 characters.                                                                                                                                                                                                                                                                                           |
| nefInfo                          | NefInfo                                | O | 0..1 | Specific data for the NEF                                                                                                                                                                                                                                                                                                                                                                                                                                                                                                                                                     |
| nwdafInfo                        | NwdafInfo                              | O | 0..1 | Specific data for the NWDAF                                                                                                                                                                                                                                                                                                                                                                                                                                                                                                                                                   |
| nwdafInfoList                    | map(NwdafInfo)                         | O | 1..N | Multiple entries of nwdafInfo. This attribute provides additional information to the nwdafInfo. nwdafInfoList may be present even if the nwdafInfo is absent. The key of the map shall be a (unique) valid JSON string per clause 7 of IETF RFC 8259 [22], with a maximum of 32 characters.                                                                                                                                                                                                                                                                                   |
| pcscfInfoList                    | map(PcscfInfo)                         | O | 1..N | Specific data for the P-CSCF.<br>The key of the map shall be a (unique) valid JSON string per clause 7 of IETF RFC 8259 [22], with a maximum of 32 characters.<br>(NOTE 7)                                                                                                                                                                                                                                                                                                                                                                                                    |
| hssInfoList                      | map(HssInfo)                           | O | 1..N | Specific data for the HSS.<br>The key of the map shall be a (unique) valid JSON string per clause 7 of IETF RFC 8259 [22], with a maximum of 32 characters.                                                                                                                                                                                                                                                                                                                                                                                                                   |
| customInfo                       | object                                 | O | 0..1 | Specific data for custom Network Functions                                                                                                                                                                                                                                                                                                                                                                                                                                                                                                                                    |
| recoveryTime                     | DateTime                               | O | 0..1 | Timestamp when the NF was (re)started                                                                                                                                                                                                                                                                                                                                                                                                                                                                                                                                         |
| nfServicePersistence             | boolean                                | O | 0..1 | - true: If present, and set to true, it indicates that the different service instances of a same NF Service in the NF instance, supporting a same API version, are capable to persist their resource state in shared storage and therefore these resources are available after a new NF service instance supporting the same API version is selected by a NF Service Consumer (see 3GPP TS 23.527 [27]).<br><br>- false (default): Otherwise, it indicates that the NF Service Instances of a same NF Service are not capable to share resource state inside the NF Instance. |
| nfServices                       | array(NFService)                       | O | 1..N | List of NF Service Instances.<br>(NOTE 10)<br><br>This attribute is deprecated; the attribute "nfServiceList" should be used instead.                                                                                                                                                                                                                                                                                                                                                                                                                                         |
| nfServiceList                    | map(NFService)                         | O | 1..N | Map of NF Service Instances, where the "serviceInstanceid" attribute of the NFService object shall be used as the key of the map.<br>(NOTE 10)                                                                                                                                                                                                                                                                                                                                                                                                                                |
| defaultNotificationSubscriptions | array(DefaultNotificationSubscription) | O | 1..N | Notification endpoints for different notification types.<br>(NOTE 6)<br>(See also NOTE 10 in clause 6.1.6.2.2)                                                                                                                                                                                                                                                                                                                                                                                                                                                                |
| lmfInfo                          | LmfInfo                                | O | 0..1 | Specific data for the LMF                                                                                                                                                                                                                                                                                                                                                                                                                                                                                                                                                     |
| gmlcInfo                         | GmlcInfo                               | O | 0..1 | Specific data for the GMLC                                                                                                                                                                                                                                                                                                                                                                                                                                                                                                                                                    |

|                                 |                                   |   |            |                                                                                                                                                                                                                                                                                                                                                                                                                                              |
|---------------------------------|-----------------------------------|---|------------|----------------------------------------------------------------------------------------------------------------------------------------------------------------------------------------------------------------------------------------------------------------------------------------------------------------------------------------------------------------------------------------------------------------------------------------------|
| snpnList                        | array(PlmnIdNid)                  | C | 1..N       | SNPN(s) of the Network Function.<br>This IE shall be present if the NF pertains to one or more SNPNs.                                                                                                                                                                                                                                                                                                                                        |
| nfSetIdList                     | array(NfSetId)                    | C | 1..N       | NF Set ID defined in clause 28.12 of 3GPP TS 23.003 [12].<br>At most one NF Set ID shall be indicated per PLMN-ID or SNPN of the NF.<br>This information shall be present if available.                                                                                                                                                                                                                                                      |
| servingScope                    | array(string)                     | O | 1..N       | The served area(s) of the NF instance.<br>The absence of this attribute does not imply the NF instance can serve every area.                                                                                                                                                                                                                                                                                                                 |
| lcHSupportInd                   | boolean                           | O | 0..1       | This IE indicates whether the NF supports Load Control based on LCI Header (see clause 6.3 of 3GPP TS 29.500 [4]).<br>- true: the NF supports the feature.<br>- false (default): the NF does not support the feature.                                                                                                                                                                                                                        |
| olcHSupportInd                  | boolean                           | O | 0..1       | This IE indicates whether the NF supports Overload Control based on OCI Header (see clause 6.4 of 3GPP TS 29.500 [4]).<br>- true: the NF supports the feature.<br>- false (default): the NF does not support the feature.                                                                                                                                                                                                                    |
| nfSetRecoveryTimeList           | map(DateTime)                     | O | 1..N       | Map of recovery time, where the key of the map is the NfSetId of NF Set(s) that the NF instance belongs to.<br><br>When present, the value of each entry of the map shall be the recovery time of the NF Set indicated by the key.                                                                                                                                                                                                           |
| serviceSetRecoveryTimeList      | map(DateTime)                     | O | 1..N       | Map of recovery time, where the key of the map is the NfServiceSetId of the NF Service Set(s) configured in the NF instance.<br><br>When present, the value of each entry of the map shall be the recovery time of the NF Service Set indicated by the key.                                                                                                                                                                                  |
| scpDomains                      | array(string)                     | O | 1..N       | When present, this IE shall carry the list of SCP domains the SCP belongs to, or the SCP domain the NF (other than SCP) or the SEPP belongs to.<br>(NOTE 9)                                                                                                                                                                                                                                                                                  |
| scplInfo                        | ScplInfo                          | O | 0..1       | Specific data for the SCP.                                                                                                                                                                                                                                                                                                                                                                                                                   |
| seppInfo                        | SeppInfo                          | O | 0..1       | Specific data for the SEPP.                                                                                                                                                                                                                                                                                                                                                                                                                  |
| vendorId                        | VendorId                          | O | 0..1       | Vendor ID of the NF instance, according to the IANA-assigned "SMI Network Management Private Enterprise Codes" [38].                                                                                                                                                                                                                                                                                                                         |
| supportedVendorSpecificFeatures | map(array(VendorSpecificFeature)) | O | 1..N(1..M) | Map of Vendor-Specific features, where the key of the map is the IANA-assigned "SMI Network Management Private Enterprise Codes" [38]. The string used as key of the map shall contain 6 decimal digits; if the SMI code has less than 6 digits, it shall be padded with leading digits "0" to complete a 6-digit string value.<br>The value of each entry of the map shall be a list (array) of VendorSpecificFeature objects.<br>(NOTE 12) |
| aanfInfoList                    | map(AanfInfo)                     | O | 1..N       | Specific data for the AANF.<br>The key of the map shall be a (unique) valid JSON string per clause 7 of IETF RFC 8259 [22], with a maximum of 32 characters.                                                                                                                                                                                                                                                                                 |
| mfaInfo                         | MfaInfo                           | O | 0..1       | Specific data for the MFAF.                                                                                                                                                                                                                                                                                                                                                                                                                  |
| easdfInfoList                   | map(EasdfInfo)                    | O | 1..N       | Specific data for the EASDF.<br>The key of the map shall be a (unique) valid JSON string per clause 7 of IETF RFC 8259 [22], with a maximum of 32 characters.<br>(NOTE 13)                                                                                                                                                                                                                                                                   |
| dccfInfo                        | DccfInfo                          | O | 0..1       | Specific data for the DCCF.                                                                                                                                                                                                                                                                                                                                                                                                                  |

|               |                |   |      |                                                                                                                                                                                                                                                             |
|---------------|----------------|---|------|-------------------------------------------------------------------------------------------------------------------------------------------------------------------------------------------------------------------------------------------------------------|
| nsacfInfoList | map(NsacfInfo) | O | 1..N | Specific data for the NSACF.<br>The key of the map shall be a (unique) valid JSON string per clause 7 of IETF RFC 8259 [22], with a maximum of 32 characters.                                                                                               |
| mbSmfInfoList | map(MbSmfInfo) | O | 1..N | MB-SMF specific data.<br>The key of the map shall be a (unique) valid JSON string per clause 7 of IETF RFC 8259 [22], with a maximum of 32 characters.                                                                                                      |
| tsctsInfoList | map(TsctsInfo) | O | 1..N | Specific data for the TSCTS.<br>The key of the map shall be a (unique) valid JSON string per clause 7 of IETF RFC 8259 [22], with a maximum of 32 characters.                                                                                               |
| mbUpfInfoList | map(MbUpfInfo) | O | 1..N | MB-UPF specific data.<br><br>The key of the map shall be a (unique) valid JSON string per clause 7 of IETF RFC 8259 [22], with a maximum of 32 characters.                                                                                                  |
| trustAfInfo   | TrustAfInfo    | O | 0..1 | Specific data for the trusted AF.                                                                                                                                                                                                                           |
| nssaafInfo    | NssaafInfo     | O | 0..1 | Specific data for the NSSAAF.                                                                                                                                                                                                                               |
| hniList       | array(Fqdn)    | C | 1..N | Identifications of Credentials Holder or Default Credentials Server.<br>This IE shall be present if the NFs are available for the case of access to an SNPN using credentials owned by a Credentials Holder or for the case of SNPN Onboarding using a DCS. |
| iwmscInfo     | IwmscInfo      | O | 0..1 | Specific data for the SMS-IWMSC.                                                                                                                                                                                                                            |
| mnpfInfo      | MnpfInfo       | O | 0..1 | Specific data for the MNPf.                                                                                                                                                                                                                                 |

- NOTE 1: At least one of the addressing parameters (fqdn, ipv4address or ipv6address) shall be included in the NF Profile. See NOTE 1 of Table 6.2.6.2.4-1 for the use of these parameters. If multiple ipv4 addresses and/or ipv6 addresses are included in the NF Profile, the NF Service Consumer shall select one of these addresses randomly, unless operator defined local policy of IP address selection, in order to avoid overload for a specific ipv4 address and/or ipv6 address.
- NOTE 2: The capacity and priority parameters, if present, are used for NF selection and load balancing. The priority and capacity attributes shall be used for NF selection in the same way that priority and weight are used for server selection as defined in IETF RFC 2782 [23].
- NOTE 3: If the requester-plmn in the query parameter is different from the PLMN of the discovered NF, then the fqdn attribute value shall contain the interPlmnFqdn value registered by the NF during NF registration (see clause 6.1.6.2.2). The requester-plmn is different from the PLMN of the discovered NF if it belongs to none of the PLMN ID(s) configured for the PLMN of the NRF.
- NOTE 4: The usage of the load parameter by the NF service consumer is implementation specific, e.g. be used for NF selection and load balancing, together with other parameters.
- NOTE 5: An NF may register multiple PLMN IDs in its profile within a PLMN comprising multiple PLMN IDs. If so, all the attributes of the NF Profile shall apply to each PLMN ID registered in the plmnList. As an exception, attributes including a PLMN ID, e.g. IMSI-based SUPI ranges, TAIs and GUAMIs, are specific to one PLMN ID and the NF may register in its profile multiple occurrences of such attributes for different PLMN IDs (e.g. the UDM may register in its profile SUPI ranges for different PLMN IDs).
- NOTE 6: For notification types that may be associated with a specific service of the NF Instance receiving the notification (see clause 6.1.6.3.4), if notification endpoints are present both in the profile of the NF instance (NFProfile) and in some of its NF Services (NFService) for a same notification type, the notification endpoint(s) of the NF Services shall be used for this notification type.
- NOTE 7: The absence of the pcscfInfoList attribute in a P-CSCF profile indicates that the P-CSCF can be selected for any DNN and Access Type, and that the P-CSCF Gm addressing information is the same as the addressing information registered in the fqdn, ipv4Addresses and ipv6Addresses attributes of the NF profile.
- NOTE 8: The absence of both the smfInfo and smfInfoList attributes in an SMF profile indicates that the SMF can be selected for any S-NSSAI listed in the sNssais and perPlmnSnsaiList IEs, or for any S-NSSAI if neither the sNssais IE nor the perPlmnSnsaiList IE are present, and for any DNN, TAI and access type.
- NOTE 9: If an NF (other than a SCP or SEPP) includes this information in its profile, this indicates that the services produced by this NF should be accessed preferably via an SCP from the SCP domain the NF belongs to.
- NOTE 10: If the NF Service Consumer that issued the discovery request indicated support for the "Service-Map" feature, the NRF shall return in the discovery response the list of NF Service Instances in the "nfServiceList" map attribute. Otherwise, the NRF shall return the list of NF Service Instances in the "nfServices" array attribute.
- NOTE 11: For API URIs constructed with an FQDN, the NF Service Consumer may use the FQDN of the target URI to do a DNS query and obtain the IP address(es) to setup the TCP connection, and ignore the IP addresses that may be present in the NFProfile; alternatively, the NF Service Consumer may use those IP addresses to setup the TCP connection, if no service-specific FQDN or IP address is provided in the NFService data and if the NF Service Consumer supports to indicate specific IP address(es) to establish an HTTP/2 connection with an FQDN in the target URI.
- NOTE 12: When present, this attribute allows an NF requesting NF Discovery (e.g. an NF Service Consumer) to determine which vendor-specific extensions are supported in a given NF (e.g. an NF Service Producer), so as to select an appropriate NF with specific capability, or to include or not the vendor-specific attributes (see 3GPP TS 29.500 [4] clause 6.6.3) required for a given feature in subsequent messages towards a certain NF. One given vendor-specific feature shall not appear in both NF Profile and NF Service Profile. If one vendor-specific feature is service related, it shall only be included in the NF Service Profile.
- NOTE 13: The absence of the easdfInfoList attributes in an EASDF profile indicates that the EASDF can be selected for any S-NSSAI, DNN, DNAI or PSA UPF N6 IP address.
- NOTE 14: This attribute may be used by the requester NF or SCP e.g. to build the authority of the Location header in 3xx response or to set the 3gpp-Sbi-apiRoot header in a response message (see clause 6.10.4 of 3GPP TS 29.500 [4]), when the NF redirects a request issued by a consumer from a different PLMN towards the discovered NF, or when the SCP has reselected the discovered NF for such a request.



6.2.6.2.4 Type: NFService

**Table 6.2.6.2.4-1: Definition of type NFService**

| Attribute name                   | Data type                              | P | Cardinality | Description                                                                                                                                                                                                                                                                                                                                                                                                                                                                                                                                                                                                   |
|----------------------------------|----------------------------------------|---|-------------|---------------------------------------------------------------------------------------------------------------------------------------------------------------------------------------------------------------------------------------------------------------------------------------------------------------------------------------------------------------------------------------------------------------------------------------------------------------------------------------------------------------------------------------------------------------------------------------------------------------|
| serviceInstanceid                | string                                 | M | 1           | Unique ID of the service instance within a given NF Instance                                                                                                                                                                                                                                                                                                                                                                                                                                                                                                                                                  |
| serviceName                      | ServiceName                            | M | 1           | Name of the service instance (e.g. "udm-sdm")                                                                                                                                                                                                                                                                                                                                                                                                                                                                                                                                                                 |
| versions                         | array(NFServiceVersion)                | M | 1..N        | The API versions supported by the NF Service and if available, the corresponding retirement date of the NF Service.<br>The different array elements shall have distinct unique values for "apiVersionInUri", and consequently, the values of "apiFullVersion" shall have a unique first digit version number.                                                                                                                                                                                                                                                                                                 |
| scheme                           | UriScheme                              | M | 1           | URI scheme (e.g. "http", "https")                                                                                                                                                                                                                                                                                                                                                                                                                                                                                                                                                                             |
| nfServiceStatus                  | NFServiceStatus                        | M | 1           | Status of the NF Service Instance                                                                                                                                                                                                                                                                                                                                                                                                                                                                                                                                                                             |
| fqdn                             | Fqdn                                   | O | 0..1        | FQDN of the NF Service Instance (see NOTE 1, NOTE 3, NOTE 9).<br>The FQDN provided as part of the NFService information has precedence over the FQDN and IP addresses provided as part of the NFProfile information (see clause 6.1.6.2.2).                                                                                                                                                                                                                                                                                                                                                                   |
| interPlmnFqdn                    | Fqdn                                   | C | 0..1        | If the requester-plmn-list query parameter is absent in the NF Discovery request, or if is present and the requester's PLMN is the same as the PLMN of the discovered NF Service, then this attribute shall be included by the NRF and it shall contain the interPlmnFqdn value registered for the NF Service during NF registration (see clause 6.1.6.2.3), if the interPlmnFqdn attribute was registered for the NF Service in the NF profile.<br>This attribute shall be absent if the requester-plmn in the query parameter is different from the PLMN of the discovered NF Service.<br>(NOTE 3, NOTE 10) |
| ipEndPoints                      | array(IpEndPoint)                      | O | 1..N        | IP address(es) and port information of the Network Function (including IPv4 and/or IPv6 address) where the service is listening for incoming service requests (see NOTE 1, NOTE 5, NOTE 6, NOTE 9).<br>IP addresses provided in ipEndPoints have precedence over IP addresses provided as part of the NFProfile information and, when using the HTTP scheme, over FQDN provided as part of the NFProfile information (see clause 6.2.6.2.3).                                                                                                                                                                  |
| apiPrefix                        | string                                 | O | 0..1        | Optional path segment(s) used to construct the {apiRoot} variable of the different API URIs, as described in 3GPP TS 29.501 [5], clause 4.4.1 (optional deployment-specific string that starts with a "/" character)                                                                                                                                                                                                                                                                                                                                                                                          |
| defaultNotificationSubscriptions | array(DefaultNotificationSubscription) | O | 1..N        | Notification endpoints for different notification types.<br>(See also NOTE 10 in clause 6.1.6.2.2)                                                                                                                                                                                                                                                                                                                                                                                                                                                                                                            |
| capacity                         | integer                                | O | 0..1        | Static capacity information within the range 0 to 65535, expressed as a weight relative to other services of the same type. (See NOTE 2)                                                                                                                                                                                                                                                                                                                                                                                                                                                                      |
| load                             | integer                                | O | 0..1        | Latest known load information of the NF Service, within the range 0 to 100 in percentage. (See NOTE 4)                                                                                                                                                                                                                                                                                                                                                                                                                                                                                                        |
| loadTimeStamp                    | DateTime                               | O | 0..1        | It indicates the point in time in which the latest load information of the NF Service Instance was sent from the NF to the NRF.                                                                                                                                                                                                                                                                                                                                                                                                                                                                               |
| priority                         | integer                                | O | 0..1        | Priority (relative to other services of the same type) within the range 0 to 65535, to be used for NF Service selection; lower values indicate a higher priority. (See NOTE 2)                                                                                                                                                                                                                                                                                                                                                                                                                                |
| recoveryTime                     | DateTime                               | O | 0..1        | Timestamp when the NF service was (re)started                                                                                                                                                                                                                                                                                                                                                                                                                                                                                                                                                                 |
| supportedFeatures                | SupportedFeatures                      | O | 0..1        | Supported Features of the NF Service instance                                                                                                                                                                                                                                                                                                                                                                                                                                                                                                                                                                 |
| nfServiceSetIdList               | array(NfServiceSetId)                  | C | 1..N        | NF Service Set ID (see clause 28.13 of 3GPP TS 23.003 [12])<br>At most one NF Service Set ID shall be indicated per PLMN-ID or SNPN of the NF.<br>This information shall be present if available.                                                                                                                                                                                                                                                                                                                                                                                                             |

|                                 |                                   |   |            |                                                                                                                                                                                                                                                                                                                                                                                                                                                                                                                                                                                          |
|---------------------------------|-----------------------------------|---|------------|------------------------------------------------------------------------------------------------------------------------------------------------------------------------------------------------------------------------------------------------------------------------------------------------------------------------------------------------------------------------------------------------------------------------------------------------------------------------------------------------------------------------------------------------------------------------------------------|
| sNssais                         | array(ExtSnsai)                   | O | 1..N       | S-NSSAIs of the NF Service. This may be a subset of the S-NSSAIs supported by the NF (see sNssais attribute in NFProfile).<br>When present, this IE represents the list of S-NSSAIs supported by the NF Service in all the PLMNs listed in the plmnList IE.                                                                                                                                                                                                                                                                                                                              |
| perPlmnSnsaiList                | array(PlmnSnsai)                  | O | 1..N       | S-NSSAIs of the NF Service per PLMN. This may be a subset of the S-NSSAIs supported per PLMN by the NF (see perPlmnSnsaiList attribute in NFProfile).<br><br>This IE may be included when the list of S-NSSAIs supported by the NF Service for each PLMN it is supporting is different. When present, this IE shall include the S-NSSAIs supported by the NF Service for each PLMN. When present, this IE shall override the sNssais IE.                                                                                                                                                 |
| vendorId                        | VendorId                          | O | 0..1       | Vendor ID of the NF Service instance, according to the IANA-assigned "SMI Network Management Private Enterprise Codes" [38].                                                                                                                                                                                                                                                                                                                                                                                                                                                             |
| supportedVendorSpecificFeatures | map(array(VendorSpecificFeature)) | O | 1..N(1..M) | Map of Vendor-Specific features, where the key of the map is the IANA-assigned "SMI Network Management Private Enterprise Codes" [38]. The string used as key of the map shall contain 6 decimal digits; if the SMI code has less than 6 digits, it shall be padded with leading digits "0" to complete a 6-digit string value.<br>The value of each entry of the map shall be a list (array) of VendorSpecificFeature objects.<br>(NOTE 7)                                                                                                                                              |
| oauth2Required                  | boolean                           | O | 0..1       | It indicates whether the NF Instance requires OAuth2-based authorization.<br>Absence of this IE means that the NF Service Producer has not provided any indication about its usage of OAuth2 for authorization.<br>(See NOTE 11)                                                                                                                                                                                                                                                                                                                                                         |
| allowedOperationsPerNfType      | map(array(string))                | C | 1..N(1..M) | Map of allowed operations on resources for each type of NF; the key of the map is the NF Type, and the value is an array of scopes.<br><br>The scopes shall be any of those defined in the API that defines the current service (identified by the "serviceName" attribute).<br><br>This IE should be present, if it is present in the registered NF service instance and if the map contains a key matching the requester's NF type. When present, this IE should only contain the key-value pair of the map matching the requester's NF type.<br><br>(NOTE 8)                          |
| allowedOperationsPerNfInstance  | map(array(string))                | C | 1..N(1..M) | Map of allowed operations on resources for a given NF Instance; the key of the map is the NF Instance Id, and the value is an array of scopes.<br><br>The scopes shall be any of those defined in the API that defines the current service (identified by the "serviceName" attribute).<br><br>This IE should be present, if it is present in the registered NF service instance and if the map contains a key matching the requester's NF instance ID. When present, this IE should only contain the key-value pair of the map matching the requester's NF Instance ID.<br><br>(NOTE 8) |

- NOTE 1: The NF Service Consumer shall construct the API URIs of the service using:  
 - For intra-PLMN signalling: If TLS is used, the FQDN present in the NF Service Profile, if any; otherwise, the FQDN present in the NF Profile. If TLS is not used, the FQDN should be used if the NF Service Consumer uses Indirect Communication via an SCP; the FQDN or the IP address in the ipEndPoints attribute may be used if the NF Service Consumer uses Direct Communication.  
 - For inter-PLMN signalling: the FQDN present in the NF Service Profile, if any; otherwise, the FQDN present in the NF Profile (see NOTE 3).
- NOTE 2: The capacity and priority parameters, if present, are used for service selection and load balancing. The priority and capacity attributes shall be used for NF selection in the same way that priority and weight are used for server selection as defined in IETF RFC 2782 [23].
- NOTE 3: If the requester-plmn in the query parameter is different from the PLMN of the discovered NF Service, then the fqdn attribute value, if included shall contain the interPlmnFqdn value registered by the NF Service during NF registration (see clause 6.1.6.2.3). The requester-plmn is different from the PLMN of the discovered NF Service if it belongs to none of the PLMN ID(s) configured for the PLMN of the NRF.
- NOTE 4: The usage of the load parameter by the NF service consumer is implementation specific, e.g. be used for NF service selection and load balancing, together with other parameters.
- NOTE 5: If the NF Service Consumer, based on the FQDN and IP address related attributes of the NFProfile and NFService, determines that it needs to use an FQDN to establish the HTTP connection with the NF Service Producer, it shall use such FQDN for DNS query and, in absence of any port information in the ipEndPoints attribute of the NF Service, it shall use the default HTTP port number, i.e. TCP port 80 for "http" URIs or TCP port 443 for "https" URIs as specified in IETF RFC 7540 [9] when invoking the service.
- NOTE 6: If multiple ipv4 addresses and/or ipv6 addresses are included in the NF Service, the NF Service Consumer shall select one of these addresses randomly, unless operator defined local policy of IP address selection, in order to avoid overload for a specific ipv4 address and/or ipv6 address.
- NOTE 7: When present, this attribute allows the NF requesting NF discovery (e.g. an NF Service Consumer) to determine which vendor-specific extensions are supported in a given NF (e.g. an Service Producer) in order to select an appropriate NF, or to include or not include the vendor-specific attributes (see 3GPP TS 29.500 [4] clause 6.6.3) required for a given feature in subsequent service requests towards a certain service instance of the NF Service Producer. One given vendor-specific feature shall not appear in both NF Profile and NF Service Profile. If one vendor-specific feature is service related, it shall only be included in the NF Service Profile.
- NOTE 8: These attributes are used by the NF Service Consumer in order to discover the additional scopes (resource/operation-level scopes) that might be required to invoke a certain service operation, based on the authorization information registered in NRF by the NF Service Producer in its NF profile. See also NOTE 11 of Table 6.1.6.2.3-1.
- NOTE 9: For API URIs constructed with an FQDN, the NF Service Consumer may use the FQDN in the target URI to do a DNS query and obtain the IP address(es) to setup the TCP connection, and ignore the IP addresses that may be present in the ipEndPoints attribute; alternatively, the NF Service Consumer may use those IP addresses to setup the TCP connection, if the NF Service Consumer supports to indicate specific IP address(es) to establish an HTTP/2 connection with an FQDN in the target URI.
- NOTE 10: This attribute may be used by the requester NF or SCP e.g. to build the authority of the Location header in 3xx response or to set the 3gpp-Sbi-apiRoot header in a response message (see clause 6.10.4 of 3GPP TS 29.500 [4]), when the NF redirects a request issued by a consumer from a different PLMN towards the discovered NF service, or when the SCP has reselected the discovered NF service for such a request.
- NOTE 11: If PLMN specific value is registered for the PLMN ID of the requester NF, the NRF shall set the oauth2Required attribute with the PLMN specific values (see description of perPlmnOauth2ReqList in clause 6.1.6.2.3).

6.2.6.2.5 Type: StoredSearchResult

**Table 6.2.6.2.5-1: Definition of type StoredSearchResult**

| Attribute name | Data type        | P | Cardinality | Description                                                             |
|----------------|------------------|---|-------------|-------------------------------------------------------------------------|
| nfnInstances   | array(NFProfile) | M | 0..N        | An array of NF Instances corresponding to a given stored search result. |

6.2.6.2.6 Type: PreferredSearch

**Table 6.2.6.2.6-1: Definition of type PreferredSearch**

| Attribute name                     | Data type | P | Cardinality | Description                                                                                                                                                                                                                                                                                                                                                                                        |
|------------------------------------|-----------|---|-------------|----------------------------------------------------------------------------------------------------------------------------------------------------------------------------------------------------------------------------------------------------------------------------------------------------------------------------------------------------------------------------------------------------|
| preferredTaiMatchInd               | boolean   | C | 0..1        | Indicates whether all the returned NFProfiles match or do not match the query parameter preferred-tai.<br>true: Match<br>false (default): Not Match                                                                                                                                                                                                                                                |
| preferredFullPlmnMatchInd          | boolean   | O | 0..1        | Indicates whether all the returned NFProfiles match or do not match the query parameter preferred-full-plmn.<br>true: Match<br>false (default): Not Match                                                                                                                                                                                                                                          |
| preferredApiVersionsMatchInd       | boolean   | O | 0..1        | Indicates whether the search result includes at least one NF Profile that matches all the preferred API versions indicated in the query parameter preferred-api-versions.<br><br>true: Match<br>false: Not Match                                                                                                                                                                                   |
| otherApiVersionsInd                | boolean   | O | 0..1        | This IE may be present if the preferred-api-versions query parameter is provided in the discovery request.<br><br>When present, this IE indicates whether there is at least one NF Profile with other API versions, i.e. that does not match all the preferred API versions indicated in the preferred-api-versions, returned in the response or not.<br><br>true: Returned<br>false: Not returned |
| preferredLocalityMatchInd          | boolean   | O | 0..1        | Indicates whether the search result includes at least one NFProfile that match the query parameter preferred-locality.<br><br>true: Match<br>false (default): Not Match                                                                                                                                                                                                                            |
| otherLocalityInd                   | boolean   | O | 0..1        | This IE may be present if preferred-locality query parameter is provided in the discovery request.<br><br>When present, this IE indicates whether there is at least one NFProfile with another locality, i.e. not matching the preferred-locality, returned in the response or not.<br><br>true: Returned<br>false (default): Not returned                                                         |
| preferredVendorSpecificFeaturesInd | boolean   | O | 0..1        | Indicates whether all the returned NFProfiles match (or do not match) the query parameter preferred-vendor-specific-features (i.e. whether they support all the preferred vendor-specific-features).<br>true: Match<br>false (default): Not Match                                                                                                                                                  |
| preferredCollocatedNFTypeInd       | boolean   | O | 0..1        | Indicates whether all the returned NFProfiles match (or do not match) the query parameter preferred-collocated-nf-types.<br>true: Match<br>false (default): Not Match                                                                                                                                                                                                                              |
| preferredPgwMatchInd               | boolean   | O | 0..1        | This IE may be present if preferred-pgw-ind query parameter is provided in the discovery request.<br><br>When present, this IE shall indicate whether all the returned NFProfiles match or do not match the query parameter preferred-pgw-ind.<br>true: Match<br>false: Not Match                                                                                                                  |

|                                                                                                                                                                                                                                                                                                                                                                                                                                                                                                                                                                                                  |         |   |      |                                                                                                                                                                                                                                                                                                                |
|--------------------------------------------------------------------------------------------------------------------------------------------------------------------------------------------------------------------------------------------------------------------------------------------------------------------------------------------------------------------------------------------------------------------------------------------------------------------------------------------------------------------------------------------------------------------------------------------------|---------|---|------|----------------------------------------------------------------------------------------------------------------------------------------------------------------------------------------------------------------------------------------------------------------------------------------------------------------|
| preferredAnalyticsDelaySnd                                                                                                                                                                                                                                                                                                                                                                                                                                                                                                                                                                       | boolean | C | 0..1 | <p>This IE shall be present if preferred-analytics-delays query parameter is provided in the discovery request.</p> <p>When present, this IE shall indicate whether all the returned NFProfiles match or do not match the query parameter preferred-analytics-delays.<br/>true: Match<br/>false: Not Match</p> |
| <p><b>NOTE:</b> The PreferredSearch data type is used to encode the preferredSearch IE in SearchResult (see clause 6.2.6.2.2) and the preferredSearch IE in the NfInstanceInfo data type (see clause 6.2.6.2.7). The description of the IEs in the PreferredSearch data type is provided for the first case. For the latter case, these IEs shall be interpreted as indicating whether the NF profile of the NF instance ID returned in the nfInstanceList IE of SearchResult matches the preference parameters, and the otherApiVersionsInd IE and the otherLocalityInd IE shall be absent.</p> |         |   |      |                                                                                                                                                                                                                                                                                                                |

## 6.2.6.2.7 Type: NfInstanceInfo

Table 6.2.6.2.7-1: Definition of type NfInstanceInfo

| Attribute name                                                                                                                                                                                                                                            | Data type       | P | Cardinality | Description                                                                                                                                                                                                                                                                                                                               |
|-----------------------------------------------------------------------------------------------------------------------------------------------------------------------------------------------------------------------------------------------------------|-----------------|---|-------------|-------------------------------------------------------------------------------------------------------------------------------------------------------------------------------------------------------------------------------------------------------------------------------------------------------------------------------------------|
| nrfDiscApiUri                                                                                                                                                                                                                                             | Uri             | C | 0..1        | <p>This IE shall be present if the NRF holding the NF profile is not the NRF that received the NFDdiscover request. It may be present otherwise.</p> <p>When present, this IE shall contain the API URI of the Nrf_NFDdiscover service of the NRF holding the NF profile. The API URI shall be formatted as specified in clause 6.2.1</p> |
| preferredSearch                                                                                                                                                                                                                                           | PreferredSearch | O | 0..1        | <p>This IE may be present to indicate whether the NF Profile matches the preferred query parameters, if the discovery request contains any of the query parameter defined in the PreferredSearch data type. This IE shall take precedence over the preferredSearch IE in the SearchResult, if any.</p>                                    |
| nrfAlteredPriorities                                                                                                                                                                                                                                      | map(integer)    | O | 1..N        | <p>This IE may be present if the NRF wishes to signal modified priorities for the NF instance.</p> <p>The key of the map shall be the JSON Pointer (as specified in IETF RFC 6901 [14]) of the corresponding priority IE in the NFProfile data type defined in clause 6.2.6.2.3.</p> <p>(NOTE)</p>                                        |
| <p><b>NOTE:</b> If this IE is present, the requester NF should apply the NRF altered priorities when selecting a NF service producer for the corresponding NF Discovery request, instead of the priorities retrieved in the corresponding NF profile.</p> |                 |   |             |                                                                                                                                                                                                                                                                                                                                           |

**EXAMPLE:** The following JSON object would represent an NfInstanceInfo where the NRF signals modified priorities for the NF instance, two NF service instances and two smfInfo instances.

```
{
  "nrfAlteredPriorities": {
    "/priority": 1000,
    "/nfServiceList/serviceinstance1/priority": 3000,
    "/nfServiceList/serviceinstance2/priority": 5000,
    "/smfInfo/priority": 20000,
    "/smfInfoList/abcd/priority": 15000
  }
}
```

## 6.2.6.2.8 Type: ScpDomainRoutingInformation

**Table 6.1.6.2.8-1: Definition of type ScpDomainRoutingInformation**

| Attribute name | Data type                  | P | Cardinality | Description                                                                                                                                                                                                                                                                                                          |
|----------------|----------------------------|---|-------------|----------------------------------------------------------------------------------------------------------------------------------------------------------------------------------------------------------------------------------------------------------------------------------------------------------------------|
| scpDomainList  | map(ScpDomainConnectivity) | M | 0..N        | This IE shall contain map of SCP domain interconnection information, where the key of the map is a SCP domain. The value of each entry shall be the interconnectivity information of the SCP domain indicated by the key.<br><br>An empty map indicates that there is no SCP domain currently registered in the NRF. |

EXAMPLE: The SCP Domain Routing Information is derived from the SCP domains registered by SCPs, e.g. if SCP x, SCP y and SCP z have registered in NRF with following SCP domains:

SCP x Profile includes: { "scpDomains": [ "SCP\_Domain\_1", "SCP\_Domain\_2" ] }

SCP y Profile includes: { "scpDomains": [ "SCP\_Domain\_2", "SCP\_Domain\_3" ] }

SCP z Profile includes: { "scpDomains": [ "SCP\_Domain\_4" ] }

then the SCP Domain Routing Information should be as following:

```
{
  "scpDomainList": {
    "SCP_Domain_1": { "connectedScpDomainList": [ "SCP_Domain_2" ] },
    "SCP_Domain_2": { "connectedScpDomainList": [ "SCP_Domain_1", "SCP_Domain_3" ] },
    "SCP_Domain_3": { "connectedScpDomainList": [ "SCP_Domain_2" ] },
    "SCP_Domain_4": { "connectedScpDomainList": [ ] }
  }
}
```

## 6.2.6.2.9 Type: ScpDomainConnectivity

**Table 6.2.6.2.9-1: Definition of type ScpDomainConnectivity**

| Attribute name         | Data type     | P | Cardinality | Description                                                                                                                                    |
|------------------------|---------------|---|-------------|------------------------------------------------------------------------------------------------------------------------------------------------|
| connectedScpDomainList | array(string) | M | 0..N        | This IE shall contain the list of interconnected SCP domains.<br><br>An empty array indicates there is no SCP Domain currently interconnected. |



## 6.2.6.2.10 Type: ScpDomainRoutingInfoSubscription

**Table 6.2.6.2.10-1: Definition of type ScpDomainRoutingInfoSubscription**

| Attribute name | Data type     | P | Cardinality | Description                                                                                                                                                                                                                                                                                     |
|----------------|---------------|---|-------------|-------------------------------------------------------------------------------------------------------------------------------------------------------------------------------------------------------------------------------------------------------------------------------------------------|
| callbackUri    | Uri           | M | 1           | Callback URI where the Service Consumer will receive the notifications from NRF.                                                                                                                                                                                                                |
| validityTime   | DateTime      | C | 0..1        | Time instant after which the subscription becomes invalid. This parameter may be sent by the client, as a hint to the server, but it shall be always sent back by the server (regardless of the presence of the attribute in the request) in the response to the subscription creation request. |
| reqInstancelId | NfInstancelId | O | 0..1        | If present, this IE shall contain the NF instance id of the Service consumer.                                                                                                                                                                                                                   |
| localInd       | boolean       | O | 0..1        | When present, this IE shall indicate whether changes of local SCP Domain Routing Information to be notified:<br>- true: changes of local SCP Domain Routing Information to be notified.<br>- false (default): changes of SCP Domain Routing Information to be notified                          |

## 6.2.6.2.11 Type: ScpDomainRoutingInfoNotification

**Table 6.2.6.2.11-1: Definition of type ScpDomainRoutingInfoNotification**

| Attribute name | Data type                   | P | Cardinality | Description                                                                                                                                                                                                                                                                                       |
|----------------|-----------------------------|---|-------------|---------------------------------------------------------------------------------------------------------------------------------------------------------------------------------------------------------------------------------------------------------------------------------------------------|
| routingInfo    | ScpDomainRoutingInformation | M | 1           | This IE shall contain the SCP Domain Routing Information after the change.                                                                                                                                                                                                                        |
| localInd       | boolean                     | O | 0..1        | When present, this IE shall indicate whether changes of local SCP Domain Routing Information is carried in the notification:<br>- true: changes of local SCP Domain Routing Information in the notification.<br>- false (default): changes of SCP Domain Routing Information in the notification. |

## 6.2.6.2.12 Type: NfServiceInstance

**Table 6.2.6.2.12-1: Definition of type NfServiceInstance**

| Attribute name                                                               | Data type      | P | Cardinality | Description                                                  |
|------------------------------------------------------------------------------|----------------|---|-------------|--------------------------------------------------------------|
| serviceInstancelId                                                           | string         | M | 1           | Unique ID of the service instance within a given NF Instance |
| nfInstancelId                                                                | NfInstancelId  | C | 0..1        | NF Instance ID of the NF service instance (NOTE)             |
| nfServiceSetId                                                               | NfServiceSetId | C | 0..1        | NF Service Set ID of the NF Service instance (NOTE)          |
| NOTE: Either the nfInstancelId IE or the nfServiceSetId IE shall be present. |                |   |             |                                                              |

## 6.2.6.2.13 Type: NoProfileMatchInfo

**Table 6.2.6.2.13-1: Definition of type NoProfileMatchInfo**

| Attribute name            | Data type                    | P | Cardinality | Description                                                                                                                                                                                                   |
|---------------------------|------------------------------|---|-------------|---------------------------------------------------------------------------------------------------------------------------------------------------------------------------------------------------------------|
| reason                    | NoProfileMatchReason         | M | 1           | This IE shall indicate the specific reason for not finding any NF instance that can match the search criteria.                                                                                                |
| queryParamCombinationList | array(QueryParamCombination) | O | 1..N        | This IE may be present if the reason IE is set to "QUERY_PARAMS_COMBINATION_NO_MATCH". If present each QueryParamCombination indicates that no NF Instance matching the QueryParamCombination has registered. |

## 6.2.6.2.14 Type: QueryParamCombination

**Table 6.2.6.2.14-1: Definition of type QueryParamCombination**

| Attribute name | Data type             | P | Cardinality | Description                                       |
|----------------|-----------------------|---|-------------|---------------------------------------------------|
| queryParams    | array(QueryParameter) | M | 1..N        | This IE shall contain a list of query parameters. |

## 6.2.6.2.15 Type: QueryParameter

**Table 6.2.6.2.15-1: Definition of type QueryParameter**

| Attribute name | Data type | P | Cardinality | Description                  |
|----------------|-----------|---|-------------|------------------------------|
| name           | string    | M | 1           | name of the query parameter  |
| value          | string    | M | 1           | value of the query parameter |

## 6.2.6.3 Simple data types and enumerations

## 6.2.6.3.1 Introduction

This clause defines simple data types and enumerations that can be referenced from data structures defined in the previous clauses.

## 6.2.6.3.2 Simple data types

The simple data types defined in table 6.2.6.3.2-1 shall be supported.

**Table 6.2.6.3.2-1: Simple data types**

| Type Name | Type Definition | Description |
|-----------|-----------------|-------------|
|           |                 |             |

## 6.2.6.3.3 Enumeration: NoProfileMatchReason

The enumeration NoProfileMatchReason indicates the specific reason for not finding any NF instance that can match the search criteria.

**Table 6.2.6.3.3-1: Enumeration NoProfileMatchReason**

| Enumeration value                   | Description                                                            |
|-------------------------------------|------------------------------------------------------------------------|
| "REQUESTER_PLMN_NOT_ALLOWED"        | NF profiles are not allowed to be discovered by the requester's PLMN   |
| "TARGET_NF_SUSPENDED"               | Target NF exists with NFStatus or NFServiceStatus "SUSPENDED"          |
| "TARGET_NF_UNDISCOVERABLE"          | Target NF exists with NFStatus or NFServiceStatus "UNDISCOVERABLE"     |
| "QUERY_PARAMS_COMBINATION_NO_MATCH" | No NF instance matching the Query Parameter Combination has registered |
| "UNSPECIFIED"                       | Other reasons                                                          |

## 6.2.7 Error Handling

### 6.2.7.1 General

HTTP error handling shall be supported as specified in clause 5.2.4 of 3GPP TS 29.500 [4].

### 6.2.7.2 Protocol Errors

Protocol errors handling shall be supported as specified in clause 5.2.7 of 3GPP TS 29.500 [4].

### 6.2.7.3 Application Errors

The application errors defined for the Nnrf\_NFDiscovery service are listed in Table 6.2.7.3-1.

**Table 6.2.7.3-1: Application errors**

| Application Error | HTTP status code | Description |
|-------------------|------------------|-------------|
|                   |                  |             |

## 6.2.8 Security

As indicated in clause 13.3 of 3GPP TS 33.501 [15], when static authorization is not used, the access to the Nnrf\_NFDiscovery API may be authorized by means of the OAuth2 protocol (see IETF RFC 6749 [16]), using the "Client Credentials" authorization grant, where the NRF plays the role of the authorization server.

If OAuth2 authorization is used on the Nnrf\_NFDiscovery API, an NF Service Consumer, prior to consuming services offered by the Nnrf\_NFDiscovery API, shall obtain a "token" from the authorization server, by invoking the Access Token Request service, as described in clause 5.4.2.2.

**NOTE:** When multiple NRFs are deployed in a network, the NRF used as authorization server is the same NRF where the Nnrf\_NFDiscovery service is invoked by the NF Service Consumer.

The Nnrf\_NFDiscovery API defines the following scopes for OAuth2 authorization:

**Table 6.2.8-1: OAuth2 scopes defined in Nnrf\_NFDiscovery API**

| Scope                             | Description                                                |
|-----------------------------------|------------------------------------------------------------|
| "nnrf-disc"                       | Access to the Nnrf_NFDiscovery API                         |
| "nnrf-disc:scp-domain:read"       | Access to read the scp-domain-routing-info resource        |
| "nnrf-disc:scp-domain:subs:write" | Access to create/delete a scp-domain subscription resource |

## 6.2.9 Features supported by the NFDiscovery service

The syntax of the supportedFeatures attribute is defined in clause 5.2.2 of 3GPP TS 29.571 [7].

The following features are defined for the Nnrf\_NFDiscovery service.

**Table 6.2.9-1: Features of supportedFeatures attribute used by Nnrf\_NFDiscovery service**

| Feature Number | Feature                     | M/O | Description                                                                                                                                                                                                                                                                                                                                                                                                                                                                                                                                                                                                                                                                                                                                                                   |
|----------------|-----------------------------|-----|-------------------------------------------------------------------------------------------------------------------------------------------------------------------------------------------------------------------------------------------------------------------------------------------------------------------------------------------------------------------------------------------------------------------------------------------------------------------------------------------------------------------------------------------------------------------------------------------------------------------------------------------------------------------------------------------------------------------------------------------------------------------------------|
| 1              | Complex-Query               | O   | Support of Complex Query expression (see clause 6.2.3.2.3.1)                                                                                                                                                                                                                                                                                                                                                                                                                                                                                                                                                                                                                                                                                                                  |
| 2              | Query-Params-Ext1           | O   | Support of the following query parameters:<br>- limit<br>- max-payload-size<br>- required-features<br>- pdu-session-types                                                                                                                                                                                                                                                                                                                                                                                                                                                                                                                                                                                                                                                     |
| 3              | Query-Param-Analytics       | O   | Support of the query parameters for Analytics identifier:<br>- event-id-list<br>- nwdaf-event-list                                                                                                                                                                                                                                                                                                                                                                                                                                                                                                                                                                                                                                                                            |
| 4              | MAPDU                       | O   | This feature indicates whether the NRF supports selection of UPF with ATSSS capability.                                                                                                                                                                                                                                                                                                                                                                                                                                                                                                                                                                                                                                                                                       |
| 5              | Query-Params-Ext2           | O   | Support of the following query parameters:<br>- requester-nf-instance-id<br>- upf-ue-ip-addr-ind<br>- pfd-data<br>- target-snpn<br>- af-ee-data<br>- w-agf-info<br>- tngf-info<br>- twif-info<br>- target-nf-set-id<br>- target-nf-service-set-id<br>- preferred-tai<br>- nef-id<br>- preferred-nf-instances<br>- notification-type<br>- serving-scope<br>- internal-group-identity<br>- preferred-api-versions<br>- v2x-support-ind<br>- redundant-gtpu<br>- redundant-transport<br>- lmf-id<br>- an-node-type<br>- rat-type<br>- ipups<br>- scp-domain-list<br>- address-domain<br>- ipv4-addr<br>- ipv6-prefix<br>- served-nf-set-id<br>- remote-plmn-id<br>- data-forwarding<br>- preferred-full-plmn<br>- requester-snpn-list<br>- max-payload-size-ext<br>- client-type |
| 6              | Service-Map                 | M   | This feature indicates whether it is supported to identify the list of NF Service Instances as a map (i.e. the "nfServiceList" attribute of NFProfile is supported).                                                                                                                                                                                                                                                                                                                                                                                                                                                                                                                                                                                                          |
| 7              | Query-Params-Ext3           | O   | Support of the following query parameters:<br>- ims-private-identity<br>- ims-public-identity<br>- msisdn<br>- requester-plmn-specific-snsai-list<br>- n1-msg-class<br>- n2-info-class                                                                                                                                                                                                                                                                                                                                                                                                                                                                                                                                                                                        |
| 8              | Query-Params-Ext4           | O   | Support of the following query parameters:<br>- realm-id<br>- storage-id                                                                                                                                                                                                                                                                                                                                                                                                                                                                                                                                                                                                                                                                                                      |
| 9              | Query-Param-vSmf-Capability | O   | Support of the query parameters for V-SMF Capability:<br>- vsmf-support-ind                                                                                                                                                                                                                                                                                                                                                                                                                                                                                                                                                                                                                                                                                                   |
| 10             | Enh-NF-Discovery            | O   | Enhanced NF Discovery<br>This feature indicates whether it is supported to return the nInstanceList IE in the NF Discovery response.                                                                                                                                                                                                                                                                                                                                                                                                                                                                                                                                                                                                                                          |

|    |                         |   |                                                                                                                                                                                                                                                                                                                                                                                                                                                                                                                                                                                                                                                                                                                                |
|----|-------------------------|---|--------------------------------------------------------------------------------------------------------------------------------------------------------------------------------------------------------------------------------------------------------------------------------------------------------------------------------------------------------------------------------------------------------------------------------------------------------------------------------------------------------------------------------------------------------------------------------------------------------------------------------------------------------------------------------------------------------------------------------|
| 11 | Query-SBIProtoc17       | O | Support of the following query parameters, for Service Based Interface Protocol Improvements defined in 3GPP Rel-17:<br><ul style="list-style-type: none"> <li>- preferred-vendor-specific-features</li> <li>- preferred-vendor-specific-nf-features</li> <li>- home-pub-key-id</li> <li>- pgw-ip</li> <li>- preferences-precedence</li> <li>- preferred-pgw-ind</li> <li>- v2x-capability</li> <li>- shared-data-id</li> </ul>                                                                                                                                                                                                                                                                                                |
| 12 | SCPDR1                  | O | SCP Domain Routing Information<br><br>An NRF supporting this feature shall allow a service consumer (i.e. a SCP) to get the SCP Domain Routing Information and subscribe/unsubscribe to the change of SCP Domain Routing Information with following service operations:<br><ul style="list-style-type: none"> <li>- SCPDomainRoutingInfoGet (see clause 5.3.2.3)</li> <li>- SCPDomainRoutingInfoSubscribe (see clause 5.3.2.4)</li> <li>- SCPDomainRoutingInfoUnsubscribe (see clause 5.3.2.6)</li> </ul> A service consumer (i.e. a SCP) supporting this feature shall be able to handle SCPDomainRoutingInfoNotify as specified in clause 5.3.2.5, if subscribed to the change of SCP Domain Routing Information in the NRF. |
| 13 | Query-Upf-Pfcp          | O | This feature indicates whether the NRF supports selection of UPF with required UP function features as defined in 3GPP TS 29.244 [21].                                                                                                                                                                                                                                                                                                                                                                                                                                                                                                                                                                                         |
| 14 | Query-5G-ProSe          | O | Support of the following query parameters, for Proximity based Services in 5GS defined in 3GPP Rel-17:<br><ul style="list-style-type: none"> <li>- prose-support-ind</li> <li>- prose-capability</li> </ul>                                                                                                                                                                                                                                                                                                                                                                                                                                                                                                                    |
| 15 | NSAC                    | O | This feature indicates the NSACF service capability.<br>Support of the following query parameters:<br><ul style="list-style-type: none"> <li>- nsacf-capability</li> </ul>                                                                                                                                                                                                                                                                                                                                                                                                                                                                                                                                                     |
| 16 | Query-MBS               | O | Support of the following query parameters, for Multicast and Broadcast Services defined in 3GPP Rel-17:<br><ul style="list-style-type: none"> <li>- mbs-session-id-list</li> <li>- mbsmf-serving-area</li> <li>- area-session-id</li> </ul>                                                                                                                                                                                                                                                                                                                                                                                                                                                                                    |
| 17 | Query-eNA-PH2           | O | Support of the following query parameters, for Enhanced Network Automation Phase 2 defined in 3GPP Rel-17:<br><ul style="list-style-type: none"> <li>- analytics-aggregation-ind</li> <li>- serving-nf-set-id</li> <li>- serving-nf-type</li> <li>- ml-analytics-info-list</li> <li>- analytics-metadata-prov-ind</li> </ul>                                                                                                                                                                                                                                                                                                                                                                                                   |
| 18 | Query-eLCS              | O | Support of the following query parameters, for 5G LCS service:<br><ul style="list-style-type: none"> <li>- gmlc-number</li> </ul>                                                                                                                                                                                                                                                                                                                                                                                                                                                                                                                                                                                              |
| 19 | Query-eEDGE-5GC         | O | Support of the following query parameters, for enhancement of support for Edge Computing in 5GC defined in 3GPP Rel-17:<br><ul style="list-style-type: none"> <li>- upf-n6-ip</li> <li>- tai-list</li> </ul>                                                                                                                                                                                                                                                                                                                                                                                                                                                                                                                   |
| 20 | Collocated-NF-Selection | O | Support of selecting a collocated NF supporting multiple NF types.                                                                                                                                                                                                                                                                                                                                                                                                                                                                                                                                                                                                                                                             |
| 21 | Query-ENPN              | O | Support of the following query parameter for the enhanced support of Non-Public Networks defined in 3GPP Rel-17:<br><ul style="list-style-type: none"> <li>- support-onboarding-capability</li> <li>- target-hni</li> <li>- remote-snpn-id</li> </ul>                                                                                                                                                                                                                                                                                                                                                                                                                                                                          |
| 22 | Query-ID_UAS            | O | Support of the following query parameters, for remote Identification of Unmanned Aerial Systems defined in 3GPP Rel-17:<br><ul style="list-style-type: none"> <li>- uas-nf-functionality-ind</li> </ul>                                                                                                                                                                                                                                                                                                                                                                                                                                                                                                                        |

|                                                                                                                                                                                                                                                                                                                                                                                                                                                                                                                                                                                                                                                                                                                                                                                                                                                                                  |                             |   |                                                                                                                                                                                                                                                                                                                                                          |
|----------------------------------------------------------------------------------------------------------------------------------------------------------------------------------------------------------------------------------------------------------------------------------------------------------------------------------------------------------------------------------------------------------------------------------------------------------------------------------------------------------------------------------------------------------------------------------------------------------------------------------------------------------------------------------------------------------------------------------------------------------------------------------------------------------------------------------------------------------------------------------|-----------------------------|---|----------------------------------------------------------------------------------------------------------------------------------------------------------------------------------------------------------------------------------------------------------------------------------------------------------------------------------------------------------|
| 23                                                                                                                                                                                                                                                                                                                                                                                                                                                                                                                                                                                                                                                                                                                                                                                                                                                                               | NRFSET                      | O | NRF Set feature<br><br>An NRF supporting this feature shall allow a NF Service Consumer to get the NRF Set Information and subscribe/unsubscribe to the change of NRF Set Information:<br><br>A NF Service Consumer supporting this feature shall be able to handle Notify of the NRF status change, if subscribed to the change of NRF set information. |
| 24                                                                                                                                                                                                                                                                                                                                                                                                                                                                                                                                                                                                                                                                                                                                                                                                                                                                               | Query-Nw-Resolution         | O | Support for the following query parameters:<br>- target-nw-resolution                                                                                                                                                                                                                                                                                    |
| 25                                                                                                                                                                                                                                                                                                                                                                                                                                                                                                                                                                                                                                                                                                                                                                                                                                                                               | Query-Param-iSmf-Capability | O | Support of the query parameters for I-SMF Capability:<br>- ismf-support-ind                                                                                                                                                                                                                                                                              |
| 26                                                                                                                                                                                                                                                                                                                                                                                                                                                                                                                                                                                                                                                                                                                                                                                                                                                                               | Query-SBIProtoc17-Ext1      | O | Support of the following query parameters, for Service Based Interface Protocol Improvements defined in 3GPP Rel-17:<br>- exclude-nfinst-list<br>- exclude-nfservinst-list<br>- exclude-nfserviceset-list<br>- exclude-nfset-list                                                                                                                        |
| 27                                                                                                                                                                                                                                                                                                                                                                                                                                                                                                                                                                                                                                                                                                                                                                                                                                                                               | Query-Upf-IpIndex           | O | Support of the query parameters for UPF selection with IpIndex:<br>- ipv4-index<br>- ipv6-index                                                                                                                                                                                                                                                          |
| 28                                                                                                                                                                                                                                                                                                                                                                                                                                                                                                                                                                                                                                                                                                                                                                                                                                                                               | Query-eNA-PH2-Ext1          | O | Support of the following query parameters, for extension of Enhanced Network Automation Phase 2 defined in 3GPP Rel-17:<br>- preferred-analytics-delays                                                                                                                                                                                                  |
| <p>Feature number: The order number of the feature within the supportedFeatures attribute (starting with 1).</p> <p>Feature: A short name that can be used to refer to the bit and to the feature.</p> <p>M/O: Defines if the implementation of the feature is mandatory ("M") or optional ("O").</p> <p>Description: A clear textual description of the feature.</p> <p>NOTE 1: An NRF that advertises support of a given feature shall support all the query parameters associated with the feature. An NRF may support none or a subset of the query parameters of features that it does not advertise as supported.</p> <p>NOTE 2: For a release under development, it is recommended to define new features for new query parameters by grouping them per 3GPP work item. Any definition of new query parameters in a frozen release requires a new feature definition.</p> |                             |   |                                                                                                                                                                                                                                                                                                                                                          |

## 6.3 Nnrf\_AccessToken Service API

### 6.3.1 General

This API reuses the API endpoints and input / output parameters specified in IETF RFC 6749 [16] as a custom operation without resources. Hence this clause does not follow the 3GPP API specification guidelines described in 3GPP TS 29.501 [5].

### 6.3.2 API URI

URIs of this API shall have the following root:

```
{nrfApiRoot}/oauth2
```

where {nrfApiRoot} represents the concatenation of the "scheme" and "authority" components of the NRF, as defined in IETF RFC 3986 [17].

### 6.3.3 Usage of HTTP

#### 6.3.3.1 General

HTTP/2, as defined in IETF RFC 7540 [9], shall be used as specified in clause 5 of 3GPP TS 29.500 [4].

HTTP/2 shall be transported as specified in clause 5.3 of 3GPP TS 29.500 [4].

HTTP messages and bodies this API shall comply with the OpenAPI [10] specification contained in Annex A.



### 6.3.3.2 HTTP standard headers

#### 6.3.3.2.1 General

The HTTP headers as specified in clause 4.4 of IETF RFC 6749 [16] shall be supported, with the exception that there shall not be "Authorization" HTTP request header in the access token request.

#### 6.3.3.2.2 Content type

The following content types shall be supported:

- The x-www-form-urlencoded format (see clause 17.13.4 of W3C HTML 4.01 Specification [26]). The use of the x-www-form-urlencoded format shall be signalled by the content type "application/x-www-form-urlencoded".
- The JSON format (IETF RFC 8259 [22]). The use of the JSON format shall be signalled by the content type "application/json". See also clause 5.4 of 3GPP TS 29.500 [4].

### 6.3.3.3 HTTP custom headers

#### 6.3.3.3.1 General

In this release of this specification, no custom headers specific to the OAuth2.0 Authorization Service API are defined. For 3GPP specific HTTP custom headers used across all service-based interfaces, see clause 5.2.3 of 3GPP TS 29.500 [4].

## 6.3.4 Custom Operations without associated resources

### 6.3.4.1 Overview

The /token endpoint as specified in IETF RFC 6749 [16] shall be supported. The "token endpoint" URI shall be:

{nrfApiRoot}/oauth2/token

where {nrfApiRoot} is defined in clause 6.3.2.

Table 6.3.4.1-1 provides an overview of the endpoints and applicable HTTP methods.

**Table 6.3.4.1-1: Custom operations without associated resources**

| Operation Name             | Custom operation URI | Mapped HTTP method | Description                                                                                                              |
|----------------------------|----------------------|--------------------|--------------------------------------------------------------------------------------------------------------------------|
| Get (Access Token Request) | /oauth2/token        | POST               | Access token request for obtaining OAuth2.0 access token. This operation maps to Nnrf_AccessToken_Get service operation. |

### 6.3.4.2 Operation: Get (Access Token Request)

#### 6.3.4.2.1 Description

This custom operation represents the process for issuing the OAuth2.0 access token.

#### 6.3.4.2.2 Operation Definition

This operation returns an OAuth 2.0 access token based on the input parameters provided. This custom operation shall use the HTTP POST method.

This method shall support the request data structures specified in table 6.3.4.2.2-1 and the response data structures and response codes specified in table 6.3.4.2.2-2. The data structure used for the POST request body shall be using x-www-form-urlencoded format as specified in clause 17.13.4 of W3C HTML 4.01 Specification [26].

**Table 6.3.4.2.2-1: Data structures supported by the POST Request Body on this endpoint**

| Data type      | P | Cardinality | Description                                                                                                                      |
|----------------|---|-------------|----------------------------------------------------------------------------------------------------------------------------------|
| AccessTokenReq | M | 1           | This IE shall contain the request information for the access token request.<br>Content-Type: "application/x-www-form-urlencoded" |

**Table 6.3.4.2.2-2: Data structures supported by the POST Response Body on this endpoint**

| Data type        | P | Cardinality | Response codes                    | Description                                                                                                                                                                                                                                                                                                                                                                           |
|------------------|---|-------------|-----------------------------------|---------------------------------------------------------------------------------------------------------------------------------------------------------------------------------------------------------------------------------------------------------------------------------------------------------------------------------------------------------------------------------------|
| AccessTokenRsp   | M | 1           | 200 OK                            | This IE shall contain the access token response information.                                                                                                                                                                                                                                                                                                                          |
| RedirectResponse | O | 0..1        | 307 Temporary Redirect            | The NRF shall generate a Location header field containing a URI pointing to the endpoint of another NRF service instance to which the request should be sent.<br>If an SCP redirects the message to another SCP then the location header field shall contain the same URI or a different URI pointing to the endpoint of the NF service producer to which the request should be sent. |
| RedirectResponse | O | 0..1        | 308 Permanent Redirect            | The NRF shall generate a Location header field containing a URI pointing to the endpoint of another NRF service instance to which the request should be sent.<br>If an SCP redirects the message to another SCP then the location header field shall contain the same URI or a different URI pointing to the endpoint of the NF service producer to which the request should be sent. |
| AccessTokenErr   | M | 1           | 400 Bad Request, 401 Unauthorized | See IETF RFC 6749 [16] clause 5.2.<br>The specific error shall be indicated in the "error" attribute of the AccessTokenErr data type, containing any of the values:<br>- invalid_request<br>- invalid_client<br>- invalid_grant<br>- unauthorized_client<br>- unsupported_grant_type<br>- invalid_scope                                                                               |
| ProblemDetails   | O | 0..1        | 400 Bad Request                   | This error shall only be returned by an SCP or SEPP for errors they originate.                                                                                                                                                                                                                                                                                                        |

**Table 6.3.4.2.2-3: Headers supported by the 200 Response Code on this endpoint**

| Name          | Data type | P | Cardinality | Description      |
|---------------|-----------|---|-------------|------------------|
| Cache-Control | string    | M | 1           | Enum: "no-store" |
| Pragma        | string    | M | 1           | Enum: "no-cache" |

**Table 6.3.4.2.2-4: Headers supported by the 400 Response Code on this endpoint**

| Name          | Data type | P | Cardinality | Description      |
|---------------|-----------|---|-------------|------------------|
| Cache-Control | string    | M | 1           | Enum: "no-store" |
| Pragma        | string    | M | 1           | Enum: "no-cache" |

**Table 6.3.4.2.2-5: Headers supported by the 307 Response Code on this endpoint**

| Name     | Data type | P | Cardinality | Description                                                                                    |
|----------|-----------|---|-------------|------------------------------------------------------------------------------------------------|
| Location | string    | M | 1           | A URI pointing to the endpoint of the NRF service instance to which the request should be sent |

**Table 6.3.4.2.2-6: Headers supported by the 308 Response Code on this endpoint**

| Name     | Data type | P | Cardinality | Description                                                                                    |
|----------|-----------|---|-------------|------------------------------------------------------------------------------------------------|
| Location | string    | M | 1           | A URI pointing to the endpoint of the NRF service instance to which the request should be sent |

## 6.3.5 Data Model

### 6.3.5.1 General

This clause specifies the application data model supported by the API.

Table 6.3.5.1-1 specifies the data types defined for the OAuth 2.0 Authorization Service API. The AccessTokenReq data structure shall be converted to the content type "application/x-www-form-urlencoded" when the OAuth 2.0 Access Token Request is invoked.

**Table 6.3.5.1-1: OAuth 2.0 Authorization service specific Data Types**

| Data type         | Clause defined | Description                                                       |
|-------------------|----------------|-------------------------------------------------------------------|
| AccessTokenReq    | 6.3.5.2.2      | Contains information related to the access token request.         |
| AccessTokenRsp    | 6.3.5.2.3      | Contains information related to the access token response.        |
| AccessTokenClaims | 6.3.5.2.4      | The claims data structure for the access token.                   |
| AccessTokenErr    | 6.3.5.2.5      | Contains error information returned in the access token response. |
| Audience          | 6.3.5.4.1      | Contains the audience claim of the access token.                  |

Table 6.3.5.1-2 specifies data types re-used by the OAuth 2.0 Authorization service from other specifications, including a reference to their respective specifications and when needed, a short description of their use.

**Table 6.3.5.1-2: OAuth 2.0 Authorization service re-used Data Types**

| Data type        | Reference          | Comments                                            |
|------------------|--------------------|-----------------------------------------------------|
| NfInstanceId     | 3GPP TS 29.571 [7] |                                                     |
| PlmnId           | 3GPP TS 29.571 [7] | PLMN ID                                             |
| NFType           | 3GPP TS 29.510     | See clause 6.1.6.3.3                                |
| Snsai            | 3GPP TS 29.571 [7] |                                                     |
| NfSetId          | 3GPP TS 29.571 [7] | NF Set ID (see clause 28.12 of 3GPP TS 23.003 [12]) |
| Uri              | 3GPP TS 29.571 [7] |                                                     |
| RedirectResponse | 3GPP TS 29.571 [7] | Response body of the redirect response message.     |
| Fqdn             | 3GPP TS 29.571 [7] | Fully Qualified Domain Name                         |

### 6.3.5.2 Structured data types

#### 6.3.5.2.1 Introduction

This clause defines the structures to be used in the APIs.

6.3.5.2.2 Type: AccessTokenReq

**Table 6.3.5.2.2-1: Definition of type AccessTokenReq**

| Attribute name     | Data type     | P | Cardinality | Description                                                                                                                                                                                                                                                                                                                                                                                                                                                                                                                                                                                                                                                                        |
|--------------------|---------------|---|-------------|------------------------------------------------------------------------------------------------------------------------------------------------------------------------------------------------------------------------------------------------------------------------------------------------------------------------------------------------------------------------------------------------------------------------------------------------------------------------------------------------------------------------------------------------------------------------------------------------------------------------------------------------------------------------------------|
| grant_type         | string        | M | 1           | This IE shall contain the grant type as "client_credentials".<br>Enum: "client_credentials"                                                                                                                                                                                                                                                                                                                                                                                                                                                                                                                                                                                        |
| nfInstanceId       | NfInstanceId  | M | 1           | This IE shall contain the NF instance id of the NF service consumer.                                                                                                                                                                                                                                                                                                                                                                                                                                                                                                                                                                                                               |
| nfType             | NFType        | C | 0..1        | This IE shall be included when the access token request is for an NF type and not for a specific NF / NF service instance. When present, this IE shall contain the NF type of the NF service consumer. (NOTE 3)                                                                                                                                                                                                                                                                                                                                                                                                                                                                    |
| targetNfType       | NFType        | C | 0..1        | This IE shall be included when the access token request is for an NF type and not for a specific NF / NF service instance. When present, this IE shall contain the NF type of the NF service producer.                                                                                                                                                                                                                                                                                                                                                                                                                                                                             |
| scope              | string        | M | 1           | This IE shall contain the scopes requested by the NF service consumer.<br><br>The scopes shall consist of a list of NF service name(s) of the NF service producer(s) or resource/operation-level scopes defined by each service API, separated by whitespaces, as described in IETF RFC 6749 [16], clause 3.3.<br><br>The service name(s) included in this attribute shall be any of the services defined in the ServiceName enumerated type (see clause 6.1.6.3.11).<br><br>The resource/operation-level scopes shall be any of those defined in the "securitySchemes" clause of each service API.<br><br>pattern: '^([a-zA-Z0-9_-:~+]) ([a-zA-Z0-9_-:~+])*\$'<br><br>See NOTE 2. |
| targetNfInstanceId | NfInstanceId  | C | 0..1        | This IE shall be included, if available and if it is an access token request for a specific NF Service Producer. When present this IE shall contain the NF Instance ID of the specific NF Service Producer for which the access token is requested.                                                                                                                                                                                                                                                                                                                                                                                                                                |
| requesterPlmn      | PlmnId        | C | 0..1        | This IE shall be included when the NF service consumer in one PLMN requests a service access authorization for an NF service producer from a different PLMN.<br>When present, this IE shall contain the PLMN ID of the requester NF service consumer. (NOTE 3) (NOTE 4)                                                                                                                                                                                                                                                                                                                                                                                                            |
| requesterPlmnList  | array(PlmnId) | C | 2..N        | This IE shall be included when the NF service consumer serving a PLMN, with more than one PLMN ID, requests a service access authorization for an NF service producer from a different PLMN.<br>When present, this IE shall contain the PLMN IDs of the requester NF service consumer. (NOTE 4)                                                                                                                                                                                                                                                                                                                                                                                    |
| requesterSnsaiList | array(Snsai)  | O | 1..N        | When present, this IE shall contain the list of S-NSSAIs of the requester NF service consumer.<br>This may be used by the NRF to validate that the requester NF service consumer is allowed to access the target NF Service Producer. (NOTE 3)                                                                                                                                                                                                                                                                                                                                                                                                                                     |
| requesterFqdn      | Fqdn          | O | 0..1        | When present, this IE shall contain the FQDN of the requester NF Service Consumer.<br>This may be used by the NRF to validate that the requester NF service consumer is allowed to access the target NF Service Producer. (NOTE 3)                                                                                                                                                                                                                                                                                                                                                                                                                                                 |

|                                                                                                                                                                                                                                                                                                                                                                                                                                                                                                                                                                                                                                                                                                                                                                                                                                                                                                                                                                                                                                                                                                                                                                                                                                                                                                                                                  |                  |   |      |                                                                                                                                                                                                                                                                                                                                       |
|--------------------------------------------------------------------------------------------------------------------------------------------------------------------------------------------------------------------------------------------------------------------------------------------------------------------------------------------------------------------------------------------------------------------------------------------------------------------------------------------------------------------------------------------------------------------------------------------------------------------------------------------------------------------------------------------------------------------------------------------------------------------------------------------------------------------------------------------------------------------------------------------------------------------------------------------------------------------------------------------------------------------------------------------------------------------------------------------------------------------------------------------------------------------------------------------------------------------------------------------------------------------------------------------------------------------------------------------------|------------------|---|------|---------------------------------------------------------------------------------------------------------------------------------------------------------------------------------------------------------------------------------------------------------------------------------------------------------------------------------------|
| requesterSnpnList                                                                                                                                                                                                                                                                                                                                                                                                                                                                                                                                                                                                                                                                                                                                                                                                                                                                                                                                                                                                                                                                                                                                                                                                                                                                                                                                | array(PlmnIdNid) | O | 1..N | When present, this IE shall contain the list of SNPNs the requester NF service consumer belongs to. This may be used by the NRF to validate that the requester NF service consumer is allowed to access the target NF Service Producer. (NOTE 3)                                                                                      |
| targetPlmn                                                                                                                                                                                                                                                                                                                                                                                                                                                                                                                                                                                                                                                                                                                                                                                                                                                                                                                                                                                                                                                                                                                                                                                                                                                                                                                                       | PlmnId           | C | 0..1 | This IE shall be included when the NF service consumer in one PLMN or SNPN requests a service access authorization for an NF service producer from a different PLMN.<br>When present, this IE shall contain the PLMN ID of the target PLMN (i.e., PLMN ID of the NF service producer).                                                |
| targetSnpn                                                                                                                                                                                                                                                                                                                                                                                                                                                                                                                                                                                                                                                                                                                                                                                                                                                                                                                                                                                                                                                                                                                                                                                                                                                                                                                                       | PlmnIdNid        | C | 0..1 | This IE shall be included when the NF service consumer in one PLMN or SNPN requests a service access authorization for an NF service producer from a different SNPN.<br>When present, this IE shall contain the SNPN ID of the target SNPN (i.e., SNPN ID of the NF service producer).                                                |
| targetSnssaiList                                                                                                                                                                                                                                                                                                                                                                                                                                                                                                                                                                                                                                                                                                                                                                                                                                                                                                                                                                                                                                                                                                                                                                                                                                                                                                                                 | array(Snssai)    | O | 1..N | This IE may be included during an access token request for an NF type and not for a specific NF / NF service instance. When present, this IE shall contain the list of S-NSSAIs of the NF Service Producer.                                                                                                                           |
| targetNsiList                                                                                                                                                                                                                                                                                                                                                                                                                                                                                                                                                                                                                                                                                                                                                                                                                                                                                                                                                                                                                                                                                                                                                                                                                                                                                                                                    | array(string)    | O | 1..N | This IE may be included during an access token request for an NF type and not for a specific NF / NF service instance. When present, this IE shall contain the list of NSIs of the NF Service Producer.                                                                                                                               |
| targetNfSetId                                                                                                                                                                                                                                                                                                                                                                                                                                                                                                                                                                                                                                                                                                                                                                                                                                                                                                                                                                                                                                                                                                                                                                                                                                                                                                                                    | NfSetId          | O | 0..1 | This IE may be included during an access token request for an NF type and not for a specific NF / NF service instance. When present, this IE shall contain the NF Set ID of the NF Service Producer.                                                                                                                                  |
| targetNfServiceSetId                                                                                                                                                                                                                                                                                                                                                                                                                                                                                                                                                                                                                                                                                                                                                                                                                                                                                                                                                                                                                                                                                                                                                                                                                                                                                                                             | NfServiceSetId   | O | 0..1 | This IE may be included during an access token request for a specific NF / NF service instance. When present, this IE shall contain the NF Service Set ID of the NF Service Producer.<br>This may be used by the NRF to validate that the requester NF service consumer is allowed to access the target NF service instance. (NOTE 3) |
| hnrAccessUri                                                                                                                                                                                                                                                                                                                                                                                                                                                                                                                                                                                                                                                                                                                                                                                                                                                                                                                                                                                                                                                                                                                                                                                                                                                                                                                                     | Uri              | C | 0..1 | If included, this IE shall contain the API URI of the Access Token Service (see clause 6.3.2) of the NRF in home PLMN.<br><br>It shall be included during an access token request for an hSMF in the home routed roaming scenario, if it is returned from the NSSF in the home PLMN (see clause 6.1.6.2.11 of 3GPP TS 29.531 [42]).   |
| sourceNfInstanceId                                                                                                                                                                                                                                                                                                                                                                                                                                                                                                                                                                                                                                                                                                                                                                                                                                                                                                                                                                                                                                                                                                                                                                                                                                                                                                                               | NfInstanceId     | C | 0..1 | This IE shall be included, if available and if it is an access token request from the DCCF as NF Service Consumer request data from NF Service Producers on behalf of the source NF.<br>When present this IE shall contain the NF Instance ID of the source NF which intend to collect data from NF Service Producer.                 |
| <p>NOTE 1: This data structure shall not be treated as a JSON object. It shall be treated as a key, value pair data structure to be encoded using x-www-form-urlencoded format as specified in clause 17.13.4 of W3C HTML 4.01 Specification [26].</p> <p>NOTE 2: Though scope attribute is optional as per IETF RFC 6749 [16], it is mandatory for 3GPP as per 3GPP TS 33.501 [15].</p> <p>NOTE 3: An access token request should be rejected if the requester NF is not allowed to access the target NF based on the authorization parameters in the NF profile of the target NF. The authorization parameters in NF Profile are those used by NRF to determine whether a given NF Instance / NF Service Instance can be discovered by an NF Service Consumer in order to consume its offered services (e.g. "allowedNfTypes", "allowedNfDomains", etc.). Based on operator's policies, an access token request not including the requester's information necessary to validate the authorization parameters in the target NF Profile may be rejected.</p> <p>NOTE 4: When the NF service consumer is serving a PLMN consisting of one PLMN ID, the attribute "requesterPlmn" shall be used; otherwise, if the NF service consumer is serving a PLMN consisting of more than one PLMN ID, the attribute "requesterPlmnList" shall be used.</p> |                  |   |      |                                                                                                                                                                                                                                                                                                                                       |

## EXAMPLE:

The following is an example of an Access Token Request message, with a request body encoded as x-www-form-urlencoded, with following input parameters:

- NF Instance Id of the NF Service Consumer: 4e0b2760-0356-42c4-b739-8d6aaa491b63
- NF Type of the NF Service Consumer: AMF
- NF Type of the NF Service Producer: UDM
- Requested scopes: "nudm-sdm", "nudm-uecm" and "nudm-ueau"
- PLMN ID of the NF Service Consumer: MCC=123, MNC=456
- PLMN ID of the NF Service Producer: MCC=321, MNC=654
- S-NSSAIs of the NF Service Producer: (SST=1, SD=A08923) and (SST=2)
- NSIs of the NF Service Producer: "Slice A, instance 1" and "Slice B, instance 2"

Note that the URL-encoding of the request body requires to percent-encode the reserved characters ([ ] { } " : ,) that appear in JSON-encoded structured input parameters (such as "requesterPlmn"), and in string input parameters (such as "scope", or "targetNsiList" array elements). Spaces are percent-encoded as '+'.

The request body, *before URL-encoding*, and displayed in multiples lines only for illustration purposes, would be:

```
grant_type=client_credentials
&nfInstanceId=4e0b2760-0356-42c4-b739-8d6aaa491b63
&nfType=AMF
&targetNfType=UDM
&scope=nudm-sdm nudm-uecm nudm-ueau
&requesterPlmn={"mcc":"123","mnc":"456"}
&targetPlmn={"mcc":"321","mnc":"654"}
&targetSnsaiList=[{"sst":1,"sd":"A08923"}, {"sst":2}]
&targetNsiList=Slice A, instance 1
&targetNsiList=Slice B, instance 2
```

The actual request message, *after URL-encoding*, and where all input parameters are contained into one single line in the request body, would be:

```
POST /oauth2/token
Content-Type: application/x-www-form-urlencoded
Accept: application/json

grant_type=client_credentials&nfInstanceId=4e0b2760-0356-42c4-b739-8d6aaa491b63&nfType=AMF&targetNfType=UDM&scope=nudm-sdm+nudm-uecm+nudm-ueau&requesterPlmn=%7B%22mcc%22%3A%22123%22%2C%22mnc%22%3A%22456%22%7D&targetPlmn=%7B%22mcc%22%3A%22321%22%2C%22mnc%22%3A%22654%22%7D&targetSnsaiList=%5B%7B%22sst%22%3A%221%2C%22sd%22%3A%22A08923%22%7D%2C%7B%22sst%22%3A%222%7D%5D&targetNsiList=Slice+A%2C+instance+1&targetNsiList=Slice+B%2C+instance+2
```

## 6.3.5.2.3 Type: AccessTokenRsp

Table 6.3.5.2.3-1: Definition of type AccessTokenRsp

| Attribute name | Data type | P | Cardinality | Description                                                                                                                                                                                                                                                                                                                                                                                                                                                                                                                                                                                                                                                                                                                                                                                                                                                                                           |
|----------------|-----------|---|-------------|-------------------------------------------------------------------------------------------------------------------------------------------------------------------------------------------------------------------------------------------------------------------------------------------------------------------------------------------------------------------------------------------------------------------------------------------------------------------------------------------------------------------------------------------------------------------------------------------------------------------------------------------------------------------------------------------------------------------------------------------------------------------------------------------------------------------------------------------------------------------------------------------------------|
| access_token   | string    | M | 1           | This IE shall contain JWS Compact Serialized representation of the JWS signed JSON object containing AccessTokenClaims (see clause 6.3.5.2.4).                                                                                                                                                                                                                                                                                                                                                                                                                                                                                                                                                                                                                                                                                                                                                        |
| token_type     | string    | M | 1           | This IE shall contain the token type, set to value "Bearer".<br>Enum: "Bearer"                                                                                                                                                                                                                                                                                                                                                                                                                                                                                                                                                                                                                                                                                                                                                                                                                        |
| expires_in     | integer   | C | 0..1        | This IE when present shall contain the number of seconds after which the access token is considered to be expired.<br>As indicated in IETF RFC 6749 [16], this attribute should be included, unless the expiration time of the token is made available by other means (e.g. deployment-specific documentation).                                                                                                                                                                                                                                                                                                                                                                                                                                                                                                                                                                                       |
| scope          | string    | C | 0..1        | This IE when present shall contain the scopes granted to the NF service consumer.<br><br>The scopes shall consist of a list of NF service name(s) of the NF service producer(s) or resource/operation-level scopes defined by each service API, separated by whitespaces, as described in IETF RFC 6749 [16], clause 3.3.<br><br>The service name(s) included in this attribute shall be any of the services defined in the ServiceName enumerated type (see clause 6.1.6.3.11).<br><br>The resource/operation-level scopes shall be any of those defined in the "securitySchemes" clause of each service API.<br><br>As indicated in IETF RFC 6749 [16], this attribute shall be present if it is different than the scope included in the access token request; if it is the same as the requested scope, this attribute may be absent.<br><br>pattern: '^([a-zA-Z0-9_-:~+]) ([a-zA-Z0-9_-:~+])*\$' |



6.3.5.2.4 Type: AccessTokenClaims

**Table 6.3.5.2.4-1: Definition of type AccessTokenClaims**

| Attribute name    | Data type    | P | Cardinality | Description                                                                                                                                                                                                                                                                                                                                                                                                                                                                                                                                                         |
|-------------------|--------------|---|-------------|---------------------------------------------------------------------------------------------------------------------------------------------------------------------------------------------------------------------------------------------------------------------------------------------------------------------------------------------------------------------------------------------------------------------------------------------------------------------------------------------------------------------------------------------------------------------|
| iss               | NfInstanceId | M | 1           | This IE shall contain NF instance id of the NRF. , corresponding to the standard "Issuer" claim described in IETF RFC 7519 [25], clause 4.1.1                                                                                                                                                                                                                                                                                                                                                                                                                       |
| sub               | NfInstanceId | M | 1           | This IE shall contain the NF instance ID of the NF service consumer, corresponding to the standard "Subject" claim described in IETF RFC 7519 [25], clause 4.1.2.                                                                                                                                                                                                                                                                                                                                                                                                   |
| aud               | Audience     | M | 1           | This IE shall contain the NF service producer's NF instance ID(s) (if the exact NF instance(s) of the NF service producer is known) or the NF type of NF service producers for which the claim is applicable, corresponding to the standard "Audience" claim described in IETF RFC 7519 [25], clause 4.1.3.                                                                                                                                                                                                                                                         |
| scope             | string       | M | 1           | This IE shall contain the name of the NF services and the resource/operation-level scopes for which the access_token is authorized for use; this claim corresponds to a private claim, as described in IETF RFC 7519 [25], clause 4.3.<br><br>pattern: '^([a-zA-Z0-9_-:~+]) ([a-zA-Z0-9_-:~+]*\$)'                                                                                                                                                                                                                                                                  |
| exp               | integer      | M | 1           | This IE shall contain the expiration time after which the access_token is considered to be expired, corresponding to the standard "Expiration Time" claim described in IETF RFC 7519 [25], clause 4.1.4.                                                                                                                                                                                                                                                                                                                                                            |
| consumerPlmnlid   | Plmnlid      | C | 0..1        | This IE shall be included if the NRF supports providing PLMN ID of the NF service consumer in the access token claims, to be interpreted for subject (sub IE), as specified in clause 13.4.1.2 of 3GPP TS 33.501 [15]. If an NF service producer that receives this IE in the token included in the authorization header does not understand this IE, it shall be ignored.                                                                                                                                                                                          |
| consumerSnpnlid   | PlmnlidNid   | C | 0..1        | This IE shall be included if the NRF supports providing SNPN ID of the NF service consumer in the access token claims, to be interpreted for subject (sub IE), as specified in clause 13.4.1.2 of 3GPP TS 33.501[15]. If an NF service producer that receives this IE in the token included in the authorization header does not understand this IE, it shall be ignored.                                                                                                                                                                                           |
| producerPlmnlid   | Plmnlid      | C | 0..1        | This IE shall be included if the access token is granted for an NF service producer belonging to an PLMN and the NRF supports providing PLMN ID of the NF service producer in the access token claims, to be interpreted for audience (aud IE), as specified in clause 13.4.1.2 of 3GPP TS 33.501 [15]. If an NF service producer that receives this IE in the token included in the authorization header does not understand this IE, it shall be ignored.                                                                                                         |
| producerSnpnlid   | PlmnlidNid   | C | 0..1        | This IE shall be included if the access token is granted for an NF service producer belonging to an SNPN and the NRF supports providing SNPN ID of the NF service producer in the access token claims, to be interpreted for audience (aud IE), as specified in clause 13.4.1.2 of 3GPP TS 33.501 [15].<br>When present, it shall contain the SNPN ID of the SNPN the target NF service producer belongs to.<br>If an NF service producer that receives this IE in the token included in the authorization header does not understand this IE, it shall be ignored. |
| producerSnsaiList | array(Snsai) | O | 1..N        | This IE may be included if the NRF supports providing list of S-NSSAIs of the NF service producer in the access token claims. If an NF service producer that receives this IE in the token included in the authorization header does not understand this IE, it shall be ignored.                                                                                                                                                                                                                                                                                   |

|                        |                |   |      |                                                                                                                                                                                                                                                                                                                                                                                                                                                                 |
|------------------------|----------------|---|------|-----------------------------------------------------------------------------------------------------------------------------------------------------------------------------------------------------------------------------------------------------------------------------------------------------------------------------------------------------------------------------------------------------------------------------------------------------------------|
| producerNsiList        | array(string)  | O | 1..N | This IE may be included if the NRF supports providing list of NSIs of the NF service producer in the access token claims. If an NF service producer that receives this IE in the token included in the authorization header does not understand this IE, it shall be ignored.                                                                                                                                                                                   |
| producerNfSetId        | NfSetId        | O | 0..1 | This IE may be included if the NRF supports providing NF Set ID of the NF service producer in the access token claims and if the audience contains an NF type. When present, it shall indicate the NF Set ID of the NF service producer instances for which the claim is applicable. If an NF service producer that receives this IE in the token included in the authorization header does not understand this IE, it shall be ignored.                        |
| producerNfServiceSetId | NfServiceSetId | O | 0..1 | This IE may be included during an access token request for a specific NF / NF service instance, if the targetNfServiceSetId IE is present in the Access Token Request.<br>When present, this IE shall contain the NF Service Set ID of the NF Service Producer for which the access token is applicable.<br>If an NF service producer that receives this IE in the token included in the authorization header does not understand this IE, it shall be ignored. |
| sourceNfInstanceId     | NfInstanceId   | C | 0..1 | This IE shall be included if the NRF supports providing NF Instance ID of the source NF in the access token claims (if it is an access token request from the DCCF as NF Service Consumer request data from NF Service Producers on behalf of the source NF), to be interpreted for subject (sub IE), as specified in Annex X of 3GPP TS 33.501 [15].                                                                                                           |

### 6.3.5.2.5 Type: AccessTokenErr

**Table 6.3.5.2.5-1: Definition of type AccessTokenErr**

| Attribute name    | Data type | P | Cardinality | Description                                                                                                                                                                                                               |
|-------------------|-----------|---|-------------|---------------------------------------------------------------------------------------------------------------------------------------------------------------------------------------------------------------------------|
| error             | string    | M | 1           | This IE shall contain the error described in IETF RFC 6749 [16], clause 5.2.<br>Enum:<br>"invalid_request"<br>"invalid_client"<br>"invalid_grant"<br>"unauthorized_client"<br>"unsupported_grant_type"<br>"invalid_scope" |
| error_description | string    | O | 0..1        | When present, this IE shall contain the human-readable additional information to indicate the error that occurred, as described in IETF RFC 6749 [16], clause 5.2.                                                        |
| error_uri         | string    | O | 0..1        | When present, this IE shall contain the URI identifying a human-readable additional information about the error, as described in IETF RFC 6749 [16], clause 5.2.                                                          |

## 6.3.5.3 Simple data types and enumerations

### 6.3.5.3.1 Introduction

This clause defines simple data types and enumerations that can be referenced from data structures defined in the previous clauses.

### 6.3.5.3.2 Simple data types

There are no specific simple data types defined in this version of this API. For the re-used data types from other specifications see clause 6.3.5.1

### 6.3.5.3.3 Void

## 6.3.5.4 Data types describing alternative data types or combinations of data types

### 6.3.5.4.1 Type: Audience

**Table 6.3.5.4.1-1: Definition of type Audience as a list of "non-exclusive alternatives"**

| Data type           | Cardinality | Description              | Applicability |
|---------------------|-------------|--------------------------|---------------|
| NFType              | 1           | NF type                  |               |
| array(NfInstanceId) | 1..N        | Array of NF Instance Ids |               |

## 6.3.6 Error Handling

### 6.3.6.1 General

HTTP error handling shall be supported as specified in IETF RFC 6749 [16] for errors returned by NRF as Oauth 2.0 authorization server, and also as specified in clause 5.2.7.4 of 3GPP TS 29.500 [4] for errors returned by SCP or SEPP.

### 6.3.6.2 Protocol Errors

Protocol errors handling shall be supported as specified in clause 5.2.7 of 3GPP TS 29.500 [4].

### 6.3.6.3 Application Errors

The application errors defined for the Nnrf\_AccessToken service are listed in Table 6.3.X.3-1, and correspond to the values of the "error" attribute (see clause 6.3.5.2.5).

**Table 6.3.6.3-1: Application errors**

| Application Error      | HTTP status code                     | Description            |
|------------------------|--------------------------------------|------------------------|
| invalid_request        | 400 Bad Request                      | See IETF RFC 6749 [16] |
| invalid_client         | 400 Bad Request,<br>401 Unauthorized | See IETF RFC 6749 [16] |
| invalid_grant          | 400 Bad Request                      | See IETF RFC 6749 [16] |
| unauthorized_client    | 400 Bad Request                      | See IETF RFC 6749 [16] |
| unsupported_grant_type | 400 Bad Request                      | See IETF RFC 6749 [16] |
| invalid_scope          | 400 Bad Request                      | See IETF RFC 6749 [16] |

## 6.4 Nnrf\_Bootstrapping Service API

### 6.4.1 API URI

URIs of this API shall have the following root:

```
{nrfApiRoot}
```

where {nrfApiRoot} represents the concatenation of the "scheme" and "authority" components of the NRF, as defined in IETF RFC 3986 [17].

## 6.4.2 Usage of HTTP

### 6.4.2.1 General

HTTP/2, as defined in IETF RFC 7540 [9], shall be used as specified in clause 5 of 3GPP TS 29.500 [4].

HTTP/2 shall be transported as specified in clause 5.3 of 3GPP TS 29.500 [4].

HTTP messages and bodies this API shall comply with the OpenAPI [10] specification contained in Annex A.

### 6.4.2.2 HTTP standard headers

#### 6.4.2.2.1 General

The mandatory standard HTTP headers as specified in clause 5.2.2.2 of 3GPP TS 29.500 [4] shall be supported.

#### 6.4.2.2.2 Content type

The following content types shall be supported:

- The JSON format (IETF RFC 8259 [22]). The use of the JSON format shall be signalled by the content type "application/json". See also clause 5.4 of 3GPP TS 29.500 [4].
- The Problem Details JSON Object (IETF RFC 7807 [11]). The use of the Problem Details JSON object in a HTTP response body shall be signalled by the content type "application/problem+json".
- The 3GPP hypermedia format as defined in 3GPP TS 29.501 [5]. The use of the 3GPP hypermedia format in a HTTP response body shall be signalled by the content type "application/3gppHal+json".

#### 6.4.2.2.3 Cache-Control

A "Cache-Control" header should be included in HTTP responses, as described in IETF RFC 7234 [20], clause 5.2. It shall contain a "max-age" value, indicating the amount of time in seconds after which the received response is considered stale.

#### 6.4.2.2.4 ETag

An "ETag" (entity-tag) header should be included in HTTP responses, as described in IETF RFC 7232 [19], clause 2.3. It shall contain a server-generated strong validator, that allows further matching of this value (included in subsequent client requests) with a given resource representation stored in the server or in a cache.

#### 6.4.2.2.5 If-None-Match

An NF Service Consumer should issue conditional GET requests towards the Nnrf\_Bootstrapping service, by including an If-None-Match header in HTTP requests, as described in IETF RFC 7232 [19], clause 3.2, containing one or several entity tags received in previous responses for the same resource.

### 6.4.2.3 HTTP custom headers

#### 6.4.2.3.1 General

In this release of this specification, no custom headers specific to the Nnrf\_Bootstrapping Service API are defined. For 3GPP specific HTTP custom headers used across all service-based interfaces, see clause 5.2.3 of 3GPP TS 29.500 [4].

## 6.4.3 Resources

### 6.4.3.1 Overview

The structure of the Resource URIs of the Nnrf\_Bootstrapping service is shown in figure 6.4.3.1-1.

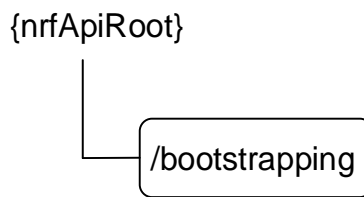

**Figure 6.4.3.1-1: Resource URI structure of the Nnrf\_Bootstrapping API**

Table 6.4.3.1-1 provides an overview of the resources and applicable HTTP methods.

**Table 6.4.3.1-1: Resources and methods overview**

| Resource name            | Resource URI               | HTTP method or custom operation | Description                                                               |
|--------------------------|----------------------------|---------------------------------|---------------------------------------------------------------------------|
| Bootstrapping (Document) | {nrfApiRoot}/bootstrapping | GET                             | Retrieve a collection of links pointing to other services exposed by NRF. |

### 6.4.3.2 Resource: Bootstrapping (Document)

#### 6.4.3.2.1 Description

This resource represents a collection of links pointing to other services exposed by NRF.

This resource is modelled as the Document resource archetype (see clause C.3 of 3GPP TS 29.501 [5]).

#### 6.4.3.2.2 Resource Definition

Resource URI: **{nrfApiRoot}/bootstrapping**

This resource shall support the resource URI variables defined in table 6.4.3.2.2-1.

**Table 6.4.3.2.2-1: Resource URI variables for this resource**

| Name       | Definition       |
|------------|------------------|
| nrfApiRoot | See clause 6.4.1 |

#### 6.4.3.2.3 Resource Standard Methods

##### 6.4.3.2.3.1 GET

This method retrieves a list of links pointing to other services exposed by NRF. This method shall support the URI query parameters specified in table 6.4.3.2.3.1-1.

**Table 6.4.3.2.3.1-1: URI query parameters supported by the GET method on this resource**

| Name | Data type | P | Cardinality | Description |
|------|-----------|---|-------------|-------------|
| n/a  | n/a       |   |             |             |

This method shall support the request data structures specified in table 6.4.3.2.3.1-2 and the response data structures and response codes specified in table 6.4.3.2.3.1-3.

**Table 6.4.3.2.3.1-2: Data structures supported by the GET Request Body on this resource**

| Data type | P | Cardinality | Description |
|-----------|---|-------------|-------------|
| n/a       |   |             |             |

**Table 6.4.3.2.3.1-3: Data structures supported by the GET Response Body on this resource**

| Data type                                                                                                                                                                                                                                          | P | Cardinality | Response codes | Description                                                                                                                                                                                             |
|----------------------------------------------------------------------------------------------------------------------------------------------------------------------------------------------------------------------------------------------------|---|-------------|----------------|---------------------------------------------------------------------------------------------------------------------------------------------------------------------------------------------------------|
| BootstrappingInfo                                                                                                                                                                                                                                  | M | 1           | 200 OK         | The response body contains a "_links" object containing the URI of each service exposed by the NRF. The response may also contain the status of the NRF and the features supported by each NRF service. |
| NOTE: The mandatory HTTP error status codes for the GET method listed in Table 5.2.7.1-1 of 3GPP TS 29.500 [4] other than those specified in the table above also apply, with a ProblemDetails data type (see clause 5.2.7 of 3GPP TS 29.500 [4]). |   |             |                |                                                                                                                                                                                                         |

## 6.4.4 Custom Operations without associated resources

There are no custom operations defined without any associated resources for the Nnrf\_Bootstrapping service in this release of the specification.

## 6.4.5 Notifications

There are no notifications defined for the Nnrf\_Bootstrapping service in this release of the specification.

## 6.4.6 Data Model

### 6.4.6.1 General

This clause specifies the application data model supported by the API.

Table 6.4.6.1-1 specifies the data types defined for the Nnrf\_Bootstrapping service-based interface protocol.

**Table 6.4.6.1-1: Nnrf\_Bootstrapping specific Data Types**

| Data type         | Clause defined | Description                                                        |
|-------------------|----------------|--------------------------------------------------------------------|
| BootstrappingInfo | 6.4.6.2.2      | Information returned by NRF in the bootstrapping response message. |
| Status            | 6.4.6.3.2      | Overall status of the NRF.                                         |

Table 6.4.6.1-2 specifies data types re-used by the Nnrf\_Bootstrapping service-based interface protocol from other specifications, including a reference to their respective specifications and when needed, a short description of their use within the Nnrf service-based interface.

**Table 6.4.6.1-2: Nnrf\_Bootstrapping re-used Data Types**

| Data type         | Reference          | Comments             |
|-------------------|--------------------|----------------------|
| LinksValueSchema  | 3GPP TS 29.571 [7] | 3GPP Hypermedia link |
| ProblemDetails    | 3GPP TS 29.571 [7] |                      |
| SupportedFeatures | 3GPP TS 29.571 [7] |                      |

## 6.4.6.2 Structured data types

### 6.4.6.2.1 Introduction

This clause defines the structures to be used in resource representations.

### 6.4.6.2.2 Type: BootstrappingInfo

**Table 6.4.6.2.2-1: Definition of type BootstrappingInfo**

| Attribute name                                                                                                                               | Data type              | P | Cardinality | Description                                                                                                                                                                                                                                                                                                                                                                                                                                                                                                                   |
|----------------------------------------------------------------------------------------------------------------------------------------------|------------------------|---|-------------|-------------------------------------------------------------------------------------------------------------------------------------------------------------------------------------------------------------------------------------------------------------------------------------------------------------------------------------------------------------------------------------------------------------------------------------------------------------------------------------------------------------------------------|
| status                                                                                                                                       | Status                 | O | 0..1        | Status of the NRF (operative, non-operative, ...) The NRF shall be considered as operative if this attribute is absent.                                                                                                                                                                                                                                                                                                                                                                                                       |
| _links                                                                                                                                       | map(LinksValueSchema)  | M | 1..N        | Map of LinksValueSchema objects, where the keys are the link relations, as described in Table 6.4.6.3.3.1-1, and the values are objects containing an "href" attribute, whose value is an absolute URI corresponding to each link relation.                                                                                                                                                                                                                                                                                   |
| nrfFeatures                                                                                                                                  | map(SupportedFeatures) | O | 1..N        | Map of features supported by the NRF, where the keys of the map are the NRF services (as defined in clause 6.1.6.3.11), and where the value indicates the features supported by the corresponding NRF services.<br>When present, the NRF shall indicate all the features of all the services it supports.<br>(NOTE)                                                                                                                                                                                                           |
| oauth2Required                                                                                                                               | map(boolean)           | O | 1..N        | When present, this IE shall indicate whether the NRF requires OAuth2-based authorization for accessing its services.<br>The key of the map shall be the name of an NRF service, e.g. "nrf-nfm" or "nrf-disc".<br><br>The value of each entry of the map shall be encoded as follows:<br>- true: OAuth2 based authorization is required.<br>- false: OAuth2 based authorization is not required.<br><br>The absence of this IE means that the NRF has not provided any indication about its usage of OAuth2 for authorization. |
| nrfSetId                                                                                                                                     | NfSetId                | O | 0..1        | NRF Set Id                                                                                                                                                                                                                                                                                                                                                                                                                                                                                                                    |
| nrfInstanceId                                                                                                                                | NfInstanceId           | O | 0..1        | NRF Instance Id                                                                                                                                                                                                                                                                                                                                                                                                                                                                                                               |
| NOTE: The absence of the nrfFeatures attribute in the BootstrappingInfo shall not be interpreted as if the NRF does not support any feature. |                        |   |             |                                                                                                                                                                                                                                                                                                                                                                                                                                                                                                                               |

## 6.4.6.3 Simple data types and enumerations

### 6.4.6.3.1 Introduction

This clause defines simple data types and enumerations that can be referenced from data structures defined in the previous clauses.



## 6.4.6.3.2 Enumeration: Status

**Table 6.4.6.3.2-1: Enumeration Status**

| Enumeration value | Description              |
|-------------------|--------------------------|
| "OPERATIVE"       | The NRF is operative     |
| "NON_OPERATIVE"   | The NRF is not operative |

## 6.4.6.3.3 Relation Types

## 6.4.6.3.3.1 General

This clause describes the possible relation types defined within NRF API. See clause 4.7.5.2 of 3GPP TS 29.501 [5] for the description of the relation types.

**Table 6.4.6.3.3.1-1: supported registered relation types**

| Relation Name | Description                                                                                                                                                                                                                                               |
|---------------|-----------------------------------------------------------------------------------------------------------------------------------------------------------------------------------------------------------------------------------------------------------|
| self          | The "href" attribute of the object associated to this relation type contains the URI of the same resource returned in the response body (i.e. the "bootstrapping" resource).                                                                              |
| manage        | The "href" attribute of the object associated to this relation type contains the URI of the resource used in the Nnrf_NFManagement API to register/deregister/update NF Instances profiles in the NRF (i.e. the "nf-instances" store resource).<br>(NOTE) |
| subscribe     | The "href" attribute of the object associated to this relation type contains the URI of the resource used in the Nnrf_NFManagement API to manage subscriptions to the NRF (i.e. the "subscriptions" collection resource).<br>(NOTE)                       |
| discover      | The "href" attribute of the object associated to this relation type contains the URI of the resource used in the Nnrf_NFDiscovery API (i.e. the "nf-instances" collection resource).                                                                      |
| authorize     | The "href" attribute of the object associated to this relation type contains the URI of the OAuth2 Access Token Request endpoint, used to request authorization to other APIs in the 5G Core Network.                                                     |
| NOTE:         | The URIs of the "manage" and "subscribe" "href" attributes shall have the same apiRoot (i.e. authority and prefix) since these service operations belong to the same service.                                                                             |

---

# Annex A (normative): OpenAPI specification

## A.1 General

This Annex specifies the formal definition of the Nnrf Service API(s). It consists of OpenAPI 3.0.0 specifications, in YAML format.

This Annex takes precedence when being discrepant to other parts of the specification with respect to the encoding of information elements and methods within the API(s).

**NOTE:** The semantics and procedures, as well as conditions, e.g. for the applicability and allowed combinations of attributes or values, not expressed in the OpenAPI definitions but defined in other parts of the specification also apply.

Informative copies of the OpenAPI specification files contained in this 3GPP Technical Specification are available on a Git-based repository, that uses the GitLab software version control system (see 3GPP TS 29.501 [5] clause 5.3.1 and 3GPP TR 21.900 [31] clause 5B).

---

## A.2 Nnrf\_NFManagement API

openapi: 3.0.0

info:

```
version: '1.2.2'
title: 'NRF NFManagement Service'
description: |
  NRF NFManagement Service.
  © 2022, 3GPP Organizational Partners (ARIB, ATIS, CCSA, ETSI, TSDSI, TTA, TTC).
  All rights reserved.
```

externalDocs:

```
description: 3GPP TS 29.510 V17.8.0; 5G System; Network Function Repository Services; Stage 3
url: 'https://www.3gpp.org/ftp/Specs/archive/29_series/29.510/'
```

servers:

```
- url: '{apiRoot}/nnrf-nfm/v1'
  variables:
    apiRoot:
      default: https://example.com
      description: apiRoot as defined in clause 4.4 of 3GPP TS 29.501
```

security:

```
- {}
- oAuth2ClientCredentials:
  - nnrf-nfm
```

paths:

```
/nf-instances:
  get:
    summary: Retrieves a collection of NF Instances
    operationId: GetNFInstances
    tags:
      - NF Instances (Store)
    security:
      - {}
      - oAuth2ClientCredentials:
        - nnrf-nfm
      - oAuth2ClientCredentials:
        - nnrf-nfm
        - nnrf-nfm:nf-instances:read
    parameters:
      - name: nf-type
        in: query
        description: Type of NF
        required: false
        schema:
```

```

    $ref: '#/components/schemas/NFType'
  - name: limit
    in: query
    description: How many items to return at one time
    required: false
    schema:
      type: integer
      minimum: 1
  - name: page-number
    in: query
    description: Page number where the response shall start
    required: false
    schema:
      type: integer
      minimum: 1
  - name: page-size
    in: query
    description: Maximum number of items in each returned page
    schema:
      type: integer
      minimum: 1
responses:
  '200':
    description: Expected response to a valid request
    content:
      application/3gppHal+json:
        schema:
          $ref: '#/components/schemas/UriList'
    headers:
      ETag:
        description: Entity Tag containing a strong validator, described in IETF RFC 7232, 2.3
        schema:
          type: string
  '307':
    description: Temporary Redirect
    content:
      application/json:
        schema:
          $ref: 'TS29571_CommonData.yaml#/components/schemas/RedirectResponse'
    headers:
      Location:
        description: The URI pointing to the resource located on the redirect target NRF
        required: true
        schema:
          type: string
  '308':
    description: Permanent Redirect
    content:
      application/json:
        schema:
          $ref: 'TS29571_CommonData.yaml#/components/schemas/RedirectResponse'
    headers:
      Location:
        description: The URI pointing to the resource located on the redirect target NRF
        required: true
        schema:
          type: string
  '400':
    $ref: 'TS29571_CommonData.yaml#/components/responses/400'
  '401':
    $ref: 'TS29571_CommonData.yaml#/components/responses/401'
  '403':
    $ref: 'TS29571_CommonData.yaml#/components/responses/403'
  '404':
    $ref: 'TS29571_CommonData.yaml#/components/responses/404'
  '406':
    $ref: 'TS29571_CommonData.yaml#/components/responses/406'
  '411':
    $ref: 'TS29571_CommonData.yaml#/components/responses/411'
  '413':
    $ref: 'TS29571_CommonData.yaml#/components/responses/413'
  '415':
    $ref: 'TS29571_CommonData.yaml#/components/responses/415'
  '429':
    $ref: 'TS29571_CommonData.yaml#/components/responses/429'
  '500':
    $ref: 'TS29571_CommonData.yaml#/components/responses/500'
  '501':

```

```

    $ref: 'TS29571_CommonData.yaml#/components/responses/501'
  '503':
    $ref: 'TS29571_CommonData.yaml#/components/responses/503'
  default:
    $ref: 'TS29571_CommonData.yaml#/components/responses/default'
options:
  summary: Discover communication options supported by NRF for NF Instances
  operationId: OptionsNFInstances
  tags:
  - NF Instances (Store)
  responses:
  '200':
    description: OK
    content:
      application/json:
        schema:
          $ref: '#/components/schemas/OptionsResponse'
    headers:
      Accept-Encoding:
        description: Accept-Encoding, described in IETF RFC 7694
        schema:
          type: string
  '204':
    description: No Content
    headers:
      Accept-Encoding:
        description: Accept-Encoding, described in IETF RFC 7694
        schema:
          type: string
  '307':
    description: Temporary Redirect
    content:
      application/json:
        schema:
          $ref: 'TS29571_CommonData.yaml#/components/schemas/RedirectResponse'
    headers:
      Location:
        description: The URI pointing to the resource located on the redirect target NRF
        required: true
        schema:
          type: string
  '308':
    description: Permanent Redirect
    content:
      application/json:
        schema:
          $ref: 'TS29571_CommonData.yaml#/components/schemas/RedirectResponse'
    headers:
      Location:
        description: The URI pointing to the resource located on the redirect target NRF
        required: true
        schema:
          type: string
  '400':
    $ref: 'TS29571_CommonData.yaml#/components/responses/400'
  '401':
    $ref: 'TS29571_CommonData.yaml#/components/responses/401'
  '403':
    $ref: 'TS29571_CommonData.yaml#/components/responses/403'
  '404':
    $ref: 'TS29571_CommonData.yaml#/components/responses/404'
  '405':
    $ref: 'TS29571_CommonData.yaml#/components/responses/405'
  '429':
    $ref: 'TS29571_CommonData.yaml#/components/responses/429'
  '500':
    $ref: 'TS29571_CommonData.yaml#/components/responses/500'
  '501':
    $ref: 'TS29571_CommonData.yaml#/components/responses/501'
  '503':
    $ref: 'TS29571_CommonData.yaml#/components/responses/503'
  default:
    $ref: 'TS29571_CommonData.yaml#/components/responses/default'

/nf-instances/{nfInstanceID}:
  get:
    summary: Read the profile of a given NF Instance
    operationId: GetNFInstance

```

```

tags:
  - NF Instance ID (Document)
security:
  - {}
  - oAuth2ClientCredentials:
    - nnrf-nfm
  - oAuth2ClientCredentials:
    - nnrf-nfm
    - nnrf-nfm:nf-instances:read
parameters:
  - name: nfInstanceID
    in: path
    description: Unique ID of the NF Instance
    required: true
    schema:
      $ref: 'TS29571_CommonData.yaml#/components/schemas/NfInstanceId'
  - name: requester-features
    in: query
    description: Features supported by the NF Service Consumer
    schema:
      $ref: 'TS29571_CommonData.yaml#/components/schemas/SupportedFeatures'
responses:
  '200':
    description: Expected response to a valid request
    headers:
      ETag:
        description: Entity Tag containing a strong validator, described in IETF RFC 7232, 2.3
        schema:
          type: string
    content:
      application/json:
        schema:
          $ref: '#/components/schemas/NFProfile'
  '307':
    description: Temporary Redirect
    content:
      application/json:
        schema:
          $ref: 'TS29571_CommonData.yaml#/components/schemas/RedirectResponse'
    headers:
      Location:
        description: The URI pointing to the resource located on the redirect target NRF
        required: true
        schema:
          type: string
  '308':
    description: Permanent Redirect
    content:
      application/json:
        schema:
          $ref: 'TS29571_CommonData.yaml#/components/schemas/RedirectResponse'
    headers:
      Location:
        description: The URI pointing to the resource located on the redirect target NRF
        required: true
        schema:
          type: string
  '400':
    $ref: 'TS29571_CommonData.yaml#/components/responses/400'
  '401':
    $ref: 'TS29571_CommonData.yaml#/components/responses/401'
  '403':
    $ref: 'TS29571_CommonData.yaml#/components/responses/403'
  '404':
    $ref: 'TS29571_CommonData.yaml#/components/responses/404'
  '406':
    $ref: 'TS29571_CommonData.yaml#/components/responses/406'
  '411':
    $ref: 'TS29571_CommonData.yaml#/components/responses/411'
  '413':
    $ref: 'TS29571_CommonData.yaml#/components/responses/413'
  '415':
    $ref: 'TS29571_CommonData.yaml#/components/responses/415'
  '429':
    $ref: 'TS29571_CommonData.yaml#/components/responses/429'
  '500':
    $ref: 'TS29571_CommonData.yaml#/components/responses/500'
  '501':

```

```

    $ref: 'TS29571_CommonData.yaml#/components/responses/501'
  '503':
    $ref: 'TS29571_CommonData.yaml#/components/responses/503'
  default:
    $ref: 'TS29571_CommonData.yaml#/components/responses/default'
put:
  summary: Register a new NF Instance
  operationId: RegisterNFInstance
  tags:
    - NF Instance ID (Document)
  parameters:
    - name: nfInstanceId
      in: path
      required: true
      description: Unique ID of the NF Instance to register
      schema:
        $ref: 'TS29571_CommonData.yaml#/components/schemas/NfInstanceId'
    - name: Content-Encoding
      in: header
      description: Content-Encoding, described in IETF RFC 7231
      schema:
        type: string
    - name: Accept-Encoding
      in: header
      description: Accept-Encoding, described in IETF RFC 7231
      schema:
        type: string
  requestBody:
    content:
      application/json:
        schema:
          $ref: '#/components/schemas/NFProfile'
    required: true
  responses:
    '200':
      description: OK (Profile Replacement)
      content:
        application/json:
          schema:
            $ref: '#/components/schemas/NFProfile'
      headers:
        Accept-Encoding:
          description: Accept-Encoding, described in IETF RFC 7694
          schema:
            type: string
        Content-Encoding:
          description: Content-Encoding, described in IETF RFC 7231
          schema:
            type: string
        ETag:
          description: Entity Tag containing a strong validator, described in IETF RFC 7232, 2.3
          schema:
            type: string
    '201':
      description: Expected response to a valid request
      content:
        application/json:
          schema:
            $ref: '#/components/schemas/NFProfile'
      headers:
        Location:
          description: >
            Contains the URI of the newly created resource, according to the structure:
            {apiRoot}/nnrf-nfm/v1/nf-instances/{nfInstanceId}
          required: true
          schema:
            type: string
        Accept-Encoding:
          description: Accept-Encoding, described in IETF RFC 7694
          schema:
            type: string
        Content-Encoding:
          description: Content-Encoding, described in IETF RFC 7231
          schema:
            type: string
        ETag:
          description: Entity Tag containing a strong validator, described in IETF RFC 7232, 2.3
          schema:

```

```

    type: string
  '307':
    description: Temporary Redirect
    content:
      application/json:
        schema:
          $ref: 'TS29571_CommonData.yaml#/components/schemas/RedirectResponse'
    headers:
      Location:
        description: The URI pointing to the resource located on the redirect target NRF
        required: true
        schema:
          type: string
  '308':
    description: Permanent Redirect
    content:
      application/json:
        schema:
          $ref: 'TS29571_CommonData.yaml#/components/schemas/RedirectResponse'
    headers:
      Location:
        description: The URI pointing to the resource located on the redirect target NRF
        required: true
        schema:
          type: string
  '400':
    $ref: 'TS29571_CommonData.yaml#/components/responses/400'
  '401':
    $ref: 'TS29571_CommonData.yaml#/components/responses/401'
  '403':
    $ref: 'TS29571_CommonData.yaml#/components/responses/403'
  '404':
    $ref: 'TS29571_CommonData.yaml#/components/responses/404'
  '411':
    $ref: 'TS29571_CommonData.yaml#/components/responses/411'
  '413':
    $ref: 'TS29571_CommonData.yaml#/components/responses/413'
  '415':
    $ref: 'TS29571_CommonData.yaml#/components/responses/415'
  '429':
    $ref: 'TS29571_CommonData.yaml#/components/responses/429'
  '500':
    $ref: 'TS29571_CommonData.yaml#/components/responses/500'
  '501':
    $ref: 'TS29571_CommonData.yaml#/components/responses/501'
  '503':
    $ref: 'TS29571_CommonData.yaml#/components/responses/503'
  default:
    $ref: 'TS29571_CommonData.yaml#/components/responses/default'
patch:
  summary: Update NF Instance profile
  operationId: UpdateNFInstance
  tags:
    - NF Instance ID (Document)
  parameters:
    - name: nfInstanceID
      in: path
      required: true
      description: Unique ID of the NF Instance to update
      schema:
        $ref: 'TS29571_CommonData.yaml#/components/schemas/NfInstanceId'
    - name: Content-Encoding
      in: header
      description: Content-Encoding, described in IETF RFC 7231
      schema:
        type: string
    - name: Accept-Encoding
      in: header
      description: Accept-Encoding, described in IETF RFC 7231
      schema:
        type: string
    - name: If-Match
      in: header
      description: Validator for conditional requests, as described in IETF RFC 7232, 3.2
      schema:
        type: string
  requestBody:
    content:

```

```
    application/json-patch+json:
      schema:
        type: array
        items:
          $ref: 'TS29571_CommonData.yaml#/components/schemas/PatchItem'
        minItems: 1
    required: true
  responses:
    '200':
      description: Expected response to a valid request
      content:
        application/json:
          schema:
            $ref: '#/components/schemas/NFProfile'
      headers:
        Accept-Encoding:
          description: Accept-Encoding, described in IETF RFC 7694
          schema:
            type: string
        ETag:
          description: Entity Tag containing a strong validator, described in IETF RFC 7232, 2.3
          schema:
            type: string
        Content-Encoding:
          description: Content-Encoding, described in IETF RFC 7231
          schema:
            type: string
    '204':
      description: Expected response with empty body
      headers:
        Accept-Encoding:
          description: Accept-Encoding, described in IETF RFC 7694
          schema:
            type: string
    '307':
      description: Temporary Redirect
      content:
        application/json:
          schema:
            $ref: 'TS29571_CommonData.yaml#/components/schemas/RedirectResponse'
      headers:
        Location:
          description: The URI pointing to the resource located on the redirect target NRF
          required: true
          schema:
            type: string
    '308':
      description: Permanent Redirect
      content:
        application/json:
          schema:
            $ref: 'TS29571_CommonData.yaml#/components/schemas/RedirectResponse'
      headers:
        Location:
          description: The URI pointing to the resource located on the redirect target NRF
          required: true
          schema:
            type: string
    '400':
      $ref: 'TS29571_CommonData.yaml#/components/responses/400'
    '403':
      $ref: 'TS29571_CommonData.yaml#/components/responses/403'
    '404':
      $ref: 'TS29571_CommonData.yaml#/components/responses/404'
    '409':
      $ref: 'TS29571_CommonData.yaml#/components/responses/409'
    '411':
      $ref: 'TS29571_CommonData.yaml#/components/responses/411'
    '412':
      $ref: 'TS29571_CommonData.yaml#/components/responses/412'
    '413':
      $ref: 'TS29571_CommonData.yaml#/components/responses/413'
    '415':
      $ref: 'TS29571_CommonData.yaml#/components/responses/415'
    '429':
      $ref: 'TS29571_CommonData.yaml#/components/responses/429'
    '500':
      $ref: 'TS29571_CommonData.yaml#/components/responses/500'
```



```

'501':
  $ref: 'TS29571_CommonData.yaml#/components/responses/501'
'503':
  $ref: 'TS29571_CommonData.yaml#/components/responses/503'
default:
  $ref: 'TS29571_CommonData.yaml#/components/responses/default'
delete:
  summary: Deregisters a given NF Instance
  operationId: DeregisterNFInstance
  tags:
    - NF Instance ID (Document)
  parameters:
    - name: nfInstanceId
      in: path
      required: true
      description: Unique ID of the NF Instance to deregister
      schema:
        $ref: 'TS29571_CommonData.yaml#/components/schemas/NfInstanceId'
  responses:
    '204':
      description: Expected response to a successful deregistration
    '307':
      description: Temporary Redirect
      content:
        application/json:
          schema:
            $ref: 'TS29571_CommonData.yaml#/components/schemas/RedirectResponse'
      headers:
        Location:
          description: The URI pointing to the resource located on the redirect target NRF
          required: true
          schema:
            type: string
    '308':
      description: Permanent Redirect
      content:
        application/json:
          schema:
            $ref: 'TS29571_CommonData.yaml#/components/schemas/RedirectResponse'
      headers:
        Location:
          description: The URI pointing to the resource located on the redirect target NRF
          required: true
          schema:
            type: string
    '400':
      $ref: 'TS29571_CommonData.yaml#/components/responses/400'
    '401':
      $ref: 'TS29571_CommonData.yaml#/components/responses/401'
    '403':
      $ref: 'TS29571_CommonData.yaml#/components/responses/403'
    '404':
      $ref: 'TS29571_CommonData.yaml#/components/responses/404'
    '411':
      $ref: 'TS29571_CommonData.yaml#/components/responses/411'
    '429':
      $ref: 'TS29571_CommonData.yaml#/components/responses/429'
    '500':
      $ref: 'TS29571_CommonData.yaml#/components/responses/500'
    '501':
      $ref: 'TS29571_CommonData.yaml#/components/responses/501'
    '503':
      $ref: 'TS29571_CommonData.yaml#/components/responses/503'
  default:
    $ref: 'TS29571_CommonData.yaml#/components/responses/default'

/subscriptions:
  post:
    summary: Create a new subscription
    operationId: CreateSubscription
    tags:
      - Subscriptions (Collection)
    parameters:
      - name: Content-Encoding
        in: header
        description: Content-Encoding, described in IETF RFC 7231
        schema:
          type: string

```

```

- name: Accept-Encoding
  in: header
  description: Accept-Encoding, described in IETF RFC 7231
  schema:
    type: string
requestBody:
  content:
    application/json:
      schema:
        $ref: '#/components/schemas/SubscriptionData'
  required: true
responses:
  '201':
    description: Expected response to a valid request
    content:
      application/json:
        schema:
          $ref: '#/components/schemas/SubscriptionData'
    headers:
      Location:
        description: >
          Contains the URI of the newly created resource, according to the structure:
          {apiRoot}/nrf-nfm/v1/subscriptions/{subscriptionId}
        required: true
        schema:
          type: string
      Accept-Encoding:
        description: Accept-Encoding, described in IETF RFC 7694
        schema:
          type: string
      Content-Encoding:
        description: Content-Encoding, described in IETF RFC 7231
        schema:
          type: string
  '307':
    description: Temporary Redirect
    content:
      application/json:
        schema:
          $ref: 'TS29571_CommonData.yaml#/components/schemas/RedirectResponse'
    headers:
      Location:
        description: The URI pointing to the resource located on the redirect target NRF
        required: true
        schema:
          type: string
  '308':
    description: Permanent Redirect
    content:
      application/json:
        schema:
          $ref: 'TS29571_CommonData.yaml#/components/schemas/RedirectResponse'
    headers:
      Location:
        description: The URI pointing to the resource located on the redirect target NRF
        required: true
        schema:
          type: string
  '400':
    $ref: 'TS29571_CommonData.yaml#/components/responses/400'
  '401':
    $ref: 'TS29571_CommonData.yaml#/components/responses/401'
  '403':
    $ref: 'TS29571_CommonData.yaml#/components/responses/403'
  '404':
    $ref: 'TS29571_CommonData.yaml#/components/responses/404'
  '411':
    $ref: 'TS29571_CommonData.yaml#/components/responses/411'
  '413':
    $ref: 'TS29571_CommonData.yaml#/components/responses/413'
  '415':
    $ref: 'TS29571_CommonData.yaml#/components/responses/415'
  '429':
    $ref: 'TS29571_CommonData.yaml#/components/responses/429'
  '500':
    $ref: 'TS29571_CommonData.yaml#/components/responses/500'
  '501':
    $ref: 'TS29571_CommonData.yaml#/components/responses/501'

```

```
'503':
  $ref: 'TS29571_CommonData.yaml#/components/responses/503'
default:
  $ref: 'TS29571_CommonData.yaml#/components/responses/default'
callbacks:
  onNFStatusEvent:
    '{$request.body#/nfStatusNotificationUri}':
      post:
        parameters:
          - name: Content-Encoding
            in: header
            description: Content-Encoding, described in IETF RFC 7231
            schema:
              type: string
        requestBody:
          description: Notification Payload
          content:
            application/json:
              schema:
                $ref: '#/components/schemas/NotificationData'
        responses:
          '204':
            description: Expected response to a successful callback processing
            headers:
              Accept-Encoding:
                description: Accept-Encoding, described in IETF RFC 7694
                schema:
                  type: string
          '307':
            description: Temporary Redirect
            content:
              application/json:
                schema:
                  $ref: 'TS29571_CommonData.yaml#/components/schemas/RedirectResponse'
            headers:
              Location:
                description: >
                The URI pointing to the resource located on another NF service
                consumer instance
                required: true
                schema:
                  type: string
          '308':
            description: Permanent Redirect
            content:
              application/json:
                schema:
                  $ref: 'TS29571_CommonData.yaml#/components/schemas/RedirectResponse'
            headers:
              Location:
                description: >
                The URI pointing to the resource located on another NF service
                consumer instance
                required: true
                schema:
                  type: string
          '400':
            $ref: 'TS29571_CommonData.yaml#/components/responses/400'
          '401':
            $ref: 'TS29571_CommonData.yaml#/components/responses/401'
          '403':
            $ref: 'TS29571_CommonData.yaml#/components/responses/403'
          '404':
            $ref: 'TS29571_CommonData.yaml#/components/responses/404'
          '411':
            $ref: 'TS29571_CommonData.yaml#/components/responses/411'
          '413':
            $ref: 'TS29571_CommonData.yaml#/components/responses/413'
          '415':
            $ref: 'TS29571_CommonData.yaml#/components/responses/415'
          '429':
            $ref: 'TS29571_CommonData.yaml#/components/responses/429'
          '500':
            $ref: 'TS29571_CommonData.yaml#/components/responses/500'
          '501':
            $ref: 'TS29571_CommonData.yaml#/components/responses/501'
          '503':
            $ref: 'TS29571_CommonData.yaml#/components/responses/503'
```

```

    default:
      $ref: 'TS29571_CommonData.yaml#/components/responses/default'
/subscriptions/{subscriptionID}:
  patch:
    summary: Updates a subscription
    operationId: UpdateSubscription
    tags:
      - Subscription ID (Document)
    parameters:
      - name: subscriptionID
        in: path
        required: true
        description: Unique ID of the subscription to update
        schema:
          type: string
          pattern: '^([0-9]{5,6})-?[^-]+$'
      - name: Content-Encoding
        in: header
        description: Content-Encoding, described in IETF RFC 7231
        schema:
          type: string
      - name: Accept-Encoding
        in: header
        description: Accept-Encoding, described in IETF RFC 7231
        schema:
          type: string
    requestBody:
      content:
        application/json-patch+json:
          schema:
            type: array
            items:
              $ref: 'TS29571_CommonData.yaml#/components/schemas/PatchItem'
      required: true
    responses:
      '200':
        description: Expected response to a valid request
        content:
          application/json:
            schema:
              $ref: '#/components/schemas/SubscriptionData'
        headers:
          Accept-Encoding:
            description: Accept-Encoding, described in IETF RFC 7694
            schema:
              type: string
          Content-Encoding:
            description: Content-Encoding, described in IETF RFC 7231
            schema:
              type: string
      '204':
        description: No Content
        headers:
          Accept-Encoding:
            description: Accept-Encoding, described in IETF RFC 7694
            schema:
              type: string
      '307':
        description: Temporary Redirect
        content:
          application/json:
            schema:
              $ref: 'TS29571_CommonData.yaml#/components/schemas/RedirectResponse'
        headers:
          Location:
            description: The URI pointing to the resource located on the redirect target NRF
            required: true
            schema:
              type: string
      '308':
        description: Permanent Redirect
        content:
          application/json:
            schema:
              $ref: 'TS29571_CommonData.yaml#/components/schemas/RedirectResponse'
        headers:
          Location:

```

```

        description: The URI pointing to the resource located on the redirect target NRF
        required: true
        schema:
            type: string
    '400':
        $ref: 'TS29571_CommonData.yaml#/components/responses/400'
    '403':
        $ref: 'TS29571_CommonData.yaml#/components/responses/403'
    '404':
        $ref: 'TS29571_CommonData.yaml#/components/responses/404'
    '411':
        $ref: 'TS29571_CommonData.yaml#/components/responses/411'
    '413':
        $ref: 'TS29571_CommonData.yaml#/components/responses/413'
    '415':
        $ref: 'TS29571_CommonData.yaml#/components/responses/415'
    '429':
        $ref: 'TS29571_CommonData.yaml#/components/responses/429'
    '500':
        $ref: 'TS29571_CommonData.yaml#/components/responses/500'
    '501':
        $ref: 'TS29571_CommonData.yaml#/components/responses/501'
    '503':
        $ref: 'TS29571_CommonData.yaml#/components/responses/503'
    default:
        $ref: 'TS29571_CommonData.yaml#/components/responses/default'
delete:
    summary: Deletes a subscription
    operationId: RemoveSubscription
    tags:
        - Subscription ID (Document)
    parameters:
        - name: subscriptionID
          in: path
          required: true
          description: Unique ID of the subscription to remove
          schema:
            type: string
            pattern: '^[0-9]{5,6}-?[^-]+$'
    responses:
        '204':
            description: Expected response to a successful subscription removal
        '307':
            description: Temporary Redirect
            content:
                application/json:
                    schema:
                        $ref: 'TS29571_CommonData.yaml#/components/schemas/RedirectResponse'
            headers:
                Location:
                    description: The URI pointing to the resource located on the redirect target NRF
                    required: true
                    schema:
                        type: string
        '308':
            description: Permanent Redirect
            content:
                application/json:
                    schema:
                        $ref: 'TS29571_CommonData.yaml#/components/schemas/RedirectResponse'
            headers:
                Location:
                    description: The URI pointing to the resource located on the redirect target NRF
                    required: true
                    schema:
                        type: string
    '400':
        $ref: 'TS29571_CommonData.yaml#/components/responses/400'
    '401':
        $ref: 'TS29571_CommonData.yaml#/components/responses/401'
    '403':
        $ref: 'TS29571_CommonData.yaml#/components/responses/403'
    '404':
        $ref: 'TS29571_CommonData.yaml#/components/responses/404'
    '411':
        $ref: 'TS29571_CommonData.yaml#/components/responses/411'
    '413':
        $ref: 'TS29571_CommonData.yaml#/components/responses/413'

```

```

'415':
  $ref: 'TS29571_CommonData.yaml#/components/responses/415'
'429':
  $ref: 'TS29571_CommonData.yaml#/components/responses/429'
'500':
  $ref: 'TS29571_CommonData.yaml#/components/responses/500'
'501':
  $ref: 'TS29571_CommonData.yaml#/components/responses/501'
'503':
  $ref: 'TS29571_CommonData.yaml#/components/responses/503'
default:
  $ref: 'TS29571_CommonData.yaml#/components/responses/default'

```

components:

```

securitySchemes:
  oAuth2ClientCredentials:
    type: oauth2
    flows:
      clientCredentials:
        tokenUrl: '/oauth2/token'
        scopes:
          nrf-nfm: Access to the Nnrf_NFManagement API
          nrf-nfm:nf-instances:read: >
            Access to read the nf-instances resource, or an individual NF Instance ID resource

```

schemas:

```

NFProfile:
  description: Information of an NF Instance registered in the NRF
  type: object
  required:
    - nfInstanceId
    - nfType
    - nfStatus
  anyOf:
    - required: [ fqdn ]
    - required: [ ipv4Addresses ]
    - required: [ ipv6Addresses ]
  properties:
    nfInstanceId:
      $ref: 'TS29571_CommonData.yaml#/components/schemas/NfInstanceId'
    nfInstanceName:
      type: string
    nfType:
      $ref: '#/components/schemas/NFType'
    nfStatus:
      $ref: '#/components/schemas/NFStatus'
    collocatedNfInstances:
      type: array
      items:
        $ref: '#/components/schemas/CollocatedNfInstance'
      minimum: 1
    heartBeatTimer:
      type: integer
      minimum: 1
    plmnList:
      type: array
      items:
        $ref: 'TS29571_CommonData.yaml#/components/schemas/PlmnId'
      minItems: 1
    snpnList:
      type: array
      items:
        $ref: 'TS29571_CommonData.yaml#/components/schemas/PlmnIdNid'
      minItems: 1
    sNssais:
      type: array
      items:
        $ref: 'TS29571_CommonData.yaml#/components/schemas/ExtSnsai'
      minItems: 1
    perPlmnSnsaiList:
      type: array
      items:
        $ref: '#/components/schemas/PlmnSnsai'
      minItems: 1
    nsiList:
      type: array

```

```

    items:
      type: string
    minItems: 1
  fqdn:
    $ref: 'TS29571_CommonData.yaml#/components/schemas/Fqdn'
  interPlmnFqdn:
    $ref: 'TS29571_CommonData.yaml#/components/schemas/Fqdn'
  ipv4Addresses:
    type: array
    items:
      $ref: 'TS29571_CommonData.yaml#/components/schemas/Ipv4Addr'
    minItems: 1
  ipv6Addresses:
    type: array
    items:
      $ref: 'TS29571_CommonData.yaml#/components/schemas/Ipv6Addr'
    minItems: 1
  allowedPlmns:
    type: array
    items:
      $ref: 'TS29571_CommonData.yaml#/components/schemas/PlmnId'
    minItems: 1
  allowedSnpsns:
    type: array
    items:
      $ref: 'TS29571_CommonData.yaml#/components/schemas/PlmnIdNid'
    minItems: 1
  allowedNfTypes:
    type: array
    items:
      $ref: '#/components/schemas/NFType'
    minItems: 1
  allowedNfDomains:
    type: array
    items:
      type: string
    minItems: 1
  allowedNssais:
    type: array
    items:
      $ref: 'TS29571_CommonData.yaml#/components/schemas/ExtSnssai'
    minItems: 1
  priority:
    type: integer
    minimum: 0
    maximum: 65535
  capacity:
    type: integer
    minimum: 0
    maximum: 65535
  load:
    type: integer
    minimum: 0
    maximum: 100
  loadTimeStamp:
    $ref: 'TS29571_CommonData.yaml#/components/schemas/DateTime'
  locality:
    type: string
  udrInfo:
    $ref: '#/components/schemas/UdrInfo'
  udrInfoList:
    description: >
      A map (list of key-value pairs) where a (unique) valid JSON string
      serves as key of UdrInfo
    type: object
    additionalProperties:
      $ref: '#/components/schemas/UdrInfo'
    minProperties: 1
  udmInfo:
    $ref: '#/components/schemas/UdmInfo'
  udmInfoList:
    description: >
      A map (list of key-value pairs) where a (unique) valid JSON string
      serves as key of UdmInfo
    type: object
    additionalProperties:
      $ref: '#/components/schemas/UdmInfo'
    minProperties: 1

```

```
ausfInfo:
  $ref: '#/components/schemas/AusfInfo'
ausfInfoList:
  description: >
    A map (list of key-value pairs) where a (unique) valid JSON string
    serves as key of AusfInfo
  type: object
  additionalProperties:
    $ref: '#/components/schemas/AusfInfo'
  minProperties: 1
amfInfo:
  $ref: '#/components/schemas/AmfInfo'
amfInfoList:
  description: >
    A map (list of key-value pairs) where a (unique) valid JSON string
    serves as key of AmfInfo
  type: object
  additionalProperties:
    $ref: '#/components/schemas/AmfInfo'
  minProperties: 1
smfInfo:
  $ref: '#/components/schemas/SmfInfo'
smfInfoList:
  description: >
    A map (list of key-value pairs) where a (unique) valid JSON string
    serves as key of SmfInfo
  type: object
  additionalProperties:
    $ref: '#/components/schemas/SmfInfo'
  minProperties: 1
upfInfo:
  $ref: '#/components/schemas/UpfInfo'
upfInfoList:
  description: >
    A map (list of key-value pairs) where a (unique) valid JSON string
    serves as key of UpfInfo
  type: object
  additionalProperties:
    $ref: '#/components/schemas/UpfInfo'
  minProperties: 1
pcfInfo:
  $ref: '#/components/schemas/PcfInfo'
pcfInfoList:
  description: >
    A map (list of key-value pairs) where a (unique) valid JSON string
    serves as key of PcfInfo
  type: object
  additionalProperties:
    $ref: '#/components/schemas/PcfInfo'
  minProperties: 1
bsfInfo:
  $ref: '#/components/schemas/BsfInfo'
bsfInfoList:
  description: >
    A map (list of key-value pairs) where a (unique) valid JSON string
    serves as key of BsfInfo
  type: object
  additionalProperties:
    $ref: '#/components/schemas/BsfInfo'
  minProperties: 1
chfInfo:
  $ref: '#/components/schemas/ChfInfo'
chfInfoList:
  description: >
    A map (list of key-value pairs) where a (unique) valid JSON string
    serves as key of ChfInfo
  type: object
  additionalProperties:
    $ref: '#/components/schemas/ChfInfo'
  minProperties: 1
nefInfo:
  $ref: '#/components/schemas/NefInfo'
nrfInfo:
  $ref: '#/components/schemas/NrfInfo'
udsfInfo:
  $ref: '#/components/schemas/UdsfInfo'
udsfInfoList:
  description: >
```



```

    A map (list of key-value pairs) where a (unique) valid JSON string
    serves as key of UdsfInfo
  type: object
  additionalProperties:
    $ref: '#/components/schemas/UdsfInfo'
  minProperties: 1
  nwdafInfo:
    $ref: '#/components/schemas/NwdafInfo'
  nwdafInfoList:
    type: object
    description: >
      A map (list of key-value pairs) where a (unique) valid JSON string
      serves as key of NwdafInfo
    additionalProperties:
      $ref: '#/components/schemas/NwdafInfo'
    minProperties: 1
  pcscfInfoList:
    description: >
      A map (list of key-value pairs) where a (unique) valid JSON string
      serves as key of PcscfInfo
    type: object
    additionalProperties:
      $ref: '#/components/schemas/PcscfInfo'
    minProperties: 1
  hssInfoList:
    description: >
      A map (list of key-value pairs) where a (unique) valid JSON string
      serves as key of HssInfo
    type: object
    additionalProperties:
      $ref: '#/components/schemas/HssInfo'
    minProperties: 1
  customInfo:
    type: object
  recoveryTime:
    $ref: 'TS29571_CommonData.yaml#/components/schemas/DateTime'
  nfServicePersistence:
    type: boolean
    default: false
  nfServices:
    deprecated: true
    type: array
    items:
      $ref: '#/components/schemas/NFService'
    minItems: 1
  nfServiceList:
    description: >
      A map (list of key-value pairs) where serviceInstanceId serves as key of NFService
    type: object
    additionalProperties:
      $ref: '#/components/schemas/NFService'
    minProperties: 1
  nfProfileChangesSupportInd:
    type: boolean
    default: false
    writeOnly: true
  nfProfileChangesInd:
    type: boolean
    default: false
    readOnly: true
  defaultNotificationSubscriptions:
    type: array
    items:
      $ref: '#/components/schemas/DefaultNotificationSubscription'
  lmfInfo:
    $ref: '#/components/schemas/LmfInfo'
  gmlcInfo:
    $ref: '#/components/schemas/GmlcInfo'
  nfSetIdList:
    type: array
    items:
      $ref: 'TS29571_CommonData.yaml#/components/schemas/NfSetId'
    minItems: 1
  servingScope:
    type: array
    items:
      type: string
    minItems: 1

```

```

lcHSupportInd:
  type: boolean
  default: false
olcHSupportInd:
  type: boolean
  default: false
nfSetRecoveryTimeList:
  description: A map (list of key-value pairs) where NfSetId serves as key of DateTime
  type: object
  additionalProperties:
    $ref: 'TS29571_CommonData.yaml#/components/schemas/DateTime'
  minProperties: 1
serviceSetRecoveryTimeList:
  description: >
    A map (list of key-value pairs) where NfServiceSetId serves as key of DateTime
  type: object
  additionalProperties:
    $ref: 'TS29571_CommonData.yaml#/components/schemas/DateTime'
  minProperties: 1
scpDomains:
  type: array
  items:
    type: string
  minItems: 1
scpInfo:
  $ref: '#/components/schemas/ScpInfo'
seppInfo:
  $ref: '#/components/schemas/SeppInfo'
vendorId:
  $ref: '#/components/schemas/VendorId'
supportedVendorSpecificFeatures:
  description: >
    The key of the map is the IANA-assigned SMI Network Management Private Enterprise Codes
  type: object
  additionalProperties:
    type: array
    items:
      $ref: '#/components/schemas/VendorSpecificFeature'
    minItems: 1
  minProperties: 1
aanfInfoList:
  type: object
  description: >
    A map (list of key-value pairs) where a (unique) valid JSON string
    serves as key of AanfInfo
  additionalProperties:
    $ref: '#/components/schemas/AanfInfo'
  minProperties: 1
5gDdnmfInfo:
  $ref: '#/components/schemas/5GDdnmfInfo'
mfafInfo:
  $ref: '#/components/schemas/MfafInfo'
easdfInfoList:
  type: object
  description: >
    A map (list of key-value pairs) where a (unique) valid JSON string
    serves as key of EasdfInfo
  additionalProperties:
    $ref: '#/components/schemas/EasdfInfo'
  minProperties: 1
dccfInfo:
  $ref: '#/components/schemas/DccfInfo'
nsacfInfoList:
  description: >
    A map (list of key-value pairs) where a (unique) valid JSON string
    serves as key of NsacfInfo
  type: object
  additionalProperties:
    $ref: '#/components/schemas/NsacfInfo'
  minProperties: 1
mbSmfInfoList:
  description: >
    A map (list of key-value pairs) where a (unique) valid JSON string
    serves as key of MbSmfInfo
  type: object
  additionalProperties:
    $ref: '#/components/schemas/MbSmfInfo'
  minProperties: 1

```

```

tsctsInfoList:
  type: object
  description: >
    A map (list of key-value pairs) where a (unique) valid JSON string
    serves as key of TsctsInfo
  additionalProperties:
    $ref: '#/components/schemas/TsctsInfo'
  minProperties: 1
mbUpfInfoList:
  type: object
  description: >
    A map (list of key-value pairs) where a (unique) valid JSON string
    serves as key of MbUpfInfo
  additionalProperties:
    $ref: '#/components/schemas/MbUpfInfo'
  minProperties: 1
trustAfInfo:
  $ref: '#/components/schemas/TrustAfInfo'
nssaafInfo:
  $ref: '#/components/schemas/NssaafInfo'
hniList:
  type: array
  items:
    $ref: 'TS29571_CommonData.yaml#/components/schemas/Fqdn'
  minItems: 1
iwmscInfo:
  $ref: '#/components/schemas/IwmscInfo'
mnpfInfo:
  $ref: '#/components/schemas/MnpfInfo'

NFService:
  description: >
    Information of a given NF Service Instance; it is part of the NFProfile of an NF Instance
  type: object
  required:
    - serviceInstanceId
    - serviceName
    - versions
    - scheme
    - nfServiceStatus
  properties:
    serviceInstanceId:
      type: string
    serviceName:
      $ref: '#/components/schemas/ServiceName'
    versions:
      type: array
      items:
        $ref: '#/components/schemas/NFServiceVersion'
      minItems: 1
    scheme:
      $ref: 'TS29571_CommonData.yaml#/components/schemas/UriScheme'
    nfServiceStatus:
      $ref: '#/components/schemas/NFServiceStatus'
    fqdn:
      $ref: 'TS29571_CommonData.yaml#/components/schemas/Fqdn'
    interPlmnFqdn:
      $ref: 'TS29571_CommonData.yaml#/components/schemas/Fqdn'
    ipEndpoints:
      type: array
      items:
        $ref: '#/components/schemas/IpEndPoint'
      minItems: 1
    apiPrefix:
      type: string
    defaultNotificationSubscriptions:
      type: array
      items:
        $ref: '#/components/schemas/DefaultNotificationSubscription'
      minItems: 1
    allowedPlmns:
      type: array
      items:
        $ref: 'TS29571_CommonData.yaml#/components/schemas/PlmnId'
      minItems: 1
    allowedSnpsns:
      type: array
      items:

```

```

    $ref: 'TS29571_CommonData.yaml#/components/schemas/PlmnIdNid'
  minItems: 1
  allowedNfTypes:
    type: array
    items:
      $ref: '#/components/schemas/NfType'
  minItems: 1
  allowedNfDomains:
    type: array
    items:
      type: string
  minItems: 1
  allowedNssais:
    type: array
    items:
      $ref: 'TS29571_CommonData.yaml#/components/schemas/ExtSnssai'
  minItems: 1
  allowedOperationsPerNfType:
    description: A map (list of key-value pairs) where NF Type serves as key
    type: object
    additionalProperties:
      type: array
      items:
        type: string
    minItems: 1
  minProperties: 1
  allowedOperationsPerNfInstance:
    description: A map (list of key-value pairs) where NF Instance Id serves as key
    type: object
    additionalProperties:
      type: array
      items:
        type: string
    minItems: 1
  minProperties: 1
  priority:
    type: integer
    minimum: 0
    maximum: 65535
  capacity:
    type: integer
    minimum: 0
    maximum: 65535
  load:
    type: integer
    minimum: 0
    maximum: 100
  loadTimeStamp:
    $ref: 'TS29571_CommonData.yaml#/components/schemas/DateTime'
  recoveryTime:
    $ref: 'TS29571_CommonData.yaml#/components/schemas/DateTime'
  supportedFeatures:
    $ref: 'TS29571_CommonData.yaml#/components/schemas/SupportedFeatures'
  nfServiceSetIdList:
    type: array
    items:
      $ref: 'TS29571_CommonData.yaml#/components/schemas/NfServiceSetId'
    minItems: 1
  sNssais:
    type: array
    items:
      $ref: 'TS29571_CommonData.yaml#/components/schemas/ExtSnssai'
    minItems: 1
  perPlmnSnssaiList:
    type: array
    items:
      $ref: '#/components/schemas/PlmnSnssai'
    minItems: 1
  vendorId:
    $ref: '#/components/schemas/VendorId'
  supportedVendorSpecificFeatures:
    description: >
      A map (list of key-value pairs) where IANA-assigned SMI Network Management
      Private Enterprise Codes serves as key
    type: object
    additionalProperties:
      type: array
      items:

```

```
    $ref: '#/components/schemas/VendorSpecificFeature'
  minItems: 1
  minProperties: 1
  oauth2Required:
    type: boolean
  perPlmnOauth2ReqList:
    $ref: '#/components/schemas/PlmnOauth2'

NFType:
  description: NF types known to NRF
  anyOf:
  - type: string
    enum:
      - NRF
      - UDM
      - AMF
      - SMF
      - AUSF
      - NEF
      - PCF
      - SMSF
      - NSSF
      - UDR
      - LMF
      - GMLC
      - 5G_EIR
      - SEPP
      - UPF
      - N3IWF
      - AF
      - UDSF
      - BSF
      - CHF
      - NWDAF
      - PCSCF
      - CBCF
      - HSS
      - UCMF
      - SOR_AF
      - SPAF
      - MME
      - SCSAS
      - SCEF
      - SCP
      - NSSAAF
      - ICSCF
      - SCSCF
      - DRA
      - IMS_AS
      - AANF
      - 5G_DDNMF
      - NSACF
      - MFAF
      - EASDF
      - DCCF
      - MB_SMF
      - TSCTSF
      - ADRF
      - GBA_BSF
      - CEF
      - MB_UPF
      - NSWOF
      - PKMF
      - MNPF
      - SMS_GMSC
      - SMS_IWMSC
      - MBSF
      - MBSTF
      - PANF
  - type: string

NefId:
  description: Identity of the NEF
  type: string

IpEndPoint:
  description: >
  IP addressing information of a given NFService;
```

```

    it consists on, e.g. IP address, TCP port, transport protocol...
  type: object
  properties:
    ipv4Address:
      $ref: 'TS29571_CommonData.yaml#/components/schemas/Ipv4Addr'
    ipv6Address:
      $ref: 'TS29571_CommonData.yaml#/components/schemas/Ipv6Addr'
    transport:
      $ref: '#/components/schemas/TransportProtocol'
    port:
      type: integer
      minimum: 0
      maximum: 65535

```

```

SubscriptionData:
  description: >
    Information of a subscription to notifications to NRF events,
    included in subscription requests and responses
  type: object
  required:
    - nfStatusNotificationUri
    - subscriptionId
  properties:
    nfStatusNotificationUri:
      type: string
    reqNfInstanceId:
      $ref: 'TS29571_CommonData.yaml#/components/schemas/NfInstanceId'
    subscrCond:
      $ref: '#/components/schemas/SubscrCond'
    subscriptionId:
      type: string
      pattern: '^([0-9]{5,6})-?[^-]+$'
      readOnly: true
    validityTime:
      $ref: 'TS29571_CommonData.yaml#/components/schemas/DateTime'
    reqNotifEvents:
      type: array
      items:
        $ref: '#/components/schemas/NotificationEventType'
      minItems: 1
    plmnId:
      $ref: 'TS29571_CommonData.yaml#/components/schemas/PlmnId'
    nid:
      $ref: 'TS29571_CommonData.yaml#/components/schemas/Nid'
    notifCondition:
      $ref: '#/components/schemas/NotifCondition'
    reqNfType:
      $ref: '#/components/schemas/NFType'
    reqNfFqdn:
      $ref: 'TS29571_CommonData.yaml#/components/schemas/Fqdn'
    reqSnssais:
      type: array
      items:
        $ref: 'TS29571_CommonData.yaml#/components/schemas/ExtSnssai'
      minItems: 1
    reqPerPlmnSnssais:
      type: array
      items:
        $ref: '#/components/schemas/PlmnSnssai'
      minItems: 1
    reqPlmnList:
      type: array
      items:
        $ref: 'TS29571_CommonData.yaml#/components/schemas/PlmnId'
      minItems: 1
    reqSnpnList:
      type: array
      items:
        $ref: 'TS29571_CommonData.yaml#/components/schemas/PlmnIdNid'
      minItems: 1
    servingScope:
      type: array
      items:
        type: string
      minItems: 1
    requesterFeatures:
      writeOnly: true
    allOf:

```

```

    - $ref: 'TS29571_CommonData.yaml#/components/schemas/SupportedFeatures'
  nrfSupportedFeatures:
    readOnly: true
    allOf:
      - $ref: 'TS29571_CommonData.yaml#/components/schemas/SupportedFeatures'
  hnrUri:
    $ref: 'TS29571_CommonData.yaml#/components/schemas/Uri'
  onboardingCapability:
    type: boolean
    default: false
  targetHni:
    $ref: 'TS29571_CommonData.yaml#/components/schemas/Fqdn'
  preferredLocality:
    type: string

SubscrCond:
  description: >
    Condition to determine the set of NFs to monitor under a certain subscription in NRF
  oneOf:
    - $ref: '#/components/schemas/NfInstanceIdCond'
    - $ref: '#/components/schemas/NfInstanceIdListCond'
    - $ref: '#/components/schemas/NfTypeCond'
    - $ref: '#/components/schemas/ServiceNameCond'
    - $ref: '#/components/schemas/ServiceNameListCond'
    - $ref: '#/components/schemas/AmfCond'
    - $ref: '#/components/schemas/GuamiListCond'
    - $ref: '#/components/schemas/NetworkSliceCond'
    - $ref: '#/components/schemas/NfGroupCond'
    - $ref: '#/components/schemas/NfGroupListCond'
    - $ref: '#/components/schemas/NfSetCond'
    - $ref: '#/components/schemas/NfServiceSetCond'
    - $ref: '#/components/schemas/UpfCond'
    - $ref: '#/components/schemas/ScpDomainCond'
    - $ref: '#/components/schemas/NwdafCond'
    - $ref: '#/components/schemas/NefCond'
    - $ref: '#/components/schemas/DccfCond'

NfInstanceIdCond:
  description: Subscription to a given NF Instance Id
  type: object
  required:
    - nInstanceId
  properties:
    nInstanceId:
      $ref: 'TS29571_CommonData.yaml#/components/schemas/NfInstanceId'

NfInstanceIdListCond:
  description: Subscription to a list of NF Instances
  type: object
  required:
    - nInstanceIdList
  properties:
    nInstanceIdList:
      type: array
      items:
        $ref: 'TS29571_CommonData.yaml#/components/schemas/NfInstanceId'
      minItems: 1

NfTypeCond:
  description: Subscription to a set of NFs based on their NF Type
  type: object
  required:
    - nType
  not:
    required: [ nGroupId ]
  properties:
    nType:
      $ref: '#/components/schemas/NFType'

ServiceNameCond:
  description: Subscription to a set of NFs based on their support for a given Service Name
  type: object
  required:
    - serviceName
  properties:
    serviceName:
      $ref: '#/components/schemas/ServiceName'

```

```

ServiceNameListCond:
  description: >
    Subscription to a set of NFs based on their support for a Service Name
    in the Servic Name list
  type: object
  required:
    - conditionType
    - serviceNameList
  properties:
    conditionType:
      type: string
      enum: [ SERVICE_NAME_LIST_COND ]
    serviceNameList:
      type: array
      items:
        $ref: '#/components/schemas/ServiceName'
      minItems: 1

AmfCond:
  description: Subscription to a set of AMFs, based on AMF Set Id and/or AMF Region Id
  type: object
  anyOf:
    - required: [ amfSetId ]
    - required: [ amfRegionId ]
  properties:
    amfSetId:
      $ref: 'TS29571_CommonData.yaml#/components/schemas/AmfSetId'
    amfRegionId:
      $ref: 'TS29571_CommonData.yaml#/components/schemas/AmfRegionId'

GuamiListCond:
  description: Subscription to a set of AMFs, based on their GUAMIs
  type: object
  required:
    - guamiList
  properties:
    guamiList:
      type: array
      items:
        $ref: 'TS29571_CommonData.yaml#/components/schemas/Guami'

NetworkSliceCond:
  description: Subscription to a set of NFs, based on the slices (S-NSSAI and NSI) they support
  type: object
  required:
    - snssaiList
  properties:
    snssaiList:
      type: array
      items:
        $ref: 'TS29571_CommonData.yaml#/components/schemas/Snssai'
    nsilist:
      type: array
      items:
        type: string

NfGroupCond:
  description: Subscription to a set of NFs based on their Group Id
  type: object
  required:
    - nfType
    - nfGroupId
  properties:
    nfType:
      type: string
      enum:
        - UDM
        - AUSF
        - UDR
        - PCF
        - CHF
        - HSS
    nfGroupId:
      $ref: 'TS29571_CommonData.yaml#/components/schemas/NfGroupId'

NfGroupListCond:
  description: Subscription to a set of NFs based on their Group Ids
  type: object

```



```

required:
- conditionType
- nfType
- nfGroupIdList
properties:
conditionType:
type: string
enum: [ NF_GROUP_LIST_COND ]
nfType:
type: string
enum:
- UDM
- AUSF
- UDR
- PCF
- CHF
- HSS
nfGroupIdList:
type: array
items:
$ref: 'TS29571_CommonData.yaml#/components/schemas/NfGroupId'
minItems: 1

NotifCondition:
description: >
Condition (list of attributes in the NF Profile) to determine whether a notification
must be sent by NRF
type: object
not:
required: [ monitoredAttributes, unmonitoredAttributes ]
properties:
monitoredAttributes:
type: array
items:
type: string
minItems: 1
unmonitoredAttributes:
type: array
items:
type: string
minItems: 1

UdrInfo:
description: Information of an UDR NF Instance
type: object
properties:
groupId:
$ref: 'TS29571_CommonData.yaml#/components/schemas/NfGroupId'
supiRanges:
type: array
items:
$ref: '#/components/schemas/SupiRange'
minItems: 1
gpsiRanges:
type: array
items:
$ref: '#/components/schemas/IdentityRange'
minItems: 1
externalGroupIdentifiersRanges:
type: array
items:
$ref: '#/components/schemas/IdentityRange'
minItems: 1
supportedDataSets:
type: array
items:
$ref: '#/components/schemas/DataSetId'
minItems: 1
sharedDataIdRanges:
type: array
items:
$ref: '#/components/schemas/SharedDataIdRange'
minItems: 1

SharedDataIdRange:
description: A range of SharedDataIds based on regular-expression matching
type: object
properties:

```

```

    pattern:
      type: string

SupiRange:
  description: >
    A range of SUPIs (subscriber identities), either based on a numeric range,
    or based on regular-expression matching
  type: object
  properties:
    start:
      type: string
      pattern: '^[0-9]+$'
    end:
      type: string
      pattern: '^[0-9]+$'
    pattern:
      type: string

IdentityRange:
  description: >
    A range of GPSIs (subscriber identities), either based on a numeric range,
    or based on regular-expression matching
  type: object
  properties:
    start:
      type: string
      pattern: '^[0-9]+$'
    end:
      type: string
      pattern: '^[0-9]+$'
    pattern:
      type: string

InternalGroupIdRange:
  description: >
    A range of Group IDs (internal group identities), either based on a numeric range,
    or based on regular-expression matching
  type: object
  properties:
    start:
      $ref: 'TS29571_CommonData.yaml#/components/schemas/GroupId'
    end:
      $ref: 'TS29571_CommonData.yaml#/components/schemas/GroupId'
    pattern:
      type: string

DataSetId:
  description: Types of data sets and subsets stored in UDR
  anyOf:
    - type: string
      enum:
        - SUBSCRIPTION
        - POLICY
        - EXPOSURE
        - APPLICATION
        - A_PFD
        - A_AFTI
        - A_IPTV
        - A_BDT
        - A_SPD
        - A_EASD
        - A_AMI
        - P_UE
        - P_SCD
        - P_BDT
        - P_PLMNUE
        - P_NSSCD
    - type: string

UdmInfo:
  description: Information of an UDM NF Instance
  type: object
  properties:
    groupId:
      $ref: 'TS29571_CommonData.yaml#/components/schemas/NfGroupId'
    supiRanges:
      type: array
      items:

```

```

    $ref: '#/components/schemas/SupiRange'
    minItems: 1
  gpsiRanges:
    type: array
    items:
      $ref: '#/components/schemas/IdentityRange'
    minItems: 1
  externalGroupIdentifiersRanges:
    type: array
    items:
      $ref: '#/components/schemas/IdentityRange'
    minItems: 1
  routingIndicators:
    type: array
    items:
      type: string
      pattern: '^[0-9]{1,4}$'
    minItems: 1
  internalGroupIdentifiersRanges:
    type: array
    items:
      $ref: '#/components/schemas/InternalGroupIdRange'
    minItems: 1
  suciInfos:
    type: array
    items:
      $ref: '#/components/schemas/SuciInfo'
    minItems: 1

AusfInfo:
  description: Information of an AUSF NF Instance
  type: object
  properties:
    groupId:
      $ref: 'TS29571_CommonData.yaml#/components/schemas/NfGroupId'
    supiRanges:
      type: array
      items:
        $ref: '#/components/schemas/SupiRange'
      minItems: 1
    routingIndicators:
      type: array
      items:
        type: string
        pattern: '^[0-9]{1,4}$'
      minItems: 1
    suciInfos:
      type: array
      items:
        $ref: '#/components/schemas/SuciInfo'
      minItems: 1

AmfInfo:
  description: Information of an AMF NF Instance
  type: object
  required:
    - amfSetId
    - amfRegionId
    - guamiList
  properties:
    amfSetId:
      $ref: 'TS29571_CommonData.yaml#/components/schemas/AmfSetId'
    amfRegionId:
      $ref: 'TS29571_CommonData.yaml#/components/schemas/AmfRegionId'
    guamiList:
      type: array
      items:
        $ref: 'TS29571_CommonData.yaml#/components/schemas/Guami'
      minItems: 1
    taiList:
      type: array
      items:
        $ref: 'TS29571_CommonData.yaml#/components/schemas/Tai'
      minItems: 1
    taiRangeList:
      type: array
      items:
        $ref: '#/components/schemas/TaiRange'

```

```

    minItems: 1
  backupInfoAmfFailure:
    type: array
    items:
      $ref: 'TS29571_CommonData.yaml#/components/schemas/Guami'
    minItems: 1
  backupInfoAmfRemoval:
    type: array
    items:
      $ref: 'TS29571_CommonData.yaml#/components/schemas/Guami'
    minItems: 1
  n2InterfaceAmfInfo:
    $ref: '#/components/schemas/N2InterfaceAmfInfo'
  amfOnboardingCapability:
    type: boolean
    default: false

SmfInfo:
  description: Information of an SMF NF Instance
  type: object
  required:
    - sNssaiSmfInfoList
  properties:
    sNssaiSmfInfoList:
      type: array
      items:
        $ref: '#/components/schemas/SnssaiSmfInfoItem'
      minItems: 1
    taiList:
      type: array
      items:
        $ref: 'TS29571_CommonData.yaml#/components/schemas/Tai'
      minItems: 1
    taiRangeList:
      type: array
      items:
        $ref: '#/components/schemas/TaiRange'
      minItems: 1
    pgwFqdn:
      $ref: 'TS29571_CommonData.yaml#/components/schemas/Fqdn'
    pgwIpAddrList:
      type: array
      items:
        $ref: 'TS29571_CommonData.yaml#/components/schemas/IpAddr'
      minItems: 1
    accessType:
      type: array
      items:
        $ref: 'TS29571_CommonData.yaml#/components/schemas/AccessType'
      minItems: 1
    priority:
      type: integer
      minimum: 0
      maximum: 65535
    vsmfSupportInd:
      type: boolean
    pgwFqdnList:
      type: array
      items:
        $ref: 'TS29571_CommonData.yaml#/components/schemas/Fqdn'
      minItems: 1
    smfOnboardingCapability:
      type: boolean
      default: false
      deprecated: true
    ismfSupportInd:
      type: boolean
    smfUPRPCapability:
      type: boolean
      default: false

SnssaiSmfInfoItem:
  description: Set of parameters supported by SMF for a given S-NSSAI
  type: object
  required:
    - sNssai
    - dnnSmfInfoList
  properties:

```

```

sNssai:
  $ref: 'TS29571_CommonData.yaml#/components/schemas/ExtSnsai'
dnnSmfInfoList:
  type: array
  items:
    $ref: '#/components/schemas/DnnSmfInfoItem'
  minItems: 1

DnnSmfInfoItem:
  description: Set of parameters supported by SMF for a given DNN
  type: object
  required:
    - dnn
  properties:
    dnn:
      anyOf:
        - $ref: 'TS29571_CommonData.yaml#/components/schemas/Dnn'
        - $ref: 'TS29571_CommonData.yaml#/components/schemas/WildcardDnn'
    dnaiList:
      type: array
      items:
        anyOf:
          - $ref: 'TS29571_CommonData.yaml#/components/schemas/Dnai'
          - $ref: '#/components/schemas/WildcardDnai'
      minItems: 1

UpfInfo:
  description: Information of an UPF NF Instance
  type: object
  required:
    - sNssaiUpfInfoList
  properties:
    sNssaiUpfInfoList:
      type: array
      items:
        $ref: '#/components/schemas/SnsaiUpfInfoItem'
      minItems: 1
    smfServingArea:
      type: array
      items:
        type: string
        minItems: 1
    interfaceUpfInfoList:
      type: array
      items:
        $ref: '#/components/schemas/InterfaceUpfInfoItem'
      minItems: 1
    iwkEpsInd:
      type: boolean
      default: false
    pduSessionTypes:
      type: array
      items:
        $ref: 'TS29571_CommonData.yaml#/components/schemas/PduSessionType'
      minItems: 1
    atsssCapability:
      $ref: 'TS29571_CommonData.yaml#/components/schemas/AtsssCapability'
    ueIpAddrInd:
      type: boolean
      default: false
    taiList:
      type: array
      items:
        $ref: 'TS29571_CommonData.yaml#/components/schemas/Tai'
      minItems: 1
    taiRangeList:
      type: array
      items:
        $ref: '#/components/schemas/TaiRange'
      minItems: 1
    wAgfInfo:
      $ref: '#/components/schemas/WAgfInfo'
    tngfInfo:
      $ref: '#/components/schemas/TngfInfo'
    twifInfo:
      $ref: '#/components/schemas/TwifInfo'
  priority:
    type: integer

```

```

    minimum: 0
    maximum: 65535
  redundantGtpu:
    type: boolean
    default: false
  ipups:
    type: boolean
    default: false
  dataForwarding:
    type: boolean
    default: false
  supportedPfcFeatures:
    type: string

SnssaiUpfInfoItem:
  description: Set of parameters supported by UPF for a given S-NSSAI
  type: object
  required:
    - sNssai
    - dnnUpfInfoList
  properties:
    sNssai:
      $ref: 'TS29571_CommonData.yaml#/components/schemas/ExtSnssai'
    dnnUpfInfoList:
      type: array
      items:
        $ref: '#/components/schemas/DnnUpfInfoItem'
      minItems: 1
    redundantTransport:
      type: boolean
      default: false

DnnUpfInfoItem:
  description: Set of parameters supported by UPF for a given DNN
  type: object
  required:
    - dnn
  properties:
    dnn:
      $ref: 'TS29571_CommonData.yaml#/components/schemas/Dnn'
    dnaiList:
      type: array
      items:
        $ref: 'TS29571_CommonData.yaml#/components/schemas/Dnai'
      minItems: 1
    pduSessionTypes:
      type: array
      items:
        $ref: 'TS29571_CommonData.yaml#/components/schemas/PduSessionType'
      minItems: 1
    ipv4AddressRanges:
      type: array
      items:
        $ref: '#/components/schemas/Ipv4AddressRange'
      minItems: 1
    ipv6PrefixRanges:
      type: array
      items:
        $ref: '#/components/schemas/Ipv6PrefixRange'
      minItems: 1
    ipv4IndexList:
      type: array
      items:
        $ref: 'TS29503_Nudm_SDM.yaml#/components/schemas/IpIndex'
      minItems: 1
    ipv6IndexList:
      type: array
      items:
        $ref: 'TS29503_Nudm_SDM.yaml#/components/schemas/IpIndex'
      minItems: 1
    dnaiNwInstanceList:
      description: >
        Map of network instance per DNAI for the DNN, where the key of the map is the DNAI.
        When present, the value of each entry of the map shall contain a N6 network instance
        that is configured for the DNAI indicated by the key.
      type: object
      additionalProperties:
        type: string

```

```

    minProperties: 1

InterfaceUpfInfoItem:
  description: Information of a given IP interface of an UPF
  type: object
  required:
    - interfaceType
  properties:
    interfaceType:
      $ref: '#/components/schemas/UPInterfaceType'
    ipv4EndpointAddresses:
      type: array
      items:
        $ref: 'TS29571_CommonData.yaml#/components/schemas/Ipv4Addr'
      minItems: 1
    ipv6EndpointAddresses:
      type: array
      items:
        $ref: 'TS29571_CommonData.yaml#/components/schemas/Ipv6Addr'
      minItems: 1
    endpointFqdn:
      $ref: 'TS29571_CommonData.yaml#/components/schemas/Fqdn'
    networkInstance:
      type: string

UPInterfaceType:
  description: Types of User-Plane interfaces of the UPF
  anyOf:
    - type: string
      enum:
        - N3
        - N6
        - N9
        - DATA_FORWARDING
        - N3MB
        - N6MB
        - N19MB
        - NMB9
    - type: string

WAgfInfo:
  description: Information of the W-AGF end-points
  type: object
  properties:
    ipv4EndpointAddresses:
      type: array
      items:
        $ref: 'TS29571_CommonData.yaml#/components/schemas/Ipv4Addr'
      minItems: 1
    ipv6EndpointAddresses:
      type: array
      items:
        $ref: 'TS29571_CommonData.yaml#/components/schemas/Ipv6Addr'
      minItems: 1
    endpointFqdn:
      $ref: 'TS29571_CommonData.yaml#/components/schemas/Fqdn'

TngfInfo:
  description: Infomation of the TNGF endpoints
  type: object
  properties:
    ipv4EndpointAddresses:
      type: array
      items:
        $ref: 'TS29571_CommonData.yaml#/components/schemas/Ipv4Addr'
      minItems: 1
    ipv6EndpointAddresses:
      type: array
      items:
        $ref: 'TS29571_CommonData.yaml#/components/schemas/Ipv6Addr'
      minItems: 1
    endpointFqdn:
      $ref: 'TS29571_CommonData.yaml#/components/schemas/Fqdn'

PcfInfo:
  description: Information of a PCF NF Instance
  type: object
  properties:

```

```

    groupId:
      $ref: 'TS29571_CommonData.yaml#/components/schemas/NfGroupId'
    dnnList:
      type: array
      items:
        $ref: 'TS29571_CommonData.yaml#/components/schemas/Dnn'
      minItems: 1
    supiRanges:
      type: array
      items:
        $ref: '#/components/schemas/SupiRange'
      minItems: 1
    gpsiRanges:
      type: array
      items:
        $ref: '#/components/schemas/IdentityRange'
      minItems: 1
    rxDiamHost:
      $ref: 'TS29571_CommonData.yaml#/components/schemas/DiameterIdentity'
    rxDiamRealm:
      $ref: 'TS29571_CommonData.yaml#/components/schemas/DiameterIdentity'
    v2xSupportInd:
      type: boolean
      default: false
    proseSupportInd:
      type: boolean
      default: false
    proseCapability:
      $ref: '#/components/schemas/ProSeCapability'
    v2xCapability:
      $ref: '#/components/schemas/V2xCapability'

BsfInfo:
  description: Information of a BSF NF Instance
  type: object
  properties:
    dnnList:
      type: array
      items:
        $ref: 'TS29571_CommonData.yaml#/components/schemas/Dnn'
      minItems: 1
    ipDomainList:
      type: array
      items:
        type: string
        minItems: 1
    ipv4AddressRanges:
      type: array
      items:
        $ref: '#/components/schemas/Ipv4AddressRange'
      minItems: 1
    ipv6PrefixRanges:
      type: array
      items:
        $ref: '#/components/schemas/Ipv6PrefixRange'
      minItems: 1
    rxDiamHost:
      $ref: 'TS29571_CommonData.yaml#/components/schemas/DiameterIdentity'
    rxDiamRealm:
      $ref: 'TS29571_CommonData.yaml#/components/schemas/DiameterIdentity'
    groupId:
      $ref: 'TS29571_CommonData.yaml#/components/schemas/NfGroupId'
    supiRanges:
      type: array
      items:
        $ref: '#/components/schemas/SupiRange'
      minItems: 1
    gpsiRanges:
      type: array
      items:
        $ref: '#/components/schemas/IdentityRange'
      minItems: 1

ChfInfo:
  description: Information of a CHF NF Instance
  type: object
  not:
    required: [ primaryChfInstance, secondaryChfInstance ]

```



```

properties:
  supiRangeList:
    type: array
    items:
      $ref: '#/components/schemas/SupiRange'
    minItems: 1
  gpsiRangeList:
    type: array
    items:
      $ref: '#/components/schemas/IdentityRange'
    minItems: 1
  plmnRangeList:
    type: array
    items:
      $ref: '#/components/schemas/PlmnRange'
    minItems: 1
  groupId:
    $ref: 'TS29571_CommonData.yaml#/components/schemas/NfGroupId'
  primaryChfInstance:
    $ref: 'TS29571_CommonData.yaml#/components/schemas/NfInstanceId'
  secondaryChfInstance:
    $ref: 'TS29571_CommonData.yaml#/components/schemas/NfInstanceId'

Ipv4AddressRange:
  description: Range of IPv4 addresses
  type: object
  properties:
    start:
      $ref: 'TS29571_CommonData.yaml#/components/schemas/Ipv4Addr'
    end:
      $ref: 'TS29571_CommonData.yaml#/components/schemas/Ipv4Addr'

Ipv6PrefixRange:
  description: Range of IPv6 prefixes
  type: object
  properties:
    start:
      $ref: 'TS29571_CommonData.yaml#/components/schemas/Ipv6Prefix'
    end:
      $ref: 'TS29571_CommonData.yaml#/components/schemas/Ipv6Prefix'

DefaultNotificationSubscription:
  description: >
    Data structure for specifying the notifications the NF service subscribes by default,
    along with callback URI
  type: object
  required:
    - notificationType
    - callbackUri
  properties:
    notificationType:
      $ref: '#/components/schemas/NotificationType'
    callbackUri:
      $ref: 'TS29571_CommonData.yaml#/components/schemas/Uri'
    nlMessageClass:
      $ref: 'TS29518_Namf_Communication.yaml#/components/schemas/NlMessageClass'
    n2InformationClass:
      $ref: 'TS29518_Namf_Communication.yaml#/components/schemas/N2InformationClass'
  versions:
    type: array
    items:
      type: string
    minItems: 1
  binding:
    type: string
  acceptedEncoding:
    type: string
  supportedFeatures:
    $ref: 'TS29571_CommonData.yaml#/components/schemas/SupportedFeatures'
  serviceInfoList:
    description: >
      A map of service specific information. The name of the corresponding service (as
      specified in ServiceName data type) is the key.
    type: object
    additionalProperties:
      $ref: '#/components/schemas/DefSubServiceInfo'
    minProperties: 1

```

```

NfSetCond:
  description: Subscription to a set of NFs based on their Set Id
  type: object
  required:
    - nfSetId
  properties:
    nfSetId:
      $ref: 'TS29571_CommonData.yaml#/components/schemas/NfSetId'

NfServiceSetCond:
  description: Subscription to a set of NFs based on their Service Set Id
  type: object
  required:
    - nfServiceSetId
  properties:
    nfServiceSetId:
      $ref: 'TS29571_CommonData.yaml#/components/schemas/NfServiceSetId'
    nfSetId:
      $ref: 'TS29571_CommonData.yaml#/components/schemas/NfSetId'

UpfCond:
  description: >
    Subscription to a set of NF Instances (UPFs), able to serve a certain service area
    (i.e. SMF serving area or TAI list)
  type: object
  required:
    - conditionType
  properties:
    conditionType:
      type: string
      enum: [ UPF_COND ]
    smfServingArea:
      type: array
      items:
        type: string
      minItems: 1
    taiList:
      type: array
      items:
        $ref: 'TS29571_CommonData.yaml#/components/schemas/Tai'
      minItems: 1

NwdafCond:
  description: >
    Subscription to a set of NF Instances (NWDAFs), identified by Analytics ID(s),
    S-NSSAI(s) or NWDAF Serving Area information, i.e. list of TAIs for which the NWDAF
    can provide analytics.
  type: object
  required:
    - conditionType
  properties:
    conditionType:
      type: string
      enum: [ NWDAF_COND ]
    analyticsIds:
      type: array
      items:
        type: string
      minItems: 1
    snssaiList:
      type: array
      items:
        $ref: 'TS29571_CommonData.yaml#/components/schemas/Snssai'
      minItems: 1
    taiList:
      type: array
      items:
        $ref: 'TS29571_CommonData.yaml#/components/schemas/Tai'
      minItems: 1
    taiRangeList:
      type: array
      items:
        $ref: '#/components/schemas/TaiRange'
      minItems: 1
    servingNfTypeList:
      type: array
      items:
        $ref: '#/components/schemas/NFType'

```

```

    minItems: 1
    servingNfSetIdList:
      type: array
      items:
        $ref: 'TS29571_CommonData.yaml#/components/schemas/NfSetId'
    minItems: 1
    mlAnalyticsList:
      type: array
      items:
        $ref: '#/components/schemas/MLAnalyticsInfo'
    minItems: 1
NefCond:
  description: >
    Subscription to a set of NF Instances (NEFs), identified by Event ID(s) provided by AF,
    S-NSSAI(s), AF Instance ID, Application Identifier, External Identifier,
    External Group Identifier, or domain name.
  type: object
  required:
    - conditionType
  properties:
    conditionType:
      type: string
      enum: [ NEF_COND ]
    afEvents:
      type: array
      items:
        $ref: 'TS29517_Naf_EventExposure.yaml#/components/schemas/AfEvent'
      minItems: 1
    snssaiList:
      type: array
      items:
        $ref: 'TS29571_CommonData.yaml#/components/schemas/Snssai'
      minItems: 1
    pfdData:
      $ref: '#/components/schemas/PfdData'
    gpsiRanges:
      type: array
      items:
        $ref: '#/components/schemas/IdentityRange'
      minItems: 1
    externalGroupIdentifiersRanges:
      type: array
      items:
        $ref: '#/components/schemas/IdentityRange'
      minItems: 1
    servedFqdnList:
      type: array
      items:
        type: string
      minItems: 1
NotificationType:
  description: >
    Types of notifications used in Default Notification URIs in the NF Profile of an NF Instance
  anyOf:
    - type: string
      enum:
        - N1_MESSAGES
        - N2_INFORMATION
        - LOCATION_NOTIFICATION
        - DATA_REMOVAL_NOTIFICATION
        - DATA_CHANGE_NOTIFICATION
        - LOCATION_UPDATE_NOTIFICATION
        - NSSAA_REAUTH_NOTIFICATION
        - NSSAA_REVOC_NOTIFICATION
        - MATCH_INFO_NOTIFICATION
        - DATA_RESTITUTION_NOTIFICATION
        - TSCTS_NOTIFICATION
        - LCS_KEY_DELIVERY_NOTIFICATION
    - type: string
TransportProtocol:
  description: Types of transport protocol used in a given IP endpoint of an NF Service Instance
  anyOf:
    - type: string
      enum:
        - TCP

```

```

- type: string

NotificationEventType:
description: Types of events sent in notifications from NRF to subscribed NF Instances
anyOf:
- type: string
  enum:
  - NF_REGISTERED
  - NF_DEREGISTERED
  - NF_PROFILE_CHANGED
- type: string

NotificationData:
description: Data sent in notifications from NRF to subscribed NF Instances
type: object
required:
- event
- nfInstanceUri
allOf:
#
# Condition: If 'event' takes value 'NF_PROFILE_CHANGED',
# then either 'nfProfile' or 'profileChanges' (but not both) must be present
#
- anyOf:
- not:
  properties:
    event:
      type: string
      enum:
      - NF_PROFILE_CHANGED
- oneOf:
  - required: [ nfProfile ]
  - required: [ profileChanges ]
#
# Condition: If 'event' takes value 'NF_REGISTERED',
# then 'nfProfile' must be present
#
- anyOf:
- not:
  properties:
    event:
      type: string
      enum:
      - NF_REGISTERED
- required: [ nfProfile ]
properties:
  event:
    $ref: '#/components/schemas/NotificationEventType'
  nfInstanceUri:
    $ref: 'TS29571_CommonData.yaml#/components/schemas/Uri'
  nfProfile:
    allOf:
    - $ref: '#/components/schemas/NFProfile'
    - not:
      required: [ interPlmnFqdn ]
    - not:
      required: [ allowedPlmns ]
    - not:
      required: [ allowedSnpsns ]
    - not:
      required: [ allowedNfTypes ]
    - not:
      required: [ allowedNfDomains ]
    - not:
      required: [ allowedNssais ]
    - properties:
      nfServices:
        type: array
        items:
          allOf:
          - $ref: '#/components/schemas/NFService'
          - not:
            required: [ interPlmnFqdn ]
          - not:
            required: [ allowedPlmns ]
          - not:
            required: [ allowedSnpsns ]
          - not:

```

```

        required: [ allowedNfTypes ]
    - not:
        required: [ allowedNfDomains ]
    - not:
        required: [ allowedNssais ]
profileChanges:
  type: array
  items:
    $ref: 'TS29571_CommonData.yaml#/components/schemas/ChangeItem'
  minItems: 1
conditionEvent:
  $ref: '#/components/schemas/ConditionEventType'
subscriptionContext:
  $ref: '#/components/schemas/SubscriptionContext'

NFStatus:
description: Status of a given NF Instance stored in NRF
anyOf:
  - type: string
  enum:
    - REGISTERED
    - SUSPENDED
    - UNDISCOVERABLE
  - type: string

NFServiceVersion:
description: Contains the version details of an NF service
type: object
required:
  - apiVersionInUri
  - apiFullVersion
properties:
  apiVersionInUri:
    type: string
  apiFullVersion:
    type: string
  expiry:
    $ref: 'TS29571_CommonData.yaml#/components/schemas/DateTime'

ServiceName:
description: Service names known to NRF
anyOf:
  - type: string
  enum:
    - nnrf-nfm
    - nnrf-disc
    - nnrf-oauth2
    - nudm-sdm
    - nudm-uecm
    - nudm-ueau
    - nudm-ee
    - nudm-pp
    - nudm-niddau
    - nudm-mt
    - nudm-ssau
    - nudm-rsds
    - namf-comm
    - namf-evts
    - namf-mt
    - namf-loc
    - namf-mbs-comm
    - namf-mbs-bc
    - nsmf-pdusession
    - nsmf-event-exposure
    - nsmf-nidd
    - nausf-auth
    - nausf-sorprotection
    - nausf-upuprotection
    - nnef-pfdmanagement
    - nnef-smcontext
    - nnef-eventexposure
    - nnef-eas-deployment-info
    - 3gpp-cp-parameter-provisioning
    - 3gpp-device-triggering
    - 3gpp-bdt
    - 3gpp-traffic-influence
    - 3gpp-chargeable-party
    - 3gpp-as-session-with-qos

```

- 3gpp-msisdn-less-mo-sms
- 3gpp-service-parameter
- 3gpp-monitoring-event
- 3gpp-nidd-configuration-trigger
- 3gpp-nidd
- 3gpp-analyticsexposure
- 3gpp-racs-parameter-provisioning
- 3gpp-ecr-control
- 3gpp-applying-bdt-policy
- 3gpp-mo-lcs-notify
- 3gpp-time-sync
- 3gpp-am-influence
- 3gpp-am-policyauthorization
- 3gpp-akma
- 3gpp-eas-deployment
- 3gpp-iptvconfiguration
- 3gpp-mbs-tmgi
- 3gpp-mbs-session
- 3gpp-authentication
- 3gpp-asti
- npcfc-am-policy-control
- npcfc-smpolicycontrol
- npcfc-policyauthorization
- npcfc-bdtpolicycontrol
- npcfc-eventexposure
- npcfc-ue-policy-control
- npcfc-am-policyauthorization
- nsmsf-sms
- nnsf-nssselection
- nnsf-nssaiavailability
- nudr-dr
- nudr-group-id-map
- nlmf-loc
- n5g-eir-eic
- nbsf-management
- nchf-spendinglimitcontrol
- nchf-convergedcharging
- nchf-offlineonlycharging
- nnwdafeventsubscription
- nnwdafeanalyticsinfo
- nnwdafe-datamanagement
- nnwdafe-mlmodelprovision
- ngmlc-loc
- nucmf-provisioning
- nucmf-uecapabilitymanagement
- nhss-sdm
- nhss-uecm
- nhss-ueau
- nhss-ee
- nhss-ims-sdm
- nhss-ims-uecm
- nhss-ims-ueau
- nhss-gba-sdm
- nhss-gba-ueau
- nsepp-telescopic
- nsoraf-sor
- nspaf-secured-packet
- nudsf-dr
- nudsf-timer
- nnsaaf-nssaa
- nnsaaf-aiw
- naanf-akma
- n5gddnmf-discovery
- nmfaf-3dadm
- nmfaf-3cadm
- neasdfs-dnscontext
- neasdfs-baselinednspattern
- ndccf-dm
- ndccf-cm
- nnsacf-nsac
- nnsacf-slice-ee
- nmbsmf-tmgi
- nmbsmf-mbssession
- nadrf-dm
- nbsp-gba
- ntctsf-time-sync
- ntctsf-qos-tscai
- ntctsf-asti

```

    - npkmf-keyreq
    - nmnpf-npstatus
    - niwmsc-smsservice
    - nmbsf-mbsuserserv
    - nmbsf-mbsuserdataing
    - nmbstf-distsession
    - npanf-prosekey
  - type: string

N2InterfaceAmfInfo:
  description: AMF N2 interface information
  type: object
  properties:
    ipv4EndpointAddress:
      type: array
      items:
        $ref: 'TS29571_CommonData.yaml#/components/schemas/Ipv4Addr'
      minItems: 1
    ipv6EndpointAddress:
      type: array
      items:
        $ref: 'TS29571_CommonData.yaml#/components/schemas/Ipv6Addr'
      minItems: 1
    amfName:
      $ref: 'TS29571_CommonData.yaml#/components/schemas/AmfName'

NFServiceStatus:
  description: Status of a given NF Service Instance of an NF Instance stored in NRF
  anyOf:
    - type: string
      enum:
        - REGISTERED
        - SUSPENDED
        - UNDISCOVERABLE
    - type: string

TaiRange:
  description: Range of TAIs (Tracking Area Identities)
  type: object
  required:
    - plmnId
    - tacRangeList
  properties:
    plmnId:
      $ref: 'TS29571_CommonData.yaml#/components/schemas/PlmnId'
    tacRangeList:
      type: array
      items:
        $ref: '#/components/schemas/TacRange'
      minItems: 1
    nid:
      $ref: 'TS29571_CommonData.yaml#/components/schemas/Nid'

TacRange:
  description: Range of TACs (Tracking Area Codes)
  type: object
  properties:
    start:
      type: string
      pattern: '^([A-Fa-f0-9]{4}|[A-Fa-f0-9]{6})$'
    end:
      type: string
      pattern: '^([A-Fa-f0-9]{4}|[A-Fa-f0-9]{6})$'
    pattern:
      type: string

PlmnRange:
  description: Range of PLMN IDs
  type: object
  properties:
    start:
      type: string
      pattern: '^([0-9]{3}[0-9]{2,3})$'
    end:
      type: string
      pattern: '^([0-9]{3}[0-9]{2,3})$'
    pattern:
      type: string

```

```
NrfInfo:
description: Information of an NRF NF Instance, used in hierarchical NRF deployments
type: object
properties:
  servedUdrInfo:
description: A map (list of key-value pairs) where nfInstanceId serves as key
type: object
additionalProperties:
  anyOf:
    - $ref: '#/components/schemas/UdrInfo'
    - $ref: 'TS29571_CommonData.yaml#/components/schemas/EmptyObject'
  minProperties: 1
  servedUdrInfoList:
description: A map (list of key-value pairs) where nfInstanceId serves as key
type: object
additionalProperties:
  description: A map (list of key-value pairs) where a valid JSON string serves as key
  type: object
  additionalProperties:
    anyOf:
      - $ref: '#/components/schemas/UdrInfo'
      - $ref: 'TS29571_CommonData.yaml#/components/schemas/EmptyObject'
    minProperties: 1
  minProperties: 1
  servedUdmInfo:
description: A map (list of key-value pairs) where nfInstanceId serves as key
type: object
additionalProperties:
  anyOf:
    - $ref: '#/components/schemas/UdmInfo'
    - $ref: 'TS29571_CommonData.yaml#/components/schemas/EmptyObject'
  minProperties: 1
  servedUdmInfoList:
description: A map (list of key-value pairs) where nfInstanceId serves as key
type: object
additionalProperties:
  description: A map (list of key-value pairs) where a valid JSON string serves as key
  type: object
  additionalProperties:
    anyOf:
      - $ref: '#/components/schemas/UdmInfo'
      - $ref: 'TS29571_CommonData.yaml#/components/schemas/EmptyObject'
    minProperties: 1
  minProperties: 1
  servedAusfInfo:
description: A map (list of key-value pairs) where nfInstanceId serves as key
type: object
additionalProperties:
  anyOf:
    - $ref: '#/components/schemas/AusfInfo'
    - $ref: 'TS29571_CommonData.yaml#/components/schemas/EmptyObject'
  minProperties: 1
  servedAusfInfoList:
description: A map (list of key-value pairs) where nfInstanceId serves as key
type: object
additionalProperties:
  description: A map (list of key-value pairs) where a valid JSON string serves as key
  type: object
  additionalProperties:
    anyOf:
      - $ref: '#/components/schemas/AusfInfo'
      - $ref: 'TS29571_CommonData.yaml#/components/schemas/EmptyObject'
    minProperties: 1
  minProperties: 1
  servedAmfInfo:
description: A map (list of key-value pairs) where nfInstanceId serves as key
type: object
additionalProperties:
  anyOf:
    - $ref: '#/components/schemas/AmfInfo'
    - $ref: 'TS29571_CommonData.yaml#/components/schemas/EmptyObject'
  minProperties: 1
  servedAmfInfoList:
description: A map (list of key-value pairs) where nfInstanceId serves as key
type: object
additionalProperties:
  description: A map (list of key-value pairs) where a valid JSON string serves as key
```



```

    type: object
    additionalProperties:
      anyOf:
        - $ref: '#/components/schemas/AmfInfo'
        - $ref: 'TS29571_CommonData.yaml#/components/schemas/EmptyObject'
    minProperties: 1
  minProperties: 1
servedSmfInfo:
  description: A map (list of key-value pairs) where nfInstanceId serves as key
  type: object
  additionalProperties:
    anyOf:
      - $ref: '#/components/schemas/SmfInfo'
      - $ref: 'TS29571_CommonData.yaml#/components/schemas/EmptyObject'
  minProperties: 1
servedSmfInfoList:
  description: A map (list of key-value pairs) where nfInstanceId serves as key
  type: object
  additionalProperties:
    description: A map (list of key-value pairs) where a valid JSON string serves as key
    type: object
    additionalProperties:
      anyOf:
        - $ref: '#/components/schemas/SmfInfo'
        - $ref: 'TS29571_CommonData.yaml#/components/schemas/EmptyObject'
      minProperties: 1
  minProperties: 1
servedUpfInfo:
  description: A map (list of key-value pairs) where nfInstanceId serves as key
  type: object
  additionalProperties:
    anyOf:
      - $ref: '#/components/schemas/UpfInfo'
      - $ref: 'TS29571_CommonData.yaml#/components/schemas/EmptyObject'
  minProperties: 1
servedUpfInfoList:
  description: A map (list of key-value pairs) where nfInstanceId serves as key
  type: object
  additionalProperties:
    description: A map (list of key-value pairs) where a valid JSON string serves as key
    type: object
    additionalProperties:
      anyOf:
        - $ref: '#/components/schemas/UpfInfo'
        - $ref: 'TS29571_CommonData.yaml#/components/schemas/EmptyObject'
      minProperties: 1
  minProperties: 1
servedPcfInfo:
  description: A map (list of key-value pairs) where nfInstanceId serves as key
  type: object
  additionalProperties:
    anyOf:
      - $ref: '#/components/schemas/PcfInfo'
      - $ref: 'TS29571_CommonData.yaml#/components/schemas/EmptyObject'
  minProperties: 1
servedPcfInfoList:
  description: A map (list of key-value pairs) where nfInstanceId serves as key
  type: object
  additionalProperties:
    description: A map (list of key-value pairs) where a valid JSON string serves as key
    type: object
    additionalProperties:
      anyOf:
        - $ref: '#/components/schemas/PcfInfo'
        - $ref: 'TS29571_CommonData.yaml#/components/schemas/EmptyObject'
      minProperties: 1
  minProperties: 1
servedBsfInfo:
  description: A map (list of key-value pairs) where nfInstanceId serves as key
  type: object
  additionalProperties:
    anyOf:
      - $ref: '#/components/schemas/BsfInfo'
      - $ref: 'TS29571_CommonData.yaml#/components/schemas/EmptyObject'
  minProperties: 1
servedBsfInfoList:
  description: A map (list of key-value pairs) where nfInstanceId serves as key
  type: object

```

```

    additionalProperties:
      description: A map (list of key-value pairs) where a valid JSON string serves as key
      type: object
      additionalProperties:
        anyOf:
          - $ref: '#/components/schemas/BsfInfo'
          - $ref: 'TS29571_CommonData.yaml#/components/schemas/EmptyObject'
      minProperties: 1
    minProperties: 1
  servedChfInfo:
    description: A map (list of key-value pairs) where nfInstanceId serves as key
    type: object
    additionalProperties:
      anyOf:
        - $ref: '#/components/schemas/ChfInfo'
        - $ref: 'TS29571_CommonData.yaml#/components/schemas/EmptyObject'
      minProperties: 1
  servedChfInfoList:
    description: A map (list of key-value pairs) where nfInstanceId serves as key
    type: object
    additionalProperties:
      description: A map (list of key-value pairs) where a valid JSON string serves as key
      type: object
      additionalProperties:
        anyOf:
          - $ref: '#/components/schemas/ChfInfo'
          - $ref: 'TS29571_CommonData.yaml#/components/schemas/EmptyObject'
        minProperties: 1
      minProperties: 1
  servedNefInfo:
    description: A map (list of key-value pairs) where nfInstanceId serves as key
    type: object
    additionalProperties:
      anyOf:
        - $ref: '#/components/schemas/NefInfo'
        - $ref: 'TS29571_CommonData.yaml#/components/schemas/EmptyObject'
      minProperties: 1
  servedNwdafInfo:
    description: A map (list of key-value pairs) where nfInstanceId serves as key
    type: object
    additionalProperties:
      anyOf:
        - $ref: '#/components/schemas/NwdafInfo'
        - $ref: 'TS29571_CommonData.yaml#/components/schemas/EmptyObject'
      minProperties: 1
  servedNwdafInfoList:
    type: object
    description: A map (list of key-value pairs) where NF Instance Id serves as key
    additionalProperties:
      type: object
      description: A map (list of key-value pairs) where a valid JSON string serves as key
      additionalProperties:
        $ref: '#/components/schemas/NwdafInfo'
      minProperties: 1
    minProperties: 1
  servedPcscfInfoList:
    description: A map (list of key-value pairs) where nfInstanceId serves as key
    type: object
    additionalProperties:
      description: A map (list of key-value pairs) where a valid JSON string serves as key
      type: object
      additionalProperties:
        anyOf:
          - $ref: '#/components/schemas/PcscfInfo'
          - $ref: 'TS29571_CommonData.yaml#/components/schemas/EmptyObject'
        minProperties: 1
      minProperties: 1
  servedGmlcInfo:
    description: A map (list of key-value pairs) where nfInstanceId serves as key
    type: object
    additionalProperties:
      anyOf:
        - $ref: '#/components/schemas/GmlcInfo'
        - $ref: 'TS29571_CommonData.yaml#/components/schemas/EmptyObject'
      minProperties: 1
  servedLmfInfo:
    description: A map (list of key-value pairs) where nfInstanceId serves as key
    type: object

```

```
    additionalProperties:
      anyOf:
        - $ref: '#/components/schemas/LmfInfo'
        - $ref: 'TS29571_CommonData.yaml#/components/schemas/EmptyObject'
    minProperties: 1
  servedNfInfo:
    description: A map (list of key-value pairs) where nfInstanceId serves as key
    type: object
    additionalProperties:
      $ref: '#/components/schemas/NfInfo'
    minProperties: 1
  servedHssInfoList:
    description: A map (list of key-value pairs) where nfInstanceId serves as key
    type: object
    additionalProperties:
      description: A map (list of key-value pairs) where a valid JSON string serves as key
      type: object
      additionalProperties:
        anyOf:
          - $ref: '#/components/schemas/HssInfo'
          - $ref: 'TS29571_CommonData.yaml#/components/schemas/EmptyObject'
        minProperties: 1
    minProperties: 1
  servedUdsfInfo:
    description: A map (list of key-value pairs) where nfInstanceId serves as key
    type: object
    additionalProperties:
      anyOf:
        - $ref: '#/components/schemas/UdsfInfo'
        - $ref: 'TS29571_CommonData.yaml#/components/schemas/EmptyObject'
    minProperties: 1
  servedUdsfInfoList:
    description: A map (list of key-value pairs) where nfInstanceId serves as key
    type: object
    additionalProperties:
      description: A map (list of key-value pairs) where a valid JSON string serves as key
      type: object
      additionalProperties:
        anyOf:
          - $ref: '#/components/schemas/UdsfInfo'
          - $ref: 'TS29571_CommonData.yaml#/components/schemas/EmptyObject'
        minProperties: 1
    minProperties: 1
  servedScpInfoList:
    description: A map (list of key-value pairs) where nfInstanceId serves as key
    type: object
    additionalProperties:
      anyOf:
        - $ref: '#/components/schemas/ScpInfo'
        - $ref: 'TS29571_CommonData.yaml#/components/schemas/EmptyObject'
    minProperties: 1
  servedSeppInfoList:
    description: A map (list of key-value pairs) where nfInstanceId serves as key
    type: object
    additionalProperties:
      anyOf:
        - $ref: '#/components/schemas/SeppInfo'
        - $ref: 'TS29571_CommonData.yaml#/components/schemas/EmptyObject'
    minProperties: 1
  servedAanfInfoList:
    description: A map (list of key-value pairs) where NF Instance Id serves as key
    type: object
    additionalProperties:
      description: A map (list of key-value pairs) where a valid JSON string serves as key
      type: object
      additionalProperties:
        anyOf:
          - $ref: '#/components/schemas/AanfInfo'
          - $ref: 'TS29571_CommonData.yaml#/components/schemas/EmptyObject'
        minProperties: 1
    minProperties: 1
  served5gDdnmfInfo:
    type: object
    additionalProperties:
      $ref: '#/components/schemas/5GDdnmfInfo'
    minProperties: 1
  servedMfafInfoList:
    type: object
    description: A map (list of key-value pairs) where NF Instance Id serves as key
```

```

    additionalProperties:
      $ref: '#/components/schemas/MfafInfo'
    minProperties: 1
  servedEasdfInfoList:
    type: object
    description: A map (list of key-value pairs) where NF Instance Id serves as key
    additionalProperties:
      type: object
      description: A map (list of key-value pairs) where a valid JSON string serves as key
      additionalProperties:
        $ref: '#/components/schemas/EasdfInfo'
      minProperties: 1
  servedDccfInfoList:
    type: object
    description: A map (list of key-value pairs) where NF Instance Id serves as key
    additionalProperties:
      $ref: '#/components/schemas/DccfInfo'
    minProperties: 1
  servedMbSmfInfoList:
    description: A map (list of key-value pairs) where nfInstanceId serves as key
    type: object
    additionalProperties:
      description: A map (list of key-value pairs) where a valid JSON string serves as key
      type: object
      additionalProperties:
        anyOf:
          - $ref: '#/components/schemas/MbSmfInfo'
          - $ref: 'TS29571_CommonData.yaml#/components/schemas/EmptyObject'
        minProperties: 1
      minProperties: 1
  servedTsctsInfoList:
    type: object
    description: A map (list of key-value pairs) where NF Instance Id serves as key
    additionalProperties:
      type: object
      description: A map (list of key-value pairs) where a valid JSON string serves as key
      additionalProperties:
        $ref: '#/components/schemas/TsctsInfo'
      minProperties: 1
    minProperties: 1
  servedMbUpfInfoList:
    type: object
    description: A map (list of key-value pairs) where NF Instance Id serves as key
    additionalProperties:
      type: object
      description: A map (list of key-value pairs) where a valid JSON string serves as key
      additionalProperties:
        $ref: '#/components/schemas/MbUpfInfo'
      minProperties: 1
    minProperties: 1
  servedTrustAfInfo:
    type: object
    description: A map (list of key-value pairs) where NF Instance Id serves as key
    additionalProperties:
      $ref: '#/components/schemas/TrustAfInfo'
    minProperties: 1
  servedNssaafInfo:
    type: object
    description: A map (list of key-value pairs) where NF Instance Id serves as key
    additionalProperties:
      $ref: '#/components/schemas/NssaafInfo'
    minProperties: 1

PlmnSnssai:
  description: List of network slices (S-NSSAIs) for a given PLMN ID
  type: object
  required:
    - plmnId
    - sNssaiList
  properties:
    plmnId:
      $ref: 'TS29571_CommonData.yaml#/components/schemas/PlmnId'
    sNssaiList:
      type: array
      items:
        $ref: 'TS29571_CommonData.yaml#/components/schemas/ExtSnssai'
      minItems: 1
  nid:

```

```

    $ref: 'TS29571_CommonData.yaml#/components/schemas/Nid'
NefInfo:
  description: Information of an NEF NF Instance
  type: object
  properties:
    nefId:
      $ref: '#/components/schemas/NefId'
    pfdData:
      $ref: '#/components/schemas/PfdData'
    afEeData:
      $ref: '#/components/schemas/AfEventExposureData'
    gpsiRanges:
      type: array
      items:
        $ref: '#/components/schemas/IdentityRange'
      minItems: 1
    externalGroupIdentifiersRanges:
      type: array
      items:
        $ref: '#/components/schemas/IdentityRange'
      minItems: 1
    servedFqdnList:
      type: array
      items:
        type: string
      minItems: 1
    taiList:
      type: array
      items:
        $ref: 'TS29571_CommonData.yaml#/components/schemas/Tai'
      minItems: 1
    taiRangeList:
      type: array
      items:
        $ref: '#/components/schemas/TaiRange'
      minItems: 1
    dnaiList:
      type: array
      items:
        $ref: 'TS29571_CommonData.yaml#/components/schemas/Dnai'
      minItems: 1
    unTrustAfInfoList:
      type: array
      items:
        $ref: '#/components/schemas/UnTrustAfInfo'
      minItems: 1
    uasNfFunctionalityInd:
      type: boolean
      default: false

PfdData:
  description: List of Application IDs and/or AF IDs managed by a given NEF Instance
  type: object
  properties:
    appIds:
      type: array
      items:
        type: string
      minItems: 1
    afIds:
      type: array
      items:
        type: string
      minItems: 1

NwdafInfo:
  description: Information of a NWDAF NF Instance
  type: object
  properties:
    eventIds:
      type: array
      items:
        $ref: 'TS29520_Nnwdaf_AnalyticsInfo.yaml#/components/schemas/EventId'
      minItems: 1
    nwdafEvents:
      type: array
      items:

```

```

    $ref: 'TS29520_Nnwdaf_EventsSubscription.yaml#/components/schemas/NwdafEvent'
  minItems: 1
  tailList:
    type: array
    items:
      $ref: 'TS29571_CommonData.yaml#/components/schemas/Tai'
  minItems: 1
  taiRangeList:
    type: array
    items:
      $ref: '#/components/schemas/TaiRange'
  minItems: 1
  nwdafCapability:
    $ref: '#/components/schemas/NwdafCapability'
  analyticsDelay:
    $ref: 'TS29571_CommonData.yaml#/components/schemas/DurationSec'
  servingNfSetIdList:
    type: array
    items:
      $ref: 'TS29571_CommonData.yaml#/components/schemas/NfSetId'
  minItems: 1
  servingNfTypeList:
    type: array
    items:
      $ref: '#/components/schemas/NFType'
  minItems: 1
  mlAnalyticsList:
    type: array
    items:
      $ref: '#/components/schemas/MLAnalyticsInfo'
  minItems: 1

LmfInfo:
  description: Information of an LMF NF Instance
  type: object
  properties:
    servingClientTypes:
      type: array
      items:
        $ref: 'TS29572_Nlmf_Location.yaml#/components/schemas/ExternalClientType'
      minItems: 1
    lmfId:
      $ref: 'TS29572_Nlmf_Location.yaml#/components/schemas/LMFIdentification'
    servingAccessTypes:
      type: array
      items:
        $ref: 'TS29571_CommonData.yaml#/components/schemas/AccessType'
      minItems: 1
    servingAnNodeTypes:
      type: array
      items:
        $ref: '#/components/schemas/AnNodeType'
      minItems: 1
    servingRatTypes:
      type: array
      items:
        $ref: 'TS29571_CommonData.yaml#/components/schemas/RatType'
      minItems: 1
    tailList:
      type: array
      items:
        $ref: 'TS29571_CommonData.yaml#/components/schemas/Tai'
      minItems: 1
    taiRangeList:
      type: array
      items:
        $ref: '#/components/schemas/TaiRange'
      minItems: 1
    supportedGADShapes:
      type: array
      items:
        $ref: 'TS29572_Nlmf_Location.yaml#/components/schemas/SupportedGADShapes'
      minItems: 1

GmlcInfo:
  description: Information of a GMLC NF Instance
  type: object
  properties:

```

```
servingClientTypes:
  type: array
  items:
    $ref: 'TS29572_Nlmf_Location.yaml#/components/schemas/ExternalClientType'
  minItems: 1
gmlcNumbers:
  type: array
  items:
    type: string
    pattern: '^[0-9]{5,15}$'
  minItems: 1

AfEventExposureData:
  description: AF Event Exposure data managed by a given NEF Instance
  type: object
  required:
    - afEvents
  properties:
    afEvents:
      type: array
      items:
        $ref: 'TS29517_Naf_EventExposure.yaml#/components/schemas/AfEvent'
      minItems: 1
    afIds:
      type: array
      items:
        type: string
      minItems: 1
    appIds:
      type: array
      items:
        type: string
      minItems: 1

PcscfInfo:
  description: Information of a P-CSCF NF Instance
  type: object
  properties:
    accessType:
      type: array
      items:
        $ref: 'TS29571_CommonData.yaml#/components/schemas/AccessType'
      minItems: 1
    dnnList:
      type: array
      items:
        $ref: 'TS29571_CommonData.yaml#/components/schemas/Dnn'
      minItems: 1
    gmFqdn:
      $ref: 'TS29571_CommonData.yaml#/components/schemas/Fqdn'
    gmIpv4Addresses:
      type: array
      items:
        $ref: 'TS29571_CommonData.yaml#/components/schemas/Ipv4Addr'
      minItems: 1
    gmIpv6Addresses:
      type: array
      items:
        $ref: 'TS29571_CommonData.yaml#/components/schemas/Ipv6Addr'
      minItems: 1
    mwFqdn:
      $ref: 'TS29571_CommonData.yaml#/components/schemas/Fqdn'
    mwIpv4Addresses:
      type: array
      items:
        $ref: 'TS29571_CommonData.yaml#/components/schemas/Ipv4Addr'
      minItems: 1
    mwIpv6Addresses:
      type: array
      items:
        $ref: 'TS29571_CommonData.yaml#/components/schemas/Ipv6Addr'
      minItems: 1
    servedIpv4AddressRanges:
      type: array
      items:
        $ref: '#/components/schemas/Ipv4AddressRange'
      minItems: 1
    servedIpv6PrefixRanges:
```

```

    type: array
    items:
      $ref: '#/components/schemas/Ipv6PrefixRange'
    minItems: 1

NfInfo:
  description: Information of a generic NF Instance
  type: object
  properties:
    nfType:
      $ref: '#/components/schemas/NFType'

HssInfo:
  description: Information of an HSS NF Instance
  type: object
  properties:
    groupId:
      $ref: 'TS29571_CommonData.yaml#/components/schemas/NfGroupId'
    imsiRanges:
      type: array
      items:
        $ref: '#/components/schemas/ImsiRange'
      minItems: 1
    imsPrivateIdentityRanges:
      type: array
      items:
        $ref: '#/components/schemas/IdentityRange'
      minItems: 1
    imsPublicIdentityRanges:
      type: array
      items:
        $ref: '#/components/schemas/IdentityRange'
      minItems: 1
    msisdnsRanges:
      type: array
      items:
        $ref: '#/components/schemas/IdentityRange'
      minItems: 1
    externalGroupIdentifiersRanges:
      type: array
      items:
        $ref: '#/components/schemas/IdentityRange'
      minItems: 1
    hssDiameterAddress:
      $ref: 'TS29503_Nudm_UECM.yaml#/components/schemas/NetworkNodeDiameterAddress'

ImsiRange:
  description: >
    A range of IMSIs (subscriber identities), either based on a numeric range,
    or based on regular-expression matching
  type: object
  properties:
    start:
      type: string
      pattern: '^[0-9]+$'
    end:
      type: string
      pattern: '^[0-9]+$'
    pattern:
      type: string

TwifInfo:
  description: Addressing information (IP addresses, FQDN) of the TWIF
  type: object
  properties:
    ipv4EndpointAddresses:
      type: array
      items:
        $ref: 'TS29571_CommonData.yaml#/components/schemas/Ipv4Addr'
      minItems: 1
    ipv6EndpointAddresses:
      type: array
      items:
        $ref: 'TS29571_CommonData.yaml#/components/schemas/Ipv6Addr'
      minItems: 1
    endpointFqdn:
      $ref: 'TS29571_CommonData.yaml#/components/schemas/Fqdn'

```



```

VendorId:
  description: Vendor ID of the NF Service instance (Private Enterprise Number assigned by IANA)
  type: string
  pattern: '^[0-9]{6}$'

VendorSpecificFeature:
  description: Information about a vendor-specific feature
  type: object
  required:
    - featureName
    - featureVersion
  properties:
    featureName:
      type: string
    featureVersion:
      type: string

AnNodeType:
  description: Access Network Node Type (gNB, ng-eNB...)
  anyOf:
    - type: string
      enum:
        - GNB
        - NG_ENB
    - type: string

UdsfInfo:
  description: Information related to UDSF
  type: object
  properties:
    groupId:
      $ref: 'TS29571_CommonData.yaml#/components/schemas/NfGroupId'
    supiRanges:
      type: array
      items:
        $ref: '#/components/schemas/SupiRange'
      minItems: 1
    storageIdRanges:
      description: >
        A map (list of key-value pairs) where realmId serves as key and each value in the map
        is an array of IdentityRanges. Each IdentityRange is a range of storageIds.
      type: object
      additionalProperties:
        type: array
        items:
          $ref: '#/components/schemas/IdentityRange'
        minItems: 1
      minProperties: 1

ScpInfo:
  description: Information of an SCP Instance
  type: object
  properties:
    scpDomainInfoList:
      description: >
        A map (list of key-value pairs) where the key of the map shall be the string
        identifying an SCP domain
      type: object
      additionalProperties:
        $ref: '#/components/schemas/ScpDomainInfo'
      minProperties: 1
    scpPrefix:
      type: string
    scpPorts:
      description: >
        Port numbers for HTTP and HTTPS. The key of the map shall be "http" or "https".
      type: object
      additionalProperties:
        type: integer
        minimum: 0
        maximum: 65535
      minProperties: 1
    addressDomains:
      type: array
      items:
        type: string
      minItems: 1
    ipv4Addresses:

```

```

    type: array
    items:
      $ref: 'TS29571_CommonData.yaml#/components/schemas/Ipv4Addr'
    minItems: 1
  ipv6Prefixes:
    type: array
    items:
      $ref: 'TS29571_CommonData.yaml#/components/schemas/Ipv6Prefix'
    minItems: 1
  ipv4AddrRanges:
    type: array
    items:
      $ref: '#/components/schemas/Ipv4AddressRange'
    minItems: 1
  ipv6PrefixRanges:
    type: array
    items:
      $ref: '#/components/schemas/Ipv6PrefixRange'
    minItems: 1
  servedNfSetIdList:
    type: array
    items:
      $ref: 'TS29571_CommonData.yaml#/components/schemas/NfSetId'
    minItems: 1
  remotePlmnList:
    type: array
    items:
      $ref: 'TS29571_CommonData.yaml#/components/schemas/PlmnId'
    minItems: 1
  remoteSnpnList:
    type: array
    items:
      $ref: 'TS29571_CommonData.yaml#/components/schemas/PlmnIdNid'
    minItems: 1
  ipReachability:
    $ref: '#/components/schemas/IpReachability'
  scpCapabilities:
    type: array
    items:
      $ref: '#/components/schemas/ScpCapability'

ScpDomainInfo:
  description: SCP Domain specific information
  type: object
  properties:
    scpFqdn:
      $ref: 'TS29571_CommonData.yaml#/components/schemas/Fqdn'
    scpIpEndpoints:
      type: array
      items:
        $ref: '#/components/schemas/IpEndPoint'
      minItems: 1
    scpPrefix:
      type: string
    scpPorts:
      description: >
        Port numbers for HTTP and HTTPS. The key of the map shall be "http" or "https".
      type: object
      additionalProperties:
        type: integer
        minimum: 0
        maximum: 65535
      minProperties: 1

ScpDomainCond:
  description: >
    Subscription to a set of NF or SCP or SEPP instances belonging to certain SCP domains
  type: object
  required:
    - scpDomains
  properties:
    scpDomains:
      type: array
      items:
        type: string
      minItems: 1
    nfTypeList:
      type: array

```

```
    items:
      $ref: '#/components/schemas/NFType'
    minItems: 1

OptionsResponse:
  description: Communication options of the NRF sent in response payload of OPTIONS method
  type: object
  properties:
    supportedFeatures:
      $ref: 'TS29571_CommonData.yaml#/components/schemas/SupportedFeatures'

ConditionEventType:
  description: >
    Indicates whether a notification is due to the NF Instance to start or stop
    being part of a condition for a subscription to a set of NFs
  anyOf:
    - type: string
      enum:
        - NF_ADDED
        - NF_REMOVED
    - type: string

SuciInfo:
  description: SUCI information containing Routing Indicator and Home Network Public Key ID
  type: object
  properties:
    routingInds:
      type: array
      items:
        type: string
        pattern: '^[0-9]{1,4}$'
      minItems: 1
    hNwPubKeyIds:
      type: array
      items:
        type: integer
      minItems: 1

SeppInfo:
  description: Information of a SEPP Instance
  type: object
  properties:
    seppPrefix:
      type: string
    seppPorts:
      description: >
        Port numbers for HTTP and HTTPS. The key of the map shall be "http" or "https".
      type: object
      additionalProperties:
        type: integer
        minimum: 0
        maximum: 65535
      minProperties: 1
    remotePlmnList:
      type: array
      items:
        $ref: 'TS29571_CommonData.yaml#/components/schemas/PlmnId'
      minItems: 1
    remoteSnpnList:
      type: array
      items:
        $ref: 'TS29571_CommonData.yaml#/components/schemas/PlmnIdNid'
      minItems: 1

IpReachability:
  description: Indicates the type(s) of IP addresses reachable via an SCP
  anyOf:
    - type: string
      enum:
        - IPV4
        - IPV6
        - IPV4V6
    - type: string

UriList:
  description: >
    Represents a set of URIs following the 3GPP hypermedia format
    (containing a "_links" attribute).
```

```
type: object
properties:
  _links:
    type: object
    description: >
      List of the URI of NF instances. It has two members whose names are item and self.
      The item attribute contains an array of URIs.
    additionalProperties:
      $ref: 'TS29571_CommonData.yaml#/components/schemas/LinksValueSchema'
    minProperties: 1
    totalItemCount:
      type: integer

AanfInfo:
description: Represents the information relative to an AANF NF Instance.
type: object
properties:
  routingIndicators:
    type: array
    items:
      type: string
      pattern: '^[0-9]{1,4}$'
    minItems: 1

5GDdnmfInfo:
description: Information of an 5G DDNMF NF Instance
type: object
required:
  - plmnId
properties:
  plmnId:
    $ref: 'TS29571_CommonData.yaml#/components/schemas/PlmnId'

WildcardDnai:
description: Wildcard DNAI
type: string
pattern: '^[*]$'

MfafInfo:
description: Information of a MFAF NF Instance
type: object
properties:
  servingNfTypeList:
    type: array
    items:
      $ref: '#/components/schemas/NFType'
    minItems: 1
  servingNfSetIdList:
    type: array
    items:
      $ref: 'TS29571_CommonData.yaml#/components/schemas/NfSetId'
    minItems: 1
  taiList:
    type: array
    items:
      $ref: 'TS29571_CommonData.yaml#/components/schemas/Tai'
    minItems: 1
  taiRangeList:
    type: array
    items:
      $ref: '#/components/schemas/TaiRange'
    minItems: 1

NwdafCapability:
description: Indicates the capability supported by the NWDAF
type: object
properties:
  analyticsAggregation:
    type: boolean
    default: false
  analyticsMetadataProvisioning:
    type: boolean
    default: false

EasdfInfo:
description: Information of an EASDF NF Instance
type: object
properties:
```

```

sNssaiEasdfInfoList:
  type: array
  items:
    $ref: '#/components/schemas/SnssaiEasdfInfoItem'
  minItems: 1
easdfN6IpAddressList:
  type: array
  items:
    $ref: 'TS29571_CommonData.yaml#/components/schemas/IpAddr'
  minItems: 1
upfN6IpAddressList:
  type: array
  items:
    $ref: 'TS29571_CommonData.yaml#/components/schemas/IpAddr'
  minItems: 1

SnssaiEasdfInfoItem:
  description: Set of parameters supported by EASDF for a given S-NSSAI
  type: object
  required:
    - sNssai
    - dnnEasdfInfoList
  properties:
    sNssai:
      $ref: 'TS29571_CommonData.yaml#/components/schemas/ExtSnssai'
    dnnEasdfInfoList:
      type: array
      items:
        $ref: '#/components/schemas/DnnEasdfInfoItem'
      minItems: 1

DnnEasdfInfoItem:
  description: Set of parameters supported by EASDF for a given DNN
  type: object
  required:
    - dnn
  properties:
    dnn:
      anyOf:
        - $ref: 'TS29571_CommonData.yaml#/components/schemas/Dnn'
        - $ref: 'TS29571_CommonData.yaml#/components/schemas/WildcardDnn'
    dnaiList:
      type: array
      items:
        $ref: 'TS29571_CommonData.yaml#/components/schemas/Dnai'
      minItems: 1

DccfInfo:
  description: Information of a DCCF NF Instance
  type: object
  properties:
    servingNfTypeList:
      type: array
      items:
        $ref: '#/components/schemas/NFType'
      minItems: 1
    servingNfSetIdList:
      type: array
      items:
        $ref: 'TS29571_CommonData.yaml#/components/schemas/NfSetId'
      minItems: 1
    taiList:
      type: array
      items:
        $ref: 'TS29571_CommonData.yaml#/components/schemas/Tai'
      minItems: 1
    taiRangeList:
      type: array
      items:
        $ref: '#/components/schemas/TaiRange'
      minItems: 1

ScpCapability:
  description: Indicates the capabilities supported by an SCP
  type: object
  anyOf:
    - type: string
      enum:
        - INDIRECT_COM_WITH_DELEG_DISC

```

```

- type: string

NsacfInfo:
  description: Information of a NSACF NF Instance
  type: object
  required:
    - nsacfCapability
  properties:
    nsacfCapability:
      $ref: '#/components/schemas/NsacfCapability'
    taiList:
      type: array
      items:
        $ref: 'TS29571_CommonData.yaml#/components/schemas/Tai'
      minItems: 1
    taiRangeList:
      type: array
      items:
        $ref: '#/components/schemas/TaiRange'
      minItems: 1

NsacfCapability:
  description: >
    NSACF service capabilities (e.g. to monitor and control the number of registered UEs
    or established PDU sessions per network slice)
  type: object
  properties:
    supportUeSAC:
      description: |
        Indicates the service capability of the NSACF to monitor and control the number of
        registered UEs per network slice for the network slice that is subject to NSAC
      true: Supported
      false (default): Not Supported
      type: boolean
      default: false
    supportPduSAC:
      description: |
        Indicates the service capability of the NSACF to monitor and control the number of
        established PDU sessions per network slice for the network slice that is subject to NSAC
      true: Supported
      false (default): Not Supported
      type: boolean
      default: false

DccfCond:
  description: >
    Subscription to a set of NF Instances (DCCFs), identified by NF types, NF Set Id(s)
    or DCCF Serving Area information, i.e. list of TAIs served by the DCCF
  type: object
  required:
    - conditionType
  properties:
    conditionType:
      type: string
      enum: [ DCCF_COND ]
    taiList:
      type: array
      items:
        $ref: 'TS29571_CommonData.yaml#/components/schemas/Tai'
      minItems: 1
    taiRangeList:
      type: array
      items:
        $ref: '#/components/schemas/TaiRange'
      minItems: 1
    servingNfTypeList:
      type: array
      items:
        $ref: '#/components/schemas/NFType'
      minItems: 1
    servingNfSetIdList:
      type: array
      items:
        $ref: 'TS29571_CommonData.yaml#/components/schemas/NfSetId'
      minItems: 1

MlAnalyticsInfo:
  description: ML Analytics Filter information supported by the Nnwdaf_MLModelProvision service

```

```

type: object
properties:
  mlAnalyticsIds:
    type: array
    items:
      $ref: 'TS29520_NnwdaF_EventsSubscription.yaml#/components/schemas/NwdaFEvent'
    minItems: 1
  snssaiList:
    type: array
    items:
      $ref: 'TS29571_CommonData.yaml#/components/schemas/Snssai'
    minItems: 1
  trackingAreaList:
    type: array
    items:
      $ref: 'TS29571_CommonData.yaml#/components/schemas/Tai'
    minItems: 1

MbSmfInfo:
description: Information of an MB-SMF NF Instance
type: object
properties:
  sNssaiInfoList:
description: A map (list of key-value pairs) where a valid JSON string serves as key
additionalProperties:
  $ref: '#/components/schemas/SnssaiMbSmfInfoItem'
minProperties: 1
  tmgiRangeList:
description: A map (list of key-value pairs) where a valid JSON string serves as key
additionalProperties:
  $ref: '#/components/schemas/TmgiRange'
minProperties: 1
  taiList:
    type: array
    items:
      $ref: 'TS29571_CommonData.yaml#/components/schemas/Tai'
    minItems: 1
  taiRangeList:
    type: array
    items:
      $ref: '#/components/schemas/TaiRange'
    minItems: 1
  mbsSessionList:
description: A map (list of key-value pairs) where a valid JSON string serves as key
additionalProperties:
  $ref: '#/components/schemas/MbsSession'
minProperties: 1

TmgiRange:
description: Range of TMGIs
type: object
required:
  - mbsServiceIdStart
  - mbsServiceIdEnd
  - plmnId
properties:
  mbsServiceIdStart:
    type: string
    pattern: '^[A-Fa-f0-9]{6}$'
  mbsServiceIdEnd:
    type: string
    pattern: '^[A-Fa-f0-9]{6}$'
  plmnId:
    $ref: 'TS29571_CommonData.yaml#/components/schemas/PlmnId'
  nid:
    $ref: 'TS29571_CommonData.yaml#/components/schemas/Nid'

MbsSession:
description: MBS Session currently served by an MB-SMF
type: object
required:
  - mbsSessionId
properties:
  mbsSessionId:
    $ref: 'TS29571_CommonData.yaml#/components/schemas/MbsSessionId'
  mbsAreaSessions:
description: A map (list of key-value pairs) where the key identifies an areaSessionId
additionalProperties:

```

```

    $ref: 'TS29571_CommonData.yaml#/components/schemas/MbsServiceAreaInfo'
    minProperties: 1

SnssaiMbSmfInfoItem:
  description: Parameters supported by an MB-SMF for a given S-NSSAI
  type: object
  required:
    - sNssai
    - dnnInfoList
  properties:
    sNssai:
      $ref: 'TS29571_CommonData.yaml#/components/schemas/ExtSnssai'
    dnnInfoList:
      type: array
      items:
        $ref: '#/components/schemas/DnnMbSmfInfoItem'
      minItems: 1

DnnMbSmfInfoItem:
  description: Parameters supported by an MB-SMF for a given DNN
  type: object
  required:
    - dnn
  properties:
    dnn:
      anyOf:
        - $ref: 'TS29571_CommonData.yaml#/components/schemas/Dnn'
        - $ref: 'TS29571_CommonData.yaml#/components/schemas/WildcardDnn'

TsctsfInfo:
  description: Information of a TSCTSF NF Instance
  type: object
  properties:
    sNssaiInfoList:
      description: A map (list of key-value pairs) where a valid JSON string serves as key
      additionalProperties:
        $ref: '#/components/schemas/SnssaiTsctsfInfoItem'
      minProperties: 1
    externalGroupIdentifiersRanges:
      type: array
      items:
        $ref: '#/components/schemas/IdentityRange'
      minItems: 1
    supiRanges:
      type: array
      items:
        $ref: '#/components/schemas/SupiRange'
      minItems: 1
    gpsiRanges:
      type: array
      items:
        $ref: '#/components/schemas/IdentityRange'
      minItems: 1
    internalGroupIdentifiersRanges:
      type: array
      items:
        $ref: '#/components/schemas/InternalGroupIdRange'
      minItems: 1

SnssaiTsctsfInfoItem:
  description: Set of parameters supported by TSCTSF for a given S-NSSAI
  type: object
  required:
    - sNssai
    - dnnInfoList
  properties:
    sNssai:
      $ref: 'TS29571_CommonData.yaml#/components/schemas/ExtSnssai'
    dnnInfoList:
      type: array
      items:
        $ref: '#/components/schemas/DnnTsctsfInfoItem'
      minItems: 1

DnnTsctsfInfoItem:
  description: Parameters supported by an TSCTSF for a given DNN
  type: object
  required:

```



```
- dnn
properties:
  dnn:
    anyOf:
      - $ref: 'TS29571_CommonData.yaml#/components/schemas/Dnn'
      - $ref: 'TS29571_CommonData.yaml#/components/schemas/WildcardDnn'

MbUpfInfo:
  description: Information of an MB-UPF NF Instance
  type: object
  required:
    - sNssaiMbUpfInfoList
  properties:
    sNssaiMbUpfInfoList:
      type: array
      items:
        $ref: '#/components/schemas/SnssaiUpfInfoItem'
      minItems: 1
    mbSmfServingArea:
      type: array
      items:
        type: string
      minItems: 1
    interfaceMbUpfInfoList:
      type: array
      items:
        $ref: '#/components/schemas/InterfaceUpfInfoItem'
      minItems: 1
    taiList:
      type: array
      items:
        $ref: 'TS29571_CommonData.yaml#/components/schemas/Tai'
      minItems: 1
    taiRangeList:
      type: array
      items:
        $ref: '#/components/schemas/TaiRange'
      minItems: 1
    priority:
      type: integer
      minimum: 0
      maximum: 65535
    supportedPfcPFeatures:
      type: string

UnTrustAfInfo:
  description: Information of a untrusted AF Instance
  type: object
  required:
    - afId
  properties:
    afId:
      type: string
    sNssaiInfoList:
      type: array
      items:
        $ref: '#/components/schemas/SnssaiInfoItem'
      minItems: 1
    mappingInd:
      type: boolean
      default: false

TrustAfInfo:
  description: Information of a trusted AF Instance
  type: object
  properties:
    sNssaiInfoList:
      type: array
      items:
        $ref: '#/components/schemas/SnssaiInfoItem'
      minItems: 1
    afEvents:
      type: array
      items:
        $ref: 'TS29517_Naf_EventExposure.yaml#/components/schemas/AfEvent'
      minItems: 1
    appIds:
      type: array
```

```

    items:
      type: string
    minItems: 1
  internalGroupId:
    type: array
    items:
      $ref: 'TS29571_CommonData.yaml#/components/schemas/GroupId'
    minItems: 1
  mappingInd:
    type: boolean
    default: false

SnssaiInfoItem:
  description: >
    Parameters supported by an NF for a given S-NSSAI Set of parameters supported by NF
    for a given S-NSSAI
  type: object
  required:
    - sNssai
    - dnnInfoList
  properties:
    sNssai:
      $ref: 'TS29571_CommonData.yaml#/components/schemas/ExtSnssai'
    dnnInfoList:
      type: array
      items:
        $ref: '#/components/schemas/DnnInfoItem'
      minItems: 1

DnnInfoItem:
  description: Set of parameters supported by NF for a given DNN
  type: object
  required:
    - dnn
  properties:
    dnn:
      anyOf:
        - $ref: 'TS29571_CommonData.yaml#/components/schemas/Dnn'
        - $ref: 'TS29571_CommonData.yaml#/components/schemas/WildcardDnn'

CollocatedNfInstance:
  description: Information of an collocated NF Instance registered in the NRF
  type: object
  required:
    - nfInstanceId
    - nfType
  properties:
    nfInstanceId:
      $ref: 'TS29571_CommonData.yaml#/components/schemas/NfInstanceId'
    nfType:
      $ref: '#/components/schemas/CollocatedNfType'

CollocatedNfType:
  description: NF types for a collocated NF
  anyOf:
    - type: string
      enum:
        - UPF
        - SMF
        - MB_UPF
        - MB_SMF
    - type: string

PlmnOauth2:
  description: Oauth2.0 required indication for a given PLMN ID
  type: object
  properties:
    oauth2RequiredPlmnIdList:
      type: array
      items:
        $ref: 'TS29571_CommonData.yaml#/components/schemas/PlmnId'
      minItems: 1
    oauth2NotRequiredPlmnIdList:
      type: array
      items:
        $ref: 'TS29571_CommonData.yaml#/components/schemas/PlmnId'
      minItems: 1

```

```
V2xCapability:
  description: Indicate the supported V2X Capability by the PCF.
  type: object
  properties:
    lteV2x:
      type: boolean
      default: false
    nrV2x:
      type: boolean
      default: false

NssaafInfo:
  description: Information of a NSSAAF Instance
  type: object
  properties:
    supiRanges:
      type: array
      items:
        $ref: '#/components/schemas/SupiRange'
      minItems: 1
    internalGroupIdentifiersRanges:
      type: array
      items:
        $ref: '#/components/schemas/InternalGroupIdRange'
      minItems: 1

ProSeCapability:
  description: Indicate the supported ProSe Capability by the PCF.
  type: object
  properties:
    proseDirectDiscovey:
      type: boolean
      default: false
    proseDirectCommunication:
      type: boolean
      default: false
    proseL2UetoNetworkRelay:
      type: boolean
      default: false
    proseL3UetoNetworkRelay:
      type: boolean
      default: false
    proseL2RemoteUe:
      type: boolean
      default: false
    proseL3RemoteUe:
      type: boolean
      default: false

SubscriptionContext:
  description: >
    Context data related to a created subscription, to be included in notifications sent by NRF
  type: object
  required:
    - subscriptionId
  properties:
    subscriptionId:
      type: string
    subscrCond:
      $ref: '#/components/schemas/SubscrCond'

IwmscInfo:
  description: Information of an SMS-IWMSC NF Instance
  type: object
  properties:
    msisdRanges:
      type: array
      items:
        $ref: '#/components/schemas/IdentityRange'
      minItems: 1
    supiRanges:
      type: array
      items:
        $ref: '#/components/schemas/SupiRange'
      minItems: 1
    taiRangeList:
      type: array
      items:
```

```

    $ref: '#/components/schemas/TaiRange'
    minItems: 1
    scNumber:
      type: string
      pattern: '^[0-9]{5,15}$'

MnpfInfo:
  description: Information of an MNPF Instance
  type: object
  properties:
    msisdnsRanges:
      type: array
      items:
        $ref: '#/components/schemas/IdentityRange'
      minItems: 1
  required:
    - msisdnsRanges

DefSubServiceInfo:
  description: Service Specific information for Default Notification Subscription.
  type: object
  properties:
    versions:
      type: array
      items:
        type: string
      minItems: 1
    supportedFeatures:
      $ref: 'TS29571_CommonData.yaml#/components/schemas/SupportedFeatures'

```

---

## A.3 Nnrf\_NFDDiscovery API

openapi: 3.0.0

```

info:
  version: '1.2.2'
  title: 'NRF NFDDiscovery Service'
  description: |
    NRF NFDDiscovery Service.
    © 2022, 3GPP Organizational Partners (ARIB, ATIS, CCSA, ETSI, TSDSI, TTA, TTC).
    All rights reserved.

externalDocs:
  description: 3GPP TS 29.510 V17.8.0; 5G System; Network Function Repository Services; Stage 3
  url: 'https://www.3gpp.org/ftp/Specs/archive/29_series/29.510/'

servers:
  - url: '{apiRoot}/nnrf-disc/v1'
    variables:
      apiRoot:
        default: https://example.com
        description: apiRoot as defined in clause 4.4 of 3GPP TS 29.501

security:
  - {}
  - oAuth2ClientCredentials:
      - nnrf-disc

paths:
  /nf-instances:
    get:
      summary: Search a collection of NF Instances
      operationId: SearchNFInstances
      tags:
        - NF Instances (Store)
      parameters:
        - name: Accept-Encoding
          in: header
          description: Accept-Encoding, described in IETF RFC 7231
          schema:
            type: string
        - name: target-nf-type
          in: query
          description: Type of the target NF
          required: true

```

```

    schema:
      $ref: 'TS29510_Nnrf_NFManagement.yaml#/components/schemas/NFType'
  - name: requester-nf-type
    in: query
    description: Type of the requester NF
    required: true
    schema:
      $ref: 'TS29510_Nnrf_NFManagement.yaml#/components/schemas/NFType'
  - name: preferred-collocated-nf-types
    in: query
    description: collocated NF types that candidate NFs should preferentially support
    schema:
      type: array
      items:
        $ref: 'TS29510_Nnrf_NFManagement.yaml#/components/schemas/CollocatedNFType'
      minItems: 1
      style: form
      explode: false
  - name: requester-nf-instance-id
    in: query
    description: NfInstanceId of the requester NF
    schema:
      $ref: 'TS29571_CommonData.yaml#/components/schemas/NfInstanceId'
  - name: service-names
    in: query
    description: Names of the services offered by the NF
    schema:
      type: array
      items:
        $ref: 'TS29510_Nnrf_NFManagement.yaml#/components/schemas/ServiceName'
      minItems: 1
      uniqueItems: true
      style: form
      explode: false
  - name: requester-nf-instance-fqdn
    in: query
    description: FQDN of the requester NF
    schema:
      $ref: 'TS29571_CommonData.yaml#/components/schemas/Fqdn'
  - name: target-plmn-list
    in: query
    description: >
      Id of the PLMN of either the target NF, or in SNPN scenario the Credentials Holder
      in the PLMN
    content:
      application/json:
        schema:
          type: array
          items:
            $ref: 'TS29571_CommonData.yaml#/components/schemas/PlmnId'
          minItems: 1
  - name: requester-plmn-list
    in: query
    description: Id of the PLMN where the NF issuing the Discovery request is located
    content:
      application/json:
        schema:
          type: array
          items:
            $ref: 'TS29571_CommonData.yaml#/components/schemas/PlmnId'
          minItems: 1
  - name: target-nf-instance-id
    in: query
    description: Identity of the NF instance being discovered
    schema:
      $ref: 'TS29571_CommonData.yaml#/components/schemas/NfInstanceId'
  - name: target-nf-fqdn
    in: query
    description: FQDN of the NF instance being discovered
    schema:
      $ref: 'TS29571_CommonData.yaml#/components/schemas/Fqdn'
  - name: hnr-uri
    in: query
    description: Uri of the home NRF
    schema:
      $ref: 'TS29571_CommonData.yaml#/components/schemas/Uri'
  - name: snssais
    in: query

```

```

description: Slice info of the target NF
content:
  application/json:
    schema:
      type: array
      items:
        $ref: 'TS29571_CommonData.yaml#/components/schemas/Snssai'
      minItems: 1
- name: requester-snssais
  in: query
  description: Slice info of the requester NF
  content:
    application/json:
      schema:
        type: array
        items:
          $ref: 'TS29571_CommonData.yaml#/components/schemas/ExtSnssai'
        minItems: 1
- name: plmn-specific-snssai-list
  in: query
  description: PLMN specific Slice info of the target NF
  content:
    application/json:
      schema:
        type: array
        items:
          $ref: 'TS29510_Nnrf_NFManagement.yaml#/components/schemas/PlmnSnssai'
        minItems: 1
- name: requester-plmn-specific-snssai-list
  in: query
  description: PLMN-specific slice info of the NF issuing the Discovery request
  content:
    application/json:
      schema:
        type: array
        items:
          $ref: 'TS29510_Nnrf_NFManagement.yaml#/components/schemas/PlmnSnssai'
        minItems: 1
- name: dnn
  in: query
  description: Dnn supported by the BSF, SMF or UPF
  schema:
    $ref: 'TS29571_CommonData.yaml#/components/schemas/Dnn'
- name: ipv4-index
  in: query
  description: The IPv4 Index supported by the candidate UPF.
  content:
    application/json:
      schema:
        $ref: 'TS29503_Nudm_SDM.yaml#/components/schemas/IpIndex'
- name: ipv6-index
  in: query
  description: The IPv6 Index supported by the candidate UPF.
  content:
    application/json:
      schema:
        $ref: 'TS29503_Nudm_SDM.yaml#/components/schemas/IpIndex'
- name: nsi-list
  in: query
  description: NSI IDs that are served by the services being discovered
  schema:
    type: array
    items:
      type: string
    minItems: 1
  style: form
  explode: false
- name: smf-serving-area
  in: query
  schema:
    type: string
- name: mbsmf-serving-area
  in: query
  schema:
    type: string
- name: tai
  in: query
  description: Tracking Area Identity

```

```

content:
  application/json:
    schema:
      $ref: 'TS29571_CommonData.yaml#/components/schemas/Tai'
- name: amf-region-id
  in: query
  description: AMF Region Identity
  schema:
    $ref: 'TS29571_CommonData.yaml#/components/schemas/AmfRegionId'
- name: amf-set-id
  in: query
  description: AMF Set Identity
  schema:
    $ref: 'TS29571_CommonData.yaml#/components/schemas/AmfSetId'
- name: guami
  in: query
  description: Guami used to search for an appropriate AMF
  content:
    application/json:
      schema:
        $ref: 'TS29571_CommonData.yaml#/components/schemas/Guami'
- name: supi
  in: query
  description: SUPI of the user
  schema:
    $ref: 'TS29571_CommonData.yaml#/components/schemas/Supi'
- name: ue-ipv4-address
  in: query
  description: IPv4 address of the UE
  schema:
    $ref: 'TS29571_CommonData.yaml#/components/schemas/Ipv4Addr'
- name: ip-domain
  in: query
  description: IP domain of the UE, which supported by BSF
  schema:
    type: string
- name: ue-ipv6-prefix
  in: query
  description: IPv6 prefix of the UE
  schema:
    $ref: 'TS29571_CommonData.yaml#/components/schemas/Ipv6Prefix'
- name: pgw-ind
  in: query
  description: Combined PGW-C and SMF or a standalone SMF
  schema:
    type: boolean
- name: preferred-pgw-ind
  in: query
  description: Indicates combined PGW-C+SMF or standalone SMF are preferred
  schema:
    type: boolean
- name: pgw
  in: query
  description: PGW FQDN of a combined PGW-C and SMF
  schema:
    $ref: 'TS29571_CommonData.yaml#/components/schemas/Fqdn'
- name: pgw-ip
  in: query
  description: PGW IP Address of a combined PGW-C and SMF
  content:
    application/json:
      schema:
        $ref: 'TS29571_CommonData.yaml#/components/schemas/IpAddr'
- name: gpsi
  in: query
  description: GPSI of the user
  schema:
    $ref: 'TS29571_CommonData.yaml#/components/schemas/Gpsi'
- name: external-group-identity
  in: query
  description: external group identifier of the user
  schema:
    $ref: 'TS29503_Nudm_SDM.yaml#/components/schemas/ExtGroupId'
- name: internal-group-identity
  in: query
  description: internal group identifier of the user
  schema:
    $ref: 'TS29571_CommonData.yaml#/components/schemas/GroupId'

```

- name: pfd-data
  - in: query
  - description: PFD data
  - content:
    - application/json:
      - schema:
        - \$ref: 'TS29510\_Nnrf\_NFManagement.yaml#/components/schemas/PfdData'
- name: data-set
  - in: query
  - description: data set supported by the NF
  - schema:
    - \$ref: 'TS29510\_Nnrf\_NFManagement.yaml#/components/schemas/DataSetId'
- name: routing-indicator
  - in: query
  - description: routing indicator in SUCI
  - schema:
    - type: string
    - pattern: '^([0-9]){1,4}\$'
- name: group-id-list
  - in: query
  - description: Group IDs of the NFs being discovered
  - schema:
    - type: array
    - items:
      - \$ref: 'TS29571\_CommonData.yaml#/components/schemas/NfGroupId'
    - minItems: 1
  - style: form
  - explode: false
- name: dnai-list
  - in: query
  - description: Data network access identifiers of the NFs being discovered
  - schema:
    - type: array
    - items:
      - \$ref: 'TS29571\_CommonData.yaml#/components/schemas/Dnai'
    - minItems: 1
  - style: form
  - explode: false
- name: pdu-session-types
  - in: query
  - description: list of PDU Session Type required to be supported by the target NF
  - schema:
    - type: array
    - items:
      - \$ref: 'TS29571\_CommonData.yaml#/components/schemas/PduSessionType'
    - minItems: 1
  - style: form
  - explode: false
- name: event-id-list
  - in: query
  - description: >  
Analytics event(s) requested to be supported by the Nnwdaf\_AnalyticsInfo service
  - schema:
    - type: array
    - items:
      - \$ref: 'TS29520\_Nnwdaf\_AnalyticsInfo.yaml#/components/schemas/EventId'
    - minItems: 1
  - style: form
  - explode: false
- name: nwdaf-event-list
  - in: query
  - description: >  
Analytics event(s) requested to be supported by the Nnwdaf\_EventsSubscription service.
  - schema:
    - type: array
    - items:
      - \$ref: 'TS29520\_Nnwdaf\_EventsSubscription.yaml#/components/schemas/NwdafEvent'
    - minItems: 1
  - style: form
  - explode: false
- name: supported-features
  - in: query
  - description: Features required to be supported by the target NF
  - schema:
    - \$ref: 'TS29571\_CommonData.yaml#/components/schemas/SupportedFeatures'
- name: upf-iwk-eps-ind
  - in: query
  - description: UPF supporting interworking with EPS or not



```

    schema:
      type: boolean
  - name: chf-supported-plmn
    in: query
    description: PLMN ID supported by a CHF
    content:
      application/json:
        schema:
          $ref: 'TS29571_CommonData.yaml#/components/schemas/PlmnId'
  - name: preferred-locality
    in: query
    description: preferred target NF location
    schema:
      type: string
  - name: access-type
    in: query
    description: AccessType supported by the target NF
    schema:
      $ref: 'TS29571_CommonData.yaml#/components/schemas/AccessType'
  - name: limit
    in: query
    description: Maximum number of NFProfiles to return in the response
    required: false
    schema:
      type: integer
      minimum: 1
  - name: required-features
    in: query
    description: Features required to be supported by the target NF
    schema:
      type: array
      items:
        $ref: 'TS29571_CommonData.yaml#/components/schemas/SupportedFeatures'
      minItems: 1
    style: form
    explode: false
  - name: complex-query
    in: query
    description: the complex query condition expression
    content:
      application/json:
        schema:
          $ref: 'TS29571_CommonData.yaml#/components/schemas/ComplexQuery'
  - name: max-payload-size
    in: query
    description: Maximum payload size of the response expressed in kilo octets
    required: false
    schema:
      type: integer
      maximum: 2000
      default: 124
  - name: max-payload-size-ext
    in: query
    description: >
      Extended query for maximum payload size of the response expressed in kilo octets
    required: false
    schema:
      type: integer
      default: 124
  - name: atsss-capability
    in: query
    description: ATSSS Capability
    content:
      application/json:
        schema:
          $ref: 'TS29571_CommonData.yaml#/components/schemas/AtsssCapability'
  - name: upf-ue-ip-addr-ind
    in: query
    description: UPF supporting allocating UE IP addresses/prefixes
    schema:
      type: boolean
  - name: client-type
    in: query
    description: Requested client type served by the NF
    content:
      application/json:
        schema:
          $ref: 'TS29572_Nlmf_Location.yaml#/components/schemas/ExternalClientType'

```

- name: lmf-id
  - in: query
  - description: LMF identification to be discovered
  - content:
    - application/json:
      - schema:
        - \$ref: 'TS29572\_Nlmf\_Location.yaml#/components/schemas/LMFIdentification'
- name: an-node-type
  - in: query
  - description: Requested AN node type served by the NF
  - content:
    - application/json:
      - schema:
        - \$ref: 'TS29510\_Nnrf\_NFManagement.yaml#/components/schemas/AnNodeType'
  - name: rat-type
    - in: query
    - description: Requested RAT type served by the NF
    - content:
      - application/json:
        - schema:
          - \$ref: 'TS29571\_CommonData.yaml#/components/schemas/RatType'
    - name: preferred-tai
      - in: query
      - description: preferred Tracking Area Identity
      - content:
        - application/json:
          - schema:
            - \$ref: 'TS29571\_CommonData.yaml#/components/schemas/Tai'
      - name: preferred-nf-instances
        - in: query
        - description: preferred NF Instances
        - schema:
          - type: array
          - items:
            - \$ref: 'TS29571\_CommonData.yaml#/components/schemas/NfInstanceId'
          - minItems: 1
        - style: form
        - explode: false
      - name: If-None-Match
        - in: header
        - description: Validator for conditional requests, as described in IETF RFC 7232, 3.2
        - schema:
          - type: string
      - name: target-snpn
        - in: query
        - description: Target SNPN Identity, or the Credentials Holder in the SNPN
        - content:
          - application/json:
            - schema:
              - \$ref: 'TS29571\_CommonData.yaml#/components/schemas/PlmnIdNid'
        - name: requester-snpn-list
          - in: query
          - description: SNPN ID(s) of the NF instance issuing the Discovery request
          - content:
            - application/json:
              - schema:
                - type: array
                - items:
                  - \$ref: 'TS29571\_CommonData.yaml#/components/schemas/PlmnIdNid'
                - minItems: 1
          - name: af-ee-data
            - in: query
            - description: NEF exposed by the AF
            - content:
              - application/json:
                - schema:
                  - \$ref: 'TS29510\_Nnrf\_NFManagement.yaml#/components/schemas/AfEventExposureData'
            - name: w-agf-info
              - in: query
              - description: UPF collocated with W-AGF
              - content:
                - application/json:
                  - schema:
                    - \$ref: 'TS29510\_Nnrf\_NFManagement.yaml#/components/schemas/WAgfInfo'
              - name: tngf-info
                - in: query
                - description: UPF collocated with TNGF
                - content:

```

    application/json:
      schema:
        $ref: 'TS29510_Nnrf_NFManagement.yaml#/components/schemas/TngfInfo'
  - name: twif-info
    in: query
    description: UPF collocated with TWIF
    content:
      application/json:
        schema:
          $ref: 'TS29510_Nnrf_NFManagement.yaml#/components/schemas/TwifInfo'
  - name: target-nf-set-id
    in: query
    description: Target NF Set ID
    schema:
      $ref: 'TS29571_CommonData.yaml#/components/schemas/NfSetId'
  - name: target-nf-service-set-id
    in: query
    description: Target NF Service Set ID
    schema:
      $ref: 'TS29571_CommonData.yaml#/components/schemas/NfServiceSetId'
  - name: nef-id
    in: query
    description: NEF ID
    schema:
      $ref: 'TS29510_Nnrf_NFManagement.yaml#/components/schemas/NefId'
  - name: notification-type
    in: query
    description: Notification Type
    schema:
      $ref: 'TS29510_Nnrf_NFManagement.yaml#/components/schemas/NotificationType'
  - name: n1-msg-class
    in: query
    description: N1 Message Class
    schema:
      $ref: 'TS29518_Namf_Communication.yaml#/components/schemas/N1MessageClass'
  - name: n2-info-class
    in: query
    description: N2 Information Class
    schema:
      $ref: 'TS29518_Namf_Communication.yaml#/components/schemas/N2InformationClass'
  - name: serving-scope
    in: query
    description: areas that can be served by the target NF
    schema:
      type: array
      items:
        type: string
      minItems: 1
      style: form
      explode: false
  - name: imsi
    in: query
    description: IMSI of the requester UE to search for an appropriate NF (e.g. HSS)
    schema:
      type: string
      pattern: '^[0-9]{5,15}$'
  - name: ims-private-identity
    in: query
    description: IMPI of the requester UE to search for a target HSS
    schema:
      type: string
  - name: ims-public-identity
    in: query
    description: IMS Public Identity of the requester UE to search for a target HSS
    schema:
      type: string
  - name: msisdn
    in: query
    description: MSISDN of the requester UE to search for a target HSS
    schema:
      type: string
  - name: preferred-api-versions
    in: query
    description: Preferred API version of the services to be discovered
    content:
      application/json:
        schema:
          description: A map (list of key-value pairs) where ServiceName serves as key

```

```

      type: object
      additionalProperties:
        type: string
      minProperties: 1
- name: v2x-support-ind
  in: query
  description: PCF supports V2X
  schema:
    type: boolean
- name: redundant-gtpu
  in: query
  description: UPF supports redundant gtp-u to be discovered
  schema:
    type: boolean
- name: redundant-transport
  in: query
  description: UPF supports redundant transport path to be discovered
  schema:
    type: boolean
- name: ipups
  in: query
  description: UPF which is configured for IPUPS functionality to be discovered
  schema:
    type: boolean
- name: scp-domain-list
  in: query
  description: SCP domains the target SCP or SEPP belongs to
  schema:
    type: array
    items:
      type: string
    minItems: 1
  style: form
  explode: false
- name: address-domain
  in: query
  description: Address domain reachable through the SCP
  schema:
    $ref: 'TS29571_CommonData.yaml#/components/schemas/Fqdn'
- name: ipv4-addr
  in: query
  description: IPv4 address reachable through the SCP
  schema:
    $ref: 'TS29571_CommonData.yaml#/components/schemas/Ipv4Addr'
- name: ipv6-prefix
  in: query
  description: IPv6 prefix reachable through the SCP
  schema:
    $ref: 'TS29571_CommonData.yaml#/components/schemas/Ipv6Prefix'
- name: served-nf-set-id
  in: query
  description: NF Set ID served by the SCP
  schema:
    $ref: 'TS29571_CommonData.yaml#/components/schemas/NfSetId'
- name: remote-plmn-id
  in: query
  description: Id of the PLMN reachable through the SCP or SEPP
  content:
    application/json:
      schema:
        $ref: 'TS29571_CommonData.yaml#/components/schemas/PlmnId'
- name: remote-snpn-id
  in: query
  description: Id of the SNPN reachable through the SCP or SEPP
  content:
    application/json:
      schema:
        $ref: 'TS29571_CommonData.yaml#/components/schemas/PlmnIdNid'
- name: data-forwarding
  in: query
  description: UPF Instance(s) configured for data forwarding are requested
  schema:
    type: boolean
- name: preferred-full-plmn
  in: query
  description: NF Instance(s) serving the full PLMN are preferred
  schema:
    type: boolean

```

```

- name: requester-features
  in: query
  description: >
    Features supported by the NF Service Consumer that is invoking
    the Nnrf_NFDiscovery service
  schema:
    $ref: 'TS29571_CommonData.yaml#/components/schemas/SupportedFeatures'
- name: realm-id
  in: query
  description: realm-id to search for an appropriate UDSF
  schema:
    type: string
- name: storage-id
  in: query
  description: storage-id to search for an appropriate UDSF
  schema:
    type: string
- name: vsmf-support-ind
  in: query
  description: V-SMF capability supported by the target NF instance(s)
  schema:
    type: boolean
- name: ismf-support-ind
  in: query
  description: I-SMF capability supported by the target NF instance(s)
  schema:
    type: boolean
- name: nrf-disc-uri
  in: query
  description: Uri of the NRF holding the NF profile of a target NF Instance
  schema:
    $ref: 'TS29571_CommonData.yaml#/components/schemas/Uri'
- name: preferred-vendor-specific-features
  in: query
  description: Preferred vendor specific features of the services to be discovered
  content:
    application/json:
      schema:
        description: A map (list of key-value pairs) where ServiceName serves as key
        type: object
        additionalProperties:
          description: >
            A map (list of key-value pairs) where IANA-assigned SMI Network Management
            Private Enterprise Codes serves as key
          type: object
          additionalProperties:
            type: array
            items:
              $ref:
                'TS29510_Nnrf_NFManagement.yaml#/components/schemas/VendorSpecificFeature'
            minItems: 1
            minProperties: 1
            minProperties: 1
- name: preferred-vendor-specific-nf-features
  in: query
  description: Preferred vendor specific features of the network function to be discovered
  content:
    application/json:
      schema:
        description: >
          A map (list of key-value pairs) where IANA-assigned SMI Network Management Private
          Enterprise Codes serves as key
        type: object
        additionalProperties:
          type: array
          items:
            $ref:
              'TS29510_Nnrf_NFManagement.yaml#/components/schemas/VendorSpecificFeature'
            minItems: 1
            minProperties: 1
- name: required-pfcp-features
  in: query
  description: PFCP features required to be supported by the target UPF
  schema:
    type: string
- name: home-pub-key-id
  in: query
  description: >

```

Indicates the Home Network Public Key ID which shall be able to be served by the NF instance

```

schema:
  type: integer
- name: prose-support-ind
  in: query
  description: PCF supports ProSe Capability
  schema:
    type: boolean
- name: analytics-aggregation-ind
  in: query
  description: analytics aggregation is supported by NWDAF or not
  schema:
    type: boolean
- name: serving-nf-set-id
  in: query
  description: NF Set Id served by target NF
  schema:
    $ref: 'TS29571_CommonData.yaml#/components/schemas/NfSetId'
- name: serving-nf-type
  in: query
  description: NF type served by the target NF
  schema:
    $ref: 'TS29510_Nnrf_NFManagement.yaml#/components/schemas/NFType'
- name: ml-analytics-info-list
  in: query
  description: Lisf of ML Analytics Filter information of Nnwdaf_MLModelProvision service
  content:
    application/json:
      schema:
        type: array
        items:
          $ref: 'TS29510_Nnrf_NFManagement.yaml#/components/schemas/MLAnalyticsInfo'
        minItems: 1
- name: analytics-metadata-prov-ind
  in: query
  description: analytics matadata provisioning is supported by NWDAF or not
  schema:
    type: boolean
- name: nsacf-capability
  in: query
  description: the service capability supported by the target NSACF
  schema:
    $ref: 'TS29510_Nnrf_NFManagement.yaml#/components/schemas/NsacfCapability'
- name: mbs-session-id-list
  in: query
  description: List of MBS Session ID(s)
  content:
    application/json:
      schema:
        type: array
        items:
          $ref: 'TS29571_CommonData.yaml#/components/schemas/MbsSessionId'
        minItems: 1
- name: area-session-id
  in: query
  description: Area Session ID
  schema:
    $ref: 'TS29571_CommonData.yaml#/components/schemas/AreaSessionId'
- name: gmlc-number
  in: query
  description: The GMLC Number supported by the GMLC
  schema:
    type: string
    pattern: '^[0-9]{5,15}$'
- name: upf-n6-ip
  in: query
  description: N6 IP address of PSA UPF supported by the EASDF
  content:
    application/json:
      schema:
        $ref: 'TS29571_CommonData.yaml#/components/schemas/IpAddr'
- name: tai-list
  in: query
  description: Tracking Area Identifiers of the NFs being discovered
  content:
    application/json:
      schema:

```

```

    type: array
    items:
      $ref: 'TS29571_CommonData.yaml#/components/schemas/Tai'
    minItems: 1
- name: preferences-precedence
  in: query
  description: >
    Indicates the precedence of the preference query parameters (from higher to lower)
  schema:
    type: array
    items:
      type: string
    minItems: 2
    style: form
    explode: false
- name: support-onboarding-capability
  in: query
  description: Indicating the support for onboarding.
  schema:
    type: boolean
    default: false
- name: uas-nf-functionality-ind
  in: query
  description: UAS NF functionality is supported by NEF or not
  schema:
    type: boolean
- name: v2x-capability
  in: query
  description: indicates the V2X capability that the target PCF needs to support.
  content:
    application/json:
      schema:
        $ref: 'TS29510_Nnrf_NFManagement.yaml#/components/schemas/V2xCapability'
- name: prose-capability
  in: query
  description: indicates the ProSe capability that the target PCF needs to support.
  content:
    application/json:
      schema:
        $ref: 'TS29510_Nnrf_NFManagement.yaml#/components/schemas/ProSeCapability'
- name: shared-data-id
  in: query
  description: Identifier of shared data stored in the NF being discovered
  schema:
    $ref: 'TS29503_Nudm_SDM.yaml#/components/schemas/SharedDataId'
- name: target-hni
  in: query
  description: Home Network Identifier query.
  schema:
    $ref: 'TS29571_CommonData.yaml#/components/schemas/Fqdn'
- name: target-nw-resolution
  in: query
  description: Resolution of the identity of the target PLMN based on the GPSI of the UE
  schema:
    type: boolean
- name: exclude-nfinst-list
  in: query
  description: NF Instance IDs to be excluded from the NF Discovery procedure
  schema:
    type: array
    items:
      $ref: 'TS29571_CommonData.yaml#/components/schemas/NfInstanceId'
    minItems: 1
    style: form
    explode: false
- name: exclude-nfservinst-list
  in: query
  description: NF service instance IDs to be excluded from the NF Discovery procedure
  content:
    application/json:
      schema:
        type: array
        items:
          $ref: '#/components/schemas/NfServiceInstance'
        minItems: 1
- name: exclude-nfserviceset-list
  in: query
  description: NF Service Set IDs to be excluded from the NF Discovery procedure

```

```

    schema:
      type: array
      items:
        $ref: 'TS29571_CommonData.yaml#/components/schemas/NfServiceSetId'
      minItems: 1
      style: form
      explode: false
- name: exclude-nfset-list
  in: query
  description: NF Set IDs to be excluded from the NF Discovery procedure
  schema:
    type: array
    items:
      $ref: 'TS29571_CommonData.yaml#/components/schemas/NfSetId'
    minItems: 1
    style: form
    explode: false
- name: preferred-analytics-delays
  in: query
  description: Preferred analytics delays supported by the NWDAF to be discovered
  content:
    application/json:
      schema:
        description: >
          A map (list of key-value pairs) where EventId or NwdafEvent serves as key
        type: object
        additionalProperties:
          $ref: 'TS29571_CommonData.yaml#/components/schemas/DurationSec'
        minProperties: 1

responses:
  '200':
    description: Expected response to a valid request
    content:
      application/json:
        schema:
          $ref: '#/components/schemas/SearchResult'
    links:
      search:
        operationId: RetrieveStoredSearch
        parameters:
          searchId: $response.body#/searchId
        description: >
          The 'searchId' parameter returned in the response can be used as the
          'searchId' parameter in the GET request to '/searches/{searchId}'
      completeSearch:
        operationId: RetrieveCompleteSearch
        parameters:
          searchId: $response.body#/searchId
        description: >
          The 'searchId' parameter returned in the response can be used as the
          'searchId' parameter in the GET request to '/searches/{searchId}/complete'
    headers:
      Cache-Control:
        description: Cache-Control containing max-age, described in IETF RFC 7234, 5.2
        schema:
          type: string
      ETag:
        description: Entity Tag containing a strong validator, described in IETF RFC 7232, 2.3
        schema:
          type: string
      Content-Encoding:
        description: Content-Encoding, described in IETF RFC 7231
        schema:
          type: string
  '307':
    description: Temporary Redirect
    content:
      application/json:
        schema:
          $ref: 'TS29571_CommonData.yaml#/components/schemas/RedirectResponse'
    headers:
      Location:
        description: The URI pointing to the resource located on the redirect target NRF
        required: true
        schema:
          type: string
  '308':

```



```

description: Permanent Redirect
content:
  application/json:
    schema:
      $ref: 'TS29571_CommonData.yaml#/components/schemas/RedirectResponse'
headers:
  Location:
    description: The URI pointing to the resource located on the redirect target NRF
    required: true
    schema:
      type: string
'400':
  $ref: 'TS29571_CommonData.yaml#/components/responses/400'
'401':
  $ref: 'TS29571_CommonData.yaml#/components/responses/401'
'403':
  $ref: 'TS29571_CommonData.yaml#/components/responses/403'
'404':
  $ref: 'TS29571_CommonData.yaml#/components/responses/404'
'406':
  $ref: 'TS29571_CommonData.yaml#/components/responses/406'
'411':
  $ref: 'TS29571_CommonData.yaml#/components/responses/411'
'413':
  $ref: 'TS29571_CommonData.yaml#/components/responses/413'
'415':
  $ref: 'TS29571_CommonData.yaml#/components/responses/415'
'429':
  $ref: 'TS29571_CommonData.yaml#/components/responses/429'
'500':
  $ref: 'TS29571_CommonData.yaml#/components/responses/500'
'501':
  $ref: 'TS29571_CommonData.yaml#/components/responses/501'
'503':
  $ref: 'TS29571_CommonData.yaml#/components/responses/503'
default:
  $ref: 'TS29571_CommonData.yaml#/components/responses/default'

```

/searches/{searchId}:

```

get:
  operationId: RetrieveStoredSearch
  tags:
    - Stored Search (Document)
  parameters:
    - $ref: '#/components/parameters/searchId'
    - name: Accept-Encoding
      in: header
      description: Accept-Encoding, described in IETF RFC 7231
      schema:
        type: string
  responses:
    '200':
      $ref: '#/components/responses/200'
    '307':
      description: Temporary Redirect
      content:
        application/json:
          schema:
            $ref: 'TS29571_CommonData.yaml#/components/schemas/RedirectResponse'
      headers:
        Location:
          description: The URI pointing to the resource located on the redirect target NRF
          required: true
          schema:
            type: string
    '308':
      description: Permanent Redirect
      content:
        application/json:
          schema:
            $ref: 'TS29571_CommonData.yaml#/components/schemas/RedirectResponse'
      headers:
        Location:
          description: The URI pointing to the resource located on the redirect target NRF
          required: true
          schema:
            type: string

```

```

/searches/{searchId}/complete:
  get:
    operationId: RetrieveCompleteSearch
    tags:
      - Complete Stored Search (Document)
    parameters:
      - $ref: '#/components/parameters/searchId'
      - name: Accept-Encoding
        in: header
        description: Accept-Encoding, described in IETF RFC 7231
        schema:
          type: string
    responses:
      '200':
        $ref: '#/components/responses/200'
      '307':
        description: Temporary Redirect
        content:
          application/json:
            schema:
              $ref: 'TS29571_CommonData.yaml#/components/schemas/RedirectResponse'
        headers:
          Location:
            description: The URI pointing to the resource located on the redirect target NRF
            required: true
            schema:
              type: string
      '308':
        description: Permanent Redirect
        content:
          application/json:
            schema:
              $ref: 'TS29571_CommonData.yaml#/components/schemas/RedirectResponse'
        headers:
          Location:
            description: The URI pointing to the resource located on the redirect target NRF
            required: true
            schema:
              type: string

/scp-domain-routing-info:
  get:
    operationId: SCPDomainRoutingInfoGet
    tags:
      - SCP Domain Routing Information (Document)
    security:
      - {}
      - oAuth2ClientCredentials:
          - nnrf-disc
      - oAuth2ClientCredentials:
          - nnrf-disc
          - nnrf-disc:scp-domain:read
    parameters:
      - name: local
        in: query
        description: Indication of local SCP Domain Routing Information
        required: false
        schema:
          type: boolean
          default: false
      - name: Accept-Encoding
        in: header
        description: Accept-Encoding, described in IETF RFC 7231
        schema:
          type: string
    responses:
      '200':
        description: Expected response to a valid request
        content:
          application/json:
            schema:
              $ref: '#/components/schemas/ScpDomainRoutingInformation'
        headers:
          Content-Encoding:
            description: Content-Encoding, described in IETF RFC 7231
            schema:
              type: string
      '307':

```

```

description: Temporary Redirect
headers:
  Location:
    description: The URI pointing to the resource located on the redirect target NRF
    required: true
    schema:
      type: string
'400':
  $ref: 'TS29571_CommonData.yaml#/components/responses/400'
'401':
  $ref: 'TS29571_CommonData.yaml#/components/responses/401'
'403':
  $ref: 'TS29571_CommonData.yaml#/components/responses/403'
'404':
  $ref: 'TS29571_CommonData.yaml#/components/responses/404'
'406':
  $ref: 'TS29571_CommonData.yaml#/components/responses/406'
'411':
  $ref: 'TS29571_CommonData.yaml#/components/responses/411'
'413':
  $ref: 'TS29571_CommonData.yaml#/components/responses/413'
'415':
  $ref: 'TS29571_CommonData.yaml#/components/responses/415'
'429':
  $ref: 'TS29571_CommonData.yaml#/components/responses/429'
'500':
  $ref: 'TS29571_CommonData.yaml#/components/responses/500'
'501':
  $ref: 'TS29571_CommonData.yaml#/components/responses/501'
'503':
  $ref: 'TS29571_CommonData.yaml#/components/responses/503'
default:
  $ref: 'TS29571_CommonData.yaml#/components/responses/default'

```

```
/scp-domain-routing-info-sub:
```

```

post:
  summary: Create a new subscription
  operationId: ScpDomainRoutingInfoSubscribe
  tags:
    - SCP Domain Routing Information Subscriptions (Collection)
  security:
    - {}
    - oAuth2ClientCredentials:
      - nnrf-disc
    - oAuth2ClientCredentials:
      - nnrf-disc
      - nnrf-disc:scp-domain-subscribe:write
  parameters:
    - name: Content-Encoding
      in: header
      description: Content-Encoding, described in IETF RFC 7231
      schema:
        type: string
    - name: Accept-Encoding
      in: header
      description: Accept-Encoding, described in IETF RFC 7231
      schema:
        type: string
  requestBody:
    content:
      application/json:
        schema:
          $ref: '#/components/schemas/ScpDomainRoutingInfoSubscription'
    required: true
  responses:
    '201':
      description: Expected response to a valid request
      content:
        application/json:
          schema:
            $ref: '#/components/schemas/ScpDomainRoutingInfoSubscription'
      headers:
        Location:
          description: >
            Contains the URI of the newly created resource, according to the structure:
            {apiRoot}/nnrf-disc/v1/scp-domain-routing-info-sub/{subscriptionID}
          required: true
          schema:

```

```

    type: string
  Accept-Encoding:
    description: Accept-Encoding, described in IETF RFC 7694
    schema:
      type: string
  Content-Encoding:
    description: Content-Encoding, described in IETF RFC 7231
    schema:
      type: string
'400':
  $ref: 'TS29571_CommonData.yaml#/components/responses/400'
'401':
  $ref: 'TS29571_CommonData.yaml#/components/responses/401'
'403':
  $ref: 'TS29571_CommonData.yaml#/components/responses/403'
'404':
  $ref: 'TS29571_CommonData.yaml#/components/responses/404'
'411':
  $ref: 'TS29571_CommonData.yaml#/components/responses/411'
'413':
  $ref: 'TS29571_CommonData.yaml#/components/responses/413'
'415':
  $ref: 'TS29571_CommonData.yaml#/components/responses/415'
'429':
  $ref: 'TS29571_CommonData.yaml#/components/responses/429'
'500':
  $ref: 'TS29571_CommonData.yaml#/components/responses/500'
'501':
  $ref: 'TS29571_CommonData.yaml#/components/responses/501'
'503':
  $ref: 'TS29571_CommonData.yaml#/components/responses/503'
default:
  $ref: 'TS29571_CommonData.yaml#/components/responses/default'
callbacks:
  onScpDomainRoutingInformationChange:
    '{$request.body#/callbackUri}':
      post:
        parameters:
          - name: Content-Encoding
            in: header
            description: Content-Encoding, described in IETF RFC 7231
            schema:
              type: string
        requestBody:
          description: Notification Payload
          content:
            application/json:
              schema:
                $ref: '#/components/schemas/ScpDomainRoutingInfoNotification'
        responses:
          '204':
            description: Expected response to a successful callback processing
            headers:
              Accept-Encoding:
                description: Accept-Encoding, described in IETF RFC 7694
                schema:
                  type: string
          '400':
            $ref: 'TS29571_CommonData.yaml#/components/responses/400'
          '401':
            $ref: 'TS29571_CommonData.yaml#/components/responses/401'
          '403':
            $ref: 'TS29571_CommonData.yaml#/components/responses/403'
          '404':
            $ref: 'TS29571_CommonData.yaml#/components/responses/404'
          '411':
            $ref: 'TS29571_CommonData.yaml#/components/responses/411'
          '413':
            $ref: 'TS29571_CommonData.yaml#/components/responses/413'
          '415':
            $ref: 'TS29571_CommonData.yaml#/components/responses/415'
          '429':
            $ref: 'TS29571_CommonData.yaml#/components/responses/429'
          '500':
            $ref: 'TS29571_CommonData.yaml#/components/responses/500'
          '501':
            $ref: 'TS29571_CommonData.yaml#/components/responses/501'
          '503':

```

```

    $ref: 'TS29571_CommonData.yaml#/components/responses/503'
  default:
    $ref: 'TS29571_CommonData.yaml#/components/responses/default'

/scp-domain-routing-info-subs/{subscriptionID}:
  delete:
    summary: Deletes a subscription
    operationId: ScpDomainRoutingInfoUnsubscribe
    tags:
      - Individual SCP Domain Routing Information Subscription (Document)
    security:
      - {}
      - oAuth2ClientCredentials:
          - nnrf-disc
      - oAuth2ClientCredentials:
          - nnrf-disc
          - nnrf-disc:scp-domain-subs:write
    parameters:
      - name: subscriptionID
        in: path
        required: true
        description: Unique ID of the subscription to remove
        schema:
          type: string
    responses:
      '204':
        description: Expected response to a successful subscription removal
      '400':
        $ref: 'TS29571_CommonData.yaml#/components/responses/400'
      '401':
        $ref: 'TS29571_CommonData.yaml#/components/responses/401'
      '403':
        $ref: 'TS29571_CommonData.yaml#/components/responses/403'
      '404':
        $ref: 'TS29571_CommonData.yaml#/components/responses/404'
      '411':
        $ref: 'TS29571_CommonData.yaml#/components/responses/411'
      '413':
        $ref: 'TS29571_CommonData.yaml#/components/responses/413'
      '415':
        $ref: 'TS29571_CommonData.yaml#/components/responses/415'
      '429':
        $ref: 'TS29571_CommonData.yaml#/components/responses/429'
      '500':
        $ref: 'TS29571_CommonData.yaml#/components/responses/500'
      '501':
        $ref: 'TS29571_CommonData.yaml#/components/responses/501'
      '503':
        $ref: 'TS29571_CommonData.yaml#/components/responses/503'
      default:
        $ref: 'TS29571_CommonData.yaml#/components/responses/default'

components:
  securitySchemes:
    oAuth2ClientCredentials:
      type: oauth2
      flows:
        clientCredentials:
          tokenUrl: '/oauth2/token'
          scopes:
            nnrf-disc: Access to the Nnrf_NFDDiscovery API
            nnrf-disc:scp-domain:read: Access to read the scp-domain-routing-info resource
            nnrf-disc:scp-domain-subs:write: Access to create/delete a scp-domain subscription

resource
  parameters:
    searchId:
      name: searchId
      in: path
      description: Id of a stored search
      required: true
      schema:
        type: string

  responses:
    '200':
      description: Expected response to a valid request

```

```

content:
  application/json:
    schema:
      $ref: '#/components/schemas/StoredSearchResult'
headers:
  Cache-Control:
    description: Cache-Control containing max-age, described in IETF RFC 7234, 5.2
    schema:
      type: string
  ETag:
    description: Entity Tag containing a strong validator, described in IETF RFC 7232, 2.3
    schema:
      type: string
  Content-Encoding:
    description: Content-Encoding, described in IETF RFC 7231
    schema:
      type: string

schemas:

SearchResult:
  description: Contains the list of NF Profiles returned in a Discovery response
  type: object
  required:
    - nfInstances
  properties:
    validityPeriod:
      type: integer
    nfInstances:
      type: array
      items:
        $ref: '#/components/schemas/NFProfile'
    searchId:
      type: string
    numNfInstComplete:
      $ref: 'TS29571_CommonData.yaml#/components/schemas/Uint32'
    preferredSearch:
      $ref: '#/components/schemas/PreferredSearch'
    nrfSupportedFeatures:
      $ref: 'TS29571_CommonData.yaml#/components/schemas/SupportedFeatures'
    nfInstanceList:
      description: List of matching NF instances. The key of the map is the NF instance ID.
      type: object
      additionalProperties:
        $ref: '#/components/schemas/NfInstanceInfo'
      minProperties: 1
    alteredPriorityInd:
      type: boolean
    noProfileMatchInfo:
      $ref: '#/components/schemas/NoProfileMatchInfo'

StoredSearchResult:
  description: >
    Contains a complete search result (i.e. a number of discovered NF Instances),
    stored by NRF as a consequence of a prior search result
  type: object
  required:
    - nfInstances
  properties:
    nfInstances:
      type: array
      items:
        $ref: '#/components/schemas/NFProfile'

NFProfile:
  description: Information of an NF Instance discovered by the NRF
  type: object
  required:
    - nfInstanceId
    - nfType
    - nfStatus
  properties:
    nfInstanceId:
      $ref: 'TS29571_CommonData.yaml#/components/schemas/NfInstanceId'
    nfInstanceName:
      type: string
    nfType:
      $ref: 'TS29510_Nnrf_NFManagement.yaml#/components/schemas/NFType'

```

```

nfStatus:
  $ref: 'TS29510_Nnrf_NFManagement.yaml#/components/schemas/NFStatus'
collocatedNfInstances:
  type: array
  items:
    $ref: 'TS29510_Nnrf_NFManagement.yaml#/components/schemas/CollocatedNfInstance'
  minimum: 1
plmnList:
  type: array
  items:
    $ref: 'TS29571_CommonData.yaml#/components/schemas/PlmnId'
  minItems: 1
sNssais:
  type: array
  items:
    $ref: 'TS29571_CommonData.yaml#/components/schemas/ExtSnsai'
  minItems: 1
perPlmnSnsaiList:
  type: array
  items:
    $ref: 'TS29510_Nnrf_NFManagement.yaml#/components/schemas/PlmnSnsai'
  minItems: 1
nsiList:
  type: array
  items:
    type: string
  minItems: 1
fqdn:
  $ref: 'TS29571_CommonData.yaml#/components/schemas/Fqdn'
interPlmnFqdn:
  $ref: 'TS29571_CommonData.yaml#/components/schemas/Fqdn'
ipv4Addresses:
  type: array
  items:
    $ref: 'TS29571_CommonData.yaml#/components/schemas/Ipv4Addr'
  minItems: 1
ipv6Addresses:
  type: array
  items:
    $ref: 'TS29571_CommonData.yaml#/components/schemas/Ipv6Addr'
  minItems: 1
capacity:
  type: integer
  minimum: 0
  maximum: 65535
load:
  type: integer
  minimum: 0
  maximum: 100
loadTimeStamp:
  $ref: 'TS29571_CommonData.yaml#/components/schemas/DateTime'
locality:
  type: string
priority:
  type: integer
  minimum: 0
  maximum: 65535
udrInfo:
  $ref: 'TS29510_Nnrf_NFManagement.yaml#/components/schemas/UdrInfo'
udrInfoList:
  description: >
    A map (list of key-value pairs) where a (unique) valid JSON string
    serves as key of UdrInfo
  type: object
  additionalProperties:
    $ref: 'TS29510_Nnrf_NFManagement.yaml#/components/schemas/UdrInfo'
  minProperties: 1
udmInfo:
  $ref: 'TS29510_Nnrf_NFManagement.yaml#/components/schemas/UdmInfo'
udmInfoList:
  description: >
    A map (list of key-value pairs) where a (unique) valid JSON string
    serves as key of UdmInfo
  type: object
  additionalProperties:
    $ref: 'TS29510_Nnrf_NFManagement.yaml#/components/schemas/UdmInfo'
  minProperties: 1
ausfInfo:

```

```
$ref: 'TS29510_Nnrf_NFManagement.yaml#/components/schemas/AusfInfo'
ausfInfoList:
  description: >
    A map (list of key-value pairs) where a (unique) valid JSON string
    serves as key of AusfInfo
  type: object
  additionalProperties:
    $ref: 'TS29510_Nnrf_NFManagement.yaml#/components/schemas/AusfInfo'
  minProperties: 1
amfInfo:
  $ref: 'TS29510_Nnrf_NFManagement.yaml#/components/schemas/AmfInfo'
amfInfoList:
  description: >
    A map (list of key-value pairs) where a (unique) valid JSON string
    serves as key of AmfInfo
  type: object
  additionalProperties:
    $ref: 'TS29510_Nnrf_NFManagement.yaml#/components/schemas/AmfInfo'
  minProperties: 1
smfInfo:
  $ref: 'TS29510_Nnrf_NFManagement.yaml#/components/schemas/SmfInfo'
smfInfoList:
  description: >
    A map (list of key-value pairs) where a (unique) valid JSON string
    serves as key of SmfInfo
  type: object
  additionalProperties:
    $ref: 'TS29510_Nnrf_NFManagement.yaml#/components/schemas/SmfInfo'
  minProperties: 1
upfInfo:
  $ref: 'TS29510_Nnrf_NFManagement.yaml#/components/schemas/UpfInfo'
upfInfoList:
  description: >
    A map (list of key-value pairs) where a (unique) valid JSON string
    serves as key of UpfInfo
  type: object
  additionalProperties:
    $ref: 'TS29510_Nnrf_NFManagement.yaml#/components/schemas/UpfInfo'
  minProperties: 1
pcfInfo:
  $ref: 'TS29510_Nnrf_NFManagement.yaml#/components/schemas/PcfInfo'
pcfInfoList:
  description: >
    A map (list of key-value pairs) where a (unique) valid JSON string
    serves as key of PcfInfo
  type: object
  additionalProperties:
    $ref: 'TS29510_Nnrf_NFManagement.yaml#/components/schemas/PcfInfo'
  minProperties: 1
bsfInfo:
  $ref: 'TS29510_Nnrf_NFManagement.yaml#/components/schemas/BsfInfo'
bsfInfoList:
  description: >
    A map (list of key-value pairs) where a (unique) valid JSON string
    serves as key of BsfInfo
  type: object
  additionalProperties:
    $ref: 'TS29510_Nnrf_NFManagement.yaml#/components/schemas/BsfInfo'
  minProperties: 1
chfInfo:
  $ref: 'TS29510_Nnrf_NFManagement.yaml#/components/schemas/ChfInfo'
chfInfoList:
  description: >
    A map (list of key-value pairs) where a (unique) valid JSON string
    serves as key of ChfInfo
  type: object
  additionalProperties:
    $ref: 'TS29510_Nnrf_NFManagement.yaml#/components/schemas/ChfInfo'
  minProperties: 1
udsfInfo:
  $ref: 'TS29510_Nnrf_NFManagement.yaml#/components/schemas/UdsfInfo'
udsfInfoList:
  description: >
    A map (list of key-value pairs) where a (unique) valid JSON string
    serves as key of UdsfInfo
  type: object
  additionalProperties:
    $ref: 'TS29510_Nnrf_NFManagement.yaml#/components/schemas/UdsfInfo'
```



```

    minProperties: 1
  nwdafInfo:
    $ref: 'TS29510_Nnrf_NFManagement.yaml#/components/schemas/NwdafInfo'
  nwdafInfoList:
    type: object
    description: >
      A map (list of key-value pairs) where a (unique) valid JSON string
      serves as key of NwdafInfo
    additionalProperties:
      $ref: 'TS29510_Nnrf_NFManagement.yaml#/components/schemas/NwdafInfo'
    minProperties: 1
  nefInfo:
    $ref: 'TS29510_Nnrf_NFManagement.yaml#/components/schemas/NefInfo'
  pcscfInfoList:
    description: >
      A map (list of key-value pairs) where a (unique) valid JSON string
      serves as key of PcscfInfo
    type: object
    additionalProperties:
      $ref: 'TS29510_Nnrf_NFManagement.yaml#/components/schemas/PcscfInfo'
    minProperties: 1
  hssInfoList:
    description: >
      A map (list of key-value pairs) where a (unique) valid JSON string
      serves as key of HssInfo
    type: object
    additionalProperties:
      $ref: 'TS29510_Nnrf_NFManagement.yaml#/components/schemas/HssInfo'
    minProperties: 1
  customInfo:
    type: object
  recoveryTime:
    $ref: 'TS29571_CommonData.yaml#/components/schemas/DateTime'
  nfServicePersistence:
    type: boolean
    default: false
  nfServices:
    deprecated: true
    type: array
    items:
      $ref: '#/components/schemas/NFService'
    minItems: 1
  nfServiceList:
    description: >
      A map (list of key-value pairs) where serviceInstanceId serves as key of NFService
    type: object
    additionalProperties:
      $ref: '#/components/schemas/NFService'
    minProperties: 1
  defaultNotificationSubscriptions:
    type: array
    items:
      $ref:
'TS29510_Nnrf_NFManagement.yaml#/components/schemas/DefaultNotificationSubscription'
  lmfInfo:
    $ref: 'TS29510_Nnrf_NFManagement.yaml#/components/schemas/LmfInfo'
  gmlcInfo:
    $ref: 'TS29510_Nnrf_NFManagement.yaml#/components/schemas/GmlcInfo'
  snpnList:
    type: array
    items:
      $ref: 'TS29571_CommonData.yaml#/components/schemas/PlmnIdNid'
    minItems: 1
  nfSetIdList:
    type: array
    items:
      $ref: 'TS29571_CommonData.yaml#/components/schemas/NfSetId'
    minItems: 1
  servingScope:
    type: array
    items:
      type: string
    minItems: 1
  lcHSupportInd:
    type: boolean
    default: false
  olcHSupportInd:
    type: boolean

```

```

    default: false
  nfSetRecoveryTimeList:
    description: A map (list of key-value pairs) where NfSetId serves as key of DateTime
    type: object
    additionalProperties:
      $ref: 'TS29571_CommonData.yaml#/components/schemas/DateTime'
    minProperties: 1
  serviceSetRecoveryTimeList:
    description: >
      A map (list of key-value pairs) where NfServiceSetId serves as key of DateTime
    type: object
    additionalProperties:
      $ref: 'TS29571_CommonData.yaml#/components/schemas/DateTime'
    minProperties: 1
  scpDomains:
    type: array
    items:
      type: string
    minItems: 1
  scpInfo:
    $ref: 'TS29510_Nnrf_NFManagement.yaml#/components/schemas/ScpInfo'
  seppInfo:
    $ref: 'TS29510_Nnrf_NFManagement.yaml#/components/schemas/SeppInfo'
  vendorId:
    $ref: 'TS29510_Nnrf_NFManagement.yaml#/components/schemas/VendorId'
  supportedVendorSpecificFeatures:
    description: >
      The key of the map is the IANA-assigned SMI Network Management Private Enterprise Codes
    type: object
    additionalProperties:
      type: array
      items:
        $ref: 'TS29510_Nnrf_NFManagement.yaml#/components/schemas/VendorSpecificFeature'
      minItems: 1
    minProperties: 1
  aanfInfoList:
    type: object
    description: >
      A map (list of key-value pairs) where a (unique) valid JSON string
      serves as key of AanfInfo
    additionalProperties:
      $ref: 'TS29510_Nnrf_NFManagement.yaml#/components/schemas/AanfInfo'
    minProperties: 1
  mfafInfo:
    $ref: 'TS29510_Nnrf_NFManagement.yaml#/components/schemas/MfafInfo'
  easdfInfoList:
    type: object
    description: >
      A map(list of key-value pairs) where a (unique) valid JSON string
      serves as key of EasdfInfo
    additionalProperties:
      $ref: 'TS29510_Nnrf_NFManagement.yaml#/components/schemas/EasdfInfo'
    minProperties: 1
  dccfInfo:
    $ref: 'TS29510_Nnrf_NFManagement.yaml#/components/schemas/DccfInfo'
  nsacfInfoList:
    description: >
      A map (list of key-value pairs) where a (unique) valid JSON string
      serves as key of NsacfInfo
    type: object
    additionalProperties:
      $ref: 'TS29510_Nnrf_NFManagement.yaml#/components/schemas/NsacfInfo'
    minProperties: 1
  mbSmfInfoList:
    description: >
      A map (list of key-value pairs) where a (unique) valid JSON string
      serves as key of MbSmfInfo
    type: object
    additionalProperties:
      $ref: 'TS29510_Nnrf_NFManagement.yaml#/components/schemas/MbSmfInfo'
    minProperties: 1
  tsctsInfoList:
    type: object
    description: >
      A map (list of key-value pairs) where a (unique) valid JSON string
      serves as key of TsctsInfo
    additionalProperties:
      $ref: 'TS29510_Nnrf_NFManagement.yaml#/components/schemas/TsctsInfo'

```

```

    minProperties: 1
  mbUpfInfoList:
    description: >
      A map (list of key-value pairs) where a (unique) valid JSON string
      serves as key of MbUpfInfo
    type: object
    additionalProperties:
      $ref: 'TS29510_Nnrf_NFManagement.yaml#/components/schemas/MbUpfInfo'
    minProperties: 1
  trustAfInfo:
    $ref: 'TS29510_Nnrf_NFManagement.yaml#/components/schemas/TrustAfInfo'
  nssaafInfo:
    $ref: 'TS29510_Nnrf_NFManagement.yaml#/components/schemas/NssaafInfo'
  hniList:
    type: array
    items:
      $ref: 'TS29571_CommonData.yaml#/components/schemas/Fqdn'
    minItems: 1
  iwmiscInfo:
    $ref: 'TS29510_Nnrf_NFManagement.yaml#/components/schemas/IwmiscInfo'
  mnpfInfo:
    $ref: 'TS29510_Nnrf_NFManagement.yaml#/components/schemas/MnpfInfo'

NFService:
  description: >
    Information of a given NF Service Instance; it is part of the NFProfile
    of an NF Instance discovered by the NRF
  type: object
  required:
    - serviceInstanceId
    - serviceName
    - versions
    - scheme
    - nfServiceStatus
  properties:
    serviceInstanceId:
      type: string
    serviceName:
      $ref: 'TS29510_Nnrf_NFManagement.yaml#/components/schemas/ServiceName'
    versions:
      type: array
      items:
        $ref: 'TS29510_Nnrf_NFManagement.yaml#/components/schemas/NFServiceVersion'
      minItems: 1
    scheme:
      $ref: 'TS29571_CommonData.yaml#/components/schemas/UriScheme'
    nfServiceStatus:
      $ref: 'TS29510_Nnrf_NFManagement.yaml#/components/schemas/NFServiceStatus'
    fqdn:
      $ref: 'TS29571_CommonData.yaml#/components/schemas/Fqdn'
    interPlmnFqdn:
      $ref: 'TS29571_CommonData.yaml#/components/schemas/Fqdn'
    ipEndPoints:
      type: array
      items:
        $ref: 'TS29510_Nnrf_NFManagement.yaml#/components/schemas/IpEndPoint'
      minItems: 1
    apiPrefix:
      type: string
    defaultNotificationSubscriptions:
      type: array
      items:
        $ref:
'TS29510_Nnrf_NFManagement.yaml#/components/schemas/DefaultNotificationSubscription'
      minItems: 1
    capacity:
      type: integer
      minimum: 0
      maximum: 65535
    load:
      type: integer
      minimum: 0
      maximum: 100
    loadTimeStamp:
      $ref: 'TS29571_CommonData.yaml#/components/schemas/DateTime'
    priority:
      type: integer
      minimum: 0

```

```

    maximum: 65535
  recoveryTime:
    $ref: 'TS29571_CommonData.yaml#/components/schemas/DateTime'
  supportedFeatures:
    $ref: 'TS29571_CommonData.yaml#/components/schemas/SupportedFeatures'
  nfServiceSetIdList:
    type: array
    items:
      $ref: 'TS29571_CommonData.yaml#/components/schemas/NfServiceSetId'
    minItems: 1
  sNssais:
    type: array
    items:
      $ref: 'TS29571_CommonData.yaml#/components/schemas/ExtSnsai'
    minItems: 1
  perPlmnSnsaiList:
    type: array
    items:
      $ref: 'TS29510_Nnrf_NFManagement.yaml#/components/schemas/PlmnSnsai'
    minItems: 1
  vendorId:
    $ref: 'TS29510_Nnrf_NFManagement.yaml#/components/schemas/VendorId'
  supportedVendorSpecificFeatures:
    description: >
      The key of the map is the IANA-assigned SMI Network Management Private Enterprise Codes
    type: object
    additionalProperties:
      type: array
      items:
        $ref: 'TS29510_Nnrf_NFManagement.yaml#/components/schemas/VendorSpecificFeature'
      minItems: 1
    minProperties: 1
  oauth2Required:
    type: boolean
  allowedOperationsPerNfType:
    description: A map (list of key-value pairs) where NF Type serves as key
    type: object
    additionalProperties:
      type: array
      items:
        type: string
        minItems: 1
    minProperties: 1
  allowedOperationsPerNfInstance:
    description: A map (list of key-value pairs) where NF Instance Id serves as key
    type: object
    additionalProperties:
      type: array
      items:
        type: string
        minItems: 1
    minProperties: 1
  PreferredSearch:
    description: >
      Contains information on whether the returned NFProfiles match the preferred query parameters
    type: object
  properties:
    preferredTaiMatchInd:
      type: boolean
      default: false
    preferredFullPlmnMatchInd:
      type: boolean
      default: false
    preferredApiVersionsMatchInd:
      type: boolean
    otherApiVersionsInd:
      type: boolean
    preferredLocalityMatchInd:
      type: boolean
      default: false
    otherLocalityInd:
      type: boolean
      default: false
    preferredVendorSpecificFeaturesInd:
      type: boolean
      default: false
    preferredCollocatedNfTypeInd:

```

```
    type: boolean
    default: false
  preferredPgwMatchInd:
    type: boolean
  preferredAnalyticsDelaysInd:
    type: boolean

NfInstanceInfo:
  description: Contains information on an NF profile matching a discovery request
  type: object
  properties:
    nrfDiscApiUri:
      $ref: 'TS29571_CommonData.yaml#/components/schemas/Uri'
    preferredSearch:
      $ref: '#/components/schemas/PreferredSearch'
    nrfAlteredPriorities:
      description: >
        The key of the map is the JSON Pointer of the priority IE in the NFProfile data type
        that is altered by the NRF
      type: object
      additionalProperties:
        type: integer
        minimum: 0
        maximum: 65535
      minProperties: 1

ScpDomainRoutingInformation:
  description: SCP Domain Routing Information
  type: object
  required:
    - scpDomainList
  properties:
    scpDomainList:
      description: |
        This IE shall contain a map of SCP domain interconnection information, where
        the key of the map is a SCP domain. The value of each entry shall be the
        interconnectivity information of the the SCP domain indicated by the key.
        An empty map indicates that there is no SCP domain currently registered in
        the NRF.
      type: object
      additionalProperties:
        $ref: '#/components/schemas/ScpDomainConnectivity'

ScpDomainConnectivity:
  description: SCP Domain Connectivity Information
  type: object
  required:
    - connectedScpDomainList
  properties:
    connectedScpDomainList:
      type: array
      items:
        type: string

ScpDomainRoutingInfoSubscription:
  description: SCP Domain Routing Information Subscription
  type: object
  required:
    - callbackUri
  properties:
    callbackUri:
      $ref: 'TS29571_CommonData.yaml#/components/schemas/Uri'
    validityTime:
      $ref: 'TS29571_CommonData.yaml#/components/schemas/DateTime'
    reqInstanceId:
      $ref: 'TS29571_CommonData.yaml#/components/schemas/NfInstanceId'
    localInd:
      type: boolean
      default: false

ScpDomainRoutingInfoNotification:
  description: SCP Domain Routing Information Notification
  type: object
  required:
    - routingInfo
  properties:
    routingInfo:
      $ref: '#/components/schemas/ScpDomainRoutingInformation'
```

```
    localInd:
      type: boolean
      default: false

  NfServiceInstance:
    description: NF service instance
    type: object
    oneOf:
      - required: [ nfInstanceId ]
      - required: [ nfServiceSetId ]
    properties:
      serviceInstanceId:
        type: string
      nfInstanceId:
        $ref: 'TS29571_CommonData.yaml#/components/schemas/NfInstanceId'
      nfServiceSetId:
        $ref: 'TS29571_CommonData.yaml#/components/schemas/NfServiceSetId'

  NoProfileMatchInfo:
    description: Provides the reason for not finding NF matching the search criteria
    type: object
    required:
      - reason
    properties:
      reason:
        $ref: '#/components/schemas/NoProfileMatchReason'
      queryParamCombinationList:
        type: array
        items:
          $ref: '#/components/schemas/QueryParamCombination'
        minItems: 1

  QueryParamCombination:
    description: Contains a list of Query Parameters
    type: object
    required:
      - queryParams
    properties:
      queryParams:
        type: array
        items:
          $ref: '#/components/schemas/QueryParameter'
        minItems: 1

  QueryParameter:
    description: Contains the name and value of a query parameter
    type: object
    required:
      - name
      - value
    properties:
      name:
        type: string
      value:
        type: string

  NoProfileMatchReason:
    description: No Profile Match Reason
    anyOf:
      - type: string
      enum:
        - REQUESTER_PLMN_NOT_ALLOWED
        - TARGET_NF_SUSPENDED
        - TARGET_NF_UNDISCOVERABLE
        - QUERY_PARAMS_COMBINATION_NO_MATCH
        - UNSPECIFIED
      - type: string
```

---

## A.4 Nnrf\_AccessToken API (NRF OAuth2 Authorization)

openapi: 3.0.0

```
info:
  version: '1.2.1'
  title: 'NRF OAuth2'
```

```
description: |
  NRF OAuth2 Authorization.
  © 2022, 3GPP Organizational Partners (ARIB, ATIS, CCSA, ETSI, TSDSI, TTA, TTC).
  All rights reserved.
```

```
externalDocs:
  description: 3GPP TS 29.510 V17.7.0; 5G System; Network Function Repository Services; Stage 3
  url: 'https://www.3gpp.org/ftp/Specs/archive/29_series/29.510/'
```

```
paths:
  /oauth2/token:
    post:
      summary: Access Token Request
      operationId: AccessTokenRequest
      tags:
        - Access Token Request
      parameters:
        - name: Content-Encoding
          in: header
          description: Content-Encoding, described in IETF RFC 7231
          schema:
            type: string
        - name: Accept-Encoding
          in: header
          description: Accept-Encoding, described in IETF RFC 7231
          schema:
            type: string
      requestBody:
        content:
          application/x-www-form-urlencoded:
            schema:
              $ref: '#/components/schemas/AccessTokenReq'
            encoding:
              requesterPlmn:
                contentType: application/json
              requesterPlmnList:
                contentType: application/json
              requesterSnsaiList:
                contentType: application/json
              requesterSnpnList:
                contentType: application/json
              targetPlmn:
                contentType: application/json
              targetSnpn:
                contentType: application/json
              targetSnsaiList:
                contentType: application/json
              targetNsiList:
                style: form
                explode: true
            required: true
      responses:
        '200':
          description: Successful Access Token Request
          content:
            application/json:
              schema:
                $ref: '#/components/schemas/AccessTokenRsp'
          headers:
            Cache-Control:
              $ref: '#/components/headers/cache-control'
            Pragma:
              $ref: '#/components/headers/pragma'
            Accept-Encoding:
              description: Accept-Encoding, described in IETF RFC 7694
              schema:
                type: string
            Content-Encoding:
              description: Content-Encoding, described in IETF RFC 7231
              schema:
                type: string
        '307':
          description: Temporary Redirect
          content:
            application/json:
              schema:
                $ref: 'TS29571_CommonData.yaml#/components/schemas/RedirectResponse'
          headers:
```

```

    Location:
      description: The URI pointing to the resource located on the redirect target NRF
      required: true
      schema:
        type: string
  '308':
    description: Permanent Redirect
    content:
      application/json:
        schema:
          $ref: 'TS29571_CommonData.yaml#/components/schemas/RedirectResponse'
    headers:
      Location:
        description: The URI pointing to the resource located on the redirect target NRF
        required: true
        schema:
          type: string
  '400':
    description: Error in the Access Token Request
    content:
      application/json:
        schema:
          $ref: '#/components/schemas/AccessTokenErr'
      application/problem+json: # error originated by an SCP or SEPP
        schema:
          $ref: 'TS29571_CommonData.yaml#/components/schemas/ProblemDetails'
    headers:
      Cache-Control:
        $ref: '#/components/headers/cache-control'
      Pragma:
        $ref: '#/components/headers/pragma'
  '401':
    $ref: 'TS29571_CommonData.yaml#/components/responses/401'
  '403':
    $ref: 'TS29571_CommonData.yaml#/components/responses/403'
  '404':
    $ref: 'TS29571_CommonData.yaml#/components/responses/404'
  '411':
    $ref: 'TS29571_CommonData.yaml#/components/responses/411'
  '413':
    $ref: 'TS29571_CommonData.yaml#/components/responses/413'
  '415':
    $ref: 'TS29571_CommonData.yaml#/components/responses/415'
  '429':
    $ref: 'TS29571_CommonData.yaml#/components/responses/429'
  '500':
    $ref: 'TS29571_CommonData.yaml#/components/responses/500'
  '501':
    $ref: 'TS29571_CommonData.yaml#/components/responses/501'
  '503':
    $ref: 'TS29571_CommonData.yaml#/components/responses/503'
  default:
    $ref: 'TS29571_CommonData.yaml#/components/responses/default'

```

```

components:
  headers:
    cache-control:
      required: true
      schema:
        type: string
      enum:
        - no-store
    pragma:
      required: true
      schema:
        type: string
      enum:
        - no-cache

```

```

schemas:
  AccessTokenReq:
    description: Contains information related to the access token request
    type: object
    required:
      - grant_type
      - nfInstanceId
      - scope
    properties:

```



```

grant_type:
  type: string
  enum:
    - client_credentials
nfInstanceId:
  $ref: 'TS29571_CommonData.yaml#/components/schemas/NfInstanceId'
nfType:
  $ref: 'TS29510_Nnrf_NFManagement.yaml#/components/schemas/NFType'
targetNfType:
  $ref: 'TS29510_Nnrf_NFManagement.yaml#/components/schemas/NFType'
scope:
  type: string
  pattern: '^([a-zA-Z0-9_-:~]+)( [a-zA-Z0-9_-:~]+)*$'
targetNfInstanceId:
  $ref: 'TS29571_CommonData.yaml#/components/schemas/NfInstanceId'
requesterPlmn:
  $ref: 'TS29571_CommonData.yaml#/components/schemas/PlmnId'
requesterPlmnList:
  type: array
  items:
    $ref: 'TS29571_CommonData.yaml#/components/schemas/PlmnId'
  minItems: 2
requesterSnsaiList:
  type: array
  items:
    $ref: 'TS29571_CommonData.yaml#/components/schemas/Snsai'
  minItems: 1
requesterFqdn:
  $ref: 'TS29571_CommonData.yaml#/components/schemas/Fqdn'
requesterSnpnList:
  type: array
  items:
    $ref: 'TS29571_CommonData.yaml#/components/schemas/PlmnIdNid'
  minItems: 1
targetPlmn:
  $ref: 'TS29571_CommonData.yaml#/components/schemas/PlmnId'
targetSnpn:
  $ref: 'TS29571_CommonData.yaml#/components/schemas/PlmnIdNid'
targetSnsaiList:
  type: array
  items:
    $ref: 'TS29571_CommonData.yaml#/components/schemas/Snsai'
  minItems: 1
targetNsiList:
  type: array
  items:
    type: string
    minItems: 1
targetNfSetId:
  $ref: 'TS29571_CommonData.yaml#/components/schemas/NfSetId'
targetNfServiceSetId:
  $ref: 'TS29571_CommonData.yaml#/components/schemas/NfServiceSetId'
hnrfaAccessTokenUri:
  $ref: 'TS29571_CommonData.yaml#/components/schemas/Uri'
sourceNfInstanceId:
  $ref: 'TS29571_CommonData.yaml#/components/schemas/NfInstanceId'

AccessTokenResp:
  description: Contains information related to the access token response
  type: object
  required:
    - access_token
    - token_type
  properties:
    access_token:
      type: string
      description: >
        JWS Compact Serialized representation of JWS signed JSON object (AccessTokenClaims)
    token_type:
      type: string
      enum:
        - Bearer
    expires_in:
      type: integer
    scope:
      type: string
      pattern: '^([a-zA-Z0-9_-:~]+)( [a-zA-Z0-9_-:~]+)*$'

```

```

AccessTokenClaims:
  description: The claims data structure for the access token
  type: object
  required:
    - iss
    - sub
    - aud
    - scope
    - exp
  properties:
    iss:
      $ref: 'TS29571_CommonData.yaml#/components/schemas/NfInstanceId'
    sub:
      $ref: 'TS29571_CommonData.yaml#/components/schemas/NfInstanceId'
    aud:
      anyOf:
        - $ref: 'TS29510_Nnrf_NFManagement.yaml#/components/schemas/NFType'
        - type: array
          items:
            $ref: 'TS29571_CommonData.yaml#/components/schemas/NfInstanceId'
          minItems: 1
    scope:
      type: string
      pattern: '^([a-zA-Z0-9_-:~+]) ([a-zA-Z0-9_-:~+])*$'
    exp:
      type: integer
    consumerPlmnId:
      $ref: 'TS29571_CommonData.yaml#/components/schemas/PlmnId'
    consumerSnpnId:
      $ref: 'TS29571_CommonData.yaml#/components/schemas/PlmnIdNid'
    producerPlmnId:
      $ref: 'TS29571_CommonData.yaml#/components/schemas/PlmnId'
    producerSnpnId:
      $ref: 'TS29571_CommonData.yaml#/components/schemas/PlmnIdNid'
    producerSnssaiList:
      type: array
      items:
        $ref: 'TS29571_CommonData.yaml#/components/schemas/Snssai'
      minItems: 1
    producerNsiList:
      type: array
      items:
        type: string
        minItems: 1
    producerNfSetId:
      $ref: 'TS29571_CommonData.yaml#/components/schemas/NfSetId'
    producerNfServiceSetId:
      $ref: 'TS29571_CommonData.yaml#/components/schemas/NfServiceSetId'
    sourceNfInstanceId:
      $ref: 'TS29571_CommonData.yaml#/components/schemas/NfInstanceId'

AccessTokenErr:
  description: Error returned in the access token response message
  type: object
  required:
    - error
  properties:
    error:
      type: string
      enum:
        - invalid_request
        - invalid_client
        - invalid_grant
        - unauthorized_client
        - unsupported_grant_type
        - invalid_scope
    error_description:
      type: string
    error_uri:
      type: string

```

---

## A.5 Nnrf\_Bootstrapping API

openapi: 3.0.0

```

info:
  version: '1.1.0'
  title: 'NRF Bootstrapping'
  description: |
    NRF Bootstrapping.
    © 2022, 3GPP Organizational Partners (ARIB, ATIS, CCSA, ETSI, TSDSI, TTA, TTC).
    All rights reserved.

externalDocs:
  description: 3GPP TS 29.510 V17.6.0; 5G System; Network Function Repository Services; Stage 3
  url: 'https://www.3gpp.org/ftp/Specs/archive/29_series/29.510/'

paths:
  /bootstrapping:
    get:
      summary: Bootstrapping Info Request
      operationId: BootstrappingInfoRequest
      tags:
        - Bootstrapping Request
      parameters:
        - name: If-None-Match
          in: header
          description: Validator for conditional requests, as described in IETF RFC 7232, 3.2
          schema:
            type: string
      responses:
        '200':
          description: Successful Bootstrapping Request
          content:
            application/3gppHal+json:
              schema:
                $ref: '#/components/schemas/BootstrappingInfo'
          headers:
            Cache-Control:
              description: Cache-Control containing max-age, described in IETF RFC 7234, 5.2
              schema:
                type: string
            ETag:
              description: Entity Tag containing a strong validator, described in IETF RFC 7232, 2.3
              schema:
                type: string
        '307':
          description: Temporary Redirect
          content:
            application/json:
              schema:
                $ref: 'TS29571_CommonData.yaml#/components/schemas/RedirectResponse'
          headers:
            Location:
              description: The URI pointing to the resource located on the redirect target NRF
              required: true
              schema:
                type: string
        '308':
          description: Permanent Redirect
          content:
            application/json:
              schema:
                $ref: 'TS29571_CommonData.yaml#/components/schemas/RedirectResponse'
          headers:
            Location:
              description: The URI pointing to the resource located on the redirect target NRF
              required: true
              schema:
                type: string
        '400':
          $ref: 'TS29571_CommonData.yaml#/components/responses/400'
        '500':
          $ref: 'TS29571_CommonData.yaml#/components/responses/500'
      default:
        $ref: 'TS29571_CommonData.yaml#/components/responses/default'

components:
  schemas:
    BootstrappingInfo:
      description: Information returned by NRF in the bootstrapping response message
      type: object
      required:

```

```
- _links
properties:
  status:
    $ref: '#/components/schemas/Status'
  _links:
    type: object
    description: >
      Map of link objects where the keys are the link relations defined in
      3GPP TS 29.510 clause 6.4.6.3.3
    additionalProperties:
      $ref: 'TS29571_CommonData.yaml#/components/schemas/LinksValueSchema'
    minProperties: 1
  nrfFeatures:
    type: object
    description: >
      Map of features supported by the NRF, where the keys are the NRF services
      as defined in 3GPP TS 29.510 clause 6.1.6.3.11
    additionalProperties:
      $ref: 'TS29571_CommonData.yaml#/components/schemas/SupportedFeatures'
    minProperties: 1
  oauth2Required:
    type: object
    description: >
      Map indicating whether the NRF requires Oauth2-based authorization for accessing
      its services. The key of the map shall be the name of an NRF service,
      e.g. "nnrf-nfm" or "nnrf-disc"
    additionalProperties:
      type: boolean
    minProperties: 1
  nrfSetId:
    $ref: 'TS29571_CommonData.yaml#/components/schemas/NfSetId'
  nrfInstanceId:
    $ref: 'TS29571_CommonData.yaml#/components/schemas/NfInstanceId'

Status:
description: Overall status of the NRF
anyOf:
- type: string
  enum:
  - OPERATIVE
  - NON_OPERATIVE
- type: string
```

---

## Annex B (normative): NF Profile changes in NFRegister and NFUpdate (NF Profile Complete Replacement) responses

### B.1 General

In the NFRegister and NFUpdate (NF Profile Complete Replacement) service operations, a NF Service Consumer may indicate to the NRF that it supports receiving NF Profile changes in the response from the NRF, by including the `nfProfileChangesSupportInd` attribute set to "true" in the NFProfile it registers to or replaces in the NRF.

The NRF may return NF Profile changes, instead of the complete NF Profile, in NFRegister or NFUpdate (NF Profile Complete Replacement) responses, if the NF Service Consumer indicated corresponding support in the request. When doing so, the NRF shall include in the NF Profile returned in the response:

- attributes that are mandatory to include in the NF Profile; if an optional IE is included (e.g. `nfServices`), attributes that are mandatory to include in this optional IE (e.g. `serviceInstanceId`) shall also be included;
- optional or conditional IEs that have been changed or added by the NRF; and
- the `nfProfileChangesInd` IE set to "true", indicating that the returned profile contains NF profile changes.

EXAMPLE 1: The NRF does not change the NF Profile received in the request.

The NRF response contains a NFProfile with just the following IEs:

- `nfInstanceId`, `nfType`, `nfStatus`; and
- `nfProfileChangesInd` IE set to "true".

EXAMPLE 2: The NRF modifies or adds the `heartbeatTimer` attribute to the NF Profile received in the request.

The NRF response contains a NFProfile with just the following IEs:

- `nfInstanceId`, `nfType`, `nfStatus`;
- `heartbeatTimer` with NRF chosen value;
- `nfProfileChangesInd` IE set to "true".

## Annex C (informative): Change history

| Date    | Meeting | TDoc.     | CR   | Rev | Cat | Subject/Comment                                                                                                                                                                                                          | New    |
|---------|---------|-----------|------|-----|-----|--------------------------------------------------------------------------------------------------------------------------------------------------------------------------------------------------------------------------|--------|
| 2017-10 | CT4#80  | C4-175271 |      |     |     | Initial draft                                                                                                                                                                                                            | 0.1.0  |
| 2017-10 | CT4#80  | C4-175395 |      |     |     | Incorporation of agreed pCRs from CT4#80: C4-175109, C4-175272, C4-175274, C4-175363                                                                                                                                     | 0.2.0  |
| 2017-12 | CT4#81  | C4-176438 |      |     |     | Incorporation of agreed pCRs from CT4#81: C4-176184, C4-176278, C4-176280, C4-176281, C4-176282                                                                                                                          | 0.3.0  |
| 2018-01 | CT4#82  | C4-181392 |      |     |     | Incorporation of agreed pCRs from CT4#82: C4-181348, C4-181351                                                                                                                                                           | 0.4.0  |
| 2018-03 | CT4#83  | C4-182435 |      |     |     | Incorporation of agreed pCRs from CT4#83: C4-182098, C4-182327, C4-182328, C4-182365, C4-182413                                                                                                                          | 0.5.0  |
| 2018-04 | CT4#84  | C4-183517 |      |     |     | Incorporation of agreed pCRs from CT4#84: C4-183450, C4-183451, C4-183452, C4-183487, C4-183488, C4-183490, C4-183491                                                                                                    | 0.6.0  |
| 2018-05 | CT4#85  | C4-184625 |      |     |     | Incorporation of agreed pCRs from CT4#85: C4-184207, C4-184208, C4-184280, C4-184466, C4-184469, C4-184478, C4-184517, C4-184519, C4-184545, C4-184595, C4-184596, C4-184597, C4-184600, C4-184615, C4-184616, C4-184626 | 0.7.0  |
| 2018-06 | CT#80   | CP-181105 |      |     |     | Presented for information and approval                                                                                                                                                                                   | 1.0.0  |
| 2018-06 | CT#80   |           |      |     |     | Approved in CT#80.                                                                                                                                                                                                       | 15.0.0 |
| 2018-09 | CT#81   | CP-182012 | 0001 | 2   | F   | Implementing the Indirect Delivery method for the GET method to retrieve NF instances                                                                                                                                    | 15.1.0 |
| 2018-09 | CT#81   | CP-182093 | 0003 | 3   | F   | Defining the range of the priority and capacity attributes and aligning their usage with SRV RFC 2782                                                                                                                    | 15.1.0 |
| 2018-09 | CT#81   | CP-182060 | 0004 | -   | F   | Corrections to descriptions, references and SUPI parameter in Discovery Request                                                                                                                                          | 15.1.0 |
| 2018-09 | CT#81   | CP-182047 | 0006 | 2   | F   | SubscriptionData                                                                                                                                                                                                         | 15.1.0 |
| 2018-09 | CT#81   | CP-182045 | 0008 | 2   | F   | Error Cases                                                                                                                                                                                                              | 15.1.0 |
| 2018-09 | CT#81   | CP-182060 | 0009 | 2   | F   | Heart Beat Procedure                                                                                                                                                                                                     | 15.1.0 |
| 2018-09 | CT#81   | CP-182060 | 0010 | 1   | B   | Vendor-Specific NF Types                                                                                                                                                                                                 | 15.1.0 |
| 2018-09 | CT#81   | CP-182044 | 0011 | 3   | F   | Presence condition of service discovery query parameters                                                                                                                                                                 | 15.1.0 |
| 2018-09 | CT#81   | CP-182060 | 0012 | 4   | F   | Description of Inter-PLMN scenarios                                                                                                                                                                                      | 15.1.0 |
| 2018-09 | CT#81   | CP-182060 | 0013 | 1   | F   | NF Service Versions                                                                                                                                                                                                      | 15.1.0 |
| 2018-09 | CT#81   | CP-182060 | 0014 | 1   | B   | Custom Headers                                                                                                                                                                                                           | 15.1.0 |
| 2018-09 | CT#81   | CP-182060 | 0015 | 1   | F   | Overall Clean-up                                                                                                                                                                                                         | 15.1.0 |
| 2018-09 | CT#81   | CP-182060 | 0016 | -   | F   | Formatting of query parameters                                                                                                                                                                                           | 15.1.0 |
| 2018-09 | CT#81   | CP-182060 | 0017 | -   | F   | Editorial corrections                                                                                                                                                                                                    | 15.1.0 |
| 2018-09 | CT#81   | CP-182060 | 0018 | 2   | F   | Backup AMF                                                                                                                                                                                                               | 15.1.0 |
| 2018-09 | CT#81   | CP-182060 | 0020 | 1   | B   | NF Service Names                                                                                                                                                                                                         | 15.1.0 |
| 2018-09 | CT#81   | CP-182060 | 0023 | -   | F   | CHF as service consumer                                                                                                                                                                                                  | 15.1.0 |
| 2018-09 | CT#81   | CP-182060 | 0024 | 3   | B   | Hierarchical NF discovery in recursion mode                                                                                                                                                                              | 15.1.0 |
| 2018-09 | CT#81   | CP-182060 | 0025 | 2   | B   | Hierarchical NF discovery in iteration mode                                                                                                                                                                              | 15.1.0 |
| 2018-09 | CT#81   | CP-182060 | 0026 | -   | F   | Correction of Allowed NF Domains                                                                                                                                                                                         | 15.1.0 |
| 2018-09 | CT#81   | CP-182060 | 0027 | -   | F   | Correction of BsInfo data type                                                                                                                                                                                           | 15.1.0 |
| 2018-09 | CT#81   | CP-182161 | 0028 | 1   | F   | IPv6 Prefix for NF / NF Service Address                                                                                                                                                                                  | 15.1.0 |
| 2018-09 | CT#81   | CP-182060 | 0030 | 1   | B   | NF Set Id                                                                                                                                                                                                                | 15.1.0 |
| 2018-09 | CT#81   | CP-182060 | 0031 | 1   | F   | URI Scheme                                                                                                                                                                                                               | 15.1.0 |
| 2018-09 | CT#81   | CP-182060 | 0032 | 2   | B   | NRF service registration                                                                                                                                                                                                 | 15.1.0 |
| 2018-09 | CT#81   | CP-182060 | 0034 | 2   | F   | Discovery of combined SMF and PGW-C                                                                                                                                                                                      | 15.1.0 |
| 2018-09 | CT#81   | CP-182163 | 0035 | 3   | F   | Support TAI Range for AMF/SMF and SUPI Range for PCF                                                                                                                                                                     | 15.1.0 |
| 2018-09 | CT#81   | CP-182060 | 0036 | 1   | F   | SUPI Range for PCF                                                                                                                                                                                                       | 15.1.0 |
| 2018-09 | CT#81   | CP-182164 | 0037 | 3   | F   | Scope for OAuth 2.0 Access Token Request                                                                                                                                                                                 | 15.1.0 |
| 2018-09 | CT#81   | CP-182060 | 0039 | 1   | F   | Corrections to NotificationData and "supi" parameter in Discovery Request                                                                                                                                                | 15.1.0 |
| 2018-09 | CT#81   | CP-182060 | 0040 | 1   | F   | Group ID in Discovery Request                                                                                                                                                                                            | 15.1.0 |
| 2018-09 | CT#81   | CP-182060 | 0041 | 1   | F   | Registering multiple Routing Indicators                                                                                                                                                                                  | 15.1.0 |
| 2018-09 | CT#81   | CP-182060 | 0045 | -   | F   | Description of Structured data types                                                                                                                                                                                     | 15.1.0 |
| 2018-09 | CT#81   | CP-182060 | 0046 | 1   | F   | Service names in Discovery Request                                                                                                                                                                                       | 15.1.0 |
| 2018-09 | CT#81   | CP-182060 | 0047 | 1   | F   | Resource structure presentation                                                                                                                                                                                          | 15.1.0 |
| 2018-09 | CT#81   | CP-182060 | 0048 | -   | B   | Default Notifications for UDM                                                                                                                                                                                            | 15.1.0 |
| 2018-09 | CT#81   | CP-182060 | 0049 | -   | F   | Cell ID in Discovery Request                                                                                                                                                                                             | 15.1.0 |
| 2018-09 | CT#81   | CP-182046 | 0050 | 2   | F   | NRF Subscription Data                                                                                                                                                                                                    | 15.1.0 |
| 2018-09 | CT#81   | CP-182060 | 0051 | 1   | F   | AMF Discovery by 5G-AN                                                                                                                                                                                                   | 15.1.0 |
| 2018-09 | CT#81   | CP-182060 | 0052 | 1   | F   | Detecting NF Failure and Restart using the NRF                                                                                                                                                                           | 15.1.0 |
| 2018-09 | CT#81   | CP-182060 | 0053 | 2   | B   | NRF Subscription Lifespan                                                                                                                                                                                                | 15.1.0 |
| 2018-09 | CT#81   | CP-182060 | 0054 | 1   | F   | NRF servers clause in OpenAPI                                                                                                                                                                                            | 15.1.0 |
| 2018-09 | CT#81   | CP-182060 | 0056 | 2   | F   | Default port number                                                                                                                                                                                                      | 15.1.0 |
| 2018-09 | CT#81   | CP-182162 | 0057 | 1   | F   | AMF Discovery Based on AMF Name                                                                                                                                                                                          | 15.1.0 |
| 2018-09 | CT#81   | CP-182060 | 0058 | -   | F   | API Version Update                                                                                                                                                                                                       | 15.1.0 |
| 2018-12 | CT#82   | CP-183018 | 0060 | 4   | F   | Heartbeat Timer                                                                                                                                                                                                          | 15.2.0 |
| 2018-12 | CT#82   | CP-183018 | 0061 | 1   | F   | Location Header                                                                                                                                                                                                          | 15.2.0 |
| 2018-12 | CT#82   | CP-183018 | 0062 | 2   | F   | NF Profile Addressing Parameters                                                                                                                                                                                         | 15.2.0 |
| 2018-12 | CT#82   | CP-183018 | 0063 | 1   | F   | NRF Notifications                                                                                                                                                                                                        | 15.2.0 |
| 2018-12 | CT#82   | CP-183018 | 0064 | -   | F   | OAuth2 Corrections                                                                                                                                                                                                       | 15.2.0 |
| 2018-12 | CT#82   | CP-183018 | 0065 | 1   | F   | Regular Expression Patterns                                                                                                                                                                                              | 15.2.0 |

|         |       |           |      |   |   |                                                                               |        |
|---------|-------|-----------|------|---|---|-------------------------------------------------------------------------------|--------|
| 2018-12 | CT#82 | CP-183183 | 0066 | 5 | F | Subscription Data                                                             | 15.2.0 |
| 2018-12 | CT#82 | CP-183147 | 0067 | 2 | F | UPF selection based on DNAI                                                   | 15.2.0 |
| 2018-12 | CT#82 | CP-183018 | 0068 | 5 | F | CHF registration and selection                                                | 15.2.0 |
| 2018-12 | CT#82 | CP-183018 | 0069 | 1 | F | Clarify the NRF management functionality in the case of hierarchical NRFs     | 15.2.0 |
| 2018-12 | CT#82 | CP-183149 | 0070 | 5 | F | OAuth2.0 Service Alignments and Corrections                                   | 15.2.0 |
| 2018-12 | CT#82 | CP-183150 | 0071 | 1 | F | HTTP Basic Authentication For OAuth2.0 Access Token Request                   | 15.2.0 |
| 2018-12 | CT#82 | CP-183018 | 0072 | 1 | F | Multiple PLMNs support                                                        | 15.2.0 |
| 2018-12 | CT#82 | CP-183018 | 0075 | 2 | F | NFService attribute in NFProfile                                              | 15.2.0 |
| 2018-12 | CT#82 | CP-183018 | 0076 | 1 | F | Corrections of ServiceName enumeration                                        | 15.2.0 |
| 2018-12 | CT#82 | CP-183018 | 0077 | 4 | F | Indicating support of EPS interworking in UPF Profile                         | 15.2.0 |
| 2018-12 | CT#82 | CP-183018 | 0079 | 2 | F | Cardinality                                                                   | 15.2.0 |
| 2018-12 | CT#82 | CP-183018 | 0081 | - | F | APIRoot Clarification                                                         | 15.2.0 |
| 2018-12 | CT#82 | CP-183018 | 0082 | 2 | F | Clarification on the reuse of the previous search results                     | 15.2.0 |
| 2018-12 | CT#82 | CP-183018 | 0083 | 1 | F | NF profile detail for hierarchical NRF                                        | 15.2.0 |
| 2018-12 | CT#82 | CP-183235 | 0084 | 3 | F | Complex query                                                                 | 15.2.0 |
| 2018-12 | CT#82 | CP-183152 | 0087 | 1 | F | SMF discovery based on S-NSSAI and DNN                                        | 15.2.0 |
| 2018-12 | CT#82 | CP-183153 | 0088 | 2 | F | CHF discovery based on GPSI and SUPI                                          | 15.2.0 |
| 2018-12 | CT#82 | CP-183146 | 0089 | 3 | F | Add access type in SMF selection                                              | 15.2.0 |
| 2018-12 | CT#82 | CP-183018 | 0090 | 2 | F | Hierarchical subscription with intermediate forwarding NRF                    | 15.2.0 |
| 2018-12 | CT#82 | CP-183018 | 0091 | 2 | F | Hierarchical subscription with intermediate redirecting NRF                   | 15.2.0 |
| 2018-12 | CT#82 | CP-183018 | 0093 | 1 | F | Notifications for subscriptions via intermediate NRF                          | 15.2.0 |
| 2018-12 | CT#82 | CP-183018 | 0096 | 1 | F | DNN and IP Domain in BSF Info                                                 | 15.2.0 |
| 2018-12 | CT#82 | CP-183018 | 0097 | 1 | F | PCF Information                                                               | 15.2.0 |
| 2018-12 | CT#82 | CP-183018 | 0100 | - | F | NF Service FQDN                                                               | 15.2.0 |
| 2018-12 | CT#82 | CP-183018 | 0101 | - | F | NRF Corrections                                                               | 15.2.0 |
| 2018-12 | CT#82 | CP-183018 | 0102 | 1 | F | Notification Data                                                             | 15.2.0 |
| 2018-12 | CT#82 | CP-183181 | 0103 | 2 | F | NRF Oauth Scopes                                                              | 15.2.0 |
| 2018-12 | CT#82 | CP-183182 | 0104 | 1 | F | NRF Subscription Handling                                                     | 15.2.0 |
| 2018-12 | CT#82 | CP-183018 | 0105 | - | F | NF Profile Change Notification                                                | 15.2.0 |
| 2018-12 | CT#82 | CP-183171 | 0107 | - | F | UDM Group ID                                                                  | 15.2.0 |
| 2018-12 | CT#82 | CP-183018 | 0108 | 2 | F | Preferred target NF Location in Discovery Request                             | 15.2.0 |
| 2018-12 | CT#82 | CP-183018 | 0109 | 1 | F | Telescopic FQDN for H NRF                                                     | 15.2.0 |
| 2018-12 | CT#82 | CP-183184 | 0112 | 1 | F | Description of NF instances/NF profile retrieval                              | 15.2.0 |
| 2018-12 | CT#82 | CP-183018 | 0113 | - | F | Content of the Subscription to notification response                          | 15.2.0 |
| 2018-12 | CT#82 | CP-183018 | 0115 | - | F | Adding new services in ServiceName enumeration                                | 15.2.0 |
| 2018-12 | CT#82 | CP-183018 | 0116 | - | F | NF Profile Service Instances                                                  | 15.2.0 |
| 2018-12 | CT#82 | CP-183018 | 0117 | - | F | API Version                                                                   | 15.2.0 |
| 2018-12 | CT#82 | CP-183180 | 0118 | 1 | F | ExternalDocs Update                                                           | 15.2.0 |
| 2019-03 | CT#83 | CP-190023 | 0119 | 1 | F | AmfRegionId and AmfSetId                                                      | 15.3.0 |
| 2019-03 | CT#83 | CP-190023 | 0120 | 1 | F | Interpretation of absence of IEs in NF Profile                                | 15.3.0 |
| 2019-03 | CT#83 | CP-190023 | 0121 | 1 | F | Usage of FQDN and IP address related attributes from NF / NF Service profiles | 15.3.0 |
| 2019-03 | CT#83 | CP-190023 | 0122 | 1 | F | AMF Region and AMF Set in PLMNs supporting multiple PLMN Ids                  | 15.3.0 |
| 2019-03 | CT#83 | CP-190023 | 0123 | 1 | F | Encoding of GUAMI query parameter in NFDDiscover Request                      | 15.3.0 |
| 2019-03 | CT#83 | CP-190023 | 0124 | 1 | F | Status for operative NF (service) not discoverable by other NFs               | 15.3.0 |
| 2019-03 | CT#83 | CP-190023 | 0126 | 1 | F | Limiting the number of NFProfiles returned in NFDDiscover response            | 15.3.0 |
| 2019-03 | CT#83 | CP-190023 | 0127 | 2 | F | Maximum payload size of NFDDiscover Response                                  | 15.3.0 |
| 2019-03 | CT#83 | CP-190155 | 0128 | 2 | F | NF Profile Changes in NF Register / NFUpdate Response                         | 15.3.0 |
| 2019-03 | CT#83 | CP-190023 | 0129 | 1 | F | supported-features query parameter of NFDDiscover Request                     | 15.3.0 |
| 2019-03 | CT#83 | CP-190023 | 0130 | 1 | F | OpenAPI Corrections                                                           | 15.3.0 |
| 2019-03 | CT#83 | CP-190023 | 0132 | 1 | F | Oauth2 Token Claims                                                           | 15.3.0 |
| 2019-03 | CT#83 | CP-190023 | 0133 | 1 | F | Oauth2 Token Type                                                             | 15.3.0 |
| 2019-03 | CT#83 | CP-190023 | 0134 | 1 | F | Authorization Attributes of NF Profile                                        | 15.3.0 |
| 2019-03 | CT#83 | CP-190023 | 0135 | 2 | F | Features of NF Discovery service                                              | 15.3.0 |
| 2019-03 | CT#83 | CP-190023 | 0136 | - | F | Subscription Authorization for Sets of NFs                                    | 15.3.0 |
| 2019-03 | CT#83 | CP-190023 | 0137 | 1 | F | S-NSSAI per PLMN                                                              | 15.3.0 |
| 2019-03 | CT#83 | CP-190059 | 0138 | 4 | F | UPF selection based on PDUSessionType                                         | 15.3.0 |
| 2019-03 | CT#83 | CP-190163 | 0139 | 2 | F | Service Names in URI Query Parameters                                         | 15.3.0 |
| 2019-03 | CT#83 | CP-190023 | 0140 | 1 | F | GLMC URI for Namf_Location EventNotify                                        | 15.3.0 |
| 2019-03 | CT#83 | CP-190023 | 0141 | 1 | F | Corrections on complex query                                                  | 15.3.0 |
| 2019-03 | CT#83 | CP-190023 | 0142 | 1 | F | NRF Notifications                                                             | 15.3.0 |
| 2019-03 | CT#83 | CP-190023 | 0143 | 1 | F | NRF Heart-Beat                                                                | 15.3.0 |
| 2019-03 | CT#83 | CP-190023 | 0144 | - | F | Addition of new Service Name                                                  | 15.3.0 |
| 2019-03 | CT#83 | CP-190023 | 0145 | - | F | API version update                                                            | 15.3.0 |
| 2019-06 | CT#84 | CP-191034 | 0146 | 3 | F | PLMN ID in Access Token Claims                                                | 15.4.0 |
| 2019-06 | CT#84 | CP-191034 | 0147 | 1 | F | Content encodings supported in HTTP requests                                  | 15.4.0 |
| 2019-06 | CT#84 | CP-191034 | 0156 | 3 | F | Correct the condition of the FQDN parameter of NFProfile and NFService        | 15.4.0 |
| 2019-06 | CT#84 | CP-191034 | 0159 | 1 | F | NRF Service Description                                                       | 15.4.0 |
| 2019-06 | CT#84 | CP-191034 | 0161 | 1 | F | Slice Info in NRF                                                             | 15.4.0 |



|         |       |           |      |   |   |                                                                                            |        |
|---------|-------|-----------|------|---|---|--------------------------------------------------------------------------------------------|--------|
| 2019-06 | CT#84 | CP-191034 | 0162 | 1 | F | Subscription Conditions                                                                    | 15.4.0 |
| 2019-06 | CT#84 | CP-191034 | 0163 | 1 | F | Vendor-Specific IEs in NF Profile                                                          | 15.4.0 |
| 2019-06 | CT#84 | CP-191034 | 0165 | 2 | F | Target PLMN List in Inter-PLMN Service Discovery                                           | 15.4.0 |
| 2019-06 | CT#84 | CP-191034 | 0167 | 2 | F | Storage of OpenAPI specification files                                                     | 15.4.0 |
| 2019-06 | CT#84 | CP-191034 | 0170 | - | F | Corrections on NFStatusUnSubscribe operation to take into account multiple NRFs            | 15.4.0 |
| 2019-06 | CT#84 | CP-191034 | 0171 | 1 | F | Corrections on UpdateSubscription operation to take into account multiple NRFs             | 15.4.0 |
| 2019-06 | CT#84 | CP-191034 | 0174 | 4 | F | Corrections on Nnrf_AccessToken Service for multiple NRFs                                  | 15.4.0 |
| 2019-06 | CT#84 | CP-191034 | 0176 | - | F | LowerCamel Correction in Data Structures                                                   | 15.4.0 |
| 2019-06 | CT#84 | CP-191034 | 0177 | - | F | Removal of Basic Authentication                                                            | 15.4.0 |
| 2019-06 | CT#84 | CP-191034 | 0178 | 1 | F | Location header in redirect response                                                       | 15.4.0 |
| 2019-06 | CT#84 | CP-191034 | 0185 | 2 | F | Add HTTP error codes in 29.510                                                             | 15.4.0 |
| 2019-09 | CT#85 | CP-192108 | 0192 | 4 | F | Add selection mechanism for multiple IP addresses in NFProfile                             | 15.4.0 |
| 2019-06 | CT#84 | CP-191034 | 0194 | 2 | F | Add retrieval of the NF profile using the URI                                              | 15.4.0 |
| 2019-06 | CT#84 | CP-191034 | 0195 | 1 | F | Add the update of subscription in a different PLMN                                         | 15.4.0 |
| 2019-06 | CT#84 | CP-191034 | 0198 | 1 | F | PLMN-IDs in Discovery Response                                                             | 15.4.0 |
| 2019-06 | CT#84 | CP-191034 | 0202 | - | F | Copyright Note in YAML files                                                               | 15.4.0 |
| 2019-06 | CT#84 | CP-191034 | 0206 | - | F | 3GPP TS 29.510 API version update                                                          | 15.4.0 |
| 2019-06 | CT#84 | CP-191052 | 0148 | 7 | B | NWDAF Discovery and Selection                                                              | 16.0.0 |
| 2019-06 | CT#84 | CP-191057 | 0149 | 4 | B | Multiple entries of pcflInfo                                                               | 16.0.0 |
| 2019-06 | CT#84 | CP-191057 | 0150 | 3 | B | Multiple entries of bsflInfo                                                               | 16.0.0 |
| 2019-06 | CT#84 | CP-191057 | 0151 | 3 | B | Multiple entries of smflInfo                                                               | 16.0.0 |
| 2019-06 | CT#84 | CP-191051 | 0154 | 5 | B | ATSSS Capability for UPF Selection                                                         | 16.0.0 |
| 2019-06 | CT#84 | CP-191057 | 0175 | 1 | B | GPSI range in pcflInfo                                                                     | 16.0.0 |
| 2019-06 | CT#84 | CP-191057 | 0180 | 2 | B | Multiple entries of xxxInfo (generalized)                                                  | 16.0.0 |
| 2019-06 | CT#84 | CP-191057 | 0186 | 2 | F | Add the name of NF Instance                                                                | 16.0.0 |
| 2019-06 | CT#84 | CP-191057 | 0187 | 3 | B | Add requester nfInstanceId parameter in NFStatusSubscribe and NFDiscovery operations       | 16.0.0 |
| 2019-06 | CT#84 | CP-191034 | 0196 | 2 | F | Correct The subscription notification procedure under the exception case                   | 16.0.0 |
| 2019-06 | CT#84 | CP-191057 | 0199 | 1 | B | PCF Group ID                                                                               | 16.0.0 |
| 2019-06 | CT#84 | CP-191057 | 0200 | 1 | B | Number of NF Instances                                                                     | 16.0.0 |
| 2019-06 | CT#84 | CP-191050 | 0201 | 1 | B | NIDDAU Service Name                                                                        | 16.0.0 |
| 2019-06 | CT#84 | CP-191054 | 0204 | 1 | B | UE IP address allocation by UPF                                                            | 16.0.0 |
| 2019-06 | CT#84 | CP-191048 | 0205 | - | B | 3GPP TS 29.510 API version update                                                          | 16.0.0 |
| 2019-09 | CT#85 | CP-192033 | 0207 | 3 | C | CBCF as Network Function                                                                   | 16.1.0 |
| 2019-09 | CT#85 | CP-192127 | 0208 | 1 | F | callbackUri the same as nfStatusNotificationUri                                            | 16.1.0 |
| 2019-09 | CT#85 | CP-192193 | 0210 | 1 | B | Extensions for I-SMF and I-UPF selection                                                   | 16.1.0 |
| 2019-09 | CT#85 | CP-192194 | 0211 | 2 | B | NF Set and NF Service Set                                                                  | 16.1.0 |
| 2019-09 | CT#85 | CP-192034 | 0212 | 2 | B | Update NRF descriptions to support AF Available Data Registration as described in TS23.288 | 16.1.0 |
| 2019-09 | CT#85 | CP-192035 | 0213 | 3 | B | SMF Selection                                                                              | 16.1.0 |
| 2019-09 | CT#85 | CP-192107 | 0215 | - | A | Expiration Time of AccessTokenClaims                                                       | 16.1.0 |
| 2019-09 | CT#85 | CP-192109 | 0217 | 1 | F | Requester PLMN ID in SubscriptionData                                                      | 16.1.0 |
| 2019-09 | CT#85 | CP-192127 | 0218 | - | F | Correct the conditions of the information included in the access token request             | 16.1.0 |
| 2019-09 | CT#85 | CP-192107 | 0222 | - | A | Slice Information in Access Token Claims                                                   | 16.1.0 |
| 2019-09 | CT#85 | CP-192130 | 0223 | 1 | B | UPF collocated with W-AGF                                                                  | 16.1.0 |
| 2019-09 | CT#85 | CP-192127 | 0224 | 2 | F | URI in Location header for subscription to NF Instances in a different PLMN                | 16.1.0 |
| 2019-09 | CT#85 | CP-192249 | 0226 | 5 | A | Support of Static IP Address                                                               | 16.1.0 |
| 2019-09 | CT#85 | CP-192133 | 0228 | 1 | B | Network Identifier for Stand-alone Non-Public Networks                                     | 16.1.0 |
| 2019-09 | CT#85 | CP-192127 | 0229 | 1 | F | SMF profile without the smflInfo attribute                                                 | 16.1.0 |
| 2019-09 | CT#85 | CP-192107 | 0231 | - | A | Authorization Attributes in NF Service                                                     | 16.1.0 |
| 2019-09 | CT#85 | CP-192123 | 0232 | - | B | Handling of authorization parameters                                                       | 16.1.0 |
| 2019-09 | CT#85 | CP-192136 | 0233 | 1 | B | P-CSCF Discovery                                                                           | 16.1.0 |
| 2019-09 | CT#85 | CP-192123 | 0235 | - | B | GPSI support for PCF Query                                                                 | 16.1.0 |
| 2019-09 | CT#85 | CP-192123 | 0236 | - | B | LMF and GMLC Info                                                                          | 16.1.0 |
| 2019-09 | CT#85 | CP-192123 | 0238 | 1 | B | NEF discovery information for PFD                                                          | 16.1.0 |
| 2019-09 | CT#85 | CP-192135 | 0239 | - | B | Services invoked by NWDAF                                                                  | 16.1.0 |
| 2019-09 | CT#85 | CP-192127 | 0240 | 1 | F | Regulation of load update notifications                                                    | 16.1.0 |
| 2019-09 | CT#85 | CP-192120 | 0242 | - | F | 3GPP TS 29.510 API version update                                                          | 16.1.0 |
| 2019-10 |       |           |      |   |   | Corrupted references fixed                                                                 | 16.1.1 |
| 2019-12 | CT#86 | CP-193063 | 0244 | - | B | Missing NFs information in NrfInfo                                                         | 16.2.0 |
| 2019-12 | CT#86 | CP-193059 | 0245 | 2 | B | P-CSCF Discovery based on preferred-locality                                               | 16.2.0 |
| 2019-12 | CT#86 | CP-193049 | 0247 | 2 | B | NEF ID                                                                                     | 16.2.0 |
| 2019-12 | CT#86 | CP-193042 | 0248 | - | F | ExternalDocs Clause                                                                        | 16.2.0 |
| 2019-12 | CT#86 | CP-193036 | 0250 | 3 | F | Support of Static IP Address                                                               | 16.2.0 |
| 2019-12 | CT#86 | CP-193063 | 0251 | 3 | B | NRF Bootstrapping                                                                          | 16.2.0 |
| 2019-12 | CT#86 | CP-193056 | 0252 | 3 | B | I-SMF selection in a mobility procedure                                                    | 16.2.0 |
| 2019-12 | CT#86 | CP-193283 | 0253 | 3 | B | UCMF Registration in NRF                                                                   | 16.2.0 |

|         |       |           |      |   |   |                                                                         |        |
|---------|-------|-----------|------|---|---|-------------------------------------------------------------------------|--------|
| 2019-12 | CT#86 | CP-193057 | 0254 | 1 | B | Handling of default notification subscriptions with Delegated Discovery | 16.2.0 |
| 2019-12 | CT#86 | CP-193063 | 0255 | 1 | B | Support of different priorities in SMF/UPF profiles for different TAIs  | 16.2.0 |
| 2019-12 | CT#86 | CP-193031 | 0256 | 1 | A | External Group ID                                                       | 16.2.0 |
| 2019-12 | CT#86 | CP-193053 | 0257 | 2 | B | Internal Group Identifier in UdmInfo                                    | 16.2.0 |
| 2019-12 | CT#86 | CP-193054 | 0258 | 1 | B | HSS Service Discovery                                                   | 16.2.0 |
| 2019-12 | CT#86 | CP-193063 | 0259 | 1 | B | NF serving scope                                                        | 16.2.0 |
| 2019-12 | CT#86 | CP-193031 | 0260 | 1 | A | S-NSSAI Discovery Parameter                                             | 16.2.0 |
| 2019-12 | CT#86 | CP-193063 | 0261 | 1 | F | NF discovery based on DNN                                               | 16.2.0 |
| 2019-12 | CT#86 | CP-193063 | 0262 | 1 | F | S-NSSAI for SMF or UPF selection                                        | 16.2.0 |
| 2019-12 | CT#86 | CP-193055 | 0264 | 2 | B | GMLC Location service                                                   | 16.2.0 |
| 2019-12 | CT#86 | CP-193063 | 0265 | - | F | Error code 404 for Hierarchical NRFs                                    | 16.2.0 |
| 2019-12 | CT#86 | CP-193063 | 0266 | 3 | B | Preferred API Version                                                   | 16.2.0 |
| 2019-12 | CT#86 | CP-193042 | 0267 | 3 | F | Clarification on Backup AMF Info                                        | 16.2.0 |
| 2019-12 | CT#86 | CP-193055 | 0269 | - | B | Location Update Notification Default Subscription                       | 16.2.0 |
| 2019-12 | CT#86 | CP-193044 | 0273 | - | F | 3GPP TS 29.510 API version update                                       | 16.2.0 |
| 2020-03 | CT#87 | CP-200025 | 0274 | 1 | B | 3GPP Rel-16 LOLC implications on Nnrf service                           | 16.3.0 |
| 2020-03 | CT#87 | CP-200039 | 0275 | 2 | F | Add Corresponding API descriptions in clause 5.1                        | 16.3.0 |
| 2020-03 | CT#87 | CP-200016 | 0277 | 3 | F | Service Discovery in a different PLMN using 3gpp-Sbi-Target-apiRoot     | 16.3.0 |
| 2020-03 | CT#87 | CP-200134 | 0278 | 3 | B | Data Type Descriptions                                                  | 16.3.0 |
| 2020-03 | CT#87 | CP-200020 | 0279 | 1 | D | Editorial corrections in clause headings                                | 16.3.0 |
| 2020-03 | CT#87 | CP-200020 | 0280 | 2 | B | Service Names                                                           | 16.3.0 |
| 2020-03 | CT#87 | CP-200029 | 0281 | 1 | B | SoR Application Function                                                | 16.3.0 |
| 2020-03 | CT#87 | CP-200035 | 0282 | 3 | B | N3 terminations of TWIF for UPF selection                               | 16.3.0 |
| 2020-03 | CT#87 | CP-200044 | 0283 | 1 | F | Correcting relevant typing errors                                       | 16.3.0 |
| 2020-03 | CT#87 | CP-200016 | 0284 | 3 | B | CHF Group ID                                                            | 16.3.0 |
| 2020-03 | CT#87 | CP-200101 | 0285 | 4 | B | S-NSSAIs of an NF Service                                               | 16.3.0 |
| 2020-03 | CT#87 | CP-200021 | 0286 | 2 | F | NFtype enumeration values for MME, SCEF and SCS/AS                      | 16.3.0 |
| 2020-03 | CT#87 | CP-200020 | 0287 | 3 | F | DNN encoding in NRF APIs                                                | 16.3.0 |
| 2020-03 | CT#87 | CP-200047 | 0288 | 2 | F | Content type of Access Token Request                                    | 16.3.0 |
| 2020-03 | CT#87 | CP-200020 | 0289 | 2 | F | Registering the AccessToken service in another NRF                      | 16.3.0 |
| 2020-03 | CT#87 | CP-200039 | 0290 | 3 | D | Editorial corrections                                                   | 16.3.0 |
| 2020-03 | CT#87 | CP-200039 | 0291 | 2 | F | Correction - formatting consistency                                     | 16.3.0 |
| 2020-03 | CT#87 | CP-200020 | 0293 | 1 | B | 29510 CR optionality of ProblemDetails                                  | 16.3.0 |
| 2020-03 | CT#87 | CP-200016 | 0294 | 1 | F | Wrong reference                                                         | 16.3.0 |
| 2020-03 | CT#87 | CP-200020 | 0295 | 1 | B | Subscription Condition for UPF                                          | 16.3.0 |
| 2020-03 | CT#87 | CP-200026 | 0297 | 1 | B | OTAF                                                                    | 16.3.0 |
| 2020-03 | CT#87 | CP-200017 | 0298 | 1 | B | Supported DNN of the I-SMF                                              | 16.3.0 |
| 2020-03 | CT#87 | CP-200036 | 0299 | - | B | PCF selection for V2X                                                   | 16.3.0 |
| 2020-03 | CT#87 | CP-200023 | 0300 | 2 | B | UPF selection for redundant transmission                                | 16.3.0 |
| 2020-03 | CT#87 | CP-200016 | 0302 | 1 | B | Service access authorization of a NF Set                                | 16.3.0 |
| 2020-03 | CT#87 | CP-200028 | 0307 | 3 | B | UDSF registration with NRF                                              | 16.3.0 |
| 2020-03 | CT#87 | CP-200016 | 0308 | - | F | API versions supported for default notification subscriptions           | 16.3.0 |
| 2020-03 | CT#87 | CP-200044 | 0309 | - | F | NF Discovery with intermediate forwarding NRF                           | 16.3.0 |
| 2020-03 | CT#87 | CP-200020 | 0310 | - | F | Modifications in the NRF service APIs for the support of compression    | 16.3.0 |
| 2020-03 | CT#87 | CP-200020 | 0311 | 1 | B | Vendor ID in NF Profile                                                 | 16.3.0 |
| 2020-03 | CT#87 | CP-200177 | 0312 | 3 | B | LMF selection                                                           | 16.3.0 |
| 2020-03 | CT#87 | CP-200020 | 0313 | 1 | B | Load Time Stamp                                                         | 16.3.0 |
| 2020-03 | CT#87 | CP-200020 | 0314 | 1 | B | Security Settings                                                       | 16.3.0 |
| 2020-03 | CT#87 | CP-200016 | 0315 | 1 | B | NFType for SCP                                                          | 16.3.0 |
| 2020-03 | CT#87 | CP-200092 | 0316 | - | F | 3GPP TS 29.510 API Version Update                                       | 16.3.0 |
| 2020-07 | CT#88 | CP-201050 | 0317 | 1 | B | Support of IPUPS Functionality                                          | 16.4.0 |
| 2020-07 | CT#88 | CP-201034 | 0318 | 1 | F | Authorization parameters in roaming scenarios                           | 16.4.0 |
| 2020-07 | CT#88 | CP-201034 | 0319 | 1 | F | Missing attributes in NrfInfo data type                                 | 16.4.0 |
| 2020-07 | CT#88 | CP-201034 | 0320 | - | F | Slice Differentiator Ranges and Wildcard                                | 16.4.0 |
| 2020-07 | CT#88 | CP-201034 | 0321 | 1 | F | Undiscoverable NF service                                               | 16.4.0 |
| 2020-07 | CT#88 | CP-201057 | 0322 | 2 | F | Supported Headers and Links Tables                                      | 16.4.0 |
| 2020-07 | CT#88 | CP-201030 | 0323 | 1 | B | Recovery Time for NF Service Set and NF Set                             | 16.4.0 |
| 2020-07 | CT#88 | CP-201022 | 0324 | 1 | A | Requester-snssais                                                       | 16.4.0 |
| 2020-07 | CT#88 | CP-201034 | 0325 | 2 | B | Resource-Level Authorization                                            | 16.4.0 |
| 2020-07 | CT#88 | CP-201034 | 0326 | - | B | Data type descriptions                                                  | 16.4.0 |
| 2020-07 | CT#88 | CP-201034 | 0327 | - | B | Storage of YAML files in ETSI Forge                                     | 16.4.0 |
| 2020-07 | CT#88 | CP-201034 | 0331 | 1 | B | Subscription Condition for a List of NF Instances                       | 16.4.0 |
| 2020-07 | CT#88 | CP-201034 | 0334 | - | B | Serving Scope for NF Subscriptions                                      | 16.4.0 |
| 2020-07 | CT#88 | CP-201046 | 0335 | 1 | B | SMF NIDD Service                                                        | 16.4.0 |
| 2020-07 | CT#88 | CP-201057 | 0336 | 1 | F | Datatype column in Resource URI variables Table                         | 16.4.0 |
| 2020-07 | CT#88 | CP-201041 | 0338 | 2 | F | ServiceName nudsf-dr missing from yaml                                  | 16.4.0 |
| 2020-07 | CT#88 | CP-201030 | 0341 | 1 | F | Presence condition of Set IDs                                           | 16.4.0 |
| 2020-07 | CT#88 | CP-201047 | 0342 | 1 | B | AMF Callback URIs for NSSAA                                             | 16.4.0 |
| 2020-07 | CT#88 | CP-201047 | 0343 | 1 | B | Introduce NSSAAF                                                        | 16.4.0 |
| 2020-07 | CT#88 | CP-201201 | 0345 | 2 | F | SCP profile registration and discovery                                  | 16.4.0 |

|         |       |           |      |   |   |                                                                                                           |        |
|---------|-------|-----------|------|---|---|-----------------------------------------------------------------------------------------------------------|--------|
| 2020-07 | CT#88 | CP-201034 | 0347 | 1 | F | Bootstrapping API                                                                                         | 16.4.0 |
| 2020-07 | CT#88 | CP-201034 | 0348 | 1 | F | Defining xxxInfoExt data types as maps                                                                    | 16.4.0 |
| 2020-07 | CT#88 | CP-201034 | 0349 | - | F | Requester's information in Access Token Request                                                           | 16.4.0 |
| 2020-07 | CT#88 | CP-201034 | 0350 | - | F | Discovery or subscription requests with missing requester's information                                   | 16.4.0 |
| 2020-07 | CT#88 | CP-201030 | 0354 | 1 | F | Supplement to NefInfo                                                                                     | 16.4.0 |
| 2020-07 | CT#88 | CP-201070 | 0355 | 1 | B | UPF for Data Forwarding                                                                                   | 16.4.0 |
| 2020-07 | CT#88 | CP-201031 | 0356 | 1 | B | V-SMF Selection for Serving Full PLMN                                                                     | 16.4.0 |
| 2020-07 | CT#88 | CP-201045 | 0357 | - | F | NRF Additional Authorization Parameters                                                                   | 16.4.0 |
| 2020-07 | CT#88 | CP-201183 | 0359 | 2 | F | NRF Notifications                                                                                         | 16.4.0 |
| 2020-07 | CT#88 | CP-201034 | 0360 | - | F | NF Services Map                                                                                           | 16.4.0 |
| 2020-07 | CT#88 | CP-201034 | 0361 | 1 | B | NRF Notification Data                                                                                     | 16.4.0 |
| 2020-07 | CT#88 | CP-201033 | 0364 | - | B | Service Name for Nhss_EE                                                                                  | 16.4.0 |
| 2020-07 | CT#88 | CP-201034 | 0365 | 1 | F | Maximum payload size                                                                                      | 16.4.0 |
| 2020-07 | CT#88 | CP-201073 | 0368 | - | F | 3GPP TS 29.510 API Version Update                                                                         | 16.4.0 |
| 2020-09 | CT#89 | CP-202118 | 0370 | - | F | HSS NF Profile Update                                                                                     | 16.5.0 |
| 2020-09 | CT#89 | CP-202043 | 0371 | 1 | F | NF Group ID                                                                                               | 16.5.0 |
| 2020-09 | CT#89 | CP-202110 | 0372 | - | F | Handling of S-NSSAI per PLMN                                                                              | 16.5.0 |
| 2020-09 | CT#89 | CP-202119 | 0375 | 1 | F | scpPrefix attribute in SCP profile                                                                        | 16.5.0 |
| 2020-09 | CT#89 | CP-202119 | 0376 | 1 | F | Resolving Editor's notes on SCP profile registration and discovery                                        | 16.5.0 |
| 2020-09 | CT#89 | CP-202110 | 0377 | - | F | NF Profile Retrieval procedure with NF Services Map                                                       | 16.5.0 |
| 2020-09 | CT#89 | CP-202118 | 0378 | - | F | Missing NF types for SBA interactions between IMS and 5GC                                                 | 16.5.0 |
| 2020-09 | CT#89 | CP-202088 | 0380 | - | F | supported-features query parameter                                                                        | 16.5.0 |
| 2020-09 | CT#89 | CP-202088 | 0381 | 1 | F | Making reqNfType as Conditional IE in SubscriptionData                                                    | 16.5.0 |
| 2020-09 | CT#89 | CP-202119 | 0383 | 3 | F | Corrections on attributes for SCP                                                                         | 16.5.0 |
| 2020-09 | CT#89 | CP-202119 | 0384 | 1 | F | Notification Binding for Default Subscription                                                             | 16.5.0 |
| 2020-09 | CT#89 | CP-202022 | 0385 | 2 | F | Message and Information class for Default Subscription                                                    | 16.5.0 |
| 2020-09 | CT#89 | CP-202110 | 0386 | 1 | F | Default TCP Port                                                                                          | 16.5.0 |
| 2020-09 | CT#89 | CP-202112 | 0387 | 1 | F | Corrections on definition of NotificationType                                                             | 16.5.0 |
| 2020-09 | CT#89 | CP-202096 | 0390 | - | F | 29.510 Rel-16 API version and External doc update                                                         | 16.5.0 |
| 2020-12 | CT#90 | CP-203034 | 0395 | 2 | F | Subscription Authorization parameters for NRF                                                             | 16.6.0 |
| 2020-12 | CT#90 | CP-203034 | 0396 | 2 | F | Add a condition to trigger NF_PROFILE_CHANGE notification from NRF for any change in allowedxxx parameter | 16.6.0 |
| 2020-12 | CT#90 | CP-203034 | 0397 | 2 | F | Replace the NFInstanceID with nfInstanceUri in Notification from NRF                                      | 16.6.0 |
| 2020-12 | CT#90 | CP-203081 | 0398 | 4 | F | Supplement to SubscrCond                                                                                  | 16.6.0 |
| 2020-12 | CT#90 | CP-203070 | 0402 | 2 | F | SCP port information                                                                                      | 16.6.0 |
| 2020-12 | CT#90 | CP-203048 | 0404 | 1 | F | preferred-api-versions query parameter                                                                    | 16.6.0 |
| 2020-12 | CT#90 | CP-203053 | 0405 | - | F | P-CSCF addresses                                                                                          | 16.6.0 |
| 2020-12 | CT#90 | CP-203054 | 0406 | 4 | F | Amendments for stateless NF support                                                                       | 16.6.0 |
| 2020-12 | CT#90 | CP-203048 | 0408 | - | F | Storage of YAML files in GitLab                                                                           | 16.6.0 |
| 2020-12 | CT#90 | CP-203048 | 0410 | - | F | Correction in NRF Bootstrapping                                                                           | 16.6.0 |
| 2020-12 | CT#90 | CP-203052 | 0413 | - | F | UDSF Info                                                                                                 | 16.6.0 |
| 2020-12 | CT#90 | CP-203054 | 0414 | 1 | F | SCP subscription                                                                                          | 16.6.0 |
| 2020-12 | CT#90 | CP-203034 | 0415 | 1 | F | NF Profile for NF as Service Consumer                                                                     | 16.6.0 |
| 2020-12 | CT#90 | CP-203048 | 0416 | 1 | F | Preferred Locality Search Result                                                                          | 16.6.0 |
| 2020-12 | CT#90 | CP-203034 | 0418 | 2 | F | V-SMF Capability                                                                                          | 16.6.0 |
| 2020-12 | CT#90 | CP-203048 | 0419 | - | F | Data Type Descriptions                                                                                    | 16.6.0 |
| 2020-12 | CT#90 | CP-203036 | 0420 | - | F | 29.510 Rel16 API version and External doc update                                                          | 16.6.0 |
| 2020-12 | CT#90 | CP-203064 | 0374 | 2 | B | NF Discovery procedure enhancements                                                                       | 17.0.0 |
| 2020-12 | CT#90 | CP-203059 | 0392 | 1 | F | Discovery answer for no match of query parameter                                                          | 17.0.0 |
| 2020-12 | CT#90 | CP-203064 | 0399 | 1 | F | Issues with definition of heartBeatTimer attribute and limit Query-parameter in Open API specification    | 17.0.0 |
| 2020-12 | CT#90 | CP-203071 | 0400 | 2 | B | Query parameter for preferred vendor-specific features                                                    | 17.0.0 |
| 2020-12 | CT#90 | CP-203064 | 0401 | 1 | F | Support of Wildcard DNN in SmfInfo                                                                        | 17.0.0 |
| 2020-12 | CT#90 | CP-203064 | 0407 | 3 | B | Select a UP function to setup PFCP Association                                                            | 17.0.0 |
| 2020-12 | CT#90 | CP-203061 | 0409 | - | D | TS References                                                                                             | 17.0.0 |
| 2020-12 | CT#90 | CP-203064 | 0411 | - | F | IP addressing                                                                                             | 17.0.0 |
| 2020-12 | CT#90 | CP-203064 | 0412 | 2 | F | Default Notifications                                                                                     | 17.0.0 |
| 2020-12 | CT#90 | CP-203069 | 0417 | 4 | B | SCP Domain Routing Information                                                                            | 17.0.0 |
| 2020-12 | CT#90 | CP-203055 | 0421 | - | F | 29.510 Rel17 API version and External doc update                                                          | 17.0.0 |
| 2021-03 | CT#91 | CP-210021 | 0369 | 3 | B | NF discovery based on SUCI information                                                                    | 17.1.0 |
| 2021-03 | CT#91 | CP-210037 | 0423 | 1 | A | Add snssaiList, pfdData, gpsIRanges, externalGroupIdentifiersRanges, servedFqdnList to NefCond            | 17.1.0 |
| 2021-03 | CT#91 | CP-210037 | 0425 | 1 | A | Add snssaiList, taiList and taiRangeList to NwdafCond                                                     | 17.1.0 |
| 2021-03 | CT#91 | CP-210043 | 0428 | 1 | A | Encoding of Monitored and Unmonitored Attributes                                                          | 17.1.0 |
| 2021-03 | CT#91 | CP-210021 | 0429 | 2 | F | Vendor Specific Features at NF Level                                                                      | 17.1.0 |
| 2021-03 | CT#91 | CP-210021 | 0430 | 1 | B | SEPP profile                                                                                              | 17.1.0 |
| 2021-03 | CT#91 | CP-210021 | 0431 | - | B | NRF supported features in Bootstrapping response                                                          | 17.1.0 |
| 2021-03 | CT#91 | CP-210043 | 0433 | - | A | Query parameters indicating a preference                                                                  | 17.1.0 |
| 2021-03 | CT#91 | CP-210043 | 0435 | - | A | NFType value for DRA                                                                                      | 17.1.0 |
| 2021-03 | CT#91 | CP-210043 | 0438 | 2 | A | P-CSCF discovery based on UE IP address R17                                                               | 17.1.0 |
| 2021-03 | CT#91 | CP-210021 | 0439 | 1 | F | P-CSCF discovery based on UE location                                                                     | 17.1.0 |

|         |       |           |      |   |   |                                                                                                                             |        |
|---------|-------|-----------|------|---|---|-----------------------------------------------------------------------------------------------------------------------------|--------|
| 2021-03 | CT#91 | CP-210053 | 0443 | - | A | Primary / Secondary CHF Instances                                                                                           | 17.1.0 |
| 2021-03 | CT#91 | CP-210021 | 0444 | 1 | B | Enhancements to BSF Info                                                                                                    | 17.1.0 |
| 2021-03 | CT#91 | CP-210021 | 0445 | 2 | B | UPF TAI Ranges                                                                                                              | 17.1.0 |
| 2021-03 | CT#91 | CP-210021 | 0446 | 1 | F | Editorial Corrections                                                                                                       | 17.1.0 |
| 2021-03 | CT#91 | CP-210021 | 0447 | 2 | B | Enhancements to NFListRetrieval service operation                                                                           | 17.1.0 |
| 2021-03 | CT#91 | CP-210022 | 0450 | - | F | Clarification of NF Set ID List                                                                                             | 17.1.0 |
| 2021-03 | CT#91 | CP-210021 | 0451 | - | F | IMSI Pattern                                                                                                                | 17.1.0 |
| 2021-03 | CT#91 | CP-210021 | 0452 | - | F | Correction to Bootstrapping service description                                                                             | 17.1.0 |
| 2021-03 | CT#91 | CP-210021 | 0453 | 2 | F | Discovery and Subscribe Operation on NF Service Set                                                                         | 17.1.0 |
| 2021-03 | CT#91 | CP-210034 | 0454 | 1 | D | Correcting Figure 5.2.2.5.4-1                                                                                               | 17.1.0 |
| 2021-03 | CT#91 | CP-210034 | 0455 | 1 | D | Correcting Figure 5.2.2.5.5-1                                                                                               | 17.1.0 |
| 2021-03 | CT#91 | CP-210034 | 0456 | - | D | Correcting Figure 5.2.2.6.4-1                                                                                               | 17.1.0 |
| 2021-03 | CT#91 | CP-210043 | 0458 | 1 | A | Essential correction to Subscription Condition data types                                                                   | 17.1.0 |
| 2021-03 | CT#91 | CP-210021 | 0459 | - | F | Supported Vendor-Specific Features                                                                                          | 17.1.0 |
| 2021-03 | CT#91 | CP-210055 | 0461 | 1 | A | Conditional PATCH                                                                                                           | 17.1.0 |
| 2021-03 | CT#91 | CP-210021 | 0464 | 1 | B | SCP Domain Routing Info Aggregation                                                                                         | 17.1.0 |
| 2021-03 | CT#91 | CP-210037 | 0466 | 4 | A | SCP Information                                                                                                             | 17.1.0 |
| 2021-03 | CT#91 | CP-210055 | 0471 | 1 | A | SubscrCond for PCF and CHF                                                                                                  | 17.1.0 |
| 2021-03 | CT#91 | CP-210026 | 0472 | 1 | B | AAAnF discovery                                                                                                             | 17.1.0 |
| 2021-03 | CT#91 | CP-210025 | 0473 | 1 | F | hNRF from NSSF in home PLMN                                                                                                 | 17.1.0 |
| 2021-03 | CT#91 | CP-210029 | 0474 | - | F | 29.510 Rel-17 API version and External doc update                                                                           | 17.1.0 |
| 2021-06 | CT#92 | CP-211028 | 0477 | - | B | UDSF Timer service                                                                                                          | 17.2.0 |
| 2021-06 | CT#92 | CP-211028 | 0478 | 2 | B | Communication options information                                                                                           | 17.2.0 |
| 2021-06 | CT#92 | CP-211027 | 0479 | - | B | Non-3GPP TAI                                                                                                                | 17.2.0 |
| 2021-06 | CT#92 | CP-211030 | 0480 | 1 | B | New NSACF NFtype added                                                                                                      | 17.2.0 |
| 2021-06 | CT#92 | CP-211065 | 0483 | 1 | F | Usage of IPv6PrefixRange                                                                                                    | 17.2.0 |
| 2021-06 | CT#92 | CP-211065 | 0485 | - | A | Smf Info Priority                                                                                                           | 17.2.0 |
| 2021-06 | CT#92 | CP-211028 | 0486 | - | F | OpenAPI Reference                                                                                                           | 17.2.0 |
| 2021-06 | CT#92 | CP-211065 | 0488 | 1 | A | Corrections to PFD Data attribute and query parameter                                                                       | 17.2.0 |
| 2021-06 | CT#92 | CP-211039 | 0489 | 1 | B | Add 5G DDNMF                                                                                                                | 17.2.0 |
| 2021-06 | CT#92 | CP-211071 | 0491 | 1 | A | Essential correction on UPF Info                                                                                            | 17.2.0 |
| 2021-06 | CT#92 | CP-211031 | 0492 | 2 | B | (I-)SMF discovery based on DNAI                                                                                             | 17.2.0 |
| 2021-06 | CT#92 | CP-211036 | 0493 | 1 | B | New services provided by NWDAF                                                                                              | 17.2.0 |
| 2021-06 | CT#92 | CP-211036 | 0494 | 2 | B | Analytics IDs per Service                                                                                                   | 17.2.0 |
| 2021-06 | CT#92 | CP-211057 | 0496 | 1 | F | Description field for map data types                                                                                        | 17.2.0 |
| 2021-06 | CT#92 | CP-211059 | 0498 | 1 | A | Error Responses for Indirect Communication                                                                                  | 17.2.0 |
| 2021-06 | CT#92 | CP-211066 | 0500 | - | A | Event IDs supported by AF                                                                                                   | 17.2.0 |
| 2021-06 | CT#92 | CP-211039 | 0501 | - | B | Add 5G DDNMF service                                                                                                        | 17.2.0 |
| 2021-06 | CT#92 | CP-211039 | 0502 | 1 | B | PCF discovery with ProSe capability indication                                                                              | 17.2.0 |
| 2021-06 | CT#92 | CP-211065 | 0504 | 1 | A | R17-Access token request verification                                                                                       | 17.2.0 |
| 2021-06 | CT#92 | CP-211036 | 0505 | 2 | B | NWDAF aggregation capability registration in the NRF                                                                        | 17.2.0 |
| 2021-06 | CT#92 | CP-211036 | 0506 | 3 | B | New DCCF NF Registration and Discovery                                                                                      | 17.2.0 |
| 2021-06 | CT#92 | CP-211036 | 0507 | 2 | B | New MFAF NF Registration and Discovery                                                                                      | 17.2.0 |
| 2021-06 | CT#92 | CP-211036 | 0508 | 2 | B | NWDAF Registration and Discovery enhancement                                                                                | 17.2.0 |
| 2021-06 | CT#92 | CP-211026 | 0509 | 1 | B | LMF discovery via TAI                                                                                                       | 17.2.0 |
| 2021-06 | CT#92 | CP-211065 | 0512 | 3 | A | Remove unused GrantType                                                                                                     | 17.2.0 |
| 2021-06 | CT#92 | CP-211034 | 0513 | 3 | B | NSI based SUPI/SUCI                                                                                                         | 17.2.0 |
| 2021-06 | CT#92 | CP-211028 | 0514 | - | F | Adding some missing description fields to data type definitions in OpenAPI specification files of the Nnrf_NFManagement API | 17.2.0 |
| 2021-06 | CT#92 | CP-211059 | 0515 | 1 | A | Redirect Responses                                                                                                          | 17.2.0 |
| 2021-06 | CT#92 | CP-211028 | 0517 | 1 | F | Nested cardinality R17                                                                                                      | 17.2.0 |
| 2021-06 | CT#92 | CP-211057 | 0518 | 2 | B | NRF Content Encoding Information                                                                                            | 17.2.0 |
| 2021-06 | CT#92 | CP-211028 | 0519 | 2 | B | SCP capabilities                                                                                                            | 17.2.0 |
| 2021-06 | CT#92 | CP-211031 | 0520 | - | B | EASDF Registration and Discovery                                                                                            | 17.2.0 |
| 2021-06 | CT#92 | CP-211028 | 0521 | - | F | Client-type query parameter alignment                                                                                       | 17.2.0 |
| 2021-06 | CT#92 | CP-211036 | 0522 | 1 | B | Analytics ID of Nnwdaf_MLModelProvision service                                                                             | 17.2.0 |
| 2021-06 | CT#92 | CP-211057 | 0525 | 1 | F | Add ConditionEventType in Table 6.1.6.1-1                                                                                   | 17.2.0 |
| 2021-06 | CT#92 | CP-211028 | 0528 | 1 | F | Supported Features for Default Subscription                                                                                 | 17.2.0 |
| 2021-06 | CT#92 | CP-211028 | 0529 | 1 | F | NRF Info                                                                                                                    | 17.2.0 |
| 2021-06 | CT#92 | CP-211028 | 0530 | - | F | Clarification of service-names query parameter                                                                              | 17.2.0 |
| 2021-06 | CT#92 | CP-211026 | 0535 | 1 | B | LMF discovery via Supported GAD shapes                                                                                      | 17.2.0 |
| 2021-06 | CT#92 | CP-211039 | 0536 | - | B | Match Information Default Notification                                                                                      | 17.2.0 |
| 2021-06 | CT#92 | CP-211050 | 0537 | - | F | 29.510 Rel-17 API version and External doc update                                                                           | 17.2.0 |
| 2021-09 | CT#93 | CP-212050 | 0539 | 1 | F | Multiple PGW FQDNs                                                                                                          | 17.3.0 |
| 2021-09 | CT#93 | CP-212083 | 0541 | 2 | B | NSACF Profile                                                                                                               | 17.3.0 |
| 2021-09 | CT#93 | CP-212030 | 0542 | 1 | B | NSACF discovery                                                                                                             | 17.3.0 |
| 2021-09 | CT#93 | CP-212050 | 0543 | 1 | D | Editorial Corrections                                                                                                       | 17.3.0 |
| 2021-09 | CT#93 | CP-212030 | 0544 | 1 | B | NSACF service name                                                                                                          | 17.3.0 |
| 2021-09 | CT#93 | CP-212031 | 0547 | - | B | Local NEF discovery                                                                                                         | 17.3.0 |
| 2021-09 | CT#93 | CP-212041 | 0548 | - | B | NFStatusSubscribe for DCCF                                                                                                  | 17.3.0 |
| 2021-09 | CT#93 | CP-212041 | 0549 | 1 | B | NFStatusSubscribe for NWDAF                                                                                                 | 17.3.0 |

|         |       |           |      |   |   |                                                                                 |        |
|---------|-------|-----------|------|---|---|---------------------------------------------------------------------------------|--------|
| 2021-09 | CT#93 | CP-212026 | 0551 | 1 | F | Returning the interPlmnFqdn attribute in NFProfile in NF Discovery response     | 17.3.0 |
| 2021-09 | CT#93 | CP-212094 | 0552 | 2 | B | MB-SMF registration and discovery                                               | 17.3.0 |
| 2021-09 | CT#93 | CP-212095 | 0553 | 1 | B | TSCTSF NF registration and discovery                                            | 17.3.0 |
| 2021-09 | CT#93 | CP-212031 | 0554 | - | F | Cardinality of servedEasdfInfoList in NrInfo                                    | 17.3.0 |
| 2021-09 | CT#93 | CP-212043 | 0556 | 1 | F | Clarification on primaryChfInstance and secondaryChfInstance                    | 17.3.0 |
| 2021-09 | CT#93 | CP-212066 | 0558 | - | A | NFType enumeration value for IMS-AS                                             | 17.3.0 |
| 2021-09 | CT#93 | CP-212060 | 0560 | - | A | 3xx description correction for SCP                                              | 17.3.0 |
| 2021-09 | CT#93 | CP-212026 | 0561 | 1 | F | Rel-17 NFDiscovery features                                                     | 17.3.0 |
| 2021-09 | CT#93 | CP-212041 | 0562 | - | B | New ADRF NF Registration and Discovery                                          | 17.3.0 |
| 2021-09 | CT#93 | CP-212041 | 0563 | - | B | NWDAF capability enhancement                                                    | 17.3.0 |
| 2021-09 | CT#93 | CP-212064 | 0565 | 1 | A | ScplInfo Data Type Definition                                                   | 17.3.0 |
| 2021-09 | CT#93 | CP-212029 | 0567 | - | B | GBA BSF NF Type and Service Name                                                | 17.3.0 |
| 2021-09 | CT#93 | CP-212064 | 0569 | - | A | ScpDomainCond data type definition                                              | 17.3.0 |
| 2021-09 | CT#93 | CP-212050 | 0570 | 1 | F | PGW IP Address                                                                  | 17.3.0 |
| 2021-09 | CT#93 | CP-212036 | 0571 | - | F | Correct incorrect data type name of 5GDdnmInfo                                  | 17.3.0 |
| 2021-09 | CT#93 | CP-212026 | 0573 | 1 | F | Corrections to the API URI                                                      | 17.3.0 |
| 2021-09 | CT#93 | CP-212059 | 0575 | - | F | 29.510 Rel-17 API version and External doc update                               | 17.3.0 |
| 2021-12 | CT#94 | CP-213097 | 0577 | 2 | B | MB-SMF registration and discovery - Updates                                     | 17.4.0 |
| 2021-12 | CT#94 | CP-213086 | 0579 | 2 | F | Correction on service operation description                                     | 17.4.0 |
| 2021-12 | CT#94 | CP-213085 | 0581 | 1 | B | Discovering whether OAuth2 authorization is required for accessing NRF services | 17.4.0 |
| 2021-12 | CT#94 | CP-213108 | 0584 | 1 | B | BSF NF Profile definition for DCAMP                                             | 17.4.0 |
| 2021-12 | CT#94 | CP-213108 | 0585 | 1 | B | New PCF Service Name for PCF AM Policy Authorization                            | 17.4.0 |
| 2021-12 | CT#94 | CP-213097 | 0586 | 1 | B | MB-UPF registration and discovery                                               | 17.4.0 |
| 2021-12 | CT#94 | CP-213093 | 0587 | 1 | B | Support for Service Specific Authorization                                      | 17.4.0 |
| 2021-12 | CT#94 | CP-213102 | 0588 | 3 | B | AF Slice and DNN registration via NEF                                           | 17.4.0 |
| 2021-12 | CT#94 | CP-213096 | 0590 | - | B | LMFInfo update for SAT access                                                   | 17.4.0 |
| 2021-12 | CT#94 | CP-213093 | 0591 | 1 | B | EASDF discovery based on UPF N6 address                                         | 17.4.0 |
| 2021-12 | CT#94 | CP-213093 | 0592 | 1 | B | Local NEF discovery based on list of TAs                                        | 17.4.0 |
| 2021-12 | CT#94 | CP-213102 | 0593 | 1 | B | Trusted AF registration and discovery                                           | 17.4.0 |
| 2021-12 | CT#94 | CP-213092 | 0595 | 1 | F | Correction of NSACF discovery                                                   | 17.4.0 |
| 2021-12 | CT#94 | CP-213085 | 0596 | - | F | Correction on ScpDomainInfo                                                     | 17.4.0 |
| 2021-12 | CT#94 | CP-213101 | 0597 | 2 | B | ServiceName data type extension to cover the missing TSCTSF and NEF services    | 17.4.0 |
| 2021-12 | CT#94 | CP-213086 | 0599 | 1 | B | Precedence of Preferred Parameters                                              | 17.4.0 |
| 2021-12 | CT#94 | CP-213193 | 0603 | 2 | A | GMLC-Number in GmlInfo                                                          | 17.4.0 |
| 2021-12 | CT#94 | CP-213097 | 0606 | 1 | B | Selection of collocated MB-SMF/SMF and MB-UPF/UPF                               | 17.4.0 |
| 2021-12 | CT#94 | CP-213091 | 0608 | - | B | New Service Names for HSS GBA Services                                          | 17.4.0 |
| 2021-12 | CT#94 | CP-213087 | 0609 | 1 | B | Group ranges in HSS Info                                                        | 17.4.0 |
| 2021-12 | CT#94 | CP-213093 | 0610 | - | B | EASDF Baseline DNS Pattern service                                              | 17.4.0 |
| 2021-12 | CT#94 | CP-213097 | 0611 | - | B | New services for MBS                                                            | 17.4.0 |
| 2021-12 | CT#94 | CP-213116 | 0612 | - | F | Incorrect reference to NF Service Set ID definition in TS 23.003                | 17.4.0 |
| 2021-12 | CT#94 | CP-213116 | 0613 | - | F | requester-plmn-list query parameter                                             | 17.4.0 |
| 2021-12 | CT#94 | CP-213088 | 0615 | 1 | F | NRF Hierarchy                                                                   | 17.4.0 |
| 2021-12 | CT#94 | CP-213087 | 0617 | 1 | B | Discovery Result Change Notification                                            | 17.4.0 |
| 2021-12 | CT#94 | CP-213131 | 0619 | 1 | F | NF Service Redundancy Level                                                     | 17.4.0 |
| 2021-12 | CT#94 | CP-213201 | 0623 | 2 | B | hNRF URI                                                                        | 17.4.0 |
| 2021-12 | CT#94 | CP-213088 | 0625 | - | A | NFType value for CEF                                                            | 17.4.0 |
| 2021-12 | CT#94 | CP-213087 | 0626 | 1 | F | Subscription on SCP domain                                                      | 17.4.0 |
| 2021-12 | CT#94 | CP-213087 | 0627 | 1 | B | PLMN Specific attributes in NF profile                                          | 17.4.0 |
| 2021-12 | CT#94 | CP-213121 | 0628 | - | F | 29.510 Rel-17 API version and External doc update                               | 17.4.0 |
| 2022-03 | CT#95 | CP-220047 | 0630 | 6 | B | SNPN impacts on NRF - DCS/CH identification                                     | 17.5.0 |
| 2022-03 | CT#95 | CP-220047 | 0632 | - | F | SNPN impacts on NRF services - R17                                              | 17.5.0 |
| 2022-03 | CT#95 | CP-220267 | 0633 | 2 | F | SNPN impacts on NRF – OnboardingCapability                                      | 17.5.0 |
| 2022-03 | CT#95 | CP-220023 | 0634 | 1 | F | Static Authorization                                                            | 17.5.0 |
| 2022-03 | CT#95 | CP-220035 | 0636 | 1 | B | MB-SMF discovery by AMF using MBS Session ID and Area Session ID                | 17.5.0 |
| 2022-03 | CT#95 | CP-220088 | 0637 | - | F | AMF name in N2InterfaceAmfInfo                                                  | 17.5.0 |
| 2022-03 | CT#95 | CP-220024 | 0638 | 1 | B | Returning NRF altered priorities when using the Enhanced NF Discovery feature   | 17.5.0 |
| 2022-03 | CT#95 | CP-220044 | 0639 | 1 | B | UAS Capability Indication for NEF                                               | 17.5.0 |
| 2022-03 | CT#95 | CP-220044 | 0640 | - | B | UAS Service Name                                                                | 17.5.0 |
| 2022-03 | CT#95 | CP-220024 | 0642 | 2 | F | SUCI information corrections                                                    | 17.5.0 |
| 2022-03 | CT#95 | CP-220043 | 0643 | 3 | B | Add ProSe Capability in PcfInfo                                                 | 17.5.0 |
| 2022-03 | CT#95 | CP-220056 | 0645 | 2 | B | Add V2X Capability                                                              | 17.5.0 |
| 2022-03 | CT#95 | CP-220057 | 0646 | 2 | B | NSSAAF registration and discovery                                               | 17.5.0 |
| 2022-03 | CT#95 | CP-220024 | 0648 | 2 | F | Handling of PLMN ID in Subscription to NF Profile Change                        | 17.5.0 |
| 2022-03 | CT#95 | CP-220036 | 0649 | 1 | B | Data Restoration Default Notification                                           | 17.5.0 |
| 2022-03 | CT#95 | CP-220023 | 0651 | - | F | NSACF Information                                                               | 17.5.0 |
| 2022-03 | CT#95 | CP-220047 | 0652 | - | B | NSSAAF AIW Service Name                                                         | 17.5.0 |
| 2022-03 | CT#95 | CP-220148 | 0653 | 4 | B | Subscription Context in Notifications                                           | 17.5.0 |

|         |       |           |      |   |   |                                                                                   |        |
|---------|-------|-----------|------|---|---|-----------------------------------------------------------------------------------|--------|
| 2022-03 | CT#95 | CP-220024 | 0654 | 1 | B | Resource-based authorization on the NRF APIs                                      | 17.5.0 |
| 2022-03 | CT#95 | CP-220092 | 0655 | - | F | NF (Service) Set Status Change                                                    | 17.5.0 |
| 2022-03 | CT#95 | CP-220023 | 0657 | 1 | B | Preferred PGW Query Parameter                                                     | 17.5.0 |
| 2022-03 | CT#95 | CP-220048 | 0658 | 1 | B | TSCTS Discovery                                                                   | 17.5.0 |
| 2022-03 | CT#95 | CP-220049 | 0659 | 1 | B | AF registration with support of mapping between UE IP address and UE ID           | 17.5.0 |
| 2022-03 | CT#95 | CP-220092 | 0667 | - | F | ServiceName data type extension to cover the missing NEF services                 | 17.5.0 |
| 2022-03 | CT#95 | CP-220053 | 0669 | 1 | B | NSWO NF                                                                           | 17.5.0 |
| 2022-03 | CT#95 | CP-220025 | 0670 | 1 | F | UDR storing of non-subscriber related data                                        | 17.5.0 |
| 2022-03 | CT#95 | CP-220024 | 0671 | - | B | UDR storing data sub-sets                                                         | 17.5.0 |
| 2022-03 | CT#95 | CP-220088 | 0672 | - | F | Subscription with GuamiListCond                                                   | 17.5.0 |
| 2022-03 | CT#95 | CP-220024 | 0673 | - | F | Bootstrapping headers                                                             | 17.5.0 |
| 2022-03 | CT#95 | CP-220084 | 0676 | - | A | Encoding of Access Token Request                                                  | 17.5.0 |
| 2022-03 | CT#95 | CP-220025 | 0677 | 1 | B | P-CSCF Restoration Enhancements                                                   | 17.5.0 |
| 2022-03 | CT#95 | CP-220024 | 0678 | - | F | HSS Type is missing for NfGroupCond                                               | 17.5.0 |
| 2022-03 | CT#95 | CP-220049 | 0685 | 1 | B | Corrections to Authorization procedure for eNA scenario                           | 17.5.0 |
| 2022-03 | CT#95 | CP-220032 | 0686 | 1 | F | Subscription Id in message body                                                   | 17.5.0 |
| 2022-03 | CT#95 | CP-220025 | 0687 | 1 | F | Error responses to NRF OAuth 2.0 Access Token Request                             | 17.5.0 |
| 2022-03 | CT#95 | CP-220025 | 0688 | 1 | B | NRF Set support                                                                   | 17.5.0 |
| 2022-03 | CT#95 | CP-220066 | 0689 | - | F | 29.510 Rel-17 API version and External doc update                                 | 17.5.0 |
| 2022-06 | CT#96 | CP-221049 | 0692 | 6 | F | Adding ismfSupportInd to the SmfInfo                                              | 17.6.0 |
| 2022-06 | CT#96 | CP-221028 | 0694 | 2 | F | Correction and clarification on NotificationType                                  | 17.6.0 |
| 2022-06 | CT#96 | CP-221049 | 0698 | 1 | F | Supported PLMN for CHF Discovery                                                  | 17.6.0 |
| 2022-06 | CT#96 | CP-221043 | 0699 | - | B | PKMF Function and Service                                                         | 17.6.0 |
| 2022-06 | CT#96 | CP-221023 | 0700 | - | F | MBS Service Area Information for Location dependent MBS session                   | 17.6.0 |
| 2022-06 | CT#96 | CP-221028 | 0701 | 1 | A | SMF profile without smfInfo and smfInfoList attributes                            | 17.6.0 |
| 2022-06 | CT#96 | CP-221023 | 0702 | - | F | MBS NF types                                                                      | 17.6.0 |
| 2022-06 | CT#96 | CP-221028 | 0703 | 1 | F | Description Fields                                                                | 17.6.0 |
| 2022-06 | CT#96 | CP-221029 | 0704 | 2 | F | Fqdn Data Type Definition                                                         | 17.6.0 |
| 2022-06 | CT#96 | CP-221031 | 0705 | - | B | Target Network Resolution                                                         | 17.6.0 |
| 2022-06 | CT#96 | CP-221031 | 0708 | 3 | B | Support of MNP                                                                    | 17.6.0 |
| 2022-06 | CT#96 | CP-221027 | 0709 | - | F | OAuth2 scopes                                                                     | 17.6.0 |
| 2022-06 | CT#96 | CP-221038 | 0710 | 1 | F | NWDAF Discovery                                                                   | 17.6.0 |
| 2022-06 | CT#96 | CP-221036 | 0712 | - | B | Remote SNPNs reachable through an SCP or SEPP                                     | 17.6.0 |
| 2022-06 | CT#96 | CP-221049 | 0714 | - | F | Delete the default value of vsmfSupportInd in A.2                                 | 17.6.0 |
| 2022-06 | CT#96 | CP-221024 | 0715 | 1 | B | MBSF/MB-STF profiles in NRF                                                       | 17.6.0 |
| 2022-06 | CT#96 | CP-221036 | 0716 | - | F | SMF UP remote provisioning capability                                             | 17.6.0 |
| 2022-06 | CT#96 | CP-221024 | 0717 | 1 | F | MB-SMF discovering AMF(s)                                                         | 17.6.0 |
| 2022-06 | CT#96 | CP-221028 | 0718 | - | F | HSS Diameter Address                                                              | 17.6.0 |
| 2022-06 | CT#96 | CP-221028 | 0719 | - | F | Locality Based Priority                                                           | 17.6.0 |
| 2022-06 | CT#96 | CP-221028 | 0720 | - | F | Application Data Subsets                                                          | 17.6.0 |
| 2022-06 | CT#96 | CP-221038 | 0721 | - | F | Clarification of DCCF Info and NWDAF Info                                         | 17.6.0 |
| 2022-06 | CT#96 | CP-221029 | 0722 | 1 | F | Encoding of Query Parameters                                                      | 17.6.0 |
| 2022-06 | CT#96 | CP-221037 | 0723 | - | F | New Service Names                                                                 | 17.6.0 |
| 2022-06 | CT#96 | CP-221031 | 0724 | - | B | NF registration and discovery of SMS-IWMSC                                        | 17.6.0 |
| 2022-06 | CT#96 | CP-221037 | 0725 | 1 | F | TSCTS Default Notification                                                        | 17.6.0 |
| 2022-06 | CT#96 | CP-221029 | 0726 | - | F | NRF Bootstrapping Headers                                                         | 17.6.0 |
| 2022-06 | CT#96 | CP-221051 | 0728 | - | F | 29.510 Rel-17 API version and External doc update                                 | 17.6.0 |
| 2022-09 | CT#97 | CP-222026 | 0729 | - | F | Add seppPrefix attribute in SEPP profile                                          | 17.7.0 |
| 2022-09 | CT#97 | CP-222037 | 0730 | - | F | CH/DCS using AAA-S vs AUSF/UDM                                                    | 17.7.0 |
| 2022-09 | CT#97 | CP-222027 | 0732 | 1 | F | nudm-rsds Service                                                                 | 17.7.0 |
| 2022-09 | CT#97 | CP-222026 | 0734 | 1 | F | Removing an editor's note                                                         | 17.7.0 |
| 2022-09 | CT#97 | CP-222026 | 0738 | - | F | Clarifications to the definition of the PreferredSearch data type                 | 17.7.0 |
| 2022-09 | CT#97 | CP-222050 | 0739 | - | F | allowedOperationsPerNfType IE and allowedOperationsPerNfInstance IE in NFService  | 17.7.0 |
| 2022-09 | CT#97 | CP-222026 | 0740 | - | F | Excluding NF (service) instances or NF (service) sets from NF Discovery procedure | 17.7.0 |
| 2022-09 | CT#97 | CP-222026 | 0741 | - | F | SD ranges and wildcard SD                                                         | 17.7.0 |
| 2022-09 | CT#97 | CP-222026 | 0742 | 1 | F | Clarification on Home Network Public Key used for Routing                         | 17.7.0 |
| 2022-09 | CT#97 | CP-222050 | 0744 | - | F | Extend AccessTokenClaim to include producerNfServiceSetId                         | 17.7.0 |
| 2022-09 | CT#97 | CP-222037 | 0745 | - | F | Extend AccessTokenReq and AccessTokenclaims to include SNPN-ID                    | 17.7.0 |
| 2022-09 | CT#97 | CP-222026 | 0746 | 2 | F | No Profile Match information                                                      | 17.7.0 |
| 2022-09 | CT#97 | CP-222037 | 0747 | 1 | F | SMF UPRP capability                                                               | 17.7.0 |
| 2022-09 | CT#97 | CP-222035 | 0748 | - | F | ProSe Anchor Function Support                                                     | 17.7.0 |
| 2022-09 | CT#97 | CP-222050 | 0749 | 1 | F | IP Index in UPF Information                                                       | 17.7.0 |
| 2022-09 | CT#97 | CP-222050 | 0750 | 1 | F | NRF Altered Priority for Enhanced NF Discovery                                    | 17.7.0 |
| 2022-09 | CT#97 | CP-222050 | 0752 | 1 | F | Service Specific Info for Default Notification Subscription                       | 17.7.0 |
| 2022-09 | CT#97 | CP-222038 | 0753 | 2 | F | NWDAF discovery based on Analytics Delay                                          | 17.7.0 |
| 2022-09 | CT#97 | CP-222026 | 0754 | 1 | F | Unknown NF Instance Id in subscription                                            | 17.7.0 |
| 2022-09 | CT#97 | CP-222026 | 0755 | - | F | Clarification of NF Discovery Service Description                                 | 17.7.0 |
| 2022-09 | CT#97 | CP-222058 | 0759 | - | F | 29.510 Rel-17 API version and External doc update                                 | 17.7.0 |

|         |       |           |      |   |   |                                                             |        |
|---------|-------|-----------|------|---|---|-------------------------------------------------------------|--------|
| 2022-12 | CT#98 | CP-223067 | 0764 | 1 | A | Notification Type for Delivery of Ciphering Key Information | 17.8.0 |
| 2022-12 | CT#98 | CP-223044 | 0771 | 2 | F | NSACF Discovery with Locality                               | 17.8.0 |
| 2022-12 | CT#98 | CP-223066 | 0786 | - | F | 29.510 Rel-17 API version and External doc update           | 17.8.0 |

---

# History

| <b>Document history</b> |              |             |
|-------------------------|--------------|-------------|
| V17.5.0                 | May 2022     | Publication |
| V17.6.0                 | July 2022    | Publication |
| V17.7.0                 | October 2022 | Publication |
| V17.8.0                 | January 2023 | Publication |
|                         |              |             |