

ETSI TS 129 510 V18.9.0 (2025-01)



**5G;
5G System;
Network function repository services;
Stage 3
(3GPP TS 29.510 version 18.9.0 Release 18)**



Reference

RTS/TSGC-0429510vi90

Keywords

5G

ETSI

650 Route des Lucioles
F-06921 Sophia Antipolis Cedex - FRANCE

Tel.: +33 4 92 94 42 00 Fax: +33 4 93 65 47 16

Siret N° 348 623 562 00017 - APE 7112B
Association à but non lucratif enregistrée à la
Sous-Préfecture de Grasse (06) N° w061004871

Important notice

The present document can be downloaded from the
[ETSI Search & Browse Standards application](#).

The present document may be made available in electronic versions and/or in print. The content of any electronic and/or print versions of the present document shall not be modified without the prior written authorization of ETSI. In case of any existing or perceived difference in contents between such versions and/or in print, the prevailing version of an ETSI deliverable is the one made publicly available in PDF format on [ETSI deliver repository](#).

Users should be aware that the present document may be revised or have its status changed, this information is available in the [Milestones listing](#).

If you find errors in the present document, please send your comments to the relevant service listed under [Committee Support Staff](#).

If you find a security vulnerability in the present document, please report it through our [Coordinated Vulnerability Disclosure \(CVD\)](#) program.

Notice of disclaimer & limitation of liability

The information provided in the present deliverable is directed solely to professionals who have the appropriate degree of experience to understand and interpret its content in accordance with generally accepted engineering or other professional standard and applicable regulations.

No recommendation as to products and services or vendors is made or should be implied.

No representation or warranty is made that this deliverable is technically accurate or sufficient or conforms to any law and/or governmental rule and/or regulation and further, no representation or warranty is made of merchantability or fitness for any particular purpose or against infringement of intellectual property rights.

In no event shall ETSI be held liable for loss of profits or any other incidental or consequential damages.

Any software contained in this deliverable is provided "AS IS" with no warranties, express or implied, including but not limited to, the warranties of merchantability, fitness for a particular purpose and non-infringement of intellectual property rights and ETSI shall not be held liable in any event for any damages whatsoever (including, without limitation, damages for loss of profits, business interruption, loss of information, or any other pecuniary loss) arising out of or related to the use of or inability to use the software.

Copyright Notification

No part may be reproduced or utilized in any form or by any means, electronic or mechanical, including photocopying and microfilm except as authorized by written permission of ETSI.

The content of the PDF version shall not be modified without the written authorization of ETSI.

The copyright and the foregoing restriction extend to reproduction in all media.

© ETSI 2025.
All rights reserved.

Intellectual Property Rights

Essential patents

IPRs essential or potentially essential to normative deliverables may have been declared to ETSI. The declarations pertaining to these essential IPRs, if any, are publicly available for **ETSI members and non-members**, and can be found in ETSI SR 000 314: "*Intellectual Property Rights (IPRs); Essential, or potentially Essential, IPRs notified to ETSI in respect of ETSI standards*", which is available from the ETSI Secretariat. Latest updates are available on the [ETSI IPR online database](#).

Pursuant to the ETSI Directives including the ETSI IPR Policy, no investigation regarding the essentiality of IPRs, including IPR searches, has been carried out by ETSI. No guarantee can be given as to the existence of other IPRs not referenced in ETSI SR 000 314 (or the updates on the ETSI Web server) which are, or may be, or may become, essential to the present document.

Trademarks

The present document may include trademarks and/or tradenames which are asserted and/or registered by their owners. ETSI claims no ownership of these except for any which are indicated as being the property of ETSI, and conveys no right to use or reproduce any trademark and/or tradename. Mention of those trademarks in the present document does not constitute an endorsement by ETSI of products, services or organizations associated with those trademarks.

DECT™, **PLUGTESTS™**, **UMTS™** and the ETSI logo are trademarks of ETSI registered for the benefit of its Members. **3GPP™**, **LTE™** and **5G™** logo are trademarks of ETSI registered for the benefit of its Members and of the 3GPP Organizational Partners. **oneM2M™** logo is a trademark of ETSI registered for the benefit of its Members and of the oneM2M Partners. **GSM®** and the GSM logo are trademarks registered and owned by the GSM Association.

Legal Notice

This Technical Specification (TS) has been produced by ETSI 3rd Generation Partnership Project (3GPP).

The present document may refer to technical specifications or reports using their 3GPP identities. These shall be interpreted as being references to the corresponding ETSI deliverables.

The cross reference between 3GPP and ETSI identities can be found at [3GPP to ETSI numbering cross-referencing](#).

Modal verbs terminology

In the present document "**shall**", "**shall not**", "**should**", "**should not**", "**may**", "**need not**", "**will**", "**will not**", "**can**" and "**cannot**" are to be interpreted as described in clause 3.2 of the [ETSI Drafting Rules](#) (Verbal forms for the expression of provisions).

"**must**" and "**must not**" are **NOT** allowed in ETSI deliverables except when used in direct citation.

Contents

Intellectual Property Rights	2
Legal Notice	2
Modal verbs terminology.....	2
Foreword.....	11
1 Scope	13
2 References	13
3 Definitions and abbreviations.....	15
3.1 Definitions	15
3.2 Abbreviations	15
4 Overview	15
5 Services Offered by the NRF	16
5.1 Introduction	16
5.2 Nnrf_NFManagement Service.....	17
5.2.1 Service Description.....	17
5.2.2 Service Operations	18
5.2.2.1 Introduction.....	18
5.2.2.2 NFRegister	20
5.2.2.2.1 General	20
5.2.2.2.2 NF (other than NRF) registration to NRF.....	20
5.2.2.2.3 NRF registration to another NRF	21
5.2.2.2.4 Shared Data registration to NRF	21
5.2.2.3 NFUpdate	22
5.2.2.3.1 General	22
5.2.2.3.1A NF Profile Complete replacement	22
5.2.2.3.1B NF Profile Partial Update	23
5.2.2.3.1C Shared Data Complete replacement.....	24
5.2.2.3.1D Shared data Partial Update	25
5.2.2.3.2 NF Heart-Beat	25
5.2.2.4 NFDeregister	27
5.2.2.4.1 General	27
5.2.2.4.2 NF Instance Deregistration.....	27
5.2.2.4.3 Shared Data Deregistration.....	27
5.2.2.5 NFStatusSubscribe	28
5.2.2.5.1 General	28
5.2.2.5.2 Subscription to NF Instances in the same PLMN.....	28
5.2.2.5.3 Subscription to NF Instances in a different PLMN	29
5.2.2.5.4 Subscription to NF Instances with intermediate forwarding NRF.....	31
5.2.2.5.5 Subscription to NF Instances with intermediate redirecting NRF.....	32
5.2.2.5.6 Update of Subscription to NF Instances	32
5.2.2.5.7 Update of Subscription to NF Instances in a different PLMN.....	33
5.2.2.6 NFStatusNotify	34
5.2.2.6.1 General	34
5.2.2.6.2 Notification from NRF in the same PLMN	34
5.2.2.6.3 Notification from NRF in a different PLMN.....	36
5.2.2.6.4 Notification for subscription via intermediate NRF	37
5.2.2.7 NFStatusUnSubscribe	37
5.2.2.7.1 General	37
5.2.2.7.2 Subscription removal in the same PLMN.....	37
5.2.2.7.3 Subscription removal in a different PLMN	38
5.2.2.8 NFListRetrieval.....	38
5.2.2.8.1 General	38
5.2.2.9 NFProfileRetrieval	39
5.2.2.9.1 General	39

5.2.2.10	SharedDataRetrieval	40
5.2.2.11	SharedDataListRetrieval	40
5.3	Nnrf_NFDiscovery Service	41
5.3.1	Service Description	41
5.3.2	Service Operations	41
5.3.2.1	Introduction	41
5.3.2.2	NFDiscover	42
5.3.2.2.1	General	42
5.3.2.2.2	Service Discovery in the same PLMN	43
5.3.2.2.3	Service Discovery in a different PLMN	44
5.3.2.2.4	Service Discovery with intermediate redirecting NRF	45
5.3.2.2.5	Service Discovery with intermediate forwarding NRF	46
5.3.2.2.6	Service Discovery with resolution of the target PLMN	48
5.3.2.3	SCPDomainRoutingInfoGet	48
5.3.2.4	SCPDomainRoutingInfoSubscribe	49
5.3.2.5	SCPDomainRoutingInfoNotify	50
5.3.2.6	SCPDomainRoutingInfoUnSubscribe	51
5.4	Nnrf_AccessToken Service	51
5.4.1	Service Description	51
5.4.2	Service Operations	51
5.4.2.1	Introduction	51
5.4.2.2	Get (Access Token Request)	51
5.4.2.2.1	General	51
5.4.2.2.2	Access Token request with intermediate forwarding NRF	53
5.4.2.2.3	Access Token request with intermediate redirecting NRF	54
5.5	Nnrf_Bootstrapping Service	55
5.5.1	Service Description	55
5.5.2	Service Operations	55
5.5.2.1	Introduction	55
5.5.2.2	Get	55
5.5.2.2.1	General	55
6	API Definitions	57
6.1	Nnrf_NFManagement Service API	57
6.1.1	API URI	57
6.1.2	Usage of HTTP	57
6.1.2.1	General	57
6.1.2.2	HTTP standard headers	57
6.1.2.2.1	General	57
6.1.2.2.2	Content type	57
6.1.2.2.3	Accept-Encoding	57
6.1.2.2.4	ETag	57
6.1.2.2.5	If-Match	58
6.1.2.3	HTTP custom headers	58
6.1.2.3.1	General	58
6.1.3	Resources	58
6.1.3.1	Overview	58
6.1.3.2	Resource: nf-instances (Store)	59
6.1.3.2.1	Description	59
6.1.3.2.2	Resource Definition	60
6.1.3.2.3	Resource Standard Methods	60
6.1.3.2.4	Resource Custom Operations	64
6.1.3.3	Resource: nf-instance (Document)	64
6.1.3.3.1	Description	64
6.1.3.3.2	Resource Definition	65
6.1.3.3.3	Resource Standard Methods	65
6.1.3.4	Resource: subscriptions (Collection)	71
6.1.3.4.1	Description	71
6.1.3.4.2	Resource Definition	71
6.1.3.4.3	Resource Standard Methods	71
6.1.3.5	Resource: subscription (Document)	73
6.1.3.5.1	Description	73

6.1.3.5.2	Resource Definition	73
6.1.3.5.3	Resource Standard Methods	73
6.1.3.6	Resource: shared-data (Document)	75
6.1.3.6.1	Description	75
6.1.3.6.2	Resource Definition	75
6.1.3.6.3	Resource Standard Methods	76
6.1.3.7	Resource: shared-data-store (Store)	82
6.1.3.7.1	Description	82
6.1.3.7.2	Resource Definition	82
6.1.3.7.3	Resource Standard Methods	82
6.1.4	Custom Operations without associated resources	82
6.1.5	Notifications	83
6.1.5.1	General	83
6.1.5.2	NF Instance Status Notification	83
6.1.5.2.1	Description	83
6.1.5.2.2	Notification Definition	83
6.1.6	Data Model	84
6.1.6.1	General	84
6.1.6.2	Structured data types	91
6.1.6.2.1	Introduction	91
6.1.6.2.2	Type: NFProfile	92
6.1.6.2.3	Type: NFService	107
6.1.6.2.4	Type: DefaultNotificationSubscription	119
6.1.6.2.5	Type: IpEndPoint	122
6.1.6.2.6	Type: UdrInfo	123
6.1.6.2.7	Type: UdmInfo	124
6.1.6.2.8	Type: AusfInfo	125
6.1.6.2.9	Type: SupiRange	126
6.1.6.2.10	Type: IdentityRange	126
6.1.6.2.11	Type: AmfInfo	127
6.1.6.2.12	Type: SmfInfo	129
6.1.6.2.13	Type: UpfInfo	132
6.1.6.2.14	Type: SnsaiUpfInfoItem	135
6.1.6.2.15	Type: DnnUpfInfoItem	136
6.1.6.2.16	Type: SubscriptionData	137
6.1.6.2.17	Type: NotificationData	143
6.1.6.2.18	Void	146
6.1.6.2.19	Type: NFServiceVersion	146
6.1.6.2.20	Type: PcfInfo	147
6.1.6.2.21	Type: BsfInfo	149
6.1.6.2.22	Type: Ipv4AddressRange	150
6.1.6.2.23	Type: Ipv6PrefixRange	150
6.1.6.2.24	Type: InterfaceUpfInfoItem	150
6.1.6.2.25	Type: UriList	151
6.1.6.2.26	Type: N2InterfaceAmfInfo	151
6.1.6.2.27	Type: TaiRange	151
6.1.6.2.28	Type: TacRange	152
6.1.6.2.29	Type: SnsaiSmfInfoItem	152
6.1.6.2.30	Type: DnnSmfInfoItem	153
6.1.6.2.31	Type: NrfInfo	154
6.1.6.2.32	Type: ChfInfo	158
6.1.6.2.33	Void	159
6.1.6.2.34	Type: PlmnRange	159
6.1.6.2.35	Type: SubscrCond	160
6.1.6.2.36	Type: NfInstanceIdCond	160
6.1.6.2.37	Type: NfTypeCond	161
6.1.6.2.38	Type: ServiceNameCond	161
6.1.6.2.39	Type: AmfCond	161
6.1.6.2.40	Type: GuamiListCond	161
6.1.6.2.41	Type: NetworkSliceCond	161
6.1.6.2.42	Type: NfGroupCond	162
6.1.6.2.43	Type: NotifCondition	162

6.1.6.2.44	Type: PlmnSnssai	162
6.1.6.2.45	Type: NwdafInfo	163
6.1.6.2.46	Type: LmfInfo	164
6.1.6.2.47	Type: GmlcInfo	166
6.1.6.2.48	Type: NefInfo	167
6.1.6.2.49	Type: PfdData.....	168
6.1.6.2.50	Type: AfEventExposureData.....	168
6.1.6.2.51	Type: WAgfInfo	168
6.1.6.2.52	Type: TngfInfo	169
6.1.6.2.53	Type: PscfInfo	169
6.1.6.2.54	Type: NfSetCond.....	170
6.1.6.2.55	Type: NfServiceSetCond	170
6.1.6.2.56	Type: NfInfo.....	170
6.1.6.2.57	Type: HssInfo	171
6.1.6.2.58	Type: ImsiRange	171
6.1.6.2.59	Type: InternalGroupIdRange.....	172
6.1.6.2.60	Type: UpfCond.....	172
6.1.6.2.61	Type: TwifInfo	172
6.1.6.2.62	Type: VendorSpecificFeature.....	173
6.1.6.2.63	Type: UdsfInfo	173
6.1.6.2.64	Type: NfInstanceIdListCond	173
6.1.6.2.65	Type: ScpInfo	174
6.1.6.2.66	Type: ScpDomainInfo	177
6.1.6.2.67	Type: ScpDomainCond	177
6.1.6.2.68	Type: OptionsResponse.....	178
6.1.6.2.69	Type: NwdafCond	178
6.1.6.2.70	Type: NefCond	179
6.1.6.2.71	Type: SuciInfo.....	179
6.1.6.2.72	Type: SeppInfo	180
6.1.6.2.73	Type: AanfInfo	180
6.1.6.2.74	Type: 5GDdnmfInfo	180
6.1.6.2.75	Type: MfafInfo	181
6.1.6.2.76	Type: NwdafCapability	182
6.1.6.2.77	Type: EasdfInfo	183
6.1.6.2.78	Type: SnssaiEasdfInfoItem.....	183
6.1.6.2.79	Type: DnnEasdfInfoItem.....	184
6.1.6.2.80	Type: DccfInfo	184
6.1.6.2.81	Type: NsacfInfo.....	185
6.1.6.2.82	Type: NsacfCapability.....	187
6.1.6.2.83	Type: DccfCond	188
6.1.6.2.84	Type: MIAnalyticsInfo	188
6.1.6.2.85	Type: MbSmfInfo	189
6.1.6.2.86	Type: TmgiRange.....	189
6.1.6.2.87	Type: MbsSession	190
6.1.6.2.88	Type: SnssaiMbSmfInfoItem	190
6.1.6.2.89	Type: DnnMbSmfInfoItem.....	190
6.1.6.2.90	Void.....	191
6.1.6.2.91	Type: TsctsfInfo	191
6.1.6.2.92	Type: SnssaiTsctsfInfoItem	191
6.1.6.2.93	Type: DnnTsctsfInfoItem	191
6.1.6.2.94	Type: MbUpfInfo	192
6.1.6.2.95	Type: UnTrustAfInfo.....	192
6.1.6.2.96	Type: TrustAfInfo	193
6.1.6.2.97	Type: SnssaiInfoItem.....	193
6.1.6.2.98	Type: DnnInfoItem.....	194
6.1.6.2.99	Type: CollocatedNfInstance	194
6.1.6.2.100	Type: ServiceNameListCond	194
6.1.6.2.101	Type: NfGroupListCond.....	194
6.1.6.2.102	Type: PlmnOauth2.....	195
6.1.6.2.103	Type: V2xCapability	195
6.1.6.2.104	Type: NssaafInfo	195
6.1.6.2.105	Type: ProSeCapability.....	196

6.1.6.2.106	Type: SharedDataIdRange	198
6.1.6.2.107	Type: SubscriptionContext	198
6.1.6.2.108	Type: IwmscInfo	198
6.1.6.2.109	Type: MnpfInfo	199
6.1.6.2.110	Type: DefSubServiceInfo	199
6.1.6.2.111	Type: LocalityDescriptionItem	199
6.1.6.2.112	Type: LocalityDescription	199
6.1.6.2.113	Type: SmsfInfo	200
6.1.6.2.114	Type: DcsfInfo	200
6.1.6.2.115	Type: MIModelInterInfo	200
6.1.6.2.116	Type: PruExistenceInfo	201
6.1.6.2.117	Type: MrfInfo	201
6.1.6.2.118	Type: MrfpInfo	201
6.1.6.2.119	Type: MfInfo	201
6.1.6.2.120	Type: A2xCapability	202
6.1.6.2.121	Type: RuleSet	203
6.1.6.2.122	Type: AdrfInfo	203
6.1.6.2.123	Type: SelectionConditions	204
6.1.6.2.124	Type: ConditionItem	205
6.1.6.2.125	Type: ConditionGroup	207
6.1.6.2.126	Type: EpdgInfo	207
6.1.6.2.127	Type: CallbackUriPrefixItem	207
6.1.6.2.128	Type: SharedData	207
6.1.6.2.129	Type: NFProfileRegistrationError	208
6.1.6.2.130	Type: SharedDataIdList	208
6.1.6.2.131	Type: PortRange	208
6.1.6.2.132	Type: SharedScope	209
6.1.6.3	Simple data types and enumerations	209
6.1.6.3.1	Introduction	209
6.1.6.3.2	Simple data types	209
6.1.6.3.3	Enumeration: NFType	209
6.1.6.3.4	Enumeration: NotificationType	213
6.1.6.3.5	Enumeration: TransportProtocol	216
6.1.6.3.6	Enumeration: NotificationEventType	216
6.1.6.3.7	Enumeration: NFStatus	216
6.1.6.3.8	Enumeration: DataSetId	216
6.1.6.3.9	Enumeration: UPInterfaceType	218
6.1.6.3.10	Relation Types	218
6.1.6.3.11	Enumeration: ServiceName	219
6.1.6.3.12	Enumeration: NFServiceStatus	223
6.1.6.3.13	Enumeration: AnNodeType	223
6.1.6.3.14	Enumeration: ConditionEventType	223
6.1.6.3.15	Enumeration: IpReachability	224
6.1.6.3.16	Enumeration: ScpCapability	224
6.1.6.3.17	Enumeration: CollocatedNfType	224
6.1.6.3.18	Enumeration: LocalityType	224
6.1.6.3.19	Enumeration: FICapabilityType	225
6.1.6.3.20	Void	225
6.1.6.3.21	Enumeration: RuleSetAction	225
6.1.6.3.22	Enumeration: DnsSecurityProtocol	225
6.1.7	Error Handling	225
6.1.7.1	General	225
6.1.7.2	Protocol Errors	225
6.1.7.3	Application Errors	225
6.1.8	Security	226
6.1.9	Features supported by the NFManagement service	226
6.2	Nnrf_NFDISCOVERY Service API	227
6.2.1	API URI	227
6.2.2	Usage of HTTP	228
6.2.2.1	General	228
6.2.2.2	HTTP standard headers	228
6.2.2.2.1	General	228

6.2.2.2.2	Content type	228
6.2.2.2.3	Cache-Control	228
6.2.2.2.4	ETag	228
6.2.2.2.5	If-None-Match.....	228
6.2.2.3	HTTP custom headers	228
6.2.2.3.1	General	228
6.2.3	Resources.....	229
6.2.3.1	Overview.....	229
6.2.3.2	Resource: nf-instances (Store)	230
6.2.3.2.1	Description	230
6.2.3.2.2	Resource Definition.....	230
6.2.3.2.3	Resource Standard Methods	230
6.2.3.2.4	Resource Custom Operations	255
6.2.3.3	Resource: Stored Search (Document)	255
6.2.3.3.1	Description	255
6.2.3.3.2	Resource Definition.....	255
6.2.3.4	Resource: Complete Stored Search (Document).....	256
6.2.3.4.1	Description	256
6.2.3.4.2	Resource Definition.....	256
6.2.3.5	Resource: SCP Domain Routing Information (Document).....	257
6.2.3.5.1	Description	257
6.2.3.5.2	Resource Definition.....	257
6.2.3.6	Resource: SCP Domain Routing Information Subscriptions (Collection)	258
6.2.3.6.1	Description	258
6.2.3.6.2	Resource Definition.....	258
6.2.3.6.3	Resource Standard Methods	258
6.2.3.7	Resource: Individual SCP Domain Routing Information Subscription (Document).....	259
6.2.3.7.1	Description	259
6.2.3.7.2	Resource Definition.....	259
6.2.3.7.3	Resource Standard Methods	259
6.2.4	Custom Operations without associated resources	260
6.2.5	Notifications	260
6.2.5.1	General	260
6.2.5.2	SCP Domain Routing Information Change Notification.....	260
6.2.5.2.1	Description	260
6.2.5.2.2	Notification Definition	261
6.2.6	Data Model	261
6.2.6.1	General	261
6.2.6.2	Structured data types	265
6.2.6.2.1	Introduction	265
6.2.6.2.2	Type: SearchResult.....	266
6.2.6.2.3	Type: NFProfile.....	269
6.2.6.2.4	Type: NFSservice.....	279
6.2.6.2.5	Type: StoredSearchResult	287
6.2.6.2.6	Type: PreferredSearch	288
6.2.6.2.7	Type: NfInstanceInfo.....	291
6.2.6.2.8	Type: ScpDomainRoutingInformation	291
6.2.6.2.9	Type: ScpDomainConnectivity	292
6.2.6.2.10	Type: ScpDomainRoutingInfoSubscription	292
6.2.6.2.11	Type: ScpDomainRoutingInfoNotification	293
6.2.6.2.12	Type: NfServiceInstance	293
6.2.6.2.13	Type: NoProfileMatchInfo	293
6.2.6.2.14	Type: QueryParamCombination.....	293
6.2.6.2.15	Type: QueryParameter.....	293
6.2.6.2.16	Type: AfData	294
6.2.6.2.17	Type: SearchResultInfo	294
6.2.6.3	Simple data types and enumerations	294
6.2.6.3.1	Introduction	294
6.2.6.3.2	Simple data types.....	294
6.2.6.3.3	Enumeration: NoProfileMatchReason.....	294
6.2.7	Error Handling	295
6.2.7.1	General	295

6.2.7.2	Protocol Errors	295
6.2.7.3	Application Errors	295
6.2.8	Security	295
6.2.9	Features supported by the NFDiscovery service	296
6.3	Nnrf_AccessToken Service API	302
6.3.1	General	302
6.3.2	API URI	302
6.3.3	Usage of HTTP	302
6.3.3.1	General	302
6.3.3.2	HTTP standard headers	302
6.3.3.2.1	General	302
6.3.3.2.2	Content type	302
6.3.3.3	HTTP custom headers	303
6.3.3.3.1	General	303
6.3.4	Custom Operations without associated resources	303
6.3.4.1	Overview	303
6.3.4.2	Operation: Get (Access Token Request)	303
6.3.4.2.1	Description	303
6.3.4.2.2	Operation Definition	303
6.3.5	Data Model	305
6.3.5.1	General	305
6.3.5.2	Structured data types	305
6.3.5.2.1	Introduction	305
6.3.5.2.2	Type: AccessTokenReq	306
6.3.5.2.3	Type: AccessTokenRsp	311
6.3.5.2.4	Type: AccessTokenClaims	312
6.3.5.2.5	Type: AccessTokenErr	315
6.3.5.2.6	Type: MIModelInterInd	315
6.3.5.3	Simple data types and enumerations	315
6.3.5.3.1	Introduction	315
6.3.5.3.2	Simple data types	315
6.3.5.3.3	Void	315
6.3.5.4	Data types describing alternative data types or combinations of data types	315
6.3.5.4.1	Type: Audience	315
6.3.6	Error Handling	316
6.3.6.1	General	316
6.3.6.2	Protocol Errors	316
6.3.6.3	Application Errors	316
6.4	Nnrf_Bootstrapping Service API	316
6.4.1	API URI	316
6.4.2	Usage of HTTP	316
6.4.2.1	General	316
6.4.2.2	HTTP standard headers	316
6.4.2.2.1	General	316
6.4.2.2.2	Content type	316
6.4.2.2.3	Cache-Control	317
6.4.2.2.4	ETag	317
6.4.2.2.5	If-None-Match	317
6.4.2.3	HTTP custom headers	317
6.4.2.3.1	General	317
6.4.3	Resources	317
6.4.3.1	Overview	317
6.4.3.2	Resource: Bootstrapping (Document)	318
6.4.3.2.1	Description	318
6.4.3.2.2	Resource Definition	318
6.4.3.2.3	Resource Standard Methods	318
6.4.4	Custom Operations without associated resources	319
6.4.5	Notifications	319
6.4.6	Data Model	319
6.4.6.1	General	319
6.4.6.2	Structured data types	319
6.4.6.2.1	Introduction	319

6.4.6.2.2	Type: BootstrappingInfo.....	320
6.4.6.3	Simple data types and enumerations	320
6.4.6.3.1	Introduction	320
6.4.6.3.2	Enumeration: Status.....	320
6.4.6.3.3	Relation Types.....	321
Annex A (normative):	OpenAPI specification.....	322
A.1	General	322
A.2	Nnrf_NFManagement API.....	322
A.3	Nnrf_NFDiscovery API	399
A.4	Nnrf_AccessToken API (NRF OAuth2 Authorization).....	431
A.5	Nnrf_Bootstrapping API	436
Annex B (normative):	NF Profile changes in NFRegister and NFUpdate responses.....	439
B.1	General	439
Annex C (normative):	Enhanced Authorization Policy using RuleSets in NF (Service) Profile.....	440
C.1	General	440
C.2	Examples of NF-Producer profile only using RuleSets (i.e. without AllowedXXX parameters) in NF (Service) Profile	440
C.3	Example of NF-Producer profile using RuleSets and AllowedXXX parameters in NF (Service) Profile.....	441
C.4	Backward Compatibility.....	442
Annex D (normative):	Support of "Canary Release" testing in the NRF	443
Annex E (informative):	Change history	447
History		459

Foreword

This Technical Specification has been produced by the 3rd Generation Partnership Project (3GPP).

The contents of the present document are subject to continuing work within the TSG and may change following formal TSG approval. Should the TSG modify the contents of the present document, it will be re-released by the TSG with an identifying change of release date and an increase in version number as follows:

Version x.y.z

where:

- x the first digit:
 - 1 presented to TSG for information;
 - 2 presented to TSG for approval;
 - 3 or greater indicates TSG approved document under change control.
- y the second digit is incremented for all changes of substance, i.e. technical enhancements, corrections, updates, etc.
- z the third digit is incremented when editorial only changes have been incorporated in the document.

In the present document, modal verbs have the following meanings:

- shall** indicates a mandatory requirement to do something
- shall not** indicates an interdiction (prohibition) to do something

The constructions "shall" and "shall not" are confined to the context of normative provisions, and do not appear in Technical Reports.

The constructions "must" and "must not" are not used as substitutes for "shall" and "shall not". Their use is avoided insofar as possible, and they are not used in a normative context except in a direct citation from an external, referenced, non-3GPP document, or so as to maintain continuity of style when extending or modifying the provisions of such a referenced document.

- should** indicates a recommendation to do something
- should not** indicates a recommendation not to do something
- may** indicates permission to do something
- need not** indicates permission not to do something

The construction "may not" is ambiguous and is not used in normative elements. The unambiguous constructions "might not" or "shall not" are used instead, depending upon the meaning intended.

- can** indicates that something is possible
- cannot** indicates that something is impossible

The constructions "can" and "cannot" are not substitutes for "may" and "need not".

- will** indicates that something is certain or expected to happen as a result of action taken by an agency the behaviour of which is outside the scope of the present document
- will not** indicates that something is certain or expected not to happen as a result of action taken by an agency the behaviour of which is outside the scope of the present document
- might** indicates a likelihood that something will happen as a result of action taken by some agency the behaviour of which is outside the scope of the present document

might not indicates a likelihood that something will not happen as a result of action taken by some agency the behaviour of which is outside the scope of the present document

In addition:

is (or any other verb in the indicative mood) indicates a statement of fact

is not (or any other negative verb in the indicative mood) indicates a statement of fact

The constructions "is" and "is not" do not indicate requirements.

1 Scope

The present document specifies the stage 3 protocol and data model for the Nnrf Service Based Interface. It provides stage 3 protocol definitions and message flows, and specifies the API for each service offered by the NRF.

The 5G System stage 2 architecture and procedures are specified in 3GPP TS 23.501 [2] and 3GPP TS 23.502 [3].

The Technical Realization of the Service Based Architecture and the Principles and Guidelines for Services Definition are specified in 3GPP TS 29.500 [4] and 3GPP TS 29.501 [5].

2 References

The following documents contain provisions which, through reference in this text, constitute provisions of the present document.

- References are either specific (identified by date of publication, edition number, version number, etc.) or non-specific.
- For a specific reference, subsequent revisions do not apply.
- For a non-specific reference, the latest version applies. In the case of a reference to a 3GPP document (including a GSM document), a non-specific reference implicitly refers to the latest version of that document *in the same Release as the present document*.

- [1] 3GPP TR 21.905: "Vocabulary for 3GPP Specifications".
- [2] 3GPP TS 23.501: "System Architecture for the 5G System; Stage 2".
- [3] 3GPP TS 23.502: "Procedures for the 5G System; Stage 2".
- [4] 3GPP TS 29.500: "5G System; Technical Realization of Service Based Architecture; Stage 3".
- [5] 3GPP TS 29.501: "5G System; Principles and Guidelines for Services Definition; Stage 3".
- [6] 3GPP TS 29.518: "5G System; Access and Mobility Management Services; Stage 3".
- [7] 3GPP TS 29.571: "5G System; Common Data Types for Service Based Interfaces; Stage 3".
- [8] ECMA-262: "ECMAScript® Language Specification", <https://www.ecma-international.org/ecma-262/5.1/>.
- [9] IETF RFC 9113: "HTTP/2".
- [10] OpenAPI Initiative, "OpenAPI Specification Version 3.0.0", <https://spec.openapis.org/oas/v3.0.0>.
- [11] IETF RFC 9457: "Problem Details for HTTP APIs".
- [12] 3GPP TS 23.003: "Numbering, Addressing and Identification".
- [13] IETF RFC 6902: "JavaScript Object Notation (JSON) Patch".
- [14] IETF RFC 6901: "JavaScript Object Notation (JSON) Pointer".
- [15] 3GPP TS 33.501: "Security architecture and procedures for 5G system".
- [16] IETF RFC 6749: "The OAuth 2.0 Authorization Framework".
- [17] IETF RFC 3986: "Uniform Resource Identifier (URI): Generic Syntax".
- [18] IETF RFC 4122: "A Universally Unique Identifier (UUID) URN Namespace".
- [19] Void.
- [20] IETF RFC 9111: "HTTP Caching".

- [21] 3GPP TS 29.244: "Interface between the Control Plane and the User Plane Nodes; Stage 3".
- [22] IETF RFC 8259: "The JavaScript Object Notation (JSON) Data Interchange Format".
- [23] IETF RFC 2782: "A DNS RR for specifying the location of services (DNS SRV)".
- [24] IETF RFC 7515: "JSON Web Signature (JWS)".
- [25] IETF RFC 7519: "JSON Web Token (JWT)".
- [26] W3C HTML 4.01 Specification, <https://www.w3.org/TR/2018/SPSD-html401-20180327/>.
- [27] 3GPP TS 23.527: "5G System; Restoration Procedures; Stage 2".
- [28] 3GPP TS 29.513: "5G System; Policy and Charging Control signalling flows and QoS parameter mapping; Stage 3".
- [29] 3GPP TS 38.413: "NG-RAN; NG Application Protocol (NGAP)".
- [30] IETF RFC 1952: "GZIP file format specification version 4.3".
- [31] 3GPP TR 21.900: "Technical Specification Group working methods".
- [32] 3GPP TS 29.520: "5G System; Network Data Analytics Services; Stage 3".
- [33] 3GPP TS 29.572: "5G System; Location Management Services; Stage 3".
- [34] 3GPP TS 23.288: "Architecture enhancements for 5G System (5GS) to support network data analytics services".
- [35] 3GPP TS 29.517: "Application Function Event Exposure Service".
- [36] 3GPP TS 29.503: "Unified Data Management Services".
- [37] 3GPP TS 29.336: "Home Subscriber Server (HSS) diameter interfaces for interworking with packet data networks and applications".
- [38] IANA: "SMI Network Management Private Enterprise Codes", <http://www.iana.org/assignments/enterprise-numbers>.
- [39] Semantic Versioning Specification: <https://semver.org>.
- [40] IETF RFC 9110: "HTTP Semantics".
- [41] Void.
- [42] 3GPP TS 29.531: "5G System; Network Slice Selection Services; Stage 3".
- [43] 3GPP TS 23.247: "Architectural enhancements for 5G multicast-broadcast services".
- [44] ITU-T Recommendation E.164: "The international public telecommunication numbering plan".
- [45] 3GPP TS 23.380: "IMS Restoration Procedures".
- [46] 3GPP TS 32.255: "Telecommunication management; Charging management; 5G data connectivity domain charging; Stage 2".
- [47] 3GPP TS 29.514: "5G System; Policy Authorization Service; Stage 3".
- [48] 3GPP TS 23.540: "5G System; Technical realization of Service Based Short Message Service; Stage 2".
- [49] 3GPP TS 29.564: "5G System; User Plane Function Services; Stage 3".
- [50] 3GPP TS 33.310: "Network Domain Security (NDS); Authentication Framework (AF)".
- [51] 3GPP TS 29.536: "5G System; Network Slice Admission Control Services; Stage 3".

- [52] IETF RFC 7858: "Specification for DNS over Transport Layer Security (TLS)".
- [53] IETF RFC 8310: "Usage Profiles for DNS over TLS and DNS over DTLS".
- [54] IETF RFC 8094: "DNS over Datagram Transport Layer Security (DTLS)".

3 Definitions and abbreviations

3.1 Definitions

For the purposes of the present document, the terms and definitions given in 3GPP TR 21.905 [1] and the following apply. A term defined in the present document takes precedence over the definition of the same term, if any, in 3GPP TR 21.905 [1].

Canary Release: When an NF Instance is software upgraded, a canary release allows to have features incrementally tested by a small set of users, which can be targeted by geographic locations or user attributes (e.g., SUPI, PEI, ...). If a feature's performance is not satisfactory, then it can be rolled back without any adverse effects on the rest of the system.

3.2 Abbreviations

For the purposes of the present document, the abbreviations given in 3GPP TR 21.905 [1] and the following apply. An abbreviation defined in the present document takes precedence over the definition of the same abbreviation, if any, in 3GPP TR 21.905 [1].

5GC	5G Core Network
CEF	Charging Enablement Function
CH	Credentials Holder
CHF	Charging Function
DCS	Default Credentials Server
DCSF	Data Channel Signaling Function
IPUPS	Inter-PLMN User Plane Security
MBS	Multicast/Broadcast Service
MB-SMF	Multicast/Broadcast Session Management Function
NF	Network Function
NRF	NF Repository Function
NWDAF	Network Data Analytics Function
PFD	Packet Flow Description
PRU	Positioning Reference Unit
SNPN	Stand-alone Non-Public Network
SSM	Source Specific IP Multicast (address)
TNGF	Trusted Non-3GPP Gateway Function
TSCTSF	Time Sensitive Communication and Time Synchronization Function
TWIF	Trusted WLAN Interworking Function
W-AGF	Wireline Access Gateway Function

4 Overview

The Network Function (NF) Repository Function (NRF) is the network entity in the 5G Core Network (5GC) supporting the following functionality:

- Maintains the NF profile of available NF instances and their supported services;
- Maintains the SCP profile of available SCP instances;
- Maintains the SEPP profile of available SEPP instances;

- Allows other NF or SCP instances to subscribe to, and get notified about, the registration in NRF of new NF instances of a given type or of SEPP instances. It also allows SCP instances to subscribe to, and get notified about, the registration in NRF of new SCP instances;
- Supports service discovery function. It receives NF Discovery Requests from NF or SCP instances, and provides the information of the available NF instances fulfilling certain criteria (e.g., supporting a given service);
- Support SCP discovery function. It receives NF Discovery Requests for SCP profiles from other SCP instances, and provides the information of the available SCP instances fulfilling certain criteria (e.g., serving a given NF set);
- Support SEPP discovery function. It receives NF Discovery Requests for SEPP profiles from other NF or SCP instances, and provides the information of the available SEPP instances fulfilling certain criteria (e.g. supporting connectivity with a remote PLMN).

Figure 4-1 shows the reference architecture for the 5GC, with focus on the NRF:

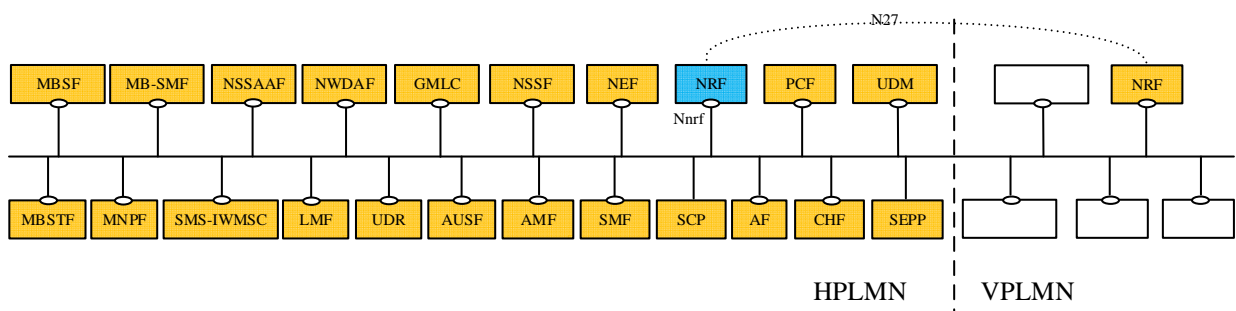

Figure 4-1: 5G System architecture

Figure 4-1 illustrates PLMN level scenarios, but this architecture is also applicable to the SNPN scenarios, as explained below.

For the sake of clarity, the NRF is never depicted in reference point representation figures, given that the NRF interacts with every other NF in the 5GC. As an exception, in the roaming case, the reference point between the vNRF and the hNRF is named as N27. The reference point name of N27 is used only for representation purposes, but its functionality is included in the services offered by the Nnrf Service-Based Interface.

In the case of SNPN, the NRF provides services e.g. in the following scenarios:

- For a SNPN for which roaming is not supported (see 3GPP TS 23.501 [2], clause 5.30.2.0);
- For the case of UE access to SNPN using credentials from Credentials Holder (see 3GPP TS 23.501 [2], clause 5.30.2.9);
- For the case of Onboarding of UEs for SNPNS (see 3GPP TS 23.501 [2], clause 5.30.2.10).

5 Services Offered by the NRF

5.1 Introduction

The NRF offers to other NFs the following services:

- Nnrf_NFManagement
- Nnrf_NFDiscovery
- Nnrf_AccessToken (OAuth2 Authorization)
- Nnrf_Bootstrapping

Table 5.1-1 summarizes the corresponding APIs defined for this specification.

Table 5.1-1: API Descriptions

Service Name	Clause	Description	OpenAPI Specification File	apiName	Annex
Nnrf_NFManagement	6.1	NRF NFManagement Service	TS29510_Nnrf_NFManagement.yaml	nnrf-nfm	A.2
Nnrf_NFDiscovery	6.2	NRF NFDiscovery Service	TS29510_Nnrf_NFDiscovery.yaml	nnrf-disc	A.3
Nnrf_AccessToken	6.3	NRF OAuth2 Authorization	TS29510_Nnrf_AccessToken.yaml		A.4
Nnrf_Bootstrapping	6.4	NRF Bootstrapping	TS29510_Nnrf_Bootstrapping.yaml		A.5

NRF provides services to the following SNPN scenarios (see clauses 4.17.4a, 4.17.5a, 5.2.7.2 and 5.2.7.3 in 3GPP TS 23.502 [3]):

- In a SNPN where roaming is not supported, which corresponds to the NRF services in the same PLMN;
- In the case of UE access to SNPN using credentials from Credentials Holder with AAA-S, which corresponds to the NRF services in the same PLMN;
- In the case of UE access to SNPN using credentials from Credentials Holder with AUSF and UDM, which corresponds to the NRF services across different PLMNs;
- In the case of Onboarding of UEs for SNPNs without using Default Credentials Server, which corresponds to the NRF services in the same PLMN;
- In the case of Onboarding of UEs for SNPNs using Default Credentials Server with AAA-S, which corresponds to the NRF services in the same PLMN;
- In the case of Onboarding of UEs for SNPNs using Default Credentials Server with AUSF and UDM, which corresponds to the NRF services across different PLMNs.

5.2 Nnrf_NFManagement Service

5.2.1 Service Description

The Nnrf_NFManagement service allows an NF, SCP or SEPP Instance in the serving PLMN to register, update or deregister its profile in the NRF.

If the "Shared-Data-Registration" feature is supported, the registered, updated or deregistered profile may contain shared data IDs. The corresponding shared data are either locally configured at the NRF by means of OAM, or are registered, updated or deregistered by the NF. In deployments where shared data are locally configured at the NRF by means of OAM support of shared data registration, update and deletion by means of the Nnrf_NFManagement service is not a required part of the "Shared-Data-Registration" feature.

NOTE: Shared Data can be used e.g. by NFs belonging to an NF Set to optimize Nnrf signalling. Alternatively, other means such as OA&M can also be used to register, update or deregister shared data belonging or not belonging to an NF Set in the NRF.

If the "Shared-Data-Retrieval" feature is supported, it allows consumers to retrieve shared data, subscribe and unsubscribe to shared data modification notifications and get notified when shared data are modified.

The Nnrf_NFManagement service also allows an NRF Instance to register, update or deregister its profile in another NRF in the same PLMN.

NOTE: Alternatively, other means such as OA&M can also be used to register, update or deregister NRF profile in another NRF.

It also allows an NF or an SCP to subscribe to be notified of registration, deregistration and profile changes of NF Instances, along with their potential NF services, or of SEPP instances. It also enables an SCP to subscribe to be notified of registration, deregistration and profile changes of other SCP instances.

The NF profile consists of general parameters of the NF Instance, and also the parameters of the different NF Service Instances exposed by the NF Instance, if applicable.

The PLMN of the NRF may comprise one or multiple PLMN IDs (i.e. MCC and MNC). An NRF configured with multiple PLMN IDs shall support registering, updating and deregistering the profile of Network Function Instances from any of these PLMN IDs.

The Nnrf_NFManagement service also allows retrieving a list of NF, SCP or SEPP Instances currently registered in the NRF or the NF Profile of a given NF, SCP or SEPP Instance.

The Nnrf_NFManagement service also allows checking whether the registered NFs, SCPs and SEPPs are operative.

5.2.2 Service Operations

5.2.2.1 Introduction

The services operations defined for the Nnrf_NFManagement service are as follows:

- **NFRegister:** It allows an NF, SCP or SEPP Instance to register its profile in the NRF; it includes the registration of the general parameters of the NF, SCP or SEPP Instance, together with the list of potential services exposed by the NF Instance. This service operation is not allowed to be invoked from an NRF in a different PLMN. If the "Shared-Data-Registration" feature is supported, the registered profile may contain shared data Ids identifying shared data, and the operation also allows consumers to register shared data in the NRF. In deployments where shared data are locally configured at the NRF by means of OAM, support of shared data registration by means of the Nnrf_NFManagement service is not a required part of the "Shared-Data-Registration" feature.
- **NFUpdate:** It allows an NF, SCP or SEPP Instance to replace, or update partially, the parameters of its profile (including the parameters of the associated services, if any) in the NRF; it also allows to add or delete individual services offered by the NF Instance. This service operation is not allowed to be invoked from an NRF in a different PLMN. If the "Shared-Data-Registration" feature is supported, it also allows consumers to update shared data in the NRF. In deployments where shared data are locally configured at the NRF by means of OAM, support of shared data update by means of the Nnrf_NFManagement service is not a required part of the "Shared-Data-Registration" feature.
- **NFDeregister:** It allows an NF, SCP or SEPP Instance to deregister its profile in the NRF, including the services offered by the NF Instance, if any. This service operation is not allowed to be invoked from an NRF in a different PLMN. If the "Shared-Data-Registration" feature is supported, it also allows consumers to deregister shared data in the NRF. In deployments where shared data are locally configured at the NRF by means of OAM, support of shared data de-registration by means of the Nnrf_NFManagement service is not a required part of the "Shared-Data-Registration" feature.
- **NFStatusSubscribe:** It allows an NF or SCP Instance to subscribe to changes on the status of NF or SEPP Instances registered in NRF. It also allows an SCP Instance to subscribe to changes on the status of other SCP Instances registered in NRF. This service operation can be invoked by an NF Instance in a different PLMN (via the local NRF in that PLMN) for changes on the status of NF Instances. It cannot be invoked by an SCP instance in a different PLMN. For changes on the status of SEPP Instance, this operation can only be invoked between the NRF and an NF Instance or SCP in the same PLMN. If the "Shared-Data-Retrieval" feature is supported, it also allows NF service consumers to create or update subscriptions to shared data change notifications in the NRF.
- **NFStatusNotify:** It allows the NRF to notify subscribed NF or SCP Instances of changes on the status of NF or SEPP Instances. It also allows the NRF to notify subscribed SCP Instances of changes on the status of SCP Instances. This service operation can be invoked directly between the NRF and an NF Instance in a different PLMN (without involvement of the local NRF in that PLMN) for changes on the status of NF Instances. It cannot be invoked between the NRF and an SCP instance in a different PLMN. For changes on the status of SEPP Instance, this operation can only be invoked between the NRF and an NF Instance or SCP in the same

PLMN.

If the "Shared-Data-Retrieval" feature is supported, it also allows NF service consumers to be notified of the shared data changes in the NRF.

- NFStatusUnsubscribe: It allows an NF or SCP Instance to unsubscribe to changes on the status of NF or SEPP Instances registered in NRF. It also allows an SCP Instance to unsubscribe to changes on the status of other SCP Instances registered in NRF. This service operation can be invoked by an NF Instance in a different PLMN (via the local NRF in that PLMN) for changes on the status of NF Instances. It cannot be invoked by an SCP instance in a different PLMN. For changes on the status of SEPP Instance, this operation can only be invoked between the NRF and an NF Instance or SCP in the same PLMN.

If the "Shared-Data-Retrieval" feature is supported, it also allows NF service consumers to delete subscriptions to shared data change notifications in the NRF.

NOTE 1: The "change of status" of the NFStatus service operations can imply a request to be notified of newly registered NF, SCP or SEPP Instances in NRF, or to be notified of profile changes of a specific NF, SCP or SEPP Instance, or to be notified of the deregistration of an NF, SCP or SEPP Instance.

NOTE 2: An NRF instance can also use the NFRegister, NFUpdate or NFDeregister service operations or OA&M system to register, update or deregister its profile in another NRF in the same PLMN.

- NFListRetrieval: It allows retrieving a list of NFs, SCPs and SEPPs currently registered in the NRF. This service operation is not allowed to be invoked from an NRF in a different PLMN.
- NFProfileRetrieval: It allows retrieving the profile of a given NF, SCP or SEPP instance. This service operation is not allowed to be invoked from an NRF in a different PLMN.
- SharedDataRetrieval: If the "Shared-Data-Retrieval" feature is supported, it allows NF service consumers to retrieve shared data from the NRF

The NFStatusSubscribe / NFStatusNotify / NFStatusUnsubscribe operations can be invoked by an NF Service Consumer (i.e., "source NF" or "SCP") requesting to be notified about events (registration, deregistration, profile change) related to an NF instance (i.e., "target NF") located in the same PLMN, or in a different PLMN, or related to a SEPP instance located in the same PLMN. An SCP can also invoke these operations to be notified about events (registration, deregistration, profile change) related to an SCP instance or SEPP instance located in the same PLMN.

In the description of these operations in clauses 5.2.2.5, 5.2.2.6 and 5.2.2.7, when the NF instances are located in the same PLMN, both source NF and target NF are said to be located in the "Serving PLMN" but, in the general case, the functionality is not restricted to the PLMN that is serving a given UE, and it shall be applicable as well to any scenario in which source NF and target NFs belong to the same PLMN.

When source NF and target NF are located in different PLMNs, the source NF is said to be in the "Serving PLMN", and the target NF (and the NRF where such NF is registered) is said to be in the "Home PLMN", similarly to the scenarios described in 3GPP TS 23.502 [3], but the functionality shall be equally applicable to any scenario between any pair of PLMNs (e.g. with the source NF in the Home PLMN and the target NF in the Serving PLMN).

The SCP and SEPP are treated by the Nnrf_NFManagement service in the same way as NFs. Specifically, the SCP and SEPP are designated with a specific NF type and NF Instance ID. However, the SCP and SEPP do not support services. Accordingly, references to "NF" or "NF Profile" in the description of the service operations in the following clauses also apply to an SCP and SEPP.

An NRF may be part of an NRF set, whereby all NRF instances of the NRF Set share the same context data (e.g. registered NF profiles, NF status subscriptions). If so:

- the NF Service Consumer may be configured with the NRF Set ID or it may discover the same in the NRF Bootstrapping response.
- The NF Service Consumer may register with any of the NRF Instance of the NRF Set. If the NRF instance where an NF Service Consumer registered is down, the NF Service Consumer needs not re-register to any new NRF instance within the NRF Set.
- The NRF may provide a binding indication to the NF service consumer, e.g. when the NF Service Consumer registers or updates its NF profile in the NRF or when it issues heartbeat requests, to indicate a preferred binding of the NF Service Consumer to one NRF instance within the NRF set, e.g. based on the location or data center of the registering/registered NF Service Consumer.

NOTE 3: The NF Service Consumer can retrieve the NRF Set Information from the NRF via the Nnrf_NFDiscovery service as specified in clause 5.3.2.1.

5.2.2.2 NFRegister

5.2.2.2.1 General

This service operation is used:

- to register an NF in the NRF by providing the NF profile of the requesting NF to the NRF, and the NRF marks the requesting NF as available to be discovered by other NFs;
- to register services associated to an existing NF Instance;
- to register NRF information in another NRF, and this information is used for forwarding or redirecting service discovery request.

If the "Shared-Data-Registration" feature is supported, this service operation is also used in deployments where shared data are not locally configured at the NRF:

- to provide shared data to the NRF.

5.2.2.2.2 NF (other than NRF) registration to NRF

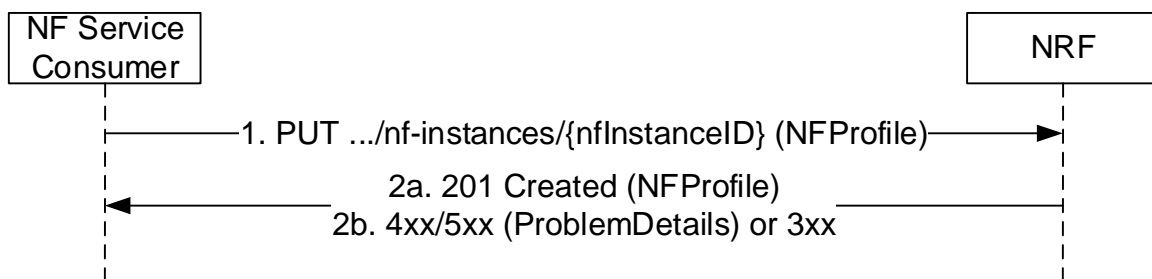

Figure 5.2.2.2.2-1: NF Instance Registration

1. The NF Service Consumer shall send a PUT request to the resource URI representing the NF Instance. The URI is determined by the NF Instance. The variable {nfInstanceID} represents an identifier, provided by the NF Service Consumer that shall be globally unique inside the PLMN of the NRF where the NF is being registered. The format of the NF Instance ID shall be a Universally Unique Identifier (UUID) version 4, as described in IETF RFC 4122 [18].

The UUIDs in URIs, HTTP request content and HTTP response content should be formatted using lower-case hexadecimal digits; if the NF Service Consumer sends a request where the UUIDs are formatted with upper-case hexadecimal letters, the NRF shall handle it as if the request had been formatted with lower-case characters.

EXAMPLE: UUID version 4: "4947a69a-f61b-4bc1-b9da-47c9c5d14b64"

The content of the PUT request shall contain a representation of the NF Instance to be created.

- 2a. On success, "201 Created" shall be returned, the content of the PUT response shall contain the representation of the created resource and the "Location" header shall contain the URI of the created resource. Additionally, the NRF returns a "heart-beat timer" containing the number of seconds expected between two consecutive heart-beat messages from an NF Instance to the NRF (see clause 5.2.2.3.2). The representation of the created resource may be a complete NF Profile or a NF Profile just including the mandatory attributes of the NF Profile and the attributes which the NRF added or changed (see Annex B).

2b. On failure or redirection:

- If the registration of the NF instance fails at the NRF due to errors in the encoding of the NFProfile JSON object, the NRF shall return "400 Bad Request" status code with the ProblemDetails IE providing details of the error.

- If the registration of the NF instance fails at the NRF due to unknown Shared Data IDs received in the NFProfile, the NRF shall return "400 Bad Request" status code with the ProblemDetails IE providing details of the error. The Application Error SHARED_DATA_ID_UNKNOWN shall be used by NRFs that are deployed without shared data being locally configured by means of OAM. In this case the unknown shared data IDs shall be conveyed together with the ProblemDetails IE to the NF service consumer. The NF service consumer may then register the unknown shared data at the NRF and retry registering. The Application Error SHARED_DATA_NOT_CONFIGURED shall be used by NRFs that are deployed with local configuration of shared data by means of OAM. The NF service consumer may retry registering without making use of shared data IDs in the NF Profile, or the registration is unsuccessful due to network misconfiguration.
- If the registration of the NF instance fails at the NRF due to NRF internal errors, the NRF shall return "500 Internal Server Error" status code with the ProblemDetails IE providing details of the error.
- In the case of redirection, the NRF shall return 3xx status code, which shall contain a Location header with an URI pointing to the endpoint of another NRF service instance.

The NRF shall allow the registration of a Network Function instance with any of the NF types described in clause 6.1.6.3.3, and it shall also allow registration of Network Function instances with custom NF types (e.g., NF type values not defined by 3GPP, or NF type values not defined by this API version).

NOTE 1: When registering a custom NF in NRF, it is recommended to use a NF type name that prevents collisions with other custom NF type names, or with NF types defined in the future by 3GPP. E.g., prefixing the custom NF type name with the string "CUSTOM_".

During the registration of a Network Function instance with a custom NF type, the NF instance may provide NF-specific data (in the "customInfo" attribute), that shall be stored by the NRF as part of the NF profile of the NF instance.

The NRF shall accept the registration of NF Instances containing Vendor-Specific attributes (see 3GPP TS 29.500 [4], clause 6.6.3), and therefore, it shall accept NF Profiles containing attributes whose type may be unknown to the NRF, and those attributes shall be stored as part of the NF's profile data in NRF.

Before an NF Instance registers its NF Profile in NRF, the NF Instance should check the capabilities of the NRF by issuing an OPTIONS request to the "nf-instances" resource (see clause 6.1.3.2.3.2), unless the NF Instance already sent a Bootstrapping Request to the NRF and received the nrfFeatures attribute in the response. The NRF may indicate in the response capabilities such as the support of receiving compressed content in the HTTP PUT request used for registration of the NF Profile, or support of specific attributes of the NF Profile.

NOTE 2: A Rel-16 NF needs to register the list of NF Service Instances in the "nfServices" array attribute towards an NRF not supporting the Service-Map feature (i.e. a Rel-15 NRF).

5.2.2.2.3 NRF registration to another NRF

The procedure specified in clause 5.2.2.2.2 applies. Additionally:

- a) the registering NRF shall set the nfType to "NRF" in the nfProfile;
- b) the registering NRF shall set the nfService to contain "nrf-disc", "nrf-nfm" and optionally "nrf-oauth2" in the nfProfile;
- c) the registering NRF may include nrfInfo which contains the information of e.g. udrInfo, udmInfo, ausfInfo, amfInfo, smfInfo, upfInfo, pcfInfo, bsfInfo, nefInfo, chfInfo, pscfInfo, lmfInfo, gmlcInfo, aanfInfo, nfInfo and nsacfInfo in the nfProfile locally configured in the NRF or the NRF received during registration of other NFs, this means the registering NRF is able to provide service for discovery of NFs subject to that information;
- d) if the NRF receives an NF registration with the nfType set to "NRF", the NRF shall use the information contained in the nfProfile to target the registering NRF when forwarding or redirecting NF service discovery request.

5.2.2.2.4 Shared Data registration to NRF

Support of this service operation is not required in deployments where shared data are locally configured at the NRF.

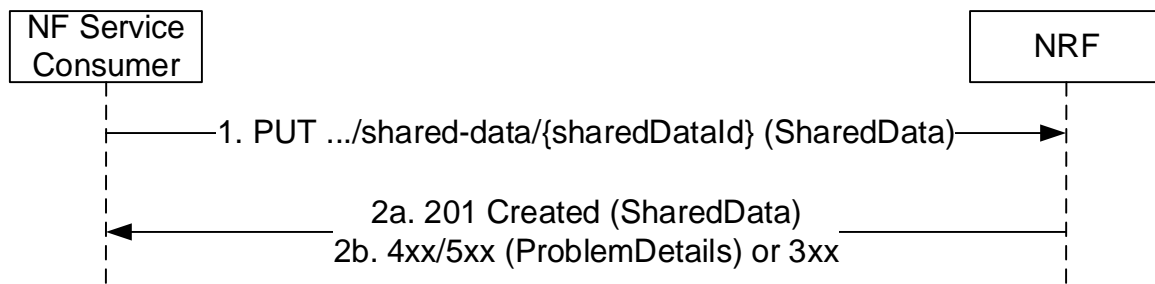

Figure 5.2.2.4-1: Shared Data Registration

1. If the feature "Shared-Data-Registration" is supported, the NF Service Consumer shall send a PUT request to the resource URI representing the Shared Data. The variable {sharedDataId} represents an identifier, provided by the NF Service Consumer that shall be globally unique inside the PLMN of the NRF where the NF is being registered. The format of the sharedDataId shall be a Universally Unique Identifier (UUID) version 4, as described in IETF RFC 4122 [18].

The UUIDs in URIs, HTTP request content and HTTP response content should be formatted using lower-case hexadecimal digits; if the NF Service Consumer sends a request where the UUIDs are formatted with upper-case hexadecimal letters, the NRF shall handle it as if the request had been formatted with lower-case characters.

EXAMPLE: UUID version 4: "4947a69a-f61b-4bc1-b9da-47c9c5d14b64"

The content of the PUT request shall contain a representation of the SharedData to be created.

- 2a. On success, "201 Created" shall be returned, the content of the PUT response shall contain the representation of the created resource and the "Location" header shall contain the URI of the created resource.
- 2b. On failure or redirection:
 - If the registration of the Shared Data fails at the NRF due to errors in the encoding of the SharedData JSON object, the NRF shall return "400 Bad Request" status code with the ProblemDetails IE providing details of the error.
 - If the Shared Data is not authorized with write access to the requesting NF (e.g. the Shared Data is shared to one specific NF Set while the requesting NF is not in that NF Set), the NRF shall return "403 Forbidden" status code with the ProblemDetails IE providing details of the error.
 - If the registration of the Shared Data fails at the NRF due to NRF internal errors, the NRF shall return "500 Internal Server Error" status code with the ProblemDetails IE providing details of the error.
 - In the case of redirection, the NRF shall return 3xx status code, which shall contain a Location header with an URI pointing to the endpoint of another NRF service instance.

5.2.2.3 NFUpdate

5.2.2.3.1 General

This service operation updates the profile of a Network Function previously registered in the NRF by providing the updated NF profile of the requesting NF to the NRF. The update operation may apply to the whole profile of the NF (complete replacement of the existing profile by a new profile), or it may apply only to a subset of the parameters of the profile (including adding/deleting/replacing services to the NF profile).

If the feature "Shared-Data-Registration" is supported, this service operation may be used to update Shared Data previously created in the NRF by providing the updated shared data to the NRF. The update operation may apply to the whole shared data (complete replacement), or it may apply only to a subset of parameters of the shared data.

5.2.2.3.1A NF Profile Complete replacement

To perform a complete replacement of the NF Profile of a given NF Instance, the NF Service Consumer shall issue an HTTP PUT request, as shown in Figure 5.2.2.3.1A-1:

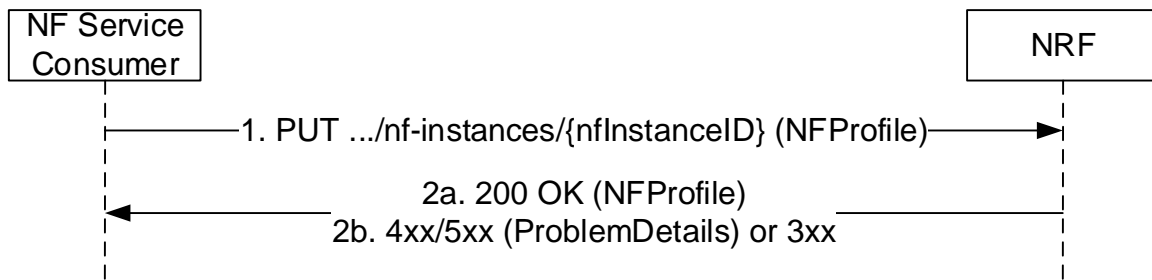

Figure 5.2.2.3.1A-1: NF Profile Complete Replacement

1. The NF Service Consumer shall send a PUT request to the resource URI representing the NF Instance. The content of the PUT request shall contain a representation of the NF Instance to be completely replaced in the NRF.
- 2a. On success, "200 OK" shall be returned, the content of the PUT response shall contain the representation of the replaced resource. The representation of the replaced resource may be a complete NF Profile or a NF Profile just including the mandatory attributes of the NF Profile and the attributes which the NRF added or changed (see Annex B).
- 2b. On failure or redirection:
 - If the update of the NF instance fails at the NRF due to errors in the encoding of the NFProfile JSON object, the NRF shall return "400 Bad Request" status code with the ProblemDetails IE providing details of the error.
 - If the update of the NF instance fails at the NRF due to NRF internal errors, the NRF shall return "500 Internal Server Error" status code with the ProblemDetails IE providing details of the error.
 - In the case of redirection, the NRF shall return 3xx status code, which shall contain a Location header with an URI pointing to the endpoint of another NRF service instance.

5.2.2.3.1B NF Profile Partial Update

To perform a partial update of the NF Profile of a given NF Instance, the NF Service Consumer shall issue an HTTP PATCH request, as shown in Figure 5.2.2.3.1B-2. This partial update shall be used to add/delete/replace individual parameters of the NF Instance, and also to add/delete/replace any of the services (and their parameters) offered by the NF Instance.

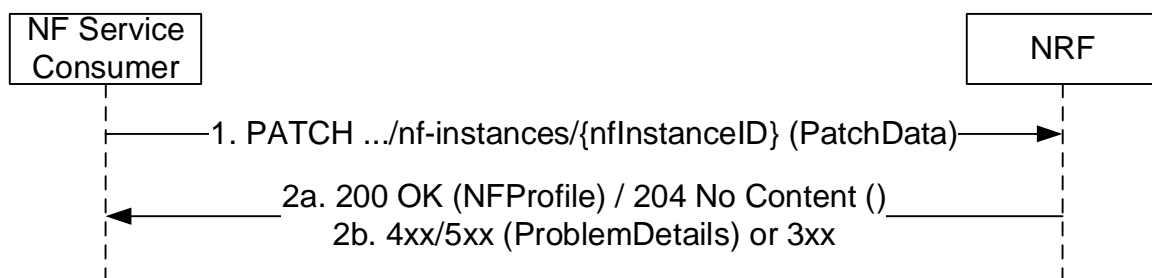

Figure 5.2.2.3.1B-2: NF Profile Partial Update

1. The NF Service Consumer shall send a PATCH request to the resource URI representing the NF Instance. The content of the PATCH request shall contain the list of operations (add/delete/replace) to be applied to the NF Profile of the NF Instance; these operations may be directed to individual parameters of the NF Profile or to the list of services (and their parameters) offered by the NF Instances. In order to leave the NF Profile in a consistent state, all the operations specified by the PATCH request body shall be executed atomically.

The NF Service Consumer should include a "If-Match" HTTP header carrying the latest entity-tag received from NRF for the NF profile to which the PATCH document shall be applied.

- 2a. On success, if all update operations are accepted by the NRF, "204 No Content" should be returned; the NRF may instead return "200 OK" with the content of the PATCH response containing the representation of the replaced resource. The representation of the replaced resource may be a complete NF Profile or a NF Profile just

including the mandatory attributes of the NF Profile and the attributes which the NRF added or changed (see Annex B).

2b. On failure or redirection:

- If the NF Instance, identified by the "nfInstanceID", is not found in the list of registered NF Instances in the NRF's database, the NRF shall return "404 Not Found" status code with the ProblemDetails IE providing details of the error.
- In the case of redirection, the NRF shall return 3xx status code, which shall contain a Location header with an URI pointing to the endpoint of another NRF service instance.
- If "If-Match" header is received with an entity tag different from the entity-tag in NRF for NF profile of the target NF instance, the NRF shall return "412 Precondition Failed" status code with the ProblemDetails IE providing details of the error.
- If no precondition was defined in the request and another confliction has been detected (e.g. to change value of a non-existing IE), the NRF shall return "409 Conflicting" status code with the ProblemDetails IE providing details of the error.

The NRF shall allow updating Vendor-Specific attributes (see 3GPP TS 29.500 [4], clause 6.6.3) that may exist in the NF Profile of a registered NF Instance.

5.2.2.3.1C Shared Data Complete replacement

Support of this service operation is not required in deployments where shared data are locally configured at the NRF.

Complete replacement of shared data is triggered by means of OA&M configuration actions. This action must be performed in a consistent way, i.e. at all NF Service Consumers that share the shared data. In addition, OA&M must ensure that only one NF Service Consumer conveys the complete replacement towards the NRF.

To perform a complete replacement of the Shared Data, the NF Service Consumer shall issue an HTTP PUT request, as shown in Figure 5.2.2.3.1C-1.

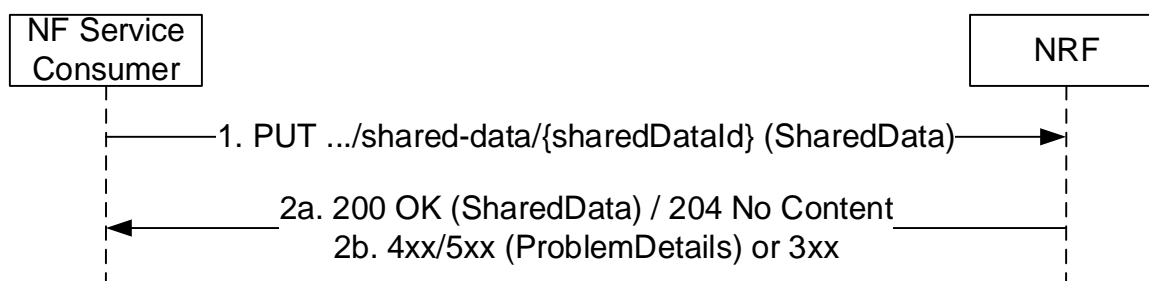

Figure 5.2.2.3.1C-1: Shared Data Complete Replacement

1. The NF Service Consumer shall send a PUT request to the resource URI representing the Shared Data. The content of the PUT request shall contain a representation of the Shared Data to be completely replaced in the NRF.
- 2a. On success, either "200 OK" shall be returned, the content of the PUT response shall contain the representation of the replaced resource, or "204 No Content" shall be returned.
- 2b. On failure or redirection:
 - If the update of the Shared Data fails at the NRF due to errors in the encoding of the SharedData JSON object, the NRF shall return "400 Bad Request" status code with the ProblemDetails IE providing details of the error.
 - If the Shared Data is not authorized with write access to the requesting NF (e.g. the Shared Data is shared to one specific NF Set while the requesting NF is not in that NF Set), the NRF shall return "403 Forbidden" status code with the ProblemDetails IE providing details of the error.
 - If the update of the Shared Data fails at the NRF due to NRF internal errors, the NRF shall return "500 Internal Server Error" status code with the ProblemDetails IE providing details of the error.

- In the case of redirection, the NRF shall return 3xx status code, which shall contain a Location header with an URI pointing to the endpoint of another NRF service instance.

5.2.2.3.1D Shared data Partial Update

Support of this service operation is not required in deployments where shared data are locally configured at the NRF.

Partial update of shared data is triggered by means of OA&M configuration actions. This action must be performed in a consistent way, i.e. at all NF Service Consumers that share the shared data. In addition, OA&M must ensure that only one NF Service Consumer conveys the partial update towards the NRF.

To perform a partial update of the Shared Data, the NF Service Consumer shall issue an HTTP PATCH request, as shown in Figure 5.2.2.3.1D-1. This partial update shall be used to add/delete/replace individual parameters of the Shared Data.

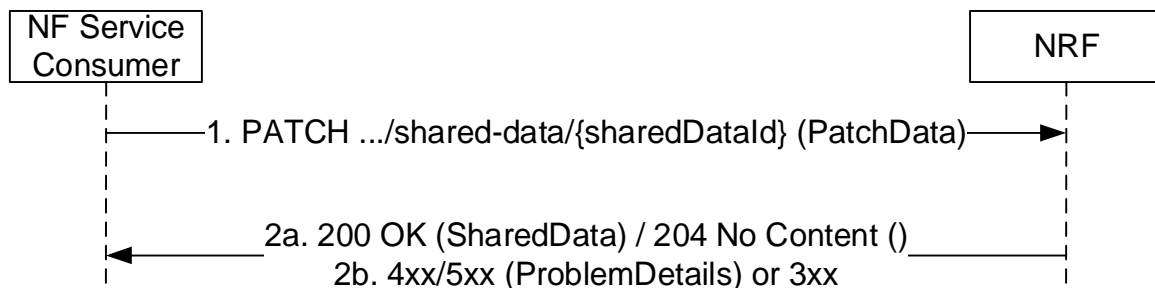

Figure 5.2.2.3.1D-1: Shared Data Partial Update

1. The NF Service Consumer shall send a PATCH request to the resource URI representing the Shared Data. The content of the PATCH request shall contain the list of operations (add/delete/replace) to be applied to the Shared Data; these operations may be directed to individual parameters of the Shared Data. In order to leave the Shared Data in a consistent state, all the operations specified by the PATCH request body shall be executed atomically.

The NF Service Consumer should include a "If-Match" HTTP header carrying the latest entity-tag received from NRF for the Shared Data to which the PATCH document shall be applied.

- 2a. On success, if all update operations are accepted by the NRF, "204 No Content" should be returned; the NRF may instead return "200 OK" with the content of the PATCH response containing the representation of the replaced resource.
- 2b. On failure or redirection:
 - If the Shared Data, identified by the "sharedDataId", is not found in the NRF's database, the NRF shall return "404 Not Found" status code with the ProblemDetails IE providing details of the error.
 - If the Shared Data is not authorized with write access to the requesting NF (e.g. the Shared Data is shared to one specific NF Set while the requesting NF is not in that NF Set), the NRF shall return "403 Forbidden" status code with the ProblemDetails IE providing details of the error.
 - In the case of redirection, the NRF shall return 3xx status code, which shall contain a Location header with an URI pointing to the endpoint of another NRF service instance.
 - If "If-Match" header is received with an entity tag different from the entity-tag in NRF for NF profile of the target NF instance, the NRF shall return "412 Precondition Failed" status code with the ProblemDetails IE providing details of the error.
 - If no precondition was defined in the request and another confliction has been detected (e.g. to change value of a non-existing IE), the NRF shall return "409 Conflicting" status code with the ProblemDetails IE providing details of the error.

5.2.2.3.2 NF Heart-Beat

Each NF that has previously registered in NRF shall contact the NRF periodically (heart-beat), by invoking the NFUpdate service operation, in order to show that the NF is still operative.

The time interval at which the NRF shall be contacted is deployment-specific, and it is returned by the NRF to the NF Service Consumer as a result of a successful registration.

When the NRF detects that a given NF has not updated its profile for a configurable amount of time (longer than the heart-beat interval), the NRF changes the status of the NF to SUSPENDED and considers that the NF and its services can no longer be discovered by other NFs via the NFDISCOVERY service. The NRF notifies NFs subscribed to receiving notifications of changes of the NF Profile that the NF status has been changed to SUSPENDED.

If the NRF modifies the heart-beat interval value of a given NF instance currently registered (e.g. as a result of an OA&M operation), it shall return the new value to the registered NF in the response of the next periodic heart-beat interaction received from that NF and, until then, the NRF shall apply the heart-beat check procedure according to the original interval value.

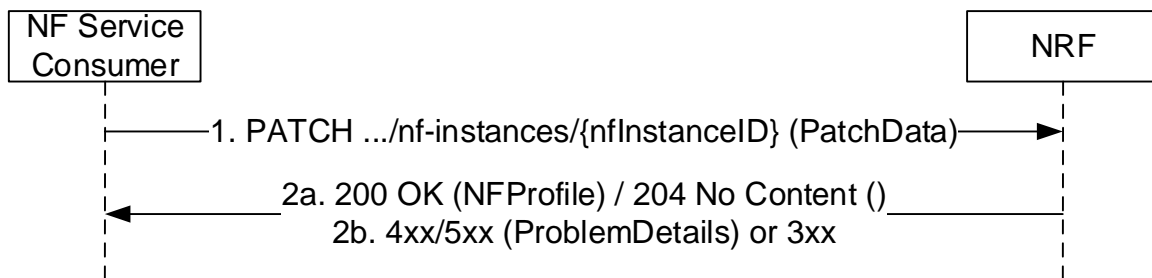

Figure 5.2.2.3.2-1: NF Heart-Beat

1. The NF Service Consumer shall send a PATCH request to the resource URI representing the NF Instance. The content of the PATCH request shall contain a "replace" operation on the "nfStatus" attribute of the NF Profile of the NF Instance, and set it to the value "REGISTERED" or "UNDISCOVERABLE".

In addition, the NF Service Consumer may also provide the load information of the NF, and/or the load information of the NF associated NF services. The provision of such load information may be limited by this NF via appropriate configuration (e.g. granularity threshold, load exceeds/falls below a certain threshold) in order to avoid notifying minor load changes.

The NF Service Consumer shall not include "If-Match" HTTP header in the Heart-Beat request if the request is not modifying any attribute in the NF profile.

- 2a. On success, the NRF should return "204 No Content"; the NRF may also answer with "200 OK" along with the full NF Profile, e.g. in cases where the NRF determines that the NF Profile has changed significantly since the last heart-beat, and wants to send the new profile to the NF Service Consumer (note that this alternative has bigger signalling overhead).

The NRF shall not generate a new entity tag for the NF profile in Heart-Beat operation if no attribute is modified.

- 2b. On failure or redirection:

- If the NF Instance, identified by the "nfInstanceId", is not found in the list of registered NF Instances in the NRF's database, the NRF shall return "404 Not Found" status code with the ProblemDetails IE providing details of the error.
- In the case of redirection, the NRF shall return 3xx status code, which shall contain a Location header with an URI pointing to the endpoint of another NRF service instance.

EXAMPLE:

```
PATCH .../nf-instances/4947a69a-f61b-4bc1-b9da-47c9c5d14b64
Content-Type: application/json-patch+json
```

```
[
  { "op": "replace", "path": "/nfStatus", "value": "REGISTERED" },
  { "op": "replace", "path": "/load", "value": 50 }
]
```

```
HTTP/2 204 No Content
```

Content-Location: .../nf-instances/4947a69a-f61b-4bc1-b9da-47c9c5d14b64

5.2.2.4 NFDeregister

5.2.2.4.1 General

This service operation removes the profile of a Network Function previously registered in the NRF.

If the "Shared-Data" feature is supported, this service operation removes the shared data previously registered in the NRF.

5.2.2.4.2 NF Instance Deregistration

It is executed by deleting a given resource identified by a "NF Instance ID". The operation is invoked by issuing a DELETE request on the URI representing the specific NF Instance.

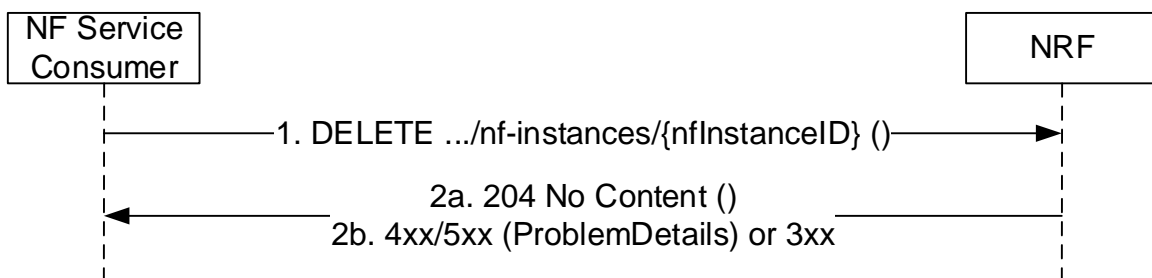

Figure 5.2.2.4.2-1: NF Instance Deregistration

1. The NF Service Consumer shall send a DELETE request to the resource URI representing the NF Instance. The request body shall be empty.
- 2a. On success, "204 No Content" shall be returned. The response body shall be empty.
- 2b. On failure or redirection:
 - If the NF Instance, identified by the "nfInstanceId", is not found in the list of registered NF Instances in the NRF's database, the NRF shall return "404 Not Found" status code with the ProblemDetails IE providing details of the error.
 - In the case of redirection, the NRF shall return 3xx status code, which shall contain a Location header with an URI pointing to the endpoint of another NRF service instance.

5.2.2.4.3 Shared Data Deregistration

Support of this service operation is not required in deployments where shared data are locally configured at the NRF.

It is executed by deleting a given resource identified by a "sharedDataId". The operation is invoked by issuing a DELETE request on the URI representing the specific Shared Data.

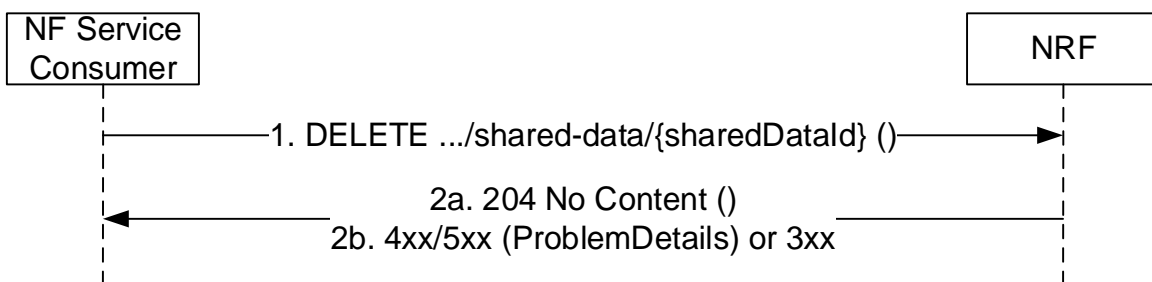

Figure 5.2.2.4.3-1: Shared Data Deregistration

1. The NF Service Consumer shall send a DELETE request to the resource URI representing the Shared Data. The request body shall be empty.
- 2a. On success, "204 No Content" shall be returned. The response body shall be empty.
- 2b. On failure or redirection:
 - If the Shared Data, identified by the "sharedDataId", is not found in the NRF's database, the NRF shall return "404 Not Found" status code with the ProblemDetails IE providing details of the error.
 - If the Shared Data is not authorized with write access to the requesting NF (e.g. the Shared Data is shared to one specific NF Set while the requesting NF is not in that NF Set), the NRF shall return "403 Forbidden" status code with the ProblemDetails IE providing details of the error.
 - In the case of redirection, the NRF shall return 3xx status code, which shall contain a Location header with an URI pointing to the endpoint of another NRF service instance.

5.2.2.5 NFStatusSubscribe

5.2.2.5.1 General

This service operation is used to:

- create a subscription so an NF Service Consumer can request to be notified when NF Instances of a given set, following certain filter criteria are registered/deregistered in NRF or when their profile is modified;
- create a subscription to a specific NF Instance so an NF Service Consumer can request to be notified when the profile of such NF Instance is modified or when the NF Instance is deregistered from NRF.

If the "Shared-Data-Retrieval" feature is supported, this service operation may also be used to create or update subscription to the shared NF profile changes in the NRF.

5.2.2.5.2 Subscription to NF Instances in the same PLMN

The subscription to notifications on NF Instances is executed creating a new individual resource under the collection resource "subscriptions". The operation is invoked by issuing a POST request on the URI representing the "subscriptions" resource.

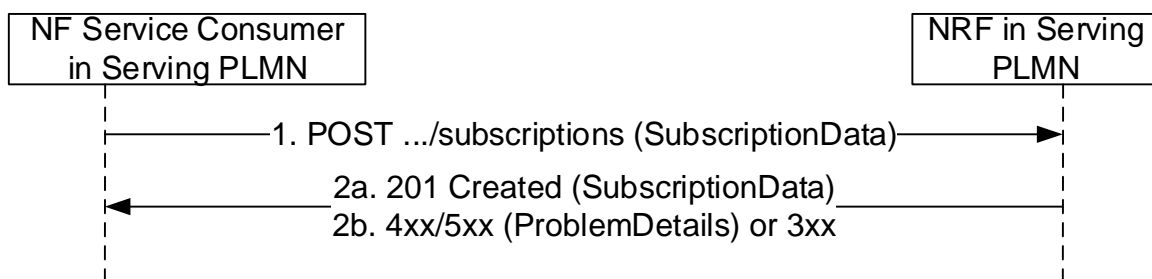

Figure 5.2.2.5.2-1: Subscription to NF Instances in the same PLMN

1. The NF Service Consumer shall send a POST request to the resource URI representing the "subscriptions" collection resource. The custom HTTP header "3gpp-Sbi-Notif-Accepted-Encoding", as defined in 3GPP TS 29.500 [4] clause 5.2.3.3.6, may be included to indicate the content-encodings supported by the NF Service Consumer receiving the notification.

The request body shall include the data indicating the type of notifications that the NF Service Consumer is interested in receiving; it also contains a callback URI, where the NF Service Consumer shall be prepared to receive the actual notification from the NRF (see NFStatusNotify operation in 5.2.2.6) and it may contain a validity time, suggested by the NF Service Consumer, representing the time span during which the subscription is desired to be kept active. When the NF Service Consumer creates multiple subscriptions in the NRF, it should use distinct callback URIs for each subscription.

The subscription request may also include additional parameters indicating the list of attributes (including Vendor-Specific attributes, see 3GPP TS 29.500 [4], clause 6.6.3) in the NF Profile to be monitored (or to be excluded from monitoring), in order to determine whether a notification from NRF should be sent, or not, when any of those attributes is changed in the profile.

The NF Service Consumer may request the creation of a subscription to a specific NF Instance, or to a set of NF Instances, where the set is determined according to different criteria specified in the request body, in the "subscrCond" attribute of the "SubscriptionData" object type (see clause 6.1.6.2.16).

The subscription shall be authorized, or rejected, by the NRF by checking the relevant input attributes (e.g. reqNFType, reqNFQdn, reqSnsais, reqPerPlmnSnsais, reqPlmnList, reqSnpnList, etc.) in the subscription request body (along with the contents of any optional OAuth2 access token provided in the API request) against the list of authorization attributes in the NF Profile of the target NF Instance to be monitored.

An SCP may request a subscription to the complete profile of NF Instances (including, e.g. the authorization attributes of the target NF Instances to be monitored). Upon receiving such a request, the NRF shall verify that the requesting entity is authorized to subscribe to the complete profile of NF instances, based on local policies or the receipt of an OAuth2 access token granting such permission. If the requesting entity is not authorized to do so, the NRF shall reject the request or handle it as a subscription request without access to the complete profile.

When the subscription request is for a set of NFs, the authorization attributes of the NF Instances in the set may differ, resulting in positive authorization of the subscription for only a part of the NF Instances in the set; in that case, the subscription to the set of NFs may be accepted by the NRF, but the NF Instances in the set that are not authorized for the NF Service Consumer that requested the subscription, shall not result in triggering any notification event from the NRF to the NF Service Consumer.

2a. On success, "201 Created" shall be returned. The response shall contain the data related to the created subscription, including the validity time, as determined by the NRF, after which the subscription becomes invalid. Once the subscription expires, if the NF Service Consumer wants to keep receiving status notifications, it shall create a new subscription in the NRF.

2b. On failure or redirection:

- If the creation of the subscription fails at the NRF due to errors in the SubscriptionData JSON object in the request body, the NRF shall return "400 Bad Request" status code with the ProblemDetails IE providing details of the error. E.g., the NRF may verify that the input attributes (e.g. reqNFType) in the subscription request match with the corresponding ones in, e.g. the public key certificate of the NF service consumer received during TLS initial handshake procedure (see 3GPP TS 33.310 [50]). If the verification is unsuccessful, the request shall be rejected with "400 Bad Request" status code and the "cause" attribute set to "INVALID_CLIENT".
- If the creation of the subscription fails at the NRF due to NRF internal errors, the NRF shall return "500 Internal Server Error" status code with the ProblemDetails IE providing details of the error.
- In the case of redirection, the NRF shall return 3xx status code, which shall contain a Location header with an URI pointing to the endpoint of another NRF service instance.

5.2.2.5.3 Subscription to NF Instances in a different PLMN

The subscription to notifications on NF Instances in a different PLMN is done by creating a resource under the collection resource "subscriptions", in the NRF of the Home PLMN.

For that, step 1 in clause 5.2.2.5.2 is executed (send a POST request to the NRF in the Serving PLMN); this request shall include the identity of the PLMN of the home NRF in the SubscriptionData parameter in the request body.

If the NRF in Serving PLMN knows that OAuth2-based authorization is required for accessing the NFManagement service of the NRF in Home PLMN, e.g. by learning this during an earlier Bootstrapping procedure or local configuration, and if the request received at the NRF in Serving PLMN does not include an access token, the NRF in Serving PLMN may reject the request with a 401 Unauthorized as specified in clause 6.7.3 of 3GPP TS 29.500 [4].

Then, steps 1-2 in Figure 5.2.2.5.3-1 are executed, between the NRF in the Serving PLMN and the NRF in the Home PLMN. In this step, the PLMN ID may be present in the SubscriptionData parameter. The NRF in the Home PLMN returns a subscriptionID identifying the created subscription.

Finally, step 2 in clause 5.2.2.5.2 is executed; a new subscriptionID shall be generated by the NRF in the Serving PLMN as indicated in step 2 of Figure 5.2.2.5.3-1, and shall be sent to the NF Service Consumer in the Serving PLMN.

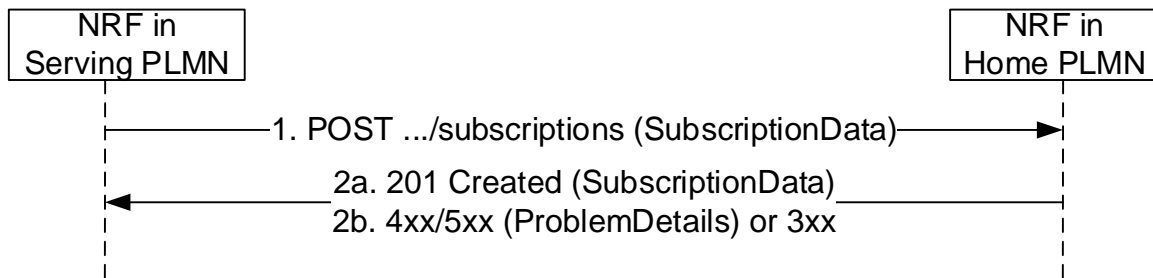

Figure 5.2.2.5.3-1: Subscription to NF Instances in a different PLMN

1. The NRF in Serving PLMN shall send a POST request to the resource URI in the NRF in Home PLMN representing the "subscriptions" collection resource. The request body shall include the SubscriptionData as received by the NRF in Serving PLMN from the NF Service Consumer in the Serving PLMN (see 5.2.2.5.2), containing the data about the type of notifications that the NF Service Consumer is interested in receiving and the callback URI where the NF Service Consumer shall be prepared to receive the notifications from the NRF (see NFStatusNotify operation in 5.2.2.6).
- 2a. On success, "201 Created" shall be returned. If the subscription is created in a different NRF in the HPLMN than the NRF in the HPLMN that receives the subscription request, the latter should include information in the subscriptionID (after the first 5 or 6 digits and "-") such as to be able to forward the subsequent subscription modification or deletion request it may receive from the NRF in the serving PLMN towards the NRF in the HPLMN holding the subscription. The information to be included in the subscriptionID is left to implementation.

If the Home NRF is located in a PLMN:

The NRF in Serving PLMN should not keep state for this created subscription and shall send to the NF Service Consumer in Serving PLMN (step 2 in 5.2.2.5.2) a subscriptionID that shall consist on the following structure:
 <MCC>+<MNC>+"-"+<OriginalSubscriptionID>

If the Home NRF is located in an SNPN:

<MCC>+<MNC>+"-"+"x3Lf57A"+":nid="+<NID>+"":<OriginalSubscriptionID>

NOTE: The fixed 7-character string "x3Lf57A" is used to prevent accidental collisions with subscription IDs generated according to earlier versions of this specification, where the subscription ID could only contain MCC and MNC values; this mechanism is commonly known as "magic cookie".

EXAMPLE 1: If the NRF in a Home PLMN (where MCC = 123, and MNC=456) creates a subscription with value "subs987654", the subscriptionID that the NRF in Serving PLMN would send to the NF Service Consumer in Serving PLMN is: "123456-subs987654"

EXAMPLE 2: If the NRF in an SNPN (where MCC = 321, MNC = 654 and NID = 023f245ac42) creates a subscription with value "subs987654", the subscriptionID that the NRF in Serving PLMN would send to the NF Service Consumer in Serving PLMN is:
 "321654-x3Lf57A:nid=023f245ac42:subs987654".

The URI in the Location header that the NRF in Serving PLMN returns to the NF Service Consumer in Serving PLMN shall contain a <subscriptionId> modified as described above and, if it is as an absolute URI, an apiRoot pointing to the address of the NRF in Serving PLMN. The subscriptionId attribute in the message body that the NRF in Serving PLMN returns to the NF Service Consumer in Serving PLMN shall also contain a <subscriptionId> modified as described above.

2b. On failure or redirection:

- If the creation of the subscription fails at the NRF due to errors in the SubscriptionData JSON object in the request body, the NRF shall return "400 Bad Request" status code with the ProblemDetails IE providing details of the error.

- If the creation of the subscription fails at the NRF due to NRF internal errors, the NRF shall return "500 Internal Server Error" status code with the ProblemDetails IE providing details of the error.
- In the case of redirection, the NRF shall return 3xx status code, which shall contain a Location header with an URI pointing to the endpoint of another NRF service instance.

5.2.2.5.4 Subscription to NF Instances with intermediate forwarding NRF

When multiple NRFs are deployed in one PLMN, an NF Instance can subscribe to changes of NF Instances registered in an NRF to which it is not directly interacting. The subscription message is forwarded by an intermediate NRF to which the subscribing NF instance is directly interacting.

For that, step 1 in clause 5.2.2.5.2 is executed (send a POST request to the NRF-1 in the Serving PLMN); this request shall include the SubscriptionData parameter in the request body.

Then, steps 1-4 in Figure 5.2.2.5.4-1 are executed between NF Service Consumer in Serving PLMN, NRF-1 in Serving PLMN and NRF-2 in Serving PLMN. In these steps, NRF-1 sends the subscription request to a pre-configured NRF-2. NRF-2 requests corresponding NRF (e.g. the NF Service Producer registered NRF) and returns a subscriptionID identifying the created subscription and this subscriptionID is sent to the NF Service Consumer via NRF-1.

Finally, step 2 in clause 5.2.2.5.2 is executed; the subscriptionID shall be sent to the NF Service Consumer.

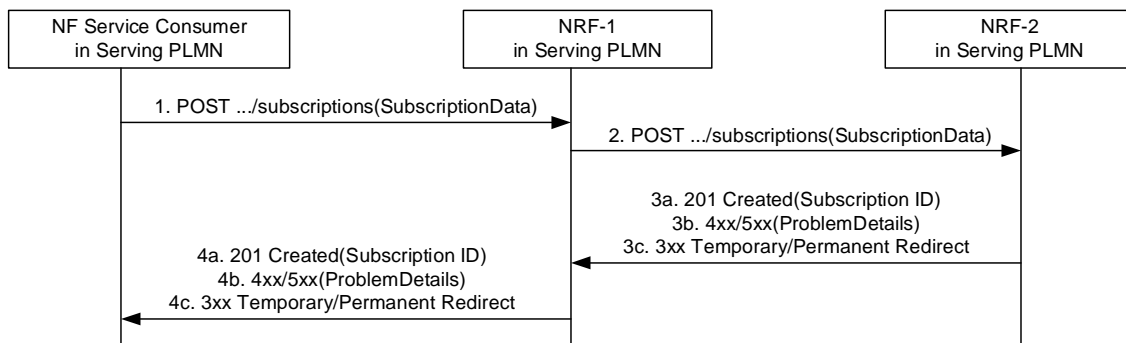

Figure 5.2.2.5.4-1: Subscription with intermediate forwarding NRF

1. NRF-1 receives a subscription request and sends the subscription request to a pre-configured NRF-2. This may for example include cases where NRF-1 does not have sufficient information as determined by the operator policy to fulfill the request locally.
2. Upon receiving a subscription request, based on the SubscriptionData contained in the subscription request (e.g. NF type) and locally stored information (see clause 5.2.2.2.3), NRF-2 shall identify the next hop NRF and forward the subscription request to that NRF (i.e. NF Service Producer registered NRF).
- 3a. On success, "201 Created" shall be returned by NRF-2.
- 3b. On failure, i.e. if the creation of the subscription fails, the NRF-2 shall return "4XX/5XX" response.
- 3c. In the case of redirection, the NRF shall return 3xx status code, which shall contain a Location header with an URI pointing to the endpoint of another NRF service instance.
- 4a. NRF-1 forwards the success response to NF Service Consumer. The content of the POST response shall contain the representation describing the status of the request and the "Location" header shall be present and shall contain the URI of the created resource. The authority and/or deployment-specific string of the apiRoot of the created resource URI may differ from the authority and/or deployment-specific string of the apiRoot of the request URI received in the POST request.
- 4b. On failure, NRF-1 forwards the error response to NF Service Consumer.
- 4c. In the case of redirection, the NRF shall return 3xx status code, which shall contain a Location header with an URI pointing to the endpoint of another NRF service instance.

5.2.2.5.5 Subscription to NF Instances with intermediate redirecting NRF

When multiple NRFs are deployed in one PLMN, an NF Instance can subscribe to changes of NF Instances registered in another NRF. The subscription message is redirected by a third NRF.

For that, step 1 in clause 5.2.2.5.2 is executed (send a POST request to the NRF-1 in the Serving PLMN); this request shall include the SubscriptionData parameter in the request body.

Then, steps 2-5 in Figure 5.2.2.5.5-1 are executed between NRF-1, NRF-2 and NRF-3.

Finally, step 2 in clause 5.2.2.5.2 is executed; the subscriptionID shall be sent to the NF Service Consumer.

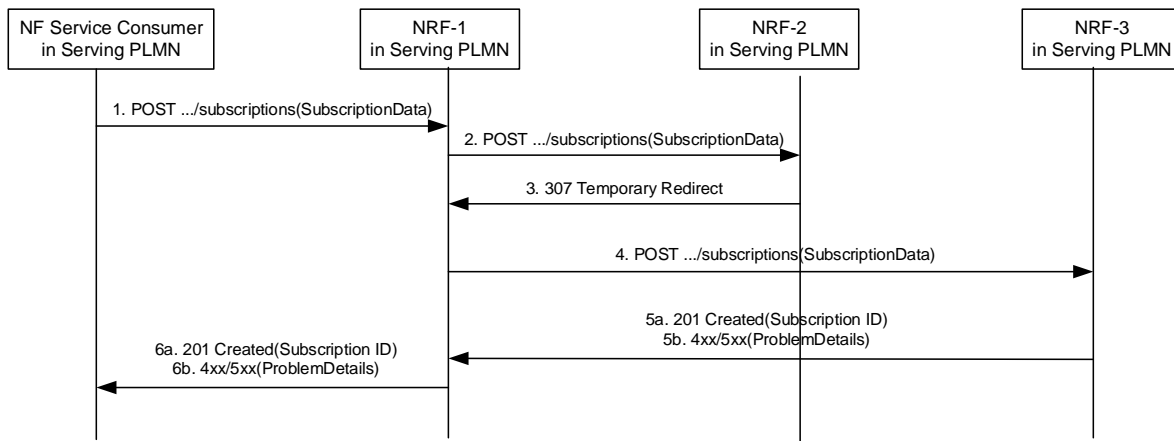

Figure 5.2.2.5.5-1: Subscription to NF Instances with intermediate redirecting NRF

1. NF Service Consumer send a subscription request to NRF-1.
2. NRF-1 receives a subscription request but does not have the information to fulfil the request. Then NRF-1 sends the subscription request to a pre-configured NRF-2.
3. Upon receiving a subscription request, based on the SubscriptionData contained in the subscription request (e.g.NF type) and locally stored information (see clause 5.2.2.2.3), NRF-2 shall identify the next hop NRF, and redirect the subscription request by returning HTTP 307 Temporary Redirect response.

The 307 Temporary Redirect response shall contain a Location header field, the host part of the URI in the Location header field represents NRF-3.

4. Upon receiving 307 Temporary Redirect response, NRF-1 sends the subscription request to NRF-3 by using the URI contained in the Location header field of the 307 Temporary Redirect response.
- 5a. On success, "201 Created" shall be returned by NRF-3.
- 5b. On failure, if the creation of the subscription fails at the NRF-3, the NRF-3 shall return "4XX/5XX" response.
- 6a. On success, "201 Created" shall be forwarded to NF Service Consumer via NRF-1. The content of the POST response shall contain the representation describing the status of the request and the "Location" header shall be present and shall contain the URI of the created resource. The authority and/or deployment-specific string of the apiRoot of the created resource URI may differ from the authority and/or deployment-specific string of the apiRoot of the request URI received in the POST request.
- 6b. On failure, if the creation of the subscription fails, "4XX/5XX" shall be forwarded to NF Service Consumer via NRF-1.

5.2.2.5.6 Update of Subscription to NF Instances

The subscription to notifications on NF Instances may be updated to refresh the validity time, when this time is about to expire. The NF Service Consumer may request a new validity time to the NRF, and the NRF shall answer with the new assigned validity time, if the operation is successful.

This operation is executed by updating the resource identified by "subscriptionID". It is invoked by issuing an HTTP PATCH request on the URI representing the individual resource received in the Location header field of the "201 Created" response received during a successful subscription (see clause 5.2.2.5).

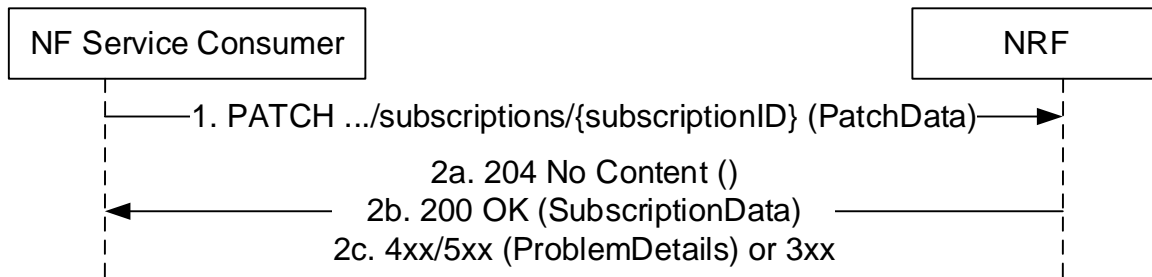

Figure 5.2.2.5.6-1: Subscription to NF Instances in the same PLMN

1. The NF Service Consumer shall send a PATCH request to the resource URI identifying the individual subscription resource. The content of the PATCH request shall contain a "replace" operation on the "validityTime" attribute of the SubscriptionData structure and shall contain a new suggested value for it; no other attribute of the resource shall be updated as part of this operation.
- 2a. On success, if the NRF accepts the extension of the lifetime of the subscription, and it accepts the requested value for the "validityTime" attribute, a response with status code "204 No Content" shall be returned.
- 2b. On success, if the NRF accepts the extension of the lifetime of the subscription, but it assigns a validity time different than the value suggested by the NF Service Consumer, a "200 OK" response code shall be returned. The response shall contain the new resource representation of the "subscription" resource, which includes the new validity time, as determined by the NRF, after which the subscription becomes invalid.
- 2c. On failure or redirection:
 - If the update of the subscription fails at the NRF due to errors in the JSON Patch object in the request body, the NRF shall return "400 Bad Request" status code with the ProblemDetails IE providing details of the error.
 - If the update of the subscription fails at the NRF due to NRF internal errors, the NRF shall return "500 Internal Server Error" status code with the ProblemDetails IE providing details of the error.
 - In the case of redirection, the NRF shall return 3xx status code, which shall contain a Location header with an URI pointing to the endpoint of another NRF service instance.

EXAMPLE:

```
PATCH .../subscriptions/2a58bf47
Content-Type: application/json-patch+json
```

```
[
  { "op": "replace", "path": "/validityTime", "value": "2018-12-30T23:20:50Z" },
]
```

```
HTTP/2 204 No Content
```

5.2.2.5.7 Update of Subscription to NF Instances in a different PLMN

The update of subscription in a different PLMN is done by updating a subscription resource identified by a "subscriptionID".

For that, step 1 in clause 5.2.2.5.6 is executed (send a PATCH request to the NRF in the Serving PLMN); this request shall include the identity of the PLMN or SNPN of the home NRF (MCC/MNC/NID values) as a component values of the subscriptionID.

Then, steps 1-2 in Figure 5.2.2.5.7-1 are executed, between the NRF in the Serving PLMN and the NRF in the Home PLMN. In this step, the subscriptionID sent to the NRF in the Home PLMN shall not contain the identity of the PLMN (i.e., it shall be the same subscriptionID value as originally generated by the NRF in the Home PLMN). The NRF in the Home PLMN returns a status code with the result of the operation.

If the subscription was created in a different NRF in the HPLMN than the NRF in the HPLMN that receives the subscription update request, the latter shall forward the request received from the NRF in the serving PLMN towards the NRF in the HPLMN holding the subscription, using the information included in the subscriptionID (see clause 5.2.2.5.3). The subscriptionID value in the request forwarded to the NRF in the HPLMN holding the subscription shall contain the same value as originally generated by the latter.

Finally, step 2 in clause 5.2.2.5.7-2 is executed; a status code is returned to the NF Service Consumer in Serving PLMN in accordance to the result received from NRF in the Home PLMN.

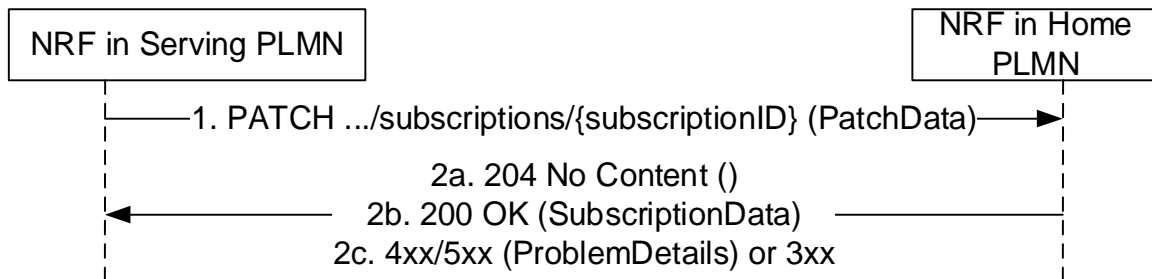

Figure 5.2.2.5.7-1: Update of Subscription to NF Instances in a different PLMN

1. The NRF in Serving PLMN shall send a PATCH request to the resource URI representing the individual subscription. The content of the PATCH request shall contain a "replace" operation on the "validityTime" attribute of the SubscriptionData structure and shall contain a new suggested value for it;
- 2a. On success, if the NRF in the Home PLMN accepts the extension of the lifetime of the subscription, and it accepts the requested value for the "validityTime" attribute, a response with status code "204 No Content" shall be returned.
- 2b. On success, if the NRF in the Home PLMN accepts the extension of the lifetime of the subscription, but it assigns a validity time different than the value suggested by the NF Service Consumer, a "200 OK" response code shall be returned. The response shall contain the new resource representation of the "subscription" resource, which includes the new validity time, as determined by the NRF in the Home PLMN, after which the subscription becomes invalid.
- 2c. On failure or redirection:
 - If the update of the subscription fails at the NRF due to errors in the JSON Patch object in the request body, the NRF shall return "400 Bad Request" status code with the ProblemDetails IE providing details of the error.
 - If the update of the subscription fails at the NRF due to NRF internal errors, the NRF shall return "500 Internal Server Error" status code with the ProblemDetails IE providing details of the error.
 - In the case of redirection, the NRF shall return 3xx status code, which shall contain a Location header with an URI pointing to the endpoint of another NRF service instance.

5.2.2.6 NFStatusNotify

5.2.2.6.1 General

This service operation notifies each NF Service Consumer that was previously subscribed to receiving notifications of registration/deregistration of NF Instances, or notifications of changes of the NF profile of a given NF Instance. The notification is sent to a callback URI that each NF Service Consumer provided during the subscription (see NFStatusSubscribe operation in 5.2.2.5).

If the "Shared-Data-Retrieval" feature is supported, this service operation may also be used to notify the shared data changes in the NRF.

5.2.2.6.2 Notification from NRF in the same PLMN

The operation is invoked by issuing a POST request to each callback URI of the different subscribed NF Instances.

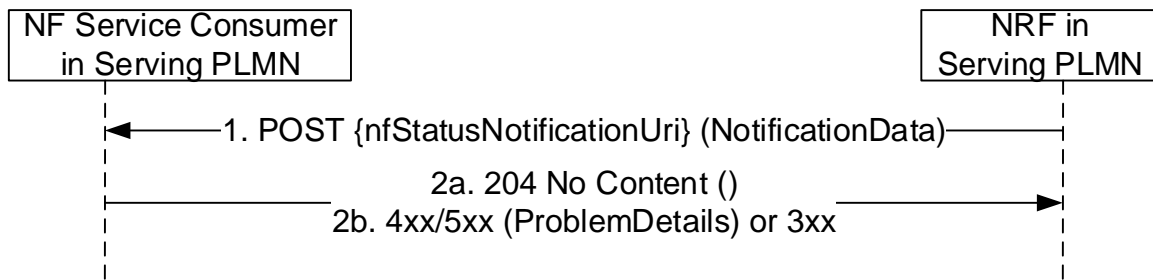

Figure 5.2.2.6.2-1: Notification from NRF in the same PLMN

1. The NRF shall send a POST request to the callback URI.

For notifications of newly registered NF Instances, the request body shall include the data associated to the newly registered NF, and its services, according to the criteria indicated by the NF Service Consumer during the subscription operation. These data shall contain the `nfInstanceURI` of the NF Instance, an indication of the event being notified ("registration"), and the new profile data (including, among others, the services offered by the NF Instance).

For notifications of changes of the profile of a NF Instance, the request body shall include the `NFInstanceID` of the NF Instance whose profile was changed, an indication of the event being notified ("profile change"), and the new profile data.

For notifications of deregistration of the NF Instance from NRF, the request body shall include the `NFInstanceID` of the deregistered NF Instance, and an indication of the event being notified ("deregistration").

NOTE: When the NF Instance changes its `NFStatus`, the NRF notifies subscribing entities with an "NF_PROFILE_CHANGED" event, except if the new `NFStatus` changes to "CANARY_RELEASE" and the subscribing entity does not support the "Canary-Release" feature (see clause 6.1.9); in such case, the NRF notifies the subscribing entities with an "NF_DEREGISTERED" event (see clause 6.1.6.3.6).

When an NF Instance is newly registered in NRF, the NRF notifies subscribing entities with an "NF_REGISTERED" event, except if such NF instance newly registers with status "CANARY_RELEASE" and the subscribing entity does not support the "Canary-Release" feature; in such case, the NRF does not send an "NF_REGISTERED" event to the subscribing entity.

When an NF Service Instance changes its `NFServiceStatus` to "CANARY_RELEASE", and the subscribing entity does not support the "Canary-Release" feature, the NRF sends a notification with an "NF_PROFILE_CHANGED" event that removes such NF Service Instance from the NF profile, so the subscribing entity can remove such instance from the list of available service instances of the corresponding NF producer.

When an NF Service Consumer subscribes to a set of NFs (using the different subscription conditions specified in clause 6.1.6.2.35), a change in the profile of the monitored NF Instance may result in such NF becoming a part of the NF set, or stops becoming a part of it (e.g., an NF Service Consumer subscribing to all NFs offering a given NF Service, and then, a certain NF Instance changes its profile by adding or removing an NF Service of its NF Profile); in such case, the NRF shall use the "NF_PROFILE_CHANGED" event type in the notification. Similarly, a change of the status (i.e. the "nfStatus" attribute of the NF Profile) shall result into the NRF to send notifications to subscribing NFs with event type set to "NF_PROFILE_CHANGED".

When an NF Service Consumer subscribes to a set of NFs, using the subscription conditions specified in clause 6.1.6.2.35, in case of a change of profile(s) of NFs potentially related to those subscription conditions, the NRF shall send notification to subscribing NF Service Consumer(s) to those NFs no longer matching the subscription conditions, and to subscribing NF Service Consumer(s) to NFs that start matching the subscription conditions. In that case, the NRF indicates in the notification data whether the notification is due to the NF Instance to newly start or stop matching the subscription condition (i.e. based on the presence of the "conditionEvent" attribute of the NotificationData).

The notification of changes of the profile may be done by the NRF either by sending the entire new NF Profile, or by indicating a number of "delta" changes (see clause 6.1.6.2.17) from an existing NF Profile that might have been previously received by the NF Service Consumer during an `NFDiscovery` search operation (see clause 5.3.2.2). If the NF Service Consumer receives "delta" changes related to an NF Service Instance (other than

adding a new NF Service Instance) that had not been previously discovered, those changes shall be ignored by the NF Service Consumer, but any other "delta" changes related to NF Service Instances previously discovered or adding a new NF Service Instance shall be applied.

Change of authorization attributes (allowedNfTypes, allowedNfDomains, allowedNssais, allowedPlmns etc) shall trigger a "NF_PROFILE_CHANGED" notification from NRF, if the change of the NF Profile results in that the NF Instance starts or stops being authorized to be accessed by an NF having subscribed to be notified about NF profile changes. In this case, the NRF indicates in the notification data whether the notification is due to the NF Instance to newly start or stop matching the subscription condition (i.e. based on the presence of the "conditionEvent" attribute of the NotificationData). Otherwise change of authorization attributes shall not trigger notification.

The notifications of new registrations, or updates of existing registrations, shall not include the content (or the changes) of the authorization attributes ("allowedXXX" attributes) of the target NF profile being monitored, unless the subscribing entity explicitly requested so, in the "completeProfileSubscription" attribute in the subscription request message, and the NRF authorized such a request.

2a. On success, "204 No content" shall be returned by the NF Service Consumer.

2b. On failure or redirection:

- If the NF Service Consumer does not consider the "nfStatusNotificationUri" as a valid notification URI (e.g., because the URI does not belong to any of the existing subscriptions created by the NF Service Consumer in the NRF), the NF Service Consumer shall return "404 Not Found" status code with the ProblemDetails IE providing details of the error.
- In the case of redirection, the NF service consumer shall return 3xx status code, which shall contain a Location header with an URI pointing to the endpoint of another NF service consumer endpoint.

5.2.2.6.3 Notification from NRF in a different PLMN

The operation is invoked by issuing a POST request to each callback URI of the different subscribed NF Instances.

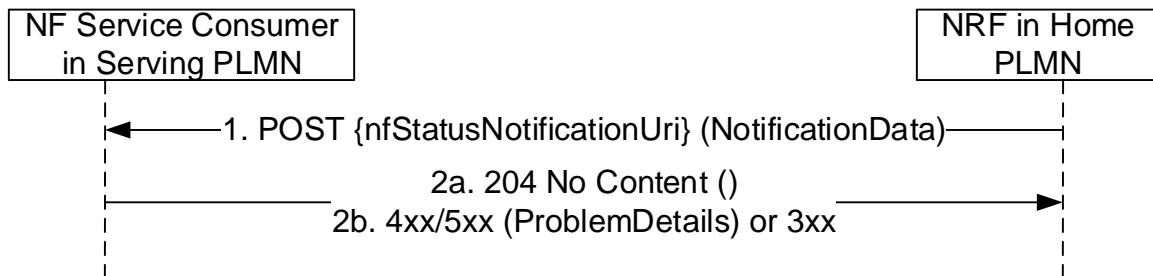

Figure 5.2.2.6.3-1: Notification from NRF in a different PLMN

Steps 1 and 2 are identical to steps 1 and 2 in Figure 5.2.2.6.2-1.

It should be noted that the POST request shall be sent directly from the NRF in Home PLMN to the NF Service Consumer in Serving PLMN, without involvement of the NRF in Serving PLMN.

5.2.2.6.4 Notification for subscription via intermediate NRF

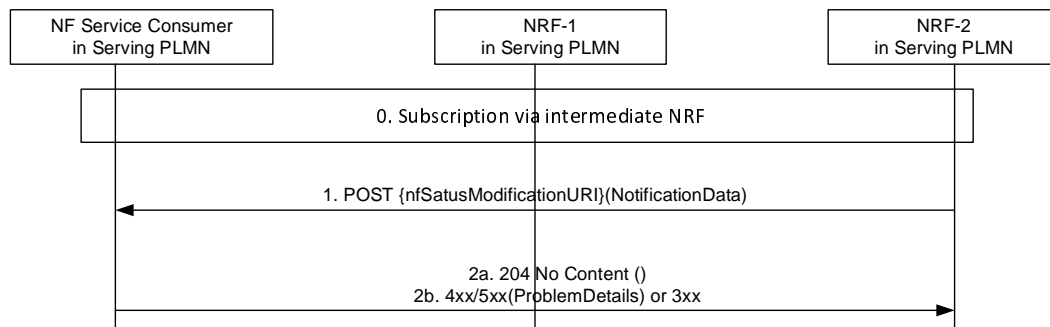

Figure 5.2.2.6.4-1: Notification for subscription via intermediate NRF

Step 0 is the NF Service Consumer creates a subscription to NRF-2 via intermediate NRF.

Steps 1 and 2 are identical to steps 1 and 2 in Figure 5.2.2.6.2-1.

The POST request shall be sent directly from NRF-2 to the NF Service Consumer without involvement of NRF-1.

5.2.2.7 NFStatusUnSubscribe

5.2.2.7.1 General

This service operation removes an existing subscription to notifications.

If the "Shared-Data-retrieval" feature is supported, this service operation may also be used to remove an existing subscription to the shared data changes in the NRF.

5.2.2.7.2 Subscription removal in the same PLMN

It is executed by deleting a given resource identified by a "subscriptionID". The operation is invoked by issuing a DELETE request on the URI representing the specific subscription received in the Location header field of the "201 Created" response received during a successful subscription (see clause 5.2.2.5).

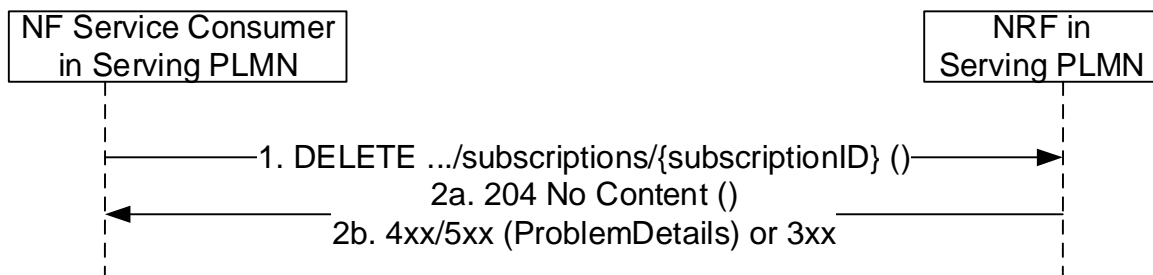

Figure 5.2.2.7.2-1: Subscription removal in the same PLMN

1. The NF Service Consumer shall send a DELETE request to the resource URI representing the individual subscription. The request body shall be empty.
- 2a. On success, "204 No Content" shall be returned. The response body shall be empty.
- 2b. On failure or redirection:
 - If the subscription, identified by the "subscriptionID", is not found in the list of active subscriptions in the NRF's database, the NRF shall return "404 Not Found" status code with the ProblemDetails IE providing details of the error.
 - In the case of redirection, the NRF shall return 3xx status code, which shall contain a Location header with an URI pointing to the endpoint of another NRF service instance.

5.2.2.7.3 Subscription removal in a different PLMN

The subscription removal in a different PLMN is done by deleting a resource identified by a "subscriptionID", in the NRF of the Home PLMN.

For that, step 1 in clause 5.2.2.7.2 is executed (send a DELETE request to the NRF in the Serving PLMN); this request shall include the identity of the PLMN or SNPN of the home NRF (MCC/MNC/NID values) as component values of the subscriptionID (see clause 5.2.2.5.3).

Then, steps 1-2 in Figure 5.2.2.7.3-1 are executed, between the NRF in the Serving PLMN and the NRF in the Home PLMN. In this step, the subscriptionID sent to the NRF in the Home PLMN shall not contain the identity of the PLMN (i.e., it shall be the same subscriptionID value as originally generated by the NRF in the Home PLMN). The NRF in the Home PLMN returns a status code with the result of the operation.

If the subscription was created in a different NRF in the HPLMN than the NRF in the HPLMN that receives the subscription delete request, the latter shall forward the request received from the NRF in the serving PLMN towards the NRF in the HPLMN holding the subscription, using the information included in the subscriptionID (see clause 5.2.2.5.3). The subscriptionID value in the request forwarded to the NRF in the HPLMN holding the subscription shall contain the same value as originally generated by the latter.

Finally, step 2 in clause 5.2.2.7.2 is executed; a status code is returned from the NRF in serving PLMN to the NF Service Consumer in Serving PLMN in accordance to the result received from NRF in Home PLMN.

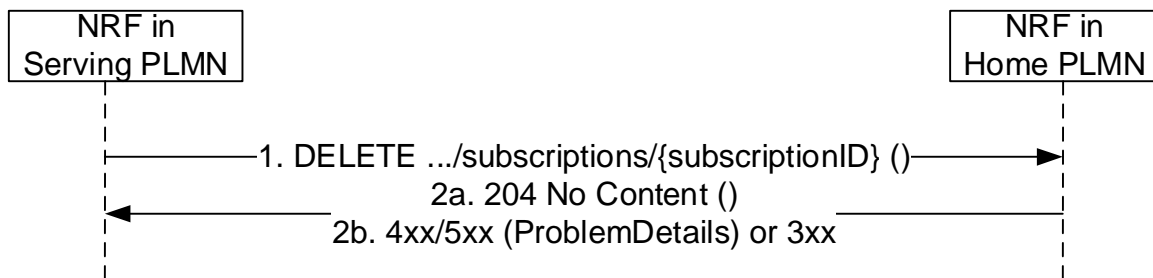

Figure 5.2.2.7.3-1: Subscription removal in a different PLMN

1. The NF Service Consumer shall send a DELETE request to the resource URI representing the individual subscription. The request body shall be empty.
- 2a. On success, "204 No Content" shall be returned. The response body shall be empty.
- 2b. On failure or redirection:
 - If the subscription, identified by the "subscriptionID", is not found in the list of active subscriptions in the NRF's database, the NRF shall return "404 Not Found" status code with the ProblemDetails IE providing details of the error.
 - In the case of redirection, the NRF shall return 3xx status code, which shall contain a Location header with an URI pointing to the endpoint of another NRF service instance.

5.2.2.8 NFListRetrieval

5.2.2.8.1 General

This service operation allows the retrieval of a list of NF Instances that are currently registered in NRF. The operation may apply to the whole set of registered NF instances or only to a subset of the NF instances, based on a given NF type and/or maximum number of NF instances to be returned.

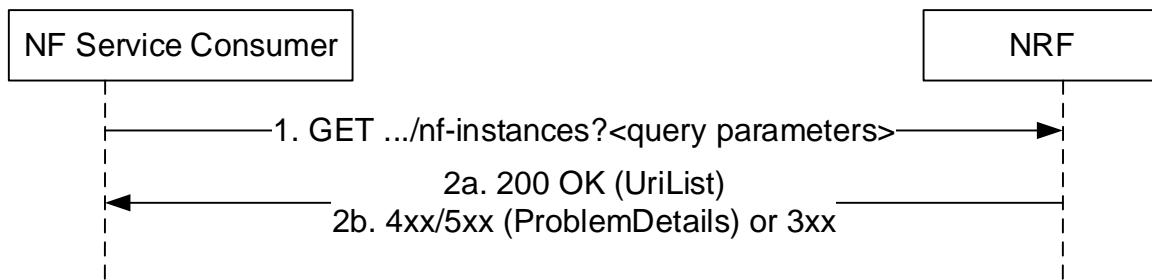

Figure 5.2.2.8.1-1: NF instance list retrieval

1. The NF Service Consumer shall send an HTTP GET request to the resource URI "nf-instances" collection resource. The optional input filter criteria (e.g. "nf-type") and pagination parameters for the retrieval request may be included in query parameters.
- 2a. On success, "200 OK" shall be returned. The response body shall contain the URI (conforming to the resource URI structure as described in clause 5.2.2.9.1) of each registered NF in the NRF that satisfy the retrieval filter criteria (e.g., all NF instances of the same NF type), or an empty list if there are no NFs to return in the query result (e.g., because there are no registered NFs in the NRF, or because there are no matching NFs of the type specified in the "nf-type" query parameter, currently registered in the NRF). The total count of items satisfying the filter criteria (e.g. "nf-type") should be returned in the response.
- 2b. On failure or redirection:
 - If the NF Service Consumer is not allowed to retrieve the registered NF instances, the NRF shall return "403 Forbidden" status code.
 - If the NF Instance list retrieval fails at the NRF due to errors in the input data in the URI query parameters, the NRF shall return "400 Bad Request" status code with the ProblemDetails IE providing details of the error.
 - If the discovery request fails at the NRF due to NRF internal errors, the NRF shall return "500 Internal Server Error" status code with the ProblemDetails IE providing details of the error.
 - In the case of redirection, the NRF shall return 3xx status code, which shall contain a Location header with an URI pointing to the endpoint of another NRF service instance.

5.2.2.9 NFProfileRetrieval

5.2.2.9.1 General

This service operation allows the retrieval of the NF profile of a given NF instance currently registered in NRF.

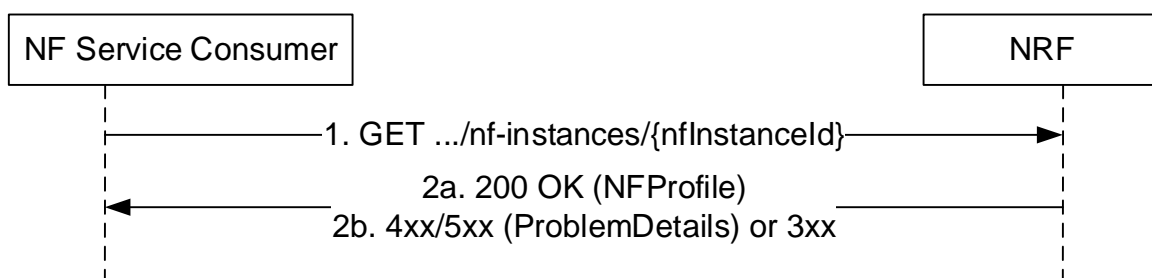

Figure 5.2.2.9.1-1: NF profile retrieval

1. The NF Service Consumer shall send an HTTP GET request to the resource URI "nf-instances/{nfInstanceId}".
- 2a. On success, "200 OK" shall be returned. The response body shall contain the NF profile of the NF instance identified in the request.
- 2b. On failure or redirection:

- If the NF Service Consumer is not allowed to retrieve the NF profile of this specific registered NF instance, the NRF shall return "403 Forbidden" status code.
- If the NF Profile retrieval fails at the NRF due to NRF internal errors, the NRF shall return "500 Internal Server Error" status code with the ProblemDetails IE providing details of the error.
- In the case of redirection, the NRF shall return 3xx status code, which shall contain a Location header with an URI pointing to the endpoint of another NRF service instance.

5.2.2.10 SharedDataRetrieval

This service operation retrieves Shared Data, by sending a HTTP GET request to the resource URI representing the "Shared Data" resource.

In deployments where shared data are locally configured at a higher level NRF by means of OAM this service operation shall be used by lower level NRFs to retrieve unknown shared data from the higher level NRF.

This service operation shall be used by Service Consumers having discovered/retrieved service profiles containing a single unknown shared data ID.

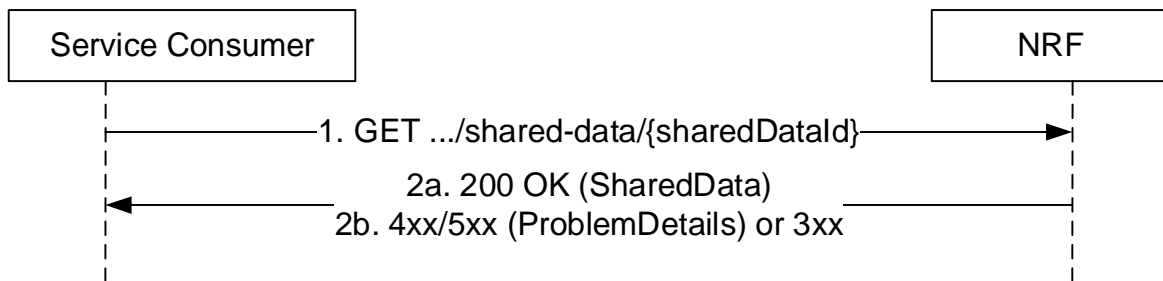

Figure 5.2.2.10-1: Shared Data Retrieval

1. The Service Consumer shall send an HTTP GET request to the resource URI "shared-data/{sharedDataId}" document resource, where the URI parameter sharedDataId identifies the requested Shared Data.
- 2a. On success, "200 OK" shall be returned with the requested Shared Data in response body.
- 2b. On failure, the NRF shall return "4xx/5xx" response and the response body may contain a ProblemDetails object describing the detailed information of the failure.
In the case of redirection, the NRF shall return 3xx status code, which shall contain a Location header with an URI pointing to the endpoint of another NRF service instance.

5.2.2.11 SharedDataListRetrieval

This service operation retrieves a list of Shared Data, by sending a HTTP GET request to the resource URI representing the "Shared Data Store" resource.

In deployments where shared data are locally configured at a higher level NRF by means of OAM this service operation shall be used by lower level NRFs to retrieve unknown shared data from the higher level NRF.

This service operation shall be used by Service Consumers having discovered/retrieved service profiles containing multiple unknown shared data IDs.

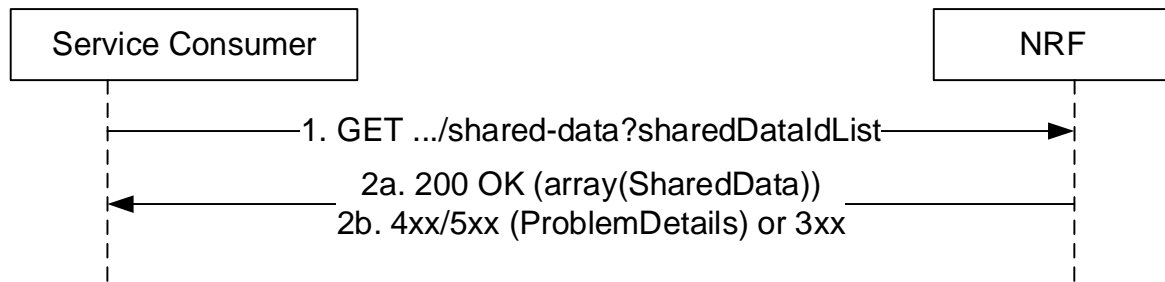

Figure 5.2.2.11-1: Shared Data List Retrieval

1. The Service Consumer shall send an HTTP GET request to the resource URI "shared-data" store resource, where the query parameter sharedDataIdList identifies the requested Shared Data.
- 2a. On success, "200 OK" shall be returned with the requested Shared Data in response body. If only a subset of the requested Shared Data is available (locally stored or could be retrieved from a higher level NRF), the NRF shall still return "200 OK" with the available and retrieved subset of the requested Shared Data in the response body.
- 2b. On failure, the NRF shall return "4xx/5xx" response and the response body may contain a ProblemDetails object describing the detailed information of the failure.
In the case of redirection, the NRF shall return 3xx status code, which shall contain a Location header with an URI pointing to the endpoint of another NRF service instance.

5.3 Nnrf_NFDiscovery Service

5.3.1 Service Description

The Nnrf_NFDiscovery service allows a NF or SCP Instance to discover other NF Instances with the potential services they offer, or to discover SEPP instances in the same PLMN, by querying the local NRF.

The Nnrf_NFDiscovery service also allows:

- an SCP to discover other SCP instances,
- an NF or SCP to discover the list of NRF instances that are part of the NRF set with, for each NRF instance, its NRF instance ID and addressing information, if the NRF is part of an NRF set.

It also allows an NRF in a PLMN to re-issue a discovery request towards an NRF in another PLMN (e.g., the HPLMN of a certain UE).

5.3.2 Service Operations

5.3.2.1 Introduction

The service operations defined for the Nnrf_NFDiscovery service are as follows:

- NFDDiscover: It provides to the NF service consumer or SCP the profile (including IP address(es) or FQDN) of the NF Instance(s) or NF Service(s) or SEPP instances matching certain input criteria. It also provides to the SCP the profile (including IP address(es) or FQDN) of the SCP Instance(s) matching certain input criteria.

The NFDDiscover operation can be invoked by an NF Service Consumer (i.e., "source NF") or SCP requesting to discover NF instances (i.e., "target NFs") located in the same PLMN, or in a different PLMN, or SEPP instances located in the same PLMN. It can also be invoked by an SCP requesting to discover SCP instances located in the same PLMN.

In the description of these operations in clause 5.3.2.2, when the NF instances are located in the same PLMN, both source NF and target NFs are said to be located in the "Serving PLMN" but, in the general case, the functionality is not restricted to the PLMN that is serving a given UE, and it shall be applicable as well to any scenario in which source NF and target NFs belong to the same PLMN.

When source NF and target NFs are located in different PLMNs, the source NF is said to be in the "Serving PLMN", and the target NFs (and the NRF where they are registered) are said to be in the "Home PLMN", similarly to the scenarios described in 3GPP TS 23.502 [3], but the functionality shall be equally applicable to any scenario between any pair of PLMNs (e.g. with the source NF in the Home PLMN and the target NF in the Serving PLMN).

The SCP and SEPP are treated by the Nnrf_NFDiscovery service in the same way as NFs. Specifically, the SCP and SEPP are designated with a specific NF type and NF Instance ID. However, the SCP and SEPP do not support services. Accordingly, references to "NF" or "NF Profile" in the description of the service operations in the following clauses also apply to an SCP and SEPP.

- SCPDomainRoutingInfoGet: It allows a service consumer (e.g. SCP) to fetch the SCP domain routing information (list of all SCP Domains registered by SCPs and the interconnected SCP domains per SCP domain), if both the SCP and the NRF supports the "SCPDRI" feature. It also allows a service consumer (e.g. NRF) to fetch the local SCP domain routing information (based on SCPs registered in the NRF as service producer), if both the NRF as service consumer and NRF as service producer supports the "SCPDRI" feature.

NOTE: Two SCP domains are considered interconnected when at least one SCP belongs to both SCP domains, i.e. at least one SCP can bridge messages between these two SCP domains.

- SCPDomainRoutingInfoSubscribe: It allows a service consumer (e.g. SCP) to create a subscription for changes of the SCP domain routing information, if both the SCP and the NRF supports the "SCPDRI" feature. It also allows a service consumer (e.g. NRF) to create a subscription for changes of local SCP domain routing information, if both the NRF as service consumer and NRF as service producer supports the "SCPDRI" feature.
- SCPDomainRoutingInfoNotify: It allows the NRF to send notification(s) to a service consumer (e.g. SCP) previously subscribed to the changes of the SCP domain routing information, if both the SCP and the NRF supports the "SCPDRI" feature. It also allows the NRF as service producer to send notification(s) to a service consumer (e.g. NRF) previously subscribed to the changes of the local SCP domain routing information, if both the NRF as service consumer and NRF as service producer supports the "SCPDRI" feature.
- SCPDomainRoutingInfoUnsubscribe: It allows a service consumer (e.g. SCP or NRF) to delete a previously created subscription for changes of the SCP domain routing information, if both the service consumer and the NRF as service producer supports the "SCPDRI" feature.

A NRF may be part of an NRF set, whereby all NRF instances of the NRF Set share the same context data (e.g. registered NF profiles, NF status subscriptions), as specified in clause 5.2.2.1. If so:

- the NF Service Consumer may be configured with the NRF Set ID or it may discover the same in the NRF Bootstrapping response;
- the NF Service Consumer may discover the NRF Set Information from the NRF via the Nnrf_NFDiscovery service by issuing an NF Discovery Request including the target-nf-type parameter set to "NRF" and the target-nf-set-id parameter set to the NRF Set ID, which allows to discover the list of NRF instances that are part of the NRF set with, for each NRF instance, its NRF Instance ID and addressing information (i.e. part of NRF profile).

NOTE: As part of the discovery of NRF instances belonging to an NRF Set, not all attributes in the NFProfile and NFService data structures (typically used for NF Consumer – NF Producer interaction) are needed for the NF Consumer to interact with the instances of the NRF Set, so the discovery response from NRF can be simplified and omit certain parameters.

5.3.2.2 NFDdiscover

5.3.2.2.1 General

This service operation discovers the set of NF Instances (and their associated NF Service Instances), represented by their NF Profile, that are currently registered in NRF and satisfy a number of input query parameters.

Before a service consumer invokes this service operation, it shall consider if it is possible to reuse the results from a previous searching (service discovery).

The service consumer should reuse the previous result if input query parameters in the new service discovery request are the same as used for the previous search and the validity period of the result is not expired.

The service consumer may consider reusing the previous result if the attributes as required for the new query consist of the query attributes from the previous query and additional query attributes. In such case, when the results of a previous query are reused, the service consumer need consider that the previous results will possibly include NF profiles that the new query would not; hence, the service consumer has to complete the filtering itself against the additional filter attributes in the new internal query.

Otherwise, if the query parameters in the new service discovery are different and don't consist of the previous query attributes and additional ones (i.e. the new query parameters, in general, don't have any relationship with those of the previous search), the reuse of cached profiles may still be done.

In these two last cases (i.e. where the query parameters of the new query are not identical to the previous query), re-using data from cached profiles may possibly yield to different results than if a new discovery was performed, and thus may be subject to operator's policy.

NOTE: Certain types of query attributes affect the contents of the NF Profiles returned in the discovery responses (e.g., "preferred-location" typically affects the setting of the "priority" attribute inside the NF Profiles returned by NRF); reusing the results from a previous query, when the new query involves any of such parameters, may not be feasible.

If an SCP receives complete NF profiles (including, e.g. the authorization attributes) from the NRF (see clauses 5.3.2.2.2 and 5.2.2.5.2), the SCP may use these cached profiles to serve new service requests received from NFs with different requester's information (e.g. different NF type, domain, S-NSSAI), but if it does so, the SCP shall check the authorization parameters of the complete profiles to ascertain that the requesting NFs are authorized to access the related NF services.

The NF Service Consumer should avoid to send multiple NF discovery requests with the same query parameters to NRF simultaneously.

5.3.2.2.2 Service Discovery in the same PLMN

This service operation is executed by querying the "nf-instances" resource. The request is sent to an NRF in the same PLMN of the NF Service Consumer.

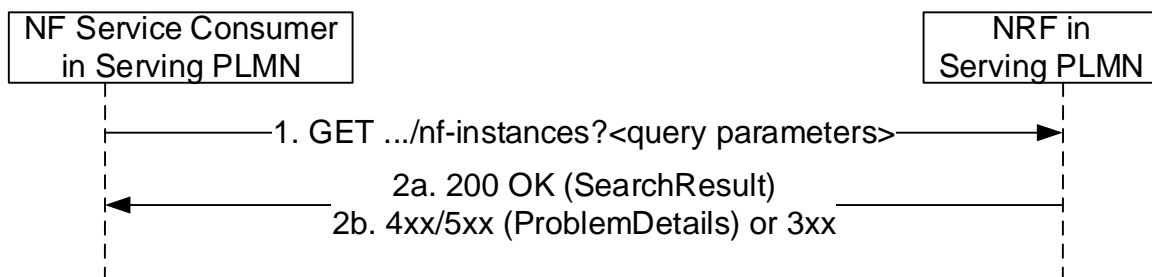

Figure 5.3.2.2.2-1: Service Discovery Request in the same PLMN

1. The NF Service Consumer shall send an HTTP GET request to the resource URI "nf-instances" collection resource. The input filter criteria for the discovery request shall be included in query parameters.

An SCP may request to discover the complete profile of NF instances (including, e.g. the authorization attributes) matching the query parameters. Upon receiving such a request, the NRF shall verify that the requesting entity is authorized to discover the complete profile of NF instances, based on local policies or the receipt of an access token granting such permission. If the requesting entity is not authorized to do so, the NRF shall reject the request or handle it as a service discovery request without access to the complete profile.

When certain query parameters in the discovery request are not supported by the NRF, the NRF shall ignore the unsupported query parameters and continue processing the request with the rest of the query parameters.

- 2a. On success, "200 OK" shall be returned. The response body shall contain a validity period, during which the search result can be cached by the NF Service Consumer, and an array of NF Profile objects, and/or a map of NFInstanceInfo objects of NF instances (if the NF service consumer indicated support of the Enh-NF-Discovery feature in the request) that satisfy the search filter criteria (e.g., all NF Instances offering a certain NF Service name in REGISTERED status, or empty array in case search filter criteria do not match a NF Instance in

REGISTERED status). In the latter case, the response may include the `noProfileMatchInfo` attribute to provide the specific reason for not finding any NF instance that can match the search filter criteria.

NOTE: In indirect communication with delegated discovery scenarios the SCPs can cache the `noProfileMatchInfo` to optimize subsequent NF discovery procedures.

If the NRF has ignored certain unsupported query parameter(s) when processing the discovery request, the NRF may additionally include the indication of ignored unsupported query parameters in the search result. The NF consumer may use the indication to identify whether the NF candidates in the search result are all usable for the service logic, i.e. all query parameter related to the key service logic are not ignored.

2b. On failure or redirection:

- If the NF Service Consumer is not allowed to discover the NF services for the requested NF type provided in the query parameters, the NRF shall return "403 Forbidden" response.
- If the discovery request fails at the NRF due to errors in the input data in the URI query parameters, the NRF shall return "400 Bad Request" status code with the `ProblemDetails` IE providing details of the error. E.g., the NRF may verify that the input attributes (e.g. `requester-nf-type`) in the discovery request match with the corresponding ones in, e.g. the public key certificate of the NF service consumer received during TLS initial handshake procedure (see 3GPP TS 33.310 [50]). If the verification is unsuccessful, the request shall be rejected with "400 Bad Request" status code and the "cause" attribute set to "INVALID_CLIENT".
- If the discovery request fails at the NRF due to NRF internal errors, the NRF shall return "500 Internal Server Error" status code with the `ProblemDetails` IE providing details of the error.
- In the case of redirection, the NRF shall return 3xx status code, which shall contain a `Location` header with an URI pointing to the endpoint of another NRF service instance.

The NF Profile objects returned in a successful result shall contain generic data of each NF Instance, applicable to any NF type, and it may also contain NF-specific data, for those NF Instances belonging to a specific type (e.g., the attribute `udrInfo` is typically present in the NF Profile when the type of the NF Instance takes the value "UDR"). In addition, the attribute `customInfo`, may be present in the NF Profile for those NF Instances with custom NF types.

For those NF Instances, the `customInfo` attribute shall be returned by NRF, if available, as part of the NF Profiles returned in the discovery response.

The NRF shall also include, in the returned NF Profile objects, the Vendor-Specific attributes (see 3GPP TS 29.500 [4], clause 6.6.3) that may have been provided by the registered NF Instances.

If the response includes a map of `NFInstanceInfo` objects of NF instances, the NF Service Consumer may retrieve the NF profiles by issuing service discovery requests with the `target-nf-instance-id` parameter identifying the target NF Instance ID, or with the `target-nf-instance-id-list` parameter identifying a list of target NF Instance IDs held by the same NRF; the service discovery request shall also include the `nrf-disc-uri` parameter set to the API URI of the `Nnrf_NFDiscovery` service of the NRF holding the NF profile(s), if the `nrfDiscApiUri` attribute was received in the `NFInstanceInfo` object and if the service discovery request is addressed to a different NRF than the NRF holding the NF profile(s).

5.3.2.2.3 Service Discovery in a different PLMN

The service discovery in a different PLMN is done by querying the "nf-instances" resource in the NRF of the Home PLMN.

For that, step 1 in clause 5.3.2.2.2 is executed (send a GET request to the NRF in the Serving PLMN); this request shall include the identity of the PLMN of the home NRF in a query parameter of the URI.

If the NRF in Serving PLMN knows that OAuth2-based authorization is required for accessing the NF Discovery service of the NRF in Home PLMN, e.g. by learning this during an earlier Bootstrapping procedure or local configuration, and if the request received at the NRF in Serving PLMN does not include an access token, the NRF in Serving PLMN may reject the request with a 401 Unauthorized as specified in clause 6.7.3 of 3GPP TS 29.500 [4].

Then, steps 1-2 in Figure 5.3.2.2.3-1 are executed, between the NRF in the Serving PLMN and the NRF in the Home PLMN. In this step, the presence of the PLMN ID of the Home NRF in the query parameter of the URI is not required.

The NRF in the Home PLMN returns a status code with the result of the operation. The NRF in the Serving PLMN shall be configured with:

- a telescopic FQDN (see 3GPP TS 23.003 [12] and 3GPP TS 29.500 [4]) of the NRF in the Home PLMN, if TLS protection between the NRF and the SEPP in the serving PLMN relies on using telescopic FQDN; or

NOTE: This is required for the NRF in the serving PLMN to route the NF discovery request to the NRF in the HPLMN through a SEPP in the serving PLMN and the SEPP to terminate the TLS connection with a wildcard certificate.

- with the SEPP FQDN (or the FQDN of the SCP if the communication between the NRF and the SEPP goes through an SCP), if TLS protection between the NRF and the SEPP in the serving PLMN relies on using the 3gpp-Sbi-Target-apiRoot header.

See clause 6.1.4.3 of 3GPP TS 29.500 [4].

Finally, step 2 in clause 5.3.2.2.2 is executed; a status code is returned to the NF Service Consumer in Serving PLMN in accordance to the result received from NRF in Home PLMN.

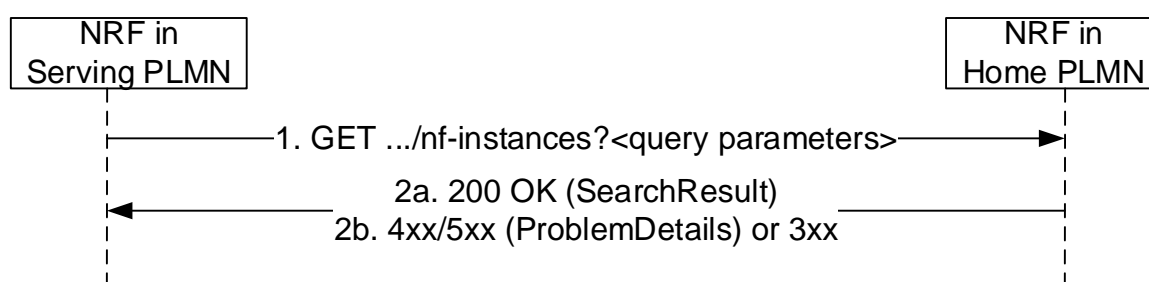

Figure 5.3.2.2.3-1: Service Discovery in a different PLMN

Steps 1 and 2 are similar to steps 1 and 2 in Figure 5.3.2.2.2-1, where the originator of the service invocation is the NRF in Serving PLMN, and the recipient of the service invocation is the NRF in the Home PLMN.

As most NF Service Consumers in Serving PLMN do not need the entire data in the NF profile of the NF producer, the NRF in the home PLMN, based on operator policies, may simplify the NF discovery response by not including the entire data which is not directly relevant to the NF discovery request (e.g. returning a subset of supiRanges, or not including taiList).

If the NRF in the home PLMN has ignored certain unsupported query parameter(s) when processing the discovery request, the NRF may additionally include the indication of ignored unsupported query parameters in the search result. If the indication of ignored unsupported query parameters is supported by the NRF in the serving PLMN, it should forward the received indication of ignored unsupported query parameters to the NF service consumer.

5.3.2.2.4 Service Discovery with intermediate redirecting NRF

When multiple NRFs are deployed in one PLMN, one NRF may query the "nf-instances" resource in a different NRF so as to fulfil the service discovery request from a NF service consumer. The query between these two NRFs is redirected by a third NRF.

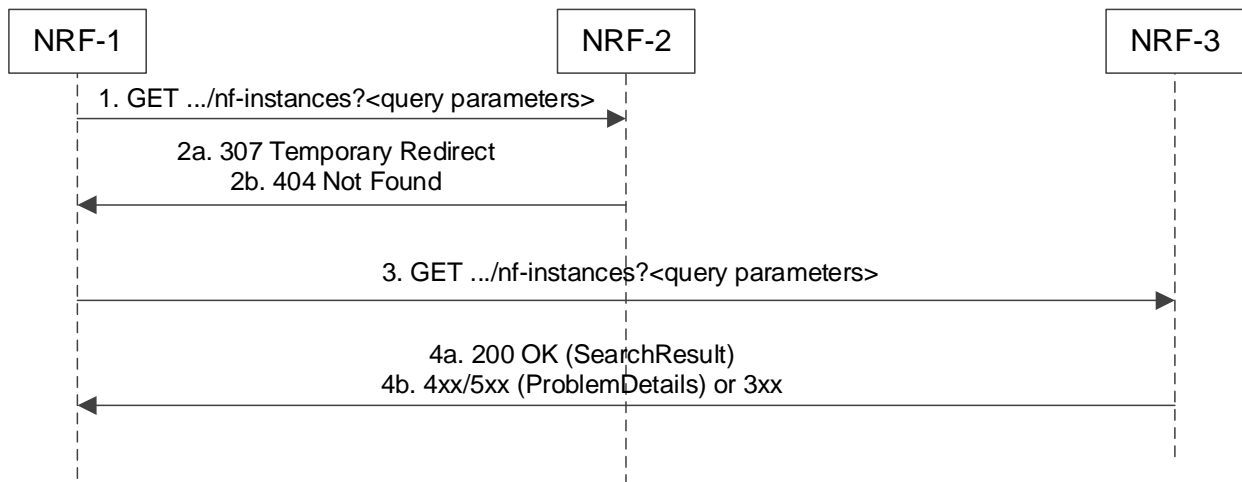

Figure 5.3.2.2.4-1: Service Discovery with intermediate redirecting NRF

1. NRF-1 receives a service discovery request but does not have the information to fulfil the request. Then NRF-1 sends the service discovery request to a pre-configured NRF-2.
- 2a. Upon receiving a service discovery request, based on the information contained in the service discovery request (e.g. the "supi" query parameter in the URI) and locally stored information NRF-2 shall identify the next hop NRF (see clause 5.2.2.2.3), and redirect the service discovery request by returning HTTP 307 Temporary Redirect response. The locally stored information in NRF-2 may:
 - a) be preconfigured; or
 - b) registered by other NRFs (see clause 5.2.2.2.3).

The 307 Temporary Redirect response shall contain a Location header field, the host part of the URI in the Location header field represents NRF-3.
- 2b. if NRF-2 does not have enough information to redirect the service discovery request, then it responds with 404 Not Found, and the rest of the steps are omitted.
3. Upon receiving 307 Temporary Redirect response, NRF-1 sends the service discovery request to NRF-3 by using the URI contained in the Location header field of the 307 Temporary Redirect response.
- 4a. Upon success, NRF-3 returns the search result.
- 4b. On failure or redirection:
 - If the NF Service Consumer is not allowed to discover the NF services for the requested NF type provided in the query parameters, the NRF shall return "403 Forbidden" response.
 - If the discovery request fails at the NRF due to errors in the input data in the URI query parameters, the NRF shall return "400 Bad Request" status code with the ProblemDetails IE providing details of the error.
 - If the discovery request fails at the NRF due to NRF internal errors, the NRF shall return "500 Internal Server Error" status code with the ProblemDetails IE providing details of the error.
 - In the case of redirection, the NRF shall return 3xx status code, which shall contain a Location header with an URI pointing to the endpoint of another NRF service instance.

5.3.2.2.5 Service Discovery with intermediate forwarding NRF

When multiple NRFs are deployed in one PLMN, one NRF may query the "nf-instances" resource in a different NRF so as to fulfil the service discovery request from a NF service consumer. The query between these two NRFs is forwarded by a third NRF.

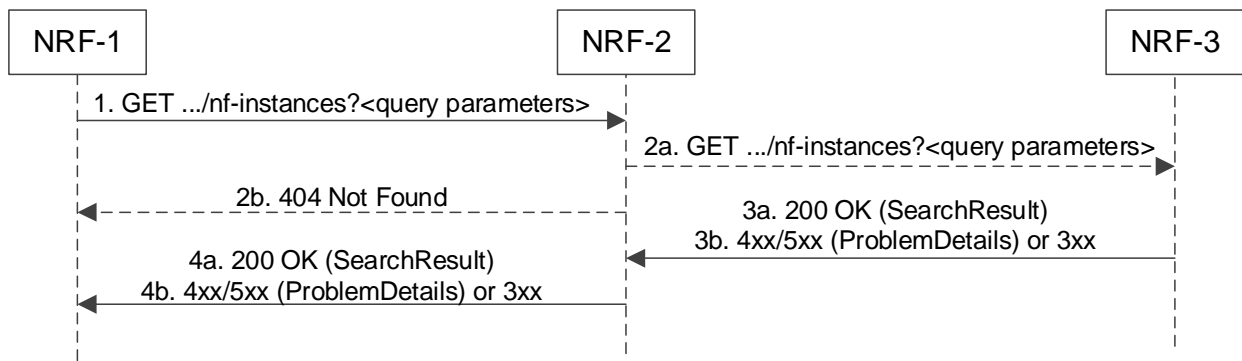

Figure 5.3.2.2.5-1: Service Discovery with intermediate forwarding NRF

1. NRF-1 receives a service discovery request and sends the service discovery request to a pre-configured NRF-2. This may for example include cases where NRF-1 does not have sufficient information as determined by the operator policy to fulfill the request locally.
- 2a. Upon receiving a service discovery request, based on the information contained in the service discovery request (e.g. the "supi" query parameter in the URI) and locally stored information, NRF-2 shall identify the next hop NRF (see clause 5.2.2.2.3), and forward the service discovery request to that NRF (i.e. NRF-3 in this example) similarly to steps 1 and 2 in Figure 5.3.2.2.2-1 where the originator of the service invocation is NRF-2 and the recipient of the service invocation is NRF-3. The locally stored information in NRF-2 may:
 - a) be preconfigured; or
 - b) registered by other NRFs (see clause 5.2.2.2.3).
- 2b. if NRF-2 does not have enough information to forward the service discovery request, then it responds with 404 Not Found, and the rest of the steps are omitted.
- 3a. Upon success, NRF-3 returns the search result.
- 3b. On failure or redirection:
 - If the NF Service Consumer is not allowed to discover the NF services for the requested NF type provided in the query parameters, the NRF shall return "403 Forbidden" response.
 - If the discovery request fails at the NRF due to errors in the input data in the URI query parameters, the NRF shall return "400 Bad Request" status code with the ProblemDetails IE providing details of the error.
 - If the discovery request fails at the NRF due to NRF internal errors, the NRF shall return "500 Internal Server Error" status code with the ProblemDetails IE providing details of the error.
 - In the case of redirection, the NRF shall return 3xx status code, which shall contain a Location header with an URI pointing to the endpoint of another NRF service instance.
- 4a. NRF-2 forwards the success response to NRF-1.
- 4b. On failure or redirection:
 - NRF-2 forwards the error response to NRF-1.
 - In the case of redirection, the NRF shall return 3xx status code, which shall contain a Location header with an URI pointing to the endpoint of another NRF service instance.

NOTE: It is not assumed that there can only be two NRF hierarchies, i.e. the NRF-3 can go on to forward the service discovery request to another NRF.

5.3.2.2.6 Service Discovery with resolution of the target PLMN

This service discovery is done by querying the "nf-instances" resource in the NRF of the target PLMN, similar to the "Service Discovery in a different PLMN", as described in clause 5.3.2.2.3.

The main difference compared with clause 5.3.2.2.3 is that the identity of the target PLMN is not explicitly provided by the NF Service Consumer.

NOTE: This can happen, e.g., when the identity of the UE involved in the service discovery is not based on IMSI, but on GPSI (MSISDN) and, therefore, the MNC/MCC of the target PLMN cannot be derived from the UE identity. It should also be noted that, in these scenarios, the MSISDN may be subject to Mobile Number Portability.

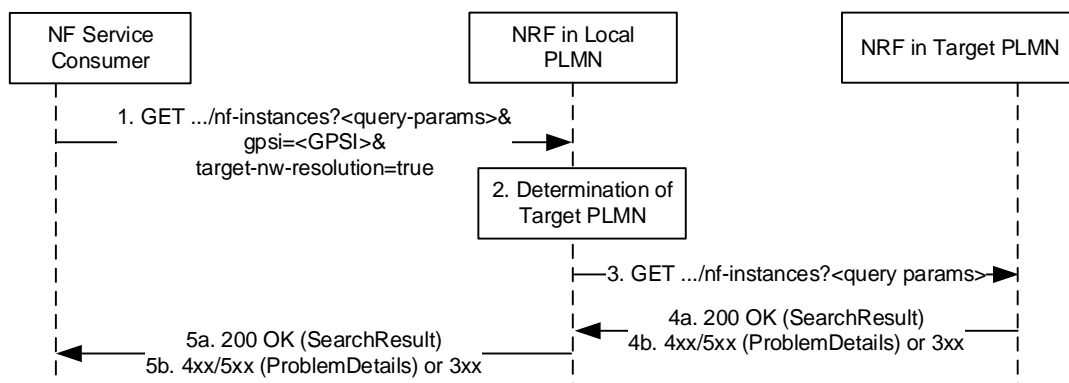

Figure 5.3.2.2.6-1: Service Discovery with resolution of the target PLMN

1. The NF Service Consumer (e.g. an SMS-GMSC) sends a GET request to the NRF in the Local PLMN (i.e., the same PLMN where the NF Service Consumer is located); given that the identity of the target PLMN is not known to the NF Service Consumer, this request shall include as query parameters the identity of the target UE for which NF Service Producers need to be discovered (i.e., the "gpsi" query parameter) and also a parameter indicating that the resolution of the target PLMN must be performed (i.e., "target-nw-resolution" set to true).
2. The NRF in the Local PLMN determines the identity of the Target PLMN, as described in 3GPP TS 23.540 [48], and determines the URI of the Nnrf_NFDiscovery service of the NRF in the Target PLMN.
3. This step is similar to step 1 in Figure 5.3.2.2.3-1, for "Service Discovery in a different PLMN", with the only difference that the "Serving/Home" PLMNs in clause 5.3.2.2.3 are replaced by "Local/Target" PLMNs in the present clause.
4. Steps 4a, 4b are similar to steps 2a, 2b in Figure 5.3.2.2.3-1.
5. Steps 5a, 5b are similar to steps 2a, 2b in Figure 5.3.2.2.2-1.

5.3.2.3 SCPDomainRoutingInfoGet

This service operation retrieves the SCP domain routing information, by sending a HTTP GET request to the resource URI representing the "SCP Domain Routing Information" resource.

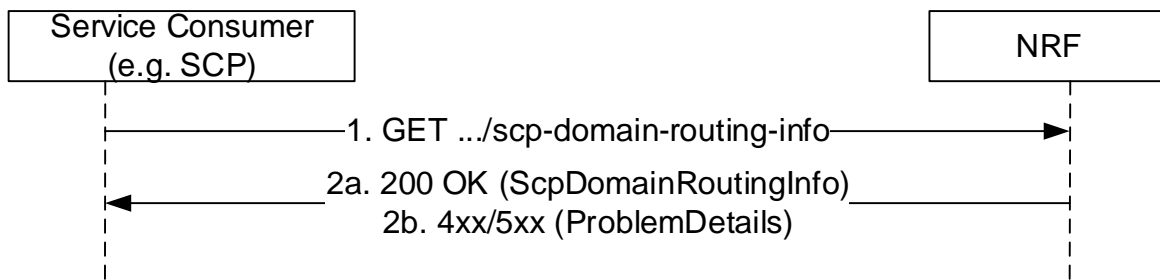

Figure 5.3.2.3-1: SCP Domain Routing Information Get

1. The Service Consumer (i.e. SCP) shall send an HTTP GET request to the resource URI "scp-domain-routing-info" document resource.
- 2a. On success, "200 OK" shall be returned with SCP Domain Routing Information in response body. SCP Domain Routing Information with empty map indicates that no SCP domain is registered in the network.
- 2b. On failure, the NRF shall return "4xx/5xx" response and the response body may contain a ProblemDetails object describing the detailed information of the failure.

When SCPs are registered to multiple NRFs in the network, any NRF providing SCP domain routing information for the whole network shall retrieve the local SCP domain routing information in other NRF(s) and perform aggregation. This service operation retrieves the local SCP domain routing information, e.g. by another NRF, by sending a HTTP GET request to the resource URI representing the "SCP Domain Routing Information" resource with "local" query parameter set to value "true".

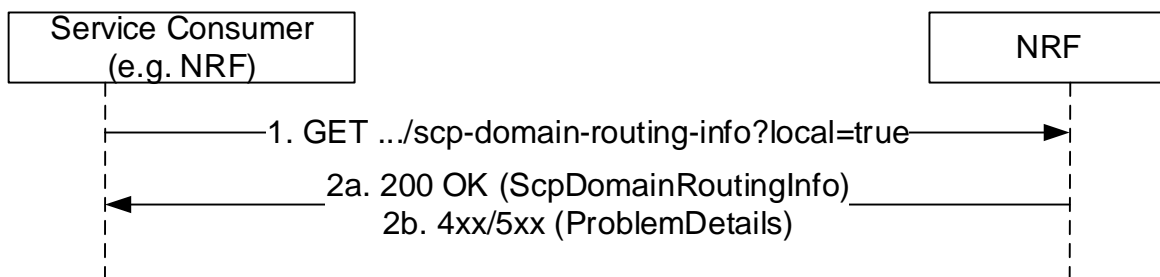

Figure 5.3.2.3-2: Local SCP Domain Routing Information Get

1. The Service Consumer (i.e. SCP) shall send an HTTP GET request to the resource URI "scp-domain-routing-info" document resource with "local" query parameter set to value "true".
- 2a. On success, "200 OK" shall be returned with local SCP Domain Routing Information in response body. SCP Domain Routing Information with empty map indicates that no SCP domain is registered in the producer NRF.
- 2b. On failure, the NRF shall return "4xx/5xx" response and the response body may contain a ProblemDetails object describing the detailed information of the failure.

NOTE: In deployments where all SCPs in the network can be managed by the same NRF, i.e. all SCPs register to and discover each other with the same NRF, the NRF managing the SCPs can generate the SCP Domain Routing Information accordingly without involvement of other NRFs.

5.3.2.4 SCPDomainRoutingInfoSubscribe

This service operation is used to create a subscription to get notification when SCP Domain Routing Information is changed, e.g. due to a SCP has registered or updated or deregistered in the network, or to get notification when local SCP Domain Routing Information is changed, e.g. due to a SCP has registered or updated or deregistered in the producer NRF. The operation is invoked by issuing a POST request to the resource URI representing the "SCP Domain Routing Info Subscriptions" collection resource.

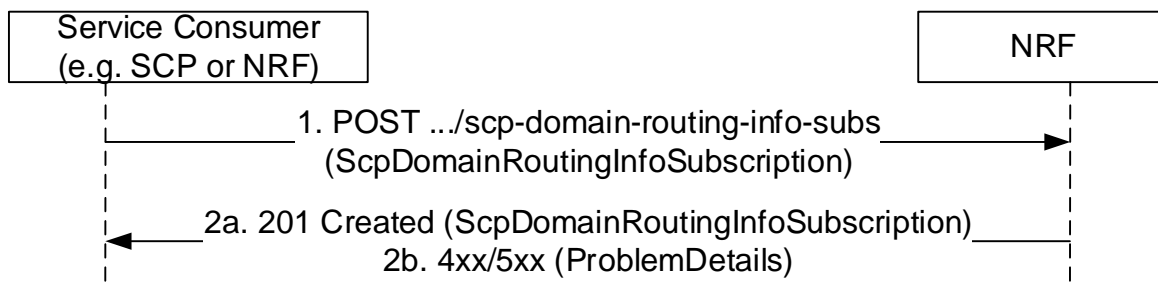

Figure 5.3.2.4-1: Subscription to SCP Domain Routing Information change

1. The Service Consumer (i.e. SCP) shall send a POST request to the URI representing the "SCP Domain Routing Info Subscriptions" collection resource. The request body shall contain the callback URI on the Service Consumer to receive the notifications.

To create a subscription for changes of local SCP Domain Routing Information, the request body shall contain the "localInd" with value "true".

- 2a. On success, "201 Created" shall be returned with "Location" header containing the resource URI to the newly created subscription resource. The response shall contain the data related to the created subscription, including the validity time, as determined by the NRF, after which the subscription becomes invalid. Once the subscription expires, if the Service Consumer wants to keep receiving notifications, it shall create a new subscription in the NRF.

- 2b. On failure, the NRF shall return "4xx/5xx" response and the response body may contain a ProblemDetails object describing the detailed information of the failure.

5.3.2.5 SCPDomainRoutingInfoNotify

This service operation notifies each subscriber for (local) SCP Domain Routing Information change. The notification is sent to a callback URI that Service Consumer provided during the subscription (see SCPDomainRoutingInfoSubscribe operation in clause 5.3.2.4). The operation is invoked by sending a POST request to the callback URI.

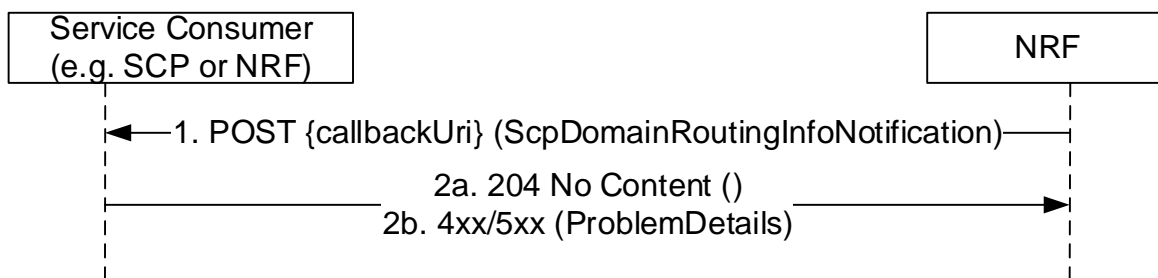

Figure 5.3.2.5-1: Notification of SCP Domain Routing Info Change

1. The NRF shall send a POST request to the callback URI. The request body shall contain the updated SCP Domain Routing Information. The request body shall contain the "localInd" IE with value "true" if the notification is for a change of local SCP Domain Routing Information. SCP Domain Routing Information with empty map indicates that no SCP domain is registered in the network (or in the producer NRF for local SCP Domain Routing Information) after the change.

- 2a. On success, "204 No content" shall be returned by the NF Service Consumer.

- 2b. On failure, the NRF shall return "4xx/5xx" response and the response body may contain a ProblemDetails object describing the detailed information of the failure.

5.3.2.6 SCPDomainRoutingInfoUnSubscribe

This service operation removes an existing subscription to SCP (local) Domain Information Change. The operation is invoked by issuing a DELETE request on the resource URI representing the "Individual SCP Domain Routing Info Subscription", which was received in the Location header field of the "201 Created" response received during a successful subscription (see clause 5.3.2.4).

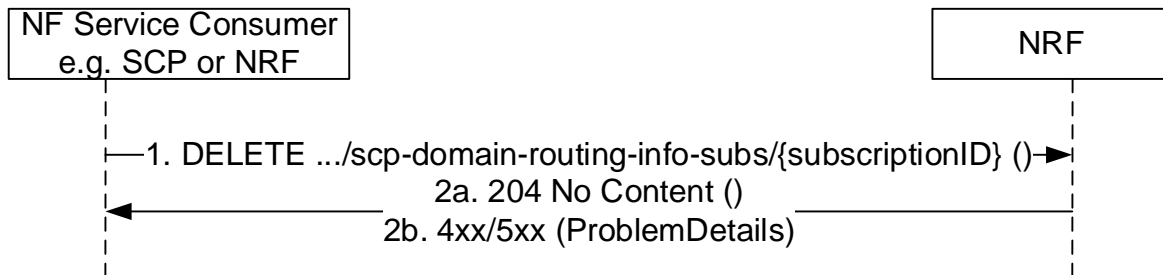

Figure 5.3.2.6-1: Unsubscribe to SCP Domain Routing Information Change

1. The Service Consumer (e.g. SCP or NRF) shall send a DELETE request to the resource URI representing the individual subscription. The request body shall be empty.
- 2a. On success, "204 No Content" shall be returned. The response body shall be empty.
- 2b. On failure, the NRF shall return "4xx/5xx" response and the response body may contain a ProblemDetails object describing the detailed information of the failure.

5.4 Nnrf_AccessToken Service

5.4.1 Service Description

The NRF offers an Nnrf_AccessToken service (used for OAuth2 authorization, see IETF RFC 6749 [16]), following the "Client Credentials" authorization grant, as specified in 3GPP TS 33.501 [15]. It exposes a "Token Endpoint" where the Access Token Request service can be requested by NF Service Consumers.

5.4.2 Service Operations

5.4.2.1 Introduction

The services operations defined for the Nnrf_AccessToken service are as follows:

- Access Token Request (i.e. Nnrf_AccessToken_Get)

5.4.2.2 Get (Access Token Request)

5.4.2.2.1 General

This service operation is used by an NF Service Consumer to request an OAuth 2.0 access token from the authorization server (NRF).

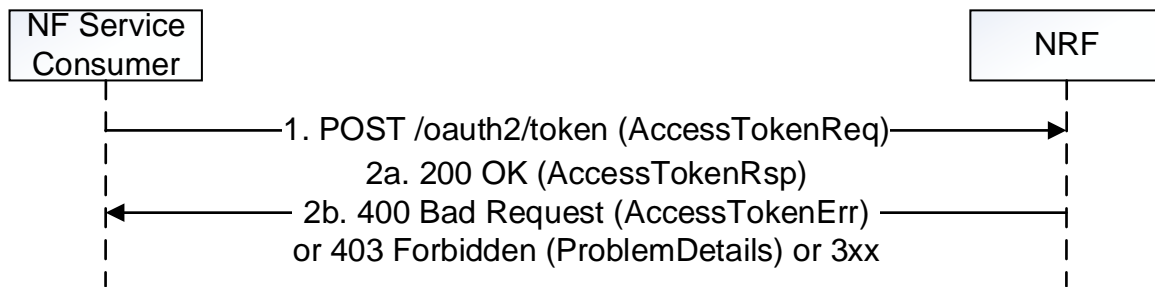

Figure 5.4.2.2.1-1: Access Token Request

1. The NF Service Consumer shall send a POST request to the "Token Endpoint", as described in IETF RFC 6749 [16], clause 3.2. The "Token Endpoint" URI shall be:

{nrfApiRoot}/oauth2/token

where {nrfApiRoot} represents the concatenation of the "scheme" and "authority" components of the NRF, as defined in IETF RFC 3986 [17].

The OAuth 2.0 Access Token Request included in the body of the HTTP POST request shall contain:

- An OAuth 2.0 grant type set to "client_credentials";
- The "scope" parameter indicating the names of the NF Services that the NF Service Consumer is trying to access (i.e., the expected NF service names);
- The NF Instance Id of the the NF Service Consumer requesting the OAuth 2.0 access token;
- NF type of the NF Service Consumer, if this is an access token request not for a specific NF Service Producer;
- NF type of the expected NF Service Producer, if this is an access token request not for a specific NF Service Producer;
- The NF Instance Id of the expected NF Service Producer, if this is an access token request for a specific NF Service Producer;
- Home and Serving PLMN IDs, if this is an access token request for use in roaming scenarios (see clause 13.4.1.2 of 3GPP TS 33.501 [15]).

The request may additionally contain:

- the NF Set ID of the expected NF service producer instances, if this is an access token request not for a specific NF Service Producer.
- the NF Instance Id of the source NF (the NF that requests data), if this is an access token request from the DCCF as NF Service Consumer request data from NF Service Producers on behalf of the source NF.

The NF Service Consumer shall use TLS for mutual authentication with the NRF in order to access this endpoint, if the PLMN uses protection at the transport layer. Otherwise, the NF Service Consumer shall use NDS or physical security to mutually authenticate with the NRF as specified in clause 13.3.1 of 3GPP TS 33.501 [15].

The NRF may verify that the input attributes (e.g. NF type) in the access token request match with the corresponding ones in the public key certificate of the NF service consumer. If the verification is successful, other authorization check shall be performed, otherwise, the request shall be rejected immediately with "400 Bad Request" status code, and "error" attribute set to "invalid_client".

- 2a. On success, "200 OK" shall be returned, the content of the POST response shall contain the requested access token and the token type set to value "Bearer". The response in addition:

- should contain the expiration time for the token as indicated in IETF RFC 6749 [16] unless the expiration time of the token is made available by other means (e.g. deployment-specific documentation); and
- shall contain the NF service name(s) of the requested NF service producer(s), if it is different from the scope included in the access token request (see IETF RFC 6749 [16]).

The access token shall be a JSON Web Token (JWT) as specified in IETF RFC 7519 [25]. The access token returned by the NRF shall include the claims encoded as a JSON object as specified in clause 6.3.5.2.4 and then digitally signed using JWS as specified in IETF RFC 7515 [24] and in clause 13.4.1 of 3GPP TS 33.501 [15].

The digitally signed access token shall be converted to the JWS Compact Serialization encoding as a string as specified in clause 7.1 of IETF RFC 7515 [24].

2b. On failure or redirection:

- If the access token request fails at the NRF, the NRF shall return "400 Bad Request" status code, including in the response content a JSON object that provides details about the specific error that occurred.
- In the case of redirection, the NRF shall return 3xx status code, which shall contain a Location header with an URI pointing to the endpoint of another NRF service instance.
- If based on operator policy the required information used to authorize the access token request, e.g. requesterSnsaiList, is not included, the NRF may return "403 Forbidden" status code with the ProblemDetails IE indicating that the missing information shall be provided.

5.4.2.2.2 Access Token request with intermediate forwarding NRF

When multiple NRFs are deployed in one PLMN, one NRF may request an OAuth2 access token to a different NRF so as to fulfil the Access Token Request from a NF service consumer. The access token request between these two NRFs is forwarded by a third NRF in this case.

For this, step 1 in clause 5.4.2.2.1 is executed (send a POST request to NRF-1 in the Serving PLMN); this request shall include the OAuth 2.0 Access Token Request in the request body.

Then, steps 1-4 in Figure 5.4.2.2.2-1 hereinafter are executed between NRF-1 in Serving PLMN, NRF-2 in Serving PLMN and NRF-3 in Serving PLMN.

Finally, step 2 in clause 5.4.2.2.1 is executed, the Access Token Response containing the requested access token, the token type and additional attributes shall be sent to the NF Service Consumer.

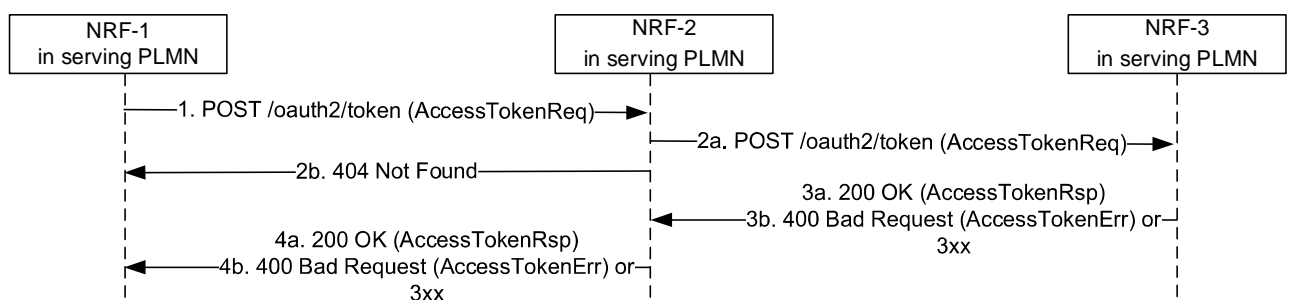

Figure 5.4.2.2.2-1: Access Token Request with intermediate forwarding NRF

1. NRF-1 receives an Access token request but does not have the information to fulfil the request. Then NRF-1 sends the Access token request to a pre-configured NRF-2.
- 2a. Upon reception of the Access token request and based on the information contained in the Access token request and locally stored information, NRF-2 shall identify the next hop NRF (see clause 5.2.2.2.3), and forward the Access token request to that NRF (i.e. NRF-3 in this example) by replacing the originator of the service invocation with NRF-2, and the recipient of the service invocation with NRF-3. The locally stored information in NRF-2 may:
 - a) be preconfigured; or

- b) registered by other NRFs (see clause 5.2.2.2.3).
- 2b. if NRF-2 does not have enough information to forward the Access token request, then it responds with 404 Not Found, and the rest of the steps are omitted.
- 3a. Upon success, NRF-3 shall return a "200 OK" status code, including in the response content the Access token response containing the requested access token, the token type and additional attributes.
- 3b. Upon failure, NRF-3 shall return "400 Bad Request" status code, including in the response content a JSON object that provides details about the specific error(s) that occurred.
- 4a. NRF-2 forwards the success response to NRF-1.
- 4b. On failure or redirection:
 - NRF-2 forwards the error response to NRF-1.
 - In the case of redirection, the NRF shall return 3xx status code, which shall contain a Location header with an URI pointing to the endpoint of another NRF service instance.

NOTE: It is not assumed that there can only be two NRF hierarchies, i.e. the NRF-3 can go on and forward the Access token request request to another NRF.

5.4.2.2.3 Access Token request with intermediate redirecting NRF

When multiple NRFs are deployed in one PLMN, one NRF may request an OAuth2 access token to a different NRF so as to fulfil the Access Token Request from a NF service consumer. The access token request between these two NRFs is redirected by a third NRF in this case.

For this, step 1 in clause 5.4.2.2.1 is executed (send a POST request to NRF-1 in the Serving PLMN); this request shall include the OAuth 2.0 Access Token Request in the request body

Then, steps 1-4 in Figure 5.4.2.2.3-1 hereinafter are executed between NRF-1 in Serving PLMN, NRF-2 in Serving PLMN and NRF-3 in Serving PLMN.

Finally, step 2 in clause 5.4.2.2.1 is executed, the Access token response containing the requested access token, the token type and additional attributes shall be sent to the NF Service Consumer.

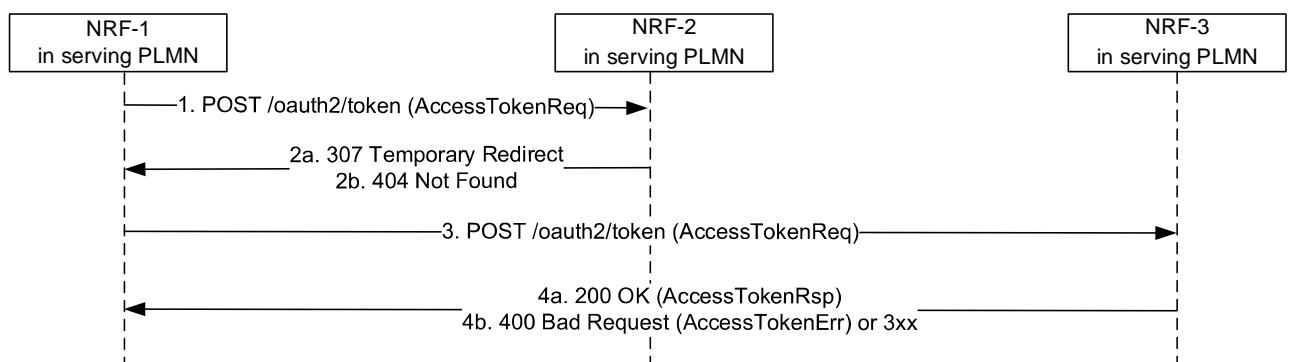

Figure 5.4.2.2.3-1: Access Token Request with intermediate redirecting NRF

1. NRF-1 receives an Access token request but does not have the information to fulfil the request. Then NRF-1 sends the Access token request to a pre-configured NRF-2.
- 2a. Upon reception of the Access token request and based on the information contained in the Access token request and locally stored information, NRF-2 shall identify the next hop NRF (see clause 5.2.2.2.3), and redirect the Access token request by returning HTTP "307 Temporary Redirect" response. The locally stored information in NRF-2 may:
 - a) be preconfigured; or
 - b) registered by other NRFs (see clause 5.2.2.2.3).

The "307 Temporary Redirect" response shall contain a Location header field, the host part of the URI in the Location header field represents NRF-3.

- 2b. if NRF-2 does not have enough information to forward the Access token request, then it responds with "404 Not Found", and the rest of the steps are omitted.
3. Upon reception of "307 Temporary Redirect" response, NRF-1 sends the Access token request to NRF-3 by using the URI contained in the Location header field of the "307 Temporary Redirect" response.
- 4a. Upon success, NRF-3 shall return a "200 OK" status code including in the response content the Access token response containing the requested access token, the token type and additional attributes.
- 4b. On failure or redirection:
 - Upon failure, the NRF-3 shall return "400 Bad Request" status code, including in the response content a JSON object that provides details about the specific error(s) that occurred.
 - In the case of redirection, the NRF shall return 3xx status code, which shall contain a Location header with an URI pointing to the endpoint of another NRF service instance.

5.5 Nnrf_Bootstrapping Service

5.5.1 Service Description

The NRF offers a Nnrf_Bootstrapping service to let NF Service Consumers of the NRF know about the services endpoints it supports, the NRF Instance ID and NRF Set ID if the NRF is part of an NRF set, by using a version-independent URI endpoint that does not need to be discovered by using a Discovery service.

This service shall be used in inter-PLMN scenarios where the NRF in a PLMN-A needs to invoke services from an NRF in PLMN-B, when there is no pre-configured information indicating the version of the services deployed in PLMN-B.

This service may also be used in intra-PLMN scenarios, to avoid configuring statically in the different NFs information about the service versions deployed in the NRF to be used by those NFs.

5.5.2 Service Operations

5.5.2.1 Introduction

The services operations defined for the Nnrf_Bootstrapping service are as follows:

- Nnrf_Bootstrapping_Get

5.5.2.2 Get

5.5.2.2.1 General

This service operation is used by an NF Service Consumer to request bootstrapping information from the NRF.

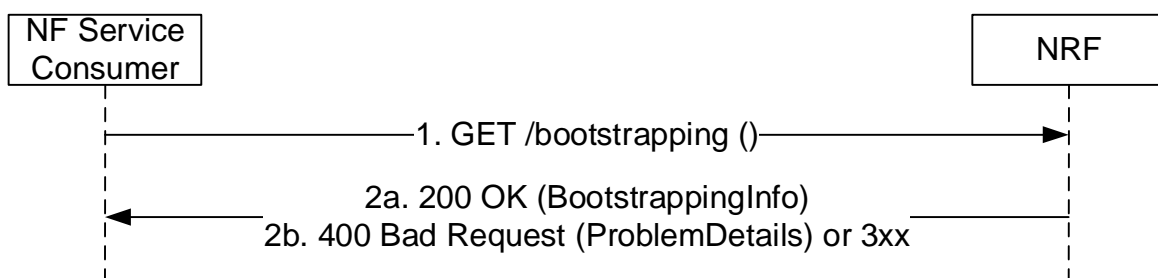

Figure 5.5.2.2.1-1: Bootstrapping Request

1. The NF Service Consumer shall send a GET request to the "Bootstrapping Endpoint".

The "Bootstrapping Endpoint" URI shall be constructed as:

```
{nrfApiRoot}/bootstrapping
```

where {nrfApiRoot} represents the concatenation of the "scheme" and "authority" components of the NRF, as defined in IETF RFC 3986 [17]; see also the definition of NRF FQDN and NRF URI in 3GPP TS 23.003 [12], clause 28.3.2.3.

- 2a. On success, "200 OK" shall be returned, the content of the GET response shall contain the requested bootstrapping information.

EXAMPLE:

```
GET https://nrf.example.com/bootstrapping
Accept: application/3gppHal+json
```

```
HTTP/2 200 OK
Content-Type: application/3gppHal+json
```

```
{
  "status": "OPERATIVE",
  "_links": {
    "self": {
      "href": "https://nrf.example.com/bootstrapping"
    },
    "manage": {
      "href": "https://nrf.example.com/nnrf-nfm/v1/nf-instances"
    },
    "subscribe": {
      "href": "https://nrf.example.com/nnrf-nfm/v1/subscriptions"
    },
    "discover": {
      "href": "https://nrf.example.com/nnrf-disc/v1/nf-instances"
    },
    "authorize": {
      "href": "https://nrf.example.com/oauth2/token"
    }
  },
  "nrfFeatures": {
    "nnrf-nfm": "1",
    "nnrf-disc": "D",
    "nnrf-oauth2": "0"
  },
  "oauth2Required": {
    "nnrf-nfm": true,
    "nnrf-disc": false
  },
  "nrfSetId": "set12.nrfset.5gc.mnc012.mcc345",
  "nrfInstanceId": "4947a69a-f61b-4bc1-b9da-47c9c5d14b67"
}
```

- 2b. On failure or redirection:

- Upon failure, the NRF shall return "400 Bad Request" status code, including in the response content a JSON object that provides details about the specific error(s) that occurred.
- In the case of redirection, the NRF shall return 3xx status code, which shall contain a Location header with an URI pointing to the endpoint of another NRF service instance.

6 API Definitions

6.1 Nnrf_NFManagement Service API

6.1.1 API URI

URIs of this API shall have the following root:

```
{apiRoot}/{apiName}/{apiVersion}
```

where "apiRoot" is defined in clause 4.4.1 of 3GPP TS 29.501 [5], the "apiName" shall be set to "nnrf-nfm" and the "apiVersion" shall be set to "v1" for the current version of this specification.

6.1.2 Usage of HTTP

6.1.2.1 General

HTTP/2, as defined in IETF RFC 9113 [9], shall be used as specified in clause 5 of 3GPP TS 29.500 [4].

HTTP/2 shall be transported as specified in clause 5.3 of 3GPP TS 29.500 [4].

HTTP messages and bodies for the Nnrf_NFManagement service shall comply with the OpenAPI [10] specification contained in Annex A.

6.1.2.2 HTTP standard headers

6.1.2.2.1 General

The mandatory standard HTTP headers as specified in clause 5.2.2.2 of 3GPP TS 29.500 [4] shall be supported.

6.1.2.2.2 Content type

The following content types shall be supported:

- JSON, as defined in IETF RFC 8259 [22], shall be used as content type of the HTTP bodies specified in the present specification as indicated in clause 5.4 of 3GPP TS 29.500 [4].
- The Problem Details JSON Object (IETF RFC 9457 [11]). The use of the Problem Details JSON object in a HTTP response body shall be signalled by the content type "application/problem+json".
- JSON Patch (IETF RFC 6902 [13]). The use of the JSON Patch format in a HTTP request body shall be signalled by the content type "application/json-patch+json".
- The 3GPP hypermedia format as defined in 3GPP TS 29.501 [5]. The use of the 3GPP hypermedia format in a HTTP response body shall be signalled by the content type "application/3gppHal+json".

6.1.2.2.3 Accept-Encoding

The NRF should support gzip coding (see IETF RFC 1952 [30]) in HTTP requests and responses and indicate so in the Accept-Encoding header, as described in clause 6.9 of 3GPP TS 29.500 [4].

NF Service Consumers of the NFManagement API should support gzip coding in HTTP requests and responses and they should support gzip coding in the reception of notification requests sent by the NRF.

6.1.2.2.4 ETag

An "ETag" (entity-tag) header should be included in HTTP responses for resource creation and resource update, as described in IETF RFC 9110 [40], clause 8.8.3. It shall contain a server-generated strong validator, that allows further

matching of this value (included in subsequent client requests) with a given resource representation stored in the server or in a cache.

An "Etag" (entity-tag) header shall not be included in HTTP responses for Heart-Beat operation.

6.1.2.2.5 If-Match

An NF Service Consumer should issue conditional PATCH request towards NRF, by including an If-Match header in HTTP requests, as described in IETF RFC 9110 [40], clause 13.1.1, containing an entity tags received in latest response for the same resource.

An NF Service Consumer shall not include If-Match header in HTTP requests for Heart-Beat operation.

6.1.2.3 HTTP custom headers

6.1.2.3.1 General

In this release of this specification, no custom headers specific to the Nnrf_NFManagement service are defined. For 3GPP specific HTTP custom headers used across all service-based interfaces, see clause 5.2.3 of 3GPP TS 29.500 [4].

6.1.3 Resources

6.1.3.1 Overview

The structure of the Resource URIs of the NFManagement service is shown in figure 6.1.3.1-1.

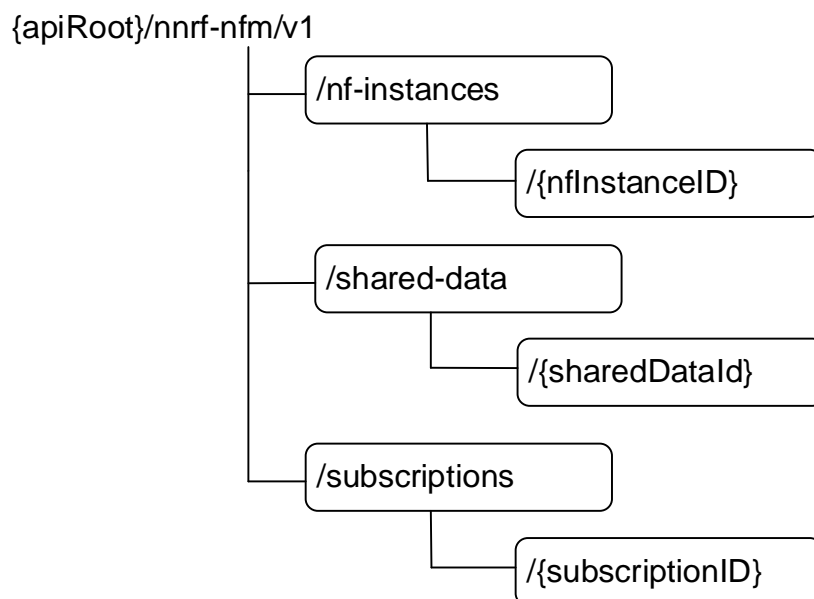

Figure 6.1.3.1-1: Resource URI structure of the NFManagement API

Table 6.1.3.1-1 provides an overview of the resources and applicable HTTP methods.

Table 6.1.3.1-1: Resources and methods overview

Resource name	Resource URI	HTTP method or custom operation	Description
nf-instances (Store)	/nf-instances	GET	Read a collection of NF Instances.
		OPTIONS	Discover the communication options supported by the NRF for this resource.
nf-instance (Document)	/nf-instances/{nfInstanceId}	GET	Read the profile of a given NF Instance.
		PUT	Register in NRF a new NF Instance, or replace the profile of an existing NF Instance, by providing an NF profile.
		PATCH	Modify the NF profile of an existing NF Instance.
		DELETE	Deregister from NRF a given NF Instance.
shared-data-store (Store)	/shared-data	GET	Read a collection of Shared Data
Shared-data (Document)	/shared-data/{sharedDataId}	GET	Read Shared Data
		PUT	Register in NRF new Shared Data, or replace the Shared Data, by providing Shared Data
		PATCH	Modify existing Shared Data
		DELETE	Delete Shared Data from the NRF
subscriptions (Collection)	/subscriptions	POST	Creates a new subscription in NRF to newly registered NF Instances. Or, if the "Shared-Data-Retrieval" feature is supported, creates a new subscription in NRF to shared data change notifications.
subscription (Document)	/subscriptions/{subscriptionID}	PATCH	Updates an existing subscription in NRF. Or, if the "Shared-Data-Retrieval" feature is supported, updates an existing subscription in NRF to shared data change notifications.
		DELETE	Deletes an existing subscription from NRF. Or, if the "Shared-Data-Retrieval" feature is supported, deletes an existing subscription in NRF to shared data change notifications.
Notification Callback	{nfStatusNotificationUri}	POST	Notify about newly created NF Instances, or about changes of the profile of a given NF Instance. Or, if the "Shared-Data-Retrieval" feature is supported, notify about shared data changes.

6.1.3.2 Resource: nf-instances (Store)

6.1.3.2.1 Description

This resource represents a collection of the different NF instances registered in the NRF.

This resource is modelled as the Store resource archetype (see clause C.3 of 3GPP TS 29.501 [5]).

6.1.3.2.2 Resource Definition

Resource URI: **{apiRoot}/nnrf-nfm/v1/nf-instances**

This resource shall support the resource URI variables defined in table 6.1.3.2.2-1.

Table 6.1.3.2.2-1: Resource URI variables for this resource

Name	Data type	Definition
apiRoot	string	See clause 6.1.1

6.1.3.2.3 Resource Standard Methods

6.1.3.2.3.1 GET

This method retrieves a list of all NF instances currently registered in the NRF. This method shall support the URI query parameters specified in table 6.1.3.2.3.1-1.

Table 6.1.3.2.3.1-1: URI query parameters supported by the GET method on this resource

Name	Data type	P	Cardinality	Description
nf-type	NFType	O	0..1	The type of NF to restrict the list of returned NF Instances.
limit	integer	C	0..1	Maximum number of items to be returned in this query; this parameter should only be provided if the "nf-type" parameter is provided. If the "page-number" and "page-size" parameters are present, the "limit" parameter shall be absent.
page-number	integer	C	0..1	This parameter shall be present if the NF Service Consumer requests the retrieval of NF Instance URIs based on <i>pages</i> (i.e. a subset of the total number of items). If present, it shall contain the page number to retrieve. The total number of pages available, N, can be determined based on the "totalItemCount" attribute of the response (see clause 6.1.6.2.25) as: $N = \text{ceiling}(\text{totalItemCount} / \text{page-size})$ The first page shall be identified by "page-number" set to 1. Minimum: 1 (See NOTE 1, NOTE 2)
page-size	integer	C	0..1	This parameter shall be present if the NF Service Consumer requests the retrieval of NF Instance URIs based on <i>pages</i> . If present, it shall contain the maximum number of items to be returned per page. Minimum: 1 (See NOTE 1, NOTE 2)
NOTE 1: The parameters "page-number" and "page-size" shall be either both present, or both absent.				
NOTE 2: If the NRF supports the pagination query parameters, it shall ensure that the response to these requests always return the same set of items for the same query parameters, as long as the ETag of the collection resource is not changed.				

EXAMPLE: The NF Service Consumer can retrieve the whole set of NF Instances URIs available in the NRF, using paginated requests, by issuing multiple GET requests, as:

GET .../nnrf-nfm/v1/nf-instances?page-number=1&page-size=100

(returns items from 0 to 99)

GET .../nnrf-nfm/v1/nf-instances?page-number=2&page-size=100

(returns items from 100 to 199)

...

GET .../nnrf-nfm/v1/nf-instances?page-number=N&page-size=100

(returns items from (N-1)*100 up to totalItemCount-1)

where the first N-1 requests return 100 items each, and the last request (page-number=N) returns between 1 and 100 items.

The NF Service Consumer can also retrieve arbitrary page numbers and page sizes, independently from any prior request previously issued; e.g.

GET .../nnrf-nfm/v1/nf-instances?page-number=4&page-size=50

(returns items from 150 to 199; assuming totalItemCount >= 200)

This method shall support the request data structures specified in table 6.1.3.2.3.1-2 and the response data structures and response codes specified in table 6.1.3.2.3.1-3.

Table 6.1.3.2.3.1-2: Data structures supported by the GET Request Body on this resource

Data type	P	Cardinality	Description
n/a			

Table 6.1.3.2.3.1-3: Data structures supported by the GET Response Body on this resource

Data type	P	Cardinality	Response codes	Description
UriList	M	1	200 OK	The response body contains a "_links" object containing the URI of each registered NF in the NRF. If there are no NFs to return in the query result (e.g., because there are no registered NFs in the NRF, or because there are no matching NFs of the type specified in the "nf-type" query parameter, currently registered in the NRF), the "_links" attribute may be absent or, if present, it shall contain only the "self" attribute (i.e. the "item" attribute shall be absent).
RedirectResponse	O	0..1	307 Temporary Redirect	The NRF shall generate a Location header field containing a URI pointing to the endpoint of another NRF service instance to which the request should be sent. If an SCP redirects the message to another SCP then the location header field shall contain the same URI or a different URI pointing to the endpoint of the NF service producer to which the request should be sent.
RedirectResponse	O	0..1	308 Permanent Redirect	The NRF shall generate a Location header field containing a URI pointing to the endpoint of another NRF service instance to which the request should be sent. If an SCP redirects the message to another SCP then the location header field shall contain the same URI or a different URI pointing to the endpoint of the NF service producer to which the request should be sent.
NOTE:	The mandatory HTTP error status codes for the GET method listed in Table 5.2.7.1-1 of 3GPP TS 29.500 [4] other than those specified in the table above also apply, with a ProblemDetails data type (see clause 5.2.7 of 3GPP TS 29.500 [4]).			

Table 6.1.3.2.3.1-4: Headers supported by the 307 Response Code on this resource

Name	Data type	P	Cardinality	Description
Location	string	M	1	A URI pointing to the endpoint of the NRF service instance to which the request should be sent

Table 6.1.3.2.3.1-5: Headers supported by the 308 Response Code on this resource

Name	Data type	P	Cardinality	Description
Location	string	M	1	A URI pointing to the endpoint of the NRF service instance to which the request should be sent

Table 6.1.3.2.3.1-6: Headers supported by the 200 Response Code on this resource

Name	Data type	P	Cardinality	Description
ETag	string	C	0..1	Entity Tag containing a strong validator, described in IETF RFC 9110 [40], clause 8.8.3. In this resource, this header shall contain a different value if the list of NF instances (regardless of the contents of each NF instance profile) stored in the NRF has changed; i.e. it shall change if there are new instances added to the NRF, or if existing instances are removed from the NRF. If the NF Service Consumer, during the course of successive paginated requests, receives a different ETag value, it shall conclude that the list of NF Instances in the NRF has changed, so it may re-start the paginated NFListRetrieval service operation.

6.1.3.2.3.2 OPTIONS

This method queries the communication options supported by the NRF (see clause 6.9 of 3GPP TS 29.500 [4]). This method shall support the URI query parameters specified in table 6.1.3.2.3.2-1.

Table 6.1.3.2.3.2-1: URI query parameters supported by the OPTIONS method on this resource

Name	Data type	P	Cardinality	Description
n/a				

This method shall support the request data structures specified in table 6.1.3.2.3.2-2 and the response data structures and response codes specified in table 6.1.3.2.3.2-3.

Table 6.1.3.2.3.2-2: Data structures supported by the OPTIONS Request Body on this resource

Data type	P	Cardinality	Description
n/a			

Table 6.1.3.2.3.2-3: Data structures supported by the OPTIONS Response Body on this resource

Data type	P	Cardinality	Response codes	Description
n/a			204 No Content	
OptionsResponse	M	1	200 OK	
RedirectResponse	O	0..1	307 Temporary Redirect	The NRF shall generate a Location header field containing a URI pointing to the endpoint of another NRF service instance to which the request should be sent. If an SCP redirects the message to another SCP then the location header field shall contain the same URI or a different URI pointing to the endpoint of the NF service producer to which the request should be sent.
RedirectResponse	O	0..1	308 Permanent Redirect	The NRF shall generate a Location header field containing a URI pointing to the endpoint of another NRF service instance to which the request should be sent. If an SCP redirects the message to another SCP then the location header field shall contain the same URI or a different URI pointing to the endpoint of the NF service producer to which the request should be sent.
ProblemDetails	O	0..1	405 Method Not Allowed	
ProblemDetails	O	0..1	501 Not Implemented	
NOTE: The mandatory HTTP error status codes for the OPTIONS method listed in Table 5.2.7.1-1 of 3GPP TS 29.500 [4] other than those specified in the table above also apply, with a ProblemDetails data type (see clause 5.2.7 of 3GPP TS 29.500 [4]).				

Table 6.1.3.2.3.2-4: Headers supported by the 200 Response Code on this resource

Name	Data type	P	Cardinality	Description
Accept-Encoding	string	O	0..1	Accept-Encoding, described in IETF RFC 9110 [40]

Table 6.1.3.2.3.2-5: Headers supported by the 307 Response Code on this resource

Name	Data type	P	Cardinality	Description
Location	string	M	1	A URI pointing to the endpoint of the NRF service instance to which the request should be sent

Table 6.1.3.2.3.2-6: Headers supported by the 308 Response Code on this resource

Name	Data type	P	Cardinality	Description
Location	string	M	1	A URI pointing to the endpoint of the NRF service instance to which the request should be sent

6.1.3.2.4 Resource Custom Operations

There are no resource custom operations for the Nnrf_NFManagement service in this release of the specification.

6.1.3.3 Resource: nf-instance (Document)

6.1.3.3.1 Description

This resource represents a single NF instance.

6.1.3.3.2 Resource Definition

Resource URI: {apiRoot}/nrf-nfm/v1/nf-instances/{nfInstanceID}

This resource shall support the resource URI variables defined in table 6.1.3.3.2-1.

Table 6.1.3.3.2-1: Resource URI variables for this resource

Name	Data type	Definition
apiRoot	string	See clause 6.1.1
nfInstanceID	NfInstanceID	Represents a specific NF Instance

6.1.3.3.3 Resource Standard Methods

6.1.3.3.3.1 GET

This method retrieves the NF Profile of a given NF instance.

This method shall support the URI query parameters specified in table 6.1.3.3.3.1-1.

Table 6.1.3.3.3.1-1: URI query parameters supported by the GET method on this resource

Name	Data type	P	Cardinality	Description
requester-features	SupportedFeatures	C	0..1	Nrf_NFManagement features supported by the NF Service Consumer that is invoking the Nrf_NFManagement service. See clause 6.1.9. This IE shall be included if at least one feature is supported by the NF Service Consumer.

This method shall support the request data structures specified in table 6.1.3.3.3.1-2 and the response data structures and response codes specified in table 6.1.3.3.3.1-3.

Table 6.1.3.3.3.1-2: Data structures supported by the GET Request Body on this resource

Data type	P	Cardinality	Description
n/a			

Table 6.1.3.3.3.1-3: Data structures supported by the GET Response Body on this resource

Data type	P	Cardinality	Response codes	Description
NFProfile	M	1	200 OK	The response body contains the profile of a given NF Instance.
RedirectResponse	O	0..1	307 Temporary Redirect	The NRF shall generate a Location header field containing a URI pointing to the endpoint of another NRF service instance to which the request should be sent. If an SCP redirects the message to another SCP then the location header field shall contain the same URI or a different URI pointing to the endpoint of the NF service producer to which the request should be sent.
RedirectResponse	O	0..1	308 Permanent Redirect	The NRF shall generate a Location header field containing a URI pointing to the endpoint of another NRF service instance to which the request should be sent. If an SCP redirects the message to another SCP then the location header field shall contain the same URI or a different URI pointing to the endpoint of the NF service producer to which the request should be sent.
NOTE: The mandatory HTTP error status codes for the GET method listed in Table 5.2.7.1-1 of 3GPP TS 29.500 [4] other than those specified in the table above also apply, with a ProblemDetails data type (see clause 5.2.7 of 3GPP TS 29.500 [4]).				

Table 6.1.3.3.3.1-4: Headers supported by the 307 Response Code on this resource

Name	Data type	P	Cardinality	Description
Location	string	M	1	A URI pointing to the endpoint of the NRF service instance to which the request should be sent

Table 6.1.3.3.3.1-5: Headers supported by the 308 Response Code on this resource

Name	Data type	P	Cardinality	Description
Location	string	M	1	A URI pointing to the endpoint of the NRF service instance to which the request should be sent

Table 6.1.3.3.3.1-6: Headers supported by the 200 Response Code on this resource

Name	Data type	P	Cardinality	Description
ETag	string	C	0..1	Entity Tag containing a strong validator, described in IETF RFC 9110 [40], clause 8.8.3

6.1.3.3.3.2 PUT

This method registers a new NF instance in the NRF, or replaces completely an existing NF instance.

This method shall support the URI query parameters specified in table 6.1.3.3.3.2-1.

Table 6.1.3.3.3.2-1: URI query parameters supported by the PUT method on this resource

Name	Data type	P	Cardinality	Description
n/a				

This method shall support the request data structures specified in table 6.1.3.3.3.2-2 and the response data structures and response codes specified in table 6.1.3.3.3.2-3.

Table 6.1.3.3.3.2-2: Data structures supported by the PUT Request Body on this resource

Data type	P	Cardinality	Description
NFProfile	M	1	Profile of the NF Instance to be registered, or completely replaced, in NRF.

Table 6.1.3.3.3.2-3: Data structures supported by the PUT Response Body on this resource

Data type	P	Cardinality	Response codes	Description
NFProfile	M	1	200 OK	This case represents the successful replacement of an existing NF Instance profile. Upon success, a response body is returned containing the replaced profile of the NF Instance.
NFProfile	M	1	201 Created	This case represents the successful registration of a new NF Instance. Upon success, a response body is returned containing the newly created NF Instance profile; also, the HTTP response shall include a "Location" HTTP header that contains the resource URI of the created NF Instance.
RedirectResponse	O	0..1	307 Temporary Redirect	The NRF shall generate a Location header field containing a URI pointing to the endpoint of another NRF service instance to which the request should be sent. If an SCP redirects the message to another SCP then the location header field shall contain the same URI or a different URI pointing to the endpoint of the NF service producer to which the request should be sent.
RedirectResponse	O	0..1	308 Permanent Redirect	The NRF shall generate a Location header field containing a URI pointing to the endpoint of another NRF service instance to which the request should be sent. If an SCP redirects the message to another SCP then the location header field shall contain the same URI or a different URI pointing to the endpoint of the NF service producer to which the request should be sent.
NFProfileRegistrationError	O	0..1	400 Bad Request	When used to report the application error SHARED_DATA_ID_UNKNOWN, the NFProfileRegistrationError shall include a list of shared data IDs that are unknown.
NOTE: The mandatory HTTP error status codes for the PUT method listed in Table 5.2.7.1-1 of 3GPP TS 29.500 [4] other than those specified in the table above also apply, with a ProblemDetails data type (see clause 5.2.7 of 3GPP TS 29.500 [4]).				

Table 6.1.3.3.3.2-4: Headers supported by the PUT method on this resource

Name	Data type	P	Cardinality	Description
Content-Encoding	string	O	0..1	Content-Encoding, described in IETF RFC 9110 [40]

Table 6.1.3.3.3.2-5: Headers supported by the 200 Response Code on this resource

Name	Data type	P	Cardinality	Description
Accept-Encoding	string	O	0..1	Accept-Encoding, described in IETF RFC 9110 [40]
ETag	string	C	0..1	Entity Tag containing a strong validator, described in IETF RFC 9110 [40], clause 8.8.3

Table 6.1.3.3.3.2-6: Headers supported by the 201 Response Code on this resource

Name	Data type	P	Cardinality	Description
Location	string	M	1	Contains the URI of the newly created resource, according to the structure: {apiRoot}/nnrf-nfm/v1/nf-instances/{nfInstanceId}
Accept-Encoding	string	O	0..1	Accept-Encoding, described in IETF RFC 9110 [40]
ETag	string	C	0..1	Entity Tag containing a strong validator, described in IETF RFC 9110 [40], clause 8.8.3

Table 6.1.3.3.3.2-7: Headers supported by the 307 Response Code on this resource

Name	Data type	P	Cardinality	Description
Location	string	M	1	A URI pointing to the endpoint of the NRF service instance to which the request should be sent

Table 6.1.3.3.3.2-8: Headers supported by the 308 Response Code on this resource

Name	Data type	P	Cardinality	Description
Location	string	M	1	A URI pointing to the endpoint of the NRF service instance to which the request should be sent

6.1.3.3.3.3 PATCH

This method updates partially the profile of a given NF instance.

This method shall support the URI query parameters specified in table 6.1.3.3.3.3-1.

Table 6.1.3.3.3.3-1: URI query parameters supported by the PATCH method on this resource

Name	Data type	P	Cardinality	Description
n/a				

This method shall support the request data structures specified in table 6.1.3.3.3.3-2 and the response data structures and response codes specified in table 6.1.3.3.3.3-3.

Table 6.1.3.3.3.3-2: Data structures supported by the PATCH Request Body on this resource

Data type	P	Cardinality	Description
array(PatchItem)	M	1	It contains the list of changes to be made to the profile of the NF Instance, according to the JSON PATCH format specified in IETF RFC 6902 [13].

Table 6.1.3.3.3-3: Data structures supported by the PATCH Response Body on this resource

Data type	P	Cardinality	Response codes	Description
NFProfile	M	1	200 OK	Upon success, a response body is returned containing the updated profile of the NF Instance.
n/a			204 No Content	Successful response sent when there is no need to provide a full updated profile of the NF Instance (e.g., in the partial update procedure when all update operations are accepted by the NRF, as described in clause 5.2.2.3.1, or in the Heart-Beat operation response described in clause 5.2.2.3.2).
RedirectResponse	O	0..1	307 Temporary Redirect	The NRF shall generate a Location header field containing a URI pointing to the endpoint of another NRF service instance to which the request should be sent. If an SCP redirects the message to another SCP then the location header field shall contain the same URI or a different URI pointing to the endpoint of the NF service producer to which the request should be sent.
RedirectResponse	O	0..1	308 Permanent Redirect	The NRF shall generate a Location header field containing a URI pointing to the endpoint of another NRF service instance to which the request should be sent. If an SCP redirects the message to another SCP then the location header field shall contain the same URI or a different URI pointing to the endpoint of the NF service producer to which the request should be sent.
ProblemDetails	O	0..1	412 Precondition Failed	The modification has failed due to the precondition in the request is not fulfilled.
ProblemDetails	O	0..1	409 Conflict	The modification has failed due to confliction (e.g. to change a value of a non-existing IE).
NOTE: The mandatory HTTP error status codes for the PATCH method listed in Table 5.2.7.1-1 of 3GPP TS 29.500 [4] other than those specified in the table above also apply, with a ProblemDetails data type (see clause 5.2.7 of 3GPP TS 29.500 [4]).				

Table 6.1.3.3.3-4: Headers supported by the 307 Response Code on this resource

Name	Data type	P	Cardinality	Description
Location	string	M	1	A URI pointing to the endpoint of the NRF service instance to which the request should be sent

Table 6.1.3.3.3-5: Headers supported by the 308 Response Code on this resource

Name	Data type	P	Cardinality	Description
Location	string	M	1	A URI pointing to the endpoint of the NRF service instance to which the request should be sent

Table 6.1.3.3.3-6: Headers supported by the PATCH method on this resource

Name	Data type	P	Cardinality	Description
If-Match	string	C	0..1	Validator for conditional requests, as described in IETF RFC 9110 [40], clause 13.1.1.

Table 6.1.3.3.3-7: Headers supported by the 200 Response Code on this resource

Name	Data type	P	Cardinality	Description
ETag	string	C	0..1	Entity Tag containing a strong validator, described in IETF RFC 9110 [40], clause 8.8.3.

6.1.3.3.3.4 DELETE

This method deregisters an existing NF instance from the NRF.

This method shall support the URI query parameters specified in table 6.1.3.3.3.4-1.

Table 6.1.3.3.3.4-1: URI query parameters supported by the DELETE method on this resource

Name	Data type	P	Cardinality	Description
n/a				

This method shall support the request data structures specified in table 6.1.3.3.3.4-2 and the response data structures and response codes specified in table 6.1.3.3.3.4-3.

Table 6.1.3.3.3.4-2: Data structures supported by the DELETE Request Body on this resource

Data type	P	Cardinality	Description
n/a			

Table 6.1.3.3.3.4-3: Data structures supported by the DELETE Response Body on this resource

Data type	P	Cardinality	Response codes	Description
n/a			204 No Content	
RedirectResponse	O	0..1	307 Temporary Redirect	The NRF shall generate a Location header field containing a URI pointing to the endpoint of another NRF service instance to which the request should be sent. If an SCP redirects the message to another SCP then the location header field shall contain the same URI or a different URI pointing to the endpoint of the NF service producer to which the request should be sent.
RedirectResponse	O	0..1	308 Permanent Redirect	The NRF shall generate a Location header field containing a URI pointing to the endpoint of another NRF service instance to which the request should be sent. If an SCP redirects the message to another SCP then the location header field shall contain the same URI or a different URI pointing to the endpoint of the NF service producer to which the request should be sent.
NOTE: The mandatory HTTP error status codes for the DELETE method listed in Table 5.2.7.1-1 of 3GPP TS 29.500 [4] other than those specified in the table above also apply, with a ProblemDetails data type (see clause 5.2.7 of 3GPP TS 29.500 [4]).				

Table 6.1.3.3.3.4-4: Headers supported by the 307 Response Code on this resource

Name	Data type	P	Cardinality	Description
Location	string	M	1	A URI pointing to the endpoint of the NRF service instance to which the request should be sent

Table 6.1.3.3.3.4-5: Headers supported by the 308 Response Code on this resource

Name	Data type	P	Cardinality	Description
Location	string	M	1	A URI pointing to the endpoint of the NRF service instance to which the request should be sent

6.1.3.4 Resource: subscriptions (Collection)

6.1.3.4.1 Description

This resource represents a collection of subscriptions of NF Instances to newly registered NF Instances.

6.1.3.4.2 Resource Definition

Resource URI: **{apiRoot}/nnrf-nfm/v1/subscriptions**

This resource shall support the resource URI variables defined in table 6.1.3.4.2-1.

Table 6.1.3.4.2-1: Resource URI variables for this resource

Name	Data type	Definition
apiRoot	string	See clause 6.1.1

6.1.3.4.3 Resource Standard Methods

6.1.3.4.3.1 POST

This method creates a new subscription. This method shall support the URI query parameters specified in table 6.1.3.4.3.1-1.

Table 6.1.3.4.3.1-1: URI query parameters supported by the POST method on this resource

Name	Data type	P	Cardinality	Description
n/a				

This method shall support the request data structures specified in table 6.1.3.4.3.1-2 and the response data structures and response codes specified in table 6.1.3.4.3.1-3.

Table 6.1.3.4.3.1-2: Data structures supported by the POST Request Body on this resource

Data type	P	Cardinality	Description
SubscriptionData	M	1	The request body contains the input parameters for the subscription. These parameters include, e.g.: - Target NF type - Target Service Name - Callback URI of the Requester NF

Table 6.1.3.4.3.1-3: Data structures supported by the POST Response Body on this resource

Data type	P	Cardinality	Response codes	Description
SubscriptionData	M	1	201 Created	This case represents the successful creation of a subscription. Upon success, the HTTP response shall include a "Location" HTTP header that contains the resource URI of the created resource.
RedirectResponse	O	0..1	307 Temporary Redirect	The NRF shall generate a Location header field containing a URI pointing to the endpoint of another NRF service instance to which the request should be sent. If an SCP redirects the message to another SCP then the location header field shall contain the same URI or a different URI pointing to the endpoint of the NF service producer to which the request should be sent.
RedirectResponse	O	0..1	308 Permanent Redirect	The NRF shall generate a Location header field containing a URI pointing to the endpoint of another NRF service instance to which the request should be sent. If an SCP redirects the message to another SCP then the location header field shall contain the same URI or a different URI pointing to the endpoint of the NF service producer to which the request should be sent.
ProblemDetails	O	0..1	400 Bad Request	The response body contains the error reason of the request message. The "cause" attribute shall be set to "INVALID_CLIENT" if some or all attributes of the NF Service Consumer in the subscription request do not match the requester information in, e.g. its public key certificate.
ProblemDetails	O	0..1	403 Forbidden	The "cause" attribute may be used to indicate one of the following application errors: - SUBSCRIPTION_NOT_ALLOWED
NOTE: The mandatory HTTP error status codes for the POST method listed in Table 5.2.7.1-1 of 3GPP TS 29.500 [4] other than those specified in the table above also apply, with a ProblemDetails data type (see clause 5.2.7 of 3GPP TS 29.500 [4]).				

Table 6.1.3.4.3.1-4: Headers supported by the 201 Response Code on this resource

Name	Data type	P	Cardinality	Description
Location	string	M	1	Contains the URI of the newly created resource, according to the structure: {apiRoot}/nrf-nfm/v1/subscriptions/{subscriptionId}

Table 6.1.3.4.3.1-5: Headers supported by the 307 Response Code on this resource

Name	Data type	P	Cardinality	Description
Location	string	M	1	A URI pointing to the endpoint of the NRF service instance to which the request should be sent

Table 6.1.3.4.3.1-6: Headers supported by the 308 Response Code on this resource

Name	Data type	P	Cardinality	Description
Location	string	M	1	A URI pointing to the endpoint of the NRF service instance to which the request should be sent

6.1.3.5 Resource: subscription (Document)

6.1.3.5.1 Description

This resource represents an individual subscription of a given NF Instance to newly registered NF Instances.

6.1.3.5.2 Resource Definition

Resource URI: {apiRoot}/nnrf-nfm/v1/subscriptions/{subscriptionID}

This resource shall support the resource URI variables defined in table 6.1.3.5.2-1.

Table 6.1.3.5.2-1: Resource URI variables for this resource

Name	Data type	Definition
apiRoot	string	See clause 6.1.1
subscriptionID	string	Represents a specific subscription

6.1.3.5.3 Resource Standard Methods

6.1.3.5.3.1 DELETE

This method terminates an existing subscription. This method shall support the URI query parameters specified in table 6.1.3.5.3.1-1.

Table 6.1.3.5.3.1-1: URI query parameters supported by the DELETE method on this resource

Name	Data type	P	Cardinality	Description
n/a				

This method shall support the request data structures specified in table 6.1.3.5.3.1-2 and the response data structures and response codes specified in table 6.1.3.5.3.1-3.

Table 6.1.3.5.3.1-2: Data structures supported by the DELETE Request Body on this resource

Data type	P	Cardinality	Description
n/a			

Table 6.1.3.5.3.1-3: Data structures supported by the DELETE Response Body on this resource

Data type	P	Cardinality	Response codes	Description
n/a			204 No Content	
RedirectResponse	O	0..1	307 Temporary Redirect	The NRF shall generate a Location header field containing a URI pointing to the endpoint of another NRF service instance to which the request should be sent. If an SCP redirects the message to another SCP then the location header field shall contain the same URI or a different URI pointing to the endpoint of the NF service producer to which the request should be sent.
RedirectResponse	O	0..1	308 Permanent Redirect	The NRF shall generate a Location header field containing a URI pointing to the endpoint of another NRF service instance to which the request should be sent. If an SCP redirects the message to another SCP then the location header field shall contain the same URI or a different URI pointing to the endpoint of the NF service producer to which the request should be sent.
NOTE: The mandatory HTTP error status codes for the DELETE method listed in Table 5.2.7.1-1 of 3GPP TS 29.500 [4] other than those specified in the table above also apply, with a ProblemDetails data type (see clause 5.2.7 of 3GPP TS 29.500 [4]).				

Table 6.1.3.5.3.1-4: Headers supported by the 307 Response Code on this resource

Name	Data type	P	Cardinality	Description
Location	string	M	1	A URI pointing to the endpoint of the NRF service instance to which the request should be sent

Table 6.1.3.5.3.1-5: Headers supported by the 308 Response Code on this resource

Name	Data type	P	Cardinality	Description
Location	string	M	1	A URI pointing to the endpoint of the NRF service instance to which the request should be sent

6.1.3.5.3.2 PATCH

This method updates an existing subscription. This method shall support the URI query parameters specified in table 6.1.3.5.3.2-1.

Table 6.1.3.5.3.2-1: URI query parameters supported by the PATCH method on this resource

Name	Data type	P	Cardinality	Description
n/a				

This method shall support the request data structures specified in table 6.1.3.5.3.2-2 and the response data structures and response codes specified in table 6.1.3.5.3.2-3.

Table 6.1.3.5.3.2-2: Data structures supported by the PATCH Request Body on this resource

Data type	P	Cardinality	Description
array(PatchItem)	M	1..N	It contains the list of changes to be made to an individual subscription, according to the JSON PATCH format specified in IETF RFC 6902 [13].

Table 6.1.3.5.3.2-3: Data structures supported by the PATCH Response Body on this resource

Data type	P	Cardinality	Response codes	Description
SubscriptionData	M	1	200 OK	
n/a			204 No Content	
RedirectResponse	O	0..1	307 Temporary Redirect	The NRF shall generate a Location header field containing a URI pointing to the endpoint of another NRF service instance to which the request should be sent. If an SCP redirects the message to another SCP then the location header field shall contain the same URI or a different URI pointing to the endpoint of the NF service producer to which the request should be sent.
RedirectResponse	O	0..1	308 Permanent Redirect	The NRF shall generate a Location header field containing a URI pointing to the endpoint of another NRF service instance to which the request should be sent. If an SCP redirects the message to another SCP then the location header field shall contain the same URI or a different URI pointing to the endpoint of the NF service producer to which the request should be sent.

Table 6.1.3.5.3.2-4: Headers supported by the 307 Response Code on this resource

Name	Data type	P	Cardinality	Description
Location	string	M	1	A URI pointing to the endpoint of the NRF service instance to which the request should be sent

Table 6.1.3.5.3.2-5: Headers supported by the 308 Response Code on this resource

Name	Data type	P	Cardinality	Description
Location	string	M	1	A URI pointing to the endpoint of the NRF service instance to which the request should be sent

6.1.3.6 Resource: shared-data (Document)

6.1.3.6.1 Description

This resource represents the SharedData identified by a sharedDataId.

6.1.3.6.2 Resource Definition

Resource URI: **{apiRoot}/nnrf-nfm/<apiVersion>/shared-data/{sharedDataId}**

This resource shall support the resource URI variables defined in table 6.1.3.6.2-1.

Table 6.1.3.6.2-1: Resource URI variables for this resource

Name	Data type	Definition
apiRoot	string	See clause 6.1.1
sharedDataId	string	String uniquely identifying SharedData. The format of the SharedDataId shall be a Universally Unique Identifier (UUID) version 4, as described in IETF RFC 4122 [18]. The hexadecimal letters should be formatted as lower-case characters by the sender, and they shall be handled as case-insensitive by the receiver. Example: "4ace9d34-2c69-4f99-92d5-a73a3fe8e23b"

6.1.3.6.3 Resource Standard Methods

6.1.3.6.3.1 GET

This method retrieves the Shared Data identified by the sharedDataId.

This method shall support the URI query parameters specified in table 6.1.3.6.3.1-1.

Table 6.1.3.6.3.1-1: URI query parameters supported by the GET method on this resource

Name	Data type	P	Cardinality	Description
requester-features	SupportedFeatures	C	0..1	Nnrf_NFManagement features supported by the NF Service Consumer that is invoking the Nnrf_NFManagement service. See clause 6.1.9. This IE shall be included if at least one feature is supported by the NF Service Consumer.

This method shall support the request data structures specified in table 6.1.3.6.3.1-2 and the response data structures and response codes specified in table 6.1.3.6.3.1-3.

Table 6.1.3.6.3.1-2: Data structures supported by the GET Request Body on this resource

Data type	P	Cardinality	Description
n/a			

Table 6.1.3.6.3.1-3: Data structures supported by the GET Response Body on this resource

Data type	P	Cardinality	Response codes	Description
SharedData	M	1	200 OK	The response body contains the shared data of a given sharedDataId.
RedirectResponse	O	0..1	307 Temporary Redirect	Temporary redirection.
RedirectResponse	O	0..1	308 Permanent Redirect	Permanent redirection.
ProblemDetails	O	0..1	400 Bad Request	The "cause" attribute may be used to indicate one of the following application errors: - SHARED_DATA_ID_UNKNOWN - SHARED_DATA_NOT_CONFIGURED
NOTE: The mandatory HTTP error status codes for the GET method listed in Table 5.2.7.1-1 of 3GPP TS 29.500 [4] other than those specified in the table above also apply, with a ProblemDetails data type (see clause 5.2.7 of 3GPP TS 29.500 [4]).				

Table 6.1.3.6.3.1-4: Headers supported by the 307 Response Code on this resource

Name	Data type	P	Cardinality	Description
Location	string	M	1	An alternative URI of the resource located on an alternative service instance within the same NRF or NRF (service) set. For the case when a request is redirected to the same target resource via a different SCP, see clause 6.10.9.1 in 3GPP TS 29.500 [4].

Table 6.1.3.6.3.1-5: Headers supported by the 308 Response Code on this resource

Name	Data type	P	Cardinality	Description
Location	string	M	1	An alternative URI of the resource located on an alternative service instance within the same NRF or NRF (service) set. For the case when a request is redirected to the same target resource via a different SCP, see clause 6.10.9.1 in 3GPP TS 29.500 [4].

Table 6.1.3.6.3.1-6: Headers supported by the 200 Response Code on this resource

Name	Data type	P	Cardinality	Description
Etag	string	C	0..1	Entity Tag containing a strong validator, described in IETF RFC 9110 [40], clause 8.8.3

6.1.3.6.3.2 PUT

This method registers new Shared Data in the NRF, or replaces completely existing Shared Data.

This method shall support the URI query parameters specified in table 6.1.3.6.3.2-1.

Table 6.1.3.6.3.2-1: URI query parameters supported by the PUT method on this resource

Name	Data type	P	Cardinality	Description
n/a				

This method shall support the request data structures specified in table 6.1.3.6.3.2-2 and the response data structures and response codes specified in table 6.1.3.6.3.2-3.

Table 6.1.3.6.3.2-2: Data structures supported by the PUT Request Body on this resource

Data type	P	Cardinality	Description
SharedData	M	1	Shared Data to be registered, or completely replaced, in NRF.

Table 6.1.3.6.3.2-3: Data structures supported by the PUT Response Body on this resource

Data type	P	Cardinality	Response codes	Description
SharedData	M	1	200 OK	This case represents the successful replacement of existing Shared Data. Upon success, a response body is returned containing the replaced Shared Data.
n/a			204 No Content	This case represents the successful replacement of existing Shared Data.
SharedData	M	1	201 Created	This case represents the successful registration of new Shared Data. Upon success, a response body is returned containing the newly created Shared Data; also, the HTTP response shall include a "Location" HTTP header that contains the resource URI of the created Shared Data.
RedirectResponse	O	0..1	307 Temporary Redirect	Temporary redirection.
RedirectResponse	O	0..1	308 Permanent Redirect	Permanent redirection.
ProblemDetails	O	0..1	400 Bad Request	The "cause" attribute may be used to indicate one of the following application errors: - SHARED_DATA_ID_UNKNOWN - SHARED_DATA_NOT_CONFIGURED
ProblemDetails	O	0..1	403 Forbidden	The "cause" attribute may be used to indicate one of the following application errors: - SHARED_DATA_WRITE_NOT_ALLOWED
NOTE: The mandatory HTTP error status codes for the PUT method listed in Table 5.2.7.1-1 of 3GPP TS 29.500 [4] other than those specified in the table above also apply, with a ProblemDetails data type (see clause 5.2.7 of 3GPP TS 29.500 [4]).				

Table 6.1.3.6.3.2-4: Headers supported by the PUT method on this resource

Name	Data type	P	Cardinality	Description
Content-Encoding	string	O	0..1	Content-Encoding, described in IETF RFC 9110 [40]

Table 6.1.3.6.3.2-5: Headers supported by the 200 Response Code on this resource

Name	Data type	P	Cardinality	Description
Accept-Encoding	string	O	0..1	Accept-Encoding, described in IETF RFC 9110 [40]
ETag	string	C	0..1	Entity Tag containing a strong validator, described in IETF RFC 9110 [40], clause 8.8.3

Table 6.1.3.6.3.2-6: Headers supported by the 201 Response Code on this resource

Name	Data type	P	Cardinality	Description
Location	string	M	1	Contains the URI of the newly created resource, according to the structure: {apiRoot}/nnrf-nfm/<apiVersion>/shared-data/{sharedDataId}
Accept-Encoding	string	O	0..1	Accept-Encoding, described in IETF RFC 9110 [40]
ETag	string	C	0..1	Entity Tag containing a strong validator, described in IETF RFC 9110 [40], clause 8.8.3

Table 6.1.3.6.3.2-7: Headers supported by the 307 Response Code on this resource

Name	Data type	P	Cardinality	Description
Location	string	M	1	An alternative URI of the resource located on an alternative service instance within the same NRF or NRF (service) set. For the case when a request is redirected to the same target resource via a different SCP, see clause 6.10.9.1 in 3GPP TS 29.500 [4].

Table 6.1.3.6.3.2-8: Headers supported by the 308 Response Code on this resource

Name	Data type	P	Cardinality	Description
Location	string	M	1	An alternative URI of the resource located on an alternative service instance within the same NRF or NRF (service) set. For the case when a request is redirected to the same target resource via a different SCP, see clause 6.10.9.1 in 3GPP TS 29.500 [4].

6.1.3.6.3.3 PATCH

This method updates partially the shared data identified by a sharedDataId.

This method shall support the URI query parameters specified in table 6.1.3.6.3.3-1.

Table 6.1.3.6.3.3-1: URI query parameters supported by the PATCH method on this resource

Name	Data type	P	Cardinality	Description
n/a				

This method shall support the request data structures specified in table 6.1.3.6.3.3-2 and the response data structures and response codes specified in table 6.1.3.6.3.3-3.

Table 6.1.3.6.3.3-2: Data structures supported by the PATCH Request Body on this resource

Data type	P	Cardinality	Description
array(PatchItem)	M	1	It contains the list of changes to be made to the shared data, according to the JSON PATCH format specified in IETF RFC 6902 [13].

Table 6.1.3.6.3.3-3: Data structures supported by the PATCH Response Body on this resource

Data type	P	Cardinality	Response codes	Description
SharedData	M	1	200 OK	Upon success, a response body is returned containing the updated Shared Data.
n/a			204 No Content	Successful response sent when there is no need to provide the full updated shared data (e.g., in the partial update procedure when all update operations are accepted by the NRF, as described in clause 5.2.2.3.1).
RedirectResponse	O	0..1	307 Temporary Redirect	Temporary redirection.
RedirectResponse	O	0..1	308 Permanent Redirect	Permanent redirection.
ProblemDetails	O	0..1	400 Bad Request	The "cause" attribute may be used to indicate one of the following application errors: - SHARED_DATA_ID_UNKNOWN - SHARED_DATA_NOT_CONFIGURED
ProblemDetails	O	0..1	403 Forbidden	The "cause" attribute may be used to indicate one of the following application errors: - SHARED_DATA_WRITE_NOT_ALLOWED
ProblemDetails	O	0..1	412 Precondition Failed	The modification has failed due to the precondition in the request is not fulfilled.
ProblemDetails	O	0..1	409 Conflict	The modification has failed due to confliction (e.g. to change a value of a non-existing IE).
NOTE: The mandatory HTTP error status codes for the PATCH method listed in Table 5.2.7.1-1 of 3GPP TS 29.500 [4] other than those specified in the table above also apply, with a ProblemDetails data type (see clause 5.2.7 of 3GPP TS 29.500 [4]).				

Table 6.1.3.6.3.3-4: Headers supported by the 307 Response Code on this resource

Name	Data type	P	Cardinality	Description
Location	string	M	1	An alternative URI of the resource located on an alternative service instance within the same NRF or NRF (service) set. For the case when a request is redirected to the same target resource via a different SCP, see clause 6.10.9.1 in 3GPP TS 29.500 [4].

Table 6.1.3.6.3.3-5: Headers supported by the 308 Response Code on this resource

Name	Data type	P	Cardinality	Description
Location	string	M	1	An alternative URI of the resource located on an alternative service instance within the same NRF or NRF (service) set. For the case when a request is redirected to the same target resource via a different SCP, see clause 6.10.9.1 in 3GPP TS 29.500 [4].

Table 6.1.3.6.3.3-6: Headers supported by the PATCH method on this resource

Name	Data type	P	Cardinality	Description
If-Match	string	C	0..1	Validator for conditional requests, as described in IETF RFC 9110 [40], clause 13.1.1.

Table 6.1.3.6.3.3-7: Headers supported by the 200 Response Code on this resource

Name	Data type	P	Cardinality	Description
ETag	string	C	0..1	Entity Tag containing a strong validator, described in IETF RFC 9110 [40], clause 8.8.3.

6.1.3.6.3.4 DELETE

This method deletes existing Shared Data from the NRF.

This method shall support the URI query parameters specified in table 6.1.3.6.3.4-1.

Table 6.1.3.6.3.4-1: URI query parameters supported by the DELETE method on this resource

Name	Data type	P	Cardinality	Description
n/a				

This method shall support the request data structures specified in table 6.1.3.6.3.4-2 and the response data structures and response codes specified in table 6.1.3.6.3.4-3.

Table 6.1.3.6.3.4-2: Data structures supported by the DELETE Request Body on this resource

Data type	P	Cardinality	Description
n/a			

Table 6.1.3.6.3.4-3: Data structures supported by the DELETE Response Body on this resource

Data type	P	Cardinality	Response codes	Description
n/a			204 No Content	
RedirectResponse	O	0..1	307 Temporary Redirect	Temporary redirection.
RedirectResponse	O	0..1	308 Permanent Redirect	Permanent redirection.
ProblemDetails	O	0..1	400 Bad Request	The "cause" attribute may be used to indicate one of the following application errors: - SHARED_DATA_ID_UNKNOWN - SHARED_DATA_NOT_CONFIGURED
ProblemDetails	O	0..1	403 Forbidden	The "cause" attribute may be used to indicate one of the following application errors: - SHARED_DATA_WRITE_NOT_ALLOWED
NOTE: The mandatory HTTP error status codes for the DELETE method listed in Table 5.2.7.1-1 of 3GPP TS 29.500 [4] other than those specified in the table above also apply, with a ProblemDetails data type (see clause 5.2.7 of 3GPP TS 29.500 [4]).				

Table 6.1.3.6.3.4-4: Headers supported by the 307 Response Code on this resource

Name	Data type	P	Cardinality	Description
Location	string	M	1	An alternative URI of the resource located on an alternative service instance within the same NRF or NRF (service) set. For the case when a request is redirected to the same target resource via a different SCP, see clause 6.10.9.1 in 3GPP TS 29.500 [4].

Table 6.1.3.6.3.4-5: Headers supported by the 308 Response Code on this resource

Name	Data type	P	Cardinality	Description
Location	string	M	1	An alternative URI of the resource located on an alternative service instance within the same NRF or NRF (service) set. For the case when a request is redirected to the same target resource via a different SCP, see clause 6.10.9.1 in 3GPP TS 29.500 [4].

6.1.3.7 Resource: shared-data-store (Store)

6.1.3.7.1 Description

This resource represents a collection of the different shared data registered in the NRF.

This resource is modelled as the Store resource archetype (see clause C.3 of 3GPP TS 29.501 [5]).

6.1.3.7.2 Resource Definition

Resource URI: `{apiRoot}/nnrf-nfm/<apiVersion>/shared-data`

This resource shall support the resource URI variables defined in table 6.1.3.7.2-1.

Table 6.1.3.7.2-1: Resource URI variables for this resource

Name	Data type	Definition
apiRoot	string	See clause 6.1.1

6.1.3.7.3 Resource Standard Methods

6.1.3.7.3.1 GET

This method retrieves a list of Shared Data registered in the NRF. This method shall support the URI query parameters specified in table 6.1.3.7.3.1-1.

Table 6.1.3.7.3.1-1: URI query parameters supported by the GET method on this resource

Name	Data type	P	Cardinality	Description
shared-data-ids	SharedDataIdList	M	1	List of shared data IDs
supported-features	SupportedFeatures	O	0..1	see 3GPP TS 29.500 [4] clause 6.6

This method shall support the request data structures specified in table 6.1.3.7.3.1-2 and the response data structures and response codes specified in table 6.1.3.7.3.1-3.

Table 6.1.3.7.3.1-2: Data structures supported by the GET Request Body on this resource

Data type	P	Cardinality	Description
n/a			

Table 6.1.3.7.3.1-3: Data structures supported by the GET Response Body on this resource

Data type	P	Cardinality	Response codes	Description
array(SharedData)	M	0..N	200 OK	Upon success, a response body containing a list of SharedData shall be returned.
ProblemDetails	O	0..1	404 Not Found	The "cause" attribute may be used to indicate one of the following application errors: - SHARED_DATA_NOT_CONFIGURED
NOTE: The mandatory HTTP error status codes for the GET method listed in Table 5.2.7.1-1 of 3GPP TS 29.500 [4] other than those specified in the table above also apply, with a ProblemDetails data type (see clause 5.2.7 of 3GPP TS 29.500 [4]).				

6.1.4 Custom Operations without associated resources

There are no custom operations defined without any associated resources for the Nnrf_NFManagement service in this release of the specification.

6.1.5 Notifications

6.1.5.1 General

This clause specifies the notifications provided by the Nnrf_NFManagement service.

The delivery of notifications shall be supported as specified in clause 6.2 of 3GPP TS 29.500 [4] for Server-initiated communication.

Table 6.1.5.1-1: Notifications overview

Notification	Resource URI	HTTP method or custom operation	Description (service operation)
NF Instance Status Notification	{nfStatusNotificationUri} (NF Service Consumer provided callback reference)	POST	Notify about registrations / deregistrations or profile changes of NF Instances

6.1.5.2 NF Instance Status Notification

6.1.5.2.1 Description

The NF Service Consumer provides a callback URI for getting notified about NF Instances status events, the NRF shall notify the NF Service Consumer, when the conditions specified in the subscription are met.

6.1.5.2.2 Notification Definition

The POST method shall be used for NF Instance Status notification and the URI shall be the callback reference provided by the NF Service Consumer during the subscription to this notification.

Resource URI: {nfStatusNotificationUri}

Support of URI query parameters is specified in table 6.1.5.2.2-1.

Table 6.1.5.2.2-1: URI query parameters supported by the POST method

Name	Data type	P	Cardinality	Description
n/a				

Support of request data structures is specified in table 6.1.5.2.2-2, and support of response data structures and response codes is specified in table 6.1.5.2-3.

Table 6.1.5.2.2-2: Data structures supported by the POST Request Body

Data type	P	Cardinality	Description
NotificationData	M	1	Representation of the NF Instance status notification.

Table 6.1.5.2.2-3: Data structures supported by the POST Response Body

Data type	P	Cardinality	Response codes	Description
N/A			204 No Content	This case represents a successful notification of the NF Instance status event.
RedirectResponse	O	0..1	307 Temporary Redirect	The NF service consumer shall generate a Location header field containing a URI pointing to the endpoint of another NF Service Consumer instance to which the notification should be sent. If an SCP redirects the message to another SCP then the location header field shall contain the same URI or a different URI pointing to the endpoint of the NF service consumer to which the notification should be sent.
RedirectResponse	O	0..1	308 Permanent Redirect	The NF service consumer shall generate a Location header field containing a URI pointing to the endpoint of another NF Service Consumer instance to which the notification should be sent. If an SCP redirects the message to another SCP then the location header field shall contain the same URI or a different URI pointing to the endpoint of the NF service consumer to which the notification should be sent.
NOTE: The mandatory HTTP error status codes for the POST method listed in Table 5.2.7.1-1 of 3GPP TS 29.500 [4] other than those specified in the table above also apply, with a ProblemDetails data type (see clause 5.2.7 of 3GPP TS 29.500 [4]).				

Table 6.1.5.2.2-4: Headers supported by the 307 Response Code on this endpoint

Name	Data type	P	Cardinality	Description
Location	string	M	1	A URI pointing to the endpoint of the NF service consumer instance to which the request should be sent

Table 6.1.5.2.2-5: Headers supported by the 308 Response Code on this endpoint

Name	Data type	P	Cardinality	Description
Location	string	M	1	A URI pointing to the endpoint of the NF service consumer instance to which the request should be sent

6.1.6 Data Model

6.1.6.1 General

This clause specifies the application data model supported by the API.

Table 6.1.6.1-1 specifies the data types defined for the Nnrf_NFManagement service-based interface protocol.

Table 6.1.6.1-1: Nnrf_NFManagement specific Data Types

Data type	Clause defined	Description
NFProfile	6.1.6.2.2	Information of an NF Instance registered in the NRF.
NFService	6.1.6.2.3	Information of a given NF Service Instance; it is part of the NFProfile of an NF Instance.
DefaultNotificationSubscription	6.1.6.2.4	Data structure for specifying the notifications the NF service subscribes by default along with callback URI.
IpEndPoint	6.1.6.2.5	IP addressing information of a given NFService; it consists on, e.g. IP address, TCP port, transport protocol...
UdrInfo	6.1.6.2.6	Information of an UDR NF Instance.
UdmInfo	6.1.6.2.7	Information of an UDM NF Instance.
AusfInfo	6.1.6.2.8	Information of an AUSF NF Instance.
SupiRange	6.1.6.2.9	A range of SUPIs (subscriber identities), either based on a numeric range, or based on regular-expression matching.
IdentityRange	6.1.6.2.10	A range of subscriber identities, either based on a numeric range, or based on regular-expression matching.
AmfInfo	6.1.6.2.11	Information of an AMF NF Instance.
SmfInfo	6.1.6.2.12	Information of an SMF NF Instance.
UpfInfo	6.1.6.2.13	Information of an UPF NF Instance.
SnsaiUpfInfoItem	6.1.6.2.14	Set of parameters supported by UPF for a given S-NSSAI.
DnnUpfInfoItem	6.1.6.2.15	Set of parameters supported by UPF for a given DNN.
SubscriptionData	6.1.6.2.16	Information of a subscription to notifications to NRF events, included in subscription requests and responses.
NotificationData	6.1.6.2.17	Data sent in notifications from NRF to subscribed NF Instances.
NFServiceVersion	6.1.6.2.19	Contains the version details of an NF service.
PcfInfo	6.1.6.2.20	Information of a PCF NF Instance.
BsfInfo	6.1.6.2.21	Information of a BSF NF Instance.
Ipv4AddressRange	6.1.6.2.22	Range of IPv4 addresses.
Ipv6PrefixRange	6.1.6.2.23	Range of IPv6 prefixes.
InterfaceUpfInfoItem	6.1.6.2.24	Information of a given IP interface of an UPF.
UriList	6.1.6.2.25	Set of URIs following 3GPP hypermedia format (containing a "_links" attribute).
N2InterfaceAmfInfo	6.1.6.2.26	AMF N2 interface information
TaiRange	6.1.6.2.27	Range of TAIs (Tracking Area Identities).
TacRange	6.1.6.2.28	Range of TACs (Tracking Area Codes).
SnsaiSmfInfoItem	6.1.6.2.29	Set of parameters supported by SMF for a given S-NSSAI.
DnnSmfInfoItem	6.1.6.2.30	Set of parameters supported by SMF for a given DNN.
NrfInfo	6.1.6.2.31	Information of an NRF NF Instance, used in hierarchical NRF deployments.
ChfInfo	6.1.6.2.32	Information of a CHF NF Instance.
PlmnRange	6.1.6.2.34	Range of PLMN IDs.
SubscrCond	6.1.6.2.35	Condition to determine the set of NFs to monitor under a certain subscription in NRF.
NfInstanceIdCond	6.1.6.2.36	Subscription to a given NF Instance Id.
NfTypeCond	6.1.6.2.37	Subscription to a set of NFs based on their NF Type.
ServiceNameCond	6.1.6.2.38	Subscription to a set of NFs based on their support for a given Service Name.
AmfCond	6.1.6.2.39	Subscription to a set of AMFs, based on AMF Set Id and/or AMF Region Id.
GuamiListCond	6.1.6.2.40	Subscription to a set of AMFs, based on their GUAMIs.
NetworkSliceCond	6.1.6.2.41	Subscription to a set of NFs, based on the slices (S-NSSAI and NSI) they support .
NfGroupCond	6.1.6.2.42	Subscription to a set of NFs based on their Group Id.
NotifCondition	6.1.6.2.43	Condition (list of attributes in the NF Profile) to determine whether a notification must be sent by NRF.
PlmnSnsai	6.1.6.2.44	List of network slices (S-NSSAIs) for a given PLMN ID.
NwdafInfo	6.1.6.2.45	Information of a NWDAF NF Instance.
LmfInfo	6.1.6.2.46	Information of an LMF NF Instance.
GmlcInfo	6.1.6.2.47	Information of a GMLC NF Instance.
NefInfo	6.1.6.2.48	Information of an NEF NF Instance.
PfdData	6.1.6.2.49	List of Application IDs and/or AF IDs managed by a given NEF Instance.
AfEventExposureData	6.1.6.2.50	AF Event Exposure data managed by a given NEF Instance.
WAgfInfo	6.1.6.2.51	Information of the W-AGF endpoints.
TngfInfo	6.1.6.2.52	Information of the TNGF endpoints.

PcscfInfo	6.1.6.2.53	Information of a P-CSCF NF Instance.
NfSetCond	6.1.6.2.54	Subscription to a set of NFs based on their Set Id.
NfServiceSetCond	6.1.6.2.55	Subscription to a set of NFs based on their Service Set Id.
NfInfo	6.1.6.2.56	Information of a generic NF Instance.
HssInfo	6.1.6.2.57	Information of an HSS NF Instance.
ImsiRange	6.1.6.2.58	A range of IMSIs (subscriber identities), either based on a numeric range, or based on regular-expression matching.
InternalGroupIdRange	6.1.6.2.59	A range of Group IDs (internal group identities), either based on a numeric range, or based on regular-expression matching.
UpfCond	6.1.6.2.60	Subscription to a set of NF Instances (UPFs), able to serve a certain service area (i.e. SMF serving area or TAI list).
TwifInfo	6.1.6.2.61	Addressing information (IP addresses, FQDN) of the TWIF.
VendorSpecificFeature	6.1.6.2.62	Information about a vendor-specific feature
UdsfInfo	6.1.6.2.63	Information related to UDSF
ScpInfo	6.1.6.2.65	Information of an SCP Instance
ScpDomainInfo	6.1.6.2.66	SCP domain information
ScpDomainCond	6.1.6.2.67	Subscription to an SCP domain
OptionsResponse	6.1.6.2.68	Communication options of the NRF
NwdafCond	6.1.6.2.69	Subscription to a set of NF Instances (NWDAFs), identified by Analytics ID(s), S-NSSAI(s) or NWDAF Serving Area information, i.e. list of TAIs for which the NWDAF can provide analytics.
NefCond	6.1.6.2.70	Subscription to a set of NF Instances (NEFs), identified by Event ID(s) provided by AF, S-NSSAI(s), AF Instance ID, Application Identifier, External Identifier, External Group Identifier, or domain name.
SuciInfo	6.1.6.2.71	SUCI information containing Routing Indicator and Home Network Public Key ID.
SeppInfo	6.1.6.2.72	Information of a SEPP Instance
AanfInfo	6.1.6.2.73	Information of an AANF NF Instance.
5GDdnmflInfo	6.1.6.2.74	Information of a 5G DDNMF NF Instance.
MfafInfo	6.1.6.2.75	Information of the MFAF NF Instance.
NwdafCapability	6.1.6.2.76	Indicates the capability supported by the NWDAF.
DccfInfo	6.1.6.2.80	Information of a DCCF NF Instance.
NsacfInfo	6.1.6.2.81	Information of an NSACF NF Instance.
NsacfCapability	6.1.6.2.82	NSACF service capability.
DccfCond	6.1.6.2.83	Subscription to a set of NF Instances (DCCFs), identified by NF types, NF Set Id(s) or DCCF Serving Area information, i.e. list of TAIs served by the DCCF.
MlAnalyticsInfo	6.1.6.2.84	ML Analytics Filter information supported by the Nnwdaf_MLModelProvision service
MbSmfInfo	6.1.6.2.85	Information of a MB-SMF NF Instance
TmgiRange	6.1.6.2.86	Range of TMGIs
MbsSession	6.1.6.2.87	MBS Session served by an MB-SMF
SnsaiMbSmfInfoltem	6.1.6.2.88	Parameters supported by an MB-SMF for a given S-NSSAI
DnnMbSmfInfoltem	6.1.6.2.89	Parameters supported by an MB-SMF for a given DNN
TsctsInfo	6.1.6.2.91	Information of a TSCTS NF Instance.
SnsaiTsctsInfoltem	6.1.6.2.92	Set of parameters supported by TSCTS for a given S-NSSAI.
DnnTsctsInfoltem	6.1.6.2.93	Set of parameters supported by TSCTS for a given DNN.
MbUpfInfo	6.1.6.2.94	Information of a MB-UPF NF Instance.
UnTrustAfInfo	6.1.6.2.95	Information of a untrusted AF Instance.
TrustAfInfo	6.1.6.2.96	Information of a trusted AF Instance
SnsaiInfoltem	6.1.6.2.97	Set of parameters supported by NF for a given S-NSSAI.
DnnInfoltem	6.1.6.2.98	Set of parameters supported by NF for a given DNN.
CollocatedNfInstance	6.1.6.2.99	Information related to collocated NF type(s) and corresponding NF Instance(s) when the NF is collocated with NFs supporting other NF types.
ServiceNameListCond	6.1.6.2.100	Subscription to a set of NF Instances that offer a service name in the Service Name list.
NfGroupListCond	6.1.6.2.101	Subscription to a set of NF Instances, identified by a NF Group Identity in the NF Group Identity list.
PlmnOauth2	6.1.6.2.102	Per PLMN Oauth2.0 indication.
V2xCapability	6.1.6.2.103	Indicate the supported V2X Capability by the PCF.
NssaafInfo	6.1.6.2.104	Information of a NSSAAF NF Instance.

ProSeCapability	6.1.6.2.105	Indicate the supported ProSe Capability by the PCF.
SharedDataIdRange	6.1.6.2.106	
SubscriptionContext	6.1.6.2.107	Context data related to a created subscription, to be included in notifications sent by NRF.
IwmscInfo	6.1.6.2.108	Information of a SMS-IWMSC NF Instance.
MnpfInfo	6.1.6.2.109	Information of an MNPF Instance.
DefSubServiceInfo	6.1.6.2.110	Service Specific Information for Default Notification Subscription.
LocalityDescriptionItem	6.1.6.2.111	Description of locality information item
LocalityDescription	6.1.6.2.112	Description of locality information comprising one or more locality information items
DcsfInfo	6.1.6.2.114	Information of a DCSF NF Instance.
MIModelInterInfo	6.1.6.2.115	ML Model Interoperability Information
PruExistenceInfo	6.1.6.2.116	PRU Existence Information
MrfInfo	6.1.6.2.117	Information of a MRF NF instance.
MrfpInfo	6.1.6.2.118	Information of a MRFP NF instance.
MfInfo	6.1.6.2.119	Information of a MF NF instance.
A2xCapability	6.1.6.2.120	Indicate the supported A2X Capability by the PCF.
RuleSet	6.1.6.2.121	List of rules specifying whether access/scopes are allowed/denied for NF-Consumers.
SelectionConditions	6.1.6.2.123	List of conditions under which an NF Instance with an NFStatus or NFServiceStatus value set to "CANARY_RELEASE", or with a "canaryRelease" attribute set to true, shall be selected by an NF Service Consumer (e.g. if the UE belongs to a range of SUPIs)
ConditionItem	6.1.6.2.124	Each of the conditions that compose the SelectionConditions. A ConditionItem consists of a number of attributes representing individual conditions (e.g. a SUPI range, or a TAI list)
ConditionGroup	6.1.6.2.125	List (array) of conditions (joined by the "and" or "or" logical relationship), under which an NF Instance with an NFStatus or NFServiceStatus value set to "CANARY_RELEASE", or with a "canaryRelease" attribute set to true, shall be selected by an NF Service Consumer.
EpdgInfo	6.1.6.2.126	Information of the ePDG endpoints.
CallbackUriPrefixItem	6.1.6.2.127	Callback URI prefix value to be used for specific notification types
SharedData	6.1.6.2.128	Shared Data
NFProfileRegistrationError	6.1.6.2.129	Extension of ProblemDetails with a list of Shared data IDs
SharedDataIdList	6.1.6.2.130	
PortRange	6.1.6.2.131	Port number Range
SharedScope	6.1.6.2.132	Authorized scope for certain operation (e.g. write operation) to a shared data
NefId	6.1.6.3.2	Identity of the NEF.
VendorId	6.1.6.3.2	Vendor ID of the NF Service instance (Private Enterprise Number assigned by IANA)
WildcardDnai	6.1.6.3.2	Wildcard DNAI
MediaCapability	6.1.6.3.2	Media capability offered by NF instance.
NFType	6.1.6.3.3	NF types known to NRF.
NotificationType	6.1.6.3.4	Types of notifications used in Default Notification URIs in the NF Profile of an NF Instance.
TransportProtocol	6.1.6.3.5	Types of transport protocol used in a given IP endpoint of an NF Service Instance.
NotificationEventType	6.1.6.3.6	Types of events sent in notifications from NRF to subscribed NF Instances.
NFStatus	6.1.6.3.7	Status of a given NF Instance stored in NRF.
DataSetId	6.1.6.3.8	Types of data sets stored in UDR.
UPInterfaceType	6.1.6.3.9	Types of User-Plane interfaces of the UPF.
ServiceName	6.1.6.3.11	Service names known to NRF.
NFServiceStatus	6.1.6.3.12	Status of a given NF Service Instance of an NF Instance stored in NRF.
AnNodeType	6.1.6.3.13	Access Network Node Type (gNB, ng-eNB...).
ConditionEventType	6.1.6.3.14	Indicates whether a notification is due to the NF Instance to start or stop being part of a condition for a subscription to a set of NFs

IpReachability	6.1.6.3.15	Indicates the type(s) of IP addresses reachable via an SCP.
CollocatedNfType	6.1.6.3.17	Possible NF types supported by a collocated NF.
LocalityType	6.1.6.3.18	Type of Locality description item.
FICapabilityType	6.1.6.3.19	Type of Federated Learning Capability
RuleSetAction	6.1.6.3.21	Specifies whether access/scope is allowed or denied for a specific NF-Consumer
DnsSecurityProtocol	6.1.6.3.22	DNS Security Protocol (e.g. DNS over TLS, DNS over DTLS)

Table 6.1.6.1-2 specifies data types re-used by the Nnrf_NFManagement service-based interface protocol from other specifications, including a reference to their respective specifications and when needed, a short description of their use within the Nnrf_NFManagement service-based interface.

Table 6.1.6.1-2: Nnrf_NFManagement re-used Data Types

Data type	Reference	Comments
N1MessageClass	3GPP TS 29.518 [6]	The N1 message type
N2InformationClass	3GPP TS 29.518 [6]	The N2 information type
IPv4Addr	3GPP TS 29.571 [7]	
IPv6Addr	3GPP TS 29.571 [7]	
IPv6Prefix	3GPP TS 29.571 [7]	
Uri	3GPP TS 29.571 [7]	
Dnn	3GPP TS 29.571 [7]	
SupportedFeatures	3GPP TS 29.571 [7]	
Snsai	3GPP TS 29.571 [7]	
PlmnId	3GPP TS 29.571 [7]	
Guami	3GPP TS 29.571 [7]	
Tai	3GPP TS 29.571 [7]	
NfInstanceId	3GPP TS 29.571 [7]	Identifier (UUID) of the NF Instance. The hexadecimal letters of the UUID should be formatted by the sender as lower-case characters and shall be handled as case-insensitive by the receiver.
LinksValueSchema	3GPP TS 29.571 [7]	3GPP Hypermedia link
UriScheme	3GPP TS 29.571 [7]	
AmfName	3GPP TS 29.571 [7]	
DateTime	3GPP TS 29.571 [7]	
Dnai	3GPP TS 29.571 [7]	
Changeltem	3GPP TS 29.571 [7]	
DiameterIdentity	3GPP TS 29.571 [7]	
AccessType	3GPP TS 29.571 [7]	
NfGroupId	3GPP TS 29.571 [7]	Network Function Group Id
AmfRegionId	3GPP TS 29.571 [7]	
AmfSetId	3GPP TS 29.571 [7]	
PduSessionType	3GPP TS 29.571 [7]	
AtsssCapability	3GPP TS 29.571 [7]	Capability to support procedures related to Access Traffic Steering, Switching, Splitting.
Nid	3GPP TS 29.571 [7]	
PlmnIdNid	3GPP TS 29.571 [7]	
NfSetId	3GPP TS 29.571 [7]	NF Set ID (see clause 28.12 of 3GPP TS 23.003 [12])
NfServiceSetId	3GPP TS 29.571 [7]	NF Service Set ID (see clause 28.13 of 3GPP TS 23.003 [12])
GroupId	3GPP TS 29.571 [7]	Internal Group Identifier
RatType	3GPP TS 29.571 [7]	RAT Type
DurationSec	3GPP TS 29.571 [7]	
RedirectResponse	3GPP TS 29.571 [7]	Response body of the redirect response message.
ExtSnsai	3GPP TS 29.571 [7]	
AreaSessionId	3GPP TS 29.571 [7]	Area Session Identifier used for an MBS session with location dependent content
MbsSessionId	3GPP TS 29.571 [7]	MBS Session Identifier
MbsServiceArea	3GPP TS 29.571 [7]	MBS Service Area
IpAddr	3GPP TS 29.571 [7]	IP Address
MbsServiceAreaInfo	3GPP TS 29.571 [7]	MBS Service Area Information for Location dependent MBS session
Fqdn	3GPP TS 29.571 [7]	Fully Qualified Domain Name
EventId	3GPP TS 29.520 [32]	Defined in Nnwdaf_AnalyticsInfo API.
NnwdafEvent	3GPP TS 29.520 [32]	Defined in Nnwdaf_EventsSubscription API.
ExternalClientType	3GPP TS 29.572 [33]	
LMFIdentification	3GPP TS 29.572 [33]	LMF Identification
AfEvent	3GPP TS 29.517 [35]	Defined in Naf_EventExposure API
SupportedGADShapes	3GPP TS 29.572 [33]	Supported GAD Shapes
NetworkNodeDiameterAddress	3GPP TS 29.503 [36]	Diameter Address of a Network Node
IpIndex	3GPP TS 29.503 [36]	IP Index
EventType	3GPP TS 29.564 [49]	Event type supported by the UPF Event Exposure service
NsacSai	3GPP TS 29.571 [7]	NSAC Service Area Identifier

6.1.6.2 Structured data types

6.1.6.2.1 Introduction

This clause defines the structures to be used in resource representations.

6.1.6.2.2 Type: NFProfile

Table 6.1.6.2.2-1: Definition of type NFProfile

Attribute name	Data type	P	Cardinality	Description	Applicability
nfInstancelid	NfInstancelid	M	1	Unique identity of the NF Instance. When conveyed within SharedData, nfInstancelid shall take the value of the Nil UUID (see IETF RFC 4122 [18]) and shall be ignored by the receiver, as the individual data take precedence.	
nfType	NFType	M	1	Type of Network Function. When conveyed within SharedData, nfType shall take the value "NULL" and shall be ignored by the receiver, as the individual data take precedence.	
nfStatus	NFStatus	M	1	Status of the NF Instance (NOTE 5) (NOTE 16) When conveyed within SharedData, nfStatus shall take the value "NULL" and shall be ignored by the receiver as the individual data take precedence.	
collocatedNfInstances	array(CollocatedNfInstance)	O	1..N	Information related to collocated NF type(s) and corresponding NF Instances when the NF is collocated with NFs supporting other NF types. (NOTE 21) In this release of the specification, following collocation scenarios are supported (see clause 6.1.6.2.99): - a MB-SMF collocated with a SMF; - a MB-UPF collocated with a UPF.	
nfInstanceName	string	O	0..1	Human readable name of the NF Instance	
heartBeatTimer	integer	C	0..1	Time in seconds expected between 2 consecutive heart-beat messages from an NF Instance to the NRF. It may be included in the registration request. When present in the request it shall contain the heartbeat time proposed by the NF service consumer. It shall be included in responses from NRF to registration requests (PUT) or in NF profile updates (PUT or PATCH). If the proposed heartbeat time is acceptable by the NRF based on the local configuration, it shall use the same value as in the registration request; otherwise the NRF shall override the value using a preconfigured value.	
plmnList	array(PlmnId)	C	1..N	PLMN(s) of the Network Function (NOTE 7). This IE shall be present if this information is available for the NF. If neither the plmnList IE nor the snpnList IE are provided, PLMN ID(s) of the PLMN of the NRF are assumed for the NF.	
snpnList	array(PlmnIdNid)	C	1..N	SNPN(s) of the Network Function. This IE shall be present if the NF pertains to one or more SNPNs.	

sNssais	array(ExtSnssai)	O	1..N	S-NSSAIs of the Network Function. If not provided, and if the perPlmnSnssaiList attribute is not present, the NF can serve any S-NSSAI. When present this IE represents the list of S-NSSAIs supported in all the PLMNs listed in the plmnList IE and all the SNPNs listed in the snpnList. If the sNssais attribute is provided in at least one NF Service, the S-NSSAIs supported by the NF Profile shall be the set or a superset of the S-NSSAIs of the NFService(s).	
perPlmnSnssaiList	array(PlmnSnssai)	O	1..N	This IE may be included when the list of S-NSSAIs supported by the NF for each PLMN it is supporting is different. When present, this IE shall include the S-NSSAIs supported by the Network Function for each PLMN supported by the Network Function. When present, this IE shall override sNssais IE. (NOTE 9) If the perPlmnSnssaiList attribute is provided in at least one NF Service, the S-NSSAIs supported per PLMN in the NF Profile shall be the set or a superset of the perPlmnSnssaiList of the NFService(s).	
nsiList	array(string)	O	1..N	NSI identities of the Network Function. If not provided, the NF can serve any NSI.	
fqdn	Fqdn	C	0..1	FQDN of the Network Function (NOTE 1) (NOTE 2) (NOTE 18). For AMF, the FQDN registered with the NRF shall be that of the AMF Name (see 3GPP TS 23.003 [12] clause 28.3.2.5). When conveyed within SharedData, fqdn shall be present and shall take the value "www.example.com" and shall be ignored by the receiver.	
interPlmnFqdn	Fqdn	C	0..1	If the NF needs to be discoverable by other NFs in a different PLMN, then an FQDN that is used for inter-PLMN routing as specified in 3GPP TS 23.003 [12] shall be registered with the NRF (NOTE 8). A change of this attribute shall result in triggering a "NF_PROFILE_CHANGED" notification from NRF towards subscribing NFs located in the same or a different PLMN, but in the latter case the new value shall be notified as a change of the "fqdn" attribute. The NRF shall not send intra-PLMN notifications containing this attribute to subscribing NFs not supporting the "Inter-Plmn-Fqdn" feature (see clause 6.1.9).	
ipv4Addresses	array(Ipv4Addr)	C	1..N	IPv4 address(es) of the Network Function (NOTE 1) (NOTE 2) (NOTE 18). Shall be absent from sharedData.	
ipv6Addresses	array(Ipv6Addr)	C	1..N	IPv6 address(es) of the Network Function (NOTE 1) (NOTE 2) (NOTE 18). Shall be absent from sharedData.	

allowedPlmns	array(PlmnlId)	O	1..N	<p>PLMNs allowed to access the NF instance. If not provided, any PLMN is allowed to access the NF.</p> <p>This attribute shall not be included in profile change notifications to subscribed NFs, unless the subscribing entity explicitly requested so, in the "completeProfileSubscription" attribute in the subscription request message, and the NRF authorized such a request (see clauses 5.2.2.6.2 and 6.1.6.2.17). (NOTE 17)</p>
allowedSnprs	array(PlmnlIdNid)	O	1..N	<p>SNPNs allowed to access the NF instance.</p> <p>If this attribute is present in the NFService and in the NF profile, the attribute from the NFService shall prevail.</p> <p>The absence of this attribute in both the NFService and in the NF profile indicates that no SNPN, other than the SNPN(s) registered in the snpnList attribute of the NF Profile (if the NF pertains to an SNPN), is allowed to access the service instance.</p> <p>This attribute shall not be included in profile change notifications to subscribed NFs, unless the subscribing entity explicitly requested so, in the "completeProfileSubscription" attribute in the subscription request message, and the NRF authorized such a request (see clauses 5.2.2.6.2 and 6.1.6.2.17). (NOTE 17)</p>
allowedNfTypes	array(NFType)	O	1..N	<p>Type of the NFs allowed to access the NF instance. If not provided, any NF type is allowed to access the NF.</p> <p>This attribute shall not be included in profile change notifications to subscribed NFs, unless the subscribing entity explicitly requested so, in the "completeProfileSubscription" attribute in the subscription request message, and the NRF authorized such a request (see clauses 5.2.2.6.2 and 6.1.6.2.17). (NOTE 17)</p>

allowedNfDomains	array(string)	O	1..N	<p>Pattern (regular expression according to the ECMA-262 dialect [8]) representing the NF domain names within the PLMN of the NRF allowed to access the NF instance.</p> <p>If not provided, any NF domain is allowed to access the NF.</p> <p>This attribute shall not be included in profile change notifications to subscribed NFs, unless the subscribing entity explicitly requested so, in the "completeProfileSubscription" attribute in the subscription request message, and the NRF authorized such a request (see clauses 5.2.2.6.2 and 6.1.6.2.17). (NOTE 17)</p>
allowedNssais	array(ExtSnsai)	O	1..N	<p>S-NSSAI of the allowed slices to access the NF instance.</p> <p>If not provided, any slice is allowed to access the NF.</p> <p>This attribute shall not be included in profile change notifications to subscribed NFs, unless the subscribing entity explicitly requested so, in the "completeProfileSubscription" attribute in the subscription request message, and the NRF authorized such a request (see clauses 5.2.2.6.2 and 6.1.6.2.17). (NOTE 17)</p>
allowedRuleSet	map(RuleSet)	O	1..N	<p>Map of rules specifying NF-Consumers allowed or denied to access the NF-Producer. The key of the map shall be a (unique) valid JSON string per clause 7 of IETF RFC 8259 [22], with a maximum of 32 characters.</p> <p>This IE may be present when the NF-Producer and the NRF support Allowed-ruleset feature as specified in clause 6.1.9.</p> <p>When NRF utilizes this parameter to determine if the NF-Consumers allowed or denied to access an NF-Producer, it matches the NF-Consumer's properties (PLMN, SNPN, nfType, NfDomain, S-NSSAIs) against each rule in decreasing order of priority (1 being the highest). When a matching rule is found, the search is stopped and the NF-Consumer is allowed/dis-allowed to access the NF-Producer (see Annex C).</p> <p>This attribute shall not be included in profile change notifications to subscribed NFs.</p> <p>If the subscribing entity included "completeProfileSubscription" attribute in the subscription request message, and the NRF authorized such a request (see clauses 5.2.2.6.2 and 6.1.6.2.17), the complete IE shall be present in the profile change notification (NOTE 17)</p>

priority	integer	O	0..1	<p>Priority (relative to other NFs of the same type) within the range 0 to 65535, to be used for NF selection; lower values indicate a higher priority. Priority may or may not be present in the nfServiceList parameters, xxxInfo parameters and in this attribute. Priority in the nfServiceList has precedence over the priority in this attribute (NOTE 4).</p> <p>Priority in xxxInfo parameter shall only be used to determine the relative priority among NF instances with the same priority at NFProfile/NFService.</p> <p>The NRF may overwrite the received priority value when exposing an NFProfile with the Nnrf_NFDiscovery service.</p>	
capacity	integer	O	0..1	<p>Static capacity information within the range 0 to 65535, expressed as a weight relative to other NF instances of the same type; if capacity is also present in the nfServiceList parameters, those will have precedence over this value. (NOTE 4).</p>	
load	integer	O	0..1	<p>Dynamic load information, within the range 0 to 100, indicates the current load percentage of the NF.</p>	
loadTimeStamp	DateTime	O	0..1	<p>It indicates the point in time in which the latest load information (sent by the NF in the "load" attribute of the NF Profile) was generated at the NF Instance.</p> <p>If the NF did not provide a timestamp, the NRF should set it to the instant when the NRF received the message where the NF provided the latest load information.</p>	
locality	string	O	0..1	<p>Operator defined information about the location of the NF instance (e.g. geographic location, data center) (NOTE 3)</p>	
extLocality	map(string)	O	1..N	<p>Operator defined information about the location of the NF instance. (NOTE 3) The key of the map shall be a (unique) valid JSON string per clause 7 of IETF RFC 8259 [22], with a maximum of 32 characters, representing a type of locality as defined in clause 6.1.6.3.18.</p> <p>Example:</p> <pre>{ "DATA_CENTER": "dc-123", "CITY": "Los Angeles", "STATE": "California" }</pre>	
udrInfo	UdrInfo	O	0..1	<p>Specific data for the UDR (ranges of SUPI, group ID ...)</p>	
udrInfoList	map(UdrInfo)	O	1..N	<p>Multiple entries of UdrInfo. This attribute provides additional information to the udrInfo. udrInfoList may be present even if the udrInfo is absent.</p> <p>The key of the map shall be a (unique) valid JSON string per clause 7 of IETF RFC 8259 [22], with a maximum of 32 characters.</p>	

udmInfo	UdmInfo	O	0..1	Specific data for the UDM (ranges of SUPI, group ID...)	
udmInfoList	map(UdmInfo)	O	1..N	Multiple entries of UdmInfo. This attribute provides additional information to the udmInfo. udmInfoList may be present even if the udmInfo is absent. The key of the map shall be a (unique) valid JSON string per clause 7 of IETF RFC 8259 [22], with a maximum of 32 characters.	
ausfInfo	AusfInfo	O	0..1	Specific data for the AUSF (ranges of SUPI, group ID...)	
ausfInfoList	map(AusfInfo)	O	1..N	Multiple entries of AusfInfo. This attribute provides additional information to the ausfInfo. ausfInfoList may be present even if the ausfInfo is absent. The key of the map shall be a (unique) valid JSON string per clause 7 of IETF RFC 8259 [22], with a maximum of 32 characters.	
amfInfo	AmfInfo	O	0..1	Specific data for the AMF (AMF Set ID, ...)	
amfInfoList	map(AmfInfo)	O	1..N	Multiple entries of AmfInfo. This attribute provides additional information to the amfInfo. amfInfoList may be present even if the amfInfo is absent. The key of the map shall be a (unique) valid JSON string per clause 7 of IETF RFC 8259 [22], with a maximum of 32 characters.	
smfInfo	SmfInfo	O	0..1	Specific data for the SMF (DNN's, ...). (NOTE 12)	
smfInfoList	map(SmfInfo)	O	1..N	Multiple entries of SmfInfo. This attribute provides additional information to the smfInfo. smfInfoList may be present even if the smfInfo is absent. The key of the map shall be a (unique) valid JSON string per clause 7 of IETF RFC 8259 [22], with a maximum of 32 characters. (NOTE 12)	
upfInfo	UpfInfo	O	0..1	Specific data for the UPF (S-NSSAI, DNN, SMF serving area, interface...)	
upfInfoList	map(UpfInfo)	O	1..N	Multiple entries of UpfInfo. This attribute provides additional information to the upfInfo. upfInfoList may be present even if the upfInfo is absent. The key of the map shall be a (unique) valid JSON string per clause 7 of IETF RFC 8259 [22], with a maximum of 32 characters.	
pcfInfo	PcfInfo	O	0..1	Specific data for the PCF.	
pcfInfoList	map(PcfInfo)	O	1..N	Multiple entries of PcfInfo. This attribute provides additional information to the pcfInfo. pcfInfoList may be present even if the pcfInfo is absent. The key of the map shall be a (unique) valid JSON string per clause 7 of IETF RFC 8259 [22], with a maximum of 32 characters.	
bsfInfo	BsfInfo	O	0..1	Specific data for the BSF.	

bsfInfoList	map(BsfInfo)	O	1..N	Multiple entries of BsfInfo. This attribute provides additional information to the bsfInfo. bsfInfoList may be present even if the bsfInfo is absent. The key of the map shall be a (unique) valid JSON string per clause 7 of IETF RFC 8259 [22], with a maximum of 32 characters.	
chfInfo	ChfInfo	O	0..1	Specific data for the CHF.	
chfInfoList	map(ChfInfo)	O	1..N	Multiple entries of ChfInfo. This attribute provides additional information to the chfInfo. chfInfoList may be present even if the chfInfo is absent. The key of the map shall be a (unique) valid JSON string per clause 7 of IETF RFC 8259 [22], with a maximum of 32 characters.	
nefInfo	NefInfo	O	0..1	Specific data for the NEF.	
nrfInfo	NrfInfo	O	0..1	Specific data for the NRF.	
udsfInfo	UdsfInfo	O	0..1	Specific data for the UDSF.	
udsfInfoList	map(UdsfInfo)	O	1..N	Multiple entries of udsfInfo. This attribute provides additional information to the udsfInfo. udsfInfoList may be present even if the udsfInfo is absent. The key of the map shall be a (unique) valid JSON string per clause 7 of IETF RFC 8259 [22], with a maximum of 32 characters.	
nwdafInfo	NwdafInfo	O	0..1	Specific data for the NWDAF.	
nwdafInfoList	map(NwdafInfo)	O	1..N	Multiple entries of nwdafInfo. This attribute provides additional information to the nwdafInfo. nwdafInfoList may be present even if the nwdafInfo is absent. The key of the map shall be a (unique) valid JSON string per clause 7 of IETF RFC 8259 [22], with a maximum of 32 characters.	
pcscfInfoList	map(PcscfInfo)	O	1..N	Specific data for the P-CSCF. The key of the map shall be a (unique) valid JSON string per clause 7 of IETF RFC 8259 [22], with a maximum of 32 characters. (NOTE 11)	
hssInfoList	map(HssInfo)	O	1..N	Specific data for the HSS. The key of the map shall be a (unique) valid JSON string per clause 7 of IETF RFC 8259 [22], with a maximum of 32 characters.	
customInfo	object	O	0..1	Specific data for custom Network Functions	
recoveryTime	DateTime	O	0..1	Timestamp when the NF was (re)started (NOTE 5) (NOTE 6)	
nfServicePersistence	boolean	O	0..1	- true: If present, and set to true, it indicates that the different service instances of a same NF Service in this NF instance, supporting a same API version, are capable to persist their resource state in shared storage and therefore these resources are available after a new NF service instance supporting the same API version is selected by a NF Service Consumer (see 3GPP TS 23.527 [27]). - false (default): Otherwise, it indicates that the NF Service Instances of a same NF Service are not capable to share resource state inside the NF Instance.	

nfServices	array(NFService)	O	1..N	<p>List of NF Service Instances. It shall include the services produced by the NF that can be discovered by other NFs, if any. (NOTE 15)</p> <p>This attribute is deprecated; the attribute "nfServiceList" should be used instead.</p>	
nfServiceList	map(NFService)	O	1..N	<p>Map of NF Service Instances, where the "serviceInstanceId" attribute of the NFService object shall be used as the key of the map. (NOTE 15)</p> <p>It shall include the services produced by the NF that can be discovered by other NFs, if any.</p>	
nfProfileChangesSupportInd	boolean	O	0..1	<p>NF Profile Changes Support Indicator. See Annex B.</p> <p>This IE may be present in the NFRegister or NFUpdate (NF Profile Complete Replacement) request and shall be absent in the response.</p> <p>true: the NF Service Consumer supports receiving NF Profile Changes in the response.</p> <p>false (default): the NF Service Consumer does not support receiving NF Profile Changes in the response.</p> <p>Write-Only: true</p>	
nfProfilePartialUpdateChangesSupportInd	boolean	O	0..1	<p>NF Profile Partial Update Changes Support Indicator. See Annex B.</p> <p>This IE may be present in the NFRegister or NFUpdate request and shall be absent in the response.</p> <p>true: the NF Service Consumer supports receiving NF Profile Changes in the response to an NF Profile Partial Update operation.</p> <p>false (default): the NF Service Consumer does not support receiving NF Profile Changes in the response to an NF Profile Partial Update operation.</p> <p>Write-Only: true</p>	
nfProfileChangesInd	boolean	O	0..1	<p>NF Profile Changes Indicator. See Annex B.</p> <p>This IE shall be absent in the request to the NRF and may be included by the NRF in NFRegister or NFUpdate response.</p> <p>true: the NF Profile contains NF Profile changes.</p> <p>false (default): complete NF Profile.</p> <p>Read-Only: true</p>	
defaultNotificationSubscriptions	array(DefaultNotificationSubscription)	O	1..N	<p>Notification endpoints for different notification types. (NOTE 10)</p>	

lmfInfo	LmfInfo	O	0..1	Specific data for the LMF.	
gmlcInfo	GmlcInfo	O	0..1	Specific data for the GMLC.	
nfSetIdList	array(NfSetId)	C	1..N	NF Set ID defined in clause 28.12 of 3GPP TS 23.003 [12]. At most one NF Set ID shall be indicated per PLMN-ID or SNPN of the NF. At most one combination of an AMF region and an AMF Set ID shall be indicated per PLMN-ID or SNPN in an AMF profile. This information shall be present if available. (NOTE 22) (NOTE 23)	
servingScope	array(string)	O	1..N	The served area(s) of the NF instance. The absence of this attribute does not imply that the NF instance can serve every area in the PLMN. (NOTE 13)	
lchSupportInd	boolean	O	0..1	This IE indicates whether the NF supports Load Control based on LCI Header (see clause 6.3 of 3GPP TS 29.500 [4]). - true: the NF supports the feature. - false (default): the NF does not support the feature.	
olchSupportInd	boolean	O	0..1	This IE indicates whether the NF supports Overload Control based on OCI Header (see clause 6.4 of 3GPP TS 29.500 [4]). - true: the NF supports the feature. - false (default): the NF does not support the feature.	
nfSetRecoveryTimeList	map(DateTime)	O	1..N	Map of recovery time, where the key of the map is the <i>NfSetId</i> of NF Set(s) that the NF instance belongs to. When present, the value of each entry of the map shall be the recovery time of the NF Set indicated by the key.	
serviceSetRecoveryTimeList	map(DateTime)	O	1..N	Map of recovery time, where the key of the map is the <i>NfServiceSetId</i> of the NF Service Set(s) configured in the NF instance. When present, the value of each entry of the map shall be the recovery time of the NF Service Set indicated by the key.	
scpDomains	array(string)	O	1..N	When present, this IE shall carry the list of SCP domains the SCP belongs to, or the SCP domain the NF (other than SCP) or the SEPP belongs to. (NOTE 14)	
scplInfo	ScplInfo	O	0..1	Specific data for the SCP.	
seppInfo	SeppInfo	O	0..1	Specific data for the SEPP.	
vendorId	VendorId	O	0..1	Vendor ID of the NF instance, according to the IANA-assigned "SMI Network Management Private Enterprise Codes" [38].	

supportedVendorSpecificFeatures	map(array(VendorSpecificFeature))	O	1..N(1..M)	Map of Vendor-Specific features, where the key of the map is the IANA-assigned "SMI Network Management Private Enterprise Codes" [38]. The string used as key of the map shall contain 6 decimal digits; if the SMI code has less than 6 digits, it shall be padded with leading digits "0" to complete a 6-digit string value. The value of each entry of the map shall be a list (array) of VendorSpecificFeature objects. (NOTE 19)	
aanfInfoList	map(AanfInfo)	O	1..N	Multiple entries of AanfInfo. The key of the map shall be a (unique) valid JSON string per clause 7 of IETF RFC 8259 [22], with a maximum of 32 characters.	
5gDdnmInfo	5GDdnmInfo	O	0..1	Specific data for the 5G DDNMF (5G DDNMF ID, ...)	
mfafInfo	MfafInfo	O	0..1	Specific data for the MFAF	
easdfInfoList	map(EasdfInfo)	O	1..N	EASDF specific data. The key of the map shall be a (unique) valid JSON string per clause 7 of IETF RFC 8259 [22], with a maximum of 32 characters. (NOTE 20)	
dccfInfo	DccfInfo	O	0..1	Specific data for the DCCF.	
nsacfInfoList	map(NsacfInfo)	O	1..N	Specific data for the NSACF. The key of the map shall be a (unique) valid JSON string per clause 7 of IETF RFC 8259 [22], with a maximum of 32 characters.	
mbSmfInfoList	map(MbSmfInfo)	O	1..N	MB-SMF specific data. The key of the map shall be a (unique) valid JSON string per clause 7 of IETF RFC 8259 [22], with a maximum of 32 characters.	
tsctsfInfoList	map(TsctsfInfo)	O	1..N	Specific data for the TSCTSF. The key of the map shall be a (unique) valid JSON string per clause 7 of IETF RFC 8259 [22], with a maximum of 32 characters.	
mbUpfInfoList	map(MbUpfInfo)	O	1..N	MB-UPF specific data. The key of the map shall be a (unique) valid JSON string per clause 7 of IETF RFC 8259 [22], with a maximum of 32 characters.	
trustAfInfo	TrustAfInfo	O	0..1	Specific data for the trusted AF.	
nssaafInfo	NssaafInfo	O	0..1	Specific data for the NSSAAF.	
hniList	array(Fqdn)	C	1..N	Identifications of Credentials Holder or Default Credentials Server. This IE shall be present if the NFs are available for the case of access to an SNPN using credentials owned by a Credentials Holder or for the case of SNPN Onboarding using a DCS.	
iwmScInfo	IwmScInfo	O	0..1	Specific data for the SMS-IWMSC.	
mnPfInfo	MnPfInfo	O	0..1	Specific data for the MNPF.	
smsfInfo	SmsfInfo	O	0..1	Specific data for the SMSF.	
dcSfInfoList	map(DcSfInfo)	O	1..N	Specific data for the DCSF. The key of the map shall be a (unique) valid JSON string per clause 7 of IETF RFC 8259 [22], with a maximum of 32 characters.	

mrflInfoList	map(MrflInfo)	O	1..N	Specific data for the MRF. The key of the map shall be a (unique) valid JSON string per clause 7 of IETF RFC 8259 [22], with a maximum of 32 characters.	
mrfpInfoList	map(MrfpInfo)	O	1..N	Specific data for the MRFP. The key of the map shall be a (unique) valid JSON string per clause 7 of IETF RFC 8259 [22], with a maximum of 32 characters.	
mflInfoList	map(MflInfo)	O	1..N	Specific data for the MF. The key of the map shall be a (unique) valid JSON string per clause 7 of IETF RFC 8259 [22], with a maximum of 32 characters.	
adrflInfoList	map(AdrflInfo)	O	1..N	Specific data for the ADRF. The key of the map shall be a (unique) valid JSON string per clause 7 of IETF RFC 8259 [22], with a maximum of 32 characters.	
selectionConditions	SelectionConditions	O	0..1	This IE is only applicable if the NFStatus is set to "CANARY_RELEASE", or if the "canaryRelease" attribute is set to true. If present, it includes the conditions under which an NF Instance with an NFStatus value set to "CANARY_RELEASE", or with a "canaryRelease" attribute set to true, shall be selected by an NF Service Consumer (e.g. if the UE belongs to a range of SUPIs)	
canaryRelease	boolean	O	0..1	This IE indicates whether an NF instance whose nfStatus is set to "REGISTERED" is in Canary Release condition, i.e. it should only be selected by NF Service Consumers under the conditions indicated by the "selectionConditions" attribute. - true: the NF is under Canary Release condition, even if the "nfStatus" is set to "REGISTERED" - false (or absent): the NF instance indicates its Canary Release condition via the "nfStatus" attribute	
exclusiveCanaryReleaseSelection	boolean	O	0..1	This IE indicates whether an NF Service Consumer should only select an NF Service Producer in Canary Release condition. - true: the consumer shall only select producers in Canary Release condition - false (or absent): the consumer may select producers not in Canary Release condition	

sharedProfileDataId	string	O	0..1	<p>A string uniquely identifying Shared Profile Data. The format of the sharedProfileDataId shall be a Universally Unique Identifier (UUID) version 4, as described in IETF RFC 4122 [18]. The hexadecimal letters should be formatted as lower-case characters by the sender, and they shall be handled as case-insensitive by the receiver.</p> <p>Example: "4ace9d34-2c69-4f99-92d5-a73a3fe8e23b"</p>	Shared-Data-Registration, Shared-Data-Retrieval
---------------------	--------	---	------	--	---

- NOTE 1: At least one of the addressing parameters (fqdn, ipv4address or ipv6address) shall be included in the NF Profile. If the NF supports the NF services with "https" URI scheme (i.e use of TLS is mandatory), then the FQDN shall be provided in the NF Profile or the NF Service profile (see clause 6.1.6.2.3) and it shall be used to construct the target URI (unless overridden by a NFService-specific FQDN). See NOTE 1 of Table 6.1.6.2.3-1 for the use of these parameters. If multiple ipv4 addresses and/or ipv6 addresses are included in the NF Profile, the NF Service Consumer of the discovery service shall select one of these addresses randomly, unless operator defined local policy of IP address selection, in order to avoid overload for a specific ipv4 address and/or ipv6 address.
- NOTE 2: If the type of Network Function is UPF, the addressing information is for the UPF N4 interface and, if the UPF registers service instances supporting the UPF Event Exposure service or the Nupf_GetUEPrivateIPAddrAndIdentifiers service without registering addressing information at these service instances level, also for accessing the UPF Event Exposure service or the Nupf_GetUEPrivateIPAddrAndIdentifiers service at these service instances. If the type of Network Function is MB-UPF, the addressing information is for the MB-UPF N4mb interface. If the type of Network Function is a P-CSCF and if no Gm FQDN or IP addresses are registered in the pcscfInfoList attribute, the addressing information is also used for the P-CSCF Gm interface.
- NOTE 3: A requester NF may use this information to select a NF instance (e.g. a NF instance preferably located in the same data center).
- NOTE 4: The capacity and priority parameters, if present, are used for NF selection and load balancing. The priority and capacity attributes shall be used for NF selection in the same way that priority and weight are used for server selection as defined in IETF RFC 2782 [23].
- NOTE 5: The NRF shall notify NFs subscribed to receiving notifications of changes of the NF profile, if the NF recoveryTime or the nfStatus is changed. See clause 6.2 of 3GPP TS 23.527 [27].
- NOTE 6: A requester NF may consider that all the resources created in the NF before the NF recovery time have been lost. This may be used to detect a restart of a NF and to trigger appropriate actions, e.g. release local resources. See clause 6.2 of 3GPP TS 23.527 [27].
- NOTE 7: A NF may register multiple PLMN IDs in its profile within a PLMN comprising multiple PLMN IDs. If so, all the attributes of the NF Profile shall apply to each PLMN ID registered in the plmnList. As an exception, attributes including a PLMN ID, e.g. IMSI-based SUPI ranges, TAIs and GUAMIs, are specific to one PLMN ID and the NF may register in its profile multiple occurrences of such attributes for different PLMN IDs (e.g. the UDM may register in its profile SUPI ranges for different PLMN IDs).
- NOTE 8: Other NFs are in a different PLMN if they belong to none of the PLMN ID(s) configured for the PLMN of the NRF.
- NOTE 9: This is for the use case where an NF (e.g. AMF) supports multiple PLMNs and the slices supported in each PLMN are different. See clause 9.2.6.2 of 3GPP TS 38.413 [29].
- NOTE 10: For notification types that may be associated with a specific service of the NF Instance receiving the notification (see clause 6.1.6.3.4), if notification endpoints are present both in the profile of the NF instance (NFProfile) and in some of its NF Services (NFService) for a same notification type, the notification endpoint(s) of the NF Services shall be used for this notification type. The defaultNotificationSubscriptions attribute may contain multiple default subscriptions for a same notification type; in that case, those default subscriptions are used as alternative notification endpoints so, for each notification event that needs to be sent, the NF Service Consumer shall select one of such subscriptions and use it to send the notification.
- NOTE 11: The absence of the pcscfInfoList attribute in a P-CSCF profile indicates that the P-CSCF can be selected for any DNN and Access Type, and that the P-CSCF Gm addressing information is the same as the addressing information registered in the fqdn, ipv4Addresses and ipv6Addresses attributes of the NF profile.
- NOTE 12: The absence of both the smfInfo and smfInfoList attributes in an SMF profile indicates that the SMF can be selected for any S-NSSAI listed in the sNssais and perPlmnSnsaiList IEs, or for any S-NSSAI if neither the sNssais IE nor the perPlmnSnsaiList IE are present, and for any DNN, TAI and access type.
- NOTE 13: The servingScope attribute may indicate geographical areas, It may be used e.g. to discover and select NFs in centralized Data Centers that are expected to serve users located in specific region(s) or province(s). It may also be used to reduce the large configuration of TAIs in the NF instances.
- NOTE 14: An NF (other than a SCP) can register at most one SCP domain in NF profile, i.e. the NF can belong to only one SCP domain. If an NF (other than a SCP) includes this information in its profile, this indicates that the services produced by this NF should be accessed preferably via an SCP from the SCP domain the NF belongs to.
- NOTE 15: If the NF Service Consumer that issues an NF profile retrieval request indicates support for the "Service-Map" feature, the NRF shall return in the NF profile retrieval response the list of NF Service Instances in the "nfServiceList" map attribute. Otherwise, the NRF shall return the list of NF Service Instances in the "nfServices" array attribute.
- NOTE 16: The nfStatus also indicate the Status of the NF instance as NF Service Consumer for notification delivery. When a notification is to be delivered to the NF instance and the NF Service Producer (or SCP) has been aware that the NF instance is not operative from the nfStatus in its NF profile, the NF Service producer (or SCP) shall reselect another NF Service Consumer as target if possible, e.g. using binding indication or discovery factors previously provided for the notification. When selecting or

reselecting an NF Service Consumer for notification delivery, not operative NF instances shall not be selected as target.

- NOTE 17: A change of this attribute shall trigger a "NF_PROFILE_CHANGED" notification from NRF, if the change of the NF Profile results in that the NF Instance starts or stops being authorized to be accessed by an NF having subscribed to be notified about NF profile changes.
- NOTE 18: For API URIs constructed with an FQDN, the NF Service Consumer may use the FQDN of the target URI to do a DNS query and obtain the IP address(es) to setup the TCP connection, and ignore the IP addresses that may be present in the NFProfile; alternatively, the NF Service Consumer may use those IP addresses to setup the TCP connection, if no service-specific FQDN or IP address is provided in the NFService data and if the NF Service Consumer supports to indicate specific IP address(es) to establish an HTTP/2 connection with an FQDN in the target URI.
- NOTE 19: When present, this attribute allows an NF requesting NF Discovery (e.g. an NF Service Consumer) to determine which vendor-specific extensions are supported in a given NF (e.g. an NF Service Producer), so as to select an appropriate NF with specific capability, or to include or not the vendor-specific attributes (see 3GPP TS 29.500 [4] clause 6.6.3) required for a given feature in subsequent messages towards a certain NF. One given vendor-specific feature shall not appear in both NF Profile and NF Service Profile. If one vendor-specific feature is service related, it shall only be included in the NF Service Profile.
- NOTE 20: The absence of the easdfInfoList attribute in an EASDF profile indicates that the EASDF can be selected for any S-NSSAI, DNN, DNAI or PSA UPF N6 IP address.
- NOTE 21: The NF service consumer when invoking NF services offered by collocated NF service producers shall follow the respective service API in the same manner as if they were not collocated with any other NF type. The NF service consumer shall not assume any optimization of signaling between the NF service consumer and the collocated NF service producers.
- NOTE 22: The nfSetIdList attribute shall be present only if all NF service instance(s) of the NF instance are redundant at NF Set level. I.e. any NF service instance shall be redundant (i.e. functionally equivalent, inter-changeable and sharing contexts) with equivalent service instance(s) of every other NF instance(s) within the indicated NF Set or, if the NF service instance belongs to an NF service set, it shall be redundant with NF service instance(s) in an equivalent NF service set of every other NF instance(s) within the indicated NF set.
- NOTE 23: The NF Instance shall be removed from an NF set or re-assigned to another NF set ONLY when there is NO ongoing resource/context associated with the NF instance.

6.1.6.2.3 Type: NFService

Table 6.1.6.2.3-1: Definition of type NFService

Attribute name	Data type	P	Cardinality	Description	Applicability
serviceInstanceId	string	M	1	Unique ID of the service instance within a given NF Instance. When conveyed within SharedData, serviceInstanceId shall take the value "NULL" and shall be ignored by the receiver, as the individual data take precedence.	
serviceName	ServiceName	M	1	Name of the service instance (e.g. "nudm-sdm"). When conveyed within SharedData, servicename shall take the value "NULL" and shall be ignored by the receiver, as the individual data take precedence.	
versions	array(NFServiceVersion)	M	1..N	The API versions supported by the NF Service and if available, the corresponding retirement date of the NF Service. The different array elements shall have distinct unique values for "apiVersionInUri", and consequently, the values of "apiFullVersion" shall have a unique first digit version number. When conveyed within SharedData a single NFServiceVersion shall be present with apiVersionInUri and apiFullVersion both set to the value "NULL", and shall be ignored by the receiver, as individual data take preference.	
scheme	UriScheme	M	1	URI scheme (e.g. "http", "https"). When conveyed within SharedData, scheme shall take the value "NULL" and shall be ignored by the receiver, as the individual data take precedence.	
nfServiceStatus	NFServiceStatus	M	1	Status of the NF Service Instance (NOTE 3) (NOTE 12). When conveyed within SharedData, nfServiceStatus shall take the value "NULL" and shall be ignored by the receiver, as the individual data take precedence.	
fqdn	Fqdn	O	0..1	FQDN of the NF Service Instance (NOTE 1) (NOTE 8) (NOTE 14) The FQDN provided as part of the NFService information has precedence over the FQDN and IP addresses provided as part of the NFProfile information (see clause 6.1.6.2.2).	

interPlmnFqdn	Fqdn	O	0..1	<p>If the NF service needs to be discoverable by other NFs in a different PLMN, then an FQDN that is used for inter PLMN routing as specified in 3GPP TS 23.003 [12] may be registered with the NRF (NOTE 1) (NOTE 6).</p> <p>A change of this attribute shall result in triggering a "NF_PROFILE_CHANGED" notification from NRF towards subscribing NFs located in the same or a different PLMN, but in the latter case the new value shall be notified as a change of the "fqdn" attribute.</p> <p>The NRF shall not send intra-PLMN notifications containing this attribute to subscribing NFs not supporting the "Inter-Plmn-Fqdn" feature (see clause 6.1.9).</p>	
ipEndPoints	array(IpEndPoint)	O	1..N	<p>IP address(es) and port information of the Network Function (including IPv4 and/or IPv6 address) where the service is listening for incoming service requests (NOTE 1) (NOTE 7) (NOTE 14). IP addresses provided in ipEndPoints have precedence over IP addresses provided as part of the NFProfile information and, when using the HTTP scheme, over FQDN provided as part of the NFProfile information (see clause 6.1.6.2.2).</p>	
apiPrefix	string	O	0..1	<p>Optional path segment(s) used to construct the {apiRoot} variable of the different API URIs, as described in 3GPP TS 29.501 [5], clause 4.4.1</p>	
callbackUriPrefixList	array(CallbackUriPrefixItem)	O	1..N	<p>Optional path segment(s) used to construct the prefix of the Callback URIs during the reselection of an NF service consumer, as described in 3GPP TS 29.501 [5], clause 4.4.3. When present, this IE shall contain callback URI prefix values to be used for specific notification types.</p>	
defaultNotificationSubscriptions	array(DefaultNotificationSubscription)	O	1..N	<p>Notification endpoints for different notification types. (See also NOTE 10 in clause 6.1.6.2.2)</p>	

allowedPlmns	array(PlmnId)	O	1..N	<p>PLMNs allowed to access the service instance (NOTE 5).</p> <p>The absence of this attribute indicates that any PLMN is allowed to access the service instance.</p> <p>When included, the allowedPlmns attribute needs not include the PLMN ID(s) registered in the plmnList attribute of the NF Profile, i.e. the PLMN ID(s) registered in the NF Profile shall be considered to be allowed to access the service instance.</p> <p>This attribute shall not be included in profile change notifications to subscribed NFs, unless the subscribing entity explicitly requested so, in the "completeProfileSubscription" attribute in the subscription request message, and the NRF authorized such a request (see clauses 5.2.2.6.2 and 6.1.6.2.17). (NOTE 13)</p>	
allowedSnpons	array(PlmnIdNid)	O	1..N	<p>SNPNs allowed to access the service instance.</p> <p>If this attribute is present in the NFService and in the NF profile, the attribute from the NFService shall prevail.</p> <p>The absence of this attribute in both the NFService and in the NF profile indicates that no SNPN, other than the SNPN(s) registered in the snpnList attribute of the NF Profile (if the NF pertains to an SNPN), is allowed to access the service instance.</p> <p>When included, the allowedSnpons attribute needs not include the PLMN ID/NID(s) registered in the snpnList attribute of the NF Profile (if the NF pertains to an SNPN), i.e. the SNPNs registered in the NF Profile (if any) shall be considered to be allowed to access the service instance.</p> <p>This attribute shall not be included in profile change notifications to subscribed NFs, unless the subscribing entity explicitly requested so, in the "completeProfileSubscription" attribute in the subscription request message, and the NRF authorized such a request (see clauses 5.2.2.6.2 and 6.1.6.2.17). (NOTE 13)</p>	

allowedNfTypes	array(NFType)	O	1..N	<p>Type of the NFs allowed to access the service instance (NOTE 5).</p> <p>This attribute shall not be included in profile change notifications to subscribed NFs, unless the subscribing entity explicitly requested so, in the "completeProfileSubscription" attribute in the subscription request message, and the NRF authorized such a request (see clauses 5.2.2.6.2 and 6.1.6.2.17). (NOTE 13)</p>	
allowedNfDomains	array(string)	O	1..N	<p>Pattern (regular expression according to the ECMA-262 dialect [8]) representing the NF domain names within the PLMN of the NRF allowed to access the service instance (NOTE 5).</p> <p>The absence of this attribute indicates that any NF domain is allowed to access the service instance.</p> <p>This attribute shall not be included in profile change notifications to subscribed NFs, unless the subscribing entity explicitly requested so, in the "completeProfileSubscription" attribute in the subscription request message, and the NRF authorized such a request (see clauses 5.2.2.6.2 and 6.1.6.2.17). (NOTE 13)</p>	
allowedNssais	array(ExtSnsai)	O	1..N	<p>S-NSSAI of the allowed slices to access the service instance (NOTE 5).</p> <p>The absence of this attribute indicates that any slice is allowed to access the service instance.</p> <p>This attribute shall not be included in profile change notifications to subscribed NFs, unless the subscribing entity explicitly requested so, in the "completeProfileSubscription" attribute in the subscription request message, and the NRF authorized such a request (see clauses 5.2.2.6.2 and 6.1.6.2.17). (NOTE 13)</p>	

<p>allowedOperationsPerNFType</p>	<p>map(array(string))</p>	<p>C</p>	<p>1..N(1..M)</p>	<p>Map of allowed operations on resources for each type of NF; the key of the map is the NF Type, and the value is an array of scopes.</p> <p>The scopes shall be any of those defined in the API that defines the current service (identified by the "serviceName" attribute).</p> <p>In an NFRegister (or NFUpdate) procedure, this IE should be present if the NF service instance supports and is configured to use resource/operation specific scope(s) for at least one NF type of NF service consumer.</p> <p>In an NFStatusNotify procedure, this IE should be present, if it is present in the registered NF service instance and if the map contains a key matching the subscriber's NF type. When present, this IE should only contain the key-value pair of the map matching the subscriber's NF type.</p> <p>(NOTE 11)</p>	
<p>allowedOperationsPerNFInstance</p>	<p>map(array(string))</p>	<p>C</p>	<p>1..N(1..M)</p>	<p>Map of allowed operations on resources for a given NF Instance; the key of the map is the NF Instance Id, and the value is an array of scopes.</p> <p>The scopes shall be any of those defined in the API that defines the current service (identified by the "serviceName" attribute).</p> <p>In an NFRegister (or NFUpdate) procedure, this IE should be present if the NF service instance supports and is configured to use resource/operation specific scope(s) for at least one NF instance of NF service consumer.</p> <p>In an NFStatusNotify procedure, this IE should be present, if it is present in the registered NF service instance and if the map contains a key matching the subscriber's NF Instance ID. When present, this IE should only contain the key-value pair of the map matching the subscriber's NF Instance ID.</p> <p>(NOTE 11)</p>	

<p>allowedOperationsPerNfInstanceOverrides</p>	<p>boolean</p>	<p>O</p>	<p>0..1</p>	<p>This IE, when present and set to true, indicates that the scopes defined in attribute "allowedOperationsPerNfInstance" for a given NF Instance ID take precedence over the scopes defined in attribute "allowedOperationsPerNfType" for the corresponding NF type of the NF Instance associated to such NF Instance ID.</p> <p>If the IE is not present, or set to false (default), it indicates that the allowed scopes are any of the scopes present either in "allowedOperationsPerNfType" or in "allowedOperationsPerNfInstance" for the NF Type and NF Instance ID of the NF Service Consumer.</p> <p>(NOTE 11)</p>	
<p>allowedScopesRuleSet</p>	<p>map(RuleSet)</p>	<p>O</p>	<p>1..N</p>	<p>Map of rules specifying scopes allowed or denied for NF-Consumers. The key of the map shall be a (unique) valid JSON string per clause 7 of IETF RFC 8259 [22], with a maximum of 32 characters.</p> <p>This IE may be present when the NF-Producer and the NRF support Allowed-ruleset feature as specified in Clause 6.1.9.</p> <p>When NRF utilizes this parameter to determine the scopes allowed or denied to an NF-Consumer, it matches the NF-Consumer's properties (PLMN, SNPN, nfType, NfDomain, S-NSSAIs, NF-Instance Id) against each rule in decreasing order of priority (1 being the highest). When a matching rule is found, the search is stopped and the scopes associated to matching rule are allowed/dis-allowed to the NF-Consumer (see Annex C).</p> <p>In an NFStatusNotify procedure, this IE may be present if the subscribing NF supports the Allowed-ruleset feature as specified in Clause 6.1.9, and should only contain the highest priority RuleSet matching the requester's NF Instance ID, nfType, PLMN-ID, SNPN-ID, NfDomain and S-NSSAI if any.</p> <p>If the subscribing entity included "completeProfileSubscription" attribute in the subscription request message, and the NRF authorized such a request (see clauses 5.2.2.6.2 and 6.1.6.2.17), the complete IE shall be present in the profile change notification (NOTE 13)</p>	

priority	integer	O	0..1	Priority (relative to other services of the same type) in the range of 0-65535, to be used for NF Service selection; lower values indicate a higher priority. (NOTE 2). The NRF may overwrite the received priority value when exposing an NFProfile with the Nnrf_NFDiscovery service.	
capacity	integer	O	0..1	Static capacity information in the range of 0-65535, expressed as a weight relative to other services of the same type. (NOTE 2).	
load	integer	O	0..1	Dynamic load information, ranged from 0 to 100, indicates the current load percentage of the NF Service.	
loadTimeStamp	DateTime	O	0..1	It indicates the point in time in which the latest load information (sent by the NF in the "load" attribute of the NF Service) was generated at the NF Service Instance. If the NF did not provide a timestamp, the NRF should set it to the instant when the NRF received the message where the NF provided the latest load information.	
recoveryTime	DateTime	O	0..1	Timestamp when the NF service was (re)started (NOTE 3) (NOTE 4)	
supportedFeatures	SupportedFeatures	O	0..1	Supported Features of the NF Service instance	
nfServiceSetIdList	array(NfServiceSetId)	C	1..N	NF Service Set ID (see clause 28.13 of 3GPP TS 23.003 [12]) At most one NF Service Set ID shall be indicated per PLMN-ID or SNPN of the NF. This information shall be present if available. (NOTE 15)	
sNssais	array(ExtSnsai)	O	1..N	S-NSSAIs of the NF Service. This may be a subset of the S-NSSAIs supported by the NF (see sNssais attribute in NFProfile). When present, this IE shall represent the list of S-NSSAIs supported by the NF Service in all the PLMNs listed in the plmnList IE and all the SNPNS listed in the snpnList and it shall prevail over the list of S-NSSAIs supported by the NF instance.	
perPlmnSnsaiList	array(PlmnSnsai)	O	1..N	S-NSSAIs of the NF Service per PLMN. This may be a subset of the S-NSSAIs supported per PLMN by the NF (see perPlmnSnsaiList attribute in NFProfile). This IE may be included when the list of S-NSSAIs supported by the NF Service for each PLMN it is supporting is different. When present, this IE shall include the S-NSSAIs supported by the NF Service for each PLMN and it shall prevail over the list of S-NSSAIs supported per PLMN by the NF instance. When present, this IE shall override the sNssais IE. (NOTE 9)	

vendorId	VendorId	O	0..1	Vendor ID of the NF Service instance, according to the IANA-assigned "SMI Network Management Private Enterprise Codes" [38].	
supportedVendorSpecificFeatures	map(array(VendorSpecificFeature))	O	1..N(1..M)	Map of Vendor-Specific features, where the key of the map is the IANA-assigned "SMI Network Management Private Enterprise Codes" [38]. The string used as key of the map shall contain 6 decimal digits; if the SMI code has less than 6 digits, it shall be padded with leading digits "0" to complete a 6-digit string value. The value of each entry of the map shall be a list (array) of VendorSpecificFeature objects. (NOTE 10)	
oauth2Required	boolean	O	0..1	It indicates whether the NF Service Instance requires Oauth2-based authorization. Absence of this IE means that the NF Service Producer has not provided any indication about its usage of Oauth2 for authorization.	
perPlmnOauth2ReqList	PlmnOauth2	O	0..1	When present, this IE shall include the Oauth2-based authorization requirement supported by the NF Service Instance per PLMN of the NF Service Consumer. This IE may be included when the Oauth2.0 authorization requirement supported by the NF Service Instance for different PLMN is different. When the requester PLMN Id is available in perPlmnOauth2ReqList IE, this IE shall override the oauth2Required IE. If the requester PLMN ID is not present in perPlmnOauth2ReqList IE, then the value of oauth2Required IE shall be applicable if available.	
selectionConditions	SelectionConditions	O	0..1	This IE is only applicable if the NFServiceStatus is set to "CANARY_RELEASE", or if the "canaryRelease" attribute is set to true. If present, it includes the conditions under which an NF Service Instance with an NFServiceStatus value set to "CANARY_RELEASE", or with a "canaryRelease" attribute set to true, shall be selected by an NF Service Consumer (e.g. if the UE belongs to a range of SUPIs)	

canaryRelease	boolean	O	0..1	<p>This IE indicates whether an NF Service instance whose nfServiceStatus is set to "REGISTERED" is in Canary Release condition, i.e. it shall only be used by NF Service Consumers under the conditions indicated by the "selectionConditions" attribute.</p> <p>- true: the NF Service instance is under Canary Release condition, even if the "nfServiceStatus" is set to "REGISTERED"</p> <p>- false (or absent): the NF Service instance indicates its Canary Release condition via the "nfServiceStatus" attribute</p>	
exclusiveCanaryReleaseSelection	boolean	O	0..1	<p>This IE indicates whether an NF Service Consumer should only select an NF Service Producer in Canary Release condition.</p> <p>- true: the consumer shall only select producers in Canary Release condition</p> <p>- false (or absent): the consumer may select producers not in Canary Release condition</p>	
sharedServiceDataId	string	O	0..1	<p>String uniquely identifying SharedServiceData. The format of the sharedServiceDataId shall be a Universally Unique Identifier (UUID) version 4, as described in IETF RFC 4122 [18]. The hexadecimal letters should be formatted as lower-case characters by the sender, and they shall be handled as case-insensitive by the receiver.</p> <p>Example: "4ace9d34-2c69-4f99-92d5-a73a3fe8e23b"</p>	Shared-Data-Registration, Shared-Data-Retrieval

<p>NOTE 1: The NF Service Consumer will construct the API URIs of the service using:</p> <ul style="list-style-type: none"> - For intra-PLMN signalling: If TLS is used, the FQDN present in the NF Service Profile, if any; otherwise, the FQDN present in the NF Profile. If TLS is not used, the FQDN should be used if the NF Service Consumer uses Indirect Communication via an SCP; the FQDN or the IP address in the ipEndpoints attribute may be used if the NF Service Consumer uses Direct Communication. - For inter-PLMN signalling: the interPlmnFqdn present in the NF Service Profile, if any; otherwise, the interPlmnFqdn present in the NF Profile. <p>See Table 6.2.6.2.4-1.</p> <p>NOTE 2: The capacity and priority parameters, if present, are used for NF selection and load balancing. The priority and capacity attributes shall be used for NF selection in the same way that priority and weight are used for server selection as defined in IETF RFC 2782 [23].</p> <p>NOTE 3: The NRF shall notify NFs subscribed to receiving notifications of changes of the NF profile, if the recoveryTime or the nfServiceStatus is changed. See clause 6.2 of 3GPP TS 23.527 [27].</p> <p>NOTE 4: A requester NF subscribed to NF status changes may consider that all the resources created in the NF service before the NF service recovery time have been lost. This may be used to detect a restart of a NF service and to trigger appropriate actions, e.g. release local resources. See clause 6.2 of 3GPP TS 23.527 [27].</p> <p>NOTE 5: If this attribute is present in the NFService and in the NF profile, the attribute from the NFService shall prevail. The absence of this attribute in the NFService and in the NFProfile indicates that there is no corresponding restriction to access the service instance. If this attribute is absent in the NF Service, but it is present in the NF Profile, the attribute from the NF Profile shall be applied.</p> <p>NOTE 6: Other NFs are in a different PLMN if they belong to none of the PLMN ID(s) configured for the PLMN of the NRF.</p> <p>NOTE 7: If multiple ipv4 addresses and/or ipv6 addresses are included in the NF Service, the NF Service Consumer of the discovery service shall select one of these addresses randomly, unless operator defined local policy of IP address selection, in order to avoid overload for a specific ipv4 address and/or ipv6 address.</p> <p>NOTE 8: If the URI scheme registered for the NF service is "https" then FQDN shall be provided in the NF Service profile or in NF Profile (see clause 6.1.6.2.2).</p> <p>NOTE 9: This is for the use case where an NF (e.g. AMF) supports multiple PLMNs and the slices supported in each PLMN are different. See clause 9.2.6.2 of 3GPP TS 38.413 [29].</p> <p>NOTE 10: When present, this attribute allows the NF requesting NF discovery (e.g. an NF Service Consumer) to determine which vendor-specific extensions are supported in a given NF (e.g. an Service Producer) in order to select an appropriate NF, or to include or not include the vendor-specific attributes (see 3GPP TS 29.500 [4] clause 6.6.3) required for a given feature in subsequent service requests towards a certain service instance of the NF Service Producer. One given vendor-specific feature shall not appear in both NF Profile and NF Service Profile. If one vendor-specific feature is service related, it shall only be included in the NF Service Profile.</p> <p>NOTE 11: These attributes are used in order to determine whether a given resource/operation-level scope shall be granted to an NF Service Consumer that requested an OAuth2 access token with a specific scope. If attribute "allowedOperationsPerNfInstanceOverrides" is absent, or set to false, the NRF shall only grant such scope in the access token, if the scope is present in either "allowedOperationsPerNfType", for the specific NF type of the NF Service Consumer, or in "allowedOperationsPerNfInstance", for the specific NF instance ID of the NF Service Consumer. If attribute "allowedOperationsPerNfInstanceOverrides" is present and set to true, the NRF shall grant such scope in the access token, if the scope is included in the "allowedOperationsPerNfInstance" attribute for the NF Instance ID of the NF Service Consumer. If attribute "allowedOperationPerNfInstanceOverrides" is present and set to true, but the NF Instance ID of the NF Service Consumer is not included in attribute "allowedOperationPerNfInstance", the NRF shall grant such scope if it is present in the "allowedOperationsPerNfType" for the specific NF type of the NF Service Consumer.</p> <p>These attributes need not be registered if the NF service instance only supports (or is configured to only use) the service-level scope for all NF service consumers allowed to access the service. When both these attributes are absent, the NRF should grant access tokens for the service-level scope only. When at least one of these IEs is present, these IEs shall indicate all the NF types or NF instances allowed to access the NF service instance, with all the corresponding scopes (i.e. the service-level scope and resource/operation specific scopes) allowed for each NF type or NF instance, i.e. any NF type or NF instance not listed in these IEs is disallowed to access the NF service instance.</p> <p>Example: if an NF service instance is configured to enable an NF type X to access all service operations including resource/operations defined with resource/operation specific scopes and an NF type Y to access only the service operations not requiring resource/operation specific scopes, the allowedOperationsPerNfType IE should be present and set as follows:</p> <pre> allowedOperationsPerNfType: { X: [<service-level scope>, <resource/operation scope 1>, <resource/operation scope 2>], Y: [<service-level scope>] </pre>

}

- NOTE 12: The `nfServiceStatus` also indicate the Status of the NF service instance as NF Service Consumer for notification delivery. When a notification is to be delivered to the NF service instance and the NF Service Producer (or SCP) has been aware that the NF service instance is not operative from the `nfServiceStatus` in the NF profile, the NF Service producer (or SCP) shall reselect another NF Service Consumer as target if possible, e.g. using binding indication or discovery factors previously provided for the notification. When selecting or reselecting an NF Service Consumer for notification delivery, not operative NF (service) instances shall not be selected as target.
- NOTE 13: A change of this attribute shall trigger a "NF_PROFILE_CHANGED" notification from NRF, if the change of the NF Profile results in that the NF Instance starts or stops being authorized to be accessed by an NF having subscribed to be notified about NF profile changes.
- NOTE 14: For API URIs constructed with an FQDN, the NF Service Consumer may use the FQDN in the target URI to do a DNS query and obtain the IP address(es) to setup the TCP connection, and ignore the IP addresses that may be present in the `ipEndpoints` attribute; alternatively, the NF Service Consumer may use those IP addresses to setup the TCP connection, if the NF Service Consumer supports to indicate specific IP address(es) to establish an HTTP/2 connection with an FQDN in the target URI.
- NOTE 15: The NF service Instance shall be removed from an NF service set or re-assigned to another NF service set ONLY when there is NO ongoing resource/context associated with the NF service instance.

6.1.6.2.4 Type: DefaultNotificationSubscription

Table 6.1.6.2.4-1: Definition of type DefaultNotificationSubscription

Attribute name	Data type	P	Cardinality	Description
notificationType	NotificationType	M	1	Type of notification for which the corresponding callback URI is provided.
callbackUri	Uri	M	1	This attribute contains a default notification endpoint to be used by a NF Service Producer towards an NF Service Consumer that has not registered explicitly a callback URI in the NF Service Producer (e.g. as a result of an implicit subscription).
interPlmnCallbackUri	Uri	C	0..1	This IE shall be present when the default notification may be sent by a NF Service Producer in a different PLMN (e.g. the NSSAAF in HPLMN sends a notification to the AMF in VPLMN to re-authorize or revoke a S-NSSAI for a roaming UE) and the callback URI indicated in the callbackUri IE is not supporting inter-PLMN access. When present, this IE shall indicate the callback URI to be used by NF Service Producers located in PLMNs that are different from the PLMN of the NF consumer.
n1MessageClass	N1MessageClass	C	0..1	If the notification type is N1_MESSAGES, this IE shall be present and shall identify the class of N1 messages to be notified.
n2InformationClass	N2InformationClass	C	0..1	If the notification type is N2_INFORMATION, this IE shall be present and shall identify the class of N2 information to be notified.
versions	array(string)	O	1..N	API versions (e.g. "v1") supported for the default notification type. (NOTE 3)
binding	string	O	0..1	When present, this IE shall contain the value of the Binding Indication for the default subscription notification (i.e. the value part of "3gpp-Sbi-Binding" header), as specified in clause 6.12.4 of 3GPP TS 29.500 [4]. (NOTE 1)
acceptedEncoding	string	O	0..1	Content encodings that are accepted by a NF Service Consumer when receiving a notification related to a default notification subscription. The value of this attribute shall be formatted as the value of the Accept-Encoding header defined in IETF RFC 9110 [40] clause 12.5.3 (e.g. acceptedEncoding: "gzip;q=1.0, identity;q=0.5, *;q=0") The absence of this IE shall not be interpreted as indicating that no specific encodings are supported, but the NF Service Consumer did not register the encodings it may support.
supportedFeatures	SupportedFeatures	O	0..1	When present, this attribute shall indicate the features of the service corresponding to the subscribed default notification, which are supported by the NF (Service) instance acting as NF service consumer. (NOTE 2, NOTE 3)

serviceInfoList	map(DefSubServiceInfo)	O	1..N	<p>This IE may be present when the notification request of the notification type may be generated by multiple services, i.e. notifications from different services may be received by the subscription.</p> <p>When present, this IE shall contain a map of service specific information. The name of the corresponding service (as specified in ServiceName data type, see clause 6.1.6.3.11) is the key of the map and the value of the map is the specific information for the indicated service supported by the NF (Service) instance acting as NF service consumer.</p> <p>For example, when the NF subscribes to default notification of "LOCATION_NOTIFICATION" type which may be sent by Namf_Location service and Nlmf_Location service, the NF may provide service specific information as below:</p> <pre> { "namf-loc" : { "versions" : ["v1"], "supportedFeatures" : "AB" }, "nlmf-loc" : { "versions" : ["v1"], "supportedFeatures" : "12" } } </pre> <p>(NOTE 3, NOTE 4)</p>
callbackUriPrefix	string	O	0..1	Optional path segment(s) used to construct the prefix of the Callback URIs during the reselection of an NF service consumer, as described in 3GPP TS 29.501 [5], clause 4.4.3
<p>NOTE 1: The binding indication for default subscription may be used by a NF service producer to reselect an alternative NF service consumer instance, when delivering a notification for a default subscription towards a specific NF consumer but the latter is not reachable. E.g. an AMF notifies corresponding uplink LPP/NRPPa messages via default subscription, to the LMF instance who previously sent downlink LPP/NRPPa message during a location procedure, If the original LMF instance is not reachable, the AMF selects an alternative LMF instance using the binding indication and delivers the notification towards the selected LMF instance.</p> <p>NOTE 2: When sending notifications towards the subscribed NF service consumer, the NF service producer shall generate the default notifications according to the supported features indicated in this attribute, e.g. to include the attributes or enumerated values related to particular features only if the corresponding features are supported, as specified in clause 6.6.2 of 3GPP TS 29.500 [4].</p> <p>NOTE 3: When the serviceInfoList IE is present, the versions IE and the supportedFeatures IE shall be absent.</p> <p>NOTE 4: When the serviceInfoList IE is present, the NF producer shall determine whether the service of the default notification is supported, i.e. whether the service is listed in the map keys. If supported, the NF producer shall generate the default notification according to the specific information of the service, i.e. the corresponding map value.</p>				

6.1.6.2.5 Type: IpEndPoint

Table 6.1.6.2.5-1: Definition of type IpEndPoint

Attribute name	Data type	P	Cardinality	Description
ipv4Address	Ipv4Addr	C	0..1	IPv4 address (NOTE 1)
ipv6Address	Ipv6Addr	C	0..1	IPv6 address (NOTE 1)
transport	TransportProtocol	O	0..1	Transport protocol
port	integer	O	0..1	Port number (NOTE 2) Minimum: 0 Maximum: 65535

NOTE 1: At most one occurrence of either ipv4Address or ipv6Address shall be included in this data structure.

NOTE 2: If the port number is absent from the ipEndpoints attribute (see clause 6.1.6.2.3), i.e. there is no "port" attribute in any of the IpEndpoints objects of the ipEndpoints array, the NF service consumer shall use the default HTTP port number, i.e. TCP port 80 for "http" URIs or TCP port 443 for "https" URIs as specified in IETF RFC 9113 [9] when invoking the service.

NOTE 3: If the "port" attribute is present, but the ipv4Address and ipv6Address attributes are absent, the NF service consumer shall use such port number along with the FQDN present in the NFService or NFProfile data types or IP address parameters present in the NFProfile data type to construct the target URI where the NF Service Producer is listening for incoming service requests.

NOTE 4: If the "port" attribute is present with any ipv4Address and ipv6Address attributes and the HTTP scheme of the service is "https", or the inter-PLMN signalling uses the "http" scheme, the NF service consumer shall use such port number along with the FQDN parameter present in the NFService or NFProfile data types to construct the target URI where the NF Service Producer is listening for incoming service requests.

NOTE 5: If the HTTP scheme of the service (see clause 6.1.6.2.3) is "https" or the inter-PLMN signalling uses the "http" scheme, the operator should not configure IpEndpoints having pairs of IP addresses and ports, with different "port" values in each entry. This is so because the authority of the target URI shall consist of an FQDN (due to the "https" scheme or inter-PLMN signalling), and it is not always possible to ensure which IP address will be used by the HTTP/2 stack after the DNS resolution has been performed.

NOTE 6: If the "ipEndpoints" array contains an entry (IpEndPoint object) containing either ipv4Address or ipv6Address, and with the "port" attribute absent, the NF Service Consumer shall use the default port for the given HTTP scheme when building a target URI that uses such IP address in the authority field of the URI.

The following examples describe valid cases of the authority of target URIs, considering the addressing information present in the NFProfile and in the NFService objects (in the "nfServiceList" map).

EXAMPLE 1:

NFProfile:

```
{
  "fqdn": "nf.example.com",
  "ipv4Addresses": [ "1.2.3.4" ],
  "nfServiceList": {
    "Service1": {
      "scheme": "http",
      "ipEndpoints": [
        { "port": 8080 },
        { "ipv4Address": "1.2.3.5", "port": 8081 }
      ]
    }
  }
}
```

Valid authority for target URIs:

<http://1.2.3.5:8081/>

Note that the IP address contained in ipEndpoints override the FQDN and IP address in NFProfile-level, so the value contained in "port" cannot be used, in this configuration.

EXAMPLE 2:

NFProfile:

```
{
  "fqdn": "nf.example.com",
  "ipv4Addresses": [ "1.2.3.4" ],
  "nfServiceList": {
```

```

    "Service1": {
      "scheme": "http",
      "fqdn": "service1.example.com",
      "ipEndPoints": [
        { "ipv4Address": "1.2.3.5", "port": 8081 },
        { "ipv4Address": "1.2.3.6" }
      ]
    }
  }
}

```

Valid authority for target URIs:

<http://1.2.3.5:8081/>
<http://1.2.3.6:80/>
<http://1.2.3.6/>

EXAMPLE 3:

NFProfile:

```

{
  "fqdn": "nf.example.com",
  "ipv4Addresses": [ "1.2.3.4" ],
  "nfServiceList": {
    "Service1": {
      "scheme": "http",
      "ipEndPoints": [
        { "port": 8080 },
      ]
    }
  }
}

```

Valid authority for target URIs:

<http://nf.example.com:8080/>
<http://1.2.3.4:8080/>

6.1.6.2.6 Type: UdrInfo

Table 6.1.6.2.6-1: Definition of type UdrInfo

Attribute name	Data type	P	Cardinality	Description
groupId	NfGroupId	O	0..1	Identity of the UDR group that is served by the UDR instance. A number of UDR instances can be considered to conform a UDR group when they serve the same set of users (identified by supiRanges and gpsiRanges), even if they are not identified by a UDR Group ID. (NOTE 1)
supiRanges	array(SupiRange)	O	1..N	List of ranges of SUPI's whose profile data is available in the UDR instance (NOTE 1)
gpsiRanges	array(IdentityRange)	O	1..N	List of ranges of GPSIs whose profile data is available in the UDR instance (NOTE 1)
externalGroupIdentifiersRanges	array(IdentityRange)	O	1..N	List of ranges of external groups whose profile data is available in the UDR instance (NOTE 1)
supportedDataSets	array(DataSetId)	O	1..N	List of supported data sets in the UDR instance. If not provided, the UDR supports all data sets.
sharedDataIdRanges	array(SharedDataIdRange)	O	1..N	List of ranges of Shared Data IDs that identify shared data available in the UDR instance (NOTE 1)
NOTE 1: If none of these parameters are provided, the UDR can serve any external group and any SUPI or GPSI and any SharedData managed by the PLMN of the UDR instance. If "supiRanges" is absent and "groupId" is present, the SUPIs served by this UDR instance are determined by the NRF; if "gpsiRanges" is absent and "groupId" is present, the GPSIs served by this UDR instance are determined by the NRF; if "externalGroupIdentifiersRanges" is absent and "groupId" is present, the ExternalGroups served by this UDR instance are determined by the NRF (see 3GPP TS 23.501 [2], clause 6.2.6.2).				

NOTE: The operator needs to ensure that the "udrInfo" of UDR instances serving the same set of users (e.g., identified by the same "groupId" or "supiRanges" and "gpsiranges" attributes) includes the same attributes and the same attribute values consistently.

For a given UDR instance, the operator needs to ensure that when both "supiRanges" and "gpsiranges" attributes are present, they refer to the same set of users consistently.

6.1.6.2.7 Type: UdmInfo

Table 6.1.6.2.7-1: Definition of type UdmInfo

Attribute name	Data type	P	Cardinality	Description
groupId	NfGroupId	O	0..1	Identity of the UDM group that is served by the UDM instance. A number of UDM instances can be considered to conform a UDM group when they serve the same set of users (identified by supiRanges and gpsiranges), even if they are not identified by a UDM Group ID. (NOTE 1)
supiRanges	array(SupiRange)	O	1..N	List of ranges of SUPIs whose profile data is available in the UDM instance (NOTE 1)
gpsiranges	array(IdentityRange)	O	1..N	List of ranges of GPSIs whose profile data is available in the UDM instance (NOTE 1)
externalGroupIdentifiers Ranges	array(IdentityRange)	O	1..N	List of ranges of external groups whose profile data is available in the UDM instance (NOTE 1)
routingIndicators	array(string)	O	1..N	List of Routing Indicator information that allows to route network signalling with SUCI (see 3GPP TS 23.003 [12]) to the UDM instance. (NOTE 4) If not provided, and "groupId" attribute is absent, the UDM can serve any Routing Indicator. Pattern: '^[0-9]{1,4}\$'
internalGroupIdentifiers Ranges	array(InternalGroupRange)	O	1..N	List of ranges of Internal Group Identifiers whose profile data is available in the UDM instance. If not provided, it does not imply that the UDM supports all internal groups.
sucInfos	array(SucInfo)	O	1..N	List of SucInfo. A SUCI that matches this information can be served by the UDM. (NOTE 2, NOTE 3) A SUCI that matches all attributes of at least one entry in this array shall be considered as a match of this information.
<p>NOTE 1: If none of these parameters are provided, the UDM can serve any external group and any SUPI or GPSI managed by the PLMN of the UDM instance. If "supiRanges" is absent and "groupId" is present, the SUPIs served by this UDM instance are determined by the NRF; if "gpsiranges" is absent and "groupId" is present, the GPSIs served by this UDM instance are determined by the NRF; if "externalGroupIdentifiersRanges" is absent, and "groupId" is present, the ExternalGroups served by this UDM instance are determined by the NRF (see 3GPP TS 23.501 [2], clause 6.2.6.2).</p> <p>NOTE 2: The combination of SUCI informations, e.g. Routing Indicator and Home Network Public Key Id, may be used as criteria for UDM discovery. In this release, the usage of Home Network Public Key identifier for UDM discovery is limited to the scenario where the UDM NF consumers belong to the same PLMN as UDM.</p> <p>NOTE 3: If the sucInfos attribute is present and contains the routingIndcs sub-attribute, then the routingIndicators attribute shall also be present.</p> <p>NOTE 4: If "routingIndicators" attribute is absent, and "groupId" is present, the set of Routing Indicators served by this UDM instance is determined by the NRF. When "groupId" is present, if the consumer of the Nnrf_Discovery service does not support the "RID-NfGroupId-Mapping" feature (see clause 6.2.9), the NRF shall include in the discovery response the list of supported "routingIndicators" served by the UDM Group ID to which this UDM instance belongs, as determined by the NRF (or leave absent the "routingIndicators" attribute to indicate that any Routing Indicator is served by this UDM instance).</p>				

NOTE: The operator needs to ensure that the "udmInfo" of UDM instances serving the same set of users (e.g., identified by the same "groupId" or "supiRanges" and "gpsiRanges" attributes) includes the same attributes and the same attribute values consistently.

For a given UDM instance, the operator needs to ensure that when both "supiRanges" and "gpsiRanges" attributes are present, they refer to the same set of users consistently; and, when both "internalGroupIdentifiersRanges" and "externalGroupIdentifiersRanges" attributes are present, they refer to the same group of users consistently.

6.1.6.2.8 Type: AusfInfo

Table 6.1.6.2.8-1: Definition of type AusfInfo

Attribute name	Data type	P	Cardinality	Description
groupId	NfGroupId	O	0..1	Identity of the AUSF group. A number of AUSF instances can be considered to conform an AUSF group when they serve the same set of users (identified by supiRanges), even if they are not identified by an AUSF Group ID. (NOTE 1)
supiRanges	array(SupiRange)	O	1..N	List of ranges of SUPIs that can be served by the AUSF instance. (NOTE 1)
routingIndicators	array(string)	O	1..N	List of Routing Indicator information that allows to route network signalling with SUCI (see 3GPP TS 23.003 [12]) to the AUSF instance. (NOTE 4) If not provided, and "groupId" attribute is absent, the AUSF can serve any Routing Indicator. Pattern: '^[0-9]{1,4}\$'
sucInfos	array(SucInfo)	O	1..N	List of SucInfo. A SUCI that matches this information can be served by the AUSF. (NOTE 2, NOTE 3) A SUCI that matches all attributes of at least one entry in this array shall be considered as a match of this information.
<p>NOTE 1: If none of these parameters are provided, the AUSF can serve any SUPI managed by the PLMN of the AUSF instance. If "supiRanges" is absent and "groupId" is present, the SUPIs served by this AUSF instance are determined by the NRF (see 3GPP TS 23.501 [2], clause 6.2.6.2).</p> <p>NOTE 2: The combination of SUCI informations, e.g. Routing Indicator and Home Network Public Key Id, can be used as criteria for AUSF discovery. In this release, the usage of Home Network Public Key identifier for AUSF discovery is limited to the scenario where the AUSF NF consumers belong to the same PLMN as AUSF.</p> <p>NOTE 3: If the sucInfos attribute is present and contains the routingInds sub-attribute, then the routingIndicators attribute shall also be present.</p> <p>NOTE 4: If "routingIndicators" attribute is absent, and "groupId" is present, the set of Routing Indicators served by this AUSF instance is determined by the NRF. When "groupId" is present, if the consumer of the Nnrf_Discovery service does not support the "RID-NfGroupId-Mapping" feature (see clause 6.2.9), the NRF shall include in the discovery response the list of supported "routingIndicators" served by the AUSF Group ID to which this AUSF instance belongs, as determined by the NRF (or leave absent the "routingIndicators" attribute to indicate that any Routing Indicator is served by this AUSF instance).</p>				

NOTE: The operator needs to ensure that the "ausfInfo" of AUSF instances serving the same set of users (e.g., identified by the same "groupId" or "supiRanges" attributes) includes the same attributes and the same attribute values consistently.

6.1.6.2.9 Type: SupiRange

Table 6.1.6.2.9-1: Definition of type SupiRange

Attribute name	Data type	P	Cardinality	Description
start	string	O	0..1	First value identifying the start of a SUPI range, to be used when the range of SUPI's can be represented as a numeric range (e.g., IMSI ranges). This string shall consist only of digits. Pattern: " $^{\wedge}[0-9]+\$$ "
end	string	O	0..1	Last value identifying the end of a SUPI range, to be used when the range of SUPI's can be represented as a numeric range (e.g. IMSI ranges). This string shall consist only of digits. Pattern: " $^{\wedge}[0-9]+\$$ "
pattern	string	O	0..1	Pattern (regular expression according to the ECMA-262 dialect [8]) representing the set of SUPI's belonging to this range. A SUPI value is considered part of the range if and only if the SUPI string fully matches the regular expression.

NOTE: Either the start and end attributes, or the pattern attribute, shall be present.

EXAMPLE 1: IMSI range. From: 123 45 6789040000 To: 123 45 6789059999 (i.e., 20,000 IMSI numbers)
JSON: { "start": "123456789040000", "end": "123456789059999" }

EXAMPLE 2: IMSI range. From: 123 45 6789040000 To: 123 45 6789049999 (i.e., 10,000 IMSI numbers)
JSON: { "pattern": " $^{\wedge}$ imsi-12345678904[0-9]{4}\$" }, or
JSON: { "start": "123456789040000", "end": "123456789049999" }

EXAMPLE 3: NAI range. "smartmeter- $\{$ factoryID $\}$ @company.com" where " $\{$ factoryID $\}$ " can be any string.
JSON: { "pattern": " $^{\wedge}$ nai-smartmeter-.\+@company\.com\$" }

6.1.6.2.10 Type: IdentityRange

Table 6.1.6.2.10-1: Definition of type IdentityRange

Attribute name	Data type	P	Cardinality	Description
start	string	O	0..1	First value identifying the start of an identity range, to be used when the range of identities can be represented as a numeric range (e.g., MSISDN ranges). This string shall consist only of digits. Pattern: " $^{\wedge}[0-9]+\$$ "
end	string	O	0..1	Last value identifying the end of an identity range, to be used when the range of identities can be represented as a numeric range (e.g. MSISDN ranges). This string shall consist only of digits. Pattern: " $^{\wedge}[0-9]+\$$ "
pattern	string	O	0..1	Pattern (regular expression according to the ECMA-262 dialect [8]) representing the set of identities belonging to this range. An identity value is considered part of the range if and only if the identity string fully matches the regular expression.

NOTE: Either the start and end attributes, or the pattern attribute, shall be present.

6.1.6.2.11 Type: AmfInfo

Table 6.1.6.2.11-1: Definition of type AmfInfo

Attribute name	Data type	P	Cardinality	Description
amfRegionId	AmfRegionId	M	1	AMF region identifier
amfSetId	AmfSetId	M	1	AMF set identifier.
guamiList	array(Guami)	M	1..N	List of supported GUAMIs
taiList	array(Tai)	O	1..N	The list of TAIs the AMF can serve. It may contain one or more non-3GPP access TAIs. The absence of this attribute and the taiRangeList attribute indicate that the AMF can be selected for any TAI in the serving network.
taiRangeList	array(TaiRange)	O	1..N	The range of TAIs the AMF can serve. It may contain non-3GPP access TAIs. The absence of this attribute and the taiList attribute indicate that the AMF can be selected for any TAI in the serving network.
backupInfoAmfFailure	array(Guami)	O	1..N	List of GUAMIs for which the AMF acts as a backup for AMF failure
backupInfoAmfRemoval	array(Guami)	O	1..N	List of GUAMIs for which the AMF acts as a backup for planned AMF removal
n2InterfaceAmfInfo	N2InterfaceAmfInfo	O	0..1	N2 interface information of the AMF. This information needs not be sent in NF Discovery responses. It may be used by the NRF to update the DNS for AMF discovery by the 5G Access Network. The procedures for updating the DNS are out of scope of this specification.
amfOnboardingCapability	boolean	O	0..1	When present, this IE indicates the AMF supports SNPN Onboarding capability. This is used for the case of Onboarding of UEs for SNPNS (see 3GPP TS 23.501 [2], clause 5.30.2.10). <ul style="list-style-type: none"> - false (default): AMF does not support SNPN Onboarding; - true: AMF supports SNPN Onboarding.
highLatencyCom	boolean	O	0..1	When present, this IE indicates whether the AMF supports High Latency communication (e.g. for NR RedCap UE). This is used for CP NF to discover AMF supporting High Latency communication (see 3GPP TS 23.501 [2], clause 6.3.5). <ul style="list-style-type: none"> - true: AMF supports High Latency communication e.g. for NR RedCap UE; - false: AMF does not support High Latency communication e.g. for NR RedCap UE.

The "backupInfoAmfFailure" attribute and "backupInfoAmfRemoval" attribute indicates the GUAMIs for which the AMF can act as Backup, when the serving AMF has failed or under planned removal.

EXAMPLE:

When AMF-A, AMF-B and AMF-C registered their NF profiles for PLMN (e.g. MCC = 234, MNC = 15) as following:

AMF-A NF Profile:

```
{
  "amfInfo": {
    "guamiList": [{ "plmnId": { "mcc": "234", "mnc": "15" }, "amfId": "000001" }],
    "backupInfoAmfFailure": [{ "plmnId": { "mcc": "234", "mnc": "15" }, "amfId": "000003" } ]
  }
}
```

AMF-B NF Profile:

```
{
  "amfInfo": {
    "guamiList": [{ "plmnId": { "mcc": "234", "mnc": "15" }, "amfId": "000002"}],
    "backupInfoAmfRemoval": [{ "plmnId": { "mcc": "234", "mnc": "15" }, "amfId": "000003"}]
  }
}
```

AMF-C NF Profile:

```
{
  "amfInfo": {
    "guamiList": [{ "plmnId": { "mcc": "234", "mnc": "15" }, "amfId": "000003"}]
  }
}
```

When one NF consumer queries NRF with a GUAMI served by AMF-C (i.e. {"plmnId":{"mcc":"234","mnc":"15"},"amfId":"000003"}), then

- if the NRF detects the AMF-C has failed, e.g. using heartbeat, the NRF shall return AMF-A instance as backup AMF; or
- if the NRF detects AMF-C has entered planned removal, i.e. received a de-registration request from AMF-C, the NRF shall return AMF-B instance as backup AMF.

6.1.6.2.12 Type: SmfInfo

Table 6.1.6.2.12-1: Definition of type SmfInfo

Attribute name	Data type	P	Cardinality	Description
sNssaiSmfInfoList	array(SnssaiSmfInfoItem)	M	1..N	List of parameters supported by the SMF per S-NSSAI (NOTE 1).
taiList	array(Tai)	O	1..N	The list of TAIs the SMF can serve. It may contain one or more non-3GPP access TAIs. The absence of this attribute and the taiRangeList attribute indicate that the SMF can be selected for any TAI in the serving network.
taiRangeList	array(TaiRange)	O	1..N	The range of TAIs the SMF can serve. It may contain non-3GPP access TAIs. The absence of this attribute and the taiList attribute indicate that the SMF can be selected for any TAI in the serving network.
pgwFqdn	Fqdn	O	0..1	The FQDN of the PGW if the SMF is a combined SMF/PGW-C.
pgwIpAddrList	array(IpAddr)	O	1..N	When present, this IE shall contain the PGW IP addresses of the combined SMF/PGW-C. Each PGW IP address shall be encoded as an IPv4 or an IPv6 address (i.e. not as an IPv6 prefix). This IE allows the NF Service consumer to find the target combined SMF/PGW-C by PGW IP Address, e.g. when only PGW IP Address is available.
accessType	array(AccessType)	C	1..2	If included, this IE shall contain the access type (3GPP_ACCESS and/or NON_3GPP_ACCESS) supported by the SMF. If not included, it shall be assumed the both access types are supported.
priority	integer	O	0..1	Priority (relative to other NFs of the same type) in the range of 0-65535, to be used for NF selection for a service request matching the attributes of the SmfInfo; lower values indicate a higher priority. The NRF may overwrite the received priority value when exposing an NFProfile with the Nnrf_NFDiscovery service. Absence of this attribute equals to having the same smfInfo priority as the priority defined at NFProfile/NFService level. (NOTE 2)
vsmfSupportInd	boolean	O	0..1	This IE may be used by an SMF to explicitly indicate the support of V-SMF capability and its preference to be selected as V-SMF. When present, this IE shall indicate whether the V-SMF capability are supported by the SMF: - true: V-SMF capability supported by the SMF - false: V-SMF capability not supported by the SMF. Absence of this IE indicates the V-SMF capability support of the SMF is not specified. (NOTE 3)
ismfSupportInd	boolean	O	0..1	This IE may be used by an SMF to explicitly indicate the support of I-SMF capability and its preference to be selected as I-SMF. When present, this IE shall indicate whether the I-SMF capability are supported by the SMF: - true: I-SMF capability supported by the SMF - false: I-SMF capability not supported by the SMF. Absence of this IE indicates the I-SMF capability support of the SMF is not specified. (NOTE 3)

pgwFqdnList	array(Fqdn)	O	1..N	When present, this attribute provides additional FQDNs to the FQDN indicated in the pgwFqdn attribute. The pgwFqdnList attribute may be present if the pgwFqdn attribute is present.
smfOnboardingCapability	boolean	O	0..1	When present, this IE indicates the SMF supports SNPN Onboarding capability and User Plane Remote Provisioning. This is used for the case of Onboarding of UEs for SNPNs (see 3GPP TS 23.501 [2], clauses 5.30.2.10 and 6.2.6.2). <ul style="list-style-type: none"> - false (default): SMF does not support SNPN Onboarding; - true: SMF supports SNPN Onboarding. (NOTE 4)
smfUPRPCapability	boolean	O	0..1	When present, this IE indicates the SMF supports User Plane Remote Provisioning (UPRP) capability. This is used for the case of Onboarding of UEs for SNPNs (see 3GPP TS 23.501 [2], clauses 5.30.2.10 and 6.2.6.2). <ul style="list-style-type: none"> - false (default): SMF does not support UPRP; - true: SMF supports UPRP.
NOTE 1: If this S-NSSAIs is present in the SmfInfo and in the NFprofile, the S-NSSAIs from the SmfInfo shall prevail.				
NOTE 2: An SMF profile may e.g. contain multiple SmfInfo entries, with each entry containing a different list of TAIs and a different priority, to differentiate the priority to select the SMF based on the user location. The priority in SmfInfo applies between SMFs or SMF Services with the same priority.				
NOTE 3: The IE should only be registered when the SMF is configured to be preferably selected as V-SMF/I-SMF.				
NOTE 4: The IE is deprecated and replaced by smfUPRPCapability attribute.				

6.1.6.2.13 Type: UpfInfo

Table 6.1.6.2.13-1: Definition of type UpfInfo

Attribute name	Data type	P	Cardinality	Description
sNssaiUpfInfoList	array(SnssaiUpfInfoItem)	M	1..N	List of parameters supported by the UPF per S-NSSAI (NOTE 1)
smfServingArea	array(string)	O	1..N	The SMF service area(s) the UPF can serve. If not provided, the UPF can serve any SMF service area.
interfaceUpfInfoList	array(InterfaceUpfInfoItem)	O	1..N	List of User Plane interfaces configured on the UPF. When this IE is provided in the NF Discovery response, the NF Service Consumer (e.g. SMF) may use this information for UPF selection. (NOTE 7)
n6TunnelInfoList	map(InterfaceUpfInfoItem)	O	1..N	This IE may be present for a UPF which may serve as a V-UPF for HR-SBO PDU sessions in the VPLMN. When present, it shall contain a map of N6 tunnelling information at the V-UPF side for establishing N6 tunnels between the V-UPF and the V-EASDF to differentiate HR-SBO PDU sessions from different DNN/S-NSSAI/HPLMNs having the same private UE IP Address, and the UPInterfaceType shall be set to "N6". The key of the map shall be a (unique) valid JSON string per clause 7 of IETF RFC 8259 [22], with a maximum of 32 characters. (NOTE 8)
iwkEpsInd	boolean	O	0..1	Indicates whether interworking with EPS is supported by the UPF. true: Supported false (default): Not Supported
sxaInd	boolean	O	0..1	Indicates whether the UPF is configured to support Sxa interface. true: Supported false: Not Supported
pduSessionTypes	array(PduSessionType)	O	1..N	List of PDU session type(s) supported by the UPF. The absence of this attribute indicates that the UPF can be selected for any PDU session type.
atsssCapability	AtsssCapability	C	0..1	If present, this IE shall indicate the ATSSS capability of the UPF. If not present, the UPF shall be regarded with no ATSSS capability.
ueIpAddrInd	boolean	O	0..1	Indicates whether the UPF supports allocating UE IP addresses/prefixes. true: supported false (default): not supported
taiList	array(Tai)	O	1..N	The list of TAIs the UPF can serve. It may contain one or more non-3GPP access TAIs. The absence of this attribute and the taiRangeList attribute indicates that the UPF can serve the whole SMF service area defined by the smfServingArea attribute.
taiRangeList	array(TaiRange)	O	1..N	The range of TAIs the UPF can serve. It may contain non-3GPP access TAIs. The absence of this attribute and the taiList attribute indicates that the UPF can serve the whole SMF service area defined by the smfServingArea attribute. (NOTE 6)
wAgfInfo	WAgfInfo	C	0..1	If present, this IE shall indicate that the UPF is collocated with W-AGF. If not present, the UPF is not collocated with W-AGF.
tngfInfo	TngfInfo	C	0..1	If present, this IE shall indicate that the UPF is collocated with TNGF. If not present, the UPF is not collocated with TNGF.

twifInfo	TwifInfo	C	0..1	If present, this IE shall indicate that the UPF is collocated with TWIF. If not present, the UPF is not collocated with TWIF.
preferredEpdgInfoList	array(EpdgInfo)	O	1..N	If present, this IE shall indicate that ePDG(s) that are preferred (e.g. for traffic efficiency, distance wise or topology wise) to be served by the UPF/PGW-U.
preferredWagfInfoList	array(WAgfInfo)	O	1..N	If present, this IE shall indicate that W-AGF(s) that are preferred (e.g. for traffic efficiency, distance wise or topology wise) to be served by the UPF.
preferredTngfInfoList	array(TngfInfo)	O	1..N	If present, this IE shall indicate that TNGF(s) that are preferred (e.g. for traffic efficiency, distance wise or topology wise) to be served by the UPF.
preferredTwifInfoList	array(TwifInfo)	O	1..N	If present, this IE shall indicate that TWIF(s) that are preferred (e.g. for traffic efficiency, distance wise or topology wise) to be served by the UPF.
priority	integer	O	0..1	Priority (relative to other NFs of the same type) in the range of 0-65535, to be used for NF selection for a service request matching the attributes of the UpfInfo; lower values indicate a higher priority. See the precedence rules in the description of the priority attribute in NFProfile, if Priority is also present in NFProfile. The NRF may overwrite the received priority value when exposing an NFProfile with the Nnrf_NFDiscovery service. (NOTE 2)
redundantGtpu	boolean	O	0..1	Indicates whether the UPF supports redundant GTP-U path. true: supported false (default): not supported
ipups	boolean	O	0..1	Indicates whether the UPF is configured for IPUPS. (NOTE 3) true: the UPF is configured for IPUPS. false (default): the UPF is not configured for IPUPS.
dataForwarding	boolean	O	0..1	Indicates whether the UPF is configured for data forwarding. (NOTE 4) When present, this IE shall be set as following: - true: the UPF is configured for data forwarding - false (default): the UPF is not configured for data forwarding If the UPF is configured for data forwarding, it shall support UP network interface with type "DATA_FORWARDING".
supportedPfcFeatures	string	O	0..1	Supported PFCP Features. A string used to indicate the PFCP features supported by the UPF, which encodes the "UP Function Features" IE as specified in Table 8.2.25-1 of 3GPP TS 29.244 [21] (starting from Octet 5), in hexadecimal representation. Each character in the string shall take a value of "0" to "9", "a" to "f" or "A" to "F" and each two characters shall represent one octet of "UP Function Features" IE (starting from Octet 5, to higher octets). For each two characters representing one octet, the first character representing the 4 most significant bits of the octet and the second character the 4 least significant bits of the octet. (NOTE 5)
upfEvents	array(EventType)	O	1..N	UPF event(s) exposed by the UPF

NOTE 1:	If this S-NSSAI is present in the UpfInfo and in the NFprofile, the S-NSSAI from the UpfInfo shall prevail.
NOTE 2:	An UPF profile may e.g. contain multiple UpfInfo entries, with each entry containing a different list of TAIs and a different priority, to differentiate the priority to select the UPF based on the user location. The priority in UpfInfo has the least precedence, i.e. it applies between UPFs with the same priority.
NOTE 3:	Any UPF can support the IPUPS functionality. In network deployments where specific UPFs are used to provide IPUPS, UPFs configured for providing IPUPS services shall be selected to provide IPUPS.
NOTE 4:	Based on operator policies, if dedicated UPFs are preferred to be used for indirect data forwarding during handover scenarios, when setting up the indirect data forwarding tunnel, the SMF should preferably select a UPF configured for data forwarding and use the network instance indicated in the Network Instance ID associated to the DATA_FORWARDING interface type in the interfaceUpfInfoList attribute.
NOTE 5:	The supportedPfcFeatures shall be provisioned in addition and be consistent with the existing UPF features (atsssCapability, uelpAddrInd, redundantGtpu and ipups) in the upfInfo, e.g. if the uelpAddrInd is set to "true", then the UEIP flag shall also be set to "1" in the supportedPfcFeatures.
NOTE 6:	This attribute should only be used by the UPF if, based on specific operator's deployment, the NRF and the SMFs intended to interwork with this UPF, have been upgraded to support this feature (i.e. to understand the definition of TAIs in the UPF profile based on ranges of TAIs).
NOTE 7:	The information elements included in the InterfaceUpfInfoItems, e.g. the Network Instance, can be used for any S-NSSAI and/or DNN which have no InterfaceUpfInfoList provisioned in the corresponding SnsaiUpfInfoItem and/or DnnUpfInfoItem.
NOTE 8:	It is deployment specific how to ensure that all the V-SMFs supporting the same V-UPF and V-EASDF select the same N6 tunnel for a given Home DNN/S-NSSAI/HPLMN ID.

6.1.6.2.14 Type: SnsaiUpfInfoItem

Table 6.1.6.2.14-1: Definition of type SnsaiUpfInfoItem

Attribute name	Data type	P	Cardinality	Description	Applicability
sNssai	ExtSnsai	M	1	Supported S-NSSAI (NOTE 1)	
dnnUpfInfoList	array(DnnUpfInfoItem)	C	1..N	List of parameters supported by the UPF per DNN (NOTE 3)	
dnnUpfInfoListId	integer	C	0..1	Identifier of a dnnUpfInfoList	DNN-List-Optimization
redundantTransport	boolean	O	0..1	Indicates whether the UPF supports redundant transport path on the transport layer in the corresponding network slice. true: supported false (default): not supported	
interfaceUpfInfoList	array(InterfaceUpfInfoItem)	O	1..N	This IE may be present to contain a list of User Plane interfaces configured on the UPF for the network slice. (NOTE 2)	
NOTE 1: A UPF may register SD ranges or a wildcard SD if the NRF and all consumers of the UPF profile have been upgraded to support SD ranges and wildcard SD in this attribute.					
NOTE 2: The interfaceUpfInfoList included in this data type SnsaiUpfInfoItem shall prevail over the one included in the UpfInfo.					
NOTE 3: If the Feature DNN-List-Optimization is not supported, dnnUpfInfoList shall be present. If the feature DNN-List-Optimization is supported, multiple repetition of the same dnnUpfInfoList value within an upfInfoList can be avoided: A given dnnUpfInfoList value may be present (together with a dnnUpfInfoListId) in only a single occurrence of the SnsaiUpfInfoItem and other occurrences may then omit the dnnUpfInfoList and instead have a dnnUpfInfoListId pointing to that dnnUpfInfoList. The significance of a dnnUpfInfoListId is limited to upfInfoList.					

6.1.6.2.15 Type: DnnUpfInfoItem

Table 6.1.6.2.15-1: Definition of type DnnUpfInfoItem

Attribute name	Data type	P	Cardinality	Description
dnn	Dnn	M	1	Supported DNN. The DNN shall contain the Network Identifier and it may additionally contain an Operator Identifier. If the Operator Identifier is not included, the DNN is supported for all the PLMNs in the plmnList of the NF Profile.
dnaiList	array(Dnai)	O	1..N	List of Data network access identifiers supported by the UPF for this DNN. The absence of this attribute indicates that the UPF can be selected for this DNN for any DNAI. (NOTE 6)
pduSessionTypes	array(PduSessionType)	O	1..N	List of PDU session type(s) supported by the UPF for a specific DNN. The absence of this attribute indicates that the UPF can be selected for this DNN for any PDU session type supported by the UPF (see clause 6.1.6.2.13).
ipv4AddressRanges	array(Ipv4AddressRange)	O	1..N	List of ranges of IPv4 addresses handled by UPF. (NOTE 1)
ipv6PrefixRanges	array(Ipv6PrefixRange)	O	1..N	List of ranges of IPv6 prefixes handled by the UPF. (NOTE 1)
natedIpv4AddressRanges	array(Ipv4AddressRange)	O	1..N	List of ranges of NATed IPv4 addresses.
natedIpv6PrefixRanges	array(Ipv6PrefixRange)	O	1..N	List of ranges of NATed IPv6 prefixes.
ipv4IndexList	array(IpIndex)	O	1..N	List of Ipv4 Index supported by the UPF. (NOTE 3)
ipv6IndexList	array(IpIndex)	O	1..N	List of Ipv6 Index supported by the UPF. (NOTE 3)
networkInstance	string	O	0..1	The N6 Network Instance (See 3GPP TS 29.244 [21]) associated with the S-NSSAI and DNN. (NOTE 4)
dnaiNwInstanceList	map(string)	O	1..N	Map of a network instance per DNAI for the DNN, where the key of the map is the DNAI. When present, the value of each entry of the map shall contain a N6 network instance that is configured for the DNAI indicated by the key. (NOTE 2)
interfaceUpfInfoList	array(InterfaceUpfInfoItem)	O	1..N	This IE may be present to contain a list of User Plane interfaces configured on the UPF for the network slice and Dnn. (NOTE 5)
NOTE 1: The list of ranges of IPv4/v6 address may be used by the SMF to select a UPF which supports a UE static IP address received in user subscription, or when the UE IP address is to be allocated by an external server, e.g. AAA/Radius Server.				
NOTE 2: This IE may be used by the SMF to determine the Network Instance associated to a given S-NSSAI, DNN and DNAI. If this IE is not present, the SMF needs to be configured with corresponding information.				
NOTE 3: The list of IPv4/v6 Indexes may be used by the SMF to select a UPF which supports a specific IP Index received from the UDM or the PCF for a UE's PDU session.				
NOTE 4: The networkInstance IE and the dnaiNwInstanceList shall not be present simultaneously. The networkInstance IE may be used by the SMF to determine the Network Instance associated to a given S-NSSAI and DNN where DNAI(s) are not configured, i.e. the dnaiNwInstanceList is not present. If this IE is not present and the dnaiNwInstanceList is also not present, the SMF needs to be configured with corresponding information. A network instance can be associated with multiple network slices if the UP function supports the "Per Slice UP Resource Management" feature as specified in clause 5.35.1 of 3GPP TS 29.244 [21].				
NOTE 5: The interfaceUpfInfoList included in this data type DnnUpfInfoItem shall prevail over the one included in the SnsaiUpfInfoItem.				
NOTE 6: To support selection of UPF deployed on satellite, an operator shall configure DNAI(s) specific for on-satellite UPF, and associate such DNAI(s) to corresponding Satellite ID(s).				

6.1.6.2.16 Type: SubscriptionData

Table 6.1.6.2.16-1: Definition of type SubscriptionData

Attribute name	Data type	P	Cardinality	Description	Applicability
nfStatusNotificationUri	Uri	M	1	Callback URI where the NF Service Consumer will receive the notifications from NRF.	
reqNfInstanceid	NfInstanceid	O	0..1	If present, this IE shall contain the NF instance id of the NF service consumer.	
sharedDataIds	array(string)	O	1..N	List of shared data IDs. The format of the sharedDataId shall be a Universally Unique Identifier (UUID) version 4, as described in IETF RFC 4122 [18]. The hexadecimal letters should be formatted as lower-case characters by the sender, and they shall be handled as case-insensitive by the receiver. Example: "4ace9d34-2c69-4f99-92d5-a73a3fe8e23b"	Shared-Data-Retrieval
subscrCond	SubscrCond	O	0..1	If present, this attributed shall contain the conditions identifying the set of NF Instances whose status is requested to be monitored. If this attribute is not present, it means that the NF Service Consumer requests a subscription to all NFs in the NRF (NOTE 1).	
subscriptionId	string	C	0..1	Subscription ID for the newly created resource. This parameter shall be absent in the request to the NRF and shall be included by NRF in the response to the subscription creation request. Read-Only: true Pattern: "^[0-9]{5,6}-(x3Lf57A:nid=[A-Fa-f0-9]{11}:)?[^\-]+\$"	
validityTime	DateTime	C	0..1	Time instant after which the subscription becomes invalid. This parameter may be sent by the client, as a hint to the server, but it shall be always sent back by the server (regardless of the presence of the attribute in the request) in the response to the subscription creation request.	
reqNotifEvents	array(NotificationEventTypes)	O	1..N	If present, this attribute shall contain the list of event types that the NF Service Consumer is interested in receiving. If this attribute is not present, it means that notifications for all event types are requested.	
reqNfType	NFType	C	0..1	An NF Service Consumer complying with this version of the specification shall include this IE. If included, this IE shall contain the NF type of the NF Service Consumer that is requesting the creation of the subscription. The NRF shall use it for authorizing the request, in the same way as the "requester-nf-type" is used in the NF Discovery service (see Table 6.2.3.2.3.1-1). When the subscription is for a set of NF Instances, the subscription may be accepted by NRF, but it shall only generate notifications from NF Instances whose authorization parameters allow the NF Service Consumer to access their services (NOTE 2).	

reqNfFqdn	Fqdn	O	0..1	<p>This IE may be present for a subscription request within the same PLMN as the NRF.</p> <p>If included, this IE shall contain the FQDN of the NF Service Consumer that is requesting the creation of the subscription. The NRF shall use it for authorizing the request, in the same way as the "requester-nf-instance-fqdn" is used in the NF Discovery service (see Table 6.2.3.2.3.1-1).</p> <p>This IE shall be ignored by the NRF if it is received from a requester NF belonging to a different PLMN.</p> <p>When the subscription is for a set of NF Instances, the subscription may be accepted by NRF, but it shall only generate notifications from NF Instances whose authorization parameters allow the NF Service Consumer to access their services (NOTE 2).</p>	
reqSnssais	array(ExtSnssai)	O	1..N	<p>If included, this IE shall contain the list of S-NSSAIs of the NF Service Consumer that is requesting the creation of the subscription. If this IE is included in a subscription request in a different PLMN, the requester NF shall provide S-NSSAI values of the target PLMN, that correspond to the S-NSSAI values of the requester NF. The NRF shall use it for authorizing the request, in the same way as the "requester-snssais" is used in the NF Discovery service (see Table 6.2.3.2.3.1-1).</p> <p>When the subscription is for a set of NF Instances, the subscription may be accepted by NRF, but it shall only generate notifications from NF Instances whose authorization parameters allow the NF Service Consumer to access their services (NOTE 2).</p>	
reqPerPlmnSnssais	array(PlmnSnssai)	O	1..N	<p>If included, this IE shall indicate the list of S-NSSAIs supported by the NF Service Consumer in each of the PLMNs it supports. The NRF shall use it for authorizing the request, in the same way as the "per-plmn-requester-snssais" is used in the NF Discovery service (see Table 6.2.3.2.3.1-1).</p> <p>When the subscription is for a set of NF Instances, the subscription may be accepted by NRF, but it shall only generate notifications from NF Instances whose authorization parameters allow the NF Service Consumer to access their services (NOTE 2).</p>	
plmnld	Plmnld	O	0..1	<p>If present, this attribute contains the target PLMN ID of the NF Instance(s) whose status is requested to be monitored.</p> <p>(NOTE 7)</p>	

nid	Nid	O	0..1	If present, this attribute contains the target NID that, together with the plmnId attribute, identifies the SNPN of the NF Instance(s) whose status is requested to be monitored.	
onboardingCapability	boolean	O	0..1	If present, this attribute indicates the NF Instance(s) whose status is requested to be monitored support SNPN Onboarding capability.	
notifCondition	NotifCondition	O	0..1	If present, this attribute contains the conditions that trigger a notification from NRF; this attribute shall only be present if the NF Service Consumer has subscribed to changes on the NF Profile (i.e., reqNotifEvents contains the value "NF_PROFILE_CHANGED", or reqNotifEvents attribute is absent) (NOTE 3). If this attribute is absent, it means that the NF Service Consumer does not indicate any restriction, or condition, on which attributes of the NF Profile shall trigger a notification from NRF. (NOTE 5).	
reqPlmnList	array(PlmnId)	C	1..N	This IE shall be included when subscribing to NF services in a different PLMN. It may be present when subscribing to NF services in the same PLMN. When included, this IE shall contain the PLMN ID(s) of the requester NF. (NOTE 2)	
reqSnpnList	array(PlmnIdNid)	C	1..N	This IE shall be included when the subscribing NF belongs to one or several SNPNS and it subscribes to NF services of a specific SNPN. When included, this IE shall contain the SNPN ID(s) of the requester NF. When the subscription is for a set of NF Instances, the subscription may be accepted by NRF, but it shall only generate notifications from NF Instances whose authorization parameters allow the NF Service Consumer to access their services. (NOTE 2)	
servingScope	array(string)	O	1..N	If present, this attribute indicates the target served area(s) of the NF instance(s) whose status is required to be monitored. (NOTE 4)	
requesterFeatures	SupportedFeatures	C	0..1	Nnrf_NFManagement features supported by the NF Service Consumer that is invoking the Nnrf_NFManagement service. See clause 6.1.9. This IE shall be included if at least one feature is supported by the NF Service Consumer. Write-Only: true (NOTE 6)	

nrfSupportedFeatures	SupportedFeatures	C	0..1	<p>Features supported by the NRF in the Nnrf_NFManagement service. See clause 6.1.9.</p> <p>This IE shall be included if at least one feature is supported by the NRF.</p> <p>Read-Only: true</p>	
hnrfUri	Uri	C	0..1	<p>If included, this IE shall contain the API URI of the NFManagement Service (see clause 6.1.1) of the home NRF.</p> <p>It shall be included if the NF Service Consumer has previously received such API URI from the NSSF in the home PLMN (see clause 6.1.6.2.11 of 3GPP TS 29.531 [42]).</p>	
targetHni	Fqdn	O	0..1	<p>If present, this attribute shall contain the identification of the Default Credentials Server or the identification of the Credentials Hoder.</p>	
preferredLocality	string	O	0..1	<p>Preferred target NF location (e.g. geographic location, data center).</p> <p>When present, the NRF should set a priority for the monitored NF instance in the notification as specified in the description of the preferred-locality in Table 6.2.3.2.3.1-1.</p>	
extPreferredLocality	map(array(Locality Description))	O	1..N(1..M)	<p>Preferred target NF location (e.g. geographic location, data center).</p> <p>The key of the map shall represent the relative priority, for the requester, of each locality description among the list of locality descriptions in this attribute, encoded as "1" (highest priority), "2", "3", ... , "n" (lowest priority). See examples in the description of the ext-preferred-locality in Table 6.2.3.2.3.1-1.</p> <p>When present, the NRF should set a priority for the monitored NF instance in the notification as specified in the description of the ext-preferred-locality in Table 6.2.3.2.3.1-1.</p>	
completeProfileSubscription	boolean	O	0..1	<p>This IE may be included by an SCP with the value true to request to monitor, and to be notified of, changes on the complete profile of the NF Instance (including authorization attributes such as the "allowedXXX" attributes of NFProfile and NFService data types). See clause 5.2.2.5.2.</p> <p>Write-Only: true</p>	

- NOTE 1: The "subscription to all NFs" may be quite demanding in terms of resources in NRF and also in terms of network traffic of the resulting notifications, so it should be authorized by NRF under very strict policies (e.g. only to a specific requesting NF, as indicated by reqNfType and reqNfQdn attributes).
- NOTE 2: The authorization parameters in NF Profile are those used by NRF to determine whether a given NF Instance / NF Service Instance can be discovered by an NF Service Consumer in order to consume its offered services (e.g. "allowedNfTypes", "allowedNfDomains", etc.). Based on operator's policies, a subscription request not including the requester's information necessary to validate the authorization parameters in NF Profiles may be rejected or may be accepted but with only generating notifications from NF Instances whose authorization parameters allow any NF Service Consumer to access their services.
- NOTE 3: The subscription to load changes may be quite demanding in terms of network traffic of the resulting notifications, thus it may be limited by the NRF via appropriate configuration (e.g. granularity threshold, load exceeds/falls below a certain threshold)
- NOTE 4: An NF instance may explicitly indicate the served areas in the NF profile when registered to NRF. When this IE is present, the NRF shall only monitor the NF instance(s) indicating at least one of the served areas in the list. If an NF instance has not indicated any served area in its NF profile, it shall not be monitored.
- NOTE 5: If the attributes to be monitored or excluded from monitoring, included as part of the "notifCondition" attribute, refer to a specific element of an array (e.g. they refer to a specific array index of the "nfServices" attribute of the NFProfile), the NRF shall apply the same condition to all elements of the same array.
- NOTE 6: If the NF Service Consumer that issued the subscription request indicated support for the "Service-Map" feature, the NRF shall send notifications of profile changes (see clause 6.1.6.2.17) affecting the list of NF Service Instances, as modifications of specific attributes of the "nfServiceList" map. Otherwise, the NRF shall send those notifications as a complete replacement of the "nfServices" array attribute.
- NOTE 7: The PLMN ID should be used by the NRF as an additional subscription condition to monitor the change of target NF profile, unless the subscription is specific to one or a list of NF(s) explicitly indicated by their NF Instance ID(s), e.g. using the NfInstanceCond or NfInstanceListCond, in which case the NRF shall not use the PLMN ID provided in the subscription (if any) as an additional subscription condition to monitor the change of target NF profile.

6.1.6.2.17 Type: NotificationData

Table 6.1.6.2.17-1: Definition of type NotificationData

Attribute name	Data type	P	Cardinality	Description	Applicability
event	NotificationEventType	M	1	Notification type. It shall take the values "NF_REGISTERED", "NF_DEREGISTERED" or "NF_PROFILE_CHANGED".	
nfInstanceUri	Uri	M	1	Uri of the NF Instance (see clause 6.1.3.3.2) associated to the notification event.	
nfProfile	NFProfile	C	0..1	New NF Profile or Updated NF Profile; it shall be present when the notification type is "NF_REGISTERED" and it may be present when the notification type is "NF_PROFILE_CHANGED". (NOTE 3) This IE, if present, shall not contain authorization attributes (such as the "allowedXXX" attributes of the NFProfile or NFService data types).	
profileChanges	array(Changeltem)	C	1..N	List of changes on the profile of the NF Instance associated to the notification event; it may be present when the notification type is "NF_PROFILE_CHANGED" (see NOTE 1, NOTE 2).	
sharedDataChanges	array(Changeltem)	C	1..N	List of changes on shared data; it shall be present when the notification type is "SHARED_DATA_CHANGED" (see NOTE 2).	Shared-Data-Retrieval
conditionEvent	ConditionEventType	C	0..1	Type of event indicating whether a change of NF Profile results in that the NF Instance starts or stops being part of a given set of NF Instances, as indicated in the subscription condition (see attribute "subscrCond" in clause 6.1.6.2.16). Type of event may also indicate whether a change of NF Profile results in that the NF Instance starts or stops being authorized to be accessed by the NF consumer, as specified in clause 5.2.2.6.2. It can take the value "NF_ADDED" (if the NF Instance starts being part of a given set or starts being authorized to be accessed by the NF consumer) or "NF_REMOVED" (if the NF Instance stops being part of a given set or stops being authorized to be accessed by the NF consumer). (NOTE 3)	
subscriptionContext	SubscriptionContext	C	0..1	It shall contain data related to the subscription to which this notification belongs to, such as the subscription ID and the subscription conditions. An NRF complying with this release of the specification shall include this attribute, to facilitate to the subscribing entity the identification of the subscription data, or context, that triggered this notification.	

completeNfProfile	NFProfile	C	0..1	<p>Complete new NF Profile or updated NF Profile; it shall be present when the notification type is "NF_REGISTERED" and it may be present when the notification type is "NF_PROFILE_CHANGED". (NOTE 3)</p> <p>This IE shall only be present if the NRF supports the "Complete-Profile-Subscription" feature, the "completeProfileSubscription" attribute is present and set to true in the request (see clause 6.1.6.2.16) and if the requesting entity is authorized to subscribe to the complete profile of NF instances.</p> <p>This IE, if present, should contain the complete set of attributes (including, e.g. the "allowedXXX" attributes of the NFProfile or NFService data types).</p>
<p>NOTE 1: If "event" attribute takes the value "NF_PROFILE_CHANGED", then one and only one of the "nfProfile", "profileChanges" or "completeNfProfile" attributes shall be present.</p> <p>NOTE 2: The NRF shall notify about NF Profile changes or shared data changes affecting attributes of type "array" only as a complete replacement of the whole array (i.e. it shall not notify about changes of individual array elements).</p> <p>NOTE 3: When a change in an NF Profile results in an NF to start being part of a given set or an NF Instance starts being authorized to be accessed by the NF consumer, the NRF shall indicate such condition by including the "conditionEvent" attribute with value "NF_ADDED", and it shall include in the notification the "nfProfile" attribute with the full NF Profile of the NF Instance; the "profileChanges" attribute shall not be included. When a change in an NFProfile results in an NF to stop being part of a given set or an NF Instance stops being authorized to be accessed by the NF consumer, the NRF shall indicate such condition by including the "conditionEvent" attribute with value "NF_REMOVED", and it shall include in the notification either the "nfProfile" or the "profileChanges" attribute. The NRF should include the IE with less information if possible.</p>				

EXAMPLE: Notification content sent from NRF when an NF Instance has changed its profile by updating the value of the "recoveryTime" attribute of its NF Profile, and updated any attribute of any of its NF Service Instances:

```

{
  "event": "NF_PROFILE_CHANGED",
  "nfInstanceUri": ".../nf-instances/4947a69a-f61b-4bc1-b9da-47c9c5d14b64",
  "profileChanges": [
    {
      "op": "REPLACE",
      "path": "/recoveryTime",
      "newValue": "2018-12-30T23:20:50Z"
    },
    {
      "op": "REPLACE",
      "path": "/nfServices",
      "newValue": [ ...new array content... ]
    }
  ]
}

```

6.1.6.2.18 Void

6.1.6.2.19 Type: NFServiceVersion

Table 6.1.6.2.19-1: Definition of type NFServiceVersion

Attribute name	Data type	P	Cardinality	Description
apiVersionInUri	string	M	1	Version of the service instance to be used in the URI for accessing the API (e.g. "v1").
apiFullVersion	string	M	1	Full version number of the API as specified in clause 4.3.1 of 3GPP TS 29.501 [5].
expiry	DateTime	O	0..1	Expiry date and time of the NF service. This represents the planned retirement date as specified in clause 4.3.1.5 of 3GPP TS 29.501 [5].

6.1.6.2.20 Type: PcfInfo

Table 6.1.6.2.20-1: Definition of type PcfInfo

Attribute name	Data type	P	Cardinality	Description
groupId	NfGroupId	O	0..1	Identity of the PCF group that is served by the PCF instance. A number of PCF instances can be considered to conform a PCF group when they serve the same set of users (identified by supiRanges and gpsiRanges), even if they are not identified by a PCF Group ID. (NOTE)
dnnList	array(Dnn)	O	1..N	DNNs supported by the PCF. The DNN shall contain the Network Identifier and it may additionally contain an Operator Identifier. If the Operator Identifier is not included, the DNN is supported for all the PLMNs in the plmnList of the NF Profile. If not provided, the PCF can serve any DNN.
supiRanges	array(SupiRange)	O	1..N	List of ranges of SUPIs that can be served by the PCF instance. (NOTE)
gpsiRanges	array(IdentityRange)	O	1..N	List of ranges of GPSIs that can be served by the PCF instance. (NOTE)
rxDiamHost	DiameterIdentity	C	0..1	This IE shall be present if the PCF supports Rx interface. When present, this IE shall indicate the Diameter host of the Rx interface for the PCF.
rxDiamRealm	DiameterIdentity	C	0..1	This IE shall be present if the PCF supports Rx interface. When present, this IE shall indicate the Diameter realm of the Rx interface for the PCF.
v2xSupportInd	boolean	O	0..1	Indicates whether V2X Policy/Parameter provisioning is supported by the PCF. true: Supported false (default): Not Supported
proseSupportInd	boolean	O	0..1	Indicates whether ProSe capability is supported by the PCF. true: Supported false (default): Not Supported
proseCapability	ProseCapability	C	0..1	This IE shall be present if the PCF supports ProSe Capability. When present, this IE shall indicate the supported ProSe Capability by the PCF.
v2xCapability	V2xCapability	C	0..1	This IE shall be present if the PCF supports V2X Capability. When present, this IE shall indicate the supported V2X Capability by the PCF.
a2xSupportInd	boolean	O	0..1	Indicates whether A2X Policy/Parameter provisioning is supported by the PCF. true: Supported false (default): Not Supported
a2xCapability	A2xCapability	C	0..1	This IE shall be present if the PCF supports A2X Capability. When present, this IE shall indicate the supported A2X Capability by the PCF.
rangingSIPosSupportInd	boolean	O	0..1	Indicates whether ranging and sidelink positioning capability is supported by the PCF. true: Supported false (default): Not Supported
urspEpsSupport	boolean	O	0..1	Indicates whether URSP delivery in EPS is supported by the PCF. true: Supported false (default): Not Supported

NOTE: If none of these parameters are provided, the PCF can serve any SUPI or GPSI managed by the PLMN of the PCF instance. If "supiRanges" is absent and "groupId" is present, the SUPIs served by this PCF instance are determined by the NRF; if "gpsiRanges" is absent and "groupId" is present, the GPSIs served by this PCF instance are determined by the NRF (see 3GPP TS 23.501 [2], clause 6.2.6.2).

NOTE: The operator needs to ensure that the "pcfInfo" of PCF instances serving the same set of users (e.g., identified by the same "groupId" or "supiRanges" and "gpsiRanges" attributes) includes the same attributes and the same attribute values consistently.

For a given PCF instance, the operator needs to ensure that when both "supiRanges" and "gpsiRanges" attributes are present, they refer to the same set of users consistently.

6.1.6.2.21 Type: BsflInfo

Table 6.1.6.2.21-1: Definition of type BsflInfo

Attribute name	Data type	P	Cardinality	Description
ipv4AddressRanges	array(Ipv4AddressRange)	O	1..N	List of ranges of IPv4 addresses handled by BSF. If not provided, the BSF can serve any IPv4 address.
dnnList	array(Dnn)	O	1..N	List of DNNs handled by the BSF. The DNN shall contain the Network Identifier and it may additionally contain an Operator Identifier. If the Operator Identifier is not included, the DNN is supported for all the PLMNs in the plmnList of the NF Profile. If not provided, the BSF can serve any DNN.
ipDomainList	array(string)	O	1..N	List of IPv4 address domains, as described in clause 6.2 of 3GPP TS 29.513 [28], handled by the BSF. If not provided, the BSF can serve any IP domain.
ipv6PrefixRanges	array(Ipv6PrefixRange)	O	1..N	List of ranges of IPv6 prefixes handled by the BSF. If not provided, the BSF can serve any IPv6 prefix.
rxDiamHost	DiameterIdentity	C	0..1	This IE shall be present if the BSF supports Rx interface. When present, this IE shall indicate the Diameter host of the Rx interface for the BSF.
rxDiamRealm	DiameterIdentity	C	0..1	This IE shall be present if the BSF supports Rx interface. When present, this IE shall indicate the Diameter realm of the Rx interface for the BSF.
groupId	NfGroupId	O	0..1	Identity of the BSF group that is served by the BSF instance. If not provided, the BSF instance does not pertain to any BSF group. (NOTE)
supiRanges	array(SupiRange)	O	1..N	List of ranges of SUPI's served by the BSF instance (NOTE)
gpsiRanges	array(IdentityRange)	O	1..N	List of ranges of GPSIs served by the BSF instance (NOTE)
NOTE: If none of these parameters are provided, the BSF can serve any SUPI or GPSI managed by the PLMN of the BSF instance. If "supiRanges" and "gpsiRanges" attributes are absent, and "groupId" is present, the SUPIs / GPSIs served by this BSF instance is determined by the NRF.				

6.1.6.2.22 Type: Ipv4AddressRange

Table 6.1.6.2.22-1: Definition of type IPv4AddressRange

Attribute name	Data type	P	Cardinality	Description
start	Ipv4Addr	M	1	First value identifying the start of an IPv4 address range
end	Ipv4Addr	M	1	Last value identifying the end of an IPv4 address range

6.1.6.2.23 Type: Ipv6PrefixRange

Table 6.1.6.2.23-1: Definition of type IPv6PrefixRange

Attribute name	Data type	P	Cardinality	Description
start	Ipv6Prefix	M	1	First value identifying the start of an IPv6 prefix range
end	Ipv6Prefix	M	1	Last value identifying the end of an IPv6 prefix range
NOTE: When Ipv6PrefixRange is used to identify a range of IPv6 addresses served by certain NF (e.g. BSF), the range of IPv6 addresses identified by the IPv6PrefixRange shall include the entire IPv6 addresses represented by the "start" and "end" IPv6 prefixes. For example, if the "start" attribute is set to "240e:006a:0000:0000::/32" and the "end" attribute is set to "250e:006a:0000:0000::/32", the Ipv6PrefixRange identifies all the IPv6 addresses from the start IPv6 address "240e:006a:0000:0000::/32" to the end IPv6 address "250e:006a:ffff:ffff:ffff:ffff:ffff:ffff/32".				

6.1.6.2.24 Type: InterfaceUpfInfoltem

Table 6.1.6.2.24-1: Definition of type InterfaceUpfInfoltem

Attribute name	Data type	P	Cardinality	Description
interfaceType	UPInterfaceType	M	1	User Plane interface type
ipv4EndpointAddresses	array(Ipv4Addr)	C	1..N	Available endpoint IPv4 address(es) of the User Plane interface (NOTE 1) (NOTE 2)
ipv6EndpointAddresses	array(Ipv6Addr)	C	1..N	Available endpoint IPv6 address(es) of the User Plane interface (NOTE 1) (NOTE 2)
endpointFqdn	Fqdn	C	0..1	FQDN of available endpoint of the User Plane interface (NOTE 1) (NOTE 2)
networkInstance	string	O	0..1	Network Instance (See 3GPP TS 29.244 [21]) associated to the User Plane interface
portRangeList	array(PortRange)	O	1..N	A list of port number range may be present to be used to establish N6 tunnels between the V-UPF and the V-EASDF.
NOTE 1: At least one of the addressing parameters (ipv4address, ipv6address or endpointFqdn) shall be included in the InterfaceUpfInfoltem.				
NOTE 2: When interfaceType is "DATA_FORWARDING", the SMF shall ignore these IEs. The UPF shall register a dummy FQDN or IP address for interfaceType "DATA_FORWARDING" (for backward compatibility reason).				

6.1.6.2.25 Type: UriList

Table 6.1.6.2.25-1: Definition of type UriList

Attribute name	Data type	P	Cardinality	Description
_links	map(LinksValueSchema)	O	1..N	See clause 4.9.4 of 3GPP TS 29.501 [5] for the description of the members. In this map, the key "item", if present, shall contain an array of objects, where each object contains an "href" attribute containing the URI of the NF Instance. If the response contains no URIs to return, the "_links" attribute may be absent; if it is included, it shall only contain the "self" key (i.e. the "item" key shall be absent), and the "totalCount" attribute shall be set to 0.
totalCount	integer	C	0..1	This attribute should be included in the response and it shall contain the total number of items matching the input filter criteria of the request (e.g. "nf-type").

6.1.6.2.26 Type: N2InterfaceAmfInfo

Table 6.1.6.2.26-1: Definition of type N2InterfaceAmfInfo

Attribute name	Data type	P	Cardinality	Description
ipv4EndpointAddress	array(Ipv4Addr)	C	1..N	Available AMF endpoint IPv4 address(es) for N2 (see NOTE 1)
ipv6EndpointAddress	array(Ipv6Addr)	C	1..N	Available AMF endpoint IPv6 address(es) for N2 (see NOTE 1)
amfName	AmfName	O	0..1	AMF Name FQDN as defined in clause 28.3.2.5 of 3GPP TS 23.003 [12].

NOTE 1: At least one of the addressing parameters (ipv4address or ipv6address) shall be included.

6.1.6.2.27 Type: TaiRange

Table 6.1.6.2.27-1: Definition of type TaiRange

Attribute name	Data type	P	Cardinality	Description
plmnId	PlmnId	M	1	PLMN ID related to the TacRange.
tacRangeList	array(TacRange)	M	1..N	The range of the TACs
nid	Nid	O	0..1	NID related to the TacRange, for an SNPN

6.1.6.2.28 Type: TacRange

Table 6.1.6.2.28-1: Definition of type TacRange

Attribute name	Data type	P	Cardinality	Description
start	string	O	0..1	First value identifying the start of a TAC range, to be used when the range of TAC's can be represented as a hexadecimal range (e.g., TAC ranges). 3-octet string identifying a tracking area code, each character in the string shall take a value of "0" to "9" or "A" to "F" and shall represent 4 bits. The most significant character representing the 4 most significant bits of the TAC shall appear first in the string, and the character representing the 4 least significant bit of the TAC shall appear last in the string. Pattern: " <code>^([A-Fa-f0-9]{4})[A-Fa-f0-9]{6}\$</code> "
end	string	O	0..1	Last value identifying the end of a TAC range, to be used when the range of TAC's can be represented as a hexadecimal range (e.g., TAC ranges). 3-octet string identifying a tracking area code, each character in the string shall take a value of "0" to "9" or "A" to "F" and shall represent 4 bits. The most significant character representing the 4 most significant bits of the TAC shall appear first in the string, and the character representing the 4 least significant bit of the TAC shall appear last in the string. Pattern: " <code>^([A-Fa-f0-9]{4})[A-Fa-f0-9]{6}\$</code> "
pattern	string	O	0..1	Pattern (regular expression according to the ECMA-262 dialect [8]) representing the set of TAC's belonging to this range. A TAC value is considered part of the range if and only if the TAC string fully matches the regular expression.

NOTE: Either the start and end attributes, or the pattern attribute, shall be present.

EXAMPLE 1: TAC range. From: 543000 To: 5433E7 (i.e., 1000 TAC numbers)
JSON: { "start": "543000", "end": "5433E7" }

EXAMPLE 2: TAC range. From: 54E000 To: 54EFFF (i.e., 4096 TAC numbers)
JSON: { "pattern": "`^54E[0-9a-fA-F]{3}$`" }, or
JSON: { "start": "54E000", "end": "54EFFF" }

6.1.6.2.29 Type: SnsaiSmfInfoItem

Table 6.1.6.2.29-1: Definition of type SnsaiSmfInfoItem

Attribute name	Data type	P	Cardinality	Description	Applicability
sNssai	ExtSnsai	M	1	Supported S-NSSAI (NOTE)	
dnnSmfInfoList	array(DnnSmfInfoItem)	C	1..N	List of parameters supported by the SMF per DNN (NOTE 2)	
dnnSmfInfoListId	integer	C	0..1	Identifier of a dnnSmfInfoList	DNN-List-Optimization

NOTE 1: An SMF may register SD ranges or a wildcard SD if the SMF profile is not discoverable from other PLMNs and if the NRF and all consumers of the SMF profile in the same PLMN have been upgraded to support SD ranges and wildcard SD in this attribute.

NOTE 2: If the Feature DNN-List-Optimization is not supported, dnnSmfInfoList shall be present. If the feature DNN-List-Optimization is supported, multiple repetition of the same dnnSmfInfoList value within an smfInfoList can be avoided: A given dnnSmfInfoList value may be present (together with a dnnSmfInfoListId) in only a single occurrence of the SnsaiSmfInfoItem and other occurrences may then omit the dnnSmfInfoList and instead have a dnnSmfInfoListId pointing to that dnnSmfInfoList. The significance of a dnnSmfInfoListId is limited to smfInfoList.

6.1.6.2.30 Type: DnnSmfInfoltem

Table 6.1.6.2.30-1: Definition of type DnnSmfInfoltem

Attribute name	Data type	P	Cardinality	Description
dnn	Dnn	M	1	Supported DNN (NOTE) or Wildcard DNN if the SMF supports all DNNs for the related S-NSSAI. The DNN shall contain the Network Identifier and it may additionally contain an Operator Identifier. If the Operator Identifier is not included, the DNN is supported for all the PLMNs in the plmnList of the NF Profile.
dnaiList	array(Dnai)	O	1..N	List of DNAIs or Wildcard DNAI supported by the SMF for this DNN. (See NOTE 2)
uePlmnRangeList	array(PlmnRange)	O	1..N	This IE may be present when the SMF is configured to establish LBO PDU sessions for inbound roaming UEs from one or more specific PLMNs. When present, this IE shall contain a list of PLMNs for which the SMF is configured to establish LBO PDU sessions for inbound roaming UEs from these PLMNs. (NOTE 3)
<p>NOTE 1: For a SMF which only supports the I-SMF related functionalities, the dnn attribute may be an invalid DNN according to operator's local policy.</p> <p>NOTE 2: The Wildcard DNAI included in the "dnaiList" attribute indicates that the SMF can be selected for this DNN for any DNAI. The absence of "dnaiList" attribute does not mean that the SMF (e.g. pre-Rel-17 compliant) does not support any DNAI, but the SMF did not indicate which DNAIs it may support.</p> <p>NOTE 3: The absence of this IE means that the SMF supports LBO PDU sessions for inbound roaming UEs from any PLMN. For inbound roaming UEs from PLMNs which have no dedicated SMF configured for establishing LBO PDU sessions, the SMF whose NF profile does not include the uePlmnRangeList shall be selected. An SMF with the uePlmnRangeList configured may still be selected for non-roaming UEs.</p>				

6.1.6.2.31 Type: NrfInfo

Table 6.1.6.2.31-1: Definition of type NrfInfo

Attribute name	Data type	P	Cardinality	Description
servedUdrInfo	map(UdrInfo)	O	1..N	This attribute contains all the udrInfo attributes locally configured in the NRF or the NRF received during NF registration. The key of the map is the nfnInstanceIcd of which the udrInfo belongs to.
servedUdrInfoList	map(map(UdrInfo))	O	1..N(1..M)	This attribute contains the udrInfoList attribute locally configured in the NRF or that the NRF received during NF registration. The key of the map is the nfnInstanceIcd to which the map entry belongs to.
servedUdmInfo	map(UdmInfo)	O	1..N	This attribute contains all the udmInfo attributes locally configured in the NRF or the NRF received during NF registration. The key of the map is the nfnInstanceIcd of which the udmInfo belongs to.
servedUdmInfoList	map(map(UdmInfo))	O	1..N(1..M)	This attribute contains the udmInfoList attribute locally configured in the NRF or that the NRF received during NF registration. The key of the map is the nfnInstanceIcd to which the map entry belongs to.
servedAusfInfo	map(AusfInfo)	O	1..N	This attribute contains all the ausfInfo attributes locally configured in the NRF or the NRF received during NF registration. The key of the map is the nfnInstanceIcd of which the ausfInfo belongs to.
servedAusfInfoList	map(map(AusfInfo))	O	1..N(1..M)	This attribute contains the ausfInfoList attribute locally configured in the NRF or that the NRF received during NF registration. The key of the map is the nfnInstanceIcd to which the map entry belongs to.
servedAmfInfo	map(AmfInfo)	O	1..N	This attribute contains all the amfInfo attributes locally configured in the NRF or the NRF received during NF registration. The key of the map is the nfnInstanceIcd of which the amfInfo belongs to.
servedAmfInfoList	map(map(AmfInfo))	O	1..N(1..M)	This attribute contains the amfInfoList attribute locally configured in the NRF or that the NRF received during NF registration. The key of the map is the nfnInstanceIcd to which the map entry belongs to.
servedSmfInfo	map(SmfInfo)	O	1..N	This attribute contains all the smfInfo attributes locally configured in the NRF or the NRF received during NF registration. The key of the map is the nfnInstanceIcd of which the smfInfo belongs to.
servedSmfInfoList	map(map(SmfInfo))	O	1..N(1..M)	This attribute contains the smfInfoList attribute locally configured in the NRF or that the NRF received during NF registration. The key of the map is the nfnInstanceIcd to which the map entry belongs to.
servedUpfInfo	map(UpfInfo)	O	1..N	This attribute contains all the upfInfo attributes locally configured in the NRF or the NRF received during NF registration. The key of the map is the nfnInstanceIcd of which the upfInfo belongs to.
servedUpfInfoList	map(map(UpfInfo))	O	1..N(1..M)	This attribute contains the upfInfoList attribute locally configured in the NRF or that the NRF received during NF registration. The key of the map is the nfnInstanceIcd to which the map entry belongs to.
servedPcfInfo	map(PcfInfo)	O	1..N	This attribute contains all the pcfInfo attributes locally configured in the NRF or the NRF received during NF registration. The key of the map is the nfnInstanceIcd of which the pcfInfo belongs to.
servedPcfInfoList	map(map(PcfInfo))	O	1..N(1..M)	This attribute contains the pcfInfoList attribute locally configured in the NRF or that the NRF received during NF registration. The key of the map is the nfnInstanceIcd to which the map entry belongs to.
servedBsInfo	map(BsInfo)	O	1..N	This attribute contains all the bsInfo attributes locally configured in the NRF or the NRF received during NF registration. The key of the map is the nfnInstanceIcd of which the bsInfo belongs to.

servedBsflInfoList	map(map(BsflInfo))	O	1..N(1..M)	This attribute contains the bsflInfoList attribute locally configured in the NRF or that the NRF received during NF registration. The key of the map is the nflInstanceld to which the map entry belongs to.
servedChflInfo	map(ChflInfo)	O	1..N	This attribute contains all the chflInfo attributes locally configured in the NRF or the NRF received during NF registration. The key of the map is the nflInstanceld of which the chflInfo belongs to.
servedChflInfoList	map(map(ChflInfo))	O	1..N(1..M)	This attribute contains the chflInfoList attribute locally configured in the NRF or that the NRF received during NF registration. The key of the map is the nflInstanceld to which the map entry belongs to.
servedNeflInfo	map(NeflInfo)	O	1..N	This attribute contains all the neflInfo attributes locally configured in the NRF or the NRF received during NF registration. The key of the map is the nflInstanceld of which the neflInfo belongs to.
servedNwdafInfo	map(NwdafInfo)	O	1..N	This attribute contains all the nwdafInfo attributes locally configured in the NRF or the NRF received during NF registration. The key of the map is the nflInstanceld of which the nwdafInfo belongs to.
servedNwdafInfoList	map(map(NwdafInfo))	O	1..N	This attribute contains all the nwdafInfo attributes locally configured in the NRF or the NRF received during NF registration. The key of the map is the nflInstanceld to which the map entry belongs to.
servedPcscflInfoList	map(map(PcscflInfo))	O	1..N(1..M)	This attribute contains all the pcscflInfo attributes locally configured in the NRF or the NRF received during NF registration. The key of the map is the nflInstanceld to which the map entry belongs to.
servedGmlcInfo	map(GmlcInfo)	O	1..N	This attribute contains all the gmlcInfo attributes locally configured in the NRF or the NRF received during NF registration. The key of the map is the nflInstanceld of which the gmlcInfo belongs to.
servedLmflInfo	map(LmflInfo)	O	1..N	This attribute contains all the lmflInfo attributes locally configured in the NRF or the NRF received during NF registration. The key of the map is the nflInstanceld of which the lmflInfo belongs to.
servedNflInfo	map(NflInfo)	O	1..N	This attribute contains information of other NFs without corresponding NF type specific Info extensions locally configured in the NRF or the NRF received during NF registration. The key of the map is the nflInstanceld of the NF.
servedHsslInfoList	map(map(HsslInfo))	O	1..N(1..M)	This attribute contains all the hsslInfo attributes locally configured in the NRF or the NRF received during NF registration. The key of the map is the nflInstanceld to which the map entry belongs to.
servedUdsflInfo	map(UdsflInfo)	O	1..N	This attribute contains all the udsflInfo attributes locally configured in the NRF or the NRF received during NF registration. The key of the map is the nflInstanceld to which the map entry belongs to.
servedUdsflInfoList	map(map(UdsflInfo))	O	1..N(1..M)	This attribute contains the udsflInfoList attribute locally configured in the NRF or that the NRF received during NF registration. The key of the map is the nflInstanceld to which the map entry belongs to.
servedScplInfoList	map(ScplInfo)	O	1..N	This attribute contains the scplInfo attribute locally configured in the NRF or that the NRF received during SCP registration. The key of the map is the nflInstanceld to which the scplInfo belongs to.
servedSeppInfoList	map(SeppInfo)	O	1..N	This attribute contains the seppInfo attribute locally configured in the NRF or that the NRF received during SEPP registration. The key of the map is the nflInstanceld to which the seppInfo belongs to.
servedAanfInfoList	map(map(AanfInfo))	O	1..N(1..M)	This attribute contains the aanfInfoList attribute locally configured in the NRF or that the NRF received during NF registration. The key of the map is the nflInstanceld to which the map entry belongs to.

served5gDdnmflInfo	map(5GDdnmflInfo)	O	1..N	This attribute contains all the 5GDdnmflInfo attributes locally configured in the NRF or the NRF received during NF registration. The key of the map is the nfnInstanceid of which the 5GDdnmflInfo belongs to.
servedMfafInfoList	map(MfafInfo)	O	1..N	This attribute contains the mfafInfo attribute locally configured in the NRF or that the NRF received during MFAF registration. The key of the map is the nfnInstanceid to which the mfafInfo belongs to.
servedEasdfInfoList	map(map(EasdfInfo))	O	1..N(1..M)	This attribute contains the easdfInfoList attribute locally configured in the NRF or that the NRF received during NF registration. The key of the map is the nfnInstanceid to which the map entry belongs to.
servedDccfInfoList	map(DccfInfo)	O	1..N	This attribute contains the dccfInfo attribute locally configured in the NRF or that the NRF received during DCCF registration. The key of the map is the nfnInstanceid to which the dccfInfo belongs to.
servedMbSmfInfoList	map(map(MbSmfInfo))	O	1..N(1..M)	This attribute contains the mbSmfInfoList attribute locally configured in the NRF or that the NRF received during NF registration. The key of the map is the nfnInstanceid to which the map entry belongs to.
servedTsctsflInfoList	map(map(TsctsflInfo))	O	1..N(1..M)	This attribute contains the tsctsflInfoList attribute locally configured in the NRF or that the NRF received during TSCTSF registration. The key of the map is the nfnInstanceid to which the map entry belongs to.
servedMbUpflInfoList	map(map(MbUpflInfo))	O	1..N(1..M)	This attribute contains the mbUpflInfoList attribute locally configured in the NRF or that the NRF received during NF registration. The key of the map is the nfnInstanceid to which the map entry belongs to.
servedTrustAfInfo	map(TrustAfInfo)	O	1..N	This attribute contains the trustAfInfo attribute locally configured in the NRF or that the NRF received during AF registration. The key of the map is the nfnInstanceid to which the map entry belongs to.
servedNssaafInfo	map(NssaafInfo)	O	1..N	This attribute contains all the nssaafInfo attributes locally configured in the NRF or the NRF received during NF registration. The key of the map is the nfnInstanceid of which the nssaafInfo belongs to.
servedDcsflInfo	map(DcsflInfo)	O	1..N	This attribute contains all the dcsflInfos attributes locally configured in the NRF or the NRF received during NF registration. The key of the map is the nfnInstanceid of which the dcsflInfo belongs to.
servedMflInfo	map(MflInfo)	O	1..N	This attribute contains all the mflInfos attributes locally configured in the NRF or the NRF received during NF registration. The key of the map is the nfnInstanceid of which the mflInfo belongs to.
servedMrflInfo	map(MrflInfo)	O	1..N	This attribute contains all the mrflInfos attributes locally configured in the NRF or the NRF received during NF registration. The key of the map is the nfnInstanceid of which the mrflInfo belongs to.
servedMrfpInfo	map(MrfpInfo)	O	1..N	This attribute contains all the mrfpInfos attributes locally configured in the NRF or the NRF received during NF registration. The key of the map is the nfnInstanceid of which the mrfpInfo belongs to.
<p>NOTE 1: The absence of these parameters means the NRF is able to serve any NF discovery request.</p> <p>NOTE 2: For any of the servedxxxInfo/servedxxxInfoList attributes (other than servedNflInfo), if the data type definition of the corresponding xxxInfo attribute allows to use an empty JSON object, the registering NRF shall include in the servedxxxInfo/servedxxxInfoList a map entry with an empty JSON object as value, to indicate the registration of an NF Instance that did not include any xxxInfo/xxxInfoList attributes; otherwise, the registering NRF shall check the support of the feature "Empty-Objects-Nrf-Info" (see clause 6.1.9) in the target NRF and, if the feature is not supported, it shall use the generic servedNflInfo attribute (instead of the servedxxxInfo corresponding to its NF type) to signal the registration of such NF instance with absent xxxInfo/xxxInfoList attributes.</p>				

6.1.6.2.32 Type: ChfInfo

Table 6.1.6.2.32-1: Definition of type ChfInfo

Attribute name	Data type	P	Cardinality	Description
supiRangeList	array(SupiRange)	O	1..N	List of ranges of SUPIs that can be served by the CHF instance. (NOTE 1)
gpsiRangeList	array(IdentityRange)	O	1..N	List of ranges of GPSI that can be served by the CHF instance. (NOTE 1)
plmnRangeList	array(PlmnRange)	O	1..N	List of ranges of PLMNs (including the PLMN IDs of the CHF instance) that can be served by the CHF instance. If not provided, the CHF can serve any PLMN.
groupId	NfGroupId	O	0..1	Identity of the CHF group that is served by the CHF instance. If not provided, the CHF instance does not pertain to any CHF group. (NOTE 1)
primaryChfInstance	NfInstanceId	C	0..1	This IE shall be present if the CHF instance serves as a secondary CHF instance of another primary CHF instance. When present, it shall be set to the NF Instance Id of the primary CHF instance. This IE shall be absent if the secondaryChfInstance is present. (NOTE 2, NOTE 3)
secondaryChfInstance	NfInstanceId	C	0..1	This IE shall be present if the CHF instance serves as a primary CHF instance of another secondary CHF instance. When present, it shall be set to the NF Instance Id of the secondary CHF instance. This IE shall be absent if the primaryChfInstance is present. (NOTE 2, NOTE 3)
NOTE 1: If none of these parameters are provided, the CHF can serve any SUPI or GPSI managed by the PLMN of the CHF instance. If "supiRangeList" and "gpsiRangeList" attributes are absent, and "groupId" is present, the SUPIs / GPSIs served by this CHF instance is determined by the NRF (see 3GPP TS 23.501 [2], clause 6.2.6.2).				
NOTE 2: The NF Service Consumer of the CHF may use these attributes as primary/secondary redundancy mechanism, or alternatively, it may also rely on the availability of an NF Set (or NF Service Set) of CHF Instances (or CHF Service Instances) for the same purpose.				
NOTE 3: If the CHF does not provide NF set ID or NF Service Set ID in NFProfile, it shall provide one of these attributes. These attributes may be present if the CHF registers an NF set ID or NF service set ID.				

6.1.6.2.33 Void

6.1.6.2.34 Type: PlmnRange

Table 6.1.6.2.34-1: Definition of type PlmnRange

Attribute name	Data type	P	Cardinality	Description
start	string	O	0..1	First value identifying the start of a PLMN range. The string shall be encoded as follows: <MCC><MNC> Pattern: '^([0-9]{3})([0-9]{2,3})\$'
end	string	O	0..1	Last value identifying the end of a PLMN range. The string shall be encoded as follows: <MCC><MNC> Pattern: '^([0-9]{3})([0-9]{2,3})\$'
pattern	string	O	0..1	Pattern (regular expression according to the ECMA-262 dialect [8]) representing the set of PLMNs belonging to this range. A PLMN value is considered part of the range if and only if the PLMN string (formatted as <MCC><MNC>) fully matches the regular expression.
NOTE: Either the start and end attributes, or the pattern attribute, shall be present.				

EXAMPLE 1: PLMN range. MCC 123, any MNC
JSON: { "start": "12300", "end": "123999" }

EXAMPLE 2: PLMN range. MCC 123, MNC within range 45 to 49
JSON: { "pattern": "^1234[5-9]\$" }, or
JSON: { "start": "12345", "end": "12349" }

EXAMPLE 3: PLMN range. MCC within range 123 to 257, any MNC
JSON: { "start": "12300", "end": "257999" }

6.1.6.2.35 Type: SubscrCond

Table 6.1.6.2.35-1: Definition of type SubscrCond as a list of mutually exclusive alternatives

Data type	Cardinality	Description
NfInstancelCond	1	Subscription to a given NF Instance
NfInstancelListCond	1	Subscription to a list of NF Instances
NfTypeCond	1	Subscription to a set of NF Instances, identified by their NF Type
ServiceNameCond	1	Subscription to a set of NF Instances that offer a certain service name
ServiceNameListCond	1	Subscription to a set of NF Instances that offer a service name in the Service Name list.
AmfCond	1	Subscription to a set of NF Instances (AMFs), belonging to a certain AMF Set and/or belonging to a certain AMF Region.
GuamiListCond	1	Subscription to a set of NF Instances (AMFs) identified by their Guamis (i.e. whose guamiList IE in the amfInfo or amfInfoList IE matches at least one of the GUAMI in the guamiList IE of the subscription).
NetworkSliceCond	1	Subscription to a set of NF Instances, identified by S-NSSAI(s) and NSI ID(s).
NfGroupCond	1	Subscription to a set of NF Instances, identified by a NF (UDM, AUSF, PCF, CHF, HSS, UDR, BSF or UDSF) Group Identity.
NfGroupListCond	1	Subscription to a set of NF Instances, identified by a NF Group Identity in the NF Group Identity list.
NfSetCond	1	Subscription to a set of NF Instances belonging to a certain NF Set.
NfServiceSetCond	1	Subscription to a set of NF Service Instances, or to a set of equivalent NF Service Instances.
UpfCond	1	Subscription to a set of NF Instances (UPFs), able to serve a certain service area (i.e. SMF serving area or TAI list).
ScpDomainCond	1	Subscription to a set of NF, SCP or SEPP instances belonging to certain SCP domains.
NwdafCond	1	Subscription to a set of NF Instances (NWDAFs), identified by Analytics ID(s), S-NSSAI(s) or NWDAF Serving Area information, i.e. list of TAIs for which the NWDAF can provide analytics.
NefCond	1	Subscription to a set of NF Instances (NEFs), identified by Event ID(s) provided by AF, S-NSSAI(s), AF Instance ID, Application Identifier, External Identifier, External Group Identifier, or domain name.
DccfCond	1	Subscription to a set of NF Instances (DCCFs), identified by NF types, NF Set Id(s) or DCCF Serving Area information, i.e. list of TAIs served by the DCCF.

6.1.6.2.36 Type: NfInstancelCond

Table 6.1.6.2.36-1: Definition of type NfInstancelCond

Attribute name	Data type	P	Cardinality	Description
nfInstancelId	NfInstancelId	M	1	NF Instance ID of the NF Instance whose status is requested to be monitored.

6.1.6.2.37 Type: NfTypeCond

Table 6.1.6.2.37-1: Definition of type NfTypeCond

Attribute name	Data type	P	Cardinality	Description
nfType	NFType	M	1	NF type of the NF Instances whose status is requested to be monitored.
NOTE: This type shall not contain the attribute "nfGroupId", to avoid that this type has a matching definition with "NfGroupCond" type.				

6.1.6.2.38 Type: ServiceNameCond

Table 6.1.6.2.38-1: Definition of type ServiceNameCond

Attribute name	Data type	P	Cardinality	Description
serviceName	ServiceName	M	1	Service name offered by the NF Instances whose status is requested to be monitored.

6.1.6.2.39 Type: AmfCond

Table 6.1.6.2.39-1: Definition of type AmfCond

Attribute name	Data type	P	Cardinality	Description
amfSetId	AmfSetId	C	1	AMF Set ID of the NF Instances (AMF) whose status is requested to be monitored.
amfRegionId	AmfRegionId	C	1	AMF Region ID of the NF Instances (AMF) whose status is requested to be monitored.
NOTE 1: At least amfSetId or amfRegionId shall be present; if both the amfRegionId and amfSetId attributes are present in the SubscriptionData, this indicates a subscription for notifications satisfying both attributes (i.e. notifications for NFs from that amfRegionId and amfSetId).				
NOTE 2: The PLMN ID (or PLMN ID and NID) of the AMF Region and AMF Set of the NF Instances (AMF) whose status is requested to be monitored may be indicated in the plmnId attribute (or plmnid and nid attributes) in the SubscriptionData.				

6.1.6.2.40 Type: GuamiListCond

Table 6.1.6.2.40-1: Definition of type GuamiListCond

Attribute name	Data type	P	Cardinality	Description
guamiList	array(Guami)	M	1..N	Guamis of the NF Instances (AMFs) whose status is requested to be monitored (i.e. whose guamiList IE in the amfInfo or amfInfoList IE matches at least one of the GUAMI in the guamiList IE of the subscription).

6.1.6.2.41 Type: NetworkSliceCond

Table 6.1.6.2.41-1: Definition of type NetworkSliceCond

Attribute name	Data type	P	Cardinality	Description
snssaiList	array(Snssai)	M	1..N	S -NSSAIs of the NF Instances whose status is requested to be monitored.
nsiList	array(string)	O	1..N	NSI IDs of the NF Instances whose status is requested to be monitored.

6.1.6.2.42 Type: NfGroupCond

Table 6.1.6.2.42-1: Definition of type NfGroupCond

Attribute name	Data type	P	Cardinality	Description
nfType	string	M	1	NF type (UDM, AUSF, PCF, UDR, HSS, CHF, BSF or UDSF) of the NF Instances whose status is requested to be monitored.
nfGroupId	NfGroupId	M	1	Group ID of the NF Instances whose status is requested to be monitored.

6.1.6.2.43 Type: NotifCondition

Table 6.1.6.2.43-1: Definition of type NotifCondition

Attribute name	Data type	P	Cardinality	Description
monitoredAttributes	array(string)	C	1..N	List of JSON Pointers (as specified in IETF RFC 6901 [14]) of attributes in the NF Profile. If this attribute is present, the NRF shall send notification only for changes in the attributes included in this list (see NOTE 1).
unmonitoredAttributes	array(string)	C	1..N	List of JSON Pointers (as specified in IETF RFC 6901 [14]) of attributes in the NF Profile. If this attribute is present, the NRF shall send notification for changes on any attribute, except for those included in this list (see NOTE 1).

NOTE 1: Attributes "monitoredAttributes" and "unmonitoredAttributes" shall not be included simultaneously

EXAMPLE 1: The following JSON object would represent a monitoring condition where the client requests to be notified of all changes on the NF Profile, except "load" attribute.

```
{
  "unmonitoredAttributes": [ "/load" ]
}
```

EXAMPLE 2: The following JSON object would represent a monitoring condition where the client requests to be notified only of changes on attribute "nfStatus":

```
{
  "monitoredAttributes": [ "/nfStatus" ]
}
```

EXAMPLE 3: The following JSON object would represent a monitoring condition where the client requests to be notified only of changes on the first item of "nfServices":

```
{
  "monitoredAttributes": [ "/nfServices/0" ]
}
```

6.1.6.2.44 Type: PlmnSnssai

Table 6.1.6.2.44-1: Definition of type PlmnSnssai

Attribute name	Data type	P	Cardinality	Description
plmnId	PlmnId	M	1	PLMN ID for which list of supported S-NSSAI(s) is provided.
sNssaiList	array(ExtSnssai)	M	1..N	The specific list of S-NSSAIs supported by the given PLMN or SNPN.
nid	Nid	O	0..1	NID for which list of supported S-NSSAI(s) is provided.

6.1.6.2.45 Type: NwdafInfo

Table 6.1.6.2.45-1: Definition of type NwdafInfo

Attribute name	Data type	P	Cardinality	Description
eventIds	array(EventId)	C	1..N	EventId(s) supported by the Nnwdaf_AnalyticsInfo service, if none are provided the NWDAF can serve any eventId.
nwdafEvents	array(NwdafEvent)	C	1..N	Event(s) supported by the Nnwdaf_EventsSubscription service, if none are provided the NWDAF can serve any nwdafEvent.
taiList	array(Tai)	O	1..N	The list of TAIs the NWDAF can serve. It may contain one or more non-3GPP access TAIs. The absence of this attribute and the taiRangeList attribute indicate that the NWDAF can be selected for any TAI in the serving network.
taiRangeList	array(TaiRange)	O	1..N	The range of TAIs the NWDAF can serve. It may contain non-3GPP access TAIs. The absence of this attribute and the taiList attribute indicate that the NWDAF can be selected for any TAI in the serving network.
nwdafCapability	NwdafCapability	O	0..1	If present, this IE shall indicate the capability of the NWDAF. If not present, the NWDAF shall be regarded with no capability.
analyticsDelay	DurationSec	O	0..1	Supported Analytics Delay related to the eventIds and nwdafEvents.
servingNfTypeList	array(NFType)	O	1..N	If present, this IE shall contain the list of NF type(s) from which the NWDAF NF can collect data. The absence of this attribute indicates that the NWDAF can collect data from any NF type.
servingNfSetIdList	array(NfSetId)	O	1..N	If present, this IE shall contain the list of NF Set Id(s) from which the NWDAF NF can collect data. The absence of this attribute indicates that the NWDAF can collect data from any NF Set.
mlAnalyticsList	array(MlAnalyticsInfo)	C	1..N	ML Analytics Filter information supported by the Nnwdaf_MLModelProvision service.

6.1.6.2.46 Type: LmflInfo

Table 6.1.6.2.46-1: Definition of type LmflInfo

Attribute name	Data type	P	Cardinality	Description
servingClientTypes	array(ExternalClientType)	C	1..N	This IE shall be present if the LMF is dedicated to serve the listed external client type(s), e.g. emergency client. The NRF should only include this LMF instance to NF discovery with "client-type" query parameter indicating one of the external client types in the list. Absence of this IE means the LMF is not dedicated to serve specific client types.
lmfld	LMFIdentification	C	0..1	When present, this ID shall indicate the LMF identification.
servingAccessTypes	array(AccessType)	C	1..N	If included, this IE shall contain the access type (i.e. 3GPP_ACCESS and/or NON_3GPP_ACCESS) supported by the LMF. If not included, it shall be assumed that all access types are supported.
servingAnNodeTypes	array(AnNodeType)	C	1..N	If included, this IE shall contain the AN node type (i.e. gNB or NG-eNB) supported by the LMF. If not included, it shall be assumed that all AN node types are supported.
servingRatTypes	array(RatType)	C	1..N	If included, this IE shall contain the RAT type (e.g. 5G NR, eLTE or any of the RAT Types specified for NR satellite access) supported by the LMF. If not included, it shall be assumed that all RAT types are supported.
taiList	array(Tai)	O	1..N	When present, this IE shall contain TAI list that the LMF can serve. It may contain one or more non-3GPP access TAIs. The absence of both this attribute and the taiRangeList attribute indicates that the LMF can be selected for any TAI in the serving network.
taiRangeList	array(TaiRange)	O	1..N	When present, this IE shall contain TAI range list that the LMF can serve. It may contain one or more non-3GPP access TAI ranges. The absence of both this attribute and the taiList attribute indicates that the LMF can be selected for any TAI in the serving network.
supportedGADShapes	array(SupportedGADShapes)	O	1..N	If included, this IE shall contain the GAD shapes supported by the LMF. If not included, it doesn't indicate that the LMF doesn't support any GAD shapes.
pruExistenceInfo	PruExistenceInfo	O	0..1	When present, this IE shall contain the PRU Existence Information.
pruSupportInd	boolean	O	0..1	This IE may be used by the LMF to indicate the support of PRU function. When the IE is present and set to true, it indicates that the PRU function is supported by the LMF. If the IE is not present or set to false (default), it indicates that the PRU function is not supported by the LMF.
rangingSposSupportInd	boolean	O	0..1	When present, this ID shall indicate whether ranging and sidelink positioning capability is supported by the LMF. true: Supported false (default): Not Supported
upPositioningInd	boolean	O	0..1	When present, this IE shall indicate whether user plane positioning capability is supported by the LMF. true: Supported false (default): Not Supported

6.1.6.2.47 Type: GmlcInfo

Table 6.1.6.2.47-1: Definition of type GmlcInfo

Attribute name	Data type	P	Cardinality	Description
servingClientTypes	array(ExternalClientType)	C	1..N	<p>This IE shall be present if the GMLC is dedicated to serve the listed external client type(s), e.g. emergency client. The NRF should only include this GMLC instance to NF discovery with "client-type" query parameter indicating one of the external client types in the list.</p> <p>Absence of this IE means the GMLC is not dedicated to serve specific client types.</p>
gmlcNumbers	array(string)	O	1..N	<p>This IE shall be present if the GMLC is configured with a number of GMLC Numbers.</p> <p>When present, each item of the array shall carry an OctetString indicating the ISDN number of the GMLC in international number format as described in ITU-T Rec. E.164 [44] and shall be encoded as a TBCD-string.</p> <p>Pattern for each item of the array: "<code>^[0-9]{5,15}\$</code>"</p>

6.1.6.2.48 Type: NefInfo

Table 6.1.6.2.48-1: Definition of type NefInfo

Attribute name	Data type	P	Cardinality	Description
nefId	NefId	C	0..1	This IE shall be present and contain the NEF ID of the NEF if NIDD service is supported.
pfdData	PfdData	O	0..1	PFD data, containing the list of internal application identifiers and/or the list of application function identifiers for which the PFDs can be provided. Absence of this attribute indicates that the PFDs for any internal application identifier and for any application function identifier can be provided.
afEeData	AfEventExposure Data	O	0..1	The AF provided event exposure data. The NEF registers such information in the NRF on behalf of the AF.
gpsiRanges	array(IdentityRange)	O	1..N	Range(s) of External Identifiers
externalGroupIdentifiers Ranges	array(IdentityRange)	O	1..N	Range(s) of External Group Identifiers
servedFqdnList	array(string)	O	1..N	Pattern (regular expression according to the ECMA-262 dialect [8]) representing the Domain names served by the NEF
taiList	array(Tai)	O	1..N	The list of TAIs the NEF can serve. It may contain one or more non-3GPP access TAIs. The absence of this attribute and the taiRangeList attribute indicates that the NEF can be selected for any TAI in the serving network.
taiRangeList	array(TaiRange)	O	1..N	The range of TAIs the NEF can serve. It may contain non-3GPP access TAIs. The absence of this attribute and the taiList attribute indicates that the NEF can be selected for any TAI in the serving network.
dnaiList	array(Dnai)	O	1..N	List of Data network access identifiers supported by the NEF. The absence of this attribute indicates that the NEF can be selected for any DNAI.
unTrustAfInfoList	array(UnTrustAfInfo)	O	1..N	List of information corresponding to the AFs.
uasNfFunctionalityInd	boolean	O	0..1	When present, this IE shall indicate whether the NEF supports UAS NF functionality: - true: UAS NF functionality is supported by the NEF - false (default): UAS NF functionality is not supported by the NEF.
multiMemAfSessQosInd	boolean	O	0..1	When present, this IE shall indicate whether the NEF supports Multi-member AF session with required QoS functionality: - true: Multi-member AF session with required QoS functionality is supported by the NEF - false (default): Multi-member AF session with required QoS functionality is not supported by the NEF.
memberUESelAssistInd	boolean	O	0..1	When present, this IE shall indicate whether the NEF supports member UE selection assistance functionality: - true: member UE selection assistance functionality is supported by the NEF - false (default): member UE selection assistance functionality is not supported by the NEF.

6.1.6.2.49 Type: PfdData

Table 6.1.6.2.49-1: Definition of type PfdData

Attribute name	Data type	P	Cardinality	Description
applds	array(string)	O	1..N	List of internal application identifiers of the managed PFDs.
aflds	array(string)	O	1..N	List of application function identifiers of the managed PFDs.

6.1.6.2.50 Type: AfEventExposureData

Table 6.1.6.2.50-1: Definition of type AfEventExposureData

Attribute name	Data type	P	Cardinality	Description
afEvents	array(AfEvent)	M	1..N	AF Event(s) exposed by the NEF after registration of the AF(s) at the NEF.
aflds	array(string)	O	1..N	Associated AF identifications to the AfEvents. The absence of this attribute indicate that the NEF can be selected for any AF. If present the ordered list of aflds shall contain as many elements as the ordered list of afEvents, where the ordering determines the association between afld and AfEvent.
applds	array(string)	O	1..N	The list of Application ID(s) the AF(s) connected to the NEF supports. The absence of this attribute indicate that the NEF can be selected for any Application. If present the ordered list of applds shall contain as many elements as the ordered list of afEvents, where the ordering determines the association between appld and AfEvent.
taiList	array(Tai)	O	1..N	This IE may be present if the AfEvent is set to "GNSS_ASSISTANCE_DATA". When present, this IE shall contain the list of TAIs the trusted AF can serve. It may contain one or more non-3GPP access TAIs. The absence of this attribute and the taiRangeList attribute indicate that the trusted AF can be selected for any TAI in the serving network.
taiRangeList	array(TaiRange)	O	1..N	This IE may be present if the AfEvent is set to "GNSS_ASSISTANCE_DATA". When present, this IE shall contain the range of TAIs the trusted AF can serve. It may contain non-3GPP access TAIs. The absence of this attribute and the taiList attribute indicate that the trusted AF can be selected for any TAI in the serving network.

6.1.6.2.51 Type: WAgfInfo

Table 6.1.6.2.51-1: Definition of type WAgfInfo

Attribute name	Data type	P	Cardinality	Description
ipv4EndpointAddresses	array(Ipv4Addr)	C	1..N	Available endpoint IPv4 address(es) of the N3 terminations (NOTE 1).
ipv6EndpointAddresses	array(Ipv6Addr)	C	1..N	Available endpoint IPv6 address(es) of the N3 terminations (NOTE 1).
endpointFqdn	Fqdn	C	0..1	Available endpoint FQDN of the N3 terminations (NOTE 1).
NOTE 1: At least one of the addressing parameters (ipv4address, ipv6address or endpointFqdn) shall be included in the WAgfInfo.				

6.1.6.2.52 Type: TngflInfo

Table 6.1.6.2.52-1: Definition of type TngflInfo

Attribute name	Data type	P	Cardinality	Description
ipv4EndpointAddresses	array(Ipv4Addr)	C	1..N	Available endpoint IPv4 address(es) of the N3 terminations (NOTE 1).
ipv6EndpointAddresses	array(Ipv6Addr)	C	1..N	Available endpoint IPv6 address(es) of the N3 terminations (NOTE 1).
endpointFqdn	Fqdn	C	0..1	Available endpoint FQDN of the N3 terminations (NOTE 1).
NOTE 1: At least one of the addressing parameters (ipv4address, ipv6address or endpointFqdn) shall be included in the TngflInfo.				

6.1.6.2.53 Type: PcsclInfo

Table 6.1.6.2.53-1: Definition of type PcsclInfo

Attribute name	Data type	P	Cardinality	Description
accessType	array(AccessType)	C	1..N	If included, this IE shall contain the access type (3GPP_ACCESS and/or NON_3GPP_ACCESS) supported by the P-CSCF. If not included, it shall be assumed that all access types are supported.
dnnList	array(Dnn)	O	1..N	DNNs supported by the P-CSCF. The DNN shall contain the Network Identifier and it may additionally contain an Operator Identifier. If the Operator Identifier is not included, the DNN is supported for all the PLMNs in the plmnList of the NF Profile. If not provided, the P-CSCF can serve any DNN.
gmFqdn	Fqdn	O	0..1	FQDN of the P-CSCF for the Gm interface
gmIpv4Addresses	array(Ipv4Addr)	O	1..N	IPv4 address(es) of the P-CSCF for the Gm interface
gmIpv6Addresses	array(Ipv6Addr)	O	1..N	IPv6 address(es) of the P-CSCF for the Gm interface
mwFqdn	Fqdn	O	0..1	FQDN of the P-CSCF for the Mw interface (NOTE)
mwIpv4Addresses	array(Ipv4Addr)	O	1..N	IPv4 address(es) of the P-CSCF for the Mw interface (NOTE)
mwIpv6Addresses	array(Ipv6Addr)	O	1..N	IPv6 address(es) of the P-CSCF for the Mw interface (NOTE)
servedIpv4AddressRanges	array(Ipv4AddressRange)	O	1..N	List of ranges of UE IPv4 addresses used on the Gm interface, served by P-CSCF. The absence of this attribute does not mean the P-CSCF can serve any IPv4 address.
servedIpv6PrefixRanges	array(Ipv6PrefixRange)	O	1..N	List of ranges of UE IPv6 prefixes used on the Gm interface, served by P-CSCF. The absence of this attribute does not mean the P-CSCF can serve any IPv6 prefix.
NOTE: The Mw addressing information of the P-CSCF may be used by other NFs (e.g., SMF) in P-CSCF restoration scenarios (see 3GPP TS 23.380 [45], clause 5.8.4.2 and clause 5.8.5.2), where a mapping between Gm and Mw addresses may be used to determine the updated list of P-CSCFs to be sent to the UE, after excluding those P-CSCF instances that have been deemed as failed by the S-CSCF.				

6.1.6.2.54 Type: NfSetCond

Table 6.1.6.2.54-1: Definition of type NfSetCond

Attribute name	Data type	P	Cardinality	Description
nfSetId	NfSetId	M	1	NF Set ID (see clause 28.12 of 3GPP TS 23.003 [12]) of NF Instances whose status is requested to be monitored.

6.1.6.2.55 Type: NfServiceSetCond

Table 6.1.6.2.55-1: Definition of type NfServiceSetCond

Attribute name	Data type	P	Cardinality	Description
nfServiceSetId	NfServiceSetId	M	1	NF Service Set ID (see clause 28.13 of 3GPP TS 23.003 [12]) of NF service instances whose status is requested to be monitored.
nfSetId	NfSetId	C	0..1	NF Set ID (see clause 28.12 of 3GPP TS 23.003 [12]). This attribute shall be included if the consumer requests to monitor the status of all equivalent NF Service Instances in the provided NF Set ID and NF Service Set ID.

6.1.6.2.56 Type: NfInfo

Table 6.1.6.2.56-1: Definition of type NfInfo

Attribute name	Data type	P	Cardinality	Description
nfType	NFType	M	1	This IE shall indicate the type of the NF.

6.1.6.2.57 Type: HssInfo

Table 6.1.6.2.57-1: Definition of type HssInfo

Attribute name	Data type	P	Cardinality	Description
groupid	NfGroupId	O	0..1	Identity of the HSS group that is served by the HSS instance. If not provided, the HSS instance does not pertain to any HSS group. (NOTE 1)
imsiRanges	array(ImsiRange)	O	1..N	List of ranges of IMSIs whose profile data is available in the HSS instance (NOTE 1)
imsPrivateIdentityRanges	array(IdentityRange)	O	1..N	List of ranges of IMS Private Identities whose profile data is available in the HSS instance (NOTE 1, NOTE 2)
imsPublicIdentityRanges	array(IdentityRange)	O	1..N	List of ranges of IMS Public Identities whose profile data is available in the HSS instance (NOTE 1)
msisdnsRanges	array(IdentityRange)	O	1..N	List of ranges of MSISDNs whose profile data is available in the HSS instance (NOTE 1)
externalGroupIdentifiersRanges	array(IdentityRange)	O	1..N	List of ranges of external group IDs that can be served by this HSS instance. If not provided, the HSS instance does not serve any external groups.
hssDiameterAddress	NetworkNodeDiameterAddress	O	0..1	Diameter Address of the HSS
additionalDiameterAddresses	array(NetworkNodeDiameterAddresses)	O	1..N	Additional Diameter Addresses of the HSS; may be present if hssDiameterAddress is present
NOTE 1: If none of these parameters are provided, the HSS can serve any IMSI or IMS Private Identity or IMS Public Identity or MSISDN managed by the PLMN of the HSS instance. If "imsiRanges", "imsPrivateIdentityRanges", "imsPublicIdentityRanges" and "msisdnsRanges" attributes are absent, and "groupid" is present, the IMSIs / IMS Private Identities / IMS Public Identities / MSISDNs served by this HSS instance is determined by the NRF.				
NOTE 2: In deployments where the users IMPIs are derived from their IMSIs (see 3GPP TS 23.003 [12], clause 13.3, the HSS shall only register imsiRanges in NRF.				

6.1.6.2.58 Type: ImsiRange

Table 6.1.6.2.58-1: Definition of type ImsiRange

Attribute name	Data type	P	Cardinality	Description
start	string	O	0..1	First value identifying the start of a IMSI range. Pattern: " $^{\wedge}$ [0-9]+\$"
end	string	O	0..1	Last value identifying the end of a IMSI range. Pattern: " $^{\wedge}$ [0-9]+\$"
pattern	string	O	0..1	Pattern (regular expression according to the ECMA-262 dialect [8]) representing the set of IMSIs belonging to this range. An IMSI value is considered part of the range if and only if the IMSI string fully matches the regular expression.
NOTE: Either the start and end attributes, or the pattern attribute, shall be present.				

6.1.6.2.59 Type: InternalGroupIdRange

Table 6.1.6.2.59-1: Definition of type InternalGroupIdRange

Attribute name	Data type	P	Cardinality	Description
start	GroupId	O	0..1	First value identifying the start of an identity range, to be used when the range of identities can be represented as a consecutive numeric range.
end	GroupId	O	0..1	Last value identifying the end of an identity range, to be used when the range of identities can be represented as a consecutive numeric range.
pattern	string	O	0..1	Pattern (regular expression according to the ECMA-262 dialect [8]) representing the set of identities belonging to this range. An identity value is considered part of the range if and only if the identity string fully matches the regular expression.
NOTE: Either the start and end attributes, or the pattern attribute, shall be present.				

6.1.6.2.60 Type: UpfCond

Table 6.1.6.2.60-1: Definition of type UpfCond

Attribute name	Data type	P	Cardinality	Description
conditionType	string	M	1	This attribute serves as discriminator, to make all data types defined in Table 6.1.6.2.35-1 mutually exclusive. In this data type, it shall take the value "UPF_COND".
smfServingArea	array(string)	C	1..N	SMF service area(s) of the UPF whose status is requested to be monitored. This IE shall be present if the monitored granularity is SMF service area(s).
taiList	array(Tai)	C	1..N	TAI(s) of the UPF whose status is requested to be monitored. This IE shall be present if the monitored granularity is TAI list.

6.1.6.2.61 Type: TwifInfo

Table 6.1.6.2.61-1: Definition of type TwifInfo

Attribute name	Data type	P	Cardinality	Description
ipv4EndpointAddresses	array(Ipv4Addr)	C	1..N	Available endpoint IPv4 address(es) of the N3 terminations (NOTE 1)
ipv6EndpointAddresses	array(Ipv6Addr)	C	1..N	Available endpoint IPv6 address(es) of the N3 terminations (NOTE 1)
endpointFqdn	Fqdn	C	0..1	Available endpoint FQDN of the N3 terminations (NOTE 1)
NOTE 1: At least one of the addressing parameters (ipv4address, ipv6address or endpointFqdn) shall be included in the TwifInfo.				

6.1.6.2.62 Type: VendorSpecificFeature

Table 6.1.6.2.62-1: Definition of type VendorSpecificFeature

Attribute name	Data type	P	Cardinality	Description
featureName	string	M	1	String representing a proprietary feature specific to a given vendor. It is recommended that the case convention for these strings is the same as for enumerated data types (i.e. UPPER_WITH_UNDERSCORE; see 3GPP TS 29.501 [5], clause 5.1.1).
featureVersion	string	M	1	String representing the version of the feature. It is recommended that the versioning system follows the Semantic Versioning Specification [39].

6.1.6.2.63 Type: UdsfInfo

Table 6.1.6.2.63-1: Definition of type UdsfInfo

Attribute name	Data type	P	Cardinality	Description
groupId	NfGroupId	O	0..1	Identity of the UDSF group that is served by the UDSF instance. If not provided, the UDSF instance does not pertain to any UDSF group.
supiRanges	array(SupiRange)	O	1..N	List of ranges of SUPIs whose profile data is available in the UDSF instance (NOTE 1)
storageIdRanges	map(array(IdentityRange))	C	1..N(1..M)	A map (list of key-value pairs) where realmId serves as key and each value in the map is an array of IdentityRanges. Each IdentityRange is a range of storageIds. A UDSF complying with this version of the specification shall include this IE. Absence indicates that the UDSF's supported realms and storages are determined by the UDSF's consumer by other means such as local provisioning.
NOTE 1: If this parameter is not provided, then the UDSF can serve any SUPI range.				

6.1.6.2.64 Type: NfInstanceIdListCond

Table 6.1.6.2.64-1: Definition of type NfInstanceIdListCond

Attribute name	Data type	P	Cardinality	Description
nfInstanceIdList	array(NfInstanceId)	C	1..N	A list of NF Instances whose status is requested to be monitored.

6.1.6.2.65 Type: ScplInfo

Table 6.1.6.2.65-1: Definition of type ScplInfo

Attribute name	Data type	P	Cardinality	Description
scpDomainInfoList	map(ScpDomainInfo)	O	1..N	SCP domain specific information of the SCP that differs from the common information in NFProfile data type. The key of the map shall be the string identifying an SCP domain.
scpPrefix	string	O	0..1	Optional deployment specific string used to construct the apiRoot of the next hop SCP, as described in clause 6.10 of 3GPP TS 29.500 [4].
scpPorts	map(integer)	C	1..N	<p>SCP port number(s) for HTTP and/or HTTPS (NOTE 1)</p> <p>This attribute shall be present if the SCP uses non-default HTTP and/or HTTPS ports and if the SCP does not provision port information within ScpDomainInfo for each SCP domain it belongs to.</p> <p>When present, it shall contain the HTTP and/or HTTPS ports.</p> <p>The key of the map shall be "http" or "https". The value shall indicate the port number for HTTP or HTTPS respectively. Minimum: 0 Maximum: 65535</p>
addressDomains	array(string)	O	1..N	<p>Pattern (regular expression according to the ECMA-262 dialect [8]) representing the address domain names reachable through the SCP.</p> <p>Absence of this IE indicates the SCP can reach any address domain names in the SCP domain(s) it belongs to.</p>
ipv4Addresses	array(Ipv4Addr)	O	1..N	<p>List of IPv4 addresses reachable through the SCP.</p> <p>This IE may be present if IPv4 addresses are reachable via the SCP.</p> <p>If IPv4 addresses are reachable via the SCP, absence of both this IE and ipv4AddrRanges IE indicates the SCP can reach any IPv4 addresses in the SCP domain(s) it belongs to.</p>
ipv6Prefixes	array(Ipv6Prefix)	O	1..N	<p>List of IPv6 prefixes reachable through the SCP.</p> <p>This IE may be present if IPv6 addresses are reachable via the SCP.</p> <p>If IPv6 addresses are reachable via the SCP, absence of both this IE and ipv6PrefixRanges IE indicates the SCP can reach any IPv6 prefixes in the SCP domain(s) it belongs to.</p>
ipv4AddrRanges	array(Ipv4AddressRange)	O	1..N	<p>List of IPv4 addresses ranges reachable through the SCP.</p> <p>This IE may be present if IPv4 addresses are reachable via the SCP.</p> <p>If IPv4 addresses are reachable via the SCP, absence of both this IE and ipv4Addresses IE indicates the SCP can reach any IPv4 addresses in the SCP domain(s) it belongs to.</p>

ipv6PrefixRanges	array(Ipv6PrefixRange)	O	1..N	<p>List of IPv6 prefixes ranges reachable through the SCP.</p> <p>This IE may be present if IPv6 addresses are reachable via the SCP.</p> <p>If IPv6 addresses are reachable via the SCP, absence of both this IE and ipv6Prefixes IE indicates the SCP can reach any IPv6 prefixes in the SCP domain(s) it belongs to.</p>
servedNfSetIdList	array(NfSetId)	O	1..N	<p>List of NF set ID of NFs served by the SCP.</p> <p>Absence of this IE indicates the SCP can reach any NF set in the SCP domain(s) it belongs to.</p>
remotePlmnList	array(PlmnId)	O	1..N	<p>List of remote PLMNs reachable through the SCP.</p> <p>Absence of this IE indicates that no remote PLMN is reachable through the SCP.</p>
remoteSnpnList	array(PlmnIdNid)	O	1..N	<p>List of remote SNPNs reachable through the SCP. The absence of this IE indicates that no remote SNPN is reachable through the SCP.</p>
ipReachability	IpReachability	O	0..1	<p>This IE may be present to indicate the type(s) of IP addresses reachable via the SCP in the SCP domain(s) it belongs to.</p> <p>Absence of this IE indicates that the SCP can be used to reach both IPv4 addresses and IPv6 addresses in the SCP domain(s) it belongs to.</p>
scpCapabilities	array(ScpCapability)	C	0..N	<p>List of SCP capabilities supported by the SCP. This IE shall be present if the SCP supports at least one SCP capability. It may be present otherwise, with an empty array, to indicate that the SCP does not support any capability of the ScpCapability data type. The absence of this attribute shall not be interpreted as an SCP that does not support any capability; this only means that the SCP (e.g. pre-Rel-17 SCP) did not register the capabilities it may support. (NOTE 2)</p>
<p>NOTE 1: If no SCP port information is present in ScpInfo or in ScpDomainInfo for a specific SCP domain, the HTTP client shall use the default HTTP port number, i.e. TCP port 80 for "http" URIs or TCP port 443 for "https" URIs as specified in IETF RFC 9113 [9] when sending a request to the SCP within the specific SCP domain.</p> <p>NOTE 2: This IE may be used by another SCP (e.g. SCP-c) to determine whether next hops' SCP(s) (e.g. SCP-p) supports Indirect Communication with Delegated Discovery, e.g. in scenarios with more than one SCP between an NF service consumer and NF service producer. This information is not intended for NF service consumers. This information shall not be used for selecting a next hop SCP. It may only be used by an SCP, once a next hop SCP is selected, to learn the capabilities of the selected SCP, and based on local policy, to determine whether to delegate the selection of the target NF service producer instance to the next hop SCP or not.</p>				

6.1.6.2.66 Type: ScpDomainInfo

Table 6.1.6.2.66-1: Definition of type ScpDomainInfo

Attribute name	Data type	P	Cardinality	Description
scpFqdn	Fqdn	C	0..1	FQDN of the SCP (NOTE)
scplpEndpoints	array(lpEndPoint)	C	1..N	IP address(es) and port information of the SCP. If port information is present in this attribute, it applies to any scheme (i.e. HTTP and HTTPS). (NOTE)
scpPorts	map(integer)	C	1..N	SCP port number(s) for HTTP and/or HTTPS. This attribute shall be present if the SCP uses different ports for HTTP and HTTPS and at least one port is not the default HTTP or HTTPS port, for this SCP domain. This attribute shall be absent if port information is present in the scplpEndpoints. When present, it shall contain the HTTP and/or HTTPS ports. The key of the map shall be "http" or "https". The value shall indicate the port number for HTTP or HTTPS respectively. Minimum: 0 Maximum: 65535 If this attribute is present, it has precedence over the scpPorts attribute of ScpInfo.
scpPrefix	string	O	0..1	Optional deployment specific string used to construct the apiRoot of the next hop SCP, as described in clause 6.10 of 3GPP TS 29.500 [4]. If the scpPrefix attribute is present in ScpInfo and in ScpDomainInfo for a specific SCP domain, the attribute in ScpDomainInfo shall prevail for this SCP domain.
NOTE:	If any of these attributes is present for a given SCP domain, it shall apply instead of the attributes fqdn, ipv4Addresses and ipv6Addresses within the NFProfile data type for the corresponding SCP Domain. If none of these attributes is present for a given SCP domain, the attributes fqdn, ipv4Addresses, and ipv6Addresses within the NFProfile data type shall apply for the corresponding SCP Domain.			

6.1.6.2.67 Type: ScpDomainCond

Table 6.1.6.2.67-1: Definition of type ScpDomainCond

Attribute name	Data type	P	Cardinality	Description
scpDomains	array(string)	M	1..N	SCP domains of NF, SCP or SEPP instances whose status is requested to be monitored.
nfTypeList	array(NFType)	C	1..N	This IE shall be present if available. When present, it shall contain the type of the NF Instances or Network Entities (pertaining to any SCP domain in the scpDomains attribute) whose status is requested to be monitored. If not present, it means that the NF Service Consumer requests a subscription to all NF, SCP and SEPP instances pertaining to any SCP domain in the scpDomains attribute.

6.1.6.2.68 Type: OptionsResponse

Table 6.1.6.2.68-1: Definition of type OptionsResponse

Attribute name	Data type	P	Cardinality	Description
supportedFeatures	SupportedFeatures	C	0..1	Supported features of the NRF, for the nf-instances store resource. See clause 6.1.9. This IE shall be included if at least one Nnrf_NFManagement feature is supported by the NRF.

6.1.6.2.69 Type: NwdafCond

Table 6.1.6.2.69-1: Definition of type NwdafCond

Attribute name	Data type	P	Cardinality	Description
conditionType	string	M	1	This attribute serves as discriminator, to make all data types defined in Table 6.1.6.2.35-1 mutually exclusive. In this data type, it shall take the value "NWDAF_COND".
analyticsIds	array(string)	O	1..N	Analytics Id(s) provided by consumers of NWDAF. In this data type, it shall take the value as defined in NwdafEvent IE and EventId IE in nwdafInfo.
snssaiList	array(Snssai)	O	1..N	S-NSSAIs of the NWDAF whose status is requested to be monitored.
taiList	array(Tai)	O	1..N	TAI(s) of the NWDAF whose status is requested to be monitored. It may contain one or more non-3GPP access TAIs.
taiRangeList	array(TaiRange)	O	1..N	The range of TAIs of the NWDAF whose status is requested to be monitored. It may contain non-3GPP access TAIs.
servingNfTypeList	array(NFType)	O	1..N	NF type(s) served by the NWDAF whose status is requested to be monitored.
servingNfSetIdList	array(NfSetId)	O	1..N	NF Set Id(s) served by the NWDAF whose status is requested to be monitored.
mlAnalyticsList	array(MlAnalyticsInfo)	C	1..N	The list of ML Analytics Filter information per Analytics ID(s) supported by the NWDAF, whose status is requested to be monitored.

6.1.6.2.70 Type: NefCond

Table 6.1.6.2.70-1: Definition of type NefCond

Attribute name	Data type	P	Cardinality	Description
conditionType	string	M	1	This attribute serves as discriminator, to make all data types defined in Table 6.1.6.2.35-1 mutually exclusive. In this data type, it shall take the value "NEF_COND".
afEvents	array(AfEvent)	O	1..N	EventId(s) supported by the AFs.
snssaiList	array(Snssai)	O	1..N	S-NSSAIs of the NEF whose status is requested to be monitored.
pfData	PfdData	O	0..1	PFD data of the NEF whose status is requested to be monitored.
gpsiRanges	array(IdentityRange)	O	1..N	Range(s) of External Identifiers of the NEF whose status is requested to be monitored.
externalGroupIdentifiers Ranges	array(IdentityRange)	O	1..N	Range(s) of External Group Identifiers of the NEF whose status is requested to be monitored.
servedFqdnList	array(string)	O	1..N	Pattern (regular expression according to the ECMA-262 dialect [8]) representing the Domain names of the NEF whose status is requested to be monitored.

6.1.6.2.71 Type: SucInfo

Table 6.1.6.2.71-1: Definition of type SucInfo

Attribute name	Data type	P	Cardinality	Description
routingInds	array(string)	O	1..N	Indicating served Routing Indicator (see 3GPP TS 23.003 [12], clause 2.2B). If not provided, the AUSF/UDM can serve any Routing Indicator.
hNwPubKeyIds	array(integer)	O	1..N	Indicating served Home Network Public Key (see 3GPP TS 23.003 [12], clause 2.2B). If not provided, the AUSF/UDM can serve any public key.
NOTE: Any combination of any routingInds value and any hNwPubKeyIds value is valid.				

6.1.6.2.72 Type: SeppInfo

Table 6.1.6.2.72-1: Definition of type SeppInfo

Attribute name	Data type	P	Cardinality	Description
seppPrefix	string	O	0..1	Optional deployment specific string used to construct the apiRoot of the next hop SEPP, as described in clause 6.10 of 3GPP TS 29.500 [4].
seppPorts	map(integer)	C	1..N	SEPP port number(s) for HTTP and/or HTTPS (NOTE 1) This attribute shall be present if the SEPP uses non-default HTTP and/or HTTPS ports. When present, it shall contain the HTTP and/or HTTPS ports. The key of the map shall be "http" or "https". The value shall indicate the port number for HTTP or HTTPS respectively. Minimum: 0 Maximum: 65535
remotePlmnList	array(PlmnlId)	O	1..N	List of remote PLMNs reachable through the SEPP. The absence of this attribute indicates that any PLMN is reachable through the SEPP. If no remote PLMN is reachable through the SEPP (e.g. for a SEPP deployed in an SNPN having connectivity only with other SNPNS), this IE shall be present and shall include a dummy PLMN ID containing the MCC value set to "000" and the MNC value set to "00".
remoteSnpnList	array(PlmnlIdNid)	O	1..N	List of remote SNPNS reachable through the SEPP. The absence of this attribute indicates that no SNPN is reachable through the SEPP.
n32Purposes	array(N32Purpose)	C	1..N	This IE should be present if the SEPP is configured to support specific N32 purposes. When present, it shall contain the list of N32 purposes supported by the SEPP. The absence of this IE indicates that the SEPP can be selected for any N32 purpose.
NOTE 1: If no SEPP port information is present in SeppInfo, the HTTP client shall use the default HTTP port number, i.e. TCP port 80 for "http" URIs or TCP port 443 for "https" URIs as specified in IETF RFC 9113 [9] when sending a request to the SEPP.				
NOTE 2: The attributes fqdn, ipv4Addresses and ipv6Addresses within the NFProfile data type shall be used to determine the SEPP address.				

6.1.6.2.73 Type: AanfInfo

Table 6.1.6.2.73-1: Definition of type AanfInfo

Attribute name	Data type	P	Cardinality	Description
routingIndicators	array(string)	O	1..N	List of Routing Indicators supported by the AAnf instance. If not provided, the AAnf can serve any Routing Indicator. Pattern: '[0-9]{1,4}\$'

6.1.6.2.74 Type: 5GDdnmflInfo

Table 6.1.6.2.74-1: Definition of type 5GDdnmflInfo

Attribute name	Data type	P	Cardinality	Description
plmnlId	PlmnlId	M	1	PLMN ID of the PLMN which the 5G DDNMF served.

6.1.6.2.75 Type: MfaflInfo

Table 6.1.6.2.75-1: Definition of type MfaflInfo

Attribute name	Data type	P	Cardinality	Description
servingNFTypeList	array(NFType)	O	1..N	If present, this IE shall contain the list of NF type(s) served by MFAF NF. The absence of this attribute indicates that the MFAF can be selected for any NF type
servingNFSetIdList	array(NfSetId)	O	1..N	If present, this IE shall contain the list of NF Set Id(s) served by MFAF NF. The absence of this attribute indicates that the MFAF can be selected for any NF Set Id.
taiList	array(Tai)	O	1..N	The list of TAIs the MFAF can serve. It may contain one or more non-3GPP access TAIs. The absence of both this attribute and the taiRangeList attribute indicates that the MFAF can be selected for any TAI in the serving network.
taiRangeList	array(TaiRange)	O	1..N	The range of TAIs the MFAF can serve. It may contain one or more non-3GPP access TAI ranges. The absence of both this attribute and the taiList attribute indicates that the MFAF can be selected for any TAI in the serving network.

6.1.6.2.76 Type: NwdafCapability

Table 6.1.6.2.76-1: Definition of type NwdafCapability

Attribute name	Data type	P	Cardinality	Description
analyticsAggregation	boolean	O	0..1	When present, this IE shall indicate whether the NWDAF supports analytics aggregation: - true: analytics aggregation capability is supported by the NWDAF - false (default): analytics aggregation capability is not supported by the NWDAF.
analyticsMetadataProvisioning	boolean	O	0..1	When present, this IE shall indicate whether the NWDAF supports analytics metadata provisioning: - true: analytics metadata provisioning capability is supported by the NWDAF - false (default): analytics metadata provisioning capability is not supported by the NWDAF.
mlModelAccuracyChecking	boolean	O	0..1	When present, this IE shall indicate whether the NWDAF containing MTLF supports ML model accuracy checking: - true: ML model accuracy checking capability is supported by the NWDAF - false (default): ML model accuracy checking capability is not supported by the NWDAF.
analyticsAccuracyChecking	boolean	O	0..1	When present, this IE shall indicate whether the NWDAF containing AnLF supports Analytics accuracy checking: - true: Analytics accuracy checking capability is supported by the NWDAF - false (default): Analytics accuracy checking capability is not supported by the NWDAF.
roamingExchange	boolean	O	0..1	When present, this IE shall indicate whether the NWDAF supports roaming exchange capability: - true: roaming exchange capability is supported by the NWDAF - false (default): roaming exchange capability is not supported by the NWDAF.

6.1.6.2.77 Type: EasdfInfo

Table 6.1.6.2.77-1: Definition of type EasdfInfo

Attribute name	Data type	P	Cardinality	Description
sNssaiEasdfInfoList	array(SnssaiEasdfInfoItem)	O	1..N	List of parameters supported by the EASDF per S-NSSAI (NOTE 1)
easdfN6IpAddressList	array(IpAddr)	O	1..N	N6 IP addresses of the EASDF
upfN6IpAddressList	array(IpAddr)	O	1..N	N6 IP addresses of PSA UPFs
n6TunnelInfoList	map(InterfaceUpfInfoItem)	O	1..N	<p>This IE may be present for a EASDF which may serve as a V-EASDF for HR-SBO PDU sessions in the VPLMN.</p> <p>When present, it shall contain a map of InterfaceUpfInfoItems, which are provisioned with the N6 tunnelling information at the V-EASDF side for establishing N6 tunnels between the V-UPF and the V-EASDF to differentiate HR-SBO PDU sessions from different DNN/S-NSSAI/HPLMNs having the same private UE IP Address, and the UPInterfaceType shall be set to "N6".</p> <p>The key of the map shall be a (unique) valid JSON string per clause 7 of IETF RFC 8259 [22], with a maximum of 32 characters.</p> <p>(NOTE 2)</p>
dnsSecurityProtocols	array(DnsSecurityProtocol)	O	1..N	<p>DNS security protocols supported by the EASDF.</p> <p>The absence of this IE shall not be interpreted as meaning that the EASDF does not support any DNS security protocol, but as meaning that it is unknown whether the EASDF supports DNS security protocols.</p>
NOTE 1: If S-NSSAIs are present in the EasdfInfo and in the NFprofile, the S-NSSAIs from the EasdfInfo shall prevail.				
NOTE 2: It is deployment specific how to ensure that all the V-SMFs supporting the same V-UPF and V-EASDF select the same N6 tunnel for a given Home DNN/S-NSSAI/HPLMN ID.				

6.1.6.2.78 Type: SnssaiEasdfInfoItem

Table 6.1.6.2.78-1: Definition of type SnssaiEasdfInfoItem

Attribute name	Data type	P	Cardinality	Description
sNssai	ExtSnssai	M	1	S-NSSAI
dnnEasdfInfoList	array(DnnEasdfInfoItem)	M	1..N	List of parameters supported by the EASDF per DNN

6.1.6.2.79 Type: DnnEasdfInfoltem

Table 6.1.6.2.79-1: Definition of type DnnEasdfInfoltem

Attribute name	Data type	P	Cardinality	Description
dnn	Dnn	M	1	Supported DNN or Wildcard DNN if the EASDF supports all DNNs for the related S-NSSAI. The DNN shall contain the Network Identifier and it may additionally contain an Operator Identifier. If the Operator Identifier is not included, the DNN is supported for all the PLMNs in the plmnList of the NF Profile.
dnaiList	array(Dnai)	O	1..N	List of Data network access identifiers supported by the EASDF for this DNN. The absence of this attribute indicates that the EASDF can be selected for this DNN for any DNAI.

6.1.6.2.80 Type: DccfInfo

Table 6.1.6.2.80-1: Definition of type DccfInfo

Attribute name	Data type	P	Cardinality	Description
servingNFtypeList	array(NFType)	O	1..N	If present, this IE shall contain the list of NF type(s) from which the DCCF NF can collect data. The absence of this attribute indicates that the DCCF can collect data from any NF type.
servingNFsetIdList	array(NfSetId)	O	1..N	If present, this IE shall contain the list of NF Set Id(s) from which the DCCF NF can collect data. The absence of this attribute indicates that the DCCF can collect data from any NF Set.
taiList	array(Tai)	O	1..N	The list of TAIs the DCCF can serve. It may contain one or more non-3GPP access TAIs. The absence of both this attribute and the taiRangeList attribute indicates that the DCCF can be selected for any TAI in the serving network.
taiRangeList	array(TaiRange)	O	1..N	The range of TAIs the DCCF can serve. It may contain one or more non-3GPP access TAI ranges. The absence of both this attribute and the taiList attribute indicates that the DCCF can be selected for any TAI in the serving network.
dataSubsRelocInd	boolean	O	0..1	When present, this IE shall indicate whether the DCCF supports relocation of data subscription: - true: relocation of data subscription is supported by the DCCF - false (default): relocation of data subscription is not supported by the DCCF.

6.1.6.2.81 Type: NsacflInfo

Table 6.1.6.2.81-1: Definition of type NsacflInfo

Attribute name	Data type	P	Cardinality	Description
nsacfCapability	NsacfCapability	M	1	Indicates the NSAC service capability supported by the NSACF.
snsaiListForEntirePlmn	array(ExtSnsai)	C	1..N	It shall only be present if the NSACF acts as the primary NSACF for at least one S-NSSAI. When present, it shall indicate the list of S-NSSAIs for which the NSACF acts as a primary NSACF for the entire PLMN (see clause 4.1A of 3GPP TS 29.536 [51]). (NOTE 3) (NOTE 5)
taiList	array(Tai)	O	1..N	The list of TAIs the NSACF can serve. It may contain one or more non-3GPP access TAIs. The absence of this attribute and the taiRangeList attribute indicate that the NSACF can be selected for any TAI in the serving network. (NOTE 1) (NOTE 2)
taiRangeList	array(TaiRange)	O	1..N	The range of TAIs the NSACF can serve. It may contain non-3GPP access TAIs. The absence of this attribute and the taiList attribute indicate that the NSACF can be selected for any TAI in the serving network. (NOTE 1) (NOTE 2)
nsacSaiList	array(NsacSai)	O	1..N	When present, it shall indicate the NSAC service areas which are supported by the NSACF (see clause 4.1A of 3GPP TS 29.536 [51]). (NOTE 4)
<p>NOTE 1: When NSACF serving area is configured with TAI list, the serving area of the NSACF should be configured to cover the complete serving area of any of its AMF and SMF consumers, i.e. the TAI list served by NSACF should include all the TAIs served by its AMF and SMF consumers. This can avoid NSACF reselection when the UE moves within the serving area of the NF consumer, e.g. avoid NSACF reselection during intra-AMF UE mobility</p> <p>NOTE 2: This attribute is deprecated; the attribute "nsacSaiList" should be used instead.</p> <p>NOTE 3: For an NSACF acting as a primary NSACF and as a distributed NSACF (see clause 4.1A of 3GPP TS 29.536 [51]), the list of S-NSSAIs included in the snsaiListForEntirePlmn attribute shall be equal to or shall be a subset of the S-NSSAI list configured in the NF profile (i.e. in the sNssais attribute) as defined in clause 6.1.6.2.2.</p> <p>NOTE 4: If the NSACF acts as a primary/central NSACF, the nsacSaiList attribute may be present with one item setting to "ENTIRE_PLMN". Otherwise, the service areas included in the nsacSaiList attribute shall only apply to the distributed NSACF and independent NSACF.</p> <p>NOTE 5: For an NSACF acting as a central NSACF, only the sNssais IE attribute configured in the NF profile shall be used and the snsaiListForEntirePlmn shall not be present.</p> <p>NOTE 6: A given NSACF shall act as only one of a central NSACF, an independent NSACF or a (primary and/or distributed) NSACF for all the S-NSSAIs that it supports in the sNssais IE attribute in the NF profile.</p>				

The following examples describe valid cases of information setting in NFProfile and NsacflInfo in difference architecture options (see clause 4.1A of 3GPP TS 29.536 [51]):

Assuming three S-NSSAIs, {S-NSSAI #1 = "255-19CDE1", S-NSSAI #2 = "255-19CDE2", S-NSSAI #3 = "255-19CDE2"} are used in the following examples.

EXAMPLE 1:

In non-hierarchical NSAC architecture, for an independent NSACF supporting S-NSSAI#1, #2 and #3 deployed in certain NSAC service areas, it registers its NF profile as following:

In the NFProfile, the sNssais is configured with the whole list of S-NSSAI it supports, e.g.:

{

```

    "sNssais": { "255-19CDE1", "255-19CDE2", "255-19CDE3" }
  }

```

NsacfInfo:

```

{
  "nsacfInfo": {
    "nsacfCapability": [{ "supportUeSAC": true }],
    "nsacSaiList ": { "AREA A", "AREA B" }
  }
}

```

EXAMPLE 2:

In non-hierarchical NSAC architecture, for a centralized NSACF supporting S-NSSAI#1, #2 and #3 and serving the entire PLMN, it registers its NF profiles as following:

In the NFProfile, the sNssais is configured with the whole list of S-NSSAI it supports, e.g.:

```

{
  "sNssais": { "255-19CDE1", "255-19CDE2", "255-19CDE3" }
}

```

NsacfInfo:

```

{
  "nsacfInfo": {
    "nsacfCapability": [{ "supportUeSAC": true }],
    "nsacSaiList ": { "ENTIRE_PLMN" }
  }
}

```

EXAMPLE 3:

In hierarchical NSAC architecture, for an NSACF supporting S-NSSAI#1, #2 and #3 and only acting as Primary NSACF, it registers its NF profile as following:

In the NFProfile, the sNssais is configured with the whole list of S-NSSAI it supports, e.g.:

```

{
  "sNssais": { "255-19CDE1", "255-19CDE2", "255-19CDE3" }
}

```

NsacfInfo:

```

{
  "nsacfInfo": {
    "nsacfCapability": [{ "supportUeSAC": true }],
    "sNssaiListForEntirePlmn": { "255-19CDE1", "255-19CDE2", "255-19CDE3" },
    "nsacSaiList ": { "ENTIRE_PLMN" }
  }
}

```

EXAMPLE 4:

In hierarchical NSAC architecture, for an NSACF supporting S-NSSAI#1, #2 and #3 and only acting as distributed NSACF, it registers its NF profile as following:

In the NFProfile, the sNssais is configured with the whole list of S-NSSAI it supports, e.g.:

```

{
  "sNssais": { "255-19CDE1", "255-19CDE2", "255-19CDE3" }
}

```

NsacfInfo:

```

{
  "nsacfInfo": {
    "nsacfCapability": [{ "supportUeSAC": true }],
    "nsacSaiList ": { "AREA A", "AREA B" }
  }
}

```

```
}

```

EXAMPLE 5:

In hierarchical NSAC architecture, for an NSACF acting as a primary NSACF for S-NSSAI #1 and #2 and acting as a distributed NSACF for S-NSSAI #2 and #3, it registers its NF profiles as following:

In the NFProfile, the sNssais is configured with the whole list of S-NSSAI it supports, e.g.:

```
{
  "sNssais": { "255-19CDE1", "255-19CDE2", "255-19CDE3" }
}
```

NsacfInfo:

```
{
  "nsacfInfo": {
    "nsacfCapability": [{ "supportUeSAC": true }],
    "nssaiListForEntirePlmn": { "255-19CDE1", "255-19CDE2" },
    "nsacSaiList": { "AREA A", "AREA B" }
  }
}
```

6.1.6.2.82 Type: NsacfCapability**Table 6.1.6.2.82-1: Definition of type NsacfCapability**

Attribute name	Data type	P	Cardinality	Description
supportUeSAC	boolean	C	0..1	Indicates the service capability of the NSACF to monitor and control the number of registered UEs per network slice for the network slice that is subject to NSAC. true: Supported false (default): Not Supported
supportPduSAC	boolean	C	0..1	Indicates the service capability of the NSACF to monitor and control the number of established PDU sessions per network slice for the network slice that is subject to NSAC. true: Supported false (default): Not Supported
supportUeWithPduSAC	boolean	C	0..1	Indicates the service capability of the NSACF to monitor and control the number of registered UEs with at least one PDU session / PDN connection for the network slice that is subject to NSAC, if EPS counting is supported by the NSACF. true: Supported false (default): Not Supported

6.1.6.2.83 Type: DccfCond

Table 6.1.6.2.83-1: Definition of type DccfCond

Attribute name	Data type	P	Cardinality	Description
conditionType	string	M	1	This attribute serves as discriminator, to make all data types defined in Table 6.1.6.2.35-1 mutually exclusive. In this data type, it shall take the value "DCCF_COND".
taiList	array(Tai)	O	1..N	TAI(s) of the DCCF whose status is requested to be monitored. It may contain one or more non-3GPP access TAIs.
taiRangeList	array(TaiRange)	O	1..N	The range of TAIs of the DCCF whose status is requested to be monitored. It may contain non-3GPP access TAIs.
servingNfTypeList	array(NFType)	O	1..N	The list of NF type(s) served by DCCF whose status is requested to be monitored.
servingNfSetIdList	array(NfSetId)	O	1..N	The list of NF Set Id(s) served by DCCF whose status is requested to be monitored.

6.1.6.2.84 Type: MIAnalyticsInfo

Table 6.1.6.2.84-1: Definition of type MIAnalyticsInfo

Attribute name	Data type	P	Cardinality	Description
mlAnalyticsIds	array(NwdafEvent)	C	1..N	Analytics Id(s) supported by the Nnwdaf_MLModelProvision service. The included Analytics Id(s) shall have the same attribute values, e.g. they shall share the same Interoperability Indicator (see clause 5.2 of 3GPP TS 23.288 [34]). If the value of one or more attributes are different for an Analytics Id, it shall be excluded from the MIAnalyticsInfo instance and shall be included in another instance of MIAnalyticsInfo. If not provided the NWDAF can serve any mlAnalyticsId, and only the attributes that are applicable to all mlAnalyticsId may be provided.
snssaiList	array(Snssai)	O	1..N	S-NSSAIs of the ML model, if none are provided the ML model for the analytics can apply to any snssai.
trackingAreaList	array(Tai)	O	1..N	Area of Interest of the ML model, if none are provided the ML model for the analytics can apply to any TAIs. If present, this IE represents the list of TAIs, it may contain one or more non-3GPP access TAIs.
mlModelInterInfo	MIModelInterInfo	C	0..1	ML Model Interoperability indicator, shall be present if the NWDAF containing MTLF supports ML Model interoperability for the provided Analytics Id(s). If none are provided the ML models are not allowed to be retrieved by any NWDAF vendors. If mlAnalyticsIds is not provided, this IE, if present, shall contain the interoperability indicator information that is valid for any Analytics Id.
flCapabilityType	FlCapabilityType	O	0..1	Federated Learning capability type of the NWDAF as specified in clause 5.2.7.2.2 of 3GPP TS 23.502 [3], if none are provided the NWDAF can not support any type.
flTimeInterval	DurationSec	O	0..1	Time interval supporting Federated Learning as specified in clause 5.2.7.2.2 of 3GPP TS 23.502 [3]. This IE may be present if the flCapabilityType attribute is present.

nfTypeList	array(NFType)	O	1..N	NF type of the data source where data can be collected as input for local model training. This IE may be present if the flCapabilityType attribute is present. (NOTE)
nfSetIdList	array(NfSetId)	O	1..N	NF Set ID of the data source where data can be collected as input for local model training. This IE may be present if the flCapabilityType attribute is present. (NOTE)
NOTE: If the attribute is also present in NwdafInfo, the attribute values provided in MIAalyticsInfo shall be a subset of the attribute values provided in NwdafInfo.				

6.1.6.2.85 Type: MbSmfInfo

Table 6.1.6.2.85-1: Definition of type MbSmfInfo

Attribute name	Data type	P	Cardinality	Description
sNssaiInfoList	map(SnssaiMbSmfInfoItem)	O	1..N	S-NSSAIs and DNNs supported by the MB-SMF (NOTE 1) The key of the map shall be a (unique) valid JSON string per clause 7 of IETF RFC 8259 [22], with a maximum of 32 characters.
tmgiRangeList	map(TmgiRange)	O	1..N	TMGI range(s) supported by the MB-SMF The key of the map shall be a (unique) valid JSON string per clause 7 of IETF RFC 8259 [22], with a maximum of 32 characters.
taiList	array(Tai)	O	1..N	List of TAIs the MB-SMF can serve. The absence of this attribute and the taiRangeList attribute indicates that the MB-SMF can be selected for any TAI in the serving network.
taiRangeList	array(TaiRange)	O	1..N	The range of TAIs the MB-SMF can serve. The absence of this attribute and the taiList attribute indicates that the MB-SMF can be selected for any TAI in the serving network.
mbsSessionList	map(MbsSession)	O	1..N	List of MBS sessions currently served by the MB-SMF The key of the map shall be a (unique) valid JSON string per clause 7 of IETF RFC 8259 [22], with a maximum of 32 characters.
NOTE 1: If S-NSSAIs are present in MbSmfInfo and in the NFprofile, the S-NSSAIs from MbSmfInfo shall prevail.				

6.1.6.2.86 Type: TmgiRange

Table 6.1.6.2.86-1: Definition of type TmgiRange

Attribute name	Data type	P	Cardinality	Description
mbsServiceIdStart	string	M	1	First MBS Service ID value identifying the start of a TMGI range. The value shall be coded as defined for the mbsServiceId attribute of the Tmgi data type defined in 3GPP TS 29.571 [7]. Pattern: '[A-Fa-f0-9]{6}\$'
mbsServiceIdEnd	string	M	1	Last MBS Service ID value identifying the end of a TMGI range. The value shall be coded as defined for the mbsServiceId attribute of the Tmgi data type defined in 3GPP TS 29.571 [7]. Pattern: '[A-Fa-f0-9]{6}\$'
plmnId	PlmnId	M	1	PLMN ID
nid	Nid	O	0..1	Network Identity used for SNPN

6.1.6.2.87 Type: MbsSession

Table 6.1.6.2.87-1: Definition of type MbsSession

Attribute name	Data type	P	Cardinality	Description
mbsSessionId	MbsSessionId	M	1	MBS session identifier
mbsAreaSessions	map(MbsServiceAreaInfo)	C	1..N	Map of Area Session Id and related MBS Service Area information used for MBS session with location dependent content. The Area Session ID together with the mbsSessionId (TMGI) uniquely identifies the MBS session in a specific MBS service area. For an MBS session with location dependent content, one map entry shall be registered for each MBS Service Area served by the MBS session. The key of the map shall be the areaSessionId.

6.1.6.2.88 Type: SnsaiMbSmfInfoItem

Table 6.1.6.2.88-1: Definition of type SnsaiMbSmfInfoItem

Attribute name	Data type	P	Cardinality	Description
sNssai	ExtSnsai	M	1	Supported S-NSSAI
dnnInfoList	array(DnnMbSmfInfoItem)	M	1..N	List of parameters supported by the MB-SMF per DNN

6.1.6.2.89 Type: DnnMbSmfInfoItem

Table 6.1.6.2.89-1: Definition of type DnnMbSmfInfoItem

Attribute name	Data type	P	Cardinality	Description
dnn	Dnn	M	1	Supported DNN or Wildcard DNN if the MB-SMF supports all DNNs for the related S-NSSAI. The DNN shall contain the Network Identifier and it may additionally contain an Operator Identifier. If the Operator Identifier is not included, the DNN is supported for all the PLMNs in the plmnList of the NF Profile.

6.1.6.2.90 Void

6.1.6.2.91 Type: TsctsflInfo

Table 6.1.6.2.91-1: Definition of type TsctsflInfo

Attribute name	Data type	P	Cardinality	Description
sNssaiInfoList	map(SnssaiTsctsflInfoItem)	O	1..N	S-NSSAIs and DNNs supported by the TSCTSF (NOTE 1) The key of the map shall be a (unique) valid JSON string per clause 7 of IETF RFC 8259 [22], with a maximum of 32 characters.
externalGroupIdentifiers Ranges	array(IdentityRange)	O	1..N	Ranges of External Group Identifiers that can be served by the TSCTSF. The absence of this IE indicates that the TSCTSF can serve any external group managed by the PLMN (or SNPN) of the TSCTSF instance.
supiRanges	array(SupiRange)	O	1..N	Ranges of SUPIs that can be served by the TSCTSF instance. (NOTE 2)
gpsiRanges	array(IdentityRange)	O	1..N	Ranges of GPSIs that can be served by the TSCTSF instance. (NOTE 2)
internalGroupIdentifiers Ranges	array(InternalGroupIdentRange)	O	1..N	Ranges of Internal Group Identifiers that can be served by the TSCTSF instance. The absence of this IE indicates that the TSCTSF can serve any internal group managed by the PLMN (or SNPN) of the TSCTSF instance.
NOTE 1: If S-NSSAIs are present in TsctsflInfo and in the NFprofile, the S-NSSAIs from TsctsflInfo shall prevail. Only one TSCTSF instance, or only the TSCTSF instances belonging to one TSCTSF Set, shall be configured in the PLMN (or SNPN) to serve a specific DNN and S-NSSAI combination.				
NOTE 2: If both parameters are not provided, the TSCTSF can serve any SUPI or GPSI managed by the PLMN (or SNPN) of the TSCTSF instance.				

6.1.6.2.92 Type: SnssaiTsctsflInfoItem

Table 6.1.6.2.92-1: Definition of type SnssaiTsctsflInfoItem

Attribute name	Data type	P	Cardinality	Description
sNssai	ExtSnssai	M	1	Supported S-NSSAI.
dnnInfoList	array(DnnTsctsflInfoItem)	M	1..N	List of parameters supported by the TSCTSF per DNN for the indicated S-NSSAI.

6.1.6.2.93 Type: DnnTsctsflInfoItem

Table 6.1.6.2.93-1: Definition of type DnnTsctsflInfoItem

Attribute name	Data type	P	Cardinality	Description
dnn	Dnn	M	1	Supported DNN or Wildcard DNN if the TSCTSF supports all DNNs for the related S-NSSAI. The DNN shall contain the Network Identifier and it may additionally contain an Operator Identifier. If the Operator Identifier is not included, the DNN is supported for all the PLMNs in the plmnList of the NF Profile.

6.1.6.2.94 Type: MbUpfInfo

Table 6.1.6.2.94-1: Definition of type MbUpfInfo

Attribute name	Data type	P	Cardinality	Description
sNssaiMbUpfInfoList	array(SnssaiUpfInfoItem)	M	1..N	List of parameters supported by the MB-UPF per S-NSSAI. (NOTE)
mbSmfServingArea	array(string)	O	1..N	The MB-SMF service area(s) the MB-UPF can serve. If not provided, the MB-UPF can serve any MB-SMF service area.
interfaceMbUpfInfoList	array(InterfaceUpfInfoItem)	O	1..N	List of User Plane interfaces configured on the MB-UPF. When this IE is provided in the NF Discovery response, the NF Service Consumer (e.g. MB-SMF) may use this information for MB-UPF selection.
taiList	array(Tai)	O	1..N	The list of TAIs the MB-UPF can serve. The absence of this attribute and the taiRangeList attribute indicates that the MB-UPF can serve the whole MB-SMF service area defined by the MbSmfServingArea attribute.
taiRangeList	array(TaiRange)	O	1..N	The range of TAIs the MB-UPF can serve. The absence of this attribute and the taiList attribute indicates that the MB-UPF can serve the whole MB-SMF service area defined by the MbSmfServingArea attribute.
priority	integer	O	0..1	Priority (relative to other NFs of the same type) in the range of 0-65535, to be used for NF selection for a service request matching the attributes of the MbUpfInfo; lower values indicate a higher priority. See the precedence rules in the description of the priority attribute in NFProfile, if Priority is also present in NFProfile. The NRF may overwrite the received priority value when exposing an NFProfile with the Nnrf_NFDiscovery service.
supportedPfcFeatures	string	O	0..1	Supported PFCP Features. A string used to indicate the PFCP features supported by the MB-UPF, which encodes the "UP Function Features" IE as specified in Table 8.2.25-1 of 3GPP TS 29.244 [21] (starting from Octet 5), in hexadecimal representation. Each character in the string shall take a value of "0" to "9", "a" to "f" or "A" to "F" and each two characters shall represent one octet of "UP Function Features" IE (starting from Octet 5, to higher octets). For each two characters representing one octet, the first character representing the 4 most significant bits of the octet and the second character the 4 least significant bits of the octet.
NOTE : If this S-NSSAIs is present in the MbUpfInfo and in the NFprofile, the S-NSSAIs from the MbUpfInfo shall prevail.				

6.1.6.2.95 Type: UnTrustAfInfo

Table 6.1.6.2.95-1: Definition of type UnTrustAfInfo

Attribute name	Data type	P	Cardinality	Description
afId	string	M	1	Associated AF id.
sNssaiInfoList	array(SnssaiInfoItem)	O	1..N	S-NSSAIs and DNNs supported by the AF.

mappingInd	boolean	O	0..1	When present, this IE indicates whether the AF supports mapping between UE IP address (IPv4 address or IPv6 prefix) and UE ID (i.e. GPSI). true: the AF supports mapping between UE IP address and UE ID; false (default): the AF does not support mapping between UE IP address and UE ID.
------------	---------	---	------	---

6.1.6.2.96 Type: TrustAfInfo

Table 6.1.6.2.96-1: Definition of type TrustAfInfo

Attribute name	Data type	P	Cardinality	Description
sNssaiInfoList	array(SnssaiInfoItem)	O	1..N	S-NSSAIs and DNNs supported by the trusted AF (NOTE 1).
afEvents	array(AfEvent)	O	1..N	AF Event(s) supported by the trusted AF.
appls	array(string)	O	1..N	The list of Application ID(s) supported by the trusted AF. The absence of this attribute indicate that the AF can be selected for any Application.
internalGroupId	array(GroupId)	O	1..N	List of Internal Group Identifiers supported by the trusted AF. If not provided, it does not imply that the AF supports all internal groups.
mappingInd	boolean	O	0..1	When present, this IE indicates whether the trusted AF supports mapping between UE IP address (IPv4 address or IPv6 prefix) and UE ID (i.e. SUPI). true: the trusted AF supports mapping between UE IP address and UE ID; false (default): the trusted AF does not support mapping between UE IP address and UE ID.
taiList	array(Tai)	O	1..N	This IE may be present if the AfEvent is set to "GNSS_ASSISTANCE_DATA". When present, this IE shall contain the list of TAIs the trusted AF can serve. It may contain one or more non-3GPP access TAIs. The absence of this attribute and the taiRangeList attribute indicate that the trusted AF can be selected for any TAI in the serving network.
taiRangeList	array(TaiRange)	O	1..N	This IE may be present if the AfEvent is set to "GNSS_ASSISTANCE_DATA". When present, this IE shall contain the range of TAIs the trusted AF can serve. It may contain non-3GPP access TAIs. The absence of this attribute and the taiList attribute indicate that the trusted AF can be selected for any TAI in the serving network.

NOTE 1: If S-NSSAIs are present in TrustAfInfo and in the NFprofile, the S-NSSAIs from TrustAfInfo shall prevail.

6.1.6.2.97 Type: SnssaiInfoItem

Table 6.1.6.2.97-1: Definition of type SnssaiInfoItem

Attribute name	Data type	P	Cardinality	Description
sNssai	ExtSnssai	M	1	Supported S-NSSAI
dnnInfoList	array(DnnInfoItem)	M	1..N	List of parameters supported by the NF per DNN

6.1.6.2.98 Type: DnnInfoItem

Table 6.1.6.2.98-1: Definition of type DnnInfoItem

Attribute name	Data type	P	Cardinality	Description
dnn	Dnn	M	1	Supported DNN or Wildcard DNN if the NF supports all DNNs for the related S-NSSAI. The DNN shall contain the Network Identifier and it may additionally contain an Operator Identifier. If the Operator Identifier is not included, the DNN is supported for all the PLMNs in the plmnList of the NF Profile.

6.1.6.2.99 Type: CollocatedNfInstance

Table 6.1.6.2.99-1: Definition of type CollocatedNfInstance

Attribute name	Data type	P	Cardinality	Description
nfInstanceId	NfInstanceId	M	1	Unique identity of the NF Instance for a collocated NF type.
nfType	CollocatedNfType	M	1	Possible NF types supported by a collocated NF. (NOTE 1, NOTE 2)
NOTE 1: Whether NFs of any NF types are collocated or not, is an implementation and/or deployment issue and needs not be known in general to the NF service consumers and therefore needs not be registered in the NF profile. This data type is only intended for specific scenarios where the discovery and selection of a combined NF service producer by a NF service consumer can allow specific optimizations. In order to retrieve the NFProfile of the collocated NF instance, the NF service consumer shall trigger a separate discovery procedure using the nfType and nfInstanceId in the CollocatedNfInstance data type.				
NOTE 2: The supported collocated NF types in this release of the specification may only be one of the following: - a MB-SMF may be collocated with a SMF (N16mb internal interface); - a MB-UPF may be collocated with a UPF (N19mb internal interface).				

6.1.6.2.100 Type: ServiceNameListCond

Table 6.1.6.2.100-1: Definition of type ServiceNameListCond

Attribute name	Data type	P	Cardinality	Description
conditionType	string	M	1	This attribute serves as discriminator, to make all data types defined in Table 6.1.6.2.35-1 mutually exclusive. In this data type, it shall take the value "SERVICE_NAME_LIST_COND".
serviceNameList	array(ServiceName)	M	1..N	Service names offered by the NF Instances whose status is requested to be monitored.

6.1.6.2.101 Type: NfGroupListCond

Table 6.1.6.2.101-1: Definition of type NfGroupListCond

Attribute name	Data type	P	Cardinality	Description
conditionType	string	M	1	This attribute serves as discriminator, to make all data types defined in Table 6.1.6.2.35-1 mutually exclusive. In this data type, it shall take the value "NF_GROUP_LIST_COND".
nfType	string	M	1	NF type (UDM, AUSF, PCF, UDR, HSS, CHF, BSF or UDSF) of the NF Instances whose status is requested to be monitored.
nfGroupIdList	array(NfGroupId)	M	1..N	Group IDs of the NF Instances whose status is requested to be monitored.

6.1.6.2.102 Type: PlmnOauth2

Table 6.1.6.2.102-1: Definition of type PlmnOauth2

Attribute name	Data type	P	Cardinality	Description
oauth2RequiredPlmnIdList	array(PlmnId)	O	1..N	It shall indicate the consumer PLMN ID list for which NF Service Instance requires Oauth2-based authorization. (See NOTE 1)
oauth2NotRequiredPlmnIdList	array(PlmnId)	O	1..N	It shall indicate the consumer PLMN ID list for which NF Service Instance does not require Oauth2-based authorization. (See NOTE 1)
NOTE 1: The same PLMN Id shall not be present in both oauth2RequiredPlmnIdList and oauth2NotRequiredPlmnIdList.				

6.1.6.2.103 Type: V2xCapability

Table 6.1.6.2.103-1: Definition of type V2xCapability

Attribute name	Data type	P	Cardinality	Description
lteV2x	boolean	O	0..1	When present, this IE shall indicate whether the PCF supports LTE V2X capability: - true: LTE V2X capability is supported by the PCF - false (default): LTE V2X capability is not supported by the PCF.
nrV2x	boolean	O	0..1	When present, this IE shall indicate whether the PCF supports NR V2X capability: - true: NR V2X capability is supported by the PCF - false (default): NR V2X capability is not supported by the PCF.

6.1.6.2.104 Type: NssaafInfo

Table 6.1.6.2.104-1: Definition of type NssaafInfo

Attribute name	Data type	P	Cardinality	Description
supiRanges	array(SupiRange)	O	1..N	List of ranges of SUPIs that can be served by the NSSAAF instance.
internalGroupIdentifiersRanges	array(InternalGroupRange)	O	1..N	List of ranges of Internal Group Identifiers that can be served by the NSSAAF instance. If not provided, it does not imply that the NSSAAF supports all internal groups.

6.1.6.2.105 Type: ProSeCapability

Table 6.1.6.2.105-1: Definition of type ProSeCapability

Attribute name	Data type	P	Cardinality	Description
proseDirectDiscoverey	boolean	O	0..1	When present, this IE shall indicate whether the PCF supports ProSe Direct Discovery: - true: ProSe Direct Discovery is supported by the PCF - false (default): ProSe Direct Discovery is not supported by the PCF.
proseDirectCommunication	boolean	O	0..1	When present, this IE shall indicate whether the PCF supports ProSe Direct Communication: - true: ProSe Direct Communication is supported by the PCF - false (default): ProSe Direct Communication is not supported by the PCF.
proseL2UetoNetworkRelay	boolean	O	0..1	When present, this IE shall indicate whether the PCF supports ProSe Layer-2 UE-to-Network Relay: - true: ProSe Layer-2 UE-to-Network Relay is supported by the PCF - false (default): ProSe Layer-2 UE-to-Network Relay is not supported by the PCF.
proseL3UetoNetworkRelay	boolean	O	0..1	When present, this IE shall indicate whether the PCF supports ProSe Layer-3 UE-to-Network Relay: - true: ProSe Layer-3 UE-to-Network Relay is supported by the PCF - false (default): ProSe Layer-3 UE-to-Network Relay is not supported by the PCF.
proseL2RemoteUe	boolean	O	0..1	When present, this IE shall indicate whether the PCF supports ProSe Layer-2 Remote UE: - true: ProSe Layer-2 Remote UE is supported by the PCF - false (default): ProSe Layer-2 Remote UE is not supported by the PCF.
proseL3RemoteUe	boolean	O	0..1	When present, this IE shall indicate whether the PCF supports ProSe Layer-3 Remote UE: - true: ProSe Layer-3 Remote UE is supported by the PCF - false (default): ProSe Layer-3 Remote UE is not supported by the PCF.
proseL2UetoUeRelay	boolean	O	0..1	When present, this IE shall indicate whether the PCF supports ProSe Layer-2 UE-to-UE Relay: - true: ProSe Layer-2 UE-to-UE Relay is supported by the PCF - false (default): ProSe Layer-2 UE-to-UE Relay is not supported by the PCF.
proseL3UetoUeRelay	boolean	O	0..1	When present, this IE shall indicate whether the PCF supports ProSe Layer-3 UE-to-UE Relay: - true: ProSe Layer-3 UE-to-UE Relay is supported by the PCF - false (default): ProSe Layer-3 UE-to-UE Relay is not supported by the PCF.
proseL2EndUe	boolean	O	0..1	When present, this IE shall indicate whether the PCF supports ProSe Layer-2 End UE: - true: ProSe Layer-2 End UE is supported by the PCF - false (default): ProSe Layer-2 End UE is not supported by the PCF.

proseL3EndUe	boolean	O	0..1	When present, this IE shall indicate whether the PCF supports ProSe Layer-3 End UE: - true: ProSe Layer-3 End UE is supported by the PCF - false (default): ProSe Layer-3 End UE is not supported by the PCF.
--------------	---------	---	------	---

6.1.6.2.106 Type: SharedDataIdRange

Table 6.1.6.2.106-1: Definition of type SharedDataIdRange

Attribute name	Data type	P	Cardinality	Description
pattern	string	O	0..1	Pattern (regular expression according to the ECMA-262 dialect [8]) representing the set of SharedDataIds belonging to this range. A SharedDataId value is considered part of the range if and only if the SharedDataId string fully matches the regular expression.

EXAMPLE: SharedDataId range. "123456-sharedAmData{localID}" where "123456" is the HPLMN id (i.e. MCC followed by MNC) and "{localID}" can be any string.
JSON: { "pattern": "^123456-sharedAmData.+\$" }

6.1.6.2.107 Type: SubscriptionContext

Table 6.1.6.2.107-1: Definition of type SubscriptionContext

Attribute name	Data type	P	Cardinality	Description
subscriptionId	string	M	1	Subscription ID of the corresponding subscription resource that originated the notification.
subscrCond	SubscrCond	O	0..1	If present, this attribute shall contain the conditions identifying the set of NF Instances whose status was requested to be monitored in the corresponding subscription that originated this notification.

6.1.6.2.108 Type: lwmsclInfo

Table 6.1.6.2.108-1: Definition of type lwmsclInfo

Attribute name	Data type	P	Cardinality	Description
msisdnranges	array(IdentityRange)	O	1..N	List of ranges of MSISDNs supported by the SMS-IW MSC. See NOTE.
supiRanges	array(SupiRange)	O	1..N	List of ranges of SUPIs supported by the SMS-IW MSC. See NOTE.
taiRangeList	array(TaiRange)	O	1..N	The range of TAIs the SMS-IW MSC can serve. The absence of this attribute indicates that the SMS-IW MSC can serve any TA.
scNumber	string	O	0..1	When present, this IE carry an OctetString indicating the ISDN number of the SC in international number format as described in ITU-T Rec. E.164 [44] and shall be encoded as a TBCD-string. Pattern: " $\wedge[0-9]\{5,15\}$ "

NOTE: If both parameters are not provided, the SMS-IW MSC can serve any SUPI or MSISDN.

6.1.6.2.109 Type: MnpfInfo

Table 6.1.6.2.109-1: Definition of type MnpfInfo

Attribute name	Data type	P	Cardinality	Description
msisdnranges	array(IdentityRange)	M	1..N	List of ranges of MSISDNs whose portability status is available in the MNPf

6.1.6.2.110 Type: DefSubServiceInfo

Table 6.1.6.2.110-1: Definition of type DefSubServiceInfo

Attribute name	Data type	P	Cardinality	Description
versions	array(string)	O	1..N	When present, this attribute shall indicate the API version (e.g. "v1") of the indicated service which are supported by the NF (Service) instance acting as NF service consumer.
supportedFeatures	SupportedFeatures	O	0..1	When present, this attribute shall indicate the features of the indicated service which are supported by the NF (Service) instance acting as NF service consumer.

6.1.6.2.111 Type: LocalityDescriptionItem

Table 6.1.6.2.111-1: Definition of type LocalityDescriptionItem

Attribute name	Data type	P	Cardinality	Description
localityType	LocalityType	M	1	Type of locality description
localityValue	string	M	1	Locality value

6.1.6.2.112 Type: LocalityDescription

Table 6.1.6.2.112-1: Definition of type LocalityDescription

Attribute name	Data type	P	Cardinality	Description
localityType	LocalityType	M	1	Type of locality description
localityValue	string	M	1	Locality value
addlLocDescrItems	array(LocalityDescriptionItem)	O	0..1	Additional locality description items This IE may be present to express a preferred locality as a set of locality description items to match with an "AND" relationship, e.g. to express a preference for NF profiles that are located in a given city and state. This may be used e.g. when a locality value of a given locality type may not be unique within the PLMN, such as cities with the same name in different states.

6.1.6.2.113 Type: SmsflInfo

Table 6.1.6.2.113-1: Definition of type SmsflInfo

Attribute name	Data type	P	Cardinality	Description
roamingUeInd	boolean	O	0..1	When present, this IE shall indicate whether the SMSF can serve roaming UE: - true: the SMSF can support roaming UEs. - false: the SMSF can not support roaming UEs. Absence of this IE indicates whether the SMSF can serve roaming UEs is not specified.
remotePlmnRangeList	array(PlmnRange)	O	1..N	This IE maybe present when the roamingUeInd IE is present with the value "true". When present, this IE shall indicate the list of ranges of remote PLMNs served by the SMSF, i.e. the SMSF can serve the roaming UEs which belong to the indicated remote PLMNs.
NOTE: If the roamingUeInd IE is present with the value "true", absence of remotePlmnRangeList IE indicates that the SMSF can serve roaming UEs from any remote PLMN.				

6.1.6.2.114 Type: DcsflInfo

Table 6.1.6.2.114-1: Definition of type DcsflInfo

Attribute name	Data type	P	Cardinality	Description
imsDomainNameList	array(imsDomainName)	O	1..N	List of IMS domain names served by the DCSF.
imsiRanges	array(ImsiRange)	O	1..N	List of ranges of IMSIs whose profile data is available in the DCSF instance. (NOTE 1)
msisdnRanges	array(IdentityRange)	O	1..N	List of ranges of MSISDNs whose profile data is available in the DCSF instance. (NOTE 1)
imsPrivateIdentityRanges	array(IdentityRange)	O	1..N	List of ranges of IMS Private Identities whose profile data is available in the DCSF instance. (NOTE 1)
imsPublicIdentityRanges	array(IdentityRange)	O	1..N	List of ranges of IMS Public Identities whose profile data is available in the DCSF instance. (NOTE 1)
NOTE 1: If none of these parameters are provided, the DCSF can serve any IMSI or IMS Private Identity or IMS Public Identity or MSISDN managed by the PLMN of the DCSF instance.				

6.1.6.2.115 Type: MIModeInterInfo

Table 6.1.6.2.115-1: Definition of type MIModeInterInfo

Attribute name	Data type	P	Cardinality	Description
vendorList	array(VendorId)	O	1..N	When present, this IE shall include the list of NWDAF vendors that are allowed to retrieve ML models from the NWDAF containing MTLF.

6.1.6.2.116 Type: PruExistenceInfo

Table 6.1.6.2.116-1: Definition of type PruExistenceInfo

Attribute name	Data type	P	Cardinality	Description
taiList	array(Tai)	O	1..N	When present, this IE shall contain PRU(s) TAI list that the LMF can serve. It may contain one or more non-3GPP access TAIs.
taiRangeList	array(TaiRange)	O	1..N	When present, this IE shall contain PRU(s) TAI range list that the LMF can serve. It may contain one or more non-3GPP access TAI ranges.

6.1.6.2.117 Type: MrfInfo

Table 6.1.6.2.117-1: Definition of type MrfInfo

Attribute name	Data type	P	Cardinality	Description
mediaCapabilityList	array(MediaCapability)	O	1..N	List of IMS media capabilities offered by the MRF. An IMS media capability that matches this information can be served by the MRF. (NOTE 1)
NOTE 1: Locality of MRF may be configured to allow the MRF consumers to discover and select candidate MRF based on Locality information. See NOTE 25 of Table 6.2.3.2.3.1-1.				

6.1.6.2.118 Type: MrfpInfo

Table 6.1.6.2.118-1: Definition of type MrfpInfo

Attribute name	Data type	P	Cardinality	Description
mediaCapabilityList	array(MediaCapability)	O	1..N	List of IMS media capabilities offered by the MRFP. An IMS media capability that matches this information can be served by the MRFP. (NOTE 1)
NOTE 1: Locality of MRFP may be configured to allow the MRFP consumers to discover and select candidate MRFP based on Locality information. See NOTE 25 of Table 6.2.3.2.3.1-1.				

6.1.6.2.119 Type: MfInfo

Table 6.1.6.2.119-1: Definition of type MfInfo

Attribute name	Data type	P	Cardinality	Description
mediaCapabilityList	array(MediaCapability)	O	1..N	List of media capabilities offered by the MF. A media capability that matches this information can be served by the MF. E.g. DC, AR. (NOTE 1)
NOTE 1: Locality of MF may be configured to allow the MF consumers to discover and select candidate MF based on Locality information. See NOTE 25 of Table 6.2.3.2.3.1-1.				

6.1.6.2.120 Type: A2xCapability

Table 6.1.6.2.120-1: Definition of type A2xCapability

Attribute name	Data type	P	Cardinality	Description
lteA2x	boolean	O	0..1	When present, this IE shall indicate whether the PCF supports LTE A2X capability: - true: LTE A2X capability is supported by the PCF - false (default): LTE A2X capability is not supported by the PCF.
nrA2x	boolean	O	0..1	When present, this IE shall indicate whether the PCF supports NR A2X capability: - true: NR A2X capability is supported by the PCF - false (default): NR A2X capability is not supported by the PCF.

6.1.6.2.121 Type: RuleSet

Table 6.1.6.2.121-1: Definition of type RuleSet

Attribute name	Data type	P	Cardinality	Description
priority	integer	M	1	Unique Priority of the rule. Lower value means higher priority.
plmns	array(PlmnlId)	O	1..N	PLMNs allowed/dis-allowed to access the service instance. When absent, NF-Consumers of all PLMNs are assumed to match this criteria.
snpns	array(PlmnlIdNid)	O	1..N	SNPNs allowed/dis-allowed to access the service instance. When absent, NF-Consumers of all SNPNs are assumed to match this criteria.
nfTypes	array(NFType)	O	1..N	Type of the NFs allowed/dis-allowed to access the service instance. When absent, NF-Consumers of all nfTypes are assumed to match this criteria.
nfDomains	array(string)	O	1..N	Pattern (regular expression according to the ECMA-262 dialect [8]) representing the NF domain names within the PLMN of the NRF allowed/dis-allowed to access the service instance. When absent, NF-Consumers of all nfDomains are assumed to match this criteria.
nssais	array(ExtSnssai)	O	1..N	S-NSSAIs of the NF-Consumers allowed/dis-allowed to access the service instance. When absent, NF-Consumers of all slices are assumed to match this criteria.
nfInstances	array(NfInstanceId)	O	1..N	NF-Instance IDs of the NF-Consumers allowed/dis-allowed to access the NF/NF-Service instance. When absent, all the NF-Consumers are assumed to match this criteria.
scopes	array(string)	O	1..N	List of scopes allowed or denied to the NF-Consumers matching the rule. The scopes shall be any of those defined in the API that defines the current service (identified by the "serviceName" attribute), including the service-level scopes. When absent, the NF-Consumer is allowed or denied full access to all the resources/operations of service instance. This IE is applicable only in NF-Service definition.
action	RuleSetAction	M	1	Specifies whether the scopes/access mentioned are allowed or denied for a specific NF-Consumer.

6.1.6.2.122 Type: AdrflInfo

Table 6.1.6.2.122-1: Definition of type AdrflInfo

Attribute name	Data type	P	Cardinality	Description
mlModelStorageInd	boolean	O	0..1	When present, this IE shall indicate whether the ADRF supports ML model storage and retrieval:

				<ul style="list-style-type: none"> - true: ML model storage capability is supported by the ADRF - false (default): ML model storage capability is not supported by the ADRF.
dataStorageInd	boolean	O	0..1	<p>When present, this IE shall indicate whether the ADRF supports data and analytics storage and retrieval capability:</p> <ul style="list-style-type: none"> - true: data and analytics storage and retrieval capability is supported by the ADRF. - false (default): data and analytics storage and retrieval capability is not supported by the ADRF.

6.1.6.2.123 Type: SelectionConditions

Table 6.1.6.2.123-1: Definition of type SelectionConditions as a list of mutually exclusive alternatives

Data type	P	Cardinality	Description
ConditionItem	O	0..1	A single condition item that shall be evaluated (as <true> or <false> to determine whether a discovered NF (Service) Instance shall be selected.
ConditionGroup	O	0..1	A group of conditions (joined by a boolean "and" or "or" connector) that shall be evaluated (as <true> or <false>) to determine whether a discovered NF (Service) Instance shall be selected.

6.1.6.2.124 Type: ConditionItem

Table 6.1.6.2.124-1: Definition of type ConditionItem

Attribute name	Data type	P	Cardinality	Description
consumerNfTypes	array(NFType)	O	1..N	The NF types of the consumers for which the conditions included in this ConditionItem apply. If this attribute is absent, the conditions are applicable to all NF consumer types.
serviceFeature	integer	O	0..1	This attribute only applies when the selectionConditions, where this ConditionItem is included, is included in a NF Service Instance. It represents a feature number of that NF Service Instance, under CANARY_RELEASE status. This condition is evaluated to <true> when the service requests from a consumer of this NF Service Instance require the support of the indicated feature on the NF Service Instance. EXAMPLE: If "serviceFeature" is set to 2, for a service instance of "nsmf-pdusession", such instance will only be selected for consumers supporting, and requiring the support from the NF Service producer, of the "MAPDU" (ATSSS) feature (see 3GPP TS 29.502, clause 6.1.8),..
vsServiceFeature	integer	O	0..1	This attribute only applies when the selectionConditions, where this ConditionItem is included, is included in a NF Service Instance. It represents a Vendor-Specific feature number of that NF Service Instance, under CANARY_RELEASE status. This condition is evaluated to <true> when the service requests from a consumer of this NF Service Instance require the support of the indicated Vendor-Specific feature on the NF Service Instance.
supiRangeList	array(SupiRange)	O	1..N	A set of SUPIs for which the NF (Service) instance under CANARY_RELEASE status shall be selected
gpsiRangeList	array(IdentityRange)	O	1..N	A set of GPSIs for which the NF (Service) instance under CANARY_RELEASE status shall be selected
impuRangeList	array(IdentityRange)	O	1..N	A set of IMS Public Identities for which the NF (Service) instance under CANARY_RELEASE status shall be selected.
impiRangeList	array(IdentityRange)	O	1..N	A set of IMS Private Identities for which the NF (Service) instance under CANARY_RELEASE status shall be selected
peiList	array(Pei)	O	1..N	A set of PEIs of the Ues for which the NF (Service) instance under CANARY_RELEASE status shall be selected
taiRangeList	array(TaiRange)	O	1..N	A set of TAIs where the NF (Service) instance under CANARY_RELEASE status shall be selected for a certain UE
dnnList	array(Dnn)	O	1..N	A set of DNNs where the NF (Service) instance under CANARY_RELEASE status shall be selected.
NOTE 1: If several attributes (conditions) are present, the evaluation logic shall be the result of a boolean "AND" of the conditions expressed in the different attributes of this object.				
NOTE 2: If an NF Service Consumer finds an unknown condition/attribute (e.g. because the attribute has been added in a later version of the specification), or if the NF Service Consumer does not have enough data to evaluate the condition, the result of the evaluation of such condition shall be <false>.				
NOTE 3: In this table, the term "CANARY_RELEASE status" shall refer to the Canary Release condition of the NF (Service) instance, which may be indicated by setting the nf(Service)Status attribute to "CANARY_RELEASE" value, or by setting the "canaryRelease" attribute to true (while keeping the nf(Service)Status as "REGISTERED").				
NOTE 4: This data type shall not contain attributes named "and" or "or", to avoid conflicting data type definition with "ConditionGroup" (see clause 6.1.6.2.125), due to the definition of "SelectionConditions" (see clause 6.1.6.2.123) as a list of mutually exclusive alternatives ("oneOf"), between "ConditionItem" and "ConditionGroup".				

6.1.6.2.125 Type: ConditionGroup

Table 6.1.6.2.125-1: Definition of type ConditionGroup

Attribute name	Data type	P	Cardinality	Description
and	array(SelectionConditions)	C	1..N	A list (array) of conditions where the overall evaluation is <true> only if all the conditions in the list are evaluated as <true>.
or	array(SelectionConditions)	C	1..N	A list (array) of conditions where the overall evaluation is <true> if at least one of the conditions in the list is evaluated as <true>.

NOTE: Exactly one of either attribute "and" or attribute "or", but not both, shall be present.

6.1.6.2.126 Type: EpdgInfo

Table 6.1.6.2.126-1: Definition of type EpdgInfo

Attribute name	Data type	P	Cardinality	Description
ipv4EndpointAddresses	array(Ipv4Addr)	C	1..N	Available endpoint IPv4 address(es) of the S2b-u terminations (NOTE).
ipv6EndpointAddresses	array(Ipv6Addr)	C	1..N	Available endpoint IPv6 address(es) of the S2b-u terminations (NOTE).

NOTE: At least one of the addressing parameters (ipv4EndpointAddresses, ipv6EndpointAddresses) shall be included in the EpdgInfo.

6.1.6.2.127 Type: CallbackUriPrefixItem

Table 6.1.6.2.127-1: Definition of type CallbackUriPrefixItem

Attribute name	Data type	P	Cardinality	Description
callbackUriPrefix	string	M	1	Optional path segment(s) used to construct the prefix of the Callback URIs during the reselection of an NF service consumer, as described in 3GPP TS 29.501 [5], clause 4.4.3
notificationTypes	array(string)	M	0..N	List of notification type values using the callback URI prefix of the callbackUriPrefix IE. Each notification type value shall be encoded as defined in Annex B of 3GPP TS 29.500 [4]. When this IE is set with an empty array, the callback URI prefix indicated in the callbackUriPrefix IE shall be used for all notification types not present in any other CallbackUriPrefixItem entry of the callbackUriPrefixList IE.

NOTE: A given notification type value shall be associated with only one callbackUriPrefix value.

6.1.6.2.128 Type: SharedData

Table 6.1.6.2.128-1: Definition of type SharedData

Attribute name	Data type	P	Cardinality	Description
sharedDataId	string	M	1	String uniquely identifying SharedData. The format of the sharedDataId shall be a Universally Unique Identifier (UUID) version 4, as described in IETF RFC 4122 [18]. The hexadecimal letters should be formatted as lower-case characters by the sender, and they shall be handled as case-insensitive by the receiver. Example: "4ace9d34-2c69-4f99-92d5-a73a3fe8e23b"

sharedProfileData	NFProfile	C	0..1	Mandatory attributes of NFProfile shall be populated as per clause 6.1.6.2.2 and shall be ignored when received. When parameters of sharedProfileData clash with non-shared profile data, the non-shared data take precedence. (NOTE 1)
sharedServiceData	NFService	C	0..1	Mandatory attributes of NFService shall be populated as per clause 6.1.6.2.3 and shall be ignored when received. When parameters of sharedServiceData clash with non-shared service data, the non-shared data take precedence. (NOTE 1)
authorizedWriteScope	SharedScope	C	0..1	It shall only be present if write access to this shared data needs authorization. When present, it indicates the authorized scope that any NF belonging to the scope is authorized with write access to this shared data. (NOTE 2)
NOTE 1: Exactly one of the conditional attributes shall be present.				
NOTE 2: To control the authorization of write access to the shared data, an authorized scope may be implicitly configured in the NRF, or be explicitly configured in parameters inside the shared data.				

6.1.6.2.129 Type: NFProfileRegistrationError

Table 6.1.6.2.129-1: Definition of type NFProfileRegistrationError as a list of to be combined data types

Data type	Cardinality	Description	Applicability
ProblemDetails	1	Detail information of the problem	
SharedDataIdList	1	Additional information to be returned in error response: List of shared data IDs.	Shared-Data-Registration

6.1.6.2.130 Type: SharedDataIdList

Table 6.1.6.2.130-1: Definition of type SharedDataIdList

Attribute name	Data type	P	Cardinality	Description
sharedDataIds	array(string)	O	1..N	List of strings, each uniquely identifying SharedData. The format of the string shall be a Universally Unique Identifier (UUID) version 4, as described in IETF RFC 4122 [18]. The hexadecimal letters should be formatted as lower-case characters by the sender, and they shall be handled as case-insensitive by the receiver. Example: "4ace9d34-2c69-4f99-92d5-a73a3fe8e23b"

6.1.6.2.131 Type: PortRange

Table 6.1.6.2.131-1: Definition of type PortRange

Attribute name	Data type	P	Cardinality	Description
start	integer	M	1	Port number Minimum: 0 Maximum: 65535
end	integer	M	1	Port number Minimum: 0 Maximum: 65535

6.1.6.2.132 Type: SharedScope

Table 6.1.6.2.132-1: Definition of type SharedScope

Attribute name	Data type	P	Cardinality	Description
nfSetIdList	array(NfSetId)	C	1..N	It shall be present if certain operation (e.g. write operation) to a given shared data is authorized to a list of NF Set. When present, it shall contain a list of NF Set ID.

6.1.6.3 Simple data types and enumerations

6.1.6.3.1 Introduction

This clause defines simple data types and enumerations that can be referenced from data structures defined in the previous clauses.

6.1.6.3.2 Simple data types

The simple data types defined in table 6.1.6.3.2-1 shall be supported.

Table 6.1.6.3.2-1: Simple data types

Type Name	Type Definition	Description
NefId	string	The NEF ID as specified in clause 4.25.2 of 3GPP TS 23.502 [3]. For combined SCEF+NEF, the NEF ID shall contain the SCEF ID encoded as specified in clause 8.4.5 of 3GPP TS 29.336 [37].
VendorId	string	Vendor ID, according to the IANA-assigned "SMI Network Management Private Enterprise Codes" [38]. It shall be formatted as a fixed 6-digit string, padding with leading digits "0" to complete a 6-digit length. Pattern: " <code>^[0-9]{6}\$</code> "
WildcardDnai	string	String representing the Wildcard DNAI. It shall contain the string "**". Pattern: " <code>^[*]*\$</code> "
ImsDomainName	string	The IMS domain name.
MediaCapability	string	String representing the media capability offered by NF instance. Pattern: " <code>^[a-zA-Z0-9_]+\$</code> "

6.1.6.3.3 Enumeration: NFType

The enumeration NFType represents the different types of Network Functions or Network Entities that can be found in the 5GC.

Table 6.1.6.3.3-1: Enumeration NFType

Enumeration value	Description
"NRF"	Network Function: NRF
"UDM"	Network Function: UDM
"AMF"	Network Function: AMF
"SMF"	Network Function: SMF
"AUSF"	Network Function: AUSF
"NEF"	Network Function: NEF
"PCF"	Network Function: PCF
"SMSF"	Network Function: SMSF
"NSSF"	Network Function: NSSF
"UDR"	Network Function: UDR
"LMF"	Network Function: LMF
"GMLC"	Network Function: GMLC
"5G_EIR"	Network Function: 5G-EIR
"SEPP"	Network Entity: SEPP
"UPF"	Network Function: UPF
"N3IWF"	Network Function and Entity: N3IWF
"AF"	Network Function: AF
"UDSF"	Network Function: UDSF
"BSF"	Network Function: BSF
"CHF"	Network Function: CHF
"NWDAF"	Network Function: NWDAF
"PCSCF"	Network Function: P-CSCF
"CBCF"	Network Function: CBCF
"UCMF"	Network Function: UCMF
"HSS"	Network Function: HSS
"SOR_AF"	Network Function: SOR-AF
"SPAF"	Network Function: SP-AF
"MME"	Network Function: MME
"SCSAS"	Network Function: SCS/AS
"SCEF"	Network Function: SCEF
"SCP"	Network Entity: SCP
"NSSAAF"	Network Function: NSSAAF
"ICSCF"	Network Function: I-CSCF
"SCSCF"	Network Function: S-CSCF
"DRA"	Network Function: DRA
"IMS_AS"	Network Function: IMS-AS
"AANF"	Network Function: AANF
"5G_DDNMF"	Network Function: 5G DDNMF
"NSACF"	Network Function: NSACF
"MFAF"	Network Function: MFAF
"EASDF"	Network Function: EASDF
"DCCF"	Network Function: DCCF
"MB_SMF"	Network Function: MB-SMF
"TSCTSF"	Network Function: TSCTSF
"ADRF"	Network Function: ADRF
"GBA_BSF"	Network Function: GBA BSF
"CEF"	Network Function: CEF
"MB_UPF"	Network Function: MB-UPF
"NSWOF"	Network Function: NSWOF
"PKMF"	Network Function: PKMF
"MNPF"	Network Function: MNPF
"SMS_GMSC"	Network Function: SMS-GMSC
"SMS_IWMSC"	Network Function: SMS-IWMSC
"MBSF"	Network Function: MBSF
"MBSTF"	Network Function: MBSTF
"PANF"	Network Function: PANF
"IP_SM_GW"	Network Function: IP-SM-GW
"SMS_ROUTER"	Network Function: SMS Router
"DCSF"	Network Function: DCSF
"MRF"	Network Function: MRF
"MRFP"	Network Function: MRFP

"MF"	Network Function: MF
"SLPKMF"	Network Function: SLPKMF
"RH"	Network Entity: Roaming Hub

6.1.6.3.4 Enumeration: NotificationType

Table 6.1.6.3.4-1: Enumeration NotificationType

Enumeration value	Description
"N1_MESSAGES"	<p>Notification of N1 messages.</p> <p>This notification type may be registered by the NF Instance in a default notification subscription at NFProfile level (see clause 6.1.6.2.2) or as part of a specific service instance.</p> <p>If the AMF registers a default notification subscription with this notification type in an NF Service Instance, it may be associated with the service "namf-comm" or with a custom service.</p> <p>If the LMF registers a default notification subscription with this notification type in an NF Service Instance, it may be associated with the service "nlmf-loc" or with a custom service.</p>
"N2_INFORMATION"	<p>Notification of N2 information.</p> <p>This notification type may be registered by the NF Instance in a default notification subscription at NFProfile level (see clause 6.1.6.2.2) or as part of a specific service instance.</p> <p>If the AMF registers a default notification subscription with this notification type in an NF Service Instance, it may be associated with the service "namf-comm" or with a custom service.</p> <p>If the LMF registers a default notification subscription with this notification type in an NF Service Instance, it may be associated with the service "nlmf-loc" or with a custom service.</p>
"LOCATION_NOTIFICATION"	<p>Notification of Location Information sent by AMF/LMF towards NF Service Consumers (e.g GMLC).</p> <p>This notification type may be registered by the NF Instance in a default notification subscription at NFProfile level (see clause 6.1.6.2.2) or as part of a specific service instance.</p> <p>If the the GMLC registers a default notification subscription with this notification type in an NF Service Instance, it may be associated with the service "ngmlc-loc" or with a custom service.</p>
"DATA_REMOVAL_NOTIFICATION"	<p>Notification of Data Removal sent by UDR (e.g., removal of UE registration data upon subscription withdrawal).</p> <p>This notification type shall be registered by the NF Instance in a default notification subscription at NFProfile level (see clause 6.1.6.2.2).</p>
"DATA_CHANGE_NOTIFICATION"	<p>Notification of Data Changes sent by UDR.</p> <p>This notification type shall be registered by the NF Instance in a default notification subscription at NFProfile level (see clause 6.1.6.2.2).</p>
"LOCATION_UPDATE_NOTIFICATION"	<p>Notification of UE Location Information Update sent by GMLC towards NF Service Consumers (e.g. H-GMLC, NEF), during MO_LR procedure.</p> <p>This notification type may be registered by the NF Instance in a default notification subscription at NFProfile level (see clause 6.1.6.2.2) or as part of a specific service instance.</p> <p>If the the GMLC registers a default notification subscription with this notification type in an NF Service Instance, it may be associated with the service "ngmlc-loc" or with a custom service.</p> <p>If the the NEF registers a default notification subscription with this notification type in an NF Service Instance, it may be associated with the service "nnef-eventexposure" or with a custom service.</p>

"NSSAA_REAUTH_NOTIFICATION"	<p>Re-authentication notification for slice-specific authentication and authorization sent by NSSAAF towards NF Service Consumers (e.g. AMF).</p> <p>This notification type should be registered by the NF Instance in a default notification subscription at NFProfile level (see clause 6.1.6.2.2); otherwise, it may be registered in a custom service instance.</p>
"NSSAA_REVOC_NOTIFICATION"	<p>Revocation notification for slice-specific authentication and authorization sent by NSSAAF towards NF Service Consumers (e.g. AMF).</p> <p>This notification type should be registered by the NF Instance in a default notification subscription at NFProfile level (see clause 6.1.6.2.2); otherwise, it may be registered in a custom service instance.</p>
"MATCH_INFO_NOTIFICATION"	<p>Notification of a matching result, and the information that can be used for charging purpose by 5G DDNMF towards NF Service Consumers (e.g. 5G DDNMF), during Discovery Reporting procedures.</p> <p>This notification type should be registered by the NF Instance in a default notification subscription at NFProfile level (see clause 6.1.6.2.2); otherwise, it may be registered in a custom service instance.</p>
"DATA_RESTORATION_NOTIFICATION"	<p>Notification by UDR to its NF Service Consumers (e.g. UDM, PCF, NEF...) or by UDM to its NF Service Consumers (e.g. AMF, SMF, SMSF...) of a potential data-loss event originated at UDR. The content of the notification shall be as described in 3GPP TS 29.503 [36], clause 5.3.2.12.2 and 6.2.5.4.</p> <p>This notification type should be registered by the NF Instance in a default notification subscription at NFProfile level (see clause 6.1.6.2.2); otherwise, it may be registered in a custom service instance.</p>
"TSCTS_NOTIFICATION"	<p>Notification sent by PCF to TSCTSF of TSC user-plane node information. The content of the notification is described in 3GPP TS 29.514 [47], clause 4.2.5.16.</p> <p>This notification type should be registered by the NF Instance in a default notification subscription at NFProfile level (see clause 6.1.6.2.2); otherwise, it may be registered in a custom service instance.</p>
"LCS_KEY_DELIVERY_NOTIFICATION"	<p>Notification sent by LMF to AMF to deliver ciphering key information.</p> <p>This notification type should be registered by the NF Instance in a default notification subscription at NFProfile level (see clause 6.1.6.2.2); otherwise, it may be registered in a custom service instance.</p>
"UUA_MM_AUTH_NOTIFICATION"	<p>Authentication notification sent by UAS-NF towards NF Service Consumers (i.e. AMF), during USS Initiated reauthorization, update authorization data or revoke authorization with UUA-MM procedures.</p> <p>This notification type should be registered by the NF Instance in a default notification subscription at NFProfile level (see clause 6.1.6.2.2); otherwise, it may be registered in a custom service instance.</p>
"DC_SESSION_EVENT_NOTIFICATION"	<p>Notification sent by IMS AS towards NF Service Consumers (i.e. DCSF) for IMS AS session event control.</p> <p>This notification type should be registered by the NF Instance in a default notification subscription at NFProfile level (see clause 6.1.6.2.2); otherwise, it may be registered in a custom service instance.</p>

6.1.6.3.5 Enumeration: TransportProtocol

Table 6.1.6.3.5-1: Enumeration TransportProtocol

Enumeration value	Description
"TCP"	Transport protocol: TCP

6.1.6.3.6 Enumeration: NotificationEventType

Table 6.1.6.3.6-1: Enumeration NotificationEventType

Enumeration value	Description	Applicability
"NF_REGISTERED"	The NF Instance has been registered in NRF	
"NF_DEREGISTERED"	The NF Instance has been deregistered from NRF (NOTE)	
"NF_PROFILE_CHANGED"	The profile of the NF Instance has been modified (NOTE)	
"SHARED_DATA_CHANGED"	Shared Data have been changed in the NRF	Shared-Data-Retrieval
NOTE:	A change of the NFStatus value shall be notified as "NF_PROFILE_CHANGED" event, except if the NFStatus is set to value "CANARY_RELEASE" and the subscribing entity does not support the "Canary-Release" feature; in such case, the subscribing entity shall be notified as a "NF_DEREGISTERED" event.	

6.1.6.3.7 Enumeration: NFStatus

Table 6.1.6.3.7-1: Enumeration NFStatus

Enumeration value	Description
"REGISTERED"	The NF Instance is registered in NRF and can be discovered by other NFs. This status may result from new registration of an NF into NRF, or when, e.g. an NF comes out of "SUSPENDED" state after, e.g. re-issue of certificate (see clause 10.6 of 3GPP TS 33.310 [50]).
"SUSPENDED"	The NF Instance is registered in NRF but it is not operative and cannot be discovered by other NFs. This status may result from a NF Heart-Beat failure (see clause 5.2.2.3.2) or a NF failure, or the expiry/revocation of NF certificate (see clause 10.6 of 3GPP TS 33.310 [50]) and may trigger restoration procedures (see clause 6.2 of 3GPP TS 23.527 [27]).
"UNDISCOVERABLE"	The NF instance is registered in NRF, is operative but cannot be discovered by other NFs. This status may be set by the NF e.g. in shutting down scenarios where the NF is still able to process requests for existing resources or sessions but cannot accept new resource creation or session establishment.
"CANARY_RELEASE"	The NF instance is registered in NRF, is operative and can be discovered and selected by other NFs under certain conditions (see SelectionConditions, in clause 6.1.6.2.123). This status may be set by the NF e.g. in upgrade scenarios or during canary testing scenarios where the NF is able to process requests for new resource creation or session establishment under certain conditions (e.g. for a restricted set of users). (NOTE 2)
NOTE 1:	An NF instance cannot be discovered by other NFs if the NF status is set to "SUSPENDED" or "UNDISCOVERABLE".
NOTE 2:	A discovered NF instance with NFStatus "CANARY_RELEASE" shall only be selected by an NF Service Consumer if the conditions included in the "selectionConditions" attribute of the NFProfile are evaluated to <true>; if such attribute is not included, the NF instance shall not be selected.

6.1.6.3.8 Enumeration: DataSetId

The enumeration DataSetId represents the different types of data sets supported by an UDR instance.

Table 6.1.6.3.8-1: Enumeration DataSetId

Enumeration value	Description
"SUBSCRIPTION"	Data set: Subscription data
"POLICY"	Data set: Policy data
"EXPOSURE"	Data set: Structured data for exposure
"APPLICATION"	Data set: Application data
"A_PFD"	ApplicationData subset: Packet Flow Descriptions
"A_AFTI"	ApplicationData subset: AF Traffic Influence Data
"A_AFQOS"	ApplicationData subset: AF Requested QoS Data
"A_IPTV"	ApplicationData subset: IPTV Config Data
"A_BDT"	ApplicationData subset: Background Data Transfer
"A_SPD"	ApplicationData subset: Service Parameter Data
"A_EASD"	ApplicationData subset: EAS Deployment Information
"A_EACI"	ApplicationData subset: ECS Address Configuration Information
"A_AMI"	ApplicationData subset: AM Influence Data
"A_DEM"	ApplicationData subset: DNAI EAS Mappings
"A_ALIM"	ApplicationData subset: Application Layer Id Mappings
"P_UE"	PolicyData subset: UE Specific Data
"P_SCD"	PolicyData subset: Sponsored Connectivity Data
"P_BDT"	PolicyData subset: Background Data Transfer
"P_PLMNUE"	PolicyData subset: PLMN specific UE policy data
"P_NSSCD"	PolicyData subset: Network Slice Specific Control Data
"P_PDTQ"	PolicyData subset: Planned Data Transfer with QoS requirements Data
"P_MBSCD"	PolicyData subset: MBS Session Policy Control Data
"P_GROUP"	PolicyData subset: Group Policy Control Data
<p>NOTE 1: Enumeration values identifying an ApplicationData subset or PolicyData subset should not be used in NF discovery requests unless UDR and NRF have been upgraded to support these values. If the UDR registers any of the defined ApplicationData subset values and/or any of the defined PolicyData subset values, it shall also register the ApplicationData data set value and/or PolicyData data set value.</p> <p>The UDR that registers the Application Data set value and/or the Policy Data set value might not register any of the defined ApplicationData subset values and/or PolicyData subset values. This does not imply that the UDR supports all the defined ApplicationData subset values and/or PolicyData subset values.</p> <p>NOTE 2: NF Service Consumers should only use the ApplicationData or PolicyData subset(s) they support when discovering UDR NF instances to avoid discovering UDRs which are not to be selected. If an NF Service Consumer is interested in discovering all ApplicationData or PolicyData subsets supported in the operator's network, the NF Service Consumer should use the "APPLICATION" or "POLICY" data set IDs when discovering UDR NF instances.</p>	

6.1.6.3.9 Enumeration: UPIInterfaceType

Table 6.1.6.3.9-1: Enumeration UPIInterfaceType

Enumeration value	Description
"N3"	User Plane Interface: N3 (or N3 for 3GPP Access, see NOTE 2)
"N6"	User Plane Interface: N6
"N9"	User Plane Interface: N9 (or N9 for non-roaming, see NOTE 3)
"DATA_FORWARDING"	User Plane Interface for indirect data forwarding. (NOTE 1)
"N6MB"	User Plane Interface: N6mb
"N19MB"	User Plane Interface: N19mb
"N3MB"	User Plane Interface: N3mb
"NMB9"	User Plane Interface: Nmb9
"S1U"	User Plane Interface: S1-U
"S5U"	User Plane Interface: S5-U
"S8U"	User Plane Interface: S8-U
"S11U"	User Plane Interface: S11-U
"S12"	User Plane Interface: S12
"S2AU"	User Plane Interface: S2AU
"S2BU"	User Plane Interface: S2BU
"N3TRUSTEDN3GPP"	User Plane Interface: N3 Trusted Non-3GPP access
"N3UNTRUSTEDN3GPP"	User Plane Interface: N3 Untrusted Non-3GPP access
"N9ROAMING"	User Plane Interface: N9 for roaming interface
"SGI"	User Plane Interface: SGI
"N19"	User Plane Interface: N19
"SXAU"	User Plane Interface: Sxa-U
"SXB�"	User Plane Interface: Sxb-U
"N4U"	User Plane Interface: N4-U
NOTE 1: This interface type may be used when a dedicated network instance is deployed for data forwarding.	
NOTE 2: If separation of N3 traffic from 3GPP access and non-3GPP access is required for a PLMN, this value should only be used for the N3 for 3GPP access.	
NOTE 3: If separation of roaming and non-roaming traffic is desired over N9, this value should only be used for N9 non-roaming interfaces.	

6.1.6.3.10 Relation Types

6.1.6.3.10.1 General

This clause describes the possible relation types defined within NRF API. See clause 4.7.5.2 of 3GPP TS 29.501 [5] for the description of the relation types.

Table 6.1.6.3.10.1-1: supported registered relation types

Relation Name
self
item

6.1.6.3.11 Enumeration: ServiceName

Table 6.1.6.3.11-1: Enumeration ServiceName

Enumeration value	Description
"nnrf-nfm"	Nnrf_NFManagement Service offered by the NRF
"nnrf-disc"	Nnrf_NFDiscovery Service offered by the NRF
"nnrf-oauth2"	Nnrf_AccessToken Service offered by the NRF
"nudm-sdm"	Nudm_SubscriberDataManagement Service offered by the UDM
"nudm-uecm"	Nudm_UEContextManagement Service offered by the UDM
"nudm-ueau"	Nudm_UEAuthentication Service offered by the UDM
"nudm-ee"	Nudm_EventExposure Service offered by the UDM
"nudm-pp"	Nudm_ParameterProvision Service offered by the UDM
"nudm-niddau"	Nudm_NIDDAuthorization Service offered by the UDM
"nudm-mt"	Nudm_MT Service offered by the UDM
"nudm-ssau"	Nudm_ServiceSpecificAuthorization Service offered by the UDM
"nudm-rsds"	Nudm_ReportSMDeliveryStatus Service offered by the UDM
"nudm-ueid"	Nudm_UEIdentifier Service offered by the UDM
"namf-comm"	Namf_Communication Service offered by the AMF
"namf-evts"	Namf_EventExposure Service offered by the AMF
"namf-mt"	Namf_MT Service offered by the AMF
"namf-loc"	Namf_Location Service offered by the AMF
"namf-mbs-comm"	Namf_MBSCommunication Service offered by AMF
"namf-mbs-bc"	Namf_MBSBroadcast Service offered by AMF
"nsmf-pdusession"	Nsmf_PDUSession Service offered by the SMF
"nsmf-event-exposure"	Nsmf_EventExposure Service offered by the SMF
"nsmf-nidd"	Nsmf_NIDD Service offered by the SMF
"nausf-auth"	Nausf_UEAuthentication Service offered by the AUSF
"nausf-sorprotection"	Nausf_SoRProtection Service offered by the AUSF
"nausf-upuprotection"	Nausf_UPUProtection Service offered by the AUSF
"nnef-pfdmanagement"	Nnef_PFDManagement offered by the NEF
"nnef-smcontext"	Nnef_SMContext Service offered by the NEF
"nnef-eventexposure"	Nnef_EventExposure Service offered by the NEF
"nnef-eas-deployment"	Nnef_EASDeployment InfoService offered by the NEF. This is the southbound part of the API (e.g. the service operations used by the SMF)
"nnef-dnai-mapping"	Nnef_DNAIMapping Service offered by the NEF
"nnef-traffic-influence-data"	Nnef_TrafficInfluenceData Service offered by the NEF
"nnef-ecs-addr-cfg-info"	Nnef_ECSAddress Service offered by the NEF
"nnef-ueid"	Nnef_UEId Service offered by the NEF
"3gpp-cp-parameter-provisioning"	Nnef_ParameterProvision Service offered by the NEF
"3gpp-device-triggering"	Nnef_Trigger Service offered by the NEF
"3gpp-bdt"	Nnef_BDTPNegotiation Service offered by the NEF
"3gpp-traffic-influence"	Nnef_TrafficInfluence Service offered by the NEF
"3gpp-chargeable-party"	Nnef_ChargeableParty Service offered by the NEF
"3gpp-as-session-with-qos"	Nnef_AFsessionWithQoS Service offered by the NEF
"3gpp-msisdn-less-mo-sms"	Nnef_MSISDN-less_MO_SMS Service offered by the NEF
"3gpp-service-parameter"	Nnef_ServiceParameter Service offered by the NEF
"3gpp-monitoring-event"	Nnef_APISupportCapability Service offered by the NEF
"3gpp-nidd-configuration-trigger"	Nnef_NIDDConfiguration Service offered by the NEF
"3gpp-nidd"	Nnef_NIDD Service offered by the NEF
"3gpp-analyticsexposure"	Nnef_AnalyticsExposure Service offered by the NEF
"3gpp-racs-parameter-provisioning"	Nnef_UCMFPProvisioning Service offered by the NEF
"3gpp-ecr-control"	Nnef_ECRrestriction Service offered by the NEF
"3gpp-applying-bdt-policy"	Nnef_ApplyPolicy Service offered by the NEF
"3gpp-mo-lcs-notify"	Nnef_Location Service offered by the NEF
"3gpp-time-sync"	Nnef_TimeSynchronization Service offered by the NEF
"3gpp-am-influence"	Nnef_AMInfluence Service offered by the NEF
"3gpp-am-policyauthorization"	Nnef_AMPolicyAuthorization
"3gpp-akma"	Nnef_AKMA Service offered by the NEF
"3gpp-eas-deployment"	Nnef_EASDeployment Service offered by the NEF. This is the northbound part (e.g. the service operations used by the AF).
"3gpp-iptvconfiguration"	Nnef_IPTV_configuration Service offered by the NEF
"3gpp-mbs-tmgi"	Nnef_MBSTMGI Service offered by the NEF
"3gpp-mbs-session"	Nnef_MBSSession Service offered by the NEF
"3gpp-authentication"	Nnef_Authentication Service offered by the NEF
"3gpp-asti"	Nnef_ASTI Service offered by the NEF

"3gpp-pdtq-policy-negotiation"	Nnef_PDTQPolicyNegotiation offered by the NEF
"3gpp-musa"	Nnef_MemberUESelectionAssistance offered by the NEF
"npcf-am-policy-control"	Npcf_AMPolicyControl Service offered by the PCF
"npcf-smpolicycontrol"	Npcf_SMPolicyControl Service offered by the PCF
"npcf-policyauthorization"	Npcf_PolicyAuthorization Service offered by the PCF
"npcf-bdtpolicycontrol"	Npcf_BDTPolicyControl Service offered by the PCF
"npcf-eventexposure"	Npcf_EventExposure Service offered by the PCF
"npcf-ue-policy-control"	Npcf_UEPolicyControl Service offered by the PCF
"npcf-am-policyauthorization"	Npcf_AM_PolicyAuthorization Service offered by the PCF
"npcf-pdtq-policy-control"	Npcf_PDTQPolicyControl Service offered by the PCF
"npcf-mbspolicycontrol"	Npcf_MBSPolicyControl Service offered by the PCF
"npcf-mbspolicyauth"	Npcf_MBSPolicyAuthorization Service offered by the PCF
"nsmf-sms"	Nsmf_SMSService Service offered by the SMSF
"nssf-nselection"	Nssf_NSSelection Service offered by the NSSF
"nssf-nssaiavailability"	Nssf_NSSAIAvailability Service offered by the NSSF
"nudr-dr"	Nudr_DataRepository Service offered by the UDR
"nudr-group-id-map"	Nudr_GroupIDmap Service offered by the UDR
"nlmf-loc"	Nlmf_Location Service offered by the LMF
"nlmf-broadcast"	Nlmf_Broadcast Service offered by the LMF
"n5g-eir-eic"	N5g-eir_EquipmentIdentityCheck Service offered by the 5G-EIR
"nbsf-management"	Nbsf_Management Service offered by the BSF
"nchf-spendinglimitcontrol"	Nchf_SpendingLimitControl Service offered by the CHF
"nchf-convergedcharging"	Nchf_Converged_Charging Service offered by the CHF
"nchf-offlineonlycharging"	Nchf_OfflineOnlyCharging Service offered by the CHF
"nwdaf-eventssubscription"	Nwdaf_EventsSubscription Service offered by the NWDAF
"nwdaf-analyticsinfo"	Nwdaf_AnalyticsInfo Service offered by the NWDAF
"nwdaf-datamanagement"	Nwdaf_DataManagement Service offered by the NWDAF
"nwdaf-mlmodelprovision"	Nwdaf_MLModelProvision Service offered by the NWDAF
"nwdaf-mlmodeltraining"	Nwdaf_MLModelTraining Service offered by the NWDAF
"nwdaf-mlmodelmonitor"	Nwdaf_MLModelMonitor Service offered by the NWDAF
"nwdaf-roamingdata"	Nwdaf_RoamingData Service offered by the NWDAF
"nwdaf-roaminganalytics"	Nwdaf_RoamingAnalytics Service offered by the NWDAF
"ngmlc-loc"	Ngmlc_Location Service offered by GMLC
"nucmf-provisioning"	Nucmf_Provisioning Service offered by UCMF
"nucmf-uecapabilitymanagement"	Nucmf_UECapabilityManagement Service offered by UCMF
"nhss-sdm"	Nhss_SubscriberDataManagement Service offered by the HSS
"nhss-uecm"	Nhss_UEContextManagement Service offered by the HSS
"nhss-ueau"	Nhss_UEAuthentication Service offered by the HSS
"nhss-ee"	Nhss_EventExposure Service offered by the HSS
"nhss-ims-sdm"	Nhss_imsSubscriberDataManagement Service offered by the HSS
"nhss-ims-uecm"	Nhss_imsUEContextManagement Service offered by the HSS
"nhss-ims-ueau"	Nhss_imsUEAuthentication Service offered by the HSS
"nhss-gba-sdm"	Nhss_gbaSubscriberDataManagement Service offered by the HSS
"nhss-gba-ueau"	Nhss_gbaUEAuthentication Service offered by the HSS
"nsepp-telescopic"	Nsepp_Telescopic_FQDN_Mapping Service offered by the SEPP
"nsoraf-sor"	Nsoraf_SteeringOfRoaming Service offered by the SOR-AF
"nspaf-secured-packed"	Nspaf_SecuredPacket Service offered by the SP-AF
"nudsf-dr"	Nudsf Data Repository service offered by the UDSF.
"nudsf-timer"	Nudsf Timer service offered by the UDSF
"nssaaf-nssaa"	Nssaaf_NSSAA service offered by the NSSAAF.
"nssaaf-aiw"	Nssaaf_AIW service offered by the NSSAAF.
"naanf-akma"	Naanf_AKMA service offered by the AAnF.
"n5gddnmf-discovery"	N5g-ddnmf_Discovery service offered by 5G DDNMF
"nmfaf-3dadatamanagement"	Nmfaf_3daDataManagement service offered by the MFAF.
"nmfaf-3cadatamanagement"	Nmfaf_3caDataManagement service offered by the MFAF.
"nmfaf-contextmanagement"	Nmfaf ContextManagement service offered by the MFAF.
"neasdf-dnscontext"	Neasdf_DNSContext service offered by the EASDF
"neasdf-baselinednspattern"	Neasdf_BaselineDNSPattern service offered by the EASDF
"ndccf-datamanagement"	Ndccf_DataManagement service offered by the DCCF.
"ndccf-contextmanagement"	Ndccf_ContextManagement service offered by the DCCF.
"nsacf-nsac"	Nsacf_NSAC service offered by the NSACF.

"nnsacf-slice-ee"	Nnsacf_SliceEventExposure service offered by the NSACF.
"nmbsmf-tmgi"	Nmbsmf TMGI service offered by the MB-SMF
"nmbsmf-mbssession"	Nmbsmf MBSsession service offered by the MB-SMF
"nadrfdatamanagement"	Nadrf_DataManagement service offered by the ADRF.
"nadrf-mlmodelmanagement"	Nadrf_MLModelManagement service offered by the ADRF.
"nbsp-gba"	Nbsp_GBA service offered by the GBA BSF.
"ntsctsf-time-sync"	Ntsctsf_TimeSynchronization service offered by the TSCTSF
"ntsctsf-qos-tscai"	Ntsctsf_QoSandTSCAssistance service offered by the TSCTSF
"ntsctsf-asti"	Ntsctsf_ASTI service offered by the TSCTSF
"npkmf-keyrequest"	Npkmf_PKMFKeyRequest service offered by the PKMF
"npkmf-userid"	Npkmf_ResolveRemoteUserId service offered by the PKMF
"npkmf-discovery"	Npkmf_Discovery service offered by the PKMF
"nmnpf-npstatus"	Nmnpf_NPStatus service offered by the MNPF
"niwmsc-smsservice"	Niwmsc_SMSservice service offered by the SMS-IWMSC
"mbsf-mbs-us"	Mbsf_MBSUserService service offered by the MBSF
"mbsf-mbs-ud-ingest"	Mbsf_MBSUserDataIngestSession service offered by the MBSF
"mbsf-distsession"	Mbsf_MBSDistributionSession service offered by the MBSTF
"panf-prosekey"	Panf_ProseKey service offered by the PAnF
"panf-userid"	Panf_ResolveRemoteUserId service offered by the PAnF
"nupf-ee"	Nupf_EventExposure service offered by the UPF
"nupf-gueip"	Nupf_GetUEPrivateIPAddrAndIdentifiers Service offered by the UPF
"naf-prose"	Naf_ProSe Service offered by the AF
"naf-eventexposure"	Naf_EventExposure Service offered by the AF
NOTE: The services defined in this table are those defined by 3GPP NFs in 5GC; however, in order to support custom services offered by standard and custom NFs, the NRF shall also accept the registration of NF Services with other service names.	

6.1.6.3.12 Enumeration: NFServiceStatus

Table 6.1.6.3.12-1: Enumeration NFServiceStatus

Enumeration value	Description
"REGISTERED"	The NF Service Instance is registered in NRF and can be discovered by other NFs. (NOTE 2)
"SUSPENDED"	The NF Service Instance is registered in NRF but it is not operative and cannot be discovered by other NFs. This status may result from a NF Service failure and may trigger restoration procedures (see clause 6.2 of 3GPP TS 23.527 [27]).
"UNDISCOVERABLE"	The NF Service instance is registered in NRF, is operative but cannot be discovered by other NFs. This status may be set by the NF e.g. in shutting down scenarios where the NF service is still able to process requests for existing resources or sessions but cannot accept new resource creation or session establishment.
"CANARY_RELEASE"	The NF Service Instance is registered in NRF, is operative and can be discovered and selected by other NFs under certain conditions (see SelectionConditions, in clause 6.1.6.2.123). This status may be set by the NF e.g. in upgrade scenarios or during canary testing scenarios where the NF is able to process requests for new resource creation or session establishment under certain conditions (e.g. for a restricted set of users). (NOTE 3)
NOTE 1: An NF service cannot be discovered by other NFs if the NF status is set to "SUSPENDED" or "UNDISCOVERABLE", regardless of the NF service status.	
NOTE 2: A discovered NF service instance with NFServiceStatus set to "REGISTERED", and with NFStatus of the NF Instance set to "CANARY_RELEASE", shall only be selected by an NF Service Consumer if the conditions included in the "selectionConditions" attribute of the NFProfile are evaluated to <true>; if such attribute is not included in NFProfile, the NF service instance shall not be selected.	
NOTE 3: A discovered NF service instance with NFServiceStatus "CANARY_RELEASE" shall only be selected by an NF Service Consumer if the conditions included in the "selectionConditions" attribute of the NFService are evaluated to <true>; if such attribute is not included in NFService, the NF service instance shall not be selected.	

6.1.6.3.13 Enumeration: AnNodeType

Table 6.1.6.3.13-1: Enumeration AnNodeType

Enumeration value	Description
"GNB"	gNB
"NG_ENB"	NG-eNB

6.1.6.3.14 Enumeration: ConditionEventType

Table 6.1.6.3.14-1: Enumeration ConditionEventType

Enumeration value	Description
"NF_ADDED"	The NF Instance notified by NRF starts being part of a condition for a subscription on a set of NFs.
"NF_REMOVED"	The NF Instance notified by NRF stops being part of a condition for a subscription on a set of NFs.

6.1.6.3.15 Enumeration: IpReachability

Table 6.1.6.3.15-1: Enumeration IpReachability

Enumeration value	Description
"IPv4"	Only IPv4 addresses are reachable.
"IPv6"	Only IPv6 addresses are reachable.
"IPv4V6"	Both IPv4 addresses and IPv6 addresses are reachable.

6.1.6.3.16 Enumeration: ScpCapability

Table 6.1.6.3.16-1: Enumeration ScpCapability

Enumeration value	Description
"INDIRECT_COM_WITH_DELEG_DISC"	Indirect communication with delegated discovery supported

6.1.6.3.17 Enumeration: CollocatedNfType

Table 6.1.6.3.17-1: Enumeration CollocatedNfType

Enumeration value	Description
"UPF"	Network function: UPF
"SMF"	Network function: SMF
"MB_UPF"	Network function: MB-UPF
"MB_SMF"	Network function: MB-SMF

6.1.6.3.18 Enumeration: LocalityType

Table 6.1.6.3.18-1: Enumeration LocalityType

Enumeration value	Description
"DATA_CENTER"	Data center
"CITY"	City
"COUNTY"	County
"DISTRICT"	District
"STATE"	State
"CANTON"	Canton
"REGION"	Region
"PROVINCE"	Province
"PREFECTURE"	Prefecture
"COUNTRY"	Country
NOTE 1: An operator may define custom locality types other than those defined in this table. The NRF and NFs shall accept locality types defined with custom locality type values.	
NOTE 2: The NRF needs not understand the semantic of the LocalityType enumeration values. The LocalityType information is used by the NRF to correlate a locality description received in the ext-preferred-locality query parameter with a locality description registered in the extLocality attribute of NFProfile with a matching LocalityType.	

6.1.6.3.19 Enumeration: FICapabilityType

Table 6.1.6.3.19-1: Enumeration FICapabilityType

Enumeration value	Description
"FL_SERVER"	NWDAF containing MTLF as Federated Learning server.
"FL_CLIENT"	NWDAF containing MTLF as Federated Learning client.
"FL_SERVER_AND_CLIENT"	NWDAF containing MTLF as Federated Learning server and client.

6.1.6.3.20 Void

6.1.6.3.21 Enumeration: RuleSetAction

Table 6.1.6.3.21-1: Enumeration RuleSetAction

Enumeration value	Description
"ALLOW"	The NF consumer is allowed to access NF producer
"DENY"	The NF consumer is not allowed to access NF Producer

6.1.6.3.22 Enumeration: DnsSecurityProtocol

Table 6.1.6.3.22-1: Enumeration DnsSecurityProtocol

Enumeration value	Description
"TLS"	DNS over TLS (see IETF RFC 7858 [52] and IETF RFC 8310 [53])
"DTLS"	DNS over DTLS (see IETF RFC 8094 [54])

6.1.7 Error Handling

6.1.7.1 General

HTTP error handling shall be supported as specified in clause 5.2.4 of 3GPP TS 29.500 [4].

6.1.7.2 Protocol Errors

Protocol errors handling shall be supported as specified in clause 5.2.7 of 3GPP TS 29.500 [4].

6.1.7.3 Application Errors

The application errors defined for the Nnrf_NFManagement service are listed in Table 6.1.7.3-1.

Table 6.1.7.3-1: Application errors

Application Error	HTTP status code	Description
SUBSCRIPTION_NOT_ALLOWED	403 Forbidden	It is used when the validation of the authorization parameters in the subscription request has failed.
SHARED_DATA_ID_UNKNOWN	400 Bad Request	It is used when the NFProfile contains Shared Data IDs for which Shared Data have not yet been registered. NFs receiving this application error may register the shared data to the NRF before retrying to register the NFProfile that contains the Shared Data ID.
SHARED_DATA_NOT_CONFIGURED	400 Bad Request	It is used when the NFProfile contains a Shared Data ID for which Shared Data have not been configured at the NRF. In this case the NFProfile registration fails due to network misconfiguration unless the NF is able to fall back to non-support of the Shared-Data-Registration feature.
SHARED_DATA_WRITE_NOT_ALLOWED	403 Forbidden	It is used when the requesting NF is not authorized with write access to a particular shared data, e.g. the shared data is only writeable within one specific NF Set.
INVALID_CLIENT	400 Bad Request	It is used when some or all attributes of the NF Service Consumer presented in the request message do not match the requester information in, e.g. its public key certificate.

6.1.8 Security

As indicated in clause 13.3 of 3GPP TS 33.501 [15], when static authorization is not used, the access to the Nnrf_NFManagement API may be authorized by means of the OAuth2 protocol (see IETF RFC 6749 [16]), using the "Client Credentials" authorization grant, where the NRF plays the role of the authorization server.

If OAuth2 authorization is used on the Nnrf_NFManagement API, an NF Service Consumer, prior to consuming services offered by the Nnrf_NFManagement API, shall obtain a "token" from the authorization server, by invoking the Access Token Request service, as described in clause 5.4.2.2.

NOTE: When multiple NRFs are deployed in a network, the NRF used as authorization server is the same NRF where the Nnrf_NFManagement service is invoked by the NF Service Producer.

The Nnrf_NFManagement API defines the following scopes for OAuth2 authorization:

Table 6.1.8-1: OAuth2 scopes defined in Nnrf_NFManagement API

Scope	Description
"nnrf-nfm"	Access to the Nnrf_NFManagement API
"nnrf-nfm:nf-instances:read"	Access to read the nf-instances resource, or an individual NF Instance ID resource
"nnrf-nfm:subscriptions:sub-complete-profile"	Access to subscribe to the complete profile of NF instances
"nnrf-nfm:nf-instance:write"	Access to write (create, update, delete) an individual NF Instance ID resource
"nnrf-nfm:shared-data:read"	Access to read shared data
"nnrf-nfm:shared-data:write"	Access to write (create, update, delete) shared data

6.1.9 Features supported by the NFManagement service

The syntax of the supportedFeatures attribute is defined in clause 5.2.2 of 3GPP TS 29.571 [7].

The following features are defined for the Nnrf_NFManagement service.

Table 6.1.9-1: Features of supportedFeatures attribute used by Nnrf_NFManagement service

Feature Number	Feature	M/O	Description
1	Service-Map	M	Support of defining in the profile of the NF Instance the list of NF Service Instances based on a map type (i.e. support of the "nfServiceList" attribute in NFProfile).
2	Empty-Objects-Nrf-Info	O	Support of receiving empty JSON objects as values in the servedxxxInfo/servedxxxInfoList map attributes of the NrfInfo data structure used by an NRF during registration into another NRF (see clause 6.1.6.2.31). An NRF that supports registering into another NRF shall support this feature.
3	Inter-Plmn-Fqdn	M	Support of receiving intra-PLMN notification of changes in the NFProfile/NFService containing the "interPlmnFqdn" attribute (see clauses 6.1.6.2.2 and 6.1.6.2.3). The NRF shall not send intra-PLMN notifications containing the "interPlmnFqdn" attribute to subscribing NF Instances that don't support this feature.
4	NRFSET	O	Support of the NRF Set feature as defined in clause 5.2.2.1. All the NRF service instances of an NRF supporting this feature shall support the NRFSET feature.
5	Complete-Profile-Subscription	O	Support subscriptions to the complete NF Profile of NF Instances (including, e.g. the authorization attributes) and their notifications.
6	Allowed-ruleset	O	Support registering RuleSets in NF (Service) profile
7	Canary-Release	O	Support of "CANARY_RELEASE" value for NFStatus and NFServiceStatus, used for e.g. canary testing
8	DNN-List-Optimization	O	Support of dnnSmfInfoListId within SnsaiSmfInfoItem, and dnnUpfInfoListId within SnsaiUpfInfoItem The NF consumer shall not make use of this feature if this feature is not supported by the NRF. See clause 5.2.2.2.2 on the NRF's supported feature detection prior to registration.
9	Shared-Data-Registration	O	If supported, NF consumers may register NFProfiles containing shared data IDs.
10	Shared-Data-Retrieval	O	If supported, NFProfiles sent to NF consumers may contain shared data IDs. Support of this feature also covers support of shared data retrieval, subscription, notification and un-subscription.
Feature number: The order number of the feature within the supportedFeatures attribute (starting with 1). Feature: A short name that can be used to refer to the bit and to the feature. M/O: Defines if the implementation of the feature is mandatory ("M") or optional ("O"). Description: A clear textual description of the feature.			

6.2 Nnrf_NFDiscovery Service API

6.2.1 API URI

The API URI of the Nnrf_NFDiscovery API shall be:

{apiRoot}/<apiName>/<apiVersion>

The request URIs used in HTTP requests from the NF service consumer towards the NF service producer shall have the Resource URI structure defined in clause 4.4.1 of 3GPP TS 29.501 [5], i.e.:

{apiRoot}/<apiName>/<apiVersion>/<apiSpecificResourceUriPart>

where:

- the {apiRoot} shall be set as defined in clause 4.4.1 of 3GPP TS 29.501 [5];
- the <apiName> shall be set to "nnrf-disc";

- the <apiVersion> shall be set to "v1" for the current version of this specification;
- the <apiSpecificResourceUriPart> shall be set as described in clause 6.2.3.

6.2.2 Usage of HTTP

6.2.2.1 General

HTTP/2, as defined in IETF RFC 9113 [9], shall be used as specified in clause 5 of 3GPP TS 29.500 [4].

HTTP/2 shall be transported as specified in clause 5.3 of 3GPP TS 29.500 [4].

HTTP messages and bodies for the Nnrf_NFDiscovery service shall comply with the OpenAPI [10] specification contained in Annex A.

6.2.2.2 HTTP standard headers

6.2.2.2.1 General

The mandatory standard HTTP headers as specified in clause 5.2.2.2 of 3GPP TS 29.500 [4] shall be supported.

6.2.2.2.2 Content type

The following content types shall be supported:

- The JSON format (IETF RFC 8259 [22]). The use of the JSON format shall be signalled by the content type "application/json". See also clause 5.4 of 3GPP TS 29.500 [4].
- The Problem Details JSON Object (IETF RFC 9457 [11]). The use of the Problem Details JSON object in a HTTP response body shall be signalled by the content type "application/problem+json".

6.2.2.2.3 Cache-Control

A "Cache-Control" header should be included in HTTP responses, as described in IETF RFC 9111 [20], clause 5.2. It shall contain a "max-age" value, indicating the amount of time in seconds after which the received response is considered stale; this value shall be the same as the content of the "validityPeriod" element described in clause 6.2.6.2.2.

6.2.2.2.4 ETag

An "ETag" (entity-tag) header should be included in HTTP responses, as described in IETF RFC 9110 [40], clause 8.8.3. It shall contain a server-generated strong validator, that allows further matching of this value (included in subsequent client requests) with a given resource representation stored in the server or in a cache.

6.2.2.2.5 If-None-Match

An NF Service Consumer should issue conditional GET request towards NRF, by including an If-None-Match header in HTTP requests, as described in IETF RFC 9110 [40], clause 13.1.2, containing one or several entity tags received in previous responses for the same resource.

6.2.2.3 HTTP custom headers

6.2.2.3.1 General

In this release of this specification, no custom headers specific to the Nnrf_NFDiscovery service are defined. For 3GPP specific HTTP custom headers used across all service-based interfaces, see clause 5.2.3 of 3GPP TS 29.500 [4].

6.2.3 Resources

6.2.3.1 Overview

The structure of the Resource URIs of the NFDisccovery service is shown in figure 6.2.3.1-1.

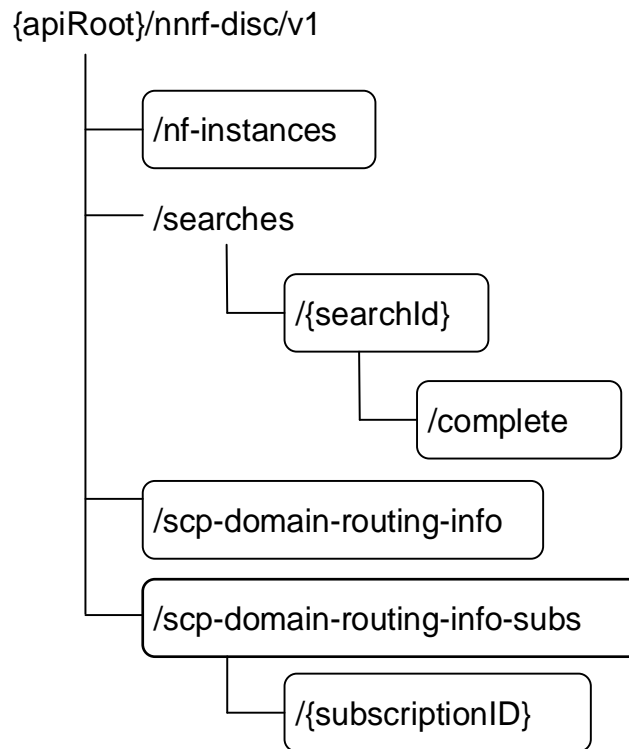

Figure 6.2.3.1-1: Resource URI structure of the NFDisccovery API

Table 6.2.3.1-1 provides an overview of the resources and applicable HTTP methods.

Table 6.2.3.1-1: Resources and methods overview

Resource name	Resource URI	HTTP method or custom operation	Description
nf-instances (Store)	/nf-instances	GET	Retrieve a collection of NF Instances according to certain filter criteria.
Stored Search (Document)	/searches/{searchId}	GET	Retrieve a collection of NF Instances, previously stored by NRF as a consequence of a prior search result.
Complete Stored Search (Document)	/searches/{searchId}/complete	GET	Retrieve a collection of NF Instances, previously stored by NRF as a consequence of a prior search result, without applying any client restriction on the number of instances (e.g. "limit" or "max-payload-size" query parameters).
SCP Domain Routing Information (Document)	/scp-domain-routing-info	GET	Retrieve the SCP Domain Routing Information.
SCP Domain Routing Info Subscriptions (Collection)	/scp-domain-routing-info-sub	POST	Subscribe to SCP Domain Routing Information change.
Individual SCP Domain Routing Info Subscription (Document)	/scp-domain-routing-info-sub/{subscriptionID}	DELETE	Unsubscribe to SCP Domain Routing Information change.

6.2.3.2 Resource: nf-instances (Store)

6.2.3.2.1 Description

This resource represents a collection of the different NF instances registered in the NRF.

This resource is modelled as the Store resource archetype (see clause C.3 of 3GPP TS 29.501 [5]).

6.2.3.2.2 Resource Definition

Resource URI: **{apiRoot}/nnrf-disc/v1/nf-instances**

This resource shall support the resource URI variables defined in table 6.2.3.2.2-1.

Table 6.2.3.2.2-1: Resource URI variables for this resource

Name	Data type	Definition
apiRoot	string	See clause 6.1.1

6.2.3.2.3 Resource Standard Methods

6.2.3.2.3.1 GET

This operation retrieves a list of NF Instances, and their offered services, currently registered in the NRF, satisfying a number of filter criteria, such as those NF Instances offering a certain service name, or those NF Instances of a given NF type (e.g., AMF).

Table 6.2.3.2.3.1-1: URI query parameters supported by the GET method on this resource

Name	Data type	P	Cardinality	Description	Applicability
target-nf-type	NFType	M	1	This IE shall contain the NF type of the target NF being discovered.	
requester-nf-type	NFType	M	1	This IE shall contain the NF type of the Requester NF that is invoking the Nnrf_NFDiscovery service.	
preferred-collocated-nf-types	array(CollocatedNFType)	O	1..N	The IE may be present to indicate desired collocated NF type(s) when the NF service consumer wants to discover candidate NFs matching the target NF Type that are preferentially collocated with other NF types. (NOTE 19)	Collocated-NF-Selection
requester-nf-instance-id	NfInstanceid	O	0..1	If included, this IE shall contain the NF instance id of the Requester NF.	Query-Params-Ext2
service-names	array(ServiceName)	O	1..N	<p>If included, this IE shall contain an array of service names for which the NRF is queried to provide the list of NF profiles.</p> <p>The NRF shall return the NF profiles that have at least one NF service matching the NF service names in this list.</p> <p>The NF services returned by the NRF (inside the nfServices or nfServiceList attributes) in each matching NFProfile shall be those services whose service name matches one of the service names included in this list.</p> <p>If not included, the NRF shall not filter based on service name.</p> <p>This array shall contain unique items.</p> <p>Example:</p> <pre>NF1 supports services: A, B, C NF2 supports services: C, D, E NF3 supports services: A, C, E NF4 supports services: B, C, D Consumer asks for service-names=A,E NRF returns: NF1 containing service A NF2 containing service E NF3 containing services A, E NF4 is not returned</pre>	
requester-nf-instance-fqdn	Fqdn	O	0..1	<p>This IE may be present for an NF discovery request within the same PLMN as the NRF.</p> <p>If included, this IE shall contain the FQDN of the Requester NF that is invoking the Nnrf_NFDiscovery service.</p> <p>The NRF shall use this to return only those NF profiles that include at least one NF service containing an entry in the "allowedNfDomains" list (see clause 6.1.6.2.3) that matches the domain of the requester NF.</p> <p>This IE shall be ignored by the NRF if it is received from a requester NF belonging to a different PLMN.</p> <p>(NOTE 12)</p>	

target-plmn-list	array(PlmnlId)	C	1..N	<p>This IE shall be included when NF services in a different PLMN, or NF services of specific PLMN ID(s) in a same PLMN comprising multiple PLMN IDs, need to be discovered. When included, this IE shall contain the PLMN ID of the target NF. If more than one PLMN ID is included, NFs from any PLMN ID present in the list matches the query parameter.</p> <p>This IE shall also be included in SNPN scenarios, when the entity owning the subscription, the Credentials Holder (see clause 5.30.2.9 in 3GPP TS 23.501 [2]) is a PLMN.</p> <p>For inter-PLMN service discovery, at most 1 PLMN ID shall be included in the list; it shall be included in the service discovery from the NF in the source PLMN sent to the NRF in the same PLMN, while it may be absent in the service discovery request sent from the source NRF to the target NRF. In such case, if the NRF receives more than 1 PLMN ID, it shall only consider the first element of the array, and ignore the rest.</p>	
requester-plmn-list	array(PlmnlId)	C	1..N	<p>This IE shall be included when NF services in a different PLMN need to be discovered. It may be present when NF services in the same PLMN need to be discovered. When included, this IE shall contain the PLMN ID(s) of the requester NF. (NOTE 12)</p>	
requester-snpn-list	array(PlmnlIdNiId)	C	1..N	<p>This IE shall be included when the Requester NF belongs to one or several SNPNs, and NF services of a specific SNPN or PLMN need to be discovered. The SNPN scenarios include use cases when CH/DCS is using AAA-S or when CH/DCS is using AUSF/UDM, see clauses 5.30.2.9.2, 5.30.2.9.3 and 5.30.2.10.2.2 in 3GPP TS 23.501 [2]). It may be present when NF services from the same SNPN need to be discovered. When present, this IE shall contain the SNPN ID(s) of the requester NF.</p> <p>The NRF shall use this to return only those NF profiles of NF Instances allowing to be discovered from the SNPNs identified by this IE, according to the "allowedSnpls" list in the NF Profile and NF Service (see clauses 6.1.6.2.2 and 6.1.6.2.3).</p>	Query-Params-Ext2
target-nf-instance-id	NfInstanceId	O	0..1	Identity of the NF instance being discovered.	
target-nf-instance-id-list	array(NfInstanceId)	O	2..N	<p>Identities of the NF instances being discovered. (NOTE 26)</p> <p>If included, the NRF shall return the NF profile of each NF instance indicated in this query parameter that is available at the NRF.</p>	Enh-NF-Discovery-Ext1
target-nf-fqdn	Fqdn	O	0..1	FQDN of the target NF instance being discovered.	
hnr-uri	Uri	C	0..1	<p>If included, this IE shall contain the API URI of the NFDISCOVERY Service (see clause 6.2.1) of the home NRF. It shall be included if the Requester NF has previously received such API URI to be used for service discovery (e.g., from the NSSF in the home PLMN as specified in clause 6.1.6.2.11 of 3GPP TS 29.531 [42]).</p>	
snssais	array(Snssai)	O	1..N	<p>If included, this IE shall contain the list of S-NSSAIs that are served by the NF (Service) Instances being discovered. The NRF shall return those NF profiles/NF services of NF (Service) Instances that have at least one of the S-NSSAIs in this list. The S-NSSAIs included in the NF profiles/NF services of NF (Service) Instances returned by the NRF shall be an interclause of the S-NSSAIs requested and the S-NSSAIs supported by those NF (Service) Instances. (NOTE 10)</p> <p>When the NF Profile of the NF Instances being discovered has defined the list of supported S-NSSAIs in the "perPlmnSnssaiList", the discovered NF Instances shall be those having any of the S-NSSAIs included in this "snssais" parameter in any of the PLMNs included in the "target-plmn-list" attribute, if present; if the "target-plmn-list" is not included, the NRF shall assume that the discovery request is for any of the PLMNs it supports.</p>	

additional-snssais	array(ExtSnssai)	O	1..N	<p>This IE may be included if the "snssais" IE is present.</p> <p>If this IE is present and supported by the NRF, when the NRF has successfully discovered NF (service) instances based on the "snssais" IE, the S-NSSAIs included in the NF profiles/NF services of NF (Service) Instances returned by the NRF shall additionally include the interclause of the S-NSSAIs listed in this IE and the S-NSSAIs supported by those NF (Service) Instances.</p> <p>When the NF Profile of the NF Instances in the discovery result has defined the list of supported S-NSSAIs in the "perPlmnSnssaiList", the additional S-NSSAIs to be included shall be the ones supported in the PLMN(s) indicated in the "target-plmn-list" attribute, if present; if the "target-plmn-list" is not present, the additional S-NSSAIs in any supported PLMN(s) shall be included.</p>	Query-SBIProtoc18
requester-snssais	array(ExtSnssai)	O	1..N	<p>If included, this IE shall contain the list of S-NSSAI of the requester NF. If this IE is included in a service discovery in a different PLMN, the requester NF shall provide S-NSSAI values of the target PLMN, that correspond to the S-NSSAI values of the requester NF.</p> <p>The NRF shall use this to return only those NF profiles of NF Instances allowing to be discovered from at least one network slice identified by this IE, according to the "allowedNssais" list in the NF Profile and NF Service (see clause 6.1.6.2.2 and 6.1.6.2.3). (NOTE 12)</p>	
plmn-specific-snssai-list	array(PlmnSnssai)	O	1..N	<p>If included, this IE shall contain the list of S-NSSAI that are served by the NF service being discovered for the corresponding PLMN provided. The NRF shall use this to identify the NF services that have registered their support for the S-NSSAIs for the corresponding PLMN given. The NRF shall return the NF profiles that have at least one S-NSSAI supported in any of the PLMNs provided in this list. The per PLMN list of S-NSSAIs included in the NF profile returned by the NRF shall be an interclause of the list requested and the list registered in the NF profile. (NOTE 10).</p>	
requester-plmn-specific-snssai-list	array(PlmnSnssai)	O	1..N	<p>If included, this IE shall contain the list of S-NSSAI of the requester NF, for each of the PLMNs it supports. The NRF shall use this to return only those NF profiles of NF Instances allowing to be discovered from at least one network slice identified by this IE, according to the "allowedNssais" and "allowedPlmns" attributes in the NF Profile and NF Service (see clause 6.1.6.2.2 and 6.1.6.2.3). (NOTE 12)</p>	Query-Params-Ext3
nsi-list	array(string)	O	1..N	<p>If included, this IE shall contain the list of NSI IDs that are served by the services being discovered.</p>	
dnn	Dnn	O	0..1	<p>If included, this IE shall contain the DNN for which NF services serving that DNN is discovered. DNN may be included if the target NF type is e.g. "BSF", "SMF", "PCF", "PCSCF", "UPF", "EASDF", "TSCTSF", "MB-UPF" or "MB-SMF".</p> <p>The DNN shall contain the Network Identifier and it may additionally contain an Operator Identifier. (NOTE 11).</p> <p>If the Snssai(s) are also included, the NF services serving the DNN shall be available in the network slice(s) identified by the Snssai(s).</p>	
ipv4-index	IpIndex	O	0..1	<p>This IE may be included if the target NF type is "UPF" and the dnn IE is included.</p> <p>When included, this IE shall indicate the IPv4 index that is supported by the candidate UPF.</p>	Query-Upf-IpIndex
ipv6-index	IpIndex	O	0..1	<p>This IE may be included if the target NF type is "UPF" and the dnn IE is included.</p> <p>When included, this IE shall indicate the IPv6 index that is supported by the candidate UPF.</p>	Query-Upf-IpIndex

smf-serving-area	string	O	0..1	If included, this IE shall contain the serving area of the SMF. It may be included if the target NF type is "UPF".	
mbsmf-serving-area	string	O	0..1	If included, this IE shall contain the serving area of the MB-SMF. It may be included if the target NF type is "MB-UPF".	Query-MBS
tai	Tai	O	0..1	Tracking Area Identity. (NOTE 22).	
amf-region-id	AmfRegionId	O	0..1	AMF Region Identity.	
amf-set-id	AmfSetId	O	0..1	AMF Set Identity.	
guami	Guami	O	0..1	Guami used to search for an appropriate AMF. (NOTE 1)	
supi	Supi	O	0..1	If included, this IE shall contain the SUPI of the requester UE to search for an appropriate NF. SUPI may be included if the target NF type is e.g. "PCF", "CHF", "AUSF", "BSF", "UDM", "TSCTSF", "NSSAAF" or "UDR".	
ue-ipv4-address	Ipv4Addr	O	0..1	The IPv4 address of the UE for which a BSF or P-CSCF or UPF needs to be discovered. (NOTE 27)	
ip-domain	string	O	0..1	The IPv4 address domain of the UE for which a BSF needs to be discovered.	
ue-ipv6-prefix	Ipv6Prefix	O	0..1	The IPv6 prefix of the UE for which a BSF or P-CSCF or UPF needs to be discovered. (NOTE 27)	
pgw-ind	boolean	O	0..1	When present, this IE indicates whether a combined SMF/PGW-C or a standalone SMF needs to be discovered. true: A combined SMF/PGW-C is requested to be discovered; false: A standalone SMF is requested to be discovered. (See NOTE 2, NOTE 21)	
preferred-pgw-ind	boolean	O	0..1	When present, this IE indicates whether combined PGW-C+SMF(s) or standalone SMF(s) are preferred. true: Combined PGW-C+SMF(s) are preferred to be discovered; false: Standalone SMF(s) are preferred to be discovered. (See NOTE 2, NOTE 20, NOTE 21)	Query-SBIProtoc17
pgw	Fqdn	O	0..1	If included, this IE shall contain the PGW FQDN which is used by the AMF to find the combined SMF/PGW-C.	
pgw-ip	IpAddr	O	0..1	If included, this IE shall contain the PGW IP Address used by the AMF to find the combined SMF/PGW-C.	Query-SBIProtoc17
gpsi	Gpsi	O	0..1	If included, this IE shall contain the GPSI of the requester UE to search for an appropriate NF. GPSI may be included if the target NF type is "CHF", "PCF", "BSF", "UDM", "TSCTSF" or "UDR".	
external-group-identity	ExtGroupId	O	0..1	If included, this IE shall contain the external group identifier of the requester UE to search for an appropriate NF. This may be included if the target NF type is "UDM", "UDR", "HSS" or "TSCTSF".	
pfd-data	PfdData	O	0..1	When present, this IE shall contain the application identifiers and/or application function identifiers in PFD management. This may be included if the target NF type is "NEF". The NRF shall return those NEF instances which can provide the PFDs for at least one of the provided application identifiers, or for at least one of the provided application function identifiers.	Query-Params-Ext2
data-set	DataSetId	O	0..1	Indicates the data set to be supported by the NF to be discovered. May be included if the target NF type is "UDR".	
routing-indicator	string	O	0..1	Routing Indicator information that allows to route network signalling with SUCI (see 3GPP TS 23.003 [12]) to an AUSF, AAnF and UDM instance capable to serve the subscriber. May be included if the target NF type is "AUSF", "AANF" or "UDM". Pattern: "[0-9]{1,4}\$"	
group-id-list	array(NfGroupId)	O	1..N	Identity of the group(s) of the NFs of the target NF type to be discovered. May be included if the target NF type is "UDR", "UDM", "HSS", "PCF", "AUSF", "BSF", "UDSF" or "CHF".	
dnai-list	array(Dnai)	O	1..N	If included, this IE shall contain the Data network access identifiers. It may be included if the target NF type is "UPF", "SMF", "EASDF" or "NEF".	

upf-iwk-eps-ind	boolean	O	0..1	<p>When present, this IE indicates whether a UPF supporting interworking with EPS needs to be discovered.</p> <p>true: A UPF supporting interworking with EPS is requested to be discovered; false: A UPF not supporting interworking with EPS is requested to be discovered. (NOTE 3)</p>	
chf-supported-plmn	Plmnlid	O	0..1	<p>If included, this IE shall contain the PLMN ID that a CHF supports (i.e., in the PlmnRange of ChfInfo attribute in the NFProfile). This IE may be included when the target NF type is "CHF".</p> <p>When an SMF discovers CHF(s) for a PDU session, the SMF shall set the value of this IE as specified in clause 5.1.9.2 of 3GPP TS 32.255 [46].</p>	
preferred-locality	string	O	0..1	<p>Preferred target NF location (e.g. geographic location, data center).</p> <p>When present, the NRF shall prefer NF profiles with a locality attribute that matches the preferred-locality.</p> <p>The NRF may return additional NFs in the response not matching the preferred target NF location, e.g. if no NF profile is found matching the preferred target NF location.</p> <p>The NRF should set a lower priority for any additional NFs on the response not matching the preferred target NF location than those matching the preferred target NF location. In addition, based on operator's policy, the NRF may set different priorities based on the localities of the NFs. (NOTE 6, NOTE 25)</p>	

ext-preferred-locality	map(array(LocalityDescription))	O	1..N(1..M)	<p>Preferred target NF location (e.g. geographic location, data center).</p> <p>The key of the map shall represent the relative priority, for the requester, of each locality description among the list of locality descriptions in this query parameter, encoded as "1" (highest priority), "2", "3", ..., "n" (lowest priority).</p> <p>When present, the NRF shall prefer NF profiles with an extLocality attribute that matches at least one LocalityDescription of the ext-preferred-locality, with the highest possible priority.</p> <p>The NRF may return additional NFs in the response not matching the preferred target NF location, e.g. if no NF profile is found matching the preferred target NF location.</p> <p>The NRF should set the priority of each NF profile returned in the response based on the priority associated with the matching locality description of the ext-preferred-locality. The NRF should set a lower priority for any additional NFs in the response not matching the preferred target NF location than those matching the preferred target NF location. In addition, based on operator's policy, the NRF may set different priorities based on the localities of the NFs. (NOTE 6)</p> <p><u>Example 1 indicating a preference to discover an NFp in the data center "dc-123" as a first choice, otherwise in the city of Los Angeles or San Diego as a second choice, otherwise in the state of California as a third choice.</u></p> <pre>{ "1": [{localityType: DATA_CENTER, localityValue: "dc-123"}], "2": [{localityType: CITY, localityValue: "Los Angeles"}, {localityType: CITY, localityValue: "San Diego"}], "3": [{localityType: STATE, localityValue: "California"}] }</pre> <p><u>Example 2 indicating a preference to discover an NFp in the data center "dc-123" as a first choice, otherwise in the data center "dc-456" or "dc-789" as a second choice.</u></p> <pre>{ "1": [{localityType: DATA_CENTER, localityValue: "dc-123"}], "2": [{localityType: DATA_CENTER, localityValue: "dc-456"}, {localityType: DATA_CENTER, localityValue: "dc-789"}] }</pre> <p><u>Example 3 indicating a preference to discover an NFp in the city of Bath and in the state of Virginia as a first choice, otherwise in the state of Virginia as a second choice.</u></p> <pre>{ "1": [{localityType: CITY, localityValue: "Bath", addLocDescrItems: [{localityType: STATE, localityValue: "Virginia"}]}, {localityType: STATE, localityValue: "Virginia"}], "2": [{localityType: STATE, localityValue: "Virginia"}] }</pre> <p>(NOTE 25)</p>	Query-SBIProtoc18
access-type	AccessType	C	0..1	<p>If included, this IE shall contain the Access type which is required to be supported by the target Network Function (i.e. SMF).</p>	
supported-features	SupportedFeatures	O	0..1	<p>List of features required to be supported by the target Network Function.</p> <p>This IE may be present only if the service-names attribute is present and if it contains a single service-name. It shall be ignored by the NRF otherwise. (NOTE 4)</p>	

required-features	array(SupportedFeatures)	O	1..N	List of features required to be supported by the target Network Function, as defined by the supportedFeatures attribute in NFService (see clauses 6.1.6.2.3 and 6.2.6.2.4). This IE may be present only if the service-names attribute is present. When present, the required-features attribute shall contain as many entries as the number of entries in the service-names attribute. The n th entry in the required-features attribute shall correspond to the n th entry in the service-names attribute. An entry corresponding to a service for which no specific feature is required shall be encoded as "0". (NOTE 24)	Query-Params-Ext1
complex-query	ComplexQuery	O	0..1	This query parameter is used to override the default logical relationship of query parameters.	Complex-Query
limit	integer	O	0..1	Maximum number of NFProfiles to be returned in the response. Minimum: 1	Query-Params-Ext1
max-payload-size	integer	O	0..1	Maximum content size (before compression, if any) of the response, expressed in kilo octets. When present, the NRF shall limit the number of NF profiles returned in the response such as to not exceed the maximum content size indicated in the request. Default: 124. Maximum: 2000 (i.e. 2 Mo).	Query-Params-Ext1
max-payload-size-ext	integer	O	0..1	Maximum content size (before compression, if any) of the response, expressed in kilo octets. When present, the NRF shall limit the number of NF profiles returned in the response such as to not exceed the maximum content size indicated in the request. This query parameter is used when the consumer supports content size bigger than 2 million octets. Default: 124	Query-Params-Ext2
pdu-session-types	array(PduSessionType)	O	1..N	List of the PDU session type (s) requested to be supported by the target Network Function (i.e. UPF).	Query-Params-Ext1
event-id-list	array(EventId)	O	1..N	If present, this attribute shall contain the list of events requested to be supported by the Nnwdaf AnalyticsInfo Service, the NRF shall return NF which support all the requested events.	Query-Param-Analytics
nwdaf-event-list	array(NwdafEvent)	O	1..N	If present, this attribute shall contain the list of events requested to be supported by the Nnwdaf_EventsSubscription service, the NRF shall return NF which support all the requested events.	Query-Param-Analytics
upf-event-list	array(EventType)	O	1..N	If present, this attribute shall contain the list of events requested to be supported by the Nupf_EventExposure service. The NRF shall return UPFs which support all the requested events.	Query-UPEAS
atsss-capability	AtsssCapability	O	0..1	When present, this IE indicates the ATSSS capability of the target UPF needs to be supported.	MAPDU
upf-ue-ip-addr-ind	boolean	O	0..1	When present, this IE indicates whether a UPF supporting allocating UE IP addresses/prefixes needs to be discovered. true: a UPF supporting UE IP addresses/prefixes allocation is requested to be discovered; false: a UPF not supporting UE IP addresses/prefixes allocation is requested to be discovered.	Query-Params-Ext2
client-type	ExternalClientType	O	0..1	When present, this IE indicates that NF(s) dedicatedly serving the specified Client Type needs to be discovered. This IE may be included when target NF Type is "LMF" and "GMLC". If no NF profile is found dedicatedly serving the requested client type, the NRF may return NF(s) not dedicatedly serving the request client type in the response.	Query-Params-Ext2
lmf-id	LMFIdentification	O	0..1	When present, this IE shall contain LMF identification to be discovered. This may be included if the target NF type is "LMF".	Query-Params-Ext2
an-node-type	AnNodeType	O	0..1	If included, this IE shall contain the AN Node type which is required to be supported by the target Network Function (i.e. LMF).	Query-Params-Ext2

rat-type	RatType	O	0..1	If included, this IE shall contain the RAT type which is required to be supported by the target Network Function (i.e. LMF).	Query-Params-Ext2
target-snpn	PlmnIdNid	C	0..1	This IE shall be included when NF services of a specific SNPN need to be discovered. When included, this IE shall contain the PLMN ID and NID of the target NF. This IE shall also be included in SNPN scenarios, when the entity owning the subscription, the Credentials Holder (see clause 5.30.2.9 in 3GPP TS 23.501 [2]) is an SNPN.	Query-Params-Ext2
af-ee-data	AfEventExposureData	O	0..1	When present, this shall contain the application events, and optionally application function identifiers, application identifiers of the AF(s). This may be included if the target NF type is "NEF".	Query-Params-Ext2
w-agf-info	WAgfInfo	O	0..1	If included, this IE shall contain the W-AGF identifiers of N3 terminations which is received by the SMF to find the combined W-AGF/UPF or the preferred UPF(s) for the W-AGF. The NRF shall return UPFs co-located with the W-AGF if any exists (see wAgfInfo attribute in UpfInfo). Otherwise, if the NRF supports the Query-UPF-Selection-N3GPP feature, the NRF shall return preferred UPF(s) for the W-AGF if any preferred UPF exist (see preferredWagfInfoList attribute in UpfInfo).	Query-Params-Ext2
tngf-info	TngfInfo	O	0..1	If included, this IE shall contain the TNGF identifiers of N3 terminations which is received by the SMF to find the combined TNGF/UPF or the preferred UPF(s) for the TNGF. The NRF shall return UPFs co-located with the TNGF if any exists (see tngfInfo attribute in UpfInfo). Otherwise, if the NRF supports the Query-UPF-Selection-N3GPP feature, the NRF shall return preferred UPF(s) for the TNGF if any preferred UPF exist (see preferredTngfInfoList attribute in UpfInfo).	Query-Params-Ext2
twif-info	TwifInfo	O	0..1	If included, this IE shall contain the TWIF identifiers of N3 terminations which is received by the SMF to find the combined TWIF/UPF or the preferred UPF(s) for the TWIF. The NRF shall return UPFs co-located with the TWIF if any exists (see twifInfo attribute in UpfInfo). Otherwise, if the NRF supports the Query-UPF-Selection-N3GPP feature, the NRF shall return preferred UPF(s) for the TWIF if any preferred UPF exist (see preferredTwifInfoList attribute in UpfInfo).	Query-Params-Ext2
upf-select-epdg-info	EpdgInfo	O	0..1	If included, this IE shall contain the EPDG identifiers of S2b-u terminations which is received by the SMF/PGW-C to find the preferred UPF/PGW-U to serve the ePDG.	Query-UPF-Selection-N3GPP
target-nf-set-id	NfSetId	O	0..1	When present, this IE shall contain the target NF Set ID (as defined in clause 28.12 of 3GPP TS 23.003 [12]) of the NF instances being discovered.	Query-Params-Ext2
target-nf-service-set-id	NfServiceSetId	O	0..1	When present, this IE shall contain the target NF Service Set ID (as defined in clause 28.13 of 3GPP TS 23.003 [12]) of the NF service instances being discovered. If this IE is provided together with the target-nf-set-id IE, the NRF shall return service instances of the NF Service Set indicated in the request and should additionally return equivalent ones, if any.	Query-Params-Ext2
preferred-tai	Tai	O	0..1	When present, the NRF shall prefer NF profiles that can serve the TAI, or the NRF shall return NF profiles not matching the TAI if no NF profile is found matching the TAI. (NOTE 5)	Query-Params-Ext2
nef-id	NefId	O	0..1	When present, this IE shall contain the NEF ID of the NEF to be discovered. This may be included if the target NF type is "NEF". (NOTE 7)	Query-Params-Ext2
preferred-nf-instances	array(NfInstanceId)	O	1..N	When present, this IE shall contain a list of preferred candidate NF instance IDs. (NOTE 8)	Query-Params-Ext2

notification-type	NotificationType	O	0..1	If included, this IE shall contain the notification type of default notification subscriptions that shall be registered in the NFProfile or NFService of the NF Instances being discovered. The NF profiles returned by the NRF shall contain all the registered default notification subscriptions, including the one corresponding to the notification-type parameter. (NOTE 9)	Query-Params-Ext2
n1-msg-class	N1MessageClass	O	0..1	This IE may be included when "notification-type" IE is present with value "N1_MESSAGES". When included, this IE shall contain the N1 message class of default notification subscriptions that shall be registered in the NFProfile or NFService of the NF Instances being discovered. The NF profiles returned by the NRF shall contain all the registered default notification subscriptions, including the one corresponding to the n1-msg-class parameter. (NOTE 9)	Query-Params-Ext3
n2-info-class	N2InformationClass	O	0..1	This IE may be included when "notification-type" IE is present with value "N2_INFORMATION". If included, this IE shall contain the notification type of default notification subscriptions that shall be registered in the NFProfile or NFService of the NF Instances being discovered. The NF profiles returned by the NRF shall contain all the registered default notification subscriptions, including the one corresponding to the n2-info-class parameter. (NOTE 9)	Query-Params-Ext3
serving-scope	array(string)	O	1..N	If present, this attribute shall contain the list of areas that can be served by the NF instances to be discovered. The NRF shall return NF profiles of NFs which can serve all the areas requested in this query parameter. (NOTE 18)	Query-Params-Ext2
ims-domain-name	string	O	1..N	If included, this IE shall contain the IMS domain name to search for an appropriate NF. IMS domain name may be included if the target NF type is "DCSF".	Query-NG-RTC
imsi	string	O	0..1	If included, this IE shall contain the IMSI of the requester UE to search for an appropriate NF. IMSI may be included if the target NF type is "HSS" or "DCSF". pattern: "^[0-9]{5,15}\$"	Query-Params-Ext2
ims-private-identity	string	O	0..1	If included, this IE shall contain the IMS Private Identity of the requester UE to search for an appropriate NF. IMS Private Identity may be included if the target NF type is "HSS" or "DCSF".	Query-Params-Ext3
ims-public-identity	string	O	0..1	If included, this IE shall contain the IMS Public Identity of the requester UE to search for an appropriate NF. IMS Public Identity may be included if the target NF type is "HSS" or "DCSF".	Query-Params-Ext3
msisdn	string	O	0..1	If included, this IE shall contain the MSISDN of the requester UE to search for an appropriate NF. IMS Public Identity may be included if the target NF type is "HSS" or "DCSF".	Query-Params-Ext3
internal-group-identity	GroupId	O	0..1	If included, this IE shall contain the internal group identifier of the UE to search for an appropriate NF. This may be included if the target NF type is "UDM", "NSSAAF" or "TSCTSF".	Query-Params-Ext2

preferred-api-versions	map(string)	O	1..N	<p>When present, this IE indicates the preferred API version of the services that are supported by the target NF instances. The key of the map is the ServiceName (see clause 6.1.6.3.11) for which the preferred API version is indicated. Each element carries the API Version Indication for the service indicated by the key. The NRF may return additional NFs in the response not matching the preferred API versions, e.g. if no NF profile is found matching the preferred-api-versions.</p> <p>An API Version Indication is a string formatted as {operator}+{API Version}.</p> <p>The following operators shall be supported:</p> <p>"=" match a version equals to the version value indicated. ">" match any version greater than the version value indicated ">=" match any version greater than or equal to the version value indicated "<" match any version less than the version value indicated "<=" match any version less than or equal to the version value indicated "^" match any version compatible with the version indicated, i.e. any version with the same major version as the version indicated.</p> <p>Precedence between versions is identified by comparing the Major, Minor, and Patch version fields numerically, from left to right.</p> <p>If no operator or an unknown operator is provided in API Version Indication, "=" operator is applied.</p> <p><u>Example of API Version Indication:</u></p> <p>Case1: "=1.2.4.operator-ext" or "1.2.4.operator-ext" means matching the service with API version "1.2.4.operator-ext" Case2: ">1.2.4" means matching the service with API versions greater than "1.2.4" Case3: "^2.3.0" or "^2" means matching the service with all API versions with major version "2".</p>	Query-Params-Ext2
v2x-support-ind	boolean	O	0..1	<p>When present, this IE indicates whether a PCF supporting V2X Policy/Parameter provisioning needs to be discovered.</p> <p>true: a PCF supporting V2X Policy/Parameter provisioning is requested to be discovered; false: a PCF not supporting V2X Policy/Parameter provisioning is requested to be discovered.</p>	Query-Params-Ext2
redundant-gtpu	boolean	O	0..1	<p>When present, this IE indicates whether a UPF supporting redundant GTP-U path needs to be discovered.</p> <p>true: a UPF supporting redundant GTP-U path is requested to be discovered; false: a UPF not supporting redundant GTP-U path is requested to be discovered.</p>	Query-Params-Ext2
redundant-transport	boolean	O	0..1	<p>When present, this IE indicates whether a UPF supporting redundant transport path on the transport layer in the corresponding network slice needs to be discovered.</p> <p>true: a UPF supporting redundant transport path on the transport layer is requested to be discovered; false: a UPF not supporting redundant transport path on the transport layer is requested to be discovered.</p> <p>If the Snsai(s) are also included, the UPF supporting redundant transport path on the transport layer shall be available in the network slice(s) identified by the Snsai(s).</p>	Query-Params-Ext2

ipups	boolean	O	0..1	When present, this IE indicates whether a UPF which is configured for IPUPS is requested to be discovered. true: a UPF which is configured for IPUPS is requested to be discovered; false: a UPF which is not configured for IPUPS is requested to be discovered.	Query-Params-Ext2
sxa-ind	boolean	O	0..1	When present, this IE indicates whether a UPF which is configured to support Sxa interface is requested to be discovered. true: a UPF which is configured to support Sxa interface is requested to be discovered; false: a UPF which is not configured to support Sxa interface is requested to be discovered.	Query-SBIProtoc18
scp-domain-list	array(string)	O	1..N	When present, this IE shall contain the SCP domain(s) the target NF, SCP or SEPP belongs to. The NRF shall return NF, SCP or SEPP profiles that belong to all the SCP domains provided in this list.	Query-Params-Ext2
address-domain	Fqdn	O	0..1	If included, this IE shall contain the address domain that shall be reachable through the SCP. This IE may be included when the target NF type is "SCP".	Query-Params-Ext2
ipv4-addr	Ipv4Addr	O	0..1	If included, this IE shall contain the IPv4 address that shall be reachable through the SCP. This IE may be included when the target NF type is "SCP".	Query-Params-Ext2
ipv6-prefix	Ipv6Prefix	O	0..1	If included, this IE shall contain the IPv6 prefix that shall be reachable through the SCP. This IE may be included when the target NF type is "SCP".	Query-Params-Ext2
served-nf-set-id	NfSetId	O	0..1	When present, this IE shall contain the NF Set ID that shall be reachable through the SCP. This IE may be included when the target NF type is "SCP".	Query-Params-Ext2
remote-plmn-id	PlmnId	O	0..1	If included, this IE shall contain the remote PLMN ID that shall be reachable through the SCP or SEPP. This IE may be included when the target NF type is "SCP" or "SEPP".	Query-Params-Ext2
remote-snpn-id	PlmnIdNid	O	0..1	If included, this IE shall contain the remote SNPN ID that shall be reachable through the SCP or SEPP. This IE may be included when the target NF type is "SCP" or "SEPP".	Query-ENPN
data-forwarding	boolean	O	0..1	This may be included if the target NF type is "UPF". (NOTE 13) When present, the IE indicates whether UPF(s) configured for data forwarding needs to be discovered. true: UPF(s) configured for data forwarding is requested to be discovered; false: UPF(s) not configured for data forwarding is requested to be discovered.	Query-Params-Ext2
preferred-full-plmn	boolean	O	0..1	When present, the NRF shall prefer NF profile(s) that can serve the full PLMN (i.e. can serve any TAI in the PLMN), or the NRF shall return other NF profiles if no NF profile serving the full PLMN is found: - true: NF instance(s) serving the full PLMN is preferred; - false: NF instance(s) serving the full PLMN is not preferred. (NOTE 14)	Query-Params-Ext2
requester-features	SupportedFeatures	C	0..1	Nnrf_NFDiscovery features supported by the Requester NF that is invoking the Nnrf_NFDiscovery service. This IE shall be included if at least one of the following features is supported by the Requester NF: - Service-Map - Enh-NF-Discovery This IE may be included otherwise.	
realm-id	string	O	0..1	May be included if the target NF type is "UDSF". If included, this IE shall contain the realm-id for which a UDSF shall be discovered.	Query-Params-Ext4

storage-id	string	O	0..1	May be included if the target NF type is "UDSF" and realm-id is included. If included, this IE shall contain the storage-id for the realm-id indicated in the realm-id IE for which a UDSF shall be discovered.	Query-Params-Ext4
vsmf-support-ind	boolean	O	0..1	This IE may be included when the target NF type is "SMF". <ul style="list-style-type: none"> - true: Target SMF(s) supporting V-SMF are preferred to be discovered; - false: Shall be handled the same way as when this optional query parameter is not received, i.e. V-SMF support is not taken as NF discovery criteria. <p>(NOTE 15)</p>	Query-Param-vSmf-Capability
ismf-support-ind	boolean	O	0..1	This IE may be included when the target NF type is "SMF". <ul style="list-style-type: none"> - true: Target SMF(s) supporting I-SMF are preferred to be discovered; - false: Shall be handled the same way as when this optional query parameter is not received, i.e. I-SMF support is not taken as NF discovery criteria. <p>(NOTE 15)</p>	Query-Param-iSmf-Capability
nrf-disc-uri	Uri	C	0..1	If included, this IE shall contain the API URI of the NFDISCOVERY Service (see clause 6.2.1) of the NRF holding the NF Profile. <p>It shall be included if:</p> <ul style="list-style-type: none"> - the target-nf-instance-id or target-nf-instance-id-list is present; - the NF Service Consumer has previously received such API URI in an earlier NF service discovery, i.e. if the target NF instance was provided in the nfiInstanceList attribute in SearchResult (see clause 6.2.6.2.2) and the nrfDiscApiUri attribute was present in the NfiInstanceInfo (see clause 6.2.6.2.7); and - the service discovery request is addressed to a different NRF than the NRF holding the NF profile. 	Enh-NF-Discovery
preferred-vendor-specific-features	map(map(array (VendorSpecificFeature)))	O	1..N(1..M(1..L))	When present, this IE indicates the list of preferred vendor-specific features supported by the target Network Function, as defined by the supportedVendorSpecificFeatures attribute in NFService (see clauses 6.1.6.2.3 and 6.2.6.2.4). NF profiles that support all the preferred features, or by default, NF profiles that contain at least one service supporting the preferred features, should be preferentially returned in the response; NF profiles in the response may not support the preferred features. <p>The key of the external map is the ServiceName (see clause 6.1.6.3.11) for which the preferred vendor-specific features is indicated. Each element carries the preferred vendor-specific features for the service indicated by the key.</p> <p>The key of the internal map is the IANA-assigned "SMI Network Management Private Enterprise Codes" [38]. The string used as key of the internal map shall contain 6 decimal digits; if the SMI code has less than 6 digits, it shall be padded with leading digits "0" to complete a 6-digit string value.</p> <p>The value of each entry of the map shall be a list (array) of VendorSpecificFeature objects.</p> <p>The NF profiles returned by the NRF shall include the full list of vendor-specific-features and not just the interclause of supported and preferred vendor-specific features.</p>	Query-SBIProtocol17

preferred-vendor-specific-nf-features	map(array(VendorSpecificFeature))	O	1..N(1..M)	<p>When present, this IE indicates the list of preferred vendor-specific features supported by the target Network Function, as defined by the supportedVendorSpecificFeatures attribute in NF profile (see clause 6.1.6.2.2 and 6.2.6.2.3). NF profiles that support all the preferred features should be preferentially returned in the response. NF profiles in the response may not support the preferred features.</p> <p>The key of the map is the IANA-assigned "SMI Network Management Private Enterprise Codes" [38]. The value of each entry of the map shall be a list (array) of VendorSpecificFeature objects.</p> <p>The NF profiles returned by the NRF shall include the full list of vendor-specific features and not just the interclause of supported and preferred vendor-specific features.</p>	Query-SBIProtocol17
required-pfcp-features	string	O	0..1	<p>List of features required to be supported by the target UPF or MB-UPF (when selecting a UPF or a MB-UPF), encoded as defined for the supportedPfcpFeatures attribute in UpfInfo (see clause 6.1.6.2.13).</p> <p>(NOTE 16)</p>	Query-Upf-Pfcp
home-pub-key-id	integer	O	0..1	<p>When present, this IE shall indicate the Home Network Public Key ID which shall be able to be served by the NF instance. May be included if the target NF type is "AUSF" or "UDM". This query parameter may only be present if the routing-indicator query parameter is also present.</p> <p>(NOTE 17)</p>	Query-SBIProtocol17
prose-support-ind	boolean	O	0..1	<p>When present, this IE indicates whether supporting ProSe capability by PCF needs to be discovered.</p> <ul style="list-style-type: none"> - true: a PCF supporting ProSe capability is requested to be discovered; - false: a PCF not supporting ProSe capability is requested to be discovered. 	Query-5G-ProSe
analytics-aggregation-ind	boolean	O	0..1	<p>This IE may be included when the target NF type is "NWDAF".</p> <ul style="list-style-type: none"> - true: An NF supporting analytics aggregation capability is requested to be discovered; - false: Shall be handled the same way as when this optional query parameter is not received. 	Query-eNA-PH2
analytics-metadata-prov-ind	boolean	O	0..1	<p>This IE may be included when the target NF type is "NWDAF".</p> <ul style="list-style-type: none"> - true: An NF supporting analytics metadata provisioning capability is requested to be discovered; - false: Shall be handled the same way as when this optional query parameter is not received. 	Query-eNA-PH2
serving-nf-set-id	NfSetId	O	0..1	<p>When present, this IE shall contain the NF Set ID that is served by the DCCF, NWDAF or MFAF. This IE may be included when the target NF type is "DCCF" or "NWDAF" or "MFAF".</p>	Query-eNA-PH2
serving-nf-type	NFType	O	0..1	<p>When present, this IE shall contain the NF type that is served by the DCCF, NWDAF or MFAF. This IE may be included when the target NF type is "DCCF" or "NWDAF" or "MFAF".</p>	Query-eNA-PH2

<p>ml-analytcs-info-list</p>	<p>array(MIAAnalytcsInfo)</p>	<p>O</p>	<p>1..N</p>	<p>If present, this attribute shall contain the list of ML Analytics Filter information per Analytics ID(s) requested to be supported by the Nnwdafl_MLModelProvision Service. The NRF shall return NWDAF profiles that support at least one of the MIAAnalytcsInfo in this list.</p> <p>An NWDAF supports a given MIAAnalytcsInfo in the list when:</p> <ul style="list-style-type: none"> - for attributes of MIAAnalytcsInfo of type array (e.g. VendorID, S-NSSAIs, TAIs...), the NWDAF profile contains at least one of the elements included in the MIAAnalytcsInfo, - if several attributes are included in a same MIAAnalytcsInfo object in the query parameter list, there is one MIAAnalytcsInfo in the NWDAF profile that matches with all of them. <p>EXAMPLE:</p> <p>"nwdaflInfo" of a certain NWDAF instance contains:</p> <pre> "mlAnalytcsList": [{ "mlAnalytcsIds": ["SLICE_LOAD_LEVEL", "NETWORK_PERFORMANCE"], "snssaiList": [{ "sst": 1 }, { "sst": 2 }], "trackingAreaList": [{ "plmnId": { "mcc": "090", "mnc": "880" }, "tac": "cb34" }], "mlModelInterInfo": { "vendorList": ["034523", "109296"] } }] </pre> <p>1) if "ml-analytcs-info-list" query parameter contains 2 MIAAnalytcsInfo objects:</p> <pre> [{ "mlAnalytcsIds": ["SLICE_LOAD_LEVEL"] }, { "snssaiList": [{ "sst": 3 }] }] </pre> <p>the instance is returned (the first MIAAnalytcsInfo item matches).</p> <p>2) if "ml-analytcs-info-list" query parameter contains:</p> <pre> [{ "mlAnalytcsIds": ["NETWORK_PERFORMANCE"], "vendorIdList": ["002145"] }] </pre> <p>the instance is NOT returned (only one MIAAnalytcsInfo is provided, where Vendor ID does not match).</p>	<p>Query-eNA-PH2</p>
<p>nsacf-capability</p>	<p>NsacfCapability</p>	<p>O</p>	<p>0..1</p>	<p>When present, this IE indicates the service capability that the target NSACF needs to support.</p>	<p>NSAC</p>

mbs-session-id-list	array(MbsSessionId)	O	1..N	<p>This IE may be present if the target NF type is "MB-SMF". When present, it shall contain the list of MBS Session ID(s) for which MB-SMF(s) are to be discovered.</p> <p>When present, for each mbs-session-id in the list, the NRF shall determine whether an MB-SMF supporting the mbs-session-id and complying with the other query parameters (if any) exists. An MB-SMF shall be considered to support the mbs-session-id if:</p> <ul style="list-style-type: none"> - the mbs-session-id contains a TMGI that is part of a TMGI range (see tmgiRangeList attribute in clause 6.1.6.2.85) registered by the MB-SMF and, if the tai query parameter is present: - if the TAI indicated in the tai query parameter can be served by the MB-SMF (see taiList and taiRangeList attributes in clause 6.1.6.2.85); <p>or</p> <ul style="list-style-type: none"> - the mbs-session-id contains a TMGI or an SSM address, that is part of the list of MBS sessions currently served by the MB-SMF (see mbsSessionList attribute in clause 6.1.6.2.85) and, if the tai query parameter is present and the MBS session is registered with an MBS Service Area (see mbsServiceArea specified in 3GPP TS 29.571 [7]): - if the TAI indicated in the tai query parameter is supported by the MBS Service Area of the MBS session. <p>If so, the NRF shall return the profile of this MB-SMF. If no MB-SMF supporting the mbs-session-id and complying with the other query parameters exists, the NRF shall return an empty response. See clause 7.1.2 of 3GPP TS 23.247 [43].</p>	Query-MBS
area-session-id	AreaSessionId	O	0..1	<p>This IE may be present if the target NF type is "MB-SMF", the mbs-session-id-list IE is present and contains only one MBS Session ID.</p> <p>When present, the IE shall contain the Area Session ID, for the MBS session indicated in the mbs-session-id-list IE, for which an MB-SMF is to be discovered.</p> <p>When this IE is present, the NRF shall return an MB-SMF profile that currently serves the MBS Session ID and Area Session ID (see mbsSessionList attribute in clause 6.1.6.2.85).</p> <p>If no MB-SMF supports the MBS Session ID and Area Session ID, the NRF shall return an empty response. See clause 7.1.2 of 3GPP TS 23.247 [43].</p>	Query-MBS
gmlc-number	string	O	0..1	<p>If included, this IE shall contain the GMLC Number of which should be supported by the target GMLC. It may be included if the target NF type is "GMLC".</p> <p>Pattern: "[^][0-9]{5,15}\$"</p>	Query-eLCS
upf-n6-ip	IpAddr	O	0..1	<p>If included, this IE shall contain the N6 IP address of PSA UPF.</p> <p>It may be included if the target NF type is "EASDF".</p>	Query-eEDGE-5GC
tai-list	array(Tai)	O	1..N	<p>If included, this IE shall contain the Tracking Area Identities requested to be supported by the NFs being discovered. The NRF shall return NFs which support all the TAIs in the list. It may be included if the target NF type is "NEF", "MB-SMF", "AMF", "NWDAF", "DCCF" or "MFAF". (NOTE 28)</p>	Query-eEDGE-5GC, Query-TAI-LIST
nf-tai-list-ind	boolean	O	0..1	<p>This query parameter may be present with the value true if the tai-list query parameter is present and the NF service consumer supports receiving from the NRF a list of NFs supporting only a subset of the TAs included in the tai-list. (NOTE 28)</p> <p>Presence of this IE with false value shall be prohibited.</p>	Query-SBIProtocol18

preferences-precedence	array(string)	O	2..N	<p>This IE may be present when multiple query parameters expressing a preference are included in the discovery request.</p> <p>When present, this IE shall indicate the relative precedence of these query parameters (from higher precedence to lower precedence). The NRF shall use the indicated precedence to prioritize the candidate NFs in the search result, among the candidate NFs partially matching the different preference query parameters, candidate matching the higher precedence preference query parameter should have higher priority.</p> <p>This IE may include any query parameter named "preferred-xxx" or "ext-preferred-xxx" (e.g. preferred-locality, preferred-tai).</p> <p>Example:</p> <p>preferences-precedence=[preferred-tai, preferred-vendor-specific-features]</p> <p>The above value indicates that the "preferred-tai" parameter has higher precedence than the "preferred-vendor-specific-features" parameter.</p>	Query-SBIProtocol17
support-onboarding-capability	boolean	O	0..1	<p>If present, this attribute indicates the target AMF or SMF instances support SNPN Onboarding. If the target is an SMF, this indicates the SMF also supports User Plane Remote Provisioning. This is used for the case of Onboarding of UEs for SNPNs (see 3GPP TS 23.501 [2], clauses 5.30.2.10 and 6.2.6.2).</p> <ul style="list-style-type: none"> - true: An NF supporting SNPN Onboarding is requested to be discovered; - false: Shall be handled the same way as when this optional query parameter is not received. 	Query-ENPN
uas-nf-functionality-ind	boolean	O	0..1	<p>This IE may be included when the target NF type is "NEF".</p> <ul style="list-style-type: none"> - true: An NF supporting UAS NF functionality is requested to be discovered; - false: Shall be handled the same way as when this optional query parameter is not received. 	Query-ID_UAS
multi-mem-af-sess-qos-ind	boolean	O	0..1	<p>This IE may be included when the target NF type is "NEF".</p> <ul style="list-style-type: none"> - true: An NF supporting Multi-member AF session with required QoS functionality is requested to be discovered. <p>Presence of this IE with false value shall be prohibited.</p>	Query-AIMLsys
member-ue-sel-assist-ind	boolean	O	0..1	<p>This IE may be included when the target NF type is "NEF".</p> <ul style="list-style-type: none"> - true: An NF supporting member UE selection assistance functionality is requested to be discovered; <p>Presence of this IE with false value shall be prohibited.</p>	Query-AIMLsys
v2x-capability	V2xCapability	O	0..1	<p>When present, this IE indicates the V2X capability that the target PCF needs to support.</p> <p>When the v2x-capability is provided as the query parameter, NRF shall return the PCF instances which support all the V2X capabilities requested.</p>	Query-SBIProtocol17
prose-capability	ProSeCapability	O	0..1	<p>When present, this IE indicates the ProSe capability that the target PCF needs to support.</p> <p>When the prose-capability is provided as the query parameter, NRF shall return the PCF instances which support all the ProSe capabilities requested.</p>	Query-5G-ProSe

shared-data-id	SharedDataId	O	0..1	Identifies the shared data that is stored in the NF (UDR) to be discovered. May be included if the target NF type is "UDR"	Query-SBIProtoc17
target-hni	Fqdn	O	0..1	If included, this IE shall contain the Home Network Identifier. If CH/DCS is using AAA Server or AUSF and UDM for primary authentication and authorization (see clauses 5.30.2.9.2, 5.30.2.9.3 and 5.30.2.10.2.2 in 3GPP TS 23.501 [2]), the sender (AMF or AUSF) populates this IE with CH/DCS ID. See also clauses 4.17.4a and 4.17.5a in TS 23.502 [3]. If the target NF is AUSF or NSSAAF and the HNI belongs to a CH/DCS with AAA Server in another domain, i.e. not in this SNPN, the NRF returns back the AUSF or NSSAAF in the same SNPN, based on the NF profile as specified in clause 6.2.6.2 in 3GPP TS 23.501 [2].	Query-ENPN
target-nw-resolution	boolean	O	0..1	If included and set to true, the NRF shall determine the identity of the target PLMN to which the NFDiscovery request shall be directed, based on the MSISDN of the UE included in the "gpsi" query parameter, as described in 3GPP TS 23.540 [48]. If included and set to false, this IE shall be ignored.	Query-Nw-Resolution
exclude-nfinst-list	array(NfInstanceId)	O	1..N	If included, this IE shall indicate the list of NF instances that should not be returned in the NF Discovery response. (NOTE 23)	Query-SBIProtoc17-Ext1
exclude-nfservinst-list	array(NfServiceInstance)	O	1..N	If included, this IE shall indicate the list of NF service instances that should not be returned in the NF Discovery response. (NOTE 23)	Query-SBIProtoc17-Ext1
exclude-nfserviceset-list	array(NfServiceSetId)	O	1..N	If included, this IE shall indicate the list of NF service sets of NF service instances that should not be returned in the NF Discovery response. (NOTE 23)	Query-SBIProtoc17-Ext1
exclude-nfset-list	array(NfSetId)	O	1..N	If included, this IE shall indicate the list of NF sets of NF instances that should not be returned in the NF Discovery response. (NOTE 23)	Query-SBIProtoc17-Ext1
preferred-analytics-delays	map(DurationSec)	O	1..N	If included, this IE shall contain the preferred Analytics Delay. The key of the map is the EventId or NwdafEvent (as defined in 3GPP TS 29.520 [33]) for which the preferred Analytics Delay is related to. Each element carries the preferred Analytics Delay for the Analytics ID indicated by the key. The NRF shall return the NWDAFs supports the Analytics ID with a supported Analytics Delay that is less than or equal to the preferred Analytics Delay, as described in clause 6.3.13 of 3GPP TS 23.501 [2]. The NRF may return NWDAFs in the response not matching the preferred Analytics Delay, e.g. if no NWDAF profile is found matching the preferred Analytics Delay.	Query-eNA-PH2-Ext1
high-latency-com	boolean	O	0..1	If present and set to true, this attribute indicates target AMF(s) instances supporting High Latency communication (e.g. for NR RedCap UE) are required. This is used by CP NF to discover AMF supporting High Latency communication (see 3GPP TS 23.501 [2], clause 6.3.5). Presence of this IE with false value shall be prohibited.	Query-HLC
nsac-sai	NsacSai	O	0..1	If included, it shall indicate the NSAC service area which shall be supported by the target NSACF. It may be included if the target NF type is "NSACF". For NSAC hierarchical or centralized architecture, if this IE is set to "ENTIRE_PLMN", this indicates the NF service consumer wants to discover a primary/central NSACF for the entire PLMN. This IE shall be set to "ENTIRE_PLMN" also in roaming scenarios to discover the HPLMN NSACF as clarified in clause 6.3.22 of 3GPP TS 23.501 [2].	Query-eNS-PH2

complete-profile	boolean	O	0..1	<p>This IE may be included by an SCP with the value true to request to discover the complete profile of NF Instances (including authorization attributes such as the "allowedXXX" attributes of NFProfile and NFService data types) matching the query parameters. See clause 5.3.2.2.2.</p> <p>Presence of this IE with false value shall be prohibited.</p>	Complete-Profile-Discovery
n32-purposes	array(N32Purpose)	O	1..N	<p>This IE may be included when the target NF type is "SEPP". When present, this IE shall indicate the requested N32 purposes to be supported by the SEPP. The NRF shall return SEPP profiles that support at least one requested N32 purpose.</p>	Query-SBIProtocol18
preferred-features	map(SupportedFeatures)	O	1..N	<p>List of features preferred to be supported by the target Network Function, as defined by the supportedFeatures attribute in NFService (see clauses 6.1.6.2.3 and 6.2.6.2.4).</p> <p>The key of the map is the Service Name as specified in clause 6.1.6.3.11. Each element carries the preferred feature(s) to be supported by the target Network Function for the indicated service.</p> <p>The NRF shall prioritize the NF candidates supporting the preferred features in the search result.</p> <p>(NOTE 24)</p>	Query-SBIProtocol18
remote-plmn-id-roaming	PlmnId	O	0..1	<p>If included, this IE shall indicate the remote PLMN that the target NF service producer can serve, i.e. the NF service producer can serve the roaming UEs which belong to the indicated remote PLMN. This IE may be included when the target NF type is "SMSF" or "SMF".</p> <p>When selecting a candidate SMSF, the NRF shall return the candidate NF service producer(s) in discovery result with the following order of preference:</p> <ul style="list-style-type: none"> - NF profiles explicitly indicated the support of roaming UE for the requested remote PLMN; then - NF profiles indicated the support of roaming UE for any remote PLMN; then - if none of above are available, NF profiles without indication of roaming UE support. <p>When selecting a candidate SMF for an LBO PDU session in VPLMN for an inbound roaming UE, the NRF shall return the candidate SMFs in discovery result in the following order:</p> <ul style="list-style-type: none"> - NF profiles with the uePlmnRangeList configured in the DnnSmfInfoltem containing the PLMN ID indicated in the remote-plmn-id-roaming query parameter; otherwise - NF profiles without a uePlmnRangeList being configured, i.e., when there is no specific SMF(s) configured to serve the UEs from the PLMN identified by the remote-plmn-id-roaming query parameter. 	Query-SBIProtocol18
pru-tai	Tai	O	0..1	<p>This may be included if the target NF type is "LMF".</p> <p>When present, this IE indicates whether LMF(s) serving a TAI with PRU(s) existence needs to be discovered.</p>	Query-eLCS-PH3

pru-support-ind	boolean	O	0..1	This IE may be included when the target NF type is "LMF". When present, this IE indicates whether the LMF(s) supporting PRU function need(s) to be discovered. true: target LMF(s) supporting PRU function are requested to be discovered; false: target LMF(s) not supporting PRU function are requested to be discovered.	Query-eLCS-PH3
preferred-up-positioning-ind	boolean	O	0..1	This IE may be included when the target NF type is "LMF". When present, this IE indicates whether the LMF(s) supporting user plane positioning capability are desired to be discovered. true: target LMF(s) supporting user plane positioning capability are desired to be discovered; Presence of this IE with false value shall be prohibited.	Query-eLCS-PH3
af-data	AfData	O	0..1	When present, this IE shall contain the event that is supported by the "AF" for trusted AF discovery.	Query-eLCS-PH3
ml-accuracy-checking-ind	boolean	O	0..1	If present and set to true, this attribute indicates target NWDAF(s) instances containing MTLF with ML Model accuracy checking capability are required. Presence of this IE with false value shall be prohibited.	Query-eNA-PH3
analytics-accuracy-checking-ind	boolean	O	0..1	If present and set to true, this attribute indicates target NWDAF(s) instances containing AnLF with Analytics accuracy checking capability are required. Presence of this IE with false value shall be prohibited.	Query-eNA-PH3
ml-model-storage-ind	boolean	O	0..1	If present and set to true, this attribute indicates target ADRF(s) instances with ML model storage and retrieval capability are required. Presence of this IE with false value shall be prohibited.	Query-eNA-PH3
data-storage-ind	boolean	O	0..1	If present and set to true, this attribute indicates target ADRF(s) instances with data and analytics storage and retrieval capability are required. Presence of this IE with false value shall be prohibited.	Query-eNA-PH3
data-subscription-relocation-support-ind	boolean	O	0..1	If present and set to true, this attribute indicates target DCCF(s) instances with relocation of data subscription support are required. Presence of this IE with false value shall be prohibited.	Query-eNA-PH3
roaming-exchange-ind	boolean	O	0..1	This IE may be included when the target NF type is "NWDAF". - true: An NF supporting roaming exchange capability is requested to be discovered. Presence of this IE with false value shall be prohibited.	Query-eNA-PH3
media-capability-list	array(MediaCapability)	O	1..N	If present, this attribute shall contain the list of media capability that can be served by the NF instances to be discovered. The NRF shall return NF profiles of NFs which can serve all the media capabilities requested in this query parameter.	Query-NG-RTC
a2x-support-ind	boolean	O	0..1	When present, this IE indicates whether a PCF supporting A2X Policy/Parameter provisioning needs to be discovered. - true: a PCF supporting A2X Policy/Parameter provisioning is requested to be discovered Presence of this IE with false value shall be prohibited.	Query-A2X

a2x-capability	A2xCapability	O	0..1	<p>When present, this IE indicates the A2X capability that the target PCF needs to support.</p> <p>When the a2x-capability is provided as the query parameter, NRF shall return the PCF instances which support all the A2X capabilities requested.</p>	Query-A2X
ranging-sl-pos-support-ind	boolean	O	0..1	<p>When present, this IE indicates whether supporting ranging and sidelink positioning capability by PCF/LMF needs to be discovered.</p> <p>- true: a PCF/LMF supporting ranging and sidelink positioning capability is requested to be discovered</p> <p>Presence of this IE with false value shall be prohibited.</p>	Query-5G-RangingSIPos
complete-search-result	boolean	O	0..1	<p>This IE may be present with the value true to indicate that all the NF profiles or NF Instance IDs matching the query parameters are requested to be returned.</p> <p>The presence of this IE with the value false shall be prohibited. (NOTE 29)</p>	Query-SBIProtocol18
ursp-delivery-eps-support-ind	boolean	O	0..1	<p>When present, this IE indicates whether a PCF supporting URSP delivery in EPS needs to be discovered.</p> <p>true: a PCF supporting URSP delivery in EPS is requested to be discovered.</p> <p>Presence of this IE with false value shall be prohibited.</p>	Query_UEPO
dns-sec-protoc	array(DnsSecurityProtocol)	O	1..N	<p>This IE may be present if the target NF type is "EASDF".</p> <p>When present, this IE shall indicate DNS Security Protocols to be supported by the NF instances being discovered.</p> <p>The NRF shall return NF profiles that support at least one of the DNS security protocols in this list. If there is no NF profile including the dnsSecurityProtocols IE matching at least one of the DNS security protocols in this list, the NRF shall return NF profiles not including the dnsSecurityProtocols IE.</p>	Query-EDGE-Ph2
vendor-ids	array(VendorId)	O	1..N	<p>When present, the IE shall contain the list of vendor Id(s) of the NF instance(s) being discovered.</p> <p>The NRF shall return only NF profiles whose vendor Id is in this list.</p> <p>This IE may be present if the target NF type is an "NWDAF" containing "AnLF".</p>	Query-eNA-Ph3_EX T

- NOTE 1: If this parameter is present and no AMF supporting the requested GUAMI is available due to AMF Failure or planned AMF removal, the NRF shall return in the response AMF instances acting as a backup for AMF failure or planned AMF removal respectively for this GUAMI (see clause 6.1.6.2.11). The NRF can detect if an AMF has failed, using the Heartbeat procedure. The NRF will receive a de-registration request from an AMF performing a planned removal.
- NOTE 2: If the combined SMF/PGW-C is requested to be discovered, the NRF shall return in the response the SMF instances registered with the SmfInfo containing pgwFqdn.
- NOTE 3: If a UPF supporting interworking with EPS is requested to be discovered, the NRF shall return in the response the UPF instances registered with the upfInfo containing iwkEpsInd set to true.
- NOTE 4: This attribute has a different semantic than what is defined in clause 6.6.2 of 3GPP TS 29.500 [4], i.e. it is not used to signal optional features of the Nnrf_NFDiscovery Service API supported by the requester NF.
- NOTE 5: The AMF may perform the SMF discovery based on the dnn, snssais and preferred-tai during a PDU session establishment procedure, and the NRF shall return the SMF profiles matching all if possible, or the SMF profiles only matching dnn and snssais. If the SMF profiles only matching dnn and snssais are returned, the AMF shall insert an I-SMF. An SMF may also perform a UPF discovery using this parameter.
- NOTE 6: The SMF may select the P-CSCF close to the UPF by setting the preferred-locality to the value of the locality of the UPF.
- NOTE 7: During EPS to 5GS idle mobility procedure, the Requester NF (i.e. SMF) discovers the anchor NEF for NIDD using the SCEF ID received from EPS as the value of the NEF ID, as specified in clause 4.11.1.3.3 of 3GPP TS 23.502 [3].
- NOTE 8: The service consumer may include a list of preferred-nf-instance-ids in the query. If so, the NRF shall first check if the NF profiles of the preferred NF instances match the other query parameters, and if so, then the NRF shall return the corresponding NF profiles; otherwise, the NRF shall return a list of candidate NF profiles matching the query parameters other than the preferred-nf-instance-ids. For example, the target AMF may set this query parameter to the SMF Instance ID and I-SMF Instance ID during an inter AMF mobility procedure to select an I-SMF.
- NOTE 9: This parameter may be used by the SCP (with other query parameters) to discover and select a NF service consumer with a default notification subscription supporting the notification type of a notification request (see clause 6.10.3.3 of 3GPP TS 29.500 [4]).
- NOTE 10: An S-NSSAI value used in discovery request query parameters shall be considered as matching the S-NSSAI value in the NF Profile or NF Service of a given NF Instance if both the SST and SD components are identical (i.e. an S-NSSAI value where SD is absent, shall not be considered as matching an S-NSSAI where SD is present, regardless if SST is equal in both).
- NOTE 11: The dnn query parameter shall be considered as matching a DNN attribute in the NF Profile of a given NF Instance if:
- both contain the same Network Identifier and Operator Identifier;
 - both contain the same Network Identifier and none contains an Operator Identifier;
 - the dnn query parameter contains the Network Identifier only, the DNN value in the NF Profile contains both the Network Identifier and Operator Identifier, and both contain the same Network Identifier; or
 - the dnn query parameter contains both the Network Identifier and Operator Identifier, the DNN value in the NF Profile contains the Network Identifier only, both contain the same Network Identifier and the Operator Identifier matches one PLMN of the NF (i.e. plmnList of the NF Profile).
- NOTE 12: Based on operator's policies, a discovery request not including the requester's information necessary to validate the authorization parameters in NF Profiles may be rejected or accepted but with only returning in the discovery response NF Instances whose authorization parameters allow any NF Service Consumer to access their services. The authorization parameters in NF Profile are those used by NRF to determine whether a given NF Instance / NF Service Instance can be discovered by an NF Service Consumer in order to consume its offered services (e.g. "allowedNfTypes", "allowedNfDomains", etc.).
- NOTE 13: Different UPF instances for data forwarding may be configured in the network e.g. for different serving areas. The SMF may use this query parameter together with others (like SMF Serving Area or TAI) in discovery to select the UPF candidate for data forwarding.
- NOTE 14: For HR roaming, if the V-PLMN requires Deployments Topologies with specific SMF Service Areas (DTSSA) but no H-SMF can be selected supporting V-SMF change, AMF may use this query parameter to select a V-SMF serving the full VPLMN if available.
- NOTE 15: The AMF may perform discovery with this parameter to find V-SMF(s)/I-SMF(s), and the NRF shall return the SMF profiles that explicitly indicated support of V-SMF/I-SMF(s) capability, if the vsmf-support-ind/ismf-support-ind query parameter is present and set to true. When performing discovery, the AMF shall use other query parameters together with this IE to ensure the required configurations and/or features are supported by the V-SMF/I-SMF(s), e.g. required Slice for the PDU session, support of DTSSA feature if V-SMF change is required for PDU Session, etc. If no SMF instances that explicitly indicated support of V-SMF/I-SMF(s) capability can be matched for the discovery, the NRF shall return matched SMF instances not indicating support of V-SMF/I-SMF(s) capability explicitly, i.e. the SMF instances not registered vsmfSupportInd/ismfSupportInd IE in the NF profile but matched to the rest query parameters, if available.
- NOTE 16: When required-pfcp-features is used as query parameter, the NRF shall return a list of candidate UPFs supporting all the required PCF features. The NRF may also return UPF profiles not including the "SupportedPfcFeatures" attribute (e.g. pre-Rel-17 UPFs) but matching the other query parameters. The NF Service Consumer, e.g. a SMF, when using required-pfcp-features as query parameter, shall also include the query parameter corresponding to the UPF features (atsss-capability, upf-ue-ip-addr-ind, redundant-

<p>gtpu) which correspond to the PFCP feature flags MPTCP and ATSSS_LL, UEIP, and RTTL respectively, if the corresponding PFCP feature is required. For example an SMF, that wishes to select a UPF supporting UE IP Address Allocation by the UP function, shall set the UEIP flag to "1" in the required-pfcp-features and also include the upf-ue-ip-addr-ind parameter set to "true".</p> <p>NOTE 17: In this release, the usage of Home Network Public Key identifier for AUSF/UDM discovery is limited to the scenario where the AUSF/UDM NF consumers belong to the same PLMN as AUSF/UDM.</p> <p>NOTE 18: The NF service consumer may derive the serving scope from e.g. the TAI of the UE, using local configuration. This parameter may be used to discover any NF that registers to the NRF, e.g. a 5GC NF or a P-CSCF.</p> <p>NOTE 19: If the NRF supports the "Collocated-NF-Selection" feature and the NF service consumer has included the "preferred-collocated-nf-types" attribute, the NRF shall return a list of candidates NFs (for the target-nf-type) matching the discovery query parameters and preferentially supporting CollocatedNFType(s) as indicated in the preferred-collocated-nf-types.</p> <p>NOTE 20: If the NRF supports this IE and the NF service consumer has included this IE with the value "true" in discovery request, the NRF shall look up and return PGW-C+SMF instances matching the other query parameters. If no matching is found, the NRF shall return a list of standalone SMF instances matching the other query parameters. If the NRF supports this IE and the NF service consumer has included this IE with the value "false" in discovery request, the NRF shall look up and return standalone SMF instances matching the other query parameters. If no matching is found, the NRF shall return a list of PGW-C+SMF instances matching the other query parameters.</p> <p>NOTE 21: Either pgw-ind IE or preferred-pgw-ind IE may be included in the discovery request.</p> <p>NOTE 22: MB-SMF may use an NRF to discover the AMF(s) serving an MBS service area (see clause 7.3.1 in 3GPP TS 23.247 [43]). For this purpose, the MB-SMF may use query parameters specified in this table, e.g. 'tai' and 'service-names', or 'snssais', or any other parameters.</p> <p>NOTE 23: This parameter may be set by an NF service consumer or SCP to filter-out specific NF (service) instances or NF (service) sets from the NF Discovery response, e.g. when the NFc knows that an NF service producer is not responsive or overloaded. See the 3gpp-Sbi-Selection-Info header in clause 5.2.3.3.10 of 3GPP TS 29.500 [4].</p> <p>NOTE 24: A feature shall not be included in both required-features IE and preferred-features IE in the same discovery request.</p> <p>NOTE 25: When Locality is configured in NSACF(s), an NSACF consumer, e.g. AMF or SMF, may use a locally configured NSACF Locality to discover the candidate NSACF, or otherwise may use its own Locality to discover the candidate NSACF. When Locality is configured in MRF(s) or MRFP(s), an MRF/MRFP consumer, e.g. IMS entity, may use a locally configured MRF/MRFP Locality to discover the candidate MRF/MRFP, or otherwise may use its own Locality to discover the candidate MRF/MRFP. When Locality is configured in MF, an MF consumer, e.g. IMS AS, may use a locally configured MF Locality to discover the candidate MF, or otherwise may use its own Locality to discover the candidate MF.</p> <p>NOTE 26: Only one of the target-nf-instance-id and target-nf-instance-id-list query parameters may be present in an NF Discovery Request.</p> <p>NOTE 27: When the query parameter "ue-ipv4-address" or "ue-ipv6-prefix" is used to discover a UPF as specified in clause 4.15.10 of 3GPP TS 23.502 [3], the NRF shall find a match by looking into either natedIpv4AddressRanges or natedIpv6PrefixRanges in the DnnUpfInfoItem.</p> <p>NOTE 28: If the NF service consumer includes a "tai-list" query parameter and the "nf-tai-list-ind" query parameter set to true, and if the NRF supports the same and the NRF is not able to find any NF supporting all TAs included in the tai-list, the NRF may return a list of NFs in the SearchResult where each NF supports at least one TA in the tai-list; in this case, the NRF should attempt to return a list of NFs that altogether support as many TAs from the tai-list as possible, and it should indicate in the SearchResultInfo attribute the list of TAs from the tai-list which are not supported by these NFs.</p> <p>NOTE 29: The NRF should return as many matching NF profiles and/or NF Instance IDs as possible in the NF Discovery Response. If all the NF profiles matching the query parameters cannot be returned in the NF Discovery response (e.g. due to the maximum payload size), the NRF may decide to store the complete search result for subsequent retrieval by the NRF consumer (see clause 6.2.3.4). Alternatively, the NRF may include all the NF instance IDs rather than NF profiles in the NF Discovery response (using the Enh-NF-Discovery feature, see clause 5.3.2.2.2).</p>
--

When certain query parameters in the discovery request are not supported by the NRF, the NRF shall ignore the unsupported query parameters and continue processing the request with the supported query parameters. The default logical relationship among the supported query parameters is logical "AND", i.e. all the provided query parameters shall be matched, with the exception of the "preferred-locality", "ext-preferred-locality", "preferred-nf-instances", "preferred-tai", "preferred-api-versions", "preferred-full-plmn", "preferred-collocated-nf-types", "preferred-pgw-ind", "preferred-analytics-delays", "preferred-features" and "mbs-session-id" query parameters (see Table 6.2.3.2.3.1-1).

The NRF may support the Complex query expression as defined in 3GPP TS 29.501 [5] for the NF Discovery service. If the "complexQuery" query parameter is included, then the logical relationship among the query parameters contained in "complexQuery" query parameter is as defined in 3GPP TS 29.571 [7].

A NRF not supporting Complex query expression shall reject a NF service discovery request including a complexQuery parameter, with a ProblemDetails IE including the cause attribute set to INVALID_QUERY_PARAM and the invalidParams attribute indicating the complexQuery parameter.

This method shall support the request data structures specified in table 6.1.3.2.3.1-2 and the response data structures and response codes specified in table 6.1.3.2.3.1-3.

Table 6.2.3.2.3.1-2: Data structures supported by the GET Request Body on this resource

Data type	P	Cardinality	Description
n/a			

Table 6.2.3.2.3.1-3: Data structures supported by the GET Response Body on this resource

Data type	P	Cardinality	Response codes	Description
SearchResult	M	1	200 OK	The response body contains the result of the search over the list of registered NF Instances.
RedirectResponse	O	0..1	307 Temporary Redirect	The response shall be used when the intermediate NRF redirects the service discovery request. The NRF shall include in this response a Location header field containing a URI pointing to the resource located on the redirect target NRF. If an SCP redirects the message to another SCP then the location header field shall contain the same URI or a different URI pointing to the endpoint of the NF service producer to which the request should be sent.
ProblemDetails	O	0..1	400 Bad Request	The response body contains the error reason of the request message. If the query parameter used to match the authorization parameter is required but not provided in the NF discovery request, the "cause" attribute shall be set to "MANDATORY_QUERY_PARAM_MISSING", and the missing query parameter shall be indicated. The "cause" attribute shall be set to "INVALID_CLIENT" if some or all attributes of the NF Service Consumer in query parameters do not match the requester information in, e.g. its public key certificate.
ProblemDetails	O	0..1	403 Forbidden	This response shall be returned if the Requester NF is not allowed to discover the NF Service(s) being queried.
ProblemDetails	O	0..1	404 Not Found	This response shall be returned if the requested resource URI as defined in clause 6.2.3.2.2 (query parameter not considered) is not found in the server. It may also be sent in hierarchical NRF deployments when the NRF needs to forward/redirect the request to another NRF but lacks information in the request to do so; similarly, the NRF shall return this response code when it is received from the upstream NRF.
ProblemDetails	O	0..1	500 Internal Server Error	The response body contains the error reason of the request message.

Table 6.2.3.2.3.1-4: Headers supported by the GET method on this endpoint

Name	Data type	P	Cardinality	Description
If-None-Match	string	C	0..1	Validator for conditional requests, as described in IETF RFC 9110 [40], clause 13.1.2

Table 6.2.3.2.3.1-5: Headers supported by the 200 Response Code on this endpoint

Name	Data type	P	Cardinality	Description
Cache-Control	string	C	0..1	Cache-Control containing max-age, described in IETF RFC 9111 [20], clause 5.2
ETag	string	C	0..1	Entity Tag containing a strong validator, described in IETF RFC 9110 [40], clause 8.8.3

Table 6.2.3.2.3.1-6: Headers supported by the 307 Response Code on this endpoint

Name	Data type	P	Cardinality	Description
Location	string	M	1	The URI pointing to the resource located on the redirect target NRF

Table 6.2.3.2.3.1-7: Links supported by the 200 Response Code on this endpoint

Name	Resource name	HTTP method or custom operation	Parameters table	Description
search	Stored Search (Document)	GET	6.2.3.2.3.1-8	The 'searchId' parameter returned in the response can be used as the 'searchId' parameter in the GET request to '/searches/{searchId}'
completeSearch	Complete Stored Search (Document)	GET	6.2.3.2.3.1-9	The 'searchId' parameter returned in the response can be used as the 'searchId' parameter in the GET request to '/searches/{searchId}/complete'

6.2.3.2.4 Resource Custom Operations

There are no resource custom operations for the Nnrf_NFDDiscovery service in this release of the specification.

6.2.3.3 Resource: Stored Search (Document)

6.2.3.3.1 Description

This resource represents a search result (i.e. a number of discovered NF Instances), stored by NRF as a consequence of a prior search result.

This resource is modelled as the Document resource archetype (see clause C.3 of 3GPP TS 29.501 [5]).

6.2.3.3.2 Resource Definition

Resource URI: {apiRoot}/nnrf-disc/v1/searches/{searchId}

This resource shall support the resource URI variables defined in table 6.2.3.3.2-1.

Table 6.2.3.3.2-1: Resource URI variables for this resource

Name	Data type	Definition
apiRoot	string	See clause 6.1.1
searchId	string	Identifier of a stored search result, returned by NRF to the NF Consumer in the original response to the NF Discovery GET operation (see clause 6.2.6.2.2).

6.2.3.3.2.1 GET

This method retrieves the NF Instances corresponding to a given stored search result.

This method shall support the URI query parameters specified in table 6.2.3.3.2.1-1.

Table 6.2.3.3.2.1-1: URI query parameters supported by the GET method on this resource

Name	Data type	P	Cardinality	Description
n/a				

This method shall support the request data structures specified in table 6.2.3.3.2.1-2 and the response data structures and response codes specified in table 6.2.3.3.2.1-3.

Table 6.2.3.3.2.1-2: Data structures supported by the GET Request Body on this resource

Data type	P	Cardinality	Description
n/a			

Table 6.2.3.3.2.1-3: Data structures supported by the GET Response Body on this resource

Data type	P	Cardinality	Response codes	Description
StoredSearchResult	M	1	200 OK	The response body contains the NF Instances corresponding to a given stored search result.
NOTE: The mandatory HTTP error status codes for the GET method listed in Table 5.2.7.1-1 of 3GPP TS 29.500 [4] other than those specified in the table above also apply, with a ProblemDetails data type (see clause 5.2.7 of 3GPP TS 29.500 [4]).				

6.2.3.4 Resource: Complete Stored Search (Document)

6.2.3.4.1 Description

This resource represents a complete search result (i.e. a number of discovered NF Instances), stored by NRF as a consequence of a prior search result, but without applying any client restrictions in terms of the number of instances to be returned (i.e. "limit" or "max-payload-size" query parameters).

This resource is modelled as the Document resource archetype (see clause C.3 of 3GPP TS 29.501 [5]).

6.2.3.4.2 Resource Definition

Resource URI: {apiRoot}/nnrf-disc/v1/searches/{searchId}/complete

This resource shall support the resource URI variables defined in table 6.2.3.4.2-1.

Table 6.2.3.4.2-1: Resource URI variables for this resource

Name	Data type	Definition
apiRoot	string	See clause 6.1.1
searchId	string	Identifier of a stored search result, returned by NRF to the NF Consumer in the original response to the NF Discovery GET operation (see clause 6.2.6.2.2).

6.2.3.4.2.1 GET

This method retrieves the NF Instances corresponding to a given stored search result.

This method shall support the URI query parameters specified in table 6.2.3.4.2.1-1.

Table 6.2.3.4.2.1-1: URI query parameters supported by the GET method on this resource

Name	Data type	P	Cardinality	Description
n/a				

This method shall support the request data structures specified in table 6.2.3.4.2.1-2 and the response data structures and response codes specified in table 6.2.3.4.3.1-3.

Table 6.2.3.4.2.1-2: Data structures supported by the GET Request Body on this resource

Data type	P	Cardinality	Description
n/a			

Table 6.2.3.4.2.1-3: Data structures supported by the GET Response Body on this resource

Data type	P	Cardinality	Response codes	Description
StoredSearchResult	M	1	200 OK	The response body contains the NF Instances corresponding to a given stored search result, but without applying any client restrictions in terms of the number of instances to be returned (i.e. "limit" or "max-payload-size" query parameters).
NOTE: The mandatory HTTP error status codes for the GET method listed in Table 5.2.7.1-1 of 3GPP TS 29.500 [4] other than those specified in the table above also apply, with a ProblemDetails data type (see clause 5.2.7 of 3GPP TS 29.500 [4]).				

6.2.3.5 Resource: SCP Domain Routing Information (Document)

6.2.3.5.1 Description

This resource represents (local) SCP Domain Routing Information, calculated by NRF based on SCPs registered in the network (or in the producer NRF for local SCP Domain Routing Information).

This resource is modelled as the Document resource archetype (see clause C.3 of 3GPP TS 29.501 [5]).

6.2.3.5.2 Resource Definition

Resource URI: **{apiRoot}/nnrf-disc/v1/scp-domain-routing-info**

This resource shall support the resource URI variables defined in table 6.2.3.5.2-1.

Table 6.2.3.5.2-1: Resource URI variables for this resource

Name	Data type	Definition
apiRoot	string	See clause 6.2.1

6.2.3.5.2.1 GET

This method retrieves the (local) SCP Domain Routing Information.

This method shall support the URI query parameters specified in table 6.2.3.5.2.1-1.

Table 6.2.3.5.2.1-1: URI query parameters supported by the GET method on this resource

Name	Data type	P	Cardinality	Description
local	boolean	O	0..1	When present, this IE shall indicate whether local SCP Domain Routing Information is to be fetched: - true: local SCP Domain Routing Information to be fetched. - false (default): SCP Domain Routing Information to be fetched

This method shall support the request data structures specified in table 6.2.3.5.2.1-2 and the response data structure and response codes specified in table 6.2.3.5.2.1-3.

Table 6.2.3.5.2.1-2: Data structures supported by the GET Request Body on this resource

Data type	P	Cardinality	Description
n/a			

Table 6.2.3.5.2.1-3: Data structures supported by the GET Response Body on this resource

Data type	P	Cardinality	Response codes	Description
ScpDomainRoutingInfo	M	1	200 OK	The response body contains SCP Domain Routing Information.
NOTE: The mandatory HTTP error status codes for the GET method listed in Table 5.2.7.1-1 of 3GPP TS 29.500 [4] other than those specified in the table above also apply, with a ProblemDetails data type (see clause 5.2.7 of 3GPP TS 29.500 [4]).				

6.2.3.6 Resource: SCP Domain Routing Information Subscriptions (Collection)

6.2.3.6.1 Description

This resource represents a collection of subscriptions of (local) SCP Domain Routing Information.

6.2.3.6.2 Resource Definition

Resource URI: {apiRoot}/nnrf-disc/v1/scp-domain-routing-info subs

This resource shall support the resource URI variables defined in table 6.2.3.6.2-1.

Table 6.1.3.6.2-1: Resource URI variables for this resource

Name	Data type	Definition
apiRoot	string	See clause 6.2.1

6.2.3.6.3 Resource Standard Methods

6.2.3.6.3.1 POST

This method creates a new subscription. This method shall support the URI query parameters specified in table 6.2.3.6.3.1-1.

Table 6.2.3.6.3.1-1: URI query parameters supported by the POST method on this resource

Name	Data type	P	Cardinality	Description
n/a				

This method shall support the request data structures specified in table 6.2.3.6.3.1-2 and the response data structure and response codes specified in table 6.2.3.6.3.1-3.

Table 6.2.3.6.3.1-2: Data structures supported by the POST Request Body on this resource

Data type	P	Cardinality	Description
ScpDomainRoutingInfoSubscription	M	1	The request body contains the input parameters for the subscription.

Table 6.2.3.6.3.1-3: Data structures supported by the POST Response Body on this resource

Data type	P	Cardinality	Response codes	Description
ScpDomainRoutingInfoSubscription	M	1	201 Created	This case represents the successful creation of a subscription. Upon success, the HTTP response shall include a "Location" HTTP header that contains the resource URI of the created resource.

NOTE: The mandatory HTTP error status codes for the POST method listed in Table 5.2.7.1-1 of 3GPP TS 29.500 [4] other than those specified in the table above also apply, with a ProblemDetails data type (see clause 5.2.7 of 3GPP TS 29.500 [4]).

Table 6.2.3.6.3.1-4: Headers supported by the 201 Response Code on this resource

Name	Data type	P	Cardinality	Description
Location	string	M	1	Contains the URI of the newly created resource, according to the structure: {apiRoot}/nnrf-disc/v1/scp-domain-routing-info-subs/{subscriptionId}

6.2.3.7 Resource: Individual SCP Domain Routing Information Subscription (Document)

6.2.3.7.1 Description

This resource represents an individual subscription of (local) SCP Domain Routing Information.

6.2.3.7.2 Resource Definition

Resource URI: {apiRoot}/nnrf-disc/v1/scp-domain-routing-info-subs/{subscriptionID}

This resource shall support the resource URI variables defined in table 6.2.3.7.2-1.

Table 6.2.3.7.2-1: Resource URI variables for this resource

Name	Data type	Definition
apiRoot	string	See clause 6.2.1
subscriptionID	string	Represents a specific subscription

6.2.3.7.3 Resource Standard Methods

6.2.3.7.3.1 DELETE

This method terminates an existing subscription. This method shall support the URI query parameters specified in table 6.2.3.7.3.1-1.

Table 6.2.3.7.3.1-1: URI query parameters supported by the DELETE method on this resource

Name	Data type	P	Cardinality	Description
n/a				

This method shall support the request data structures specified in table 6.2.3.7.3.1-2 and the response data structure and response codes specified in table 6.2.3.7.3.1-3.

Table 6.2.3.7.3.1-2: Data structures supported by the DELETE Request Body on this resource

Data type	P	Cardinality	Description
n/a			

Table 6.2.3.7.3.1-3: Data structures supported by the DELETE Response Body on this resource

Data type	P	Cardinality	Response codes	Description
n/a			204 No Content	
NOTE: The mandatory HTTP error status codes for the DELETE method listed in Table 5.2.7.1-1 of 3GPP TS 29.500 [4] other than those specified in the table above also apply, with a ProblemDetails data type (see clause 5.2.7 of 3GPP TS 29.500 [4]).				

6.2.4 Custom Operations without associated resources

There are no custom operations defined without any associated resources for the Nnrf_NFDDiscovery service in this release of this specification.

6.2.5 Notifications

6.2.5.1 General

This clause specifies the notifications provided by the Nnrf_NFDDiscovery service.

The delivery of notifications shall be supported as specified in clause 6.2 of 3GPP TS 29.500 [4] for Server-initiated communication.

Table 6.2.5.1-1: Notifications overview

Notification	Resource URI	HTTP method or custom operation	Description (service operation)
SCP Domain Routing Information Change Notification	{callbackUri} (NF Service Consumer provided callback reference)	POST	Notify about change of SCP Domain Routing Information

6.2.5.2 SCP Domain Routing Information Change Notification

6.2.5.2.1 Description

The NF Service Consumer provides a callback URI for getting notified about change of (local) SCP Domain Routing Information, the NRF shall notify the NF Service Consumer, when the (local) SCP Domain Routing Information is updated.

6.2.5.2.2 Notification Definition

The POST method shall be used for SCP Domain Routing Information Change Notification and the URI shall be the callback reference provided by the NF Service Consumer during the subscription to this notification.

Resource URI: {callbackUri}

Support of URI query parameters are specified in table 6.2.5.2.2-1.

Table 6.2.5.2.2-1: URI query parameters supported by the POST method

Name	Data type	P	Cardinality	Description
n/a				

Support of request data structures is specified in table 6.2.5.2.2-2, and support of response data structures and response codes is specified in table 6.2.5.2-3.

Table 6.2.5.2.2-2: Data structures supported by the POST Request Body

Data type	P	Cardinality	Description
ScpDomainRoutingInfoNotification	M	1	Representation of the SCP Domain Routing Information Change Notification.

Table 6.2.5.2.2-3: Data structures supported by the POST Response Body

Data type	P	Cardinality	Response codes	Description
N/A			204 No Content	This case represents a successful notification of SCP Domain Routing Information Change.
NOTE: The mandatory HTTP error status codes for the POST method listed in Table 5.2.7.1-1 of 3GPP TS 29.500 [4] other than those specified in the table above also apply, with a ProblemDetails data type (see clause 5.2.7 of 3GPP TS 29.500 [4]).				

6.2.6 Data Model

6.2.6.1 General

This clause specifies the application data model supported by the API.

Table 6.2.6.1-1 specifies the data types defined for the Nnrf_NFDiscovery service based interface protocol.

Table 6.2.6.1-1: Nnrf_NFDiscovery specific Data Types

Data type	Clause defined	Description
SearchResult	6.2.6.2.2	Contains the list of NF Profiles returned in a Discovery response.
NFProfile	6.2.6.2.3	Information of an NF Instance discovered by the NRF.
NFService	6.2.6.2.4	Information of a given NF Service Instance; it is part of the NFProfile of an NF Instance discovered by the NRF.
StoredSearchResult	6.2.6.2.5	Contains a complete search result (i.e. a number of discovered NF Instances), stored by NRF as a consequence of a prior search result.
PreferredSearch	6.2.6.2.6	Contains information on whether the returned NFProfiles match the preferred query parameters.
NfInstanceInfo	6.2.6.2.7	Contains information on an NF profile matching a discovery request.
ScpDomainRoutingInfo	6.2.6.2.8	SCP Domain Routing Information
ScpDomainConnectivity	6.2.6.2.9	SCP Domain Routing Information
ScpDomainRoutingInfoSubscription	6.2.6.2.10	SCP Domain Routing Information Subscription
ScpDomainRoutingInfoNotification	6.2.6.2.11	Notification for SCP Domain Routing Information Update
NfServiceInstance	6.2.6.2.12	NF service instance
NoProfileMatchInfo	6.2.6.2.13	No Profile Matching information
QueryParamCombination	6.2.6.2.14	Contains a list of query parameters
QueryParameter	6.2.6.2.15	Contains name and value of a query parameter
AfData	6.2.6.2.16	Contains information supported by the trusted AF.
SearchResultInfo	6.2.6.2.17	Contains additional information related to the SearchResult.

Table 6.2.6.1-2 specifies data types re-used by the Nnrf_NFDiscovery service-based interface protocol from other specifications and from other service APIs in current specification, including a reference to the respective specifications and when needed, a short description of their use within the Nnrf_NFDiscovery service-based interface.

Table 6.2.6.1-2: Nnrf_NFDiscovery re-used Data Types

Data type	Reference	Comments
Snssai	3GPP TS 29.571 [7]	
Plmnld	3GPP TS 29.571 [7]	
Dnn	3GPP TS 29.571 [7]	
Tai	3GPP TS 29.571 [7]	
SupportedFeatures	3GPP TS 29.571 [7]	
NfInstanceId	3GPP TS 29.571 [7]	Identifier (UUID) of the NF Instance. The hexadecimal letters of the UUID should be formatted by the sender as lower-case characters and shall be handled as case-insensitive by the receiver.
Uri	3GPP TS 29.571 [7]	
Gpsi	3GPP TS 29.571 [7]	
Groupld	3GPP TS 29.571 [7]	
Guami	3GPP TS 29.571 [7]	
IPv4Addr	3GPP TS 29.571 [7]	
IPv6Addr	3GPP TS 29.571 [7]	
UriScheme	3GPP TS 29.571 [7]	
Dnai	3GPP TS 29.571 [7]	
NfGroupld	3GPP TS 29.571 [7]	Identifier of a NF Group
PduSessionType	3GPP TS 29.571 [7]	
AtsssCapability	3GPP TS 29.571 [7]	
PlmnldNid	3GPP TS 29.571 [7]	
NfSetld	3GPP TS 29.571 [7]	
NfServiceSetld	3GPP TS 29.571 [7]	
ExtSnssai	3GPP TS 29.571 [7]	
DurationSec	3GPP TS 29.571 [7]	
RedirectResponse	3GPP TS 29.571 [7]	Response body of the redirect response message.
MbsSessionld	3GPP TS 29.571 [7]	MBS Session Identifier
IpAddr	3GPP TS 29.571 [7]	IP Address
AreaSessionld	3GPP TS 29.571 [7]	Area Session Identifier used for an MBS session with location dependent content
Fqdn	3GPP TS 29.571 [7]	Fully Qualified Domain Name
NsacSai	3GPP TS 29.571 [7]	NSAC Service Area Identifier
Eventld	3GPP TS 29.520 [32]	Defined in Nnwdaf_AnalyticsInfo API.
NwdafEvent	3GPP TS 29.520 [32]	Defined in Nnwdaf_EventsSubscription API.
ExtGroupld	3GPP TS 29.503 [36]	
SharedDataId	3GPP TS 29.503 [36]	
ExternalClientType	3GPP TS 29.572 [33]	
SupportedGADShapes	3GPP TS 29.572 [33]	Supported GAD Shapes
EventType	3GPP TS 29.564 [49]	Event type supported by the UPF Event Exposure service
DefaultNotificationSubscription	Clause 6.1.6.2.4	Defined in Nnrf_NFManagement API.
IPEndPoint	Clause 6.1.6.2.5	Defined in Nnrf_NFManagement API.
NFType	Clause 6.1.6.3.3	Defined in Nnrf_NFManagement API.
UdrInfo	Clause 6.1.6.2.6	Defined in Nnrf_NFManagement API.
UdmInfo	Clause 6.1.6.2.7	Defined in Nnrf_NFManagement API.
AusfInfo	Clause 6.1.6.2.8	Defined in Nnrf_NFManagement API.
SupiRange	Clause 6.1.6.2.9	Defined in Nnrf_NFManagement API.
AmfInfo	Clause 6.1.6.2.11	Defined in Nnrf_NFManagement API.
SmfInfo	Clause 6.1.6.2.12	Defined in Nnrf_NFManagement API.
UpfInfo	Clause 6.1.6.2.13	Defined in Nnrf_NFManagement API.
PcfInfo	Clause 6.1.6.2.20	Defined in Nnrf_NFManagement API.
BsfInfo	Clause 6.1.6.2.21	Defined in Nnrf_NFManagement API.
ChfInfo	Clause 6.1.6.2.32	Defined in Nnrf_NFManagement API.
NFServiceVersion	Clause 6.1.6.2.19	Defined in Nnrf_NFManagement API.
PlmnSnssai	Clause 6.1.6.2.44	Defined in Nnrf_NFManagement API.
NwdafInfo	Clause 6.1.6.2.45	Defined in Nnrf_NFManagement API.
NFStatus	Clause 6.1.6.3.7	Defined in Nnrf_NFManagement API.
DataSetld	Clause 6.1.6.3.8	Defined in Nnrf_NFManagement API.
ServiceName	Clause 6.1.6.3.11	Defined in Nnrf_NFManagement API.
NFServiceStatus	Clause 6.1.6.3.12	Defined in Nnrf_NFManagement API.
LmfInfo	Clause 6.1.6.2.46	Defined in Nnrf_NFManagement API.
GmlcInfo	Clause 6.1.6.2.47	Defined in Nnrf_NFManagement API.
NefInfo	Clause 6.1.6.2.48	Defined in Nnrf_NFManagement API.
PfdData	Clause 6.1.6.2.49	Defined in Nnrf_NFManagement API.
AfEventExposureData	Clause 6.1.6.2.50	Defined in Nnrf_NFManagement API.

PcscfInfo	Clause 6.1.6.2.53	Defined in Nnrf_NFManagement API.
HssInfo	Clause 6.1.6.2.57	Defined in Nnrf_NFManagement API.
ImsiRange	Clause 6.1.6.2.58	Defined in Nnrf_NFManagement API.
VendorSpecificFeature	Clause 6.1.6.2.62	Defined in Nnrf_NFManagement API.
ScplInfo	Clause 6.1.6.2.65	Defined in Nnrf_NFManagement API.
NefId	Clause 6.1.6.3.2	Defined in Nnrf_NFManagement API.
VendorId	Clause 6.1.6.3.2	Defined in Nnrf_NFManagement API.
AnNodeType	Clause 6.1.6.3.13	Defined in Nnrf_NFManagement API.
SucilInfo	Clause 6.1.6.2.71	Defined in Nnrf_NFManagement API.
SeppInfo	Clause 6.1.6.2.72	Defined in Nnrf_NFManagement API.
NsacfInfo	Clause 6.1.6.2.81	Defined in Nnrf_NFManagement API.
NsacfCapability	Clause 6.1.6.2.82	Defined in Nnrf_NFManagement API.
MIAnalyticsInfo	Clause 6.1.6.2.84	Defined in Nnrf_NFManagement API.
MbSmfInfo	Clause 6.1.6.2.85	Defined in Nnrf_NFManagement API.
TsctsInfo	Clause 6.1.6.2.91	Defined in Nnrf_NFManagement API.
MbUpfInfo	Clause 6.1.6.2.94	Defined in Nnrf_NFManagement API.
TrustAfInfo	Clause 6.1.6.2.96	Defined in Nnrf_NFManagement API.
CollocatedNfInstance	Clause 6.1.6.2.99	Defined in Nnrf_NFManagement API.
NsaaafInfo	Clause 6.1.6.2.104	Defined in Nnrf_NFManagement API.
IwmscInfo	Clause 6.1.6.2.108	Defined in Nnrf_NFManagement API.
MnpfInfo	Clause 6.1.6.2.109	Defined in Nnrf_NFManagement API.
LocalityDescriptionItem	Clause 6.1.6.2.111	Defined in Nnrf_NFManagement API.
LocalityDescription	Clause 6.1.6.2.112	Defined in Nnrf_NFManagement API.
DcsfInfo	Clause 6.1.6.2.114	Defined in Nnrf_NFManagement API.
MrfInfo	Clause 6.1.6.2.117	Defined in Nnrf_NFManagement API.
MrfpInfo	Clause 6.1.6.2.118	Defined in Nnrf_NFManagement API.
MfInfo	Clause 6.1.6.2.119	Defined in Nnrf_NFManagement API.
LocalityType	Clause 6.1.6.3.18	Defined in Nnrf_NFManagement API.
AdrfInfo	Clause 6.1.6.2.122	Defined in Nnrf_NFManagement API.
SelectionConditions	Clause 6.1.6.2.123	Defined in Nnrf_NFManagement API.
CallbackUriPrefixItem	Clause 6.1.6.2.127	Defined in Nnrf_NFManagement API.
DnsSecurityProtocol	Clause 6.1.6.3.22	Defined in Nnrf_NFManagement API.

6.2.6.2 Structured data types

6.2.6.2.1 Introduction

This clause defines the structures to be used in resource representations.

6.2.6.2.2 Type: SearchResult

Table 6.2.6.2.2-1: Definition of type SearchResult

Attribute name	Data type	P	Cardinality	Description	Applicability
validityPeriod	integer	M	1	It shall contain the time in seconds during which the discovery result is considered valid and can be cached by the NF Service Consumer. This value shall be the same as the value contained in the "max-age" parameter of the "Cache-Control" header field sent in the HTTP response.	
nflInstances	array(NFProfile)	M	0..N	It shall contain an array of NF Instance profiles, matching the search criteria indicated by the query parameters of the discovery request. If the nflInstancesList IE is absent, an empty array means there is no NF instance that can match the search criteria. NF instance profiles included in this IE shall not contain authorization attributes (such as the "allowedXXX" attributes of the NFProfile or NFService data types).	
completeNflInstances	array(NFProfile)	C	1..N	When present, it shall contain an array of complete NF Instance profiles (including authorization attributes such as the "allowedXXX" attributes of the NFProfile or NFService data types), matching the search criteria indicated by the query parameters of the discovery request. This IE shall only be present if the NRF supports the "Complete-Profile-Discovery" feature, the "complete-profile" query parameter is present and set to true in the request (see clause 6.2.3.2.3.1) and if the requesting entity is authorized to discover the complete profile of NF instances.	
searchId	string	O	0..1	This IE may be present if the NRF stores the result of the current service discovery response in a given URL (server-side caching), to make it available in the future to NF Service Consumers without having to compute the whole search process again.	
numNflInstComplete	Uint32	O	0..1	This IE may be present when the total number of NF Instances found by NRF, as the result of the service discovery process, is higher than the actual number of NF Instances included in the attribute nflInstances of the SearchResult object. This may happen due to the NF Service Consumer including in the discovery request parameters such as "limit" or "max-payload-size".	
preferredSearch	PreferredSearch	C	0..1	This IE shall be present to indicate whether all the returned NFProfiles match the preferred query parameters, if the discovery request contains any of the query parameter defined in the PreferredSearch data type.	
nrfSupportedFeatures	SupportedFeatures	C	0..1	Features supported by the NRF for the NFDiscovery service (see clause 6.2.9). This IE should be present if the NRF supports at least one feature.	
nflInstanceList	map(NflInstanceInfo)	O	1..N	This IE may be present if the NF Discovery request indicated support of the Enh-NF-Discovery feature. When present, this IE shall contain a map of NflInstanceInfo of NF instance profiles matching the search criteria indicated by the query parameters of the discovery request. The key of the map shall be the NF instance ID. (NOTE 2)	

searchResultInfo	SearchResultInfo	C	0..1	This IE should be present if the NF Discovery Request includes a tai-list query parameter and the "nf-tai-list-ind" query parameter set to true, when the NFs included in the nfnInstances or nfnInstanceList altogether support only a subset of TAs included in the tai-list.	Query-SBIProtoc18
alteredPriorityInd	boolean	O	0..1	This IE shall indicate whether the NRF altered the priority values returned in the search result or not. (NOTE 1, NOTE 3) When present, this IE shall be set as following: - true: NF instances with NRF altered priority are returned in the search result. - false: the NRF has not altered priority values in any NF instance returned in the search result	
noProfileMatchInfo	NoProfileMatchInfo	O	0..1	This IE may be present if an empty array of nfnInstances is conveyed and the nfnInstancesList IE is absent; otherwise it shall be absent. If present, it shall indicate the specific reason for not finding any NF instance that can match the search criteria.	
ignoredQueryParams	array(string)	O	1..N	This IE may be present when the NRF has ignored unsupported query parameters when processing the discovery request. When present, this IE shall list the ignored unsupported query parameters for this discovery. Each array item shall uniquely indicate one ignored query parameter, with the query parameter name as specified in Table 6.2.3.2.3.1-1.	
<p>NOTE 1: If NRF altered priority values are returned in the search result, when the NF consumer receives a different priority value in a subsequent NF Profile change notification for NF instance(s) returned in the search result, the NF consumer should not overwrite the NRF altered priority in the cached search result.</p> <p>NOTE 2: If the alteredPriorityInd IE is present and set to true and the nrfAlteredPriorities IE is not included for a certain NF instance of the nfnInstanceList, the NF consumer shall apply the priorities retrieved in the corresponding NF profile for this NF instance when selecting a NF service producer for the corresponding NF Discovery request.</p> <p>NOTE 3: This IE shall be set if the NRF altered the priority values of one or more NF instances returned in the search result, regardless of whether the NF instances are returned in the nfnInstances IE and/or nfnInstanceList IE.</p>					

6.2.6.2.3 Type: NFProfile

Table 6.2.6.2.3-1: Definition of type NFProfile

Attribute name	Data type	P	Cardinality	Description	Applicability
nflInstanceid	NflInstanceid	M	1	Unique identity of the NF Instance.	
nfType	NFType	M	1	Type of Network Function	
nfStatus	NFStatus	M	1	Status of the NF Instance	
collocatedNflInstances	array(CollocatedNflInstance)	O	1..N	Information related collocated NF type(s) and corresponding NF Instance(s) when the NF is collocated with NFs supporting other NF types	
nflInstanceName	string	O	0..1	Human readable name of the NF Instance	
plmnList	array(PlmnId)	C	1..N	PLMN(s) of the Network Function (NOTE 5). This IE shall be present if this information is available for the NF. If neither the plmnList IE nor the snpnList IE were provided by the NF during registration, the NRF should return the list of PLMN ID(s) of the PLMN of the NRF. If both the plmnList IE and the snpnList IE are absent in the response, PLMN ID(s) of the PLMN of the NRF are assumed for the NF.	
sNssais	array(ExtSnsai)	O	1..N	S-NSSAIs of the Network Function. If not provided, and if the perPlmnSnsaiList attribute is not present, the NF can serve any S-NSSAI. If the sNSSAIs attribute is provided in at least one NF Service, the sNssais attribute in the NF Profile shall be present and be the set or a superset of the sNSSAIs of the NFService(s).	
perPlmnSnsaiList	array(PlmnSnsai)	O	1..N	The per-PLMN list of S-NSSAI(s) supported by the Network Function. If the perPlmnSnsaiList attribute is provided in at least one NF Service, the perPlmnSnsaiList attribute in the NF Profile shall be present and be the set or a superset of the perPlmnSnsaiList of the NFService(s).	
nsiList	array(string)	O	1..N	List of NSIs of the Network Function. If not provided, the NF can serve any NSI.	
fqdn	Fqdn	C	0..1	FQDN of the Network Function (NOTE 1, NOTE 3, NOTE 11)	
interPlmnFqdn	Fqdn	C	0..1	If the requester-plmn-list query parameter is absent in the NF Discovery request, or if is present and the requester's PLMN is the same as the PLMN of the discovered NF, then this attribute shall be included by the NRF and it shall contain the interPlmnFqdn value registered by the NF during NF registration (see clause 6.1.6.2.2), if the interPlmnFqdn attribute was registered in the NF profile. This attribute shall be absent if the requester-plmn in the query parameter is different from the PLMN of the discovered NF. (NOTE 3, NOTE 14)	
ipv4Addresses	array(Ipv4Addr)	C	1..N	IPv4 address(es) of the Network Function (NOTE 1, NOTE 11)	
ipv6Addresses	array(Ipv6Addr)	C	1..N	IPv6 address(es) of the Network Function (NOTE 1, NOTE 11)	

allowedPlmns	array(PlmnId)	C	1..N	<p>PLMNs allowed to access the NF instance.</p> <p>This attribute may be present in a complete NF profile (i.e. in the completeNfInstances IE in the SearchResult or StoredSearchResult data types). It shall not be present otherwise.</p> <p>If not provided, any PLMN is allowed to access the NF.</p>	
allowedSnpns	array(PlmnIdNid)	C	1..N	<p>SNPNs allowed to access the NF instance.</p> <p>This attribute may be present in a complete NF profile (i.e. in the completeNfInstances IE in the SearchResult or StoredSearchResult data types). It shall not be present otherwise.</p> <p>If this attribute is present in the NFService and in the NF profile, the attribute from the NFService shall prevail.</p> <p>The absence of this attribute in both the NFService and in the NF profile indicates that no SNPN, other than the SNPN(s) registered in the snpnList attribute of the NF Profile (if the NF pertains to an SNPN), is allowed to access the service instance.</p>	
allowedNfTypes	array(NFType)	C	1..N	<p>Type of the NFs allowed to access the NF instance.</p> <p>This attribute may be present in a complete NF profile (i.e. in the completeNfInstances IE in the SearchResult or StoredSearchResult data types). It shall not be present otherwise.</p> <p>If not provided, any NF type is allowed to access the NF.</p>	
allowedNfDomains	array(string)	C	1..N	<p>Pattern (regular expression according to the ECMA-262 dialect [8]) representing the NF domain names within the PLMN of the NRF allowed to access the NF instance.</p> <p>This attribute may be present in a complete NF profile (i.e. in the completeNfInstances IE in the SearchResult or StoredSearchResult data types). It shall not be present otherwise.</p> <p>If not provided, any NF domain is allowed to access the NF.</p>	
allowedNssais	array(ExtSnsai)	C	1..N	<p>S-NSSAI of the allowed slices to access the NF instance.</p> <p>This attribute may be present in a complete NF profile (i.e. in the completeNfInstances IE in the SearchResult or StoredSearchResult data types). It shall not be present otherwise.</p> <p>If not provided, any slice is allowed to access the NF.</p>	

allowedRuleSet	map(RuleSet)	O	1..N	<p>Map of rules specifying NF-Consumers allowed or denied to access NF-Producer. The key of the map shall be a (unique) valid JSON string per clause 7 of IETF RFC 8259 [22], with a maximum of 32 characters.</p> <p>This IE may be present in a complete NF profile (i.e. in the completeNfInstances IE in the SearchResult or StoredSearchResult data types) if the NF-Consumer supports Allowed-ruleset feature as specified in Clause 6.2.9. It shall not be present otherwise.</p>	
capacity	integer	O	0..1	Static capacity information within the range 0 to 65535, expressed as a weight relative to other NF instances of the same type; if capacity is also present in the nfServiceList parameters, those will have precedence over this value. (See NOTE 2)	
load	integer	O	0..1	Latest known load information of the NF within the range 0 to 100 in percentage (See NOTE 4)	
loadTimeStamp	DateTime	O	0..1	It indicates the point in time in which the latest load information of the NF Instance was sent from the NF to the NRF.	
locality	string	O	0..1	Operator defined information about the location of the NF instance (e.g. geographic location, data center)	
extLocality	map(string)	O	1..N	<p>Operator defined information about the location of the NF instance. (NOTE 3)</p> <p>The key of the map shall be a (unique) valid JSON string per clause 7 of IETF RFC 8259 [22], with a maximum of 32 characters, representing a type of locality as defined in clause 6.1.6.3.18.</p> <p>Example:</p> <pre>{ "DATA_CENTER": "dc-123", "CITY": "Los Angeles", "STATE": "California" }</pre>	
priority	integer	O	0..1	<p>Priority (relative to other NFs of the same type) within the range 0 to 65535, to be used for NF selection; lower values indicate a higher priority. Priority may or may not be present in the nfServiceList parameters, xxxInfo parameters and in this attribute. Priority in the nfServiceList has precedence over the priority in this attribute. (NOTE 2)</p> <p>Priority in xxxInfo parameter shall only be used to determine the relative priority among NF instances with the same priority at NFProfile/NFService.</p>	
udrInfo	UdrInfo	O	0..1	Specific data for the UDR (ranges of SUPI, ...)	

udrInfoList	map(UdrInfo)	O	1..N	Multiple entries of UdrInfo. This attribute provides additional information to the udrInfo. udrInfoList may be present even if the udrInfo is absent. The key of the map shall be a (unique) valid JSON string per clause 7 of IETF RFC 8259 [22], with a maximum of 32 characters.	
udmInfo	UdmInfo	O	0..1	Specific data for the UDM	
udmInfoList	map(UdmInfo)	O	1..N	Multiple entries of UdmInfo. This attribute provides additional information to the udmInfo. udmInfoList may be present even if the udmInfo is absent. The key of the map shall be a (unique) valid JSON string per clause 7 of IETF RFC 8259 [22], with a maximum of 32 characters.	
ausInfo	AusInfo	O	0..1	Specific data for the AUSF	
ausInfoList	map(AusInfo)	O	1..N	Multiple entries of AusInfo. This attribute provides additional information to the ausInfo. ausInfoList may be present even if the ausInfo is absent. The key of the map shall be a (unique) valid JSON string per clause 7 of IETF RFC 8259 [22], with a maximum of 32 characters.	
amfInfo	AmfInfo	O	0..1	Specific data for the AMF (AMF Set ID, ...)	
amfInfoList	map(AmfInfo)	O	1..N	Multiple entries of AmfInfo. This attribute provides additional information to the amfInfo. amfInfoList may be present even if the amfInfo is absent. The key of the map shall be a (unique) valid JSON string per clause 7 of IETF RFC 8259 [22], with a maximum of 32 characters.	
smfInfo	SmfInfo	O	0..1	Specific data for the SMF (DNN's, ...). (NOTE 8)	
smfInfoList	map(SmfInfo)	O	1..N	Multiple entries of SmfInfo. This attribute provides additional information to the smfInfo. smfInfoList may be present even if the smfInfo is absent. The key of the map shall be a (unique) valid JSON string per clause 7 of IETF RFC 8259 [22], with a maximum of 32 characters. (NOTE 8)	
upfInfo	UpfInfo	O	0..1	Specific data for the UPF (S-NSSAI, DNN, SMF serving area, ...)	
upfInfoList	map(UpfInfo)	O	1..N	Multiple entries of UpfInfo. This attribute provides additional information to the upfInfo. upfInfoList may be present even if the upfInfo is absent. The key of the map shall be a (unique) valid JSON string per clause 7 of IETF RFC 8259 [22], with a maximum of 32 characters.	
pcfInfo	PcfInfo	O	0..1	Specific data for the PCF	
pcfInfoList	map(PcfInfo)	O	1..N	Multiple entries of PcfInfo. This attribute provides additional information to the pcfInfo. pcfInfoList may be present even if the pcfInfo is absent. The key of the map shall be a (unique) valid JSON string per clause 7 of IETF RFC 8259 [22], with a maximum of 32 characters.	
bsfInfo	BsfInfo	O	0..1	Specific data for the BSF	

bsflInfoList	map(BsflInfo)	O	1..N	Multiple entries of BsflInfo. This attribute provides additional information to the bsflInfo. bsflInfoList may be present even if the bsflInfo is absent. The key of the map shall be a (unique) valid JSON string per clause 7 of IETF RFC 8259 [22], with a maximum of 32 characters.	
chflInfo	ChflInfo	O	0..1	Specific data for the CHF	
chflInfoList	map(ChflInfo)	O	1..N	Multiple entries of ChflInfo. This attribute provides additional information to the chflInfo. chflInfoList may be present even if the chflInfo is absent. The key of the map shall be a (unique) valid JSON string per clause 7 of IETF RFC 8259 [22], with a maximum of 32 characters.	
udsflInfo	UdsflInfo	O	0..1	Specific data for the UDSF	
udsflInfoList	map(UdsflInfo)	O	1..N	Multiple entries of udsflInfo. This attribute provides additional information to the udsflInfo. udsflInfoList may be present even if the udsflInfo is absent. The key of the map shall be a (unique) valid JSON string per clause 7 of IETF RFC 8259 [22], with a maximum of 32 characters.	
neflInfo	NeflInfo	O	0..1	Specific data for the NEF	
nwdafInfo	NwdafInfo	O	0..1	Specific data for the NWDAF	
nwdafInfoList	map(NwdafInfo)	O	1..N	Multiple entries of nwdafInfo. This attribute provides additional information to the nwdafInfo. nwdafInfoList may be present even if the nwdafInfo is absent. The key of the map shall be a (unique) valid JSON string per clause 7 of IETF RFC 8259 [22], with a maximum of 32 characters.	
pcscflInfoList	map(PcscflInfo)	O	1..N	Specific data for the P-CSCF. The key of the map shall be a (unique) valid JSON string per clause 7 of IETF RFC 8259 [22], with a maximum of 32 characters. (NOTE 7)	
hsslInfoList	map(HsslInfo)	O	1..N	Specific data for the HSS. The key of the map shall be a (unique) valid JSON string per clause 7 of IETF RFC 8259 [22], with a maximum of 32 characters.	
customInfo	object	O	0..1	Specific data for custom Network Functions	
recoveryTime	DateTime	O	0..1	Timestamp when the NF was (re)started	
nfServicePersistence	boolean	O	0..1	- true: If present, and set to true, it indicates that the different service instances of a same NF Service in the NF instance, supporting a same API version, are capable to persist their resource state in shared storage and therefore these resources are available after a new NF service instance supporting the same API version is selected by a NF Service Consumer (see 3GPP TS 23.527 [27]). - false (default): Otherwise, it indicates that the NF Service Instances of a same NF Service are not capable to share resource state inside the NF Instance.	

nfServices	array(NFService)	O	1..N	List of NF Service Instances. (NOTE 10) This attribute is deprecated; the attribute "nfServiceList" should be used instead.	
nfServiceList	map(NFService)	O	1..N	Map of NF Service Instances, where the "serviceInstanceId" attribute of the NFService object shall be used as the key of the map. (NOTE 10)	
defaultNotificationSubscriptions	array(DefaultNotificationSubscription)	O	1..N	Notification endpoints for different notification types. (NOTE 6) (See also NOTE 10 in clause 6.1.6.2.2)	
lmfInfo	LmfInfo	O	0..1	Specific data for the LMF	
gmlcInfo	GmlcInfo	O	0..1	Specific data for the GMLC	
snpnList	array(PlmnIdNid)	C	1..N	SNPN(s) of the Network Function. This IE shall be present if the NF pertains to one or more SNPNs.	
nfSetIdList	array(NfSetId)	C	1..N	NF Set ID defined in clause 28.12 of 3GPP TS 23.003 [12]. At most one NF Set ID shall be indicated per PLMN-ID or SNPN of the NF. At most one combination of an AMF region and an AMF Set ID shall be indicated per PLMN-ID or SNPN in an AMF profile. This information shall be present if available.	
servingScope	array(string)	O	1..N	The served area(s) of the NF instance. The absence of this attribute does not imply the NF instance can serve every area.	
lchSupportInd	boolean	O	0..1	This IE indicates whether the NF supports Load Control based on LCI Header (see clause 6.3 of 3GPP TS 29.500 [4]). - true: the NF supports the feature. - false (default): the NF does not support the feature.	
olchSupportInd	boolean	O	0..1	This IE indicates whether the NF supports Overload Control based on OCI Header (see clause 6.4 of 3GPP TS 29.500 [4]). - true: the NF supports the feature. - false (default): the NF does not support the feature.	
nfSetRecoveryTimeList	map(DateTime)	O	1..N	Map of recovery time, where the key of the map is the NfSetId of NF Set(s) that the NF instance belongs to. When present, the value of each entry of the map shall be the recovery time of the NF Set indicated by the key.	
serviceSetRecoveryTimeList	map(DateTime)	O	1..N	Map of recovery time, where the key of the map is the NfServiceSetId of the NF Service Set(s) configured in the NF instance. When present, the value of each entry of the map shall be the recovery time of the NF Service Set indicated by the key.	
scpDomains	array(string)	O	1..N	When present, this IE shall carry the list of SCP domains the SCP belongs to, or the SCP domain the NF (other than SCP) or the SEPP belongs to. (NOTE 9)	
scplInfo	ScplInfo	O	0..1	Specific data for the SCP.	
seppInfo	SeppInfo	O	0..1	Specific data for the SEPP.	

vendorId	VendorId	O	0..1	Vendor ID of the NF instance, according to the IANA-assigned "SMI Network Management Private Enterprise Codes" [38].	
supportedVendorSpecificFeatures	map(array(VendorSpecificFeature))	O	1..N(1..M)	Map of Vendor-Specific features, where the key of the map is the IANA-assigned "SMI Network Management Private Enterprise Codes" [38]. The string used as key of the map shall contain 6 decimal digits; if the SMI code has less than 6 digits, it shall be padded with leading digits "0" to complete a 6-digit string value. The value of each entry of the map shall be a list (array) of VendorSpecificFeature objects. (NOTE 12)	
aanfInfoList	map(AanfInfo)	O	1..N	Specific data for the AANF. The key of the map shall be a (unique) valid JSON string per clause 7 of IETF RFC 8259 [22], with a maximum of 32 characters.	
mfafInfo	MfafInfo	O	0..1	Specific data for the MFAF.	
easdfInfoList	map(EasdfInfo)	O	1..N	Specific data for the EASDF. The key of the map shall be a (unique) valid JSON string per clause 7 of IETF RFC 8259 [22], with a maximum of 32 characters. (NOTE 13)	
dccfInfo	DccfInfo	O	0..1	Specific data for the DCCF.	
nsacfInfoList	map(NsacfInfo)	O	1..N	Specific data for the NSACF. The key of the map shall be a (unique) valid JSON string per clause 7 of IETF RFC 8259 [22], with a maximum of 32 characters.	
mbSmfInfoList	map(MbSmfInfo)	O	1..N	MB-SMF specific data. The key of the map shall be a (unique) valid JSON string per clause 7 of IETF RFC 8259 [22], with a maximum of 32 characters.	
tsctsfInfoList	map(TsctsfInfo)	O	1..N	Specific data for the TSCTSF. The key of the map shall be a (unique) valid JSON string per clause 7 of IETF RFC 8259 [22], with a maximum of 32 characters.	
mbUpfInfoList	map(MbUpfInfo)	O	1..N	MB-UPF specific data. The key of the map shall be a (unique) valid JSON string per clause 7 of IETF RFC 8259 [22], with a maximum of 32 characters.	
trustAfInfo	TrustAfInfo	O	0..1	Specific data for the trusted AF.	
nssaafInfo	NssaafInfo	O	0..1	Specific data for the NSSAAF.	
hniList	array(Fqdn)	C	1..N	Identifications of Credentials Holder or Default Credentials Server. This IE shall be present if the NFs are available for the case of access to an SNPN using credentials owned by a Credentials Holder or for the case of SNPN Onboarding using a DCS.	
iwmsclInfo	IwmsclInfo	O	0..1	Specific data for the SMS-IWMSC.	
mnpfInfo	MnpfInfo	O	0..1	Specific data for the MNPF.	
smsfInfo	SmsfInfo	O	0..1	Specific data for the SMSF.	
dcfsInfoList	map(DcfsInfo)	O	1..N	DCSF specific data. The key of the map shall be a (unique) valid JSON string per clause 7 of IETF RFC 8259 [22], with a maximum of 32 characters.	

mrflInfoList	map(MrflInfo)	O	1..N	MRF specific data. The key of the map shall be a (unique) valid JSON string per clause 7 of IETF RFC 8259 [22], with a maximum of 32 characters.	
mrfpInfoList	map(MrflInfo)	O	1..N	MRFP specific data. The key of the map shall be a (unique) valid JSON string per clause 7 of IETF RFC 8259 [22], with a maximum of 32 characters.	
mflInfoList	map(MflInfo)	O	1..N	MF specific data. The key of the map shall be a (unique) valid JSON string per clause 7 of IETF RFC 8259 [22], with a maximum of 32 characters.	
adrflInfoList	map(AdrflInfo)	O	1..N	ADRF specific data. The key of the map shall be a (unique) valid JSON string per clause 7 of IETF RFC 8259 [22], with a maximum of 32 characters.	
selectionConditions	SelectionConditions	O	0..1	This IE is only applicable if the NFStatus is set to "CANARY_RELEASE", or if the "canaryRelease" attribute is set to true. If present, it includes the conditions under which an NF Instance with an NFStatus value set to "CANARY_RELEASE", or with a "canaryRelease" attribute is set to true, shall be selected by an NF Service Consumer (e.g. if the UE belongs to a range of SUPIs)	
canaryRelease	boolean	O	0..1	This IE indicates whether an NF instance whose nfStatus is set to "REGISTERED" is in Canary Release condition, i.e. it should only be selected by NF Service Consumers under the conditions indicated by the "selectionConditions" attribute. - true: the NF is under Canary Release condition, even if the "nfStatus" is set to "REGISTERED" - false (or absent): the NF instance indicates its Canary Release condition via the "nfStatus" attribute	
exclusiveCanaryReleaseSelection	boolean	O	0..1	This IE indicates whether an NF Service Consumer should only select an NF Service Producer in Canary Release condition. - true: the consumer shall only select producers in Canary Release condition - false (or absent): the consumer may select producers not in Canary Release condition	
sharedProfileDataId	string	O	0..1	String uniquely identifying SharedProfileData. The format of the sharedProfileDataId shall be a Universally Unique Identifier (UUID) version 4, as described in IETF RFC 4122 [18]. The hexadecimal letters should be formatted as lower-case characters by the sender, and they shall be handled as case-insensitive by the receiver. Example: "4ace9d34-2c69-4f99-92d5-a73a3fe8e23b"	Shared-Data

- NOTE 1: At least one of the addressing parameters (fqdn, ipv4address or ipv6address) shall be included in the NF Profile. See NOTE 1 of Table 6.2.6.2.4-1 for the use of these parameters. If multiple ipv4 addresses and/or ipv6 addresses are included in the NF Profile, the NF Service Consumer shall select one of these addresses randomly, unless operator defined local policy of IP address selection, in order to avoid overload for a specific ipv4 address and/or ipv6 address.
- NOTE 2: The capacity and priority parameters, if present, are used for NF selection and load balancing. The priority and capacity attributes shall be used for NF selection in the same way that priority and weight are used for server selection as defined in IETF RFC 2782 [23].
- NOTE 3: If the requester-plmn in the query parameter is different from the PLMN of the discovered NF, then the fqdn attribute value shall contain the interPlmnFqdn value registered by the NF during NF registration (see clause 6.1.6.2.2). The requester-plmn is different from the PLMN of the discovered NF if it belongs to none of the PLMN ID(s) configured for the PLMN of the NRF.
- NOTE 4: The usage of the load parameter by the NF service consumer is implementation specific, e.g. be used for NF selection and load balancing, together with other parameters.
- NOTE 5: An NF may register multiple PLMN IDs in its profile within a PLMN comprising multiple PLMN IDs. If so, all the attributes of the NF Profile shall apply to each PLMN ID registered in the plmnList. As an exception, attributes including a PLMN ID, e.g. IMSI-based SUPI ranges, TAIs and GUAMIs, are specific to one PLMN ID and the NF may register in its profile multiple occurrences of such attributes for different PLMN IDs (e.g. the UDM may register in its profile SUPI ranges for different PLMN IDs).
- NOTE 6: For notification types that may be associated with a specific service of the NF Instance receiving the notification (see clause 6.1.6.3.4), if notification endpoints are present both in the profile of the NF instance (NFProfile) and in some of its NF Services (NFService) for a same notification type, the notification endpoint(s) of the NF Services shall be used for this notification type.
- NOTE 7: The absence of the pcsclInfoList attribute in a P-CSCF profile indicates that the P-CSCF can be selected for any DNN and Access Type, and that the P-CSCF Gm addressing information is the same as the addressing information registered in the fqdn, ipv4Addresses and ipv4Addresses attributes of the NF profile.
- NOTE 8: The absence of both the smflInfo and smflInfoList attributes in an SMF profile indicates that the SMF can be selected for any S-NSSAI listed in the sNssais and perPlmnSnsaiList IEs, or for any S-NSSAI if neither the sNssais IE nor the perPlmnSnsaiList IE are present, and for any DNN, TAI and access type.
- NOTE 9: If an NF (other than a SCP or SEPP) includes this information in its profile, this indicates that the services produced by this NF should be accessed preferably via an SCP from the SCP domain the NF belongs to.
- NOTE 10: If the NF Service Consumer that issued the discovery request indicated support for the "Service-Map" feature, the NRF shall return in the discovery response the list of NF Service Instances in the "nfServiceList" map attribute. Otherwise, the NRF shall return the list of NF Service Instances in the "nfServices" array attribute.
- NOTE 11: For API URIs constructed with an FQDN, the NF Service Consumer may use the FQDN of the target URI to do a DNS query and obtain the IP address(es) to setup the TCP connection, and ignore the IP addresses that may be present in the NFProfile; alternatively, the NF Service Consumer may use those IP addresses to setup the TCP connection, if no service-specific FQDN or IP address is provided in the NFService data and if the NF Service Consumer supports to indicate specific IP address(es) to establish an HTTP/2 connection with an FQDN in the target URI.
- NOTE 12: When present, this attribute allows an NF requesting NF Discovery (e.g. an NF Service Consumer) to determine which vendor-specific extensions are supported in a given NF (e.g. an NF Service Producer), so as to select an appropriate NF with specific capability, or to include or not the vendor-specific attributes (see 3GPP TS 29.500 [4] clause 6.6.3) required for a given feature in subsequent messages towards a certain NF. One given vendor-specific feature shall not appear in both NF Profile and NF Service Profile. If one vendor-specific feature is service related, it shall only be included in the NF Service Profile.
- NOTE 13: The absence of the easdfInfoList attributes in an EASDF profile indicates that the EASDF can be selected for any S-NSSAI, DNN, DNAI or PSA UPF N6 IP address.
- NOTE 14: This attribute may be used by the requester NF or SCP e.g. to build the authority of the Location header in 3xx response or to set the 3gpp-Sbi-apiRoot header in a response message (see clause 6.10.4 of 3GPP TS 29.500 [4]), when the NF redirects a request issued by a consumer from a different PLMN towards the discovered NF, or when the SCP has reselected the discovered NF for such a request.

6.2.6.2.4 Type: NFService

Table 6.2.6.2.4-1: Definition of type NFService

Attribute name	Data type	P	Cardinality	Description	Applicability
serviceInstanceId	string	M	1	Unique ID of the service instance within a given NF Instance	
serviceName	ServiceName	M	1	Name of the service instance (e.g. "udm-sdm")	
versions	array(NFServiceVersion)	M	1..N	The API versions supported by the NF Service and if available, the corresponding retirement date of the NF Service. The different array elements shall have distinct unique values for "apiVersionInUri", and consequently, the values of "apiFullVersion" shall have a unique first digit version number.	
scheme	UriScheme	M	1	URI scheme (e.g. "http", "https")	
nfServiceStatus	NFServiceStatus	M	1	Status of the NF Service Instance	
fqdn	Fqdn	O	0..1	FQDN of the NF Service Instance (see NOTE 1, NOTE 3, NOTE 9). The FQDN provided as part of the NFService information has precedence over the FQDN and IP addresses provided as part of the NFProfile information (see clause 6.1.6.2.2).	
interPlmnFqdn	Fqdn	C	0..1	If the requester-plmn-list query parameter is absent in the NF Discovery request, or if is present and the requester's PLMN is the same as the PLMN of the discovered NF Service, then this attribute shall be included by the NRF and it shall contain the interPlmnFqdn value registered for the NF Service during NF registration (see clause 6.1.6.2.3), if the interPlmnFqdn attribute was registered for the NF Service in the NF profile. This attribute shall be absent if the requester-plmn in the query parameter is different from the PLMN of the discovered NF Service. (NOTE 3, NOTE 10)	
ipEndPoints	array(IpEndPoint)	O	1..N	IP address(es) and port information of the Network Function (including IPv4 and/or IPv6 address) where the service is listening for incoming service requests (see NOTE 1, NOTE 5, NOTE 6, NOTE 9). IP addresses provided in ipEndPoints have precedence over IP addresses provided as part of the NFProfile information and, when using the HTTP scheme, over FQDN provided as part of the NFProfile information (see clause 6.2.6.2.3).	
apiPrefix	string	O	0..1	Optional path segment(s) used to construct the {apiRoot} variable of the different API URIs, as described in 3GPP TS 29.501 [5], clause 4.4.1 (optional deployment-specific string that starts with a "/" character)	
callbackUriPrefixList	array(CallbackUriPrefixItem)	O	1..N	Optional path segment(s) used to construct the prefix of the Callback URIs during the reselection of an NF service consumer, as described in 3GPP TS 29.501 [5], clause 4.4.3. When present, this IE shall contain callback URI prefix values to be used for specific notification types.	
defaultNotificationSubscriptions	array(DefaultNotificationSubscription)	O	1..N	Notification endpoints for different notification types. (See also NOTE 10 in clause 6.1.6.2.2)	

allowedPlmns	array(PlmnId)	C	1..N	<p>PLMNs allowed to access the service instance (NOTE 12).</p> <p>This attribute may be present in a complete NF profile (i.e. in the completeNfInstances IE in the SearchResult or StoredSearchResult data types). It shall not be present otherwise.</p> <p>The absence of this attribute indicates that any PLMN is allowed to access the service instance.</p> <p>When included, the allowedPlmns attribute needs not include the PLMN ID(s) registered in the plmnList attribute of the NF Profile, i.e. the PLMN ID(s) registered in the NF Profile shall be considered to be allowed to access the service instance.</p>	
allowedSnpsns	array(PlmnIdNid)	C	1..N	<p>SNPNs allowed to access the service instance.</p> <p>This attribute may be present in a complete NF profile (i.e. in the completeNfInstances IE in the SearchResult or StoredSearchResult data types). It shall not be present otherwise.</p> <p>If this attribute is present in the NFService and in the NF profile, the attribute from the NFService shall prevail.</p> <p>The absence of this attribute in both the NFService and in the NF profile indicates that no SNPN, other than the SNPN(s) registered in the snpnList attribute of the NF Profile (if the NF pertains to an SNPN), is allowed to access the service instance.</p> <p>When included, the allowedSnpsns attribute needs not include the PLMN ID/NID(s) registered in the snpnList attribute of the NF Profile (if the NF pertains to an SNPN), i.e. the SNPNs registered in the NF Profile (if any) shall be considered to be allowed to access the service instance.</p>	
allowedNFtypes	array(NFType)	C	1..N	<p>Type of the NFs allowed to access the service instance (NOTE 12).</p> <p>This attribute may be present in a complete NF profile (i.e. in the completeNfInstances IE in the SearchResult or StoredSearchResult data types). It shall not be present otherwise.</p>	

allowedNfDomains	array(string)	C	1..N	<p>Pattern (regular expression according to the ECMA-262 dialect [8]) representing the NF domain names within the PLMN of the NRF allowed to access the service instance (NOTE 12).</p> <p>This attribute may be present in a complete NF profile (i.e. in the completeNfInstances IE in the SearchResult or StoredSearchResult data types). It shall not be present otherwise.</p> <p>The absence of this attribute indicates that any NF domain is allowed to access the service instance.</p>	
allowedNssais	array(ExtSnsai)	C	1..N	<p>S-NSSAI of the allowed slices to access the service instance (NOTE 12).</p> <p>This attribute may be present in a complete NF profile (i.e. in the completeNfInstances IE in the SearchResult or StoredSearchResult data types). It shall not be present otherwise.</p> <p>The absence of this attribute indicates that any slice is allowed to access the service instance.</p>	
capacity	integer	O	0..1	Static capacity information within the range 0 to 65535, expressed as a weight relative to other services of the same type. (See NOTE 2)	
load	integer	O	0..1	Latest known load information of the NF Service, within the range 0 to 100 in percentage. (See NOTE 4)	
loadTimeStamp	DateTime	O	0..1	It indicates the point in time in which the latest load information of the NF Service Instance was sent from the NF to the NRF.	
priority	integer	O	0..1	Priority (relative to other services of the same type) within the range 0 to 65535, to be used for NF Service selection; lower values indicate a higher priority. (See NOTE 2)	
recoveryTime	DateTime	O	0..1	Timestamp when the NF service was (re)started	
supportedFeatures	SupportedFeatures	O	0..1	Supported Features of the NF Service instance	
nfServiceSetIdList	array(NfServiceSetId)	C	1..N	<p>NF Service Set ID (see clause 28.13 of 3GPP TS 23.003 [12])</p> <p>At most one NF Service Set ID shall be indicated per PLMN-ID or SNPN of the NF. This information shall be present if available.</p>	
sNssais	array(ExtSnsai)	O	1..N	<p>S-NSSAIs of the NF Service. This may be a subset of the S-NSSAIs supported by the NF (see sNssais attribute in NFProfile).</p> <p>When present, this IE represents the list of S-NSSAIs supported by the NF Service in all the PLMNs listed in the plmnList IE and all the SNPNS listed in the snpnList.</p>	

perPlmnSnssaiList	array(PlmnSnssai)	O	1..N	<p>S-NSSAIs of the NF Service per PLMN. This may be a subset of the S-NSSAIs supported per PLMN by the NF (see perPlmnSnssaiList attribute in NFPProfile).</p> <p>This IE may be included when the list of S-NSSAIs supported by the NF Service for each PLMN it is supporting is different. When present, this IE shall include the S-NSSAIs supported by the NF Service for each PLMN. When present, this IE shall override the sNssais IE.</p>	
vendorId	VendorId	O	0..1	Vendor ID of the NF Service instance, according to the IANA-assigned "SMI Network Management Private Enterprise Codes" [38].	
supportedVendorSpecificFeatures	map(array(VendorSpecificFeature))	O	1..N(1..M)	<p>Map of Vendor-Specific features, where the key of the map is the IANA-assigned "SMI Network Management Private Enterprise Codes" [38]. The string used as key of the map shall contain 6 decimal digits; if the SMI code has less than 6 digits, it shall be padded with leading digits "0" to complete a 6-digit string value.</p> <p>The value of each entry of the map shall be a list (array) of VendorSpecificFeature objects.</p> <p>(NOTE 7)</p>	
oauth2Required	boolean	O	0..1	<p>It indicates whether the NF Instance requires Oauth2-based authorization. Absence of this IE means that the NF Service Producer has not provided any indication about its usage of Oauth2 for authorization.</p> <p>(See NOTE 11)</p>	
allowedOperationsPerNfType	map(array(string))	C	1..N(1..M)	<p>Map of allowed operations on resources for each type of NF; the key of the map is the NF Type, and the value is an array of scopes.</p> <p>The scopes shall be any of those defined in the API that defines the current service (identified by the "serviceName" attribute).</p> <p>This IE should be present, if it is present in the registered NF service instance and if the map contains a key matching the requester's NF type. When present, this IE should only contain the key-value pair of the map matching the requester's NF type.</p> <p>(NOTE 8)</p>	

allowedOperationsPerNfInstance	map(array(string))	C	1..N(1..M)	<p>Map of allowed operations on resources for a given NF Instance; the key of the map is the NF Instance Id, and the value is an array of scopes.</p> <p>The scopes shall be any of those defined in the API that defines the current service (identified by the "serviceName" attribute).</p> <p>This IE should be present, if it is present in the registered NF service instance and if the map contains a key matching the requester's NF instance ID. When present, this IE should only contain the key-value pair of the map matching the requester's NF Instance ID.</p> <p>(NOTE 8)</p>	
allowedOperationsPerNfInstanceOverrides	boolean	O	0..1	<p>This IE, when present and set to true, indicates that the scopes defined in attribute "allowedOperationsPerNfInstance" for a given NF Instance ID take precedence over the scopes defined in attribute "allowedOperationsPerNfType" for the corresponding NF type of the NF Instance associated to such NF Instance ID.</p> <p>If the IE is not present, or set to false (default), it indicates that the allowed scopes are any of the scopes present either in "allowedOperationsPerNfType" or in "allowedOperationsPerNfInstance".</p>	
allowedScopesRuleSet	map(RuleSet)	O	1..N	<p>Map of rules specifying scopes allowed or denied for NF-Consumers. The key of the map shall be a (unique) valid JSON string per clause 7 of IETF RFC 8259 [22], with a maximum of 32 characters.</p> <p>This IE may be present when the NF-Consumer supports Allowed-ruleset feature as specified in clause 6.2.9.</p> <p>When present, the IE should only contain the highest priority RuleSet matching the requester's NF Instance ID, nfType, PLMN-ID, SNPN-ID, NfDomain and S-NSSAI if any (see Annex C).</p> <p>If the requesting entity included "complete-profile" query parameter in the request message, and the NRF authorized such a request (see clause 5.3.2.2.2), the complete IE shall be present in the discovery response.</p>	
selectionConditions	SelectionConditions	O	0..1	<p>This IE is only applicable if the NFServiceStatus is set to "CANARY_RELEASE", or if the "canaryRelease" attribute is set to true.</p> <p>If present, it includes the conditions under which an NF Service Instance with an NFServiceStatus value set to "CANARY_RELEASE", or with a "canaryRelease" attribute is set to true, shall be selected by an NF Service Consumer (e.g. if the UE belongs to a range of SUPIs)</p>	

canaryRelease	boolean	O	0..1	<p>This IE indicates whether an NF Service instance whose nfServiceStatus is set to "REGISTERED" is in Canary Release condition, i.e. it shall only be used by NF Service Consumers under the conditions indicated by the "selectionConditions" attribute.</p> <p>- true: the NF Service instance is under Canary Release condition, even if the "nfServiceStatus" is set to "REGISTERED"</p> <p>- false (or absent): the NF Service instance indicates its Canary Release condition via the "nfServiceStatus" attribute</p>	
exclusiveCanaryReleaseSelection	boolean	O	0..1	<p>This IE indicates whether an NF Service Consumer should only select an NF Service Producer in Canary Release condition.</p> <p>- true: the consumer shall only select producers in Canary Release condition</p> <p>- false (or absent): the consumer may select producers not in Canary Release condition</p>	
sharedServiceDataId	string	O	0..1	<p>String uniquely identifying SharedServiceData. The format of the sharedServiceDataId shall be a Universally Unique Identifier (UUID) version 4, as described in IETF RFC 4122 [18]. The hexadecimal letters should be formatted as lower-case characters by the sender, and they shall be handled as case-insensitive by the receiver.</p> <p>Example: "4ace9d34-2c69-4f99-92d5-a73a3fe8e23b"</p>	Shared-Data

- NOTE 1: The NF Service Consumer shall construct the API URIs of the service using:
- For intra-PLMN signalling: If TLS is used, the FQDN present in the NF Service Profile, if any; otherwise, the FQDN present in the NF Profile. If TLS is not used, the FQDN should be used if the NF Service Consumer uses Indirect Communication via an SCP; the FQDN or the IP address in the ipEndpoints attribute may be used if the NF Service Consumer uses Direct Communication.
 - For inter-PLMN signalling: the FQDN present in the NF Service Profile, if any; otherwise, the FQDN present in the NF Profile (see NOTE 3).
- NOTE 2: The capacity and priority parameters, if present, are used for service selection and load balancing. The priority and capacity attributes shall be used for NF selection in the same way that priority and weight are used for server selection as defined in IETF RFC 2782 [23].
- NOTE 3: If the requester-plmn in the query parameter is different from the PLMN of the discovered NF Service, then the fqdn attribute value, if included shall contain the interPlmnFqdn value registered by the NF Service during NF registration (see clause 6.1.6.2.3). The requester-plmn is different from the PLMN of the discovered NF Service if it belongs to none of the PLMN ID(s) configured for the PLMN of the NRF.
- NOTE 4: The usage of the load parameter by the NF service consumer is implementation specific, e.g. be used for NF service selection and load balancing, together with other parameters.
- NOTE 5: If the NF Service Consumer, based on the FQDN and IP address related attributes of the NFProfile and NFService, determines that it needs to use an FQDN to establish the HTTP connection with the NF Service Producer, it shall use such FQDN for DNS query and, in absence of any port information in the ipEndpoints attribute of the NF Service, it shall use the default HTTP port number, i.e. TCP port 80 for "http" URIs or TCP port 443 for "https" URIs as specified in IETF RFC 9113 [9] when invoking the service.
- NOTE 6: If multiple ipv4 addresses and/or ipv6 addresses are included in the NF Service, the NF Service Consumer shall select one of these addresses randomly, unless operator defined local policy of IP address selection, in order to avoid overload for a specific ipv4 address and/or ipv6 address.
- NOTE 7: When present, this attribute allows the NF requesting NF discovery (e.g. an NF Service Consumer) to determine which vendor-specific extensions are supported in a given NF (e.g. an Service Producer) in order to select an appropriate NF, or to include or not include the vendor-specific attributes (see 3GPP TS 29.500 [4] clause 6.6.3) required for a given feature in subsequent service requests towards a certain service instance of the NF Service Producer. One given vendor-specific feature shall not appear in both NF Profile and NF Service Profile. If one vendor-specific feature is service related, it shall only be included in the NF Service Profile.
- NOTE 8: These attributes are used by the NF Service Consumer in order to discover the additional scopes (resource/operation-level scopes) that might be required to invoke a certain service operation, based on the authorization information registered in NRF by the NF Service Producer in its NF profile. See also NOTE 11 of Table 6.1.6.2.3-1.
- NOTE 9: For API URIs constructed with an FQDN, the NF Service Consumer may use the FQDN in the target URI to do a DNS query and obtain the IP address(es) to setup the TCP connection, and ignore the IP addresses that may be present in the ipEndpoints attribute; alternatively, the NF Service Consumer may use those IP addresses to setup the TCP connection, if the NF Service Consumer supports to indicate specific IP address(es) to establish an HTTP/2 connection with an FQDN in the target URI.
- NOTE 10: This attribute may be used by the requester NF or SCP e.g. to build the authority of the Location header in 3xx response or to set the 3gpp-Sbi-apiRoot header in a response message (see clause 6.10.4 of 3GPP TS 29.500 [4]), when the NF redirects a request issued by a consumer from a different PLMN towards the discovered NF service, or when the SCP has reselected the discovered NF service for such a request.
- NOTE 11: If PLMN specific value is registered for the PLMN ID of the requester NF, the NRF shall set the oauth2Required attribute with the PLMN specific values (see description of perPlmnOauth2ReqList in clause 6.1.6.2.3).
- NOTE 12: If this attribute is present in the NFService and in the NF profile, the attribute from the NFService shall prevail. The absence of this attribute in the NFService and in the NFProfile indicates that there is no corresponding restriction to access the service instance. If this attribute is absent in the NF Service, but it is present in the NF Profile, the attribute from the NF Profile shall be applied.

6.2.6.2.5 Type: StoredSearchResult

Table 6.2.6.2.5-1: Definition of type StoredSearchResult

Attribute name	Data type	P	Cardinality	Description
nfInstances	array(NFProfile)	M	0..N	An array of NF Instances corresponding to a given stored search result. NF instance profiles included in this IE shall not contain authorization attributes (such as the "allowedXXX" attributes of the NFProfile or NFService data types).
completeNfInstances	array(NFProfile)	C	1..N	When present, it shall contain an array of complete NF Instance profiles (including authorization attributes such as the "allowedXXX" attributes of the NFProfile or NFService data types), matching the search criteria indicated by the query parameters of the discovery request. This IE shall only be present if the NRF supports the "Complete-Profile-Discovery" feature, the "complete-profile" query parameter is present and set to true in the request (see clause 6.2.3.2.3.1), and if the requesting entity is authorized to discover the complete profile of NF instances.

6.2.6.2.6 Type: PreferredSearch

Table 6.2.6.2.6-1: Definition of type PreferredSearch

Attribute name	Data type	P	Cardinality	Description
preferredTaiMatchInd	boolean	C	0..1	Indicates whether all the returned NFProfiles match or do not match the query parameter preferred-tai. true: Match false (default): Not Match
preferredFullPlmnMatchInd	boolean	O	0..1	Indicates whether all the returned NFProfiles match or do not match the query parameter preferred-full-plmn. true: Match false (default): Not Match
preferredApiVersionsMatchInd	boolean	O	0..1	Indicates whether the search result includes at least one NF Profile that matches all the preferred API versions indicated in the query parameter preferred-api-versions. true: Match false: Not Match
otherApiVersionsInd	boolean	O	0..1	This IE may be present if the preferred-api-versions query parameter is provided in the discovery request. When present, this IE indicates whether there is at least one NF Profile with other API versions, i.e. that does not match all the preferred API versions indicated in the preferred-api-versions, returned in the response or not. true: Returned false: Not returned
preferredLocalityMatchInd	boolean	O	0..1	Indicates whether the search result includes at least one NFProfile that match the query parameter preferred-locality or ext-preferred-locality. true: Match false (default): Not Match
otherLocalityInd	boolean	O	0..1	This IE may be present if the preferred-locality or ext-preferred-locality query parameter is provided in the discovery request. When present, this IE indicates whether there is at least one NFProfile with another locality, i.e. not matching the preferred-locality or ext-preferred-locality, returned in the response or not. true: Returned false (default): Not returned
preferredVendorSpecificFeaturesInd	boolean	O	0..1	Indicates whether all the returned NFProfiles match (or do not match) the query parameter preferred-vendor-specific-features (i.e. whether they support all the preferred vendor-specific-features). true: Match false (default): Not Match
preferredCollocatedNFTypeInd	boolean	O	0..1	Indicates whether all the returned NFProfiles match (or do not match) the query parameter preferred-collocated-nf-types. true: Match false (default): Not Match
preferredPgwMatchInd	boolean	O	0..1	This IE may be present if preferred-pgw-ind query parameter is provided in the discovery request. When present, this IE shall indicate whether all the returned NFProfiles match or do not match the query parameter preferred-pgw-ind. true: Match false: Not Match

preferredAnalyticsDelay sInd	boolean	C	0..1	This IE shall be present if preferred-analytics-delays query parameter is provided in the discovery request. When present, this IE shall indicate whether all the returned NFProfiles match or do not match the query parameter preferred-analytics-delays. true: Match false: Not Match
preferredFeaturesMatch Ind	boolean	O	0..1	Indicates whether the search result includes at least one NFProfile that supports all the preferred feature(s) indicated by the query parameter preferred-features. true: Supported false: Not supported
noPreferredFeaturesInd	boolean	O	0..1	Indicates whether the search result includes at least one NFProfile not supporting all the preferred feature(s) indicated by the query parameter preferred-features. true: Returned false: Not returned
NOTE: The PreferredSearch data type is used to encode the preferredSearch IE in SearchResult (see clause 6.2.6.2.2) and the preferredSearch IE in the NfInstanceInfo data type (see clause 6.2.6.2.7). The description of the IEs in the PreferredSearch data type is provided for the first case. For the latter case, these IEs shall be interpreted as indicating whether the NF profile of the NF instance ID returned in the nfInstanceList IE of SearchResult matches the preference parameters, and the otherApiVersionsInd IE and the otherLocalityInd IE shall be absent.				

6.2.6.2.7 Type: NfInstanceInfo

Table 6.2.6.2.7-1: Definition of type NfInstanceInfo

Attribute name	Data type	P	Cardinality	Description
nrfDiscApiUri	Uri	C	0..1	This IE shall be present if the NRF holding the NF profile is not the NRF that received the NFDiscDiscover request. It may be present otherwise. When present, this IE shall contain the API URI of the Nnrf_NFDiscDiscover service of the NRF holding the NF profile. The API URI shall be formatted as specified in clause 6.2.1
preferredSearch	PreferredSearch	O	0..1	This IE may be present to indicate whether the NF Profile matches the preferred query parameters, if the discovery request contains any of the query parameter defined in the PreferredSearch data type. This IE shall take precedence over the preferredSearch IE in the SearchResult, if any.
nrfAlteredPriorities	map(integer)	O	1..N	This IE may be present if the NRF wishes to signal modified priorities for the NF instance. The key of the map shall be the JSON Pointer (as specified in IETF RFC 6901 [14]) of the corresponding priority IE in the NFProfile data type defined in clause 6.2.6.2.3. (NOTE)
nrfSupportedFeatures	SupportedFeatures	C	0..1	Features supported by the NRF for the NFDiscDiscover service (see clause 6.2.9). This IE should be present if the nrfDiscApiUri IE is present and if the NRF holding the NF profile supports at least one feature. When present, this IE shall indicate the features supported by the NRF holding the NF profile.
NOTE:	If this IE is present, the requester NF should apply the NRF altered priorities when selecting a NF service producer for the corresponding NF Discovery request, instead of the priorities retrieved in the corresponding NF profile.			

EXAMPLE: The following JSON object would represent an NfInstanceInfo where the NRF signals modified priorities for the NF instance, two NF service instances and two smfInfo instances.

```
{
  "nrfAlteredPriorities": {
    "/priority": 1000,
    "/nfServiceList/serviceinstance1/priority": 3000,
    "/nfServiceList/serviceinstance2/priority": 5000,
    "/smfInfo/priority": 20000,
    "/smfInfoList/abcd/priority": 15000
  }
}
```

6.2.6.2.8 Type: ScpDomainRoutingInformation

Table 6.1.6.2.8-1: Definition of type ScpDomainRoutingInformation

Attribute name	Data type	P	Cardinality	Description
scpDomainList	map(ScpDomainConnectivity)	M	0..N	This IE shall contain map of SCP domain interconnection information, where the key of the map is a SCP domain. The value of each entry shall be the interconnectivity information of the SCP domain indicated by the key. An empty map indicates that there is no SCP domain currently registered in the NRF.

EXAMPLE: The SCP Domain Routing Information is derived from the SCP domains registered by SCPs, e.g. if SCP x, SCP y and SCP z have registered in NRF with following SCP domains:

SCP x Profile includes: { "scpDomains": ["SCP_Domain_1", "SCP_Domain_2"] }

SCP y Profile includes: { "scpDomains": ["SCP_Domain_2", "SCP_Domain_3"] }

SCP z Profile includes: { "scpDomains": ["SCP_Domain_4"] }

then the SCP Domain Routing Information should be as following:

```
{
  "scpDomainList": {
    "SCP_Domain_1": { "connectedScpDomainList": [ "SCP_Domain_2" ] },
    "SCP_Domain_2": { "connectedScpDomainList": [ "SCP_Domain_1", "SCP_Domain_3" ] },
    "SCP_Domain_3": { "connectedScpDomainList": [ "SCP_Domain_2" ] },
    "SCP_Domain_4": { "connectedScpDomainList": [ ] }
  }
}
```

6.2.6.2.9 Type: ScpDomainConnectivity

Table 6.2.6.2.9-1: Definition of type ScpDomainConnectivity

Attribute name	Data type	P	Cardinality	Description
connectedScpDomainList	array(string)	M	0..N	This IE shall contain the list of interconnected SCP domains. An empty array indicates there is no SCP Domain currently interconnected.

6.2.6.2.10 Type: ScpDomainRoutingInfoSubscription

Table 6.2.6.2.10-1: Definition of type ScpDomainRoutingInfoSubscription

Attribute name	Data type	P	Cardinality	Description
callbackUri	Uri	M	1	Callback URI where the Service Consumer will receive the notifications from NRF.
validityTime	DateTime	C	0..1	Time instant after which the subscription becomes invalid. This parameter may be sent by the client, as a hint to the server, but it shall be always sent back by the server (regardless of the presence of the attribute in the request) in the response to the subscription creation request.
reqInstancelId	NfInstancelId	O	0..1	If present, this IE shall contain the NF instance id of the Service consumer.
localInd	boolean	O	0..1	When present, this IE shall indicate whether changes of local SCP Domain Routing Information to be notified: - true: changes of local SCP Domain Routing Information to be notified. - false (default): changes of SCP Domain Routing Information to be notified

6.2.6.2.11 Type: ScpDomainRoutingInfoNotification

Table 6.2.6.2.11-1: Definition of type ScpDomainRoutingInfoNotification

Attribute name	Data type	P	Cardinality	Description
routingInfo	ScpDomainRoutingInformation	M	1	This IE shall contain the SCP Domain Routing Information after the change.
localInd	boolean	O	0..1	When present, this IE shall indicate whether changes of local SCP Domain Routing Information is carried in the notification: - true: changes of local SCP Domain Routing Information in the notification. - false (default): changes of SCP Domain Routing Information in the notification.

6.2.6.2.12 Type: NfServiceInstance

Table 6.2.6.2.12-1: Definition of type NfServiceInstance

Attribute name	Data type	P	Cardinality	Description
serviceInstanceId	string	M	1	Unique ID of the service instance within a given NF Instance
nfInstanceId	NfInstanceId	C	0..1	NF Instance ID of the NF service instance (NOTE)
nfServiceSetId	NfServiceSetId	C	0..1	NF Service Set ID of the NF Service instance (NOTE)
NOTE: Either the nfInstanceId IE or the nfServiceSetId IE shall be present.				

6.2.6.2.13 Type: NoProfileMatchInfo

Table 6.2.6.2.13-1: Definition of type NoProfileMatchInfo

Attribute name	Data type	P	Cardinality	Description
reason	NoProfileMatchReason	M	1	This IE shall indicate the specific reason for not finding any NF instance that can match the search criteria.
queryParamCombinationList	array(QueryParamCombination)	O	1..N	This IE may be present if the reason IE is set to "QUERY_PARAMS_COMBINATION_NO_MATCH". If present each QueryParamCombination indicates that no NF Instance matching the QueryParamCombination has registered.

6.2.6.2.14 Type: QueryParamCombination

Table 6.2.6.2.14-1: Definition of type QueryParamCombination

Attribute name	Data type	P	Cardinality	Description
queryParams	array(QueryParameter)	M	1..N	This IE shall contain a list of query parameters.

6.2.6.2.15 Type: QueryParameter

Table 6.2.6.2.15-1: Definition of type QueryParameter

Attribute name	Data type	P	Cardinality	Description
name	string	M	1	name of the query parameter
value	string	M	1	value of the query parameter

6.2.6.2.16 Type: AfData

Table 6.2.6.2.16-1: Definition of type AfData

Attribute name	Data type	P	Cardinality	Description
afEvents	array(AfEvent)	M	1..N	AF Event(s) supported by the trusted AF.
taiList	array(Tai)	O	1..N	This IE may be present if the AfEvent is set to "GNSS_ASSISTANCE_DATA". When present, this IE shall contain the list of TAIs the trusted AF can serve. It may contain one or more non-3GPP access TAIs. The absence of this attribute and the taiRangeList attribute indicate that the trusted AF can be selected for any TAI in the serving network.
taiRangeList	array(TaiRange)	O	1..N	This IE may be present if the AfEvent is set to "GNSS_ASSISTANCE_DATA". When present, this IE shall contain the range of TAIs the trusted AF can serve. It may contain non-3GPP access TAIs. The absence of this attribute and the taiList attribute indicate that the trusted AF can be selected for any TAI in the serving network.

6.2.6.2.17 Type: SearchResultInfo

Table 6.2.6.2.17-1: Definition of type SearchResultInfo

Attribute name	Data type	P	Cardinality	Description
unsatisfiedTaiList	array(Tai)	C	1..N	This IE should be present if the NF Discovery Request includes a tai-list query parameter and the "nf-ta-list-ind" query parameter set to true, when the NFs included in the nfInstances or nfInstanceList altogether support only a subset of TAs included in the tai-list. When present, this IE shall include a list of TAs which are unsatisfied, i.e. the NFs included in the nfInstances or nfInstanceList do not support these TAs.

6.2.6.3 Simple data types and enumerations

6.2.6.3.1 Introduction

This clause defines simple data types and enumerations that can be referenced from data structures defined in the previous clauses.

6.2.6.3.2 Simple data types

The simple data types defined in table 6.2.6.3.2-1 shall be supported.

Table 6.2.6.3.2-1: Simple data types

Type Name	Type Definition	Description

6.2.6.3.3 Enumeration: NoProfileMatchReason

The enumeration NoProfileMatchReason indicates the specific reason for not finding any NF instance that can match the search criteria. These reasons are considered as applicable for the time span indicated by the "validityPeriod" of the SearchResult in the discovery response (see clause 6.2.6.2.2).

Table 6.2.6.3.3-1: Enumeration NoProfileMatchReason

Enumeration value	Description
"REQUESTER_PLMN_NOT_ALLOWED"	NF profiles are not allowed to be discovered by the requester's PLMN
"TARGET_NF_SUSPENDED"	Target NF exists with NFStatus or NFServiceStatus "SUSPENDED"
"TARGET_NF_UNDISCOVERABLE"	Target NF exists with NFStatus or NFServiceStatus "UNDISCOVERABLE"
"QUERY_PARAMS_COMBINATION_NO_MATCH"	No NF instance matching the Query Parameter Combination has registered (NOTE 2)
"TARGET_NF_TYPE_NOT_SUPPORTED"	The operator has not deployed any NF instance matching the target NF type of the discovery request (NOTE 1, NOTE 2)
"UNSPECIFIED"	Other reasons
NOTE 1: Based on local policy, the NRF may be configured with a list of NF types that are not supported on the operator's PLMN, so that NF Service Consumers, when receiving this reason on the discovery response, may act accordingly (e.g. to skip subscribing to changes on NF instances with such NF type).	
NOTE 2: If there are no matching instances due to the presence of "target-nf-type" query parameter containing an NF type not supported on the operator's PLMN, the value of the NoProfileMatchReason shall be "TARGET_NF_TYPE_NOT_SUPPORTED", rather than "QUERY_PARAMS_COMBINATION_NO_MATCH".	

6.2.7 Error Handling

6.2.7.1 General

HTTP error handling shall be supported as specified in clause 5.2.4 of 3GPP TS 29.500 [4].

6.2.7.2 Protocol Errors

Protocol errors handling shall be supported as specified in clause 5.2.7 of 3GPP TS 29.500 [4].

6.2.7.3 Application Errors

The application errors defined for the Nnrf_NFDiscovery service are listed in Table 6.2.7.3-1.

Table 6.2.7.3-1: Application errors

Application Error	HTTP status code	Description
INVALID_CLIENT	400 Bad Request	It is used when some or all attributes of the NF Service Consumer in query parameters do not match the requester information in, e.g. its public key certificate.

6.2.8 Security

As indicated in clause 13.3 of 3GPP TS 33.501 [15], when static authorization is not used, the access to the Nnrf_NFDiscovery API may be authorized by means of the OAuth2 protocol (see IETF RFC 6749 [16]), using the "Client Credentials" authorization grant, where the NRF plays the role of the authorization server.

If OAuth2 authorization is used on the Nnrf_NFDiscovery API, an NF Service Consumer, prior to consuming services offered by the Nnrf_NFDiscovery API, shall obtain a "token" from the authorization server, by invoking the Access Token Request service, as described in clause 5.4.2.2.

NOTE: When multiple NRFs are deployed in a network, the NRF used as authorization server is the same NRF where the Nnrf_NFDiscovery service is invoked by the NF Service Consumer.

The Nnrf_NFDiscovery API defines the following scopes for OAuth2 authorization:

Table 6.2.8-1: Oauth2 scopes defined in Nnrf_NFDiscovery API

Scope	Description
"nnrf-disc"	Access to the Nnrf_NFDiscovery API
"nnrf-disc:scp-domain:read"	Access to read the scp-domain-routing-info resource
"nnrf-disc:scp-domain-subs:write"	Access to create/delete a scp-domain subscription resource
"nnrf-disc:nf-instances:read-complete-profile"	Access to the Nnrf_NFDiscovery API enabling the discovery of the complete profile of NF instances

6.2.9 Features supported by the NFDiscovery service

The syntax of the supportedFeatures attribute is defined in clause 5.2.2 of 3GPP TS 29.571 [7].

The following features are defined for the Nnrf_NFDiscovery service.

Table 6.2.9-1: Features of supportedFeatures attribute used by Nnrf_NFDiscovery service

Feature Number	Feature	M/O	Description
1	Complex-Query	O	Support of Complex Query expression (see clause 6.2.3.2.3.1)
2	Query-Params-Ext1	O	Support of the following query parameters: - limit - max-payload-size - required-features - pdu-session-types
3	Query-Param-Analytics	O	Support of the query parameters for Analytics identifier: - event-id-list - nwdaf-event-list
4	MAPDU	O	This feature indicates whether the NRF supports selection of UPF with ATSSS capability.
5	Query-Params-Ext2	O	Support of the following query parameters: - requester-nf-instance-id - upf-ue-ip-addr-ind - pfd-data - target-snpn - af-ee-data - w-agf-info - tngf-info - twif-info - target-nf-set-id - target-nf-service-set-id - preferred-tai - nef-id - preferred-nf-instances - notification-type - serving-scope - internal-group-identity - preferred-api-versions - v2x-support-ind - redundant-gtpu - redundant-transport - lmf-id - an-node-type - rat-type - ipups - scp-domain-list - address-domain - ipv4-addr - ipv6-prefix - served-nf-set-id - remote-plmn-id - data-forwarding - preferred-full-plmn - requester-snpn-list - max-payload-size-ext - client-type
6	Service-Map	M	This feature indicates whether it is supported to identify the list of NF Service Instances as a map (i.e. the "nfServiceList" attribute of NFProfile is supported).
7	Query-Params-Ext3	O	Support of the following query parameters: - ims-private-identity - ims-public-identity - msisdn - requester-plmn-specific-snsai-list - n1-msg-class - n2-info-class
8	Query-Params-Ext4	O	Support of the following query parameters: - realm-id - storage-id
9	Query-Param-vSmf-Capability	O	Support of the query parameters for V-SMF Capability: - vsmf-support-ind
10	Enh-NF-Discovery	O	Enhanced NF Discovery This feature indicates whether it is supported to return the nInstanceList IE in the NF Discovery response.

11	Query-SBIProtoc17	O	Support of the following query parameters, for Service Based Interface Protocol Improvements defined in 3GPP Rel-17: <ul style="list-style-type: none"> - preferred-vendor-specific-features - preferred-vendor-specific-nf-features - home-pub-key-id - pgw-ip - preferences-precedence - preferred-pgw-ind - v2x-capability - shared-data-id
12	SCPDR1	O	SCP Domain Routing Information An NRF supporting this feature shall allow a service consumer (i.e. a SCP) to get the SCP Domain Routing Information and subscribe/unsubscribe to the change of SCP Domain Routing Information with following service operations: <ul style="list-style-type: none"> - SCPDomainRoutingInfoGet (see clause 5.3.2.3) - SCPDomainRoutingInfoSubscribe (see clause 5.3.2.4) - SCPDomainRoutingInfoUnsubscribe (see clause 5.3.2.6) A service consumer (i.e. a SCP) supporting this feature shall be able to handle SCPDomainRoutingInfoNotify as specified in clause 5.3.2.5, if subscribed to the change of SCP Domain Routing Information in the NRF.
13	Query-Upf-Pfcp	O	This feature indicates whether the NRF supports selection of UPF with required UP function features as defined in 3GPP TS 29.244 [21].
14	Query-5G-ProSe	O	Support of the following query parameters, for Proximity based Services in 5GS defined in 3GPP Rel-17: <ul style="list-style-type: none"> - prose-support-ind - prose-capability
15	NSAC	O	This feature indicates the NSACF service capability. Support of the following query parameters: <ul style="list-style-type: none"> - nsacf-capability
16	Query-MBS	O	Support of the following query parameters, for Multicast and Broadcast Services defined in 3GPP Rel-17: <ul style="list-style-type: none"> - mbs-session-id-list - mbsmf-serving-area - area-session-id
17	Query-eNA-PH2	O	Support of the following query parameters, for Enhanced Network Automation Phase 2 defined in 3GPP Rel-17: <ul style="list-style-type: none"> - analytics-aggregation-ind - serving-nf-set-id - serving-nf-type - ml-analytics-info-list - analytics-metadata-prov-ind
18	Query-eLCS	O	Support of the following query parameters, for 5G LCS service: <ul style="list-style-type: none"> - gmlc-number
19	Query-eEDGE-5GC	O	Support of the following query parameters, for enhancement of support for Edge Computing in 5GC defined in 3GPP Rel-17: <ul style="list-style-type: none"> - upf-n6-ip - tai-list The query parameter tai-list may be used to discover NEF.
20	Collocated-NF-Selection	O	Support of selecting a collocated NF supporting multiple NF types.
21	Query-ENPN	O	Support of the following query parameter for the enhanced support of Non-Public Networks defined in 3GPP Rel-17: <ul style="list-style-type: none"> - support-onboarding-capability - target-hni - remote-snpn-id
22	Query-ID_UAS	O	Support of the following query parameters, for remote Identification of Unmanned Aerial Systems defined in 3GPP Rel-17: <ul style="list-style-type: none"> - uas-nf-functionality-ind
23	NRFSET	O	Support of the NRF Set feature as defined in clause 5.3.2.1. All the NRF service instances of an NRF supporting this feature shall support the NRFSET feature.

24	Query-Nw-Resolution	O	Support for the following query parameters: - target-nw-resolution
25	Query-Param-iSmf-Capability	O	Support of the query parameters for I-SMF Capability: - ismf-support-ind
26	Query-SBIProtoc17-Ext1	O	Support of the following query parameters, for Service Based Interface Protocol Improvements defined in 3GPP Rel-17: - exclude-nfinst-list - exclude-nfservinst-list - exclude-nfserviceset-list - exclude-nfset-list
27	Query-Upf-IpIndex	O	Support of the query parameters for UPF selection with IpIndex: - ipv4-index - ipv6-index
28	Query-eNA-PH2-Ext1	O	Support of the following query parameters, for extension of Enhanced Network Automation Phase 2 defined in 3GPP Rel-17: - preferred-analytics-delays
29	Query-HLC	O	Support of the query parameters for AMF selection with High Latency Communication capability: - high-latency-com
30	Query-SBIProtoc18	O	Support of the following query parameters, for Service Based Interface Protocol Improvements defined in 3GPP Rel-18: - ext-preferred-locality - n32-purposes - preferred-features - sxa-ind - remote-plmn-id-roaming - nf-tai-list-ind - complete-search-result - additional-snsais
31	Complete-Profile-Discovery	O	Support discovery of complete NF profiles (including authorization attributes such as the "allowedXXX" attributes of NFProfile and NFService data types) of NF instances matching the query parameters.
32	Query-UPEAS	O	Support of the following query parameter, for UPF enhancement for Exposure and SBA defined in 3GPP Rel-18: - upf-event-list
33	Enh-NF-Discovery-Ext1	O	Support of the following query parameter defined in 3GPP Rel-18: - target-nf-instance-id-list
34	Query-NG-RTC	O	Support of the following query parameters for NG_RTC defined in 3GPP Rel-18: - ims-domain-name - media-capability-list
35	Query-eLCS-PH3	O	Support of the following query parameters, for 5G LCS Phase 3 service defined in 3GPP Rel-18: - pru-tai - af-data - pru-support-ind - preferred-up-positioning-ind
36	Query-eNA-PH3	O	Support of the following query parameters, for Enhanced Network Automation Phase 3 defined in 3GPP Rel-18: - ml-accuracy-checking-ind - analytics-accuracy-checking-ind - ml-model-storage-ind - data-storage-ind - data-subscription-relocation-support-ind - roaming-exchange-ind
37	Query-A2X	O	Support of the following query parameters, for A2X in 5GS defined in 3GPP Rel-18: - a2x-support-ind - a2x-capability
38	Allowed-ruleset	O	Support receiving ruleSets in NF (Service) profile
39	Query-AIMLsys	O	Support for the following query parameters, for System Support for AI/ML-based Services defined in 3GPP Rel-18: - multi-mem-af-sess-qos-ind - member-ue-sel-assist-ind

40	Canary-Release	O	<p>Support of "CANARY_RELEASE" value for NFStatus and NFServiceStatus, used for canary testing.</p> <p>The NRF shall not return, in the discovery response, NF Instances, or NF Service Instances, whose NFStatus or NFService status respectively is set to value "CANARY_RELEASE", unless the consumer of the discovery service has indicated support of the "Canary-Release" feature.</p>
41	Query-UPF-Selection-N3GPP	O	<p>Support of the following query parameters, for selection of preferred UPF for PDU sessions via non-3GPP access:</p> <ul style="list-style-type: none"> - upf-select-epdg-info <p>An NRF supporting this feature shall also support discovery of the preferred UPF(s) for a W-AGF/TNGF/TWIF using the following query parameters:</p> <ul style="list-style-type: none"> - w-agf-info - tngf-info - twif-info
42	Query-5G-RangingSIPos	O	<p>Support of the following query parameter, for Ranging and Sidelink positioning in 5GS defined in 3GPP Rel-18:</p> <ul style="list-style-type: none"> - ranging-sl-pos-support-ind
43	Query-eNS-PH2	O	<p>Support of the following query parameters, for Enhanced Network Slice Phase 2 defined in 3GPP Rel-17 onwards:</p> <ul style="list-style-type: none"> - nsac-sai
44	RID-NfGroupId-Mapping	O	<p>Support the capability of mapping between Routing Indicator and NF Group ID by the NRF.</p> <p>If the consumer of the discovery service has not indicated support of the "RID-NfGroupId-Mapping" feature, the NRF shall not return in the discovery response NF instances (of UDMs and AUSFs) containing (in "UdmInfo" and "AusInfo" respectively) an NF Group ID and no Routing Indicators to indicate that the mapping between both will be done by the NRF (see clauses 6.1.6.2.7 and 6.1.6.2.8).</p>
45	Query_UEPO	O	<p>Support of the following query parameter(s) for PCF:</p> <ul style="list-style-type: none"> - ursp-delivery-eps-support-ind
46	DNN-List-Optimization	O	<p>Support of dnnSmfInfoListId within SnsaiSmfInfoItem, and dnnUpfInfoListId within SnsaiUpfInfoItem</p> <p>If the consumer of the discovery service has not indicated support of the DNN-List-Optimization feature, the NRF shall provide the complete list of DNNs in dnnSmfInfoList or the dnnUpfInfoList.</p>
47	Shared-Data	O	<p>Support of Shared Data IDs in search results.</p> <p>If supported, NFProfiles within search results may contain a sharedProfileDataId identifying shared profile data and NFServices may contain a sharedServiceDataId identifying shared service data.</p> <p>If not supported by the consumer, the NRF shall substitute values of the referenced shared data into the NF profile it returns to the consumer.</p> <p>NRFs supporting this feature shall also support the Shared-Data-Retrieval feature of the NFManagement service.</p>
48	Query-EDGE-Ph2	O	<p>Support of the following query parameter, for the support of Edge Computing Phase 2 defined in 3GPP Rel-18:</p> <ul style="list-style-type: none"> - dns-sec-protoc
49	Query-TAI-LIST	O	<p>Support discovery of target NF with service area within a list of TAIs.</p> <p>The feature supports the following query parameter(s):</p> <ul style="list-style-type: none"> - tai-list <p>The query parameter is applicable to discover any target NF type.</p>
50	Query-eNA-Ph3_EXT	O	<p>Support the discovery of an NWDAF containing AnLF, whose vendor Id is in the ML Model Interoperability indicator of the NWDAF containing MTLF. See clause 5.2 of 3GPP TS 23.288 [34] and clause 6.3.13 of 3GPP TS 23.501 [2].</p> <p>The feature supports the following query parameter(s):</p> <ul style="list-style-type: none"> - vendor-ids

Feature number: The order number of the feature within the supportedFeatures attribute (starting with 1).
Feature: A short name that can be used to refer to the bit and to the feature.
M/O: Defines if the implementation of the feature is mandatory ("M") or optional ("O").
Description: A clear textual description of the feature.
NOTE 1: An NRF that advertises support of a given feature shall support all the query parameters associated with the feature. An NRF may support none or a subset of the query parameters of features that it does not advertise as supported.
NOTE 2: For a release under development, it is recommended to define new features for new query parameters by grouping them per 3GPP work item. Any definition of new query parameters in a frozen release requires a new feature definition.

6.3 Nnrf_AccessToken Service API

6.3.1 General

This API reuses the API endpoints and input / output parameters specified in IETF RFC 6749 [16] as a custom operation without resources. Hence this clause does not follow the 3GPP API specification guidelines described in 3GPP TS 29.501 [5].

6.3.2 API URI

URIs of this API shall have the following root:

{nrfApiRoot}/oauth2

where {nrfApiRoot} represents the concatenation of the "scheme" and "authority" components of the NRF, as defined in IETF RFC 3986 [17].

6.3.3 Usage of HTTP

6.3.3.1 General

HTTP/2, as defined in IETF RFC 9113 [9], shall be used as specified in clause 5 of 3GPP TS 29.500 [4].

HTTP/2 shall be transported as specified in clause 5.3 of 3GPP TS 29.500 [4].

HTTP messages and bodies this API shall comply with the OpenAPI [10] specification contained in Annex A.

6.3.3.2 HTTP standard headers

6.3.3.2.1 General

The HTTP headers as specified in clause 4.4 of IETF RFC 6749 [16] shall be supported, with the exception that there shall not be "Authorization" HTTP request header in the access token request.

6.3.3.2.2 Content type

The following content types shall be supported:

- The x-www-form-urlencoded format (see clause 17.13.4 of W3C HTML 4.01 Specification [26]). The use of the x-www-form-urlencoded format shall be signalled by the content type "application/x-www-form-urlencoded".
- The JSON format (IETF RFC 8259 [22]). The use of the JSON format shall be signalled by the content type "application/json". See also clause 5.4 of 3GPP TS 29.500 [4].

6.3.3.3 HTTP custom headers

6.3.3.3.1 General

In this release of this specification, no custom headers specific to the OAuth2.0 Authorization Service API are defined. For 3GPP specific HTTP custom headers used across all service-based interfaces, see clause 5.2.3 of 3GPP TS 29.500 [4].

6.3.4 Custom Operations without associated resources

6.3.4.1 Overview

The /token endpoint as specified in IETF RFC 6749 [16] shall be supported. The "token endpoint" URI shall be:

{nrfApiRoot}/oauth2/token

where {nrfApiRoot} is defined in clause 6.3.2.

Table 6.3.4.1-1 provides an overview of the endpoints and applicable HTTP methods.

Table 6.3.4.1-1: Custom operations without associated resources

Operation Name	Custom operation URI	Mapped HTTP method	Description
Get (Access Token Request)	/oauth2/token	POST	Access token request for obtaining OAuth2.0 access token. This operation maps to Nnrf_AccessToken_Get service operation.

6.3.4.2 Operation: Get (Access Token Request)

6.3.4.2.1 Description

This custom operation represents the process for issuing the OAuth2.0 access token.

6.3.4.2.2 Operation Definition

This operation returns an OAuth 2.0 access token based on the input parameters provided. This custom operation shall use the HTTP POST method.

This method shall support the request data structures specified in table 6.3.4.2.2-1 and the response data structures and response codes specified in table 6.3.4.2.2-2. The data structure used for the POST request body shall be using x-www-form-urlencoded format as specified in clause 17.13.4 of W3C HTML 4.01 Specification [26].

Table 6.3.4.2.2-1: Data structures supported by the POST Request Body on this endpoint

Data type	P	Cardinality	Description
AccessTokenReq	M	1	This IE shall contain the request information for the access token request. Content-Type: "application/x-www-form-urlencoded"

Table 6.3.4.2.2-2: Data structures supported by the POST Response Body on this endpoint

Data type	P	Cardinality	Response codes	Description
AccessTokenRsp	M	1	200 OK	This IE shall contain the access token response information.
RedirectResponse	O	0..1	307 Temporary Redirect	The NRF shall generate a Location header field containing a URI pointing to the endpoint of another NRF service instance to which the request should be sent. If an SCP redirects the message to another SCP then the location header field shall contain the same URI or a different URI pointing to the endpoint of the NF service producer to which the request should be sent.
RedirectResponse	O	0..1	308 Permanent Redirect	The NRF shall generate a Location header field containing a URI pointing to the endpoint of another NRF service instance to which the request should be sent. If an SCP redirects the message to another SCP then the location header field shall contain the same URI or a different URI pointing to the endpoint of the NF service producer to which the request should be sent.
AccessTokenErr	M	1	400 Bad Request, 401 Unauthorized	See IETF RFC 6749 [16] clause 5.2. The specific error shall be indicated in the "error" attribute of the AccessTokenErr data type, containing any of the values: - invalid_request - invalid_client - invalid_grant - unauthorized_client - unsupported_grant_type - invalid_scope
ProblemDetails	O	0..1	400 Bad Request	This error shall only be returned by an SCP or SEPP for errors they originate.
ProblemDetails	O	0..1	403 Forbidden	This response shall be returned if the requester NF is not allowed to request token for the NF being requested, and the "cause" attribute shall be set to: - "MISSING_PARAMETER" to indicate the missing requester's information. The missing parameter shall be indicated in "invalidParams" attribute of ProblemDetails.

Table 6.3.4.2.2-3: Headers supported by the 200 Response Code on this endpoint

Name	Data type	P	Cardinality	Description
Cache-Control	string	M	1	Enum: "no-store"
Pragma	string	M	1	Enum: "no-cache"

Table 6.3.4.2.2-4: Headers supported by the 400 Response Code on this endpoint

Name	Data type	P	Cardinality	Description
Cache-Control	string	M	1	Enum: "no-store"
Pragma	string	M	1	Enum: "no-cache"

Table 6.3.4.2.2-5: Headers supported by the 307 Response Code on this endpoint

Name	Data type	P	Cardinality	Description
Location	string	M	1	A URI pointing to the endpoint of the NRF service instance to which the request should be sent

Table 6.3.4.2-6: Headers supported by the 308 Response Code on this endpoint

Name	Data type	P	Cardinality	Description
Location	string	M	1	A URI pointing to the endpoint of the NRF service instance to which the request should be sent

6.3.5 Data Model

6.3.5.1 General

This clause specifies the application data model supported by the API.

Table 6.3.5.1-1 specifies the data types defined for the OAuth 2.0 Authorization Service API. The AccessTokenReq data structure shall be converted to the content type "application/x-www-form-urlencoded" when the OAuth 2.0 Access Token Request is invoked.

Table 6.3.5.1-1: OAuth 2.0 Authorization service specific Data Types

Data type	Clause defined	Description
AccessTokenReq	6.3.5.2.2	Contains information related to the access token request.
AccessTokenRsp	6.3.5.2.3	Contains information related to the access token response.
AccessTokenClaims	6.3.5.2.4	The claims data structure for the access token.
AccessTokenErr	6.3.5.2.5	Contains error information returned in the access token response.
MIModelInterIInd	6.3.5.2.6	Contains the Interoperability Information, i.e. vendor list, per Analytics Id.
Audience	6.3.5.4.1	Contains the audience claim of the access token.

Table 6.3.5.1-2 specifies data types re-used by the OAuth 2.0 Authorization service from other specifications and from the service APIs within current specification, including a reference to the respective specifications and when needed, a short description of their use.

Table 6.3.5.1-2: OAuth 2.0 Authorization service re-used Data Types

Data type	Reference	Comments
NfInstanceId	3GPP TS 29.571 [7]	Identifier (UUID) of the NF Instance. The hexadecimal letters of the UUID should be formatted by the sender as lower-case characters and shall be handled as case-insensitive by the receiver.
PlmnId	3GPP TS 29.571 [7]	PLMN ID
NFType	Clause 6.1.6.3.3	Defined in Nnrf_NFManagement API.
Snsai	3GPP TS 29.571 [7]	
NfSetId	3GPP TS 29.571 [7]	NF Set ID (see clause 28.12 of 3GPP TS 23.003 [12])
Uri	3GPP TS 29.571 [7]	
RedirectResponse	3GPP TS 29.571 [7]	Response body of the redirect response message.
Fqdn	3GPP TS 29.571 [7]	Fully Qualified Domain Name
NwdafEvent	3GPP TS 29.520 [32]	Defined in Nnwdaf_EventsSubscription API. Represents the NWDAF event.
VendorId	Clause 6.1.6.3.2	Defined in Nnrf_NFManagement API. Vendor ID of the NF Service instance (Private Enterprise Number assigned by IANA)

6.3.5.2 Structured data types

6.3.5.2.1 Introduction

This clause defines the structures to be used in the APIs.

6.3.5.2.2 Type: AccessTokenReq

Table 6.3.5.2.2-1: Definition of type AccessTokenReq

Attribute name	Data type	P	Cardinality	Description
grant_type	string	M	1	This IE shall contain the grant type as "client_credentials". Enum: "client_credentials"
nfInstanceId	NfInstanceId	M	1	This IE shall contain the NF instance id of the NF service consumer.
nfType	NFType	C	0..1	This IE shall be included when the access token request is for an NF type and not for a specific NF / NF service instance. When present, this IE shall contain the NF type of the NF service consumer. (NOTE 3)
targetNfType	NFType	C	0..1	This IE shall be included when the access token request is for an NF type and not for a specific NF / NF service instance. When present, this IE shall contain the NF type of the NF service producer.
scope	string	M	1	This IE shall contain the scopes requested by the NF service consumer. The scopes shall consist of a list of NF service name(s) of the NF service producer(s) or resource/operation-level scopes defined by each service API, separated by whitespaces, as described in IETF RFC 6749 [16], clause 3.3. The service name(s) included in this attribute shall be any of the services defined in the ServiceName enumerated type (see clause 6.1.6.3.11). The resource/operation-level scopes shall be any of those defined in the "securitySchemes" clause of each service API. pattern: '^([a-zA-Z0-9_-:~])+([a-zA-Z0-9_-:~]+)*\$' See NOTE 2.
targetNfInstanceId	NfInstanceId	C	0..1	This IE shall be included, if available and if it is an access token request for a specific NF Service Producer. When present this IE shall contain the NF Instance ID of the specific NF Service Producer for which the access token is requested.
requesterPlmn	PlmnId	C	0..1	This IE shall be included when the NF service consumer in one PLMN requests a service access authorization for an NF service producer from a different PLMN. It may be present when a service access authorization in the same PLMN need to be requested. When present, this IE shall contain the PLMN ID of the requester NF service consumer. (NOTE 3) (NOTE 4)
requesterPlmnList	array(PlmnId)	C	2..N	This IE shall be included when the NF service consumer serving a PLMN, with more than one PLMN ID, requests a service access authorization for an NF service producer from a different PLMN. It may be present when a service access authorization in the same PLMN, with more than one PLMN ID, need to be requested. When present, this IE shall contain the PLMN IDs of the requester NF service consumer. (NOTE 4)

requesterSnssaiList	array(Snssai)	O	1..N	When present, this IE shall contain the list of S-NSSAIs of the requester NF service consumer. If this IE is included in an Access Token Request sent towards a different PLMN, the requester NF shall provide S-NSSAI values of the target PLMN, that correspond to the S-NSSAI values of the requester NF. This may be used by the NRF to validate that the requester NF service consumer is allowed to access the target NF Service Producer. (NOTE 3)
requesterFqdn	Fqdn	O	0..1	When present, this IE shall contain the FQDN of the requester NF Service Consumer. This may be used by the NRF to validate that the requester NF service consumer is allowed to access the target NF Service Producer. (NOTE 3)
requesterSnpnList	array(PlmnIdNid)	O	1..N	When present, this IE shall contain the list of SNPNS the requester NF service consumer belongs to. This may be used by the NRF to validate that the requester NF service consumer is allowed to access the target NF Service Producer. (NOTE 3)
targetPlmn	PlmnId	C	0..1	This IE shall be included when the NF service consumer in one PLMN or SNPN requests a service access authorization for an NF service producer from a different PLMN. When present, this IE shall contain the PLMN ID of the target PLMN (i.e., PLMN ID of the NF service producer).
targetSnpn	PlmnIdNid	C	0..1	This IE shall be included when the NF service consumer in one PLMN or SNPN requests a service access authorization for an NF service producer from a different SNPN. When present, this IE shall contain the SNPN ID of the target SNPN (i.e., SNPN ID of the NF service producer).
targetSnssaiList	array(Snssai)	O	1..N	This IE may be included during an access token request for an NF type and not for a specific NF / NF service instance. When present, this IE shall contain the list of S-NSSAIs of the NF Service Producer.
targetNsiList	array(string)	O	1..N	This IE may be included during an access token request for an NF type and not for a specific NF / NF service instance. When present, this IE shall contain the list of NSIs of the NF Service Producer.
targetNfSetId	NfSetId	O	0..1	This IE may be included during an access token request for an NF type and not for a specific NF / NF service instance. When present, this IE shall contain the NF Set ID of the NF Service Producer.
targetNfServiceSetId	NfServiceSetId	O	0..1	This IE may be included during an access token request for a specific NF / NF service instance. When present, this IE shall contain the NF Service Set ID of the NF Service Producer. This may be used by the NRF to validate that the requester NF service consumer is allowed to access the target NF service instance. (NOTE 3)
hnrAccessUri	Uri	C	0..1	If included, this IE shall contain the API URI of the Access Token Service (see clause 6.3.2) of the NRF in home PLMN. It shall be included during an access token request for an hSMF in the home routed roaming scenario, if it is returned from the NSSF in the home PLMN (see clause 6.1.6.2.11 of 3GPP TS 29.531 [42]).

sourceNfInstanceId	NfInstanceId	C	0..1	<p>This IE shall be included, if available and if it is an access token request from the DCCF as NF Service Consumer request data from NF Service Producers on behalf of the source NF. When present this IE shall contain the NF Instance ID of the source NF which intend to collect data from NF Service Producer.</p> <p>This IE shall be included, if available and if the requester is an NWDAF containing MTLF service that requests ML model(s) on behalf of another ML model consumer. When present, this IE shall contain the NF Instance ID of the ML model consumer (e.g. NWDAF containing AnLF). See Annex X.10 of 3GPP TS 33.501 [15].</p>
vendorId	VendorId	C	0..1	Vendor Id of requester, shall be included if the requester is an NWDAF containing MTLF and/or AnLF requesting access token to be used for MTLF and/or AnLF service(s) (see Annex X.10 of 3GPP TS 33.501 [15]).
analyticsIds	array(NwdafEvent)	C	1..N	Analytics Id(s) of requester, shall be included if the requester is an NWDAF containing MTLF and/or AnLF requesting access token to be used for MTLF and/or AnLF service(s) (see Annex X.10 of 3GPP TS 33.501 [15]).
requesterInterIndList	array(MIModelInterInd)	C	1..N	This IE shall be included if the NF Service consumer is NWDAF containing MTLF requesting access token to be used for MTLF service(s) and the requester supports interoperability, i.e. the IE is available. The IE contains the Interoperability indicator of the requester per Analytics ID (see Annex X.10 of 3GPP TS 33.501 [15]).
sourceVendorId	VendorId	C	0..1	<p>This IE shall be included, if available and if the requester is an NWDAF containing MTLF service that requests ML model(s) on behalf of another ML model consumer.</p> <p>When present, this IE shall contain the Vendor ID of the ML model consumer (e.g. NWDAF containing AnLF). See Annex X.10 of 3GPP TS 33.501 [15].</p>
<p>NOTE 1: This data structure shall not be treated as a JSON object. It shall be treated as a key, value pair data structure to be encoded using x-www-form-urlencoded format as specified in clause 17.13.4 of W3C HTML 4.01 Specification [26].</p> <p>NOTE 2: Though scope attribute is optional as per IETF RFC 6749 [16], it is mandatory for 3GPP as per 3GPP TS 33.501 [15].</p> <p>NOTE 3: An access token request should be rejected if the requester NF is not allowed to access the target NF based on the authorization parameters in the NF profile of the target NF. The authorization parameters in NF Profile are those used by NRF to determine whether a given NF Instance / NF Service Instance can be discovered by an NF Service Consumer in order to consume its offered services (e.g. "allowedNfTypes", "allowedNfDomains", etc.). Based on operator's policies, an access token request not including the requester's information necessary to validate the authorization parameters in the target NF Profile may be rejected.</p> <p>NOTE 4: When the NF service consumer is serving a PLMN consisting of one PLMN ID, the attribute "requesterPlmn" shall be used; otherwise, if the NF service consumer is serving a PLMN consisting of more than one PLMN ID, the attribute "requesterPlmnList" shall be used.</p>				

EXAMPLE:

The following is an example of an Access Token Request message, with a request body encoded as x-www-form-urlencoded, with following input parameters:

- NF Instance Id of the NF Service Consumer: 4e0b2760-0356-42c4-b739-8d6aaa491b63
- NF Type of the NF Service Consumer: AMF
- NF Type of the NF Service Producer: UDM
- Requested scopes: "nudm-sdm", "nudm-uecm" and "nudm-ueau"

- PLMN ID of the NF Service Consumer: MCC=123, MNC=456
- PLMN ID of the NF Service Producer: MCC=321, MNC=654
- S-NSSAIs of the NF Service Producer: (SST=1, SD=A08923) and (SST=2)
- NSIs of the NF Service Producer: "Slice A, instance 1" and "Slice B, instance 2"

Note that the URL-encoding of the request body requires to percent-encode the reserved characters ([] { } " : ,) that appear in JSON-encoded structured input parameters (such as "requesterPlmn"), and in string input parameters (such as "scope", or "targetNsiList" array elements). Spaces are percent-encoded as '+'.

The request body, *before URL-encoding*, and displayed in multiples lines only for illustration purposes, would be:

```
grant_type=client_credentials
&nfInstanceId=4e0b2760-0356-42c4-b739-8d6aaa491b63
&nfType=AMF
&targetNfType=UDM
&scope=nudm-sdm nudm-uecm nudm-ueau
&requesterPlmn={"mcc":"123","mnc":"456"}
&targetPlmn={"mcc":"321","mnc":"654"}
&targetSnsaiList=[{"sst":1,"sd":"A08923"}, {"sst":2}]
&targetNsiList=Slice A, instance 1
&targetNsiList=Slice B, instance 2
```

The actual request message, *after URL-encoding*, and where all input parameters are contained into one single line in the request body, would be:

```
POST /oauth2/token
Content-Type: application/x-www-form-urlencoded
Accept: application/json

grant_type=client_credentials&nfInstanceId=4e0b2760-0356-42c4-b739-8d6aaa491b63&nfType=AMF&targetNfType=UDM&scope=nudm-sdm+nudm-uecm+nudm-ueau&requesterPlmn=%7B%22mcc%22%3A%22123%22%2C%22mnc%22%3A%22456%22%7D&targetPlmn=%7B%22mcc%22%3A%22321%22%2C%22mnc%22%3A%22654%22%7D&targetSnsaiList=%5B%7B%22sst%22%3A%221%22%2C%22sd%22%3A%22A08923%22%7D%2C%7B%22sst%22%3A%222%22%7D%5D&targetNsiList=Slice+A%2C+instance+1&targetNsiList=Slice+B%2C+instance+2
```

6.3.5.2.3 Type: AccessTokenRsp

Table 6.3.5.2.3-1: Definition of type AccessTokenRsp

Attribute name	Data type	P	Cardinality	Description
access_token	string	M	1	This IE shall contain JWS Compact Serialized representation of the JWS signed JSON object containing AccessTokenClaims (see clause 6.3.5.2.4).
token_type	string	M	1	This IE shall contain the token type, set to value "Bearer". Enum: "Bearer"
expires_in	integer	C	0..1	This IE when present shall contain the number of seconds after which the access token is considered to be expired. As indicated in IETF RFC 6749 [16], this attribute should be included, unless the expiration time of the token is made available by other means (e.g. deployment-specific documentation).
scope	string	C	0..1	This IE when present shall contain the scopes granted to the NF service consumer. The scopes shall consist of a list of NF service name(s) of the NF service producer(s) or resource/operation-level scopes defined by each service API, separated by whitespaces, as described in IETF RFC 6749 [16], clause 3.3. The service name(s) included in this attribute shall be any of the services defined in the ServiceName enumerated type (see clause 6.1.6.3.11). The resource/operation-level scopes shall be any of those defined in the "securitySchemes" clause of each service API. As indicated in IETF RFC 6749 [16], this attribute shall be present if it is different than the scope included in the access token request; if it is the same as the requested scope, this attribute may be absent. pattern: '^([a-zA-Z0-9_-:~+]) ([a-zA-Z0-9_-:~+])*\$'

6.3.5.2.4 Type: AccessTokenClaims

Table 6.3.5.2.4-1: Definition of type AccessTokenClaims

Attribute name	Data type	P	Cardinality	Description
iss	NfInstanceId	M	1	This IE shall contain NF instance id of the NRF. , corresponding to the standard "Issuer" claim described in IETF RFC 7519 [25], clause 4.1.1
sub	NfInstanceId	M	1	This IE shall contain the NF instance ID of the NF service consumer, corresponding to the standard "Subject" claim described in IETF RFC 7519 [25], clause 4.1.2.
aud	Audience	M	1	This IE shall contain the NF service producer's NF instance ID(s) (if the exact NF instance(s) of the NF service producer is known) or the NF type of NF service producers for which the claim is applicable, corresponding to the standard "Audience" claim described in IETF RFC 7519 [25], clause 4.1.3.
scope	string	M	1	This IE shall contain the name of the NF services and the resource/operation-level scopes for which the access_token is authorized for use; this claim corresponds to a private claim, as described in IETF RFC 7519 [25], clause 4.3. pattern: '^([a-zA-Z0-9_-:~+]) ([a-zA-Z0-9_-:~+]*\$)'
exp	integer	M	1	This IE shall contain the expiration time after which the access_token is considered to be expired, corresponding to the standard "Expiration Time" claim described in IETF RFC 7519 [25], clause 4.1.4.
consumerPlmnlid	Plmnlid	C	0..1	This IE shall be included if the NRF supports providing PLMN ID of the NF service consumer in the access token claims, to be interpreted for subject (sub IE), as specified in clause 13.4.1.2 of 3GPP TS 33.501 [15]. If an NF service producer that receives this IE in the token included in the authorization header does not understand this IE, it shall be ignored.
consumerSnpnlid	PlmnlidNid	C	0..1	This IE shall be included if the NRF supports providing SNPN ID of the NF service consumer in the access token claims, to be interpreted for subject (sub IE), as specified in clause 13.4.1.2 of 3GPP TS 33.501[15]. If an NF service producer that receives this IE in the token included in the authorization header does not understand this IE, it shall be ignored.
producerPlmnlid	Plmnlid	C	0..1	This IE shall be included if the access token is granted for an NF service producer belonging to an PLMN and the NRF supports providing PLMN ID of the NF service producer in the access token claims, to be interpreted for audience (aud IE), as specified in clause 13.4.1.2 of 3GPP TS 33.501 [15]. If an NF service producer that receives this IE in the token included in the authorization header does not understand this IE, it shall be ignored.
producerSnpnlid	PlmnlidNid	C	0..1	This IE shall be included if the access token is granted for an NF service producer belonging to an SNPN and the NRF supports providing SNPN ID of the NF service producer in the access token claims, to be interpreted for audience (aud IE), as specified in clause 13.4.1.2 of 3GPP TS 33.501 [15]. When present, it shall contain the SNPN ID of the SNPN the target NF service producer belongs to. If an NF service producer that receives this IE in the token included in the authorization header does not understand this IE, it shall be ignored.
producerSnsaiList	array(Snsai)	O	1..N	This IE may be included if the NRF supports providing list of S-NSSAIs of the NF service producer in the access token claims. If an NF service producer that receives this IE in the token included in the authorization header does not understand this IE, it shall be ignored.

producerNsiList	array(string)	O	1..N	This IE may be included if the NRF supports providing list of NSIs of the NF service producer in the access token claims. If an NF service producer that receives this IE in the token included in the authorization header does not understand this IE, it shall be ignored.
producerNfSetId	NfSetId	O	0..1	This IE may be included if the NRF supports providing NF Set ID of the NF service producer in the access token claims and if the audience contains an NF type. When present, it shall indicate the NF Set ID of the NF service producer instances for which the claim is applicable. If an NF service producer that receives this IE in the token included in the authorization header does not understand this IE, it shall be ignored.
producerNfServiceSetId	NfServiceSetId	O	0..1	This IE may be included during an access token request for a specific NF / NF service instance, if the targetNfServiceSetId IE is present in the Access Token Request. When present, this IE shall contain the NF Service Set ID of the NF Service Producer for which the access token is applicable. If an NF service producer that receives this IE in the token included in the authorization header does not understand this IE, it shall be ignored.
sourceNfInstanceId	NfInstanceId	C	0..1	This IE shall be included if the NRF supports providing NF Instance ID of the source NF in the access token claims, if: - it is an access token request from the DCCF as NF Service Consumer request data from NF Service Producers on behalf of the source NF, to be interpreted as subject (sub IE). See Annex X of 3GPP TS 33.501 [15], or - it is an access token request from an NWDAF containing MTLF service when the NWDAF requests ML models on behalf of another ML model consumer; in this case, this IE shall contain the NF Instance ID of the ML model consumer (e.g. NWDAF containing AnLF). See Annex X.10 of 3GPP TS 33.501 [15].
analyticsIdList	array(NwdafEvent)	C	1..N	This IE shall be provided when the producer is an NWDAF containing MTLF and/or AnLF and requested access token to be used for MTLF and/or AnLF service(s). The IE contains Analytics Id(s) that the consumer is authorized to access as specified in Annex X.10 of 3GPP TS 33.501 [15].

6.3.5.2.5 Type: AccessTokenErr

Table 6.3.5.2.5-1: Definition of type AccessTokenErr

Attribute name	Data type	P	Cardinality	Description
error	string	M	1	This IE shall contain the error described in IETF RFC 6749 [16], clause 5.2. Enum: "invalid_request" "invalid_client" "invalid_grant" "unauthorized_client" "unsupported_grant_type" "invalid_scope"
error_description	string	O	0..1	When present, this IE shall contain the human-readable additional information to indicate the error that occurred, as described in IETF RFC 6749 [16], clause 5.2.
error_uri	string	O	0..1	When present, this IE shall contain the URI identifying a human-readable additional information about the error, as described in IETF RFC 6749 [16], clause 5.2.

6.3.5.2.6 Type: MIModelInterInd

Table 6.3.5.2.6-1: Definition of type MIModelInterInd

Attribute name	Data type	P	Cardinality	Description
analyticsId	NwdafEvent	M	1	Analytics Id that support interoperability.
vendorList	array(VendorId)	M	1..N	This IE shall include the list of NWDAF vendors that are allowed to retrieve ML models from the NWDAF containing MTLF for the provided analyticsId.

6.3.5.3 Simple data types and enumerations

6.3.5.3.1 Introduction

This clause defines simple data types and enumerations that can be referenced from data structures defined in the previous clauses.

6.3.5.3.2 Simple data types

There are no specific simple data types defined in this version of this API. For the re-used data types from other specifications see clause 6.3.5.1

6.3.5.3.3 Void

6.3.5.4 Data types describing alternative data types or combinations of data types

6.3.5.4.1 Type: Audience

Table 6.3.5.4.1-1: Definition of type Audience as a list of "non-exclusive alternatives"

Data type	Cardinality	Description	Applicability
NFType	1	NF type	
array(NfInstanceId)	1..N	Array of NF Instance Ids	

6.3.6 Error Handling

6.3.6.1 General

HTTP error handling shall be supported as specified in IETF RFC 6749 [16] for errors returned by NRF as Oauth 2.0 authorization server, and also as specified in clause 5.2.7.4 of 3GPP TS 29.500 [4] for errors returned by SCP or SEPP.

6.3.6.2 Protocol Errors

Protocol errors handling shall be supported as specified in clause 5.2.7 of 3GPP TS 29.500 [4].

6.3.6.3 Application Errors

The application errors defined for the Nnrf_AccessToken service are listed in Table 6.3.6.3-1 and correspond to the values of the "error" attribute (see clause 6.3.5.2.5).

Table 6.3.6.3-1: Application errors

Application Error	HTTP status code	Description
invalid_request	400 Bad Request	See IETF RFC 6749 [16]
invalid_client	400 Bad Request, 401 Unauthorized	See IETF RFC 6749 [16]
invalid_grant	400 Bad Request	See IETF RFC 6749 [16]
unauthorized_client	400 Bad Request	See IETF RFC 6749 [16]
unsupported_grant_type	400 Bad Request	See IETF RFC 6749 [16]
invalid_scope	400 Bad Request	See IETF RFC 6749 [16]

6.4 Nnrf_Bootstrapping Service API

6.4.1 API URI

URIs of this API shall have the following root:

```
{nrfApiRoot}
```

where {nrfApiRoot} represents the concatenation of the "scheme" and "authority" components of the NRF, as defined in IETF RFC 3986 [17].

6.4.2 Usage of HTTP

6.4.2.1 General

HTTP/2, as defined in IETF RFC 9113 [9], shall be used as specified in clause 5 of 3GPP TS 29.500 [4].

HTTP/2 shall be transported as specified in clause 5.3 of 3GPP TS 29.500 [4].

HTTP messages and bodies this API shall comply with the OpenAPI [10] specification contained in Annex A.

6.4.2.2 HTTP standard headers

6.4.2.2.1 General

The mandatory standard HTTP headers as specified in clause 5.2.2.2 of 3GPP TS 29.500 [4] shall be supported.

6.4.2.2.2 Content type

The following content types shall be supported:

- The JSON format (IETF RFC 8259 [22]). The use of the JSON format shall be signalled by the content type "application/json". See also clause 5.4 of 3GPP TS 29.500 [4].
- The Problem Details JSON Object (IETF RFC 9457 [11]). The use of the Problem Details JSON object in a HTTP response body shall be signalled by the content type "application/problem+json".
- The 3GPP hypermedia format as defined in 3GPP TS 29.501 [5]. The use of the 3GPP hypermedia format in a HTTP response body shall be signalled by the content type "application/3gppHal+json".

6.4.2.2.3 Cache-Control

A "Cache-Control" header should be included in HTTP responses, as described in IETF RFC 9111 [20], clause 5.2. It shall contain a "max-age" value, indicating the amount of time in seconds after which the received response is considered stale.

6.4.2.2.4 ETag

An "ETag" (entity-tag) header should be included in HTTP responses, as described in IETF RFC 9110 [40], clause 8.8.3. It shall contain a server-generated strong validator, that allows further matching of this value (included in subsequent client requests) with a given resource representation stored in the server or in a cache.

6.4.2.2.5 If-None-Match

An NF Service Consumer should issue conditional GET requests towards the Nnrf_Bootstrapping service, by including an If-None-Match header in HTTP requests, as described in IETF RFC 9110 [40], clause 13.1.2, containing one or several entity tags received in previous responses for the same resource.

6.4.2.3 HTTP custom headers

6.4.2.3.1 General

In this release of this specification, no custom headers specific to the Nnrf_Bootstrapping Service API are defined. For 3GPP specific HTTP custom headers used across all service-based interfaces, see clause 5.2.3 of 3GPP TS 29.500 [4].

6.4.3 Resources

6.4.3.1 Overview

The structure of the Resource URIs of the Nnrf_Bootstrapping service is shown in figure 6.4.3.1-1.

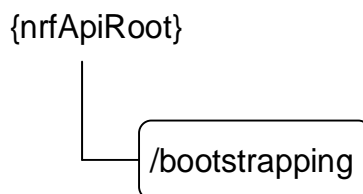

Figure 6.4.3.1-1: Resource URI structure of the Nnrf_Bootstrapping API

Table 6.4.3.1-1 provides an overview of the resources and applicable HTTP methods.

Table 6.4.3.1-1: Resources and methods overview

Resource name	Resource URI	HTTP method or custom operation	Description
Bootstrapping (Document)	{nrfApiRoot}/bootstrapping	GET	Retrieve a collection of links pointing to other services exposed by NRF.

6.4.3.2 Resource: Bootstrapping (Document)

6.4.3.2.1 Description

This resource represents a collection of links pointing to other services exposed by NRF.

This resource is modelled as the Document resource archetype (see clause C.3 of 3GPP TS 29.501 [5]).

6.4.3.2.2 Resource Definition

Resource URI: **{nrfApiRoot}/bootstrapping**

This resource shall support the resource URI variables defined in table 6.4.3.2.2-1.

Table 6.4.3.2.2-1: Resource URI variables for this resource

Name	Definition
nrfApiRoot	See clause 6.4.1

6.4.3.2.3 Resource Standard Methods

6.4.3.2.3.1 GET

This method retrieves a list of links pointing to other services exposed by NRF. This method shall support the URI query parameters specified in table 6.4.3.2.3.1-1.

Table 6.4.3.2.3.1-1: URI query parameters supported by the GET method on this resource

Name	Data type	P	Cardinality	Description
n/a	n/a			

This method shall support the request data structures specified in table 6.4.3.2.3.1-2 and the response data structures and response codes specified in table 6.4.3.2.3.1-3.

Table 6.4.3.2.3.1-2: Data structures supported by the GET Request Body on this resource

Data type	P	Cardinality	Description
n/a			

Table 6.4.3.2.3.1-3: Data structures supported by the GET Response Body on this resource

Data type	P	Cardinality	Response codes	Description
BootstrappingInfo	M	1	200 OK	The response body contains a "_links" object containing the URI of each service exposed by the NRF. The response may also contain the status of the NRF and the features supported by each NRF service.
NOTE: The mandatory HTTP error status codes for the GET method listed in Table 5.2.7.1-1 of 3GPP TS 29.500 [4] other than those specified in the table above also apply, with a ProblemDetails data type (see clause 5.2.7 of 3GPP TS 29.500 [4]).				

6.4.4 Custom Operations without associated resources

There are no custom operations defined without any associated resources for the Nnrf_Bootstrapping service in this release of the specification.

6.4.5 Notifications

There are no notifications defined for the Nnrf_Bootstrapping service in this release of the specification.

6.4.6 Data Model

6.4.6.1 General

This clause specifies the application data model supported by the API.

Table 6.4.6.1-1 specifies the data types defined for the Nnrf_Bootstrapping service-based interface protocol.

Table 6.4.6.1-1: Nnrf_Bootstrapping specific Data Types

Data type	Clause defined	Description
BootstrappingInfo	6.4.6.2.2	Information returned by NRF in the bootstrapping response message.
Status	6.4.6.3.2	Overall status of the NRF.

Table 6.4.6.1-2 specifies data types re-used by the Nnrf_Bootstrapping service-based interface protocol from other specifications, including a reference to their respective specifications and when needed, a short description of their use within the Nnrf service-based interface.

Table 6.4.6.1-2: Nnrf_Bootstrapping re-used Data Types

Data type	Reference	Comments
LinksValueSchema	3GPP TS 29.571 [7]	3GPP Hypermedia link
NfInstanceId	3GPP TS 29.571 [7]	Identifier (UUID) of the NF Instance. The hexadecimal letters of the UUID should be formatted by the sender as lower-case characters and shall be handled as case-insensitive by the receiver.
ProblemDetails	3GPP TS 29.571 [7]	
SupportedFeatures	3GPP TS 29.571 [7]	

6.4.6.2 Structured data types

6.4.6.2.1 Introduction

This clause defines the structures to be used in resource representations.

6.4.6.2.2 Type: BootstrappingInfo

Table 6.4.6.2.2-1: Definition of type BootstrappingInfo

Attribute name	Data type	P	Cardinality	Description
status	Status	O	0..1	Status of the NRF (operative, non-operative, ...) The NRF shall be considered as operative if this attribute is absent.
_links	map(LinksValueSchema)	M	1..N	Map of LinksValueSchema objects, where the keys are the link relations, as described in Table 6.4.6.3.3.1-1, and the values are objects containing an "href" attribute, whose value is an absolute URI corresponding to each link relation.
nrfFeatures	map(SupportedFeatures)	O	1..N	Map of features supported by the NRF, where the keys of the map are the NRF services (as defined in clause 6.1.6.3.11), and where the value indicates the features supported by the corresponding NRF services. When present, the NRF shall indicate all the features of all the services it supports. (NOTE)
oauth2Required	map(boolean)	O	1..N	When present, this IE shall indicate whether the NRF requires Oauth2-based authorization for accessing its services. The key of the map shall be the name of an NRF service, e.g. "nnrf-nfm" or "nnrf-disc". The value of each entry of the map shall be encoded as follows: - true: OAuth2 based authorization is required. - false: OAuth2 based authorization is not required. The absence of this IE means that the NRF has not provided any indication about its usage of Oauth2 for authorization.
nrfSetId	NfSetId	O	0..1	NRF Set Id
nrfInstanceId	NfInstanceId	O	0..1	NRF Instance Id
NOTE: The absence of the nrfFeatures attribute in the BootstrappingInfo shall not be interpreted as if the NRF does not support any feature.				

6.4.6.3 Simple data types and enumerations

6.4.6.3.1 Introduction

This clause defines simple data types and enumerations that can be referenced from data structures defined in the previous clauses.

6.4.6.3.2 Enumeration: Status

Table 6.4.6.3.2-1: Enumeration Status

Enumeration value	Description
"OPERATIVE"	The NRF is operative
"NON_OPERATIVE"	The NRF is not operative

6.4.6.3.3 Relation Types

6.4.6.3.3.1 General

This clause describes the possible relation types defined within NRF API. See clause 4.7.5.2 of 3GPP TS 29.501 [5] for the description of the relation types.

Table 6.4.6.3.3.1-1: supported registered relation types

Relation Name	Description
self	The "href" attribute of the object associated to this relation type contains the URI of the same resource returned in the response body (i.e. the "bootstrapping" resource).
manage	The "href" attribute of the object associated to this relation type contains the URI of the resource used in the Nnrf_NFManagement API to register/deregister/update NF Instances profiles in the NRF (i.e. the "nf-instances" store resource). (NOTE)
subscribe	The "href" attribute of the object associated to this relation type contains the URI of the resource used in the Nnrf_NFManagement API to manage subscriptions to the NRF (i.e. the "subscriptions" collection resource). (NOTE)
discover	The "href" attribute of the object associated to this relation type contains the URI of the resource used in the Nnrf_NFDiscovery API (i.e. the "nf-instances" collection resource).
authorize	The "href" attribute of the object associated to this relation type contains the URI of the OAuth2 Access Token Request endpoint, used to request authorization to other APIs in the 5G Core Network.
NOTE:	The URIs of the "manage" and "subscribe" "href" attributes shall have the same apiRoot (i.e. authority and prefix) since these service operations belong to the same service.

Annex A (normative): OpenAPI specification

A.1 General

This Annex specifies the formal definition of the Nnrf Service API(s). It consists of OpenAPI 3.0.0 specifications, in YAML format.

This Annex takes precedence when being discrepant to other parts of the specification with respect to the encoding of information elements and methods within the API(s).

NOTE: The semantics and procedures, as well as conditions, e.g. for the applicability and allowed combinations of attributes or values, not expressed in the OpenAPI definitions but defined in other parts of the specification also apply.

Informative copies of the OpenAPI specification files contained in this 3GPP Technical Specification are available on a Git-based repository, that uses the GitLab software version control system (see 3GPP TS 29.501 [5] clause 5.3.1 and 3GPP TR 21.900 [31] clause 5B).

A.2 Nnrf_NFManagement API

openapi: 3.0.0

info:

```
version: '1.3.2'
title: 'NRF NFManagement Service'
description: |
  NRF NFManagement Service.
  © 2024, 3GPP Organizational Partners (ARIB, ATIS, CCSA, ETSI, TSDSI, TTA, TTC).
  All rights reserved.
```

externalDocs:

```
description: 3GPP TS 29.510 V18.9.0; 5G System; Network Function Repository Services; Stage 3
url: 'https://www.3gpp.org/ftp/Specs/archive/29_series/29.510/'
```

servers:

```
- url: '{apiRoot}/nnrf-nfm/v1'
  variables:
    apiRoot:
      default: https://example.com
      description: apiRoot as defined in clause 4.4 of 3GPP TS 29.501
```

security:

```
- {}
- oAuth2ClientCredentials:
  - nnrf-nfm
```

paths:

```
/nf-instances:
  get:
    summary: Retrieves a collection of NF Instances
    operationId: GetNFInstances
    tags:
      - NF Instances (Store)
    security:
      - {}
      - oAuth2ClientCredentials:
        - nnrf-nfm
      - oAuth2ClientCredentials:
        - nnrf-nfm
        - nnrf-nfm:nf-instances:read
    parameters:
      - name: nf-type
        in: query
        description: Type of NF
        required: false
        schema:
```

```

    $ref: '#/components/schemas/NFType'
  - name: limit
    in: query
    description: How many items to return at one time
    required: false
    schema:
      type: integer
      minimum: 1
  - name: page-number
    in: query
    description: Page number where the response shall start
    required: false
    schema:
      type: integer
      minimum: 1
  - name: page-size
    in: query
    description: Maximum number of items in each returned page
    schema:
      type: integer
      minimum: 1
responses:
  '200':
    description: Expected response to a valid request
    content:
      application/3gppHal+json:
        schema:
          $ref: '#/components/schemas/UriList'
    headers:
      ETag:
        description: >
          Entity Tag containing a strong validator, described in IETF RFC 9110, 8.8.3
        schema:
          type: string
  '307':
    description: Temporary Redirect
    content:
      application/json:
        schema:
          $ref: 'TS29571_CommonData.yaml#/components/schemas/RedirectResponse'
    headers:
      Location:
        description: The URI pointing to the resource located on the redirect target NRF
        required: true
        schema:
          type: string
  '308':
    description: Permanent Redirect
    content:
      application/json:
        schema:
          $ref: 'TS29571_CommonData.yaml#/components/schemas/RedirectResponse'
    headers:
      Location:
        description: The URI pointing to the resource located on the redirect target NRF
        required: true
        schema:
          type: string
  '400':
    $ref: 'TS29571_CommonData.yaml#/components/responses/400'
  '401':
    $ref: 'TS29571_CommonData.yaml#/components/responses/401'
  '403':
    $ref: 'TS29571_CommonData.yaml#/components/responses/403'
  '404':
    $ref: 'TS29571_CommonData.yaml#/components/responses/404'
  '406':
    $ref: 'TS29571_CommonData.yaml#/components/responses/406'
  '411':
    $ref: 'TS29571_CommonData.yaml#/components/responses/411'
  '413':
    $ref: 'TS29571_CommonData.yaml#/components/responses/413'
  '415':
    $ref: 'TS29571_CommonData.yaml#/components/responses/415'
  '429':
    $ref: 'TS29571_CommonData.yaml#/components/responses/429'
  '500':
    $ref: 'TS29571_CommonData.yaml#/components/responses/500'

```

```

'501':
  $ref: 'TS29571_CommonData.yaml#/components/responses/501'
'503':
  $ref: 'TS29571_CommonData.yaml#/components/responses/503'
default:
  $ref: 'TS29571_CommonData.yaml#/components/responses/default'
options:
  summary: Discover communication options supported by NRF for NF Instances
  operationId: OptionsNFInstances
  tags:
    - NF Instances (Store)
  responses:
    '200':
      description: OK
      content:
        application/json:
          schema:
            $ref: '#/components/schemas/OptionsResponse'
      headers:
        Accept-Encoding:
          description: Accept-Encoding, described in IETF RFC 9110
          schema:
            type: string
    '204':
      description: No Content
      headers:
        Accept-Encoding:
          description: Accept-Encoding, described in IETF RFC 9110
          schema:
            type: string
    '307':
      description: Temporary Redirect
      content:
        application/json:
          schema:
            $ref: 'TS29571_CommonData.yaml#/components/schemas/RedirectResponse'
      headers:
        Location:
          description: The URI pointing to the resource located on the redirect target NRF
          required: true
          schema:
            type: string
    '308':
      description: Permanent Redirect
      content:
        application/json:
          schema:
            $ref: 'TS29571_CommonData.yaml#/components/schemas/RedirectResponse'
      headers:
        Location:
          description: The URI pointing to the resource located on the redirect target NRF
          required: true
          schema:
            type: string
    '400':
      $ref: 'TS29571_CommonData.yaml#/components/responses/400'
    '401':
      $ref: 'TS29571_CommonData.yaml#/components/responses/401'
    '403':
      $ref: 'TS29571_CommonData.yaml#/components/responses/403'
    '404':
      $ref: 'TS29571_CommonData.yaml#/components/responses/404'
    '405':
      $ref: 'TS29571_CommonData.yaml#/components/responses/405'
    '429':
      $ref: 'TS29571_CommonData.yaml#/components/responses/429'
    '500':
      $ref: 'TS29571_CommonData.yaml#/components/responses/500'
    '501':
      $ref: 'TS29571_CommonData.yaml#/components/responses/501'
    '503':
      $ref: 'TS29571_CommonData.yaml#/components/responses/503'
  default:
    $ref: 'TS29571_CommonData.yaml#/components/responses/default'

/nf-instances/{nfInstanceID}:
  get:
    summary: Read the profile of a given NF Instance

```

```

operationId: GetNFInstance
tags:
  - NF Instance ID (Document)
security:
  - {}
  - oAuth2ClientCredentials:
    - nnrf-nfm
  - oAuth2ClientCredentials:
    - nnrf-nfm
    - nnrf-nfm:nf-instances:read
parameters:
  - name: nfInstanceId
    in: path
    description: Unique ID of the NF Instance
    required: true
    schema:
      $ref: 'TS29571_CommonData.yaml#/components/schemas/NfInstanceId'
  - name: requester-features
    in: query
    description: Features supported by the NF Service Consumer
    schema:
      $ref: 'TS29571_CommonData.yaml#/components/schemas/SupportedFeatures'
responses:
  '200':
    description: Expected response to a valid request
    headers:
      ETag:
        description: >
          Entity Tag containing a strong validator, described in IETF RFC 9110, 8.8.3
        schema:
          type: string
    content:
      application/json:
        schema:
          $ref: '#/components/schemas/NFProfile'
  '307':
    description: Temporary Redirect
    content:
      application/json:
        schema:
          $ref: 'TS29571_CommonData.yaml#/components/schemas/RedirectResponse'
    headers:
      Location:
        description: The URI pointing to the resource located on the redirect target NRF
        required: true
        schema:
          type: string
  '308':
    description: Permanent Redirect
    content:
      application/json:
        schema:
          $ref: 'TS29571_CommonData.yaml#/components/schemas/RedirectResponse'
    headers:
      Location:
        description: The URI pointing to the resource located on the redirect target NRF
        required: true
        schema:
          type: string
  '400':
    $ref: 'TS29571_CommonData.yaml#/components/responses/400'
  '401':
    $ref: 'TS29571_CommonData.yaml#/components/responses/401'
  '403':
    $ref: 'TS29571_CommonData.yaml#/components/responses/403'
  '404':
    $ref: 'TS29571_CommonData.yaml#/components/responses/404'
  '406':
    $ref: 'TS29571_CommonData.yaml#/components/responses/406'
  '411':
    $ref: 'TS29571_CommonData.yaml#/components/responses/411'
  '413':
    $ref: 'TS29571_CommonData.yaml#/components/responses/413'
  '415':
    $ref: 'TS29571_CommonData.yaml#/components/responses/415'
  '429':
    $ref: 'TS29571_CommonData.yaml#/components/responses/429'
  '500':

```

```

    $ref: 'TS29571_CommonData.yaml#/components/responses/500'
  '501':
    $ref: 'TS29571_CommonData.yaml#/components/responses/501'
  '503':
    $ref: 'TS29571_CommonData.yaml#/components/responses/503'
  default:
    $ref: 'TS29571_CommonData.yaml#/components/responses/default'
put:
  summary: Register a new NF Instance
  operationId: RegisterNFInstance
  tags:
    - NF Instance ID (Document)
  security:
    - {}
    - OAuth2ClientCredentials:
      - nrf-nfm
    - OAuth2ClientCredentials:
      - nrf-nfm
      - nrf-nfm:nf-instance:write
  parameters:
    - name: nfInstanceId
      in: path
      required: true
      description: Unique ID of the NF Instance to register
      schema:
        $ref: 'TS29571_CommonData.yaml#/components/schemas/NfInstanceId'
    - name: Content-Encoding
      in: header
      description: Content-Encoding, described in IETF RFC 9110
      schema:
        type: string
    - name: Accept-Encoding
      in: header
      description: Accept-Encoding, described in IETF RFC 9110
      schema:
        type: string
  requestBody:
    content:
      application/json:
        schema:
          $ref: '#/components/schemas/NFProfile'
    required: true
  responses:
    '200':
      description: OK (Profile Replacement)
      content:
        application/json:
          schema:
            $ref: '#/components/schemas/NFProfile'
      headers:
        Accept-Encoding:
          description: Accept-Encoding, described in IETF RFC 9110
          schema:
            type: string
        Content-Encoding:
          description: Content-Encoding, described in IETF RFC 9110
          schema:
            type: string
        ETag:
          description: >
            Entity Tag containing a strong validator, described in IETF RFC 9110, 8.8.3
          schema:
            type: string
    '201':
      description: Expected response to a valid request
      content:
        application/json:
          schema:
            $ref: '#/components/schemas/NFProfile'
      headers:
        Location:
          description: >
            Contains the URI of the newly created resource, according to the structure:
            {apiRoot}/nrf-nfm/v1/nf-instances/{nfInstanceId}
          required: true
          schema:
            type: string
        Accept-Encoding:

```

```

    description: Accept-Encoding, described in IETF RFC 9110
    schema:
      type: string
  Content-Encoding:
    description: Content-Encoding, described in IETF RFC 9110
    schema:
      type: string
  ETag:
    description: >
      Entity Tag containing a strong validator, described in IETF RFC 9110, 8.8.3
    schema:
      type: string
'307':
  description: Temporary Redirect
  content:
    application/json:
      schema:
        $ref: 'TS29571_CommonData.yaml#/components/schemas/RedirectResponse'
  headers:
    Location:
      description: The URI pointing to the resource located on the redirect target NRF
      required: true
      schema:
        type: string
'308':
  description: Permanent Redirect
  content:
    application/json:
      schema:
        $ref: 'TS29571_CommonData.yaml#/components/schemas/RedirectResponse'
  headers:
    Location:
      description: The URI pointing to the resource located on the redirect target NRF
      required: true
      schema:
        type: string
'400':
  description: Bad Request
  content:
    application/problem+json:
      schema:
        $ref: '#/components/schemas/NFProfileRegistrationError'
'401':
  $ref: 'TS29571_CommonData.yaml#/components/responses/401'
'403':
  $ref: 'TS29571_CommonData.yaml#/components/responses/403'
'404':
  $ref: 'TS29571_CommonData.yaml#/components/responses/404'
'411':
  $ref: 'TS29571_CommonData.yaml#/components/responses/411'
'413':
  $ref: 'TS29571_CommonData.yaml#/components/responses/413'
'415':
  $ref: 'TS29571_CommonData.yaml#/components/responses/415'
'429':
  $ref: 'TS29571_CommonData.yaml#/components/responses/429'
'500':
  $ref: 'TS29571_CommonData.yaml#/components/responses/500'
'501':
  $ref: 'TS29571_CommonData.yaml#/components/responses/501'
'503':
  $ref: 'TS29571_CommonData.yaml#/components/responses/503'
default:
  $ref: 'TS29571_CommonData.yaml#/components/responses/default'
patch:
  summary: Update NF Instance profile
  operationId: UpdateNFInstance
  tags:
    - NF Instance ID (Document)
  security:
    - {}
    - OAuth2ClientCredentials:
      - nrf-nfm
    - OAuth2ClientCredentials:
      - nrf-nfm
      - nrf-nfm:nf-instance:write
  parameters:
    - name: nfInstanceId

```



```

    in: path
    required: true
    description: Unique ID of the NF Instance to update
    schema:
      $ref: 'TS29571_CommonData.yaml#/components/schemas/NfInstanceId'
  - name: Content-Encoding
    in: header
    description: Content-Encoding, described in IETF RFC 9110
    schema:
      type: string
  - name: Accept-Encoding
    in: header
    description: Accept-Encoding, described in IETF RFC 9110
    schema:
      type: string
  - name: If-Match
    in: header
    description: Validator for conditional requests, as described in IETF RFC 9110, 13.1.1
    schema:
      type: string
requestBody:
  content:
    application/json-patch+json:
      schema:
        type: array
        items:
          $ref: 'TS29571_CommonData.yaml#/components/schemas/PatchItem'
        minItems: 1
      required: true
  responses:
    '200':
      description: Expected response to a valid request
      content:
        application/json:
          schema:
            $ref: '#/components/schemas/NFProfile'
      headers:
        Accept-Encoding:
          description: Accept-Encoding, described in IETF RFC 9110
          schema:
            type: string
        ETag:
          description: >
            Entity Tag containing a strong validator, described in IETF RFC 9110, 8.8.3
          schema:
            type: string
        Content-Encoding:
          description: Content-Encoding, described in IETF RFC 9110
          schema:
            type: string
    '204':
      description: Expected response with empty body
      headers:
        Accept-Encoding:
          description: Accept-Encoding, described in IETF RFC 9110
          schema:
            type: string
    '307':
      description: Temporary Redirect
      content:
        application/json:
          schema:
            $ref: 'TS29571_CommonData.yaml#/components/schemas/RedirectResponse'
      headers:
        Location:
          description: The URI pointing to the resource located on the redirect target NRF
          required: true
          schema:
            type: string
    '308':
      description: Permanent Redirect
      content:
        application/json:
          schema:
            $ref: 'TS29571_CommonData.yaml#/components/schemas/RedirectResponse'
      headers:
        Location:
          description: The URI pointing to the resource located on the redirect target NRF

```

```

      required: true
      schema:
        type: string
    '400':
      $ref: 'TS29571_CommonData.yaml#/components/responses/400'
    '403':
      $ref: 'TS29571_CommonData.yaml#/components/responses/403'
    '404':
      $ref: 'TS29571_CommonData.yaml#/components/responses/404'
    '409':
      $ref: 'TS29571_CommonData.yaml#/components/responses/409'
    '411':
      $ref: 'TS29571_CommonData.yaml#/components/responses/411'
    '412':
      $ref: 'TS29571_CommonData.yaml#/components/responses/412'
    '413':
      $ref: 'TS29571_CommonData.yaml#/components/responses/413'
    '415':
      $ref: 'TS29571_CommonData.yaml#/components/responses/415'
    '429':
      $ref: 'TS29571_CommonData.yaml#/components/responses/429'
    '500':
      $ref: 'TS29571_CommonData.yaml#/components/responses/500'
    '501':
      $ref: 'TS29571_CommonData.yaml#/components/responses/501'
    '503':
      $ref: 'TS29571_CommonData.yaml#/components/responses/503'
    default:
      $ref: 'TS29571_CommonData.yaml#/components/responses/default'
delete:
  summary: Deregisters a given NF Instance
  operationId: DeregisterNFInstance
  tags:
    - NF Instance ID (Document)
  security:
    - {}
    - oAuth2ClientCredentials:
      - nrf-nfm
    - oAuth2ClientCredentials:
      - nrf-nfm
      - nrf-nfm:nf-instance:write
  parameters:
    - name: nfInstanceId
      in: path
      required: true
      description: Unique ID of the NF Instance to deregister
      schema:
        $ref: 'TS29571_CommonData.yaml#/components/schemas/NfInstanceId'
  responses:
    '204':
      description: Expected response to a successful deregistration
    '307':
      description: Temporary Redirect
      content:
        application/json:
          schema:
            $ref: 'TS29571_CommonData.yaml#/components/schemas/RedirectResponse'
      headers:
        Location:
          description: The URI pointing to the resource located on the redirect target NRF
          required: true
          schema:
            type: string
    '308':
      description: Permanent Redirect
      content:
        application/json:
          schema:
            $ref: 'TS29571_CommonData.yaml#/components/schemas/RedirectResponse'
      headers:
        Location:
          description: The URI pointing to the resource located on the redirect target NRF
          required: true
          schema:
            type: string
    '400':
      $ref: 'TS29571_CommonData.yaml#/components/responses/400'
    '401':

```

```

    $ref: 'TS29571_CommonData.yaml#/components/responses/401'
  '403':
    $ref: 'TS29571_CommonData.yaml#/components/responses/403'
  '404':
    $ref: 'TS29571_CommonData.yaml#/components/responses/404'
  '411':
    $ref: 'TS29571_CommonData.yaml#/components/responses/411'
  '429':
    $ref: 'TS29571_CommonData.yaml#/components/responses/429'
  '500':
    $ref: 'TS29571_CommonData.yaml#/components/responses/500'
  '501':
    $ref: 'TS29571_CommonData.yaml#/components/responses/501'
  '503':
    $ref: 'TS29571_CommonData.yaml#/components/responses/503'
  default:
    $ref: 'TS29571_CommonData.yaml#/components/responses/default'

```

/shared-data:

```

get:
  summary: Retrieves a collection of Shared Data
  operationId: GetSharedDataCollection
  tags:
    - Shared Data (Store)
  security:
    - {}
    - oAuth2ClientCredentials:
        - nnrf-nfm
    - oAuth2ClientCredentials:
        - nnrf-nfm
        - nnrf-nfm:shared-data:read
  parameters:
    - name: shared-data-ids
      in: query
      description: List of shared data IDs
      required: true
      style: form
      explode: false
      schema:
        $ref: '#/components/schemas/SharedDataIdList'
    - name: supported-features
      in: query
      description: Supported Features
      schema:
        $ref: 'TS29571_CommonData.yaml#/components/schemas/SupportedFeatures'
  responses:
    '200':
      description: Expected response to a valid request
      content:
        application/json:
          schema:
            type: array
            items:
              $ref: '#/components/schemas/SharedData'
    '400':
      $ref: 'TS29571_CommonData.yaml#/components/responses/400'
    '401':
      $ref: 'TS29571_CommonData.yaml#/components/responses/401'
    '403':
      $ref: 'TS29571_CommonData.yaml#/components/responses/403'
    '404':
      $ref: 'TS29571_CommonData.yaml#/components/responses/404'
    '406':
      $ref: 'TS29571_CommonData.yaml#/components/responses/406'
    '411':
      $ref: 'TS29571_CommonData.yaml#/components/responses/411'
    '413':
      $ref: 'TS29571_CommonData.yaml#/components/responses/413'
    '415':
      $ref: 'TS29571_CommonData.yaml#/components/responses/415'
    '429':
      $ref: 'TS29571_CommonData.yaml#/components/responses/429'
    '500':
      $ref: 'TS29571_CommonData.yaml#/components/responses/500'
    '501':
      $ref: 'TS29571_CommonData.yaml#/components/responses/501'
    '503':
      $ref: 'TS29571_CommonData.yaml#/components/responses/503'

```

```

default:
  $ref: 'TS29571_CommonData.yaml#/components/responses/default'

```

```

/shared-data/{sharedDataId}:

```

```

  get:

```

```

    summary: Read the shared data identified by a given NF sharedDataId
    operationId: GetSharedData

```

```

    tags:

```

```

      - Shared Data (Document)

```

```

    security:

```

```

      - {}

```

```

      - oAuth2ClientCredentials:

```

```

        - nnrF-nfm

```

```

      - oAuth2ClientCredentials:

```

```

        - nnrF-nfm

```

```

        - nnrF-nfm:shared-data:read

```

```

    parameters:

```

```

      - name: sharedDataId

```

```

        in: path

```

```

        description: Unique ID of the Shared Data

```

```

        required: true

```

```

        schema:

```

```

          type: string

```

```

          format: uuid

```

```

      - name: requester-features

```

```

        in: query

```

```

        description: Features supported by the NF Service Consumer

```

```

        schema:

```

```

          $ref: 'TS29571_CommonData.yaml#/components/schemas/SupportedFeatures'

```

```

    responses:

```

```

      '200':

```

```

        description: Expected response to a valid request

```

```

        headers:

```

```

          ETag:

```

```

            description: Entity Tag containing a strong validator, described in IETF RFC 9110,

```

```

            schema:

```

```

              type: string

```

```

        content:

```

```

          application/json:

```

```

            schema:

```

```

              $ref: '#/components/schemas/SharedData'

```

```

      '307':

```

```

        description: Temporary Redirect

```

```

        content:

```

```

          application/json:

```

```

            schema:

```

```

              $ref: 'TS29571_CommonData.yaml#/components/schemas/RedirectResponse'

```

```

        headers:

```

```

          Location:

```

```

            description: The URI pointing to the resource located on the redirect target NRF

```

```

            required: true

```

```

            schema:

```

```

              type: string

```

```

      '308':

```

```

        description: Permanent Redirect

```

```

        content:

```

```

          application/json:

```

```

            schema:

```

```

              $ref: 'TS29571_CommonData.yaml#/components/schemas/RedirectResponse'

```

```

        headers:

```

```

          Location:

```

```

            description: The URI pointing to the resource located on the redirect target NRF

```

```

            required: true

```

```

            schema:

```

```

              type: string

```

```

      '400':

```

```

        $ref: 'TS29571_CommonData.yaml#/components/responses/400'

```

```

      '401':

```

```

        $ref: 'TS29571_CommonData.yaml#/components/responses/401'

```

```

      '403':

```

```

        $ref: 'TS29571_CommonData.yaml#/components/responses/403'

```

```

      '404':

```

```

        $ref: 'TS29571_CommonData.yaml#/components/responses/404'

```

```

      '406':

```

```

        $ref: 'TS29571_CommonData.yaml#/components/responses/406'

```

```

      '411':

```

```

        $ref: 'TS29571_CommonData.yaml#/components/responses/411'

```

8.8.3

```

'413':
  $ref: 'TS29571_CommonData.yaml#/components/responses/413'
'415':
  $ref: 'TS29571_CommonData.yaml#/components/responses/415'
'429':
  $ref: 'TS29571_CommonData.yaml#/components/responses/429'
'500':
  $ref: 'TS29571_CommonData.yaml#/components/responses/500'
'501':
  $ref: 'TS29571_CommonData.yaml#/components/responses/501'
'503':
  $ref: 'TS29571_CommonData.yaml#/components/responses/503'
default:
  $ref: 'TS29571_CommonData.yaml#/components/responses/default'
put:
  summary: Register new Shared Data
  operationId: RegisterSharedData
  tags:
    - Shared Data (Document)
  security:
    - {}
    - oAuth2ClientCredentials:
        - nrf-nfm
    - oAuth2ClientCredentials:
        - nrf-nfm
        - nrf-nfm:shared-data:write
  parameters:
    - name: sharedDataId
      in: path
      required: true
      description: Unique ID of the Shared Data to register
      schema:
        type: string
        format: uuid
    - name: Content-Encoding
      in: header
      description: Content-Encoding, described in IETF RFC 9110
      schema:
        type: string
    - name: Accept-Encoding
      in: header
      description: Accept-Encoding, described in IETF RFC 9110
      schema:
        type: string
  requestBody:
    content:
      application/json:
        schema:
          $ref: '#/components/schemas/SharedData'
        required: true
  responses:
    '200':
      description: OK (Shared Data Replacement)
      content:
        application/json:
          schema:
            $ref: '#/components/schemas/SharedData'
      headers:
        Accept-Encoding:
          description: Accept-Encoding, described in IETF RFC 9110
          schema:
            type: string
        Content-Encoding:
          description: Content-Encoding, described in IETF RFC 9110
          schema:
            type: string
        ETag:
          description: Entity Tag containing a strong validator, described in IETF RFC 9110,
8.8.3
          schema:
            type: string
    '201':
      description: Expected response to a valid request
      content:
        application/json:
          schema:
            $ref: '#/components/schemas/SharedData'
      headers:

```

```

      Location:
        description: >
          Contains the URI of the newly created resource, according to the structure:
          {apiRoot}/nnrf-nfm/<apiVersion>/shared-data/{sharedDataId}
        required: true
        schema:
          type: string
      Accept-Encoding:
        description: Accept-Encoding, described in IETF RFC 9110
        schema:
          type: string
      Content-Encoding:
        description: Content-Encoding, described in IETF RFC 9110
        schema:
          type: string
      ETag:
        description: Entity Tag containing a strong validator, described in IETF RFC 9110,
8.8.3
        schema:
          type: string
    '204':
      description: No Content (Shared Data Replacement)
    '307':
      description: Temporary Redirect
      content:
        application/json:
          schema:
            $ref: 'TS29571_CommonData.yaml#/components/schemas/RedirectResponse'
      headers:
        Location:
          description: The URI pointing to the resource located on the redirect target NRF
          required: true
          schema:
            type: string
    '308':
      description: Permanent Redirect
      content:
        application/json:
          schema:
            $ref: 'TS29571_CommonData.yaml#/components/schemas/RedirectResponse'
      headers:
        Location:
          description: The URI pointing to the resource located on the redirect target NRF
          required: true
          schema:
            type: string
    '400':
      $ref: 'TS29571_CommonData.yaml#/components/responses/400'
    '401':
      $ref: 'TS29571_CommonData.yaml#/components/responses/401'
    '403':
      $ref: 'TS29571_CommonData.yaml#/components/responses/403'
    '404':
      $ref: 'TS29571_CommonData.yaml#/components/responses/404'
    '411':
      $ref: 'TS29571_CommonData.yaml#/components/responses/411'
    '413':
      $ref: 'TS29571_CommonData.yaml#/components/responses/413'
    '415':
      $ref: 'TS29571_CommonData.yaml#/components/responses/415'
    '429':
      $ref: 'TS29571_CommonData.yaml#/components/responses/429'
    '500':
      $ref: 'TS29571_CommonData.yaml#/components/responses/500'
    '501':
      $ref: 'TS29571_CommonData.yaml#/components/responses/501'
    '503':
      $ref: 'TS29571_CommonData.yaml#/components/responses/503'
    default:
      $ref: 'TS29571_CommonData.yaml#/components/responses/default'
  patch:
    summary: Update Shared Data
    operationId: UpdateSharedData
    tags:
      - Shared Data (Document)
    security:
      - {}
      - oAuth2ClientCredentials:

```

```

- nrf-nfm
- oAuth2ClientCredentials:
- nrf-nfm
- nrf-nfm:shared-data:write
parameters:
- name: sharedDataId
  in: path
  required: true
  description: Unique ID of shared data to update
  schema:
    type: string
    format: uuid
- name: Content-Encoding
  in: header
  description: Content-Encoding, described in IETF RFC 9110
  schema:
    type: string
- name: Accept-Encoding
  in: header
  description: Accept-Encoding, described in IETF RFC 9110
  schema:
    type: string
- name: If-Match
  in: header
  description: Validator for conditional requests, as described in IETF RFC 9110, 13.1.1
  schema:
    type: string
requestBody:
  content:
    application/json-patch+json:
      schema:
        type: array
        items:
          $ref: 'TS29571_CommonData.yaml#/components/schemas/PatchItem'
        minItems: 1
      required: true
responses:
  '200':
    description: Expected response to a valid request
    content:
      application/json:
        schema:
          $ref: '#/components/schemas/SharedData'
    headers:
      Accept-Encoding:
        description: Accept-Encoding, described in IETF RFC 9110
        schema:
          type: string
      ETag:
        description: Entity Tag containing a strong validator, described in IETF RFC 9110,
8.8.3
        schema:
          type: string
      Content-Encoding:
        description: Content-Encoding, described in IETF RFC 9110
        schema:
          type: string
  '204':
    description: Expected response with empty body
    headers:
      Accept-Encoding:
        description: Accept-Encoding, described in IETF RFC 9110
        schema:
          type: string
  '307':
    description: Temporary Redirect
    content:
      application/json:
        schema:
          $ref: 'TS29571_CommonData.yaml#/components/schemas/RedirectResponse'
    headers:
      Location:
        description: The URI pointing to the resource located on the redirect target NRF
        required: true
        schema:
          type: string
  '308':
    description: Permanent Redirect

```

```

    content:
      application/json:
        schema:
          $ref: 'TS29571_CommonData.yaml#/components/schemas/RedirectResponse'
    headers:
      Location:
        description: The URI pointing to the resource located on the redirect target NRF
        required: true
        schema:
          type: string
  '400':
    $ref: 'TS29571_CommonData.yaml#/components/responses/400'
  '403':
    $ref: 'TS29571_CommonData.yaml#/components/responses/403'
  '404':
    $ref: 'TS29571_CommonData.yaml#/components/responses/404'
  '409':
    $ref: 'TS29571_CommonData.yaml#/components/responses/409'
  '411':
    $ref: 'TS29571_CommonData.yaml#/components/responses/411'
  '412':
    $ref: 'TS29571_CommonData.yaml#/components/responses/412'
  '413':
    $ref: 'TS29571_CommonData.yaml#/components/responses/413'
  '415':
    $ref: 'TS29571_CommonData.yaml#/components/responses/415'
  '429':
    $ref: 'TS29571_CommonData.yaml#/components/responses/429'
  '500':
    $ref: 'TS29571_CommonData.yaml#/components/responses/500'
  '501':
    $ref: 'TS29571_CommonData.yaml#/components/responses/501'
  '503':
    $ref: 'TS29571_CommonData.yaml#/components/responses/503'
  default:
    $ref: 'TS29571_CommonData.yaml#/components/responses/default'
delete:
  summary: Delete Shared Data identified by a given sharedDataId
  operationId: DeleteSharedData
  tags:
    - Shared Data (Document)
  security:
    - {}
    - oAuth2ClientCredentials:
      - nnrf-nfm
    - oAuth2ClientCredentials:
      - nnrf-nfm
      - nnrf-nfm:shared-data:write
  parameters:
    - name: sharedDataId
      in: path
      required: true
      description: Unique ID of the Shared Data to deregister
      schema:
        type: string
        format: uuid
  responses:
    '204':
      description: Expected response to a successful deregistration
    '307':
      description: Temporary Redirect
      content:
        application/json:
          schema:
            $ref: 'TS29571_CommonData.yaml#/components/schemas/RedirectResponse'
      headers:
        Location:
          description: The URI pointing to the resource located on the redirect target NRF
          required: true
          schema:
            type: string
    '308':
      description: Permanent Redirect
      content:
        application/json:
          schema:
            $ref: 'TS29571_CommonData.yaml#/components/schemas/RedirectResponse'
      headers:

```



```

    Location:
      description: The URI pointing to the resource located on the redirect target NRF
      required: true
      schema:
        type: string
  '400':
    $ref: 'TS29571_CommonData.yaml#/components/responses/400'
  '401':
    $ref: 'TS29571_CommonData.yaml#/components/responses/401'
  '403':
    $ref: 'TS29571_CommonData.yaml#/components/responses/403'
  '404':
    $ref: 'TS29571_CommonData.yaml#/components/responses/404'
  '411':
    $ref: 'TS29571_CommonData.yaml#/components/responses/411'
  '429':
    $ref: 'TS29571_CommonData.yaml#/components/responses/429'
  '500':
    $ref: 'TS29571_CommonData.yaml#/components/responses/500'
  '501':
    $ref: 'TS29571_CommonData.yaml#/components/responses/501'
  '503':
    $ref: 'TS29571_CommonData.yaml#/components/responses/503'
  default:
    $ref: 'TS29571_CommonData.yaml#/components/responses/default'

/subscriptions:
  post:
    summary: Create a new subscription
    operationId: CreateSubscription
    tags:
      - Subscriptions (Collection)
    security:
      - {}
      - oAuth2ClientCredentials:
          - nnrf-nfm
      - oAuth2ClientCredentials:
          - nnrf-nfm
          - nnrf-nfm:subscriptions:subs-complete-profile
    parameters:
      - name: Content-Encoding
        in: header
        description: Content-Encoding, described in IETF RFC 9110
        schema:
          type: string
      - name: Accept-Encoding
        in: header
        description: Accept-Encoding, described in IETF RFC 9110
        schema:
          type: string
    requestBody:
      content:
        application/json:
          schema:
            $ref: '#/components/schemas/SubscriptionData'
      required: true
    responses:
      '201':
        description: Expected response to a valid request
        content:
          application/json:
            schema:
              $ref: '#/components/schemas/SubscriptionData'
        headers:
          Location:
            description: >
              Contains the URI of the newly created resource, according to the structure:
              {apiRoot}/nnrf-nfm/v1/subscriptions/{subscriptionId}
            required: true
            schema:
              type: string
          Accept-Encoding:
            description: Accept-Encoding, described in IETF RFC 9110
            schema:
              type: string
          Content-Encoding:
            description: Content-Encoding, described in IETF RFC 9110
            schema:

```

```

    type: string
'307':
  description: Temporary Redirect
  content:
    application/json:
      schema:
        $ref: 'TS29571_CommonData.yaml#/components/schemas/RedirectResponse'
  headers:
    Location:
      description: The URI pointing to the resource located on the redirect target NRF
      required: true
      schema:
        type: string
'308':
  description: Permanent Redirect
  content:
    application/json:
      schema:
        $ref: 'TS29571_CommonData.yaml#/components/schemas/RedirectResponse'
  headers:
    Location:
      description: The URI pointing to the resource located on the redirect target NRF
      required: true
      schema:
        type: string
'400':
  $ref: 'TS29571_CommonData.yaml#/components/responses/400'
'401':
  $ref: 'TS29571_CommonData.yaml#/components/responses/401'
'403':
  $ref: 'TS29571_CommonData.yaml#/components/responses/403'
'404':
  $ref: 'TS29571_CommonData.yaml#/components/responses/404'
'411':
  $ref: 'TS29571_CommonData.yaml#/components/responses/411'
'413':
  $ref: 'TS29571_CommonData.yaml#/components/responses/413'
'415':
  $ref: 'TS29571_CommonData.yaml#/components/responses/415'
'429':
  $ref: 'TS29571_CommonData.yaml#/components/responses/429'
'500':
  $ref: 'TS29571_CommonData.yaml#/components/responses/500'
'501':
  $ref: 'TS29571_CommonData.yaml#/components/responses/501'
'503':
  $ref: 'TS29571_CommonData.yaml#/components/responses/503'
default:
  $ref: 'TS29571_CommonData.yaml#/components/responses/default'
callbacks:
  onNFStatusEvent:
    '{$request.body#/nfStatusNotificationUri}':
      post:
        parameters:
          - name: Content-Encoding
            in: header
            description: Content-Encoding, described in IETF RFC 9110
            schema:
              type: string
        requestBody:
          description: Notification content
          content:
            application/json:
              schema:
                $ref: '#/components/schemas/NotificationData'
        responses:
          '204':
            description: Expected response to a successful callback processing
            headers:
              Accept-Encoding:
                description: Accept-Encoding, described in IETF RFC 9110
                schema:
                  type: string
          '307':
            description: Temporary Redirect
            content:
              application/json:
                schema:

```

```

        $ref: 'TS29571_CommonData.yaml#/components/schemas/RedirectResponse'
headers:
  Location:
    description: >
      The URI pointing to the resource located on another NF service
      consumer instance
    required: true
    schema:
      type: string
'308':
  description: Permanent Redirect
  content:
    application/json:
      schema:
        $ref: 'TS29571_CommonData.yaml#/components/schemas/RedirectResponse'
headers:
  Location:
    description: >
      The URI pointing to the resource located on another NF service
      consumer instance
    required: true
    schema:
      type: string
'400':
  $ref: 'TS29571_CommonData.yaml#/components/responses/400'
'401':
  $ref: 'TS29571_CommonData.yaml#/components/responses/401'
'403':
  $ref: 'TS29571_CommonData.yaml#/components/responses/403'
'404':
  $ref: 'TS29571_CommonData.yaml#/components/responses/404'
'411':
  $ref: 'TS29571_CommonData.yaml#/components/responses/411'
'413':
  $ref: 'TS29571_CommonData.yaml#/components/responses/413'
'415':
  $ref: 'TS29571_CommonData.yaml#/components/responses/415'
'429':
  $ref: 'TS29571_CommonData.yaml#/components/responses/429'
'500':
  $ref: 'TS29571_CommonData.yaml#/components/responses/500'
'501':
  $ref: 'TS29571_CommonData.yaml#/components/responses/501'
'503':
  $ref: 'TS29571_CommonData.yaml#/components/responses/503'
default:
  $ref: 'TS29571_CommonData.yaml#/components/responses/default'

/subscriptions/{subscriptionID}:
  patch:
    summary: Updates a subscription
    operationId: UpdateSubscription
    tags:
      - Subscription ID (Document)
    parameters:
      - name: subscriptionID
        in: path
        required: true
        description: Unique ID of the subscription to update
        schema:
          type: string
          pattern: '^([0-9]{5,6}-(x3Lf57A:nid=[A-Fa-f0-9]{11}:)?)[^-]+$'
      - name: Content-Encoding
        in: header
        description: Content-Encoding, described in IETF RFC 9110
        schema:
          type: string
      - name: Accept-Encoding
        in: header
        description: Accept-Encoding, described in IETF RFC 9110
        schema:
          type: string
    requestBody:
      content:
        application/json-patch+json:
          schema:
            type: array
            items:

```

```

    $ref: 'TS29571_CommonData.yaml#/components/schemas/PatchItem'
  required: true
  responses:
    '200':
      description: Expected response to a valid request
      content:
        application/json:
          schema:
            $ref: '#/components/schemas/SubscriptionData'
      headers:
        Accept-Encoding:
          description: Accept-Encoding, described in IETF RFC 9110
          schema:
            type: string
        Content-Encoding:
          description: Content-Encoding, described in IETF RFC 9110
          schema:
            type: string
    '204':
      description: No Content
      headers:
        Accept-Encoding:
          description: Accept-Encoding, described in IETF RFC 9110
          schema:
            type: string
    '307':
      description: Temporary Redirect
      content:
        application/json:
          schema:
            $ref: 'TS29571_CommonData.yaml#/components/schemas/RedirectResponse'
      headers:
        Location:
          description: The URI pointing to the resource located on the redirect target NRF
          required: true
          schema:
            type: string
    '308':
      description: Permanent Redirect
      content:
        application/json:
          schema:
            $ref: 'TS29571_CommonData.yaml#/components/schemas/RedirectResponse'
      headers:
        Location:
          description: The URI pointing to the resource located on the redirect target NRF
          required: true
          schema:
            type: string
    '400':
      $ref: 'TS29571_CommonData.yaml#/components/responses/400'
    '403':
      $ref: 'TS29571_CommonData.yaml#/components/responses/403'
    '404':
      $ref: 'TS29571_CommonData.yaml#/components/responses/404'
    '411':
      $ref: 'TS29571_CommonData.yaml#/components/responses/411'
    '413':
      $ref: 'TS29571_CommonData.yaml#/components/responses/413'
    '415':
      $ref: 'TS29571_CommonData.yaml#/components/responses/415'
    '429':
      $ref: 'TS29571_CommonData.yaml#/components/responses/429'
    '500':
      $ref: 'TS29571_CommonData.yaml#/components/responses/500'
    '501':
      $ref: 'TS29571_CommonData.yaml#/components/responses/501'
    '503':
      $ref: 'TS29571_CommonData.yaml#/components/responses/503'
  default:
    $ref: 'TS29571_CommonData.yaml#/components/responses/default'
delete:
  summary: Deletes a subscription
  operationId: RemoveSubscription
  tags:
    - Subscription ID (Document)
  parameters:
    - name: subscriptionID

```

```

    in: path
    required: true
    description: Unique ID of the subscription to remove
    schema:
      type: string
      pattern: '^[0-9]{5,6}-(x3Lf57A:nid=[A-Fa-f0-9]{11}:)?[^-]+$'
responses:
  '204':
    description: Expected response to a successful subscription removal
  '307':
    description: Temporary Redirect
    content:
      application/json:
        schema:
          $ref: 'TS29571_CommonData.yaml#/components/schemas/RedirectResponse'
    headers:
      Location:
        description: The URI pointing to the resource located on the redirect target NRF
        required: true
        schema:
          type: string
  '308':
    description: Permanent Redirect
    content:
      application/json:
        schema:
          $ref: 'TS29571_CommonData.yaml#/components/schemas/RedirectResponse'
    headers:
      Location:
        description: The URI pointing to the resource located on the redirect target NRF
        required: true
        schema:
          type: string
  '400':
    $ref: 'TS29571_CommonData.yaml#/components/responses/400'
  '401':
    $ref: 'TS29571_CommonData.yaml#/components/responses/401'
  '403':
    $ref: 'TS29571_CommonData.yaml#/components/responses/403'
  '404':
    $ref: 'TS29571_CommonData.yaml#/components/responses/404'
  '411':
    $ref: 'TS29571_CommonData.yaml#/components/responses/411'
  '413':
    $ref: 'TS29571_CommonData.yaml#/components/responses/413'
  '415':
    $ref: 'TS29571_CommonData.yaml#/components/responses/415'
  '429':
    $ref: 'TS29571_CommonData.yaml#/components/responses/429'
  '500':
    $ref: 'TS29571_CommonData.yaml#/components/responses/500'
  '501':
    $ref: 'TS29571_CommonData.yaml#/components/responses/501'
  '503':
    $ref: 'TS29571_CommonData.yaml#/components/responses/503'
  default:
    $ref: 'TS29571_CommonData.yaml#/components/responses/default'

```

components:

```

securitySchemes:
  oAuth2ClientCredentials:
    type: oauth2
    flows:
      clientCredentials:
        tokenUrl: '/oauth2/token'
        scopes:
          nnrf-nfm: Access to the Nnrf_NFManagement API
          nnrf-nfm:nf-instances:read: >
            Access to read the nf-instances resource, or an individual NF Instance ID resource
          nnrf-nfm:subscriptions:subs-complete-profile: >
            Access to subscribe to the complete profile of NF instances
          nnrf-nfm:nf-instance:write: >
            Access to write (create, update, delete) an individual NF Instance ID resource
          nnrf-nfm:shared-data:read: >
            Access to read shared data
          nnrf-nfm:shared-data:write: >
            Access to write (create, update, delete) shared data

```

schemas:

```

NFProfile:
  description: Information of an NF Instance registered in the NRF
  type: object
  required:
    - nfInstanceId
    - nfType
    - nfStatus
  anyOf:
    - required: [ fqdn ]
    - required: [ ipv4Addresses ]
    - required: [ ipv6Addresses ]
  properties:
    nfInstanceId:
      $ref: 'TS29571_CommonData.yaml#/components/schemas/NfInstanceId'
    nfInstanceName:
      type: string
    nfType:
      $ref: '#/components/schemas/NFType'
    nfStatus:
      $ref: '#/components/schemas/NFStatus'
    collocatedNfInstances:
      type: array
      items:
        $ref: '#/components/schemas/CollocatedNfInstance'
      minItems: 1
    heartBeatTimer:
      type: integer
      minimum: 1
    plmnList:
      type: array
      items:
        $ref: 'TS29571_CommonData.yaml#/components/schemas/PlmnId'
      minItems: 1
    snpnList:
      type: array
      items:
        $ref: 'TS29571_CommonData.yaml#/components/schemas/PlmnIdNid'
      minItems: 1
    sNssais:
      type: array
      items:
        $ref: 'TS29571_CommonData.yaml#/components/schemas/ExtSnsai'
      minItems: 1
    perPlmnSnsaiList:
      type: array
      items:
        $ref: '#/components/schemas/PlmnSnsai'
      minItems: 1
    nsilList:
      type: array
      items:
        type: string
      minItems: 1
    fqdn:
      $ref: 'TS29571_CommonData.yaml#/components/schemas/Fqdn'
    interPlmnFqdn:
      $ref: 'TS29571_CommonData.yaml#/components/schemas/Fqdn'
    ipv4Addresses:
      type: array
      items:
        $ref: 'TS29571_CommonData.yaml#/components/schemas/Ipv4Addr'
      minItems: 1
    ipv6Addresses:
      type: array
      items:
        $ref: 'TS29571_CommonData.yaml#/components/schemas/Ipv6Addr'
      minItems: 1
    allowedPlmns:
      type: array
      items:
        $ref: 'TS29571_CommonData.yaml#/components/schemas/PlmnId'
      minItems: 1
    allowedSnpns:
      type: array
      items:

```

```

    $ref: 'TS29571_CommonData.yaml#/components/schemas/PlmnIdNid'
  minItems: 1
  allowedNfTypes:
    type: array
    items:
      $ref: '#/components/schemas/NFType'
  minItems: 1
  allowedNfDomains:
    type: array
    items:
      type: string
  minItems: 1
  allowedNssais:
    type: array
    items:
      $ref: 'TS29571_CommonData.yaml#/components/schemas/ExtSnssai'
  minItems: 1
  allowedRuleSet:
    description: A map (list of key-value pairs) where a valid JSON pointer Id serves as key
    type: object
    additionalProperties:
      $ref: '#/components/schemas/RuleSet'
  minProperties: 1
  priority:
    type: integer
    minimum: 0
    maximum: 65535
  capacity:
    type: integer
    minimum: 0
    maximum: 65535
  load:
    type: integer
    minimum: 0
    maximum: 100
  loadTimeStamp:
    $ref: 'TS29571_CommonData.yaml#/components/schemas/DateTime'
  locality:
    type: string
  extLocality:
    description: >
      A map (list of key-value pairs) where a (unique) valid JSON string serves
      as key representing a type of locality
    type: object
    additionalProperties:
      type: string
    minProperties: 1
  udrInfo:
    $ref: '#/components/schemas/UdrInfo'
  udrInfoList:
    description: >
      A map (list of key-value pairs) where a (unique) valid JSON string
      serves as key of UdrInfo
    type: object
    additionalProperties:
      $ref: '#/components/schemas/UdrInfo'
    minProperties: 1
  udmInfo:
    $ref: '#/components/schemas/UdmInfo'
  udmInfoList:
    description: >
      A map (list of key-value pairs) where a (unique) valid JSON string
      serves as key of UdmInfo
    type: object
    additionalProperties:
      $ref: '#/components/schemas/UdmInfo'
    minProperties: 1
  ausfInfo:
    $ref: '#/components/schemas/AusfInfo'
  ausfInfoList:
    description: >
      A map (list of key-value pairs) where a (unique) valid JSON string
      serves as key of AusfInfo
    type: object
    additionalProperties:
      $ref: '#/components/schemas/AusfInfo'
    minProperties: 1
  amfInfo:

```

```
$ref: '#/components/schemas/AmfInfo'
amfInfoList:
  description: >
    A map (list of key-value pairs) where a (unique) valid JSON string
    serves as key of AmfInfo
  type: object
  additionalProperties:
    $ref: '#/components/schemas/AmfInfo'
  minProperties: 1
smfInfo:
  $ref: '#/components/schemas/SmfInfo'
smfInfoList:
  description: >
    A map (list of key-value pairs) where a (unique) valid JSON string
    serves as key of SmfInfo
  type: object
  additionalProperties:
    $ref: '#/components/schemas/SmfInfo'
  minProperties: 1
upfInfo:
  $ref: '#/components/schemas/UpfInfo'
upfInfoList:
  description: >
    A map (list of key-value pairs) where a (unique) valid JSON string
    serves as key of UpfInfo
  type: object
  additionalProperties:
    $ref: '#/components/schemas/UpfInfo'
  minProperties: 1
pcfInfo:
  $ref: '#/components/schemas/PcfInfo'
pcfInfoList:
  description: >
    A map (list of key-value pairs) where a (unique) valid JSON string
    serves as key of PcfInfo
  type: object
  additionalProperties:
    $ref: '#/components/schemas/PcfInfo'
  minProperties: 1
bsfInfo:
  $ref: '#/components/schemas/BsfInfo'
bsfInfoList:
  description: >
    A map (list of key-value pairs) where a (unique) valid JSON string
    serves as key of BsfInfo
  type: object
  additionalProperties:
    $ref: '#/components/schemas/BsfInfo'
  minProperties: 1
chfInfo:
  $ref: '#/components/schemas/ChfInfo'
chfInfoList:
  description: >
    A map (list of key-value pairs) where a (unique) valid JSON string
    serves as key of ChfInfo
  type: object
  additionalProperties:
    $ref: '#/components/schemas/ChfInfo'
  minProperties: 1
nefInfo:
  $ref: '#/components/schemas/NefInfo'
nrfInfo:
  $ref: '#/components/schemas/NrfInfo'
udsfInfo:
  $ref: '#/components/schemas/UdsfInfo'
udsfInfoList:
  description: >
    A map (list of key-value pairs) where a (unique) valid JSON string
    serves as key of UdsfInfo
  type: object
  additionalProperties:
    $ref: '#/components/schemas/UdsfInfo'
  minProperties: 1
nwdafInfo:
  $ref: '#/components/schemas/NwdafInfo'
nwdafInfoList:
  type: object
  description: >
```



```
    A map (list of key-value pairs) where a (unique) valid JSON string
    serves as key of NwdafInfo
  additionalProperties:
    $ref: '#/components/schemas/NwdafInfo'
  minProperties: 1
  pcscfInfoList:
    description: >
      A map (list of key-value pairs) where a (unique) valid JSON string
      serves as key of PcscfInfo
    type: object
    additionalProperties:
      $ref: '#/components/schemas/PcscfInfo'
    minProperties: 1
  hssInfoList:
    description: >
      A map (list of key-value pairs) where a (unique) valid JSON string
      serves as key of HssInfo
    type: object
    additionalProperties:
      $ref: '#/components/schemas/HssInfo'
    minProperties: 1
  customInfo:
    type: object
  recoveryTime:
    $ref: 'TS29571_CommonData.yaml#/components/schemas/DateTime'
  nfServicePersistence:
    type: boolean
    default: false
  nfServices:
    deprecated: true
    type: array
    items:
      $ref: '#/components/schemas/NFService'
    minItems: 1
  nfServiceList:
    description: >
      A map (list of key-value pairs) where serviceInstanceId serves as key of NFService
    type: object
    additionalProperties:
      $ref: '#/components/schemas/NFService'
    minProperties: 1
  nfProfileChangesSupportInd:
    type: boolean
    default: false
    writeOnly: true
  nfProfilePartialUpdateChangesSupportInd:
    type: boolean
    default: false
    writeOnly: true
  nfProfileChangesInd:
    type: boolean
    default: false
    readOnly: true
  defaultNotificationSubscriptions:
    type: array
    items:
      $ref: '#/components/schemas/DefaultNotificationSubscription'
  lmfInfo:
    $ref: '#/components/schemas/LmfInfo'
  gmlcInfo:
    $ref: '#/components/schemas/GmlcInfo'
  nfSetIdList:
    type: array
    items:
      $ref: 'TS29571_CommonData.yaml#/components/schemas/NfSetId'
    minItems: 1
  servingScope:
    type: array
    items:
      type: string
    minItems: 1
  lcHSupportInd:
    type: boolean
    default: false
  olcHSupportInd:
    type: boolean
    default: false
  nfSetRecoveryTimeList:
```

```

description: A map (list of key-value pairs) where NfSetId serves as key of DateTime
type: object
additionalProperties:
  $ref: 'TS29571_CommonData.yaml#/components/schemas/DateTime'
minProperties: 1
serviceSetRecoveryTimeList:
description: >
  A map (list of key-value pairs) where NfServiceSetId serves as key of DateTime
type: object
additionalProperties:
  $ref: 'TS29571_CommonData.yaml#/components/schemas/DateTime'
minProperties: 1
scpDomains:
type: array
items:
  type: string
minItems: 1
scpInfo:
  $ref: '#/components/schemas/ScpInfo'
seppInfo:
  $ref: '#/components/schemas/SeppInfo'
vendorId:
  $ref: '#/components/schemas/VendorId'
supportedVendorSpecificFeatures:
description: >
  The key of the map is the IANA-assigned SMI Network Management Private Enterprise Codes
type: object
additionalProperties:
  type: array
  items:
    $ref: '#/components/schemas/VendorSpecificFeature'
  minItems: 1
minProperties: 1
aanfInfoList:
type: object
description: >
  A map (list of key-value pairs) where a (unique) valid JSON string
  serves as key of AanfInfo
additionalProperties:
  $ref: '#/components/schemas/AanfInfo'
minProperties: 1
5gDdnmfInfo:
  $ref: '#/components/schemas/5GDdnmfInfo'
mfafInfo:
  $ref: '#/components/schemas/MfafInfo'
easdfInfoList:
type: object
description: >
  A map (list of key-value pairs) where a (unique) valid JSON string
  serves as key of EasdfInfo
additionalProperties:
  $ref: '#/components/schemas/EasdfInfo'
minProperties: 1
dccbInfo:
  $ref: '#/components/schemas/DccbInfo'
nsacfInfoList:
description: >
  A map (list of key-value pairs) where a (unique) valid JSON string
  serves as key of NsacfInfo
type: object
additionalProperties:
  $ref: '#/components/schemas/NsacfInfo'
minProperties: 1
mbSmfInfoList:
description: >
  A map (list of key-value pairs) where a (unique) valid JSON string
  serves as key of MbSmfInfo
type: object
additionalProperties:
  $ref: '#/components/schemas/MbSmfInfo'
minProperties: 1
tsctsInfoList:
type: object
description: >
  A map (list of key-value pairs) where a (unique) valid JSON string
  serves as key of TsctsInfo
additionalProperties:
  $ref: '#/components/schemas/TsctsInfo'

```

```

    minProperties: 1
  mbUpfInfoList:
    type: object
    description: >
      A map (list of key-value pairs) where a (unique) valid JSON string
      serves as key of MbUpfInfo
    additionalProperties:
      $ref: '#/components/schemas/MbUpfInfo'
    minProperties: 1
  trustAfInfo:
    $ref: '#/components/schemas/TrustAfInfo'
  nssaafInfo:
    $ref: '#/components/schemas/NssaafInfo'
  hniList:
    type: array
    items:
      $ref: 'TS29571_CommonData.yaml#/components/schemas/Fqdn'
    minItems: 1
  iwmscInfo:
    $ref: '#/components/schemas/IwmscInfo'
  mnpfInfo:
    $ref: '#/components/schemas/MnpfInfo'
  smsfInfo:
    $ref: '#/components/schemas/SmsfInfo'
  dcsfInfoList:
    type: object
    description: >
      A map (list of key-value pairs) where a (unique) valid JSON string
      serves as key of DcsfInfo
    additionalProperties:
      $ref: '#/components/schemas/DcsfInfo'
    minProperties: 1
  mrfInfoList:
    type: object
    description: >
      A map (list of key-value pairs) where a (unique) valid JSON string
      serves as key of MrfInfo
    additionalProperties:
      $ref: '#/components/schemas/MrfInfo'
    minProperties: 1
  mrfpInfoList:
    type: object
    description: >
      A map (list of key-value pairs) where a (unique) valid JSON string
      serves as key of MrfpInfo
    additionalProperties:
      $ref: '#/components/schemas/MrfpInfo'
    minProperties: 1
  mfInfoList:
    type: object
    description: >
      A map (list of key-value pairs) where a (unique) valid JSON string
      serves as key of MfInfo
    additionalProperties:
      $ref: '#/components/schemas/MfInfo'
    minProperties: 1
  adrfInfoList:
    type: object
    description: >
      A map (list of key-value pairs) where a (unique) valid JSON string
      serves as key of AdrfInfo
    additionalProperties:
      $ref: '#/components/schemas/AdrfInfo'
    minProperties: 1
  selectionConditions:
    $ref: '#/components/schemas/SelectionConditions'
  canaryRelease:
    type: boolean
    default: false
  exclusiveCanaryReleaseSelection:
    type: boolean
    default: false
  sharedProfileDataId:
    type: string
    format: uuid

SharedData:
  description: Shared Data

```

```

type: object
required:
  - sharedDataId
properties:
  sharedDataId:
    type: string
    format: uuid
  sharedProfileData:
    $ref: '#/components/schemas/NFProfile'
  sharedServiceData:
    $ref: '#/components/schemas/NFService'
  authorizedWriteScope:
    $ref: '#/components/schemas/SharedScope'

SharedScope:
description: Authorized Scope for a Shared Data
type: object
properties:
  nfSetIdList:
    type: array
    items:
      $ref: 'TS29571_CommonData.yaml#/components/schemas/NfSetId'
    minItems: 1

NFProfileRegistrationError:
description: NF Profile Registration Error.
allOf:
  - $ref: 'TS29571_CommonData.yaml#/components/schemas/ProblemDetails'
  - $ref: '#/components/schemas/SharedDataIdList'

SharedDataIdList:
description: Shared Data IDs
type: object
required:
  - sharedDataIds
properties:
  sharedDataIds:
    type: array
    items:
      type: string
      format: uuid
    minItems: 1

NFService:
description: >
  Information of a given NF Service Instance; it is part of the NFProfile of an NF Instance
type: object
required:
  - serviceInstanceId
  - serviceName
  - versions
  - scheme
  - nfServiceStatus
properties:
  serviceInstanceId:
    type: string
  serviceName:
    $ref: '#/components/schemas/ServiceName'
  versions:
    type: array
    items:
      $ref: '#/components/schemas/NFServiceVersion'
    minItems: 1
  scheme:
    $ref: 'TS29571_CommonData.yaml#/components/schemas/UriScheme'
  nfServiceStatus:
    $ref: '#/components/schemas/NFServiceStatus'
  fqdn:
    $ref: 'TS29571_CommonData.yaml#/components/schemas/Fqdn'
  interPlmnFqdn:
    $ref: 'TS29571_CommonData.yaml#/components/schemas/Fqdn'
  ipEndpoints:
    type: array
    items:
      $ref: '#/components/schemas/IpEndPoint'
    minItems: 1
  apiPrefix:
    type: string

```

```
callbackUriPrefixList:
  type: array
  items:
    $ref: '#/components/schemas/CallbackUriPrefixItem'
  minItems: 1
defaultNotificationSubscriptions:
  type: array
  items:
    $ref: '#/components/schemas/DefaultNotificationSubscription'
  minItems: 1
allowedPlmns:
  type: array
  items:
    $ref: 'TS29571_CommonData.yaml#/components/schemas/PlmnId'
  minItems: 1
allowedSnpsns:
  type: array
  items:
    $ref: 'TS29571_CommonData.yaml#/components/schemas/PlmnIdNid'
  minItems: 1
allowedNfTypes:
  type: array
  items:
    $ref: '#/components/schemas/NFType'
  minItems: 1
allowedNfDomains:
  type: array
  items:
    type: string
  minItems: 1
allowedNssais:
  type: array
  items:
    $ref: 'TS29571_CommonData.yaml#/components/schemas/ExtSnssai'
  minItems: 1
allowedOperationsPerNfType:
  description: A map (list of key-value pairs) where NF Type serves as key
  type: object
  additionalProperties:
    type: array
    items:
      type: string
    minItems: 1
  minProperties: 1
allowedOperationsPerNfInstance:
  description: A map (list of key-value pairs) where NF Instance Id serves as key
  type: object
  additionalProperties:
    type: array
    items:
      type: string
    minItems: 1
  minProperties: 1
allowedOperationsPerNfInstanceOverrides:
  type: boolean
  default: false
allowedScopesRuleSet:
  description: A map (list of key-value pairs) where a valid JSON pointer Id serves as key
  type: object
  additionalProperties:
    $ref: '#/components/schemas/RuleSet'
  minProperties: 1
priority:
  type: integer
  minimum: 0
  maximum: 65535
capacity:
  type: integer
  minimum: 0
  maximum: 65535
load:
  type: integer
  minimum: 0
  maximum: 100
loadTimeStamp:
  $ref: 'TS29571_CommonData.yaml#/components/schemas/DateTime'
recoveryTime:
  $ref: 'TS29571_CommonData.yaml#/components/schemas/DateTime'
```

```

supportedFeatures:
  $ref: 'TS29571_CommonData.yaml#/components/schemas/SupportedFeatures'
nfServiceSetIdList:
  type: array
  items:
    $ref: 'TS29571_CommonData.yaml#/components/schemas/NfServiceSetId'
  minItems: 1
sNssais:
  type: array
  items:
    $ref: 'TS29571_CommonData.yaml#/components/schemas/ExtSnssai'
  minItems: 1
perPlmnSnssaiList:
  type: array
  items:
    $ref: '#/components/schemas/PlmnSnssai'
  minItems: 1
vendorId:
  $ref: '#/components/schemas/VendorId'
supportedVendorSpecificFeatures:
  description: >
    A map (list of key-value pairs) where IANA-assigned SMI Network Management
    Private Enterprise Codes serves as key
  type: object
  additionalProperties:
    type: array
    items:
      $ref: '#/components/schemas/VendorSpecificFeature'
    minItems: 1
  minProperties: 1
oauth2Required:
  type: boolean
perPlmnOauth2ReqList:
  $ref: '#/components/schemas/PlmnOauth2'
selectionConditions:
  $ref: '#/components/schemas/SelectionConditions'
canaryRelease:
  type: boolean
  default: false
exclusiveCanaryReleaseSelection:
  type: boolean
  default: false
sharedServiceDataId:
  type: string
  format: uuid

NFType:
  description: NF types known to NRF
  anyOf:
  - type: string
  - enum:
    - NRF
    - UDM
    - AMF
    - SMF
    - AUSF
    - NEF
    - PCF
    - SMSF
    - NSSF
    - UDR
    - LMF
    - GMLC
    - 5G_EIR
    - SEPP
    - UPF
    - N3IWF
    - AF
    - UDSF
    - BSF
    - CHF
    - NWDAF
    - PCSCF
    - CBCF
    - HSS
    - UCMF
    - SOR_AF
    - SPAF

```

- MME
- SCSAS
- SCEF
- SCP
- NSSAAF
- ICSCF
- SCSCF
- DRA
- IMS_AS
- AANF
- 5G_DDNMF
- NSACF
- MFAF
- EASDF
- DCCF
- MB_SMF
- TSCTSF
- ADRF
- GBA_BSF
- CEF
- MB_UPF
- NSWOF
- PKMF
- MNPF
- SMS_GMSC
- SMS_IWMSC
- MBSF
- MBSTF
- PANF
- IP_SM_GW
- SMS_ROUTER
- DCSF
- MRF
- MRFP
- MF
- SLPKMF
- RH

- type: string

NefId:

description: Identity of the NEF
type: string

IpEndPoint:

description: >
IP addressing information of a given NFService;
it consists on, e.g. IP address, TCP port, transport protocol...
type: object
not:
required: [ipv4Address, ipv6Address]
properties:
ipv4Address:
 \$ref: 'TS29571_CommonData.yaml#/components/schemas/Ipv4Addr'
ipv6Address:
 \$ref: 'TS29571_CommonData.yaml#/components/schemas/Ipv6Addr'
transport:
 \$ref: '#/components/schemas/TransportProtocol'
port:
 type: integer
 minimum: 0
 maximum: 65535

SubscriptionData:

description: >
Information of a subscription to notifications to NRF events,
included in subscription requests and responses
type: object
required:
- nfStatusNotificationUri
properties:
nfStatusNotificationUri:
 type: string
reqNfInstanceId:
 \$ref: 'TS29571_CommonData.yaml#/components/schemas/NfInstanceId'
sharedDataIds:
 type: array
 items:
 type: string

```

    minItems: 1
  subscrCond:
    $ref: '#/components/schemas/SubscrCond'
  subscriptionId:
    type: string
    pattern: '^([0-9]{5,6})-(x3Lf57A:nid=[A-Fa-f0-9]{11}:)?[^-]+$'
    readOnly: true
  validityTime:
    $ref: 'TS29571_CommonData.yaml#/components/schemas/DateTime'
  reqNotifEvents:
    type: array
    items:
      $ref: '#/components/schemas/NotificationEventType'
    minItems: 1
  plmnId:
    $ref: 'TS29571_CommonData.yaml#/components/schemas/PlmnId'
  nid:
    $ref: 'TS29571_CommonData.yaml#/components/schemas/Nid'
  notifCondition:
    $ref: '#/components/schemas/NotifCondition'
  reqNfType:
    $ref: '#/components/schemas/NFType'
  reqNfFqdn:
    $ref: 'TS29571_CommonData.yaml#/components/schemas/Fqdn'
  reqSnssais:
    type: array
    items:
      $ref: 'TS29571_CommonData.yaml#/components/schemas/ExtSnssai'
    minItems: 1
  reqPerPlmnSnssais:
    type: array
    items:
      $ref: '#/components/schemas/PlmnSnssai'
    minItems: 1
  reqPlmnList:
    type: array
    items:
      $ref: 'TS29571_CommonData.yaml#/components/schemas/PlmnId'
    minItems: 1
  reqSnpnList:
    type: array
    items:
      $ref: 'TS29571_CommonData.yaml#/components/schemas/PlmnIdNid'
    minItems: 1
  servingScope:
    type: array
    items:
      type: string
    minItems: 1
  requesterFeatures:
    writeOnly: true
    allOf:
      - $ref: 'TS29571_CommonData.yaml#/components/schemas/SupportedFeatures'
  nrfSupportedFeatures:
    readOnly: true
    allOf:
      - $ref: 'TS29571_CommonData.yaml#/components/schemas/SupportedFeatures'
  hnrfUri:
    $ref: 'TS29571_CommonData.yaml#/components/schemas/Uri'
  onboardingCapability:
    type: boolean
    default: false
  targetHni:
    $ref: 'TS29571_CommonData.yaml#/components/schemas/Fqdn'
  preferredLocality:
    type: string
  extPreferredLocality:
    description: >
      A map (list of key-value pairs) where the key of the map represents the relative
      priority, for the requester, of each locality description among the list of locality
      descriptions in this query parameter, encoded as "1" (highest priority), "2", "3", ...,
      "n" (lowest priority)
    type: object
  additionalProperties:
    type: array
    items:
      $ref: '#/components/schemas/LocalityDescription'
    minItems: 1

```



```

    minProperties: 1
    completeProfileSubscription:
      type: boolean
      default: false
      writeOnly: true

SubscrCond:
  description: >
    Condition to determine the set of NFs to monitor under a certain subscription in NRF
  oneOf:
    - $ref: '#/components/schemas/NfInstanceIdCond'
    - $ref: '#/components/schemas/NfInstanceIdListCond'
    - $ref: '#/components/schemas/NfTypeCond'
    - $ref: '#/components/schemas/ServiceNameCond'
    - $ref: '#/components/schemas/ServiceNameListCond'
    - $ref: '#/components/schemas/AmfCond'
    - $ref: '#/components/schemas/GuamiListCond'
    - $ref: '#/components/schemas/NetworkSliceCond'
    - $ref: '#/components/schemas/NfGroupCond'
    - $ref: '#/components/schemas/NfGroupListCond'
    - $ref: '#/components/schemas/NfSetCond'
    - $ref: '#/components/schemas/NfServiceSetCond'
    - $ref: '#/components/schemas/UpfCond'
    - $ref: '#/components/schemas/ScpDomainCond'
    - $ref: '#/components/schemas/NwdafCond'
    - $ref: '#/components/schemas/NefCond'
    - $ref: '#/components/schemas/DccfCond'

NfInstanceIdCond:
  description: Subscription to a given NF Instance Id
  type: object
  required:
    - nfInstanceId
  properties:
    nfInstanceId:
      $ref: 'TS29571_CommonData.yaml#/components/schemas/NfInstanceId'

NfInstanceIdListCond:
  description: Subscription to a list of NF Instances
  type: object
  required:
    - nfInstanceIdList
  properties:
    nfInstanceIdList:
      type: array
      items:
        $ref: 'TS29571_CommonData.yaml#/components/schemas/NfInstanceId'
      minItems: 1

NfTypeCond:
  description: Subscription to a set of NFs based on their NF Type
  type: object
  required:
    - nfType
  allOf:
    - not:
        required: [ nfGroupId ]
    - not:
        required: [ conditionType, nfGroupIdList ]
  properties:
    nfType:
      $ref: '#/components/schemas/NFType'

ServiceNameCond:
  description: Subscription to a set of NFs based on their support for a given Service Name
  type: object
  required:
    - serviceName
  properties:
    serviceName:
      $ref: '#/components/schemas/ServiceName'

ServiceNameListCond:
  description: >
    Subscription to a set of NFs based on their support for a Service Name
    in the Servic Name list
  type: object
  required:

```

```

    - conditionType
    - serviceNameList
  properties:
    conditionType:
      type: string
      enum: [ SERVICE_NAME_LIST_COND ]
    serviceNameList:
      type: array
      items:
        $ref: '#/components/schemas/ServiceName'
      minItems: 1

AmfCond:
  description: Subscription to a set of AMFs, based on AMF Set Id and/or AMF Region Id
  type: object
  anyOf:
    - required: [ amfSetId ]
    - required: [ amfRegionId ]
  properties:
    amfSetId:
      $ref: 'TS29571_CommonData.yaml#/components/schemas/AmfSetId'
    amfRegionId:
      $ref: 'TS29571_CommonData.yaml#/components/schemas/AmfRegionId'

GuamiListCond:
  description: Subscription to a set of AMFs, based on their GUAMIs
  type: object
  required:
    - guamiList
  properties:
    guamiList:
      type: array
      items:
        $ref: 'TS29571_CommonData.yaml#/components/schemas/Guami'

NetworkSliceCond:
  description: Subscription to a set of NFs, based on the slices (S-NSSAI and NSI) they support
  type: object
  required:
    - snssaiList
  properties:
    snssaiList:
      type: array
      items:
        $ref: 'TS29571_CommonData.yaml#/components/schemas/Snssai'
    nsiList:
      type: array
      items:
        type: string

NfGroupCond:
  description: Subscription to a set of NFs based on their Group Id
  type: object
  required:
    - nfType
    - nfGroupId
  properties:
    nfType:
      type: string
      enum:
        - UDM
        - AUSF
        - UDR
        - PCF
        - CHF
        - HSS
        - BSF
        - UDSF
    nfGroupId:
      $ref: 'TS29571_CommonData.yaml#/components/schemas/NfGroupId'

NfGroupListCond:
  description: Subscription to a set of NFs based on their Group Ids
  type: object
  required:
    - conditionType
    - nfType
    - nfGroupIdList

```

```

properties:
  conditionType:
    type: string
    enum: [ NF_GROUP_LIST_COND ]
  nfType:
    type: string
    enum:
      - UDM
      - AUSF
      - UDR
      - PCF
      - CHF
      - HSS
      - BSS
      - UDSF
  nfGroupIdList:
    type: array
    items:
      $ref: 'TS29571_CommonData.yaml#/components/schemas/NfGroupId'
    minItems: 1

NotifCondition:
  description: >
    Condition (list of attributes in the NF Profile) to determine whether a notification
    must be sent by NRF
  type: object
  not:
    required: [ monitoredAttributes, unmonitoredAttributes ]
  properties:
    monitoredAttributes:
      type: array
      items:
        type: string
      minItems: 1
    unmonitoredAttributes:
      type: array
      items:
        type: string
      minItems: 1

UdrInfo:
  description: Information of an UDR NF Instance
  type: object
  properties:
    groupId:
      $ref: 'TS29571_CommonData.yaml#/components/schemas/NfGroupId'
    supiRanges:
      type: array
      items:
        $ref: '#/components/schemas/SupiRange'
      minItems: 1
    gpsiRanges:
      type: array
      items:
        $ref: '#/components/schemas/IdentityRange'
      minItems: 1
    externalGroupIdentifiersRanges:
      type: array
      items:
        $ref: '#/components/schemas/IdentityRange'
      minItems: 1
    supportedDataSets:
      type: array
      items:
        $ref: '#/components/schemas/DataSetId'
      minItems: 1
    sharedDataIdRanges:
      type: array
      items:
        $ref: '#/components/schemas/SharedDataIdRange'
      minItems: 1

SharedDataIdRange:
  description: A range of SharedDataIds based on regular-expression matching
  type: object
  properties:
    pattern:
      type: string

```

```
SupiRange:
  description: >
    A range of SUPIs (subscriber identities), either based on a numeric range,
    or based on regular-expression matching
  type: object
  oneOf:
    - required: [ start, end ]
    - required: [ pattern ]
  properties:
    start:
      type: string
      pattern: '^[0-9]+$'
    end:
      type: string
      pattern: '^[0-9]+$'
    pattern:
      type: string

IdentityRange:
  description: >
    A range of GPSIs (subscriber identities), either based on a numeric range,
    or based on regular-expression matching
  type: object
  oneOf:
    - required: [ start, end ]
    - required: [ pattern ]
  properties:
    start:
      type: string
      pattern: '^[0-9]+$'
    end:
      type: string
      pattern: '^[0-9]+$'
    pattern:
      type: string

InternalGroupIdRange:
  description: >
    A range of Group IDs (internal group identities), either based on a numeric range,
    or based on regular-expression matching
  type: object
  oneOf:
    - required: [ start, end ]
    - required: [ pattern ]
  properties:
    start:
      $ref: 'TS29571_CommonData.yaml#/components/schemas/GroupId'
    end:
      $ref: 'TS29571_CommonData.yaml#/components/schemas/GroupId'
    pattern:
      type: string

DataSetId:
  description: Types of data sets and subsets stored in UDR
  anyOf:
    - type: string
      enum:
        - SUBSCRIPTION
        - POLICY
        - EXPOSURE
        - APPLICATION
        - A_PFD
        - A_AFTI
        - A_AFQOS
        - A_IPTV
        - A_BDT
        - A_SPD
        - A_EASD
        - A_EACI
        - A_AMI
        - A_DEM
        - A_ALIM
        - P_UE
        - P_SCD
        - P_BDT
        - P_PLMNUE
        - P_NSSCD
```

- P_PDTQ
- P_MBSCD
- P_GROUP
- type: string

UdmInfo:

```

description: Information of an UDM NF Instance
type: object
properties:
  groupId:
    $ref: 'TS29571_CommonData.yaml#/components/schemas/NfGroupId'
  supiRanges:
    type: array
    items:
      $ref: '#/components/schemas/SupiRange'
    minItems: 1
  gpsiRanges:
    type: array
    items:
      $ref: '#/components/schemas/IdentityRange'
    minItems: 1
  externalGroupIdentifiersRanges:
    type: array
    items:
      $ref: '#/components/schemas/IdentityRange'
    minItems: 1
  routingIndicators:
    type: array
    items:
      type: string
      pattern: '^([0-9]){1,4}$'
    minItems: 1
  internalGroupIdentifiersRanges:
    type: array
    items:
      $ref: '#/components/schemas/InternalGroupIdRange'
    minItems: 1
  suciInfos:
    type: array
    items:
      $ref: '#/components/schemas/SuciInfo'
    minItems: 1

```

AusfInfo:

```

description: Information of an AUSF NF Instance
type: object
properties:
  groupId:
    $ref: 'TS29571_CommonData.yaml#/components/schemas/NfGroupId'
  supiRanges:
    type: array
    items:
      $ref: '#/components/schemas/SupiRange'
    minItems: 1
  routingIndicators:
    type: array
    items:
      type: string
      pattern: '^([0-9]){1,4}$'
    minItems: 1
  suciInfos:
    type: array
    items:
      $ref: '#/components/schemas/SuciInfo'
    minItems: 1

```

AmfInfo:

```

description: Information of an AMF NF Instance
type: object
required:
  - amfSetId
  - amfRegionId
  - guamiList
properties:
  amfSetId:
    $ref: 'TS29571_CommonData.yaml#/components/schemas/AmfSetId'
  amfRegionId:
    $ref: 'TS29571_CommonData.yaml#/components/schemas/AmfRegionId'

```

```

guamiList:
  type: array
  items:
    $ref: 'TS29571_CommonData.yaml#/components/schemas/Guami'
  minItems: 1
taiList:
  type: array
  items:
    $ref: 'TS29571_CommonData.yaml#/components/schemas/Tai'
  minItems: 1
taiRangeList:
  type: array
  items:
    $ref: '#/components/schemas/TaiRange'
  minItems: 1
backupInfoAmfFailure:
  type: array
  items:
    $ref: 'TS29571_CommonData.yaml#/components/schemas/Guami'
  minItems: 1
backupInfoAmfRemoval:
  type: array
  items:
    $ref: 'TS29571_CommonData.yaml#/components/schemas/Guami'
  minItems: 1
n2InterfaceAmfInfo:
  $ref: '#/components/schemas/N2InterfaceAmfInfo'
amfOnboardingCapability:
  type: boolean
  default: false
highLatencyCom:
  type: boolean

SmfInfo:
  description: Information of an SMF NF Instance
  type: object
  required:
    - sNssaiSmfInfoList
  properties:
    sNssaiSmfInfoList:
      type: array
      items:
        $ref: '#/components/schemas/SnssaiSmfInfoItem'
      minItems: 1
    taiList:
      type: array
      items:
        $ref: 'TS29571_CommonData.yaml#/components/schemas/Tai'
      minItems: 1
    taiRangeList:
      type: array
      items:
        $ref: '#/components/schemas/TaiRange'
      minItems: 1
    pgwFqdn:
      $ref: 'TS29571_CommonData.yaml#/components/schemas/Fqdn'
    pgwIpAddrList:
      type: array
      items:
        $ref: 'TS29571_CommonData.yaml#/components/schemas/IpAddr'
      minItems: 1
    accessType:
      type: array
      items:
        $ref: 'TS29571_CommonData.yaml#/components/schemas/AccessType'
      minItems: 1
    priority:
      type: integer
      minimum: 0
      maximum: 65535
    vsmfSupportInd:
      type: boolean
    pgwFqdnList:
      type: array
      items:
        $ref: 'TS29571_CommonData.yaml#/components/schemas/Fqdn'
      minItems: 1
    smfOnboardingCapability:

```

```

    type: boolean
    default: false
    deprecated: true
    ismfSupportInd:
      type: boolean
    smfUPRPCapability:
      type: boolean
      default: false

SnssaiSmfInfoItem:
  description: Set of parameters supported by SMF for a given S-NSSAI
  type: object
  required:
    - sNssai
  anyOf:
    - required: [ dnnSmfInfoList ]
    - required: [ dnnSmfInfoListId ]
  properties:
    sNssai:
      $ref: 'TS29571_CommonData.yaml#/components/schemas/ExtSnssai'
    dnnSmfInfoList:
      type: array
      items:
        $ref: '#/components/schemas/DnnSmfInfoItem'
      minItems: 1
    dnnSmfInfoListId:
      type: integer

DnnSmfInfoItem:
  description: Set of parameters supported by SMF for a given DNN
  type: object
  required:
    - dnn
  properties:
    dnn:
      anyOf:
        - $ref: 'TS29571_CommonData.yaml#/components/schemas/Dnn'
        - $ref: 'TS29571_CommonData.yaml#/components/schemas/WildcardDnn'
    dnaiList:
      type: array
      items:
        anyOf:
          - $ref: 'TS29571_CommonData.yaml#/components/schemas/Dnai'
          - $ref: '#/components/schemas/WildcardDnai'
      minItems: 1
    uePlmnRangeList:
      type: array
      items:
        $ref: '#/components/schemas/PlmnRange'
      minItems: 1

UpfInfo:
  description: Information of an UPF NF Instance
  type: object
  required:
    - sNssaiUpfInfoList
  properties:
    sNssaiUpfInfoList:
      type: array
      items:
        $ref: '#/components/schemas/SnssaiUpfInfoItem'
      minItems: 1
    smfServingArea:
      type: array
      items:
        type: string
      minItems: 1
    interfaceUpfInfoList:
      type: array
      items:
        $ref: '#/components/schemas/InterfaceUpfInfoItem'
      minItems: 1
    n6TunnelInfoList:
      description: >
        A map of InterfaceUpfInfoItems containing the N6 tunnelling information for establishing
        a N6 tunnel between the V-UPF and the V-EASDF, where a valid JSON string serves as key.
      type: object
      additionalProperties:

```

```

    $ref: '#/components/schemas/InterfaceUpfInfoItem'
  minProperties: 1
  iwkEpsInd:
    type: boolean
    default: false
  sxaInd:
    type: boolean
  pduSessionTypes:
    type: array
    items:
      $ref: 'TS29571_CommonData.yaml#/components/schemas/PduSessionType'
    minItems: 1
  atsssCapability:
    $ref: 'TS29571_CommonData.yaml#/components/schemas/AtsssCapability'
  ueIpAddrInd:
    type: boolean
    default: false
  taiList:
    type: array
    items:
      $ref: 'TS29571_CommonData.yaml#/components/schemas/Tai'
    minItems: 1
  taiRangeList:
    type: array
    items:
      $ref: '#/components/schemas/TaiRange'
    minItems: 1
  wAgfInfo:
    $ref: '#/components/schemas/WAgfInfo'
  tngfInfo:
    $ref: '#/components/schemas/TngfInfo'
  twifInfo:
    $ref: '#/components/schemas/TwifInfo'
  preferredEpdgInfoList:
    type: array
    items:
      $ref: '#/components/schemas/EpdgInfo'
    minItems: 1
  preferredWAgfInfoList:
    type: array
    items:
      $ref: '#/components/schemas/WAgfInfo'
    minItems: 1
  preferredTngfInfoList:
    type: array
    items:
      $ref: '#/components/schemas/TngfInfo'
    minItems: 1
  preferredTwifInfoList:
    type: array
    items:
      $ref: '#/components/schemas/TwifInfo'
    minItems: 1
  priority:
    type: integer
    minimum: 0
    maximum: 65535
  redundantGtpu:
    type: boolean
    default: false
  ipups:
    type: boolean
    default: false
  dataForwarding:
    type: boolean
    default: false
  supportedPfcPFeatures:
    type: string
  upfEvents:
    type: array
    items:
      $ref: 'TS29564_Nupf_EventExposure.yaml#/components/schemas/EventType'
    minItems: 1

SnssaiUpfInfoItem:
  description: Set of parameters supported by UPF for a given S-NSSAI
  type: object
  required:

```



```

- sNssai
anyOf:
- required: [ dnnUpfInfoList ]
- required: [ dnnUpfInfoListId ]
properties:
  sNssai:
    $ref: 'TS29571_CommonData.yaml#/components/schemas/ExtSnsai'
  dnnUpfInfoList:
    type: array
    items:
      $ref: '#/components/schemas/DnnUpfInfoItem'
    minItems: 1
  redundantTransport:
    type: boolean
    default: false
  interfaceUpfInfoList:
    type: array
    items:
      $ref: '#/components/schemas/InterfaceUpfInfoItem'
    minItems: 1
  dnnUpfInfoListId:
    type: integer

DnnUpfInfoItem:
  description: Set of parameters supported by UPF for a given DNN
  type: object
  required:
  - dnn
  properties:
    dnn:
      $ref: 'TS29571_CommonData.yaml#/components/schemas/Dnn'
    dnaiList:
      type: array
      items:
        $ref: 'TS29571_CommonData.yaml#/components/schemas/Dnai'
      minItems: 1
    pduSessionTypes:
      type: array
      items:
        $ref: 'TS29571_CommonData.yaml#/components/schemas/PduSessionType'
      minItems: 1
    ipv4AddressRanges:
      type: array
      items:
        $ref: '#/components/schemas/Ipv4AddressRange'
      minItems: 1
    ipv6PrefixRanges:
      type: array
      items:
        $ref: '#/components/schemas/Ipv6PrefixRange'
      minItems: 1
    natedIpv4AddressRanges:
      type: array
      items:
        $ref: '#/components/schemas/Ipv4AddressRange'
      minItems: 1
    natedIpv6PrefixRanges:
      type: array
      items:
        $ref: '#/components/schemas/Ipv6PrefixRange'
      minItems: 1
    ipv4IndexList:
      type: array
      items:
        $ref: 'TS29503_Nudm_SDM.yaml#/components/schemas/IpIndex'
      minItems: 1
    ipv6IndexList:
      type: array
      items:
        $ref: 'TS29503_Nudm_SDM.yaml#/components/schemas/IpIndex'
      minItems: 1
    networkInstance:
      description: >
        The N6 Network Instance associated with the S-NSSAI and DNN.
      type: string
    dnaiNwInstanceList:
      description: >
        Map of network instance per DNAI for the DNN, where the key of the map is the DNAI.

```

When present, the value of each entry of the map shall contain a N6 network instance that is configured for the DNAI indicated by the key.

```

type: object
additionalProperties:
  type: string
minProperties: 1
interfaceUpfInfoList:
  type: array
  items:
    $ref: '#/components/schemas/InterfaceUpfInfoItem'
minItems: 1
not:
  required: [ networkInstance, dnaiNwInstanceList ]

```

```

InterfaceUpfInfoItem:
description: Information of a given IP interface of an UPF
type: object
required:
  - interfaceType
anyOf:
  - required: [ endpointFqdn ]
  - required: [ ipv4EndpointAddresses ]
  - required: [ ipv6EndpointAddresses ]
properties:
  interfaceType:
    $ref: '#/components/schemas/UPInterfaceType'
  ipv4EndpointAddresses:
    type: array
    items:
      $ref: 'TS29571_CommonData.yaml#/components/schemas/Ipv4Addr'
    minItems: 1
  ipv6EndpointAddresses:
    type: array
    items:
      $ref: 'TS29571_CommonData.yaml#/components/schemas/Ipv6Addr'
    minItems: 1
  endpointFqdn:
    $ref: 'TS29571_CommonData.yaml#/components/schemas/Fqdn'
  networkInstance:
    type: string
  portRangeList:
    type: array
    items:
      $ref: '#/components/schemas/PortRange'
    minItems: 1

```

```

UPInterfaceType:
description: Types of User-Plane interfaces of the UPF
anyOf:
  - type: string
    enum:
      - N3
      - N6
      - N9
      - DATA_FORWARDING
      - N3MB
      - N6MB
      - N19MB
      - NMB9
      - S1U
      - S5U
      - S8U
      - S11U
      - S12
      - S2AU
      - S2BU
      - N3TRUSTEDN3GPP
      - N3UNTRUSTEDN3GPP
      - N9ROAMING
      - SGI
      - N19
      - SXAU
      - SXBU
      - N4U
  - type: string

```

```

WAgfInfo:
description: Information of the W-AGF end-points

```

```

type: object
anyOf:
  - required: [ endpointFqdn ]
  - required: [ ipv4EndpointAddresses ]
  - required: [ ipv6EndpointAddresses ]
properties:
  ipv4EndpointAddresses:
    type: array
    items:
      $ref: 'TS29571_CommonData.yaml#/components/schemas/Ipv4Addr'
    minItems: 1
  ipv6EndpointAddresses:
    type: array
    items:
      $ref: 'TS29571_CommonData.yaml#/components/schemas/Ipv6Addr'
    minItems: 1
  endpointFqdn:
    $ref: 'TS29571_CommonData.yaml#/components/schemas/Fqdn'

TngfInfo:
description: Infomation of the TNGF endpoints
type: object
anyOf:
  - required: [ endpointFqdn ]
  - required: [ ipv4EndpointAddresses ]
  - required: [ ipv6EndpointAddresses ]
properties:
  ipv4EndpointAddresses:
    type: array
    items:
      $ref: 'TS29571_CommonData.yaml#/components/schemas/Ipv4Addr'
    minItems: 1
  ipv6EndpointAddresses:
    type: array
    items:
      $ref: 'TS29571_CommonData.yaml#/components/schemas/Ipv6Addr'
    minItems: 1
  endpointFqdn:
    $ref: 'TS29571_CommonData.yaml#/components/schemas/Fqdn'

PcfInfo:
description: Information of a PCF NF Instance
type: object
properties:
  groupId:
    $ref: 'TS29571_CommonData.yaml#/components/schemas/NfGroupId'
  dnnList:
    type: array
    items:
      $ref: 'TS29571_CommonData.yaml#/components/schemas/Dnn'
    minItems: 1
  supiRanges:
    type: array
    items:
      $ref: '#/components/schemas/SupiRange'
    minItems: 1
  gpsiRanges:
    type: array
    items:
      $ref: '#/components/schemas/IdentityRange'
    minItems: 1
  rxDiamHost:
    $ref: 'TS29571_CommonData.yaml#/components/schemas/DiameterIdentity'
  rxDiamRealm:
    $ref: 'TS29571_CommonData.yaml#/components/schemas/DiameterIdentity'
  v2xSupportInd:
    type: boolean
    default: false
  proseSupportInd:
    type: boolean
    default: false
  proseCapability:
    $ref: '#/components/schemas/ProSeCapability'
  v2xCapability:
    $ref: '#/components/schemas/V2xCapability'
  a2xSupportInd:
    type: boolean
    default: false

```

```

a2xCapability:
  $ref: '#/components/schemas/A2xCapability'
rangingSlPosSupportInd:
  type: boolean
  default: false
urspEpsSupport:
  description: URSP delivery in EPS is supported by the PCF
  type: boolean
  default: false

BsfInfo:
  description: Information of a BSF NF Instance
  type: object
  properties:
    dnnList:
      type: array
      items:
        $ref: 'TS29571_CommonData.yaml#/components/schemas/Dnn'
      minItems: 1
    ipDomainList:
      type: array
      items:
        type: string
      minItems: 1
    ipv4AddressRanges:
      type: array
      items:
        $ref: '#/components/schemas/Ipv4AddressRange'
      minItems: 1
    ipv6PrefixRanges:
      type: array
      items:
        $ref: '#/components/schemas/Ipv6PrefixRange'
      minItems: 1
    rxDiamHost:
      $ref: 'TS29571_CommonData.yaml#/components/schemas/DiameterIdentity'
    rxDiamRealm:
      $ref: 'TS29571_CommonData.yaml#/components/schemas/DiameterIdentity'
    groupId:
      $ref: 'TS29571_CommonData.yaml#/components/schemas/NfGroupId'
    supiRanges:
      type: array
      items:
        $ref: '#/components/schemas/SupiRange'
      minItems: 1
    gpsiRanges:
      type: array
      items:
        $ref: '#/components/schemas/IdentityRange'
      minItems: 1

ChfInfo:
  description: Information of a CHF NF Instance
  type: object
  not:
    required: [ primaryChfInstance, secondaryChfInstance ]
  properties:
    supiRangeList:
      type: array
      items:
        $ref: '#/components/schemas/SupiRange'
      minItems: 1
    gpsiRangeList:
      type: array
      items:
        $ref: '#/components/schemas/IdentityRange'
      minItems: 1
    plmnRangeList:
      type: array
      items:
        $ref: '#/components/schemas/PlmnRange'
      minItems: 1
    groupId:
      $ref: 'TS29571_CommonData.yaml#/components/schemas/NfGroupId'
    primaryChfInstance:
      $ref: 'TS29571_CommonData.yaml#/components/schemas/NfInstanceId'
    secondaryChfInstance:
      $ref: 'TS29571_CommonData.yaml#/components/schemas/NfInstanceId'

```

```

Ipv4AddressRange:
  description: Range of IPv4 addresses
  type: object
  properties:
    start:
      $ref: 'TS29571_CommonData.yaml#/components/schemas/Ipv4Addr'
    end:
      $ref: 'TS29571_CommonData.yaml#/components/schemas/Ipv4Addr'

Ipv6PrefixRange:
  description: Range of IPv6 prefixes
  type: object
  properties:
    start:
      $ref: 'TS29571_CommonData.yaml#/components/schemas/Ipv6Prefix'
    end:
      $ref: 'TS29571_CommonData.yaml#/components/schemas/Ipv6Prefix'

DefaultNotificationSubscription:
  description: >
    Data structure for specifying the notifications the NF service subscribes by default,
    along with callback URI
  type: object
  required:
    - notificationType
    - callbackUri
  properties:
    notificationType:
      $ref: '#/components/schemas/NotificationType'
    callbackUri:
      $ref: 'TS29571_CommonData.yaml#/components/schemas/Uri'
    interPlmnCallbackUri:
      $ref: 'TS29571_CommonData.yaml#/components/schemas/Uri'
    nlMessageClass:
      $ref: 'TS29518_Namf_Communication.yaml#/components/schemas/NlMessageClass'
    n2InformationClass:
      $ref: 'TS29518_Namf_Communication.yaml#/components/schemas/N2InformationClass'
  versions:
    type: array
    items:
      type: string
    minItems: 1
  binding:
    type: string
  acceptedEncoding:
    type: string
  supportedFeatures:
    $ref: 'TS29571_CommonData.yaml#/components/schemas/SupportedFeatures'
  serviceInfoList:
    description: >
      A map of service specific information. The name of the corresponding service (as
      specified in ServiceName data type) is the key.
    type: object
    additionalProperties:
      $ref: '#/components/schemas/DefSubServiceInfo'
    minProperties: 1
  callbackUriPrefix:
    type: string

NfSetCond:
  description: Subscription to a set of NFs based on their Set Id
  type: object
  required:
    - nfSetId
  properties:
    nfSetId:
      $ref: 'TS29571_CommonData.yaml#/components/schemas/NfSetId'

NfServiceSetCond:
  description: Subscription to a set of NFs based on their Service Set Id
  type: object
  required:
    - nfServiceSetId
  properties:
    nfServiceSetId:
      $ref: 'TS29571_CommonData.yaml#/components/schemas/NfServiceSetId'
    nfSetId:

```

```

    $ref: 'TS29571_CommonData.yaml#/components/schemas/NfSetId'

UpfCond:
  description: >
    Subscription to a set of NF Instances (UPFs), able to serve a certain service area
    (i.e. SMF serving area or TAI list)
  type: object
  required:
    - conditionType
  properties:
    conditionType:
      type: string
      enum: [ UPF_COND ]
    smfServingArea:
      type: array
      items:
        type: string
      minItems: 1
    taiList:
      type: array
      items:
        $ref: 'TS29571_CommonData.yaml#/components/schemas/Tai'
      minItems: 1

NwdafCond:
  description: >
    Subscription to a set of NF Instances (NWDAFs), identified by Analytics ID(s),
    S-NSSAI(s) or NWDAF Serving Area information, i.e. list of TAIs for which the NWDAF
    can provide analytics.
  type: object
  required:
    - conditionType
  properties:
    conditionType:
      type: string
      enum: [ NWDAF_COND ]
    analyticsIds:
      type: array
      items:
        type: string
      minItems: 1
    snssaiList:
      type: array
      items:
        $ref: 'TS29571_CommonData.yaml#/components/schemas/Snssai'
      minItems: 1
    taiList:
      type: array
      items:
        $ref: 'TS29571_CommonData.yaml#/components/schemas/Tai'
      minItems: 1
    taiRangeList:
      type: array
      items:
        $ref: '#/components/schemas/TaiRange'
      minItems: 1
    servingNfTypeList:
      type: array
      items:
        $ref: '#/components/schemas/NFType'
      minItems: 1
    servingNfSetIdList:
      type: array
      items:
        $ref: 'TS29571_CommonData.yaml#/components/schemas/NfSetId'
      minItems: 1
    mlAnalyticsList:
      type: array
      items:
        $ref: '#/components/schemas/MLAnalyticsInfo'
      minItems: 1

NefCond:
  description: >
    Subscription to a set of NF Instances (NEFs), identified by Event ID(s) provided by AF,
    S-NSSAI(s), AF Instance ID, Application Identifier, External Identifier,
    External Group Identifier, or domain name.
  type: object

```

```

required:
- conditionType
properties:
conditionType:
type: string
enum: [ NEF_COND ]
afEvents:
type: array
items:
$ref: 'TS29517_Naf_EventExposure.yaml#/components/schemas/AfEvent'
minItems: 1
snssaiList:
type: array
items:
$ref: 'TS29571_CommonData.yaml#/components/schemas/Snssai'
minItems: 1
pfdData:
$ref: '#/components/schemas/PfdData'
gpsiranges:
type: array
items:
$ref: '#/components/schemas/IdentityRange'
minItems: 1
externalGroupIdentifiersRanges:
type: array
items:
$ref: '#/components/schemas/IdentityRange'
minItems: 1
servedFqdnList:
type: array
items:
type: string
minItems: 1

NotificationType:
description: >
Types of notifications used in Default Notification URIs in the NF Profile of an NF Instance
anyOf:
- type: string
enum:
- N1_MESSAGES
- N2_INFORMATION
- LOCATION_NOTIFICATION
- DATA_REMOVAL_NOTIFICATION
- DATA_CHANGE_NOTIFICATION
- LOCATION_UPDATE_NOTIFICATION
- NSSAA_REAUTH_NOTIFICATION
- NSSAA_REVOC_NOTIFICATION
- MATCH_INFO_NOTIFICATION
- DATA_RESTORE_NOTIFICATION
- TSCTS_NOTIFICATION
- LCS_KEY_DELIVERY_NOTIFICATION
- UUA_MM_AUTH_NOTIFICATION
- DC_SESSION_EVENT_NOTIFICATION
- type: string

TransportProtocol:
description: Types of transport protocol used in a given IP endpoint of an NF Service Instance
anyOf:
- type: string
enum:
- TCP
- type: string

NotificationEventType:
description: Types of events sent in notifications from NRF to subscribed NF Instances
anyOf:
- type: string
enum:
- NF_REGISTERED
- NF_DEREGISTERED
- NF_PROFILE_CHANGED
- SHARED_DATA_CHANGED
- type: string

NotificationData:
description: Data sent in notifications from NRF to subscribed NF Instances
type: object

```

```

required:
  - event
  - nfInstanceUri
allof:
  #
  # Condition: If 'event' takes value 'NF_PROFILE_CHANGED',
  # then one of 'nfProfile', 'profileChanges' or 'completeNfProfile' must be present
  #
  - anyOf:
    - not:
      properties:
        event:
          type: string
          enum:
            - NF_PROFILE_CHANGED
    - oneOf:
      - required: [ nfProfile ]
      - required: [ profileChanges ]
      - required: [ completeNfProfile ]
  #
  # Condition: If 'event' takes value 'NF_REGISTERED',
  # then one of 'nfProfile' or 'completeNfProfile' must be present
  #
  - anyOf:
    - not:
      properties:
        event:
          type: string
          enum:
            - NF_REGISTERED
    - oneOf:
      - required: [ nfProfile ]
      - required: [ completeNfProfile ]
  #
  # Condition: If 'event' takes value 'SHARED_DATA_CHANGED',
  # then 'sharedDataChanges' must be present
  #
  - anyOf:
    - not:
      properties:
        event:
          type: string
          enum:
            - SHARED_DATA_CHANGED
    - required: [ sharedDataChanges ]
properties:
  event:
    $ref: '#/components/schemas/NotificationEventType'
  nfInstanceUri:
    $ref: 'TS29571_CommonData.yaml#/components/schemas/Uri'
  nfProfile:
    allof:
      - $ref: '#/components/schemas/NFProfile'
      - not:
          required: [ allowedPlmns ]
      - not:
          required: [ allowedSnpsns ]
      - not:
          required: [ allowedNFTypes ]
      - not:
          required: [ allowedNFDomains ]
      - not:
          required: [ allowedNssais ]
      - properties:
          nfServices:
            type: array
            items:
              allof:
                - $ref: '#/components/schemas/NFService'
                - not:
                    required: [ allowedPlmns ]
                - not:
                    required: [ allowedSnpsns ]
                - not:
                    required: [ allowedNFTypes ]
                - not:
                    required: [ allowedNFDomains ]
                - not:

```



```

        required: [ allowedNssais ]
    nfServiceList:
        type: object
        additionalProperties:
            allOf:
                - $ref: '#/components/schemas/NFService'
                - not:
                    required: [ allowedPlmns ]
                - not:
                    required: [ allowedSnpsns ]
                - not:
                    required: [ allowedNfTypes ]
                - not:
                    required: [ allowedNfDomains ]
                - not:
                    required: [ allowedNssais ]
    profileChanges:
        type: array
        items:
            $ref: 'TS29571_CommonData.yaml#/components/schemas/ChangeItem'
        minItems: 1
    sharedDataChanges:
        type: array
        items:
            $ref: 'TS29571_CommonData.yaml#/components/schemas/ChangeItem'
        minItems: 1
    conditionEvent:
        $ref: '#/components/schemas/ConditionEventType'
    subscriptionContext:
        $ref: '#/components/schemas/SubscriptionContext'
    completeNfProfile:
        $ref: '#/components/schemas/NFProfile'

NFStatus:
description: Status of a given NF Instance stored in NRF
anyOf:
- type: string
  enum:
    - REGISTERED
    - SUSPENDED
    - UNDISCOVERABLE
    - CANARY_RELEASE
- type: string

NFServiceVersion:
description: Contains the version details of an NF service
type: object
required:
- apiVersionInUri
- apiFullVersion
properties:
  apiVersionInUri:
    type: string
  apiFullVersion:
    type: string
  expiry:
    $ref: 'TS29571_CommonData.yaml#/components/schemas/DateTime'

ServiceName:
description: Service names known to NRF
anyOf:
- type: string
  enum:
    - nrf-nfm
    - nrf-disc
    - nrf-oauth2
    - nudm-sdm
    - nudm-uecm
    - nudm-ueau
    - nudm-ee
    - nudm-pp
    - nudm-niddau
    - nudm-mt
    - nudm-ssau
    - nudm-rsds
    - nudm-ueid
    - namf-comm
    - namf-evts

```

- namf-mt
- namf-loc
- namf-mbs-comm
- namf-mbs-bc
- nsmf-pdusession
- nsmf-event-exposure
- nsmf-nidd
- nausf-auth
- nausf-sorprotection
- nausf-upuprotection
- nnef-pfdmanagement
- nnef-smcontext
- nnef-eventexposure
- nnef-eas-deployment
- nnef-dnai-mapping
- nnef-traffic-influence-data
- nnef-ecs-addr-cfg-info
- nnef-ueid
- 3gpp-cp-parameter-provisioning
- 3gpp-device-triggering
- 3gpp-bdt
- 3gpp-traffic-influence
- 3gpp-chargeable-party
- 3gpp-as-session-with-qos
- 3gpp-msisdn-less-mo-sms
- 3gpp-service-parameter
- 3gpp-monitoring-event
- 3gpp-nidd-configuration-trigger
- 3gpp-nidd
- 3gpp-analyticsexposure
- 3gpp-racs-parameter-provisioning
- 3gpp-ecr-control
- 3gpp-applying-bdt-policy
- 3gpp-mo-lcs-notify
- 3gpp-time-sync
- 3gpp-am-influence
- 3gpp-am-policyauthorization
- 3gpp-akma
- 3gpp-eas-deployment
- 3gpp-iptvconfiguration
- 3gpp-mbs-tmgi
- 3gpp-mbs-session
- 3gpp-authentication
- 3gpp-asti
- 3gpp-pdtq-policy-negotiation
- 3gpp-musa
- npcfc-am-policy-control
- npcfc-smpolicycontrol
- npcfc-policyauthorization
- npcfc-bdtpolicycontrol
- npcfc-eventexposure
- npcfc-ue-policy-control
- npcfc-am-policyauthorization
- npcfc-pdtq-policy-control
- npcfc-mbspolicycontrol
- npcfc-mbspolicyauth
- nsmsf-sms
- nnssf-nssselection
- nnssf-nssaiavailability
- nudr-dr
- nudr-group-id-map
- nlmf-loc
- nlmf-broadcast
- n5g-eir-eic
- nbsf-management
- nchf-spendinglimitcontrol
- nchf-convergedcharging
- nchf-offlineonlycharging
- nnwdaf-eventssubscription
- nnwdaf-analyticsinfo
- nnwdaf-datamanagement
- nnwdaf-mlmodelprovision
- nnwdaf-mlmodeltraining
- nnwdaf-mlmodelmonitor
- nnwdaf-roamingdata
- nnwdaf-roaminganalytics
- ngmlc-loc
- nucmf-provisioning

- nucmf-uecapabilitymanagement
- nhss-sdm
- nhss-uecm
- nhss-ueau
- nhss-ee
- nhss-ims-sdm
- nhss-ims-uecm
- nhss-ims-ueau
- nhss-gba-sdm
- nhss-gba-ueau
- nsepp-telescopic
- nsoraf-sor
- nspaf-secured-packet
- nudsf-dr
- nudsf-timer
- nnsaaf-nssaa
- nnsaaf-aiw
- naanf-akma
- n5gddnmf-discovery
- nmfaf-3datamanagement
- nmfaf-3cadatamanagement
- nmfaf-contextmanagement
- neasdf-dnscontext
- neasdf-baselinednspattern
- ndccf-datamanagement
- ndccf-contextmanagement
- nnsacf-nsac
- nnsacf-slice-ee
- nmbsmf-tmgi
- nmbsmf-mbssession
- nadrf-datamanagement
- nadrf-mlmodelmanagement
- nbsp-gba
- ntscsf-time-sync
- ntscsf-qos-tscai
- ntscsf-asti
- npkmf-keyreq
- npkmf-userid
- npkmf-discovery
- nmnpf-npstatus
- niwmsc-smsservice
- nmbsf-mbs-us
- nmbsf-mbs-ud-ingest
- mmbstf-distsession
- npanf-prosekey
- npanf-userid
- nupf-ee
- nupf-gueip
- naf-prose
- naf-eventexposure
- type: string

N2InterfaceAmfInfo:

description: AMF N2 interface information
 type: object
 anyOf:
 - required: [ipv4EndpointAddress]
 - required: [ipv6EndpointAddress]
 properties:
 ipv4EndpointAddress:
 type: array
 items:
 \$ref: 'TS29571_CommonData.yaml#/components/schemas/Ipv4Addr'
 minItems: 1
 ipv6EndpointAddress:
 type: array
 items:
 \$ref: 'TS29571_CommonData.yaml#/components/schemas/Ipv6Addr'
 minItems: 1
 amfName:
 \$ref: 'TS29571_CommonData.yaml#/components/schemas/AmfName'

NFServiceStatus:

description: Status of a given NF Service Instance of an NF Instance stored in NRF
 anyOf:
 - type: string
 enum:
 - REGISTERED

```

    - SUSPENDED
    - UNDISCOVERABLE
    - CANARY_RELEASE
  - type: string

TaiRange:
  description: Range of TAIs (Tracking Area Identities)
  type: object
  required:
    - plmnId
    - tacRangeList
  properties:
    plmnId:
      $ref: 'TS29571_CommonData.yaml#/components/schemas/PlmnId'
    tacRangeList:
      type: array
      items:
        $ref: '#/components/schemas/TacRange'
      minItems: 1
    nid:
      $ref: 'TS29571_CommonData.yaml#/components/schemas/Nid'

TacRange:
  description: Range of TACs (Tracking Area Codes)
  type: object
  oneOf:
    - required: [ start, end ]
    - required: [ pattern ]
  properties:
    start:
      type: string
      pattern: '^([A-Fa-f0-9]{4}|[A-Fa-f0-9]{6})$'
    end:
      type: string
      pattern: '^([A-Fa-f0-9]{4}|[A-Fa-f0-9]{6})$'
    pattern:
      type: string

PlmnRange:
  description: Range of PLMN IDs
  type: object
  oneOf:
    - required: [ start, end ]
    - required: [ pattern ]
  properties:
    start:
      type: string
      pattern: '^([0-9]{3}[0-9]{2,3})$'
    end:
      type: string
      pattern: '^([0-9]{3}[0-9]{2,3})$'
    pattern:
      type: string

NrfInfo:
  description: Information of an NRF NF Instance, used in hierarchical NRF deployments
  type: object
  properties:
    servedUdrInfo:
      description: A map (list of key-value pairs) where nfInstanceId serves as key
      type: object
      additionalProperties:
        anyOf:
          - $ref: '#/components/schemas/UdrInfo'
          - $ref: 'TS29571_CommonData.yaml#/components/schemas/EmptyObject'
      minProperties: 1
    servedUdrInfoList:
      description: A map (list of key-value pairs) where nfInstanceId serves as key
      type: object
      additionalProperties:
        description: A map (list of key-value pairs) where a valid JSON string serves as key
        type: object
        additionalProperties:
          anyOf:
            - $ref: '#/components/schemas/UdrInfo'
            - $ref: 'TS29571_CommonData.yaml#/components/schemas/EmptyObject'
        minProperties: 1
      minProperties: 1

```

```
servedUdmInfo:
  description: A map (list of key-value pairs) where nfInstanceId serves as key
  type: object
  additionalProperties:
    anyOf:
      - $ref: '#/components/schemas/UdmInfo'
      - $ref: 'TS29571_CommonData.yaml#/components/schemas/EmptyObject'
  minProperties: 1
servedUdmInfoList:
  description: A map (list of key-value pairs) where nfInstanceId serves as key
  type: object
  additionalProperties:
    description: A map (list of key-value pairs) where a valid JSON string serves as key
    type: object
    additionalProperties:
      anyOf:
        - $ref: '#/components/schemas/UdmInfo'
        - $ref: 'TS29571_CommonData.yaml#/components/schemas/EmptyObject'
  minProperties: 1
  minProperties: 1
servedAusfInfo:
  description: A map (list of key-value pairs) where nfInstanceId serves as key
  type: object
  additionalProperties:
    anyOf:
      - $ref: '#/components/schemas/AusfInfo'
      - $ref: 'TS29571_CommonData.yaml#/components/schemas/EmptyObject'
  minProperties: 1
servedAusfInfoList:
  description: A map (list of key-value pairs) where nfInstanceId serves as key
  type: object
  additionalProperties:
    description: A map (list of key-value pairs) where a valid JSON string serves as key
    type: object
    additionalProperties:
      anyOf:
        - $ref: '#/components/schemas/AusfInfo'
        - $ref: 'TS29571_CommonData.yaml#/components/schemas/EmptyObject'
  minProperties: 1
  minProperties: 1
servedAmfInfo:
  description: A map (list of key-value pairs) where nfInstanceId serves as key
  type: object
  additionalProperties:
    anyOf:
      - $ref: '#/components/schemas/AmfInfo'
      - $ref: 'TS29571_CommonData.yaml#/components/schemas/EmptyObject'
  minProperties: 1
servedAmfInfoList:
  description: A map (list of key-value pairs) where nfInstanceId serves as key
  type: object
  additionalProperties:
    description: A map (list of key-value pairs) where a valid JSON string serves as key
    type: object
    additionalProperties:
      anyOf:
        - $ref: '#/components/schemas/AmfInfo'
        - $ref: 'TS29571_CommonData.yaml#/components/schemas/EmptyObject'
  minProperties: 1
  minProperties: 1
servedSmfInfo:
  description: A map (list of key-value pairs) where nfInstanceId serves as key
  type: object
  additionalProperties:
    anyOf:
      - $ref: '#/components/schemas/SmfInfo'
      - $ref: 'TS29571_CommonData.yaml#/components/schemas/EmptyObject'
  minProperties: 1
servedSmfInfoList:
  description: A map (list of key-value pairs) where nfInstanceId serves as key
  type: object
  additionalProperties:
    description: A map (list of key-value pairs) where a valid JSON string serves as key
    type: object
    additionalProperties:
      anyOf:
        - $ref: '#/components/schemas/SmfInfo'
        - $ref: 'TS29571_CommonData.yaml#/components/schemas/EmptyObject'
```

```

    minProperties: 1
  minProperties: 1
  servedUpfInfo:
    description: A map (list of key-value pairs) where nfInstanceId serves as key
    type: object
    additionalProperties:
      anyOf:
        - $ref: '#/components/schemas/UpfInfo'
        - $ref: 'TS29571_CommonData.yaml#/components/schemas/EmptyObject'
  minProperties: 1
  servedUpfInfoList:
    description: A map (list of key-value pairs) where nfInstanceId serves as key
    type: object
    additionalProperties:
      description: A map (list of key-value pairs) where a valid JSON string serves as key
      type: object
      additionalProperties:
        anyOf:
          - $ref: '#/components/schemas/UpfInfo'
          - $ref: 'TS29571_CommonData.yaml#/components/schemas/EmptyObject'
  minProperties: 1
  minProperties: 1
  servedPcfInfo:
    description: A map (list of key-value pairs) where nfInstanceId serves as key
    type: object
    additionalProperties:
      anyOf:
        - $ref: '#/components/schemas/PcfInfo'
        - $ref: 'TS29571_CommonData.yaml#/components/schemas/EmptyObject'
  minProperties: 1
  servedPcfInfoList:
    description: A map (list of key-value pairs) where nfInstanceId serves as key
    type: object
    additionalProperties:
      description: A map (list of key-value pairs) where a valid JSON string serves as key
      type: object
      additionalProperties:
        anyOf:
          - $ref: '#/components/schemas/PcfInfo'
          - $ref: 'TS29571_CommonData.yaml#/components/schemas/EmptyObject'
  minProperties: 1
  minProperties: 1
  servedBsfInfo:
    description: A map (list of key-value pairs) where nfInstanceId serves as key
    type: object
    additionalProperties:
      anyOf:
        - $ref: '#/components/schemas/BsfInfo'
        - $ref: 'TS29571_CommonData.yaml#/components/schemas/EmptyObject'
  minProperties: 1
  servedBsfInfoList:
    description: A map (list of key-value pairs) where nfInstanceId serves as key
    type: object
    additionalProperties:
      description: A map (list of key-value pairs) where a valid JSON string serves as key
      type: object
      additionalProperties:
        anyOf:
          - $ref: '#/components/schemas/BsfInfo'
          - $ref: 'TS29571_CommonData.yaml#/components/schemas/EmptyObject'
  minProperties: 1
  minProperties: 1
  servedChfInfo:
    description: A map (list of key-value pairs) where nfInstanceId serves as key
    type: object
    additionalProperties:
      anyOf:
        - $ref: '#/components/schemas/ChfInfo'
        - $ref: 'TS29571_CommonData.yaml#/components/schemas/EmptyObject'
  minProperties: 1
  servedChfInfoList:
    description: A map (list of key-value pairs) where nfInstanceId serves as key
    type: object
    additionalProperties:
      description: A map (list of key-value pairs) where a valid JSON string serves as key
      type: object
      additionalProperties:
        anyOf:

```

```

    - $ref: '#/components/schemas/ChfInfo'
    - $ref: 'TS29571_CommonData.yaml#/components/schemas/EmptyObject'
  minProperties: 1
  minProperties: 1
  servedNefInfo:
    description: A map (list of key-value pairs) where nfInstanceId serves as key
    type: object
    additionalProperties:
      anyOf:
        - $ref: '#/components/schemas/NefInfo'
        - $ref: 'TS29571_CommonData.yaml#/components/schemas/EmptyObject'
  minProperties: 1
  servedNwdafInfo:
    description: A map (list of key-value pairs) where nfInstanceId serves as key
    type: object
    additionalProperties:
      anyOf:
        - $ref: '#/components/schemas/NwdafInfo'
        - $ref: 'TS29571_CommonData.yaml#/components/schemas/EmptyObject'
  minProperties: 1
  servedNwdafInfoList:
    type: object
    description: A map (list of key-value pairs) where NF Instance Id serves as key
    additionalProperties:
      type: object
      description: A map (list of key-value pairs) where a valid JSON string serves as key
      additionalProperties:
        $ref: '#/components/schemas/NwdafInfo'
      minProperties: 1
    minProperties: 1
  servedPcscfInfoList:
    description: A map (list of key-value pairs) where nfInstanceId serves as key
    type: object
    additionalProperties:
      description: A map (list of key-value pairs) where a valid JSON string serves as key
      type: object
      additionalProperties:
        anyOf:
          - $ref: '#/components/schemas/PcscfInfo'
          - $ref: 'TS29571_CommonData.yaml#/components/schemas/EmptyObject'
      minProperties: 1
    minProperties: 1
  servedGmlcInfo:
    description: A map (list of key-value pairs) where nfInstanceId serves as key
    type: object
    additionalProperties:
      anyOf:
        - $ref: '#/components/schemas/GmlcInfo'
        - $ref: 'TS29571_CommonData.yaml#/components/schemas/EmptyObject'
  minProperties: 1
  servedLmfInfo:
    description: A map (list of key-value pairs) where nfInstanceId serves as key
    type: object
    additionalProperties:
      anyOf:
        - $ref: '#/components/schemas/LmfInfo'
        - $ref: 'TS29571_CommonData.yaml#/components/schemas/EmptyObject'
  minProperties: 1
  servedNfInfo:
    description: A map (list of key-value pairs) where nfInstanceId serves as key
    type: object
    additionalProperties:
      $ref: '#/components/schemas/NfInfo'
  minProperties: 1
  servedHssInfoList:
    description: A map (list of key-value pairs) where nfInstanceId serves as key
    type: object
    additionalProperties:
      description: A map (list of key-value pairs) where a valid JSON string serves as key
      type: object
      additionalProperties:
        anyOf:
          - $ref: '#/components/schemas/HssInfo'
          - $ref: 'TS29571_CommonData.yaml#/components/schemas/EmptyObject'
      minProperties: 1
    minProperties: 1
  servedUdsfInfo:
    description: A map (list of key-value pairs) where nfInstanceId serves as key

```

```

type: object
additionalProperties:
  anyOf:
    - $ref: '#/components/schemas/UdsfInfo'
    - $ref: 'TS29571_CommonData.yaml#/components/schemas/EmptyObject'
minProperties: 1
servedUdsfInfoList:
description: A map (list of key-value pairs) where nfInstanceId serves as key
type: object
additionalProperties:
  description: A map (list of key-value pairs) where a valid JSON string serves as key
  type: object
  additionalProperties:
    anyOf:
      - $ref: '#/components/schemas/UdsfInfo'
      - $ref: 'TS29571_CommonData.yaml#/components/schemas/EmptyObject'
    minProperties: 1
  minProperties: 1
servedScpInfoList:
description: A map (list of key-value pairs) where nfInstanceId serves as key
type: object
additionalProperties:
  anyOf:
    - $ref: '#/components/schemas/ScpInfo'
    - $ref: 'TS29571_CommonData.yaml#/components/schemas/EmptyObject'
  minProperties: 1
servedSeppInfoList:
description: A map (list of key-value pairs) where nfInstanceId serves as key
type: object
additionalProperties:
  anyOf:
    - $ref: '#/components/schemas/SeppInfo'
    - $ref: 'TS29571_CommonData.yaml#/components/schemas/EmptyObject'
  minProperties: 1
servedAanfInfoList:
description: A map (list of key-value pairs) where NF Instance Id serves as key
type: object
additionalProperties:
  description: A map (list of key-value pairs) where a valid JSON string serves as key
  type: object
  additionalProperties:
    anyOf:
      - $ref: '#/components/schemas/AanfInfo'
      - $ref: 'TS29571_CommonData.yaml#/components/schemas/EmptyObject'
    minProperties: 1
served5gDdnmfInfo:
type: object
additionalProperties:
  $ref: '#/components/schemas/5GDdnmfInfo'
minProperties: 1
servedMfafInfoList:
type: object
description: A map (list of key-value pairs) where NF Instance Id serves as key
additionalProperties:
  $ref: '#/components/schemas/MfafInfo'
minProperties: 1
servedEasdfInfoList:
type: object
description: A map (list of key-value pairs) where NF Instance Id serves as key
additionalProperties:
  type: object
  description: A map (list of key-value pairs) where a valid JSON string serves as key
  additionalProperties:
    $ref: '#/components/schemas/EasdfInfo'
  minProperties: 1
servedDccfInfoList:
type: object
description: A map (list of key-value pairs) where NF Instance Id serves as key
additionalProperties:
  $ref: '#/components/schemas/DccfInfo'
minProperties: 1
servedMbSmfInfoList:
description: A map (list of key-value pairs) where nfInstanceId serves as key
type: object
additionalProperties:
  description: A map (list of key-value pairs) where a valid JSON string serves as key
  type: object
  additionalProperties:

```



```

    anyOf:
      - $ref: '#/components/schemas/MbSmfInfo'
      - $ref: 'TS29571_CommonData.yaml#/components/schemas/EmptyObject'
    minProperties: 1
  minProperties: 1
  servedTsctsInfoList:
    type: object
    description: A map (list of key-value pairs) where NF Instance Id serves as key
    additionalProperties:
      type: object
      description: A map (list of key-value pairs) where a valid JSON string serves as key
      additionalProperties:
        $ref: '#/components/schemas/TsctsInfo'
      minProperties: 1
  minProperties: 1
  servedMbUpfInfoList:
    type: object
    description: A map (list of key-value pairs) where NF Instance Id serves as key
    additionalProperties:
      type: object
      description: A map (list of key-value pairs) where a valid JSON string serves as key
      additionalProperties:
        $ref: '#/components/schemas/MbUpfInfo'
      minProperties: 1
  minProperties: 1
  servedTrustAfInfo:
    type: object
    description: A map (list of key-value pairs) where NF Instance Id serves as key
    additionalProperties:
      $ref: '#/components/schemas/TrustAfInfo'
    minProperties: 1
  servedNssaafInfo:
    type: object
    description: A map (list of key-value pairs) where NF Instance Id serves as key
    additionalProperties:
      $ref: '#/components/schemas/NssaafInfo'
    minProperties: 1
  servedDcsfInfo:
    type: object
    description: A map (list of key-value pairs) where NF Instance Id serves as key
    additionalProperties:
      $ref: '#/components/schemas/DcsfInfo'
    minProperties: 1
  servedMfInfo:
    type: object
    description: A map (list of key-value pairs) where NF Instance Id serves as key
    additionalProperties:
      $ref: '#/components/schemas/MfInfo'
    minProperties: 1
  servedMrfInfo:
    type: object
    description: A map (list of key-value pairs) where NF Instance Id serves as key
    additionalProperties:
      $ref: '#/components/schemas/MrfInfo'
    minProperties: 1
  servedMrfpInfo:
    type: object
    description: A map (list of key-value pairs) where NF Instance Id serves as key
    additionalProperties:
      $ref: '#/components/schemas/MrfpInfo'
    minProperties: 1

PlmnSnssai:
  description: List of network slices (S-NSSAIs) for a given PLMN ID
  type: object
  required:
    - plmnId
    - sNssaiList
  properties:
    plmnId:
      $ref: 'TS29571_CommonData.yaml#/components/schemas/PlmnId'
    sNssaiList:
      type: array
      items:
        $ref: 'TS29571_CommonData.yaml#/components/schemas/ExtSnssai'
      minItems: 1
  nid:
    $ref: 'TS29571_CommonData.yaml#/components/schemas/Nid'

```

```

NefInfo:
  description: Information of an NEF NF Instance
  type: object
  properties:
    nefId:
      $ref: '#/components/schemas/NefId'
    pfdData:
      $ref: '#/components/schemas/PfdData'
    afEeData:
      $ref: '#/components/schemas/AfEventExposureData'
    gpsiRanges:
      type: array
      items:
        $ref: '#/components/schemas/IdentityRange'
      minItems: 1
    externalGroupIdentifiersRanges:
      type: array
      items:
        $ref: '#/components/schemas/IdentityRange'
      minItems: 1
    servedFqdnList:
      type: array
      items:
        type: string
      minItems: 1
    tailList:
      type: array
      items:
        $ref: 'TS29571_CommonData.yaml#/components/schemas/Tai'
      minItems: 1
    taiRangeList:
      type: array
      items:
        $ref: '#/components/schemas/TaiRange'
      minItems: 1
    dnaiList:
      type: array
      items:
        $ref: 'TS29571_CommonData.yaml#/components/schemas/Dnai'
      minItems: 1
    unTrustAfInfoList:
      type: array
      items:
        $ref: '#/components/schemas/UnTrustAfInfo'
      minItems: 1
    uasNfFunctionalityInd:
      type: boolean
      default: false
    multiMemAfSessQosInd:
      type: boolean
      default: false
    memberUESelAssistInd:
      type: boolean
      default: false

PfdData:
  description: List of Application IDs and/or AF IDs managed by a given NEF Instance
  type: object
  properties:
    appIds:
      type: array
      items:
        type: string
      minItems: 1
    afIds:
      type: array
      items:
        type: string
      minItems: 1

NwdafInfo:
  description: Information of a NWDAF NF Instance
  type: object
  properties:
    eventIds:
      type: array
      items:

```

```

    $ref: 'TS29520_Nnwdaf_AnalyticsInfo.yaml#/components/schemas/EventId'
  minItems: 1
  nwdafEvents:
    type: array
    items:
      $ref: 'TS29520_Nnwdaf_EventsSubscription.yaml#/components/schemas/NwdafEvent'
  minItems: 1
  taiList:
    type: array
    items:
      $ref: 'TS29571_CommonData.yaml#/components/schemas/Tai'
  minItems: 1
  taiRangeList:
    type: array
    items:
      $ref: '#/components/schemas/TaiRange'
  minItems: 1
  nwdafCapability:
    $ref: '#/components/schemas/NwdafCapability'
  analyticsDelay:
    $ref: 'TS29571_CommonData.yaml#/components/schemas/DurationSec'
  servingNfSetIdList:
    type: array
    items:
      $ref: 'TS29571_CommonData.yaml#/components/schemas/NfSetId'
  minItems: 1
  servingNfTypeList:
    type: array
    items:
      $ref: '#/components/schemas/NFType'
  minItems: 1
  mlAnalyticsList:
    type: array
    items:
      $ref: '#/components/schemas/MLAnalyticsInfo'
  minItems: 1

LmfInfo:
  description: Information of an LMF NF Instance
  type: object
  properties:
    servingClientTypes:
      type: array
      items:
        $ref: 'TS29572_Nlmf_Location.yaml#/components/schemas/ExternalClientType'
      minItems: 1
    lmfId:
      $ref: 'TS29572_Nlmf_Location.yaml#/components/schemas/LMFIdentification'
    servingAccessTypes:
      type: array
      items:
        $ref: 'TS29571_CommonData.yaml#/components/schemas/AccessType'
      minItems: 1
    servingAnNodeTypes:
      type: array
      items:
        $ref: '#/components/schemas/AnNodeType'
      minItems: 1
    servingRatTypes:
      type: array
      items:
        $ref: 'TS29571_CommonData.yaml#/components/schemas/RatType'
      minItems: 1
    taiList:
      type: array
      items:
        $ref: 'TS29571_CommonData.yaml#/components/schemas/Tai'
      minItems: 1
    taiRangeList:
      type: array
      items:
        $ref: '#/components/schemas/TaiRange'
      minItems: 1
    supportedGADShapes:
      type: array
      items:
        $ref: 'TS29572_Nlmf_Location.yaml#/components/schemas/SupportedGADShapes'
      minItems: 1

```

```

pruExistenceInfo:
  $ref: '#/components/schemas/PruExistenceInfo'
pruSupportInd:
  type: boolean
  default: false
rangingslposSupportInd:
  type: boolean
  default: false
upPositioningInd:
  description: user plane positioning capability is supported by the LMF
  type: boolean
  default: false

GmlcInfo:
  description: Information of a GMLC NF Instance
  type: object
  properties:
    servingClientTypes:
      type: array
      items:
        $ref: 'TS29572_Nlmf_Location.yaml#/components/schemas/ExternalClientType'
      minItems: 1
    gmlcNumbers:
      type: array
      items:
        type: string
        pattern: '^[0-9]{5,15}$'
      minItems: 1

AfEventExposureData:
  description: AF Event Exposure data managed by a given NEF Instance
  type: object
  required:
    - afEvents
  properties:
    afEvents:
      type: array
      items:
        $ref: 'TS29517_Naf_EventExposure.yaml#/components/schemas/AfEvent'
      minItems: 1
    afIds:
      type: array
      items:
        type: string
      minItems: 1
    appIds:
      type: array
      items:
        type: string
      minItems: 1
    taiList:
      type: array
      items:
        $ref: 'TS29571_CommonData.yaml#/components/schemas/Tai'
      minItems: 1
    taiRangeList:
      type: array
      items:
        $ref: '#/components/schemas/TaiRange'
      minItems: 1

PcscfInfo:
  description: Information of a P-CSCF NF Instance
  type: object
  properties:
    accessType:
      type: array
      items:
        $ref: 'TS29571_CommonData.yaml#/components/schemas/AccessType'
      minItems: 1
    dnnList:
      type: array
      items:
        $ref: 'TS29571_CommonData.yaml#/components/schemas/Dnn'
      minItems: 1
    gmFqdn:
      $ref: 'TS29571_CommonData.yaml#/components/schemas/Fqdn'
    gmIpv4Addresses:

```

```

    type: array
    items:
      $ref: 'TS29571_CommonData.yaml#/components/schemas/Ipv4Addr'
    minItems: 1
  gmIpv6Addresses:
    type: array
    items:
      $ref: 'TS29571_CommonData.yaml#/components/schemas/Ipv6Addr'
    minItems: 1
  mwFqdn:
    $ref: 'TS29571_CommonData.yaml#/components/schemas/Fqdn'
  mwIpv4Addresses:
    type: array
    items:
      $ref: 'TS29571_CommonData.yaml#/components/schemas/Ipv4Addr'
    minItems: 1
  mwIpv6Addresses:
    type: array
    items:
      $ref: 'TS29571_CommonData.yaml#/components/schemas/Ipv6Addr'
    minItems: 1
  servedIpv4AddressRanges:
    type: array
    items:
      $ref: '#/components/schemas/Ipv4AddressRange'
    minItems: 1
  servedIpv6PrefixRanges:
    type: array
    items:
      $ref: '#/components/schemas/Ipv6PrefixRange'
    minItems: 1

NfInfo:
  description: Information of a generic NF Instance
  type: object
  properties:
    nfType:
      $ref: '#/components/schemas/NFType'

HssInfo:
  description: Information of an HSS NF Instance
  type: object
  properties:
    groupId:
      $ref: 'TS29571_CommonData.yaml#/components/schemas/NfGroupId'
    imsiRanges:
      type: array
      items:
        $ref: '#/components/schemas/ImsiRange'
      minItems: 1
    imsPrivateIdentityRanges:
      type: array
      items:
        $ref: '#/components/schemas/IdentityRange'
      minItems: 1
    imsPublicIdentityRanges:
      type: array
      items:
        $ref: '#/components/schemas/IdentityRange'
      minItems: 1
    msisdnsRanges:
      type: array
      items:
        $ref: '#/components/schemas/IdentityRange'
      minItems: 1
    externalGroupIdentifiersRanges:
      type: array
      items:
        $ref: '#/components/schemas/IdentityRange'
      minItems: 1
    hssDiameterAddress:
      $ref: 'TS29503_Nudm_UECM.yaml#/components/schemas/NetworkNodeDiameterAddress'
    additionalDiamAddresses:
      type: array
      items:
        $ref: 'TS29503_Nudm_UECM.yaml#/components/schemas/NetworkNodeDiameterAddress'
      minItems: 1

```

```
ImsiRange:
  description: >
    A range of IMSIs (subscriber identities), either based on a numeric range,
    or based on regular-expression matching
  type: object
  oneOf:
    - required: [ start, end ]
    - required: [ pattern ]
  properties:
    start:
      type: string
      pattern: '^[0-9]+$'
    end:
      type: string
      pattern: '^[0-9]+$'
    pattern:
      type: string

TwifInfo:
  description: Addressing information (IP addresses, FQDN) of the TWIF
  type: object
  anyOf:
    - required: [ endpointFqdn ]
    - required: [ ipv4EndpointAddresses ]
    - required: [ ipv6EndpointAddresses ]
  properties:
    ipv4EndpointAddresses:
      type: array
      items:
        $ref: 'TS29571_CommonData.yaml#/components/schemas/Ipv4Addr'
      minItems: 1
    ipv6EndpointAddresses:
      type: array
      items:
        $ref: 'TS29571_CommonData.yaml#/components/schemas/Ipv6Addr'
      minItems: 1
    endpointFqdn:
      $ref: 'TS29571_CommonData.yaml#/components/schemas/Fqdn'

VendorId:
  description: Vendor ID of the NF Service instance (Private Enterprise Number assigned by IANA)
  type: string
  pattern: '^[0-9]{6}$'

VendorSpecificFeature:
  description: Information about a vendor-specific feature
  type: object
  required:
    - featureName
    - featureVersion
  properties:
    featureName:
      type: string
    featureVersion:
      type: string

AnNodeType:
  description: Access Network Node Type (gNB, ng-eNB...)
  anyOf:
    - type: string
      enum:
        - GNB
        - NG_ENB
    - type: string

UdsfInfo:
  description: Information related to UDSF
  type: object
  properties:
    groupId:
      $ref: 'TS29571_CommonData.yaml#/components/schemas/NfGroupId'
    supiRanges:
      type: array
      items:
        $ref: '#/components/schemas/SupiRange'
      minItems: 1
    storageIdRanges:
      description: >
```

```

    A map (list of key-value pairs) where realmId serves as key and each value in the map
    is an array of IdentityRanges. Each IdentityRange is a range of storageIds.
  type: object
  additionalProperties:
    type: array
    items:
      $ref: '#/components/schemas/IdentityRange'
    minItems: 1
  minProperties: 1

ScpInfo:
  description: Information of an SCP Instance
  type: object
  properties:
    scpDomainInfoList:
      description: >
        A map (list of key-value pairs) where the key of the map shall be the string
        identifying an SCP domain
      type: object
      additionalProperties:
        $ref: '#/components/schemas/ScpDomainInfo'
      minProperties: 1
    scpPrefix:
      type: string
    scpPorts:
      description: >
        Port numbers for HTTP and HTTPS. The key of the map shall be "http" or "https".
      type: object
      additionalProperties:
        type: integer
        minimum: 0
        maximum: 65535
      minProperties: 1
    addressDomains:
      type: array
      items:
        type: string
      minItems: 1
    ipv4Addresses:
      type: array
      items:
        $ref: 'TS29571_CommonData.yaml#/components/schemas/Ipv4Addr'
      minItems: 1
    ipv6Prefixes:
      type: array
      items:
        $ref: 'TS29571_CommonData.yaml#/components/schemas/Ipv6Prefix'
      minItems: 1
    ipv4AddrRanges:
      type: array
      items:
        $ref: '#/components/schemas/Ipv4AddressRange'
      minItems: 1
    ipv6PrefixRanges:
      type: array
      items:
        $ref: '#/components/schemas/Ipv6PrefixRange'
      minItems: 1
    servedNfSetIdList:
      type: array
      items:
        $ref: 'TS29571_CommonData.yaml#/components/schemas/NfSetId'
      minItems: 1
    remotePlmnList:
      type: array
      items:
        $ref: 'TS29571_CommonData.yaml#/components/schemas/PlmnId'
      minItems: 1
    remoteSnpnList:
      type: array
      items:
        $ref: 'TS29571_CommonData.yaml#/components/schemas/PlmnIdNid'
      minItems: 1
    ipReachability:
      $ref: '#/components/schemas/IpReachability'
    scpCapabilities:
      type: array
      items:

```

```

    $ref: '#/components/schemas/ScpCapability'

ScpDomainInfo:
  description: SCP Domain specific information
  type: object
  properties:
    scpFqdn:
      $ref: 'TS29571_CommonData.yaml#/components/schemas/Fqdn'
    scpIpEndpoints:
      type: array
      items:
        $ref: '#/components/schemas/IpEndPoint'
      minItems: 1
    scpPrefix:
      type: string
    scpPorts:
      description: >
        Port numbers for HTTP and HTTPS. The key of the map shall be "http" or "https".
      type: object
      additionalProperties:
        type: integer
        minimum: 0
        maximum: 65535
      minProperties: 1

ScpDomainCond:
  description: >
    Subscription to a set of NF or SCP or SEPP instances belonging to certain SCP domains
  type: object
  required:
    - scpDomains
  properties:
    scpDomains:
      type: array
      items:
        type: string
      minItems: 1
    nfTypeList:
      type: array
      items:
        $ref: '#/components/schemas/NFType'
      minItems: 1

OptionsResponse:
  description: Communication options of the NRF sent in response content of OPTIONS method
  type: object
  properties:
    supportedFeatures:
      $ref: 'TS29571_CommonData.yaml#/components/schemas/SupportedFeatures'

ConditionEventType:
  description: >
    Indicates whether a notification is due to the NF Instance to start or stop
    being part of a condition for a subscription to a set of NFs
  anyOf:
    - type: string
      enum:
        - NF_ADDED
        - NF_REMOVED
    - type: string

SuciInfo:
  description: SUCI information containing Routing Indicator and Home Network Public Key ID
  type: object
  properties:
    routingInds:
      type: array
      items:
        type: string
        pattern: '^[0-9]{1,4}$'
      minItems: 1
    hNwPubKeyIds:
      type: array
      items:
        type: integer
      minItems: 1

SeppInfo:

```



```

description: Information of a SEPP Instance
type: object
properties:
  seppPrefix:
    type: string
  seppPorts:
    description: >
      Port numbers for HTTP and HTTPS. The key of the map shall be "http" or "https".
    type: object
    additionalProperties:
      type: integer
      minimum: 0
      maximum: 65535
    minProperties: 1
  remotePlmnList:
    type: array
    items:
      $ref: 'TS29571_CommonData.yaml#/components/schemas/PlmnId'
    minItems: 1
  remoteSnpnList:
    type: array
    items:
      $ref: 'TS29571_CommonData.yaml#/components/schemas/PlmnIdNid'
    minItems: 1
  n32Purposes:
    description: N32 purposes supported by the SEPP
    type: array
    items:
      $ref: 'TS29573_N32_Handshake.yaml#/components/schemas/N32Purpose'
    minItems: 1

IpReachability:
description: Indicates the type(s) of IP addresses reachable via an SCP
anyOf:
  - type: string
    enum:
      - IPV4
      - IPV6
      - IPV4V6
  - type: string

UriList:
description: >
  Represents a set of URIs following the 3GPP hypermedia format
  (containing a "_links" attribute).
type: object
properties:
  _links:
    type: object
    description: >
      List of the URI of NF instances. It has two members whose names are item and self.
      The item attribute contains an array of URIs.
    additionalProperties:
      $ref: 'TS29571_CommonData.yaml#/components/schemas/LinksValueSchema'
    minProperties: 1
  totalItemCount:
    type: integer

AanfInfo:
description: Represents the information relative to an AANF NF Instance.
type: object
properties:
  routingIndicators:
    type: array
    items:
      type: string
      pattern: '^[0-9]{1,4}$'
    minItems: 1

5GDdnmfInfo:
description: Information of an 5G DDNMF NF Instance
type: object
required:
  - plmnId
properties:
  plmnId:
    $ref: 'TS29571_CommonData.yaml#/components/schemas/PlmnId'

```

```

WildcardDnai:
  description: Wildcard DNAI
  type: string
  pattern: '^[*]*$'

MfafInfo:
  description: Information of a MFAF NF Instance
  type: object
  properties:
    servingNFTypeList:
      type: array
      items:
        $ref: '#/components/schemas/NFType'
      minItems: 1
    servingNfSetIdList:
      type: array
      items:
        $ref: 'TS29571_CommonData.yaml#/components/schemas/NfSetId'
      minItems: 1
    taiList:
      type: array
      items:
        $ref: 'TS29571_CommonData.yaml#/components/schemas/Tai'
      minItems: 1
    taiRangeList:
      type: array
      items:
        $ref: '#/components/schemas/TaiRange'
      minItems: 1

NwdafCapability:
  description: Indicates the capability supported by the NWDAF
  type: object
  properties:
    analyticsAggregation:
      type: boolean
      default: false
    analyticsMetadataProvisioning:
      type: boolean
      default: false
    mlModelAccuracyChecking:
      type: boolean
      default: false
    analyticsAccuracyChecking:
      type: boolean
      default: false
    roamingExchange:
      type: boolean
      default: false

EasdfInfo:
  description: Information of an EASDF NF Instance
  type: object
  properties:
    sNssaiEasdfInfoList:
      type: array
      items:
        $ref: '#/components/schemas/SnssaiEasdfInfoItem'
      minItems: 1
    easdfN6IpAddressList:
      type: array
      items:
        $ref: 'TS29571_CommonData.yaml#/components/schemas/IpAddr'
      minItems: 1
    upfN6IpAddressList:
      type: array
      items:
        $ref: 'TS29571_CommonData.yaml#/components/schemas/IpAddr'
      minItems: 1
    n6TunnelInfoList:
      description: >
        A map of InterfaceUpfInfoItems containing the N6 tunnelling information for establishing
        a N6 tunnel between the V-UPF and the V-EASDF, where a valid JSON string serves as key.
      type: object
      additionalProperties:
        $ref: '#/components/schemas/InterfaceUpfInfoItem'
      minProperties: 1
    dnsSecurityProtocols:

```

```

    type: array
    items:
      $ref: '#/components/schemas/DnsSecurityProtocol'
    minItems: 1

SnssaiEasdfInfoItem:
  description: Set of parameters supported by EASDF for a given S-NSSAI
  type: object
  required:
    - sNssai
    - dnnEasdfInfoList
  properties:
    sNssai:
      $ref: 'TS29571_CommonData.yaml#/components/schemas/ExtSnssai'
    dnnEasdfInfoList:
      type: array
      items:
        $ref: '#/components/schemas/DnnEasdfInfoItem'
      minItems: 1

DnnEasdfInfoItem:
  description: Set of parameters supported by EASDF for a given DNN
  type: object
  required:
    - dnn
  properties:
    dnn:
      anyOf:
        - $ref: 'TS29571_CommonData.yaml#/components/schemas/Dnn'
        - $ref: 'TS29571_CommonData.yaml#/components/schemas/WildcardDnn'
    dnaiList:
      type: array
      items:
        $ref: 'TS29571_CommonData.yaml#/components/schemas/Dnai'
      minItems: 1

DccfInfo:
  description: Information of a DCCF NF Instance
  type: object
  properties:
    servingNfTypeList:
      type: array
      items:
        $ref: '#/components/schemas/NFType'
      minItems: 1
    servingNfSetIdList:
      type: array
      items:
        $ref: 'TS29571_CommonData.yaml#/components/schemas/NfSetId'
      minItems: 1
    taiList:
      type: array
      items:
        $ref: 'TS29571_CommonData.yaml#/components/schemas/Tai'
      minItems: 1
    taiRangeList:
      type: array
      items:
        $ref: '#/components/schemas/TaiRange'
      minItems: 1
    dataSubsRelocInd:
      type: boolean
      default: false

ScpCapability:
  description: Indicates the capabilities supported by an SCP
  anyOf:
    - type: string
      enum:
        - INDIRECT_COM_WITH_DELEG_DISC
    - type: string

NsacfInfo:
  description: Information of a NSACF NF Instance
  type: object
  required:
    - nsacfCapability
  properties:

```

```

nsacfCapability:
  $ref: '#/components/schemas/NsacfCapability'
snssaiListForEntirePlmn:
  type: array
  items:
    $ref: 'TS29571_CommonData.yaml#/components/schemas/ExtSnssai'
  minItems: 1
taiList:
  deprecated: true
  type: array
  items:
    $ref: 'TS29571_CommonData.yaml#/components/schemas/Tai'
  minItems: 1
taiRangeList:
  deprecated: true
  type: array
  items:
    $ref: '#/components/schemas/TaiRange'
  minItems: 1
nsacSaiList:
  type: array
  items:
    $ref: 'TS29571_CommonData.yaml#/components/schemas/NsacSai'
  minItems: 1

NsacfCapability:
  description: >
    NSACF service capabilities (e.g. to monitor and control the number of registered UEs
    or established PDU sessions per network slice)
  type: object
  properties:
    supportUeSAC:
      description: |
        Indicates the service capability of the NSACF to monitor and control the number of
        registered UEs per network slice for the network slice that is subject to NSAC
      true: Supported
      false (default): Not Supported
      type: boolean
      default: false
    supportPduSAC:
      description: |
        Indicates the service capability of the NSACF to monitor and control the number of
        established PDU sessions per network slice for the network slice that is subject to NSAC
      true: Supported
      false (default): Not Supported
      type: boolean
      default: false
    supportUeWithPduSAC:
      description: |
        Indicates the service capability of the NSACF to control the number of registered UEs
        with at least one PDU session / PDN connection per network slice for the network slice
        that is subject to NSAC, if EPS counting is supported by the NSACF.
      true: Supported
      false (default): Not Supported
      type: boolean
      default: false

DccfCond:
  description: >
    Subscription to a set of NF Instances (DCCFs), identified by NF types, NF Set Id(s)
    or DCCF Serving Area information, i.e. list of TAIs served by the DCCF
  type: object
  required:
    - conditionType
  properties:
    conditionType:
      type: string
      enum: [ DCCF_COND ]
  taiList:
    type: array
    items:
      $ref: 'TS29571_CommonData.yaml#/components/schemas/Tai'
    minItems: 1
  taiRangeList:
    type: array
    items:
      $ref: '#/components/schemas/TaiRange'
    minItems: 1

```

```
    servingNfTypeList:
      type: array
      items:
        $ref: '#/components/schemas/NFType'
      minItems: 1
    servingNfSetIdList:
      type: array
      items:
        $ref: 'TS29571_CommonData.yaml#/components/schemas/NfSetId'
      minItems: 1

MlAnalyticsInfo:
  description: ML Analytics Filter information supported by the Nnwdaf_MLModelProvision service
  type: object
  properties:
    mlAnalyticsIds:
      type: array
      items:
        $ref: 'TS29520_Nnwdaf_EventsSubscription.yaml#/components/schemas/NwdafEvent'
      minItems: 1
    snssaiList:
      type: array
      items:
        $ref: 'TS29571_CommonData.yaml#/components/schemas/Snssai'
      minItems: 1
    trackingAreaList:
      type: array
      items:
        $ref: 'TS29571_CommonData.yaml#/components/schemas/Tai'
      minItems: 1
    mlModelInterInfo:
      $ref: '#/components/schemas/MlModelInterInfo'
    flCapabilityType:
      $ref: '#/components/schemas/FlCapabilityType'
    flTimeInterval:
      $ref: 'TS29571_CommonData.yaml#/components/schemas/DurationSec'
    nfTypeList:
      type: array
      items:
        $ref: '#/components/schemas/NFType'
      minItems: 1
    nfSetIdList:
      type: array
      items:
        $ref: 'TS29571_CommonData.yaml#/components/schemas/NfSetId'
      minItems: 1

MbSmfInfo:
  description: Information of an MB-SMF NF Instance
  type: object
  properties:
    sNssaiInfoList:
      description: A map (list of key-value pairs) where a valid JSON string serves as key
      additionalProperties:
        $ref: '#/components/schemas/SnssaiMbSmfInfoItem'
      minProperties: 1
    tmgiRangeList:
      description: A map (list of key-value pairs) where a valid JSON string serves as key
      additionalProperties:
        $ref: '#/components/schemas/TmgiRange'
      minProperties: 1
    taiList:
      type: array
      items:
        $ref: 'TS29571_CommonData.yaml#/components/schemas/Tai'
      minItems: 1
    taiRangeList:
      type: array
      items:
        $ref: '#/components/schemas/TaiRange'
      minItems: 1
    mbsSessionList:
      description: A map (list of key-value pairs) where a valid JSON string serves as key
      additionalProperties:
        $ref: '#/components/schemas/MbsSession'
      minProperties: 1

TmgiRange:
```

```

description: Range of TMGIs
type: object
required:
  - mbsServiceIdStart
  - mbsServiceIdEnd
  - plmnId
properties:
  mbsServiceIdStart:
    type: string
    pattern: '^[A-Fa-f0-9]{6}$'
  mbsServiceIdEnd:
    type: string
    pattern: '^[A-Fa-f0-9]{6}$'
  plmnId:
    $ref: 'TS29571_CommonData.yaml#/components/schemas/PlmnId'
  nid:
    $ref: 'TS29571_CommonData.yaml#/components/schemas/Nid'

MbsSession:
description: MBS Session currently served by an MB-SMF
type: object
required:
  - mbsSessionId
properties:
  mbsSessionId:
    $ref: 'TS29571_CommonData.yaml#/components/schemas/MbsSessionId'
  mbsAreaSessions:
    description: A map (list of key-value pairs) where the key identifies an areaSessionId
    additionalProperties:
      $ref: 'TS29571_CommonData.yaml#/components/schemas/MbsServiceAreaInfo'
    minProperties: 1

SnssaiMbSmfInfoItem:
description: Parameters supported by an MB-SMF for a given S-NSSAI
type: object
required:
  - sNssai
  - dnnInfoList
properties:
  sNssai:
    $ref: 'TS29571_CommonData.yaml#/components/schemas/ExtSnssai'
  dnnInfoList:
    type: array
    items:
      $ref: '#/components/schemas/DnnMbSmfInfoItem'
    minItems: 1

DnnMbSmfInfoItem:
description: Parameters supported by an MB-SMF for a given DNN
type: object
required:
  - dnn
properties:
  dnn:
    anyOf:
      - $ref: 'TS29571_CommonData.yaml#/components/schemas/Dnn'
      - $ref: 'TS29571_CommonData.yaml#/components/schemas/WildcardDnn'

TsctsfInfo:
description: Information of a TSCTSF NF Instance
type: object
properties:
  sNssaiInfoList:
    description: A map (list of key-value pairs) where a valid JSON string serves as key
    additionalProperties:
      $ref: '#/components/schemas/SnssaiTsctsfInfoItem'
    minProperties: 1
  externalGroupIdentifiersRanges:
    type: array
    items:
      $ref: '#/components/schemas/IdentityRange'
    minItems: 1
  supiRanges:
    type: array
    items:
      $ref: '#/components/schemas/SupiRange'
    minItems: 1
  gpsiRanges:

```

```

    type: array
    items:
      $ref: '#/components/schemas/IdentityRange'
    minItems: 1
  internalGroupIdentifiersRanges:
    type: array
    items:
      $ref: '#/components/schemas/InternalGroupIdRange'
    minItems: 1

SnssaiTsctsfInfoItem:
  description: Set of parameters supported by TSCTSF for a given S-NSSAI
  type: object
  required:
    - sNssai
    - dnnInfoList
  properties:
    sNssai:
      $ref: 'TS29571_CommonData.yaml#/components/schemas/ExtSnssai'
    dnnInfoList:
      type: array
      items:
        $ref: '#/components/schemas/DnnTsctsfInfoItem'
      minItems: 1

DnnTsctsfInfoItem:
  description: Parameters supported by an TSCTSF for a given DNN
  type: object
  required:
    - dnn
  properties:
    dnn:
      anyOf:
        - $ref: 'TS29571_CommonData.yaml#/components/schemas/Dnn'
        - $ref: 'TS29571_CommonData.yaml#/components/schemas/WildcardDnn'

MbUpfInfo:
  description: Information of an MB-UPF NF Instance
  type: object
  required:
    - sNssaiMbUpfInfoList
  properties:
    sNssaiMbUpfInfoList:
      type: array
      items:
        $ref: '#/components/schemas/SnssaiUpfInfoItem'
      minItems: 1
    mbSmfServingArea:
      type: array
      items:
        type: string
      minItems: 1
    interfaceMbUpfInfoList:
      type: array
      items:
        $ref: '#/components/schemas/InterfaceUpfInfoItem'
      minItems: 1
    taiList:
      type: array
      items:
        $ref: 'TS29571_CommonData.yaml#/components/schemas/Tai'
      minItems: 1
    taiRangeList:
      type: array
      items:
        $ref: '#/components/schemas/TaiRange'
      minItems: 1
    priority:
      type: integer
      minimum: 0
      maximum: 65535
    supportedPfcFeatures:
      type: string

UnTrustAfInfo:
  description: Information of a untrusted AF Instance
  type: object
  required:

```

```

- afId
properties:
  afId:
    type: string
  sNssaiInfoList:
    type: array
    items:
      $ref: '#/components/schemas/SnssaiInfoItem'
    minItems: 1
  mappingInd:
    type: boolean
    default: false

TrustAfInfo:
description: Information of a trusted AF Instance
type: object
properties:
  sNssaiInfoList:
    type: array
    items:
      $ref: '#/components/schemas/SnssaiInfoItem'
    minItems: 1
  afEvents:
    type: array
    items:
      $ref: 'TS29517_Naf_EventExposure.yaml#/components/schemas/AfEvent'
    minItems: 1
  appIds:
    type: array
    items:
      type: string
    minItems: 1
  internalGroupId:
    type: array
    items:
      $ref: 'TS29571_CommonData.yaml#/components/schemas/GroupId'
    minItems: 1
  mappingInd:
    type: boolean
    default: false
  taiList:
    type: array
    items:
      $ref: 'TS29571_CommonData.yaml#/components/schemas/Tai'
    minItems: 1
  taiRangeList:
    type: array
    items:
      $ref: '#/components/schemas/TaiRange'
    minItems: 1

SnssaiInfoItem:
description: >
  Parameters supported by an NF for a given S-NSSAI Set of parameters supported by NF
  for a given S-NSSAI
type: object
required:
- sNssai
- dnnInfoList
properties:
  sNssai:
    $ref: 'TS29571_CommonData.yaml#/components/schemas/ExtSnssai'
  dnnInfoList:
    type: array
    items:
      $ref: '#/components/schemas/DnnInfoItem'
    minItems: 1

DnnInfoItem:
description: Set of parameters supported by NF for a given DNN
type: object
required:
- dnn
properties:
  dnn:
    anyOf:
      - $ref: 'TS29571_CommonData.yaml#/components/schemas/Dnn'
      - $ref: 'TS29571_CommonData.yaml#/components/schemas/WildcardDnn'

```



```
CollocatedNfInstance:
  description: Information of an collocated NF Instance registered in the NRF
  type: object
  required:
    - nfInstanceId
    - nfType
  properties:
    nfInstanceId:
      $ref: 'TS29571_CommonData.yaml#/components/schemas/NfInstanceId'
    nfType:
      $ref: '#/components/schemas/CollocatedNfType'
```

```
CollocatedNfType:
  description: NF types for a collocated NF
  anyOf:
    - type: string
      enum:
        - UPF
        - SMF
        - MB_UPF
        - MB_SMF
    - type: string
```

```
PlmnOauth2:
  description: Oauth2.0 required indication for a given PLMN ID
  type: object
  properties:
    oauth2RequiredPlmnIdList:
      type: array
      items:
        $ref: 'TS29571_CommonData.yaml#/components/schemas/PlmnId'
      minItems: 1
    oauth2NotRequiredPlmnIdList:
      type: array
      items:
        $ref: 'TS29571_CommonData.yaml#/components/schemas/PlmnId'
      minItems: 1
```

```
V2xCapability:
  description: Indicate the supported V2X Capability by the PCF.
  type: object
  properties:
    lteV2x:
      type: boolean
      default: false
    nrV2x:
      type: boolean
      default: false
```

```
NssaafInfo:
  description: Information of a NSSAAF Instance
  type: object
  properties:
    supiRanges:
      type: array
      items:
        $ref: '#/components/schemas/SupiRange'
      minItems: 1
    internalGroupIdentifiersRanges:
      type: array
      items:
        $ref: '#/components/schemas/InternalGroupIdRange'
      minItems: 1
```

```
ProSeCapability:
  description: Indicate the supported ProSe Capability by the PCF.
  type: object
  properties:
    proseDirectDiscoverey:
      type: boolean
      default: false
    proseDirectCommunication:
      type: boolean
      default: false
    proseL2UetoNetworkRelay:
      type: boolean
      default: false
```

```
proseL3UetoNetworkRelay:
  type: boolean
  default: false
proseL2RemoteUe:
  type: boolean
  default: false
proseL3RemoteUe:
  type: boolean
  default: false
proseL2UetoUeRelay:
  type: boolean
  default: false
proseL3UetoUeRelay:
  type: boolean
  default: false
proseL2EndUe:
  type: boolean
  default: false
proseL3EndUe:
  type: boolean
  default: false

SubscriptionContext:
  description: >
    Context data related to a created subscription, to be included in notifications sent by NRF
  type: object
  required:
    - subscriptionId
  properties:
    subscriptionId:
      type: string
    subscrCond:
      $ref: '#/components/schemas/SubscrCond'

IwmscInfo:
  description: Information of an SMS-IWMSC NF Instance
  type: object
  properties:
    msisdRanges:
      type: array
      items:
        $ref: '#/components/schemas/IdentityRange'
      minItems: 1
    supiRanges:
      type: array
      items:
        $ref: '#/components/schemas/SupiRange'
      minItems: 1
    taiRangeList:
      type: array
      items:
        $ref: '#/components/schemas/TaiRange'
      minItems: 1
    scNumber:
      type: string
      pattern: '^[0-9]{5,15}$'

MnpfInfo:
  description: Information of an MNPf Instance
  type: object
  properties:
    msisdRanges:
      type: array
      items:
        $ref: '#/components/schemas/IdentityRange'
      minItems: 1
  required:
    - msisdRanges

DefSubServiceInfo:
  description: Service Specific information for Default Notification Subscription.
  type: object
  properties:
    versions:
      type: array
      items:
        type: string
      minItems: 1
```

```
supportedFeatures:
  $ref: 'TS29571_CommonData.yaml#/components/schemas/SupportedFeatures'

LocalityDescriptionItem:
  description: Locality description item
  type: object
  properties:
    localityType:
      $ref: '#/components/schemas/LocalityType'
    localityValue:
      type: string
  required:
    - localityType
    - localityValue

LocalityDescription:
  description: Locality description
  type: object
  properties:
    localityType:
      $ref: '#/components/schemas/LocalityType'
    localityValue:
      type: string
    addlLocDescrItems:
      type: array
      items:
        $ref: '#/components/schemas/LocalityDescriptionItem'
      minItems: 1
  required:
    - localityType
    - localityValue

LocalityType:
  description: >
    Type of locality description. An operator may define custom locality type values other
    than those listed in this enumeration.
  anyOf:
    - type: string
      enum:
        - DATA_CENTER
        - CITY
        - COUNTY
        - DISTRICT
        - STATE
        - CANTON
        - REGION
        - PROVINCE
        - PREFECTURE
        - COUNTRY
    - type: string

SmsfInfo:
  description: Specific Data for SMSF
  type: object
  properties:
    roamingUeInd:
      type: boolean
    remotePlmnRangeList:
      type: array
      items:
        $ref: '#/components/schemas/PlmnRange'
      minItems: 1

DcsfInfo:
  description: Information of a DCSF NF Instance
  type: object
  properties:
    imsDomainNameList:
      type: array
      items:
        $ref: '#/components/schemas/ImsDomainName'
    imsiRanges:
      type: array
      items:
        $ref: '#/components/schemas/ImsiRange'
      minItems: 1
    imsPrivateIdentityRanges:
      type: array
```

```
    items:
      $ref: '#/components/schemas/IdentityRange'
    minItems: 1
  imsPublicIdentityRanges:
    type: array
    items:
      $ref: '#/components/schemas/IdentityRange'
    minItems: 1
  msisdnranges:
    type: array
    items:
      $ref: '#/components/schemas/IdentityRange'
    minItems: 1

ImsDomainName:
  description: IMS Domain Name
  type: string

MlModelInterInfo:
  description: ML Model Interoperability Information
  type: object
  properties:
    vendorList:
      type: array
      items:
        $ref: '#/components/schemas/VendorId'
      minItems: 1

PruExistenceInfo:
  description: PRU Existence Information
  type: object
  properties:
    taiList:
      type: array
      items:
        $ref: 'TS29571_CommonData.yaml#/components/schemas/Tai'
      minItems: 1
    taiRangeList:
      type: array
      items:
        $ref: '#/components/schemas/TaiRange'
      minItems: 1

FlCapabilityType:
  description: >
    Type of Federated Learning Capability.
  anyOf:
    - type: string
      enum:
        - FL_SERVER
        - FL_CLIENT
        - FL_SERVER_AND_CLIENT
    - type: string

MrfInfo:
  description: Information of a Mrf NF Instance
  type: object
  properties:
    mediaCapabilityList:
      type: array
      items:
        $ref: '#/components/schemas/MediaCapability'
      minItems: 1

MrfpInfo:
  description: Information of a Mrfp NF Instance
  type: object
  properties:
    mediaCapabilityList:
      type: array
      items:
        $ref: '#/components/schemas/MediaCapability'
      minItems: 1

MfInfo:
  description: Information of a MF NF Instance
  type: object
  properties:
```

```
mediaCapabilityList:
  type: array
  items:
    $ref: '#/components/schemas/MediaCapability'
  minItems: 1

EpdgInfo:
  description: Information of the ePDG end-points
  type: object
  anyOf:
    - required: [ ipv4EndpointAddresses ]
    - required: [ ipv6EndpointAddresses ]
  properties:
    ipv4EndpointAddresses:
      type: array
      items:
        $ref: 'TS29571_CommonData.yaml#/components/schemas/Ipv4Addr'
      minItems: 1
    ipv6EndpointAddresses:
      type: array
      items:
        $ref: 'TS29571_CommonData.yaml#/components/schemas/Ipv6Addr'
      minItems: 1

MediaCapability:
  description: media capability offered by NF instance
  type: string
  pattern: '^[a-zA-Z0-9_]+$'

A2xCapability:
  description: Indicate the supported A2X Capability by the PCF.
  type: object
  properties:
    lteA2x:
      type: boolean
      default: false
    nrA2x:
      type: boolean
      default: false

RuleSet:
  type: object
  required:
    - priority
    - action
  properties:
    priority:
      type: integer
      minimum: 0
      maximum: 65535
    plmns:
      type: array
      items:
        $ref: 'TS29571_CommonData.yaml#/components/schemas/PlmnId'
      minItems: 1
    snpns:
      type: array
      items:
        $ref: 'TS29571_CommonData.yaml#/components/schemas/PlmnIdNid'
      minItems: 1
    nfTypes:
      type: array
      items:
        $ref: '#/components/schemas/NFType'
      minItems: 1
    nfDomains:
      type: array
      items:
        type: string
      minItems: 1
    nssais:
      type: array
      items:
        $ref: 'TS29571_CommonData.yaml#/components/schemas/ExtSnssai'
      minItems: 1
    nfInstances:
      type: array
      items:
```

```

    $ref: 'TS29571_CommonData.yaml#/components/schemas/NfInstanceId'
  scopes:
    type: array
    items:
      type: string
    minItems: 1
  action:
    $ref: '#/components/schemas/RuleSetAction'

RuleSetAction:
  description: >
    Specifies whether access/scope is allowed or denied for a specific NF-Consumer.
  anyOf:
    - type: string
      enum:
        - ALLOW
        - DENY
    - type: string

AdrfInfo:
  description: Information of an ADRF NF Instance
  type: object
  properties:
    mlModelStorageInd:
      type: boolean
      default: false
    dataStorageInd:
      type: boolean
      default: false

SelectionConditions:
  description: >
    It contains the set of conditions that shall be evaluated to determine whether a consumer
    shall select a given producer. The producer shall only be selected if the evaluation of
    the conditions is <true>. The set of conditions can be represented by a single
    ConditionItem or by a ConditionGroup, where the latter contains a (recursive) list of
    conditions joined by the "and" or "or" logical relationships.
  oneOf:
    - $ref: '#/components/schemas/ConditionItem'
    - $ref: '#/components/schemas/ConditionGroup'

ConditionGroup:
  description: >
    List (array) of conditions (joined by the "and" or "or" logical relationship),
    under which an NF Instance with an NFStatus or NFServiceStatus value set to,
    "CANARY_RELEASE", or with a "canaryRelease" attribute set to true,
    shall be selected by an NF Service Consumer.
  type: object
  oneOf:
    - required: [ and ]
    - required: [ or ]
  properties:
    and:
      type: array
      items:
        $ref: '#/components/schemas/SelectionConditions'
      minItems: 1
    or:
      type: array
      items:
        $ref: '#/components/schemas/SelectionConditions'
      minItems: 1

ConditionItem:
  description: >
    A ConditionItem consists of a number of attributes representing individual conditions
    (e.g. a SUPI range, or a TAI list). If several attributes/conditions are present,
    the evaluation of the ConditionItem is <true> if all attributes/conditions are evaluated
    as <true> (i.e., it follows the AND logical relationship).
  type: object
  allof:
    - not:
        required: [ and ]
    - not:
        required: [ or ]
  properties:
    consumerNfTypes:
      type: array

```

```

    items:
      $ref: '#/components/schemas/NFType'
    minItems: 1
  serviceFeature:
    type: integer
    minimum: 1
  vsServiceFeature:
    type: integer
    minimum: 1
  supiRangeList:
    type: array
    items:
      $ref: '#/components/schemas/SupiRange'
    minItems: 1
  gpsiRangeList:
    type: array
    items:
      $ref: '#/components/schemas/IdentityRange'
    minItems: 1
  impuRangeList:
    type: array
    items:
      $ref: '#/components/schemas/IdentityRange'
    minItems: 1
  impiRangeList:
    type: array
    items:
      $ref: '#/components/schemas/IdentityRange'
    minItems: 1
  peiList:
    type: array
    items:
      $ref: 'TS29571_CommonData.yaml#/components/schemas/Pei'
    minItems: 1
  taiRangeList:
    type: array
    items:
      $ref: '#/components/schemas/TaiRange'
    minItems: 1
  dnnList:
    type: array
    items:
      $ref: 'TS29571_CommonData.yaml#/components/schemas/Dnn'
    minItems: 1

CallbackUriPrefixItem:
  description: callback URI prefix value to be used for specific notification types
  type: object
  properties:
    callbackUriPrefix:
      type: string
    notificationTypes:
      type: array
      items:
        type: string
  required:
    - callbackUriPrefix
    - notificationTypes

PortRange:
  description: Range of port numbers
  type: object
  properties:
    start:
      type: integer
      minimum: 0
      maximum: 65535
    end:
      type: integer
      minimum: 0
      maximum: 65535
  required:
    - start
    - end

DnsSecurityProtocol:
  description: DNS security protocol
  anyOf:

```

- type: string
- enum:
 - TLS
 - DTLS
- type: string

A.3 Nnrf_NFDiscovery API

openapi: 3.0.0

info:

```

version: '1.3.2'
title: 'NRF NFDiscovery Service'
description: |
  NRF NFDiscovery Service.
  © 2024, 3GPP Organizational Partners (ARIB, ATIS, CCSA, ETSI, TSDSI, TTA, TTC).
  All rights reserved.

```

externalDocs:

```

description: 3GPP TS 29.510 V18.9.0; 5G System; Network Function Repository Services; Stage 3
url: 'https://www.3gpp.org/ftp/Specs/archive/29_series/29.510/'

```

servers:

```

- url: '{apiRoot}/nnrf-disc/v1'
  variables:
    apiRoot:
      default: https://example.com
      description: apiRoot as defined in clause 4.4 of 3GPP TS 29.501

```

security:

```

- {}
- oAuth2ClientCredentials:
  - nnrf-disc
- oAuth2ClientCredentials:
  - nnrf-disc
  - nnrf-disc:nf-instances:read-complete-profile

```

paths:

```

/nf-instances:
  get:
    summary: Search a collection of NF Instances
    operationId: SearchNFInstances
    tags:
      - NF Instances (Store)
    parameters:
      - name: Accept-Encoding
        in: header
        description: Accept-Encoding, described in IETF RFC 9110
        schema:
          type: string
      - name: target-nf-type
        in: query
        description: Type of the target NF
        required: true
        schema:
          $ref: 'TS29510_Nnrf_NFManagement.yaml#/components/schemas/NFType'
      - name: requester-nf-type
        in: query
        description: Type of the requester NF
        required: true
        schema:
          $ref: 'TS29510_Nnrf_NFManagement.yaml#/components/schemas/NFType'
      - name: preferred-collocated-nf-types
        in: query
        description: collocated NF types that candidate NFs should preferentially support
        schema:
          type: array
          items:
            $ref: 'TS29510_Nnrf_NFManagement.yaml#/components/schemas/CollocatedNFType'
          minItems: 1
        style: form
        explode: false
      - name: requester-nf-instance-id
        in: query
        description: NfInstanceId of the requester NF

```



```

    schema:
      $ref: 'TS29571_CommonData.yaml#/components/schemas/NfInstanceId'
  - name: service-names
    in: query
    description: Names of the services offered by the NF
    schema:
      type: array
      items:
        $ref: 'TS29510_Nnrf_NFManagement.yaml#/components/schemas/ServiceName'
      minItems: 1
      uniqueItems: true
    style: form
    explode: false
  - name: requester-nf-instance-fqdn
    in: query
    description: FQDN of the requester NF
    schema:
      $ref: 'TS29571_CommonData.yaml#/components/schemas/Fqdn'
  - name: target-plmn-list
    in: query
    description: >
      Id of the PLMN of either the target NF, or in SNPN scenario the Credentials Holder
      in the PLMN
    content:
      application/json:
        schema:
          type: array
          items:
            $ref: 'TS29571_CommonData.yaml#/components/schemas/PlmnId'
            minItems: 1
  - name: requester-plmn-list
    in: query
    description: Id of the PLMN where the NF issuing the Discovery request is located
    content:
      application/json:
        schema:
          type: array
          items:
            $ref: 'TS29571_CommonData.yaml#/components/schemas/PlmnId'
            minItems: 1
  - name: target-nf-instance-id
    in: query
    description: Identity of the NF instance being discovered
    schema:
      $ref: 'TS29571_CommonData.yaml#/components/schemas/NfInstanceId'
  - name: target-nf-instance-id-list
    in: query
    description: Identities of the NF instances being discovered
    schema:
      type: array
      items:
        $ref: 'TS29571_CommonData.yaml#/components/schemas/NfInstanceId'
      minItems: 2
    style: form
    explode: false
  - name: target-nf-fqdn
    in: query
    description: FQDN of the NF instance being discovered
    schema:
      $ref: 'TS29571_CommonData.yaml#/components/schemas/Fqdn'
  - name: hnr-uri
    in: query
    description: Uri of the home NRF
    schema:
      $ref: 'TS29571_CommonData.yaml#/components/schemas/Uri'
  - name: snssais
    in: query
    description: Slice info of the target NF
    content:
      application/json:
        schema:
          type: array
          items:
            $ref: 'TS29571_CommonData.yaml#/components/schemas/Snssai'
            minItems: 1
  - name: additional-snssais
    in: query
    description: Additional Slices supported by the target NF (Service) instances

```

```

content:
  application/json:
    schema:
      type: array
      items:
        $ref: 'TS29571_CommonData.yaml#/components/schemas/ExtSnssai'
      minItems: 1
- name: requester-snssais
  in: query
  description: Slice info of the requester NF
  content:
    application/json:
      schema:
        type: array
        items:
          $ref: 'TS29571_CommonData.yaml#/components/schemas/ExtSnssai'
        minItems: 1
- name: plmn-specific-snssai-list
  in: query
  description: PLMN specific Slice info of the target NF
  content:
    application/json:
      schema:
        type: array
        items:
          $ref: 'TS29510_Nnrf_NFManagement.yaml#/components/schemas/PlmnSnssai'
        minItems: 1
- name: requester-plmn-specific-snssai-list
  in: query
  description: PLMN-specific slice info of the NF issuing the Discovery request
  content:
    application/json:
      schema:
        type: array
        items:
          $ref: 'TS29510_Nnrf_NFManagement.yaml#/components/schemas/PlmnSnssai'
        minItems: 1
- name: dnn
  in: query
  description: Dnn supported by the BSF, SMF or UPF
  schema:
    $ref: 'TS29571_CommonData.yaml#/components/schemas/Dnn'
- name: ipv4-index
  in: query
  description: The IPv4 Index supported by the candidate UPF.
  content:
    application/json:
      schema:
        $ref: 'TS29503_Nudm_SDM.yaml#/components/schemas/IpIndex'
- name: ipv6-index
  in: query
  description: The IPv6 Index supported by the candidate UPF.
  content:
    application/json:
      schema:
        $ref: 'TS29503_Nudm_SDM.yaml#/components/schemas/IpIndex'
- name: nsi-list
  in: query
  description: NSI IDs that are served by the services being discovered
  schema:
    type: array
    items:
      type: string
    minItems: 1
    style: form
    explode: false
- name: smf-serving-area
  in: query
  schema:
    type: string
- name: mbsmf-serving-area
  in: query
  schema:
    type: string
- name: tai
  in: query
  description: Tracking Area Identity
  content:

```

```

    application/json:
      schema:
        $ref: 'TS29571_CommonData.yaml#/components/schemas/Tai'
  - name: amf-region-id
    in: query
    description: AMF Region Identity
    schema:
      $ref: 'TS29571_CommonData.yaml#/components/schemas/AmfRegionId'
  - name: amf-set-id
    in: query
    description: AMF Set Identity
    schema:
      $ref: 'TS29571_CommonData.yaml#/components/schemas/AmfSetId'
  - name: guami
    in: query
    description: Guami used to search for an appropriate AMF
    content:
      application/json:
        schema:
          $ref: 'TS29571_CommonData.yaml#/components/schemas/Guami'
  - name: supi
    in: query
    description: SUPI of the user
    schema:
      $ref: 'TS29571_CommonData.yaml#/components/schemas/Supi'
  - name: ue-ipv4-address
    in: query
    description: IPv4 address of the UE
    schema:
      $ref: 'TS29571_CommonData.yaml#/components/schemas/Ipv4Addr'
  - name: ip-domain
    in: query
    description: IP domain of the UE, which supported by BSF
    schema:
      type: string
  - name: ue-ipv6-prefix
    in: query
    description: IPv6 prefix of the UE
    schema:
      $ref: 'TS29571_CommonData.yaml#/components/schemas/Ipv6Prefix'
  - name: pgw-ind
    in: query
    description: Combined PGW-C and SMF or a standalone SMF
    schema:
      type: boolean
  - name: preferred-pgw-ind
    in: query
    description: Indicates combined PGW-C+SMF or standalone SMF are preferred
    schema:
      type: boolean
  - name: pgw
    in: query
    description: PGW FQDN of a combined PGW-C and SMF
    schema:
      $ref: 'TS29571_CommonData.yaml#/components/schemas/Fqdn'
  - name: pgw-ip
    in: query
    description: PGW IP Address of a combined PGW-C and SMF
    content:
      application/json:
        schema:
          $ref: 'TS29571_CommonData.yaml#/components/schemas/IpAddr'
  - name: gpsi
    in: query
    description: GPSI of the user
    schema:
      $ref: 'TS29571_CommonData.yaml#/components/schemas/Gpsi'
  - name: external-group-identity
    in: query
    description: external group identifier of the user
    schema:
      $ref: 'TS29503_Nudm_SDM.yaml#/components/schemas/ExtGroupId'
  - name: internal-group-identity
    in: query
    description: internal group identifier of the user
    schema:
      $ref: 'TS29571_CommonData.yaml#/components/schemas/GroupId'
  - name: pfd-data

```

```

    in: query
    description: PFD data
    content:
      application/json:
        schema:
          $ref: 'TS29510_Nnrf_NFManagement.yaml#/components/schemas/PfdData'
- name: data-set
  in: query
  description: data set supported by the NF
  schema:
    $ref: 'TS29510_Nnrf_NFManagement.yaml#/components/schemas/DataSetId'
- name: routing-indicator
  in: query
  description: routing indicator in SUCI
  schema:
    type: string
    pattern: '^[0-9]{1,4}$'
- name: group-id-list
  in: query
  description: Group IDs of the NFs being discovered
  schema:
    type: array
    items:
      $ref: 'TS29571_CommonData.yaml#/components/schemas/NfGroupId'
    minItems: 1
  style: form
  explode: false
- name: dnai-list
  in: query
  description: Data network access identifiers of the NFs being discovered
  schema:
    type: array
    items:
      $ref: 'TS29571_CommonData.yaml#/components/schemas/Dnai'
    minItems: 1
  style: form
  explode: false
- name: pdu-session-types
  in: query
  description: list of PDU Session Type required to be supported by the target NF
  schema:
    type: array
    items:
      $ref: 'TS29571_CommonData.yaml#/components/schemas/PduSessionType'
    minItems: 1
  style: form
  explode: false
- name: event-id-list
  in: query
  description: >
    Analytics event(s) requested to be supported by the Nnwdaf_AnalyticsInfo service
  schema:
    type: array
    items:
      $ref: 'TS29520_Nnwdaf_AnalyticsInfo.yaml#/components/schemas/EventId'
    minItems: 1
  style: form
  explode: false
- name: nwdaf-event-list
  in: query
  description: >
    Analytics event(s) requested to be supported by the Nnwdaf_EventsSubscription service.
  schema:
    type: array
    items:
      $ref: 'TS29520_Nnwdaf_EventsSubscription.yaml#/components/schemas/NwdafEvent'
    minItems: 1
  style: form
  explode: false
- name: upf-event-list
  in: query
  description: >
    Event(s) requested to be supported by the Nupf_EventExposure service.
  schema:
    type: array
    items:
      $ref: 'TS29564_Nupf_EventExposure.yaml#/components/schemas/EventType'
    minItems: 1

```

```

    style: form
    explode: false
  - name: supported-features
    in: query
    description: Features required to be supported by the target NF
    schema:
      $ref: 'TS29571_CommonData.yaml#/components/schemas/SupportedFeatures'
  - name: upf-iwk-eps-ind
    in: query
    description: UPF supporting interworking with EPS or not
    schema:
      type: boolean
  - name: chf-supported-plmn
    in: query
    description: PLMN ID supported by a CHF
    content:
      application/json:
        schema:
          $ref: 'TS29571_CommonData.yaml#/components/schemas/PlmnId'
  - name: preferred-locality
    in: query
    description: preferred target NF location
    schema:
      type: string
  - name: ext-preferred-locality
    in: query
    description: >
      preferred target NF location
      A map (list of key-value pairs) where the key of the map represents the relative
      priority, for the requester, of each locality description among the list of locality
      descriptions in this query parameter, encoded as "1" (highest priority), "2", "3", ...,
      "n" (lowest priority)
    content:
      application/json:
        schema:
          type: object
          additionalProperties:
            type: array
            items:
              $ref: 'TS29510_Nnrf_NFManagement.yaml#/components/schemas/LocalityDescription'
            minItems: 1
          minProperties: 1
  - name: access-type
    in: query
    description: AccessType supported by the target NF
    schema:
      $ref: 'TS29571_CommonData.yaml#/components/schemas/AccessType'
  - name: limit
    in: query
    description: Maximum number of NFProfiles to return in the response
    required: false
    schema:
      type: integer
      minimum: 1
  - name: required-features
    in: query
    description: Features required to be supported by the target NF
    schema:
      type: array
      items:
        $ref: 'TS29571_CommonData.yaml#/components/schemas/SupportedFeatures'
      minItems: 1
    style: form
    explode: false
  - name: complex-query
    in: query
    description: the complex query condition expression
    content:
      application/json:
        schema:
          $ref: 'TS29571_CommonData.yaml#/components/schemas/ComplexQuery'
  - name: max-payload-size
    in: query
    description: Maximum content size of the response expressed in kilo octets
    required: false
    schema:
      type: integer
      maximum: 2000

```

```
    default: 124
- name: max-payload-size-ext
  in: query
  description: >
    Extended query for maximum content size of the response expressed in kilo octets
  required: false
  schema:
    type: integer
    default: 124
- name: atsss-capability
  in: query
  description: ATSSS Capability
  content:
    application/json:
      schema:
        $ref: 'TS29571_CommonData.yaml#/components/schemas/AtsssCapability'
- name: upf-ue-ip-addr-ind
  in: query
  description: UPF supporting allocating UE IP addresses/prefixes
  schema:
    type: boolean
- name: client-type
  in: query
  description: Requested client type served by the NF
  content:
    application/json:
      schema:
        $ref: 'TS29572_Nlmf_Location.yaml#/components/schemas/ExternalClientType'
- name: lmf-id
  in: query
  description: LMF identification to be discovered
  content:
    application/json:
      schema:
        $ref: 'TS29572_Nlmf_Location.yaml#/components/schemas/LMFIdentification'
- name: an-node-type
  in: query
  description: Requested AN node type served by the NF
  content:
    application/json:
      schema:
        $ref: 'TS29510_Nnrf_NFManagement.yaml#/components/schemas/AnNodeType'
- name: rat-type
  in: query
  description: Requested RAT type served by the NF
  content:
    application/json:
      schema:
        $ref: 'TS29571_CommonData.yaml#/components/schemas/RatType'
- name: preferred-tai
  in: query
  description: preferred Tracking Area Identity
  content:
    application/json:
      schema:
        $ref: 'TS29571_CommonData.yaml#/components/schemas/Tai'
- name: preferred-nf-instances
  in: query
  description: preferred NF Instances
  schema:
    type: array
    items:
      $ref: 'TS29571_CommonData.yaml#/components/schemas/NfInstanceId'
    minItems: 1
  style: form
  explode: false
- name: If-None-Match
  in: header
  description: Validator for conditional requests, as described in IETF RFC 9110, 13.1.2
  schema:
    type: string
- name: target-snpn
  in: query
  description: Target SNPN Identity, or the Credentials Holder in the SNPN
  content:
    application/json:
      schema:
        $ref: 'TS29571_CommonData.yaml#/components/schemas/PlmnIdNid'
```

- name: requester-snpn-list
in: query
description: SNPN ID(s) of the NF instance issuing the Discovery request
content:
 application/json:
 schema:
 type: array
 items:
 \$ref: 'TS29571_CommonData.yaml#/components/schemas/PlmnIdNid'
 minItems: 1
- name: af-ee-data
in: query
description: NEF exposed by the AF
content:
 application/json:
 schema:
 \$ref: 'TS29510_Nnrf_NFManagement.yaml#/components/schemas/AfEventExposureData'
- name: w-agf-info
in: query
description: UPF collocated with W-AGF
content:
 application/json:
 schema:
 \$ref: 'TS29510_Nnrf_NFManagement.yaml#/components/schemas/WAgfInfo'
- name: tngf-info
in: query
description: UPF collocated with TNGF
content:
 application/json:
 schema:
 \$ref: 'TS29510_Nnrf_NFManagement.yaml#/components/schemas/TngfInfo'
- name: twif-info
in: query
description: UPF collocated with TWIF
content:
 application/json:
 schema:
 \$ref: 'TS29510_Nnrf_NFManagement.yaml#/components/schemas/TwifInfo'
- name: upf-select-epdg-info
in: query
description: The ePDG information to find a preferred UPF
content:
 application/json:
 schema:
 \$ref: 'TS29510_Nnrf_NFManagement.yaml#/components/schemas/EpdgInfo'
- name: target-nf-set-id
in: query
description: Target NF Set ID
schema:
 \$ref: 'TS29571_CommonData.yaml#/components/schemas/NfSetId'
- name: target-nf-service-set-id
in: query
description: Target NF Service Set ID
schema:
 \$ref: 'TS29571_CommonData.yaml#/components/schemas/NfServiceSetId'
- name: nef-id
in: query
description: NEF ID
schema:
 \$ref: 'TS29510_Nnrf_NFManagement.yaml#/components/schemas/NefId'
- name: notification-type
in: query
description: Notification Type
schema:
 \$ref: 'TS29510_Nnrf_NFManagement.yaml#/components/schemas/NotificationType'
- name: n1-msg-class
in: query
description: N1 Message Class
schema:
 \$ref: 'TS29518_Namf_Communication.yaml#/components/schemas/N1MessageClass'
- name: n2-info-class
in: query
description: N2 Information Class
schema:
 \$ref: 'TS29518_Namf_Communication.yaml#/components/schemas/N2InformationClass'
- name: serving-scope
in: query
description: areas that can be served by the target NF

```

schema:
  type: array
  items:
    type: string
  minItems: 1
  style: form
  explode: false
- name: imsi
  in: query
  description: IMSI of the requester UE to search for an appropriate NF (e.g. HSS, DCSF)
  schema:
    type: string
    pattern: '^[0-9]{5,15}$'
- name: ims-private-identity
  in: query
  description: IMPI of the requester UE to search for a target HSS or DCSF
  schema:
    type: string
- name: ims-public-identity
  in: query
  description: IMS Public Identity of the requester UE to search for a target HSS or DCSF
  schema:
    type: string
- name: msisdn
  in: query
  description: MSISDN of the requester UE to search for a target HSS or DCSF
  schema:
    type: string
- name: preferred-api-versions
  in: query
  description: Preferred API version of the services to be discovered
  content:
    application/json:
      schema:
        description: A map (list of key-value pairs) where ServiceName serves as key
        type: object
        additionalProperties:
          type: string
        minProperties: 1
- name: v2x-support-ind
  in: query
  description: PCF supports V2X
  schema:
    type: boolean
- name: redundant-gtpu
  in: query
  description: UPF supports redundant gtp-u to be discovered
  schema:
    type: boolean
- name: redundant-transport
  in: query
  description: UPF supports redundant transport path to be discovered
  schema:
    type: boolean
- name: ipups
  in: query
  description: UPF which is configured for IPUPS functionality to be discovered
  schema:
    type: boolean
- name: sxa-ind
  in: query
  description: UPF which is configured to support sxa interface
  schema:
    type: boolean
- name: scp-domain-list
  in: query
  description: SCP domains the target SCP or SEPP belongs to
  schema:
    type: array
    items:
      type: string
    minItems: 1
  style: form
  explode: false
- name: address-domain
  in: query
  description: Address domain reachable through the SCP
  schema:

```



```

    $ref: 'TS29571_CommonData.yaml#/components/schemas/Fqdn'
- name: ipv4-addr
  in: query
  description: IPv4 address reachable through the SCP
  schema:
    $ref: 'TS29571_CommonData.yaml#/components/schemas/Ipv4Addr'
- name: ipv6-prefix
  in: query
  description: IPv6 prefix reachable through the SCP
  schema:
    $ref: 'TS29571_CommonData.yaml#/components/schemas/Ipv6Prefix'
- name: served-nf-set-id
  in: query
  description: NF Set ID served by the SCP
  schema:
    $ref: 'TS29571_CommonData.yaml#/components/schemas/NfSetId'
- name: remote-plmn-id
  in: query
  description: Id of the PLMN reachable through the SCP or SEPP
  content:
    application/json:
      schema:
        $ref: 'TS29571_CommonData.yaml#/components/schemas/PlmnId'
- name: remote-snpn-id
  in: query
  description: Id of the SNPN reachable through the SCP or SEPP
  content:
    application/json:
      schema:
        $ref: 'TS29571_CommonData.yaml#/components/schemas/PlmnIdNid'
- name: data-forwarding
  in: query
  description: UPF Instance(s) configured for data forwarding are requested
  schema:
    type: boolean
- name: preferred-full-plmn
  in: query
  description: NF Instance(s) serving the full PLMN are preferred
  schema:
    type: boolean
- name: requester-features
  in: query
  description: >
    Features supported by the NF Service Consumer that is invoking
    the Nnrf_NFDiscovery service
  schema:
    $ref: 'TS29571_CommonData.yaml#/components/schemas/SupportedFeatures'
- name: realm-id
  in: query
  description: realm-id to search for an appropriate UDSF
  schema:
    type: string
- name: storage-id
  in: query
  description: storage-id to search for an appropriate UDSF
  schema:
    type: string
- name: vsmf-support-ind
  in: query
  description: V-SMF capability supported by the target NF instance(s)
  schema:
    type: boolean
- name: ismf-support-ind
  in: query
  description: I-SMF capability supported by the target NF instance(s)
  schema:
    type: boolean
- name: nrf-disc-uri
  in: query
  description: Uri of the NRF holding the NF profile of a target NF Instance
  schema:
    $ref: 'TS29571_CommonData.yaml#/components/schemas/Uri'
- name: preferred-vendor-specific-features
  in: query
  description: Preferred vendor specific features of the services to be discovered
  content:
    application/json:
      schema:

```

```

    description: A map (list of key-value pairs) where ServiceName serves as key
    type: object
    additionalProperties:
      description: >
        A map (list of key-value pairs) where IANA-assigned SMI Network Management
        Private Enterprise Codes serves as key
      type: object
      additionalProperties:
        type: array
        items:
          $ref:
'TS29510_Nnrf_NFManagement.yaml#/components/schemas/VendorSpecificFeature'
      minItems: 1
      minProperties: 1
      minProperties: 1
- name: preferred-vendor-specific-nf-features
  in: query
  description: Preferred vendor specific features of the network function to be discovered
  content:
    application/json:
      schema:
        description: >
          A map (list of key-value pairs) where IANA-assigned SMI Network Management Private
          Enterprise Codes serves as key
        type: object
        additionalProperties:
          type: array
          items:
            $ref:
'TS29510_Nnrf_NFManagement.yaml#/components/schemas/VendorSpecificFeature'
        minItems: 1
        minProperties: 1
- name: required-pfcp-features
  in: query
  description: PFCP features required to be supported by the target UPF
  schema:
    type: string
- name: home-pub-key-id
  in: query
  description: >
    Indicates the Home Network Public Key ID which shall be able to be served
    by the NF instance
  schema:
    type: integer
- name: prose-support-ind
  in: query
  description: PCF supports ProSe Capability
  schema:
    type: boolean
- name: analytics-aggregation-ind
  in: query
  description: analytics aggregation is supported by NWDAF or not
  schema:
    type: boolean
- name: serving-nf-set-id
  in: query
  description: NF Set Id served by target NF
  schema:
    $ref: 'TS29571_CommonData.yaml#/components/schemas/NfSetId'
- name: serving-nf-type
  in: query
  description: NF type served by the target NF
  schema:
    $ref: 'TS29510_Nnrf_NFManagement.yaml#/components/schemas/NFType'
- name: ml-analytics-info-list
  in: query
  description: Lisf of ML Analytics Filter information of Nnwdaf_MLModelProvision service
  content:
    application/json:
      schema:
        type: array
        items:
          $ref: 'TS29510_Nnrf_NFManagement.yaml#/components/schemas/MLAnalyticsInfo'
        minItems: 1
- name: analytics-metadata-prov-ind
  in: query
  description: analytics matadata provisioning is supported by NWDAF or not
  schema:

```

- type: boolean
- name: nsacf-capability
 - in: query
 - description: the service capability supported by the target NSACF
 - schema:
 - \$ref: 'TS29510_Nnrf_NFManagement.yaml#/components/schemas/NsacfCapability'
- name: mbs-session-id-list
 - in: query
 - description: List of MBS Session ID(s)
 - content:
 - application/json:
 - schema:
 - type: array
 - items:
 - \$ref: 'TS29571_CommonData.yaml#/components/schemas/MbsSessionId'
 - minItems: 1
- name: area-session-id
 - in: query
 - description: Area Session ID
 - schema:
 - \$ref: 'TS29571_CommonData.yaml#/components/schemas/AreaSessionId'
- name: gmlc-number
 - in: query
 - description: The GMLC Number supported by the GMLC
 - schema:
 - type: string
 - pattern: '^[0-9]{5,15}\$'
- name: upf-n6-ip
 - in: query
 - description: N6 IP address of PSA UPF supported by the EASDF
 - content:
 - application/json:
 - schema:
 - \$ref: 'TS29571_CommonData.yaml#/components/schemas/IpAddr'
- name: tai-list
 - in: query
 - description: Tracking Area Identifiers of the NFs being discovered
 - content:
 - application/json:
 - schema:
 - type: array
 - items:
 - \$ref: 'TS29571_CommonData.yaml#/components/schemas/Tai'
 - minItems: 1
- name: nf-tai-list-ind
 - in: query
 - description: the NF service consumer supports candidate nfs supporting a subset of TAIs
 - schema:
 - type: boolean
 - enum:
 - true
- name: preferences-precedence
 - in: query
 - description: >
 - Indicates the precedence of the preference query parameters (from higher to lower)
 - schema:
 - type: array
 - items:
 - type: string
 - minItems: 2
 - style: form
 - explode: false
- name: support-onboarding-capability
 - in: query
 - description: Indicating the support for onboarding.
 - schema:
 - type: boolean
 - default: false
- name: uas-nf-functionality-ind
 - in: query
 - description: UAS NF functionality is supported by NEF or not
 - schema:
 - type: boolean
- name: multi-mem-af-sess-qos-ind
 - in: query
 - description: Multi-member AF session with required QoS is supported by NEF or not
 - schema:
 - type: boolean

```

    enum:
      - true
- name: member-ue-sel-assist-ind
  in: query
  description: member UE selection assistance functionality is supported by NEF or not
  schema:
    type: boolean
    enum:
      - true
- name: v2x-capability
  in: query
  description: indicates the V2X capability that the target PCF needs to support.
  content:
    application/json:
      schema:
        $ref: 'TS29510_Nnrf_NFManagement.yaml#/components/schemas/V2xCapability'
- name: prose-capability
  in: query
  description: indicates the ProSe capability that the target PCF needs to support.
  content:
    application/json:
      schema:
        $ref: 'TS29510_Nnrf_NFManagement.yaml#/components/schemas/ProSeCapability'
- name: shared-data-id
  in: query
  description: Identifier of shared data stored in the NF being discovered
  schema:
    $ref: 'TS29503_Nudm_SDM.yaml#/components/schemas/SharedDataId'
- name: target-hni
  in: query
  description: Home Network Identifier query.
  schema:
    $ref: 'TS29571_CommonData.yaml#/components/schemas/Fqdn'
- name: target-nw-resolution
  in: query
  description: Resolution of the identity of the target PLMN based on the GPSI of the UE
  schema:
    type: boolean
- name: exclude-nfinst-list
  in: query
  description: NF Instance IDs to be excluded from the NF Discovery procedure
  schema:
    type: array
    items:
      $ref: 'TS29571_CommonData.yaml#/components/schemas/NfInstanceId'
    minItems: 1
  style: form
  explode: false
- name: exclude-nfservinst-list
  in: query
  description: NF service instance IDs to be excluded from the NF Discovery procedure
  content:
    application/json:
      schema:
        type: array
        items:
          $ref: '#/components/schemas/NfServiceInstance'
        minItems: 1
- name: exclude-nfserviceset-list
  in: query
  description: NF Service Set IDs to be excluded from the NF Discovery procedure
  schema:
    type: array
    items:
      $ref: 'TS29571_CommonData.yaml#/components/schemas/NfServiceSetId'
    minItems: 1
  style: form
  explode: false
- name: exclude-nfset-list
  in: query
  description: NF Set IDs to be excluded from the NF Discovery procedure
  schema:
    type: array
    items:
      $ref: 'TS29571_CommonData.yaml#/components/schemas/NfSetId'
    minItems: 1
  style: form
  explode: false

```

- name: preferred-analytics-delays
in: query
description: Preferred analytics delays supported by the NWDAF to be discovered
content:
 application/json:
 schema:
 description: >
 A map (list of key-value pairs) where EventId or NwdafEvent serves as key
 type: object
 additionalProperties:
 \$ref: 'TS29571_CommonData.yaml#/components/schemas/DurationSec'
 minProperties: 1
- name: high-latency-com
in: query
description: Indicating the support for High Latency communication.
schema:
 type: boolean
 enum:
 - true
- name: nsac-sai
in: query
description: NSAC Service Area Identifier
schema:
 \$ref: 'TS29571_CommonData.yaml#/components/schemas/NsacSai'
- name: complete-profile
in: query
description: request to discover the complete profile of NF instances
schema:
 type: boolean
 enum:
 - true
- name: n32-purposes
in: query
description: N32 purposes to be supported by the SEPP
schema:
 type: array
 items:
 \$ref: 'TS29573_N32_Handshake.yaml#/components/schemas/N32Purpose'
 minItems: 1
style: form
explode: false
- name: preferred-features
in: query
description: Preferred features to be supported by the target Network Function.
content:
 application/json:
 schema:
 description: >
 A map (list of key-value pairs) where Service Name serves as the key.
 type: object
 additionalProperties:
 \$ref: 'TS29571_CommonData.yaml#/components/schemas/SupportedFeatures'
 minProperties: 1
- name: remote-plmn-id-roaming
in: query
description: Id of the remote PLMN served by the target NF service producer
content:
 application/json:
 schema:
 \$ref: 'TS29571_CommonData.yaml#/components/schemas/PlmnId'
- name: pru-tai
in: query
description: LMF(s) serving the TAI with PRU(s) existence
content:
 application/json:
 schema:
 \$ref: 'TS29571_CommonData.yaml#/components/schemas/Tai'
- name: pru-support-ind
in: query
description: Indicating the support of PRU function
schema:
 type: boolean
- name: af-data
in: query
description: events supported by the trusted AFs being discovered
content:
 application/json:
 schema:

```
    $ref: '#/components/schemas/AfData'
- name: ml-accuracy-checking-ind
  in: query
  description: Indicating the support for ML Model Accuracy checking.
  schema:
    type: boolean
    enum:
      - true
- name: analytics-accuracy-checking-ind
  in: query
  description: Indicating the support for Analytics Accuracy checking.
  schema:
    type: boolean
    enum:
      - true
- name: a2x-support-ind
  in: query
  description: PCF supports A2X
  schema:
    type: boolean
    enum:
      - true
- name: a2x-capability
  in: query
  description: indicates the A2X capability that the target PCF needs to support.
  content:
    application/json:
      schema:
        $ref: 'TS29510_Nnrf_NFManagement.yaml#/components/schemas/A2xCapability'
- name: ml-model-storage-ind
  in: query
  description: Indicating the support for ML model storage and retrieval capability.
  schema:
    type: boolean
    enum:
      - true
- name: data-storage-ind
  in: query
  description: >
    Indicating the support for data and analytics storage and retrieval capability.
  schema:
    type: boolean
    enum:
      - true
- name: data-subscription-relocation-support-ind
  in: query
  description: Indicating the support for relocation of data subscription.
  schema:
    type: boolean
    enum:
      - true
- name: ims-domain-name
  in: query
  description: Indicating the IMS domain name to search for a target DCSF.
  schema:
    type: string
- name: media-capability-list
  in: query
  description: Indicating the media capability list to search for a target MF, MRF or MRFP.
  schema:
    type: array
    items:
      $ref: 'TS29510_Nnrf_NFManagement.yaml#/components/schemas/MediaCapability'
    minItems: 1
  style: form
  explode: false
- name: roaming-exchange-ind
  in: query
  description: Indicating the support for roaming exchange.
  schema:
    type: boolean
    enum:
      - true
- name: ranging-sl-pos-support-ind
  in: query
  description: PCF or LMF supports ranging and sidelink positioning Capability
  schema:
    type: boolean
```

```

    enum:
      - true
  - name: preferred-up-positioning-ind
    in: query
    description: LMF supporting user plane positioning capability
    schema:
      type: boolean
      enum:
        - true
  - name: complete-search-result
    in: query
    description: >
      Indicates that all the NF profiles or NF Instance IDs matching the query parameters
      are requested to be returned
    schema:
      type: boolean
      enum:
        - true
  - name: ursp-delivery-eps-support-ind
    in: query
    description: >
      Indicates whether a PCF supporting URSP delivery in EPS needs to be discovered
    schema:
      type: boolean
      enum:
        - true
  - name: dns-sec-protoc
    in: query
    description: DNS security protocols
    schema:
      type: array
      items:
        $ref: 'TS29510_Nnrf_NFManagement.yaml#/components/schemas/DnsSecurityProtocol'
      minItems: 1
    style: form
    explode: false
  - name: vendor-ids
    in: query
    description: vendor Ids of the NF instances being discovered
    schema:
      type: array
      items:
        $ref: 'TS29510_Nnrf_NFManagement.yaml#/components/schemas/VendorId'
      minItems: 1
    style: form
    explode: false

responses:
  '200':
    description: Expected response to a valid request
    content:
      application/json:
        schema:
          $ref: '#/components/schemas/SearchResult'
    links:
      search:
        operationId: RetrieveStoredSearch
        parameters:
          searchId: $response.body#/searchId
        description: >
          The 'searchId' parameter returned in the response can be used as the
          'searchId' parameter in the GET request to '/searches/{searchId}'
      completeSearch:
        operationId: RetrieveCompleteSearch
        parameters:
          searchId: $response.body#/searchId
        description: >
          The 'searchId' parameter returned in the response can be used as the
          'searchId' parameter in the GET request to '/searches/{searchId}/complete'
    headers:
      Cache-Control:
        description: Cache-Control containing max-age, described in IETF RFC 9111, 5.2
        schema:
          type: string
      ETag:
        description: >
          Entity Tag containing a strong validator, described in IETF RFC 9110, 8.8.3
        schema:

```

```

        type: string
      Content-Encoding:
        description: Content-Encoding, described in IETF RFC 9110
        schema:
          type: string
    '307':
      description: Temporary Redirect
      content:
        application/json:
          schema:
            $ref: 'TS29571_CommonData.yaml#/components/schemas/RedirectResponse'
      headers:
        Location:
          description: The URI pointing to the resource located on the redirect target NRF
          required: true
          schema:
            type: string
    '308':
      description: Permanent Redirect
      content:
        application/json:
          schema:
            $ref: 'TS29571_CommonData.yaml#/components/schemas/RedirectResponse'
      headers:
        Location:
          description: The URI pointing to the resource located on the redirect target NRF
          required: true
          schema:
            type: string
    '400':
      $ref: 'TS29571_CommonData.yaml#/components/responses/400'
    '401':
      $ref: 'TS29571_CommonData.yaml#/components/responses/401'
    '403':
      $ref: 'TS29571_CommonData.yaml#/components/responses/403'
    '404':
      $ref: 'TS29571_CommonData.yaml#/components/responses/404'
    '406':
      $ref: 'TS29571_CommonData.yaml#/components/responses/406'
    '411':
      $ref: 'TS29571_CommonData.yaml#/components/responses/411'
    '413':
      $ref: 'TS29571_CommonData.yaml#/components/responses/413'
    '415':
      $ref: 'TS29571_CommonData.yaml#/components/responses/415'
    '429':
      $ref: 'TS29571_CommonData.yaml#/components/responses/429'
    '500':
      $ref: 'TS29571_CommonData.yaml#/components/responses/500'
    '501':
      $ref: 'TS29571_CommonData.yaml#/components/responses/501'
    '503':
      $ref: 'TS29571_CommonData.yaml#/components/responses/503'
    default:
      $ref: 'TS29571_CommonData.yaml#/components/responses/default'

/searches/{searchId}:
  get:
    operationId: RetrieveStoredSearch
    tags:
      - Stored Search (Document)
    parameters:
      - $ref: '#/components/parameters/searchId'
      - name: Accept-Encoding
        in: header
        description: Accept-Encoding, described in IETF RFC 9110
        schema:
          type: string
    responses:
      '200':
        $ref: '#/components/responses/200'
      '307':
        description: Temporary Redirect
        content:
          application/json:
            schema:
              $ref: 'TS29571_CommonData.yaml#/components/schemas/RedirectResponse'
        headers:

```



```

    Location:
      description: The URI pointing to the resource located on the redirect target NRF
      required: true
      schema:
        type: string
  '308':
    description: Permanent Redirect
    content:
      application/json:
        schema:
          $ref: 'TS29571_CommonData.yaml#/components/schemas/RedirectResponse'
    headers:
      Location:
        description: The URI pointing to the resource located on the redirect target NRF
        required: true
        schema:
          type: string

/searches/{searchId}/complete:
  get:
    operationId: RetrieveCompleteSearch
    tags:
      - Complete Stored Search (Document)
    parameters:
      - $ref: '#/components/parameters/searchId'
      - name: Accept-Encoding
        in: header
        description: Accept-Encoding, described in IETF RFC 9110
        schema:
          type: string
    responses:
      '200':
        $ref: '#/components/responses/200'
      '307':
        description: Temporary Redirect
        content:
          application/json:
            schema:
              $ref: 'TS29571_CommonData.yaml#/components/schemas/RedirectResponse'
        headers:
          Location:
            description: The URI pointing to the resource located on the redirect target NRF
            required: true
            schema:
              type: string
      '308':
        description: Permanent Redirect
        content:
          application/json:
            schema:
              $ref: 'TS29571_CommonData.yaml#/components/schemas/RedirectResponse'
        headers:
          Location:
            description: The URI pointing to the resource located on the redirect target NRF
            required: true
            schema:
              type: string

/scp-domain-routing-info:
  get:
    operationId: SCPDomainRoutingInfoGet
    tags:
      - SCP Domain Routing Information (Document)
    security:
      - {}
      - oAuth2ClientCredentials:
          - nnrf-disc
      - oAuth2ClientCredentials:
          - nnrf-disc
          - nnrf-disc:scp-domain:read
    parameters:
      - name: local
        in: query
        description: Indication of local SCP Domain Routing Information
        required: false
        schema:
          type: boolean
          default: false

```

```

- name: Accept-Encoding
  in: header
  description: Accept-Encoding, described in IETF RFC 9110
  schema:
    type: string
responses:
  '200':
    description: Expected response to a valid request
    content:
      application/json:
        schema:
          $ref: '#/components/schemas/ScpDomainRoutingInformation'
    headers:
      Content-Encoding:
        description: Content-Encoding, described in IETF RFC 9110
        schema:
          type: string
  '307':
    description: Temporary Redirect
    headers:
      Location:
        description: The URI pointing to the resource located on the redirect target NRF
        required: true
        schema:
          type: string
  '400':
    $ref: 'TS29571_CommonData.yaml#/components/responses/400'
  '401':
    $ref: 'TS29571_CommonData.yaml#/components/responses/401'
  '403':
    $ref: 'TS29571_CommonData.yaml#/components/responses/403'
  '404':
    $ref: 'TS29571_CommonData.yaml#/components/responses/404'
  '406':
    $ref: 'TS29571_CommonData.yaml#/components/responses/406'
  '411':
    $ref: 'TS29571_CommonData.yaml#/components/responses/411'
  '413':
    $ref: 'TS29571_CommonData.yaml#/components/responses/413'
  '415':
    $ref: 'TS29571_CommonData.yaml#/components/responses/415'
  '429':
    $ref: 'TS29571_CommonData.yaml#/components/responses/429'
  '500':
    $ref: 'TS29571_CommonData.yaml#/components/responses/500'
  '501':
    $ref: 'TS29571_CommonData.yaml#/components/responses/501'
  '503':
    $ref: 'TS29571_CommonData.yaml#/components/responses/503'
  default:
    $ref: 'TS29571_CommonData.yaml#/components/responses/default'

/scp-domain-routing-info-subscribe:
  post:
    summary: Create a new subscription
    operationId: ScpDomainRoutingInfoSubscribe
    tags:
      - SCP Domain Routing Information Subscriptions (Collection)
    security:
      - {}
      - oAuth2ClientCredentials:
          - nnrfdisc
      - oAuth2ClientCredentials:
          - nnrfdisc
          - nnrfdisc:scp-domain-subscribe:write
    parameters:
      - name: Content-Encoding
        in: header
        description: Content-Encoding, described in IETF RFC 9110
        schema:
          type: string
      - name: Accept-Encoding
        in: header
        description: Accept-Encoding, described in IETF RFC 9110
        schema:
          type: string
    requestBody:
      content:

```

```

    application/json:
      schema:
        $ref: '#/components/schemas/ScpDomainRoutingInfoSubscription'
    required: true
  responses:
    '201':
      description: Expected response to a valid request
      content:
        application/json:
          schema:
            $ref: '#/components/schemas/ScpDomainRoutingInfoSubscription'
      headers:
        Location:
          description: >
            Contains the URI of the newly created resource, according to the structure:
            {apiRoot}/nnrf-disc/v1/scp-domain-routing-info-subs/{subscriptionID}
          required: true
          schema:
            type: string
        Accept-Encoding:
          description: Accept-Encoding, described in IETF RFC 9110
          schema:
            type: string
        Content-Encoding:
          description: Content-Encoding, described in IETF RFC 9110
          schema:
            type: string
    '400':
      $ref: 'TS29571_CommonData.yaml#/components/responses/400'
    '401':
      $ref: 'TS29571_CommonData.yaml#/components/responses/401'
    '403':
      $ref: 'TS29571_CommonData.yaml#/components/responses/403'
    '404':
      $ref: 'TS29571_CommonData.yaml#/components/responses/404'
    '411':
      $ref: 'TS29571_CommonData.yaml#/components/responses/411'
    '413':
      $ref: 'TS29571_CommonData.yaml#/components/responses/413'
    '415':
      $ref: 'TS29571_CommonData.yaml#/components/responses/415'
    '429':
      $ref: 'TS29571_CommonData.yaml#/components/responses/429'
    '500':
      $ref: 'TS29571_CommonData.yaml#/components/responses/500'
    '501':
      $ref: 'TS29571_CommonData.yaml#/components/responses/501'
    '503':
      $ref: 'TS29571_CommonData.yaml#/components/responses/503'
    default:
      $ref: 'TS29571_CommonData.yaml#/components/responses/default'
  callbacks:
    onScpDomainRoutingInformationChange:
      '{$request.body#/callbackUri}':
        post:
          parameters:
            - name: Content-Encoding
              in: header
              description: Content-Encoding, described in IETF RFC 9110
              schema:
                type: string
          requestBody:
            description: Notification content
            content:
              application/json:
                schema:
                  $ref: '#/components/schemas/ScpDomainRoutingInfoNotification'
          responses:
            '204':
              description: Expected response to a successful callback processing
              headers:
                Accept-Encoding:
                  description: Accept-Encoding, described in IETF RFC 9110
                  schema:
                    type: string
            '400':
              $ref: 'TS29571_CommonData.yaml#/components/responses/400'
            '401':

```

```

    $ref: 'TS29571_CommonData.yaml#/components/responses/401'
  '403':
    $ref: 'TS29571_CommonData.yaml#/components/responses/403'
  '404':
    $ref: 'TS29571_CommonData.yaml#/components/responses/404'
  '411':
    $ref: 'TS29571_CommonData.yaml#/components/responses/411'
  '413':
    $ref: 'TS29571_CommonData.yaml#/components/responses/413'
  '415':
    $ref: 'TS29571_CommonData.yaml#/components/responses/415'
  '429':
    $ref: 'TS29571_CommonData.yaml#/components/responses/429'
  '500':
    $ref: 'TS29571_CommonData.yaml#/components/responses/500'
  '501':
    $ref: 'TS29571_CommonData.yaml#/components/responses/501'
  '503':
    $ref: 'TS29571_CommonData.yaml#/components/responses/503'
  default:
    $ref: 'TS29571_CommonData.yaml#/components/responses/default'

```

```

/scp-domain-routing-info-subs/{subscriptionID}:
  delete:
    summary: Deletes a subscription
    operationId: ScpDomainRoutingInfoUnsubscribe
    tags:
      - Individual SCP Domain Routing Information Subscription (Document)
    security:
      - {}
      - oAuth2ClientCredentials:
          - nrf-disc
      - oAuth2ClientCredentials:
          - nrf-disc
          - nrf-disc:scp-domain-subs:write
    parameters:
      - name: subscriptionID
        in: path
        required: true
        description: Unique ID of the subscription to remove
        schema:
          type: string
    responses:
      '204':
        description: Expected response to a successful subscription removal
      '400':
        $ref: 'TS29571_CommonData.yaml#/components/responses/400'
      '401':
        $ref: 'TS29571_CommonData.yaml#/components/responses/401'
      '403':
        $ref: 'TS29571_CommonData.yaml#/components/responses/403'
      '404':
        $ref: 'TS29571_CommonData.yaml#/components/responses/404'
      '411':
        $ref: 'TS29571_CommonData.yaml#/components/responses/411'
      '413':
        $ref: 'TS29571_CommonData.yaml#/components/responses/413'
      '415':
        $ref: 'TS29571_CommonData.yaml#/components/responses/415'
      '429':
        $ref: 'TS29571_CommonData.yaml#/components/responses/429'
      '500':
        $ref: 'TS29571_CommonData.yaml#/components/responses/500'
      '501':
        $ref: 'TS29571_CommonData.yaml#/components/responses/501'
      '503':
        $ref: 'TS29571_CommonData.yaml#/components/responses/503'
      default:
        $ref: 'TS29571_CommonData.yaml#/components/responses/default'

```

components:

```

securitySchemes:
  oAuth2ClientCredentials:
    type: oauth2
    flows:
      clientCredentials:
        tokenUrl: '/oauth2/token'

```

```

    scopes:
      nnrf-disc: Access to the Nnrf_NFDiscovery API
      nnrf-disc:scp-domain:read: Access to read the scp-domain-routing-info resource
      nnrf-disc:scp-domain-subs:write: Access to create/delete a scp-domain subscription
resource
  nnrf-disc:nf-instances:read-complete-profile: >
    Access to the Nnrf_NFDiscovery API enabling the discovery of the complete profile
    of NF instances

parameters:
  searchId:
    name: searchId
    in: path
    description: Id of a stored search
    required: true
    schema:
      type: string

responses:
  '200':
    description: Expected response to a valid request
    content:
      application/json:
        schema:
          $ref: '#/components/schemas/StoredSearchResult'
    headers:
      Cache-Control:
        description: Cache-Control containing max-age, described in IETF RFC 9111, 5.2
        schema:
          type: string
      ETag:
        description: >
          Entity Tag containing a strong validator, described in IETF RFC 9110, 8.8.3
        schema:
          type: string
      Content-Encoding:
        description: Content-Encoding, described in IETF RFC 9110
        schema:
          type: string

schemas:

  SearchResult:
    description: Contains the list of NF Profiles returned in a Discovery response
    type: object
    required:
      - validityPeriod
      - nfInstances
    properties:
      validityPeriod:
        type: integer
      nfInstances:
        type: array
        items:
          $ref: '#/components/schemas/NFProfile'
      completeNfInstances:
        type: array
        items:
          $ref: '#/components/schemas/NFProfile'
      minItems: 1
      searchId:
        type: string
      numNfInstComplete:
        $ref: 'TS29571_CommonData.yaml#/components/schemas/Uint32'
      preferredSearch:
        $ref: '#/components/schemas/PreferredSearch'
      nrfSupportedFeatures:
        $ref: 'TS29571_CommonData.yaml#/components/schemas/SupportedFeatures'
      nfInstanceList:
        description: List of matching NF instances. The key of the map is the NF instance ID.
        type: object
        additionalProperties:
          $ref: '#/components/schemas/NfInstanceInfo'
        minProperties: 1
      searchResultInfo:
        $ref: '#/components/schemas/SearchResultInfo'
      alteredPriorityInd:
        type: boolean

```

```

noProfileMatchInfo:
  $ref: '#/components/schemas/NoProfileMatchInfo'
ignoredQueryParams:
  type: array
  items:
    type: string
  minItems: 1

StoredSearchResult:
  description: >
    Contains a complete search result (i.e. a number of discovered NF Instances),
    stored by NRF as a consequence of a prior search result
  type: object
  required:
    - nfInstances
  properties:
    nfInstances:
      type: array
      items:
        $ref: '#/components/schemas/NFProfile'
    completeNfInstances:
      type: array
      items:
        $ref: '#/components/schemas/NFProfile'
      minItems: 1

NFProfile:
  description: Information of an NF Instance discovered by the NRF
  type: object
  required:
    - nfInstanceId
    - nfType
    - nfStatus
  properties:
    nfInstanceId:
      $ref: 'TS29571_CommonData.yaml#/components/schemas/NfInstanceId'
    nfInstanceName:
      type: string
    nfType:
      $ref: 'TS29510_Nnrf_NFManagement.yaml#/components/schemas/NFType'
    nfStatus:
      $ref: 'TS29510_Nnrf_NFManagement.yaml#/components/schemas/NFStatus'
    collocatedNfInstances:
      type: array
      items:
        $ref: 'TS29510_Nnrf_NFManagement.yaml#/components/schemas/CollocatedNfInstance'
      minItems: 1
    plmnList:
      type: array
      items:
        $ref: 'TS29571_CommonData.yaml#/components/schemas/PlmnId'
      minItems: 1
    sNssais:
      type: array
      items:
        $ref: 'TS29571_CommonData.yaml#/components/schemas/ExtSnssai'
      minItems: 1
    perPlmnSnssaiList:
      type: array
      items:
        $ref: 'TS29510_Nnrf_NFManagement.yaml#/components/schemas/PlmnSnssai'
      minItems: 1
    nsiList:
      type: array
      items:
        type: string
      minItems: 1
    fqdn:
      $ref: 'TS29571_CommonData.yaml#/components/schemas/Fqdn'
    interPlmnFqdn:
      $ref: 'TS29571_CommonData.yaml#/components/schemas/Fqdn'
    ipv4Addresses:
      type: array
      items:
        $ref: 'TS29571_CommonData.yaml#/components/schemas/Ipv4Addr'
      minItems: 1
    ipv6Addresses:
      type: array

```

```

    items:
      $ref: 'TS29571_CommonData.yaml#/components/schemas/Ipv6Addr'
    minItems: 1
  allowedPlmns:
    type: array
    items:
      $ref: 'TS29571_CommonData.yaml#/components/schemas/PlmnId'
    minItems: 1
  allowedSnps:
    type: array
    items:
      $ref: 'TS29571_CommonData.yaml#/components/schemas/PlmnIdNid'
    minItems: 1
  allowedNfTypes:
    type: array
    items:
      $ref: 'TS29510_Nnrf_NFManagement.yaml#/components/schemas/NFType'
    minItems: 1
  allowedNfDomains:
    type: array
    items:
      type: string
    minItems: 1
  allowedNssais:
    type: array
    items:
      $ref: 'TS29571_CommonData.yaml#/components/schemas/ExtSnssai'
    minItems: 1
  allowedRuleSet:
    description: A map (list of key-value pairs) where a valid JSON pointer Id serves as key
    type: object
    additionalProperties:
      $ref: 'TS29510_Nnrf_NFManagement.yaml#/components/schemas/RuleSet'
    minProperties: 1
  capacity:
    type: integer
    minimum: 0
    maximum: 65535
  load:
    type: integer
    minimum: 0
    maximum: 100
  loadTimeStamp:
    $ref: 'TS29571_CommonData.yaml#/components/schemas/DateTime'
  locality:
    type: string
  extLocality:
    description: >
      A map (list of key-value pairs) where a (unique) valid JSON string serves
      as key representing a type of locality
    type: object
    additionalProperties:
      type: string
    minProperties: 1
  priority:
    type: integer
    minimum: 0
    maximum: 65535
  udrInfo:
    $ref: 'TS29510_Nnrf_NFManagement.yaml#/components/schemas/UdrInfo'
  udrInfoList:
    description: >
      A map (list of key-value pairs) where a (unique) valid JSON string
      serves as key of UdrInfo
    type: object
    additionalProperties:
      $ref: 'TS29510_Nnrf_NFManagement.yaml#/components/schemas/UdrInfo'
    minProperties: 1
  udmInfo:
    $ref: 'TS29510_Nnrf_NFManagement.yaml#/components/schemas/UdmInfo'
  udmInfoList:
    description: >
      A map (list of key-value pairs) where a (unique) valid JSON string
      serves as key of UdmInfo
    type: object
    additionalProperties:
      $ref: 'TS29510_Nnrf_NFManagement.yaml#/components/schemas/UdmInfo'
    minProperties: 1

```

```
ausfInfo:
  $ref: 'TS29510_Nnrf_NFManagement.yaml#/components/schemas/AusfInfo'
ausfInfoList:
  description: >
    A map (list of key-value pairs) where a (unique) valid JSON string
    serves as key of AusfInfo
  type: object
  additionalProperties:
    $ref: 'TS29510_Nnrf_NFManagement.yaml#/components/schemas/AusfInfo'
  minProperties: 1
amfInfo:
  $ref: 'TS29510_Nnrf_NFManagement.yaml#/components/schemas/AmfInfo'
amfInfoList:
  description: >
    A map (list of key-value pairs) where a (unique) valid JSON string
    serves as key of AmfInfo
  type: object
  additionalProperties:
    $ref: 'TS29510_Nnrf_NFManagement.yaml#/components/schemas/AmfInfo'
  minProperties: 1
smfInfo:
  $ref: 'TS29510_Nnrf_NFManagement.yaml#/components/schemas/SmfInfo'
smfInfoList:
  description: >
    A map (list of key-value pairs) where a (unique) valid JSON string
    serves as key of SmfInfo
  type: object
  additionalProperties:
    $ref: 'TS29510_Nnrf_NFManagement.yaml#/components/schemas/SmfInfo'
  minProperties: 1
upfInfo:
  $ref: 'TS29510_Nnrf_NFManagement.yaml#/components/schemas/UpfInfo'
upfInfoList:
  description: >
    A map (list of key-value pairs) where a (unique) valid JSON string
    serves as key of UpfInfo
  type: object
  additionalProperties:
    $ref: 'TS29510_Nnrf_NFManagement.yaml#/components/schemas/UpfInfo'
  minProperties: 1
pcfInfo:
  $ref: 'TS29510_Nnrf_NFManagement.yaml#/components/schemas/PcfInfo'
pcfInfoList:
  description: >
    A map (list of key-value pairs) where a (unique) valid JSON string
    serves as key of PcfInfo
  type: object
  additionalProperties:
    $ref: 'TS29510_Nnrf_NFManagement.yaml#/components/schemas/PcfInfo'
  minProperties: 1
bsfInfo:
  $ref: 'TS29510_Nnrf_NFManagement.yaml#/components/schemas/BsfInfo'
bsfInfoList:
  description: >
    A map (list of key-value pairs) where a (unique) valid JSON string
    serves as key of BsfInfo
  type: object
  additionalProperties:
    $ref: 'TS29510_Nnrf_NFManagement.yaml#/components/schemas/BsfInfo'
  minProperties: 1
chfInfo:
  $ref: 'TS29510_Nnrf_NFManagement.yaml#/components/schemas/ChfInfo'
chfInfoList:
  description: >
    A map (list of key-value pairs) where a (unique) valid JSON string
    serves as key of ChfInfo
  type: object
  additionalProperties:
    $ref: 'TS29510_Nnrf_NFManagement.yaml#/components/schemas/ChfInfo'
  minProperties: 1
udsfInfo:
  $ref: 'TS29510_Nnrf_NFManagement.yaml#/components/schemas/UdsfInfo'
udsfInfoList:
  description: >
    A map (list of key-value pairs) where a (unique) valid JSON string
    serves as key of UdsfInfo
  type: object
  additionalProperties:
```



```

    $ref: 'TS29510_Nnrf_NFManagement.yaml#/components/schemas/UdsfInfo'
  minProperties: 1
  nwdafInfo:
    $ref: 'TS29510_Nnrf_NFManagement.yaml#/components/schemas/NwdafInfo'
  nwdafInfoList:
    type: object
    description: >
      A map (list of key-value pairs) where a (unique) valid JSON string
      serves as key of NwdafInfo
    additionalProperties:
      $ref: 'TS29510_Nnrf_NFManagement.yaml#/components/schemas/NwdafInfo'
    minProperties: 1
  nefInfo:
    $ref: 'TS29510_Nnrf_NFManagement.yaml#/components/schemas/NefInfo'
  pcscfInfoList:
    description: >
      A map (list of key-value pairs) where a (unique) valid JSON string
      serves as key of PcscfInfo
    type: object
    additionalProperties:
      $ref: 'TS29510_Nnrf_NFManagement.yaml#/components/schemas/PcscfInfo'
    minProperties: 1
  hssInfoList:
    description: >
      A map (list of key-value pairs) where a (unique) valid JSON string
      serves as key of HssInfo
    type: object
    additionalProperties:
      $ref: 'TS29510_Nnrf_NFManagement.yaml#/components/schemas/HssInfo'
    minProperties: 1
  customInfo:
    type: object
  recoveryTime:
    $ref: 'TS29571_CommonData.yaml#/components/schemas/DateTime'
  nfServicePersistence:
    type: boolean
    default: false
  nfServices:
    deprecated: true
    type: array
    items:
      $ref: '#/components/schemas/NFService'
    minItems: 1
  nfServiceList:
    description: >
      A map (list of key-value pairs) where serviceInstanceId serves as key of NFService
    type: object
    additionalProperties:
      $ref: '#/components/schemas/NFService'
    minProperties: 1
  defaultNotificationSubscriptions:
    type: array
    items:
      $ref:
'TS29510_Nnrf_NFManagement.yaml#/components/schemas/DefaultNotificationSubscription'
  lmfInfo:
    $ref: 'TS29510_Nnrf_NFManagement.yaml#/components/schemas/LmfInfo'
  gmlcInfo:
    $ref: 'TS29510_Nnrf_NFManagement.yaml#/components/schemas/GmlcInfo'
  snpnList:
    type: array
    items:
      $ref: 'TS29571_CommonData.yaml#/components/schemas/PlmnIdNid'
    minItems: 1
  nfSetIdList:
    type: array
    items:
      $ref: 'TS29571_CommonData.yaml#/components/schemas/NfSetId'
    minItems: 1
  servingScope:
    type: array
    items:
      type: string
    minItems: 1
  lcHSupportInd:
    type: boolean
    default: false
  olcHSupportInd:

```

```

    type: boolean
    default: false
  nfSetRecoveryTimeList:
    description: A map (list of key-value pairs) where NfSetId serves as key of DateTime
    type: object
    additionalProperties:
      $ref: 'TS29571_CommonData.yaml#/components/schemas/DateTime'
    minProperties: 1
  serviceSetRecoveryTimeList:
    description: >
      A map (list of key-value pairs) where NfServiceSetId serves as key of DateTime
    type: object
    additionalProperties:
      $ref: 'TS29571_CommonData.yaml#/components/schemas/DateTime'
    minProperties: 1
  scpDomains:
    type: array
    items:
      type: string
    minItems: 1
  scpInfo:
    $ref: 'TS29510_Nnrf_NFManagement.yaml#/components/schemas/ScpInfo'
  seppInfo:
    $ref: 'TS29510_Nnrf_NFManagement.yaml#/components/schemas/SeppInfo'
  vendorId:
    $ref: 'TS29510_Nnrf_NFManagement.yaml#/components/schemas/VendorId'
  supportedVendorSpecificFeatures:
    description: >
      The key of the map is the IANA-assigned SMI Network Management Private Enterprise Codes
    type: object
    additionalProperties:
      type: array
      items:
        $ref: 'TS29510_Nnrf_NFManagement.yaml#/components/schemas/VendorSpecificFeature'
      minItems: 1
    minProperties: 1
  aanfInfoList:
    type: object
    description: >
      A map (list of key-value pairs) where a (unique) valid JSON string
      serves as key of AanfInfo
    additionalProperties:
      $ref: 'TS29510_Nnrf_NFManagement.yaml#/components/schemas/AanfInfo'
    minProperties: 1
  mfafInfo:
    $ref: 'TS29510_Nnrf_NFManagement.yaml#/components/schemas/MfafInfo'
  easdfInfoList:
    type: object
    description: >
      A map (list of key-value pairs) where a (unique) valid JSON string
      serves as key of EasdfInfo
    additionalProperties:
      $ref: 'TS29510_Nnrf_NFManagement.yaml#/components/schemas/EasdfInfo'
    minProperties: 1
  dccfInfo:
    $ref: 'TS29510_Nnrf_NFManagement.yaml#/components/schemas/DccfInfo'
  nsacfInfoList:
    description: >
      A map (list of key-value pairs) where a (unique) valid JSON string
      serves as key of NsacfInfo
    type: object
    additionalProperties:
      $ref: 'TS29510_Nnrf_NFManagement.yaml#/components/schemas/NsacfInfo'
    minProperties: 1
  mbSmfInfoList:
    description: >
      A map (list of key-value pairs) where a (unique) valid JSON string
      serves as key of MbSmfInfo
    type: object
    additionalProperties:
      $ref: 'TS29510_Nnrf_NFManagement.yaml#/components/schemas/MbSmfInfo'
    minProperties: 1
  tsctsfInfoList:
    type: object
    description: >
      A map (list of key-value pairs) where a (unique) valid JSON string
      serves as key of TsctsfInfo
    additionalProperties:

```

```

    $ref: 'TS29510_Nnrf_NFManagement.yaml#/components/schemas/TsctsfInfo'
  minProperties: 1
  mbUpfInfoList:
    description: >
      A map (list of key-value pairs) where a (unique) valid JSON string
      serves as key of MbUpfInfo
    type: object
    additionalProperties:
      $ref: 'TS29510_Nnrf_NFManagement.yaml#/components/schemas/MbUpfInfo'
    minProperties: 1
  trustAfInfo:
    $ref: 'TS29510_Nnrf_NFManagement.yaml#/components/schemas/TrustAfInfo'
  nssaafInfo:
    $ref: 'TS29510_Nnrf_NFManagement.yaml#/components/schemas/NssaafInfo'
  hniList:
    type: array
    items:
      $ref: 'TS29571_CommonData.yaml#/components/schemas/Fqdn'
    minItems: 1
  iwmscInfo:
    $ref: 'TS29510_Nnrf_NFManagement.yaml#/components/schemas/IwmscInfo'
  mnpfInfo:
    $ref: 'TS29510_Nnrf_NFManagement.yaml#/components/schemas/MnpfInfo'
  smsfInfo:
    $ref: 'TS29510_Nnrf_NFManagement.yaml#/components/schemas/SmsfInfo'
  dcsfInfoList:
    description: >
      A map (list of key-value pairs) where a (unique) valid JSON string
      serves as key of DcsfInfo
    type: object
    additionalProperties:
      $ref: 'TS29510_Nnrf_NFManagement.yaml#/components/schemas/DcsfInfo'
  mrfInfoList:
    description: >
      A map (list of key-value pairs) where a (unique) valid JSON string
      serves as key of MrfInfo
    type: object
    additionalProperties:
      $ref: 'TS29510_Nnrf_NFManagement.yaml#/components/schemas/MrfInfo'
  mrfpInfoList:
    description: >
      A map (list of key-value pairs) where a (unique) valid JSON string
      serves as key of MrfpInfo
    type: object
    additionalProperties:
      $ref: 'TS29510_Nnrf_NFManagement.yaml#/components/schemas/MrfpInfo'
  mfInfoList:
    description: >
      A map (list of key-value pairs) where a (unique) valid JSON string
      serves as key of MfInfo
    type: object
    additionalProperties:
      $ref: 'TS29510_Nnrf_NFManagement.yaml#/components/schemas/MfInfo'
  adrfInfoList:
    type: object
    description: >
      A map (list of key-value pairs) where a (unique) valid JSON string
      serves as key of AdrfInfo
    additionalProperties:
      $ref: 'TS29510_Nnrf_NFManagement.yaml#/components/schemas/AdrfInfo'
    minProperties: 1
  selectionConditions:
    $ref: 'TS29510_Nnrf_NFManagement.yaml#/components/schemas/SelectionConditions'
  canaryRelease:
    type: boolean
    default: false
  exclusiveCanaryReleaseSelection:
    type: boolean
    default: false
  sharedProfileDataId:
    type: string
    format: uuid

NfService:
  description: >
    Information of a given NF Service Instance; it is part of the NFProfile
    of an NF Instance discovered by the NRF
  type: object

```

```

required:
- serviceInstanceId
- serviceName
- versions
- scheme
- nfServiceStatus
properties:
serviceInstanceId:
  type: string
serviceName:
  $ref: 'TS29510_Nnrf_NFManagement.yaml#/components/schemas/ServiceName'
versions:
  type: array
  items:
    $ref: 'TS29510_Nnrf_NFManagement.yaml#/components/schemas/NFServiceVersion'
  minItems: 1
scheme:
  $ref: 'TS29571_CommonData.yaml#/components/schemas/UriScheme'
nfServiceStatus:
  $ref: 'TS29510_Nnrf_NFManagement.yaml#/components/schemas/NFServiceStatus'
fqdn:
  $ref: 'TS29571_CommonData.yaml#/components/schemas/Fqdn'
interPlmnFqdn:
  $ref: 'TS29571_CommonData.yaml#/components/schemas/Fqdn'
ipEndpoints:
  type: array
  items:
    $ref: 'TS29510_Nnrf_NFManagement.yaml#/components/schemas/IpEndPoint'
  minItems: 1
apiPrefix:
  type: string
callbackUriPrefixList:
  type: array
  items:
    $ref: 'TS29510_Nnrf_NFManagement.yaml#/components/schemas/CallbackUriPrefixItem'
  minItems: 1
defaultNotificationSubscriptions:
  type: array
  items:
    $ref:
'TS29510_Nnrf_NFManagement.yaml#/components/schemas/DefaultNotificationSubscription'
  minItems: 1
allowedPlmns:
  type: array
  items:
    $ref: 'TS29571_CommonData.yaml#/components/schemas/PlmnId'
  minItems: 1
allowedSnpsns:
  type: array
  items:
    $ref: 'TS29571_CommonData.yaml#/components/schemas/PlmnIdNid'
  minItems: 1
allowedNfTypes:
  type: array
  items:
    $ref: 'TS29510_Nnrf_NFManagement.yaml#/components/schemas/NFType'
  minItems: 1
allowedNfDomains:
  type: array
  items:
    type: string
  minItems: 1
allowedNssais:
  type: array
  items:
    $ref: 'TS29571_CommonData.yaml#/components/schemas/ExtSnssai'
  minItems: 1
capacity:
  type: integer
  minimum: 0
  maximum: 65535
load:
  type: integer
  minimum: 0
  maximum: 100
loadTimeStamp:
  $ref: 'TS29571_CommonData.yaml#/components/schemas/DateTime'
priority:

```

```

    type: integer
    minimum: 0
    maximum: 65535
  recoveryTime:
    $ref: 'TS29571_CommonData.yaml#/components/schemas/DateTime'
  supportedFeatures:
    $ref: 'TS29571_CommonData.yaml#/components/schemas/SupportedFeatures'
  nfServiceSetIdList:
    type: array
    items:
      $ref: 'TS29571_CommonData.yaml#/components/schemas/NfServiceSetId'
    minItems: 1
  sNssais:
    type: array
    items:
      $ref: 'TS29571_CommonData.yaml#/components/schemas/ExtSnsai'
    minItems: 1
  perPlmnSnsaiList:
    type: array
    items:
      $ref: 'TS29510_Nnrf_NFManagement.yaml#/components/schemas/PlmnSnsai'
    minItems: 1
  vendorID:
    $ref: 'TS29510_Nnrf_NFManagement.yaml#/components/schemas/VendorId'
  supportedVendorSpecificFeatures:
    description: >
      The key of the map is the IANA-assigned SMI Network Management Private Enterprise Codes
    type: object
    additionalProperties:
      type: array
      items:
        $ref: 'TS29510_Nnrf_NFManagement.yaml#/components/schemas/VendorSpecificFeature'
      minItems: 1
    minProperties: 1
  oauth2Required:
    type: boolean
  allowedOperationsPerNfType:
    description: A map (list of key-value pairs) where NF Type serves as key
    type: object
    additionalProperties:
      type: array
      items:
        type: string
        minItems: 1
    minProperties: 1
  allowedOperationsPerNfInstance:
    description: A map (list of key-value pairs) where NF Instance Id serves as key
    type: object
    additionalProperties:
      type: array
      items:
        type: string
        minItems: 1
    minProperties: 1
  allowedOperationsPerNfInstanceOverrides:
    type: boolean
    default: false
  allowedScopesRuleSet:
    description: A map (list of key-value pairs) where a valid JSON pointer Id serves as key
    type: object
    additionalProperties:
      $ref: 'TS29510_Nnrf_NFManagement.yaml#/components/schemas/RuleSet'
    minProperties: 1
  selectionConditions:
    $ref: 'TS29510_Nnrf_NFManagement.yaml#/components/schemas/SelectionConditions'
  canaryRelease:
    type: boolean
    default: false
  exclusiveCanaryReleaseSelection:
    type: boolean
    default: false
  sharedServiceDataId:
    type: string
    format: uuid

PreferredSearch:
  description: >
    Contains information on whether the returned NFProfiles match the preferred query parameters

```

```

type: object
properties:
  preferredTaiMatchInd:
    type: boolean
    default: false
  preferredFullPlmnMatchInd:
    type: boolean
    default: false
  preferredApiVersionsMatchInd:
    type: boolean
  otherApiVersionsInd:
    type: boolean
  preferredLocalityMatchInd:
    type: boolean
    default: false
  otherLocalityInd:
    type: boolean
    default: false
  preferredVendorSpecificFeaturesInd:
    type: boolean
    default: false
  preferredCollocatedNfTypeInd:
    type: boolean
    default: false
  preferredPgwMatchInd:
    type: boolean
  preferredAnalyticsDelaysInd:
    type: boolean
  preferredFeaturesMatchInd:
    type: boolean
  noPreferredFeaturesInd:
    type: boolean

NfInstanceInfo:
  description: Contains information on an NF profile matching a discovery request
  type: object
  properties:
    nrfDiscApiUri:
      $ref: 'TS29571_CommonData.yaml#/components/schemas/Uri'
    preferredSearch:
      $ref: '#/components/schemas/PreferredSearch'
    nrfAlteredPriorities:
      description: >
        The key of the map is the JSON Pointer of the priority IE in the NFProfile data type
        that is altered by the NRF
      type: object
      additionalProperties:
        type: integer
        minimum: 0
        maximum: 65535
      minProperties: 1
    nrfSupportedFeatures:
      $ref: 'TS29571_CommonData.yaml#/components/schemas/SupportedFeatures'

ScpDomainRoutingInformation:
  description: SCP Domain Routing Information
  type: object
  required:
    - scpDomainList
  properties:
    scpDomainList:
      description: |
        This IE shall contain a map of SCP domain interconnection information, where
        the key of the map is a SCP domain. The value of each entry shall be the
        interconnectivity information of the the SCP domain indicated by the key.
        An empty map indicates that there is no SCP domain currently registered in
        the NRF.
      type: object
      additionalProperties:
        $ref: '#/components/schemas/ScpDomainConnectivity'

ScpDomainConnectivity:
  description: SCP Domain Connectivity Information
  type: object
  required:
    - connectedScpDomainList
  properties:
    connectedScpDomainList:

```

```
    type: array
    items:
      type: string

ScpDomainRoutingInfoSubscription:
  description: SCP Domain Routing Information Subscription
  type: object
  required:
    - callbackUri
  properties:
    callbackUri:
      $ref: 'TS29571_CommonData.yaml#/components/schemas/Uri'
    validityTime:
      $ref: 'TS29571_CommonData.yaml#/components/schemas/DateTime'
    reqInstanceId:
      $ref: 'TS29571_CommonData.yaml#/components/schemas/NfInstanceId'
    localInd:
      type: boolean
      default: false

ScpDomainRoutingInfoNotification:
  description: SCP Domain Routing Information Notification
  type: object
  required:
    - routingInfo
  properties:
    routingInfo:
      $ref: '#/components/schemas/ScpDomainRoutingInformation'
    localInd:
      type: boolean
      default: false

NfServiceInstance:
  description: NF service instance
  type: object
  oneOf:
    - required: [ nfInstanceId ]
    - required: [ nfServiceSetId ]
  properties:
    serviceInstanceId:
      type: string
    nfInstanceId:
      $ref: 'TS29571_CommonData.yaml#/components/schemas/NfInstanceId'
    nfServiceSetId:
      $ref: 'TS29571_CommonData.yaml#/components/schemas/NfServiceSetId'

NoProfileMatchInfo:
  description: Provides the reason for not finding NF matching the search criteria
  type: object
  required:
    - reason
  properties:
    reason:
      $ref: '#/components/schemas/NoProfileMatchReason'
    queryParamCombinationList:
      type: array
      items:
        $ref: '#/components/schemas/QueryParamCombination'
      minItems: 1

QueryParamCombination:
  description: Contains a list of Query Parameters
  type: object
  required:
    - queryParams
  properties:
    queryParams:
      type: array
      items:
        $ref: '#/components/schemas/QueryParameter'
      minItems: 1

QueryParameter:
  description: Contains the name and value of a query parameter
  type: object
  required:
    - name
    - value
```

```

properties:
  name:
    type: string
  value:
    type: string

NoProfileMatchReason:
description: No Profile Match Reason
anyOf:
- type: string
  enum:
    - REQUESTER_PLMN_NOT_ALLOWED
    - TARGET_NF_SUSPENDED
    - TARGET_NF_UNDISCOVERABLE
    - QUERY_PARAMS_COMBINATION_NO_MATCH
    - TARGET_NF_TYPE_NOT_SUPPORTED
    - UNSPECIFIED
- type: string

AfData:
description: Contains information supported by the trusted AF
type: object
properties:
  afEvents:
    type: array
    items:
      $ref: 'TS29517_Naf_EventExposure.yaml#/components/schemas/AfEvent'
    minItems: 1
  taiList:
    type: array
    items:
      $ref: 'TS29571_CommonData.yaml#/components/schemas/Tai'
    minItems: 1
  taiRangeList:
    type: array
    items:
      $ref: 'TS29510_Nnrf_NFManagement.yaml#/components/schemas/TaiRange'
    minItems: 1
  required:
    - afEvents

SearchResultInfo:
description: Contains additional information to the search result
type: object
properties:
  unsatisfiedTaiList:
    type: array
    items:
      $ref: 'TS29571_CommonData.yaml#/components/schemas/Tai'
    minItems: 1

```

A.4 Nnrf_AccessToken API (NRF OAuth2 Authorization)

openapi: 3.0.0

```

info:
  version: '1.3.1'
  title: 'NRF OAuth2'
  description: |
    NRF OAuth2 Authorization.
    © 2024, 3GPP Organizational Partners (ARIB, ATIS, CCSA, ETSI, TSDSI, TTA, TTC).
    All rights reserved.

externalDocs:
  description: 3GPP TS 29.510 V18.8.0; 5G System; Network Function Repository Services; Stage 3
  url: 'https://www.3gpp.org/ftp/Specs/archive/29_series/29.510/'

servers:
- url: '{nrfApiRoot}'
  variables:
    nrfApiRoot:
      default: https://example.com
      description: >
        nrfApiRoot represents the concatenation of the "scheme" and "authority" components
        (as defined in IETF RFC 3986) of the NRF

```



```

paths:
  /oauth2/token:
    post:
      summary: Access Token Request
      operationId: AccessTokenRequest
      tags:
        - Access Token Request
      parameters:
        - name: Content-Encoding
          in: header
          description: Content-Encoding, described in IETF RFC 9110
          schema:
            type: string
        - name: Accept-Encoding
          in: header
          description: Accept-Encoding, described in IETF RFC 9110
          schema:
            type: string
      requestBody:
        content:
          application/x-www-form-urlencoded:
            schema:
              $ref: '#/components/schemas/AccessTokenReq'
            encoding:
              requesterPlmn:
                contentType: application/json
              requesterPlmnList:
                contentType: application/json
              requesterSnssaiList:
                contentType: application/json
              requesterSnpnList:
                contentType: application/json
              targetPlmn:
                contentType: application/json
              targetSnpn:
                contentType: application/json
              targetSnssaiList:
                contentType: application/json
              targetNsiList:
                style: form
                explode: true
            required: true
      responses:
        '200':
          description: Successful Access Token Request
          content:
            application/json:
              schema:
                $ref: '#/components/schemas/AccessTokenRsp'
          headers:
            Cache-Control:
              $ref: '#/components/headers/cache-control'
            Pragma:
              $ref: '#/components/headers/pragma'
            Accept-Encoding:
              description: Accept-Encoding, described in IETF RFC 9110
              schema:
                type: string
            Content-Encoding:
              description: Content-Encoding, described in IETF RFC 9110
              schema:
                type: string
        '307':
          description: Temporary Redirect
          content:
            application/json:
              schema:
                $ref: 'TS29571_CommonData.yaml#/components/schemas/RedirectResponse'
          headers:
            Location:
              description: The URI pointing to the resource located on the redirect target NRF
              required: true
              schema:
                type: string
        '308':
          description: Permanent Redirect
          content:

```

```

    application/json:
      schema:
        $ref: 'TS29571_CommonData.yaml#/components/schemas/RedirectResponse'
  headers:
    Location:
      description: The URI pointing to the resource located on the redirect target NRF
      required: true
      schema:
        type: string
  '400':
    description: Error in the Access Token Request
    content:
      application/json:
        schema:
          $ref: '#/components/schemas/AccessTokenErr'
      application/problem+json: # error originated by an SCP or SEPP
        schema:
          $ref: 'TS29571_CommonData.yaml#/components/schemas/ProblemDetails'
    headers:
      Cache-Control:
        $ref: '#/components/headers/cache-control'
      Pragma:
        $ref: '#/components/headers/pragma'
  '401':
    $ref: 'TS29571_CommonData.yaml#/components/responses/401'
  '403':
    $ref: 'TS29571_CommonData.yaml#/components/responses/403'
  '404':
    $ref: 'TS29571_CommonData.yaml#/components/responses/404'
  '411':
    $ref: 'TS29571_CommonData.yaml#/components/responses/411'
  '413':
    $ref: 'TS29571_CommonData.yaml#/components/responses/413'
  '415':
    $ref: 'TS29571_CommonData.yaml#/components/responses/415'
  '429':
    $ref: 'TS29571_CommonData.yaml#/components/responses/429'
  '500':
    $ref: 'TS29571_CommonData.yaml#/components/responses/500'
  '501':
    $ref: 'TS29571_CommonData.yaml#/components/responses/501'
  '503':
    $ref: 'TS29571_CommonData.yaml#/components/responses/503'
  default:
    $ref: 'TS29571_CommonData.yaml#/components/responses/default'

```

```

components:
  headers:
    cache-control:
      required: true
      schema:
        type: string
        enum:
          - no-store
    pragma:
      required: true
      schema:
        type: string
        enum:
          - no-cache

```

```

schemas:
  AccessTokenReq:
    description: Contains information related to the access token request
    type: object
    required:
      - grant_type
      - nfInstanceId
      - scope
    properties:
      grant_type:
        type: string
        enum:
          - client_credentials
      nfInstanceId:
        $ref: 'TS29571_CommonData.yaml#/components/schemas/NfInstanceId'
      nfType:
        $ref: 'TS29510_Nnrf_NFManagement.yaml#/components/schemas/NFType'

```

```

targetNfType:
  $ref: 'TS29510_Nnrf_NFManagement.yaml#/components/schemas/NFType'
scope:
  type: string
  pattern: '^[a-zA-Z0-9_-]+)([a-zA-Z0-9_-]+)*$'
targetNfInstanceId:
  $ref: 'TS29571_CommonData.yaml#/components/schemas/NfInstanceId'
requesterPlmn:
  $ref: 'TS29571_CommonData.yaml#/components/schemas/PlmnId'
requesterPlmnList:
  type: array
  items:
    $ref: 'TS29571_CommonData.yaml#/components/schemas/PlmnId'
  minItems: 2
requesterSnssaiList:
  type: array
  items:
    $ref: 'TS29571_CommonData.yaml#/components/schemas/Snssai'
  minItems: 1
requesterFqdn:
  $ref: 'TS29571_CommonData.yaml#/components/schemas/Fqdn'
requesterSnpnList:
  type: array
  items:
    $ref: 'TS29571_CommonData.yaml#/components/schemas/PlmnIdNid'
  minItems: 1
targetPlmn:
  $ref: 'TS29571_CommonData.yaml#/components/schemas/PlmnId'
targetSnpn:
  $ref: 'TS29571_CommonData.yaml#/components/schemas/PlmnIdNid'
targetSnssaiList:
  type: array
  items:
    $ref: 'TS29571_CommonData.yaml#/components/schemas/Snssai'
  minItems: 1
targetNsiList:
  type: array
  items:
    type: string
  minItems: 1
targetNfSetId:
  $ref: 'TS29571_CommonData.yaml#/components/schemas/NfSetId'
targetNfServiceSetId:
  $ref: 'TS29571_CommonData.yaml#/components/schemas/NfServiceSetId'
hnrfaAccessUri:
  $ref: 'TS29571_CommonData.yaml#/components/schemas/Uri'
sourceNfInstanceId:
  $ref: 'TS29571_CommonData.yaml#/components/schemas/NfInstanceId'
vendorId:
  $ref: 'TS29510_Nnrf_NFManagement.yaml#/components/schemas/VendorId'
analyticsIds:
  type: array
  items:
    $ref: 'TS29520_Nnwdaf_EventsSubscription.yaml#/components/schemas/NwdafEvent'
  minItems: 1
requesterInterIndList:
  type: array
  items:
    $ref: '#/components/schemas/M1ModelInterInd'
  minItems: 1
sourceVendorId:
  $ref: 'TS29510_Nnrf_NFManagement.yaml#/components/schemas/VendorId'

AccessTokenRsp:
  description: Contains information related to the access token response
  type: object
  required:
    - access_token
    - token_type
  properties:
    access_token:
      type: string
      description: >
        JWS Compact Serialized representation of JWS signed JSON object (AccessTokenClaims)
    token_type:
      type: string
      enum:
        - Bearer

```

```

    expires_in:
      type: integer
    scope:
      type: string
      pattern: '^([a-zA-Z0-9_-:~])( [a-zA-Z0-9_-:~]+)*$'
  AccessTokenClaims:
    description: The claims data structure for the access token
    type: object
    required:
      - iss
      - sub
      - aud
      - scope
      - exp
    properties:
      iss:
        $ref: 'TS29571_CommonData.yaml#/components/schemas/NfInstanceId'
      sub:
        $ref: 'TS29571_CommonData.yaml#/components/schemas/NfInstanceId'
      aud:
        anyOf:
          - $ref: 'TS29510_Nnrf_NFManagement.yaml#/components/schemas/NFType'
          - type: array
            items:
              $ref: 'TS29571_CommonData.yaml#/components/schemas/NfInstanceId'
            minItems: 1
      scope:
        type: string
        pattern: '^([a-zA-Z0-9_-:~])( [a-zA-Z0-9_-:~]+)*$'
      exp:
        type: integer
      consumerPlmnId:
        $ref: 'TS29571_CommonData.yaml#/components/schemas/PlmnId'
      consumerSnpnId:
        $ref: 'TS29571_CommonData.yaml#/components/schemas/PlmnIdNid'
      producerPlmnId:
        $ref: 'TS29571_CommonData.yaml#/components/schemas/PlmnId'
      producerSnpnId:
        $ref: 'TS29571_CommonData.yaml#/components/schemas/PlmnIdNid'
      producerSnssaiList:
        type: array
        items:
          $ref: 'TS29571_CommonData.yaml#/components/schemas/Snssai'
        minItems: 1
      producerNsiList:
        type: array
        items:
          type: string
          minItems: 1
      producerNfSetId:
        $ref: 'TS29571_CommonData.yaml#/components/schemas/NfSetId'
      producerNfServiceSetId:
        $ref: 'TS29571_CommonData.yaml#/components/schemas/NfServiceSetId'
      sourceNfInstanceId:
        $ref: 'TS29571_CommonData.yaml#/components/schemas/NfInstanceId'
      analyticsIdList:
        type: array
        items:
          $ref: 'TS29520_Nnwdaf_EventsSubscription.yaml#/components/schemas/NwdafEvent'
        minItems: 1
  AccessTokenErr:
    description: Error returned in the access token response message
    type: object
    required:
      - error
    properties:
      error:
        type: string
        enum:
          - invalid_request
          - invalid_client
          - invalid_grant
          - unauthorized_client
          - unsupported_grant_type
          - invalid_scope
      error_description:

```

```

    type: string
  error_uri:
    type: string

  MlModelInterInd:
    description: ML Model Interoperability Indicator per Analytics Id
    type: object
    properties:
      analyticsId:
        $ref: 'TS29520_Nnwdaf_EventsSubscription.yaml#/components/schemas/NwdafEvent'
      vendorList:
        type: array
        items:
          $ref: 'TS29510_Nnrf_NFManagement.yaml#/components/schemas/VendorId'
        minItems: 1
    required:
      - analyticsId
      - vendorList

```

A.5 Nnrf_Bootstrapping API

openapi: 3.0.0

```

info:
  version: '1.2.0'
  title: 'NRF Bootstrapping'
  description: |
    NRF Bootstrapping.
    © 2024, 3GPP Organizational Partners (ARIB, ATIS, CCSA, ETSI, TSDSI, TTA, TTC).
    All rights reserved.

```

```

externalDocs:
  description: 3GPP TS 29.510 V18.7.0; 5G System; Network Function Repository Services; Stage 3
  url: 'https://www.3gpp.org/ftp/Specs/archive/29_series/29.510/'

```

```

servers:
  - url: '{nrfApiRoot}'
    variables:
      nrfApiRoot:
        default: https://example.com
        description: >
          nrfApiRoot represents the concatenation of the "scheme" and "authority" components
          (as defined in IETF RFC 3986) of the NRF

```

```

paths:
  /bootstrapping:
    get:
      summary: Bootstrapping Info Request
      operationId: BootstrappingInfoRequest
      tags:
        - Bootstrapping Request
      parameters:
        - name: If-None-Match
          in: header
          description: Validator for conditional requests, as described in IETF RFC 9110, 13.1.2
          schema:
            type: string
      responses:
        '200':
          description: Successful Bootstrapping Request
          content:
            application/3gppHal+json:
              schema:
                $ref: '#/components/schemas/BootstrappingInfo'
          headers:
            Cache-Control:
              description: Cache-Control containing max-age, described in IETF RFC 9111, 5.2
              schema:
                type: string
            ETag:
              description: >
                Entity Tag containing a strong validator, described in IETF RFC 9110, 8.8.3
              schema:
                type: string
        '307':

```

```

description: Temporary Redirect
content:
  application/json:
    schema:
      $ref: 'TS29571_CommonData.yaml#/components/schemas/RedirectResponse'
headers:
  Location:
    description: The URI pointing to the resource located on the redirect target NRF
    required: true
    schema:
      type: string
'308':
description: Permanent Redirect
content:
  application/json:
    schema:
      $ref: 'TS29571_CommonData.yaml#/components/schemas/RedirectResponse'
headers:
  Location:
    description: The URI pointing to the resource located on the redirect target NRF
    required: true
    schema:
      type: string
'400':
  $ref: 'TS29571_CommonData.yaml#/components/responses/400'
'500':
  $ref: 'TS29571_CommonData.yaml#/components/responses/500'
default:
  $ref: 'TS29571_CommonData.yaml#/components/responses/default'

```

components:

schemas:

BootstrappingInfo:

description: Information returned by NRF in the bootstrapping response message

type: object

required:

- _links

properties:

status:

\$ref: '#/components/schemas/Status'

_links:

type: object

description: >

Map of link objects where the keys are the link relations defined in 3GPP TS 29.510 clause 6.4.6.3.3

additionalProperties:

\$ref: 'TS29571_CommonData.yaml#/components/schemas/LinksValueSchema'

minProperties: 1

nrfFeatures:

type: object

description: >

Map of features supported by the NRF, where the keys are the NRF services as defined in 3GPP TS 29.510 clause 6.1.6.3.11

additionalProperties:

\$ref: 'TS29571_CommonData.yaml#/components/schemas/SupportedFeatures'

minProperties: 1

oauth2Required:

type: object

description: >

Map indicating whether the NRF requires Oauth2-based authorization for accessing its services. The key of the map shall be the name of an NRF service, e.g. "nnrf-nfm" or "nnrf-disc"

additionalProperties:

type: boolean

minProperties: 1

nrfSetId:

\$ref: 'TS29571_CommonData.yaml#/components/schemas/NfSetId'

nrfInstanceId:

\$ref: 'TS29571_CommonData.yaml#/components/schemas/NfInstanceId'

Status:

description: Overall status of the NRF

anyOf:

- type: string

enum:

- OPERATIVE

- NON_OPERATIVE

- type: string

Annex B (normative): NF Profile changes in NFRegister and NFUpdate responses

B.1 General

In the NFRegister and NFUpdate (NF Profile Complete Replacement and NF Profile Partial Update) service operations, a NF Service Consumer may indicate to the NRF that it supports receiving NF Profile changes in the response from the NRF, by including the `nfProfileChangesSupportInd` and/or the `nfProfilePartialUpdateChangesSupportInd` attributes set to "true" in the NFProfile it registers to or replaces in the NRF.

NOTE 1: For NFRegister and NFUpdate (NF Profile Complete Replacement), the NF Service Consumer can indicate its support of the corresponding capability during the initial NFRegister operation or during the NF Profile Complete Replacement.

NOTE 2: For NF Profile Partial Update (which uses the HTTP PATCH operation), the NF Service Consumer can indicate its support of the corresponding capability during the initial NFRegister operation, or during an NF Profile Complete Replacement (i.e., in the content of the corresponding HTTP PUT request), and can also indicate support of this capability after the initial registration, in a PATCH request, by setting to true the `nfProfilePartialUpdateChangesSupportInd` attribute.

The NRF may return NF Profile changes, instead of the complete NF Profile, in NFRegister or NFUpdate responses, if the NF Service Consumer has indicated corresponding support in its NFProfile data. When doing so, the NRF shall include in the NF Profile returned in the response:

- attributes that are mandatory to include in the NF Profile; if an optional IE is included (e.g. `nfServices`), attributes that are mandatory to include in this optional IE (e.g. `serviceInstanceId`) shall also be included;
- optional or conditional IEs that have been changed or added by the NRF; and
- the `nfProfileChangesInd` IE set to "true", indicating that the returned profile contains NF profile changes.

EXAMPLE 1: The NRF does not change the NF Profile received in the request.

The NRF response contains a NFProfile with just the following IEs:

- `nfInstanceId`, `nfType`, `nfStatus`; and
- `nfProfileChangesInd` IE set to "true".

EXAMPLE 2: The NRF modifies or adds the `heartbeatTimer` attribute to the NF Profile received in the request.

The NRF response contains a NFProfile with just the following IEs:

- `nfInstanceId`, `nfType`, `nfStatus`;
- `heartbeatTimer` with NRF chosen value;
- `nfProfileChangesInd` IE set to "true".

Annex C (normative): Enhanced Authorization Policy using RuleSets in NF (Service) Profile

C.1 General

When scope of authorizations allowed to NF-Service-Consumers of different PLMNs, S-NSSAIs, SNPNs, NF-Domains etc. are different, it is not always possible for an NF (Service) Producer to register an authorization profile into NRF using allowedXXX parameters alone. The Allowed-ruleset feature addresses such requirements by extending the authorization policy with a prioritized list of RuleSets in the NF (Service) profile.

This clause provides configuration examples and guidance on handling backward compatibility when the Allowed-ruleset feature is deployed.

C.2 Examples of NF-Producer profile only using RuleSets (i.e. without AllowedXXX parameters) in NF (Service) Profile

This clause provides configuration examples of allowedScopesRuleSet parameter in the NF-Service profile (Clause 6.1.6.2.3).

Following is an example of rules formed by para-phrasing the individual RuleSets registered by an NF-Service-Producer:

priority 1 plmns <> nfTypes <> nfInstances <> scopes <> allow

priority 2 plmns <> nfTypes <> scopes <> allow

priority 3 plmns <> nfTypes <> allow

priority 100 deny

When a NF-Service-Consumer requests an access-token from NRF, the NRF matches the properties of the NF-Service-Consumer (PLMN, SNPN, nfType, NfDomain, S-NSSAIs, NF-Instance Id etc.) against these rules in decreasing order of priority (1 being the highest). If a match is found, search stops, and the matching rule is applied to determine the scope to be granted.

Consider 3 NF-Service Producers **p1**, **p2** and **p3** who need to register their NF-Service Profile into NRF. Each of these producers define operation level scopes Op1, Op2 and Op3 and the service-level scope.

- NF-Service-Producer **p1** allows all NF-Service-Consumers with nfType=A to access its resources unrestricted. However NF-Service-Consumers with nfType=B are limited to Op1 and Op2. It may register, in the NF-Service-Profile:

priority 2 nfType {B} scopes {Op1, Op2, service level scope} allow

priority 5 nfType {A} allow

priority 100 deny

- NF-Service-Producer **p2** allows all NF-Service-Consumers with nfType=A to access its resources unrestricted. NF-Service-Consumers with nfType=B are limited to Op1 and Op2. It additionally wants to allow NF-Service-Consumer with NF-Instance-ID=X to Op3 only. It may register, in the NF-Service-Profile:

priority 2 nfInstance-id {X} scopes {Op3, service level scope} allow

```

priority 5 nfType {B} scopes {Op1, Op2, service level scope} allow
priority 10 nfType {A} allow
priority 100 deny

```

- NF-Service-Producer **p3** allows all NF-Service-Consumers of PLMN1 of nfType=A or nfType=B to access its resources unrestricted. However, for the NFs of PLMN2, NF-Service-Consumers of nfType=A are allowed to access its resources unrestricted, but the NF-Service-Consumers of nfType=B are limited to Op1 and Op2. It may register, in the NF-Service-Profile:

```

priority 2 plmn {plmn1} nfType {A,B} allow
priority 5 plmn {plmn2} nfType {A} allow
priority 10 plmn {plmn2} nfType {B} scopes {Op1, Op2, service level scope} allow
priority 100 deny

```

Absence of scopes in a rule indicates that all service operations/all scopes are allowed.

Rule with no identification of NF-Consumer (e.g. priority 100 rule in example above) indicates the rule applies to all.

Similar examples apply to allowedRuleSet parameter in NF-Profile (Clause 6.1.6.2.2), however without the scopes parameter, as in the case of NF-Profile, the allowedRuleSet parameter is used to determine whether an NF-Consumer is allowed or not allowed to access the NF-Producer.

C.3 Example of NF-Producer profile using RuleSets and AllowedXXX parameters in NF (Service) Profile

When a NF (Service) producer registers both the AllowedXXX parameters and the allowedScopesRuleSet parameter in the NF-Service Profile, the authorization scopes assigned to an NF-Consumer are determined by performing a logical OR operation of the two sets of parameters. The helps implementations to use Allowed-ruleset feature only when the authorization policy cannot be configured using the AllowedXXX parameters alone.

This clause provides configuration examples with allowedScopesRuleSet parameter in the NF-Service profile (Clause 6.1.6.2.3) along with allowedXXX parameters.

Consider the example of NF-Service-Producer **p3** in Annex C.2, which allows all NF-Service-Consumers of PLMN1 of nfType=A or nfType=B to access its resources unrestricted. However, for the NFs of PLMN2, NF-Service-Consumers of nfType=A are allowed to access its resources unrestricted, but the NF-Service-Consumers of nfType=B are limited to Op1 and Op2. This can be achieved by configuring the rules as:

```

{
  allowedPLMNs = plmn1
  allowedNfTypes = A,B
}
OR
{
  priority 5 plmn {plmn2} nfType {A} allow
  priority 10 plmn {plmn2} nfType {B} scopes {Op1, Op2, service level scope} allow
}

```

Similar examples apply with allowedRuleSet parameter in NF-Profile (Clause 6.1.6.2.2), however without the scopes parameter, as in the case of NF-Profile, the allowedRuleSet parameter is used to determine whether an NF-Consumer is allowed or not allowed to access the NF-Producer.

C.4 Backward Compatibility

This clause provides examples for addressing backward compatibility issues with the Allowed-ruleset feature.

Consider an NF-Producer *p1* supporting Allowed-ruleset feature which registers its following NF-Service profile into NRF utilizing the new `allowedScopesRuleSet` parameter:

```
priority 2 nfInstance-id {X} scopes {Op3, service level scope} allow
priority 5 nfType {B} scopes {Op1, Op2, service level scope} allow
priority 10 nfType {A} allow
priority 15 nssais {1,2} scopes {Op1, service level scope} allow
priority 100 deny
```

Consider an NF-Consumer *c1* which does **not** support the Allowed-ruleset feature and discovers NF-Producer *p1* using `Nnrf_NFDiscovery` service.

- If the highest priority rule matching NF-Consumer *c1* is priority 2, the NRF may include, in the `Nnrf_NFDiscovery_Get` response, parameter `allowedOperationsPerNfInstance`, containing applicable scopes.
- If the highest priority rule matching NF-Consumer *c1* is priority 5, the NRF may include, in the `Nnrf_NFDiscovery_Get` response, parameter `allowedOperationsPerNfType`, containing applicable scopes.
- If the highest priority rule matching NF-Consumer *c1* is priority 10, the NRF may not include, in the `Nnrf_NFDiscovery_Get` response, the parameters `allowedOperationsPerNfInstance` and `allowedOperationsPerNfType`.
- If the highest priority rule matching NF-Consumer *c1* is priority 15, the NRF may include, in the `Nnrf_NFDiscovery_Get` response, any of the parameters `allowedOperationsPerNfInstance` or `allowedOperationsPerNfType`, containing applicable scopes.

If entities (e.g. SCP) of a network are configured to use Complete Profile Subscription or Complete Profile Discovery feature, the Allowed-ruleset feature shall only be deployed if all these entities in the network have been upgraded to support and use the Allowed-ruleset feature.

NF-Producers shall only be configured to use the Allowed-ruleset feature after NRFs in the network are upgraded and configured to use the Allowed-ruleset feature, as otherwise NF-Producers would need to translate RuleSets to existing service access control parameters (i.e. `allowedPlmns`, `allowedSnpsns`, `allowedNfTypes` etc.) which may not always be possible.

Annex D (normative): Support of "Canary Release" testing in the NRF

This feature allows a network operator to deploy new software features in a Network Function (NF) in a controlled manner, by isolating the NF (Service) Instances that implement the new features, and steering solely a part of the traffic that, otherwise, would be sent towards such NF (Service) Instance producer.

This is achieved by means of the following mechanisms:

- Setting the NF (Service) Instance in Canary Release condition. This can be done by:
 - setting the NFStatus, or NFServiceStatus, of the NF service producer, to the value "CANARY_RELEASE", or
 - setting the "canaryRelease" attribute to true in the NFProfile or NFService, while keeping the NF(Service)Status as "REGISTERED"
- Defining in the NFProfile or NFService of the NF service producer a set of selection conditions, that will be evaluated by an NF service consumer when attempting to select a candidate producer

The set of conditions may include, e.g.:

- The NF type of the consumer
- A feature number that is required by the consumer to select (and send traffic to) a producer
- A set of specific UEs (e.g. based on SUPI ranges, GPSI ranges, IMPU/IMPI ranges, list of PEIs)
- Any UE camping on a TAI within a set of TAI ranges
- A list of DNNs

In order to allow flexibility in the definition of the selection conditions, the above conditions can be combined by means of "and" / "or" logical operators.

EXAMPLE: An SMF is deployed with a new software feature, and the operator wishes to test it by carrying traffic to it with the following conditions:

- The SMF shall only be selected by an AMF, a NEF, or an NWDAF
- The SMF shall only be selected by the AMF when:
 - its selection requires the support of the "ATSSS" feature (which corresponds with feature number #2 in the "nsmf-pdusession" service)
 - the UE belongs to a certain range of SUPIs
 - the UE is camping on a TAI belonging to a range of TAIs
- When the SMF is selected by the NEF, it shall only do it for a certain DNN
- When the SMF is selected by the NWDAF, it shall only do it when the UE is camping on a TAI belonging to a range of TAIs

An example of the "selectionConditions" attribute could be as follows (note that there might be different logical expressions to encode the same logic):

```
"selectionConditions": {
  "or": [
    {
      "and": [
        { "consumerNfType": [ "AMF" ] },
        { "serviceFeature": 2 },
        { "supiRange": { "start": "1234511111", "end": "1234599999" } },
        { "taiRange": {
```

```

        "plmnId": { "mcc": "123", "mnc": "45" },
        "tacRangeList": [
          { "start": "000011", "end": "0000ff" }
        ]
      }
    ]
  },
  {
    "and": [
      { "consumerNfType": [ "NEF" ] },
      { "dnnList": [ "internet.operator.com" ] }
    ]
  },
  {
    "and": [
      { "consumerNfType": [ "NWDAF" ] },
      { "taiRange": {
        "plmnId": { "mcc": "123", "mnc": "45" },
        "tacRangeList": [
          { "start": "000011", "end": "000022" }
        ]
      }
    ]
  }
]
}

```

or, alternatively, with a more simplified encoding, based on the fact that the individual conditions (attributes) inside ConditionItem (see clause 6.1.6.2.124) are evaluated following the "AND" logical operator:

```

"selectionConditions": {
  "or": [
    {
      "consumerNfType": [ "AMF" ],
      "serviceFeature": 2,
      "supiRange": { "start": "1234511111", "end": "1234599999" },
      "taiRange": {
        "plmnId": { "mcc": "123", "mnc": "45" },
        "tacRangeList": [
          { "start": "000011", "end": "0000ff" }
        ]
      }
    }
  ],
  {
    "consumerNfType": [ "NEF" ],
    "dnnList": [ "internet.operator.com" ]
  },
  {
    "consumerNfType": [ "NWDAF" ],
    "taiRange": {
      "plmnId": { "mcc": "123", "mnc": "45" },
      "tacRangeList": [
        { "start": "000011", "end": "000022" }
      ]
    }
  }
]
}

```

Once the producer has defined the selection conditions in its NFProfile, registered at the NRF, the sequence of steps for selection an NF after it is deployed with a "canary" software release, would be as follows:

1. NF Service Instance to be software-upgraded changes its status to "UNDISCOVERABLE", and potential consumers are notified
2. NF Service Instance gets progressively emptied of existing sessions, until no sessions remain
3. NF Service Instance may optionally change its status to "SUSPENDED", to ensure that no residual traffic is sent to the NF Service Instance, and potential consumers are notified
4. NF Service Instance is software-upgraded

5. NF Service Instance with new software registers in NRF indicating its Canary Release condition, by setting its NF(Service)Status to "CANARY_RELEASE" or by setting the "canaryRelease" attribute to true while keeping its NF(Service)Status as "REGISTERED", and includes the set of conditions for selection (e.g. a SUPI range)
6. Consumer NF sends discovery to NRF with usual discovery parameters and gets matching NF Instances containing NF Services with status "REGISTERED" or "CANARY_RELEASE"
7. Consumer performs selection from the list of candidate NFs and, if the producer NF is in Canary Release condition, such NF shall only be selected if the selection conditions match (e.g. it shall only be selected if the SUPI matches the SUPI range indicated by the producer NF).

The selection of the candidate producers shall take into account the attributes of the discovered NFProfiles, and in addition, the consumer shall evaluate the attributes in the selection conditions, which shall take precedence over the attributes of the NFProfile of the producer, for those NF (Service) Instances in Canary Release condition.

If multiple candidate producers are available with NF (Service) status set to "REGISTERED" or "CANARY_RELEASE", the consumer shall preferably select a producer in "CANARY_RELEASE" status except if the "exclusiveCanaryReleaseSelection" attribute is present and set to true; in this case, the consumer shall only select producers in Canary Release condition (for which the selection conditions match), and shall not select those producers that are not in Canary Release condition.

NOTE: In the scenario of exclusive selection of Canary NF producers, the operator typically conducts very restricted Canary tests where the NF consumer only considers as valid candidate NF producer those instances in Canary condition, and discards all other NF producers (in non-Canary condition); the benefit of these tests is to check if the traffic case (for the selection conditions of the Canary nodes) actually end up in success or failure, rather than, e.g., ensuring that the traffic cases complete successfully after the consumer re-selects a non-Canary candidate producer. In these test scenarios, the operator need to ensure that the "exclusiveCanaryReleaseSelection" flag is consistently set in all the Canary NF producers; otherwise, the consumer can send traffic exclusively to Canary NF producers as long as there is one instance among the candidate producers having the "exclusiveCanaryReleaseSelection" set to true.

For the case of Indirect Communication, the selection of a candidate producer may be done by the SCP. In that case, the SCP needs to be able to evaluate the selection conditions for those producers in Canary Release condition. Since the SCP does not count with this information at its disposal (e.g. the different identities of the UE for which a service request is invoked via the SCP), it shall be provided by the consumer, e.g. by including the "3gpp-Sbi-Correlation-Info" HTTP header or by including the corresponding discovery headers ("3gpp-Sbi-Discovery") containing the UE identities involved in the specific traffic case.

In certain cases, the operator may want to maintain the NF Instance fully operative (so it keeps serving traffic to any consumer), at the same time as testing the new software features; in such case, the operator may deploy distinct service instances, some of which may keep the old software version and keep the "REGISTERED" NFServiceStatus, while other service instances may be deployed with the new software version, and set the NFServiceStatus to "CANARY_RELEASE", to ensure that it is only selected by consumers when the desired conditions are met.

Another alternative approach to maintain the node fully operative may be achieved by setting the "canaryRelease" indication to true in the NFProfile or NFService of the NF (Service) instance, while keeping both the NFStatus and NFServiceStatus as "REGISTERED". This way, all consumers that do not support the Canary Release feature will keep discovering and potentially selecting such NF (Service) instance, so it will keep serving traffic normally for legacy consumers; however, if the consumer supports the Canary Release feature, it shall check the "canaryRelease" flag and, if set to true, it shall evaluate the selection conditions, similarly as if the NF(Service)Status would be set to "CANARY_RELEASE".

An SCP or SEPP Network Entities may be set under Canary Release condition and define a set of selection conditions at NFProfile level to indicate to potential consumers that such Network Entity (SCP or SEPP) should only be selected if the selection conditions match.

Given that there are no services defined for an SCP, it is not possible to have an SCP "operative" (i.e. to be able to serve traffic to any consumer) when the status is set to "CANARY_RELEASE" and the consumers might not support the "CANARY_RELEASE" feature. However, it is possible to keep the SCP operative (and serve traffic to consumers not supporting such feature) by setting the "canaryRelease" attribute to true in the NFProfile of the SCP, and keep the NFStatus as "REGISTERED".

For a SEPP, the same considerations as with SCP apply, since there are no SEPP services per-se, in relation to the selection of SEPP instances, and the invocation of its N32-related message transfer capabilities.

However, a SEPP Network Entity may set the NFServiceStatus of a "nsepp-telescopic" service instance (while keeping the NFStatus of the SEPP set to "REGISTERED"). In this case, it is possible to have several instances of this service deployed, where some of them have the NFServiceStatus set to "REGISTERED" (and any consumer may select them) and others set to "CANARY_RELEASE", so consumers should only select such service instance when the selection conditions match.

Annex E (informative): Change history

Date	Meeting	TDoc.	CR	Rev	Cat	Subject/Comment	New
2017-10	CT4#80	C4-175271				Initial draft	0.1.0
2017-10	CT4#80	C4-175395				Incorporation of agreed pCRs from CT4#80: C4-175109, C4-175272, C4-175274, C4-175363	0.2.0
2017-12	CT4#81	C4-176438				Incorporation of agreed pCRs from CT4#81: C4-176184, C4-176278, C4-176280, C4-176281, C4-176282	0.3.0
2018-01	CT4#82	C4-181392				Incorporation of agreed pCRs from CT4#82: C4-181348, C4-181351	0.4.0
2018-03	CT4#83	C4-182435				Incorporation of agreed pCRs from CT4#83: C4-182098, C4-182327, C4-182328, C4-182365, C4-182413	0.5.0
2018-04	CT4#84	C4-183517				Incorporation of agreed pCRs from CT4#84: C4-183450, C4-183451, C4-183452, C4-183487, C4-183488, C4-183490, C4-183491	0.6.0
2018-05	CT4#85	C4-184625				Incorporation of agreed pCRs from CT4#85: C4-184207, C4-184208, C4-184280, C4-184466, C4-184469, C4-184478, C4-184517, C4-184519, C4-184545, C4-184595, C4-184596, C4-184597, C4-184600, C4-184615, C4-184616, C4-184626	0.7.0
2018-06	CT#80	CP-181105				Presented for information and approval	1.0.0
2018-06	CT#80					Approved in CT#80.	15.0.0
2018-09	CT#81	CP-182012	0001	2	F	Implementing the Indirect Delivery method for the GET method to retrieve NF instances	15.1.0
2018-09	CT#81	CP-182093	0003	3	F	Defining the range of the priority and capacity attributes and aligning their usage with SRV RFC 2782	15.1.0
2018-09	CT#81	CP-182060	0004	-	F	Corrections to descriptions, references and SUPI parameter in Discovery Request	15.1.0
2018-09	CT#81	CP-182047	0006	2	F	SubscriptionData	15.1.0
2018-09	CT#81	CP-182045	0008	2	F	Error Cases	15.1.0
2018-09	CT#81	CP-182060	0009	2	F	Heart Beat Procedure	15.1.0
2018-09	CT#81	CP-182060	0010	1	B	Vendor-Specific NF Types	15.1.0
2018-09	CT#81	CP-182044	0011	3	F	Presence condition of service discovery query parameters	15.1.0
2018-09	CT#81	CP-182060	0012	4	F	Description of Inter-PLMN scenarios	15.1.0
2018-09	CT#81	CP-182060	0013	1	F	NF Service Versions	15.1.0
2018-09	CT#81	CP-182060	0014	1	B	Custom Headers	15.1.0
2018-09	CT#81	CP-182060	0015	1	F	Overall Clean-up	15.1.0
2018-09	CT#81	CP-182060	0016	-	F	Formatting of query parameters	15.1.0
2018-09	CT#81	CP-182060	0017	-	F	Editorial corrections	15.1.0
2018-09	CT#81	CP-182060	0018	2	F	Backup AMF	15.1.0
2018-09	CT#81	CP-182060	0020	1	B	NF Service Names	15.1.0
2018-09	CT#81	CP-182060	0023	-	F	CHF as service consumer	15.1.0
2018-09	CT#81	CP-182060	0024	3	B	Hierarchical NF discovery in recursion mode	15.1.0
2018-09	CT#81	CP-182060	0025	2	B	Hierarchical NF discovery in iteration mode	15.1.0
2018-09	CT#81	CP-182060	0026	-	F	Correction of Allowed NF Domains	15.1.0
2018-09	CT#81	CP-182060	0027	-	F	Correction of BsInfo data type	15.1.0
2018-09	CT#81	CP-182161	0028	1	F	IPv6 Prefix for NF / NF Service Address	15.1.0
2018-09	CT#81	CP-182060	0030	1	B	NF Set Id	15.1.0
2018-09	CT#81	CP-182060	0031	1	F	URI Scheme	15.1.0
2018-09	CT#81	CP-182060	0032	2	B	NRF service registration	15.1.0
2018-09	CT#81	CP-182060	0034	2	F	Discovery of combined SMF and PGW-C	15.1.0
2018-09	CT#81	CP-182163	0035	3	F	Support TAI Range for AMF/SMF and SUPI Range for PCF	15.1.0
2018-09	CT#81	CP-182060	0036	1	F	SUPI Range for PCF	15.1.0
2018-09	CT#81	CP-182164	0037	3	F	Scope for OAuth 2.0 Access Token Request	15.1.0
2018-09	CT#81	CP-182060	0039	1	F	Corrections to NotificationData and "supi" parameter in Discovery Request	15.1.0
2018-09	CT#81	CP-182060	0040	1	F	Group ID in Discovery Request	15.1.0
2018-09	CT#81	CP-182060	0041	1	F	Registering multiple Routing Indicators	15.1.0
2018-09	CT#81	CP-182060	0045	-	F	Description of Structured data types	15.1.0
2018-09	CT#81	CP-182060	0046	1	F	Service names in Discovery Request	15.1.0
2018-09	CT#81	CP-182060	0047	1	F	Resource structure presentation	15.1.0
2018-09	CT#81	CP-182060	0048	-	B	Default Notifications for UDM	15.1.0
2018-09	CT#81	CP-182060	0049	-	F	Cell ID in Discovery Request	15.1.0
2018-09	CT#81	CP-182046	0050	2	F	NRF Subscription Data	15.1.0
2018-09	CT#81	CP-182060	0051	1	F	AMF Discovery by 5G-AN	15.1.0
2018-09	CT#81	CP-182060	0052	1	F	Detecting NF Failure and Restart using the NRF	15.1.0
2018-09	CT#81	CP-182060	0053	2	B	NRF Subscription Lifespan	15.1.0
2018-09	CT#81	CP-182060	0054	1	F	NRF servers clause in OpenAPI	15.1.0
2018-09	CT#81	CP-182060	0056	2	F	Default port number	15.1.0
2018-09	CT#81	CP-182162	0057	1	F	AMF Discovery Based on AMF Name	15.1.0
2018-09	CT#81	CP-182060	0058	-	F	API Version Update	15.1.0
2018-12	CT#82	CP-183018	0060	4	F	Heartbeat Timer	15.2.0
2018-12	CT#82	CP-183018	0061	1	F	Location Header	15.2.0
2018-12	CT#82	CP-183018	0062	2	F	NF Profile Addressing Parameters	15.2.0
2018-12	CT#82	CP-183018	0063	1	F	NRF Notifications	15.2.0
2018-12	CT#82	CP-183018	0064	-	F	OAuth2 Corrections	15.2.0
2018-12	CT#82	CP-183018	0065	1	F	Regular Expression Patterns	15.2.0

2018-12	CT#82	CP-183183	0066	5	F	Subscription Data	15.2.0
2018-12	CT#82	CP-183147	0067	2	F	UPF selection based on DNAI	15.2.0
2018-12	CT#82	CP-183018	0068	5	F	CHF registration and selection	15.2.0
2018-12	CT#82	CP-183018	0069	1	F	Clarify the NRF management functionality in the case of hierarchical NRFs	15.2.0
2018-12	CT#82	CP-183149	0070	5	F	OAuth2.0 Service Alignments and Corrections	15.2.0
2018-12	CT#82	CP-183150	0071	1	F	HTTP Basic Authentication For OAuth2.0 Access Token Request	15.2.0
2018-12	CT#82	CP-183018	0072	1	F	Multiple PLMNs support	15.2.0
2018-12	CT#82	CP-183018	0075	2	F	NFService attribute in NFProfile	15.2.0
2018-12	CT#82	CP-183018	0076	1	F	Corrections of ServiceName enumeration	15.2.0
2018-12	CT#82	CP-183018	0077	4	F	Indicating support of EPS interworking in UPF Profile	15.2.0
2018-12	CT#82	CP-183018	0079	2	F	Cardinality	15.2.0
2018-12	CT#82	CP-183018	0081	-	F	APIRoot Clarification	15.2.0
2018-12	CT#82	CP-183018	0082	2	F	Clarification on the reuse of the previous search results	15.2.0
2018-12	CT#82	CP-183018	0083	1	F	NF profile detail for hierarchical NRF	15.2.0
2018-12	CT#82	CP-183235	0084	3	F	Complex query	15.2.0
2018-12	CT#82	CP-183152	0087	1	F	SMF discovery based on S-NSSAI and DNN	15.2.0
2018-12	CT#82	CP-183153	0088	2	F	CHF discovery based on GPSI and SUPI	15.2.0
2018-12	CT#82	CP-183146	0089	3	F	Add access type in SMF selection	15.2.0
2018-12	CT#82	CP-183018	0090	2	F	Hierarchical subscription with intermediate forwarding NRF	15.2.0
2018-12	CT#82	CP-183018	0091	2	F	Hierarchical subscription with intermediate redirecting NRF	15.2.0
2018-12	CT#82	CP-183018	0093	1	F	Notifications for subscriptions via intermediate NRF	15.2.0
2018-12	CT#82	CP-183018	0096	1	F	DNN and IP Domain in BSF Info	15.2.0
2018-12	CT#82	CP-183018	0097	1	F	PCF Information	15.2.0
2018-12	CT#82	CP-183018	0100	-	F	NF Service FQDN	15.2.0
2018-12	CT#82	CP-183018	0101	-	F	NRF Corrections	15.2.0
2018-12	CT#82	CP-183018	0102	1	F	Notification Data	15.2.0
2018-12	CT#82	CP-183181	0103	2	F	NRF Oauth Scopes	15.2.0
2018-12	CT#82	CP-183182	0104	1	F	NRF Subscription Handling	15.2.0
2018-12	CT#82	CP-183018	0105	-	F	NF Profile Change Notification	15.2.0
2018-12	CT#82	CP-183171	0107	-	F	UDM Group ID	15.2.0
2018-12	CT#82	CP-183018	0108	2	F	Preferred target NF Location in Discovery Request	15.2.0
2018-12	CT#82	CP-183018	0109	1	F	Telescopic FQDN for H NRF	15.2.0
2018-12	CT#82	CP-183184	0112	1	F	Description of NF instances/NF profile retrieval	15.2.0
2018-12	CT#82	CP-183018	0113	-	F	Content of the Subscription to notification response	15.2.0
2018-12	CT#82	CP-183018	0115	-	F	Adding new services in ServiceName enumeration	15.2.0
2018-12	CT#82	CP-183018	0116	-	F	NF Profile Service Instances	15.2.0
2018-12	CT#82	CP-183018	0117	-	F	API Version	15.2.0
2018-12	CT#82	CP-183180	0118	1	F	ExternalDocs Update	15.2.0
2019-03	CT#83	CP-190023	0119	1	F	AmfRegionId and AmfSetId	15.3.0
2019-03	CT#83	CP-190023	0120	1	F	Interpretation of absence of IEs in NF Profile	15.3.0
2019-03	CT#83	CP-190023	0121	1	F	Usage of FQDN and IP address related attributes from NF / NF Service profiles	15.3.0
2019-03	CT#83	CP-190023	0122	1	F	AMF Region and AMF Set in PLMNs supporting multiple PLMN Ids	15.3.0
2019-03	CT#83	CP-190023	0123	1	F	Encoding of GUAMI query parameter in NFDDiscover Request	15.3.0
2019-03	CT#83	CP-190023	0124	1	F	Status for operative NF (service) not discoverable by other NFs	15.3.0
2019-03	CT#83	CP-190023	0126	1	F	Limiting the number of NFProfiles returned in NFDDiscover response	15.3.0
2019-03	CT#83	CP-190023	0127	2	F	Maximum payload size of NFDDiscover Response	15.3.0
2019-03	CT#83	CP-190155	0128	2	F	NF Profile Changes in NF Register / NFUpdate Response	15.3.0
2019-03	CT#83	CP-190023	0129	1	F	supported-features query parameter of NFDDiscover Request	15.3.0
2019-03	CT#83	CP-190023	0130	1	F	OpenAPI Corrections	15.3.0
2019-03	CT#83	CP-190023	0132	1	F	Oauth2 Token Claims	15.3.0
2019-03	CT#83	CP-190023	0133	1	F	Oauth2 Token Type	15.3.0
2019-03	CT#83	CP-190023	0134	1	F	Authorization Attributes of NF Profile	15.3.0
2019-03	CT#83	CP-190023	0135	2	F	Features of NF Discovery service	15.3.0
2019-03	CT#83	CP-190023	0136	-	F	Subscription Authorization for Sets of NFs	15.3.0
2019-03	CT#83	CP-190023	0137	1	F	S-NSSAI per PLMN	15.3.0
2019-03	CT#83	CP-190059	0138	4	F	UPF selection based on PDUSessionType	15.3.0
2019-03	CT#83	CP-190163	0139	2	F	Service Names in URI Query Parameters	15.3.0
2019-03	CT#83	CP-190023	0140	1	F	GLMC URI for Namf_Location EventNotify	15.3.0
2019-03	CT#83	CP-190023	0141	1	F	Corrections on complex query	15.3.0
2019-03	CT#83	CP-190023	0142	1	F	NRF Notifications	15.3.0
2019-03	CT#83	CP-190023	0143	1	F	NRF Heart-Beat	15.3.0
2019-03	CT#83	CP-190023	0144	-	F	Addition of new Service Name	15.3.0
2019-03	CT#83	CP-190023	0145	-	F	API version update	15.3.0
2019-06	CT#84	CP-191034	0146	3	F	PLMN ID in Access Token Claims	15.4.0
2019-06	CT#84	CP-191034	0147	1	F	Content encodings supported in HTTP requests	15.4.0
2019-06	CT#84	CP-191034	0156	3	F	Correct the condition of the FQDN parameter of NFProfile and NFService	15.4.0
2019-06	CT#84	CP-191034	0159	1	F	NRF Service Description	15.4.0
2019-06	CT#84	CP-191034	0161	1	F	Slice Info in NRF	15.4.0

2019-06	CT#84	CP-191034	0162	1	F	Subscription Conditions	15.4.0
2019-06	CT#84	CP-191034	0163	1	F	Vendor-Specific IEs in NF Profile	15.4.0
2019-06	CT#84	CP-191034	0165	2	F	Target PLMN List in Inter-PLMN Service Discovery	15.4.0
2019-06	CT#84	CP-191034	0167	2	F	Storage of OpenAPI specification files	15.4.0
2019-06	CT#84	CP-191034	0170	-	F	Corrections on NFStatusUnSubscribe operation to take into account multiple NRFs	15.4.0
2019-06	CT#84	CP-191034	0171	1	F	Corrections on UpdateSubscription operation to take into account multiple NRFs	15.4.0
2019-06	CT#84	CP-191034	0174	4	F	Corrections on Nnrf_AccessToken Service for multiple NRFs	15.4.0
2019-06	CT#84	CP-191034	0176	-	F	LowerCamel Correction in Data Structures	15.4.0
2019-06	CT#84	CP-191034	0177	-	F	Removal of Basic Authentication	15.4.0
2019-06	CT#84	CP-191034	0178	1	F	Location header in redirect response	15.4.0
2019-06	CT#84	CP-191034	0185	2	F	Add HTTP error codes in 29.510	15.4.0
2019-09	CT#85	CP-192108	0192	4	F	Add selection mechanism for multiple IP addresses in NFProfile	15.4.0
2019-06	CT#84	CP-191034	0194	2	F	Add retrieval of the NF profile using the URI	15.4.0
2019-06	CT#84	CP-191034	0195	1	F	Add the update of subscription in a different PLMN	15.4.0
2019-06	CT#84	CP-191034	0198	1	F	PLMN-IDs in Discovery Response	15.4.0
2019-06	CT#84	CP-191034	0202	-	F	Copyright Note in YAML files	15.4.0
2019-06	CT#84	CP-191034	0206	-	F	3GPP TS 29.510 API version update	15.4.0
2019-06	CT#84	CP-191052	0148	7	B	NWDAF Discovery and Selection	16.0.0
2019-06	CT#84	CP-191057	0149	4	B	Multiple entries of pcflInfo	16.0.0
2019-06	CT#84	CP-191057	0150	3	B	Multiple entries of bsflInfo	16.0.0
2019-06	CT#84	CP-191057	0151	3	B	Multiple entries of smflInfo	16.0.0
2019-06	CT#84	CP-191051	0154	5	B	ATSSS Capability for UPF Selection	16.0.0
2019-06	CT#84	CP-191057	0175	1	B	GPSI range in pcflInfo	16.0.0
2019-06	CT#84	CP-191057	0180	2	B	Multiple entries of xxxInfo (generalized)	16.0.0
2019-06	CT#84	CP-191057	0186	2	F	Add the name of NF Instance	16.0.0
2019-06	CT#84	CP-191057	0187	3	B	Add requester nfnInstanceId parameter in NFStatusSubscribe and NFDiscovery operations	16.0.0
2019-06	CT#84	CP-191034	0196	2	F	Correct The subscription notification procedure under the exception case	16.0.0
2019-06	CT#84	CP-191057	0199	1	B	PCF Group ID	16.0.0
2019-06	CT#84	CP-191057	0200	1	B	Number of NF Instances	16.0.0
2019-06	CT#84	CP-191050	0201	1	B	NIDDAU Service Name	16.0.0
2019-06	CT#84	CP-191054	0204	1	B	UE IP address allocation by UPF	16.0.0
2019-06	CT#84	CP-191048	0205	-	B	3GPP TS 29.510 API version update	16.0.0
2019-09	CT#85	CP-192033	0207	3	C	CBCF as Network Function	16.1.0
2019-09	CT#85	CP-192127	0208	1	F	callbackUri the same as nfnStatusNotificationUri	16.1.0
2019-09	CT#85	CP-192193	0210	1	B	Extensions for I-SMF and I-UPF selection	16.1.0
2019-09	CT#85	CP-192194	0211	2	B	NF Set and NF Service Set	16.1.0
2019-09	CT#85	CP-192034	0212	2	B	Update NRF descriptions to support AF Available Data Registration as described in TS23.288	16.1.0
2019-09	CT#85	CP-192035	0213	3	B	SMF Selection	16.1.0
2019-09	CT#85	CP-192107	0215	-	A	Expiration Time of AccessTokenClaims	16.1.0
2019-09	CT#85	CP-192109	0217	1	F	Requester PLMN ID in SubscriptionData	16.1.0
2019-09	CT#85	CP-192127	0218	-	F	Correct the conditions of the information included in the access token request	16.1.0
2019-09	CT#85	CP-192107	0222	-	A	Slice Information in Access Token Claims	16.1.0
2019-09	CT#85	CP-192130	0223	1	B	UPF collocated with W-AGF	16.1.0
2019-09	CT#85	CP-192127	0224	2	F	URI in Location header for subscription to NF Instances in a different PLMN	16.1.0
2019-09	CT#85	CP-192249	0226	5	A	Support of Static IP Address	16.1.0
2019-09	CT#85	CP-192133	0228	1	B	Network Identifier for Stand-alone Non-Public Networks	16.1.0
2019-09	CT#85	CP-192127	0229	1	F	SMF profile without the smflInfo attribute	16.1.0
2019-09	CT#85	CP-192107	0231	-	A	Authorization Attributes in NF Service	16.1.0
2019-09	CT#85	CP-192123	0232	-	B	Handling of authorization parameters	16.1.0
2019-09	CT#85	CP-192136	0233	1	B	P-CSCF Discovery	16.1.0
2019-09	CT#85	CP-192123	0235	-	B	GPSI support for PCF Query	16.1.0
2019-09	CT#85	CP-192123	0236	-	B	LMF and GMLC Info	16.1.0
2019-09	CT#85	CP-192123	0238	1	B	NEF discovery information for PFD	16.1.0
2019-09	CT#85	CP-192135	0239	-	B	Services invoked by NWDAF	16.1.0
2019-09	CT#85	CP-192127	0240	1	F	Regulation of load update notifications	16.1.0
2019-09	CT#85	CP-192120	0242	-	F	3GPP TS 29.510 API version update	16.1.0
2019-10						Corrupted references fixed	16.1.1
2019-12	CT#86	CP-193063	0244	-	B	Missing NFs information in NrfInfo	16.2.0
2019-12	CT#86	CP-193059	0245	2	B	P-CSCF Discovery based on preferred-locality	16.2.0
2019-12	CT#86	CP-193049	0247	2	B	NEF ID	16.2.0
2019-12	CT#86	CP-193042	0248	-	F	ExternalDocs Clause	16.2.0
2019-12	CT#86	CP-193036	0250	3	F	Support of Static IP Address	16.2.0
2019-12	CT#86	CP-193063	0251	3	B	NRF Bootstrapping	16.2.0
2019-12	CT#86	CP-193056	0252	3	B	I-SMF selection in a mobility procedure	16.2.0
2019-12	CT#86	CP-193283	0253	3	B	UCMF Registration in NRF	16.2.0

2019-12	CT#86	CP-193057	0254	1	B	Handling of default notification subscriptions with Delegated Discovery	16.2.0
2019-12	CT#86	CP-193063	0255	1	B	Support of different priorities in SMF/UPF profiles for different TAIs	16.2.0
2019-12	CT#86	CP-193031	0256	1	A	External Group ID	16.2.0
2019-12	CT#86	CP-193053	0257	2	B	Internal Group Identifier in UdmlInfo	16.2.0
2019-12	CT#86	CP-193054	0258	1	B	HSS Service Discovery	16.2.0
2019-12	CT#86	CP-193063	0259	1	B	NF serving scope	16.2.0
2019-12	CT#86	CP-193031	0260	1	A	S-NSSAI Discovery Parameter	16.2.0
2019-12	CT#86	CP-193063	0261	1	F	NF discovery based on DNN	16.2.0
2019-12	CT#86	CP-193063	0262	1	F	S-NSSAI for SMF or UPF selection	16.2.0
2019-12	CT#86	CP-193055	0264	2	B	GMLC Location service	16.2.0
2019-12	CT#86	CP-193063	0265	-	F	Error code 404 for Hierarchical NRFs	16.2.0
2019-12	CT#86	CP-193063	0266	3	B	Preferred API Version	16.2.0
2019-12	CT#86	CP-193042	0267	3	F	Clarification on Backup AMF Info	16.2.0
2019-12	CT#86	CP-193055	0269	-	B	Location Update Notification Default Subscription	16.2.0
2019-12	CT#86	CP-193044	0273	-	F	3GPP TS 29.510 API version update	16.2.0
2020-03	CT#87	CP-200025	0274	1	B	3GPP Rel-16 LOLC implications on Nnrf service	16.3.0
2020-03	CT#87	CP-200039	0275	2	F	Add Corresponding API descriptions in clause 5.1	16.3.0
2020-03	CT#87	CP-200016	0277	3	F	Service Discovery in a different PLMN using 3gpp-Sbi-Target-apiRoot	16.3.0
2020-03	CT#87	CP-200134	0278	3	B	Data Type Descriptions	16.3.0
2020-03	CT#87	CP-200020	0279	1	D	Editorial corrections in clause headings	16.3.0
2020-03	CT#87	CP-200020	0280	2	B	Service Names	16.3.0
2020-03	CT#87	CP-200029	0281	1	B	SoR Application Function	16.3.0
2020-03	CT#87	CP-200035	0282	3	B	N3 terminations of TWIF for UPF selection	16.3.0
2020-03	CT#87	CP-200044	0283	1	F	Correcting relevant typing errors	16.3.0
2020-03	CT#87	CP-200016	0284	3	B	CHF Group ID	16.3.0
2020-03	CT#87	CP-200101	0285	4	B	S-NSSAIs of an NF Service	16.3.0
2020-03	CT#87	CP-200021	0286	2	F	NFtype enumeration values for MME, SCEF and SCS/AS	16.3.0
2020-03	CT#87	CP-200020	0287	3	F	DNN encoding in NRF APIs	16.3.0
2020-03	CT#87	CP-200047	0288	2	F	Content type of Access Token Request	16.3.0
2020-03	CT#87	CP-200020	0289	2	F	Registering the AccessToken service in another NRF	16.3.0
2020-03	CT#87	CP-200039	0290	3	D	Editorial corrections	16.3.0
2020-03	CT#87	CP-200039	0291	2	F	Correction - formatting consistency	16.3.0
2020-03	CT#87	CP-200020	0293	1	B	29510 CR optionality of ProblemDetails	16.3.0
2020-03	CT#87	CP-200016	0294	1	F	Wrong reference	16.3.0
2020-03	CT#87	CP-200020	0295	1	B	Subscription Condition for UPF	16.3.0
2020-03	CT#87	CP-200026	0297	1	B	OTAF	16.3.0
2020-03	CT#87	CP-200017	0298	1	B	Supported DNN of the I-SMF	16.3.0
2020-03	CT#87	CP-200036	0299	-	B	PCF selection for V2X	16.3.0
2020-03	CT#87	CP-200023	0300	2	B	UPF selection for redundant transmission	16.3.0
2020-03	CT#87	CP-200016	0302	1	B	Service access authorization of a NF Set	16.3.0
2020-03	CT#87	CP-200028	0307	3	B	UDSF registration with NRF	16.3.0
2020-03	CT#87	CP-200016	0308	-	F	API versions supported for default notification subscriptions	16.3.0
2020-03	CT#87	CP-200044	0309	-	F	NF Discovery with intermediate forwarding NRF	16.3.0
2020-03	CT#87	CP-200020	0310	-	F	Modifications in the NRF service APIs for the support of compression	16.3.0
2020-03	CT#87	CP-200020	0311	1	B	Vendor ID in NF Profile	16.3.0
2020-03	CT#87	CP-200177	0312	3	B	LMF selection	16.3.0
2020-03	CT#87	CP-200020	0313	1	B	Load Time Stamp	16.3.0
2020-03	CT#87	CP-200020	0314	1	B	Security Settings	16.3.0
2020-03	CT#87	CP-200016	0315	1	B	NFType for SCP	16.3.0
2020-03	CT#87	CP-200092	0316	-	F	3GPP TS 29.510 API Version Update	16.3.0
2020-07	CT#88	CP-201050	0317	1	B	Support of IPUPS Functionality	16.4.0
2020-07	CT#88	CP-201034	0318	1	F	Authorization parameters in roaming scenarios	16.4.0
2020-07	CT#88	CP-201034	0319	1	F	Missing attributes in NrfInfo data type	16.4.0
2020-07	CT#88	CP-201034	0320	-	F	Slice Differentiator Ranges and Wildcard	16.4.0
2020-07	CT#88	CP-201034	0321	1	F	Undiscoverable NF service	16.4.0
2020-07	CT#88	CP-201057	0322	2	F	Supported Headers and Links Tables	16.4.0
2020-07	CT#88	CP-201030	0323	1	B	Recovery Time for NF Service Set and NF Set	16.4.0
2020-07	CT#88	CP-201022	0324	1	A	Requester-snssais	16.4.0
2020-07	CT#88	CP-201034	0325	2	B	Resource-Level Authorization	16.4.0
2020-07	CT#88	CP-201034	0326	-	B	Data type descriptions	16.4.0
2020-07	CT#88	CP-201034	0327	-	B	Storage of YAML files in ETSI Forge	16.4.0
2020-07	CT#88	CP-201034	0331	1	B	Subscription Condition for a List of NF Instances	16.4.0
2020-07	CT#88	CP-201034	0334	-	B	Serving Scope for NF Subscriptions	16.4.0
2020-07	CT#88	CP-201046	0335	1	B	SMF NIDD Service	16.4.0
2020-07	CT#88	CP-201057	0336	1	F	Datatype column in Resource URI variables Table	16.4.0
2020-07	CT#88	CP-201041	0338	2	F	ServiceName nudsf-dr missing from yaml	16.4.0
2020-07	CT#88	CP-201030	0341	1	F	Presence condition of Set IDs	16.4.0
2020-07	CT#88	CP-201047	0342	1	B	AMF Callback URIs for NSSAA	16.4.0
2020-07	CT#88	CP-201047	0343	1	B	Introduce NSSAAF	16.4.0
2020-07	CT#88	CP-201201	0345	2	F	SCP profile registration and discovery	16.4.0

2020-07	CT#88	CP-201034	0347	1	F	Bootstrapping API	16.4.0
2020-07	CT#88	CP-201034	0348	1	F	Defining xxxInfoExt data types as maps	16.4.0
2020-07	CT#88	CP-201034	0349	-	F	Requester's information in Access Token Request	16.4.0
2020-07	CT#88	CP-201034	0350	-	F	Discovery or subscription requests with missing requester's information	16.4.0
2020-07	CT#88	CP-201030	0354	1	F	Supplement to NefInfo	16.4.0
2020-07	CT#88	CP-201070	0355	1	B	UPF for Data Forwarding	16.4.0
2020-07	CT#88	CP-201031	0356	1	B	V-SMF Selection for Serving Full PLMN	16.4.0
2020-07	CT#88	CP-201045	0357	-	F	NRF Additional Authorization Parameters	16.4.0
2020-07	CT#88	CP-201183	0359	2	F	NRF Notifications	16.4.0
2020-07	CT#88	CP-201034	0360	-	F	NF Services Map	16.4.0
2020-07	CT#88	CP-201034	0361	1	B	NRF Notification Data	16.4.0
2020-07	CT#88	CP-201033	0364	-	B	Service Name for Nhss_EE	16.4.0
2020-07	CT#88	CP-201034	0365	1	F	Maximum payload size	16.4.0
2020-07	CT#88	CP-201073	0368	-	F	3GPP TS 29.510 API Version Update	16.4.0
2020-09	CT#89	CP-202118	0370	-	F	HSS NF Profile Update	16.5.0
2020-09	CT#89	CP-202043	0371	1	F	NF Group ID	16.5.0
2020-09	CT#89	CP-202110	0372	-	F	Handling of S-NSSAI per PLMN	16.5.0
2020-09	CT#89	CP-202119	0375	1	F	scpPrefix attribute in SCP profile	16.5.0
2020-09	CT#89	CP-202119	0376	1	F	Resolving Editor's notes on SCP profile registration and discovery	16.5.0
2020-09	CT#89	CP-202110	0377	-	F	NF Profile Retrieval procedure with NF Services Map	16.5.0
2020-09	CT#89	CP-202118	0378	-	F	Missing NF types for SBA interactions between IMS and 5GC	16.5.0
2020-09	CT#89	CP-202088	0380	-	F	supported-features query parameter	16.5.0
2020-09	CT#89	CP-202088	0381	1	F	Making reqNfType as Conditional IE in SubscriptionData	16.5.0
2020-09	CT#89	CP-202119	0383	3	F	Corrections on attributes for SCP	16.5.0
2020-09	CT#89	CP-202119	0384	1	F	Notification Binding for Default Subscription	16.5.0
2020-09	CT#89	CP-202022	0385	2	F	Message and Information class for Default Subscription	16.5.0
2020-09	CT#89	CP-202110	0386	1	F	Default TCP Port	16.5.0
2020-09	CT#89	CP-202112	0387	1	F	Corrections on definition of NotificationType	16.5.0
2020-09	CT#89	CP-202096	0390	-	F	29.510 Rel-16 API version and External doc update	16.5.0
2020-12	CT#90	CP-203034	0395	2	F	Subscription Authorization parameters for NRF	16.6.0
2020-12	CT#90	CP-203034	0396	2	F	Add a condition to trigger NF_PROFILE_CHANGE notification from NRF for any change in allowedxxx parameter	16.6.0
2020-12	CT#90	CP-203034	0397	2	F	Replace the NFInstanceID with nfInstanceUri in Notification from NRF	16.6.0
2020-12	CT#90	CP-203081	0398	4	F	Supplement to SubscrCond	16.6.0
2020-12	CT#90	CP-203070	0402	2	F	SCP port information	16.6.0
2020-12	CT#90	CP-203048	0404	1	F	preferred-api-versions query parameter	16.6.0
2020-12	CT#90	CP-203053	0405	-	F	P-CSCF addresses	16.6.0
2020-12	CT#90	CP-203054	0406	4	F	Amendments for stateless NF support	16.6.0
2020-12	CT#90	CP-203048	0408	-	F	Storage of YAML files in GitLab	16.6.0
2020-12	CT#90	CP-203048	0410	-	F	Correction in NRF Bootstrapping	16.6.0
2020-12	CT#90	CP-203052	0413	-	F	UDSF Info	16.6.0
2020-12	CT#90	CP-203054	0414	1	F	SCP subscription	16.6.0
2020-12	CT#90	CP-203034	0415	1	F	NF Profile for NF as Service Consumer	16.6.0
2020-12	CT#90	CP-203048	0416	1	F	Preferred Locality Search Result	16.6.0
2020-12	CT#90	CP-203034	0418	2	F	V-SMF Capability	16.6.0
2020-12	CT#90	CP-203048	0419	-	F	Data Type Descriptions	16.6.0
2020-12	CT#90	CP-203036	0420	-	F	29.510 Rel16 API version and External doc update	16.6.0
2020-12	CT#90	CP-203064	0374	2	B	NF Discovery procedure enhancements	17.0.0
2020-12	CT#90	CP-203059	0392	1	F	Discovery answer for no match of query parameter	17.0.0
2020-12	CT#90	CP-203064	0399	1	F	Issues with definition of heartBeatTimer attribute and limit Query-parameter in Open API specification	17.0.0
2020-12	CT#90	CP-203071	0400	2	B	Query parameter for preferred vendor-specific features	17.0.0
2020-12	CT#90	CP-203064	0401	1	F	Support of Wildcard DNN in SmfInfo	17.0.0
2020-12	CT#90	CP-203064	0407	3	B	Select a UP function to setup PFCP Association	17.0.0
2020-12	CT#90	CP-203061	0409	-	D	TS References	17.0.0
2020-12	CT#90	CP-203064	0411	-	F	IP addressing	17.0.0
2020-12	CT#90	CP-203064	0412	2	F	Default Notifications	17.0.0
2020-12	CT#90	CP-203069	0417	4	B	SCP Domain Routing Information	17.0.0
2020-12	CT#90	CP-203055	0421	-	F	29.510 Rel17 API version and External doc update	17.0.0
2021-03	CT#91	CP-210021	0369	3	B	NF discovery based on SUCI information	17.1.0
2021-03	CT#91	CP-210037	0423	1	A	Add snssaiList, pfdData, gpsIRanges, externalGroupIdentifiersRanges, servedFqdnList to NefCond	17.1.0
2021-03	CT#91	CP-210037	0425	1	A	Add snssaiList, taiList and taiRangeList to NwdafCond	17.1.0
2021-03	CT#91	CP-210043	0428	1	A	Encoding of Monitored and Unmonitored Attributes	17.1.0
2021-03	CT#91	CP-210021	0429	2	F	Vendor Specific Features at NF Level	17.1.0
2021-03	CT#91	CP-210021	0430	1	B	SEPP profile	17.1.0
2021-03	CT#91	CP-210021	0431	-	B	NRF supported features in Bootstrapping response	17.1.0
2021-03	CT#91	CP-210043	0433	-	A	Query parameters indicating a preference	17.1.0
2021-03	CT#91	CP-210043	0435	-	A	NFType value for DRA	17.1.0
2021-03	CT#91	CP-210043	0438	2	A	P-CSCF discovery based on UE IP address R17	17.1.0
2021-03	CT#91	CP-210021	0439	1	F	P-CSCF discovery based on UE location	17.1.0

2021-03	CT#91	CP-210053	0443	-	A	Primary / Secondary CHF Instances	17.1.0
2021-03	CT#91	CP-210021	0444	1	B	Enhancements to BSF Info	17.1.0
2021-03	CT#91	CP-210021	0445	2	B	UPF TAI Ranges	17.1.0
2021-03	CT#91	CP-210021	0446	1	F	Editorial Corrections	17.1.0
2021-03	CT#91	CP-210021	0447	2	B	Enhancements to NFListRetrieval service operation	17.1.0
2021-03	CT#91	CP-210022	0450	-	F	Clarification of NF Set ID List	17.1.0
2021-03	CT#91	CP-210021	0451	-	F	IMSI Pattern	17.1.0
2021-03	CT#91	CP-210021	0452	-	F	Correction to Bootstrapping service description	17.1.0
2021-03	CT#91	CP-210021	0453	2	F	Discovery and Subscribe Operation on NF Service Set	17.1.0
2021-03	CT#91	CP-210034	0454	1	D	Correcting Figure 5.2.2.5.4-1	17.1.0
2021-03	CT#91	CP-210034	0455	1	D	Correcting Figure 5.2.2.5.5-1	17.1.0
2021-03	CT#91	CP-210034	0456	-	D	Correcting Figure 5.2.2.6.4-1	17.1.0
2021-03	CT#91	CP-210043	0458	1	A	Essential correction to Subscription Condition data types	17.1.0
2021-03	CT#91	CP-210021	0459	-	F	Supported Vendor-Specific Features	17.1.0
2021-03	CT#91	CP-210055	0461	1	A	Conditional PATCH	17.1.0
2021-03	CT#91	CP-210021	0464	1	B	SCP Domain Routing Info Aggregation	17.1.0
2021-03	CT#91	CP-210037	0466	4	A	SCP Information	17.1.0
2021-03	CT#91	CP-210055	0471	1	A	SubscrCond for PCF and CHF	17.1.0
2021-03	CT#91	CP-210026	0472	1	B	AAAnF discovery	17.1.0
2021-03	CT#91	CP-210025	0473	1	F	hNRF from NSSF in home PLMN	17.1.0
2021-03	CT#91	CP-210029	0474	-	F	29.510 Rel-17 API version and External doc update	17.1.0
2021-06	CT#92	CP-211028	0477	-	B	UDSF Timer service	17.2.0
2021-06	CT#92	CP-211028	0478	2	B	Communication options information	17.2.0
2021-06	CT#92	CP-211027	0479	-	B	Non-3GPP TAI	17.2.0
2021-06	CT#92	CP-211030	0480	1	B	New NSACF NFtype added	17.2.0
2021-06	CT#92	CP-211065	0483	1	F	Usage of IPv6PrefixRange	17.2.0
2021-06	CT#92	CP-211065	0485	-	A	Smf Info Priority	17.2.0
2021-06	CT#92	CP-211028	0486	-	F	OpenAPI Reference	17.2.0
2021-06	CT#92	CP-211065	0488	1	A	Corrections to PFD Data attribute and query parameter	17.2.0
2021-06	CT#92	CP-211039	0489	1	B	Add 5G DDNMF	17.2.0
2021-06	CT#92	CP-211071	0491	1	A	Essential correction on UPF Info	17.2.0
2021-06	CT#92	CP-211031	0492	2	B	(I-)SMF discovery based on DNAI	17.2.0
2021-06	CT#92	CP-211036	0493	1	B	New services provided by NWDAF	17.2.0
2021-06	CT#92	CP-211036	0494	2	B	Analytics IDs per Service	17.2.0
2021-06	CT#92	CP-211057	0496	1	F	Description field for map data types	17.2.0
2021-06	CT#92	CP-211059	0498	1	A	Error Responses for Indirect Communication	17.2.0
2021-06	CT#92	CP-211066	0500	-	A	Event IDs supported by AF	17.2.0
2021-06	CT#92	CP-211039	0501	-	B	Add 5G DDNMF service	17.2.0
2021-06	CT#92	CP-211039	0502	1	B	PCF discovery with ProSe capability indication	17.2.0
2021-06	CT#92	CP-211065	0504	1	A	R17-Access token request verification	17.2.0
2021-06	CT#92	CP-211036	0505	2	B	NWDAF aggregation capability registration in the NRF	17.2.0
2021-06	CT#92	CP-211036	0506	3	B	New DCCF NF Registration and Discovery	17.2.0
2021-06	CT#92	CP-211036	0507	2	B	New MFAF NF Registration and Discovery	17.2.0
2021-06	CT#92	CP-211036	0508	2	B	NWDAF Registration and Discovery enhancement	17.2.0
2021-06	CT#92	CP-211026	0509	1	B	LMF discovery via TAI	17.2.0
2021-06	CT#92	CP-211065	0512	3	A	Remove unused GrantType	17.2.0
2021-06	CT#92	CP-211034	0513	3	B	NSI based SUPI/SUCI	17.2.0
2021-06	CT#92	CP-211028	0514	-	F	Adding some missing description fields to data type definitions in OpenAPI specification files of the Nnrf_NFManagement API	17.2.0
2021-06	CT#92	CP-211059	0515	1	A	Redirect Responses	17.2.0
2021-06	CT#92	CP-211028	0517	1	F	Nested cardinality R17	17.2.0
2021-06	CT#92	CP-211057	0518	2	B	NRF Content Encoding Information	17.2.0
2021-06	CT#92	CP-211028	0519	2	B	SCP capabilities	17.2.0
2021-06	CT#92	CP-211031	0520	-	B	EASDF Registration and Discovery	17.2.0
2021-06	CT#92	CP-211028	0521	-	F	Client-type query parameter alignment	17.2.0
2021-06	CT#92	CP-211036	0522	1	B	Analytics ID of Nnwdaf_MLModelProvision service	17.2.0
2021-06	CT#92	CP-211057	0525	1	F	Add ConditionEventType in Table 6.1.6.1-1	17.2.0
2021-06	CT#92	CP-211028	0528	1	F	Supported Features for Default Subscription	17.2.0
2021-06	CT#92	CP-211028	0529	1	F	NRF Info	17.2.0
2021-06	CT#92	CP-211028	0530	-	F	Clarification of service-names query parameter	17.2.0
2021-06	CT#92	CP-211026	0535	1	B	LMF discovery via Supported GAD shapes	17.2.0
2021-06	CT#92	CP-211039	0536	-	B	Match Information Default Notification	17.2.0
2021-06	CT#92	CP-211050	0537	-	F	29.510 Rel-17 API version and External doc update	17.2.0
2021-09	CT#93	CP-212050	0539	1	F	Multiple PGW FQDNs	17.3.0
2021-09	CT#93	CP-212083	0541	2	B	NSACF Profile	17.3.0
2021-09	CT#93	CP-212030	0542	1	B	NSACF discovery	17.3.0
2021-09	CT#93	CP-212050	0543	1	D	Editorial Corrections	17.3.0
2021-09	CT#93	CP-212030	0544	1	B	NSACF service name	17.3.0
2021-09	CT#93	CP-212031	0547	-	B	Local NEF discovery	17.3.0
2021-09	CT#93	CP-212041	0548	-	B	NFStatusSubscribe for DCCF	17.3.0
2021-09	CT#93	CP-212041	0549	1	B	NFStatusSubscribe for NWDAF	17.3.0

2021-09	CT#93	CP-212026	0551	1	F	Returning the interPlmnFqdn attribute in NFProfile in NF Discovery response	17.3.0
2021-09	CT#93	CP-212094	0552	2	B	MB-SMF registration and discovery	17.3.0
2021-09	CT#93	CP-212095	0553	1	B	TSCTSF NF registration and discovery	17.3.0
2021-09	CT#93	CP-212031	0554	-	F	Cardinality of servedEasdfInfoList in NrInfo	17.3.0
2021-09	CT#93	CP-212043	0556	1	F	Clarification on primaryChfInstance and secondaryChfInstance	17.3.0
2021-09	CT#93	CP-212066	0558	-	A	NFType enumeration value for IMS-AS	17.3.0
2021-09	CT#93	CP-212060	0560	-	A	3xx description correction for SCP	17.3.0
2021-09	CT#93	CP-212026	0561	1	F	Rel-17 NFDiscovery features	17.3.0
2021-09	CT#93	CP-212041	0562	-	B	New ADRF NF Registration and Discovery	17.3.0
2021-09	CT#93	CP-212041	0563	-	B	NWDAF capability enhancement	17.3.0
2021-09	CT#93	CP-212064	0565	1	A	ScplInfo Data Type Definition	17.3.0
2021-09	CT#93	CP-212029	0567	-	B	GBA BSF NF Type and Service Name	17.3.0
2021-09	CT#93	CP-212064	0569	-	A	ScpDomainCond data type definition	17.3.0
2021-09	CT#93	CP-212050	0570	1	F	PGW IP Address	17.3.0
2021-09	CT#93	CP-212036	0571	-	F	Correct incorrect data type name of 5GDdnmInfo	17.3.0
2021-09	CT#93	CP-212026	0573	1	F	Corrections to the API URI	17.3.0
2021-09	CT#93	CP-212059	0575	-	F	29.510 Rel-17 API version and External doc update	17.3.0
2021-12	CT#94	CP-213097	0577	2	B	MB-SMF registration and discovery - Updates	17.4.0
2021-12	CT#94	CP-213086	0579	2	F	Correction on service operation description	17.4.0
2021-12	CT#94	CP-213085	0581	1	B	Discovering whether OAuth2 authorization is required for accessing NRF services	17.4.0
2021-12	CT#94	CP-213108	0584	1	B	BSF NF Profile definition for DCAMP	17.4.0
2021-12	CT#94	CP-213108	0585	1	B	New PCF Service Name for PCF AM Policy Authorization	17.4.0
2021-12	CT#94	CP-213097	0586	1	B	MB-UPF registration and discovery	17.4.0
2021-12	CT#94	CP-213093	0587	1	B	Support for Service Specific Authorization	17.4.0
2021-12	CT#94	CP-213102	0588	3	B	AF Slice and DNN registration via NEF	17.4.0
2021-12	CT#94	CP-213096	0590	-	B	LMFInfo update for SAT access	17.4.0
2021-12	CT#94	CP-213093	0591	1	B	EASDF discovery based on UPF N6 address	17.4.0
2021-12	CT#94	CP-213093	0592	1	B	Local NEF discovery based on list of TAs	17.4.0
2021-12	CT#94	CP-213102	0593	1	B	Trusted AF registration and discovery	17.4.0
2021-12	CT#94	CP-213092	0595	1	F	Correction of NSACF discovery	17.4.0
2021-12	CT#94	CP-213085	0596	-	F	Correction on ScpDomainInfo	17.4.0
2021-12	CT#94	CP-213101	0597	2	B	ServiceName data type extension to cover the missing TSCTSF and NEF services	17.4.0
2021-12	CT#94	CP-213086	0599	1	B	Precedence of Preferred Parameters	17.4.0
2021-12	CT#94	CP-213193	0603	2	A	GMLC-Number in GmlInfo	17.4.0
2021-12	CT#94	CP-213097	0606	1	B	Selection of collocated MB-SMF/SMF and MB-UPF/UPF	17.4.0
2021-12	CT#94	CP-213091	0608	-	B	New Service Names for HSS GBA Services	17.4.0
2021-12	CT#94	CP-213087	0609	1	B	Group ranges in HSS Info	17.4.0
2021-12	CT#94	CP-213093	0610	-	B	EASDF Baseline DNS Pattern service	17.4.0
2021-12	CT#94	CP-213097	0611	-	B	New services for MBS	17.4.0
2021-12	CT#94	CP-213116	0612	-	F	Incorrect reference to NF Service Set ID definition in TS 23.003	17.4.0
2021-12	CT#94	CP-213116	0613	-	F	requester-plmn-list query parameter	17.4.0
2021-12	CT#94	CP-213088	0615	1	F	NRF Hierarchy	17.4.0
2021-12	CT#94	CP-213087	0617	1	B	Discovery Result Change Notification	17.4.0
2021-12	CT#94	CP-213131	0619	1	F	NF Service Redundancy Level	17.4.0
2021-12	CT#94	CP-213201	0623	2	B	hNRF URI	17.4.0
2021-12	CT#94	CP-213088	0625	-	A	NFType value for CEF	17.4.0
2021-12	CT#94	CP-213087	0626	1	F	Subscription on SCP domain	17.4.0
2021-12	CT#94	CP-213087	0627	1	B	PLMN Specific attributes in NF profile	17.4.0
2021-12	CT#94	CP-213121	0628	-	F	29.510 Rel-17 API version and External doc update	17.4.0
2022-03	CT#95	CP-220047	0630	6	B	SNPN impacts on NRF - DCS/CH identification	17.5.0
2022-03	CT#95	CP-220047	0632	-	F	SNPN impacts on NRF services - R17	17.5.0
2022-03	CT#95	CP-220267	0633	2	F	SNPN impacts on NRF – OnboardingCapability	17.5.0
2022-03	CT#95	CP-220023	0634	1	F	Static Authorization	17.5.0
2022-03	CT#95	CP-220035	0636	1	B	MB-SMF discovery by AMF using MBS Session ID and Area Session ID	17.5.0
2022-03	CT#95	CP-220088	0637	-	F	AMF name in N2InterfaceAmfInfo	17.5.0
2022-03	CT#95	CP-220024	0638	1	B	Returning NRF altered priorities when using the Enhanced NF Discovery feature	17.5.0
2022-03	CT#95	CP-220044	0639	1	B	UAS Capability Indication for NEF	17.5.0
2022-03	CT#95	CP-220044	0640	-	B	UAS Service Name	17.5.0
2022-03	CT#95	CP-220024	0642	2	F	SUCI information corrections	17.5.0
2022-03	CT#95	CP-220043	0643	3	B	Add ProSe Capability in PcfInfo	17.5.0
2022-03	CT#95	CP-220056	0645	2	B	Add V2X Capability	17.5.0
2022-03	CT#95	CP-220057	0646	2	B	NSSAAF registration and discovery	17.5.0
2022-03	CT#95	CP-220024	0648	2	F	Handling of PLMN ID in Subscription to NF Profile Change	17.5.0
2022-03	CT#95	CP-220036	0649	1	B	Data Restoration Default Notification	17.5.0
2022-03	CT#95	CP-220023	0651	-	F	NSACF Information	17.5.0
2022-03	CT#95	CP-220047	0652	-	B	NSSAAF AIW Service Name	17.5.0
2022-03	CT#95	CP-220148	0653	4	B	Subscription Context in Notifications	17.5.0

2022-03	CT#95	CP-220024	0654	1	B	Resource-based authorization on the NRF APIs	17.5.0
2022-03	CT#95	CP-220092	0655	-	F	NF (Service) Set Status Change	17.5.0
2022-03	CT#95	CP-220023	0657	1	B	Preferred PGW Query Parameter	17.5.0
2022-03	CT#95	CP-220048	0658	1	B	TSCTS Discovery	17.5.0
2022-03	CT#95	CP-220049	0659	1	B	AF registration with support of mapping between UE IP address and UE ID	17.5.0
2022-03	CT#95	CP-220092	0667	-	F	ServiceName data type extension to cover the missing NEF services	17.5.0
2022-03	CT#95	CP-220053	0669	1	B	NSWO NF	17.5.0
2022-03	CT#95	CP-220025	0670	1	F	UDR storing of non-subscriber related data	17.5.0
2022-03	CT#95	CP-220024	0671	-	B	UDR storing data sub-sets	17.5.0
2022-03	CT#95	CP-220088	0672	-	F	Subscription with GuamiListCond	17.5.0
2022-03	CT#95	CP-220024	0673	-	F	Bootstrapping headers	17.5.0
2022-03	CT#95	CP-220084	0676	-	A	Encoding of Access Token Request	17.5.0
2022-03	CT#95	CP-220025	0677	1	B	P-CSCF Restoration Enhancements	17.5.0
2022-03	CT#95	CP-220024	0678	-	F	HSS Type is missing for NfGroupCond	17.5.0
2022-03	CT#95	CP-220049	0685	1	B	Corrections to Authorization procedure for eNA scenario	17.5.0
2022-03	CT#95	CP-220032	0686	1	F	Subscription Id in message body	17.5.0
2022-03	CT#95	CP-220025	0687	1	F	Error responses to NRF OAuth 2.0 Access Token Request	17.5.0
2022-03	CT#95	CP-220025	0688	1	B	NRF Set support	17.5.0
2022-03	CT#95	CP-220066	0689	-	F	29.510 Rel-17 API version and External doc update	17.5.0
2022-06	CT#96	CP-221049	0692	6	F	Adding ismfSupportInd to the SmfInfo	17.6.0
2022-06	CT#96	CP-221028	0694	2	F	Correction and clarification on NotificationType	17.6.0
2022-06	CT#96	CP-221049	0698	1	F	Supported PLMN for CHF Discovery	17.6.0
2022-06	CT#96	CP-221043	0699	-	B	PKMF Function and Service	17.6.0
2022-06	CT#96	CP-221023	0700	-	F	MBS Service Area Information for Location dependent MBS session	17.6.0
2022-06	CT#96	CP-221028	0701	1	A	SMF profile without smfInfo and smfInfoList attributes	17.6.0
2022-06	CT#96	CP-221023	0702	-	F	MBS NF types	17.6.0
2022-06	CT#96	CP-221028	0703	1	F	Description Fields	17.6.0
2022-06	CT#96	CP-221029	0704	2	F	Fqdn Data Type Definition	17.6.0
2022-06	CT#96	CP-221031	0705	-	B	Target Network Resolution	17.6.0
2022-06	CT#96	CP-221031	0708	3	B	Support of MNP	17.6.0
2022-06	CT#96	CP-221027	0709	-	F	OAuth2 scopes	17.6.0
2022-06	CT#96	CP-221038	0710	1	F	NWDAF Discovery	17.6.0
2022-06	CT#96	CP-221036	0712	-	B	Remote SNPNs reachable through an SCP or SEPP	17.6.0
2022-06	CT#96	CP-221049	0714	-	F	Delete the default value of vsmfSupportInd in A.2	17.6.0
2022-06	CT#96	CP-221024	0715	1	B	MBSF/MB-STF profiles in NRF	17.6.0
2022-06	CT#96	CP-221036	0716	-	F	SMF UP remote provisioning capability	17.6.0
2022-06	CT#96	CP-221024	0717	1	F	MB-SMF discovering AMF(s)	17.6.0
2022-06	CT#96	CP-221028	0718	-	F	HSS Diameter Address	17.6.0
2022-06	CT#96	CP-221028	0719	-	F	Locality Based Priority	17.6.0
2022-06	CT#96	CP-221028	0720	-	F	Application Data Subsets	17.6.0
2022-06	CT#96	CP-221038	0721	-	F	Clarification of DCCF Info and NWDAF Info	17.6.0
2022-06	CT#96	CP-221029	0722	1	F	Encoding of Query Parameters	17.6.0
2022-06	CT#96	CP-221037	0723	-	F	New Service Names	17.6.0
2022-06	CT#96	CP-221031	0724	-	B	NF registration and discovery of SMS-IWMSC	17.6.0
2022-06	CT#96	CP-221037	0725	1	F	TSCTS Default Notification	17.6.0
2022-06	CT#96	CP-221029	0726	-	F	NRF Bootstrapping Headers	17.6.0
2022-06	CT#96	CP-221051	0728	-	F	29.510 Rel-17 API version and External doc update	17.6.0
2022-09	CT#97	CP-222026	0729	-	F	Add seppPrefix attribute in SEPP profile	17.7.0
2022-09	CT#97	CP-222037	0730	-	F	CH/DCS using AAA-S vs AUSF/UDM	17.7.0
2022-09	CT#97	CP-222027	0732	1	F	nudm-rsds Service	17.7.0
2022-09	CT#97	CP-222026	0734	1	F	Removing an editor's note	17.7.0
2022-09	CT#97	CP-222026	0738	-	F	Clarifications to the definition of the PreferredSearch data type	17.7.0
2022-09	CT#97	CP-222050	0739	-	F	allowedOperationsPerNfType IE and allowedOperationsPerNfInstance IE in NFService	17.7.0
2022-09	CT#97	CP-222026	0740	-	F	Excluding NF (service) instances or NF (service) sets from NF Discovery procedure	17.7.0
2022-09	CT#97	CP-222026	0741	-	F	SD ranges and wildcard SD	17.7.0
2022-09	CT#97	CP-222026	0742	1	F	Clarification on Home Network Public Key used for Routing	17.7.0
2022-09	CT#97	CP-222050	0744	-	F	Extend AccessTokenClaim to include producerNfServiceSetId	17.7.0
2022-09	CT#97	CP-222037	0745	-	F	Extend AccessTokenReq and AccessTokenclaims to include SNPN-ID	17.7.0
2022-09	CT#97	CP-222026	0746	2	F	No Profile Match information	17.7.0
2022-09	CT#97	CP-222037	0747	1	F	SMF UPRP capability	17.7.0
2022-09	CT#97	CP-222035	0748	-	F	ProSe Anchor Function Support	17.7.0
2022-09	CT#97	CP-222050	0749	1	F	IP Index in UPF Information	17.7.0
2022-09	CT#97	CP-222050	0750	1	F	NRF Altered Priority for Enhanced NF Discovery	17.7.0
2022-09	CT#97	CP-222050	0752	1	F	Service Specific Info for Default Notification Subscription	17.7.0
2022-09	CT#97	CP-222038	0753	2	F	NWDAF discovery based on Analytics Delay	17.7.0
2022-09	CT#97	CP-222026	0754	1	F	Unknown NF Instance Id in subscription	17.7.0
2022-09	CT#97	CP-222026	0755	-	F	Clarification of NF Discovery Service Description	17.7.0
2022-09	CT#97	CP-222058	0759	-	F	29.510 Rel-17 API version and External doc update	17.7.0

2022-09	CT#97	CP-222021	0733	-	B	Additional HSS Diameter Addresses in HssInfo	18.0.0
2022-09	CT#97	CP-222021	0735	2	B	Locality based NF Discovery enhancements	18.0.0
2022-09	CT#97	CP-222021	0756	1	B	Allowed Operations per NF Type or NF Instance	18.0.0
2022-09	CT#97	CP-222025	0761	-	F	29.510 Rel-18 API version and External doc update	18.0.0
2022-12	CT#98	CP-223029	0737	2	B	SEPP registration and discovery with N32 purpose	18.1.0
2022-12	CT#98	CP-223067	0765	1	A	Notification Type for Delivery of Ciphering Key Information	18.1.0
2022-12	CT#98	CP-223029	0766	3	F	IP Ranges and IP Index	18.1.0
2022-12	CT#98	CP-223027	0767	1	F	Default network instance for a S-NSSAI and DNN	18.1.0
2022-12	CT#98	CP-223029	0768	2	B	UPF Selection	18.1.0
2022-12	CT#98	CP-223088	0769	2	B	Discovery by SCP of complete NF Profile	18.1.0
2022-12	CT#98	CP-223044	0772	2	A	NSACF Discovery with Locality	18.1.0
2022-12	CT#98	CP-223090	0773	2	B	Preferred Features	18.1.0
2022-12	CT#98	CP-223029	0774	3	B	SMSF For Roaming UEs	18.1.0
2022-12	CT#98	CP-223027	0775	-	F	Additional HSS Diameter Addresses in HssInfo	18.1.0
2022-12	CT#98	CP-223027	0782	1	F	OpenApi Semantic Checks	18.1.0
2022-12	CT#98	CP-223027	0783	-	F	Clarification of IpEndPoint	18.1.0
2022-12	CT#98	CP-223029	0784	2	F	Optimization of NF service discovery for avoiding duplicated signaling overhead	18.1.0
2022-12	CT#98	CP-223033	0785	-	F	29.510 Rel-18 API version and External doc update	18.1.0
2023-03	CT#99	CP-230077	0789	2	F	Reusing tai-list URI query parameter for 5MBS	18.2.0
2023-03	CT#99	CP-230029	0791	1	F	Interpretation of False Value in Query Parameters	18.2.0
2023-03	CT#99	CP-230085	0793	3	A	AMF Support for High Latency Communication	18.2.0
2023-03	CT#99	CP-230034	0794	-	B	Registration and Discovery of UPF Event Exposure service	18.2.0
2023-03	CT#99	CP-230029	0795	1	B	Retrieving NF profiles of a list of target NF Instance IDs	18.2.0
2023-03	CT#99	CP-230029	0796	-	F	nfServiceList in NotificationData	18.2.0
2023-03	CT#99	CP-230029	0797	1	F	nfSetId in AMF profile	18.2.0
2023-03	CT#99	CP-230057	0798	-	F	allowedSnps in NF profile and requester-snpn-list in NF Discovery Request	18.2.0
2023-03	CT#99	CP-230057	0799	-	F	plmnList IE in NF profile of an NF pertaining to an SNPN	18.2.0
2023-03	CT#99	CP-230059	0800	-	F	requesterSnssaiList IE in Access Token Request	18.2.0
2023-03	CT#99	CP-230077	0802	-	A	Errors in the definition of the collocatedNfInstances IE	18.2.0
2023-03	CT#99	CP-230034	0805	1	B	Discovery of the serving UPF for a PDU session using NATed IP address	18.2.0
2023-03	CT#99	CP-230081	0807	-	A	Nudm UE Identifier Service	18.2.0
2023-03	CT#99	CP-230094	0810	-	A	Essential Correction for Requester-Features Query Parameter	18.2.0
2023-03	CT#99	CP-230029	0812	-	F	Lower case of UUIDs in URIs	18.2.0
2023-03	CT#99	CP-230064	0816	2	F	URI scheme used for inter-PLMN signalling	18.2.0
2023-03	CT#99	CP-230071	0817	-	F	29.510 Rel-18 API version and External doc update	18.2.0
2023-06	CT#100	CP-231025	0819	-	F	allowedNFTypes contradiction correction	18.3.0
2023-06	CT#100	CP-231031	0820	1	B	PRU serving LMF(s) discovery	18.3.0
2023-06	CT#100	CP-231122	0821	2	B	GNSS assistance data collection from AF	18.3.0
2023-06	CT#100	CP-231047	0823	1	B	NWDAF selection on support ML model sharing	18.3.0
2023-06	CT#100	CP-231084	0827	1	A	Align the description of Requester PLMN List IEs	18.3.0
2023-06	CT#100	CP-231123	0828	1	B	Enhancement of NRF services to support DCSF registration and discovery	18.3.0
2023-06	CT#100	CP-231079	0832	-	A	Handling of NRF Subscriptions in SNPN scenarios	18.3.0
2023-06	CT#100	CP-231028	0833	1	F	Content of Profile Update response messages	18.3.0
2023-06	CT#100	CP-231035	0835	2	F	Clarification for NATed IP Address	18.3.0
2023-06	CT#100	CP-231035	0836	1	B	Registration and Discovery of Nupf_GetPrivateUEIPAddr service	18.3.0
2023-06	CT#100	CP-231050	0837	3	B	NRF service enhancement to support MRF registration and discovery	18.3.0
2023-06	CT#100	CP-231078	0840	1	A	Add service Npanf_ResolveRemoteUserId	18.3.0
2023-06	CT#100	CP-231078	0842	1	A	Add service Npkmf_ResolveRemoteUserId	18.3.0
2023-06	CT#100	CP-231042	0843	-	B	Add PCF capability of supporting 5G ProSe UE-to-UE relay	18.3.0
2023-06	CT#100	CP-231050	0844	3	B	NRF service enhancement to support DCMF registration and discovery	18.3.0
2023-06	CT#100	CP-231073	0846	-	A	Default Notification for Inter-Plmn Access	18.3.0
2023-06	CT#100	CP-231028	0847	1	B	Indication of Ignored Query Parameters	18.3.0
2023-06	CT#100	CP-231084	0849	1	A	Unsupported Query Parameter Handling	18.3.0
2023-06	CT#100	CP-231047	0850	-	B	Accuracy checking capability in NWDAF	18.3.0
2023-06	CT#100	CP-231047	0851	2	B	NWDAF containing MTLF selection	18.3.0
2023-06	CT#100	CP-231071	0854	2	A	Removal of OpenAPI constraint for interPlmnFqdn in NotificationData	18.3.0
2023-06	CT#100	CP-231028	0855	-	D	Typo correction	18.3.0
2023-06	CT#100	CP-231070	0856	-	F	29.510 Rel-18 API version and External doc update	18.3.0
2023-09	CT#101	CP-232033	0770	5	B	Enhancements to Authorization Policy in NF-Service Profile	18.4.0
2023-09	CT#101	CP-232033	0852	4	B	Support for Canary Testing via NRF	18.4.0
2023-09	CT#101	CP-232033	0858	-	F	NefInfo clarification	18.4.0
2023-09	CT#101	CP-232050	0859	1	B	NEF Registration and Discovery for Multi-member AF session capability	18.4.0
2023-09	CT#101	CP-232033	0863	1	B	Additional OAuth2 scope for the NRF Management API	18.4.0
2023-09	CT#101	CP-232033	0864	1	B	Prefix in Callback URIs	18.4.0
2023-09	CT#101	CP-232033	0865	-	F	Array cardinality correction	18.4.0
2023-09	CT#101	CP-232033	0867	2	B	NF Instances supporting at least one TA in the ta-list	18.4.0

2023-09	CT#101	CP-232042	0868	2	B	Extension of NWDAF registration information to reflect roaming exchange capability	18.4.0
2023-09	CT#101	CP-232050	0869	1	B	New PCF and NEF services	18.4.0
2023-09	CT#101	CP-232050	0870	-	B	New PDTQ related UDR PolicyData subset	18.4.0
2023-09	CT#101	CP-232033	0871	-	F	Removal of OpenAPI constraint for interPlmnFqdn in NotificationData	18.4.0
2023-09	CT#101	CP-232046	0872	-	B	PCF selection for A2X	18.4.0
2023-09	CT#101	CP-232045	0873	1	B	Missing ims-domain-name and media-capability-list in the OpenAPI of Nnrf_NFDDiscovery Service API	18.4.0
2023-09	CT#101	CP-232035	0874	1	B	Support PRU function of LMF profile	18.4.0
2023-09	CT#101	CP-232047	0876	1	A	Default Notification Type for UUA-MM	18.4.0
2023-09	CT#101	CP-232033	0877	2	B	Preferred UPF Selection for Non-3GPP PDU Session	18.4.0
2023-09	CT#101	CP-232078	0881	1	A	Essential Correction on Notification Data for NF Instance Removed from NF Set	18.4.0
2023-09	CT#101	CP-232042	0883	1	B	ADRF registration and discovery	18.4.0
2023-09	CT#101	CP-232042	0885	1	B	Support for relocation of data subscription as a new capability of DCCF	18.4.0
2023-09	CT#101	CP-232045	0886	3	F	Change DCMF to MF	18.4.0
2023-09	CT#101	CP-232049	0887	1	B	Update on LMF selection for Ranging_SL	18.4.0
2023-09	CT#101	CP-232049	0888	2	B	Update on PCF selection for Ranging_SL	18.4.0
2023-09	CT#101	CP-232060	0890	-	F	29.510 Rel-18 API version and External doc update	18.4.0
2023-12	CT#102	CP-233046	0893	4	B	NSACF Role Definition	18.5.0
2023-12	CT#102	CP-233039	0895	1	B	NSACF Capability for counting the number of UEs with at least one PDU session / PDN connection	18.5.0
2023-12	CT#102	CP-233027	0896	-	F	PGW IP addresses in SmfInfo	18.5.0
2023-12	CT#102	CP-233028	0897	1	B	Callback URI prefix	18.5.0
2023-12	CT#102	CP-233027	0898	-	F	Corrections of the service-names and validityPeriod IEs	18.5.0
2023-12	CT#102	CP-233059	0900	1	B	Mapping between Routing Indicator and NF Group ID	18.5.0
2023-12	CT#102	CP-233027	0901	-	B	Resolution of Editor's Note on Canary Release tests	18.5.0
2023-12	CT#102	CP-233028	0902	1	F	HTTP RFCs obsoleted by IETF RFC 9110, 9111 and 9113	18.5.0
2023-12	CT#102	CP-233030	0903	2	F	Clarification of IpEndpoint data structure	18.5.0
2023-12	CT#102	CP-233029	0904	1	B	ProblemDetails RFC 7807 obsoleted by 9457	18.5.0
2023-12	CT#102	CP-233048	0906	-	B	Remove EN for IP address and IP range used for MF registration and discovery	18.5.0
2023-12	CT#102	CP-233045	0909	-	F	Completing the description of roaming-exchange-ind	18.5.0
2023-12	CT#102	CP-233045	0910	1	B	Completion and alignment of ADRF information for registration and discovery	18.5.0
2023-12	CT#102	CP-233037	0911	1	B	User plane positioning capability of LMF	18.5.0
2023-12	CT#102	CP-233031	0914	6	B	Indication in NF registration for authorization based on sufficient slice information	18.5.0
2023-12	CT#102	CP-233050	0915	-	B	Update to support SLPKMF	18.5.0
2023-12	CT#102	CP-233064	0918	6	B	NSAC service area support for hplmn and vplmn NF consumers	18.5.0
2023-12	CT#102	CP-233047	0919	-	F	Missing DataSetIds in UdrInfo	18.5.0
2023-12	CT#102	CP-233069	0921	-	A	Service Name for Npkmf_Discovery Service	18.5.0
2023-12	CT#102	CP-233031	0923	3	B	S-NSSAIs in NF Discovery Result	18.5.0
2023-12	CT#102	CP-233041	0925	1	B	Discovering all the NF profiles or NF Instance IDs matching the query parameters	18.5.0
2023-12	CT#102	CP-233032	0926	-	B	Nnef_DNAIMapping service	18.5.0
2023-12	CT#102	CP-233038	0927	-	B	Nnef_TrafficInfluenceData and Nnef_ECSEAddress services	18.5.0
2023-12	CT#102	CP-233044	0928	-	F	Naf_ProSe and Naf_EventExposure services	18.5.0
2023-12	CT#102	CP-233044	0929	-	F	Incorrect cardinality of the mbs-session-id-list query parameter	18.5.0
2023-12	CT#102	CP-233063	0931	-	A	MBS services and data set	18.5.0
2023-12	CT#102	CP-233075	0932	1	B	Additional User Plane Interfaces	18.5.0
2023-12	CT#102	CP-233031	0933	2	B	Traffic Separation at User Plane Interfaces	18.5.0
2023-12	CT#102	CP-233048	0935	1	B	Update the MediaCapability data type to string	18.5.0
2023-12	CT#102	CP-233045	0936	3	F	Corrections of the input parameters for discovery of NWDAF with FL capability	18.5.0
2023-12	CT#102	CP-233050	0937	-	F	Correction of query parameter Ranging-SI-Pos-Indication	18.5.0
2023-12	CT#102	CP-233059	0938	4	B	Simplifying the NF service discovery response of inter-PLMN	18.5.0
2023-12	CT#102	CP-233046	0942	1	B	Extending the description of sNssais to SNPN	18.5.0
2023-12	CT#102	CP-233032	0943	1	B	Aligning the service name with stage-2 specification	18.5.0
2023-12	CT#102	CP-233045	0945	1	B	Adding new data analytics services in enumeration table	18.5.0
2023-12	CT#102	CP-233060	0947	-	F	29.510 Rel-18 API version and External doc update	18.5.0
2024-03	CT#103	CP-240036	0905	5	B	Shared Data in Nnrf_NFManagement and Nnrf_NFDDiscovery APIs	18.6.0
2024-03	CT#103	CP-240028	0949	3	B	UpfInfo and SmfInfo optimization	18.6.0
2024-03	CT#103	CP-240038	0952	-	F	DNAI configuration for UPF deployed on satellite	18.6.0
2024-03	CT#103	CP-240042	0953	3	F	Clarification on Served Slice List Configured for an NSACF	18.6.0
2024-03	CT#103	CP-240031	0954	-	B	Nnef_UEId service	18.6.0
2024-03	CT#103	CP-240028	0955	1	B	SMF Selection based on PLMN ID of UE for an LBO PDU Session	18.6.0
2024-03	CT#103	CP-240028	0956	1	F	NoProfileMatchInfo caching in SCPs	18.6.0
2024-03	CT#103	CP-240030	0957	3	F	Specific load notification for NFStatus subscribe	18.6.0
2024-03	CT#103	CP-240055	0959	-	B	Roaming Hub as NF Type	18.6.0

2024-03	CT#103	CP-240047	0960	1	B	New capabilities of PCF for registration and discovery	18.6.0
2024-03	CT#103	CP-240044	0961	1	F	Correction of the query parameter for A2X capability	18.6.0
2024-03	CT#103	CP-240041	0962	-	B	Align ML Model Interoperability indicator to stage 2 specification	18.6.0
2024-03	CT#103	CP-240030	0963	2	F	Completing LMF NF Profile for registration in NRF	18.6.0
2024-03	CT#103	CP-240057	0966	-	A	Corrections to the NRF Set feature	18.6.0
2024-03	CT#103	CP-240066	0968	-	A	Corrections to the service names	18.6.0
2024-03	CT#103	CP-240041	0969	-	B	New NWDAF services	18.6.0
2024-03	CT#103	CP-240028	0972	-	B	Resolution of Editor's Note in Canary Test Annex	18.6.0
2024-03	CT#103	CP-240028	0973	1	B	Exclusive Selection of "Canary Release" instances	18.6.0
2024-03	CT#103	CP-240028	0974	-	F	NF_NOT_FOUND application error	18.6.0
2024-03	CT#103	CP-240028	0975	2	B	Unsupported NF Type	18.6.0
2024-03	CT#103	CP-240028	0976	1	F	SubscriptionId in Subscription Create message	18.6.0
2024-03	CT#103	CP-240058	0978	-	A	SMS-SBI NF Types	18.6.0
2024-03	CT#103	CP-240056	0980	-	F	29.510 Rel-18 API version and External doc update	18.6.0
2024-06	CT#104	CP-241028	0982	-	F	Correct the reference to mbsServiceArea	18.7.0
2024-06	CT#104	CP-241028	0983	1	F	False Value of I/V-SMF Support Indication	18.7.0
2024-06	CT#104	CP-241042	0984	5	F	Clarification on presence of IE of snssaiListForEntirePlmn and nsacSaiList in NsacInfo	18.7.0
2024-06	CT#104	CP-241036	0986	-	F	Shared Data corrections and clean up	18.7.0
2024-06	CT#104	CP-241036	0987	3	F	Retrieval of multiple shared data	18.7.0
2024-06	CT#104	CP-241050	0989	-	F	Add the nlmf_broadcast service to the service name list	18.7.0
2024-06	CT#104	CP-241028	0990	-	F	Missed UDSF for NF Group Id Query	18.7.0
2024-06	CT#104	CP-241050	0991	-	F	Incorrect IE Name in Default Notification Subscription Data Type	18.7.0
2024-06	CT#104	CP-241028	0993	2	F	Definition of SelectionConditions	18.7.0
2024-06	CT#104	CP-241028	0994	-	F	Addition of "servers" section in OpenAPI	18.7.0
2024-06	CT#104	CP-241031	0995	1	B	N6 tunnel Information for a V-UPF or a V-EASDF for HR-SBO PDU sessions	18.7.0
2024-06	CT#104	CP-241028	0996	1	B	Clarify NRF behavior upon receiving invalid client information in discovery request	18.7.0
2024-06	CT#104	CP-241050	0997	1	F	Clarifying the self-references and editorial corrections	18.7.0
2024-06	CT#104	CP-241071	0998	3	F	Alignment of discovery parameters with stage-2	18.7.0
2024-06	CT#104	CP-241050	1000	1	F	Missing description in the API	18.7.0
2024-06	CT#104	CP-241036	1001	2	F	Write Access to Shared Profile Data	18.7.0
2024-06	CT#104	CP-241054	1003	1	F	Add a reference of NsacSai	18.7.0
2024-06	CT#104	CP-241042	1004	1	F	Examples of NsacInfo for different deployments	18.7.0
2024-06	CT#104	CP-241041	1005	2	F	Correction of NWDAF registration	18.7.0
2024-06	CT#104	CP-241041	1006	4	B	Specifying access token request and claims for NWDAF containing MTLF	18.7.0
2024-06	CT#104	CP-241031	1007	-	F	ECS Address Configuration Information (EACI) application data subset	18.7.0
2024-06	CT#104	CP-241031	1008	1	F	DNS security protocols supported by (V-)EASDF	18.7.0
2024-06	CT#104	CP-241028	1009	1	F	SEPP profile when no remote PLMN is reachable through the SEPP	18.7.0
2024-06	CT#104	CP-241053	1011	-	A	Corrections to SubscrCond data structure	18.7.0
2024-06	CT#104	CP-241028	1012	2	F	Clarifications to udrlInfo, udmlInfo, ausfInfo and pcflInfo	18.7.0
2024-06	CT#104	CP-241071	1013	1	F	Matching of ML Analytics Info	18.7.0
2024-06	CT#104	CP-241028	1014	1	B	Handling of certificate expiry/re-issue	18.7.0
2024-06	CT#104	CP-241044	1015	1	B	Add new NotificationType for DC session event notification	18.7.0
2024-06	CT#104	CP-241052	1018	-	F	29.510 Rel-18 API version and External doc update	18.7.0
2024-09	CT#105	CP-242053	1020	-	F	Missing Pilcrow in yaml	18.8.0
2024-09	CT#105	CP-242039	1023	1	F	Clarify the NF Type in the NfGroupCond	18.8.0
2024-09	CT#105	CP-242039	1026	1	F	Missing Application Data Subsets within dataSetId	18.8.0
2024-09	CT#105	CP-242048	1027	1	F	Update the NrfInfo to include the information of DCSF, MF, MRF and MRFP	18.8.0
2024-09	CT#105	CP-242053	1034	-	F	Incorrect URI in Figure 5.3.2.6-1 (SCPDomainRoutingInfoUnSubscribe)	18.8.0
2024-09	CT#105	CP-242053	1035	1	F	Correction on RFC Clause Reference	18.8.0
2024-09	CT#105	CP-242213	1037	2	F	Authorize ML model service consumer	18.8.0
2024-09	CT#105	CP-242054	1044	-	F	29.510 Rel-18 API version and External doc update	18.8.0
2024-12	CT#106	CP-243028	1065	1	F	Discovery of AnLF based of vendor Id	18.9.0
2024-12	CT#106	CP-243024	1070	1	F	Correction of PCF information	18.9.0
2024-12	CT#106	CP-243021	1077	1	A	DataSetId Usage Essential Correction	18.9.0
2024-12	CT#106	CP-243028	1093	2	F	Addition of missing service	18.9.0
2024-12	CT#106	CP-243068	1114	-	F	API version and External doc update	18.9.0

History

Document history		
V18.6.0	May 2024	Publication
V18.7.0	July 2024	Publication
V18.8.0	September 2024	Publication
V18.9.0	January 2025	Publication