

ETSI TS 129 531 V18.6.0 (2024-05)



**5G;
5G System;
Network Slice Selection Services;
Stage 3
(3GPP TS 29.531 version 18.6.0 Release 18)**



Reference

RTS/TSGC-0429531 vi60

Keywords

5G

ETSI

650 Route des Lucioles
F-06921 Sophia Antipolis Cedex - FRANCE

Tel.: +33 4 92 94 42 00 Fax: +33 4 93 65 47 16

Siret N° 348 623 562 00017 - APE 7112B
Association à but non lucratif enregistrée à la
Sous-Préfecture de Grasse (06) N° w061004871

Important notice

The present document can be downloaded from:

<https://www.etsi.org/standards-search>

The present document may be made available in electronic versions and/or in print. The content of any electronic and/or print versions of the present document shall not be modified without the prior written authorization of ETSI. In case of any existing or perceived difference in contents between such versions and/or in print, the prevailing version of an ETSI deliverable is the one made publicly available in PDF format at www.etsi.org/deliver.

Users of the present document should be aware that the document may be subject to revision or change of status.

Information on the current status of this and other ETSI documents is available at

<https://portal.etsi.org/TB/ETSIDeliverableStatus.aspx>

If you find errors in the present document, please send your comment to one of the following services:

<https://portal.etsi.org/People/CommitteeSupportStaff.aspx>

If you find a security vulnerability in the present document, please report it through our
Coordinated Vulnerability Disclosure Program:

<https://www.etsi.org/standards/coordinated-vulnerability-disclosure>

Notice of disclaimer & limitation of liability

The information provided in the present deliverable is directed solely to professionals who have the appropriate degree of experience to understand and interpret its content in accordance with generally accepted engineering or other professional standard and applicable regulations.

No recommendation as to products and services or vendors is made or should be implied.

No representation or warranty is made that this deliverable is technically accurate or sufficient or conforms to any law and/or governmental rule and/or regulation and further, no representation or warranty is made of merchantability or fitness for any particular purpose or against infringement of intellectual property rights.

In no event shall ETSI be held liable for loss of profits or any other incidental or consequential damages.

Any software contained in this deliverable is provided "AS IS" with no warranties, express or implied, including but not limited to, the warranties of merchantability, fitness for a particular purpose and non-infringement of intellectual property rights and ETSI shall not be held liable in any event for any damages whatsoever (including, without limitation, damages for loss of profits, business interruption, loss of information, or any other pecuniary loss) arising out of or related to the use of or inability to use the software.

Copyright Notification

No part may be reproduced or utilized in any form or by any means, electronic or mechanical, including photocopying and microfilm except as authorized by written permission of ETSI.

The content of the PDF version shall not be modified without the written authorization of ETSI.

The copyright and the foregoing restriction extend to reproduction in all media.

© ETSI 2024.
All rights reserved.

Intellectual Property Rights

Essential patents

IPRs essential or potentially essential to normative deliverables may have been declared to ETSI. The declarations pertaining to these essential IPRs, if any, are publicly available for **ETSI members and non-members**, and can be found in ETSI SR 000 314: "*Intellectual Property Rights (IPRs); Essential, or potentially Essential, IPRs notified to ETSI in respect of ETSI standards*", which is available from the ETSI Secretariat. Latest updates are available on the ETSI Web server (<https://ipr.etsi.org/>).

Pursuant to the ETSI Directives including the ETSI IPR Policy, no investigation regarding the essentiality of IPRs, including IPR searches, has been carried out by ETSI. No guarantee can be given as to the existence of other IPRs not referenced in ETSI SR 000 314 (or the updates on the ETSI Web server) which are, or may be, or may become, essential to the present document.

Trademarks

The present document may include trademarks and/or tradenames which are asserted and/or registered by their owners. ETSI claims no ownership of these except for any which are indicated as being the property of ETSI, and conveys no right to use or reproduce any trademark and/or tradename. Mention of those trademarks in the present document does not constitute an endorsement by ETSI of products, services or organizations associated with those trademarks.

DECT™, **PLUGTESTS™**, **UMTS™** and the ETSI logo are trademarks of ETSI registered for the benefit of its Members. **3GPP™** and **LTE™** are trademarks of ETSI registered for the benefit of its Members and of the 3GPP Organizational Partners. **oneM2M™** logo is a trademark of ETSI registered for the benefit of its Members and of the oneM2M Partners. **GSM®** and the GSM logo are trademarks registered and owned by the GSM Association.

Legal Notice

This Technical Specification (TS) has been produced by ETSI 3rd Generation Partnership Project (3GPP).

The present document may refer to technical specifications or reports using their 3GPP identities. These shall be interpreted as being references to the corresponding ETSI deliverables.

The cross reference between 3GPP and ETSI identities can be found under <https://webapp.etsi.org/key/queryform.asp>.

Modal verbs terminology

In the present document "**shall**", "**shall not**", "**should**", "**should not**", "**may**", "**need not**", "**will**", "**will not**", "**can**" and "**cannot**" are to be interpreted as described in clause 3.2 of the [ETSI Drafting Rules](#) (Verbal forms for the expression of provisions).

"**must**" and "**must not**" are **NOT** allowed in ETSI deliverables except when used in direct citation.

Contents

Intellectual Property Rights	2
Legal Notice	2
Modal verbs terminology.....	2
Foreword.....	6
1 Scope	8
2 References	8
3 Definitions and abbreviations.....	9
3.1 Definitions	9
3.2 Abbreviations	9
4 Overview	9
4.1 Introduction	9
5 Services offered by the NSSF	9
5.1 Introduction	9
5.2 Nnssf_NSSelection Service.....	10
5.2.1 Service Description.....	10
5.2.2 Service Operations.....	10
5.2.2.1 Introduction.....	10
5.2.2.2 GET.....	11
5.2.2.2.1 General	11
5.2.2.2.2 Get service operation of Nnssf_NSSelection service	11
5.2.2.2.3 Get service operation of Nnssf_NSSelection service during the PDU session establishment.....	13
5.2.2.2.4 Get service operation of Nnssf_NSSelection service during UE configuration update procedure.....	14
5.3 Nnssf_NSSAIAvailability Service.....	15
5.3.1 Service Description.....	15
5.3.2 Service Operations.....	15
5.3.2.1 Introduction.....	15
5.3.2.2 Update Service Operation	16
5.3.2.2.1 General	16
5.3.2.3 Subscribe Service Operation	17
5.3.2.3.1 Creation of a subscription.....	17
5.3.2.3.2 Modification of a subscription.....	18
5.3.2.4 Unsubscribe Service Operation.....	19
5.3.2.4.1 General	19
5.3.2.5 Notify Service Operation	19
5.3.2.5.1 General	19
5.3.2.6 Delete Service Operation	20
5.3.2.6.1 General	20
5.3.2.7 Options Service Operation	21
5.3.2.7.1 General	21
6 API Definitions	22
6.1 Nnssf_NSSelection Service API	22
6.1.1 API URI.....	22
6.1.2 Usage of HTTP.....	22
6.1.2.1 General	22
6.1.2.2 HTTP standard headers	22
6.1.2.2.1 General	22
6.1.2.2.2 Content type	22
6.1.2.3.1 General	22
6.1.3 Resources.....	23
6.1.3.1 Overview.....	23
6.1.3.2 Resource: Network Slice Information.....	23

6.1.3.2.1	Description	23
6.1.3.2.2	Resource Definition	23
6.1.3.2.3	Resource Standard Methods	23
6.1.3.2.4	Resource Custom Operations	25
6.1.4	Custom Operations without associated resources	26
6.1.5	Notifications	26
6.1.6	Data Model	26
6.1.6.1	General	26
6.1.6.2	Structured data types	27
6.1.6.2.1	Introduction	27
6.1.6.2.2	Type: AuthorizedNetworkSliceInfo	28
6.1.6.2.3	Type: SubscribedSnsai	32
6.1.6.2.4	Void	32
6.1.6.2.5	Type: AllowedSnsai	32
6.1.6.2.6	Type: AllowedNssai	32
6.1.6.2.7	Type: NsiInformation	33
6.1.6.2.8	Type: MappingOfSnsai	33
6.1.6.2.9	Void	34
6.1.6.2.10	Type: SliceInfoForRegistration	34
6.1.6.2.11	Type: SliceInfoForPDUSession	37
6.1.6.2.12	Type: ConfiguredSnsai	37
6.1.6.2.13	Type: SliceInfoForUEConfigurationUpdate	38
6.1.6.2.14	Type: NsagInfo	40
6.1.6.3	Simple data types and enumerations	40
6.1.6.3.1	Introduction	40
6.1.6.3.2	Simple data types	40
6.1.6.3.3	Enumeration: RoamingIndication	41
6.1.6.4	Binary data	41
6.1.7	Error Handling	41
6.1.7.1	General	41
6.1.7.2	Protocol Errors	41
6.1.7.3	Application Errors	41
6.1.8	Feature negotiation	41
6.1.9	Security	42
6.1.10	HTTP redirection	42
6.2	Nnssf_NSSAIAvailability Service API	42
6.2.1	API URI	42
6.2.2	Usage of HTTP	43
6.2.2.1	General	43
6.2.2.2	HTTP standard headers	43
6.2.2.2.1	General	43
6.2.2.2.2	Content type	43
6.2.2.2.3	Accept-Encoding	43
6.2.2.3	HTTP custom headers	43
6.2.2.3.1	General	43
6.2.3	Resources	44
6.2.3.1	Overview	44
6.2.3.2	Resource: NSSAI Availability Document	45
6.2.3.2.1	Description	45
6.2.3.2.2	Resource Definition	45
6.2.3.2.3	Resource Standard Methods	45
6.2.3.3	Resource: NSSAI Availability Notification Subscriptions Collection	49
6.2.3.3.1	Description	49
6.2.3.3.2	Resource Definition	49
6.2.3.3.3	Resource Standard Methods	49
6.2.3.4	Resource: Individual NSSAI Availability Notification Subscriptions	51
6.2.3.4.1	Description	51
6.2.3.4.2	Resource Definition	51
6.2.3.4.3	Resource Standard Methods	51
6.2.3.5	Resource: NSSAI Availability Store	53
6.2.3.5.1	Description	53
6.2.3.5.2	Resource Definition	53

6.2.3.5.3	Resource Standard Methods	53
6.2.4	Custom Operations without associated resources	54
6.2.5	Notifications	55
6.2.5.1	General	55
6.2.5.2	NSSAI Availability Notification	55
6.2.5.2.1	Description	55
6.2.5.2.2	Notification Definition	55
6.2.5.2.3	Notification Standard Methods.....	55
6.2.6	Data Model	56
6.2.6.1	General	56
6.2.6.2	Structured data types	57
6.2.6.2.1	Introduction	57
6.2.6.2.2	Type: NssaiAvailabilityInfo	58
6.2.6.2.3	Type: SupportedNssaiAvailabilityData	58
6.2.6.2.4	Type: AuthorizedNssaiAvailabilityData.....	59
6.2.6.2.5	Type: RestrictedSnsai	60
6.2.6.2.6	Type: AuthorizedNssaiAvailabilityInfo	60
6.2.6.2.7	Type: PatchDocument	60
6.2.6.2.8	Type: NssfEventSubscriptionCreateData	61
6.2.6.2.9	Type: NssfEventSubscriptionCreatedData	63
6.2.6.2.10	Type: NssfEventNotification	64
6.2.6.2.11	Type: SnsaiReplacementSubscribeInfo	65
6.2.6.2.12	Type: NsiUnavailabilitySubscribeInfo	65
6.2.6.3	Simple data types and enumerations	65
6.2.6.3.1	Introduction	65
6.2.6.3.2	Simple data types.....	65
6.2.6.3.3	Enumeration: NssfEventType.....	66
6.2.6.4	Binary data	66
6.2.7	Error Handling	66
6.2.7.1	General	66
6.2.7.2	Protocol Errors	66
6.2.7.3	Application Errors.....	66
6.2.8	Feature negotiation	67
6.2.9	Security	68
6.2.10	HTTP redirection.....	69
Annex A (normative): OpenAPI specification.....		70
A.1	General	70
A.2	Nssf_NSSelection API	70
A.3	Nssf_NSSAIAvailability API.....	76
Annex B (informative): Change history		87
History		91

Foreword

This Technical Specification has been produced by the 3rd Generation Partnership Project (3GPP).

The contents of the present document are subject to continuing work within the TSG and may change following formal TSG approval. Should the TSG modify the contents of the present document, it will be re-released by the TSG with an identifying change of release date and an increase in version number as follows:

Version x.y.z

where:

- x the first digit:
 - 1 presented to TSG for information;
 - 2 presented to TSG for approval;
 - 3 or greater indicates TSG approved document under change control.
- y the second digit is incremented for all changes of substance, i.e. technical enhancements, corrections, updates, etc.
- z the third digit is incremented when editorial only changes have been incorporated in the document.

In the present document, modal verbs have the following meanings:

- shall** indicates a mandatory requirement to do something
- shall not** indicates an interdiction (prohibition) to do something

The constructions "shall" and "shall not" are confined to the context of normative provisions, and do not appear in Technical Reports.

The constructions "must" and "must not" are not used as substitutes for "shall" and "shall not". Their use is avoided insofar as possible, and they are not used in a normative context except in a direct citation from an external, referenced, non-3GPP document, or so as to maintain continuity of style when extending or modifying the provisions of such a referenced document.

- should** indicates a recommendation to do something
- should not** indicates a recommendation not to do something
- may** indicates permission to do something
- need not** indicates permission not to do something

The construction "may not" is ambiguous and is not used in normative elements. The unambiguous constructions "might not" or "shall not" are used instead, depending upon the meaning intended.

- can** indicates that something is possible
- cannot** indicates that something is impossible

The constructions "can" and "cannot" are not substitutes for "may" and "need not".

- will** indicates that something is certain or expected to happen as a result of action taken by an agency the behaviour of which is outside the scope of the present document
- will not** indicates that something is certain or expected not to happen as a result of action taken by an agency the behaviour of which is outside the scope of the present document
- might** indicates a likelihood that something will happen as a result of action taken by some agency the behaviour of which is outside the scope of the present document

might not indicates a likelihood that something will not happen as a result of action taken by some agency the behaviour of which is outside the scope of the present document

In addition:

is (or any other verb in the indicative mood) indicates a statement of fact

is not (or any other negative verb in the indicative mood) indicates a statement of fact

The constructions "is" and "is not" do not indicate requirements.

1 Scope

The present document specifies the stage 3 protocol and data model for the Nnssf Service Based Interface. It provides stage 3 protocol definitions and message flows, and specifies the API for each service offered by the NSSF.

The 5G System stage 2 architecture and procedures are specified in 3GPP TS 23.501 [2] and 3GPP TS 23.502 [3].

The Technical Realization of the Service Based Architecture and the Principles and Guidelines for Services Definition are specified in 3GPP TS 29.500 [4] and 3GPP TS 29.501 [5].

2 References

The following documents contain provisions which, through reference in this text, constitute provisions of the present document.

- References are either specific (identified by date of publication, edition number, version number, etc.) or non-specific.
- For a specific reference, subsequent revisions do not apply.
- For a non-specific reference, the latest version applies. In the case of a reference to a 3GPP document (including a GSM document), a non-specific reference implicitly refers to the latest version of that document *in the same Release as the present document*.

- [1] 3GPP TR 21.905: "Vocabulary for 3GPP Specifications".
- [2] 3GPP TS 23.501: "System Architecture for the 5G System; Stage 2".
- [3] 3GPP TS 23.502: "Procedures for the 5G System; Stage 2".
- [4] 3GPP TS 29.500: "5G System; Technical Realization of Service Based Architecture; Stage 3".
- [5] 3GPP TS 29.501: "5G System; Principles and Guidelines for Services Definition; Stage 3".
- [6] OpenAPI: "OpenAPI Specification Version 3.0.0", <https://spec.openapis.org/oas/v3.0.0>.
- [7] 3GPP TS 29.571: "5G System; Common Data Types for Service Based Interfaces; Stage 3".
- [8] IETF RFC 6902: "JavaScript Object Notation (JSON) Patch".
- [9] 3GPP TS 23.003: "Numbering, addressing and identification".
- [10] IETF RFC 9113: "HTTP/2".
- [11] 3GPP TS 33.501: "Security architecture and procedures for 5G system".
- [12] IETF RFC 6749: "The OAuth 2.0 Authorization Framework".
- [13] 3GPP TS 29.510: "Network Function Repository Services; Stage 3".
- [14] IETF RFC 8259: "The JavaScript Object Notation (JSON) Data Interchange Format".
- [15] IETF RFC 9457: "Problem Details for HTTP APIs".
- [16] IETF RFC 1952: "GZIP file format specification version 4.3".
- [17] 3GPP TR 21.900: "Technical Specification Group working methods".
- [18] IETF RFC 9110: "HTTP Semantics".
- [19] Void
- [20] 3GPP TS 24.501: "Non-Access-Stratum (NAS) protocol for 5G System (5GS); Stage 3".
- [21] 3GPP TS 38.413: "NG-RAN; NG Application Protocol (NGAP); Stage 3".

3 Definitions and abbreviations

3.1 Definitions

For the purposes of the present document, the terms and definitions given in 3GPP TR 21.905 [1] and the following apply. A term defined in the present document takes precedence over the definition of the same term, if any, in 3GPP TR 21.905 [1].

3.2 Abbreviations

For the purposes of the present document, the abbreviations given in 3GPP TR 21.905 [1] and the following apply. An abbreviation defined in the present document takes precedence over the definition of the same abbreviation, if any, in 3GPP TR 21.905 [1].

NSAG	Network Slice AS Group
------	------------------------

4 Overview

4.1 Introduction

Within the 5GC, the NSSF offers services to the AMF and NSSF in a different PLMN via the Nnssf service based interface (see 3GPP TS 23.501 [2] and 3GPP TS 23.502 [3]).

Figure 4.1-1 provides the reference model (in service based interface representation and in reference point representation), with focus on the NSSF and the scope of the present specification.

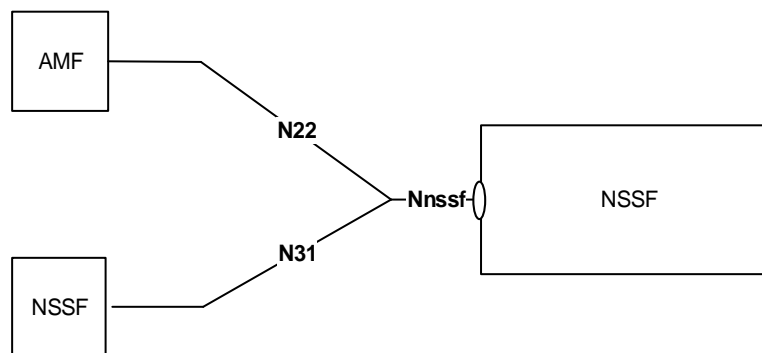

Figure 4.1-1: NSSF in 5G System architecture

The functionalities supported by the NSSF are listed in clause 6.2.14 of 3GPP TS 23.501 [2].

5 Services offered by the NSSF

5.1 Introduction

The NSSF supports the following services.

Table 5.1-1: NF Services provided by NSSF

Service Name	Description	Example Consumer
Nnssf_NSSelection	This service enables Network Slice selection in both the Serving PLMN and the HPLMN	AMF, V-NSSF
Nnssf_NSSAIAvailability	This service enables to update the S-NSSAI(s) the NF service consumer (e.g AMF) supports on a per TA basis on the NSSF and to subscribe and notify any change in status, on a per TA basis, of the SNSSAIs available per TA (unrestricted) and the restricted S-NSSAI(s) per PLMN in that TA in the serving PLMN of the UE. This service also enables the notification of the Network Slice Replacement and Network Slice Instance Replacement to the NF Service Consumer. This service also enables to subscribe and unsubscribe to the notification of any changes in the status of the NSSAI validity time information.	AMF, V-NSSF

Table 5.1-2 summarizes the corresponding APIs defined for this specification.

Table 5.1-2: API Descriptions

Service Name	Clause	Description	OpenAPI Specification File	apiName	Annex
Nnssf_NSSelection	6.1	NSSF Network Slice Selection Service	TS29531_Nnssf_NSSelection.yaml	nnssf-nssselection	A.2
Nnssf_NSSAIAvailability	6.2	NSSF NSSAI Availability Service	TS29531_Nnssf_NSSAIAvailability.yaml	nnssf-nssaiavailability	A.3

5.2 Nnssf_NSSelection Service

5.2.1 Service Description

The Nnssf_NSSelection service is used by an NF Service Consumer (e.g. AMF or NSSF in a different PLMN) to retrieve the information related to network slice in the non-roaming and roaming case.

It also enables the NSSF to provide to the AMF the Allowed NSSAI and the Configured NSSAI for the Serving PLMN.

It also enables the NSSF to provide to the AMF the NSAG information associated with the Configured NSSAI for the Serving PLMN.

The NF service consumer discovers the NSSF based on the local configuration. The NSSF in a different PLMN is discovered based on the self-constructed FQDN as specified in 3GPP TS 23.003 [9].

5.2.2 Service Operations

5.2.2.1 Introduction

For the Nnssf_NSSelection service the following service operations are defined:

- Get.

5.2.2.2 GET

5.2.2.2.1 General

The Get operation shall be invoked by the AMF in the non-roaming or roaming scenario to retrieve:

- The slice selection information including the Allowed NSSAI, Configured NSSAI, target AMF Set or the list of candidate AMF(s), and optionally
 - The Mapping Of Allowed NSSAI;
 - The Mapping Of Configured NSSAI;
 - NSI ID(s) associated with the Network Slice instances of the Allowed NSSAI;
 - NRF(s) to be used to select NFs/services within the selected Network Slice instance(s) and NRF to be used to determine the list of candidate AMF(s) from the AMF Set, during Registration procedure;
 - Information on whether the S-NSSAI(s) not included in the Allowed NSSAI which were part of the Requested NSSAI are rejected in the serving PLMN or in the current TA;
 - The Target NSSAI that includes the S-NSSAI(s) as defined in clause 5.3.4.3.3 of 3GPP TS 23.501 [2], and
 - The NSAG information associated with Configured NSSAI as defined in clause 5.15.14 of 3GPP TS 23.501 [2].
- The NRF to be used to select NFs/services within the selected network slice instance, and optionally the NSI ID associated with the S-NSSAI provided in the input, during the PDU Session Establishment procedure.
- The slice mapping information including the mapping of S-NSSAI(s) of the VPLMN to corresponding HPLMN S-NSSAI(s).

The Get operation shall also be invoked by the vNSSF in the roaming scenario to retrieve:

- The hNRF to be used to select NFs/services within the selected network slice instance in the HPLMN, and optionally the NSI ID associated with the S-NSSAI provided in the input, during the PDU Session Establishment procedure.

It is used in the following procedures:

- Registration procedure (see clause 4.2.2.2.2 of 3GPP TS 23.502 [3]);
- Registration with AMF re-allocation (see clause 4.2.2.2.3 of 3GPP TS 23.502 [3]);
- EPS to 5GS handover using N26 interface (see clause 4.11.1.2.2 of 3GPP TS 23.502 [3]);
- EPS to 5GS mobility registration procedure (see clauses 4.11.1.3.3, 4.11.1.3.3A, 4.11.1.3.4 and 4.23.12 of 3GPP TS 23.502 [3]);
- Xn and N2 Handover procedures with PLMN change (see clauses 4.9.1, 4.23.7 and 4.23.11 of 3GPP TS 23.502 [3]);
- UE Configuration Update procedure (see clause 4.2.4.2 of 3GPP TS 23.502 [3]);
- SMF selection for non-roaming and roaming with local breakout (see clause 4.3.2.2.3.2 of 3GPP TS 23.502 [3]) or SMF selection for home-routed roaming scenario (see clause 4.3.2.2.3.3 of 3GPP TS 23.502 [3]).

NOTE: The list of procedures above, which trigger invoking of the Nnssf_NSSelection_Get service operation, is not exhaustive.

5.2.2.2.2 Get service operation of Nnssf_NSSelection service

In this procedure, the NF Service Consumer (e.g. AMF) retrieves the slice selection information including the Allowed NSSAI, Configured NSSAI, target AMF Set or the list of candidate AMF(s) and other optional information.

This service operation shall also be used to retrieve the slice mapping information including the mapping of S-NSSAI(s) of the VPLMN to corresponding HPLMN S-NSSAI(s), e.g. during inter-PLMN mobility procedure and/or mobility procedure within VPLMN from EPS to 5GS.

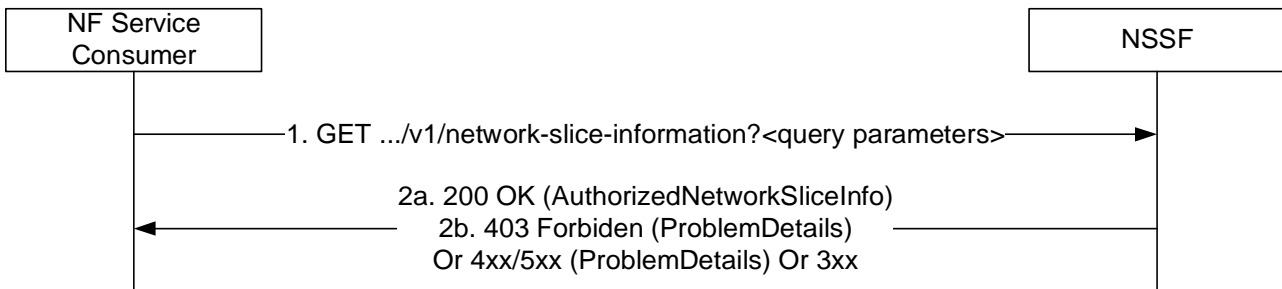

Figure 5.2.2.2-1: Retrieve the network slice information during the mobility procedure

- 1 The AMF shall send a GET request to the NSSF.

If the AMF wants to retrieve the slice selection information, one or more of the following parameters shall be included in the slice-info-request-for-registration query parameter:

- Requested NSSAI and Subscribed S-NSSAI(s) with the indication if marked as default S-NSSAI and the associated subscribed NSSRG information;
- optionally UE support of subscription-based restrictions to simultaneous registration of network slice feature Indication;
- UDM indication to provide all subscribed S-NSSAIs for UEs not indicating support of subscription-based restrictions to simultaneous registration of network slices feature;
- Indication of the support of NSAG by the UE.

If the AMF wants to retrieve the slice mapping information, the following parameters shall be included in the slice-info-request-for-registration query parameter:

- sNssaiForMapping IE and;
- requestMapping IE.

In both scenarios, the AMF shall also include the following parameters in the message:

- PLMN ID of the SUPI in roaming scenarios;
- TAI;
- NF type of the NF service consumer and;
- Requester ID.

- 2a On success, "200 OK" shall be returned when the NSSF is able to find authorized network slice information for the requested network slice selection information, the response body shall include a content containing at least the following parameters:

- Allowed NSSAI and;
- target AMF Set or the list of candidate AMF(s).

The content may additionally contain the following parameters:

- a target AMF Service Set;
- Target NSSAI.

"200 OK" shall also be returned when the NSSF is able to find the requested slicing mapping information, the response body shall include a content containing the mapping of S-NSSAI(s) of the VPLMN to corresponding HPLMN S-NSSAI(s) included in the allowedNssaiList IE.

NSSFs of a PLMN that implement AMF reallocation via RAN by supporting the NGAP REROUTE NAS REQUEST procedure (see clause 8.6.5 of 3GPP TS 38.413 [21]) should return the target AMF set ID in its response. The NSSF may query the NRF to discover target AMF Set if this information is not known by other means (e.g. if not provided by AMF during Nnssf_NSSAIAvailability_Update service operation).

If subscribed NSSRG list is provided, the NSSF shall provide the compatible S-NSSAIs in the Allowed NSSAI as defined in clause 5.15.12 of 3GPP TS 23.501 [2] and compatible S-NSSAIs in the Target NSSAI (if provided).

If the request indicated that UE does not support subscription-based restrictions to simultaneous registration of network slice feature, and UDM has requested to provide all subscribed S-NSSAIs for such UEs, Configured NSSAI, if included, shall be provided ignoring the NSSRG restrictions.

If the AMF has indicated the support of NSAG by the UE, the NSSF shall include the "nsagInfoList" attribute with NSAG information if available.

- 2b If no slice instances can be found for the requested slice selection information or the requested slice mapping information, then the NSSF shall return a 403 Forbidden response with the "ProblemDetails" IE containing the Application Error "SNSSAI_NOT_SUPPORTED" (cf. Table 6.1.7.3-1).

On failure or redirection, the NSSF shall return one of the HTTP status codes together with the response body listed in Table 6.1.3.2.3.1-3.

5.2.2.2.3 Get service operation of Nnssf_NSSelection service during the PDU session establishment

In this procedure, the NF Service Consumer (e.g. AMF) retrieves the NRF and the optionally the NSI ID of the network slice instance:

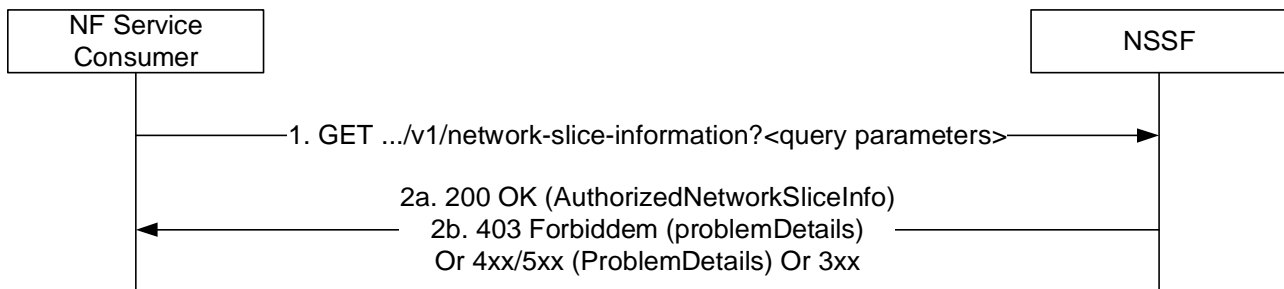

Figure 5.2.2.2.3-1: Retrieve the network slice information during the PDU session establishment procedure

- 1 The NF Service consumer (e.g. AMF or NSSF in the different PLMN) shall send a GET request to the NSSF.

The request shall include query parameters, contain at least the following parameters:

- S-NSSAI;
- S-NSSAI from the HPLMN that maps to the S-NSSAI from the Allowed NSSAI of the Serving PLMN;
- the NF type of the NF service consumer;
- Requester ID and;
- non-roaming/LBO roaming/HR roaming indication.

For the request towards an NSSF in the Serving PLMN, the query parameters shall also contain the PLMN ID of the SUPI and TAI.

- 2a On success, "200 OK" shall be returned when the NSSF is able to find network slice instance information for the requested network slice selection information, the response body shall include a content containing at least the NRF to be used to select NFs/services within the selected Network Slice instance;
- 2b If no slice instances can be found for the requested slice selection information, then the NSSF shall return a 403 Forbidden response with the "ProblemDetails" IE containing the Application Error "SNSSAI_NOT_SUPPORTED" (cf. Table 6.1.7.3-1).

On failure or redirection, the NSSF shall return one of the HTTP status codes together with the response body listed in Table 6.1.3.2.3.1-3.

5.2.2.2.4 Get service operation of Nnssf_NSSelection service during UE configuration update procedure

In this procedure, the NF Service Consumer (e.g. AMF) retrieves network slice configuration information (e.g. the Allowed NSSAI and the Configured NSSAI) during the UE configuration update procedure.

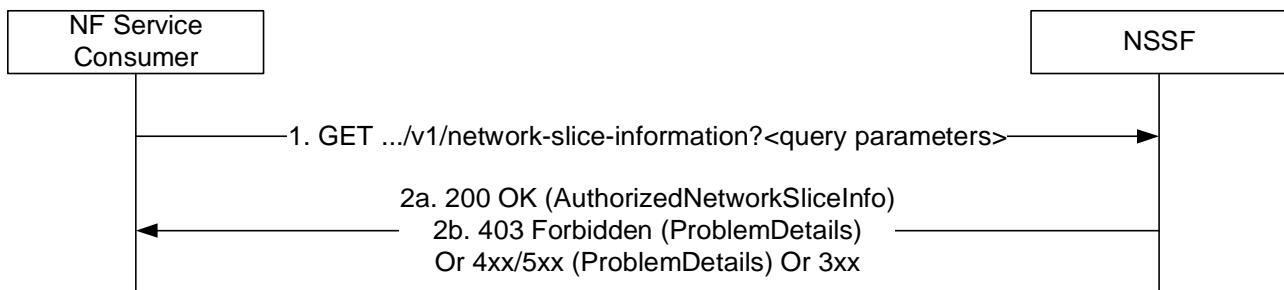

Figure 5.2.2.2.4-1: Retrieve the network slice information during UE configuration update procedure

- 1 The NF Service consumer (e.g. AMF) shall send a GET request to the NSSF. The request shall include query parameters:
 - Subscribed S-NSSAI(s) with the indication if the S-NSSAI is marked as default S-NSSAI and the associated subscribed NSSRG information;
 - optionally UE support of subscription-based restrictions to simultaneous registration of network slice feature Indication;
 - UDM indication to provide all subscribed S-NSSAIs for UEs not indicating support of subscription-based restrictions to simultaneous registration of network slices feature;
 - Rejected S-NSSAI(s) for the Registration Area;
 - PLMN ID of the SUPI;
 - TAI;
 - Indication of the support of NSAG by the UE;
 - NF type of the NF service consumer and;
 - the NF instance ID of the requester NF.

NOTE: When the AMF invokes UE Configuration Update procedure to determine the Target NSSAI to redirect the UE to the dedicated frequency band(s) for an S-NSSAI (as specified in clause 5.3.4.3.3 of 3GPP TS 23.501 [2]), the AMF provides the Allowed NSSAI and the rejected S-NSSAI(s) for the current Registration Area to the NSSF; the Allowed NSSAI and Rejected S-NSSAI(s) for the RA does not include any S-NSSAI that failed for Network Slice-Specific Authentication and Authorization. The AMF does not include the Requested NSSAI to the NSSF in this procedure, thus the NSSF will not provide Allowed NSSAI again to the AMF in the response.

2a On success, "200 OK" shall be returned when the NSSF is able to find authorized network slice information for the requested network slice selection information, the response body shall include a content containing at least the following parameters:

- Allowed NSSAI;
- Configured NSSAI and;
- optionally Target NSSAI.

If subscribed NSSRG list is provided, the NSSF shall provide the compatible S-NSSAIs in the Allowed NSSAI as defined in the clause 5.15.12 of 3GPP TS 23.501 [2] and compatible S-NSSAIs in the Target NSSAI(if provided).

If the request indicated that UE does not support subscription-based restrictions to simultaneous registration of network slice feature, and UDM has requested to provide all subscribed S-NSSAIs for such UEs, the NSSF shall provide Configured NSSAI ignoring the NSSRG restrictions.

If the AMF has indicated the support of NSAG by the UE, the NSSF shall include the "nsagInfoList" attribute with NSAG information if available.

2b If no slice instances can be found for the requested slice selection information, then the NSSF shall return a 403 Forbidden response with the "ProblemDetails" IE containing the Application Error "SNSSAI_NOT_SUPPORTED" (cf. Table 6.1.7.3-1).

On failure or redirection, the NSSF shall return one of the HTTP status codes together with the response body listed in Table 6.1.3.2.3.1-3.

5.3 Nnsf_NSSAIAvailability Service

5.3.1 Service Description

The Nnsf_NSSAIAvailability service is used by the NF service consumer (e.g. AMF) to update the S-NSSAI(s) the AMF supports on a per TA basis on the NSSF, subscribe and unsubscribe the notification of any changes to the NSSAI availability information on a per TA basis, of the S-NSSAIs available per TA (unrestricted) and the restricted S-NSSAI(s) per PLMN in that TA in the serving PLMN of the UE.

It also enables the NF service consumer (e.g. AMF) to update the NSAG(s) associated with the S-NSSAI(s) supported by the AMF on a per TA basis.

It also enables the NF service consumer (e.g., AMF, V-NSSF) to receive updates for Network Slice Replacement and Network Slice Instance Replacement.

It also used by the NF service consumer (e.g. AMF) to subscribe and unsubscribe to the notification of any changes in the status of the NSSAI validity time information.

If the service operation is invoked for subscription to Network Slice Replacement and/or Network Slice Instance Replacement notification from AMF for roaming scenarios, then AMF shall subscribe to notification to the V-NSSF, which in turn shall subscribe to notification to the H-NSSF. If the event is triggered, the AMF receives the notification from V-NSSF and the V-NSSF receives the notification from H-NSSF.

5.3.2 Service Operations

5.3.2.1 Introduction

For the Nnsf_NSSAIAvailability service the following service operations are defined:

- Update;
- Subscribe;
- Unsubscribe;

- Notify;
- Delete;
- Options.

5.3.2.2 Update Service Operation

5.3.2.2.1 General

The Update operation shall be used by an NF Service Consumer (e.g. AMF) to update the NSSF with the S-NSSAI(s) the NF service consumer (e.g. AMF) supports per TA, and get the availability of the S-NSSAI(s) per TA for the S-NSSAI(s) the NF service consumer (e.g. AMF) supports.

The Update operation may also be used by an NF Service Consumer (e.g. AMF) to update the NSSF with the NSAG(s) associated with the S-NSSAI(s) supported by the NF Service Consumer (e.g. AMF) on per TA basis, and to get the availability of the NSAG(s) per TA for the NSAG(s) supported by the NF Service Consumer (e.g. AMF).

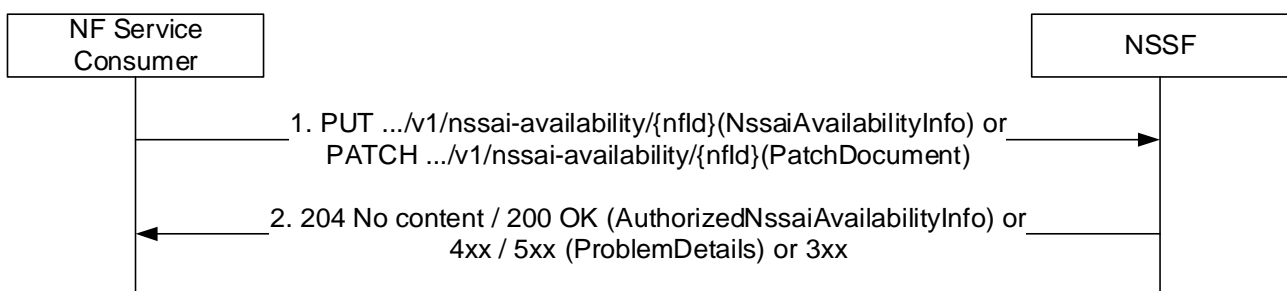

Figure 5.3.2.2.1-1: Update the S-NSSAI(s) the AMF supports per TA

1. The NF service consumer (e.g. AMF) shall send a PUT request to the resource representing the NSSAI Availability information of the individual NF, identified by the {nflid}, to replace or create the NSSAI Availability information of the NF.

The content shall contain the NssaiAvailabilityInfo which contains one or more representations of the individual supportedSnsai information to be replaced.

The NssaiAvailabilityInfo in the content may contain NSAG information.

The NF service consumer (e.g. AMF) shall send a PATCH request to the resource representing the NSSAI Availability information of the individual NF, identified by the {nflid}, to update the NSSAI Availability information of the NF.

The content shall contain the PatchDocument which contains one or more PatchItem instructions for updating the individual supportedSnsai resources.

The content may contain the PatchDocument which contains one or more PatchItem instructions for updating the NSAG information.

2. On success, "204 No content" shall be returned if Authorized NSSAI Availability is empty after the update; otherwise, "200 OK" shall be returned, the content of the PUT/PATCH response shall contain the representation describing the status of the request and the complete AuthorizedNssaiAvailabilityData information representing the current state of the AuthorizedNssaiAvailabilityInfo.

If there is no supported S-NSSAI(s) authorized by the NSSF for the TA, the NSSF shall not return the AuthorizedNssaiAvailabilityData for the corresponding TA in the response.

On failure or redirection, the NSSF shall return one of the HTTP status code together with the response body listed in Table 6.2.3.2.3.1-2 / Table 6.2.3.2.3.2-2.

5.3.2.3 Subscribe Service Operation

5.3.2.3.1 Creation of a subscription

The Subscribe Operation is used by a NF Service Consumer (e.g. AMF, V-NSSF) to subscribe to a notification of:

- Network Slice Replacement;
- Network Slice Instance Replacement;
- any changes in status of the NSSAI availability information (e.g. S-NSSAIs available per TA and the restricted S-NSSAI(s) per PLMN in that TA in the serving PLMN of the UE) upon this is updated by another AMF; and/or
- any changes in the status of the NSSAI validity time information.

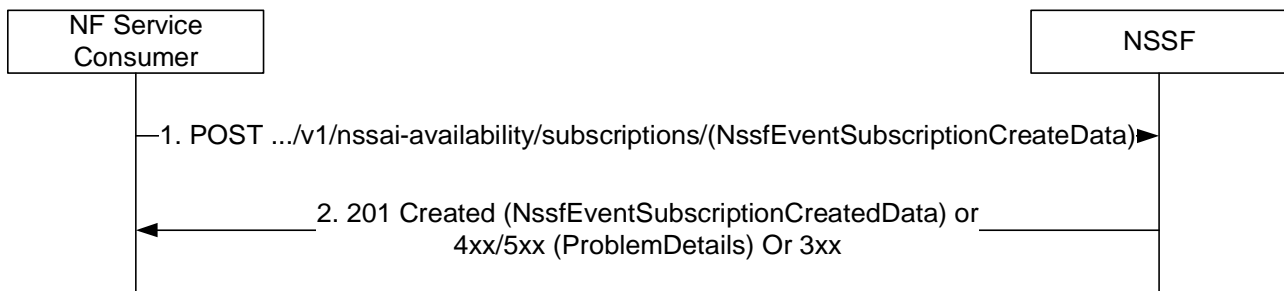

Figure 5.3.2.3.1-1 Create a subscription

1. The NF Service Consumer shall send a POST request to create a subscription resource in the NSSF. The content of the POST request shall contain a representation of the individual event subscription resource to be created in the `NssfEventSubscriptionCreateData`.

The request shall indicate the type(s) of events for which the subscription is created, i.e., Network Slice Replacement, Network Slice Instance Replacement, any changes in the status of the NSSAI validity time information and/or of any changes in status of the NSSAI availability information.

The request may contain an expiry time, suggested by the NF Service Consumer as a hint, representing the time upto during which the subscription is desired to be kept active and describes the maximum duration after which the subscribed event shall stop generating report.

The request may also indicate a specific AMF Set to restrict the subscriptions to notifications applicable to the AMF Set (i.e. notifications related to S-NSSAIs supported by the AMF Set). If the AMF Set is provided and the NSSF support the "SATAS" feature (see clause 6.2.8), the NF Service Consumer may also indicate that the subscription is for all TAI(s) associated with the AMF Set.

If the service operation is invoked for subscription to Network Slice Replacement notification, then the request shall contain:

- for VPLMN S-NSSAI: the list of S-NSSAIs in the VPLMN served by the NF Service Consumer that may be replaced with, the NF type of the NF Service Consumer (e.g., AMF) and the NF instance ID of the requester NF.
- for HPLMN S-NSSAI: the list of S-NSSAIs in the HPLMN that the S-NSSAI may be replaced with, the NF type of the NF Service Consumer (e.g., AMF, V-NSSF), the NF instance ID of the requester NF and the HPLMN ID.

If the service operation is invoked for subscription to Network Slice Instance Replacement notification, then the request shall contain:

- the list of S-NSSAIs and/or the list of NSI IDs that may become congested or no longer available.

2. On success, "201 Created" shall be returned, and the content of the POST response shall contain the representation describing the status of the created subscription in `NssfEventSubscriptionCreatedData`.

For a subscription to any changes in status of the NSSAI availability information, the `NssfEventSubscriptionCreatedData` may contain the `AuthorizedNssaiAvailabilityData` information, if available.

If there is no supported S-NSSAIs authorized by the NSSF for the TA, the NSSF shall not return the `AuthorizedNssaiAvailabilityData` for the corresponding TA in the response.

The Location header shall contain the location (URI) of the created subscription resource.

The response, based on operator policy and taking into account the expiry time included in the request, may contain the expiry time, as determined by the NSSF, after which the subscription becomes invalid. Once the subscription expires, if the NF Service Consumer wants to keep receiving notifications, it shall create a new subscription in the NSSF. The NSSF shall not provide the same expiry time for many subscriptions in order to avoid all of them expiring and recreating the subscription at the same time. If the expiry time is not included in the response, the NF Service Consumer shall consider the subscription to be valid without an expiry time.

On failure or redirection, the NSSF shall return one of the HTTP status code together with the response body listed in Table 6.2.3.3.1-2.

5.3.2.3.2 Modification of a subscription

The Subscribe Operation may be used by a NF Service Consumer (e.g. AMF, V-NSSF) towards an NSSF supporting the SUMOD feature, when it needs to modify an existing subscription previously created by itself.

The NF Service Consumer shall modify the subscription by using HTTP method PATCH with the URI of the individual subscription resource to be modified.

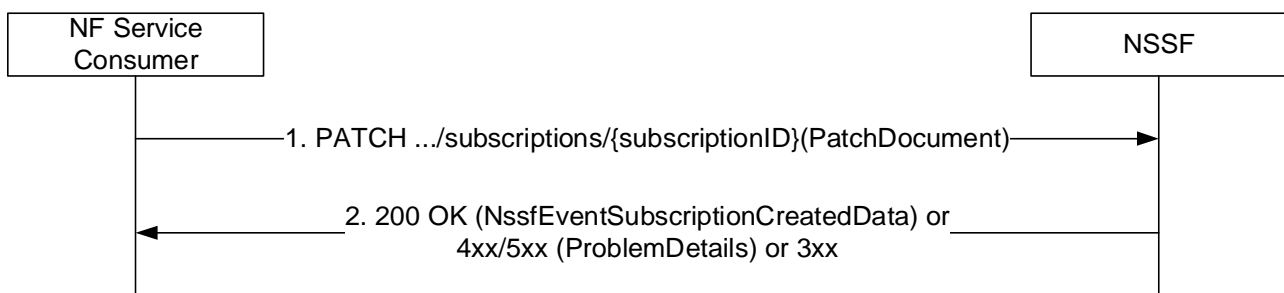

Figure 5.3.2.3.2-1 Modify a subscription

1. The NF Service Consumer (e.g. AMF, V-NSSF) shall send a PATCH request to the resource URI identifying the individual subscription resource. The content shall contain the `PatchDocument` which contains one or more `PatchItem` instructions for updating the subscription data.

The NF Service Consumer shall not change the event IE included in the `NssfEventSubscriptionCreateData` by invoking the PATCH request message.

For a subscription to any changes in status of the NSSAI availability information, the `taiList` IE may only be set to an empty array in PATCH request if the NF service consumer and NSSF support the ONSSAI feature.

2. On success, "200 OK" shall be returned, the content of the PATCH response shall contain the representation describing the updated subscription in `NssfEventSubscriptionCreatedData`.

For a subscription to any changes in status of the NSSAI availability information, if there is no supported S-NSSAIs authorized by the NSSF for the TA, the NSSF shall not return the `AuthorizedNssaiAvailabilityData` for the corresponding TA in the response.

On failure or redirection, the NSSF shall return one of the HTTP status code together with the response body listed in Table 6.2.3.4.3.2-2.

5.3.2.4 Unsubscribe Service Operation

5.3.2.4.1 General

The Unsubscribe Operation is used by a NF Service Consumer (e.g. AMF, V-NSSF) to unsubscribe to a notification of any previously subscribed changes to the NSSAI availability information, Network Slice Replacement, Network Slice Instance Replacement and/or NSSAI validity time information.

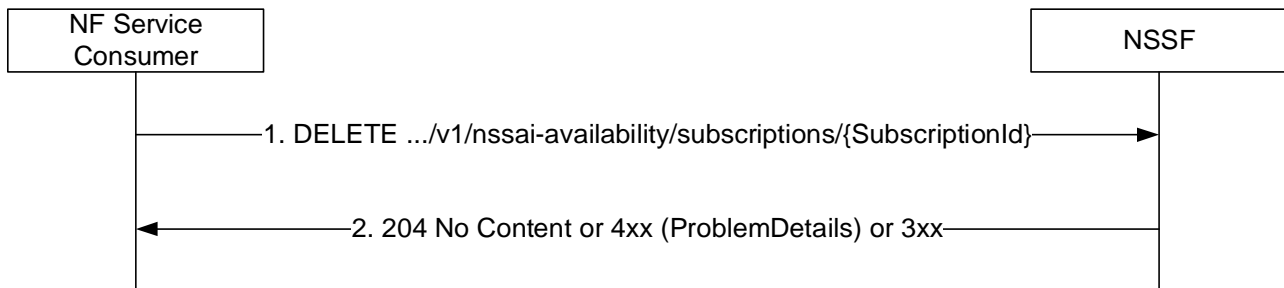

Figure 5.3.2.4.1-1 Unsubscribe a subscription

1. The NF Service Consumer shall send a DELETE request to delete an existing subscription resource in the NSSF.
2. If the request is accepted, the NSSF shall respond with the status code 204 indicating the resource identified by subscription ID is successfully deleted.

On failure or redirection, the NSSF shall return one of the HTTP status code together with the response body listed in Table 6.2.3.4.3.1-2.

5.3.2.5 Notify Service Operation

5.3.2.5.1 General

The Notify Service operation shall be used by the NSSF to update the NF Service Consumer (e.g. AMF) with any change in status, on a per TA basis, of the S-NSSAIs available per TA (unrestricted) and the S-NSSAIs restricted per PLMN in that TA in the serving PLMN of the UE.

The service operation is also used to notify the NF Service Consumer (e.g., AMF, V-NSSF) of Network Slice Replacement and/or Network Slice Instance Replacement.

The service operation is also used to notify the NF Service Consumer (e.g., AMF) of any changes in the status of the NSSAI validity time information.

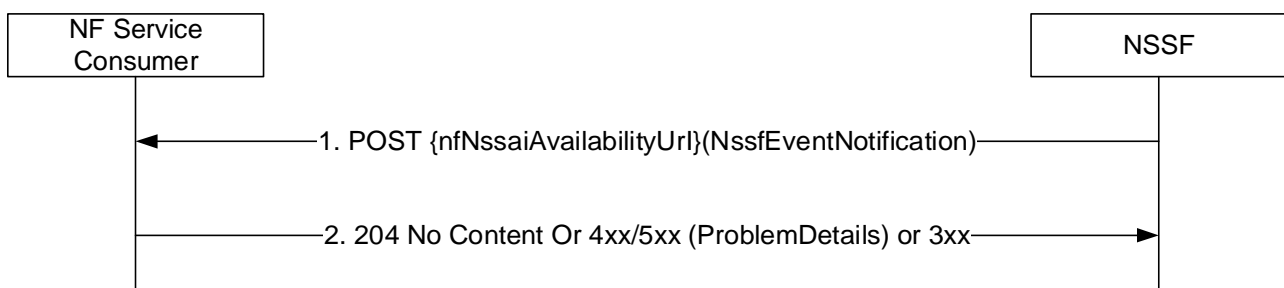

Figure 5.3.2.5.1-1: Update the AMF with any S-NSSAIs restricted per TA

1. The NSSF shall send a POST request to the resource representing the NSSF availability resource in the NF service consumer (e.g. AMF, V-NSSF). The content of the POST request shall contain the one representations of the individual NssfEventNotification resource.

For a subscription to any changes in status of the NSSAI availability information:

- If there is no supported S-NSSAIs authorized by the NSSF for the TA, the NSSF shall not return the AuthorizedNssaiAvailabilityData for the corresponding TA in the notification.
- If there is no supported S-NSSAIs authorized by the NSSF for all TAs and the NF Service Consumer has indicated support of "EANAN" feature, the NSSF shall set authorizedNssaiAvailabilityData attribute to an empty array.

For a subscription to Network Slice Instance Replacement:

- If the NSSF supports the NSIUN feature (see clause 6.2.8) and if the Network Slice instance becomes no longer available, the NSSF shall notify the NF Service Consumer (e.g., AMF, V-NSSF) having subscribed to this event for the related S-NSSAI and/or NSI ID that the NSI is no longer available. In that case, the POST request from the NSSF shall contain the list of S-NSSAIs and the associated NSI IDs for which the status is changed (e.g., which become congested or no longer available). The request may also contain congestion mitigation information.

For a subscription to Network Slice Replacement:

- If the NSSF supports the NSRP feature (see clause 6.2.8) and if the NSSF detects that an S-NSSAI becomes unavailable (e.g., based on OAM or NWDAF analytics output), the NSSF shall send Network Slice Replacement for the S-NSSAI to the NF service consumer if the NF service consumer has subscribed to this event for the related S-NSSAI. The notification shall include an alternative S-NSSAI which can be used by the NF service consumer to replace the unavailable S-NSSAI. In case of roaming, the notification shall include:
 - for VPLMN S-NSSAI replacement: the alternative VPLMN S-NSSAI for the S-NSSAI and the corresponding mapping to the S-NSSAI to be replaced.
 - for HPLMN S-NSSAI replacement: the alternative HPLMN S-NSSAI for the S-NSSAI and the corresponding mapping to the HPLMN S-NSSAI to be replaced and the HPLMN ID.
- The NSSF shall notify the NF service consumer when the S-NSSAI becomes available again. The notification shall contain:
 - an indication to stop Network Slice replacement for new UEs; or
 - an indication to terminate Network Slice Replacement for all the UEs and move back the PDU sessions from the alternative S-NSSAI to the S-NSSAI.
- The NSSF may provide to the NF service consumer congestion mitigation information for Network Slice Replacement that may contain:
 - the percentage of registered UEs that is applied for Network Slice Replacement; or
 - an indication that the Network Slice Replacement applies to new UEs registering with the S-NSSAI.

If the notification is triggered by the AMF that updates the supported S-NSSAIs per TA by using the Update operation, the NSSF shall not send the notification to the same AMF.

For a subscription to any changes in the status of the NSSAI validity time information:

- the NSSF shall notify the NF service consumer when the validity timer related to the subscribed S-NSSAI(s) are changed by including the S-NSSAI(s) and associated validity time for each S-NSSAI.

2. On success, "204 No Content" shall be returned and the content of the POST response shall be empty.

On failure or redirection, the NF service consumer shall return one of the HTTP status code together with the response body listed in Table 6.2.5.2.3.1-2.

5.3.2.6 Delete Service Operation

5.3.2.6.1 General

The Delete Service operation shall be used by the NF service consumer (e.g. AMF) to delete the NSSAI availability information stored for the NF service consumer in the NSSF.

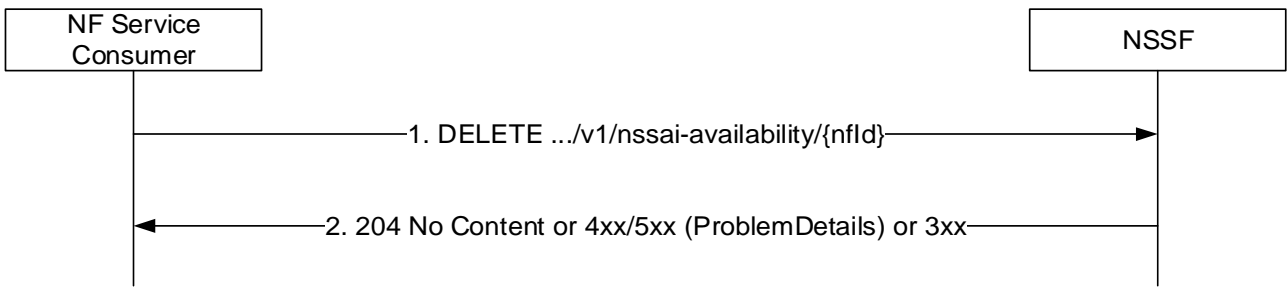

Figure 5.3.2.6.1-1: Delete the NSSAI Availability Information at NSSF

1. The NF service consumer (e.g. AMF) shall send a DELETE request to remove the NSSAI availability information for the NF service consumer represented by the {nfId} (e.g. AMF ID).
2. The NSSF shall delete the NSSAI Availability information for the individual AMF and shall return the 204 No Content status code.

On failure or redirection, the NSSF shall return one of the HTTP status code together with the response body listed in Table 6.2.3.2.3.3-2.

5.3.2.7 Options Service Operation

5.3.2.7.1 General

The Options service operation is used by a NF Service Consumer (e.g. AMF) to discover the communication options supported by the NSSF for the resource.

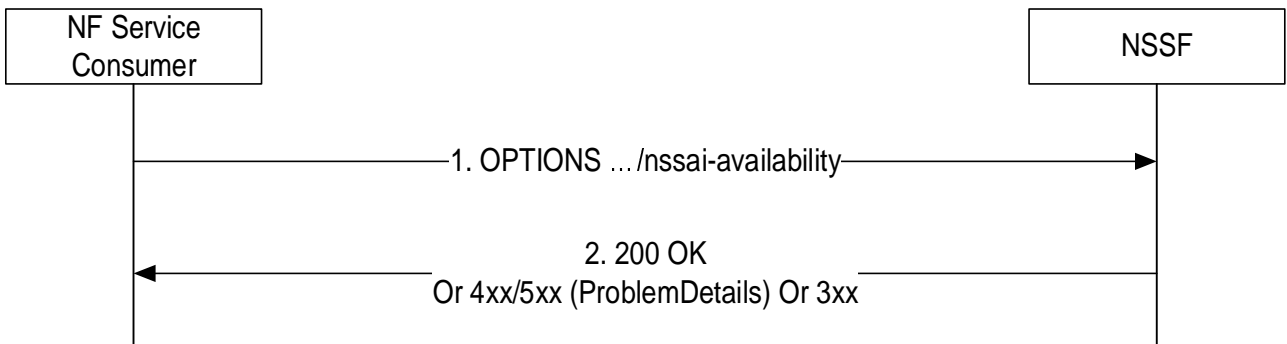

Figure 5.3.2.7.1-1: Procedure for the discovery of communication options supported by the NSSF

1. The NF service consumer (e.g. AMF) shall send an OPTIONS request to discover the communication options supported by the NSSF for the resource.
2. If the request is accepted, the NSSF shall respond with the status code 200 OK and include an Accept-Encoding header (as described in IETF RFC 9110 [18]).

On failure or redirection, the NSSF shall return one of the HTTP status code listed in Table 6.2.3.5.3.1-3.

6 API Definitions

6.1 Nnssf_NSSelection Service API

6.1.1 API URI

The Nnssf_NSSelection service shall use the Nnssf_NSSelection API.

The API URI of the Nnssf_NSSelection API shall be:

{apiRoot}/nssf-nselection/<apiVersion>

The request URIs used in HTTP requests from the NF service consumer towards the NF service producer shall have the Resource URI structure defined in clause 4.4.1 of 3GPP TS 29.501 [5], i.e.:

{apiRoot}/nssf-nselection/<apiVersion>/<apiSpecificResourceUriPart>

with the following components:

- The {apiRoot} shall be set as described in 3GPP TS 29.501 [5].
- The <apiVersion> shall be "v2".
- The <apiSpecificResourceUriPart> shall be set as described in clause 6.1.3.

6.1.2 Usage of HTTP

6.1.2.1 General

HTTP/2, IETF RFC 9113 [10], shall be used as specified in clause 5 of 3GPP TS 29.500 [4].

An OpenAPI [6] specification of HTTP messages and content bodies for the Nnssf_NSSelection service is specified in Annex A.

6.1.2.2 HTTP standard headers

6.1.2.2.1 General

See clause 5.2.2 of 3GPP TS 29.500 [4] for the usage of HTTP standard headers.

6.1.2.2.2 Content type

The following content types shall be supported:

- JSON, as defined in IETF RFC 8259 [14], shall be used as content type of the HTTP bodies specified in the present specification as indicated in clause 5.4 of 3GPP TS 29.500 [4].
 - The Problem Details JSON Object (IETF RFC 9457 [15]). The use of the Problem Details JSON object in a HTTP response body shall be signalled by the content type "application/problem+json".
- #### 6.1.2.3 HTTP custom headers

6.1.2.3.1 General

In this release of this specification, no custom headers specific to the Nnssf_NSSelection service are defined. For 3GPP specific HTTP custom headers used across all service based interfaces, see clause 5.2.3 of 3GPP TS 29.500 [4].

6.1.3 Resources

6.1.3.1 Overview

This clause describes the structure for the Resource URIs and the resources and methods used for the service.

Figure 6.1.3.1-1 describes the resource URI structure of the Nnssf_NSSelection API.

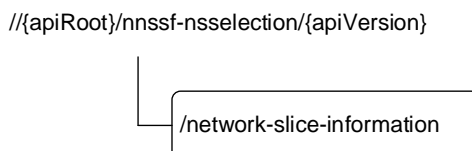

Figure 6.1.3.1-1: Resource URI structure of the nnsf_nssselection API

Table 6.1.3.1-1 provides an overview of the resources and applicable HTTP methods.

Table 6.1.3.1-1: Resources and methods overview

Resource name	Resource URI	HTTP method or custom operation	Description
Network Slice Information	/network-slice-information	GET	To retrieve network slice information. See clause 6.1.3.2.3.1. Maps to Nnssf_NSSelection_Get service operation.

6.1.3.2 Resource: Network Slice Information

6.1.3.2.1 Description

This resource represents the network slice related information maintained by the NSSF. This resource is modelled with the Document resource archetype (see clause C.1 of 3GPP TS 29.501 [5]).

6.1.3.2.2 Resource Definition

Resource URI: **{apiRoot}/nnsf-nssselection/<apiVersion>/network-slice-information**

This resource shall support the resource URI variables defined in table 6.1.3.2.2-1.

Table 6.1.3.2.2-1: Resource URI variables for this resource

Name	Data type	Definition
apiRoot	string	See clause 6.1.1

6.1.3.2.3 Resource Standard Methods

6.1.3.2.3.1 GET

This method retrieves the information related to the selected slice based on the input query parameters provided by the NF service consumer specified in table 6.1.3.2.3.1-1.

This method shall support input query parameters specified in table 6.1.3.2.3.1-1 and the response data structure and response codes specified in table 6.1.3.2.3.1-3.

Table 6.1.3.2.3.1-1: URI query parameters supported by the GET method on this resource

Name	Data type	P	Cardinality	Description
nf-type	NFType	M	1	This IE shall contain the NF type of the NF service consumer.
nf-id	NfInstanceId	M	1	This IE shall contain the NF identifier of the NF service consumer.
slice-info-request-for-registration	SliceInfoForRegistration	C	0..1	This IE shall be present when the network slice information is requested during the Registration procedure or during EPS to 5GS handover procedure using N26 interface towards an NSSF in the serving PLMN.
slice-info-request-for-pdu-session	SliceInfoForPDUSession	C	0..1	This IE shall be present when the network slice information is requested during the PDU session establishment procedure.
slice-info-request-for-ue-cu	SliceInfoForUEConfigurationUpdate	C	0..1	This IE shall be present when the network slice information is requested during UE configuration update procedure.
home-plmn-id	PlmnId	C	0..1	This IE shall be present in the request towards an NSSF in the serving PLMN if the subscriber is a roamer to the serving PLMN. When present, this IE shall contain the home PLMN Id of the UE.
tai	Tai	C	0..1	This IE shall be present in the request towards an NSSF in the serving PLMN. When present, this IE shall contain the TAI the UE is currently located.
supported-features	SupportedFeatures	C	0..1	This IE shall be present if at least one optional feature defined in clause 6.1.8 is supported.

Table 6.1.3.2.3.1-2: Data structures supported by the GET Request Body on this resource

Data type	P	Cardinality	Description
n/a			

Table 6.1.3.2.3.1-3: Data structures supported by the GET Response Body on this resource

Data type	P	Cardinality	Response codes	Description
AuthorizedNetworkSliceInfo	M	1	200 OK	This case represents a successful return of the authorized network slice information selected for the corresponding request.
RedirectResponse	O	0..1	307 Temporary Redirect	Temporary redirection. (NOTE 2)
RedirectResponse	O	0..1	308 Permanent Redirect	Permanent redirection. (NOTE 2)
ProblemDetails	O	0..1	403 Forbidden	This represents the case, where the NF service consumer is not authorized to retrieve the slice selection information or the all of the SNSSAIs included in the requested slice selection information is not supported in the PLMN. The application specific error information shall be provided in the "cause" attribute. The "cause" attribute shall be set to: - SNSSAI_NOT_SUPPORTED, if the SNSSAI included in the requested slice selection information is not allowed and there is no default NSSAI value provided in the request. - NOT_AUTHORIZED, if the NF service consumer identified by the NF Id is not authorized to retrieve the slice selection information. See table 6.1.7.3-1 for the description of this error.
NOTE 1: The mandatory HTTP error status codes for the GET method listed in Table 5.2.7.1-1 of 3GPP TS 29.500 [4] other than those specified in the table above also apply, with a ProblemDetails data type (see clause 5.2.7 of 3GPP TS 29.500 [4]).				
NOTE 2: RedirectResponse may be inserted by an SCP or SEPP, see clause 6.10.9.1 of 3GPP TS 29.500 [4].				

Table 6.1.3.2.3.1-4: Headers supported by the 307 Response Code on this resource

Name	Data type	P	Cardinality	Description
Location	string	M	1	An alternative URI of the resource located on an alternative service instance within the same NSSF or NSSF (service) set. For the case, when a request is redirected to the same target resource via a different SCP or SEPP, see clause 6.10.9.1 in 3GPP TS 29.500 [4].
3gpp-Sbi-Target-Nf-Id	string	O	0..1	Identifier of the target NF (service) instance ID towards which the request is redirected

Table 6.1.3.2.3.1-5: Headers supported by the 308 Response Code on this resource

Name	Data type	P	Cardinality	Description
Location	string	M	1	An alternative URI of the resource located on an alternative service instance within the same NSSF or NSSF (service) set. For the case, when a request is redirected to the same target resource via a different SCP or SEPP, see clause 6.10.9.1 in 3GPP TS 29.500 [4].
3gpp-Sbi-Target-Nf-Id	string	O	0..1	Identifier of the target NF (service) instance ID towards which the request is redirected

6.1.3.2.4 Resource Custom Operations

There are no custom methods supported on the network-slice-information collection resource.

6.1.4 Custom Operations without associated resources

There are no custom operations without associated resources defined for the Nnssf_NSSelection service in this version of this API.

6.1.5 Notifications

In this release of this specification, there are no notifications defined for the Nnssf_NSSelection service.

6.1.6 Data Model

6.1.6.1 General

This clause specifies the application data model supported by the API.

Table 6.1.6.1-1 specifies the data types defined for the Nnssf service based interface protocol.

Table 6.1.6.1-1: Nnssf_NSSelection specific Data Types

Data type	Clause defined	Description
AuthorizedNetworkSliceInfo	6.1.6.2.2	Contains the authorized network slice information.
SubscribedSnssai	6.1.6.2.3	Contains the subscribed S-NSSAI.
AllowedSnssai	6.1.6.2.5	Contains the authorized S-NSSAI and optional mapped home S-NSSAI and network slice instance information.
AllowedNssai	6.1.6.2.6	Contains an array of allowed S-NSSAI that constitute the Allowed NSSAI information for the authorized network slice information.
NsiInformation	6.1.6.2.7	Contains the API URIs of NRF services to be used to discover NFs/services, subscribe to NF status changes and/or request access tokens within the selected Network Slice instance and optional the Identifier of the selected Network Slice instance.
MappingOfSnssai	6.1.6.2.8	Contains the mapping of S-NSSAI in the serving network and the value of the home network.
SliceInfoForRegistration	6.1.6.2.10	Contains the slice information requested during a Registration procedure.
SliceInfoForPDUSession	6.1.6.2.11	Contains the slice information requested during PDU Session establishment procedure.
ConfiguredSnssai	6.1.6.2.12	Contains the configured S-NSSAI(s) authorized by the NSSF in the serving PLMN and optional mapped home S-NSSAI.
SliceInfoForUEConfigurationUpdate	6.1.6.2.13	Contains the slice information requested during UE configuration update procedure.
NsagInfo	6.1.6.2.14	Contains NSAG information.
Nsild	6.1.6.3.2	Contains the Identifier of the selected Network Slice instance.
RoamingIndication	6.1.6.3.3	Contains the indication on roaming.

Table 6.1.6.1-2 specifies data types re-used by the Nnssf. service based interface protocol from other specifications, including a reference to their respective specifications and when needed, a short description of their use within the Nnssf service based interface.

Table 6.1.6.1-2: Nnssf re-used Data Types

Data type	Reference	Comments
SupportedFeatures	3GPP TS 29.571 [7]	Used to negotiate the applicability of the optional features defined in table 6.1.8-1.
AccessType	3GPP TS 29.571 [7]	Used to specify the access type for which a slice information is applicable.
NfServiceSetId	3GPP TS 29.571 [7]	NF Service Set Identifier
RedirectResponse	3GPP TS 29.571 [7]	
NFType	3GPP TS 29.510 [13]	Type of Network Function.
NsSrg	3GPP TS 29.571 [7]	Network slice simultaneous registration groups
NsagId	3GPP TS 29.571 [7]	Network Slice AS Group ID
TaiRange	3GPP TS 29.510 [13]	Range of TAIs
Tai	3GPP TS 29.571 [7]	
Snssai	3GPP TS 29.571 [7]	
NfInstanceId	3GPP TS 29.571 [7]	

6.1.6.2 Structured data types

6.1.6.2.1 Introduction

This clause defines the structures to be used in resource representations.

6.1.6.2.2 Type: AuthorizedNetworkSliceInfo

Table 6.1.6.2.2-1: Definition of type AuthorizedNetworkSliceInfo

Attribute name	Data type	P	Cardinality	Description	Applicability
allowedNssaiList	array(AllowedNssai)	C	1..N	<p>This IE shall be included if:</p> <ul style="list-style-type: none"> - the NSSF received the Requested NSSAI and the subscribed S-NSSAI(s); or - the "requestMapping" flag in the corresponding request was set to "true"; or - if neither Requested NSSAI nor the mapping of Requested NSSAI was provided to the NSSF or none of the S-NSSAIs in the Requested NSSAI are permitted (provided that there is at least a subscribed S-NSSAI marked as default which is available in the current TA). <p>When present, this IE shall contain the allowed S-NSSAI(s) authorized by the NSSF in the serving PLMN per access type if the Requested NSSAI and the subscribed S-NSSAI(s) received (NOTE 4), or this IE shall contain the mapping of S-NSSAI(s) of the VPLMN to corresponding HPLMN S-NSSAI(s) if requestMapping flag was set to "true".</p> <p>NSSF may consider load level information of a Network Slice instance, provided by the NWDAF, to exclude slices that are overloaded.</p>	
configuredNssai	array(ConfiguredS nssai)	C	1..N	<p>This IE shall be included if:</p> <ul style="list-style-type: none"> - the NSSF did not receive any Requested NSSAI; or - the Requested NSSAI includes an S-NSSAI that is not valid in the Serving PLMN; or - the NSSF has received "defaultConfiguredSnsaiInd" set to "true"; or - the network slice information is requested during UE configuration update procedure. <p>When present, this IE shall contain the configured S-NSSAI(s) authorized by the NSSF in the serving PLMN.</p> <p>This IE shall not be included if the "requestMapping" IE was included in the request message and was set to "true".</p> <p>NSSF may consider load level information of a Network Slice instance, provided by the NWDAF, to exclude slices that are overloaded.</p>	

targetAmfSet	string	O	0..1	<p>This IE may be included by the NSSF based on configuration and if the NSSF received the Requested NSSAI and the subscribed S-NSSAI(s). When present, this IE shall contain the target AMF set which shall be constructed from PLMN-ID (i.e. three decimal digits MCC and two or three decimal digits MNC), AMF Region Id (8 bit), and AMF Set Id (10 bit).</p> <p>This IE shall not be included if the "requestMapping" IE was included in the request message and was set to "true". Pattern: '^([0-9]{3}-[0-9]{2,3}-[A-Fa-f0-9]{2}-[0-3][A-Fa-f0-9]{2})\$' (NOTE 1, NOTE 2, NOTE 3)</p>	
candidateAmfList	array(NfInstanceId)	O	1..N	<p>This IE may be included by the NSSF based on configuration and if the NSSF received the Requested NSSAI and the subscribed S-NSSAI(s). When present, this IE shall contain the list of candidate AMF(s).</p> <p>This IE shall not be included if the "requestMapping" IE was included in the request message and was set to "true". (NOTE 2, NOTE 3)</p>	
rejectedNssaiInPLMN	array(Snssai)	O	1..N	<p>This IE may be included by the NSSF if the NSSF received the Requested NSSAI and the subscribed S-NSSAI(s). When present, this IE shall contain the rejected NSSAI in the PLMN.</p> <p>NSSF may consider load level information of a Network Slice instance, provided by the NWDAF, to exclude slices that are overloaded. Such slices may be included in this attribute.</p>	
rejectedNssaiInTA	array(Snssai)	O	1..N	<p>This IE may be included by the NSSF if the NSSF received the Requested NSSAI and the subscribed S-NSSAI(s). When present, this IE shall contain the rejected NSSAI in the current TA.</p> <p>NSSF may consider load level information of a Network Slice instance, provided by the NWDAF, to exclude slices that are overloaded. Such slices may be included in this attribute.</p>	
nsiInformation	NsiInformation	C	0..1	<p>This IE shall be included by the NSSF if the NSSF received the S-NSSAI (i.e. during PDU session establishment procedure in non-roaming or LBO roaming).</p> <p>This IE shall also be included by the hNSSF and forwarded by the vNSSF if the hNSSF received the S-NSSAI (i.e. during PDU session establishment procedure in HR roaming).</p> <p>This IE shall not be included if the "requestMapping" IE was included in the request message and was set to "true".</p>	
supportedFeatures	SupportedFeatures	C	0..1	<p>This IE shall be present if at least one optional feature defined in clause 6.1.8 is supported.</p>	

nrfAmfSet	Uri	O	0..1	This IE may be included by the NSSF based on configuration and if the target AMF Set is included. When present, this IE shall contain the API URI of the NRF NFDISCOVERY Service (see clause 6.2.1 of 3GPP TS 29.510 [13]) to be used to determine the list of candidate AMF(s) from the AMF Set. (NOTE 2)	
nrfAmfSetNfmgtUri	Uri	C	0..1	This IE should be present if the nrfAmfSet is present. When present, it shall contain the API URI of the NRF NFMANAGEMENT Service (see clause 6.1.1 of 3GPP TS 29.510 [13]). (NOTE 2)	
nrfAmfSetAccessTokenUri	Uri	O	0..1	When present, this IE shall contain the API URI of the NRF ACCESS TOKEN Service (see clause 6.3.2 of 3GPP TS 29.510 [13]). (NOTE 2)	
nrfOauth2Required	map(boolean)	O	1..N	This IE may be present if the nrfAmfSet IE or the nrfAmfSetNfmgtUri IE is present. When present, this IE shall indicate whether the NRF requires OAuth2-based authorization for accessing its services. The key of the map shall be the name of an NRF service, e.g. "nrf-nfm" or "nrf-disc". The value of each entry of the map shall be encoded as follows: - true: OAuth2 based authorization is required. - false: OAuth2 based authorization is not required. If this IE is present and set to true, then the nrfAmfSetAccessTokenUri IE shall be present and shall be used to request access token for NRF services. The absence of this IE means that the NRF has not provided any indication about its usage of OAuth2 for authorization. (NOTE 2)	
targetAmfServiceSet	NfServiceSetId	O	0..1	When present, this IE shall contain the target AMF service set. (NOTE 1, NOTE 2)	
targetNssai	array(Snssai)	O	1..N	This IE may be included by the NSSF if the NSSF received the Requested NSSAI and TAI, or the NSSF received the rejected NSSAI of current Registration Area. When present, this IE shall contain S-NSSAI(s) as defined in clause 5.3.4.3.3 of 3GPP TS 23.501 [2].	TargetNssai
nsagInfos	array(NsagInfo)	C	1..N	This attribute shall be present if the AMF has indicated the support of NSAG by the UE, and the NSAG information is available to the NSSF. This attribute contains the list of NSAG information.	

NOTE 1: The NF Service Consumer uses the PLMN ID, AMF Region, AMF Set and AMF Service Set to perform a NF Discovery to the NRF.
NOTE 2: These attributes should be absent if the NSSF provides a Target NSSAI in targetNssai attribute in order to redirect or handover the UE to a cell of another TA as defined in clause 5.15.5.2.1 of 3GPP TS 23.501 [2].
NOTE 3: The targetAmfSet attribute and the candidateAmfList attribute should not be present simultaneously.
NOTE 4: The authorized allowed S-NSSAIs may contain also Subscribed S-NSSAIs not marked as default and/or that were not part of the Requested NSSAI based on local policy configuration at NSSF.

6.1.6.2.3 Type: SubscribedSnsai

Table 6.1.6.2.3-1: Definition of type SubscribedSnsai

Attribute name	Data type	P	Cardinality	Description
subscribedSnsai	Snsai	M	1	This IE shall contain the subscribed S-NSSAI.
defaultIndication	boolean	O	0..1	If it is set, the subscribed S-NSSAI is a default subscribed S-NSSAI.
subscribedNsSrgList	array(NsSrg)	O	1..N	If present, this IE shall contain the subscribed network slice simultaneous registration groups applicable to the subscribedSnsai.

6.1.6.2.4 Void

6.1.6.2.5 Type: AllowedSnsai

Table 6.1.6.2.5-1: Definition of type AllowedSnsai

Attribute name	Data type	P	Cardinality	Description
allowedSnsai	Snsai	M	1	This IE shall contain the allowed S-NSSAI in the serving PLMN.
nsiInformationList	array(NsiInformation)	O	1..N	This IE may be present when the NSSF provides the Allowed NSSAI information to the NF service consumer (e.g AMF). If present, this IE shall include the information related to the network slice instance corresponding to the allowed S-NSSAI.
mappedHomeSnsai	Snsai	O	0..1	When present, this IE shall contain the mapped S-NSSAI value of home network corresponding to the allowed S-NSSAI in the serving PLMN.

6.1.6.2.6 Type: AllowedNssai

Table 6.1.6.2.6-1: Definition of type AllowedNssai

Attribute name	Data type	P	Cardinality	Description
allowedSnsaiList	array(AllowedSnsai)	M	1..N	This IE shall contain the allowed S-NSSAI in the serving PLMN. (NOTE)
accessType	AccessType	M	1	This IE shall contain the access type to which this Allowed NSSAI belongs.
NOTE:	The maximum number of allowed S-NSSAIs shall not exceed the maximum number defined in 3GPP TS 24.501 [20].			

6.1.6.2.7 Type: NsilInformation

Table 6.1.6.2.7-1: Definition of type NsilInformation

Attribute name	Data type	P	Cardinality	Description
nrflid	Uri	M	1	This IE shall contain the API URI of the NRF NFDISCOVERY Service (see clause 6.2.1 of 3GPP TS 29.510 [13]) to be used to select the NFs/services within the selected Network Slice instance.
nsild	Nsild	O	0..1	This IE may be optionally included by the NSSF. When present, this IE shall contain the Identifier of the selected Network Slice instance
nrnfMgtUri	Uri	O	0..1	This IE should be present. When present, it shall contain the API URI of the NRF NFManagement Service (see clause 6.1.1 of 3GPP TS 29.510 [13]).
nrfaAccessUri	Uri	O	0..1	When present, this IE shall contain the API URI of the NRF Access Token Service (see clause 6.3.2 of 3GPP TS 29.510 [13]).
nrfoAuth2Required	map(boolean)	O	1..N	<p>This IE may be present if the nrflid IE or the nrnfMgtUri IE is present.</p> <p>When present, this IE shall indicate whether the NRF requires OAuth2-based authorization for accessing its services.</p> <p>The key of the map shall be the name of an NRF service, e.g. "nrnf-nfm" or "nrnf-disc".</p> <p>The value of each entry of the map shall be encoded as follows:</p> <ul style="list-style-type: none"> - true: OAuth2 based authorization is required. - false: OAuth2 based authorization is not required. <p>The absence of this IE means that the NRF has not provided any indication about its usage of OAuth2 for authorization.</p>

6.1.6.2.8 Type: MappingOfSnssai

Table 6.1.6.2.8-1: Definition of type MappingOfSnssai

Attribute name	Data type	P	Cardinality	Description
servingSnssai	Snssai	M	1	This IE shall contain the S-NSSAI value of serving network.
homeSnssai	Snssai	M	1	This IE shall contain the mapped S-NSSAI value of home network.

6.1.6.2.9 Void

6.1.6.2.10 Type: SliceInfoForRegistration

Table 6.1.6.2.10-1: Definition of type SliceInfoForRegistration

Attribute name	Data type	P	Cardinality	Description
subscribedNssai	array(SubscribedSnssai)	C	1..N	This IE shall be included during the initial registration procedure or during mobility registration procedure in 5GS. This IE may also be included during EPS to 5GS handover procedure/Idle mode Mobility Registration Procedure using N26 interface or the handover procedure within 5GS. When present, this IE shall contain the list of subscribed S-NSSAIs along with an indication for each S-NSSAI if it is a default S-NSSAI.
allowedNssaiCurrentAccess	AllowedNssai	C	0..1	This IE shall be included during an initial registration procedure in 5GS or during mobility registration update procedure in 5GS with a native 5G-GUTI as the old GUTI, and an Allowed NSSAI for the current access type of the UE is available at the NF service consumer (e.g. AMF).
allowedNssaiOtherAccess	AllowedNssai	C	0..1	This IE shall be present during an initial registration procedure in 5GS or during mobility registration update procedure in 5GS with a native 5G-GUTI as the old GUTI, and if the UE was registered with the NF service consumer (e.g. AMF) earlier for another access type and an Allowed NSSAI for the other access type is available at the NF service consumer (e.g. AMF).
sNssaiForMapping	array(Snssai)	C	1..N	This IE shall be included if the requestMapping IE is set to true. When included, this IE shall contain the set of S-NSSAIs obtained from PGW+SMF in the HPLMN for PDU sessions that are handed over from EPS to 5GS, or shall contain the set of HPLMN S-NSSAIs obtained from source AMF during handover procedure within 5GS, or shall contain the S-NSSAIs for the HPLMN received from the UE during EPS to 5GS Idle mode Mobility Registration Procedure using N26 interface/idle state mobility registration procedure in 5GS.
mappingOfNssai	array(MappingOfSnssai)	O	1..N	This IE may be present when the network slice information is requested during the Registration procedure in roaming scenarios. If present, this IE shall contain the mapping of S-NSSAI of the VPLMN to corresponding HPLMN S-NSSAI, for the S-NSSAIs included in the requestedNssai and allowedNssai IEs for the current and other access types. This IE may also be present when the network slice information is requested during EPS to 5GS handover procedure using N26 interface or the handover procedure within 5GS. If present, this IE shall contain the mapping of S-NSSAI of the VPLMN to corresponding HPLMN S-NSSAI, for the S-NSSAIs included in the requestedNssai IE.
requestedNssai	array(Snssai)	O	1..N	This IE may contain the set of S-NSSAIs requested by the UE, it shall be the S-NSSAIs in hPLMN in non-roaming scenario, or the S-NSSAIs in vPLMN in LBO/HR roaming scenario. During EPS to 5GS handover procedure using N26 interface, this IE may contain the set of S-NSSAIs in the serving PLMN obtained from PGW+SMF in VPLMN, or mapped from the set of S-NSSAIs obtained from PGW+SMF in the HPLMN. During handover procedure within 5GS, this IE may contain the set of S-NSSAIs in the serving PLMN obtained from the source AMF, or mapped from the set of HPLMN S-NSSAIs obtained from source AMF.

defaultConfiguredSnsaiInd	boolean	C	0..1	<p>This IE shall be present when the UE includes the Default Configured NSSAI Indication during the Registration procedure or when the AMF receives the network slice subscription change indication (NSSCI) from UDM.</p> <p>true: The NSSF is required to return Configured NSSAI; false (default): The NSSF is not required to return Configured NSSAI.</p>
requestMapping	boolean	O	0..1	<p>This IE may be present when the Nnssf_NSSelection_Get procedure is invoked during EPS to 5GS Mobility Registration Procedure (Idle State) using N26 interface or during EPS to 5GS handover procedure using N26 interface. This IE may also be present when Nnssf_NSSelection_Get procedure is invoked during idle state Mobility Registration Procedure or handover procedure in 5GS.</p> <p>When present this IE shall indicate to the NSSF that the NSSF shall return the VPLMN specific mapped SNSSAI values for the S-NSSAI values in the sNssaiForMapping IE.</p>
ueSupNssrgInd	boolean	C	0..1	<p>This IE shall be present in the request towards an NSSF in the serving PLMN when UE has indicated the support of NSSRG feature. When present, this IE shall contain the indication of UE support of subscription-based restrictions to simultaneous registration of network slice feature.</p> <p>This IE shall be set as follows: - true: the UE supports NSSRG feature - false: the UE does not support NSSRG feature.</p>
suppressNssrgInd	boolean	O	0..1	<p>When present, this IE shall contain the UDM indication to provide all subscribed S-NSSAIs for UEs not indicating support of subscription-based restrictions to simultaneous registration of network slices. This IE may be present and set to true if the ueSupNssrgInd is set to false.</p> <p>This IE shall be set as follows: - true: UDM Indication to suppress NSSRG is present and set to TRUE - false: UDM Indication to suppress NSSRG is set to FALSE or not present</p>
nsagSupported	boolean	C	0..1	<p>This IE shall be present if the UE has indicated support of NSAG in the 5GMM procedure.</p> <p>true: the UE supports NSAG. false (default): the UE does not support NSAG.</p>

6.1.6.2.11 Type: SliceInfoForPDUSession

Table 6.1.6.2.11-1: Definition of type SliceInfoForPDUSession

Attribute name	Data type	P	Cardinality	Description
sNssai	Snssai	M	1	This IE shall contain the requested S-NSSAI for the PDU session, when the AMF queries the NSSF in the serving PLMN. When the vNSSF queries the hNSSF during PDU session establishment for home routed roaming case, this IE shall contain the S-NSSAI from the HPLMN that maps to the S-NSSAI from the Allowed NSSAI of the Serving PLMN, as obtained from the NF Service Consumer of the vNSSF.
roamingIndication	RoamingIndication	M	1	This IE shall contain the indication whether the UE is in non-roaming, LBO roaming or HR roaming.
homeSnssai	Snssai	C	0..1	This IE shall be included by the NF Service Consumer (e.g. AMF) towards the vNSSF during PDU session establishment procedure in home routed roaming scenario. This IE shall contain the S-NSSAI of the HPLMN that maps to the S-NSSAI from the Allowed NSSAI of the Serving PLMN when the UE is in the roaming scenario.

6.1.6.2.12 Type: ConfiguredSnssai

Table 6.1.6.2.12-1: Definition of type ConfiguredSNssai

Attribute name	Data type	P	Cardinality	Description
configuredSnssai	Snssai	M	1	This IE shall contain the configured S-NSSAI in the serving PLMN.
mappedHomeSnssai	Snssai	O	0..1	When present, this IE shall contain the mapped S-NSSAI value of home network corresponding to the configured S-NSSAI in the serving PLMN.

6.1.6.2.13 Type: SliceInfoForUEConfigurationUpdate

Table 6.1.6.2.13-1: Definition of type SliceInfoForUEConfigurationUpdate

Attribute name	Data type	P	Cardinality	Description	Applicability
subscribedNssai	array(SubscribedSnssai)	C	1..N	This IE shall be included during UE configuration update procedure in 5GS. When present, this IE shall contain the list of subscribed S-NSSAIs along with an indication for each S-NSSAI if it is a default S-NSSAI.	
allowedNssaiCurrentAccess	AllowedNssai	O	0..1	This IE may be included during UE configuration update procedure in 5GS. When present, this IE shall contain the list of allowed S-NSSAIs in the AMF for the current access type of the UE.	
allowedNssaiOtherAccess	AllowedNssai	O	0..1	This IE may be included during UE configuration update procedure in 5GS. When present, this IE shall contain the list of allowed S-NSSAIs in the AMF for the other access type of the UE.	
defaultConfiguredSnssaiInd	boolean	O	0..1	This IE may be present if the UE included the Default Configured NSSAI Indication during the recent Registration procedure, or if the AMF recently received the network slice subscription change indication (NSSCI) from UDM. true: The NSSF is required to return Configured NSSAI; false (default): The NSSF is not required to return Configured NSSAI.	
requestedNssai	array(Snssai)	O	1..N	This IE may contain the set of S-NSSAIs requested by the UE in the recent registration procedure, it shall be the S-NSSAIs in hPLMN in non-roaming scenario, or the S-NSSAIs in vPLMN in LBO/HR roaming scenario.	
mappingOfNssai	array(MappingOfSnssai)	O	1..N	This IE may be present when the network slice information is requested during UE configuration update procedure in roaming scenarios. If present, this IE shall contain the mapping of S-NSSAI of the VPLMN to corresponding HPLMN S-NSSAI, for the S-NSSAIs included in the requestedNssai and the allowedNssai IEs for the current and other access types.	
ueSupNssrgInd	boolean	C	0..1	This IE shall be present in the request towards an NSSF in the serving PLMN when UE has indicated the support of NSSRG feature. When present, this IE shall contain the indication of UE support of subscription-based restrictions to simultaneous registration of network slice feature. This IE shall be set as follows: - true: the UE supports NSSRG feature - false: the UE does not support NSSRG feature.	
suppressNssrgInd	boolean	O	0..1	When present, this IE shall contain the UDM indication to provide all subscribed S-NSSAIs for UEs not indicating support of subscription-based restrictions to simultaneous registration of network slices. This IE may be present and set to true if the ueSupNssrgInd is set to false. This IE shall be set as follows: - true: UDM Indication to suppress NSSRG is present and set to TRUE - false: UDM Indication to suppress NSSRG is set to FALSE or not present	

rejectedNssaiRa	array(Snssai)	O	1..N	This IE may be present when the UE is needed to be redirected to the dedicated frequency band(s) for an S-NSSAI (as specified in clause 5.3.4.3.3 of 3GPP TS 23.501 [2]). When present, this IE shall indicate the rejected S-NSSAI(s) of the Registration Area.	TargetNssai
nsagSupported	boolean	C	0..1	This IE shall be present if the UE has indicated support of NSAG in the 5GMM procedure. true: the UE supports NSAG. false (default): the UE does not support NSAG.	

6.1.6.2.14 Type: NsagInfo

Table 6.1.6.2.14-1: Definition of type NsagInfo

Attribute name	Data type	P	Cardinality	Description
nsagIds	array(NsagId)	M	1..N	The list of NSAG IDs, see 3GPP TS 38.413 [21]
snssaiList	array(Snssai)	M	1..N	This attribute contains the S-NSSAI(s) which are associated with the NSAGs identified by the nsagIds.
taiList	array(Tai)	O	1..N	This attribute indicates the TA(s) within which the association between the NSAGs identified by the nsagIds and the S-NSSAI(s) is valid. (NOTE)
taiRangeList	array(TaiRange)	O	1..N	This attribute indicates the TA(s) within which the association between the NSAGs identified by the nsagIds and the S-NSSAI(s) is valid. (NOTE)
NOTE: The absence of both taiList and taiRangeList attributes means the association between the NSAGs identified by the nsagIds and the S-NSSAI(s) is valid across the PLMN				

6.1.6.3 Simple data types and enumerations

6.1.6.3.1 Introduction

This clause defines simple data types and enumerations that can be referenced from data structures defined in the previous clauses.

6.1.6.3.2 Simple data types

The simple data types defined in table 6.1.6.3.2-1 shall be supported.

Table 6.1.6.3.2-1: Simple data types

Type Name	Type Definition	Description
Nsild	string	Represents the Network Slice Instance Identifier

6.1.6.3.3 Enumeration: RoamingIndication

Table 6.1.6.3.3-1: Enumeration RoamingIndication

Enumeration value	Description
NON_ROAMING	This value indicates that the UE is not roaming.
LOCAL_BREAKOUT	This value indicates that the UE is roaming but is using a local breakout PDU session.
HOME_ROUTED_ROAMING	This value indicates that the UE is roaming and is using a home routed PDU session.

6.1.6.4 Binary data

There is no binary data used for the Nnssf_NSSelection service in this version of the API.

6.1.7 Error Handling

6.1.7.1 General

HTTP error handling shall be supported as specified in clause 5.2.4 of 3GPP TS 29.500 [4].

6.1.7.2 Protocol Errors

Protocol Error Handling shall be supported as specified in clause 5.2.7.2 of 3GPP TS 29.500 [4].

6.1.7.3 Application Errors

The common application errors defined in the Table 5.2.7.2-1 in 3GPP TS 29.500 [4] may also be used for the Nnssf_NSSelection service. The following application errors listed in Table 6.1.7.3-1 are specific for the Nnssf_NSSelection service.

Table 6.1.7.3-1: Application errors

Application Error	HTTP status code	Description
SNSSAI_NOT_SUPPORTED	403 Forbidden	This cause value shall be set when the requested slice selection information is for SNSSAI(s) not supported.
NOT_AUTHORIZED	403 Forbidden	The request is rejected due to the NF service consumer is not authorized to retrieve the slice selection information.

6.1.8 Feature negotiation

The feature negotiation mechanism specified in clause 6.6 of 3GPP TS 29.500 [4] shall be used to negotiate the optional features applicable between the NSSF and the NF Service Consumer, for the Nnssf_NSSelection service, if any.

The NF Service Consumer shall indicate the optional features it supports for the Nnssf_NSSelection service, if any, by including the supportedFeatures attribute in the HTTP GET request when requesting the NSSF to provide the Allowed NSSAI information.

The NSSF shall determine the supported features for the requested network slice information resource as specified in clause 6.6 of 3GPP TS 29.500 [4] and shall indicate the supported features by including the supportedFeatures attribute in the Allowed NSSAI information it returns in the HTTP response.

The syntax of the supportedFeatures attribute is defined in clause 5.2.2 of 3GPP TS 29.571 [7].

The following features are defined for the Nnssf_NSSelection service.

Table 6.1.8-1: Features of supportedFeatures attribute used by Nnssf_NSSelection service

Feature Number	Feature	M/O	Description
1	ES3XX	M	Extended Support of HTTP 307/308 redirection An NF Service Consumer (e.g. AMF) that supports this feature shall support handling of HTTP 307/308 redirection for any service operation of the Nnssf_NSSelection service. An NF Service Consumer that does not support this feature does only support HTTP redirection as specified for 3GPP Release 15.
2	TargetNssai	O	Target NSSAI An NF Service Consumer (e.g. AMF) and NSSF that supports this feature shall support handling of Target NSSAI as specified in clause 5.3.4.3.3 and clause 5.15.5.2.1 of 3GPP TS 23.501 [2].
Feature number: The order number of the feature within the supportedFeatures attribute (starting with 1). Feature: A short name that can be used to refer to the bit and to the feature. M/O: Defines if the implementation of the feature is mandatory ("M") or optional ("O"). Description: A clear textual description of the feature.			

6.1.9 Security

As indicated in 3GPP TS 33.501 [11] and 3GPP TS 29.500 [4], the access to the Nnssf_NSSelection API may be authorized by means of the OAuth2 protocol (see IETF RFC 6749 [12]), based on local configuration, using the "Client Credentials" authorization grant, where the NRF (see 3GPP TS 29.510 [13]) plays the role of the authorization server.

If OAuth2 is used, an NF Service Consumer, prior to consuming services offered by the Nnssf_NSSelection API, shall obtain a "token" from the authorization server, by invoking the Access Token Request service, as described in 3GPP TS 29.510 [13], clause 5.4.2.2.

NOTE: When multiple NRFs are deployed in a network, the NRF used as authorization server is the same NRF that the NF Service Consumer used for discovering the Nnssf_NSSelection service.

The Nnssf_NSSelection API does not define any scopes for OAuth2 authorization.

6.1.10 HTTP redirection

An HTTP request may be redirected to a different NSSF service instance, within the same NSSF or a different NSSF of an NSSF set, e.g. when an NSSF service instance is part of an NSSF (service) set or when using indirect communications (see 3GPP TS 29.500 [4]). See the ES3XX feature in clause 6.1.8.

An SCP that reselects a different NSSF producer instance will return the NF Instance ID of the new NSSF producer instance in the 3gpp-Sbi-Producer-Id header, as specified in clause 6.10.3.4 of 3GPP TS 29.500 [4].

If an NSSF within an NSSF set redirects a service request to a different NSSF of the set using a 307 Temporary Redirect or 308 Permanent Redirect status code, the identity of the new NSSF towards which the service request is redirected shall be indicated in the 3gpp-Sbi-Target-Nf-Id header of the 307 Temporary Redirect or 308 Permanent Redirect response as specified in clause 6.10.9.1 of 3GPP TS 29.500 [4].

6.2 Nnssf_NSSAIAvailability Service API

6.2.1 API URI

The Nnssf_NSSAIAvailability service shall use the Nnssf_NSSAIAvailability API.

The API URI of the Nnssf_NSSAIAvailability API shall be:

{apiRoot}/nssf-nssaiavailability/<apiVersion>

The request URIs used in HTTP requests from the NF service consumer towards the NF service producer shall have the Resource URI structure defined in clause 4.4.1 of 3GPP TS 29.501 [5], i.e.:

{apiRoot}/nssf-nssaiavailability/<apiVersion>/<apiSpecificResourceUriPart>

with the following components:

- The {apiRoot} shall be set as described in 3GPP TS 29.501 [5].
- The <apiVersion> shall be "v1".
- The <apiSpecificResourceUriPart> shall be set as described in clause 6.2.3.

6.2.2 Usage of HTTP

6.2.2.1 General

HTTP/2, IETF RFC 9113 [10], shall be used as specified in clause 5 of 3GPP TS 29.500 [4].

An OpenAPI [6] specification of HTTP messages and content bodies for the Nssf_NSSAIAvailability service is specified in Annex A.

6.2.2.2 HTTP standard headers

6.2.2.2.1 General

See clause 5.2.2 of 3GPP TS 29.500 [4] for the usage of HTTP standard headers.

6.2.2.2.2 Content type

The JSON format shall be supported. The use of JSON format shall be as specified in clause 5.4 of 3GPP TS 29.500 [4].

The following content types shall be supported:

- JSON, as defined in IETF RFC 8259 [14], shall be used as content type of the HTTP bodies specified in the present specification as indicated in clause 5.4 of 3GPP TS 29.500 [4].
- The Problem Details JSON Object (IETF RFC 9457 [15]). The use of the Problem Details JSON object in a HTTP response body shall be signalled by the content type "application/problem+json".
- JSON Patch (IETF RFC 6902 [8]). The use of the JSON Patch format in a HTTP request body shall be signalled by the content type "application/json-patch+json".

6.2.2.2.3 Accept-Encoding

The NSSF should support gzip coding (see IETF RFC 1952 [16]) in HTTP requests and responses and indicate so in the Accept-Encoding header, as described in clause 6.9 of 3GPP TS 29.500 [4].

6.2.2.3 HTTP custom headers

6.2.2.3.1 General

In this release of this specification, no custom headers specific to the Nssf_NSSAIAvailability service are defined. For 3GPP specific HTTP custom headers used across all service based interfaces, see clause 5.2.3 of 3GPP TS 29.500 [4].

6.2.3 Resources

6.2.3.1 Overview

This clause describes the structure for the Resource URIs and the resources and methods used for the service.

Figure 6.2.3.1-1 describes the resource URI structure of the Nnssf_NSSAIAvailability API.

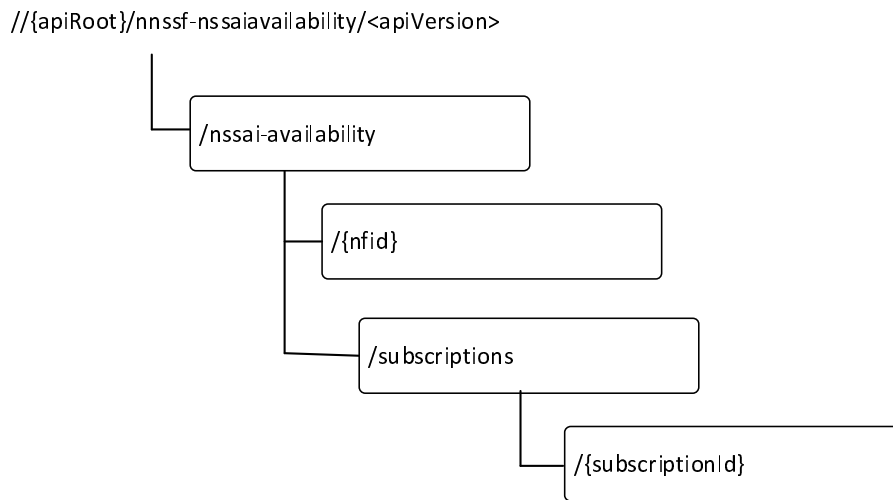

Figure 6.2.3.1-1: Resource URI structure of the Nnssf_NSSAIAvailability API

Table 6.2.3.1-1 provides an overview of the resources and applicable HTTP methods.

Table 6.2.3.1-1: Resources and methods overview

Resource name	Resource URI	HTTP method or custom operation	Description
NSSAI Availability Store	/nssai-availability	OPTIONS	Discover the communication options supported by the NSSF for this resource.
NSSAI Availability Document	/nssai-availability/{nfd}	PUT	Updates the NSSF with the S-NSSAIs the NF service consumer (e.g. AMF) supports per TA.
		PATCH	Updates the NSSF with the S-NSSAIs the NF service consumer (e.g. AMF) supports per TA.
		DELETE	Delete the resource of the S-NSSAIs supported per TA by the NF service consumer (e.g. AMF)
NSSAI Availability Notification Subscriptions Collection	/nssai-availability/subscriptions	POST	Create a subscription to the notification of any changes to the NSSAI availability information, Network Slice Replacement or Network Slice Instance Replacement.
Individual NSSAI Availability Notification Subscriptions	/nssai-availability/subscriptions/{subscriptionId}	DELETE	Unsubscribe to the notification of any changes to the NSSAI availability information, Network Slice Replacement or Network Slice Instance Replacement.
		PATCH	Modify a subscription.

6.2.3.2 Resource: NSSAI Availability Document

6.2.3.2.1 Description

This resource represents a single NSSAI Availability resource.

This resource is modelled with the Document resource archetype (see clause C.1 of 3GPP TS 29.501 [5]).

6.2.3.2.2 Resource Definition

Resource URI: {apiRoot}/nssf-nssaiavailability/<apiVersion>/nssai-availability/{nfId}

This resource shall support the resource URI variables defined in table 6.2.3.2.2-1.

Table 6.2.3.2.2-1: Resource URI variables for this resource

Name	Data type	Definition
apiRoot	string	See clause 6.2.1
nfId	NfInstanceId	Represents the Identifier of the AMF for which the NSSAI Availability information is updated.

6.2.3.2.3 Resource Standard Methods

6.2.3.2.3.1 PUT

This method shall support the request data structures specified in table 6.2.3.2.3.1-1 and the response data structures and response codes specified in table 6.2.3.2.3.1-2.

Table 6.2.3.2.3.1-1: Data structures supported by the PUT Request Body on this resource

Data type	P	Cardinality	Description
NssaiAvailabilityInfo	M	1	This IE contains the information regarding the NssaiAvailabilityData for the NF Service Consumer (e.g AMF).

Table 6.2.3.2.3.1-2: Data structures supported by the PUT Response Body on this resource

Data type	P	Cardinality	Response codes	Description
AuthorizedNssaiAvailabilityInfo	M	1	200 OK	This case represents a successful update of the NSSF with the S-NSSAIs the AMF supports per TA. The authorized NSSAI availability (i.e. S-NSSAIs available per TA (unrestricted) and any S-NSSAIs restricted per PLMN in that TA in the serving PLMN of the UE) information shall be returned in the response content.
N/A			204 No Content	This case represents a successful update of the NSSF with the S-NSSAIs the AMF supports per TA, and the authorized NSSAI availability is empty after the update.
RedirectResponse	O	0..1	307 Temporary Redirect	Temporary redirection. (NOTE 2)
RedirectResponse	O	0..1	308 Permanent Redirect	Permanent redirection. (NOTE 2)
ProblemDetails	O	0..1	403 Forbidden	When the NF service consumer is not authorized to update the NSSAI availability information or the TAI/S-NSSAI information provided is not supported in the PLMN, the "cause" attribute shall be set to: <ul style="list-style-type: none"> - SNSSAI_NOT_SUPPORTED, if the S-NSSAI provided is not supported in the PLMN. - NOT_AUTHORIZED, if the NF service consumer identified by the NF Id is not authorized to update the NSSAI availability information. See table 6.2.7.3-1 for the description of this error.
NOTE 1: The mandatory HTTP error status codes for the PUT method listed in Table 5.2.7.1-1 of 3GPP TS 29.500 [4] other than those specified in the table above also apply, with a ProblemDetails data type (see clause 5.2.7 of 3GPP TS 29.500 [4]).				
NOTE 2: RedirectResponse may be inserted by an SCP, see clause 6.10.9.1 of 3GPP TS 29.500 [4].				

Table 6.2.3.2.3.1-3: Headers supported by the PUT method on this resource

Name	Data type	P	Cardinality	Description
Content-Encoding	string	O	0..1	Content-Encoding, described in IETF RFC 9110 [18]

Table 6.2.3.2.3.1-4: Headers supported by the 200 Response Code on this resource

Name	Data type	P	Cardinality	Description
Accept-Encoding	string	O	0..1	Accept-Encoding, described in IETF RFC 9110 [18]

Table 6.2.3.2.3.1-5: Headers supported by the 307 Response Code on this resource

Name	Data type	P	Cardinality	Description
Location	string	M	1	An alternative URI of the resource located on an alternative service instance within the same NSSF or NSSF (service) set. For the case, when a request is redirected to the same target resource via a different SCP, see clause 6.10.9.1 in 3GPP TS 29.500 [4].
3gpp-Sbi-Target-Nf-Id	string	O	0..1	Identifier of the target NF (service) instance ID towards which the request is redirected

Table 6.2.3.2.3.1-6: Headers supported by the 308 Response Code on this resource

Name	Data type	P	Cardinality	Description
Location	string	M	1	An alternative URI of the resource located on an alternative service instance within the same NSSF or NSSF (service) set. For the case, when a request is redirected to the same target resource via a different SCP, see clause 6.10.9.1 in 3GPP TS 29.500 [4].
3gpp-Sbi-Target-Nf-Id	string	O	0..1	Identifier of the target NF (service) instance ID towards which the request is redirected

6.2.3.2.3.2 PATCH

This method shall support the request data structures specified in table 6.2.3.2.3.2-1 and the response data structures and response codes specified in table 6.2.3.2.3.2-2.

Table 6.2.3.2.3.2-1: Data structures supported by the PATCH Request Body on this resource

Data type	P	Cardinality	Description
PatchDocument	M	1	This IE contains the information regarding the JSON patch instructions for updating the supportedSnsai(s) in NssaiAvailabilityInfo.

Table 6.2.3.2.3.2-2: Data structures supported by the PATCH Response Body on this resource

Data type	P	Cardinality	Response codes	Description
AuthorizedNssaiAvailabilityInfo	M	1	200 OK	This case represents a successful update of the NSSF with the S-NSSAIs the AMF supports per TA. If the authorized NSSAI availability (i.e. S-NSSAIs available per TA (unrestricted) and any S-NSSAIs restricted per PLMN in that TA in the serving PLMN of the UE) is changed, the NSSF shall return a data structure of type "AuthorizedNssaiAvailabilityInfo" in the response payload body.
N/A			204 No Content	This case represents a successful update of the NSSF with the S-NSSAIs the AMF supports per TA, and the authorized NSSAI availability is empty after the update.
RedirectResponse	O	0..1	307 Temporary Redirect	Temporary redirection. (NOTE 2)
RedirectResponse	O	0..1	308 Permanent Redirect	Permanent redirection. (NOTE 2)
ProblemDetails	O	0..1	403 Forbidden	When the NF service consumer is not authorized to update the NSSAI availability information or the S-NSSAI information provided is not supported in the PLMN, the "cause" attribute shall be set to: <ul style="list-style-type: none"> - SNSSAI_NOT_SUPPORTED, if the S-NSSAI provided is not supported in the PLMN. - NOT_AUTHORIZED, if the NF service consumer identified by the NF Id is not authorized to update the NSSAI availability information. See table 6.2.7.3-1 for the description of this error.
ProblemDetails	O	0..1	404 Not Found	The "cause" attribute may be used to indicate one of the following application error: <ul style="list-style-type: none"> - RESOURCE_NOT_FOUND See table 6.2.7.3-1 for the description of this error.
NOTE 1: The mandatory HTTP error status codes for the PATCH method listed in Table 5.2.7.1-1 of 3GPP TS 29.500 [4] other than those specified in the table above also apply, with a ProblemDetails data type (see clause 5.2.7 of 3GPP TS 29.500 [4]).				
NOTE 2: RedirectResponse may be inserted by an SCP, see clause 6.10.9.1 of 3GPP TS 29.500 [4].				

Table 6.2.3.2.3.2-3: Headers supported by the 307 Response Code on this resource

Name	Data type	P	Cardinality	Description
Location	string	M	1	An alternative URI of the resource located on an alternative service instance within the same NSSF or NSSF (service) set. For the case, when a request is redirected to the same target resource via a different SCP, see clause 6.10.9.1 in 3GPP TS 29.500 [4].
3gpp-Sbi-Target-Nf-Id	string	O	0..1	Identifier of the target NF (service) instance ID towards which the request is redirected

Table 6.2.3.2.3.2-4: Headers supported by the 308 Response Code on this resource

Name	Data type	P	Cardinality	Description
Location	string	M	1	An alternative URI of the resource located on an alternative service instance within the same NSSF or NSSF (service) set. For the case, when a request is redirected to the same target resource via a different SCP, see clause 6.10.9.1 in 3GPP TS 29.500 [4].
3gpp-Sbi-Target-Nf-Id	string	O	0..1	Identifier of the target NF (service) instance ID towards which the request is redirected

6.2.3.2.3.3 DELETE

This method shall support the request data structures specified in table 6.2.3.2.3.3-1 and the response data structures and response codes specified in table 6.2.3.2.3.3-2.

Table 6.2.3.2.3.3-1: Data structures supported by the DELETE Request Body on this resource

Data type	P	Cardinality	Description
n/a			

Table 6.2.3.2.3.3-2: Data structures supported by the DELETE Response Body on this resource

Data type	P	Cardinality	Response codes	Description
n/a			204 No Content	
RedirectResponse	O	0..1	307 Temporary Redirect	Temporary redirection. (NOTE 2)
RedirectResponse	O	0..1	308 Permanent Redirect	Permanent redirection. (NOTE 2)
ProblemDetails	O	0..1	404 Not Found	The "cause" attribute may be used to indicate one of the following application error: - RESOURCE_NOT_FOUND See table 6.2.7.3-1 for the description of this error.

NOTE 1: The mandatory HTTP error status codes for the DELETE method listed in Table 5.2.7.1-1 of 3GPP TS 29.500 [4] other than those specified in the table above also apply, with a ProblemDetails data type (see clause 5.2.7 of 3GPP TS 29.500 [4]).

NOTE 2: RedirectResponse may be inserted by an SCP, see clause 6.10.9.1 of 3GPP TS 29.500 [4].

Table 6.2.3.2.3.3-3: Headers supported by the 307 Response Code on this resource

Name	Data type	P	Cardinality	Description
Location	string	M	1	An alternative URI of the resource located on an alternative service instance within the same NSSF or NSSF (service) set. For the case, when a request is redirected to the same target resource via a different SCP, see clause 6.10.9.1 in 3GPP TS 29.500 [4].
3gpp-Sbi-Target-Nf-Id	string	O	0..1	Identifier of the target NF (service) instance ID towards which the request is redirected

Table 6.2.3.2.3.3-4: Headers supported by the 308 Response Code on this resource

Name	Data type	P	Cardinality	Description
Location	string	M	1	An alternative URI of the resource located on an alternative service instance within the same NSSF or NSSF (service) set. For the case, when a request is redirected to the same target resource via a different SCP, see clause 6.10.9.1 in 3GPP TS 29.500 [4].
3gpp-Sbi-Target-Nf-Id	string	O	0..1	Identifier of the target NF (service) instance ID towards which the request is redirected

6.2.3.3 Resource: NSSAI Availability Notification Subscriptions Collection

6.2.3.3.1 Description

This resource represents the collection of NSSAI Availability Notification Subscriptions in the NSSF.

This resource is modelled with the Collection resource archetype (see clause C.2 of 3GPP TS 29.501 [5]).

6.2.3.3.2 Resource Definition

Resource URI: {apiRoot}/nssf-nssaiavailability/<apiVersion>/nssai-availability/subscriptions

This resource shall support the resource URI variables defined in table 6.2.3.3.2-1.

Table 6.2.3.3.2-1: Resource URI variables for this resource

Name	Data type	Definition
apiRoot	string	See clause 6.2.1

6.2.3.3.3 Resource Standard Methods

6.2.3.3.3.1 POST

This method shall support the request data structures specified in table 6.2.3.3.3.1-1 and the response data structures and response codes specified in table 6.2.3.3.3.1-2.

Table 6.2.3.3.3.1-1: Data structures supported by the POST Request Body on this resource

Data type	P	Cardinality	Description
NssfEventSubscriptionCreateData	M	1	This IE contains the information of an NSSF Event Subscription to be created.

Table 6.2.3.3.1-2: Data structures supported by the POST Response Body on this resource

Data type	P	Cardinality	Response codes	Description
NssfEventSubscriptionCreatedData	M	1	201 Created	This case represents a successful creation of an NSSF Event subscription.
RedirectResponse	O	0..1	307 Temporary Redirect	Temporary redirection. The response shall include a Location header field containing a different URI, or the same URI if this is a redirection triggered by an SCP to the same target resource via another SCP. In the former case, the URI shall be an alternative URI of the resource located on an alternative service instance within the same NSSF or NSSF (service) set. (NOTE 2)
RedirectResponse	O	0..1	308 Permanent Redirect	Permanent redirection. The response shall include a Location header field containing a different URI, or the same URI if this is a redirection triggered by an SCP to the same target resource via another SCP. In the former case, the URI shall be an alternative URI of the resource located on an alternative service instance within the same NSSF or NSSF (service) set. (NOTE 2)
ProblemDetails	O	0..1	403 Forbidden	The "cause" attribute may be used to indicate one of the following application error: - NOT_AUTHORIZED See table 6.2.7.3-1 for the description of these errors.
NOTE 1: The mandatory HTTP error status codes for the POST method listed in Table 5.2.7.1-1 of 3GPP TS 29.500 [4] other than those specified in the table above also apply, with a ProblemDetails data type (see clause 5.2.7 of 3GPP TS 29.500 [4]).				
NOTE 2: RedirectResponse may be inserted by an SCP, see clause 6.10.9.1 of 3GPP TS 29.500 [4].				

Table 6.2.3.3.1-3: Headers supported by the 201 Response Code on this resource

Name	Data type	P	Cardinality	Description
Location	string	M	1	Contains the URI of the newly created resource, according to the structure: {apiRoot}/nssf-nssaiavailability/<apiVersion>/nssaiavailability/subscriptions/{subscriptionId}

Table 6.2.3.3.1-4: Headers supported by the 307 Response Code on this resource

Name	Data type	P	Cardinality	Description
Location	string	M	1	An alternative URI of the resource located on an alternative service instance within the same NSSF or NSSF (service) set. Or the same URI, if a request is redirected to the same target resource via a different SCP.
3gpp-Sbi-Target-Nf-Id	string	O	0..1	Identifier of the target NF (service) instance ID towards which the request is redirected

Table 6.2.3.3.1-5: Headers supported by the 308 Response Code on this resource

Name	Data type	P	Cardinality	Description
Location	string	M	1	An alternative URI of the resource located on an alternative service instance within the same NSSF or NSSF (service) set. Or the same URI, if a request is redirected to the same target resource via a different SCP.
3gpp-Sbi-Target-Nf-Id	string	O	0..1	Identifier of the target NF (service) instance ID towards which the request is redirected

6.2.3.4 Resource: Individual NSSAI Availability Notification Subscriptions

6.2.3.4.1 Description

This resource represents an Individual NSSAI Availability Notification Subscriptions resources generated by the NSSF.

This resource is modelled with the Document resource archetype (see clause C.1 of 3GPP TS 29.501 [5]).

6.2.3.4.2 Resource Definition

Resource URI: {apiRoot}/nssf-nssaiavailability/{apiVersion}/nssai-availability/subscriptions/{subscriptionId}

This resource shall support the resource URI variables defined in table 6.2.3.4.2-1.

Table 6.2.3.4.2-1: Resource URI variables for this resource

Name	Data type	Definition
apiRoot	string	See clause 6.2.1
subscriptionId	string	Represents the Identifier of the subscription.

6.2.3.4.3 Resource Standard Methods

6.2.3.4.3.1 DELETE

This method shall support the request data structures specified in table 6.2.3.4.3.1-1 and the response data structures and response codes specified in table 6.2.3.4.3.1-2.

Table 6.2.3.4.3.1-1: Data structures supported by the DELETE Request Body on this resource

Data type	P	Cardinality	Description
N/A			

Table 6.2.3.4.3.1-2: Data structures supported by the DELETE Response Body on this resource

Data type	P	Cardinality	Response codes	Description
N/A			204 No Content	This case represents a successful deletion of the subscription.
RedirectResponse	O	0..1	307 Temporary Redirect	Temporary redirection. (NOTE 2)
RedirectResponse	O	0..1	308 Permanent Redirect	Permanent redirection. (NOTE 2)
ProblemDetails	O	0..1	404 Not Found	This represents the case when the subscription resource is unavailable.

NOTE 1: The mandatory HTTP error status codes for the DELETE method listed in Table 5.2.7.1-1 of 3GPP TS 29.500 [4] other than those specified in the table above also apply, with a ProblemDetails data type (see clause 5.2.7 of 3GPP TS 29.500 [4]).

NOTE 2: RedirectResponse may be inserted by an SCP, see clause 6.10.9.1 of 3GPP TS 29.500 [4].

Table 6.2.3.4.3.1-3: Headers supported by the 307 Response Code on this resource

Name	Data type	P	Cardinality	Description
Location	string	M	1	An alternative URI of the resource located on an alternative service instance within the same NSSF or NSSF (service) set. For the case, when a request is redirected to the same target resource via a different SCP, see clause 6.10.9.1 in 3GPP TS 29.500 [4].
3gpp-Sbi-Target-Nf-Id	string	O	0..1	Identifier of the target NF (service) instance ID towards which the request is redirected

Table 6.2.3.4.3.1-4: Headers supported by the 308 Response Code on this resource

Name	Data type	P	Cardinality	Description
Location	string	M	1	An alternative URI of the resource located on an alternative service instance within the same NSSF or NSSF (service) set. For the case, when a request is redirected to the same target resource via a different SCP, see clause 6.10.9.1 in 3GPP TS 29.500 [4].
3gpp-Sbi-Target-Nf-Id	string	O	0..1	Identifier of the target NF (service) instance ID towards which the request is redirected

6.2.3.4.3.2 PATCH

This method shall support the request data structures specified in table 6.2.3.4.3.2-1 and the response data structures and response codes specified in table 6.2.3.4.3.2-2.

Table 6.2.3.4.3.2-1: Data structures supported by the PATCH Request Body on this resource

Data type	P	Cardinality	Description
PatchDocument	M	1	This IE contains the information regarding the JSON patch instructions for updating the NssfEventSubscriptionCreateData.

Table 6.2.3.4.3.2-2: Data structures supported by the PATCH Response Body on this resource

Data type	P	Cardinality	Response codes	Description
NssfEventSubscriptionCreatedData	M	1	200 OK	This case represents a successful update of the subscription.
RedirectResponse	O	0..1	307 Temporary Redirect	Temporary redirection. (NOTE 2)
RedirectResponse	O	0..1	308 Permanent Redirect	Permanent redirection. (NOTE 2)
ProblemDetails	O	0..1	404 Not Found	Indicates the modification of subscription has failed due to application error. The "cause" attribute may be used to indicate one of the following application errors: - SUBSCRIPTION_NOT_FOUND.

NOTE 1: The mandatory HTTP error status codes for the PATCH method listed in Table 5.2.7.1-1 of 3GPP TS 29.500 [4] other than those specified in the table above also apply, with a ProblemDetails data type (see clause 5.2.7 of 3GPP TS 29.500 [4]).

NOTE 2: RedirectResponse may be inserted by an SCP, see clause 6.10.9.1 of 3GPP TS 29.500 [4].

Table 6.2.3.4.3.2-3: Headers supported by the 307 Response Code on this resource

Name	Data type	P	Cardinality	Description
Location	string	M	1	An alternative URI of the resource located on an alternative service instance within the same NSSF or NSSF (service) set. For the case, when a request is redirected to the same target resource via a different SCP, see clause 6.10.9.1 in 3GPP TS 29.500 [4].
3gpp-Sbi-Target-Nf-Id	string	O	0..1	Identifier of the target NF (service) instance ID towards which the request is redirected

Table 6.2.3.4.3.2-4: Headers supported by the 308 Response Code on this resource

Name	Data type	P	Cardinality	Description
Location	string	M	1	An alternative URI of the resource located on an alternative service instance within the same NSSF or NSSF (service) set. For the case, when a request is redirected to the same target resource via a different SCP, see clause 6.10.9.1 in 3GPP TS 29.500 [4].
3gpp-Sbi-Target-Nf-Id	string	O	0..1	Identifier of the target NF (service) instance ID towards which the request is redirected

6.2.3.5 Resource: NSSAI Availability Store

6.2.3.5.1 Description

This resource represents a collection of NSSAI Availability resources.

This resource is modelled with the Store resource archetype (see clause C.1 of 3GPP TS 29.501 [5]).

6.2.3.5.2 Resource Definition

Resource URI: {apiRoot}/nssf-nssaiavailability/<apiVersion>/nssai-availability

This resource shall support the resource URI variables defined in table 6.2.3.5.2-1.

Table 6.2.3.5.2-1: Resource URI variables for this resource

Name	Data type	Definition
apiRoot	string	See clause 6.2.1

6.2.3.5.3 Resource Standard Methods

6.2.3.5.3.1 OPTIONS

This method queries the communication options supported by the NSSF (see clause 6.9 of 3GPP TS 29.500 [4]). This method shall support the URI query parameters specified in table 6.1.3.5.3.1-1.

Table 6.2.3.5.3.1-1: URI query parameters supported by the OPTIONS method on this resource

Name	Data type	P	Cardinality	Description
n/a				

This method shall support the request data structures specified in table 6.2.3.5.3.1-2 and the response data structures and response codes specified in table 6.2.3.5.3.2-3.

Table 6.2.3.5.3.1-2: Data structures supported by the OPTIONS Request Body on this resource

Data type	P	Cardinality	Description
n/a			

Table 6.2.3.5.3.1-3: Data structures supported by the OPTIONS Response Body on this resource

Data type	P	Cardinality	Response codes	Description
n/a			200 OK	
RedirectResponse	O	0..1	307 Temporary Redirect	Temporary redirection. (NOTE 2)
RedirectResponse	O	0..1	308 Permanent Redirect	Permanent redirection. (NOTE 2)
ProblemDetails	O	0..1	405 Method Not Allowed	
ProblemDetails	O	0..1	501 Not Implemented	
NOTE 1: The mandatory HTTP error status codes for the OPTIONS method listed in Table 5.2.7.1-1 of 3GPP TS 29.500 [4] other than those specified in the table above also apply, with a ProblemDetails data type (see clause 5.2.7 of 3GPP TS 29.500 [4]).				
NOTE 2: RedirectResponse may be inserted by an SCP, see clause 6.10.9.1 of 3GPP TS 29.500 [4].				

Table 6.2.3.5.3.1-4: Headers supported by the 200 Response Code on this resource

Name	Data type	P	Cardinality	Description
Accept-Encoding	string	O	0..1	Accept-Encoding, described in IETF RFC 9110 [18]

Table 6.2.3.5.3.1-5: Headers supported by the 307 Response Code on this resource

Name	Data type	P	Cardinality	Description
Location	string	M	1	An alternative URI of the resource located on an alternative service instance within the same NSSF or NSSF (service) set. For the case, when a request is redirected to the same target resource via a different SCP, see clause 6.10.9.1 in 3GPP TS 29.500 [4].
3gpp-Sbi-Target-Nf-Id	string	O	0..1	Identifier of the target NF (service) instance ID towards which the request is redirected

Table 6.2.3.5.3.1-6: Headers supported by the 308 Response Code on this resource

Name	Data type	P	Cardinality	Description
Location	string	M	1	An alternative URI of the resource located on an alternative service instance within the same NSSF or NSSF (service) set. For the case, when a request is redirected to the same target resource via a different SCP, see clause 6.10.9.1 in 3GPP TS 29.500 [4].
3gpp-Sbi-Target-Nf-Id	string	O	0..1	Identifier of the target NF (service) instance ID towards which the request is redirected

6.2.4 Custom Operations without associated resources

There are no custom operations without associated resources for the Nnssf_NSSAIAvailability service in this version of the API.

6.2.5 Notifications

6.2.5.1 General

This clause specifies the notifications provided by the Nnssf_NSSAIAvailability service.

Table 6.2.5.1-1: Notifications overview

Notification	Callback URI	HTTP method or custom operation	Description (service operation)
NSSAI Availability Notification	{nfNssaiAvailabilityUri}	POST	

6.2.5.2 NSSAI Availability Notification

6.2.5.2.1 Description

If the NF Service Consumer (e.g. AMF or V-NSSF) has provided the callback URI for getting notified about the NSSAI availability information, Network Slice Replacement or Network Slice Instance Replacement, the NSSF shall notify the NF Service Consumer whenever the NSSAI availability information, Network Slice Replacement or Network Slice Instance Replacement is updated.

6.2.5.2.2 Notification Definition

Callback URI: {nfNssaiAvailabilityUri}

This callback URI is provided by the NF Service Consumer (e.g. AMF or V-NSSF) during subscription creation invoked by the NF Service Consumer.

Table 6.2.5.2.2-1: Resources and methods overview

Resource name	Callback URI	HTTP method or custom operation	Description
NSSAI Availability Notification Callback	{nfNssaiAvailabilityUri}	POST	The NSSF uses this callback URI to Update the AMF with any S-NSSAIs restricted per TA in the serving PLMN of the UE or to notify the Network Slice Replacement or Network Slice Instance Replacement event.

6.2.5.2.3 Notification Standard Methods

6.2.5.2.3.1 POST

This method shall support the request data structures specified in table 6.2.5.2.3.1-1 and the response data structures and response codes specified in table 6.2.5.2.3.1-2.

Table 6.2.5.2.3.1-1: Data structures supported by the POST Request Body on this resource

Data type	P	Cardinality	Description
NssfEventNotification	M	1	Representation of the data to be sent to the NF service consumer (e.g. AMF or V-NSSF).

Table 6.2.5.2.3.1-2: Data structures supported by the POST Response Body on this resource

Data type	P	Cardinality	Response codes	Description
n/a			204 No Content	This case represents a successful handling of notification in the NF service consumer (e.g. AMF or V-NSSF).
RedirectResponse	O	0..1	307 Temporary Redirect	Temporary redirection. In the former case, the URI shall be an URI pointing to the endpoint of another NF service consumer to which the notification should be sent. (NOTE 2)
RedirectResponse	O	0..1	308 Permanent Redirect	Permanent redirection. In the former case, the URI shall be an URI pointing to the endpoint of another NF service consumer to which the notification should be sent. (NOTE 2)
ProblemDetails	O	0..1	400 Bad Request	The "cause" attribute may be used to indicate one of the following application errors: - RESOURCE_CONTEXT_NOT_FOUND See table 6.2.7.3-1 for the description of this error.
ProblemDetails	O	0..1	404 Not Found	The "cause" attribute may be used to indicate one of the following application errors: - RESOURCE_URI_STRUCTURE_NOT_FOUND See table 6.2.7.3-1 for the description of this error.
NOTE 1: The mandatory HTTP error status codes for the POST method listed in Table 5.2.7.1-1 of 3GPP TS 29.500 [4] other than those specified in the table above also apply, with a ProblemDetails data type (see clause 5.2.7 of 3GPP TS 29.500 [4]).				
NOTE 2: RedirectResponse may be inserted by an SCP, see clause 6.10.9.1 of 3GPP TS 29.500 [4].				

Table 6.2.5.2.3.1-3: Headers supported by the 307 Response Code on this resource

Name	Data type	P	Cardinality	Description
Location	string	M	1	A URI pointing to the endpoint of another NF service consumer to which the notification should be sent. For the case, when a request is redirected to the same target resource via a different SCP, see clause 6.10.9.1 in 3GPP TS 29.500 [4].
3gpp-Sbi-Target-Nf-Id	string	O	0..1	Identifier of the target NF (service) instance ID towards which the request is redirected

Table 6.2.5.2.3.1-4: Headers supported by the 308 Response Code on this resource

Name	Data type	P	Cardinality	Description
Location	string	M	1	A URI pointing to the endpoint of another NF service consumer to which the notification should be sent. For the case, when a request is redirected to the same target resource via a different SCP, see clause 6.10.9.1 in 3GPP TS 29.500 [4].
3gpp-Sbi-Target-Nf-Id	string	O	0..1	Identifier of the target NF (service) instance ID towards which the request is redirected

6.2.6 Data Model

6.2.6.1 General

This clause specifies the application data model supported by the API.

Table 6.2.6.1-1 specifies the data types defined for the Nnssf_NSSAIAvailability service based interface protocol.

Table 6.2.6.1-1: Nnssf_NSSAIAvailability specific Data Types

Data type	Clause defined	Description
NssaiAvailabilityInfo	6.2.6.2.2	This contains the Nssai availability information requested by the AMF.
SupportedNssaiAvailabilityData	6.2.6.2.3	This contains the Nssai availability data information per TA supported by the AMF.
AuthorizedNssaiAvailabilityData	6.2.6.2.4	This contains the Nssai availability data information per TA authorized by the NSSF
RestrictedSnssai	6.2.6.2.5	This contains the restricted SNssai information per PLMN.
AuthorizedNssaiAvailabilityInfo	6.2.6.2.6	This contains the Nssai availability data information authorized by the NSSF
PatchDocument	6.2.6.2.7	This contains the JSON Patch instructions for updating the subscription at the NSSF.
NssfEventSubscriptionCreateData	6.2.6.2.8	This contains the information for event subscription.
NssfEventSubscriptionCreatedData	6.2.6.2.9	This contains the information for created event subscription.
NssfEventNotification	6.2.6.2.10	This contains the notification for created event subscription.
SnssaiReplacementSubscribeInfo	6.2.6.2.11	This contains the input requirements for Network Slice Replacement event subscription.
NsiUnavailabilitySubscribeInfo	6.2.6.2.12	This contains the input requirements for Network Slice Instance Replacement event subscription.
NssfEventType	6.2.6.3.3	This contains the event for the subscription.

Table 6.2.6.1-2 specifies data types re-used by the Nnssf service based interface protocol from other specifications.

Table 6.2.6.1-2: Nnssf re-used Data Types

Data type	Reference	Comments
SupportedFeatures	3GPP TS 29.571 [7]	Used to negotiate the applicability of the optional features defined in table 6.2.8-1.
Snssai	3GPP TS 29.571 [7]	
PatchItem	3GPP TS 29.571 [7]	Identifies the JSON Patch instructions
DateTime	3GPP TS 29.571 [7]	
RedirectResponse	3GPP TS 29.571 [7]	
NfInstanceId	3GPP TS 29.571 [7]	
ExtSnssai	3GPP TS 29.571 [7]	
NsagId	3GPP TS 29.571 [7]	Network Slice AS Group ID
SnssaiReplacelInfo	3GPP TS 29.571 [7]	Alternative S-NSSAI information
PlmnId	3GPP TS 29.571 [7]	
TaiRange	3GPP TS 29.510 [13]	
NFType	3GPP TS 29.510 [13]	
NsagInfo	3GPP TS 29.531	See clause 6.1.6.2.14
Nsild	3GPP TS 29.531	See clause 6.1.6.3.2

6.2.6.2 Structured data types

6.2.6.2.1 Introduction

This clause defines the structures to be used in resource representations.

6.2.6.2.2 Type: NssaiAvailabilityInfo

Table 6.2.6.2.2-1: Definition of type NssaiAvailabilityInfo

Attribute name	Data type	P	Cardinality	Description
supportedNssaiAvailabilityData	array(SupportedNssaiAvailabilityData)	M	1..N	This IE shall contain the information regarding the S-NSSAIs the NF service consumer (e.g. AMF) and the 5G-AN supports per TA.
supportedFeatures	SupportedFeatures	C	0..1	This IE shall be present if at least one optional feature defined in clause 6.2.8 is supported
amfSetId	string	O	0..1	This IE may be included to indicate the AMF set identifier for the AMFs serving the TAIs where the NSSAI is available. When present, this IE shall be constructed from PLMN-ID (i.e. three decimal digits MCC and two or three decimal digits MNC), AMF Region Id (8 bit), and AMF Set Id (10 bit). Pattern: '^([0-9]{3}-[0-9]{2,3}-[A-Fa-f0-9]{2}-[0-3][A-Fa-f0-9]{2})\$'

6.2.6.2.3 Type: SupportedNssaiAvailabilityData

Table 6.2.6.2.3-1: Definition of type SupportedNssaiAvailabilityData

Attribute name	Data type	P	Cardinality	Description	Applicability
tai	Tai	M	1	This IE shall contain the identifier of the Tracking Area	
supportedSnssaiList	array(ExtSnssai)	M	1..N	This IE shall contain the S-NSSAI(s) supported by the AMF for the TA.	
taiList	array(Tai)	O	1..N	When present, this IE shall contain additional TAIs with the same list of supported S-NSSAIs. (NOTE)	ONSSAI
taiRangeList	array(TaiRange)	O	1..N	When present, this IE shall contain range(s) of TAIs with the same list of supported S-NSSAIs. (NOTE)	ONSSAI
nsagInfos	array(NsagInfo)	O	1..N	When present, this IE shall contain the associations between NSAGs and S-NSSAIs.	
NOTE: The taiList IE shall not include the TAI contained in the tai IE. The taiRangeList IE may encompass the TAI contained in the tai IE.					

6.2.6.2.4 Type: AuthorizedNssaiAvailabilityData

Table 6.2.6.2.4-1: Definition of type AuthorizedNssaiAvailabilityData

Attribute name	Data type	P	Cardinality	Description	Applicability
tai	Tai	M	1	This IE shall contain the identifier of the Tracking Area.	
supportedSnssaiList	array(ExtSnssai)	M	1..N	This IE shall contain the S-NSSAI(s) supported by the AMF and 5G-AN and authorized by the NSSF for the TA.	
restrictedSnssaiList	array(RestrictedSnssai)	O	1..N	This IE may contain the restricted S-NSSAI(s) per PLMN for the TA. If the restricted S-NSSAI is not present, the S-NSSAIs indicated in supportedSnssaiList are not restricted in this TA for any PLMN. When present, this IE shall be included only by the NSSF.	
taiList	array(Tai)	O	1..N	When present, this IE shall contain additional TAIs with the same lists of supported and restricted S-NSSAIs. (NOTE)	ONSSAI
taiRangeList	array(TaiRange)	O	1..N	When present, this IE shall contain range(s) of TAIs with the same lists of supported and restricted S-NSSAIs. (NOTE)	ONSSAI
nsagInfos	array(NsagInfo)	O	1..N	When present, this IE shall contain the associations between NSAGs and S-NSSAIs.	
NOTE: The taiList IE shall not include the TAI contained in the tai IE. The taiRangeList IE may encompass the TAI contained in the tai IE.					

6.2.6.2.5 Type: RestrictedSnsai

Table 6.2.6.2.5-1: Definition of type RestrictedSnsai

Attribute name	Data type	P	Cardinality	Description	Applicability
homePlmnId	PlmnId	M	1	This IE shall contain the home PLMN ID of the PLMN with which the serving network has roaming agreement. This IE shall be ignored if the roamingRestriction is set to "true".	
sNssaiList	array(ExtSnsai)	M	1..N	This IE shall contain the array of restricted S-NSSAIs for the home PLMN Id.	
homePlmnIdList	array(PlmnId)	O	1..N	When present, this IE shall contain additional home PLMN IDs with which the serving network has roaming agreement and with the same list of restricted S-NSSAIs.	ONSSAI
roamingRestriction	boolean	O	0..1	When present, it shall be set as follows: - true: the list of restricted S-NSSAIs are applicable to all of the home PLMN IDs with which the serving network has roaming agreement; - false (default): the list of restricted S-NSSAIs are applicable to part of the home PLMN IDs with which the serving network has roaming agreement as included in the homePlmnId and homePlmnIdList IEs.	ONSSAI

6.2.6.2.6 Type: AuthorizedNssaiAvailabilityInfo

Table 6.2.6.2.6 -1: Definition of type AuthorizedNssaiAvailabilityInfo

Attribute name	Data type	P	Cardinality	Description
authorizedNssaiAvailabilityData	array(AuthorizedNssaiAvailabilityData)	M	1..N	Contains the authorized NSSAI availability information.
supportedFeatures	SupportedFeatures	C	0..1	This IE shall be present if at least one optional feature defined in clause 6.2.8 is supported

6.2.6.2.7 Type: PatchDocument

Table 6.2.6.2.7-1: Definition of type PatchDocument

Attribute name	Data type	P	Cardinality	Description
N/A	array(PatchItem)	M	1..N	An array of patch instructions to update the NSSAI availability information or the NssfEventSubscriptionCreateData at the NSSF. See 3GPP TS 29.571 [7].

6.2.6.2.8 Type: NssfEventSubscriptionCreateData

Table 6.2.6.2.8-1: Definition of type NssfEventSubscriptionCreateData

Attribute name	Data type	P	Cardinality	Description	Applicability
nfNssaiAvailabilityUri	Uri	M	1	Identifies the recipient of notifications sent by the NF service consumer (e.g. AMF, V-NSSF) for this subscription	
taiList	array(Tai)	C	0..N	When present, this IE shall identify the TAIs supported by the NF service consumer (e.g. AMF). This IE shall be present if the NF Service Consumer subscribes to the SNSSAI_STATUS_CHANGE_REPORT event. This IE may be absent if the NSSF supports the NSRP feature or the NSIUN feature and the NF service consumer does not subscribe to the SNSSAI_STATUS_CHANGE_REPORT event. (NOTE)	
event	NssfEventType	M	1	Describes the event to be subscribed for this subscription.	
additionalEvents	array(NssfEventType)	C	1..N	This IE shall be present if the NSSF supports the NSRP feature or the NSIUN feature and the NF Service Consumer wishes to subscribe to more than one event type. When present, this IE shall indicate the additional event(s) requested to be subscribed.	
expiry	DateTime	O	0..1	This IE may be included by the NF service consumer. When present, this IE shall represent the suggested UTC time after which the subscription becomes invalid.	
amfSetId	string	O	0..1	This IE may be included for "SNSSAI_STATUS_CHANGE_REPORT" event, to identify a specific AMF Set for which this subscription applies. When present, this IE shall be constructed from PLMN-ID (i.e. three decimal digits MCC and two or three decimal digits MNC), AMF Region Id (8 bit), and AMF Set Id (10 bit). Pattern: '^([0-9]{3}-[0-9]{2,3})-[A-Fa-f0-9]{2}-[0-3][A-Fa-f0-9]{2}\$'	
taiRangeList	array(TaiRange)	O	1..N	Identifies a list of TAI ranges supported by the NF service consumer (e.g. AMF) to be applied for "SNSSAI_STATUS_CHANGE_REPORT" event. The NF service consumer shall only include this IE when it knows that the NSSF supports the "ONSSAI" feature. (NOTE)	ONSSAI
amfId	NfInstanceId	O	0..1	This IE may be included to indicate the instance identity of the network function creating the subscription for "SNSSAI_STATUS_CHANGE_REPORT" event.	

supportedFeatures	SupportedFeatures	C	0..1	This IE shall be present if at least one optional feature defined in clause 6.2.8 is supported.	
allAmfSetTailInd	boolean	O	0..1	This IE may be present when amfSetId is present. When present, this IE shall indicate whether the subscription is for all TAIs of the AMF set: - true: all TAIs of the AMF Set is subscribed. - false (default): indicated TAIs (in the taiList IE and/or taiRangeList IE) are subscribed.	SATAS
nsrpSubscribeInfo	SnssaiReplacementSubscribeInfo	C	0..1	This IE shall be present when the NF Service Consumer subscribes to the Network Slice Replacement event.	
nsiunSubscribeInfo	NsiUnavailabilitySubscribeInfo	C	0..1	This IE shall be present when the NF Service Consumer subscribes to the Network Slice Instance Replacement event.	
validityTimeSubList	array(Snssai)	C	1..N	This IE shall be present when the NF Service Consumer subscribes to "SNSSAI_VALIDITY_TIME_REPORT" event. When present, this IE shall include the list of S-NSSAIs to be subscribed.	
NOTE: For event "SNSSAI_STATUS_CHANGE_REPORT", the taiList attribute shall only be set to an empty array if the NSSF supports the "ONSSAI" feature and taiRangeList IE is present, or if the NSSF supports the "SATAS" feature and the allAmfSetTailInd IE is present with value true. A NF service consumer (e.g. AMF) may provide both taiRangeList and taiList attributes, to carry individual TAI(s) in the taiList attribute and ranges of TAIs in the taiRangeList attribute.					

6.2.6.2.9 Type: NssfEventSubscriptionCreatedData

Table 6.2.6.2.9-1: Definition of type NssfEventSubscriptionCreatedData

Attribute name	Data type	P	Cardinality	Description
subscriptionId	string	M	1	Identifies the subscription Id for the created subscription.
expiry	DateTime	C	0..1	This IE shall be included, if, based on operator policy and taking into account the expiry time included in the request, the NSSF needs to include an expiry time. When present, it represents the UTC time after which the subscribed event shall stop generating report and the subscription becomes invalid. Upon reaching this expiry time the NF service consumer shall delete the representation of the subscription it may have.
authorizedNssaiAvailabilityData	array(AuthorizedNssaiAvailabilityData)	O	1..N	This IE may be included if the NF Service Consumer requested to subscribe to changes in the status of NSSAI availability information and if the authorized NSSAI availability (i.e. S-NSSAIs available per TA (unrestricted) and any S-NSSAIs restricted per PLMN in that TA in the serving PLMN of the UE) is available.
supportedFeatures	SupportedFeatures	C	0..1	This IE shall be present if at least one optional feature defined in clause 6.2.8 is supported.

6.2.6.2.10 Type: NssfEventNotification

Table 6.2.6.2.10-1: Definition of type NssfEventNotification

Attribute name	Data type	P	Cardinality	Description	Applicability
subscriptionId	string	M	1	Indicates which subscription generated event notification. This parameter is generated by NSSF and returned in "Location" header in HTTP responses. This can be useful if a NF use a common call-back URI for multiple subscriptions.	
authorizedNssaiAvailabilityData	array(AuthorizedNssaiAvailabilityData)	C	0..N	This IE shall be present for a notification of changes in the status of the NSSAI availability information. When present, this IE shall contain the authorized NSSAI availability information for all TAs the AMF subscribed to. Each element shall contain the current status of the list of S-NSSAI available in a TA and the list of S-NSSAI restricted per PLMN in that TA. The NF Service Consumer shall replace any authorizedNssaiAvailabilityData received earlier by the new authorizedNssaiAvailabilityData received in the notification. When no supported S-NSSAIs authorized by the NSSF for all TAs, this IE shall contain an empty array indicating Authorized NSSAI Availability information is empty. When received this IE with empty array, the NF Service Consumer shall remove any locally stored authorizedNssaiAvailabilityData previously received from NSSF. (NOTE)	
altNssai	array(SnssaiReplaceInfo)	C	1..N	The IE shall be present for a notification of Network Slice Replacement. When present, this IE shall indicate the impacted S-NSSAIs if one or more of S-NSSAIs availability status changed from available to not available and vice versa, and the current status for each reported S-NSSAI. This IE may contain the alternative S-NSSAI per impacted S-NSSAI for the S-NSSAIs that are reported as being not available. See clause 5.15.19 in 3GPP TS 23.501 [2].	NSRP
unavailableNsIList	array(NsIId)	C	1..N	This IE shall be present for a of Network Slice Instance Replacement. When present, this IE shall indicate the NSI IDs for which the status has changed (e.g., that are congested or no longer available).	NSIUN
nssaiValidityTimeInfo	map(DateTime)	C	1..N	The IE shall be present for a notification of NSSAI validity time information. A map (list of key-value pairs where Snssai converted to string serves as key; see 3GPP TS 29.571 [7] clause 5.4.4.2) of the current validity time.	
NOTE:	For event "NSSAI_STATUS_CHANGE_REPORT", the NSSF shall only send notification with empty array to NF Service Consumer previously indicated support of "EANAN" feature, when there is no supported S-NSSAIs authorized by the NSSF for all TAs.				

6.2.6.2.11 Type: SnssaiReplacementSubscriberInfo

Table 6.2.6.2.11-1: Definition of type SnssaiReplacementSubscriberInfo

Attribute name	Data type	P	Cardinality	Description
snssaiToSubscribe	array(Snssai)	M	0..N	This IE shall indicate the S-NSSAIs for which notification is requested during Network Slice Replacement. In the case of roaming it shall indicate: - the VPLMN S-NSSAIs for which notification is requested in case of Network Slice Replacement; or - the HPLMN S-NSSAIs for which notification is requested in case of Network Slice Replacement. (NOTE)
nfType	NFType	M	1	This IE shall contain the NF type of the NF service consumer.
nflid	NfInstanceld	M	1	This IE shall contain the NF identifier of the NF service consumer.
plmnld	Plmnld	C	0..1	This IE shall be present in roaming scenarios, if the indicated S-NSSAI is an HPLMN S-NSSAI. It may be present otherwise. When present, it shall indicate the PLMN ID of the S-NSSAI.
NOTE: The snssaiToSubscribe attribute shall be set to an empty array for a Network Slice Replacement subscription applying to all S-NSSAIs.				

6.2.6.2.12 Type: NsiUnavailabilitySubscriberInfo

Table 6.2.6.2.12-1: Definition of type NsiUnavailabilitySubscriberInfo

Attribute name	Data type	P	Cardinality	Description
nsiToSubscribe	array(Nsild)	O	0..N	When present, this IE shall indicate the identifier of the Network Slice Instance(s) for which notifications are requested in case the status of the NSI changes (e.g., becomes congested or no longer available). (NOTE 1) (NOTE 3)
snssaiToSubscribe	array(Snssai)	O	0..N	When present, this IE shall indicate the identifier of the S-NSSAI related to the NSI for which notifications shall be invoked in case the NSI becomes congested or no longer available. (NOTE 2) (NOTE 3)
NOTE 1: The nsiToSubscribe attribute shall be set to an empty array for a Network Slice Instance Replacement subscription applying to all NSIs.				
NOTE 2: The snssaiToSubscribe attribute shall be set to an empty array for a Network Slice Instance Replacement subscription applying to all S-NSSAIs.				
NOTE 3: At least one of the nsiToSubscribe IE or snssaiToSubscribe IE shall be present.				

6.2.6.3 Simple data types and enumerations

6.2.6.3.1 Introduction

This clause defines simple data types and enumerations that can be referenced from data structures defined in the previous clauses.

6.2.6.3.2 Simple data types

The simple data types defined in table 6.2.6.3.2-1 shall be supported.

Table 6.2.6.3.2-1: Simple data types

Type Name	Type Definition	Description
	<one simple data type, e.g. boolean, integer, null, number, string>	

6.2.6.3.3 Enumeration: NssfEventType

Table 6.2.6.3.3-1: Enumeration NssfEventType

Enumeration value	Description
"SNSSAI_STATUS_CHANGE_REPORT"	A NF subscribes to this event to receive the status change about the current S-NSSAI available (i.e unrestricted) per TA and the status change about the list of restricted S-NSSAI per TA and per PLMN in the serving PLMN of the UE.
"SNSSAI_REPLACEMENT_REPORT"	A NF subscribes to this event to receive a replacement S-NSSAI for each impacted S-NSSAI. See clause 5.15.19 of 3GPP TS 23.501 [2].
"NSI_UNAVAILABILITY_REPORT"	A NF subscribes to this event to receive the list of unavailable NSIs (e.g., due to overload). See clause 5.15.20 of 3GPP TS 23.501 [2].
"SNSSAI_VALIDITY_TIME_REPORT"	A NF subscribes to this event to receive the status change about NSSAI validity time information. See clause 5.2.16.3.4 of 3GPP TS 23.502 [3].

6.2.6.4 Binary data

There is no binary data used for the Nssf_NSSAIavailability service in this version of the API.

6.2.7 Error Handling

6.2.7.1 General

HTTP error handling shall be supported as specified in clause 5.2.4 of 3GPP TS 29.500 [4].

6.2.7.2 Protocol Errors

Protocol Error Handling shall be supported as specified in clause 5.2.7.2 of 3GPP TS 29.500 [4].

6.2.7.3 Application Errors

The common application errors defined in the Table 5.2.7.2-1 in 3GPP TS 29.500 [4] may also be used for the Nssf_NSSAIavailability service. The following application errors listed in Table 6.1.7.3-1 are specific for the Nssf_NSSAIavailability service.

Table 6.2.7.3-1: Application errors

Application Error	HTTP status code	Description
RESOURCE_CONTEXT_NOT_FOUND	400 Bad Request	Indicates that the NF Service Consumer (e.g. AMF) received a notification request from NSSF on an existing callback URI, but the corresponding context does not exist at the NF Service Consumer.
SNSSAI_NOT_SUPPORTED	403 Forbidden	The request is rejected due to the SNSSAI provided in the request is not supported in the PLMN.
NOT_AUTHORIZED	403 Forbidden	The request is rejected due to the NF service consumer is not authorized to update the NSSAI availability information, or subscribe for the NSSAI availability information notification.
RESOURCE_NOT_FOUND	404 Not Found	The request is rejected due to the NF service consumer is authorized, but the resource related to the NF Id for which the NSSAI availability information is updated or deleted is unavailable.
SUBSCRIPTION_NOT_FOUND	404 Not Found	Indicates the modification of subscription has failed due to an application error when the subscription is not found in the NSSF.
RESOURCE_URI_STRUCTURE_NOT_FOUND	404 Not Found	Indicates that the NF Service Consumer (e.g. AMF) received a notification request from NSSF on a callback URI that is not known to the NF Service Consumer.

6.2.8 Feature negotiation

The feature negotiation mechanism specified in clause 6.6 of 3GPP TS 29.500 [4] shall be used to negotiate the optional features applicable between the NSSF and the NF Service Consumer, for the Nnssf_NSSAIAvailability service, if any.

The NF Service Consumer shall indicate the optional features it supports for the Nnssf_NSSAIAvailability service, if any, by including the supportedFeatures attribute in the HTTP PUT request when requesting the NSSF to update the NSSAI Availability information.

The NSSF shall determine the supported features for the updated NSSAI Availability information resource as specified in clause 6.6 of 3GPP TS 29.500 [4] and shall indicate the supported features by including the supportedFeatures attribute in the authorized NSSAI availability information it returns in the HTTP response.

The syntax of the supportedFeatures attribute is defined in clause 5.2.2 of 3GPP TS 29.571 [7].

The following features are defined for the Nnssf_NSSAIAvailability service.

Table 6.2.8-1: Features of supportedFeatures attribute used by Nnssf_NSSAIAvailability service

Feature Number	Feature	M/O	Description
1	ONSSAI	O	Optimized NSSAI Availability Data encoding When this feature is supported: <ul style="list-style-type: none"> - NSSAI Availability data may be signalled per list or range(s) of TAIs (see clauses 6.2.6.2.3 and 6.2.6.2.4); and - RestrictedSnsai may encode a list of Home PLMN IDs or may be applicable to all of the Home PLMN IDs (see clause 6.2.6.2.5). - NSSF event subscription may encode a list of TAI ranges (see clause 6.2.6.2.8).
2	SUMOD	O	Subscription Modification in Subscribe Service Operation When this feature is supported, the subscription of NSSAI availability information is supported to be modified (see clause 5.3.2.3.2).
3	EANAN	O	Empty Authorized NSSAI Availability Notification A NSSF supporting this feature shall send a notification to NF consumer (as subscriber) with empty array of Authorized NSSAI Availability Data, when no supported NSSAI Authorized by the NSSF for all TAs after latest update and the NF consumer indicated support of this feature. A NF Consumer support this feature shall accept empty array of Authorized NSSAI Availability Data in a notification from NSSF and delete locally stored Authorized NSSAI Availability Data previously received.
4	ES3XX	M	Extended Support of HTTP 307/308 redirection An NF Service Consumer (e.g. AMF) that supports this feature shall support handling of HTTP 307/308 redirection for any service operation of the Nnssf_NSSAIAvailability service. An NF Service Consumer that does not support this feature does only support HTTP redirection as specified for 3GPP Release 15.
5	SATAS	O	Subscribe ALL TAIs for AMF Set A NSSF supporting this feature shall support the NF Consumer to subscribe to all TAI(s) for an AMF set.
6	NSIUN	O	Network Slice Instance Unavailability Notification An NF Service Consumer (e.g., AMF, V-NSSF) and NSSF supporting this feature shall support notifications from the NSSF to the NF Service Consumer about the unavailability of Network Slice Instances, as specified in clause 5.15.5.3 of 3GPP TS 23.501 [2].
7	NSRP	O	Network Slice Replacement An NF service consumer (e.g., AMF, V-NSSF) that supports this feature shall support network slice replacement as specified in clause 5.15.19 of 3GPP TS 23.501 [2].
<p>Feature number: The order number of the feature within the supportedFeatures attribute (starting with 1).</p> <p>Feature: A short name that can be used to refer to the bit and to the feature.</p> <p>M/O: Defines if the implementation of the feature is mandatory ("M") or optional ("O").</p> <p>Description: A clear textual description of the feature.</p>			

6.2.9 Security

As indicated in 3GPP TS 33.501 [11] and 3GPP TS 29.500 [4], the access to the Nnssf_NSSAIAvailability API may be authorized by means of the OAuth2 protocol (see IETF RFC 6749 [12]), based on local configuration, using the "Client Credentials" authorization grant, where the NRF (see 3GPP TS 29.510 [13]) plays the role of the authorization server.

If OAuth2 is used, an NF Service Consumer, prior to consuming services offered by the Nnssf_NSSAIAvailability API, shall obtain a "token" from the authorization server, by invoking the Access Token Request service, as described in 3GPP TS 29.510 [13], clause 5.4.2.2.

NOTE: When multiple NRFs are deployed in a network, the NRF used as authorization server is the same NRF that the NF Service Consumer used for discovering the Nnssf_NSSAIAvailability service.

The Nnssf_NSSAIAvailability API does not define any scopes for OAuth2 authorization.

6.2.10 HTTP redirection

An HTTP request may be redirected to a different NSSF service instance, within the same NSSF or a different NSSF of an NSSF set, e.g. when an NSSF service instance is part of an NSSF (service) set or when using indirect communications (see 3GPP TS 29.500 [4]). See the ES3XX feature in clause 6.2.8.

An SCP that reselects a different NSSF producer instance will return the NF Instance ID of the new NSSF producer instance in the 3gpp-Sbi-Producer-Id header, as specified in clause 6.10.3.4 of 3GPP TS 29.500 [4].

If an NSSF within an NSSF set redirects a service request to a different NSSF of the set using a 307 Temporary Redirect or 308 Permanent Redirect status code, the identity of the new NSSF towards which the service request is redirected shall be indicated in the 3gpp-Sbi-Target-Nf-Id header of the 307 Temporary Redirect or 308 Permanent Redirect response as specified in clause 6.10.9.1 of 3GPP TS 29.500 [4].

Annex A (normative): OpenAPI specification

A.1 General

This Annex specifies the formal definition of the Nnssf_NSSelection service. It consists of OpenAPI 3.0.0 specifications, in YAML format.

This Annex takes precedence when being discrepant to other parts of the specification with respect to the encoding of information elements and methods within the API(s).

NOTE: The semantics and procedures, as well as conditions, e.g. for the applicability and allowed combinations of attributes or values, not expressed in the OpenAPI definitions but defined in other parts of the specification also apply.

Informative copies of the OpenAPI specification files contained in this 3GPP Technical Specification are available on a Git-based repository that uses the GitLab software version control system (see 3GPP TS 29.501 [5] clause 5.3.1 and 3GPP TR 21.900 [7] clause 5B).

A.2 Nnssf_NSSelection API

```
openapi: 3.0.0

info:
  version: '2.3.0-alpha.3'
  title: 'NSSF NS Selection'
  description: |
    NSSF Network Slice Selection Service.
    © 2024, 3GPP Organizational Partners (ARIB, ATIS, CCSA, ETSI, TSDSI, TTA, TTC).
    All rights reserved.
security:
  - {}
  - oAuth2ClientCredentials:
    - nnssf-nssselection
servers:
  - url: '{apiRoot}/nnssf-nssselection/v2'
    variables:
      apiRoot:
        default: https://example.com
        description: apiRoot as defined in clause 4.4 of 3GPP TS 29.501
externalDocs:
  description: 3GPP TS 29.531 V18.6.0; 5G System; Network Slice Selection Services; Stage 3
  url: https://www.3gpp.org/ftp/Specs/archive/29_series/29.531/
paths:
  /network-slice-information:
    get:
      summary: Retrieve the Network Slice Selection Information
      tags:
        - Network Slice Information (Document)
      operationId: NSSelectionGet
      parameters:
        - name: nf-type
          in: query
          description: NF type of the NF service consumer
          required: true
          schema:
            $ref: 'TS29510_Nnrf_NFManagement.yaml#/components/schemas/NFType'
        - name: nf-id
          in: query
          description: NF Instance ID of the NF service consumer
          required: true
          schema:
            $ref: 'TS29571_CommonData.yaml#/components/schemas/NfInstanceId'
        - name: slice-info-request-for-registration
          in: query
```

```

description: Requested network slice information during Registration procedure
content:
  application/json:
    schema:
      $ref: '#/components/schemas/SliceInfoForRegistration'
- name: slice-info-request-for-pdu-session
  in: query
  description: >
    Requested network slice information during PDU session establishment procedure
  content:
    application/json:
      schema:
        $ref: '#/components/schemas/SliceInfoForPDUSession'
- name: slice-info-request-for-ue-cu
  in: query
  description: Requested network slice information during UE configuration update procedure
  content:
    application/json:
      schema:
        $ref: '#/components/schemas/SliceInfoForUEConfigurationUpdate'
- name: home-plmn-id
  in: query
  description: PLMN ID of the HPLMN
  content:
    application/json:
      schema:
        $ref: 'TS29571_CommonData.yaml#/components/schemas/PlmnId'
- name: tai
  in: query
  description: TAI of the UE
  content:
    application/json:
      schema:
        $ref: 'TS29571_CommonData.yaml#/components/schemas/Tai'
- name: supported-features
  in: query
  description: Features required to be supported by the NFs in the target slice instance
  schema:
    $ref: 'TS29571_CommonData.yaml#/components/schemas/SupportedFeatures'

responses:
  '200':
    description: OK (Successful Network Slice Selection)
    content:
      application/json:
        schema:
          $ref: '#/components/schemas/AuthorizedNetworkSliceInfo'
  '307':
    $ref: 'TS29571_CommonData.yaml#/components/responses/307'
  '308':
    $ref: 'TS29571_CommonData.yaml#/components/responses/308'
  '400':
    $ref: 'TS29571_CommonData.yaml#/components/responses/400'
  '401':
    $ref: 'TS29571_CommonData.yaml#/components/responses/401'
  '403':
    $ref: 'TS29571_CommonData.yaml#/components/responses/403'
  '404':
    $ref: 'TS29571_CommonData.yaml#/components/responses/404'
  '406':
    $ref: 'TS29571_CommonData.yaml#/components/responses/406'
  '414':
    $ref: 'TS29571_CommonData.yaml#/components/responses/414'
  '429':
    $ref: 'TS29571_CommonData.yaml#/components/responses/429'
  '500':
    $ref: 'TS29571_CommonData.yaml#/components/responses/500'
  '502':
    $ref: 'TS29571_CommonData.yaml#/components/responses/502'
  '503':
    $ref: 'TS29571_CommonData.yaml#/components/responses/503'
  default:
    description: Unexpected error

components:
  securitySchemes:
    oAuth2ClientCredentials:
      type: oauth2

```



```

flows:
  clientCredentials:
    tokenUrl: '{nrfApiRoot}/oauth2/token'
    scopes:
      nnsf-nssselection: Access to the Nnsf_NSSelection API
schemas:

#
# STRUCTURED TYPES
#

AuthorizedNetworkSliceInfo:
  description: Contains the authorized network slice information
  type: object
  properties:
    allowedNssaiList:
      type: array
      items:
        $ref: '#/components/schemas/AllowedNssai'
      minItems: 1
    configuredNssai:
      type: array
      items:
        $ref: '#/components/schemas/ConfiguredSnssai'
      minItems: 1
    targetAmfSet:
      type: string
      pattern: '^[0-9]{3}-[0-9]{2,3}-[A-Fa-f0-9]{2}-[0-3][A-Fa-f0-9]{2}$'
    candidateAmfList:
      type: array
      items:
        $ref: 'TS29571_CommonData.yaml#/components/schemas/NfInstanceId'
      minItems: 1
    rejectedNssaiInPlmn:
      type: array
      items:
        $ref: 'TS29571_CommonData.yaml#/components/schemas/Snssai'
      minItems: 1
    rejectedNssaiInTa:
      type: array
      items:
        $ref: 'TS29571_CommonData.yaml#/components/schemas/Snssai'
      minItems: 1
    nsiInformation:
      $ref: '#/components/schemas/NsiInformation'
    supportedFeatures:
      $ref: 'TS29571_CommonData.yaml#/components/schemas/SupportedFeatures'
    nrfAmfSet:
      $ref: 'TS29571_CommonData.yaml#/components/schemas/Uri'
    nrfAmfSetNfMgtUri:
      $ref: 'TS29571_CommonData.yaml#/components/schemas/Uri'
    nrfAmfSetAccessTokenUri:
      $ref: 'TS29571_CommonData.yaml#/components/schemas/Uri'
    nrfOauth2Required:
      type: object
      description: >
        Map indicating whether the NRF requires Oauth2-based authorization for accessing
        its services. The key of the map shall be the name of an NRF service,
        e.g. "nnrf-nfm" or "nnrf-disc"
      additionalProperties:
        type: boolean
      minProperties: 1
    targetAmfServiceSet:
      $ref: 'TS29571_CommonData.yaml#/components/schemas/NfServiceSetId'
    targetNssai:
      type: array
      items:
        $ref: 'TS29571_CommonData.yaml#/components/schemas/Snssai'
      minItems: 1
    nsagInfos:
      type: array
      items:
        $ref: '#/components/schemas/NsagInfo'
      minItems: 1

SubscribedSnssai:
  description: Contains the subscribed S-NSSAI
  type: object

```

```

required:
  - subscribedSnssai
properties:
  subscribedSnssai:
    $ref: 'TS29571_CommonData.yaml#/components/schemas/Snssai'
  defaultIndication:
    type: boolean
  subscribedNsSrgList:
    type: array
    items:
      $ref: 'TS29571_CommonData.yaml#/components/schemas/NsSrg'
    minItems: 1

AllowedSnssai:
description: >
  Contains the authorized S-NSSAI and optional mapped home S-NSSAI and
  network slice instance information
type: object
required:
  - allowedSnssai
properties:
  allowedSnssai:
    $ref: 'TS29571_CommonData.yaml#/components/schemas/Snssai'
  nsiInformationList:
    type: array
    items:
      $ref: '#/components/schemas/NsiInformation'
    minItems: 1
  mappedHomeSnssai:
    $ref: 'TS29571_CommonData.yaml#/components/schemas/Snssai'

AllowedNssai:
description: >
  Contains an array of allowed S-NSSAI that constitute the allowed NSSAI information
  for the authorized network slice information
type: object
required:
  - allowedSnssaiList
  - accessType
properties:
  allowedSnssaiList:
    type: array
    items:
      $ref: '#/components/schemas/AllowedSnssai'
    minItems: 1
  accessType:
    $ref: 'TS29571_CommonData.yaml#/components/schemas/AccessType'

NsiInformation:
description: >
  Contains the API URIs of NRF services to be used to discover NFs/services,
  subscribe to NF status changes and/or request access tokens within the selected
  Network Slice instance and optional the Identifier of the selected Network Slice instance
type: object
required:
  - nrfId
properties:
  nrfId:
    $ref: 'TS29571_CommonData.yaml#/components/schemas/Uri'
  nsiId:
    $ref: '#/components/schemas/NsiId'
  nrfNfMgtUri:
    $ref: 'TS29571_CommonData.yaml#/components/schemas/Uri'
  nrfAccessTokenUri:
    $ref: 'TS29571_CommonData.yaml#/components/schemas/Uri'
  nrfOauth2Required:
    type: object
    description: >
      Map indicating whether the NRF requires Oauth2-based authorization for accessing
      its services. The key of the map shall be the name of an NRF service,
      e.g. "nnrf-nfm" or "nnrf-disc"
    additionalProperties:
      type: boolean
    minProperties: 1

MappingOfSnssai:
description: >

```

```

    Contains the mapping of S-NSSAI in the serving network and the value of the home network
  type: object
  required:
    - servingSnssai
    - homeSnssai
  properties:
    servingSnssai:
      $ref: 'TS29571_CommonData.yaml#/components/schemas/Snssai'
    homeSnssai:
      $ref: 'TS29571_CommonData.yaml#/components/schemas/Snssai'

SliceInfoForRegistration:
  description: Contains the slice information requested during a Registration procedure
  type: object
  properties:
    subscribedNssai:
      type: array
      items:
        $ref: '#/components/schemas/SubscribedSnssai'
      minItems: 1
    allowedNssaiCurrentAccess:
      $ref: '#/components/schemas/AllowedNssai'
    allowedNssaiOtherAccess:
      $ref: '#/components/schemas/AllowedNssai'
    sNssaiForMapping:
      type: array
      items:
        $ref: 'TS29571_CommonData.yaml#/components/schemas/Snssai'
      minItems: 1
    requestedNssai:
      type: array
      items:
        $ref: 'TS29571_CommonData.yaml#/components/schemas/Snssai'
      minItems: 1
    defaultConfiguredSnssaiInd:
      type: boolean
      default: false
    mappingOfNssai:
      type: array
      items:
        $ref: '#/components/schemas/MappingOfSnssai'
      minItems: 1
    requestMapping:
      type: boolean
    ueSupNssrgInd:
      type: boolean
    suppressNssrgInd:
      type: boolean
    nsagSupported:
      type: boolean
      default: false

SliceInfoForPDUSession:
  description: >
    Contains the slice information requested during PDU Session establishment procedure
  type: object
  required:
    - sNssai
    - roamingIndication
  properties:
    sNssai:
      $ref: 'TS29571_CommonData.yaml#/components/schemas/Snssai'
    roamingIndication:
      $ref: '#/components/schemas/RoamingIndication'
    homeSnssai:
      $ref: 'TS29571_CommonData.yaml#/components/schemas/Snssai'

SliceInfoForUEConfigurationUpdate:
  description: >
    Contains the slice information requested during UE configuration update procedure
  type: object
  properties:
    subscribedNssai:
      type: array
      items:
        $ref: '#/components/schemas/SubscribedSnssai'
      minItems: 1

```

```

    allowedNssaiCurrentAccess:
      $ref: '#/components/schemas/AllowedNssai'
    allowedNssaiOtherAccess:
      $ref: '#/components/schemas/AllowedNssai'
    defaultConfiguredSnssaiInd:
      type: boolean
      default: false
    requestedNssai:
      type: array
      items:
        $ref: 'TS29571_CommonData.yaml#/components/schemas/Snssai'
      minItems: 1
    mappingOfNssai:
      type: array
      items:
        $ref: '#/components/schemas/MappingOfSnssai'
      minItems: 1
    ueSupNssrgInd:
      type: boolean
    suppressNssrgInd:
      type: boolean
    rejectedNssaiRa:
      type: array
      items:
        $ref: 'TS29571_CommonData.yaml#/components/schemas/Snssai'
      minItems: 1
    nsagSupported:
      type: boolean
      default: false

ConfiguredSnssai:
  description: >
    Contains the configured S-NSSAI(s) authorized by the NSSF in the serving PLMN and optional
mapped home S-NSSAI
  type: object
  required:
    - configuredSnssai
  properties:
    configuredSnssai:
      $ref: 'TS29571_CommonData.yaml#/components/schemas/Snssai'
    mappedHomeSnssai:
      $ref: 'TS29571_CommonData.yaml#/components/schemas/Snssai'

NsagInfo:
  description: >
    Contains the association of NSAGs and S-NSSAI(s) along with the TA(s) within which
the association is valid.
  type: object
  required:
    - nsagIds
    - snssaiList
  properties:
    nsagIds:
      type: array
      items:
        $ref: 'TS29571_CommonData.yaml#/components/schemas/NsagId'
      minItems: 1
    snssaiList:
      type: array
      items:
        $ref: 'TS29571_CommonData.yaml#/components/schemas/Snssai'
      minItems: 1
    taiList:
      type: array
      items:
        $ref: 'TS29571_CommonData.yaml#/components/schemas/Tai'
      minItems: 1
    taiRangeList:
      type: array
      items:
        $ref: 'TS29510_Nnrf_NFManagement.yaml#/components/schemas/TaiRange'
      minItems: 1

#
# SIMPLE TYPES
#

NsiId:

```

```

description: Contains the Identifier of the selected Network Slice instance
type: string

```

```

#
# ENUMS
#

```

```

RoamingIndication:
  description: Contains the indication on roaming
  anyOf:
    - type: string
      enum:
        - NON_ROAMING
        - LOCAL_BREAKOUT
        - HOME_ROUTED_ROAMING
    - type: string

```

A.3 Nssf_NSSAIAvailability API

openapi: 3.0.0

```

info:
  version: '1.3.0-alpha.6'
  title: 'NSSF NSSAI Availability'
  description: |
    NSSF NSSAI Availability Service.
    © 2024, 3GPP Organizational Partners (ARIB, ATIS, CCSA, ETSI, TSDSI, TTA, TTC).
    All rights reserved.
security:
  - {}
  - oAuth2ClientCredentials:
      - nssf-nssaiavailability
servers:
  - url: '{apiRoot}/nssf-nssaiavailability/v1'
    variables:
      apiRoot:
        default: https://example.com
        description: apiRoot as defined in clause 4.4 of 3GPP TS 29.501
externalDocs:
  description: 3GPP TS 29.531 V18.6.0; 5G System; Network Slice Selection Services; Stage 3
  url: https://www.3gpp.org/ftp/Specs/archive/29_series/29.531/
paths:
  /nssai-availability/{nfId}:
    put:
      summary: Updates/replaces the NSSF with the S-NSSAIs the NF service consumer (e.g AMF)supports
      per TA
      tags:
        - NF Instance ID (Document)
      operationId: NSSAIAvailabilityPut
      parameters:
        - name: nfId
          in: path
          description: Identifier of the NF service consumer instance
          required: true
          schema:
            $ref: 'TS29571_CommonData.yaml#/components/schemas/NfInstanceId'
        - name: Content-Encoding
          in: header
          description: Content-Encoding, described in IETF RFC 9110
          schema:
            type: string
        - name: Accept-Encoding
          in: header
          description: Accept-Encoding, described in IETF RFC 9110
          schema:
            type: string
      requestBody:
        description: Parameters to update/replace at the NSSF, the S-NSSAIs supported per TA
        required: true
        content:
          application/json:
            schema:
              $ref: '#/components/schemas/NssaiAvailabilityInfo'
      responses:

```

```

'200':
  description: OK (Successful update of SNSSAI information per TA)
  content:
    application/json:
      schema:
        $ref: '#/components/schemas/AuthorizedNssaiAvailabilityInfo'
  headers:
    Accept-Encoding:
      description: Accept-Encoding, described in IETF RFC 9110
      schema:
        type: string
    Content-Encoding:
      description: Content-Encoding, described in IETF RFC 9110
      schema:
        type: string
'204':
  description: No Content (No supported slices after Successful update)
'307':
  $ref: 'TS29571_CommonData.yaml#/components/responses/307'
'308':
  $ref: 'TS29571_CommonData.yaml#/components/responses/308'
'400':
  $ref: 'TS29571_CommonData.yaml#/components/responses/400'
'401':
  $ref: 'TS29571_CommonData.yaml#/components/responses/401'
'403':
  $ref: 'TS29571_CommonData.yaml#/components/responses/403'
'404':
  $ref: 'TS29571_CommonData.yaml#/components/responses/404'

'411':
  $ref: 'TS29571_CommonData.yaml#/components/responses/411'
'413':
  $ref: 'TS29571_CommonData.yaml#/components/responses/413'
'415':
  $ref: 'TS29571_CommonData.yaml#/components/responses/415'
'429':
  $ref: 'TS29571_CommonData.yaml#/components/responses/429'
'500':
  $ref: 'TS29571_CommonData.yaml#/components/responses/500'
'502':
  $ref: 'TS29571_CommonData.yaml#/components/responses/502'
'503':
  $ref: 'TS29571_CommonData.yaml#/components/responses/503'
default:
  description: Unexpected error

```

patch:

summary: Updates an already existing S-NSSAIs per TA provided by the NF service consumer (e.g AMF)

tags:

- NF Instance ID (Document)

operationId: NSSAIAvailabilityPatch

parameters:

- name: nfId
 - in: path
 - description: Identifier of the NF service consumer instance
 - required: true
 - schema:
 - type: string
- name: Content-Encoding
 - in: header
 - description: Content-Encoding, described in IETF RFC 9110
 - schema:
 - type: string
- name: Accept-Encoding
 - in: header
 - description: Accept-Encoding, described in IETF RFC 9110
 - schema:
 - type: string

requestBody:

description: JSON Patch instructions to update at the NSSF, the S-NSSAIs supported per TA

required: true

content:

- application/json-patch+json:
 - schema:
 - \$ref: '#/components/schemas/PatchDocument'

```

responses:
  '200':
    description: OK (Successful update of SNSSAI information per TA)
    content:
      application/json:
        schema:
          $ref: '#/components/schemas/AuthorizedNssaiAvailabilityInfo'
    headers:
      Accept-Encoding:
        description: Accept-Encoding, described in IETF RFC 9110
        schema:
          type: string
      Content-Encoding:
        description: Content-Encoding, described in IETF RFC 9110
        schema:
          type: string
  '204':
    description: No Content (No supported slices after Successful update)
  '307':
    $ref: 'TS29571_CommonData.yaml#/components/responses/307'
  '308':
    $ref: 'TS29571_CommonData.yaml#/components/responses/308'
  '400':
    $ref: 'TS29571_CommonData.yaml#/components/responses/400'
  '401':
    $ref: 'TS29571_CommonData.yaml#/components/responses/401'
  '403':
    $ref: 'TS29571_CommonData.yaml#/components/responses/403'
  '404':
    $ref: 'TS29571_CommonData.yaml#/components/responses/404'
  '411':
    $ref: 'TS29571_CommonData.yaml#/components/responses/411'
  '413':
    $ref: 'TS29571_CommonData.yaml#/components/responses/413'
  '415':
    $ref: 'TS29571_CommonData.yaml#/components/responses/415'
  '429':
    $ref: 'TS29571_CommonData.yaml#/components/responses/429'
  '500':
    $ref: 'TS29571_CommonData.yaml#/components/responses/500'
  '502':
    $ref: 'TS29571_CommonData.yaml#/components/responses/502'
  '503':
    $ref: 'TS29571_CommonData.yaml#/components/responses/503'
  default:
    description: Unexpected error

```

delete:

summary: Deletes an already existing S-NSSAIs per TA provided by the NF service consumer (e.g AMF)

```

tags:
  - NF Instance ID (Document)
operationId: NSSAIAvailabilityDelete
parameters:
  - name: nfId
    in: path
    description: Identifier of the NF service consumer instance
    required: true
    schema:
      type: string

```

```

responses:
  '204':
    description: No Content (Successful deletion of SNSSAI information per TA)
  '307':
    $ref: 'TS29571_CommonData.yaml#/components/responses/307'
  '308':
    $ref: 'TS29571_CommonData.yaml#/components/responses/308'
  '400':
    $ref: 'TS29571_CommonData.yaml#/components/responses/400'
  '401':
    $ref: 'TS29571_CommonData.yaml#/components/responses/401'
  '403':
    $ref: 'TS29571_CommonData.yaml#/components/responses/403'
  '404':

```

```

    $ref: 'TS29571_CommonData.yaml#/components/responses/404'
  '429':
    $ref: 'TS29571_CommonData.yaml#/components/responses/429'
  '500':
    $ref: 'TS29571_CommonData.yaml#/components/responses/500'
  '502':
    $ref: 'TS29571_CommonData.yaml#/components/responses/502'
  '503':
    $ref: 'TS29571_CommonData.yaml#/components/responses/503'

default:
  description: Unexpected error

/nssai-availability/subscriptions:
  post:
    summary: Creates subscriptions for notification about updates to NSSAI availability
    information
    tags:
      - Subscriptions (Collection)
    operationId: NSSAIAvailabilityPost
    parameters:
      - name: Content-Encoding
        in: header
        description: Content-Encoding, described in IETF RFC 9110
        schema:
          type: string
    requestBody:
      description: Subscription for notification about updates to NSSAI availability information
      required: true
      content:
        application/json:
          schema:
            $ref: '#/components/schemas/NssfEventSubscriptionCreateData'
    callbacks:
      nssaiAvailabilityNotification:
        '{request.body#/nfNssaiAvailabilityUri}':
          post:
            parameters:
              - name: Content-Encoding
                in: header
                description: Content-Encoding, described in IETF RFC 9110
                schema:
                  type: string
            requestBody: # contents of the callback message
            required: true
            content:
              application/json:
                schema:
                  $ref: '#/components/schemas/NssfEventNotification'
    responses:
      '204':
        description: No Content (successful notification)
        headers:
          Accept-Encoding:
            description: Accept-Encoding, described in IETF RFC 9110
            schema:
              type: string
      '307':
        $ref: 'TS29571_CommonData.yaml#/components/responses/307'
      '308':
        $ref: 'TS29571_CommonData.yaml#/components/responses/308'
      '400':
        $ref: 'TS29571_CommonData.yaml#/components/responses/400'
      '401':
        $ref: 'TS29571_CommonData.yaml#/components/responses/401'
      '403':
        $ref: 'TS29571_CommonData.yaml#/components/responses/403'
      '404':
        $ref: 'TS29571_CommonData.yaml#/components/responses/404'
      '411':
        $ref: 'TS29571_CommonData.yaml#/components/responses/411'
      '413':
        $ref: 'TS29571_CommonData.yaml#/components/responses/413'
      '415':
        $ref: 'TS29571_CommonData.yaml#/components/responses/415'
      '429':

```



```

    $ref: 'TS29571_CommonData.yaml#/components/responses/429'
  '500':
    $ref: 'TS29571_CommonData.yaml#/components/responses/500'
  '502':
    $ref: 'TS29571_CommonData.yaml#/components/responses/502'
  '503':
    $ref: 'TS29571_CommonData.yaml#/components/responses/503'
  default:
    description: Unexpected error

responses:
  '201':
    description: Created (Successful creation of subscription for notification)
    content:
      application/json:
        schema:
          $ref: '#/components/schemas/NssfEventSubscriptionCreatedData'
    headers:
      Location:
        description: >
          Contains the URI of the newly created resource, according to the structure:
          {apiRoot}/nssf-nssaiavailability/<apiVersion>/nssai-
availability/subscriptions/{subscriptionId}
        required: true
        schema:
          type: string
      Content-Encoding:
        description: Content-Encoding, described in IETF RFC 9110
        schema:
          type: string
  '307':
    $ref: 'TS29571_CommonData.yaml#/components/responses/307'
  '308':
    $ref: 'TS29571_CommonData.yaml#/components/responses/308'
  '400':
    $ref: 'TS29571_CommonData.yaml#/components/responses/400'
  '401':
    $ref: 'TS29571_CommonData.yaml#/components/responses/401'
  '403':
    $ref: 'TS29571_CommonData.yaml#/components/responses/403'
  '404':
    $ref: 'TS29571_CommonData.yaml#/components/responses/404'

  '411':
    $ref: 'TS29571_CommonData.yaml#/components/responses/411'
  '413':
    $ref: 'TS29571_CommonData.yaml#/components/responses/413'
  '415':
    $ref: 'TS29571_CommonData.yaml#/components/responses/415'
  '429':
    $ref: 'TS29571_CommonData.yaml#/components/responses/429'
  '500':
    $ref: 'TS29571_CommonData.yaml#/components/responses/500'
  '502':
    $ref: 'TS29571_CommonData.yaml#/components/responses/502'
  '503':
    $ref: 'TS29571_CommonData.yaml#/components/responses/503'
  default:
    description: Unexpected error

/nssai-availability/subscriptions/{subscriptionId}:
  delete:
    summary: Deletes an already existing NSSAI availability notification subscription
    tags:
      - Subscription ID (Document)
    operationId: NSSAIAvailabilityUnsubscribe
    parameters:
      - name: subscriptionId
        in: path
        description: Identifier of the subscription for notification
        required: true
        schema:
          type: string

responses:
  '204':
    description: >

```

```

    No Content (Successful deletion of subscription for NSSAI Availability notification)
  '307':
    $ref: 'TS29571_CommonData.yaml#/components/responses/307'
  '308':
    $ref: 'TS29571_CommonData.yaml#/components/responses/308'
  '400':
    $ref: 'TS29571_CommonData.yaml#/components/responses/400'
  '401':
    $ref: 'TS29571_CommonData.yaml#/components/responses/401'
  '403':
    $ref: 'TS29571_CommonData.yaml#/components/responses/403'
  '404':
    $ref: 'TS29571_CommonData.yaml#/components/responses/404'

  '429':
    $ref: 'TS29571_CommonData.yaml#/components/responses/429'
  '500':
    $ref: 'TS29571_CommonData.yaml#/components/responses/500'
  '502':
    $ref: 'TS29571_CommonData.yaml#/components/responses/502'
  '503':
    $ref: 'TS29571_CommonData.yaml#/components/responses/503'

  default:
    description: Unexpected error

patch:
  summary: updates an already existing NSSAI availability notification subscription
  tags:
    - Subscription ID (Document)
  operationId: NSSAIAvailabilitySubModifyPatch
  parameters:
    - name: subscriptionId
      in: path
      description: Identifier of the subscription for notification
      required: true
      schema:
        type: string
    - name: Content-Encoding
      in: header
      description: Content-Encoding, described in IETF RFC 9110
      schema:
        type: string
  requestBody:
    description: >
      JSON Patch instructions to update at the NSSF,
      the NSSAI availability notification subscription
    required: true
    content:
      application/json-patch+json:
        schema:
          $ref: '#/components/schemas/PatchDocument'

  responses:
    '200':
      description: OK (Successful update of NSSAI availability notification subscription)
      content:
        application/json:
          schema:
            $ref: '#/components/schemas/NssfEventSubscriptionCreatedData'
      headers:
        Content-Encoding:
          description: Content-Encoding, described in IETF RFC 9110
          schema:
            type: string
    '307':
      $ref: 'TS29571_CommonData.yaml#/components/responses/307'
    '308':
      $ref: 'TS29571_CommonData.yaml#/components/responses/308'
    '400':
      $ref: 'TS29571_CommonData.yaml#/components/responses/400'
    '401':
      $ref: 'TS29571_CommonData.yaml#/components/responses/401'
    '403':
      $ref: 'TS29571_CommonData.yaml#/components/responses/403'
    '404':
      $ref: 'TS29571_CommonData.yaml#/components/responses/404'
    '411':

```

```

    $ref: 'TS29571_CommonData.yaml#/components/responses/411'
  '413':
    $ref: 'TS29571_CommonData.yaml#/components/responses/413'
  '415':
    $ref: 'TS29571_CommonData.yaml#/components/responses/415'
  '429':
    $ref: 'TS29571_CommonData.yaml#/components/responses/429'
  '500':
    $ref: 'TS29571_CommonData.yaml#/components/responses/500'
  '502':
    $ref: 'TS29571_CommonData.yaml#/components/responses/502'
  '503':
    $ref: 'TS29571_CommonData.yaml#/components/responses/503'
  default:
    description: Unexpected error

/nssai-availability:
  options:
    summary: Discover communication options supported by NSSF for NSSAI Availability
    operationId: NSSAIAvailabilityOptions
    tags:
      - NSSAI Availability Store
  responses:
    '200':
      description: OK
      headers:
        Accept-Encoding:
          description: Accept-Encoding, described in IETF RFC 9110
          schema:
            type: string
    '307':
      $ref: 'TS29571_CommonData.yaml#/components/responses/307'
    '308':
      $ref: 'TS29571_CommonData.yaml#/components/responses/308'
    '400':
      $ref: 'TS29571_CommonData.yaml#/components/responses/400'
    '401':
      $ref: 'TS29571_CommonData.yaml#/components/responses/401'
    '403':
      $ref: 'TS29571_CommonData.yaml#/components/responses/403'
    '404':
      $ref: 'TS29571_CommonData.yaml#/components/responses/404'
    '405':
      $ref: 'TS29571_CommonData.yaml#/components/responses/405'
    '429':
      $ref: 'TS29571_CommonData.yaml#/components/responses/429'
    '500':
      $ref: 'TS29571_CommonData.yaml#/components/responses/500'
    '501':
      $ref: 'TS29571_CommonData.yaml#/components/responses/501'
    '502':
      $ref: 'TS29571_CommonData.yaml#/components/responses/502'
    '503':
      $ref: 'TS29571_CommonData.yaml#/components/responses/503'
  default:
    $ref: 'TS29571_CommonData.yaml#/components/responses/default'

components:
  securitySchemes:
    oAuth2ClientCredentials:
      type: oauth2
      flows:
        clientCredentials:
          tokenUrl: '{nrfApiRoot}/oauth2/token'
          scopes:
            nssf-nssaiavailability: Access to the Nssf_NSSAIAvailability API

schemas:

#
# STRUCTURED TYPES
#

NssaiAvailabilityInfo:
  description: This contains the Nssai availability information requested by the AMF
  type: object
  required:
    - supportedNssaiAvailabilityData

```

```

properties:
  supportedNssaiAvailabilityData:
    type: array
    items:
      $ref: '#/components/schemas/SupportedNssaiAvailabilityData'
    minItems: 1
  supportedFeatures:
    $ref: 'TS29571_CommonData.yaml#/components/schemas/SupportedFeatures'
  amfSetId:
    type: string
    pattern: '^[0-9]{3}-[0-9]{2,3}-[A-Fa-f0-9]{2}-[0-3][A-Fa-f0-9]{2}$'

```

```

SupportedNssaiAvailabilityData:
  description: This contains the Nssai availability data information per TA supported by the AMF
  type: object
  required:
    - tai
    - supportedSnssaiList
  properties:
    tai:
      $ref: 'TS29571_CommonData.yaml#/components/schemas/Tai'
    supportedSnssaiList:
      type: array
      items:
        $ref: 'TS29571_CommonData.yaml#/components/schemas/ExtSnssai'
      minItems: 1
    taiList:
      type: array
      items:
        $ref: 'TS29571_CommonData.yaml#/components/schemas/Tai'
      minItems: 1
    taiRangeList:
      type: array
      items:
        $ref: 'TS29510_Nnrf_NFManagement.yaml#/components/schemas/TaiRange'
      minItems: 1
    nsagInfos:
      type: array
      items:
        $ref: 'TS29531_Nnssf_NSSelection.yaml#/components/schemas/NsagInfo'
      minItems: 1

```

```

AuthorizedNssaiAvailabilityData:
  description: This contains the Nssai availability data information per TA authorized by the
NSSF
  type: object
  required:
    - tai
    - supportedSnssaiList
  properties:
    tai:
      $ref: 'TS29571_CommonData.yaml#/components/schemas/Tai'
    supportedSnssaiList:
      type: array
      items:
        $ref: 'TS29571_CommonData.yaml#/components/schemas/ExtSnssai'
      minItems: 1
    restrictedSnssaiList:
      type: array
      items:
        $ref: '#/components/schemas/RestrictedSnssai'
      minItems: 1
    taiList:
      type: array
      items:
        $ref: 'TS29571_CommonData.yaml#/components/schemas/Tai'
      minItems: 1
    taiRangeList:
      type: array
      items:
        $ref: 'TS29510_Nnrf_NFManagement.yaml#/components/schemas/TaiRange'
      minItems: 1
    nsagInfos:
      type: array
      items:
        $ref: 'TS29531_Nnssf_NSSelection.yaml#/components/schemas/NsagInfo'
      minItems: 1

```

```

RestrictedSnssai:
  description: This contains the restricted SNssai information per PLMN
  type: object
  required:
    - homePlmnId
    - sNssaiList
  properties:
    homePlmnId:
      $ref: 'TS29571_CommonData.yaml#/components/schemas/PlmnId'
    sNssaiList:
      type: array
      items:
        $ref: 'TS29571_CommonData.yaml#/components/schemas/ExtSnssai'
      minItems: 1
    homePlmnIdList:
      type: array
      items:
        $ref: 'TS29571_CommonData.yaml#/components/schemas/PlmnId'
      minItems: 1
    roamingRestriction:
      type: boolean
      default: false

AuthorizedNssaiAvailabilityInfo:
  description: This contains the Nssai availability data information authorized by the NSSF
  type: object
  required:
    - authorizedNssaiAvailabilityData
  properties:
    authorizedNssaiAvailabilityData:
      type: array
      items:
        $ref: '#/components/schemas/AuthorizedNssaiAvailabilityData'
      minItems: 1
    supportedFeatures:
      $ref: 'TS29571_CommonData.yaml#/components/schemas/SupportedFeatures'

NssfEventSubscriptionCreateData:
  description: This contains the information for event subscription
  type: object
  required:
    - nfNssaiAvailabilityUri
    - event
  properties:
    nfNssaiAvailabilityUri:
      $ref: 'TS29571_CommonData.yaml#/components/schemas/Uri'
    taiList:
      type: array
      items:
        $ref: 'TS29571_CommonData.yaml#/components/schemas/Tai'
    event:
      $ref: '#/components/schemas/NssfEventType'
    additionalEvents:
      type: array
      items:
        $ref: '#/components/schemas/NssfEventType'
      minItems: 1
    expiry:
      $ref: 'TS29571_CommonData.yaml#/components/schemas/DateTime'
    amfSetId:
      type: string
      pattern: '^[0-9]{3}-[0-9]{2,3}-[A-Fa-f0-9]{2}-[0-3][A-Fa-f0-9]{2}$'
    taiRangeList:
      type: array
      items:
        $ref: 'TS29510_Nnrf_NFManagement.yaml#/components/schemas/TaiRange'
      minItems: 1
    amfId:
      $ref: 'TS29571_CommonData.yaml#/components/schemas/NfInstanceId'
    supportedFeatures:
      $ref: 'TS29571_CommonData.yaml#/components/schemas/SupportedFeatures'
    allAmfSetTaiInd:
      type: boolean
      default: false
    nsrpSubscribeInfo:
      $ref: '#/components/schemas/SnssaiReplacementSubscribeInfo'
    nsiunSubscribeInfo:
      $ref: '#/components/schemas/NsiUnavailabilitySubscribeInfo'

```

```

    validityTimeSubList:
      type: array
      items:
        $ref: 'TS29571_CommonData.yaml#/components/schemas/Snssai'
      minItems: 1

NssfEventSubscriptionCreatedData:
  description: This contains the information for created event subscription
  type: object
  required:
    - subscriptionId
  properties:
    subscriptionId:
      type: string
    expiry:
      $ref: 'TS29571_CommonData.yaml#/components/schemas/DateTime'
    authorizedNssaiAvailabilityData:
      type: array
      items:
        $ref: '#/components/schemas/AuthorizedNssaiAvailabilityData'
      minItems: 1
    supportedFeatures:
      $ref: 'TS29571_CommonData.yaml#/components/schemas/SupportedFeatures'

NssfEventNotification:
  description: This contains the notification for created event subscription
  type: object
  required:
    - subscriptionId
  properties:
    subscriptionId:
      type: string
    authorizedNssaiAvailabilityData:
      type: array
      items:
        $ref: '#/components/schemas/AuthorizedNssaiAvailabilityData'
    altNssai:
      type: array
      items:
        $ref: 'TS29571_CommonData.yaml#/components/schemas/SnssaiReplaceInfo'
      minItems: 1
      description: >
        Indicate the impacted S-NSSAIs, the current status for each reported S-NSSAI, and
        if available the alternative S-NSSAI per impacted S-NSSAI for the S-NSSAIs that are
        reported as being not available.
    unavailableNsiList:
      type: array
      items:
        $ref: 'TS29531_Nnssf_NSSelection.yaml#/components/schemas/NsiId'
      minItems: 1
    nssaiValidityTimeInfo:
      description: >
        A map(list of key-value pairs where single Nssai serves as key)
        of the current validity time
      type: object
      additionalProperties:
        $ref: 'TS29571_CommonData.yaml#/components/schemas/DateTime'

SnssaiReplacementSubscribeInfo:
  description: >
    Present if the NF service consumer subscribes to events related to
    Network Slice Replacement.
  type: object
  properties:
    snssaiToSubscribe:
      type: array
      items:
        $ref: 'TS29571_CommonData.yaml#/components/schemas/Snssai'
    nfType:
      $ref: 'TS29510_Nnrf_NFManagement.yaml#/components/schemas/NFType'
    nfId:
      $ref: 'TS29571_CommonData.yaml#/components/schemas/NfInstanceId'
    plmnId:
      $ref: 'TS29571_CommonData.yaml#/components/schemas/PlmnId'
  required:
    - snssaiToSubscribe
    - nfType
    - nfId

```

```
NsiUnavailabilitySubscribeInfo:
  description: >
    Present if the NF service consumer subscribes to events related to
    Network Slice Instance Replacement.
  type: object
  properties:
    nsiToSubscribe:
      type: array
      items:
        $ref: 'TS29531_Nnssf_NSSelection.yaml#/components/schemas/NsiId'
    snssaiToSubscribe:
      type: array
      items:
        $ref: 'TS29571_CommonData.yaml#/components/schemas/Snssai'

PatchDocument:
  description: >
    This contains the JSON Patch instructions for updating the Nssai availability data
    information at the NSSF
  type: array
  items:
    $ref: 'TS29571_CommonData.yaml#/components/schemas/PatchItem'
  minItems: 1

#
# SIMPLE TYPES
#

#
# ENUMS
#

NssfEventType:
  description: This contains the event for the subscription
  anyOf:
    - type: string
      enum:
        - SNSSAI_STATUS_CHANGE_REPORT
        - SNSSAI_REPLACEMENT_REPORT
        - NSI_UNAVAILABILITY_REPORT
        - SNSSAI_VALIDITY_TIME_REPORT
    - type: string
```

Annex B (informative): Change history

Change history							
Date	Meeting	TDoc	CR	Rev	Cat	Subject/Comment	New version
2017-10	CT4#80	C4-175279				Initial Draft.	0.1.0
2017-10	CT4#81	C4-175398				Implementation of C4-175280	0.2.0
2018-01	CT4#82	C4-181394				Implementation of C4-181240, C4-181242, C4-181244, C4-181355, C4-181356, C4-181357	0.3.0
2018-03	CT4#83	C4-182438				Implementation of C4-182087, C4-182294, C4-182295, C4-182296, C4-182297, C4-182298, C4-182299	0.4.0
2018-03	CT#79	CP-180035				Presented for information	1.0.0
2018-04	CT4#84	C4-183519				Implementation of C4-183068, C4-183071, C4-183431, C4-183432, C4-183433	1.1.0
2018-05	CT4#85	C4-184631				Implementation of C4-184602, C4-184023, C4-184024, C4-184025, C4-184026, C4-184603, C4-184527, C4-184528, C4-184604, C4-184632	1.2.0
2018-06	CT#80	CP-181108				Presented for approval	2.0.0
2018-06	CT#80					Approved in CT#80.	15.0.0
2018-09	CT#81	CP-182160	0001	5	F	Alignment of Nnssf_NSSelection_Get service operation with stage 2	15.1.0
2018-09	CT#81	CP-182014	0002	2	F	Adding NRF corresponding to an AMF set	15.1.0
2018-09	CT#81	CP-182167	0003	4	F	Corrections to NSSF Data Types	15.1.0
2018-09	CT#81	CP-182063	0004		F	Corrections to NSSAIAvailability Service Operations	15.1.0
2018-09	CT#81	CP-182063	0005	1	F	Configured NSSAI for HPLMN - Alignment with Stage 2	15.1.0
2018-09	CT#81	CP-182063	0006		F	Correction to NRF Id in NSIInformation	15.1.0
2018-09	CT#81	CP-182063	0007		F	Description of Structured data types	15.1.0
2018-09	CT#81	CP-182063	0008		F	API version number update	15.1.0
2018-12	CT#82	CP-183022	0009		F	Type Definition of AllowedNssai	15.2.0
2018-12	CT#82	CP-183022	0010	1	F	Correction to Slice Information For Registration	15.2.0
2018-12	CT#82	CP-183022	0011		F	API Root	15.2.0
2018-12	CT#82	CP-183022	0012	3	F	Common Error Status Codes	15.2.0
2018-12	CT#82	CP-183148	0013	2	F	Array Range Correction	15.2.0
2018-12	CT#82	CP-183022	0016	1	F	OpenAPI Corrections	15.2.0
2018-12	CT#82	CP-183022	0017	2	F	Subscription Lifetime for NSSAI Availability Event Subscription	15.2.0
2018-12	CT#82	CP-183022	0018		F	Correction of Resource URI structure	15.2.0
2018-12	CT#82	CP-183022	0019		F	Add Delete Service Operation in Nnssf_NSSAIAvailability Service	15.2.0
2018-12	CT#82	CP-183022	0020	2	F	Add the Default Configured NSSAI Indication in Nnssf_NSSelection Service	15.2.0
2018-12	CT#82	CP-183022	0021		F	CR 0021 29.531 Rel-15 Resource Uri Correction	15.2.0
2018-12	CT#82	CP-183022	0022		F	Correction to NssaiAvailabilityInfo	15.2.0
2018-12	CT#82	CP-183022	0023	2	F	Make OAuth2.0 Optional to Use	15.2.0
2018-12	CT#82	CP-183022	0024		F	ExternalDocs	15.2.0
2018-12	CT#82	CP-183022	0025		F	API Version	15.2.0
2019-03	CT#83	CP-190027	0026	1	F	Definition of TargetAmfSet	15.3.0
2019-03	CT#83	CP-190027	0027	1	F	OpenAPI Corrections	15.3.0
2019-03	CT#83	CP-190027	0029		F	Add missing NFType reference in reused data types	15.3.0
2019-03	CT#83	CP-190027	0030	2	F	Clarify the conditions of returning Configured NSSAI.	15.3.0
2019-03	CT#83	CP-190027	0031	1	F	Service operation of Nnssf_NSSelection service during UE configuration update procedure	15.3.0
2019-03	CT#83	CP-190171	0032	1	F	API version update	15.3.0
2019-06	CT#84	CP-191039	0033	1	F	Content encodings supported in HTTP requests	15.4.0
2019-06	CT#84	CP-191039	0034	4	F	Add AMFset in NssaiAvailabilityInfo	15.4.0
2019-06	CT#84	CP-191039	0036	2	F	Storage of OpenAPI specification files	15.4.0
2019-06	CT#84	CP-191039	0039	1	F	API URIs of the NRF	15.4.0
2019-06	CT#84	CP-191039	0040	1	F	Subscription to and notification of NSSF events	15.4.0
2019-06	CT#84	CP-191039	0041	2	F	Essential Correction on Application Error returned by NSSF	15.4.0
2019-06	CT#84	CP-191039	0042	1	F	Copyright Note in YAML file	15.4.0
2019-06	CT#84	CP-191039	0043		F	3GPP TS 29.531 API version update	15.4.0
2019-09	CT#85	CP-192111	0045		F	Essential Correction on AllowedNssai	15.5.0
2019-09	CT#85	CP-192131	0044	1	B	Slice selection during handover from 4G to 5G	16.0.0
2019-12	CT#86	CP-193048	0047	1	B	Subscribed NSSAI from the UDM	16.1.0
2019-12	CT#86	CP-193044	0049		F	3GPP TS 29.531 API version update	16.1.0
2020-03	CT#87	CP-200039	0050	2	F	Add Corresponding API descriptions in clause 5.1	16.2.0
2020-03	CT#87	CP-200020	0051	2	B	Optimized NSSAI Availability Data encoding	16.2.0
2020-03	CT#87	CP-200020	0052	3	B	AMF Service Set ID in Nnssf_NSSelection response	16.2.0
2020-03	CT#87	CP-200039	0053	2	D	Editorial corrections	16.2.0
2020-03	CT#87	CP-200039	0054	1	F	Correction - formatting consistency	16.2.0
2020-03	CT#87	CP-200020	0055	2	B	29531 CR optionality of ProblemDetails	16.2.0
2020-03	CT#87	CP-200020	0056	1	F	Modifications in the API of Nnssf_NSSAIAvailability service for the support of compression	16.2.0
2020-03	CT#87	CP-200020	0057	2	F	Corrections in the NSSF specification	16.2.0
2020-03	CT#87	CP-200052	0058		F	3GPP TS 29.531 Rel16 API External doc update	16.2.0
2020-07	CT#88	CP-201058	0059		F	Storage of YAML files in ETSI Forge	16.3.0
2020-07	CT#88	CP-201058	0060	3	F	Supported Headers Tables for Request and Response codes	16.3.0

2020-07	CT#88	CP-201058	0061	1	F	Add a new Notifications Overview Table	16.3.0
2020-07	CT#88	CP-201034	0062	1	F	Remaining modifications in the API of Nnssf_NSSAIAvailability service for the support of compression	16.3.0
2020-07	CT#88	CP-201034	0063		F	Slice Differentiator Ranges and Wildcard	16.3.0
2020-07	CT#88	CP-201058	0064	1	B	Restricted Snsai for roaming users	16.3.0
2020-07	CT#88	CP-201034	0065		F	PATCH Response	16.3.0
2020-07	CT#88	CP-201058	0066	1	F	Data type column in Resource URI variables Table	16.3.0
2020-07	CT#88	CP-201058	0067		F	mappingOfNssai IE in SliceInfoForRegistration	16.3.0
2020-07	CT#88	CP-201058	0068	1	F	URI of the Nnssf_NSSSelection and Nnssf_NSSAIAvailability Services	16.3.0
2020-07	CT#88	CP-201058	0069	1	F	Error code corrections	16.3.0
2020-07	CT#88	CP-201326	0071	1	F	29.531 Rel-16 API version and External doc update	16.3.0
2020-09	CT#89	CP-202090	0072		F	Essential correction to event SNSSAI_STATUS_CHANGE_REPORT	16.4.0
2020-09	CT#89	CP-202090	0073	1	F	Slice selection based on Load Analytics Information from NWDAF	16.4.0
2020-09	CT#89	CP-202090	0074	3	F	TAI Range List Served by an AMF	16.4.0
2020-09	CT#89	CP-202090	0077	1	F	Request mapping of S-NSSAI	16.4.0
2020-09	CT#89	CP-202090	0078	2	F	Subscription modification	16.4.0
2020-09	CT#89	CP-202035	0080	2	F	Notify Empty Authorized NSSAI Availability	16.4.0
2020-09	CT#89	CP-202096	0081		F	29.531 Rel-16 API version and External doc update	16.4.0
2020-12	CT#90-e	CP-203162	0082	1	F	HTTP 3xx redirection	16.5.0
2020-12	CT#90-e	CP-203040	0083	1	F	Mapping of S-NSSAIs in HPLMN and VPLMN	16.5.0
2020-12	CT#90-e	CP-203040	0084	1	F	Number of allowed S-NSSAIs	16.5.0
2020-12	CT#90-e	CP-203035	0085		F	Storage of YAML files in 3GPP Forge	16.5.0
2020-12	CT#90-e	CP-203036	0086		F	API version and External doc update	16.5.0
2021-03	CT#91-e	CP-210043	0090		F	OpenAPI syntax error	16.6.0
2021-03	CT#91-e	CP-210054	0091		F	29.531 Rel-16 API version and External doc update	16.6.0
2021-03	CT#91-e	CP-210034	0088	1	F	OpenAPI Reference	17.0.0
2021-03	CT#91-e	CP-210025	0089	1	F	N31 interface between NSSFs	17.0.0
2021-06	CT#92-e	CP-211083	0094		A	Essential correction on Nssai Availability Document Update	17.1.0
2021-06	CT#92-e	CP-211028	0095		F	Data Types Descriptions	17.1.0
2021-06	CT#92-e	CP-211059	0097	1	F	Redirect Responses	17.1.0
2021-06	CT#92-e	CP-211046	0098		F	Miscellaneous corrections	17.1.0
2021-06	CT#92-e	CP-211050	0100		F	29.531 Rel-17 API version and External doc update	17.1.0
2021-09	CT#93-e	CP-212075	0106		A	Incorrect references	17.2.0
2021-09	CT#93-e	CP-212052	0101		F	SNSSAI_NOT_SUPPORTED	17.2.0
2021-09	CT#93-e	CP-212030	0102	3	B	NSSRG value	17.2.0
2021-09	CT#93-e	CP-212030	0103	3	B	Missing indication of UE support of NSSRG functionality in NSSF service	17.2.0
2021-09	CT#93-e	CP-212030	0104	2	B	Target NSSAI	17.2.0
2021-09	CT#93-e	CP-212045	0107	1	F	NSSAIAvailability Notify	17.2.0
2021-09	CT#93-e	CP-212059	0108		F	29.531 Rel-17 API version and External doc update	17.2.0
2021-12	CT#94-e	CP-213085	0111		B	Indicating possible use of OAuth2 authorization in NSSF response	17.3.0
2021-12	CT#94-e	CP-213085	0114		F	Corrections to the API URI	17.3.0
2021-12	CT#94-e	CP-213086	0112	1	F	Correction on requestedNssai	17.3.0
2021-12	CT#94-e	CP-213086	0115		F	Notification Errors	17.3.0
2021-12	CT#94-e	CP-213092	0110	1	B	UDM indication to provide full set of subscribed S-NSSAIs	17.3.0
2021-12	CT#94-e	CP-213092	0113	1	B	Rejected S-NSSAIs for RA in NS Selection	17.3.0
2021-12	CT#94-e	CP-213092	0119	1	B	Target NSSAI correction	17.3.0
2021-12	CT#94-e	CP-213092	0116		F	Configured NSSAI can include S-NSSAIs with different NSSRG values	17.3.0
2021-12	CT#94-e	CP-213113	0117	1	F	Configured NSSAI shall be returned by NSSF to AMF during UCU procedure	17.3.0
2021-12	CT#94-e	CP-213113	0118	1	F	Clarification on the condition when AMF can retrieve slice mapping information	17.3.0
2021-12	CT#94-e	CP-213121	0120		F	29.531 Rel-17 API version and External doc update	17.3.0
2022-03	CT#95-e	CP-220024	0126		F	Formatting of Description Fields	17.4.0
2022-03	CT#95-e	CP-220087	0122		F	Correction on ExtSnsai	17.4.0
2022-03	CT#95-e	CP-220087	0123		F	Adding use case for sending Allowed NSSAI aligned with stage 2	17.4.0
2022-03	CT#95-e	CP-220092	0124	1	D	Capitalize allowed NSSAI and target NSSAI	17.4.0
2022-03	CT#95-e	CP-220066	0127		F	29.531 Rel-17 API version and External doc update	17.4.0
2022-06	CT#96	CP-221033	0129	1	F	Redirect or handover the UE to a cell of another TA	17.5.0
2022-06	CT#96	CP-221029	0130	2	F	Clarification on targetAmfSet in AuthorizedNetworkSliceInfo	17.5.0
2022-06	CT#96	CP-221055	0131	4	F	Nnssf_NSSSelection service update to support NSAG	17.5.0
2022-06	CT#96	CP-221055	0132	3	F	Nnssf_NSSAIAvailability service update to support NSAG	17.5.0
2022-06	CT#96	CP-221033	0135	1	F	Correction on OpenAPI	17.5.0
2022-06	CT#96	CP-221051	0136		F	29.531 Rel-17 API version and External doc update	17.5.0
2022-09	CT#97e	CP-222055	0140	1	F	Cleanup of the service operation description	17.6.0
2022-09	CT#97e	CP-222021	0137	1	B	Subscribe to All TAIs for AMF Set	18.0.0
2022-09	CT#97e	CP-222025	0142		F	29.531 Rel-18 API version and External doc update	18.0.0
2022-12	CT#98e	CP-223028	0143	1	F	Missing mandatory status codes in OpenAPI	18.1.0
2022-12	CT#98e	CP-223033	0144	-	F	29.531 Rel-18 API version and External doc update	18.1.0

2023-03	CT#99	CP-230072	0146	1	A	Essential correction of MNC encoding targetAmfSet	18.2.0
2023-03	CT#99	CP-230071	0148	-	F	29.531 Rel-18 API version and External doc update	18.2.0
2023-06	CT#100	CP-231028	0147	3	F	Location header description	18.3.0
2023-06	CT#100	CP-231027	0151	1	F	Clarify the inclusion of targetAmfSet IE and candidateAmfList IE	18.3.0
2023-06	CT#100	CP-231025	0152	-	F	Clarify the inclusion of ueSupNssrgInd IE	18.3.0
2023-06	CT#100	CP-231027	0153	1	F	Clarify the content of mappingOfNssai IE	18.3.0
2023-06	CT#100	CP-231025	0154	-	F	Update data types re-used by Nnssf_NSSelection service	18.3.0
2023-06	CT#100	CP-231048	0155	1	B	Discontinuity of NSI for PDU sessions	18.3.0
2023-06	CT#100	CP-231048	0156	5	B	Support of Alternative S-NSSAI	18.3.0
2023-06	CT#100	CP-231069	0159	1	F	Editorial corrections	18.3.0
2023-06	CT#100	CP-231028	0160	-	F	Removal of apiVersion from resource URI variables tables	18.3.0
2023-06	CT#100	CP-231070	0161	-	F	29.531 Rel-18 API version and External doc update	18.3.0
2023-09	CT#101	CP-232069	0163	3	B	Updates on Subscription, Unsubscription and Notification of NSSF for Network Slice and Network Slice Instance replacement	18.4.0
2023-09	CT#101	CP-232043	0164	1	B	Nnssf_NSSAIAvailability Service update for Network Slice Replacement	18.4.0
2023-09	CT#101	CP-232043	0165	1	B	Remove the Editor's NOTE on Network Slice instance Replacement	18.4.0
2023-09	CT#101	CP-232058	0166	1	F	Major API version	18.4.0
2023-09	CT#101	CP-232060	0167	-	F	29.531 Rel-18 API version and External doc update	18.4.0
2023-12	CT#102	CP-233027	0168	-	F	HTTP RFCs obsoleted by IETF RFC 9110 and 9113	18.5.0
2023-12	CT#102	CP-233044	0169	-	F	Correction on the description of DateTime	18.5.0
2023-12	CT#102	CP-233071	0172	2	A	Update of subscribed NSSAI when UE is not registered in network	18.5.0
2023-12	CT#102	CP-233058	0175	3	A	Correction of API TS29531_Nnssf_NSSAIAvailability.yaml, error in amfSetId pattern	18.5.0
2023-12	CT#102	CP-233030	0176	-	F	ProblemDetails RFC 7807 obsoleted by 9457	18.5.0
2023-12	CT#102	CP-233060	0180	-	F	29.531 Rel-18 API version and External doc update	18.5.0
2024-03	CT#103	CP-240053	0185	2	F	Presence Condition of Default Configured S-NSSAI Indication	18.6.0
2024-03	CT#103	CP-240071	0187	1	A	NSSF determination of Allowed NSSAI	18.6.0
2024-03	CT#103	CP-240042	0188	1	B	Clarification on Congestion Mitigation Information during NSSAIAvailability Notification for Network Slice Replacement	18.6.0
2024-03	CT#103	CP-240042	0191	1	F	Support Network Slice Replacement and Network Slice Instance Replacement in roaming	18.6.0
2024-03	CT#103	CP-240042	0192	1	B	Service operation update for S-NSSAI validity time	18.6.0
2024-03	CT#103	CP-240042	0193	1	B	Data type definition for S-NSSAI validity time	18.6.0
2024-03	CT#103	CP-240053	0194	-	F	Editorial and Style Corrections	18.6.0
2024-03	CT#103	CP-240042	0196	-	F	Editorial corrections	18.6.0
2024-03	CT#103	CP-240056	0197	-	F	29.531 Rel-18 API version and External doc update	18.6.0

History

Document history		
V18.6.0	May 2024	Publication