

ETSI TS 129 551 V16.6.0 (2021-01)



**5G;
5G System;
Packet Flow Description Management Service;
Stage 3
(3GPP TS 29.551 version 16.6.0 Release 16)**



ReferenceRTS/TSGC-0329551vg60

Keywords5G

ETSI

650 Route des Lucioles
F-06921 Sophia Antipolis Cedex - FRANCE

Tel.: +33 4 92 94 42 00 Fax: +33 4 93 65 47 16

Siret N° 348 623 562 00017 - NAF 742 C
Association à but non lucratif enregistrée à la
Sous-Préfecture de Grasse (06) N° 7803/88

Important notice

The present document can be downloaded from:

<http://www.etsi.org/standards-search>

The present document may be made available in electronic versions and/or in print. The content of any electronic and/or print versions of the present document shall not be modified without the prior written authorization of ETSI. In case of any existing or perceived difference in contents between such versions and/or in print, the prevailing version of an ETSI deliverable is the one made publicly available in PDF format at www.etsi.org/deliver.

Users of the present document should be aware that the document may be subject to revision or change of status.

Information on the current status of this and other ETSI documents is available at

<https://portal.etsi.org/TB/ETSIDeliverableStatus.aspx>

If you find errors in the present document, please send your comment to one of the following services:

<https://portal.etsi.org/People/CommitteeSupportStaff.aspx>

Copyright Notification

No part may be reproduced or utilized in any form or by any means, electronic or mechanical, including photocopying and microfilm except as authorized by written permission of ETSI.

The content of the PDF version shall not be modified without the written authorization of ETSI.

The copyright and the foregoing restriction extend to reproduction in all media.

© ETSI 2021.

All rights reserved.

DECT™, **PLUGTESTS™**, **UMTS™** and the ETSI logo are trademarks of ETSI registered for the benefit of its Members.

3GPP™ and **LTE™** are trademarks of ETSI registered for the benefit of its Members and of the 3GPP Organizational Partners.

oneM2M™ logo is a trademark of ETSI registered for the benefit of its Members and of the oneM2M Partners.

GSM® and the GSM logo are trademarks registered and owned by the GSM Association.

Intellectual Property Rights

Essential patents

IPRs essential or potentially essential to normative deliverables may have been declared to ETSI. The information pertaining to these essential IPRs, if any, is publicly available for **ETSI members and non-members**, and can be found in ETSI SR 000 314: "*Intellectual Property Rights (IPRs); Essential, or potentially Essential, IPRs notified to ETSI in respect of ETSI standards*", which is available from the ETSI Secretariat. Latest updates are available on the ETSI Web server (<https://ipr.etsi.org/>).

Pursuant to the ETSI IPR Policy, no investigation, including IPR searches, has been carried out by ETSI. No guarantee can be given as to the existence of other IPRs not referenced in ETSI SR 000 314 (or the updates on the ETSI Web server) which are, or may be, or may become, essential to the present document.

Trademarks

The present document may include trademarks and/or tradenames which are asserted and/or registered by their owners. ETSI claims no ownership of these except for any which are indicated as being the property of ETSI, and conveys no right to use or reproduce any trademark and/or tradename. Mention of those trademarks in the present document does not constitute an endorsement by ETSI of products, services or organizations associated with those trademarks.

Legal Notice

This Technical Specification (TS) has been produced by ETSI 3rd Generation Partnership Project (3GPP).

The present document may refer to technical specifications or reports using their 3GPP identities. These shall be interpreted as being references to the corresponding ETSI deliverables.

The cross reference between 3GPP and ETSI identities can be found under <http://webapp.etsi.org/key/queryform.asp>.

Modal verbs terminology

In the present document "**shall**", "**shall not**", "**should**", "**should not**", "**may**", "**need not**", "**will**", "**will not**", "**can**" and "**cannot**" are to be interpreted as described in clause 3.2 of the [ETSI Drafting Rules](#) (Verbal forms for the expression of provisions).

"**must**" and "**must not**" are **NOT** allowed in ETSI deliverables except when used in direct citation.

Contents

Intellectual Property Rights	2
Legal Notice	2
Modal verbs terminology.....	2
Foreword.....	5
1 Scope	6
2 References	6
3 Definitions, symbols and abbreviations	7
3.1 Definitions	7
3.2 Abbreviations	7
4 Packet Flow Description Management Service.....	7
4.1 Service Description	7
4.1.1 Overview	7
4.1.2 Service Architecture	7
4.1.3 Network Functions.....	8
4.1.3.1 Packet Flow Description Function (PFDF)	8
4.1.3.2 NF Service Consumers.....	8
4.2 Service Operations	8
4.2.1 Introduction.....	8
4.2.2 Nnef_PFDmanagement_Fetch Service Operation	9
4.2.2.1 General	9
4.2.2.2 Retrieval of PFDs.....	9
4.2.3 Nnef_PFDmanagement_Subscribe Service Operation	10
4.2.3.1 General	10
4.2.3.2 Subscription for event notifications on PFDs change	10
4.2.3.3 Subscription update for event notifications on PFDs change.....	11
4.2.4 Nnef_PFDmanagement_Notify Service Operation.....	11
4.2.4.1 General	11
4.2.4.2 Notification of PFD change.....	12
4.2.5 Nnef_PFDmanagement_Unsubscribe Service Operation	12
4.2.5.1 General	12
4.2.5.2 Unsubscribe from event notifications on PFDs change.....	12
5 Nnef_PFDmanagement API.....	13
5.1 Introduction	13
5.2 Usage of HTTP.....	13
5.2.1 General.....	13
5.2.2 HTTP standard headers.....	13
5.2.2.1 General	13
5.2.2.2 Content type	13
5.2.3 HTTP custom headers.....	14
5.3 Resources	14
5.3.1 Resource Structure.....	14
5.3.2 Resource: PFD of applications.....	15
5.3.2.1 Description	15
5.3.2.2 Resource definition	15
5.3.2.3 Resource Standard Methods.....	15
5.3.2.3.1 GET	15
5.3.2.4 Resource Custom Operations	15
5.3.3 Resource: Individual application PFD	15
5.3.3.1 Description	15
5.3.3.2 Resource definition	16
5.3.3.3 Resource Standard Methods.....	16
5.3.3.3.1 GET	16
5.3.3.4 Resource Custom Operations	16

5.3.4	Resource: PFD subscriptions	16
5.3.4.1	Description	16
5.3.4.2	Resource definition	16
5.3.4.3	Resource Standard Methods.....	17
5.3.4.3.1	POST	17
5.3.4.4	Resource Custom Operations	17
5.3.5	Resource: Individual PFD subscription	17
5.3.5.1	Description	17
5.3.5.2	Resource definition	17
5.3.5.3	Resource Standard Methods.....	18
5.3.5.3.1	DELETE.....	18
5.3.5.3.2	PUT	18
5.3.5.4	Resource Custom Operations	19
5.4	Custom Operations without associated resources.....	19
5.5	Notifications	19
5.5.1	General.....	19
5.5.2	PFD Change Notification.....	19
5.5.2.1	Description	19
5.5.2.2	Target URI	19
5.5.2.3	Standard Methods	19
5.5.2.3.1	POST	19
5.6	Data Model.....	20
5.6.1	General.....	20
5.6.2	Structured data types.....	21
5.6.2.1	Introduction.....	21
5.6.2.2	Type: PfdDataForApp.....	21
5.6.2.3	Type: PfdSubscription.....	21
5.6.2.4	Type: PfdChangeNotification	22
5.6.2.5	Type: PfdContent	22
5.6.2.6	Type: PfdChangeReport.....	23
5.6.3	Simple data types and enumerations	23
5.6.3.1	Introduction.....	23
5.6.3.2	Simple data types	23
5.7	Error handling	23
5.7.1	General.....	23
5.7.2	Protocol Errors.....	23
5.7.3	Application Errors	23
5.8	Feature negotiation.....	24
5.9	Security	24
Annex A (normative): OpenAPI specification.....		25
A.1	General	25
A.2	Nnef_PFDmanagement API.....	25
Annex B (informative): Change history		31
History		32

Foreword

This Technical Specification has been produced by the 3rd Generation Partnership Project (3GPP).

The contents of the present document are subject to continuing work within the TSG and may change following formal TSG approval. Should the TSG modify the contents of the present document, it will be re-released by the TSG with an identifying change of release date and an increase in version number as follows:

Version x.y.z

where:

- x the first digit:
 - 1 presented to TSG for information;
 - 2 presented to TSG for approval;
 - 3 or greater indicates TSG approved document under change control.
- y the second digit is incremented for all changes of substance, i.e. technical enhancements, corrections, updates, etc.
- z the third digit is incremented when editorial only changes have been incorporated in the document.

1 Scope

The present document provides the stage 3 specification of the PFD Management Service of the 5G system.

The stage 2 definition and related procedures of the PFD Management Service are contained in 3GPP TS 23.502 [3] and 3GPP TS 23.503 [4]. The 5G System Architecture is defined in 3GPP TS 23.501 [2].

The Technical Realization of the Service Based Architecture and the Principles and Guidelines for Services Definition of the 5G System are specified in 3GPP TS 29.500 [5] and 3GPP TS 29.501 [6].

The Packet Flow Description Function (PFDF) provides the PFD Management Service to NF consumers (e.g. Session Management Function). The PFDF is functionality within the NEF.

2 References

The following documents contain provisions which, through reference in this text, constitute provisions of the present document.

- References are either specific (identified by date of publication, edition number, version number, etc.) or non-specific.
- For a specific reference, subsequent revisions do not apply.
- For a non-specific reference, the latest version applies. In the case of a reference to a 3GPP document (including a GSM document), a non-specific reference implicitly refers to the latest version of that document *in the same Release as the present document*.

- [1] 3GPP TR 21.905: "Vocabulary for 3GPP Specifications".
- [2] 3GPP TS 23.501: "System Architecture for the 5G System; Stage 2".
- [3] 3GPP TS 23.502: "Procedures for the 5G System; Stage 2".
- [4] 3GPP TS 23.503: "Policy and Charging Control Framework for the 5G System; Stage 2".
- [5] 3GPP TS 29.500: "5G System; Technical Realization of Service Based Architecture; Stage 3".
- [6] 3GPP TS 29.501: "5G System; Principles and Guidelines for Services Definition; Stage 3".
- [7] IETF RFC 7540: "Hypertext Transfer Protocol Version 2 (HTTP/2)".
- [8] IETF RFC 8259: "The JavaScript Object Notation (JSON) Data Interchange Format".
- [9] OpenAPI: "OpenAPI 3.0.0 Specification", <https://github.com/OAI/OpenAPI-Specification/blob/master/versions/3.0.0.md>.
- [10] 3GPP TS 29.571: "5G System; Common Data Types for Service Based Interfaces Stage 3".
- [11] 3GPP TS 29.122: "T8 reference point for Northbound APIs".
- [12] 3GPP TS 29.251: "Gw and Gwn reference points for sponsored data connectivity".
- [13] 3GPP TS 29.510: "5G System; Network Function Repository Services; Stage 3".
- [14] 3GPP TS 33.501: "Security architecture and procedures for 5G system".
- [15] IETF RFC 6749: "The OAuth 2.0 Authorization Framework".
- [16] IETF RFC 7807: "Problem Details for HTTP APIs".
- [17] 3GPP TR 21.900: "Technical Specification Group working methods".

3 Definitions, symbols and abbreviations

3.1 Definitions

For the purposes of the present document, the terms and definitions given in 3GPP TR 21.905 [1] and the following apply. A term defined in the present document takes precedence over the definition of the same term, if any, in 3GPP TR 21.905 [1].

3.2 Abbreviations

For the purposes of the present document, the abbreviations given in 3GPP TR 21.905 [1] and the following apply. An abbreviation defined in the present document takes precedence over the definition of the same abbreviation, if any, in 3GPP TR 21.905 [1].

JSON	JavaScript Object Notation
NEF	Network Exposure Function
NRF	Network Repository Function
PFD	Packet Flow Description
PFDF	Packet Flow Description Function
SBI	Service Based Interface
SMF	Session Management Function

4 Packet Flow Description Management Service

4.1 Service Description

4.1.1 Overview

The PFD Management Service, as defined as defined in 3GPP TS 23.501 [2], 3GPP TS 23.502 [3] and 3GPP TS 23.503 [4], is provided by the Packet Flow Description Function (PFDF).

The only known NF Service Consumer is the SMF.

This service:

- allows an SMF to subscribe to and unsubscribe from PFD changes;
- notifies an SMF about changes of PFDs; and
- allows an SMF to retrieve PFDs.

4.1.2 Service Architecture

The 5G System Architecture is defined in 3GPP TS 23.501 [2]. The Policy and Charging related 5G architecture is also described in 3GPP TS 23.503 [4].

The PFD Management Service is provided by the PFDF to NF service consumers (e.g. SMF) and shown in the SBI representation model in Figure 4.1.2-1. The PFDF is a functionality within the NEF.

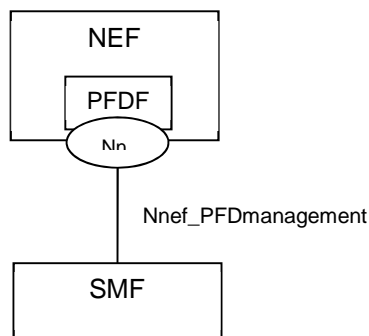

Figure 4.1.2-1: Reference Architecture for the Nnef_PFDmanagement Service; SBI representation



Figure 4.1.2-2: Reference Architecture for the Nnef_PFDmanagement Service; reference point representation

4.1.3 Network Functions

4.1.3.1 Packet Flow Description Function (PFDF)

The Packet Flow Description Function (PFDF):

- provides PFDs associated with one or more Application Identifiers; and
- allows NF consumers to subscribe to and unsubscribe from notifications on changes of PFDs for Application Identifier.

4.1.3.2 NF Service Consumers

The SMF shall support:

- requesting and receiving the PFD(s) for one or more Application Identifiers.

4.2 Service Operations

4.2.1 Introduction

Service operations defined for the Nnef_PFDmanagement Service are shown in table 4.2.1-1.

Table 4.2.1-1: Nnef_PFDmanagement Service Operations

Service Operation Name	Description	Initiated by
Nnef_PFDmanagement_Fetch	Provides the PFDs for application identifier(s) to the NF service consumer.	SMF
Nnef_PFDmanagement_Subscribe	Allows NF service consumers to subscribe to notifications on events when the PFDs for application identifier(s) change.	SMF
Nnef_PFDmanagement_Notify	Notifies NF service consumers to update and/or delete the PFDs for application identifier(s).	PFDF
Nnef_PFDmanagement_Unsubscribe	Allows NF service consumers to unsubscribe from notifications on PFDs change events.	SMF

4.2.2 Nnef_PFDmanagement_Fetch Service Operation

4.2.2.1 General

The Nnef_PFDmanagement_Fetch service operation provides means for the NF service consumer to retrieve the PFDs for one or more application identifier(s).

The following procedures using the Nnef_PFDmanagement_Fetch service operation are supported:

- Retrieval of PFDs.

4.2.2.2 Retrieval of PFDs

This procedure, as shown in Figure 4.2.2.2-1, is used to retrieve PFDs for an application identifier from the PFDF. This procedure enables the NF service consumer to retrieve PFDs for an Application Identifier(s) from the PFDF:

- when a PCC rule with this application identifier is provided/activated by the PCF and the PFDs provided by the PFDF are not available at the NF service consumer;
- when the caching timer for an application identifier elapses and a PCC rule for this application identifier is still active.

When the SMF removes the last PCC rule that refers to the corresponding application identifier, or when the caching timer expires and no PCC rule refers to the application identifier, the SMF may remove the PFD(s) related with the application identifier.

The PFDs retrieved from PFDF take precedence over any PFDs pre-configured in the SMF. If all PFDs retrieved from the PFDF are removed for an application identifier, the pre-configured PFDs shall be applied again for the application identifier.

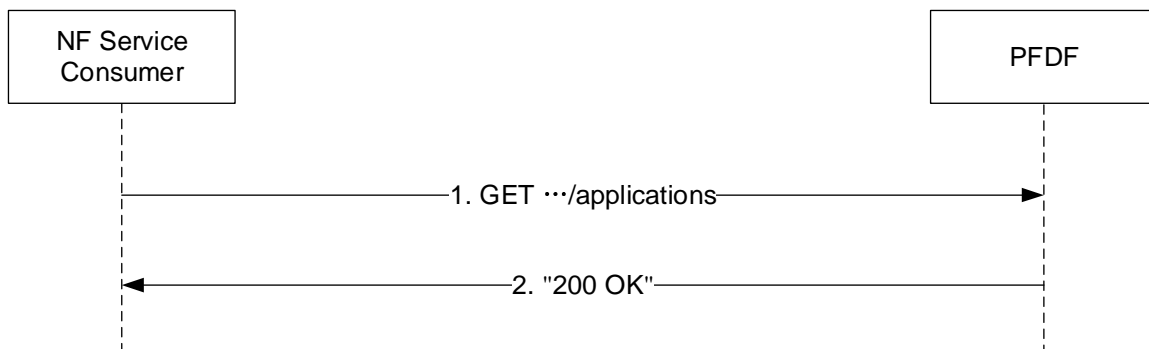

Figure 4.2.2.2-1: Retrieval of PFDs

1. The NF service consumer (e.g. SMF) shall send a GET request to the resource representing the PFDs for the requested application identifier(s):
 - for PFDs of an individual application identifier, the request URI shall be set to "{apiRoot}/nnef-pfdmanagement/v1/applications/{appId}"; and
 - for PFD of a collection of application identifiers, the request URI shall be set to "{apiRoot}/nnef-pfdmanagement/v1/applications/" with query parameters indicating the requested application identifier(s).
2. On success, an HTTP "200 OK" response shall be returned, with the payload body containing a representation of an "Individual application PFD" resource or a "PFD of applications" resource for the requested application identifier(s). The NF service consumer shall replace the stored PFD(s) retrieved from the PFDF with the new received PFD(s) for the requested application identifier(s). If the PFD(s) of one or more requested application identifier(s) are not provided in the response, the NF service consumer shall remove the PFD(s) of these requested application identifier(s) and re-apply the pre-configured PFDs.

On failure, one of the HTTP status codes listed in table 5.3.2.3.1-3 or table 5.3.3.3.1-3 shall be returned. For "404 Not Found", the NF service consumer shall remove the PFD(s) of the requested application identifier(s) in the NF service consumer and re-apply the pre-configured PFDs.

4.2.3 Nnef_PFDmanagement_Subscribe Service Operation

4.2.3.1 General

The Nnef_PFDmanagement_Subscribe service operation enables the NF service consumer to subscribe to notifications on events when the PFDs for application identifier(s) change.

The following procedures using the Nnef_PFDmanagement_Subscribe service operation are supported:

- Subscription for event notifications on PFDs change;
- Subscription update for event notifications on PFD change.

4.2.3.2 Subscription for event notifications on PFDs change

This procedure, as shown in Figure 4.2.3.2-1, is used to subscribe to notifications on events when the PFDs for application identifier(s) change.

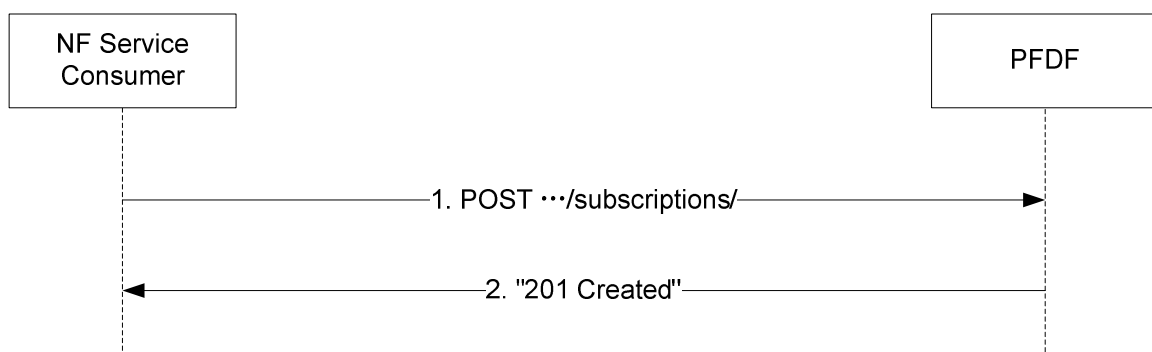

Figure 4.2.3.2-1: Creation of a subscription for event notifications on PFDs change

1. The NF service consumer (e.g. SMF) shall send a POST request to the request URI representing the collection of PFD subscriptions resource "{apiRoot}/nnef-pfdmanagement/v1/subscriptions". The request payload body shall include:
 - subscribed application identifier(s) optionally, and;
 - an URI where to receive the requested notifications as "notifyUri" attribute.

2. If the request is accepted, the PFD shall:

- create a new subscription;
- assign a subscriptionId;
- store the subscription; and
- send an HTTP "201 Created" response, with the payload body containing a representation of the created subscription, and the Location header containing the resource URI of the created subscription "{apiRoot}/nnef-pfdmanagement/v1/subscriptions/{subscriptionId}".

Otherwise, one of the HTTP status codes listed in table 5.3.4.3.1-3 shall be returned.

4.2.3.3 Subscription update for event notifications on PFDs change

This procedure, as shown in Figure 4.2.3.3-1, is used to update an existing subscription to notifications on events when the PFDs for application identifier(s) change.

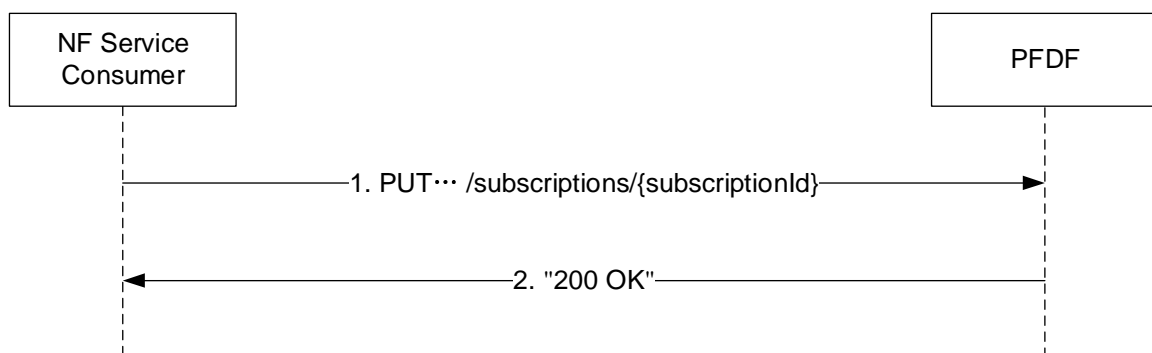

Figure 4.2.3.3-1: Update of a subscription for event notifications on PFDs change

1. If the feature PfdChgSubsUpdate is supported, the NF service consumer (e.g. SMF) shall send a PUT request to the resource URI representing the targeted PFD subscription resource "{apiRoot}/nnef-pfdmanagement/v1/subscriptions/{subscriptionId}". The request payload body shall include:

- subscribed application identifier(s) optionally; and
- an URI where to receive the requested notifications as "notifyUri" attribute.

2. If the feature PfdChgSubsUpdate is supported and the request is accepted, the PFD shall:

- update the subscription; and
- send an HTTP "200 OK" response, with the payload body containing a representation of the updated subscription.

Otherwise, one of the HTTP status codes listed in table 5.3.5.3.2-3 shall be returned.

4.2.4 Nnef_PFDmanagement_Notify Service Operation

4.2.4.1 General

The Nnef_PFDmanagement_Notify service operation notifies the NF service consumer to update and/or delete the PFDs for application identifier(s).

The following procedures using the Nnef_PFDmanagement_Notify service operation are supported:

- Management of PFDs.

4.2.4.2 Notification of PFD change

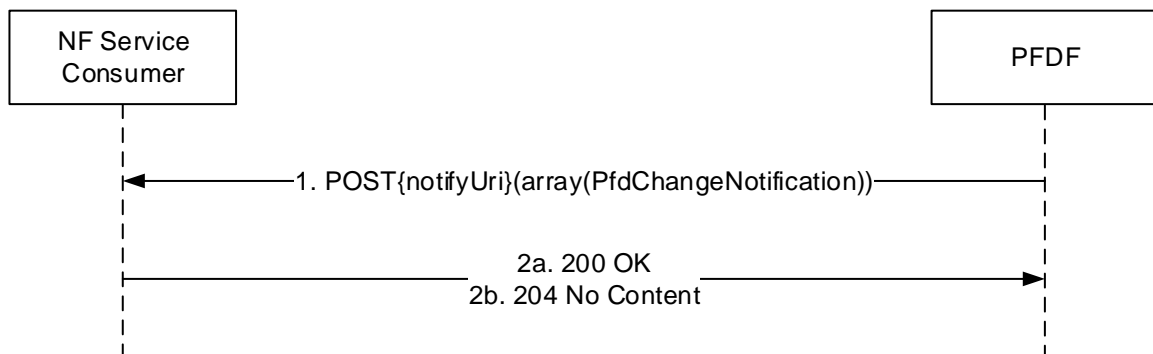

Figure 4.2.4.2-1: Notification of PFD change

1. The PFDf shall send a POST request to the NF service consumer (e.g. SMF) targeting the URI "{notifyUri}", where {notifyUri} is the notification URI provided during the creation of the subscription resource, as specified in subclause 4.2.3.2. The payload body of the POST request shall contain one or more PfdChangeNotification data structure(s).
2. If the notification is accepted, the NF service consumer shall reply with:
 - "204 No Content" indicating the successful provisioning of all PFDs; or
 - "200 OK" and the payload body of the response shall contain "PfdChangeReport" data structure with detailed information of failed application(s).

Otherwise, one of the HTTP status codes listed in table 5.5.2.3.1-3 shall be returned.

4.2.5 Nnef_PFDmanagement_Unsubscribe Service Operation

4.2.5.1 General

The Nnef_PFDmanagement_Unsubscribe service operation is used by the NF service consumer to unsubscribe from notifications on PFD change events.

The following procedures using the Nnef_PFDmanagement_Unsubscribe service operation are supported:

- Unsubscribe from event notifications on PFDs change.

4.2.5.2 Unsubscribe from event notifications on PFDs change

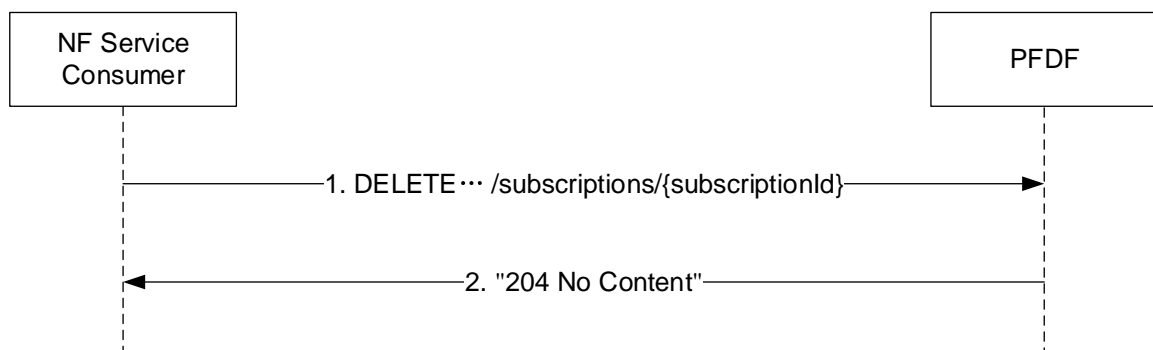

Figure 4.2.5.2-1: Unsubscribe from event notifications on PFDs change

1. The NF Service Consumer (e.g. SMF) shall send a DELETE request to the resource URI representing the individual PFD subscription. The request body shall be empty.

2. If the request is accepted, an HTTP "204 No Content" response shall be returned. The response body shall be empty.

Otherwise, one of the HTTP status codes listed in table 5.3.5.3.1-3 shall be returned.

5 Nnef_PFDmanagement API

5.1 Introduction

The Packet Flow Description Management Service shall use the Nnef_PFDmanagement API.

The API URI of the Nnef_PFDmanagement API shall be:

{apiRoot}/<apiName>/<apiVersion>/

The request URIs used in HTTP requests from the NF service consumer towards the PFDF shall have the Resource URI structure defined in subclause 4.4.1 of 3GPP TS 29.501 [6], i.e.:

{apiRoot}/<apiName>/<apiVersion>/<apiSpecificResourceUriPart>

with the following components:

- The {apiRoot} shall be set as described in 3GPP TS 29.501 [6].
- The <apiName> shall be "nnef-pfdmanagement".
- The <apiVersion> shall be "v1".
- The <apiSpecificResourceUriPart> shall be set as described in subclause 5.3.

5.2 Usage of HTTP

5.2.1 General

HTTP/2, IETF RFC 7540 [7], shall be used as specified in subclause 5.2 of 3GPP TS 29.500 [5].

HTTP/2 shall be transported as specified in subclause 5.3 of 3GPP TS 29.500 [5].

The OpenAPI [9] specification of HTTP messages and content bodies for the Nnef_PFDmanagement service is contained in Annex A.

5.2.2 HTTP standard headers

5.2.2.1 General

See subclause 5.2.2 of 3GPP TS 29.500 [5] for the usage of HTTP standard headers.

5.2.2.2 Content type

JSON, IETF RFC 8259 [8], shall be used as content type of the HTTP bodies specified in the present specification, as specified in subclause 5.4 of 3GPP TS 29.500 [5]. The use of the JSON format shall be signalled by the content type "application/json".

"Problem Details" JSON object shall be used to indicate additional details of the error in a HTTP response body and shall be signalled by the content type "application/problem+json", as defined in IETF RFC 7807 [16].

5.2.3 HTTP custom headers

None

5.3 Resources

5.3.1 Resource Structure

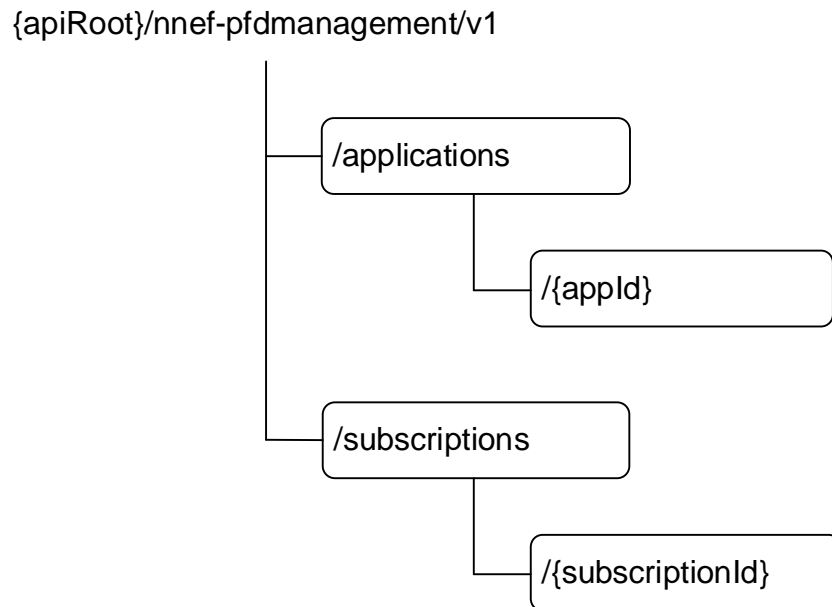

Figure 5.3.1-1: Resource URI structure of the Nnef_PFDmanagement API

Table 5.3.1-1 provides an overview of the resources and applicable HTTP methods.

Table 5.3.1-1: Resources and methods overview

Resource name	Resource URI	HTTP method or custom operation	Description
PFD of applications	/applications	GET	Nnef_PFDmanagement_Fetch. Retrieve PFDs for one or multiple applications using query parameters.
Individual application PFD	/applications/{appld}	GET	Nnef_PFDmanagement_Fetch. Retrieve the PFD for an application.
PFD subscriptions	/subscriptions	POST	Nnef_PFDmanagement_Subscribe. Subscribe the notification of PFD changes.
Individual PFD subscription	/subscriptions/{subscriptionId}	PUT	Update a subscription to PFD change notifications.
Individual PFD subscription	/subscriptions/{subscriptionId}	DELETE	Nnef_PFDmanagement_Unsubscribe. Delete a subscription to PFD change notifications.

5.3.2 Resource: PFD of applications

5.3.2.1 Description

This resource represents PFDs for all applications.

5.3.2.2 Resource definition

Resource URI: **{apiRoot}/nnef-pfdmanagement/v1/applications**

This resource shall support the resource URI variables defined in table 5.3.2.2-1.

Table 5.3.2.2-1: Resource URI variables for this resource

Name	Data type	Definition
apiRoot	string	See subclause 5.1

5.3.2.3 Resource Standard Methods

5.3.2.3.1 GET

This method shall support the URI query parameters specified in table 5.3.2.3.1-1.

Table 5.3.2.3.1-1: URI query parameters supported by the GET method on this resource

Name	Data type	P	Cardinality	Description
application-ids	array(ApplicationId)	M	1..N	The requested application identifier(s) for which PFDs shall be returned.
supported-features	SupportedFeatures	O	0..1	To filter irrelevant responses related to unsupported features.

This method shall support the request data structures specified in table 5.3.2.3.1-2 and the response data structures and response codes specified in table 5.3.2.3.1-3.

Table 5.3.2.3.1-2: Data structures supported by the GET Request Body on this resource

Data type	P	Cardinality	Description
n/a			

Table 5.3.2.3.1-3: Data structures supported by the GET Response Body on this resource

Data type	P	Cardinality	Response codes	Description
array(PfdDataforApp)	M	0..N	200 OK	The PFDs for one or more application identifier(s) provided in the request URI are returned.
NOTE: In addition, the HTTP status codes which are specified as mandatory in table 5.2.7.1-1 of 3GPP TS 29.500 [5] for the GET method shall also apply.				

5.3.2.4 Resource Custom Operations

None.

5.3.3 Resource: Individual application PFD

5.3.3.1 Description

This resource represents the PFD identified by an application identifier.

5.3.3.2 Resource definition

Resource URI: {apiRoot}/nnef-pfdmanagement/v1/applications/{appId}

This resource shall support the resource URI variables defined in table 5.3.3.2-1.

Table 5.3.3.2-1: Resource URI variables for this resource

Name	Data type	Definition
apiRoot	string	See subclause 5.1.
appId	string	Identifies a set of PFD for an application identifier.

5.3.3.3 Resource Standard Methods

5.3.3.3.1 GET

This method shall support the URI query parameters specified in table 5.3.3.3.1-1.

Table 5.3.3.3.1-1: URI query parameters supported by the GET method on this resource

Name	Data type	P	Cardinality	Description
supported-features	SupportedFeatures	O	0..1	To filter irrelevant responses related to unsupported features.

This method shall support the request data structures specified in table 5.3.3.3.1-2 and the response data structures and response codes specified in table 5.3.3.3.1-3.

Table 5.3.3.3.1-2: Data structures supported by the GET Request Body on this resource

Data type	P	Cardinality	Description
n/a			

Table 5.3.3.3.1-3: Data structures supported by the GET Response Body on this resource

Data type	P	Cardinality	Response codes	Description
PfdDataForApp	M	1	200 OK	A representation of PFDs for an application in the request URI is returned.
NOTE: In addition, the HTTP status codes which are specified as mandatory in table 5.2.7.1-1 of 3GPP TS 29.500 [5] for the GET method shall also apply.				

5.3.3.4 Resource Custom Operations

None.

5.3.4 Resource: PFD subscriptions

5.3.4.1 Description

This resource represents a collection of subscriptions created by NF service consumers of Nnef_PFDmanagement service.

5.3.4.2 Resource definition

Resource URI: {apiRoot}/nnef-pfdmanagement/v1/subscriptions

This resource shall support the resource URI variables defined in table 5.3.4.2-1.

Table 5.3.4.2-1: Resource URI variables for this resource

Name	Data type	Definition
apiRoot	string	See subclause 5.1

5.3.4.3 Resource Standard Methods

5.3.4.3.1 POST

This method shall support the URI query parameters specified in table 5.3.4.3.1-1.

Table 5.3.4.3.1-1: URI query parameters supported by the POST method on this resource

Name	Data type	P	Cardinality	Description
n/a				

This method shall support the request data structures specified in table 5.3.4.3.1-2 and the response data structures and response codes specified in table 5.3.4.3.1-3.

Table 5.3.4.3.1-2: Data structures supported by the POST Request Body on this resource

Data type	P	Cardinality	Description
PfdSubscription	M	1	Create a PfdSubscription resource.

Table 5.3.4.3.1-3: Data structures supported by the POST Response Body on this resource

Data type	P	Cardinality	Response codes	Description
PfdSubscription	M	1	201 Created	The creation of a PfdSubscription resource is confirmed and a representation of that resource is returned.
NOTE: In addition, the HTTP status codes which are specified as mandatory in table 5.2.7.1-1 of 3GPP TS 29.500 [5] for the POST method shall also apply.				

Table 5.3.4.3.1-4: Headers supported by the 201 Response Code on this resource

Name	Data type	P	Cardinality	Description
Location	string	M	1	Contains the URI of the newly created resource, according to the structure: {apiRoot}/nnef-pfdmanagement/v1/subscriptions/{subscriptionId}

5.3.4.4 Resource Custom Operations

None.

5.3.5 Resource: Individual PFD subscription

5.3.5.1 Description

This resource represents an individual PFD subscription created by an NF service consumer of the Nnef_PFDmanagement service.

5.3.5.2 Resource definition

Resource URI: {apiRoot}/nnef-pfdmanagement/v1/subscriptions/{subscriptionId}

This resource shall support the resource URI variables defined in table 5.3.5.2-1.

Table 5.3.5.2-1: Resource URI variables for this resource

Name	Data type	Definition
apiRoot	string	See subclause 5.1
subscriptionId	string	Identifies an individual subscription to the PFD management service

5.3.5.3 Resource Standard Methods

5.3.5.3.1 DELETE

This method shall support the URI query parameters specified in table 5.3.5.3.1-1.

Table 5.3.5.3.1-1: URI query parameters supported by the DELETE method on this resource

Name	Data type	P	Cardinality	Description
n/a				

This method shall support the request data structures specified in table 5.3.5.3.1-2 and the response data structures and response codes specified in table 5.3.5.3.1-3.

Table 5.3.5.3.1-2: Data structures supported by the DELETE Request Body on this resource

Data type	P	Cardinality	Description
n/a			

Table 5.3.5.3.1-3: Data structures supported by the DELETE Response Body on this resource

Data type	P	Cardinality	Response codes	Description
n/a			204 No Content	The PfdSubscription resource matching the subscriptionId was deleted successfully.
NOTE: In addition, the HTTP status codes which are specified as mandatory in table 5.2.7.1-1 of 3GPP TS 29.500 [5] for the DELETE method shall also apply.				

5.3.5.3.2 PUT

This method shall support the URI query parameters specified in table 5.3.5.3.2-1.

Table 5.3.5.3.2-1: URI query parameters supported by the PUT method on this resource

Name	Data type	P	Cardinality	Description
n/a				

This method shall support the request data structures specified in table 5.3.5.3.2-2 and the response data structures and response codes specified in table 5.3.5.3.2-3.

Table 5.3.5.3.2-2: Data structures supported by the PUT Request Body on this resource

Data type	P	Cardinality	Description
PfdSubscription	M	1	Update a PfdSubscription resource.

Table 5.3.5.3.2-3: Data structures supported by the PUT Response Body on this resource

Data type	P	Cardinality	Response codes	Description
PfdSubscription	M	1	200 OK	The update of a PfdSubscription resource is confirmed and a representation of that resource is returned.
NOTE: In addition, the HTTP status codes which are specified as mandatory in table 5.2.7.1-1 of 3GPP TS 29.500 [5] for the PUT method shall also apply.				

5.3.5.4 Resource Custom Operations

None.

5.4 Custom Operations without associated resources

None

5.5 Notifications

5.5.1 General

Notifications shall comply to subclause 6.2 of 3GPP TS 29.500 [5] and subclause 4.6.2.3 of 3GPP TS 29.501 [6].

Table 5.5.1-1: Notifications overview

Notification	Callback URI	HTTP method or custom operation	Description (service operation)
PFD Change Notification	{notifyUri}	POST	Notification of PFD change.

5.5.2 PFD Change Notification

5.5.2.1 Description

The PFD Change Notification is used by the PFD to inform the NF service consumer, which has subscribed to this Notification via the PFD subscriptions resource.

5.5.2.2 Target URI

The Callback URI "{**notifyUri**}" shall be used with the callback URI variables defined in table 5.5.2.2-1.

Table 5.5.2.2-1: Callback URI variables

Name	Data type	Definition
notifyUri	Uri	The Notification Uri as assigned within the PFD subscriptions resource and described within the PfdSubscription data type (see table 5.6.2.3-1).

5.5.2.3 Standard Methods

5.5.2.3.1 POST

This method shall support the URI query parameters specified in table 5.5.2.3.1-1.

Table 5.5.2.3.1-1: URI query parameters supported by the POST method on this resource

Name	Data type	P	Cardinality	Description
n/a				

This method shall support the request data structures specified in table 5.5.2.3.1-2 and the response data structures and response codes specified in table 5.5.2.3.1-3.

Table 5.5.2.3.1-2: Data structures supported by the POST Request Body on this resource

Data type	P	Cardinality	Description
array(PfdChangeNotification)	M	1..N	Provides PFD change information.

Table 5.5.2.3.1-3: Data structures supported by the POST Response Body on this resource

Data type	P	Cardinality	Response codes	Description
n/a			204 No Content	The PFD operation in the notification is performed successfully, i.e. all PFD changes are accepted by the SMF.
array(PfdChangeReport)	M	1..N	200 OK	The PFD operation in the notification is performed and the PfdChangeReport indicates failure reason for each failed application in the partial success.
ProblemDetails	O	0..1	500 Internal Server Error	The server encountered an unexpected condition that prevented it from fulfilling the request. PFDs for all applications are not accepted by the SMF. (NOTE 2)
NOTE 1: In addition, the HTTP status codes which are specified as mandatory in table 5.2.7.1-1 of 3GPP TS 29.500 [5] for the POST method shall also apply.				
NOTE 2: Failure cases are described in subclause 5.7.				

5.6 Data Model

5.6.1 General

This subclause specifies the application data model supported by the API.

Table 5.6.1-1 specifies the data types defined for the Nnef_PFDmanagement service based interface protocol.

Table 5.6.1-1: Nnef_PFDmanagement specific Data Types

Data type	Section defined	Description	Applicability
PfdDataForApp	5.6.2.2	Represents the PFDs for an application identifier.	
PfdSubscription	5.6.2.3	Represents a PFD subscription.	
PfdChangeNotification	5.6.2.4	Represents PFD change information.	
PfdContent	5.6.2.5	Represents the content of a PFD for an application identifier.	
PfdChangeReport	5.6.2.6	Represents error of PFD change.	

Table 5.6.1-2 specifies data types re-used by the Nnef_PFDmanagement service based interface protocol from other specifications, including a reference to their respective specifications and when needed, a short description of their use within the Nnef_PFDmanagement service based interface.

Table 5.6.1-2: Nnef_PFDmanagement re-used Data Types

Data type	Reference	Comments	Applicability
ApplicationId	3GPP TS 29.571 [10]		
DomainNameProtocol	3GPP TS 29.122 [11]		
DateTime	3GPP TS 29.571 [10]		
SupportedFeatures	3GPP TS 29.571 [10]		
Uri	3GPP TS 29.571 [10]		

5.6.2 Structured data types

5.6.2.1 Introduction

This subclause defines the structures to be used in resource representations.

Allowed structures are: array, object.

5.6.2.2 Type: PfdDataForApp

Table 5.6.2.2-1: Definition of type PfdDataForApp

Attribute name	Data type	P	Cardinality	Description	Applicability
applicationId	ApplicationId	M	1	Identifier of an application.	
pfds	array(PfdContent)	M	1..N	PFDs for the application identifier.	
cachingTime	DateTime	O	0..1	Caching time for an application identifier.	

5.6.2.3 Type: PfdSubscription

Table 5.6.2.3-1: Definition of type PfdSubscription

Attribute name	Data type	P	Cardinality	Description	Applicability
applicationIds	array(ApplicationId)	O	1..N	Identifiers of applications with PFDs change.	
notifyUri	Uri	M	1	Identifies the recipient of notifications sent by PFDF for this subscription.	
supportedFeatures	SupportedFeatures	M	1	List of supported features used as described in subclause 5.8. This parameter shall be provided by the NF service consumer in the POST request that request the creation of a subscription, and shall be provided by the PFDF in the response of corresponding request.	

5.6.2.4 Type: PfdChangeNotification

Table 5.6.2.4-1: Definition of type PfdChangeNotification

Attribute name	Data type	P	Cardinality	Description	Applicability
applicationId	ApplicationId	M	1	Identifier of an application.	
removalFlag	boolean	C	0..1	Indication of removal of PFDs for an existing application identifier.	
partialFlag	boolean	C	0..1	Indication of partial update of PFDs for an existing application identifier if this operation is supported according to feature negotiation.	PartialUpdate
pfd	array(PfdContent)	C	1..N	PFD creation/update for the application identifier as specified in subclause 6.3.3.5 of 3GPP TS 29.251 [12].	

5.6.2.5 Type: PfdContent

Table 5.6.2.5-1: Definition of type PfdContent

Attribute name	Data type	P	Cardinality	Description	Applicability
pfdId	string	C	0..1	Identifies a PFD of an application identifier. If PartialUpdate feature is supported during PFD change event subscription, this attribute shall be provided by the PFD.	
flowDescriptions	array(string)	O	1..N	Represents a 3-tuple with protocol, server ip and server port for UL/DL application traffic. (NOTE)	
urls	array(string)	O	1..N	Indicates a URL or a regular expression which is used to match the significant parts of the URL. (NOTE)	
domainNames	array(string)	O	1..N	Indicates an FQDN or a regular expression as a domain name matching criteria. (NOTE)	
dnProtocol	DomainNameProtocol	C	0..1	Indicates the additional protocol and protocol field for domain names to be matched, it may only be provided when domainNames attribute is present.	DomainNameProtocol
NOTE: If a PFD contains multiple filter types, the PFD is only matched when every filter type contained in the PFD has a matching value.					

5.6.2.6 Type: PfdChangeReport

Table 5.6.2.6-1: PfdChangeReport

Attribute name	Data type	P	Cardinality	Description	Applicability
pfdError	ProblemDetails	M	1	More information on the error shall be provided in the "cause" attribute of the "ProblemDetails" structure. The "cause" attribute in the ProblemDetails shall be set to one of following application errors (see table 5.2.7.1-1 of 3GPP TS 29.500 [5]): - SYSTEM_FAILURE - INSUFFICIENT_RESOURCES - UNSPECIFIED_NF_FAILURE	
applicationId	array(ApplicationId)	M	1..N	Indicates the application identifier(s) which PFD(s) are failed to be added or modified.	

5.6.3 Simple data types and enumerations

5.6.3.1 Introduction

This subclause defines simple data types and enumerations that can be referenced from data structures defined in the previous subclauses.

5.6.3.2 Simple data types

The simple data types defined in table 5.6.3.2-1 shall be supported.

Table 5.6.3.2-1: Simple data types

Type Name	Type Definition	Description	Applicability

5.7 Error handling

5.7.1 General

HTTP error handling shall be supported as specified in subclause 5.2.4 of 3GPP TS 29.500 [5].

For the Nnef_PFDmanagement API, HTTP error responses shall be supported as specified in subclause 4.8 of 3GPP TS 29.501 [6]. Protocol errors and application errors specified in table 5.2.7.2-1 of 3GPP TS 29.500 [5] shall be supported for an HTTP method if the corresponding HTTP status codes are specified as mandatory for that HTTP method in table 5.2.7.1-1 of 3GPP TS 29.500 [5].

In addition, the requirements in the following subclauses shall apply.

5.7.2 Protocol Errors

In this Release of the specification, there are no additional protocol errors applicable for the Nnef_PFDmanagement API.

5.7.3 Application Errors

The application errors defined for the Nnef_PFDmanagement service are listed in table 5.7.3-1.

Table 5.7.3-1: Application errors

Application Error	HTTP status code	Description
SYSTEM_FAILURE	500 Internal Server Error	Something functions wrongly in PFD provisioning or the PFD provisioning does not function at all. (NOTE)
INSUFFICIENT_RESOURCE	500 Internal Server Error	There is limitation for resource storage. (NOTE)
UNSPECIFIED_NF_FAILURE	500 Internal Server Error	Unspecified reason. (NOTE)
NOTE: This application error is included in the responses to the POST request of PFD change notification.		

5.8 Feature negotiation

The optional features in table 5.8-1 are defined for the Nnef_PFDmanagement API. They shall be negotiated using the extensibility mechanism defined in subclause 6.6 of 3GPP TS 29.500 [5].

Table 5.8-1: Supported Features

Feature number	Feature Name	Description
1	PartialUpdate	The PFD can use this feature for partial update of PFDs.
2	DomainNameProtocol	This feature supports the additional protocol matching condition for the domain name in PFD data.
3	PfdChgSubsUpdate	The SMF can use this feature for updating the PFD change subscription.

5.9 Security

As indicated in 3GPP TS 33.501 [14] and 3GPP TS 29.500 [5], the access to the Nnef_PFDmanagement API may be authorized by means of the OAuth2 protocol (see IETF RFC 6749 [15]), based on local configuration, using the "Client Credentials" authorization grant, where the NRF (see 3GPP TS 29.510 [13]) plays the role of the authorization server.

If OAuth2 is used, an NF Service Consumer, prior to consuming services offered by the Nnef_PFDmanagement API, shall obtain a "token" from the authorization server, by invoking the Access Token Request service, as described in 3GPP TS 29.510 [13], subclause 5.4.2.2.

NOTE: When multiple NRFs are deployed in a network, the NRF used as authorization server is the same NRF that the NF Service Consumer used for discovering the Nnef_PFDmanagement service.

The Nnef_PFDmanagement API defines a single scope "nnef-pfdmanagement" for OAuth2 authorization (as specified in 3GPP TS 33.501 [14]) for the entire service, and it does not define any additional scopes at resource or operation level.

Annex A (normative): OpenAPI specification

A.1 General

The present Annex contains an OpenAPI [9] specification of HTTP messages and content bodies used by the Nnef_PFDmanagement API.

This Annex shall take precedence when being discrepant to other parts of the specification with respect to the encoding of information elements and methods within the API.

NOTE: The semantics and procedures, as well as conditions, e.g. for the applicability and allowed combinations of attributes or values, not expressed in the OpenAPI definitions but defined in other parts of the specification also apply.

Informative copies of the OpenAPI specification file contained in this 3GPP Technical Specification are available on a Git-based repository that uses the GitLab software version control system (see clause 5B of the 3GPP TR 21.900 [17] and subclause 5.3.1 of the 3GPP TS 29.501 [6] for further information):

A.2 Nnef_PFDmanagement API

```

openapi: 3.0.0
info:
  title: Nnef_PFDmanagement Service API
  version: 1.1.0
  description: |
    Packet Flow Description Management Service.
    © 2020, 3GPP Organizational Partners (ARIB, ATIS, CCSA, ETSI, TSDSI, TTA, TTC).
    All rights reserved.
#
externalDocs:
  description: 3GPP TS 29.551 v16.4.0, 5G System; Packet Flow Description Management Service
  url: 'http://www.3gpp.org/ftp/Specs/archive/29_series/29.551/'
#
servers:
  - url: '{apiRoot}/nnef-pfdmanagement/v1'
    variables:
      apiRoot:
        default: https://example.com
        description: apiRoot as defined in subclause 4.4 of 3GPP TS 29.501
security:
  - {}
  - oAuth2ClientCredentials:
    - nnef-pfdmanagement
paths:
  /applications:
    get:
      summary: Retrieve PFDs for all applications or for one or multiple applications with query
parameter.
      tags:
        - PFD of applications
      operationId: Nnef_PFDmanagement_AllFetch
      parameters:
        - name: application-ids
          description: The required application identifier(s) for the returned PFDs.
          in: query
          required: true
          schema:
            type: array
            items:
              $ref: 'TS29571_CommonData.yaml#/components/schemas/ApplicationId'
            minItems: 1
        - name: supported-features
          in: query
          description: To filter irrelevant responses related to unsupported features
          schema:
            $ref: 'TS29571_CommonData.yaml#/components/schemas/SupportedFeatures'

```

```

responses:
  '200':
    description: The PFDs for one or more application identifier(s) in the request URI are
returned.
    content:
      application/json:
        schema:
          type: array
          items:
            $ref: '#/components/schemas/PfdDataForApp'
          minItems: 0
  '400':
    $ref: 'TS29571_CommonData.yaml#/components/responses/400'
  '401':
    $ref: 'TS29571_CommonData.yaml#/components/responses/401'
  '403':
    $ref: 'TS29571_CommonData.yaml#/components/responses/403'
  '404':
    $ref: 'TS29571_CommonData.yaml#/components/responses/404'
  '406':
    $ref: 'TS29571_CommonData.yaml#/components/responses/406'
  '414':
    $ref: 'TS29571_CommonData.yaml#/components/responses/414'
  '429':
    $ref: 'TS29571_CommonData.yaml#/components/responses/429'
  '500':
    $ref: 'TS29571_CommonData.yaml#/components/responses/500'
  '503':
    $ref: 'TS29571_CommonData.yaml#/components/responses/503'

/applications/{appId}:
  get:
    summary: Retrieve the PFD for an application.
    tags:
      - Individual application PFD
    operationId: Nnef_PFDmanagement_IndAppFetch
    parameters:
      - name: appId
        description: The required application identifier(s) for the returned PFDs.
        in: path
        required: true
        schema:
          type: string
      - name: supported-features
        in: query
        description: To filter irrelevant responses related to unsupported features
        schema:
          $ref: 'TS29571_CommonData.yaml#/components/schemas/SupportedFeatures'
    responses:
      '200':
        description: A representation of PFDs for an application in the request URI is returned.
        content:
          application/json:
            schema:
              $ref: '#/components/schemas/PfdDataForApp'
      '400':
        $ref: 'TS29571_CommonData.yaml#/components/responses/400'
      '401':
        $ref: 'TS29571_CommonData.yaml#/components/responses/401'
      '403':
        $ref: 'TS29571_CommonData.yaml#/components/responses/403'
      '404':
        $ref: 'TS29571_CommonData.yaml#/components/responses/404'
      '406':
        $ref: 'TS29571_CommonData.yaml#/components/responses/406'
      '429':
        $ref: 'TS29571_CommonData.yaml#/components/responses/429'
      '414':
        $ref: 'TS29571_CommonData.yaml#/components/responses/414'
      '500':
        $ref: 'TS29571_CommonData.yaml#/components/responses/500'
      '503':
        $ref: 'TS29571_CommonData.yaml#/components/responses/503'

/subscriptions:
  post:
    summary: Subscribe the notification of PFD changes.
    tags:

```

```

- PFD subscriptions
operationId: Nnef_PFDmanagement_CreateSubscr
requestBody:
  description: a PfdSubscription resource to be created.
  required: true
  content:
    application/json:
      schema:
        $ref: '#/components/schemas/PfdSubscription'
callbacks:
  PfdChangeNotification:
    '{request.body#/notifyUri}':
      post:
        summary: Notification of PFD change.
        tags:
          - PfdChangeNotification data
        operationId: Nnef_PFDmanagement_Notify
        requestBody:
          required: true
          content:
            application/json:
              schema:
                type: array
                items:
                  $ref: '#/components/schemas/PfdChangeNotification'
                minItems: 1
        responses:
          '200':
            description: The PFD operation in the notification is performed and the
PfdChangeReport indicates failure reason.
            content:
              application/json:
                schema:
                  type: array
                  items:
                    $ref: '#/components/schemas/PfdChangeReport'
                  minItems: 1
          '204':
            description: The PFD operation in the notification is performed successfully.
          '400':
            $ref: 'TS29571_CommonData.yaml#/components/responses/400'
          '401':
            $ref: 'TS29571_CommonData.yaml#/components/responses/401'
          '403':
            $ref: 'TS29571_CommonData.yaml#/components/responses/403'
          '404':
            $ref: 'TS29571_CommonData.yaml#/components/responses/404'
          '411':
            $ref: 'TS29571_CommonData.yaml#/components/responses/411'
          '413':
            $ref: 'TS29571_CommonData.yaml#/components/responses/413'
          '415':
            $ref: 'TS29571_CommonData.yaml#/components/responses/415'
          '429':
            $ref: 'TS29571_CommonData.yaml#/components/responses/429'
          '500':
            $ref: 'TS29571_CommonData.yaml#/components/responses/500'
          '503':
            $ref: 'TS29571_CommonData.yaml#/components/responses/503'

responses:
  '201':
    description: The creation of a PfdSubscription resource is confirmed and a representation
of that resource is returned.
    content:
      application/json:
        schema:
          $ref: '#/components/schemas/PfdSubscription'
    headers:
      Location:
        description: 'Contains the URI of the newly created resource, according to the
structure: {apiRoot}/nnef-pfdmanagement/v1/subscriptions/{subscriptionId}'
        required: true
        schema:
          type: string
  '400':
    $ref: 'TS29571_CommonData.yaml#/components/responses/400'

```

```

'401':
  $ref: 'TS29571_CommonData.yaml#/components/responses/401'
'403':
  $ref: 'TS29571_CommonData.yaml#/components/responses/403'
'404':
  $ref: 'TS29571_CommonData.yaml#/components/responses/404'
'411':
  $ref: 'TS29571_CommonData.yaml#/components/responses/411'
'413':
  $ref: 'TS29571_CommonData.yaml#/components/responses/413'
'415':
  $ref: 'TS29571_CommonData.yaml#/components/responses/415'
'429':
  $ref: 'TS29571_CommonData.yaml#/components/responses/429'
'500':
  $ref: 'TS29571_CommonData.yaml#/components/responses/500'
'503':
  $ref: 'TS29571_CommonData.yaml#/components/responses/503'

/subscriptions/{subscriptionId}:
  put:
    summary: Updates/replaces an existing subscription resource
    tags:
      - Individual PFD subscription
    operationId: Nnef_PFDmanagement_ModifySubscr
    parameters:
      - name: subscriptionId
        description: Identify the subscription.
        in: path
        required: true
        schema:
          type: string
    requestBody:
      description: Parameters to update/replace the existing subscription
      required: true
      content:
        application/json:
          schema:
            $ref: '#/components/schemas/PfdSubscription'
    responses:
      '200':
        description: OK (Successful update of the subscription)
        content:
          application/json:
            schema:
              $ref: '#/components/schemas/PfdSubscription'
      '400':
        $ref: 'TS29571_CommonData.yaml#/components/responses/400'
      '401':
        $ref: 'TS29571_CommonData.yaml#/components/responses/401'
      '403':
        $ref: 'TS29571_CommonData.yaml#/components/responses/403'
      '404':
        $ref: 'TS29571_CommonData.yaml#/components/responses/404'
      '411':
        $ref: 'TS29571_CommonData.yaml#/components/responses/411'
      '413':
        $ref: 'TS29571_CommonData.yaml#/components/responses/413'
      '415':
        $ref: 'TS29571_CommonData.yaml#/components/responses/415'
      '429':
        $ref: 'TS29571_CommonData.yaml#/components/responses/429'
      '500':
        $ref: 'TS29571_CommonData.yaml#/components/responses/500'
      '503':
        $ref: 'TS29571_CommonData.yaml#/components/responses/503'
      default:
        $ref: 'TS29571_CommonData.yaml#/components/responses/default'

  delete:
    summary: Delete a subscription of PFD change notification.
    tags:
      - Individual PFD subscription
    operationId: Nnef_PFDmanagement_Unsubscribe
    parameters:
      - name: subscriptionId
        description: Identify the subscription.
        in: path

```

```

        required: true
        schema:
          type: string
      responses:
        '204':
          description: The PfdSubscription resource matching the subscriptionId was deleted
successfully.
        '400':
          $ref: 'TS29571_CommonData.yaml#/components/responses/400'
        '401':
          $ref: 'TS29571_CommonData.yaml#/components/responses/401'
        '403':
          $ref: 'TS29571_CommonData.yaml#/components/responses/403'
        '404':
          $ref: 'TS29571_CommonData.yaml#/components/responses/404'
        '429':
          $ref: 'TS29571_CommonData.yaml#/components/responses/429'
        '500':
          $ref: 'TS29571_CommonData.yaml#/components/responses/500'
        '503':
          $ref: 'TS29571_CommonData.yaml#/components/responses/503'

components:
  securitySchemes:
    oAuth2ClientCredentials:
      type: oauth2
      flows:
        clientCredentials:
          tokenUrl: '{nrfApiRoot}/oauth2/token'
          scopes:
            nnef-pfdmanagement: Access to the Nnef_PFDmanagement API
  schemas:
#
# STRUCTURED DATA TYPES
#
  PfdContent:
    type: object
    properties:
      pfdId:
        type: string
        description: Identifies a PDF of an application identifier.
      flowDescriptions:
        type: array
        items:
          type: string
        minItems: 1
        description: Represents a 3-tuple with protocol, server ip and server port for UL/DL
application traffic.
      urls:
        type: array
        items:
          type: string
        minItems: 1
        description: Indicates a URL or a regular expression which is used to match the
significant parts of the URL.
      domainNames:
        type: array
        items:
          type: string
        minItems: 1
        description: Indicates an FQDN or a regular expression as a domain name matching criteria.
      dnProtocol:
        $ref: 'TS29122_PfdManagement.yaml#/components/schemas/DomainNameProtocol'

  PfdDataForApp:
    type: object
    properties:
      applicationId:
        $ref: 'TS29571_CommonData.yaml#/components/schemas/ApplicationId'
      pfd:
        type: array
        items:
          $ref: '#/components/schemas/PfdContent'
        minItems: 1
      cachingTime:
        $ref: 'TS29571_CommonData.yaml#/components/schemas/DateTime'
    required:

```

```
- applicationId
- pfd

PfdSubscription:
  type: object
  properties:
    applicationIds:
      type: array
      items:
        $ref: 'TS29571_CommonData.yaml#/components/schemas/ApplicationId'
      minItems: 1
    notifyUri:
      $ref: 'TS29571_CommonData.yaml#/components/schemas/Uri'
    supportedFeatures:
      $ref: 'TS29571_CommonData.yaml#/components/schemas/SupportedFeatures'
  required:
    - notifyUri
    - supportedFeatures

PfdChangeNotification:
  type: object
  properties:
    applicationId:
      $ref: 'TS29571_CommonData.yaml#/components/schemas/ApplicationId'
    removalFlag:
      type: boolean
      default: false
    partialFlag:
      type: boolean
      default: false
    pfd:
      type: array
      items:
        $ref: '#/components/schemas/PfdContent'
      minItems: 1
  required:
    - applicationId

PfdChangeReport:
  type: object
  properties:
    pfdError:
      $ref: 'TS29571_CommonData.yaml#/components/schemas/ProblemDetails'
    applicationId:
      type: array
      items:
        $ref: 'TS29571_CommonData.yaml#/components/schemas/ApplicationId'
      minItems: 1
  required:
    - pfdError
    - applicationId
```

Annex B (informative): Change history

Change history							
Date	Meeting	TDoc	CR	Rev	Cat	Subject/Comment	New version
2018-01						TS skeleton of PFD Management Service specification	0.0.0
2018-01	CT3#94					Includes the following contribution agreed by CT3 at CT3#94: C3-180045, C3-180270, C3-180271.	0.1.0
2018-03	CT3#95					Includes the following contribution agreed by CT3 at CT3#95: C3-181100, C3-181262, C3-181102, C3-181103, C3-181314.	0.2.0
2018-04	CT3#96					Includes the following contribution agreed by CT3 at CT3#96: C3-182153, C3-182411, C3-182412, C3-182413, C3-182414, C3-182477, C3-182478.	0.3.0
2018-05	CT3#97					Includes the following contribution agreed by CT3 at CT3#97: C3-183115, C3-183557, C3-183558, C3-183560.	0.4.0
2018-06	CT#80	CP-181029				TS sent to plenary for approval	1.0.0
2018-06	CT#80	CP-181029				TS approved by plenary	15.0.0
2018-09	CT#81	CP-182015	0001	2	F	Protocol error statement	15.1.0
2018-09	CT#81	CP-182015	0002	1	F	Description of Structured data types	15.1.0
2018-12	CT#82	CP-183205	0003		F	Default value for apiRoot	15.2.0
2018-12	CT#82	CP-183205	0004	3	F	Cardinality	15.2.0
2018-12	CT#82	CP-183205	0005	1	F	Correct Nnef_PFDmanagement API	15.2.0
2018-12	CT#82	CP-183205	0006		F	Location Header	15.2.0
2018-12	CT#82	CP-183205	0007	1	F	Alignment of openAPI	15.2.0
2018-12	CT#82	CP-183205	0008		F	API version update	15.2.0
2018-12	CT#82	CP-183205	0009		F	Security	15.2.0
2018-12	CT#82	CP-183205	0010		F	Content type	15.2.0
2019-03	CT#83	CP-190116	0011	1	F	Fetch PFD for all applications	15.3.0
2019-03	CT#83	CP-190116	0014	1	F	Correction of resource URIs	15.3.0
2019-03	CT#83	CP-190130	0010	1	B	PUT for PFD change subscription	16.0.0
2019-03	CT#83	CP-190121	0012	3	B	PFD extension	16.0.0
2019-03	CT#83					Open API version update by MCC	16.0.0
2019-06	CT#84	CP-191083	0016	2	A	Precedence of OpenAPI file	16.1.0
2019-06	CT#84	CP-191083	0019		A	Correction to Notification of PFD change	16.1.0
2019-06	CT#84	CP-191083	0021		A	Copyright Note in YAML file	16.1.0
2019-06	CT#84	CP-191101	0023	2	F	API version Update	16.1.0
2019-09	CT#85	CP-192149	0025	2	A	Correct presence condition in PFD definition	16.2.0
2020-03	CT#87e	CP-200215	0026		F	Reference of Error code	16.3.0
2020-03	CT#87e	CP-200216	0027		F	Update of OpenAPI version and TS version in externalDocs field	16.3.0
2020-06	CT#88e	CP-201244	0028		F	Non-unique operation identifiers	16.4.0
2020-06	CT#88e	CP-201244	0029	1	F	Storage of YAML files in ETSI Forge	16.4.0
2020-06	CT#88e	CP-201256	0030	1	F	URI of the Nnef_PFDmanagement service	16.4.0
2020-06	CT#88e	CP-201244	0031	1	F	Optionality of ProblemDetails	16.4.0
2020-06	CT#88e	CP-201244	0032	1	F	Supported headers, Resource Data type and yaml mapping	16.4.0
2020-06	CT#88e	CP-201255	0033		F	Update of OpenAPI version and TS version in externalDocs field	16.4.0
2020-09	CT#89e	CP-202056	0035		A	Correction to the PFD change notification	16.5.0
2020-12	CT#90e	CP-203077	0040	2	F	Essential corrections and alignments	16.6.0
2020-12	CT#90e	CP-203120	0045	1	A	Correction to PFD retrieval in PULL mode	16.6.0
2020-12	CT#90e	CP-203120	0048		A	Correction to notification URI of PFD change notification	16.6.0
2020-12	CT#90e	CP-203139	0052	1	F	Storage of YAML files in 3GPP Forge	16.6.0

History

Document history		
V16.4.0	August 2020	Publication
V16.5.0	November 2020	Publication
V16.6.0	January 2021	Publication