

# ETSI TS 129 551 V17.9.0 (2024-01)



**5G;  
5G System;  
Packet Flow Description Management Service;  
Stage 3  
(3GPP TS 29.551 version 17.9.0 Release 17)**



---

**Reference**

RTS/TSGC-0329551vh90

---

**Keywords**

5G

**ETSI**

---

650 Route des Lucioles  
F-06921 Sophia Antipolis Cedex - FRANCE

Tel.: +33 4 92 94 42 00 Fax: +33 4 93 65 47 16

Siret N° 348 623 562 00017 - APE 7112B  
Association à but non lucratif enregistrée à la  
Sous-Préfecture de Grasse (06) N° w061004871

---

**Important notice**

The present document can be downloaded from:

<https://www.etsi.org/standards-search>

The present document may be made available in electronic versions and/or in print. The content of any electronic and/or print versions of the present document shall not be modified without the prior written authorization of ETSI. In case of any existing or perceived difference in contents between such versions and/or in print, the prevailing version of an ETSI deliverable is the one made publicly available in PDF format at [www.etsi.org/deliver](http://www.etsi.org/deliver).

Users of the present document should be aware that the document may be subject to revision or change of status.

Information on the current status of this and other ETSI documents is available at

<https://portal.etsi.org/TB/ETSIDeliverableStatus.aspx>

If you find errors in the present document, please send your comment to one of the following services:

<https://portal.etsi.org/People/CommitteeSupportStaff.aspx>

If you find a security vulnerability in the present document, please report it through our  
Coordinated Vulnerability Disclosure Program:

<https://www.etsi.org/standards/coordinated-vulnerability-disclosure>

---

**Notice of disclaimer & limitation of liability**

The information provided in the present deliverable is directed solely to professionals who have the appropriate degree of experience to understand and interpret its content in accordance with generally accepted engineering or other professional standard and applicable regulations.

No recommendation as to products and services or vendors is made or should be implied.

No representation or warranty is made that this deliverable is technically accurate or sufficient or conforms to any law and/or governmental rule and/or regulation and further, no representation or warranty is made of merchantability or fitness for any particular purpose or against infringement of intellectual property rights.

In no event shall ETSI be held liable for loss of profits or any other incidental or consequential damages.

Any software contained in this deliverable is provided "AS IS" with no warranties, express or implied, including but not limited to, the warranties of merchantability, fitness for a particular purpose and non-infringement of intellectual property rights and ETSI shall not be held liable in any event for any damages whatsoever (including, without limitation, damages for loss of profits, business interruption, loss of information, or any other pecuniary loss) arising out of or related to the use of or inability to use the software.

---

**Copyright Notification**

No part may be reproduced or utilized in any form or by any means, electronic or mechanical, including photocopying and microfilm except as authorized by written permission of ETSI.

The content of the PDF version shall not be modified without the written authorization of ETSI.

The copyright and the foregoing restriction extend to reproduction in all media.

© ETSI 2024.  
All rights reserved.

---

# Intellectual Property Rights

## Essential patents

IPRs essential or potentially essential to normative deliverables may have been declared to ETSI. The declarations pertaining to these essential IPRs, if any, are publicly available for **ETSI members and non-members**, and can be found in ETSI SR 000 314: "*Intellectual Property Rights (IPRs); Essential, or potentially Essential, IPRs notified to ETSI in respect of ETSI standards*", which is available from the ETSI Secretariat. Latest updates are available on the ETSI Web server (<https://ipr.etsi.org/>).

Pursuant to the ETSI Directives including the ETSI IPR Policy, no investigation regarding the essentiality of IPRs, including IPR searches, has been carried out by ETSI. No guarantee can be given as to the existence of other IPRs not referenced in ETSI SR 000 314 (or the updates on the ETSI Web server) which are, or may be, or may become, essential to the present document.

## Trademarks

The present document may include trademarks and/or tradenames which are asserted and/or registered by their owners. ETSI claims no ownership of these except for any which are indicated as being the property of ETSI, and conveys no right to use or reproduce any trademark and/or tradename. Mention of those trademarks in the present document does not constitute an endorsement by ETSI of products, services or organizations associated with those trademarks.

**DECT™**, **PLUGTESTS™**, **UMTS™** and the ETSI logo are trademarks of ETSI registered for the benefit of its Members. **3GPP™** and **LTE™** are trademarks of ETSI registered for the benefit of its Members and of the 3GPP Organizational Partners. **oneM2M™** logo is a trademark of ETSI registered for the benefit of its Members and of the oneM2M Partners. **GSM®** and the GSM logo are trademarks registered and owned by the GSM Association.

---

# Legal Notice

This Technical Specification (TS) has been produced by ETSI 3rd Generation Partnership Project (3GPP).

The present document may refer to technical specifications or reports using their 3GPP identities. These shall be interpreted as being references to the corresponding ETSI deliverables.

The cross reference between 3GPP and ETSI identities can be found under <https://webapp.etsi.org/key/queryform.asp>.

---

# Modal verbs terminology

In the present document "**shall**", "**shall not**", "**should**", "**should not**", "**may**", "**need not**", "**will**", "**will not**", "**can**" and "**cannot**" are to be interpreted as described in clause 3.2 of the [ETSI Drafting Rules](#) (Verbal forms for the expression of provisions).

"**must**" and "**must not**" are **NOT** allowed in ETSI deliverables except when used in direct citation.

# Contents

Intellectual Property Rights .....	2
Legal Notice .....	2
Modal verbs terminology.....	2
Foreword.....	6
1 Scope .....	7
2 References .....	7
3 Definitions, symbols and abbreviations .....	8
3.1 Definitions .....	8
3.2 Abbreviations .....	8
4 Packet Flow Description Management Service.....	8
4.1 Service Description .....	8
4.1.1 Overview .....	8
4.1.2 Service Architecture .....	8
4.1.3 Network Functions.....	9
4.1.3.1 Packet Flow Description Function (PFDF) .....	9
4.1.3.2 NF Service Consumers.....	9
4.2 Service Operations .....	9
4.2.1 Introduction.....	9
4.2.2 Nnef_PFDmanagement_Fetch Service Operation .....	10
4.2.2.1 General .....	10
4.2.2.2 Retrieval of PFDs by the full pull .....	10
4.2.2.3 Retrieval of PFDs by the partial pull.....	11
4.2.3 Nnef_PFDmanagement_Subscribe Service Operation .....	13
4.2.3.1 General .....	13
4.2.3.2 Subscription for event notifications on PFDs change .....	13
4.2.3.3 Subscription update for event notifications on PFDs change.....	14
4.2.4 Nnef_PFDmanagement_Notify Service Operation.....	14
4.2.4.1 General.....	14
4.2.4.2 Notification of PFD change.....	15
4.2.4.3 Notification PUSH .....	15
4.2.5 Nnef_PFDmanagement_Unsubscribe Service Operation .....	16
4.2.5.1 General .....	16
4.2.5.2 Unsubscribe from event notifications on PFDs change.....	16
5 Nnef_PFDmanagement API.....	17
5.1 Introduction .....	17
5.2 Usage of HTTP.....	17
5.2.1 General.....	17
5.2.2 HTTP standard headers.....	17
5.2.2.1 General .....	17
5.2.2.2 Content type .....	17
5.2.3 HTTP custom headers.....	18
5.2.3.1 General .....	18
5.3 Resources .....	18
5.3.1 Resource Structure.....	18
5.3.2 Resource: PFD of applications.....	19
5.3.2.1 Description .....	19
5.3.2.2 Resource definition .....	19
5.3.2.3 Resource Standard Methods.....	19
5.3.2.3.1 GET .....	19
5.3.2.4 Resource Custom Operations .....	20
5.3.2.4.1 Overview .....	20
5.3.2.4.2 Operation: partialpull.....	20
5.3.2.4.2.1 Description.....	20

5.3.2.4.2.2	Operation Definition .....	20
5.3.3	Resource: Individual application PFD .....	20
5.3.3.1	Description .....	20
5.3.3.2	Resource definition .....	21
5.3.3.3	Resource Standard Methods .....	21
5.3.3.3.1	GET .....	21
5.3.3.4	Resource Custom Operations .....	22
5.3.4	Resource: PFD subscriptions .....	22
5.3.4.1	Description .....	22
5.3.4.2	Resource definition .....	22
5.3.4.3	Resource Standard Methods .....	22
5.3.4.3.1	POST .....	22
5.3.4.4	Resource Custom Operations .....	23
5.3.5	Resource: Individual PFD subscription .....	23
5.3.5.1	Description .....	23
5.3.5.2	Resource definition .....	23
5.3.5.3	Resource Standard Methods .....	23
5.3.5.3.1	DELETE .....	23
5.3.5.3.2	PUT .....	24
5.3.5.4	Resource Custom Operations .....	25
5.4	Custom Operations without associated resources .....	25
5.5	Notifications .....	25
5.5.1	General .....	25
5.5.2	PFD Change Notification .....	26
5.5.2.1	Description .....	26
5.5.2.2	Target URI .....	26
5.5.2.3	Standard Methods .....	26
5.5.2.3.1	POST .....	26
5.5.3	Notification Push .....	27
5.5.3.1	Description .....	27
5.5.3.2	Target URI .....	27
5.5.3.3	Standard Methods .....	28
5.5.3.3.1	POST .....	28
5.6	Data Model .....	29
5.6.1	General .....	29
5.6.2	Structured data types .....	29
5.6.2.1	Introduction .....	29
5.6.2.2	Type: PfdDataForApp .....	30
5.6.2.3	Type: PfdSubscription .....	30
5.6.2.4	Type: PfdChangeNotification .....	31
5.6.2.5	Type: PfdContent .....	31
5.6.2.6	Type: PfdChangeReport .....	32
5.6.2.7	Type: NotificationPush .....	32
5.6.2.8	Type: ApplicationForPfdRequest .....	32
5.6.3	Simple data types and enumerations .....	32
5.6.3.1	Introduction .....	32
5.6.3.2	Simple data types .....	32
5.6.3.3	Enumeration: PfdOperation .....	33
5.7	Error handling .....	33
5.7.1	General .....	33
5.7.2	Protocol Errors .....	33
5.7.3	Application Errors .....	33
5.8	Feature negotiation .....	34
5.9	Security .....	34
<b>Annex A (normative):</b>	<b>OpenAPI specification .....</b>	<b>35</b>
A.1	General .....	35
A.2	Nnef_PFDmanagement API .....	35
<b>Annex B (informative):</b>	<b>Change history .....</b>	<b>44</b>

History .....47

---

# Foreword

This Technical Specification has been produced by the 3rd Generation Partnership Project (3GPP).

The contents of the present document are subject to continuing work within the TSG and may change following formal TSG approval. Should the TSG modify the contents of the present document, it will be re-released by the TSG with an identifying change of release date and an increase in version number as follows:

Version x.y.z

where:

- x the first digit:
  - 1 presented to TSG for information;
  - 2 presented to TSG for approval;
  - 3 or greater indicates TSG approved document under change control.
- y the second digit is incremented for all changes of substance, i.e. technical enhancements, corrections, updates, etc.
- z the third digit is incremented when editorial only changes have been incorporated in the document.

---

# 1 Scope

The present document provides the stage 3 specification of the PFD Management Service of the 5G system.

The stage 2 definition and related procedures of the PFD Management Service are contained in 3GPP TS 23.502 [3] and 3GPP TS 23.503 [4]. The 5G System Architecture is defined in 3GPP TS 23.501 [2].

The Technical Realization of the Service Based Architecture and the Principles and Guidelines for Services Definition of the 5G System are specified in 3GPP TS 29.500 [5] and 3GPP TS 29.501 [6].

The Packet Flow Description Function (PFDF) provides the PFD Management Service to NF service consumers (e.g. Session Management Function). The PFDF is functionality within the NEF.

---

# 2 References

The following documents contain provisions which, through reference in this text, constitute provisions of the present document.

- References are either specific (identified by date of publication, edition number, version number, etc.) or non-specific.
- For a specific reference, subsequent revisions do not apply.
- For a non-specific reference, the latest version applies. In the case of a reference to a 3GPP document (including a GSM document), a non-specific reference implicitly refers to the latest version of that document *in the same Release as the present document*.

- [1] 3GPP TR 21.905: "Vocabulary for 3GPP Specifications".
- [2] 3GPP TS 23.501: "System Architecture for the 5G System; Stage 2".
- [3] 3GPP TS 23.502: "Procedures for the 5G System; Stage 2".
- [4] 3GPP TS 23.503: "Policy and Charging Control Framework for the 5G System; Stage 2".
- [5] 3GPP TS 29.500: "5G System; Technical Realization of Service Based Architecture; Stage 3".
- [6] 3GPP TS 29.501: "5G System; Principles and Guidelines for Services Definition; Stage 3".
- [7] IETF RFC 7540: "Hypertext Transfer Protocol Version 2 (HTTP/2)".
- [8] IETF RFC 8259: "The JavaScript Object Notation (JSON) Data Interchange Format".
- [9] OpenAPI: "OpenAPI Specification Version 3.0.0", <https://spec.openapis.org/oas/v3.0.0>.
- [10] 3GPP TS 29.571: "5G System; Common Data Types for Service Based Interfaces Stage 3".
- [11] 3GPP TS 29.122: "T8 reference point for Northbound APIs".
- [12] 3GPP TS 29.251: "Gw and Gwn reference points for sponsored data connectivity".
- [13] 3GPP TS 29.510: "5G System; Network Function Repository Services; Stage 3".
- [14] 3GPP TS 33.501: "Security architecture and procedures for 5G system".
- [15] IETF RFC 6749: "The OAuth 2.0 Authorization Framework".
- [16] IETF RFC 7807: "Problem Details for HTTP APIs".
- [17] 3GPP TR 21.900: "Technical Specification Group working methods".
- [18] IETF RFC 6733: "Diameter Base Protocol".



---

## 3 Definitions, symbols and abbreviations

### 3.1 Definitions

For the purposes of the present document, the terms and definitions given in 3GPP TR 21.905 [1] and the following apply. A term defined in the present document takes precedence over the definition of the same term, if any, in 3GPP TR 21.905 [1].

### 3.2 Abbreviations

For the purposes of the present document, the abbreviations given in 3GPP TR 21.905 [1] and the following apply. An abbreviation defined in the present document takes precedence over the definition of the same abbreviation, if any, in 3GPP TR 21.905 [1].

JSON	JavaScript Object Notation
NEF	Network Exposure Function
NRF	Network Repository Function
PFD	Packet Flow Description
PFDF	Packet Flow Description Function
SBI	Service Based Interface
SMF	Session Management Function

---

## 4 Packet Flow Description Management Service

### 4.1 Service Description

#### 4.1.1 Overview

The PFD Management Service, as defined in 3GPP TS 23.501 [2], 3GPP TS 23.502 [3] and 3GPP TS 23.503 [4], is provided by the Packet Flow Description Function (PFDF).

The only known NF service consumer is the SMF.

This service:

- allows a NF service consumer (e.g. SMF) to subscribe to and unsubscribe from PFD changes;
- notifies a NF service consumer (e.g.SMF) about changes of PFDs;
- notifies a NF service consumer (e.g.SMF) to retrieve the PFDs; and
- allows a NF service consumer (e.g. SMF) to retrieve PFDs.

#### 4.1.2 Service Architecture

The 5G System Architecture is defined in 3GPP TS 23.501 [2]. The Policy and Charging related 5G architecture is also described in 3GPP TS 23.503 [4].

The PFD Management Service is provided by the PFDF to NF service consumers (e.g. SMF) and shown in the SBI representation model in Figure 4.1.2-1. The PFDF is a functionality within the NEF.

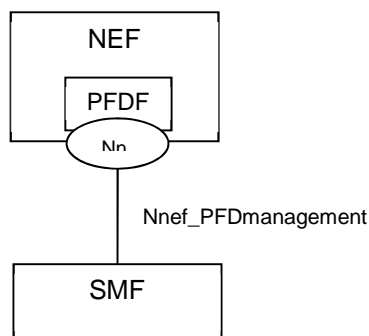

Figure 4.1.2-1: Reference Architecture for the Nnef\_PFDmanagement Service; SBI representation



Figure 4.1.2-2: Reference Architecture for the Nnef\_PFDmanagement Service; reference point representation

## 4.1.3 Network Functions

### 4.1.3.1 Packet Flow Description Function (PFDf)

The Packet Flow Description Function (PFDf):

- provides PFDs associated with one or more Application Identifiers;
- notifies a NF service consumer to retrieve the PFDs; and
- allows NF service consumers to subscribe to and unsubscribe from notifications on changes of PFDs for Application Identifier.

### 4.1.3.2 NF Service Consumers

The SMF shall support:

- requesting and receiving the PFD(s) for one or more Application Identifiers.

## 4.2 Service Operations

### 4.2.1 Introduction

Service operations defined for the Nnef\_PFDmanagement Service are shown in table 4.2.1-1.

**Table 4.2.1-1: Nnef\_PFDmanagement Service Operations**

Service Operation Name	Description	Initiated by
Nnef_PFDmanagement_Fetch	Provides the PFDs for application identifier(s) to the NF service consumer by the full pull or partial pull.	NF service consumer (e.g. SMF)
Nnef_PFDmanagement_Subscribe	Allows NF service consumers to subscribe to notifications on events when the PFDs for application identifier(s) change.	NF service consumer (e.g. SMF)
Nnef_PFDmanagement_Notify	Notifies NF service consumers to update and/or delete the PFDs for application identifier(s) or notifies NF service consumer to retrieve the PFDs for application identifier(s).	PFDF
Nnef_PFDmanagement_Unsubscribe	Allows NF service consumers to unsubscribe from notifications on PFDs change events.	NF service consumer (e.g. SMF)

## 4.2.2 Nnef\_PFDmanagement\_Fetch Service Operation

### 4.2.2.1 General

The Nnef\_PFDmanagement\_Fetch service operation provides means for the NF service consumer to retrieve the PFDs for one or more application identifier(s). This service operation enables the NF service consumer to retrieve PFDs for an Application Identifier(s) from the PFDF when:

- a PCC rule with this application identifier is provided/activated by the PCF and the PFDs provided by the PFDF are not available at the NF service consumer; or
- the caching timer for an application identifier elapses and a PCC rule for this application identifier is still active.

When the NF service consumer removes the last PCC rule that refers to the corresponding application identifier, or when the caching timer expires and no PCC rule refers to the application identifier, the NF service consumer may remove the PFD(s) related with the application identifier.

The PFDs retrieved from PFDF take precedence over any PFDs pre-configured in the NF service consumer. If all PFDs retrieved from the PFDF are removed for an application identifier, the pre-configured PFDs shall be applied again for the application identifier.

The PFDF may provide caching time value via the "cachingTime" attribute or, if the feature CachingTimer is supported, via the "cachingTimer" attribute, together with the PFDs for an application identifier. The caching time value retrieved from the PFDF takes precedence over the default caching time value configured in the NF service consumer. If no caching time value is received from the PFDF, the configured default caching time value shall be applied.

NOTE x1: The NF service consumer(s) and the PFDF(s) within an operator network are configured with the same default caching time value to be applied for all application identifiers.

NOTE x2: The configuration of a caching time value per application identifier in the PFDF is based on the SLA between the operator and the ASP.

The following procedures using the Nnef\_PFDmanagement\_Fetch service operation are supported:

- Retrieval of PFDs by the full pull.
- Retrieval of PFDs by the partial pull.

### 4.2.2.2 Retrieval of PFDs by the full pull

This procedure, as shown in Figure 4.2.2.2-1, is used to retrieve PFDs from the PFDF by the full pull for requested application identifier(s).

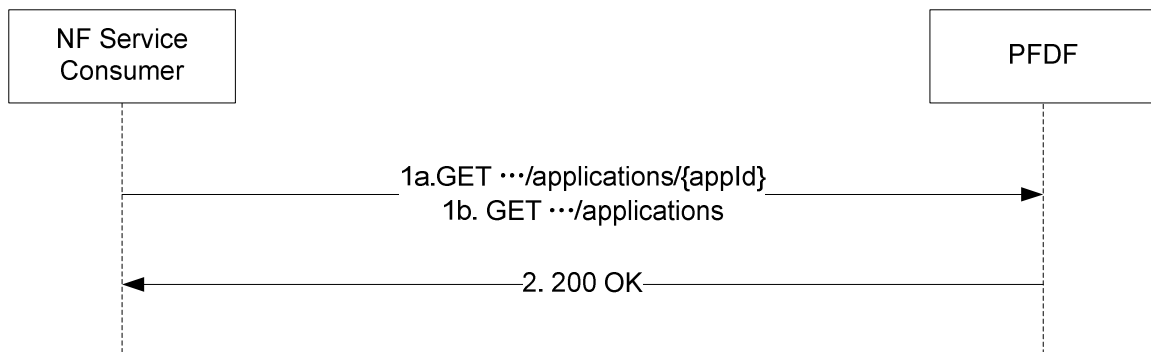

**Figure 4.2.2.2-1: Retrieval of PFDs by the full pull**

1. The NF service consumer (e.g. SMF) shall send a GET request to the resource representing the PFDs for the requested application identifier(s):
  - for PFDs of an individual application identifier, the request URI shall be set to "{apiRoot}/nnef-pfdmanagement/v1/applications/{appId}" (as shown in figure 4.2.2.2-1, step 1a); and
  - for PFD of a collection of application identifiers, the request URI shall be set to "{apiRoot}/nnef-pfdmanagement/v1/applications" (as shown in figure 4.2.2.2-1, step 1b) with query parameters indicating the requested application identifier(s).
2. On success, an HTTP "200 OK" response shall be returned, with the payload body containing a representation of an "Individual application PFD" resource or a "PFD of applications" resource for the requested application identifier(s). The NF service consumer shall replace the stored PFD(s) retrieved from the PFDF with the new received PFD(s) for the requested application identifier(s). If the PFD(s) of one or more requested application identifier(s) are not provided in the response, the NF service consumer shall remove the PFD(s) of these requested application identifier(s) and re-apply the pre-configured PFDs.

If errors occur when processing the HTTP GET request, the PFDF shall send an HTTP error response as specified in clause 5.7. For "404 Not Found", the NF service consumer shall remove the PFD(s) of the requested application identifier(s) in the NF service consumer and re-apply the pre-configured PFDs.

If the feature "ES3XX" is supported, and the PFDF determines the received HTTP GET request needs to be redirected, the PFDF shall send an HTTP redirect response as specified in clause 6.10.9 of 3GPP TS 29.500 [5].

#### 4.2.2.3 Retrieval of PFDs by the partial pull

This procedure, as shown in Figure 4.2.2.3-1, is used to retrieve PFDs from the PFDF by the partial pull for requested application identifier(s) if the "PartialPull" feature defined in clause 5.8 is supported both by NF service consumer and PFDF.

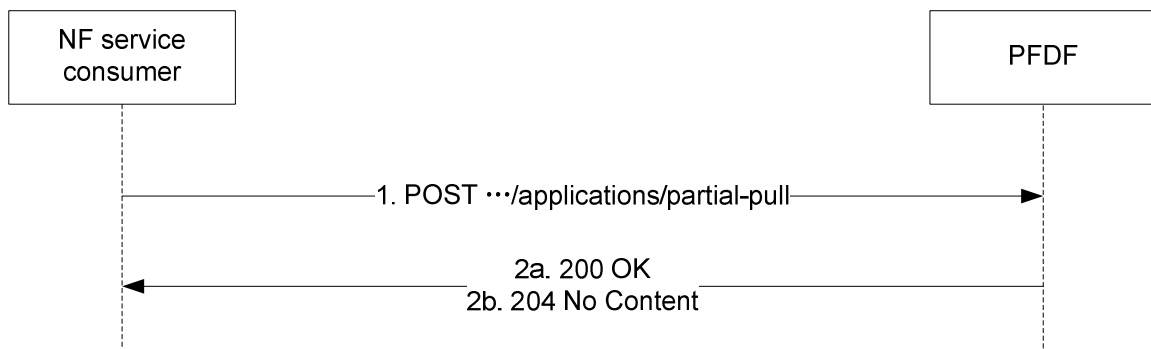

**Figure 4.2.2.3-1: Retrieval of PFDs by the partial pull**

1. The NF service consumer (e.g. SMF) shall send an HTTP POST message to the resource "{apiRoot}/nnef-pfdmanagement/v1/applications/partialpull". The NF service consumer shall include one or more ApplicationForPfdRequest data structure in the payload body of the HTTP POST. With the

ApplicationForPfdRequest data structure, the NF service consumer shall include the application identifier within the "applicationId" attribute and the timestamp of the PFDs received in the last provisioning for the application identifier within the "pfdTimestamp" attribute. The NF service consumer may also request full set of PFD(s) of an application identifier without including the timestamp if it is not available.

2. If the PFDF accepted the HTTP POST request, the PFDF shall send to the NF service consumer:
  - the HTTP "200 OK" response (as shown in figure 4.2.2.3-1, step 2a) including one or more PfdDataForApp data structure if the NF service consumer requests the PFD(s) for an application identifier(s) without the timestamp or if the NF service consumer requests PFD(s) for an application identifier(s) with timestamp and the PFDF determines that corresponding PFD(s) is changed since the last request based on the timestamp received in the request for the application identifier. Within the PfdDataForApp data type, the PFDF shall include the application identifier within the "applicationId" attribute, the new timestamp within the "pfdTimestamp" attribute, the "partialFlag" attribute if applicable and create/update/remove the PFDs as follows:
    - include the full list of the PFD(s) within the "pfd" attribute for the application identifier which is requested without the timestamp;
    - include the full list of the PFD(s) within the "pfd" attribute for the application identifier if all the PFD(s) are changed for the application identifier since the last request based on the timestamp;
    - for the application identifier whose PFD(s) are partially changed:
      - include the new PFD(s) with new PFD identifier(s) within the "pfd" attribute if the new PFD(s) is added for the application identifier and the "partialFlag" attribute set to true;
      - include the new PFD(s) with existing PFD identifier(s) within the "pfd" attribute if the existing PFD(s) is updated for the application identifier and the "partialFlag" attribute set to true;
      - include the existing PFD identifier(s) without any content within the "pfd" attribute if the existing PFD(s) is removed for the application identifier and the "partialFlag" attribute set to true;
    - not include the "pfd" attribute if the PFD(s) is removed for the application identifier.

NOTE 1: The PFDF does not include the PfdDataForApp data type for the application identifier whose PFD(s) is not updated since last request.

NOTE 2: If the PFDF determines that the PFDs are changed since the last request but cannot determine what changes have been applied to the individual PFD(s) for an application identifier, the PFDF can include the full list of the PFD(s) in the PfdDataForApp data type.

- the HTTP "204 No Content" response (as shown in figure 4.2.2.3-1, step 2b) if the PFD(s) for all the requested application identifier(s) are not changed since last request.

When the NF service consumer receives the response with "200 OK" status code, the NF service consumer shall

- remove the all existing PFD(s) (if available) and install all the new provided PFD(s) for an application identifier if full list of PFD(s) is received but "partialFlag" attribute is not received;
- delete the existing PFD(s) for an application identifier(s) where no PFD(s) is received;
- for an application identifier(s) where the PFD(s) is provided and "partialFlag" attribute is also provided and set to true:
  - install a new PFD(s) if the new PFD(s) with a new PFD identifier(s) is received;
  - update an existing PFD(s) if a new PFD(s) with the same PFD identifier(s) is received;
  - delete an existing PFD(s) if the same PFD identifier(s) without any content is received;
  - reserve an existing PFD(s) if the PFD identifier(s) is not received.

## 4.2.3 Nnef\_PFDmanagement\_Subscribe Service Operation

### 4.2.3.1 General

The Nnef\_PFDmanagement\_Subscribe service operation enables the NF service consumer to subscribe to notifications on events when the PFDs for application identifier(s) change.

The following procedures using the Nnef\_PFDmanagement\_Subscribe service operation are supported:

- Subscription for event notifications on PFDs change;
- Subscription update for event notifications on PFD change.

### 4.2.3.2 Subscription for event notifications on PFDs change

This procedure, as shown in Figure 4.2.3.2-1, is used to subscribe to notifications on events when the PFDs for application identifier(s) change.

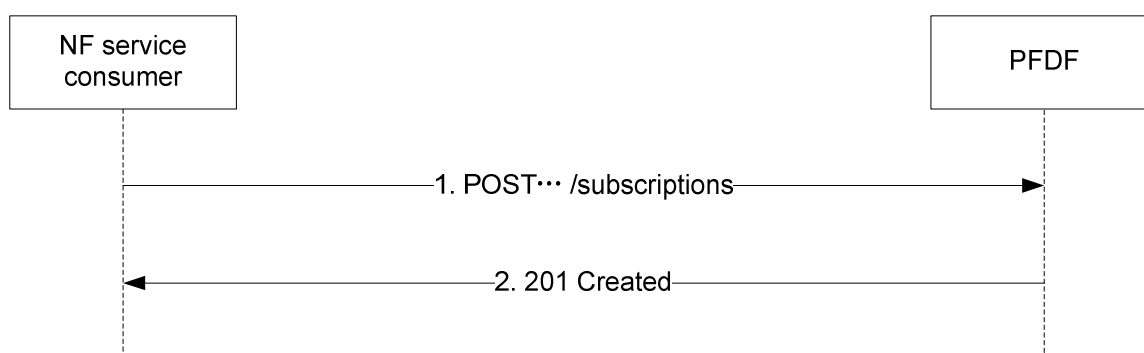

**Figure 4.2.3.2-1: Creation of a subscription for event notifications on PFDs change**

1. The NF service consumer (e.g. SMF) shall send a POST request to the request URI representing the collection of PFD subscriptions resource "{apiRoot}/nnef-pfdmanagement/v1/subscriptions". The NF service consumer shall include the PfdSubscription data type in the request payload body. Within the PfdSubscription data type, the NF service consumer shall include:
  - an URI where to receive the requested notifications as "notifyUri" attribute;
 and may include:
  - subscribed application identifier(s) within the "applicationIds" attribute.
2. If the request is accepted, the PFDf shall:
  - create a new subscription;
  - assign a subscriptionId;
  - store the subscription; and
  - send an HTTP "201 Created" response, with the payload body containing a representation of the created subscription, and the Location header containing the resource URI of the created subscription "{apiRoot}/nnef-pfdmanagement/v1/subscriptions/{subscriptionId}".

Otherwise, one of the HTTP status codes listed in table 5.3.4.3.1-3 shall be returned.

**NOTE:** The PFDs that have been provisioned to the PFDf before the NF service consumer performs the subscription are not notified to the NF service consumer as a result of this subscription, but the NF service consumer can retrieve them before performing the subscription by invoking Nnef\_PFDmanagement\_Fetch Service Operation.

### 4.2.3.3 Subscription update for event notifications on PFDs change

This procedure, as shown in Figure 4.2.3.3-1, is used to update an existing subscription to notifications on events when the PFDs for application identifier(s) change.



**Figure 4.2.3.3-1: Update of a subscription for event notifications on PFDs change**

1. If the feature PfdChgSubsUpdate is supported, the NF service consumer (e.g. SMF) shall send a PUT request to the resource URI representing the targeted PFD subscription resource "`{apiRoot}/nnef-pfdmanagement/v1/subscriptions/{subscriptionId}`". The NF service consumer shall include the PfdSubscription data type in the request payload body. Within the PfdSubscription data type, the NF service consumer shall include:
  - an URI where to receive the requested notifications as "notifyUri" attribute;
 and may include:
  - subscribed application identifier(s) within the "applicationIds" attribute.

NOTE 1: The "notifyUri" attribute within the PfdSubscription data structure can be modified to request that subsequent notifications are sent to a new NF service consumer.

2. If the feature PfdChgSubsUpdate is supported and the request is accepted, the PFDF shall:
  - update the subscription; and
  - send an HTTP "200 OK" response with the payload body containing a representation of the updated subscription.

Otherwise, if errors occur when processing the HTTP PUT request, the PFDF shall send an HTTP error response as specified in clause 5.7. If the feature "ES3XX" is supported, and the PFDF determines the received HTTP PUT request needs to be redirected, the PFDF shall send an HTTP redirect response as specified in clause 6.10.9 of 3GPP TS 29.500 [5].

NOTE 2: The PFDs that have been provisioned to the PFDF before the NF service consumer performs the subscription are not notified to the NF service consumer as a result of this subscription, but the NF service consumer can retrieve them before performing the subscription by invoking Nnef\_PFDmanagement\_Fetch Service Operation.

## 4.2.4 Nnef\_PFDmanagement\_Notify Service Operation

### 4.2.4.1 General

The Nnef\_PFDmanagement\_Notify service operation notifies the NF service consumer to update, delete or retrieve the PFDs for application identifier(s).

The following procedures using the Nnef\_PFDmanagement\_Notify service operation are supported:

- Notification of PFD change.

- Notification PUSH

#### 4.2.4.2 Notification of PFD change

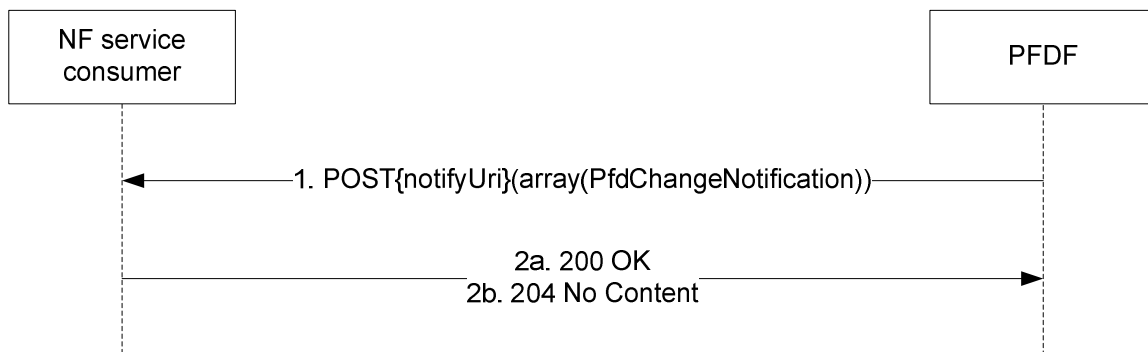
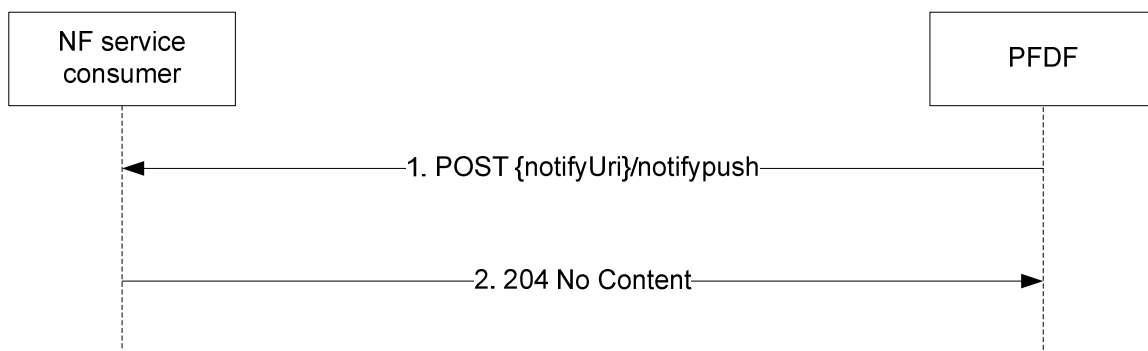

**Figure 4.2.4.2-1: Notification of PFD change**

1. The PFDf shall send a POST request to the NF service consumer (e.g. SMF) targeting the URI "{notifyUri}", where {notifyUri} is the notification URI provided during the creation or modification of the subscription resource as specified in clause 4.2.3. The payload body of the POST request shall contain one or more PfdChangeNotification data structure(s).
2. If the notification is accepted, the NF service consumer shall reply with:
  - "204 No Content" indicating the successful provisioning of all PFDs; or
  - "200 OK" and the payload body of the response shall contain "PfdChangeReport" data structure with detailed information of failed application(s).

Otherwise, if errors occur when processing the HTTP POST request, the NF service consumer shall send an HTTP error response as specified in clause 5.7. If the feature "ES3XX" is supported, and the NF service consumer determines the received HTTP POST request needs to be redirected, the NF service consumer shall send an HTTP redirect response as specified in clause 6.10.9 of 3GPP TS 29.500 [5].

#### 4.2.4.3 Notification PUSH



**Figure 4.2.4.3-1: Notification PUSH**

1. If the NotificationPush feature defined in clause 5.8 is supported, and when the PFDf only notifies the NF service consumer to retrieve or remove the PFDs for application identifier(s), then the PFDf shall send a POST request to the NF service consumer (e.g. SMF) with "{notifyUri}/notifypush" as URI (where the "notifyUri" was previously supplied by the NF service consumer) and one or more NotificationPush data structure as request body. Each NotificationPush data structure shall include the application identifier(s) within the "appIds" attribute, the "pfdOp" attribute set to the applicable value and may include the "allowedDelay" attribute containing the allowed delay time if received when the "pfdOp" attribute is set to "RETRIEVE", "FULLPULL" or "PARTIALPULL".



- 2 If the NF service consumer accepts the received POST request, the NF service consumer shall send an HTTP "204 No Content" response.

After the successful processing of the HTTP POST request,

- if the PFDF requests the NF service consumer to retrieve the PFD(s) with the "pfdOp" attribute set to the value "RETRIEVE" or without the "pfdOp" attribute, the NF service consumer shall determine to invoke the full pull procedure defined in clause 4.2.2.2 or invoke the partial pull procedure defined in clause 4.2.2.3 if the "PartialPull" feature is supported to retrieve the PFD(s) for the application identifier(s).
- if the "PartialPull" feature is supported and if the PFDF requests the NF service consumer to retrieve the PFD(s) with the "pfdOp" attribute set to the value "FULLPULL", the NF service consumer shall invoke the full pull procedure defined in clause 4.2.2.2.
- if the "PartialPull" feature is supported and if the PFDF indicates the NF service consumer to retrieve the PFD(s) with the "pfdOp" attribute set to the value "PARTIALPULL", the NF service consumer may invoke the partial full procedure defined in clause 4.2.2.3.
- for all above cases, if the "allowedDelay" attribute is provided for one or more application(s), the NF service consumer shall retrieve the PFD within the allowed delay time.
- if the PFDF requests the NF service consumer to remove the PFD(s) with the "pfdOp" attribute set to the value "REMOVE", the NF service consumer shall remove the PFD(s) for the application identifier(s) and re-apply the pre-configured PFDs.

If errors occur when processing the HTTP POST request, the NF service consumer shall send an HTTP error response as specified in clause 5.7.

If the feature "ES3XX" is supported, and the NF service consumer determines the received HTTP POST request needs to be redirected, the NF service consumer shall send an HTTP redirect response as specified in clause 6.10.9 of 3GPP TS 29.500 [5].

## 4.2.5 Nnef\_PFDmanagement\_Unsubscribe Service Operation

### 4.2.5.1 General

The Nnef\_PFDmanagement\_Unsubscribe service operation is used by the NF service consumer to unsubscribe from notifications on PFD change events.

The following procedures using the Nnef\_PFDmanagement\_Unsubscribe service operation are supported:

- Unsubscribe from event notifications on PFDs change.

### 4.2.5.2 Unsubscribe from event notifications on PFDs change

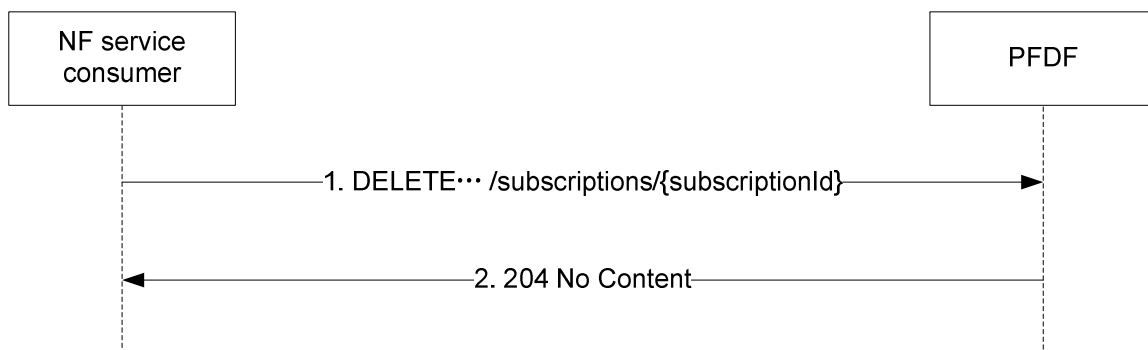

**Figure 4.2.5.2-1: Unsubscribe from event notifications on PFDs change**

1. The NF service consumer (e.g. SMF) shall send a DELETE request to the resource URI representing the individual PFD subscription. The request body shall be empty.

2. If the request is accepted, an HTTP "204 No Content" response shall be returned. The response body shall be empty.

Otherwise, if errors occur when processing the HTTP DELETE request, the PFDF consumer shall send an HTTP error response as specified in clause 5.7. If the feature "ES3XX" is supported, and the PFDF determines the received HTTP DELETE request needs to be redirected, the PFDF shall send an HTTP redirect response as specified in clause 6.10.9 of 3GPP TS 29.500 [5].

---

## 5 Nnef\_PFDmanagement API

### 5.1 Introduction

The Packet Flow Description Management Service shall use the Nnef\_PFDmanagement API.

The API URI of the Nnef\_PFDmanagement API shall be:

{apiRoot}/<apiName>/<apiVersion>

The request URIs used in HTTP requests from the NF service consumer towards the PFDF shall have the Resource URI structure defined in clause 4.4.1 of 3GPP TS 29.501 [6], i.e.:

**{apiRoot}/<apiName>/<apiVersion>/<apiSpecificResourceUriPart>**

with the following components:

- The {apiRoot} shall be set as described in 3GPP TS 29.501 [6].
- The <apiName> shall be "nnef-pfdmanagement".
- The <apiVersion> shall be "v1".
- The <apiSpecificResourceUriPart> shall be set as described in clause 5.3.

### 5.2 Usage of HTTP

#### 5.2.1 General

HTTP/2, IETF RFC 7540 [7], shall be used as specified in clause 5.2 of 3GPP TS 29.500 [5].

HTTP/2 shall be transported as specified in clause 5.3 of 3GPP TS 29.500 [5].

The OpenAPI [9] specification of HTTP messages and content bodies for the Nnef\_PFDmanagement service is contained in Annex A.

#### 5.2.2 HTTP standard headers

##### 5.2.2.1 General

See clause 5.2.2 of 3GPP TS 29.500 [5] for the usage of HTTP standard headers.

##### 5.2.2.2 Content type

JSON, IETF RFC 8259 [8], shall be used as content type of the HTTP bodies specified in the present specification, as specified in clause 5.4 of 3GPP TS 29.500 [5]. The use of the JSON format shall be signalled by the content type "application/json".

"Problem Details" JSON object shall be used to indicate additional details of the error in a HTTP response body and shall be signalled by the content type "application/problem+json", as defined in IETF RFC 7807 [16].

## 5.2.3 HTTP custom headers

### 5.2.3.1 General

The Nnef\_PFDmanagement API shall support HTTP custom header fields specified in clause 5.2.3.2 of 3GPP TS 29.500 [4] and may support HTTP custom header fields specified in clause 5.2.3.3 of 3GPP TS 29.500 [4].

In this Release of the specification, no specific custom headers are defined for the Nnef\_PFDmanagement API.

## 5.3 Resources

### 5.3.1 Resource Structure

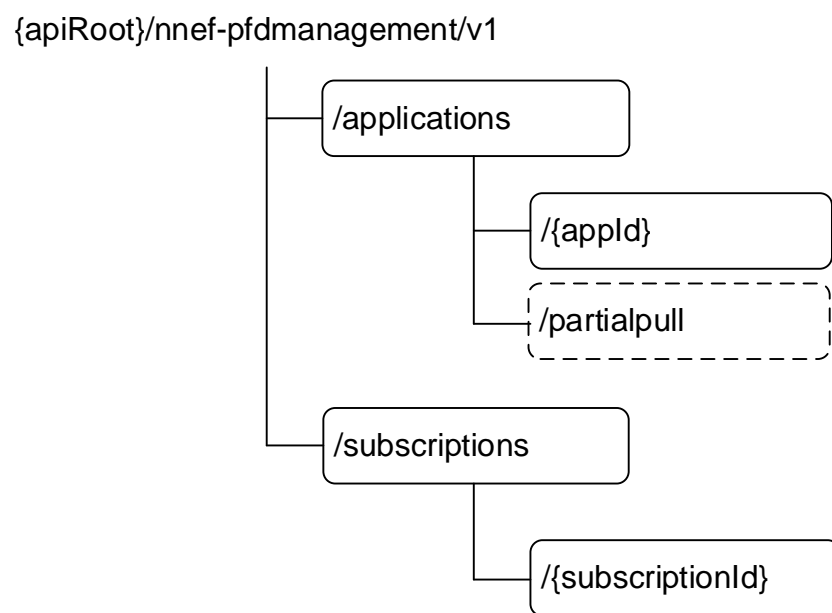

**Figure 5.3.1-1: Resource URI structure of the Nnef\_PFDmanagement API**

Table 5.3.1-1 provides an overview of the resources and applicable HTTP methods.

**Table 5.3.1-1: Resources and methods overview**

Resource name	Resource URI	HTTP method or custom operation	Description
PFD of applications	/applications	GET	Nnef_PFDmanagement_Fetch. Retrieve PFDs for one or multiple applications using query parameters.
	/applications/partialpull	partialpull (POST)	Request PFDs for one or multiple application identifier(s) by the partial update.
Individual application PFD	/applications/{appld}	GET	Nnef_PFDmanagement_Fetch. Retrieve the PFD for an application.
PFD subscriptions	/subscriptions	POST	Nnef_PFDmanagement_Subscribe. Subscribe the notification of PFD changes.
Individual PFD subscription	/subscriptions/{subscriptionId}	PUT	Nnef_PFDmanagement_Subscribe. Update a subscription to PFD change notifications.
Individual PFD subscription	/subscriptions/{subscriptionId}	DELETE	Nnef_PFDmanagement_Unsubscribe. Delete a subscription to PFD change notifications.

## 5.3.2 Resource: PFD of applications

### 5.3.2.1 Description

This resource represents PFDs for all applications.

### 5.3.2.2 Resource definition

Resource URI: **{apiRoot}/nnef-pfdmanagement/v1/applications**

This resource shall support the resource URI variables defined in table 5.3.2.2-1.

**Table 5.3.2.2-1: Resource URI variables for this resource**

Name	Data type	Definition
apiRoot	string	See clause 5.1

### 5.3.2.3 Resource Standard Methods

#### 5.3.2.3.1 GET

This method shall support the URI query parameters specified in table 5.3.2.3.1-1.

**Table 5.3.2.3.1-1: URI query parameters supported by the GET method on this resource**

Name	Data type	P	Cardinality	Description
application-ids	array(ApplicationId)	M	1..N	The requested application identifier(s) for which PFD(s) shall be returned.
supported-features	SupportedFeatures	O	0..1	To filter irrelevant responses related to unsupported features.

This method shall support the request data structures specified in table 5.3.2.3.1-2 and the response data structures and response codes specified in table 5.3.2.3.1-3.

**Table 5.3.2.3.1-2: Data structures supported by the GET Request Body on this resource**

Data type	P	Cardinality	Description
n/a			

**Table 5.3.2.3.1-3: Data structures supported by the GET Response Body on this resource**

Data type	P	Cardinality	Response codes	Description
array(PfdDataForApp)	M	0..N	200 OK	The PFDs for one or more application identifier(s) provided in the request URI are returned.
NOTE: In addition, the HTTP status codes which are specified as mandatory in table 5.2.7.1-1 of 3GPP TS 29.500 [5] for the GET method shall also apply.				

### 5.3.2.4 Resource Custom Operations

#### 5.3.2.4.1 Overview

**Table 5.3.2.4.1-1: Custom operations**

Operation Name	Custom operation URI	HTTP method or custom operation	Description
Partialpull	/applications/partialpull	partialpull (POST)	Request PFDs for one or multiple application identifier(s) by the partial update.

#### 5.3.2.4.2 Operation: partialpull

##### 5.3.2.4.2.1 Description

##### 5.3.2.4.2.2 Operation Definition

This custom operation requests PFDs for one ore multiple application identifier(s) by the partial update..

This operation shall support the request data structures specified in table 5.3.2.4.2.2-1 and the response data structure and response codes specified in table 5.3.2.4.2.2-2.

**Table 5.3.2.4.2.2-1: Data structures supported by the POST Request Body on this resource**

Data type	P	Cardinality	Description
array(ApplicationForPfdRequest)	M	1	Contains the application Identifier(s) for PFDs request.

**Table 5.3.2.4.2.2-2: Data structures supported by the POST Response Body on this resource**

Data type	P	Cardinality	Response codes	Description
array(PfdDataForApp)	M	0..N	200 OK	The PFDs for one or more application identifier(s) are returned.
n/a			204 No Content	
NOTE: The mandatory HTTP error status codes for the POST method listed in table 5.2.7.1-1 of 3GPP TS 29.500 [4] shall also apply.				

### 5.3.3 Resource: Individual application PFD

#### 5.3.3.1 Description

This resource represents the PFD identified by an application identifier.

### 5.3.3.2 Resource definition

Resource URI: {apiRoot}/nnef-pfdmanagement/v1/applications/{appId}

This resource shall support the resource URI variables defined in table 5.3.3.2-1.

**Table 5.3.3.2-1: Resource URI variables for this resource**

Name	Data type	Definition
apiRoot	string	See clause 5.1.
appId	string	Identifies a set of PFD for an application identifier.

### 5.3.3.3 Resource Standard Methods

#### 5.3.3.3.1 GET

This method shall support the URI query parameters specified in table 5.3.3.3.1-1.

**Table 5.3.3.3.1-1: URI query parameters supported by the GET method on this resource**

Name	Data type	P	Cardinality	Description
supported-features	SupportedFeatures	O	0..1	To filter irrelevant responses related to unsupported features.

This method shall support the request data structures specified in table 5.3.3.3.1-2 and the response data structures and response codes specified in table 5.3.3.3.1-3.

**Table 5.3.3.3.1-2: Data structures supported by the GET Request Body on this resource**

Data type	P	Cardinality	Description
n/a			

**Table 5.3.3.3.1-3: Data structures supported by the GET Response Body on this resource**

Data type	P	Cardinality	Response codes	Description
PfdDataForApp	M	1	200 OK	A representation of PFDs for an application in the request URI is returned.
RedirectResponse	O	0..1	307 Temporary Redirect	Temporary redirection, during Individual PFD subscription retrieval. The response shall include a Location header field containing an alternative URI of the resource located in an alternative PFD (service) instance. Applicable if the feature "ES3XX" is supported.
RedirectResponse	O	0..1	308 Permanent Redirect	Permanent redirection, during Individual PFD subscription retrieval. The response shall include a Location header field containing an alternative URI of the resource located in an alternative PFD (service) instance. Applicable if the feature "ES3XX" is supported.
NOTE: In addition, the HTTP status codes which are specified as mandatory in table 5.2.7.1-1 of 3GPP TS 29.500 [5] for the GET method shall also apply.				

**Table 5.3.3.3.1-4: Headers supported by the 307 Response Code on this resource**

Name	Data type	P	Cardinality	Description
Location	string	M	1	An alternative URI of the resource located in an alternative PFD (service) instance.
3gpp-Sbi-Target-Nf-Id	string	O	0..1	Identifier of the target NF (service) instance towards which the request is redirected

**Table 5.3.3.3.1-5: Headers supported by the 308 Response Code on this resource**

Name	Data type	P	Cardinality	Description
Location	string	M	1	An alternative URI of the resource located in an alternative PFD (service) instance.
3gpp-Sbi-Target-Nf-Id	string	O	0..1	Identifier of the target NF (service) instance towards which the request is redirected

### 5.3.3.4 Resource Custom Operations

None.

## 5.3.4 Resource: PFD subscriptions

### 5.3.4.1 Description

This resource represents a collection of subscriptions created by NF service consumers of Nnef\_PFDmanagement service.

### 5.3.4.2 Resource definition

Resource URI: {apiRoot}/nnef-pfdmanagement/v1/subscriptions

This resource shall support the resource URI variables defined in table 5.3.4.2-1.

**Table 5.3.4.2-1: Resource URI variables for this resource**

Name	Data type	Definition
apiRoot	string	See clause 5.1

### 5.3.4.3 Resource Standard Methods

#### 5.3.4.3.1 POST

This method shall support the URI query parameters specified in table 5.3.4.3.1-1.

**Table 5.3.4.3.1-1: URI query parameters supported by the POST method on this resource**

Name	Data type	P	Cardinality	Description
n/a				

This method shall support the request data structures specified in table 5.3.4.3.1-2 and the response data structures and response codes specified in table 5.3.4.3.1-3.

**Table 5.3.4.3.1-2: Data structures supported by the POST Request Body on this resource**

Data type	P	Cardinality	Description
PfdSubscription	M	1	Create a PfdSubscription resource.

**Table 5.3.4.3.1-3: Data structures supported by the POST Response Body on this resource**

Data type	P	Cardinality	Response codes	Description
PfdSubscription	M	1	201 Created	The creation of a PfdSubscription resource is confirmed and a representation of that resource is returned.
NOTE: In addition, the HTTP status codes which are specified as mandatory in table 5.2.7.1-1 of 3GPP TS 29.500 [5] for the POST method shall also apply.				

**Table 5.3.4.3.1-4: Headers supported by the 201 Response Code on this resource**

Name	Data type	P	Cardinality	Description
Location	string	M	1	Contains the URI of the newly created resource, according to the structure: {apiRoot}/nnef-pfdmanagement/v1/subscriptions/{subscriptionId}

#### 5.3.4.4 Resource Custom Operations

None.

### 5.3.5 Resource: Individual PFD subscription

#### 5.3.5.1 Description

This resource represents an individual PFD subscription created by an NF service consumer of the Nnef\_PFDmanagement service.

#### 5.3.5.2 Resource definition

Resource URI: {apiRoot}/nnef-pfdmanagement/v1/subscriptions/{subscriptionId}

This resource shall support the resource URI variables defined in table 5.3.5.2-1.

**Table 5.3.5.2-1: Resource URI variables for this resource**

Name	Data type	Definition
apiRoot	string	See clause 5.1
subscriptionId	string	Identifies an individual subscription to the PFD management service

#### 5.3.5.3 Resource Standard Methods

##### 5.3.5.3.1 DELETE

This method shall support the URI query parameters specified in table 5.3.5.3.1-1.

**Table 5.3.5.3.1-1: URI query parameters supported by the DELETE method on this resource**

Name	Data type	P	Cardinality	Description
n/a				

This method shall support the request data structures specified in table 5.3.5.3.1-2 and the response data structures and response codes specified in table 5.3.5.3.1-3.



**Table 5.3.5.3.1-2: Data structures supported by the DELETE Request Body on this resource**

Data type	P	Cardinality	Description
n/a			

**Table 5.3.5.3.1-3: Data structures supported by the DELETE Response Body on this resource**

Data type	P	Cardinality	Response codes	Description
n/a			204 No Content	The PfdSubscription resource matching the subscriptionId was deleted successfully.
RedirectResponse	O	0..1	307 Temporary Redirect	Temporary redirection, during Individual PFD subscription deletion. The response shall include a Location header field containing an alternative URI of the resource located in an alternative PFDF (service) instance. Applicable if the feature "ES3XX" is supported.
RedirectResponse	O	0..1	308 Permanent Redirect	Permanent redirection, during Individual PFD subscription deletion. The response shall include a Location header field containing an alternative URI of the resource located in an alternative PFDF (service) instance. Applicable if the feature "ES3XX" is supported.
NOTE: In addition, the HTTP status codes which are specified as mandatory in table 5.2.7.1-1 of 3GPP TS 29.500 [5] for the DELETE method shall also apply.				

**Table 5.3.5.3.1-4: Headers supported by the 307 Response Code on this resource**

Name	Data type	P	Cardinality	Description
Location	string	M	1	An alternative URI of the resource located in an alternative PFDF (service) instance.
3gpp-Sbi-Target-Nf-Id	string	O	0..1	Identifier of the target NF (service) instance towards which the request is redirected

**Table 5.3.5.3.1-5: Headers supported by the 308 Response Code on this resource**

Name	Data type	P	Cardinality	Description
Location	string	M	1	An alternative URI of the resource located in an alternative PFDF (service) instance.
3gpp-Sbi-Target-Nf-Id	string	O	0..1	Identifier of the target NF (service) instance towards which the request is redirected

### 5.3.5.3.2 PUT

This method shall support the URI query parameters specified in table 5.3.5.3.2-1.

**Table 5.3.5.3.2-1: URI query parameters supported by the PUT method on this resource**

Name	Data type	P	Cardinality	Description
n/a				

This method shall support the request data structures specified in table 5.3.5.3.2-2 and the response data structures and response codes specified in table 5.3.5.3.2-3.

**Table 5.3.5.3.2-2: Data structures supported by the PUT Request Body on this resource**

Data type	P	Cardinality	Description
PfdSubscription	M	1	Update a PfdSubscription resource.

**Table 5.3.5.3.2-3: Data structures supported by the PUT Response Body on this resource**

Data type	P	Cardinality	Response codes	Description
PfdSubscription	M	1	200 OK	The update of a PfdSubscription resource is confirmed and a representation of that resource is returned.
RedirectResponse	O	0..1	307 Temporary Redirect	Temporary redirection, during Individual PFD subscription modification. The response shall include a Location header field containing an alternative URI of the resource located in an alternative PFDF (service) instance. Applicable if the feature "ES3XX" is supported.
RedirectResponse	O	0..1	308 Permanent Redirect	Permanent redirection, during Individual PFD subscription modification. The response shall include a Location header field containing an alternative URI of the resource located in an alternative PFDF (service) instance. Applicable if the feature "ES3XX" is supported.
NOTE: In addition, the HTTP status codes which are specified as mandatory in table 5.2.7.1-1 of 3GPP TS 29.500 [5] for the PUT method shall also apply.				

**Table 5.3.5.3.2-4: Headers supported by the 307 Response Code on this resource**

Name	Data type	P	Cardinality	Description
Location	string	M	1	An alternative URI of the resource located in an alternative PFDF (service) instance.
3gpp-Sbi-Target-Nf-Id	string	O	0..1	Identifier of the target NF (service) instance towards which the request is redirected

**Table 5.3.5.3.2-5: Headers supported by the 308 Response Code on this resource**

Name	Data type	P	Cardinality	Description
Location	string	M	1	An alternative URI of the resource located in an alternative PFDF (service) instance.
3gpp-Sbi-Target-Nf-Id	string	O	0..1	Identifier of the target NF (service) instance towards which the request is redirected

#### 5.3.5.4 Resource Custom Operations

None.

### 5.4 Custom Operations without associated resources

None

## 5.5 Notifications

### 5.5.1 General

Notifications shall comply to clause 6.2 of 3GPP TS 29.500 [5] and clause 4.6.2.3 of 3GPP TS 29.501 [6].

**Table 5.5.1-1: Notifications overview**

Notification	Callback URI	HTTP method or custom operation	Description (service operation)
PFD Change Notification	{notifyUri}	POST	Notification of PFD change.
Notification Push	{notifyUri}/notifypush	notifypush (POST)	Notifies NF service consumer to retrieve the PFDs for application identifier(s).

## 5.5.2 PFD Change Notification

### 5.5.2.1 Description

The PFD Change Notification is used by the PFDF to inform the NF service consumer, which has subscribed to this Notification via the PFD subscriptions resource.

### 5.5.2.2 Target URI

The Callback URI "{**notifyUri**}" shall be used with the callback URI variables defined in table 5.5.2.2-1.

**Table 5.5.2.2-1: Callback URI variables**

Name	Data type	Definition
notifyUri	Uri	The Notification Uri as assigned within the PFD subscriptions resource and described within the PfdSubscription data type (see table 5.6.2.3-1).

### 5.5.2.3 Standard Methods

#### 5.5.2.3.1 POST

This method shall support the URI query parameters specified in table 5.5.2.3.1-1.

**Table 5.5.2.3.1-1: URI query parameters supported by the POST method on this resource**

Name	Data type	P	Cardinality	Description
n/a				

This method shall support the request data structures specified in table 5.5.2.3.1-2 and the response data structures and response codes specified in table 5.5.2.3.1-3.

**Table 5.5.2.3.1-2: Data structures supported by the POST Request Body on this resource**

Data type	P	Cardinality	Description
array(PfdChangeNotification)	M	1..N	Provides PFD change information.

**Table 5.5.2.3.1-3: Data structures supported by the POST Response Body on this resource**

Data type	P	Cardinality	Response codes	Description
n/a			204 No Content	The PFD operation in the notification is performed successfully, i.e. all PFD changes are accepted by the NF service consumer.
array(PfdChangeReport)	M	1..N	200 OK	The PFD operation in the notification is performed and the PfdChangeReport indicates failure reason for each failed application in the partial success.
RedirectResponse	O	0..1	307 Temporary Redirect	Temporary redirection, during PFD Change Notification. The response shall include a Location header field containing an alternative URI representing the end point of an alternative NF consumer (service) instance where the notification should be sent. Applicable if the feature "ES3XX" is supported.
RedirectResponse	O	0..1	308 Permanent Redirect	Permanent redirection, during PFD Change Notification. The response shall include a Location header field containing an alternative URI representing the end point of an alternative NF consumer (service) instance where the notification should be sent. Applicable if the feature "ES3XX" is supported.
ProblemDetails	O	0..1	500 Internal Server Error	The server encountered an unexpected condition that prevented it from fulfilling the request. PFDs for all applications are not accepted by the NF service consumer. (NOTE 2)
NOTE 1: In addition, the HTTP status codes which are specified as mandatory in table 5.2.7.1-1 of 3GPP TS 29.500 [5] for the POST method shall also apply.				
NOTE 2: Failure cases are described in clause 5.7.				

**Table 5.5.2.3.1-4: Headers supported by the 307 Response Code on this resource**

Name	Data type	P	Cardinality	Description
Location	string	M	1	An alternative URI representing the end point of an alternative NF consumer (service) instance towards which the notification should be redirected.
3gpp-Sbi-Target-Nf-Id	string	O	0..1	Identifier of the target NF (service) instance towards which the notification request is redirected

**Table 5.5.2.3.1-5: Headers supported by the 308 Response Code on this resource**

Name	Data type	P	Cardinality	Description
Location	string	M	1	An alternative URI representing the end point of an alternative NF consumer (service) instance towards which the notification should be redirected.
3gpp-Sbi-Target-Nf-Id	string	O	0..1	Identifier of the target NF (service) instance towards which the notification request is redirected

## 5.5.3 Notification Push

### 5.5.3.1 Description

The Notification Push is used by the PFD to inform the NF service consumer, which has subscribed to this Notification via the PFD subscriptions resource.

### 5.5.3.2 Target URI

The Callback URI "{notifyUri}/notifypush" shall be used with the callback URI variables defined in table 5.5.3.2-1.

**Table 5.5.3.2-1: Callback URI variables**

Name	Data type	Definition
notifyUri	Uri	The Notification Uri as assigned within the PFD subscriptions resource and described within the PfdSubscription data type (see table 5.6.2.3-1).

### 5.5.3.3 Standard Methods

#### 5.5.3.3.1 POST

This method shall support the URI query parameters specified in table 5.5.3.3.1-1.

**Table 5.5.3.3.1-1: URI query parameters supported by the POST method on this resource**

Name	Data type	P	Cardinality	Description
n/a				

This method shall support the request data structures specified in table 5.5.3.3.1-2 and the response data structures and response codes specified in table 5.5.3.3.1-3.

**Table 5.5.3.3.1-2: Data structures supported by the POST Request Body on this resource**

Data type	P	Cardinality	Description
array(NotificationPush)	M	1..N	Provides the information for the NF service consumer to retrieve and/or remove the PFDs.

**Table 5.5.3.3.1-3: Data structures supported by the POST Response Body on this resource**

Data type	P	Cardinality	Response codes	Description
n/a			204 No Content	Notification PUSH is accepted.
RedirectResponse	O	0..1	307 Temporary Redirect	Temporary redirection, during PFD Change Notification. The response shall include a Location header field containing an alternative URI representing the end point of an alternative NF consumer (service) instance where the notification should be sent. Applicable if the feature "ES3XX" is supported.
RedirectResponse	O	0..1	308 Permanent Redirect	Permanent redirection, during PFD Change Notification. The response shall include a Location header field containing an alternative URI representing the end point of an alternative NF consumer (service) instance where the notification should be sent. Applicable if the feature "ES3XX" is supported.

NOTE 1: In addition, the HTTP status codes which are specified as mandatory in table 5.2.7.1-1 of 3GPP TS 29.500 [5] for the POST method shall also apply.

NOTE 2: Failure cases are described in clause 5.7.

**Table 5.5.3.3.1-4: Headers supported by the 307 Response Code on this resource**

Name	Data type	P	Cardinality	Description
Location	string	M	1	An alternative URI representing the end point of an alternative NF consumer (service) instance towards which the notification should be redirected.
3gpp-Sbi-Target-Nf-Id	string	O	0..1	Identifier of the target NF (service) instance towards which the notification request is redirected

**Table 5.5.3.3.1-5: Headers supported by the 308 Response Code on this resource**

Name	Data type	P	Cardinality	Description
Location	string	M	1	An alternative URI representing the end point of an alternative NF consumer (service) instance towards which the notification should be redirected.
3gpp-Sbi-Target-Nf-Id	string	O	0..1	Identifier of the target NF (service) instance towards which the notification request is redirected

## 5.6 Data Model

### 5.6.1 General

This clause specifies the application data model supported by the API.

Table 5.6.1-1 specifies the data types defined for the Nnef\_PFDmanagement service based interface protocol.

**Table 5.6.1-1: Nnef\_PFDmanagement specific Data Types**

Data type	Section defined	Description	Applicability
ApplicationForPfdRequest	5.6.2.8	Contains the application identifier(s) for the PFDs request.	PartialPull
NotificationPush	5.6.2.7	Provides the information for the NF service consumer to retrieve the PFDs and/or remove the PFDs of the applicable application identifier(s).	NotificationPush
PfdChangeNotification	5.6.2.4	Represents PFD change information.	
PfdChangeReport	5.6.2.6	Represents error of PFD change.	
PfdContent	5.6.2.5	Represents the content of a PFD for an application identifier.	
PfdDataForApp	5.6.2.2	Represents the PFDs for an application identifier.	
PfdOperation	5.6.3.3	Indicates the operation of the PFDs.	NotificationPush
PfdSubscription	5.6.2.3	Represents a PFD subscription.	

Table 5.6.1-2 specifies data types re-used by the Nnef\_PFDmanagement service based interface protocol from other specifications, including a reference to their respective specifications and when needed, a short description of their use within the Nnef\_PFDmanagement service based interface.

**Table 5.6.1-2: Nnef\_PFDmanagement re-used Data Types**

Data type	Reference	Comments	Applicability
ApplicationId	3GPP TS 29.571 [10]		
DateTime	3GPP TS 29.571 [10]		
DomainNameProtocol	3GPP TS 29.122 [11]	Indicates the additional protocol and protocol field for domain names to be matched.	DomainNameProtocol
DurationSec	3GPP TS 29.571 [10]	Identifies a period of time in units of seconds.	NotificationPush
RedirectResponse	3GPP TS 29.571 [10]	Contains redirection related information.	ES3XX
SupportedFeatures	3GPP TS 29.571 [10]		
Uri	3GPP TS 29.571 [10]		

### 5.6.2 Structured data types

#### 5.6.2.1 Introduction

This clause defines the structures to be used in resource representations.

Allowed structures are: array, object.

### 5.6.2.2 Type: PfdDataForApp

**Table 5.6.2.2-1: Definition of type PfdDataForApp**

Attribute name	Data type	P	Cardinality	Description	Applicability
applicationId	ApplicationId	M	1	Identifier of an application.	
pfds	array(PfdContent)	C	1..N	PFDs for the application identifier.	
cachingTime	DateTime	O	0..1	Caching time for an application identifier.	
cachingTimer	DurationSec	O	0..1	Caching timer for an application identifier expressed as duration with unit of second.	CachingTimer
pfdTimestamp	DateTime	O	0..1	The value represents the UTC time set for the PFD(s) of the application identifier provisioning by the PFD.	PartialPull
partialFlag	boolean	O	0..1	Indication of partial update of PFDs for an existing application identifier if it is included and set to "true". Otherwise set to "false" indicates not supporting partial update of PFDs for an existing application identifier. The default value "false" applies if the attribute is not present.	PartialPull
supportedFeatures	SupportedFeatures	C	0..1	Used to negotiate the applicability of the optional features.  This attribute shall be present in in the HTTP GET response if the "supported-features" attribute query parameter is included in the HTTP GET request.	
NOTE: The "pfd" attribute shall be included if the "PartialPull" feature is not supported.					

### 5.6.2.3 Type: PfdSubscription

**Table 5.6.2.3-1: Definition of type PfdSubscription**

Attribute name	Data type	P	Cardinality	Description	Applicability
applicationIds	array(ApplicationId)	O	1..N	Identifiers of applications with PFDs change.	
notifyUri	Uri	M	1	Identifies the recipient of notifications sent by PFD for this subscription.	
supportedFeatures	SupportedFeatures	M	1	List of supported features used as described in clause 5.8.	

## 5.6.2.4 Type: PfdChangeNotification

Table 5.6.2.4-1: Definition of type PfdChangeNotification

Attribute name	Data type	P	Cardinality	Description	Applicability
applicationId	ApplicationId	M	1	Identifier of an application.	
removalFlag	boolean	O	0..1	Indication of removal of PFDs for an existing application identifier. Set to "true" indicates the PFDs are removed. Set to "false" indicates the PFDs are not removed. Default value is "false" if omitted.	
partialFlag	boolean	O	0..1	Indication of partial update of PFDs for an existing application identifier if this operation is supported according to feature negotiation. Set to "true" indicates partial update of PFDs for the included application identifier. Set to "false" indicates not partial update of PFDs for the included application identifier. Default value is "false" if omitted.	PartialUpdate
pfd	array(PfdContent )	O	1..N	PFD creation/update for the application identifier as specified in clause 6.3.3.5 of 3GPP TS 29.251 [12].	

## 5.6.2.5 Type: PfdContent

Table 5.6.2.5-1: Definition of type PfdContent

Attribute name	Data type	P	Cardinality	Description	Applicability
pfdId	string	C	0..1	Identifies a PFD of an application identifier. If PartialUpdate or PartialPull feature is supported, this attribute shall be provided by the PFD.	
flowDescriptions	array(string)	O	1..N	Represents a 3-tuple with protocol, server ip and server port for UL/DL application traffic. The content of the string has the same encoding as the IPFilterRule AVP value as defined in IETF RFC 6733 [18]. (NOTE)	
urls	array(string)	O	1..N	Indicates a URL or a regular expression which is used to match the significant parts of the URL. (NOTE)	
domainNames	array(string)	O	1..N	Indicates an FQDN or a regular expression as a domain name matching criteria. (NOTE)	
dnProtocol	DomainNameProtocol	C	0..1	Indicates the additional protocol and protocol field for domain names to be matched, it may only be provided when domainNames attribute is present.	DomainNameProtocol
NOTE: If a PFD contains multiple filter types, the PFD is only matched when every filter type contained in the PFD has a matching value.					



## 5.6.2.6 Type: PfdChangeReport

Table 5.6.2.6-1: PfdChangeReport

Attribute name	Data type	P	Cardinality	Description	Applicability
pfdError	ProblemDetails	M	1	More information on the error shall be provided in the "cause" attribute of the "ProblemDetails" structure. The "cause" attribute in the ProblemDetails shall be set to one of following application errors (see table 5.2.7.1-1 of 3GPP TS 29.500 [5]): - SYSTEM_FAILURE - INSUFFICIENT_RESOURCES - UNSPECIFIED_NF_FAILURE	
applicationId	array(ApplicationId)	M	1..N	Indicates the application identifier(s) which PFD(s) are failed to be added or modified.	

## 5.6.2.7 Type: NotificationPush

Table 5.6.2.7-1: Definition of type NotificationPush

Attribute name	Data type	P	Cardinality	Description	Applicability
applds	array(ApplicationId)	M	1..N	Identifiers of one or more applications.	
allowedDelay	DurationSec	O	0..1	Indicates the time limit that the NF service consumer shall retrieve the PFD(s).	
pfdOp	PfdOperation	O	0..1	Indication the operation of the PFDs.	

## 5.6.2.8 Type: ApplicationForPfdRequest

Table 5.6.2.8-1: Definition of ApplicationForPfdRequest

Attribute name	Data type	P	Cardinality	Description	Applicability
applicationId	ApplicationId	M	1	Identifier of an application.	
pfdTimestamp	DateTime	O	1	The value represents the UTC time set for the PFD(s) of the application identifier provisioning by the PFD.	

## 5.6.3 Simple data types and enumerations

## 5.6.3.1 Introduction

This clause defines simple data types and enumerations that can be referenced from data structures defined in the previous clauses.

## 5.6.3.2 Simple data types

The simple data types defined in table 5.6.3.2-1 shall be supported.

**Table 5.6.3.2-1: Simple data types**

Type Name	Type Definition	Description	Applicability

### 5.6.3.3 Enumeration: PfdOperation

**Table 5.6.3.3-1: Enumeration PfdOperation**

Enumeration value	Description	Applicability
RETRIEVE	Indicates to retrieve the PFD(s) for the application identifier(s). The NF service consumer determines which pull procedure can be applied to retrieve the PFD(s).	
FULLPULL	Indicates to retrieve the PFD(s) for the application identifier(s) by the full pull procedure.	
PARTIALPULL	Indicates to retrieve the PFD(s) for the application identifier(s) by the partial pull procedure. The NF consumer may decide to use full pull procedure instead if needed.	
REMOVE	Indicates to remove the PFD(s) for the application identifier(s).	

## 5.7 Error handling

### 5.7.1 General

HTTP error handling shall be supported as specified in clause 5.2.4 of 3GPP TS 29.500 [5].

For the Nnef\_PFDmanagement API, HTTP error responses shall be supported as specified in clause 4.8 of 3GPP TS 29.501 [6].

Protocol errors and application errors specified in table 5.2.7.2-1 of 3GPP TS 29.500 [5] shall be supported for an HTTP method if the corresponding HTTP status codes are specified as mandatory for that HTTP method in table 5.2.7.1-1 of 3GPP TS 29.500 [5].

In addition, the requirements in the following clauses shall apply.

### 5.7.2 Protocol Errors

In this Release of the specification, there are no additional protocol errors applicable for the Nnef\_PFDmanagement API.

### 5.7.3 Application Errors

The application errors defined for the Nnef\_PFDmanagement service are listed in table 5.7.3-1.

**Table 5.7.3-1: Application errors**

Application Error	HTTP status code	Description
SYSTEM_FAILURE	500 Internal Server Error	Something functions wrongly in PFD provisioning or the PFD provisioning does not function at all. (NOTE)
INSUFFICIENT_RESOURCE	500 Internal Server Error	There is limitation for resource storage. (NOTE)
UNSPECIFIED_NF_FAILURE	500 Internal Server Error	Unspecified reason. (NOTE)
NOTE: This application error is included in the responses to the POST request of PFD change notification.		

## 5.8 Feature negotiation

The optional features in table 5.8-1 are defined for the Nnef\_PFDmanagement API. They shall be negotiated using the extensibility mechanism defined in clause 6.6 of 3GPP TS 29.500 [5].

**Table 5.8-1: Supported Features**

Feature number	Feature Name	Description
1	PartialUpdate	The PFDF can use this feature for partial update of PFDs.
2	DomainNameProtocol	This feature supports the additional protocol matching condition for the domain name in PFD data.
3	PfdChgSubsUpdate	The NF service consumer can use this feature for updating the PFD change subscription.
4	ES3XX	Extended Support for 3xx redirections. This feature indicates the support of redirection for any service operation, according to Stateless NF procedures as specified in clauses 6.5.3.2 and 6.5.3.3 of 3GPP TS 29.500 [5] and according to HTTP redirection principles for indirect communication, as specified in clause 6.10.9 of 3GPP TS 29.500 [5].
5	PartialPull	The NF service consumer can use this feature to retrieve the PFDs by the partial update.
6	NotificationPush	The PFDF can use this feature to notify the NF service consumer to retrieve the PFDs.
7	CachingTimer	The PFDF and the NF service consumer can use this feature to support caching timer with unit of duration second.

## 5.9 Security

As indicated in 3GPP TS 33.501 [14] and 3GPP TS 29.500 [5], the access to the Nnef\_PFDmanagement API may be authorized by means of the OAuth2 protocol (see IETF RFC 6749 [15]), based on local configuration, using the "Client Credentials" authorization grant, where the NRF (see 3GPP TS 29.510 [13]) plays the role of the authorization server.

If OAuth2 is used, an NF service consumer, prior to consuming services offered by the Nnef\_PFDmanagement API, shall obtain a "token" from the authorization server, by invoking the Access Token Request service, as described in 3GPP TS 29.510 [13], clause 5.4.2.2.

**NOTE:** When multiple NRFs are deployed in a network, the NRF used as authorization server is the same NRF that the NF service consumer used for discovering the Nnef\_PFDmanagement service.

The Nnef\_PFDmanagement API defines a single scope "nnef-pfdmanagement" for OAuth2 authorization (as specified in 3GPP TS 33.501 [14]) for the entire service, and it does not define any additional scopes at resource or operation level.

# Annex A (normative): OpenAPI specification

## A.1 General

The present Annex contains an OpenAPI [9] specification of HTTP messages and content bodies used by the Nnef\_PFDmanagement API.

This Annex shall take precedence when being discrepant to other parts of the specification with respect to the encoding of information elements and methods within the API.

**NOTE:** The semantics and procedures, as well as conditions, e.g. for the applicability and allowed combinations of attributes or values, not expressed in the OpenAPI definitions but defined in other parts of the specification also apply.

Informative copies of the OpenAPI specification file contained in this 3GPP Technical Specification are available on a Git-based repository that uses the GitLab software version control system (see clause 5B of the 3GPP TR 21.900 [17] and clause 5.3.1 of the 3GPP TS 29.501 [6] for further information):

## A.2 Nnef\_PFDmanagement API

```

openapi: 3.0.0
info:
  title: Nnef_PFDmanagement Service API
  version: 1.2.2
  description: |
    Packet Flow Description Management Service.
    © 2023, 3GPP Organizational Partners (ARIB, ATIS, CCSA, ETSI, TSDSI, TTA, TTC).
    All rights reserved.
#
externalDocs:
  description: 3GPP TS 29.551 v17.9.0, 5G System; Packet Flow Description Management Service
  url: 'https://www.3gpp.org/ftp/Specs/archive/29_series/29.551/'
#
servers:
  - url: '{apiRoot}/nnef-pfdmanagement/v1'
    variables:
      apiRoot:
        default: https://example.com
        description: apiRoot as defined in clause 4.4 of 3GPP TS 29.501
security:
  - {}
  - oAuth2ClientCredentials:
      - nnef-pfdmanagement
paths:
  /applications:
    get:
      summary: Retrieve PFDs for all applications or for one or multiple applications with query
parameter.
      tags:
        - PFD of applications
      operationId: Nnef_PFDmanagement_AllFetch
      parameters:
        - name: application-ids
          description: The required application identifier(s) for the returned PFDs.
          in: query
          required: true
          schema:
            type: array
            items:
              $ref: 'TS29571_CommonData.yaml#/components/schemas/ApplicationId'
            minItems: 1
        - name: supported-features
          in: query
          description: To filter irrelevant responses related to unsupported features
          schema:
            $ref: 'TS29571_CommonData.yaml#/components/schemas/SupportedFeatures'

```

```

responses:
  '200':
    description: >
      The PFDs for one or more application identifier(s) in the request URI are returned.
    content:
      application/json:
        schema:
          type: array
          items:
            $ref: '#/components/schemas/PfdDataForApp'
          minItems: 0
  '400':
    $ref: 'TS29571_CommonData.yaml#/components/responses/400'
  '401':
    $ref: 'TS29571_CommonData.yaml#/components/responses/401'
  '403':
    $ref: 'TS29571_CommonData.yaml#/components/responses/403'
  '404':
    $ref: 'TS29571_CommonData.yaml#/components/responses/404'
  '406':
    $ref: 'TS29571_CommonData.yaml#/components/responses/406'
  '414':
    $ref: 'TS29571_CommonData.yaml#/components/responses/414'
  '429':
    $ref: 'TS29571_CommonData.yaml#/components/responses/429'
  '500':
    $ref: 'TS29571_CommonData.yaml#/components/responses/500'
  '503':
    $ref: 'TS29571_CommonData.yaml#/components/responses/503'
  default:
    $ref: 'TS29571_CommonData.yaml#/components/responses/default'

/applications/partialpull:
  post:
    summary: retrieve the PFD(s) by partial update
    operationId: Nnef_PFDmanagement_AppFetchPartialUpdate
    tags:
      - PFD of applications by partial update
    requestBody:
      required: true
      content:
        application/json:
          schema:
            type: array
            items:
              $ref: '#/components/schemas/ApplicationForPfdRequest'
            minItems: 1
    responses:
      '200':
        description: OK. Changed PFD(s) is returned
        content:
          application/json:
            schema:
              type: array
              items:
                $ref: '#/components/schemas/PfdDataForApp'
              minItems: 1
      '204':
        description: The PFD(s) is not changed
      '400':
        $ref: 'TS29571_CommonData.yaml#/components/responses/400'
      '401':
        $ref: 'TS29571_CommonData.yaml#/components/responses/401'
      '403':
        $ref: 'TS29571_CommonData.yaml#/components/responses/403'
      '404':
        $ref: 'TS29571_CommonData.yaml#/components/responses/404'
      '411':
        $ref: 'TS29571_CommonData.yaml#/components/responses/411'
      '413':
        $ref: 'TS29571_CommonData.yaml#/components/responses/413'
      '415':
        $ref: 'TS29571_CommonData.yaml#/components/responses/415'
      '429':
        $ref: 'TS29571_CommonData.yaml#/components/responses/429'
      '500':
        $ref: 'TS29571_CommonData.yaml#/components/responses/500'
      '503':

```

```

    $ref: 'TS29571_CommonData.yaml#/components/responses/503'
  default:
    $ref: 'TS29571_CommonData.yaml#/components/responses/default'

/applications/{appId}:
  get:
    summary: Retrieve the PFD for an application.
    tags:
      - Individual application PFD
    operationId: Nnef_PFDmanagement_IndAppFetch
    parameters:
      - name: appId
        description: The required application identifier(s) for the returned PFDs.
        in: path
        required: true
        schema:
          type: string
      - name: supported-features
        in: query
        description: To filter irrelevant responses related to unsupported features
        schema:
          $ref: 'TS29571_CommonData.yaml#/components/schemas/SupportedFeatures'
    responses:
      '200':
        description: A representation of PFDs for an application in the request URI is returned.
        content:
          application/json:
            schema:
              $ref: '#/components/schemas/PfdDataForApp'
      '307':
        $ref: 'TS29571_CommonData.yaml#/components/responses/307'
      '308':
        $ref: 'TS29571_CommonData.yaml#/components/responses/308'
      '400':
        $ref: 'TS29571_CommonData.yaml#/components/responses/400'
      '401':
        $ref: 'TS29571_CommonData.yaml#/components/responses/401'
      '403':
        $ref: 'TS29571_CommonData.yaml#/components/responses/403'
      '404':
        $ref: 'TS29571_CommonData.yaml#/components/responses/404'
      '406':
        $ref: 'TS29571_CommonData.yaml#/components/responses/406'
      '429':
        $ref: 'TS29571_CommonData.yaml#/components/responses/429'
      '414':
        $ref: 'TS29571_CommonData.yaml#/components/responses/414'
      '500':
        $ref: 'TS29571_CommonData.yaml#/components/responses/500'
      '503':
        $ref: 'TS29571_CommonData.yaml#/components/responses/503'
    default:
      $ref: 'TS29571_CommonData.yaml#/components/responses/default'

/subscriptions:
  post:
    summary: Subscribe the notification of PFD changes.
    tags:
      - PFD subscriptions
    operationId: Nnef_PFDmanagement_CreateSubscr
    requestBody:
      description: a PfdSubscription resource to be created.
      required: true
      content:
        application/json:
          schema:
            $ref: '#/components/schemas/PfdSubscription'
    callbacks:
      PfdChangeNotification:
        '{request.body#/notifyUri}':
          post:
            summary: Notification of PFD change.
            tags:
              - PfdChangeNotification data
            operationId: Nnef_PFDmanagement_Notify
            requestBody:
              required: true
              content:

```

```

    application/json:
      schema:
        type: array
        items:
          $ref: '#/components/schemas/PfdChangeNotification'
        minItems: 1
  responses:
    '200':
      description: >
        The PFD operation in the notification is performed and the
        PfdChangeReport indicates failure reason.
      content:
        application/json:
          schema:
            type: array
            items:
              $ref: '#/components/schemas/PfdChangeReport'
            minItems: 1
    '204':
      description: The PFD operation in the notification is performed successfully.
    '307':
      $ref: 'TS29571_CommonData.yaml#/components/responses/307'
    '308':
      $ref: 'TS29571_CommonData.yaml#/components/responses/308'
    '400':
      $ref: 'TS29571_CommonData.yaml#/components/responses/400'
    '401':
      $ref: 'TS29571_CommonData.yaml#/components/responses/401'
    '403':
      $ref: 'TS29571_CommonData.yaml#/components/responses/403'
    '404':
      $ref: 'TS29571_CommonData.yaml#/components/responses/404'
    '411':
      $ref: 'TS29571_CommonData.yaml#/components/responses/411'
    '413':
      $ref: 'TS29571_CommonData.yaml#/components/responses/413'
    '415':
      $ref: 'TS29571_CommonData.yaml#/components/responses/415'
    '429':
      $ref: 'TS29571_CommonData.yaml#/components/responses/429'
    '500':
      $ref: 'TS29571_CommonData.yaml#/components/responses/500'
    '503':
      $ref: 'TS29571_CommonData.yaml#/components/responses/503'
    default:
      $ref: 'TS29571_CommonData.yaml#/components/responses/default'

NotificationPush:
  '{request.body#/notifyUri}/notifypush':
    post:
      summary: Notification Push.
      tags:
        - NotificationPush data
      operationId: Nnef_PFDmanagement_PushNotify
      requestBody:
        required: true
        content:
          application/json:
            schema:
              type: array
              items:
                $ref: '#/components/schemas/NotificationPush'
              minItems: 1
      responses:
        '204':
          description: Notificaiton PUSH is accepted.
        '307':
          $ref: 'TS29571_CommonData.yaml#/components/responses/307'
        '308':
          $ref: 'TS29571_CommonData.yaml#/components/responses/308'
        '400':
          $ref: 'TS29571_CommonData.yaml#/components/responses/400'
        '401':
          $ref: 'TS29571_CommonData.yaml#/components/responses/401'
        '403':
          $ref: 'TS29571_CommonData.yaml#/components/responses/403'
        '404':
          $ref: 'TS29571_CommonData.yaml#/components/responses/404'

```

```

    '411':
      $ref: 'TS29571_CommonData.yaml#/components/responses/411'
    '413':
      $ref: 'TS29571_CommonData.yaml#/components/responses/413'
    '415':
      $ref: 'TS29571_CommonData.yaml#/components/responses/415'
    '429':
      $ref: 'TS29571_CommonData.yaml#/components/responses/429'
    '500':
      $ref: 'TS29571_CommonData.yaml#/components/responses/500'
    '503':
      $ref: 'TS29571_CommonData.yaml#/components/responses/503'
    default:
      $ref: 'TS29571_CommonData.yaml#/components/responses/default'

responses:
  '201':
    description: >
      The creation of a PfdSubscription resource is confirmed and a representation of
      that resource is returned.
    content:
      application/json:
        schema:
          $ref: '#/components/schemas/PfdSubscription'
    headers:
      Location:
        description: >
          Contains the URI of the newly created resource, according to the structure
          {apiRoot}/nnef-pfdmanagement/v1/subscriptions/{subscriptionId}
        required: true
        schema:
          type: string
  '400':
    $ref: 'TS29571_CommonData.yaml#/components/responses/400'
  '401':
    $ref: 'TS29571_CommonData.yaml#/components/responses/401'
  '403':
    $ref: 'TS29571_CommonData.yaml#/components/responses/403'
  '404':
    $ref: 'TS29571_CommonData.yaml#/components/responses/404'
  '411':
    $ref: 'TS29571_CommonData.yaml#/components/responses/411'
  '413':
    $ref: 'TS29571_CommonData.yaml#/components/responses/413'
  '415':
    $ref: 'TS29571_CommonData.yaml#/components/responses/415'
  '429':
    $ref: 'TS29571_CommonData.yaml#/components/responses/429'
  '500':
    $ref: 'TS29571_CommonData.yaml#/components/responses/500'
  '503':
    $ref: 'TS29571_CommonData.yaml#/components/responses/503'
  default:
    $ref: 'TS29571_CommonData.yaml#/components/responses/default'

/subscriptions/{subscriptionId}:
  put:
    summary: Updates/replaces an existing subscription resource
    tags:
      - Individual PFD subscription
    operationId: Nnef_PFDmanagement_ModifySubscr
    parameters:
      - name: subscriptionId
        description: Identify the subscription.
        in: path
        required: true
        schema:
          type: string
    requestBody:
      description: Parameters to update/replace the existing subscription
      required: true
      content:
        application/json:
          schema:
            $ref: '#/components/schemas/PfdSubscription'
    responses:
      '200':
        description: OK (Successful update of the subscription)

```



```

    content:
      application/json:
        schema:
          $ref: '#/components/schemas/PfdSubscription'
    '307':
      $ref: 'TS29571_CommonData.yaml#/components/responses/307'
    '308':
      $ref: 'TS29571_CommonData.yaml#/components/responses/308'
    '400':
      $ref: 'TS29571_CommonData.yaml#/components/responses/400'
    '401':
      $ref: 'TS29571_CommonData.yaml#/components/responses/401'
    '403':
      $ref: 'TS29571_CommonData.yaml#/components/responses/403'
    '404':
      $ref: 'TS29571_CommonData.yaml#/components/responses/404'
    '411':
      $ref: 'TS29571_CommonData.yaml#/components/responses/411'
    '413':
      $ref: 'TS29571_CommonData.yaml#/components/responses/413'
    '415':
      $ref: 'TS29571_CommonData.yaml#/components/responses/415'
    '429':
      $ref: 'TS29571_CommonData.yaml#/components/responses/429'
    '500':
      $ref: 'TS29571_CommonData.yaml#/components/responses/500'
    '503':
      $ref: 'TS29571_CommonData.yaml#/components/responses/503'
  default:
    $ref: 'TS29571_CommonData.yaml#/components/responses/default'

delete:
  summary: Delete a subscription of PFD change notification.
  tags:
    - Individual PFD subscription
  operationId: Nnef_PFDmanagement_Unsubscribe
  parameters:
    - name: subscriptionId
      description: Identify the subscription.
      in: path
      required: true
      schema:
        type: string
  responses:
    '204':
      description: >
        The PfdSubscription resource matching the subscriptionId was deleted successfully.
    '307':
      $ref: 'TS29571_CommonData.yaml#/components/responses/307'
    '308':
      $ref: 'TS29571_CommonData.yaml#/components/responses/308'
    '400':
      $ref: 'TS29571_CommonData.yaml#/components/responses/400'
    '401':
      $ref: 'TS29571_CommonData.yaml#/components/responses/401'
    '403':
      $ref: 'TS29571_CommonData.yaml#/components/responses/403'
    '404':
      $ref: 'TS29571_CommonData.yaml#/components/responses/404'
    '429':
      $ref: 'TS29571_CommonData.yaml#/components/responses/429'
    '500':
      $ref: 'TS29571_CommonData.yaml#/components/responses/500'
    '503':
      $ref: 'TS29571_CommonData.yaml#/components/responses/503'
  default:
    $ref: 'TS29571_CommonData.yaml#/components/responses/default'

components:
  securitySchemes:
    oAuth2ClientCredentials:
      type: oauth2
      flows:
        clientCredentials:
          tokenUrl: '{nrfApiRoot}/oauth2/token'
          scopes:
            nnef-pfdmanagement: Access to the Nnef_PFDmanagement API
  schemas:

```

```

#
# STRUCTURED DATA TYPES
#
PfdContent:
  description: Represents the content of a PFD for an application identifier.
  type: object
  properties:
    pfdId:
      type: string
      description: Identifies a PDF of an application identifier.
    flowDescriptions:
      type: array
      items:
        type: string
      minItems: 1
      description: >
        Represents a 3-tuple with protocol, server ip and server port for UL/DL
        application traffic.
    urls:
      type: array
      items:
        type: string
      minItems: 1
      description: >
        Indicates a URL or a regular expression which is used to match the significant parts
        of the URL.
    domainNames:
      type: array
      items:
        type: string
      minItems: 1
      description: Indicates an FQDN or a regular expression as a domain name matching criteria.
    dnProtocol:
      $ref: 'TS29122_PfdManagement.yaml#/components/schemas/DomainNameProtocol'

PfdDataForApp:
  description: Represents the PFDs for an application identifier.
  type: object
  properties:
    applicationId:
      $ref: 'TS29571_CommonData.yaml#/components/schemas/ApplicationId'
    pfd:
      type: array
      items:
        $ref: '#/components/schemas/PfdContent'
      minItems: 1
    cachingTime:
      $ref: 'TS29571_CommonData.yaml#/components/schemas/DateTime'
    cachingTimer:
      $ref: 'TS29571_CommonData.yaml#/components/schemas/DurationSec'
    pfdTimestamp:
      $ref: 'TS29571_CommonData.yaml#/components/schemas/DateTime'
    partialFlag:
      type: boolean
      description: >
        Indication of partial update of PFDs for an existing application identifier if it is
        included and set to true. Otherwise set to false indicates not supporting partial
        update of PFDs for an existing application identifier. The default value false
        applies if the attribute is not present.
      default: false
    supportedFeatures:
      $ref: 'TS29571_CommonData.yaml#/components/schemas/SupportedFeatures'
  required:
    - applicationId

PfdSubscription:
  description: Represents a PFD subscription.
  type: object
  properties:
    applicationIds:
      type: array
      items:
        $ref: 'TS29571_CommonData.yaml#/components/schemas/ApplicationId'
      minItems: 1
    notifyUri:
      $ref: 'TS29571_CommonData.yaml#/components/schemas/Uri'
    supportedFeatures:
      $ref: 'TS29571_CommonData.yaml#/components/schemas/SupportedFeatures'

```

```

required:
- notifyUri
- supportedFeatures

PfdChangeNotification:
description: Represents information related to a notification of PFD change.
type: object
properties:
  applicationId:
    $ref: 'TS29571_CommonData.yaml#/components/schemas/ApplicationId'
  removalFlag:
    type: boolean
    description: >
      Indication of removal of PFDs for an existing application identifier.
      Set to true indicates the PFDs are removed.
      Set to false indicates the PFDs are not removed.
      Default value is false if omitted.
    default: false
  partialFlag:
    type: boolean
    description: >
      Indication of partial update of PFDs for an existing application identifier
      if this operation is supported according to feature negotiation.
      Set to true indicates partial update PFDs for the included application identifier.
      Set to false indicates not partial update PFDs for the included application identifier.
      Default value is "false" if omitted.
    default: false
  pfd:
    type: array
    items:
      $ref: '#/components/schemas/PfdContent'
    minItems: 1
required:
- applicationId

NotificationPush:
description: >
  Represents the information to be used by the NF service consumer to retrieve the
  PFDs and/or remove the PFDs of the applicable application identifier(s).
type: object
properties:
  appIds:
    type: array
    items:
      $ref: 'TS29571_CommonData.yaml#/components/schemas/ApplicationId'
    minItems: 1
  allowedDelay:
    $ref: 'TS29571_CommonData.yaml#/components/schemas/DurationSec'
  pfdOp:
    $ref: '#/components/schemas/PfdOperation'
required:
- appIds

PfdChangeReport:
description: Represents an error report on PFD change.
type: object
properties:
  pfdError:
    $ref: 'TS29571_CommonData.yaml#/components/schemas/ProblemDetails'
  applicationId:
    type: array
    items:
      $ref: 'TS29571_CommonData.yaml#/components/schemas/ApplicationId'
    minItems: 1
required:
- pfdError
- applicationId

PfdOperation:
description: Indicates the operation to be applied on PFD(s).
anyOf:
- type: string
  enum:
    - RETRIEVE
    - FULLPULL
    - PARTIALPULL
    - REMOVE
- type: string

```

```
ApplicationForPfdRequest:
  description: Contains the application identifier(s) for the PFD(s) request.
  type: object
  properties:
    applicationId:
      $ref: 'TS29571_CommonData.yaml#/components/schemas/ApplicationId'
    pfdTimestamp:
      $ref: 'TS29571_CommonData.yaml#/components/schemas/DateTime'
  required:
    - applicationId
```

## Annex B (informative): Change history

Change history							
Date	Meeting	TDoc	CR	Rev	Cat	Subject/Comment	New version
2018-01						TS skeleton of PFD Management Service specification	0.0.0
2018-01	CT3#94					Includes the following contribution agreed by CT3 at CT3#94: C3-180045, C3-180270, C3-180271.	0.1.0
2018-03	CT3#95					Includes the following contribution agreed by CT3 at CT3#95: C3-181100, C3-181262, C3-181102, C3-181103, C3-181314.	0.2.0
2018-04	CT3#96					Includes the following contribution agreed by CT3 at CT3#96: C3-182153, C3-182411, C3-182412, C3-182413, C3-182414, C3-182477, C3-182478.	0.3.0
2018-05	CT3#97					Includes the following contribution agreed by CT3 at CT3#97: C3-183115, C3-183557, C3-183558, C3-183560.	0.4.0
2018-06	CT#80	CP-181029				TS sent to plenary for approval	1.0.0
2018-06	CT#80	CP-181029				TS approved by plenary	15.0.0
2018-09	CT#81	CP-182015	0001	2	F	Protocol error statement	15.1.0
2018-09	CT#81	CP-182015	0002	1	F	Description of Structured data types	15.1.0
2018-12	CT#82	CP-183205	0003		F	Default value for apiRoot	15.2.0
2018-12	CT#82	CP-183205	0004	3	F	Cardinality	15.2.0
2018-12	CT#82	CP-183205	0005	1	F	Correct Nnef_PFDmanagement API	15.2.0
2018-12	CT#82	CP-183205	0006		F	Location Header	15.2.0
2018-12	CT#82	CP-183205	0007	1	F	Alignment of openAPI	15.2.0
2018-12	CT#82	CP-183205	0008		F	API version update	15.2.0
2018-12	CT#82	CP-183205	0009		F	Security	15.2.0
2018-12	CT#82	CP-183205	0010		F	Content type	15.2.0
2019-03	CT#83	CP-190116	0011	1	F	Fetch PFD for all applications	15.3.0
2019-03	CT#83	CP-190116	0014	1	F	Correction of resource URIs	15.3.0
2019-03	CT#83	CP-190130	0010	1	B	PUT for PFD change subscription	16.0.0
2019-03	CT#83	CP-190121	0012	3	B	PFD extension	16.0.0
2019-03	CT#83					Open API version update by MCC	16.0.0
2019-06	CT#84	CP-191083	0016	2	A	Precedence of OpenAPI file	16.1.0
2019-06	CT#84	CP-191083	0019		A	Correction to Notification of PFD change	16.1.0
2019-06	CT#84	CP-191083	0021		A	Copyright Note in YAML file	16.1.0
2019-06	CT#84	CP-191101	0023	2	F	API version Update	16.1.0
2019-09	CT#85	CP-192149	0025	2	A	Correct presence condition in PFD definition	16.2.0
2020-03	CT#87e	CP-200215	0026		F	Reference of Error code	16.3.0
2020-03	CT#87e	CP-200216	0027		F	Update of OpenAPI version and TS version in externalDocs field	16.3.0
2020-06	CT#88e	CP-201244	0028		F	Non-unique operation identifiers	16.4.0
2020-06	CT#88e	CP-201244	0029	1	F	Storage of YAML files in ETSI Forge	16.4.0
2020-06	CT#88e	CP-201256	0030	1	F	URI of the Nnef_PFDmanagement service	16.4.0
2020-06	CT#88e	CP-201244	0031	1	F	Optionality of ProblemDetails	16.4.0
2020-06	CT#88e	CP-201244	0032	1	F	Supported headers, Resource Data type and yaml mapping	16.4.0
2020-06	CT#88e	CP-201255	0033		F	Update of OpenAPI version and TS version in externalDocs field	16.4.0
2020-09	CT#89e	CP-202056	0035		A	Correction to the PFD change notification	16.5.0
2020-09	CT#89e	CP-202205	0038	2	B	Notification PUSH	17.0.0
2020-09	CT#89e	CP-202085	0039		F	Update of OpenAPI version and TS version in externalDocs field	17.0.0
2020-12	CT#90e	CP-203078	0041	2	A	Essential corrections and alignments	17.1.0
2020-12	CT#90e	CP-203135	0042	1	F	Corrections to Notification Push procedure	17.1.0
2020-12	CT#90e	CP-203120	0046	1	A	Correction to PFD retrieval in PULL mode	17.1.0
2020-12	CT#90e	CP-203120	0049		A	Correction to notification URI of PFD change notification	17.1.0
2020-12	CT#90e	CP-203135	0050	1	B	PULL mode enhancement	17.1.0
2020-12	CT#90e	CP-203135	0051	1	B	Remove the EN within the PushNotification	17.1.0
2020-12	CT#90e	CP-203139	0053	1	A	Storage of YAML files in 3GPP Forge	17.1.0
2020-12	CT#90e	CP-203135	0054		F	NotificationPush data type definition	17.1.0
2020-12	CT#90e	CP-203141	0055	1	F	Non-unique operation identifiers	17.1.0
2020-12	CT#90e	CP-203153	0056		F	Update of OpenAPI version and TS version in externalDocs field	17.1.0
2021-03	CT#91e	CP-210191	0058	1	A	Support of stateless NFs	17.2.0
2021-03	CT#91e	CP-210215	0059	5	B	Resolve the FFS for notification push	17.2.0
2021-03	CT#91e	CP-210215	0060	3	B	Partial pull update	17.2.0
2021-03	CT#91e	CP-210215	0061	5	F	Corrections on partial pull	17.2.0
2021-03	CT#91e	CP-210218	0062		F	OpenAPI reference	17.2.0
2021-03	CT#91e	CP-210222	0064	1	A	notifyUri used by notification	17.2.0
2021-03	CT#91e	CP-210215	0065		F	Invalid Nnef_PFDmanagement OpenAPI file	17.2.0
2021-03	CT#91e	CP-210215	0066		B	Correction to the name of custom operation	17.2.0
2021-03	CT#91e	CP-210215	0067	1	B	Overall description of notification push	17.2.0
2021-03	CT#91e	CP-210219	0069		F	Adding some missing description fields to data type definitions in OpenAPI specification files	17.2.0
2021-03	CT#91e	CP-210200	0072		A	Datatype and figure corrections	17.2.0
2021-03	CT#91e	CP-210220	0073		F	Custom header clarification	17.2.0
2021-03	CT#91e	CP-210221	0074	1	F	Terminology alignment usage of NF service consumer	17.2.0
2021-03	CT#91e	CP-210240	0076		F	Update of OpenAPI version and TS version in externalDocs field	17.2.0
2021-06	CT#92e	CP-211208	0079	1	A	Correction of request URI in 4.2.2.2	17.3.0

2021-06	CT#92e	CP-211200	0081	1	A	Temporary and Permanent Redirection	17.3.0
2021-06	CT#92e	CP-211265	0083		F	Update of OpenAPI version and TS version in externalDocs field	17.3.0
2021-09	CT#93e	CP-212084	0084	1	F	Correction to custom operation partialpull	17.4.0
2021-09	CT#93e	CP-212217	0085	1	F	mandate the attribute pfdOp	17.4.0
2021-09	CT#93e	CP-212190	0088		A	default caching time value	17.4.0
2021-09	CT#93e	CP-212190	0091		A	Presentation condition of pfdId attribute	17.4.0
2021-09	CT#93e	CP-212223	0092		F	Update of OpenAPI version and TS version in externalDocs field	17.4.0
2021-12	CT#94e	CP-213239	0093		F	Aligning API URI with SBI template	17.5.0
2021-12	CT#94e	CP-213243	0094		F	Correction to presence condition of supportedFeatures in PfdSubscription	17.5.0
2021-12	CT#94e	CP-213215	0097	1	A	Correction to PFD management in push mode	17.5.0
2021-12	CT#94e	CP-213224	0099	1	A	Adding supported features in GET response	17.5.0
2021-12	CT#94e	CP-213246	0101		F	Update of OpenAPI version and TS version in externalDocs field	17.5.0
2022-03	CT#95e	CP-220201	0102	1	F	Description fields format alignment	17.6.0
2022-03	CT#95e	CP-220194	0103		F	Update of info and externalDocs fields	17.6.0
2022-06	CT#96	CP-221119	0106	1	F	Correcting the description of the encoding used for flow descriptions	17.7.0
2022-06	CT#96	CP-221152	0107		F	Update of info and externalDocs fields	17.7.0
2022-09	CT#97e	CP-222122	0108	1	F	Corrections to caching timer	17.8.0
2022-09	CT#97e	CP-222121	0109		F	Update of info and externalDocs fields	17.8.0
2022-12	CT#102	CP-233278	0116		F	Corrections to boolean type definitions	17.9.0
2022-12	CT#102	CP-233260	0119		F	Update of info and externalDocs fields	17.9.0

---

# History

<b>Document history</b>		
V17.6.0	May 2022	Publication
V17.7.0	July 2022	Publication
V17.8.0	September 2022	Publication
V17.9.0	January 2024	Publication