

# ETSI TS 129 552 V17.4.0 (2023-04)



**5G;  
5G System;  
Network Data Analytics signalling flows;  
Stage 3  
(3GPP TS 29.552 version 17.4.0 Release 17)**



---

**Reference**

RTS/TSGC-0329552vh40

---

**Keywords**

5G

**ETSI**

650 Route des Lucioles  
F-06921 Sophia Antipolis Cedex - FRANCE

---

Tel.: +33 4 92 94 42 00 Fax: +33 4 93 65 47 16

Siret N° 348 623 562 00017 - APE 7112B  
Association à but non lucratif enregistrée à la  
Sous-Préfecture de Grasse (06) N° w061004871

---

**Important notice**

---

The present document can be downloaded from:

<https://www.etsi.org/standards-search>

The present document may be made available in electronic versions and/or in print. The content of any electronic and/or print versions of the present document shall not be modified without the prior written authorization of ETSI. In case of any existing or perceived difference in contents between such versions and/or in print, the prevailing version of an ETSI deliverable is the one made publicly available in PDF format at [www.etsi.org/deliver](http://www.etsi.org/deliver).

Users of the present document should be aware that the document may be subject to revision or change of status.

Information on the current status of this and other ETSI documents is available at

<https://portal.etsi.org/TB/ETSIDeliverableStatus.aspx>

If you find errors in the present document, please send your comment to one of the following services:

<https://portal.etsi.org/People/CommitteeSupportStaff.aspx>

If you find a security vulnerability in the present document, please report it through our  
Coordinated Vulnerability Disclosure Program:

<https://www.etsi.org/standards/coordinated-vulnerability-disclosure>

---

**Notice of disclaimer & limitation of liability**

---

The information provided in the present deliverable is directed solely to professionals who have the appropriate degree of experience to understand and interpret its content in accordance with generally accepted engineering or other professional standard and applicable regulations.

No recommendation as to products and services or vendors is made or should be implied.

No representation or warranty is made that this deliverable is technically accurate or sufficient or conforms to any law and/or governmental rule and/or regulation and further, no representation or warranty is made of merchantability or fitness for any particular purpose or against infringement of intellectual property rights.

In no event shall ETSI be held liable for loss of profits or any other incidental or consequential damages.

Any software contained in this deliverable is provided "AS IS" with no warranties, express or implied, including but not limited to, the warranties of merchantability, fitness for a particular purpose and non-infringement of intellectual property rights and ETSI shall not be held liable in any event for any damages whatsoever (including, without limitation, damages for loss of profits, business interruption, loss of information, or any other pecuniary loss) arising out of or related to the use of or inability to use the software.

---

**Copyright Notification**

---

No part may be reproduced or utilized in any form or by any means, electronic or mechanical, including photocopying and microfilm except as authorized by written permission of ETSI.

The content of the PDF version shall not be modified without the written authorization of ETSI.

The copyright and the foregoing restriction extend to reproduction in all media.

© ETSI 2023.  
All rights reserved.

---

# Intellectual Property Rights

## Essential patents

IPRs essential or potentially essential to normative deliverables may have been declared to ETSI. The declarations pertaining to these essential IPRs, if any, are publicly available for **ETSI members and non-members**, and can be found in ETSI SR 000 314: "*Intellectual Property Rights (IPRs); Essential, or potentially Essential, IPRs notified to ETSI in respect of ETSI standards*", which is available from the ETSI Secretariat. Latest updates are available on the ETSI Web server (<https://ipr.etsi.org/>).

Pursuant to the ETSI Directives including the ETSI IPR Policy, no investigation regarding the essentiality of IPRs, including IPR searches, has been carried out by ETSI. No guarantee can be given as to the existence of other IPRs not referenced in ETSI SR 000 314 (or the updates on the ETSI Web server) which are, or may be, or may become, essential to the present document.

## Trademarks

The present document may include trademarks and/or tradenames which are asserted and/or registered by their owners. ETSI claims no ownership of these except for any which are indicated as being the property of ETSI, and conveys no right to use or reproduce any trademark and/or tradename. Mention of those trademarks in the present document does not constitute an endorsement by ETSI of products, services or organizations associated with those trademarks.

**DECT™**, **PLUGTESTS™**, **UMTS™** and the ETSI logo are trademarks of ETSI registered for the benefit of its Members. **3GPP™** and **LTE™** are trademarks of ETSI registered for the benefit of its Members and of the 3GPP Organizational Partners. **oneM2M™** logo is a trademark of ETSI registered for the benefit of its Members and of the oneM2M Partners. **GSM®** and the GSM logo are trademarks registered and owned by the GSM Association.

---

# Legal Notice

This Technical Specification (TS) has been produced by ETSI 3rd Generation Partnership Project (3GPP).

The present document may refer to technical specifications or reports using their 3GPP identities. These shall be interpreted as being references to the corresponding ETSI deliverables.

The cross reference between 3GPP and ETSI identities can be found under <https://webapp.etsi.org/key/queryform.asp>.

---

# Modal verbs terminology

In the present document "**shall**", "**shall not**", "**should**", "**should not**", "**may**", "**need not**", "**will**", "**will not**", "**can**" and "**cannot**" are to be interpreted as described in clause 3.2 of the [ETSI Drafting Rules](#) (Verbal forms for the expression of provisions).

"**must**" and "**must not**" are **NOT** allowed in ETSI deliverables except when used in direct citation.

# Contents

Intellectual Property Rights .....	2
Legal Notice .....	2
Modal verbs terminology.....	2
Foreword.....	5
1 Scope .....	7
2 References .....	7
3 Definitions of terms, symbols and abbreviations .....	8
3.1 Terms.....	8
3.2 Symbols.....	9
3.3 Abbreviations .....	9
4 Reference Architecture for Data Analytics .....	9
4.1 General .....	9
4.2 Data Collection.....	10
4.3 Analytics Exposure.....	10
4.4 Data Storage and Retrieval.....	11
5 Signalling Flows for the Network Data Analytics Framework .....	12
5.1 General .....	12
5.2 Analytics Exposure Procedures .....	12
5.2.1 General.....	12
5.2.2 Network data analytics Subscribe/Unsubscribe/Notify.....	12
5.2.2.1 Analytics Subscribe/Unsubscribe/Notify initiated by 5GC NFs, OAM or AFs .....	12
5.2.2.2 Analytics Subscribe/Unsubscribe/Notify initiated by AFs via the NEF .....	13
5.2.3 Network data analytics information request .....	14
5.2.3.1 Analytics information request initiated by 5GC NFs, OAM or AFs.....	14
5.2.3.2 Analytics information request initiated by AFs via the NEF .....	15
5.2.4 Analytics Exposure via DCCF.....	15
5.2.5 Analytics Exposure via DCCF and MFAF .....	19
5.3 Analytics Aggregation from Multiple NWDAFs .....	24
5.3.1 General.....	24
5.3.2 Analytics aggregation with provisioning of Area of Interest .....	24
5.3.3 Analytics aggregation without provisioning of Area of Interest.....	26
5.4 Procedures for Analytics Transferring .....	27
5.4.1 Analytics context transfer initiated by target NWDAF selected by the NWDAF service consumer.....	27
5.4.2 Analytics Subscription Transfer initiated by source NWDAF.....	29
5.4.3 Prepared analytics subscription transfer .....	32
5.5 Data Collection.....	34
5.5.1 Procedure for Data Collection from NFs .....	34
5.5.1.1 Data Collection from NFs .....	34
5.5.2 Data collection profile registration .....	35
5.5.3 Procedure for Data Collection using DCCF .....	37
5.5.3.1 Data Collection via DCCF .....	37
5.5.3.2 Data Collection via Messaging Framework .....	40
5.6 ML Model provisioning procedures .....	45
5.6.1 General.....	45
5.6.2 ML Model Subscribe/Unsubscribe/Notify procedure .....	45
5.7 Procedures for Specific Network Data Analytics .....	46
5.7.1 General.....	46
5.7.2 Network Slice (Instance) load level Analytics.....	46
5.7.3 Observed Service Experience Analytics .....	49
5.7.4 NF load Analytics .....	52
5.7.5 Network Performance Analytics.....	55
5.7.6 UE Mobility Analytics.....	57
5.7.7 UE Communication Analytics .....	60

5.7.8	Expected UE behavioural Analytics .....	63
5.7.9	Abnormal UE behavioural Analytics .....	64
5.7.10	User Data Congestion Analytics .....	65
5.7.11	QoS Sustainability Analytics .....	68
5.7.12	Dispersion Analytics .....	69
5.7.13	WLAN Performance Analytics .....	72
5.7.14	Session Management Congestion Control Experience Analytics .....	74
5.7.15	Redundant Transmission Experience Analytics .....	75
5.7.16	DN Performance Analytics .....	78
5.8	Procedures for NWDAF Discovery and Selection .....	80
5.8.1	General .....	80
5.8.2	Procedures related to NRF .....	81
5.8.2.1	General .....	81
5.8.2.2	NWDAF Registration in NRF .....	81
5.8.2.3	Consumer discovery and selection of NWDAF in NRF .....	81
5.8.3	Procedures related to UDM .....	81
5.8.3.1	General .....	81
5.8.3.2	NWDAF containing AnLF Registration/Deregistration in UDM .....	81
5.8.3.2.1	NWDAF containing AnLF Registration in UDM .....	81
5.8.3.2.2	NWDAF containing AnLF Update of Registration in UDM .....	82
5.8.3.2.3	NWDAF containing AnLF De-Registration in UDM .....	82
5.8.3.3	Consumer discovery and selection of NWDAF containing AnLF in UDM .....	83
5.8.4	Procedures for PCF learning NWDAF IDs for served UEs .....	84
5.9	Analytics Data Repository procedures .....	84
5.9.1	General .....	84
5.9.2	Historical Data and Analytics Storage/Retrieval/Deletion procedure .....	85
5.9.3	Historical Data and Analytics Storage via Notifications .....	86
<b>Annex A (informative): Change history .....</b>		<b>89</b>
History .....		90

---

# Foreword

This Technical Specification has been produced by the 3rd Generation Partnership Project (3GPP).

The contents of the present document are subject to continuing work within the TSG and may change following formal TSG approval. Should the TSG modify the contents of the present document, it will be re-released by the TSG with an identifying change of release date and an increase in version number as follows:

Version x.y.z

where:

- x the first digit:
  - 1 presented to TSG for information;
  - 2 presented to TSG for approval;
  - 3 or greater indicates TSG approved document under change control.
- y the second digit is incremented for all changes of substance, i.e. technical enhancements, corrections, updates, etc.
- z the third digit is incremented when editorial only changes have been incorporated in the document.

In the present document, modal verbs have the following meanings:

- shall** indicates a mandatory requirement to do something
- shall not** indicates an interdiction (prohibition) to do something

The constructions "shall" and "shall not" are confined to the context of normative provisions, and do not appear in Technical Reports.

The constructions "must" and "must not" are not used as substitutes for "shall" and "shall not". Their use is avoided insofar as possible, and they are not used in a normative context except in a direct citation from an external, referenced, non-3GPP document, or so as to maintain continuity of style when extending or modifying the provisions of such a referenced document.

- should** indicates a recommendation to do something
- should not** indicates a recommendation not to do something
- may** indicates permission to do something
- need not** indicates permission not to do something

The construction "may not" is ambiguous and is not used in normative elements. The unambiguous constructions "might not" or "shall not" are used instead, depending upon the meaning intended.

- can** indicates that something is possible
- cannot** indicates that something is impossible

The constructions "can" and "cannot" are not substitutes for "may" and "need not".

- will** indicates that something is certain or expected to happen as a result of action taken by an agency the behaviour of which is outside the scope of the present document
- will not** indicates that something is certain or expected not to happen as a result of action taken by an agency the behaviour of which is outside the scope of the present document
- might** indicates a likelihood that something will happen as a result of action taken by some agency the behaviour of which is outside the scope of the present document

**might not** indicates a likelihood that something will not happen as a result of action taken by some agency the behaviour of which is outside the scope of the present document

In addition:

**is** (or any other verb in the indicative mood) indicates a statement of fact

**is not** (or any other negative verb in the indicative mood) indicates a statement of fact

The constructions "is" and "is not" do not indicate requirements.

---

# 1 Scope

The present document specifies detailed call flows of Network Data Analytics over the Nnwdaf, Nsmf, Npcf, Nnsacf, Namf, Nmrf, Nnssf, Nnef, Naf, Ndcf, Nadrf, Nmfa and Nudm service-based interfaces and their relationship with the flow level signalling in 5G system.

NOTE: The call flows depicted in this Technical Specification do not cover all traffic cases.

The stage 2 definition and procedures of Network Data Analytics are contained in 3GPP TS 23.288 [2] and 3GPP TS 23.502 [3]. The 5G System Architecture is defined in 3GPP TS 23.501 [4].

Detailed definitions of the involved services are provided in 3GPP TS 29.520 [5], 3GPP TS 29.508 [6], 3GPP TS 29.523 [7], 3GPP TS 29.554 [8], 3GPP TS 29.521 [9], 3GPP TS 29.522 [10], 3GPP TS 29.591 [11], 3GPP TS 29.517 [12], 3GPP TS 29.574 [15], 3GPP TS 29.575 [16], 3GPP TS 29.576 [17], 3GPP TS 29.503 [22], 3GPP TS 29.510 [23], 3GPP TS 29.507 [24] and 3GPP TS 29.512 [25].

The Technical Realization of the Service Based Architecture and the Principles and Guidelines for Services Definition of the 5G System are specified in 3GPP TS 29.500 [13] and 3GPP TS 29.501 [14].

---

# 2 References

The following documents contain provisions which, through reference in this text, constitute provisions of the present document.

- References are either specific (identified by date of publication, edition number, version number, etc.) or non-specific.
- For a specific reference, subsequent revisions do not apply.
- For a non-specific reference, the latest version applies. In the case of a reference to a 3GPP document (including a GSM document), a non-specific reference implicitly refers to the latest version of that document *in the same Release as the present document*.

- [1] 3GPP TR 21.905: "Vocabulary for 3GPP Specifications".
- [2] 3GPP TS 23.288: "Architecture enhancements for 5G System (5GS) to support network data analytics services".
- [3] 3GPP TS 23.502: "Procedures for the 5G System; Stage 2".
- [4] 3GPP TS 23.501: "System Architecture for the 5G System; Stage 2".
- [5] 3GPP TS 29.520: "5G System; Network Data Analytics Services; Stage 3".
- [6] 3GPP TS 29.508: "5G System; Session Management Event Exposure Service; Stage 3".
- [7] 3GPP TS 29.523: "5G System; Policy Control Event Exposure Service; Stage 3".
- [8] 3GPP TS 29.554: "5G System; Background Data Transfer Policy Control Service; Stage 3".
- [9] 3GPP TS 29.521: "5G System; Binding Support Management Service; Stage 3".
- [10] 3GPP TS 29.522: "5G System; Network Exposure Function Northbound APIs; Stage 3".
- [11] 3GPP TS 29.591: "5G System; Network Exposure Function Southbound Services; Stage 3".
- [12] 3GPP TS 29.517: "5G System; Application Function Event Exposure Service; Stage 3".
- [13] 3GPP TS 29.500: "5G System; Technical Realization of Service Based Architecture; Stage 3".
- [14] 3GPP TS 29.501: "5G System; Principles and Guidelines for Services Definition; Stage 3".
- [15] 3GPP TS 29.574: "5G System; Data Collection Coordination Services; Stage 3".



- [16] 3GPP TS 29.575: "5G System; Analytics Data Repository Services; Stage 3".
- [17] 3GPP TS 29.576: "5G System; Messaging Framework Adaptor Services; Stage 3".
- [18] 3GPP TS 29.518: "5G System; Access and Mobility Management Services; Stage 3".
- [19] 3GPP TS 28.532: "Management and orchestration; Generic management services".
- [20] 3GPP TS 29.536: "5G System: Network Slice Admission Control Services; Stage 3".
- [21] 3GPP TS 29.531: "5G System: Network Slice Selection Services; Stage 3".
- [22] 3GPP TS 29.503: "5G System; Unified Data Management Services; Stage 3".
- [23] 3GPP TS 29.510: "5G System; Network Function Repository Services; Stage 3".
- [24] 3GPP TS 29.507: "5G System; Access and Mobility Policy Control Service; Stage 3".
- [25] 3GPP TS 29.512: "5G System; Session Management Policy Control Service; Stage 3".
- [26] 3GPP TS 29.510: "5G System: Network function repository services; Stage 3".
- [27] 3GPP TS 28.552: "Management and orchestration; 5G performance measurements".
- [28] 3GPP TS 28.533: "Management and orchestration; Architecture framework".
- [29] 3GPP TS 37.320: " Radio measurement collection for Minimization of Drive Tests (MDT); Overall description".
- [30] 3GPP TS 28.554: " Management and orchestration; 5G end to end Key Performance Indicators (KPI)".
- [31] 3GPP TS 28.550: "Management and orchestration; Performance assurance".
- [32] 3GPP TS 37.320: "Radio measurement collection for Minimization of Drive Tests (MDT); Overall description; stage 2".
- [33] 3GPP TS 38.331: "NR; Radio Resource Control (RRC) protocol specification".
- [34] 3GPP TS 36.331: "Radio Resource Control (RRC); Protocol specification".
- [35] 3GPP TS 38.215: "NR; Physical layer measurements".
- [36] 3GPP TS 28.310: "Management and orchestration; Energy efficiency of 5G".
- [37] 3GPP TS 28.545: "Management and orchestration; Fault Supervision (FS)".

---

## 3 Definitions of terms, symbols and abbreviations

### 3.1 Terms

For the purposes of the present document, the terms given in 3GPP TR 21.905 [1] and the following apply. A term defined in the present document takes precedence over the definition of the same term, if any, in 3GPP TR 21.905 [1].

## 3.2 Symbols

None.

## 3.3 Abbreviations

For the purposes of the present document, the abbreviations given in 3GPP TR 21.905 [1] and the following apply. An abbreviation defined in the present document takes precedence over the definition of the same abbreviation, if any, in 3GPP TR 21.905 [1].

ADRF	Analytics Data Repository Function
AF	Application Function
AMF	Access and Mobility Management Function
AnLF	Analytics Logical Function
DCCF	Data Collection Coordination Function
MFAF	Messaging Framework Adaptor Function
MDT	Minimization of Drive Tests
ML	Machine Learning
MTLF	Model Training Logical Function
NEF	Network Exposure Function
NRF	Network Repository Function
NSACF	Network Slice Admission Control Function
NWDAF	Network Data Analytics Function
PCF	Policy Control Function
SMF	Session Management Function
UDM	Unified Data Management

---

# 4 Reference Architecture for Data Analytics

## 4.1 General

For the enablement of network data analytics services, the NWDAF interacts with different entities for different purposes:

- Data Collection:
  - a) collecting Data from OAM and/or 5GC NFs (e.g. AMF);
  - b) collecting Data from untrusted AF via NEF; and/or
  - c) collecting Analytics and/or Data from 5GC NFs via DCCF or via DCCF together with ADRF and/or MFAF or via NWDAF hosting DCCF i.e. an NWDAF that implements DCCF functionality internally and supports the Nnwdaf\_DataManagement API;
- Analytics Exposure:
  - a) Exposing Analytics to 5GC NFs;
  - b) Exposing Analytics to untrusted AF via NEF; and/or
  - c) Exposing Analytics to 5GC NFs via DCCF or via DCCF together with ADRF and/or MFAF or via NWDAF hosting DCCF and/or ADRF i.e. an NWDAF that implements DCCF and/or ADRF functionality internally and supports the Nnwdaf\_DataManagement API;
- Storing and Retrieving data in ADRF.

The entities mentioned above interact also with each other as described in the procedures of clause 5.

## 4.2 Data Collection

As depicted in Figure 4.2-1, the 5G System architecture allows NWDAF to collect data from any 5GC NF (e.g. AMF, SMF) and/or OAM directly or via DCCF, DCCF together with ADRF and/or MFAF, or via NWDAF.

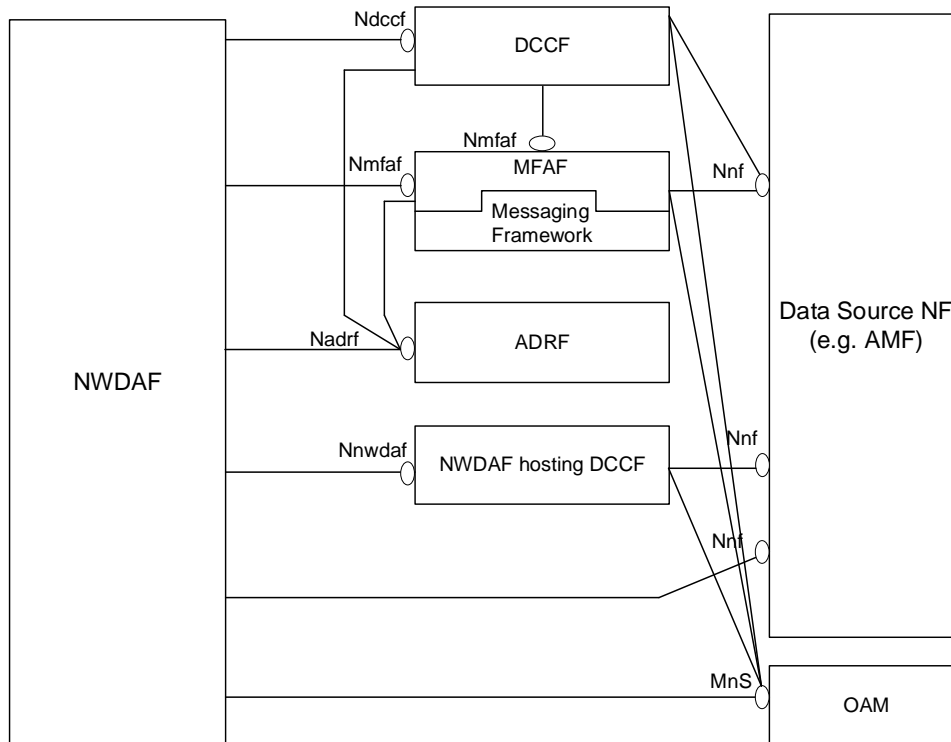

**Figure 4.2-1: Data Collection Architecture**

When DCCF, ADRF, MFAF or NWDAF hosting DCCF are present in the network, whether the NWDAF directly contacts the Data Source NF or goes via the DCCF, or NWDAF hosting DCCF is based on configuration of the NWDAF.

The Data Source NF may be AMF, SMF, UDM, AF, NSACF, NRF and/or NEF with the related data collection procedures described in clause 5.5. The Data Source NF may also be UPF while how to collect data from UPF is not defined in this release of the specification. If the Data Source is OAM, The NWDAF may collect relevant management data from the services in the OAM as configured by the PLMN operator. The NWDAF may use the OAM services e.g. generic performance assurance and fault supervision management services as defined in TS 28.532 [19], PM (Performance Management) services as defined in TS 28.550 [31] and/or FS (Fault Supervision) services as defined in TS 28.545 [37].

For the specific analytics event, the applicable Data Source NF(s) and the related data collection procedures and scope are described in the corresponding analytics event subclause within clause 5.7.

## 4.3 Analytics Exposure

As depicted in Figure 4.3-1, the 5G System architecture allows NWDAF to expose data to any 5GC NF (e.g. AMF) directly or via DCCF/MFAF.

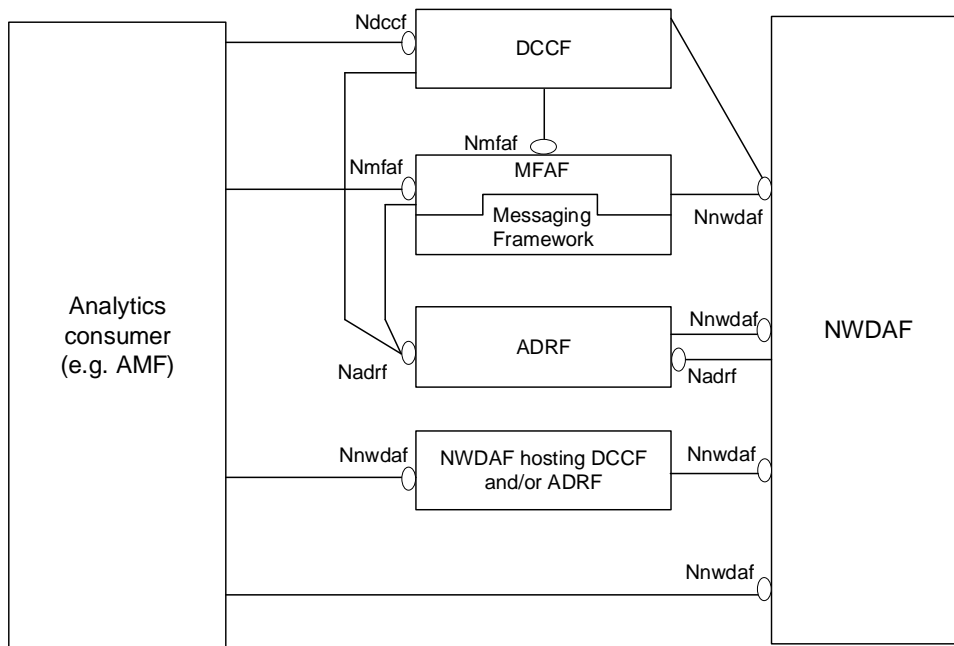

**Figure 4.3-1: Analytics Exposing Architecture**

When DCCF, ADRF, MFAF or NWDAF are present in the network, whether the Analytics consumer directly contacts the NWDAF or goes via the DCCF or via the NWDAF hosting DCCF and/or ADRF is based on configuration of the Analytics consumer.

The Analytics consumer may be AMF, SMF, NSSF, PCF, AF, NEF, OAM and/or CEF when directly contacts NWDAF with the related analytics exposure procedures described in clause 5.2.2 and clause 5.2.3. The Analytics consumers may be AMF, SMF, NSSF, PCF AF and/or NEF when contacts via the DCCF with the related analytics exposure procedures described in clause 5.2.4 and clause 5.2.5.

For the specific analytics event, the applicable Analytics consumer(s) and the related analytics exposure procedures and scope are described in the corresponding analytics event subclause within clause 5.7.

### 4.4 Data Storage and Retrieval

As depicted in Figure 4.4-1, the 5G System architecture allows the consumer to store and retrieve the collected data in the ADRF directly or via DCCF/MFAF.

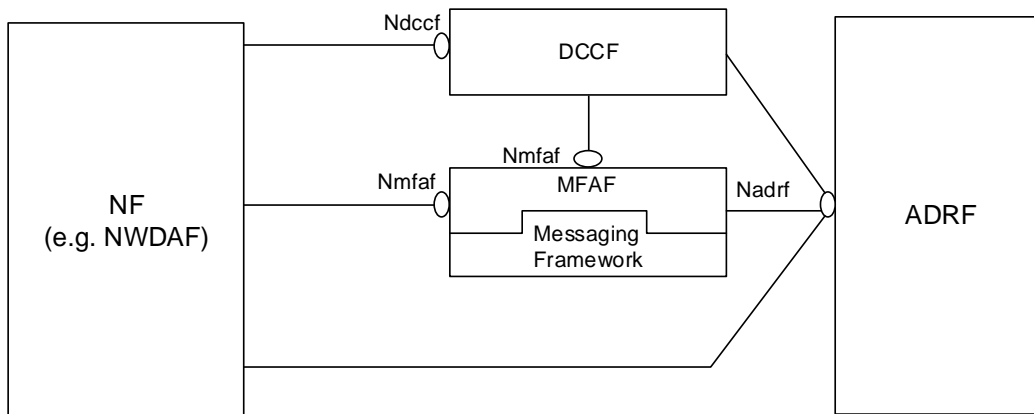

**Figure 4.4-1: Data Storage and Retrieval Architecture**

## 5 Signalling Flows for the Network Data Analytics Framework

### 5.1 General

This clause describes the Network Data Analytics related Signalling Flows, including the procedures for analytics exposure, analytics aggregation from multiple NWDAFs, analytics context and analytics subscription transferring between different NWDAFs, ML model provisioning, data collection, specified Network Data Analytics generation and the NWDAF discovery and selection. The specific NF service operations which are used in these procedures are also provided in the procedure descriptions.

### 5.2 Analytics Exposure Procedures

#### 5.2.1 General

The analytics exposure procedures allow the NF service consumers (i.e. NFs, OAM and AFs) to obtain the analytics information from the NWDAF.

#### 5.2.2 Network data analytics Subscribe/Unsubscribe/Notify

##### 5.2.2.1 Analytics Subscribe/Unsubscribe/Notify initiated by 5GC NFs, OAM or AFs

This procedure is used by the NF service consumers (i.e. NFs, OAM and AFs) to subscribe to/unsubscribe from analytics information directly from the NWDAF, it is also used by the NWDAF to notify the observed analytics event(s) to the NF service consumer if subscribed before.

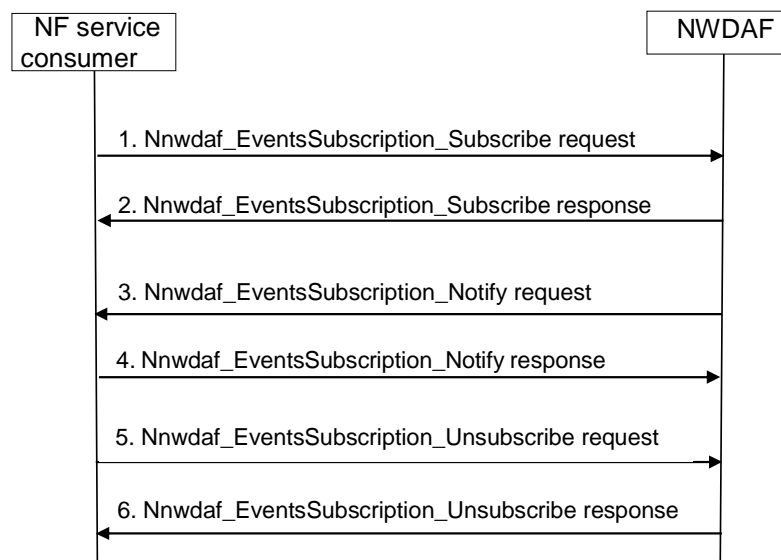

**Figure 5.2.2.1-1: Analytics Subscribe/Unsubscribe/Notify initiated by 5GC NFs, OAM or AFs**

1. In order to subscribe to notification(s) of analytics information from the NWDAF, the NF service consumer invokes `Nnwdaf_EventsSubscription_Subscribe` service operation by sending an HTTP POST request targeting the resource "NWDAF Events Subscriptions". The request includes the subscribed events and may include event filter information.

In order to update the existing subscription, the NF service consumer invokes `Nnwdaf_EventsSubscription_Subscribe` service operation by sending an HTTP PUT request with Resource URI of the resource "Individual NWDAF Event Subscription".

2. The NWDAF responds to the Nnwdaf\_EventsSubscription\_Subscribe service operation. Upon receipt of the HTTP POST request, if the subscription is accepted to be created, the NWDAF responds to the NF service consumer with "201 Created", and the URI of the created subscription is included in the Location header field.  
  
Upon receipt of the HTTP PUT request, if the subscription is accepted to be updated, the NWDAF responds to the NF service consumer with "200 OK" or "204 No Content"
3. If the NWDAF observes the subscribed event(s), the NWDAF invokes Nnwdaf\_EventsSubscription\_Notify service operation to report the event(s) by sending an HTTP POST request with {notificationURI} as Notification URI.
4. The NF service consumer sends an HTTP "204 No Content" response to the NWDAF.
5. In order to unsubscribe to the notification(s) of analytics information from the NWDAF, the NF service consumer invokes Nnwdaf\_EventsSubscription\_Unsubscribe service operation by sending an HTTP DELETE request targeting the resource "Individual NWDAF Event Subscription", to the NWDAF to unsubscribe from analytics information. The request includes the event subscriptionId of the existing subscription that is to be deleted.
6. The NWDAF responds to the Nnwdaf\_EventsSubscription\_Unsubscribe service operation. If the unsubscription is accepted, the NWDAF responds with "204 No Content".

NOTE: For details of Nnwdaf\_EventsSubscription\_Subscribe/Unsubscribe/Notify service operations refer to 3GPP TS 29.520 [5].

### 5.2.2.2 Analytics Subscribe/Unsubscribe/Notify initiated by AFs via the NEF

This procedure is used by the AF to subscribe to/unsubscribe from analytics information from the NWDAF via the NEF, it is also used by the NWDAF to notify the analytics event(s) to the AF via the NEF, if subscribed before.

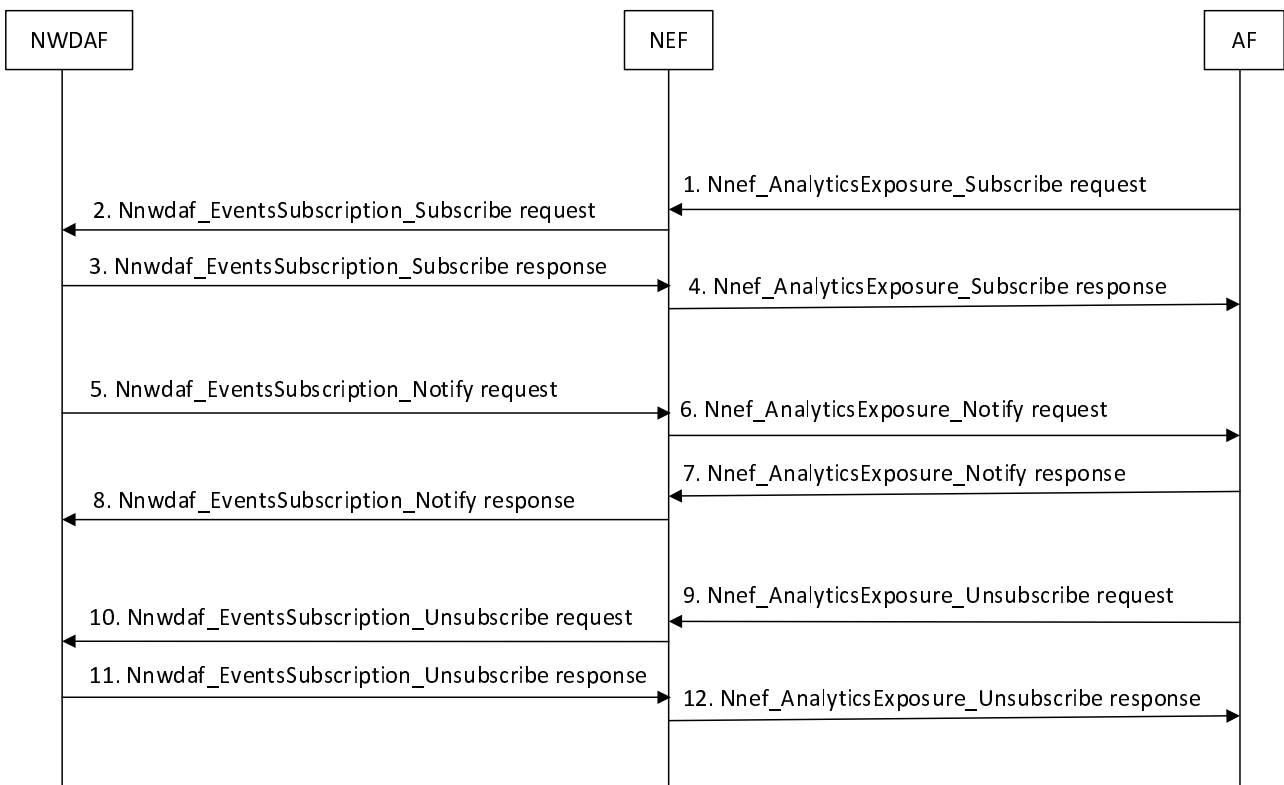

Figure 5.2.2.2-1: Analytics Subscribe/Unsubscribe/Notify initiated by AFs via the NEF

1. In order to subscribe to notification(s) of analytics exposure via the NEF, the AF invokes the Nnef\_AnalyticsExposure\_Subscribe request by sending an HTTP POST request message targeting the resource "Analytics Exposure Subscriptions" as defined in clause 4.4.14.1 of 3GPP TS 29.522 [10].

In order to update an existing analytics exposure subscription, the AF shall send an HTTP PUT request message to the NEF to the resource "Individual Analytics Exposure Subscription" requesting to change the subscription.

2. Upon receipt of the HTTP request from the AF, if the AF is authorized with the requested analytics event(s) and the requested parameters comply with the inbound restriction in the analytics exposure mapping, the NEF shall invoke Nnwdaf\_EventsSubscription\_Subscribe service operation as described in step 1 in clause 5.2.2.1.
3. The NWDAF responds to the Nnwdaf\_EventsSubscription\_Subscribe service operation as described in step 2 in clause 5.2.2.1.
4. Upon receipt of the HTTP request response from the NWDAF, the NEF shall invoke the Nnef\_AnalyticsExposure\_Subscribe response message by mapping and forwarding the response to the AF.
5. If the NWDAF observes the subscribed event(s), the NWDAF invokes Nnwdaf\_EventsSubscription\_Notify service operation as described in step 3 in clause 5.2.2.1 to the NEF.
6. If the NEF receives an analytics information notification from the NWDAF indicating that the subscribed analytics event has been detected, the NEF shall invoke the Nnef\_AnalyticsExposure\_Notify request by sending HTTP POST request message provide a notification to the AF request including the AnalyticsEventNotification data structure at least with the detected analytics event identified by the notification URI together with the notification correlation identifier received during creation of the Individual Analytics Exposure Subscription.
7. Upon receipt of the analytics event notification, the AF shall respond the NEF with a "204 No Content" status code to confirm the received notification in Nnef\_AnalyticsExposure\_Notify response message.
8. The NEF shall forward the HTTP "204 No Content" response to the NWDAF.
9. In order to delete an existing analytics exposure subscription, the AF shall invoke the Nnef\_AnalyticsExposure\_Unsubscribe request by sending an HTTP DELETE request message to the NEF to the resource "Individual Analytics Exposure Subscription".
10. If the NEF receives an HTTP DELETE request from the AF, the NEF shall invoke the Nnwdaf\_EventsSubscription\_Unsubscribe service operation as described in step 5 in clause 5.2.2.1.
11. The NWDAF responds to the Nnwdaf\_EventsSubscription\_Unsubscribe service operation as described in step 6 in clause 5.2.2.1.
12. The NEF shall forward the HTTP "204 No Content" response to the AF.

NOTE: Details of AnalyticsExposure API refer to clause 4.4.14 and clause 5.6 of 3GPP TS 29.522 [4].

## 5.2.3 Network data analytics information request

### 5.2.3.1 Analytics information request initiated by 5GC NFs, OAM or AFs

This procedure is used by the NF service consumers (i.e. 5GC NFs, OAM and AFs) to retrieve analytics information directly from the NWDAF.

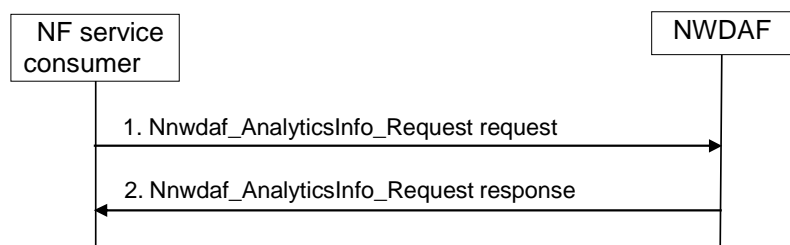

**Figure 5.2.3.1-1: Network data analytics info request procedure**

1. The NF Service Consumer invokes Nnwdaf\_AnalyticsInfo\_Request service operation by sending an HTTP GET request targeting the resource "NWDAF Analytics", to the NWDAF to request the analytics information. The request includes analytics identifier and related event filter information.

2. The NWDAF responds to the Nnwdaf\_AnalyticsInfo\_Request service operation. If the request is accepted, the response includes the requested analytics information with "200 OK".

NOTE: For details of Nnwdaf\_AnalyticsInfo\_Request service operation refer to 3GPP TS 29.520 [5].

### 5.2.3.2 Analytics information request initiated by AFs via the NEF

This procedure is used by the AFs to retrieve analytics information from the NWDAF via the NEF.

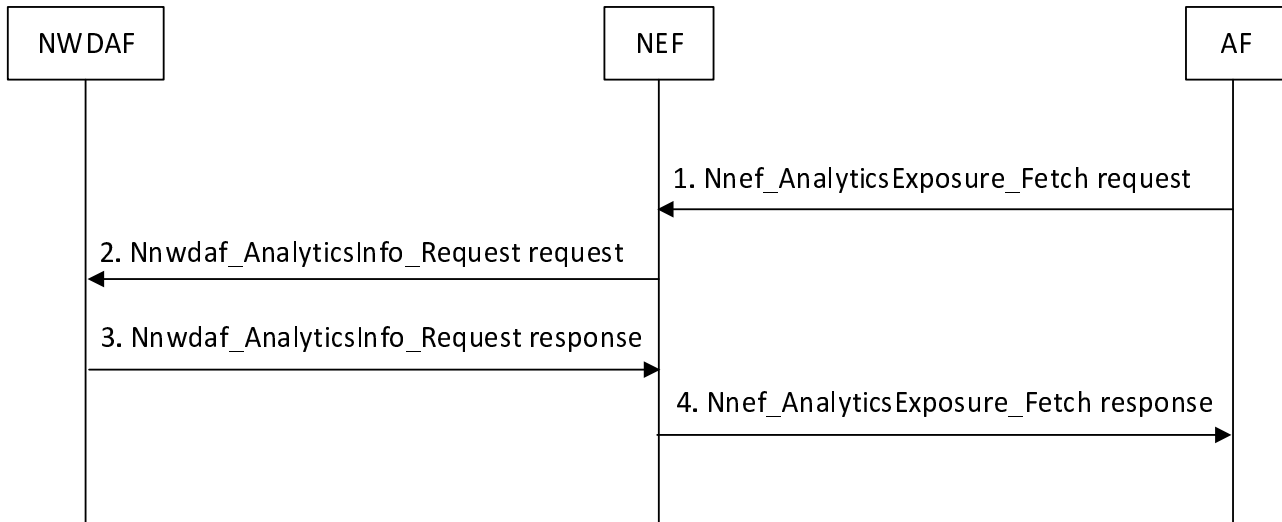

**Figure 5.2.3.2-1: Analytics Request initiated by AFs via the NEF**

1. In order to fetch analytics information, the AF invoke the Nnef\_AnalyticsExposure\_Fetch request by sending an HTTP POST request message to the NEF to the customized operation URI "{apiRoot}/3gpp-analyticsexposure/v1/fetch" as defined in clause 4.4.14.2 of 3GPP TS 29.522 [10].
2. Upon receipt of the HTTP request from the AF, if the AF is authorized with the requested analytics event(s) and the requested parameters comply with the inbound restriction in the analytics exposure mapping, the NEF shall invoke the Nnwdaf\_AnalyticsInfo\_Request service operation as described in step 1 in clause 5.2.3.1.
3. The NWDAF responds with the analytics information as described in step 2 in clause 5.2.3.1 to the NEF.
4. The NEF responds with the analytics information to the AF.

NOTE: Details of AnalyticsExposure API refer to clause 4.4.14 and clause 5.6 of 3GPP TS 29.522 [4].

### 5.2.4 Analytics Exposure via DCCF

This procedure is used by NF service consumer(s) based on local configuration, to subscribe/unsubscribe to NWDAF analytics event(s) via the DCCF, and upon the delivery option "Delivery via DCCF" configured on the DCCF, also used by DCCF to notify the NF service consumer(s) of the analytics information via the DCCF if subscribed before.



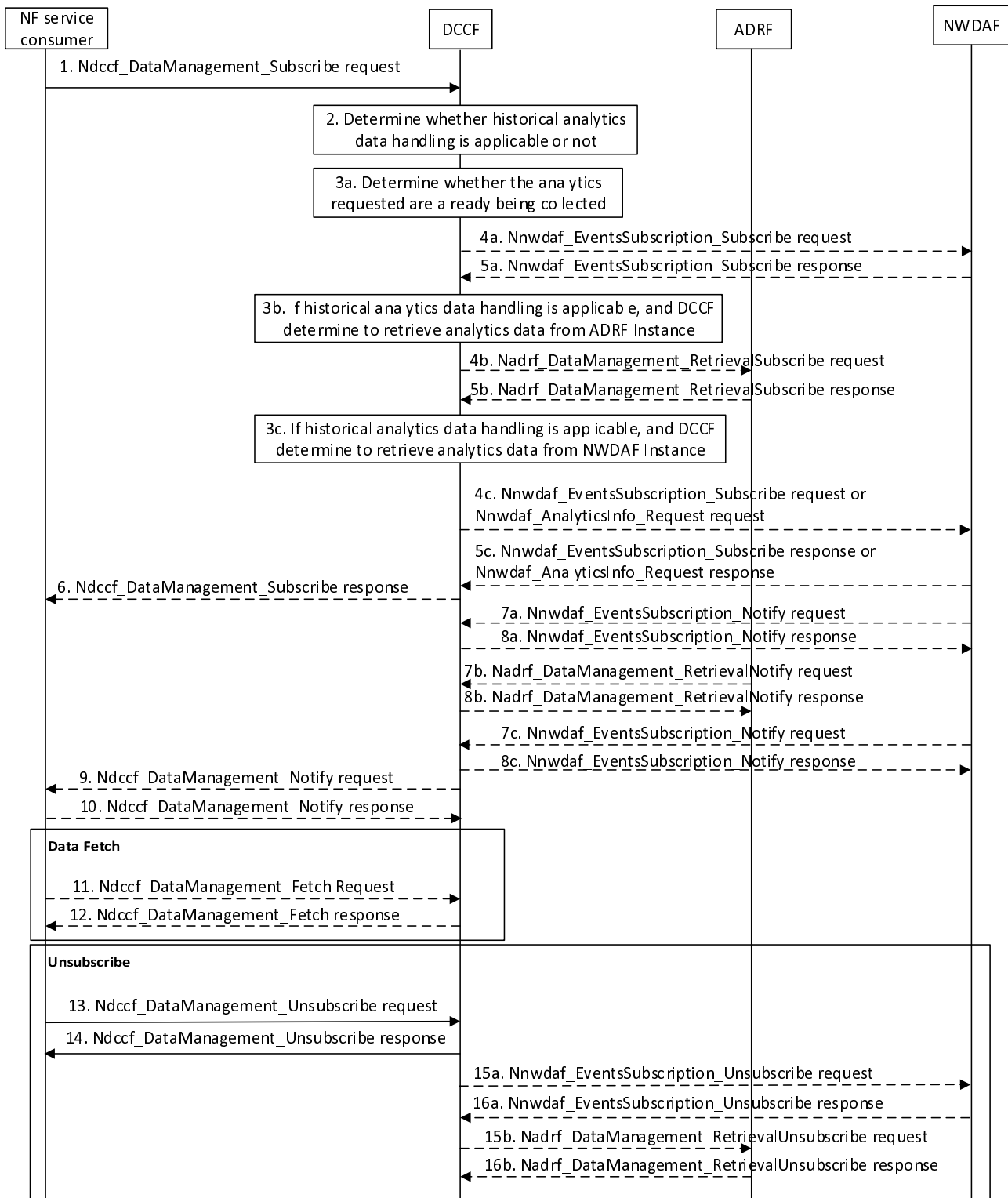

Figure 5.2.4-1: Analytics Exposure via DCCF

1. In order to subscribe to notification(s) of analytics exposure via the DCCF based on local configuration, the NF service consumer invokes the Ndccf\_DataManagement\_Subscribe service operation by sending an HTTP POST request message targeting the resource "DCCF Analytics Subscriptions", the HTTP POST message shall include the NdccfAnalyticsSubscription data structure as request body with parameters as defined in clause 5.1.6.2.2 of 3GPP TS 29.574 [15].
2. The DCCF keeps track of the analytics actively being collected for the Analytics Subscription it is coordinating. The NWDAF or ADRF may register the analytics data profile (may include the analytics data related service

operation, Analytics Specification, NWDAF ID or ADRF ID) with the DCCF. The DCCF may then determine whether certain historical analytics data may be available in the NWDAF or ADRF based on the analytics data profile and the request time window.

If the historical analytics data handling is not applicable or not supported, the DCCF shall proceed step 3a, skip step 3b, step 4b, step 5b, step 3c, step 4c and step 5c.

If the historical analytics data is available in an ADRF, the DCCF shall proceed step 3a and step 3b, skip step 3c, step 4c and step 5c.

If the historical analytics data is available in an NWDAF, the DCCF shall proceed step 3a and step 3c, skip step 3b, step 4b and step 5b.

3a. The DCCF shall determine whether the analytics requested are already being collected.

If the requested analytics are already being collected by an NF service consumer, the DCCF adds the new NF service consumer to the list of NF service consumers that are subscribed for these analytics.

If the DCCF cannot handle the subscription request, shall take the error handling as defined in clause 4.2.2.2.2 of 3GPP TS 29.574 [15]

If the DCCF determines that no subscriptions need to be created or modified (e.g. because all the data can be made available either via pre-existing subscriptions or because of the historical data handling) then step 4a and step 5a are skipped.

3aa. The DCCF may respond to the `Ndpcf_DataManagement_Subscribe` service operation with HTTP "201 Created" status code with the message body containing a representation of the created subscription if the DCCF add the new NF service consumer to the list of NF service consumers that are subscribed, or if error case happened may respond with corresponding error information.

4a If the analytics requested at step 1 are not already available yet, the DCCF shall invoke the `Nnwdaf_EventsSubscription_Subscribe` service operation by sending an HTTP POST request message request to the NWDAF targeting the resource "NWDAF Events Subscriptions" to subscribe to a new analytics exposure subscription, or if the analytics subscribed in step 1 partially matches an analytics that is already being collected by the DCCF from an NWDAF, and a modification of this subscription to the NWDAF would satisfy both the existing analytics subscriptions as well as the newly requested analytics, by sending an HTTP PUT request to the resource "Individual Analytics Exposure Subscription" to replace an existing analytics exposure subscription. The request includes the subscribed event(s) and event filter information received from the NF service consumer, mapping to the parameters as defined in clause 5.1 of 3GPP TS 29.520 [5].

NOTE: If the NWDAF instance or NWDAF Set is not identified by the NF service consumer, the DCCF determines the NWDAF instances that can provide analytics. If the consumer requested storage of analytics in an ADRF but an ADRF ID is not provided by the NF service consumer, or the collected analytics is to be stored in an ADRF according to configuration on the DCCF, the DCCF selects an ADRF to store the collected analytics data.

5a The NWDAF responds to the `Nnwdaf_EventsSubscription_Subscribe` service operation.

Upon receipt of the HTTP POST request, if the subscription is accepted to be created, the NWDAF responds to the DCCF with "201 Created" status code, and the URI of the created subscription is included in the Location header field.

Upon receipt of the HTTP PUT request, if the subscription is accepted to be updated, the NWDAF responds to the DCCF with "200 OK" or "204 No Content" status code.

3b If the historical analytics data handling is applicable, and the DCCF determine to retrieve analytics data from the ADRF, the DCCF shall determine which ADRF instances might provide the analytics.

4b In order to retrieve the historical analytics data from the ADRF, the DCCF shall invoke the `Nadrf_DataManagement_RetrievalSubscribe` service operation by sending an HTTP POST request message targeting the resource "ADRF Data Retrieval Subscriptions", the HTTP POST message shall include the `NadrfDataRetrievalSubscription` data structure as request body with parameters as defined in clause 5.1.6 of 3GPP TS 29.575 [16].

5b The ADRF responds to the `Nadrf_DataManagement_RetrievalSubscribe` service operation.

Upon receipt of the HTTP POST request, if the subscription is accepted to be created, the ADRF responds to the DCCF with "201 Created" status code, and the URI of the created subscription is included in the Location header field.

3c If the historical analytics data handling is applicable, and the DCCF determine to retrieve analytics data from the NWDAF, the DCCF shall determine which NWDAF instances might provide the analytics as described and proceed step 4c.

4c In order to retrieve the historical analytics data from the NWDAF, the DCCF may invoke the Nnwdafeventssubscription\_subscribe service operation by sending an HTTP POST request message targeting the resource "NWDAF Events Subscriptions", the HTTP POST message shall include the Nnwdafeventssubscription data structure as request body with parameters as defined in clause 5.1.6 of 3GPP TS 29.520 [5] or Nnwdafeventsanalyticsinfo\_request request by sending an HTTP GET request message targeting the resource "NWDAF Analytics" with parameters as defined in clause 5.2.3.2.3.1 of 3GPP TS 29.520 [5].

5c The NWDAF responds to the Nnwdafeventssubscription\_subscribe or Nnwdafeventsanalyticsinfo\_request service operation.

Upon receipt of the HTTP POST request, if the subscription is accepted to be created, the NWDAF responds to the DCCF with "201 Created" status code, and the URI of the created subscription is included in the Location header field.

6. The DCCF responds to the Ndcf\_datamanagement\_subscribe service operation with HTTP "201 Created" status code with the message body containing a representation of the created subscription.

7a. (conditional)When the analytics are available, the NWDAF invokes the Nnwdafeventssubscription\_notify service operation by sending an HTTP POST request message to notify the analytics information to the DCCF.

8a. The DCCF responds to the Nnwdafeventssubscription\_notify service operation with HTTP "204 No Content" status code.

7b. (conditional)When the historical analytics data are available in the ADRF, the ADRF shall invoke the Ndcf\_datamanagement\_retrieval\_notify service operation by sending an HTTP POST request message to notify the historical analytics or Fetch Instructions to the DCCF.

8b. The DCCF responds to the Ndcf\_datamanagement\_retrieval\_notify service operation with HTTP "204 No Content" status code.

7c. (conditional)When the historical analytics data are available in the NWDAF, the NWDAF may invoke the Nnwdafeventssubscription\_notify service operation by sending an HTTP POST request message to notify the historical analytics data to the DCCF.

8c. The DCCF responds to the Nnwdafeventssubscription\_notify service operation with HTTP "204 No Content" status code.

9. Upon the delivery option "Delivery via DCCF" configured on the DCCF, the DCCF invokes the Ndcf\_datamanagement\_notify service operation by sending HTTP POST request message(s) to send the analytics data to all notification endpoints indicated in step 1. Analytics sent to notification endpoints may be processed and formatted by the DCCF so they conform to delivery requirements for each NF service consumer or notification endpoint.

NOTE: According to Formatting Instructions provided by the NF service consumer, multiple notifications from a NWDAF can be combined in a single Ndcf\_datamanagement\_notify so many notifications from an NWDAF results in fewer notifications (or one notification) to the NF service consumer. Alternatively, a notification can instruct the analytics notification endpoint to fetch the analytics from the DCCF.

10. The NF service consumer responds to the Ndcf\_datamanagement\_notify service operation with HTTP "204 No Content" status code.

11. (conditional) The NF service consumer invokes the Ndcf\_datamanagement\_fetch service operation by sending an HTTP GET request message to fetch the analytics from the DCCF before an expiry time, if received the fetch instruction in Ndcf\_datamanagement\_notify service operation in step 9.

12. The NF service consumer responds to the Ndcf\_DataManagement\_Fetch service operation with HTTP "204 No Content" status code.
13. When the NF service consumer no longer need the subscription to the analytics requested in step 1, shall invoke the Ndcf\_DataManagement\_Unsubscribe service operation by sending an HTTP DELETE request message with "{xxx}" as Resource URI, where "{subscriptionId}" is the event subscriptionId of the existing subscription that is to be deleted., using the Subscription Correlation Id received in response to its subscription in step 1. The DCCF removes the NF service consumer from the list of NF service consumers that are subscribed for these analytics.
14. The DCCF responds to the Ndcf\_DataManagement\_Unsubscribe service operation with HTTP "204 No Content" status code, upon removed the NF service consumer from the list of NF service consumers that are subscribed for these analytics
- 15a. If there are no other NF service consumers subscribed to the analytics, the DCCF invokes the Nnwdf\_EventsSubscription\_Unsubscribe service operation by sending an HTTP DELETE request message to the NWDAF.
- 16a. The NWDAF responds to the Nnwdf\_EventsSubscription\_Unsubscribe service operation with HTTP "204 No Content" status code, upon the analytics event(s) subscription is removed.
- 15b. If DCCF determines that no other NF service consumers requiring the historical analytics data from the ADRF, the DCCF may invoke the Ndrf\_DataManagement\_RetrievalUnSubscribe service operation by sending an HTTP DELETE request message to the ADRF.
- 16b. The ADRF responds to the Ndrf\_DataManagement\_RetrievalUnSubscribe service operation with HTTP "204 No Content" status code, upon the analytics data retrieval subscription is removed.

## 5.2.5 Analytics Exposure via DCCF and MFAF

This procedure is used by NF service consumer(s) based on local configuration, to subscribe/unsubscribe to NWDAF analytics event(s) via the DCCF, and upon the delivery option "Delivery via Messaging Framework " configured on the DCCF, the 3GPP DCCF Adaptor (3da) Data Management service and 3GPP Consumer Adaptor (3ca) Data Management service of the Messaging Framework Adaptor Function (MFAF) are used to interact with the 3GPP Network and the Messaging Framework for analytics information delivery to the NF service consumer(s) subscribed notification endpoint(s).

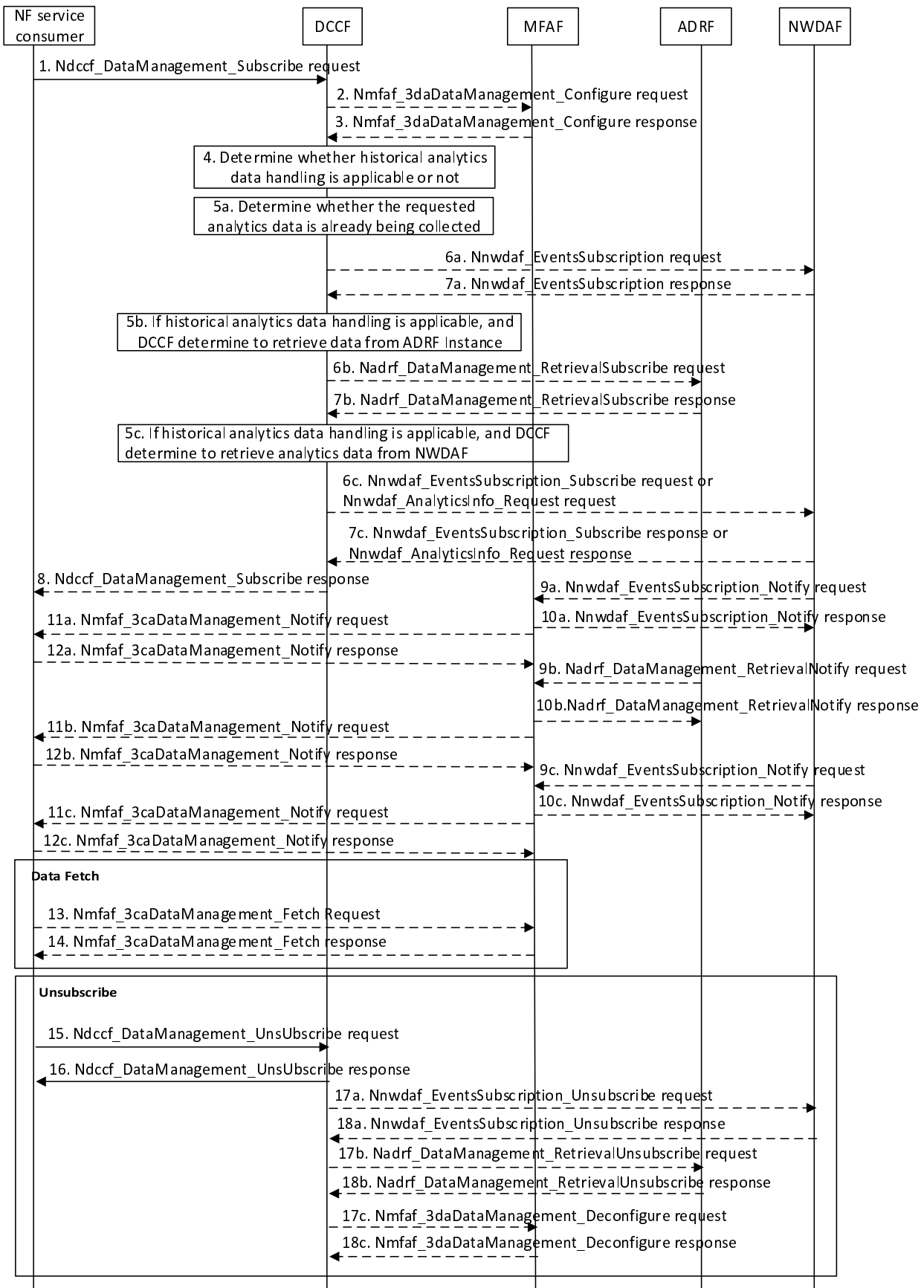

Figure 5.2.5-1: Analytics Exposure via DCCF and Messaging Framework

1. In order to subscribe to notification(s) of analytics exposure via the DCCF based on local configuration, the NF service consumer invokes the `Ndccf_DataManagement_Subscribe` service operation by sending an HTTP POST request message targeting the resource "DCCF Analytics Subscriptions", the HTTP POST message shall include the `NdccfAnalyticsSubscription` data structure as request body with parameters as defined in clause 5.1.6.2.2 of 3GPP TS 29.574 [15].
2. Upon the delivery option "Delivery via MFAF" configured on the DCCF, in order to create configuration of mapping data in the MFAF, the DCCF shall invoke the `Nmfaf_3daDataManagement_Configure` service operation by sending an HTTP POST request message targeting the resource "MFAF Configurations", the HTTP POST message shall include the `MfafConfiguration` data structure as request body with parameters as defined in clause 5.1.6 of 3GPP TS 29.576 [17].
3. The MFAF responds to the `Nmfaf_3daDataManagement_Configure` service operation.

Upon receipt of the HTTP POST request, if the configuration is accepted to be created, the MFAF responds to the DCCF with "201 Created", and the URI of the created configuration is included in the Location header field.

4. The DCCF keeps track of the analytics actively being collected for the Analytics Subscription it is coordinating. The NWDAF or ADRF may register the analytics data profile (may include the analytics data collection related service operation, Analytics Specification, NWDAF ID or ADRF ID) with the DCCF. The DCCF may then determine whether certain historical analytics data may be available in the NWDAF or ADRF based on the analytics data profile and the request time window.

If the historical analytics data handling is not applicable or not supported, the DCCF shall proceed step 5a, skip step 5b step 6b, step 7b, step 5c step 6c and step 7c.

If the historical analytics data is available in an ADRF, the DCCF shall proceed step 5a and step 5b, skip step 5c, step 6c and step 7c.

If the historical data is available in an NWDAF, the DCCF shall proceed step 5a and step 5c, skip step 5b, step 6b and step 7b.

- 5a. The DCCF shall determine whether the analytics data requested in step 1 are already being collected.

If the analytics data requested are already being collected by an NF service consumer, the DCCF adds the NF service consumer to the list of analytics consumers that are subscribed for these data.

If the DCCF cannot handle the subscription request, shall take the error handling as defined in clause 4.2.2.2.2 of 3GPP TS 29.574 [15]

If the DCCF determines that no subscriptions need to be created or modified (e.g. because all the data can be made available either via pre-existing subscriptions or because of the historical data handling) then step 6a and step 7a are skipped.

- 5aa. The DCCF may respond to the `Ndccf_DataManagement_Subscribe` service operation with HTTP "201 Created" status code with the message body containing a representation of the created subscription if the DCCF adds the new NF service consumer to the list of NF service consumers that are subscribed, or if error case happened may respond with corresponding error information.
- 6a. If the requested data at step 1 are not already available yet, the DCCF shall invoke the `NnwdafeventsSubscription_Subscribe` service operation by sending an HTTP POST request message request to the NWDAF targeting the resource "NWDAF Events Subscriptions" to subscribe to a new analytics exposure subscription, or if the analytics subscribed in step 1 partially matches an analytics that is already being collected by the DCCF from an NWDAF, and a modification of this subscription to the NWDAF would satisfy both the existing analytics subscriptions as well as the newly requested analytics, by sending an HTTP PUT request to the resource "Individual Analytics Exposure Subscription" to replace an existing analytics exposure subscription. The request includes the subscribed event(s) and event filter information received from the NF service consumer, mapping to the parameters as defined in clause 5.1 of 3GPP TS 29.520 [5].

NOTE 1: If the NWDAF instance or NWDAF Set is not identified by the NF service consumer, the DCCF determines the NWDAF instances that can provide analytics. If the consumer requested storage of analytics in an ADRF but an ADRF ID is not provided by the NF service consumer, or the collected analytics is to be stored in an ADRF according to configuration on the DCCF, the DCCF selects an ADRF to store the collected data.

7a The NWDAF responds to the `Nnwdaf_EventsSubscription_Subscribe` service operation.

Upon receipt of the HTTP POST request, if the subscription is accepted to be created, the NWDAF responds to the DCCF with "201 Created" status code, and the URI of the created subscription is included in the Location header field.

Upon receipt of the HTTP PUT request, if the subscription is accepted to be updated, the NWDAF responds to the DCCF with "200 OK" or "204 No Content" status code.

5b If the historical analytics data handling is applicable, and the DCCF determine to retrieve analytics data from the ADRF, the DCCF shall determine which ADRF instances might provide the analytics.

6b In order to retrieve the historical analytics data from the ADRF, the DCCF shall invoke the `Nadrf_DataManagement_RetrievalSubscribe` service operation by sending an HTTP POST request message targeting the resource "ADRF Data Retrieval Subscriptions", the HTTP POST message shall include the `NadrfDataRetrievalSubscription` data structure as request body with parameters as defined in clause 5.1.6 of 3GPP TS 29.575 [16].

7b The ADRF responds to the `Nadrf_DataManagement_RetrievalSubscribe` service operation.

Upon receipt of the HTTP POST request, if the subscription is accepted to be created, the ADRF responds to the DCCF with "201 Created" status code, and the URI of the created subscription is included in the Location header field.

5c If the historical data handling is applicable, and the DCCF determines to retrieve analytics data from the NWDAF, the DCCF shall determine which NWDAF instances might provide the analytics as described and proceed step 6c.

6c In order to retrieve the historical analytics data from the NWDAF, the DCCF may invoke the `Nnwdaf_EventsSubscription_Subscribe` service operation by sending an HTTP POST request message targeting the resource "NWDAF Events Subscriptions", the HTTP POST message shall include the `NnwdafEventsSubscription` data structure as request body with parameters as defined in clause 5.1.6 of 3GPP TS 29.520 [5] or `Nnwdaf_AnalyticsInfo_Request` request by sending an HTTP GET request message targeting the resource "NWDAF Analytics" with parameters as defined in clause 5.2.3.2.3.1 of 3GPP TS 29.520 [5].

7c The NWDAF responds to the `Nnwdaf_EventsSubscription_Subscribe` or `Nnwdaf_AnalyticsInfo_Request` service operation.

Upon receipt of the HTTP POST request, if the subscription is accepted to be created, the NWDAF responds to the DCCF with "201 Created", and the URI of the created subscription is included in the Location header field.

8. The DCCF responds to the `Ndpcf_DataManagement_Subscribe` service operation with HTTP "201 Created" status code with the message body containing a representation of the created subscription.

9a. (conditional)When the analytics are available, the NWDAF invokes the `Nnwdaf_EventsSubscription_Notify` service operation by sending an HTTP POST request message to notify the analytics information to the MFAF.

10a. The MFAF responds to the `Nnwdaf_EventsSubscription_Notify` service operation with HTTP "204 No Content" status code.

11a. The MFAF invokes the `Nmfaf_3caDataManagement_Notify` service operation by sending HTTP POST request message(s) to send the analytics data to all notification endpoints indicated in step 1. Analytics data sent to notification endpoints may be processed and formatted by the MFAF so that they conform to delivery requirements for each NF service consumer and/or notification endpoint.

NOTE 2: According to Formatting Instructions provided by the NF service consumer, multiple notifications from the NWDAF can be combined in a single `Nmfaf_3caDataManagement_Notify` so that many notifications from an NWDAF result in fewer notifications (or one notification) to the NF service consumer and/or the subscribed notification endpoint(s). Alternatively, a notification can instruct the analytics data notification endpoint to fetch the analytics data from the MFAF.

12a.The NF service consumer responds to the `Nmfaf_3caDataManagement_Notify` service operation with HTTP "204 No Content" status code.

- 9b. (conditional) When the historical analytics data are available in the ADRF, the ADRF shall invoke the Ndrf\_DataManagement\_RetrievalNotify service operation by sending an HTTP POST request message to notify the historical analytics or Fetch Instructions to the MFAF.
- 10b. The MFAF responds to the Ndrf\_DataManagement\_RetrievalNotify service operation with HTTP "204 No Content" status code.
- 11b. The MFAF invokes the Nmfafe\_3caDataManagement\_Notify service operation by sending HTTP POST request message(s) to send the analytics data to all notification endpoints indicated in step 1. Analytics data sent to notification endpoints may be processed and formatted by the MFAF so that they conform to delivery requirements for each NF service consumer or notification endpoint.
- NOTE 3: According to Formatting Instructions provided by the NF service consumer, multiple notifications from an ADRF can be combined in a single Nmfafe\_3caDataManagement\_Notify so many notifications from an ADRF results in fewer notifications (or one notification) to the NF service consumer and/or the subscribed notification endpoint(s). Alternatively, a notification can instruct the analytics data notification endpoint to fetch the analytics data from the MFAF.
- 12b. The NF service consumer responds to the Nmfafe\_3caDataManagement\_Notify service operation with HTTP "204 No Content" status code.
- 9c. (conditional) When the historical analytics data are available in the NWDAF, the NWDAF may invoke the Nnwdafe\_EventsSubscription\_Notify service operation by sending an HTTP POST request message to notify the historical analytics data to the MFAF.
- 10c. The MFAF responds to the Nnwdafe\_EventsSubscription\_Notify service operation with HTTP "204 No Content" status code.
- 11c. The MFAF invokes the Nmfafe\_3caDataManagement\_Notify service operation by sending HTTP POST request message(s) to send the analytics data to all notification endpoints indicated in step 1. Analytics data sent to notification endpoints may be processed and formatted by the MFAF so they conform to delivery requirements for each NF service consumer or notification endpoint.
- NOTE 4: According to Formatting Instructions provided by the NF service consumer, multiple notifications from a NWDAF can be combined in a single Nmfafe\_3caDataManagement\_Notify so many notifications from a NWDAF results in fewer notifications (or one notification) to the NF service consumer and/or the subscribed notification endpoint(s). Alternatively, a notification can instruct the analytics data notification endpoint to fetch the analytics data from the MFAF.
- 12c. The NF service consumer responds to the Nmfafe\_3caDataManagement\_Notify service operation with HTTP "204 No Content" status code.
13. (conditional) The NF service consumer invoke the Nmfafe\_3caDataManagement\_Fetch service operation by sending an HTTP GET request message to fetch the data from the MFAF before an expiry time, if received the fetch instruction in Nmfafe\_3caDataManagement\_Notify service operation in step 11a, step 11b or step 11c.
14. The MFAF responds to the Nmfafe\_3caDataManagement\_Fetch service operation with HTTP "200 OK" status code with the message body containing the NmfafeResourceRecord data structure.
15. When the NF service consumer no longer need the subscription to the requested data in step 1, shall invoke the Ndccf\_DataManagement\_Unsubscribe service operation by sending an HTTP DELETE request message with "{apiRoot}/nnwdafe-datamanagement/v1/subscriptions/{subscriptionId}" as Resource URI, where "{subscriptionId}" is the event subscriptionId of the existing subscription that is to be deleted., using the Subscription Correlation Id received in response to its subscription in step 1. The DCCF removes the NF service consumer from the list of NF service consumers that are subscribed for these analytics data.
16. The DCCF responds to the Ndccf\_DataManagement\_Unsubscribe service operation with HTTP "204 No Content" status code, upon removed the NF service consumer from the list of NF service consumers that are subscribed for these analytics data.
- 17a. If there are no other NF service consumers subscribed to the analytics data, the DCCF invoke the Nnwdafe\_EventsSubscription\_Unsubscribe service operation by sending an HTTP DELETE request message to the NWDAF.



- 18a. The DWDAF responds to the Nnwdaf\_EventsSubscription\_Unsubscribe service operation with HTTP "204 No Content" status code, upon the analytics event(s) subscription is removed.
- 17b. If DCCF determines that no other NF service consumers requiring the historical analytics data from the ADRF, the DCCF may invoke the Nadrif\_DataManagement\_RetrievalUnSubscribe service operation by sending an HTTP DELETE request message to the ADRF.
- 18b. The ADRF responds to the Nadrif\_DataManagement\_RetrievalUnSubscribe service operation with HTTP "204 No Content" status code, upon the data retrieval subscription is removed.
- 17c. When DCCF determines that NF service consumer mapping has to be removed from MFAF, the DCCF may invoke the Nmfaif\_3daDataManagement\_Deconfigure service operation by sending an HTTP DELETE request message to the MFAF.
- 18c. The MFAF responds to the Nmfaif\_3daDataManagement\_Deconfigure service operation with HTTP "204 No Content" status code, upon removing the individual resource linked to the delete request.

## 5.3 Analytics Aggregation from Multiple NWDAFs

### 5.3.1 General

Analytics Aggregation refers to the case in which an NWDAF with respective capabilities aggregates the analytics provided by other NWDAFs to serve a request from an NF service consumer.

If multiple NWDAFs are deployed, an NWDAF instance may be specialized to provide Analytics for one or more Analytics event(s). Each NWDAF instance may serve a certain Area of Interest or TAI(s) and multiple NWDAFs may be needed to serve a particular Analytics event collectively. An NWDAF may have the capability to aggregate the Analytics (per Analytics event) received from the other NWDAFs and/or the Analytics generated by itself. Analytics aggregation applies to scenarios where NWDAF service consumer requests or subscribes to analytics with or without provisioning of Area of Interest.

### 5.3.2 Analytics aggregation with provisioning of Area of Interest

This procedure is used by the service consumer to request Analytics event(s) for an Area of Interest, in which multiple NWDAFs are required to serve the request collectively.



**Figure 5.3.2-1: Analytics aggregation with provisioning of Area of Interest**

1a-1c. In order to obtain the specific network data analytics, the NF service consumer selects an NWDaf (e.g. NWDaf1) with aggregation capability according to the results returned by NRF or available information obtained by other means. The NWDaf service consumer invokes Nnwdaf\_AnalyticsInfo\_Request or Nnwdaf\_EventsSubscription\_Subscribe service operations as described in clause 5.2.3.1 and clause 5.2.2.1 to the selected NWDaf.

In the request message, the analytics event, analytics filter information including the Area of Interest (e.g. TAI-1, TAI-2, TAI-n, if available) and the Target of Analytics Reporting are provided. The NWDaf service consumer may indicate the time when the analytics is needed in "timeAnaNeeded" attribute, which needs to be equal or greater than the supported Analytics Delay per Analytics event of the Aggregator NWDaf.

2-5b. The Aggregator NWDaf selects the other NWDaf instances, which collectively can cover the area of interest indicated in the request, according to the results returned by the NRF and/or the UDM, or available information obtained by other means. The Aggregator NWDaf invokes Nnwdaf\_AnalyticsInfo\_Request or Nnwdaf\_EventsSubscription\_Subscribe service operations to each selected NWDaf (e.g. NWDaf2, NWDaf3) as described in clause 4.2.2.2 or clause 4.3.2.2 of 3GPP TS 29.520 [5].

6-9b. The selected NWDAFs send response or notification containing the requested analytics to the Aggregator NWDAF. If the selected NWDAFs (e.g. NWDAF 2 and/or NWDAF 3) cannot reply or notify the requested analytics before the expiry of the time that the Aggregator NWDAF has indicated, they may send an error response or error notification to the Aggregator NWDAF including a "revised waiting time" in "rvWaitTime" attribute.

10. The Aggregator NWDAF aggregates the analytics received from the selected NWDAFs and the analytics of its own.

11a-11c. The Aggregator NWDAF sends a response or notification containing the aggregated output analytics for the requested Analytics event(s) to the NWDAF service consumer.

If the Aggregator NWDAF cannot reply or notify the requested analytics before the expiry of the time that the consumer has indicated in "timeAnaNeeded" attribute, it may send an error response or error notification to the consumer including a "revised waiting time" in "rvWaitTime" attribute.

### 5.3.3 Analytics aggregation without provisioning of Area of Interest

This procedure is used by the service consumer to request Analytics event(s) without providing an Area of Interest, in which multiple NWDAFs are required to serve the request collectively.

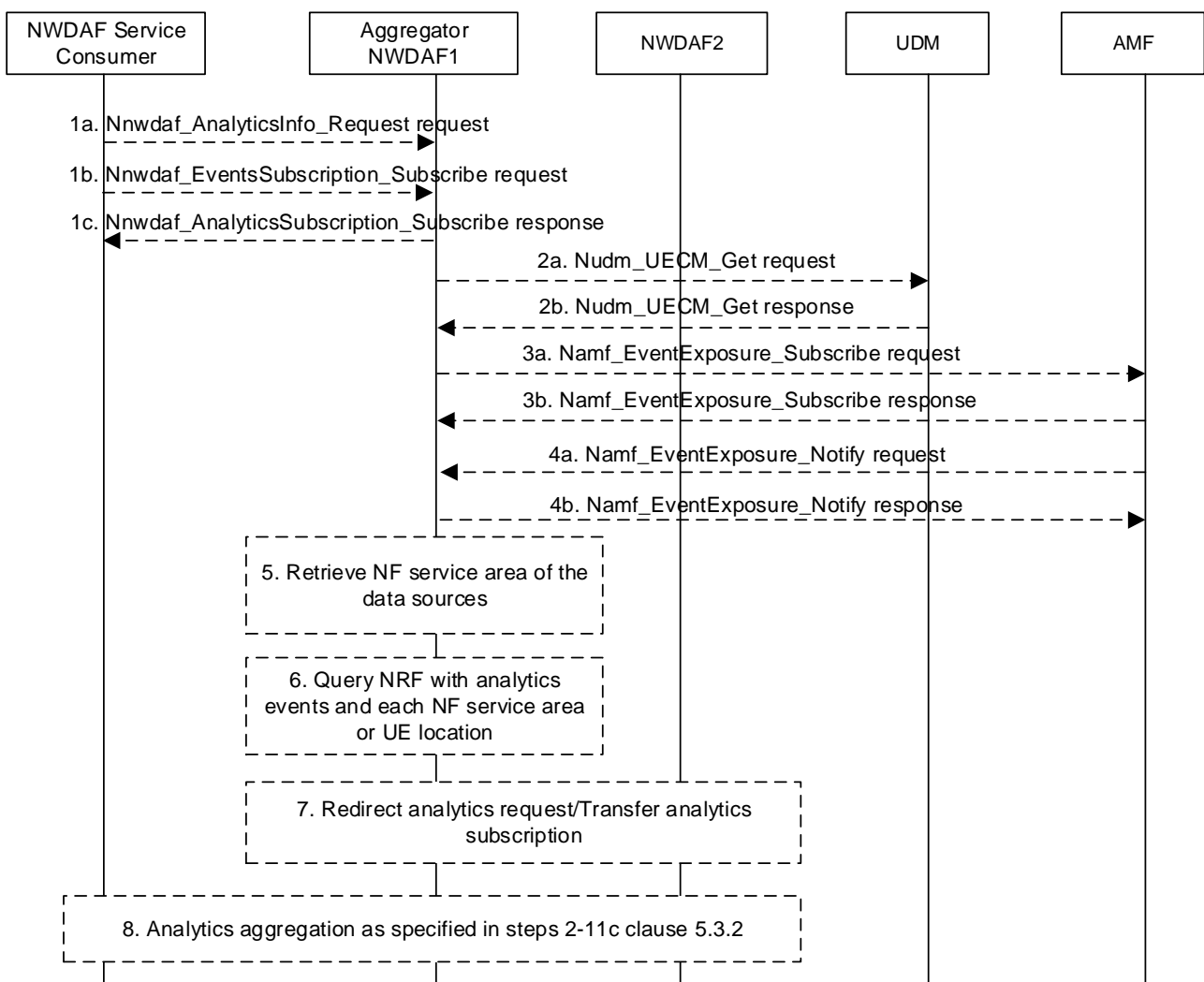

Figure 5.3.3-1: Analytics aggregation without provisioning of Area of Interest

1a-1c. In order to obtain the specific network data analytics, the NF service consumer selects an NWDAF (e.g. NWDAF1) with aggregation capability according to the results returned by NRF or available information obtained by other means. The NWDAF service consumer invokes Nnwdaf\_AnalyticsInfo\_Request or Nnwdaf\_EventsSubscription\_Subscribe service operations as described in clause 5.2.3.1 and clause 5.2.2.1 to the

selected NWDAF. If not, the NWDAF service consumer should select a NWDAF with large serving area from the candidate NWDAFs which supports analytics aggregation, e.g. NWDAF1.

- 2a-4b. If the requested analytics requires UE location information, e.g. for the Analytics events "UE\_MOBILITY", "ABNORMAL\_BEHAVIOUR", or "USER\_DATA\_CONGESTION", then:
- 2a-2b: The Aggregator NWDAF may query UDM to discover the NWDAF serving the UE by invoking Nudm\_UECM\_Get service operation as described in clause 5.3.2.5.12 of 3GPP TS 29.503 [23], if it is supported.
  - 3a-4b: The Aggregator NWDAF may determine the AMF serving the UE, then requests UE location information from the AMF by invoking Namf\_EventExposure\_Subscribe service operation as described in clause 5.3.2.2.2 of 3GPP TS 29.518 [18]. The AMF notifies the UE location information by invoking Namf\_EventExposure\_Notify service operation as described in 3GPP TS 29.518 [18] clause 5.3.2.4.
5. If the requested analytics does not require UE location information, e.g. for the Analytics events "SERVICE\_EXPERIENCE", "NF\_LOAD", or "UE\_COMM", the Aggregator NWDAF can determine the NFs to be contacted for data collection.
6. With the data obtained in step 3a-5, the Aggregator NWDAF may query the NRF for discovering the required NWDAF, by sending an NF discovery request including UE location or NF serving area as a filter to NRF, and obtains candidates target NWDAF(s) that can provide the required analytics.
7. If a single target NWDAF (e.g. NWDAF2) can provide the requested analytics data, the Aggregator NWDAF can redirect the Nnwdafe\_AnalyticsInfo\_Request to that target NWDAF or request an analytics subscription transfer to that target NWDAF.
8. If the Aggregator NWDAF decides to request analytics from one or more target NWDAFs, the steps 2-9b of the analytics aggregation procedure in clause 5.3.2 are executed.

## 5.4 Procedures for Analytics Transferring

### 5.4.1 Analytics context transfer initiated by target NWDAF selected by the NWDAF service consumer

The procedure in below figure is used when an NWDAF service consumer decides to select a new NWDAF instance due to internal or external triggers, e.g. the NWDAF service consumer starts serving a UE with analytics subscription information received upon UE context transfer procedure as described in 3GPP TS 23.502 [3], or the NWDAF service consumer starts to request NF related analytics, or the NWDAF service consumer receives a "Termination Request" for an existing analytics subscription from an NWDAF. The NWDAF service consumer sends to the target NWDAF information about the NWDAF previously used for analytics subscription, if available, in Nnwdafe\_EventsSubscription\_Subscribe service operation. The target NWDAF may initiate the transfer of the analytics context, using the Nnwdafe\_AnalyticsInfo\_ContextTransfer.

The procedure in below figure is also used when an Aggregator NWDAF, as the NWDAF service consumer, decides to select a new NWDAF to request output analytics for analytics aggregation. For example, upon receiving a Termination Request from one of the NWDAFs that are collectively serving a request for analytics subscription, the Aggregator NWDAF queries the NRF or UDM to select a target NWDAF using information e.g. the UE location, the 5GC NFs (identified by their NF Set IDs or NF types) serving the UE or to be contacted for data collection (if Area of Interest is not provisioned for the requested analytics), or the subset of AoI (if Area of Interest is provisioned for the requested analytics). Then, the Aggregator NWDAF sends information about the NWDAF previously used for analytics subscription, if available, in Nnwdafe\_EventsSubscription\_Subscribe service operation towards the selected target NWDAF.

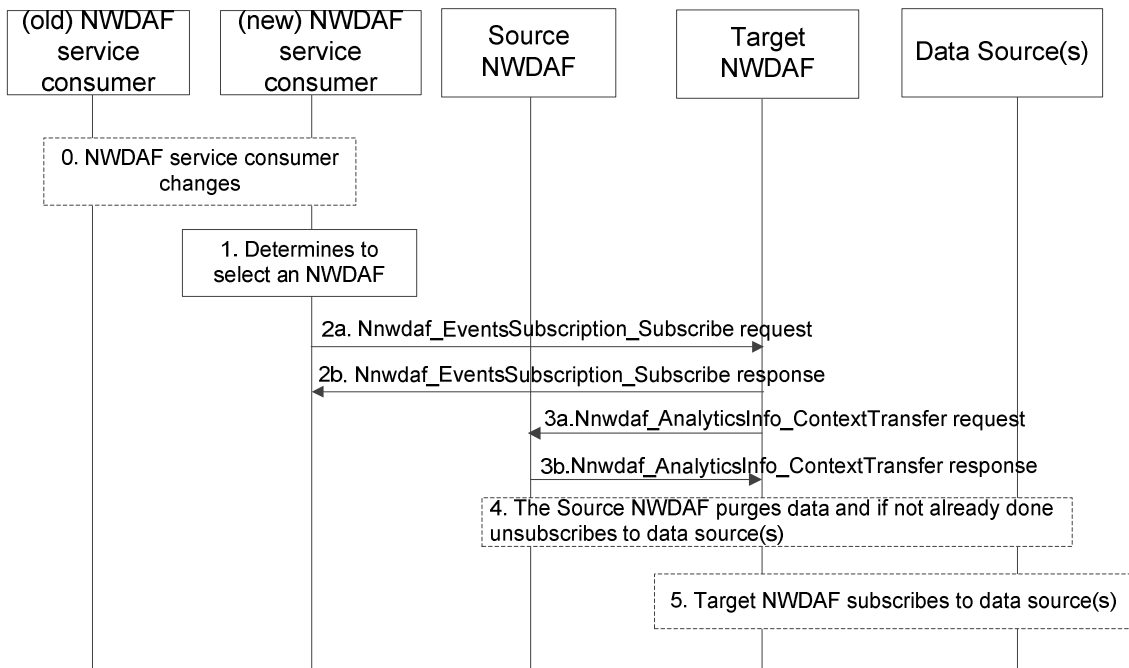

**Figure 5.4.1-1: Analytics context transfer initiated by target NWDAF selected by the NWDAF service consumer**

0. When the NWDAF service consumer (e.g. AMF) changes, the new NWDAF service consumer may receive the old subscription information from the old NWDAF service consumer.
1. The NWDAF service consumer determines to select an NWDAF instance. The NWDAF service consumer discovers and selects the target NWDAF as specified in clause 5.8.
2. To send a request for analytics subscription to the target NWDAF, the NWDAF service consumer invokes `Nnwdaf_EventsSubscription_Subscribe` service operation by sending the HTTP POST request message targeting the resource "NWDAF Events Subscriptions" to the target NWDAF. The NWDAF service consumer includes information on the previous analytics subscription (e.g., NWDAF ID and Subscription ID) which relates to the requested analytics subscription, if available. If the target NWDAF accepts the analytics subscription request, it responds with HTTP "201 Created" to the NWDAF service consumer. Details are described in clause 4.2.2.2 of 3GPP TS 29.520 [5].

If the target NWDAF does not receive information of previous analytics subscription in step 2, for UE related Analytics, the target NWDAF may discover previously used NWDAF in UDM as specified in clause 5.8.

**NOTE:** If the selected target NWDAF instance is the same as the source NWDAF instance (as received from the other consumer in step 0), the new NWDAF service consumer invokes `Nnwdaf_EventsSubscription_Subscribe` service operation by sending the HTTP PUT request message targeting the resource "Individual NWDAF Event Subscription" to the target NWDAF, and the target NWDAF will update the existing analytics subscription to the new NWDAF service consumer. Following steps are skipped.

3. If the target NWDAF decides to request an analytics context transfer from the previously used NWDAF, it invokes the `Nnwdaf_AnalyticsInfo_ContextTransfer` service operation by sending the HTTP GET request message targeting the resource "NWDAF Context" to the source NWDAF as described in clause 4.3.2.3 of 3GPP TS 29.520 [5].

Target NWDAF is now ready to generate analytics information by taking into account the information received in step 3.

4. [Optional] Source NWDAF may purge analytics context after completion of step 3a, if performed, and if not already done, unsubscribes from the data source(s) and/or model source(s) that are no longer needed for the remaining analytics subscriptions.

5. [Optional] Target NWDAF may subscribe to relevant data source(s) and/or model source(s), if it is not yet subscribed to the data source(s) and/or model source(s).

## 5.4.2 Analytics Subscription Transfer initiated by source NWDAF

The procedure in below figure is used by a source NWDAF instance to request the transfer of analytics subscription(s) to another target NWDAF instance, using the `NnwdaF_EventsSubscription_Transfer` service operation.

If the source NWDAF discovers that the NWDAF service consumer may change concurrently to this procedure, the source NWDAF should not perform the procedure. In such a case, the source NWDAF may send a message to indicate to the NWDAF service consumer that it will not serve this subscription anymore.

NOTE 1: To discover the possible change of NWDAF service consumer, if the Analytics Event is UE related, the source NWDAF takes actions responding to external trigger (such as UE mobility), for example, checking if the Target of Analytics Reporting is still within the serving area of the analytics consumer, if the serving area information is available.

NOTE 2: Handling of overload situation or preparation for a graceful shutdown are preferably executed inside an NWDAF Set, when available, therefore, not requiring an analytics subscription transfer as described in this clause. Below procedure is applicable for analytics subscription transfer across NF Sets or if the NWDAF is not deployed in a Set.

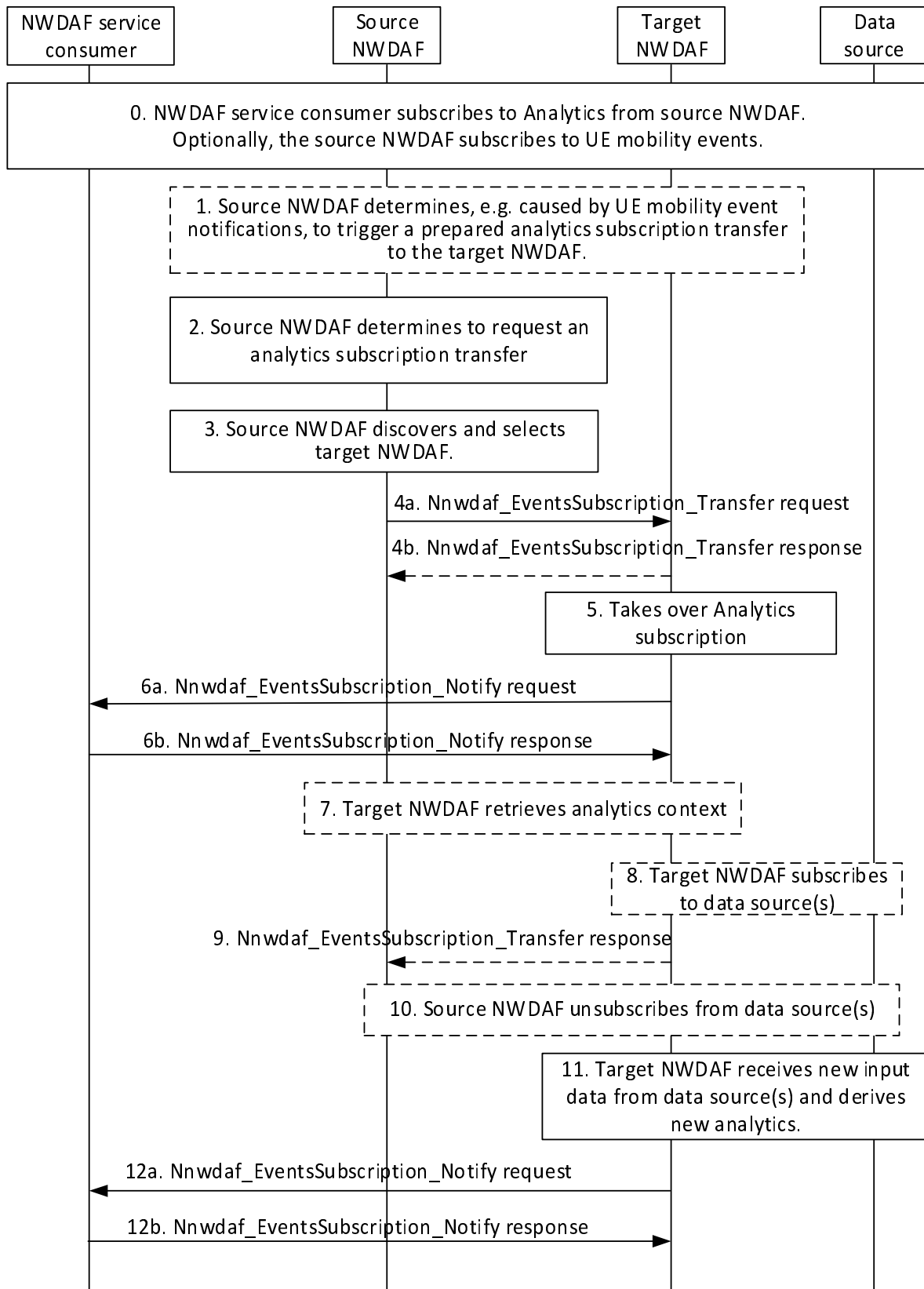

**Figure 5.4.2-1: Analytics subscription transfer initiated by source NWDAF**

0. The NWDAF service consumer subscribes to analytics from source NWDAF. The NWDAF service consumer may send its NF ID or serving area, enabling the source NWDAF to determine whether the following analytics subscription transfer procedure is applicable. Optionally the source NWDAF subscribes to UE mobility events.

1. [Optional] Source NWDAF determines, e.g. triggered by a UE mobility event notification, to prepare an analytics subscription transfer to target NWDAF(s) as described in clause 5.4.3 with steps 0-1, 5- 6 will be followed.
2. Source NWDAF determines, e.g. based on the UE location information received and the analytics consumer's serving area either directly received in step 0 or indirectly received via NRF, to perform an analytics subscription transfer to target NWDAF(s). Therefore, the source NWDAF determines the analytics subscription(s) to be transferred to a target NWDAF.
3. Source NWDAF performs an NWDAF discovery and selects the target NWDAF. NWDAF discovery may be skipped if the target NWDAF had already been discovered as part of a prepared analytics subscription transfer. In the case of aggregated analytics from multiple NWDAFs, the source NWDAF may use the set of NWDAF identifiers related to aggregated analytics to preferably select a target NWDAF that is already serving the consumer.
4. Source NWDAF requests, using `Nnwdafeventssubscriptiontransfer` service operation, a transfer of the analytics subscription(s) determined in step 2 to the target NWDAF as described in clause 4.2.2.5 of 3GPP TS 29.520 [5], the response message in step 4b is optional.
5. Target NWDAF accepts the analytics subscription transfer and takes over the analytics generation based on the information received from the source NWDAF.

The ML model related information namely `ModelInfo` may be provided by the source NWDAF in the `Nnwdafeventssubscriptiontransfer` request message.

- If the instance ID or set ID of NWDAF(s) containing MTLF carried in "modelProvIds" attribute is provided in the `Nnwdafeventssubscriptiontransfer`, target NWDAF may request or subscribe to the ML model(s) from the indicated NWDAF(s).

NOTE 3: If the provided ID(s) of NWDAF(s) containing MTLF carried in "modelProvIds" attribute are not part of the locally configured ID(s) of NWDAFs containing MTLF, the target NWDAF discovers the NWDAF(s) containing MTLF as described in clause 5.8.2.3.

- When the source NWDAF itself provides the ML models, the address of ML model files may be provided, and the target NWDAF retrieves the ML model(s) from the indicated address.

Target NWDAF may use the above retrieved ML models and the ML models retrieved from the locally configured NWDAFs containing MTLF for the transferred analytics subscription.

NOTE 4: If not yet done during a prepared analytics subscription transfer, the target NWDAF allocates a new Subscription ID to the received analytics subscriptions.

NOTE 5: The target NWDAF might already have received information on some/all of the analytics subscriptions as part of the prepared analytics subscription transfer request received in step 1 and, thus, might already have started to prepare for the analytics generation, e.g. by having already subscribed to relevant event notifications.

6. Target NWDAF informs the NWDAF service consumer about the successful analytics subscription transfer using a `Nnwdafeventssubscriptionnotify` request message. A new Subscription ID, which was assigned by the target NWDAF, is provided in the Subscription ID and the old Subscription ID, which was allocated by the source NWDAF, is provided in the Old Subscription ID parameter of this message.

NOTE 6: Notification correlation information in the `Nnwdafeventssubscriptionnotify` message allows the NWDAF service consumer to correlate the notifications to the initial subscription request made with the source NWDAF in step 0.

NOTE 7: The existing Analytics context in the source NWDAF is not deleted directly but will be purged first when it was collected by the target NWDAF.

NOTE 8: If this subscription is used as input for analytics aggregation by the NWDAF service consumer, the NWDAF service consumer may inform the other NWDAFs instance participating in this analytics aggregation that the Set of NWDAF identifiers of NWDAF instances used by the NWDAF service consumer for this analytics aggregation has changed using the `Nnwdafeventssubscriptionsubscribe` service operation as described in clause 4.2.2.2 of 3GPP TS 29.520 [5].



7. [Conditional] If "analytics context identifier(s)" had been included in the Nnwdaf\_EventsSubscription\_Transfer Request received in step 4, the target NWDAF requests the "analytics context" by invoking the Nnwdaf\_AnalyticsInfo\_ContextTransfer service operation as described in clause 4.3.2.3 of 3GPP TS 29.520 [5].
8. [Optional] Target NWDAF subscribes to relevant data source(s), if it is not yet subscribed to the data source(s) for the data required for the Analytics.
9. [Optional] Target NWDAF confirms the analytics subscription transfer to the source NWDAF by sending Nnwdaf\_EventsSubscription\_Transfer response message as described in clause 4.2.2.5 of 3GPP TS 29.520 [5], if the response has not been sent in step 4b.
10. [Optional] Source NWDAF unsubscribes with the data source(s) that are no longer needed for the remaining analytics subscriptions. In addition, Source NWDAF unsubscribes with the NWDAF(s) containing MTLF, if exist, which are no longer needed for the remaining analytics subscriptions.

NOTE 9: At this point, the analytics subscription transfer is deemed completed, i.e. the source NWDAF can delete all information related to the successfully transferred analytics subscription.

11-12. Target NWDAF at some point derives new output analytics based on new input data and notifies the NWDAF service consumer about the new analytics using a Nnwdaf\_EventsSubscription\_Notify message as described in clause 4.2.2.4 of 3GPP TS 29.520 [5].

### 5.4.3 Prepared analytics subscription transfer

The procedure in below figure is used by a NWDAF instance to request another NWDAF instance for a prepared analytics subscription transfer from the source NWDAF instance, using the Nnwdaf\_EventsSubscription\_Transfer service operation.

- NOTE 1: The source NWDAF might determine that it needs to prepare to transfer analytics to another NWDAF instance, e.g. when the source NWDAF estimates for UE related analytics subscription that the UE might enter an area which is not covered by the source NWDAF (e.g., by subscribing to AMF event exposure service for UE mobility event notifications, by performing UE mobility analytics, or by subscribing to another NWDAF providing UE mobility analytics). If the source NWDAF discovers that the analytics consumer may change concurrently to this procedure, the source NWDAF does not perform the procedure. If the procedure makes use of predictions to determine the candidate NWDAFs, care must be taken with regards to load and signalling cost when sending data to an NWDAF that will not eventually start serving the UE.
- NOTE 2: The source NWDAF might also determine that it needs to prepare to transfer analytics subscriptions to another NWDAF instance, as the source NWDAF wants to resolve an internal load situation or prepare for a graceful shutdown.
- NOTE 3: Handling of overload situation or preparation for a graceful shutdown are preferably executed inside an NWDAF Set, when available.

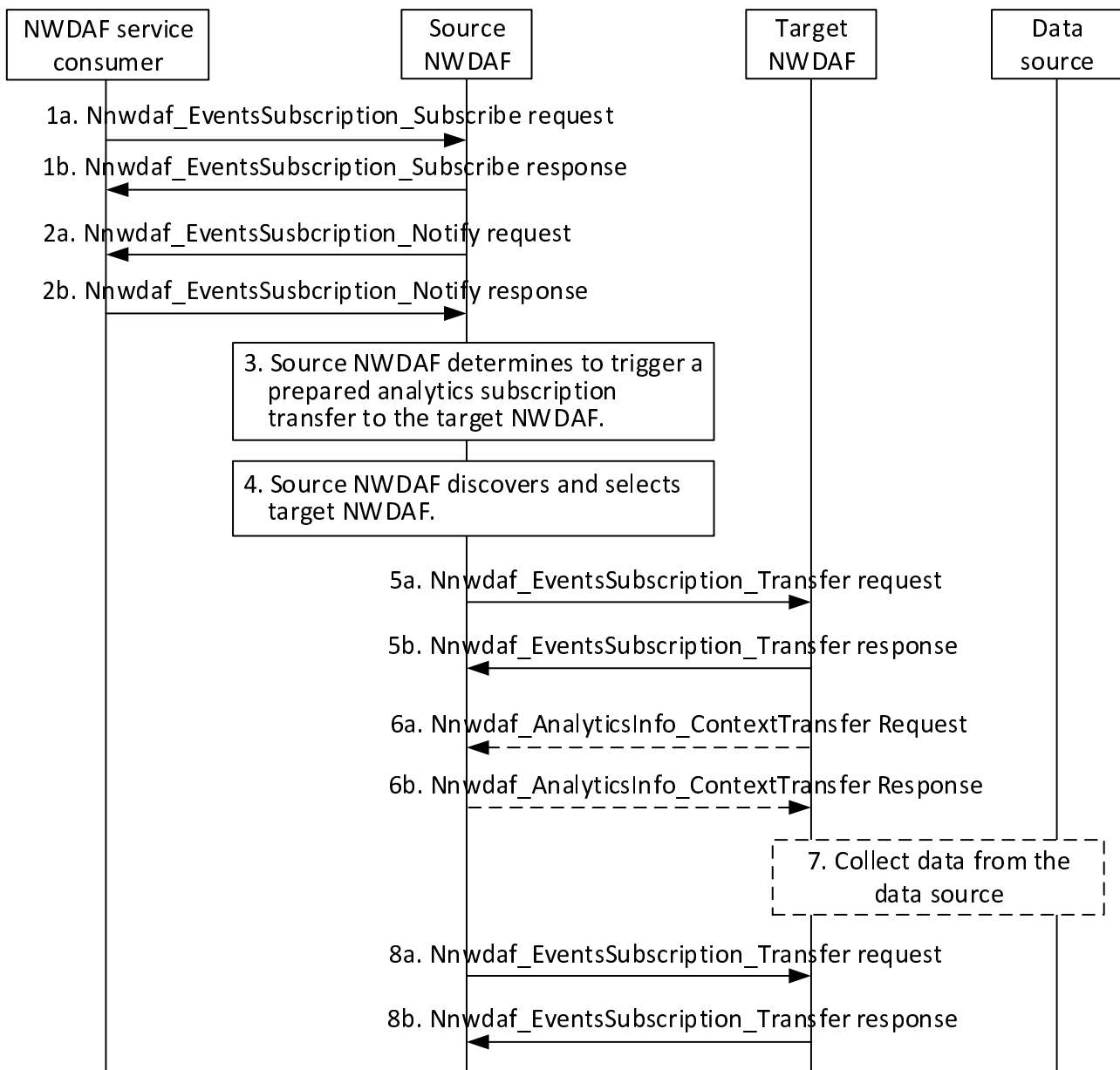

**Figure 5.4.3-1: Prepared analytics subscription transfer**

1a-1b. The NWDAF service consumer subscribes to analytics from source NWDAF by invoking `Nnwdaf_EventsSubscription_Subscribe` service operation. The source NWDAF responds to `Nnwdaf_EventsSubscription_Subscribe` service operation.

2a-2b. The source NWDAF generates the requested analytics and notify the NWDAF service consumer by invoking the `Nnwdaf_EventsSubscription_Notify` service operation. The NWDAF service consumer responds to the `Nnwdaf_EventsSubscription_Notify` service operation.

3. The source NWDAF determines that it needs to prepare to transfer the analytics subscription to another NWDAF instance.

4. The source NWDAF discovers and selects the target NWDAF as described in clause 5.8.2.3.

5a-5b. The source NWDAF invokes `Nnwdaf_EventsSubscription_Transfer` service operation by sending an HTTP POST request to the target NWDAF and the "transReqType" attribute in the request message is set to "PREPARE". The target NWDAF sends an HTTP "201 Created" to the source NWDAF.

6a-6b. If analytics context identifier information had been included in the `Nnwdaf_EventsSubscription_Transfer` request message, the target NWDAF requests the analytics context information from the source NWDAF by

invoking the Nnwdaf\_AnalyticsInfo\_ContextTransfer service operation by sending the HTTP GET request message targeting the resource "NWDAF Context" to the source NWDAF.

7. The target NWDAF collect the data required for the analytics from the relevant data source(s), if it is not yet collected.

8a-8b. The source NWDAF invokes the Nnwdaf\_EventsSubscription\_Transfer service operation by sending an HTTP DELETE request to cancel the prepared analytics subscription transfer. The target NWDAF sends response to the source NWDAF and deletes the analytics data that is no longer needed. If the target NWDAF had already subscribed to entities to collect data or ML models during the analytics subscription preparation, it unsubscribes from those entities if the subscriptions are not needed for other active analytics subscriptions.

## 5.5 Data Collection

### 5.5.1 Procedure for Data Collection from NFs

#### 5.5.1.1 Data Collection from NFs

The procedure in Figure 5.5.1-1 is used by NWDAF to subscribe/unsubscribe at NFs in order to be notified for data collection on related event(s), using Event Exposure Services as listed in Table 6.2.2.1-1 defined in TS 23.288 [2] clause 6.2.2.

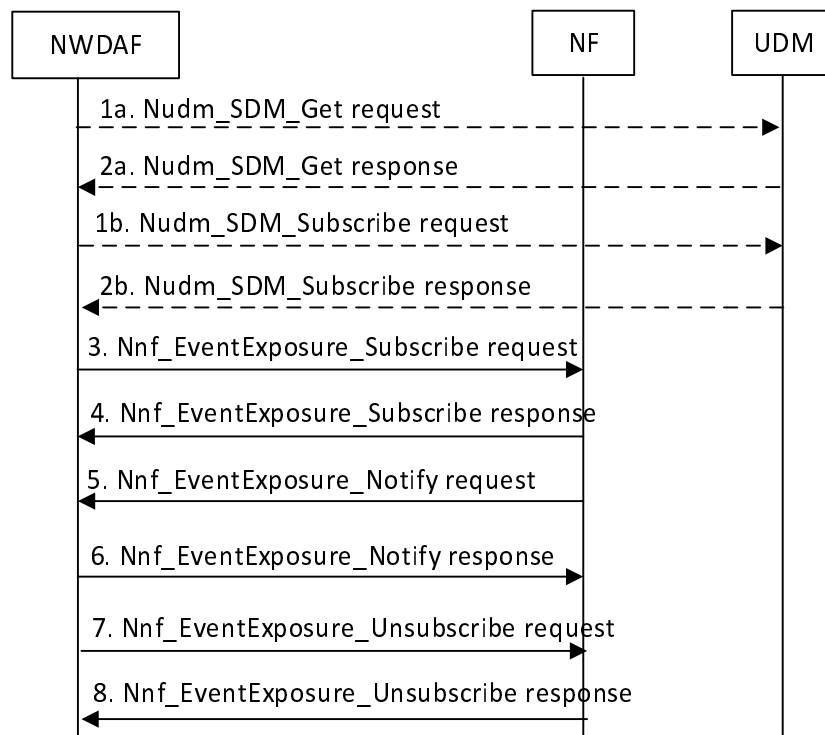

Figure 5.5.1.1-1: Event Exposure Subscribe/Unsubscribe for NFs

1a. If data is to be collected for a user, i.e. for a SUPI or GPSI, [the user consent has not been checked by the data consumer](#), and local policy and regulations require to check user consent, the NWDAF invokes Nudm\_SDM\_Get service operation by sending an HTTP GET request targeting the resource "AccessAndMobilitySubscriptionData" to the UDM to request the data type "User consent" as described in clause 5.2.2.2 of 3GPP TS 29.503 [22]. Otherwise the procedure begins with step 3.

2a. The UDM responds to the Nudm\_SDM\_Get service operation. If the request is accepted, the response includes the requested data with "200 OK". In subsequent steps, the NWDAF excludes the SUPI or GPSI from requests to collect data for users for whom the user consent is not granted.

- 1b. For the users for which the user consent is granted, the NWDAF subscribes to notifications of changes of the user consent by invoking the Nudm\_SDM\_Subscribe service operation by sending an HTTP POST request targeting the resource "SdmSubscriptions" to the UDM as described in clause 5.2.2.3 of 3GPP TS 29.503 [22].
- 2b. The UDM responds to the Nudm\_SDM\_Subscribe service operation. If the request is accepted, the UDM responds with "201 Created".
3. In order to subscribe to notifications (or to modify subscriptions to notifications) of data events from the data source NF (e.g. UDM, AMF, SMF, NEF, AF), the NWDAF invokes the Nnf\_EventExposure\_Subscribe service operation by sending an HTTP POST (or PUT, for modification) request targeting the resource representing event exposure subscriptions of that NF, e.g. as described in clause 5.5.2.2 of 3GPP TS 29.503 [22] for the UDM, clause 5.3.2.2 of 3GPP TS 29.518 [18] for the AMF, clause 4.2.3 of 3GPP TS 29.508 [6] for the SMF, clause 4.2.2.2 of 3GPP TS 29.591 [11] for the NEF, or clause 4.2.2 of 3GPP TS 29.517 [12] for the AF.
4. The NF responds to the Nnf\_EventExposure\_Subscribe service operation. Upon receipt of the HTTP POST request, if the subscription is accepted to be created, the NF responds to the NWDAF with "201 Created", and the URI of the created subscription is included in the Location header field.
5. If the NF observes the subscribed event(s), the NF invokes Nnf\_EventExposure\_Notify service operation to report the event(s) by sending an HTTP POST request, e.g. as described in clause 5.5.2.4 of 3GPP TS 29.503 [22] for the UDM, clause 5.3.2.4 of 3GPP TS 29.518 [18] for the AMF, clause 4.2.2 of 3GPP TS 29.508 [6] for the SMF, clause 4.2.2.4 of 3GPP TS 29.591 [11] for the NEF, or clause 4.2.4 of 3GPP TS 29.517 [12] for the AF.
6. The NWDAF sends an HTTP "204 No Content" response to the NF.
7. In order to unsubscribe to the notifications of data events from the NWDAF, the NWDAF invokes Nnf\_EventExposure\_Unsubscribe service operation by sending an HTTP DELETE request targeting the resource that represents the previously created individual event exposure subscription, e.g. as described in clause 5.5.2.3 of 3GPP TS 29.503 [22] for the UDM, clause 5.3.2.3 of 3GPP TS 29.518 [18] for the AMF, clause 4.2.4 of 3GPP TS 29.508 [6] for the SMF, clause 4.2.2.3 of 3GPP TS 29.591 [11] for the NEF, clause 4.2.3 of 3GPP TS 29.517 [12] for the AF. The request includes the event subscriptionId of the existing subscription that is to be deleted.
8. The NF responds to the Nnf\_EventExposure\_Unsubscribe service operation. If the subscription deletion is accepted, the NF responds with "204 No Content".

## 5.5.2 Data collection profile registration

This procedure depicted in Figure 5.5.2-1 is used by NWDAF or ADRF to register/update a data collection profile to the DCCF during/after the procedure of data collection.

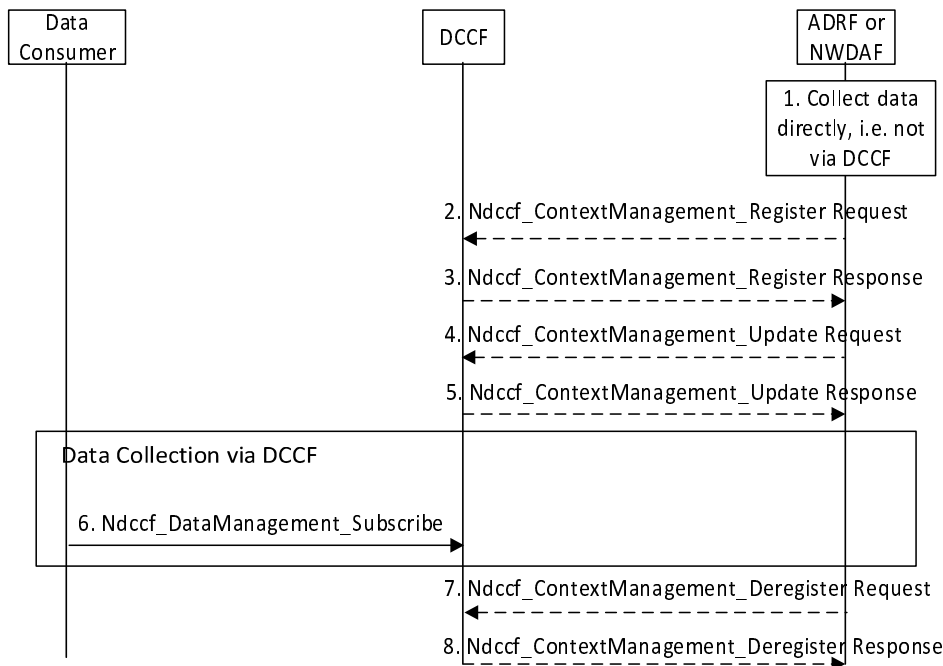

**Figure 5.5.2-1: Procedure for the NWDAF or ADRF to register data profile to DCCF**

1. An ADRF or NWDAF instance is collecting or has collected data directly, e.g. from collocated NF.
2. In order to register a data collection profile, the ADRF or NWDAF invokes the `Ndccf_ContextManagement_Register` service operation by sending an HTTP POST request targeting the resource "DCCF Data Collection Profiles" as described in clause 4.3.2.2 of 3GPP TS 29.574 [15].
3. The DCCF responds to the `Ndccf_ContextManagement_Register` service operation. Upon receipt of the HTTP POST request, if the data profile is accepted to be created, the DCCF responds to the ADRF or NWDAF with "201 Created", and the URI of the created profile is included in the Location header field.
4. In order to update a data collection profile, the Data Consumer invokes the `Ndccf_ContextManagement_Update` service operation by sending an HTTP PUT request targeting the resource "Individual DCCF Data Collection Profile" as described in clause 4.3.2.3 of 3GPP TS 29.574 [15].
5. The DCCF responds to the `Ndccf_ContextManagement_Update` service operation. Upon receipt of the HTTP PUT request, if the data profile is accepted to be updated, the DCCF responds to the ADRF or NWDAF with "200 OK" with a response body containing a representation of the updated data profile or "204 No Content".
6. To obtain historical data and if the data consumer is configured to collect data via the DCCF using the `Ndccf_DataManagement_Subscribe` service operation, the data consumer uses the procedures described in clause 5.5.3.
7. The ADRF or NWDAF requests to delete a registered data collection profile at the DCCF invoking the `Ndccf_ContextManagement_Deregister` service operation by sending a HTTP DELETE request targeting the "Individual DCCF Data Collection Profile" resource of the DCCF as described in clause 4.3.2.4 of 3GPP TS 29.574 [15].
8. The DCCF responds to the `Ndccf_ContextManagement_Deregister` service operation with HTTP "204 No Content" status code, if the data collection profile is successfully removed.

### 5.5.3 Procedure for Data Collection using DCCF

#### 5.5.3.1 Data Collection via DCCF

The procedure depicted in Figure 5.5.3.1-1 is used by a data consumer (e.g. NWDAF) to obtain data and be notified of events via the DCCF using the Ndccf\_DataManagement\_Subscribe service operation. Whether the data consumer directly contacts the Data Source or goes via the DCCF is based on configuration of the data consumer.

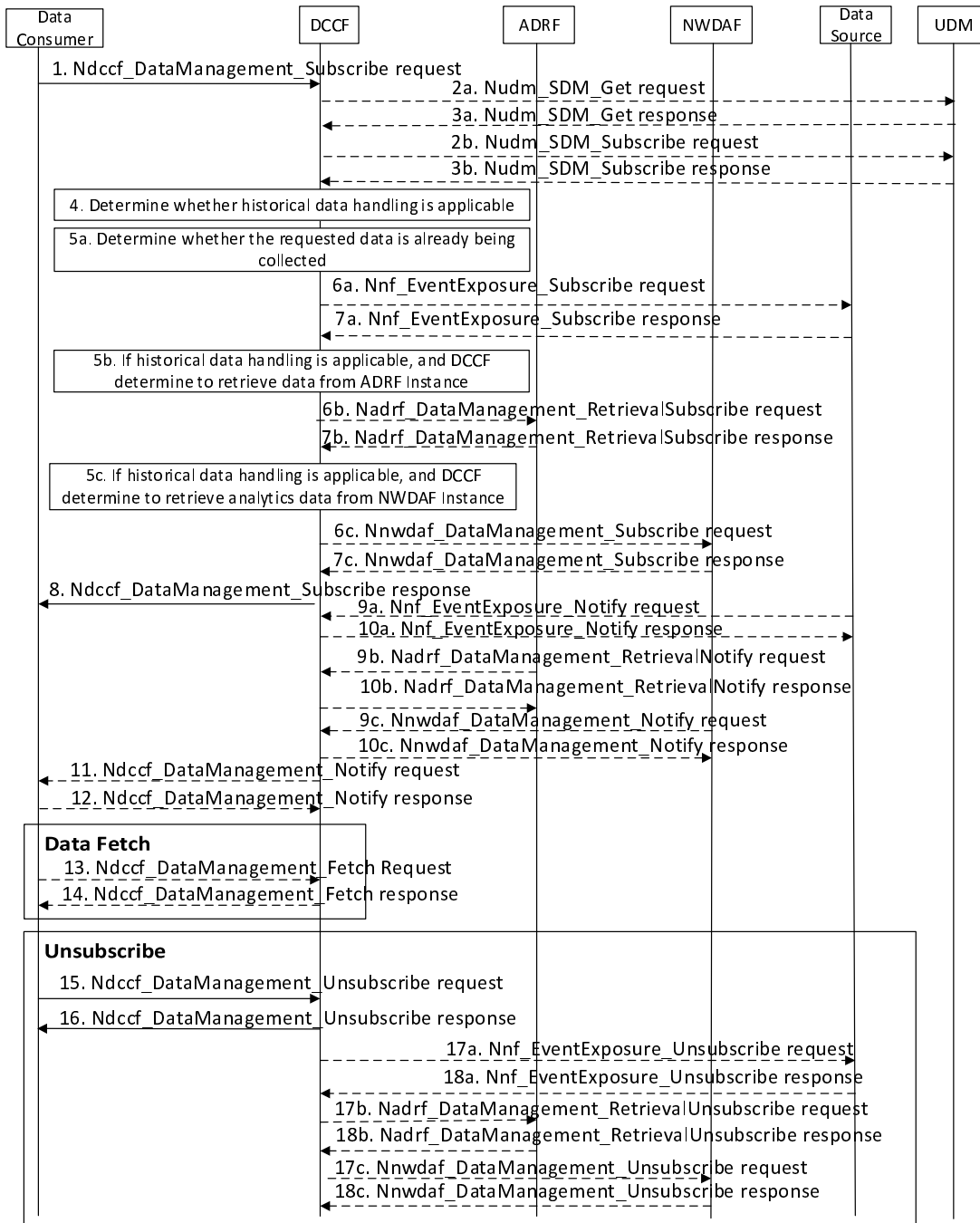

Figure 5.5.3.1-1: Data Collection via DCCF

1. In order to subscribe to notification(s) of events exposure via the DCCF based on local configuration, the Data Consumer invokes the Ndccf\_DataManagement\_Subscribe service operation by sending an HTTP POST request targeting the resource "DCCF Data Subscriptions" as described in clause 4.2.2.2.4 of 3GPP TS 29.574 [15].
- 2a. If data is to be collected for a user, i.e. for a SUPI or GPSI, **the user consent has not been checked by the data consumer**, and local policy and regulations require to check user consent, the DCCF invokes the

Nudm\_SDM\_Get service operation by sending an HTTP GET request targeting the resource "AccessAndMobilitySubscriptionData" at the UDM to request the data type "User consent" as described in clause 5.2.2.2 of 3GPP TS 29.503 [22]. Otherwise the procedure continues with step 4.

- 3a. The UDM responds to the Nudm\_SDM\_Get service operation. If the request is accepted, the response includes the requested data with "200 OK". In subsequent steps, the NWDAF excludes the SUPI or GPSI from requests to collect data for users for whom the user consent is not granted.
- 2b. For the users for which the user consent is granted, the DCCF subscribes to notifications of changes of the user consent by invoking the Nudm\_SDM\_Subscribe service operation by sending an HTTP POST request targeting the resource "SdmSubscriptions" at the UDM as described in clause 5.2.2.3 of 3GPP TS 29.503 [22].
- 3b. The UDM responds to the Nudm\_SDM\_Subscribe service operation. If the request is accepted, the UDM responds with "201 Created" status code.
4. The DCCF determines the NF type(s) and/or OAM to retrieve the data based on the Service Operation requested in step 1. If the NF instance or NF Set ID is not provided by the data consumer. The DCCF determines the NF instances that can provide data as described in TS 23.288 [2] clause 5A.2 and clause 6.2.2.2. If the consumer requested storage of data in an ADRF but the ADRF ID is not provided by the data consumer, or the collected data is to be stored in an ADRF according to configuration on the DCCF, the DCCF selects an ADRF to store the collected data.

The DCCF keeps track of the data actively being collected from the Data Sources it is coordinating. The NWDAF or ADRF may register the data collection profile (including the data collection related Service Operation, Analytics/Data Specification, NWDAF ID or ADRF ID) with the DCCF. The DCCF may then determine whether certain historical data may be available in the NWDAF or ADRF based on the data collection profile and the request time window.

If the historical data handling is not applicable or not supported, the DCCF shall proceed with step 5a and skip step 5b, step 6b, step 7b, step 5c, step 6c, and step 7c.

If the historical data is available in an ADRF, the DCCF shall proceed with step 5a and step 5b, and skip step 5c, step 6c, and step 7c.

If the historical data is available in an NWDAF, the DCCF shall proceed with step 5a and step 5c, and skip step 5b, step 6b, and step 7b.

- 5a. The DCCF shall determine whether the data requested in step 1 are already being collected.

If the data requested are already being collected by a data consumer, the DCCF adds the data consumer to the list of data consumers that are subscribed for these data.

If the DCCF determines that no subscriptions need to be created or modified (e.g. because all the data can be made available either via pre-existing subscriptions or because of the historical data handling) then step 6a and step 7a are skipped.

- 6a. If the data requested in step 1 are not yet available, the DCCF shall invoke the Nnf\_EventExposure\_Subscribe service operation by sending an HTTP POST request message request to the NF targeting the resource representing event exposure subscriptions to subscribe to a new event exposure subscription, e.g. as described in clause 5.5.2.2 of 3GPP TS 29.503 [22] for the UDM, clause 5.3.2.2 of 3GPP TS 29.518 [18] for the AMF, clause 4.2.3 of 3GPP TS 29.508 [6] for the SMF, clause 4.2.2.2 of 3GPP TS 29.591 [11] for the NEF, or clause 4.2.2 of 3GPP TS 29.517 [12] for the AF.

Otherwise, if the requested data subscribed in step 1 partially matches data that is already being collected by the DCCF from an NF, and a modification of this subscription to the NF would satisfy both the existing data subscriptions as well as the newly requested data, the DCCF shall send a request to the individual event exposure subscription resource to update an existing event exposure subscription, e.g. as described in clause 5.5.2.5 of 3GPP TS 29.503 [22] for the UDM, clause 5.3.2.2.3 of 3GPP TS 29.518 [18] for the AMF, clause 4.2.3.3 of 3GPP TS 29.508 [6] for the SMF, clause 4.2.2.2.3 of 3GPP TS 29.591 [11] for the NEF, or clause 4.2.2.3 of 3GPP TS 29.517 [12] for the AF.

- 7a. The NF responds to the Nnf\_EventExposure\_Subscribe service operation.

Upon receipt of an HTTP POST request, if the subscription is accepted to be created, the NF responds to the DCCF with "201 Created" status code, and the URI of the created subscription is included in the Location header field.

Upon receipt of an HTTP PUT request, if the subscription is accepted to be updated, the NF responds to the DCCF with "200 OK" or "204 No Content" status code.

5b. If the historical data handling is applicable, and the DCCF determines to retrieve data from the ADRF, the DCCF shall determine which ADRF instances might provide the data.

6b. In order to retrieve the historical data from the ADRF, the DCCF shall invoke the Ndrf\_DataManagement\_RetrievalSubscribe service operation by sending an HTTP POST request message targeting the resource "ADRF Data Retrieval Subscriptions" as described in clause 4.2.2.6 of 3GPP TS 29.575 [16].

7b. The ADRF responds to the Ndrf\_DataManagement\_RetrievalSubscribe service operation.

Upon receipt of the HTTP POST request, if the subscription is accepted to be created, the ADRF responds to the DCCF with "201 Created" status code, and the URI of the created subscription is included in the Location header field.

5c. If the historical data handling is applicable, and the DCCF determines to retrieve data from the NWDAF, the DCCF shall determine which NWDAF instances might provide the requested data.

6c. In order to retrieve the historical data from the NWDAF, the DCCF shall invoke the Nnwdafter\_DataManagement\_Subscribe service operation by sending an HTTP POST request message targeting the resource "NWDAF Data Management Subscriptions", as described in clause 4.4.2.2 of 3GPP TS 29.520 [5].

7c. The NWDAF responds to the Nnwdafter\_DataManagement\_Subscribe service operation.

Upon receipt of the HTTP POST request, if the subscription is accepted to be created, the NWDAF responds to the DCCF with "201 Created" status code, and the URI of the created subscription is included in the Location header field.

8. The DCCF responds to the Ndccf\_DataManagement\_Subscribe service operation with HTTP "204 No Content" status code.

9a. When the data are available, the NF invokes the Nnf\_EventExposure\_Notify service operation by sending an HTTP POST request message to notify the data events to the DCCF, e.g. as described in clause 5.5.2.4 of 3GPP TS 29.503 [22] for the UDM, clause 5.3.2.4 of 3GPP TS 29.518 [18] for the AMF, clause 4.2.2 of 3GPP TS 29.508 [6] for the SMF, clause 4.2.2.4 of 3GPP TS 29.591 [11] for the NEF, or clause 4.2.4 of 3GPP TS 29.517 [12] for the AF.

10a. The DCCF responds to the Nnf\_EventExposure\_Notify service operation with HTTP "204 No Content" status code.

9b. When the historical data are available in the ADRF, the ADRF shall invoke the Ndrf\_DataManagement\_RetrievalNotify service operation by sending an HTTP POST request message to notify the historical data or Fetch Instructions to the DCCF as described in clause 4.2.2.8 of 3GPP TS 29.575 [16].

10b. The DCCF responds to the Ndrf\_DataManagement\_RetrievalNotify service operation with HTTP "204 No Content" status code.

9c. When the historical data are available in the NWDAF, the NWDAF shall invoke the Nnwdafter\_DataManagement\_Notify service operation by sending an HTTP POST request message to notify the historical data to the DCCF as described in clause 4.4.2.4 of 3GPP TS 29.520 [5].

10c. The DCCF responds to the Nnwdafter\_DataManagement\_Notify service operation with HTTP "204 No Content" status code.

11. If the DCCF is configured to deliver the data itself (and not via the MFAF), the DCCF invokes the Ndccf\_DataManagement\_Notify service operation by sending HTTP POST request message(s) to send the data to all notification endpoints indicated in step 1. Data sent to notification endpoints may be processed and



formatted by the DCCF, so they conform to delivery requirements for each NF service consumer or notification endpoint.

NOTE: According to Formatting Instructions provided by the NF service consumer, multiple notifications from a NF can be combined in a single `Ndccf_DataManagement_Notify` so that many notifications from an NF result in fewer notifications (or one notification) to the Data Consumer. Alternatively, a notification can instruct the data notification endpoint to fetch the data from the DCCF.

12. The NF service consumer responds to the `Ndccf_DataManagement_Notify` service operation with HTTP "204 No Content" status code.
13. The Data Consumer invokes the `Ndccf_DataManagement_Fetch` service operation by sending an HTTP GET request message as described in clause 4.2.2.5 of 3GPP TS 29.574 [15] to fetch the data from the DCCF before an expiry time, if the fetch instruction was previously received via the `NdccfDataManagement_Notify` service operation in step 11.
14. The DCCF responds to the `Ndccf_DataManagement_Fetch` service operation with HTTP "200 OK" status code with the message body containing the data received earlier from the data source.
15. When the NF service consumer no longer needs the subscription to the requested data in step 1, it shall invoke the `Ndccf_DataManagement_Unsubscribe` service operation by sending an HTTP DELETE request message as described in clause 4.2.2.3.3 of 3GPP TS 29.574 [15]. The DCCF removes the NF service consumer from the list of NF service consumers that are subscribed for these data.
16. The DCCF responds to the `Ndccf_DataManagement_Unsubscribe` service operation with HTTP "204 No Content" status code, if the NF service consumer is successfully removed from the list of NF service consumers that are subscribed for these data.
- 17a. If there are no other NF service consumers subscribed to the data, the DCCF invokes the `Nnf_EventExposure_Unsubscribe` service operation by sending an HTTP DELETE request message to the Data Source, e.g. as described in clause 5.5.2.3 of 3GPP TS 29.503 [22] for the UDM, clause 5.3.2.3 of 3GPP TS 29.518 [18] for the AMF, clause 4.2.4 of 3GPP TS 29.508 [6] for the SMF, clause 4.2.2.3 of 3GPP TS 29.591 [11] for the NEF, or clause 4.2.3 in 3GPP TS 29.517 [12] for the AF.
- 18a. The Data Source responds to the `Nnf_EventExposure_Unsubscribe` service operation with HTTP "204 No Content" status code, if the data event(s) subscription is successfully removed.
- 17b. If the DCCF determines that no other NF service consumers require the historical data from the ADRF, the DCCF invokes the `Nadrf_DataManagement_RetrievalUnsubscribe` service operation by sending an HTTP DELETE request message to the ADRF as described in clause 4.2.2.7 of 3GPP TS 29.575 [16].
- 18b. The ADRF responds to the `Nadrf_DataManagement_RetrievalUnsubscribe` service operation with HTTP "204 No Content" status code, if the data retrieval subscription is successfully removed.
- 17c. If DCCF determines that no other NF service consumers require the historical data from the NWDAF, the DCCF invokes the `Nnwdaf_DataManagement_Unsubscribe` service operation by sending an HTTP DELETE request message to the NWDAF as described in clause 4.4.2.3 of 3GPP TS 29.520 [5].
- 18c. The NWDAF responds to the `Nnwdaf_DataManagement_Unsubscribe` service operation with HTTP "204 No Content" status code, if the data subscription is successfully removed.

### 5.5.3.2 Data Collection via Messaging Framework

This procedure depicted in Figure 5.5.3.2-1 is used by a data consumer (e.g. NWDAF) to obtain data and be notified of events using the DCCF and a Messaging Framework. The 3GPP DCCF Adaptor (3da) Data Management service and 3GPP Consumer Adaptor (3ca) Data Management service of the Messaging Framework Adaptor Function (MFAF) are used to interact with the Messaging Framework. Whether the data consumer directly contacts the Data Source or goes via the DCCF is based on configuration.

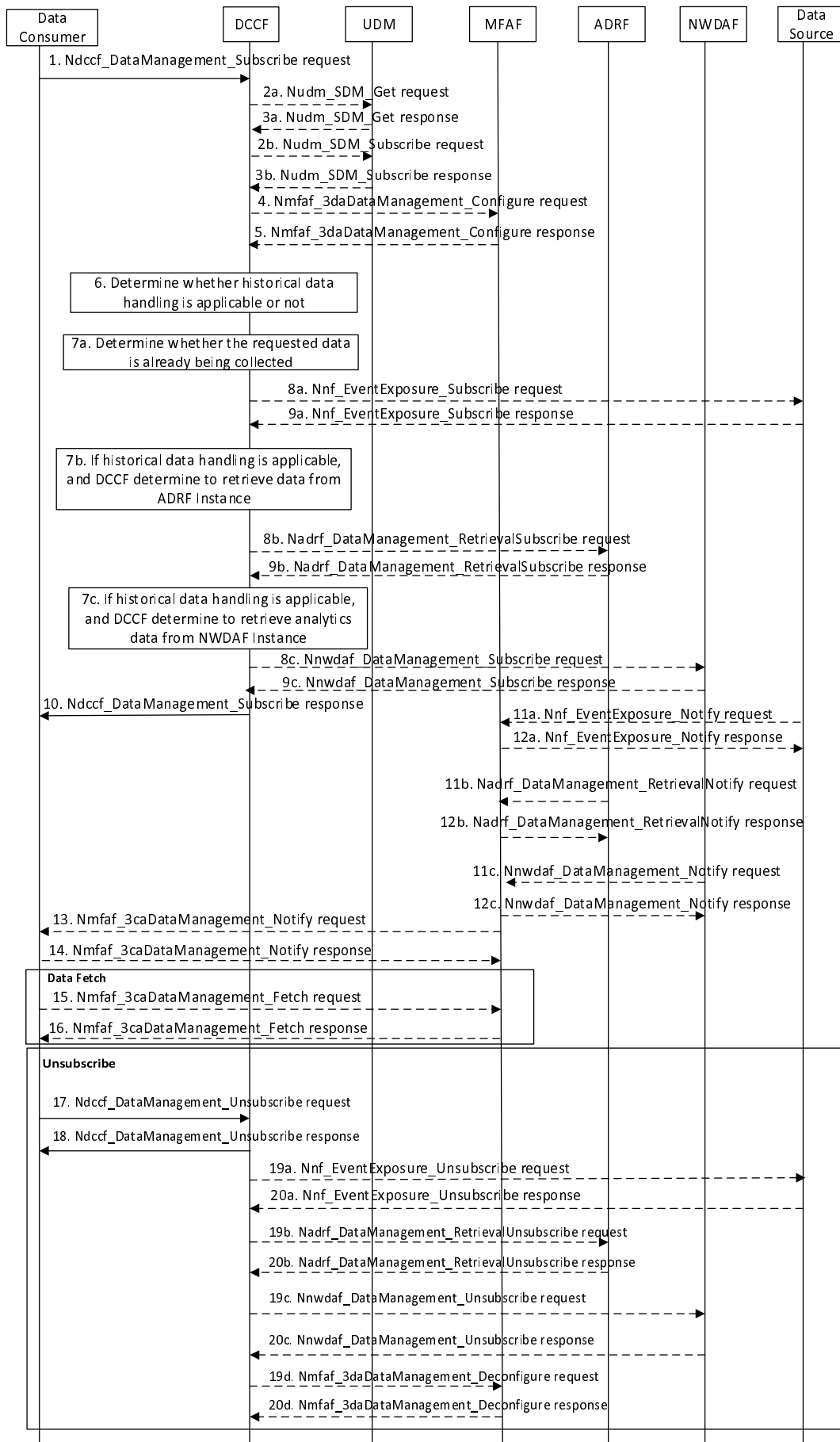

Figure 5.5.3.2-1: Data Collection via DCCF and via Messaging Framework

1. In order to subscribe to notification(s) of events exposure via the DCCF based on local configuration, the Data Consumer invokes the Ndcf\_DataManagement\_Subscribe service operation by sending an HTTP POST request message targeting the resource "DCCF Data Subscriptions", as described in clause 4.2.2.2.4 of 3GPP TS 29.574 [15].
- 2a. If data is to be collected for a user, i.e. for a SUPI or GPSI, **the user consent has not been checked by the data consumer**, and local policy and regulations require to check user consent, the DCCF invokes Nudm\_SDM\_Get service operation by sending an HTTP GET request message targeting the resource "AccessAndMobilitySubscriptionData" at the UDM to request the data type "User consent" as described in clause 5.2.2.2 of 3GPP TS 29.503 [22]. Otherwise the procedure continues with step 4.
- 3a. The UDM responds to the Nudm\_SDM\_Get service operation. If the request is accepted, the response includes the requested data with "200 OK" status code. In subsequent steps, the NWDAF excludes the SUPI or GPSI from requests to collect data for users for whom the user consent is not granted.
- 2b. For the users for which the user consent is granted, the DCCF subscribes to notifications of changes of the user consent by invoking the Nudm\_SDM\_Subscribe service operation by sending an HTTP POST request message targeting the resource "SdmSubscriptions" at the UDM as described in clause 5.2.2.3 of 3GPP TS 29.503 [22].
- 3b. The UDM responds to the Nudm\_SDM\_Subscribe service operation. If the request is accepted, the UDM responds with "201 Created" status code.
4. If the DCCF is configured to perform data delivery via the MFAF, in order to create configuration of mapping data in the MFAF, the DCCF shall invoke the Nmfaf\_3daDataManagement\_Configure service operation by sending an HTTP POST request message targeting the resource "MFAF Configurations", as described in clause 4.2.2.2.2 of 3GPP TS 29.576 [17].

In order to update configuration of mapping data in the MFAF, the DCCF shall invoke the Nmfaf\_3daDataManagement\_Configure service operation by sending an HTTP PUT request message targeting the resource "Individual MFAF Configuration", as described in clause 4.2.2.2.3 of 3GPP TS 29.576 [17].

5. The MFAF responds to the Nmfaf\_3daDataManagement\_Configure service operation.

Upon receipt of the HTTP POST request message, if the configuration is accepted to be created, the MFAF responds to the DCCF with "201 Created" status code, and the URI of the created configuration is included in the Location header field.

Upon receipt of the HTTP PUT request message, if the configuration is accepted to be updated, the MFAF responds to the DCCF with "200 OK" or "204 No Content" status code.

6. The DCCF determines the NF type(s) and/or OAM to retrieve the data based on the Service Operation requested in step 1. If the NF instance or NF Set ID is not provided by the data consumer, the DCCF determines the NF instances that can provide data as described in TS 23.288 [2] clause 5A.2 and clause 6.2.2.2. If the consumer requested storage of data in an ADRF but the ADRF ID is not provided by the data consumer, or the collected data is to be stored in an ADRF according to configuration on the DCCF, the DCCF selects an ADRF to store the collected data.

The DCCF keeps track of the data actively being collected from the Data Sources it is coordinating. The NWDAF or ADRF may register the data collection profile (including the data collection related Service Operation, Analytics/Data Specification, NWDAF ID or ADRF ID) with the DCCF. The DCCF may then determine whether certain historical data may be available in the NWDAF or ADRF based on the data collection profile and the request time window.

If the historical data handling is not applicable or not supported, the DCCF shall proceed with step 7a, and skip step 7b, step 8b, step 9b, step 7c, step 8c, and step 9c.

If the historical data is available in an ADRF, the DCCF shall proceed with step 7a and step 7b, and skip step 7c, step 8c, and step 9c.

If the historical data is available in an NWDAF, the DCCF shall proceed with step 7a and step 7c, and skip step 7b, step 8b, and step 9b.

- 7a. The DCCF shall determine whether the data requested in step 1 are already being collected.

If the data requested are already being collected by a data consumer, the DCCF adds the data consumer to the list of data consumers that are subscribed for these data.

If the DCCF determines that no subscriptions need to be created or modified (e.g. because all the data can be made available either via pre-existing subscriptions or because of the historical data handling) then step 8a and step 9a are skipped.

- 8a. If data requested in step 1 are not available yet, the DCCF shall invoke the `Nnf_EventExposure_Subscribe` service operation by sending an HTTP POST request message request to the NF targeting the resource representing event exposure subscriptions to subscribe to a new event exposure subscription, e.g. as described in clause 5.5.2.2 of 3GPP TS 29.503 [22] for the UDM, clause 5.3.2.2 of 3GPP TS 29.518 [18] for the AMF, clause 4.2.3 of 3GPP TS 29.508 [6] for the SMF, clause 4.2.2.2 of 3GPP TS 29.591 [11] for the NEF, or clause 4.2.2 of 3GPP TS 29.517 [12] for the AF.

Otherwise, if the requested data subscribed in step 1 partially matches data that is already being collected by the DCCF from an NF, and a modification of this subscription to the NF would satisfy both the existing data subscriptions as well as the newly requested data, the DCCF shall send a request to the individual event exposure subscription resource to update an existing event exposure subscription, e.g. as described in clause 5.5.2.5 of 3GPP TS 29.503 [22] for the UDM, clause 5.3.2.2.3 of 3GPP TS 29.518 [18] for the AMF, clause 4.2.3.3 of 3GPP TS 29.508 [6] for the SMF, clause 4.2.2.2.3 of 3GPP TS 29.591 [11] for the NEF, or clause 4.2.2.3 of 3GPP TS 29.517 [12] for the AF.

- 9a. The NF responds to the `Nnf_EventExposure_Subscribe` service operation.

Upon receipt of the HTTP POST request message, if the subscription is accepted to be created, the NF responds to the DCCF with "201 Created" status code, and the URI of the created subscription is included in the Location header field.

Upon receipt of the HTTP PUT request message, if the subscription is accepted to be updated, the NF responds to the DCCF with "200 OK" or "204 No Content" status code.

- 7b. If the historical data handling is applicable, and the DCCF determines to retrieve data from the ADRF, the DCCF shall determine which ADRF instances might provide the data.

- 8b. In order to retrieve the historical data from the ADRF, the DCCF shall invoke the `Nadrf_DataManagement_RetrievalSubscribe` service operation by sending an HTTP POST request message targeting the resource "ADRF Data Retrieval Subscriptions", as described in clause 4.2.2.6 of 3GPP TS 29.575 [16].

- 9b. The ADRF responds to the `Nadrf_DataManagement_RetrievalSubscribe` service operation.

Upon receipt of the HTTP POST request message, if the subscription is accepted to be created, the ADRF responds to the DCCF with "201 Created" status code, and the URI of the created subscription is included in the Location header field.

- 7c. If the historical data handling is applicable, and the DCCF determines to retrieve data from the NWDAF, the DCCF shall determine which NWDAF instances might provide the data.

- 8c. In order to retrieve the historical data from the NWDAF, the DCCF shall invoke the `Nnwdaf_DataManagement_Subscribe` service operation by sending an HTTP POST request message targeting the resource "NWDAF Data Management Subscriptions", as described in clause 4.4.2.2 of 3GPP TS 29.520 [5].

- 9c. The NWDAF responds to the `Nnwdaf_DataManagement_Subscribe` service operation.

Upon receipt of the HTTP POST request message, if the subscription is accepted to be created, the NWDAF responds to the DCCF with "201 Created" status code, and the URI of the created subscription is included in the Location header field.

10. The DCCF responds to the `Ndccf_DataManagement_Subscribe` service operation with HTTP "204 No Content" status code.

- 11a. When the data are available, the NF invokes the `Nnf_EventExposure_Notify` service operation by sending an HTTP POST request message to notify the data events to the MFAF, e.g. as described in clause 5.5.2.4 of 3GPP TS 29.503 [22] for the UDM, clause 5.3.2.4 of 3GPP TS 29.518 [18] for the AMF, clause 4.2.2 of

3GPP TS 29.508 [6] for the SMF, clause 4.2.2.4 of 3GPP TS 29.591 [11] for the NEF, or clause 4.2.4 of 3GPP TS 29.517 [12] for the AF.

- 12a. The MFAF responds to the Nnf\_EventExposure\_Notify service operation with HTTP "204 No Content" status code.
  - 11b. When the historical data are available in the ADRF, the ADRF shall invoke the Ndrf\_DataManagement\_RetrievalNotify service operation by sending an HTTP POST request message to notify the historical data or Fetch Instructions to the MFAF as described in clause 4.2.2.8 of 3GPP TS 29.575 [16].
  - 12b. The MFAF responds to the Ndrf\_DataManagement\_RetrievalNotify service operation with HTTP "204 No Content" status code.
  - 11c. When the historical data are available in the NWDAF, the NWDAF shall invoke the Nnwdaf\_DataManagement\_Notify service operation by sending an HTTP POST request message to notify the historical data to the MFAF as described in clause 4.4.2.4 of 3GPP TS 29.520 [5].
  - 12c. The MFAF responds to the Nnwdaf\_DataManagement\_Notify service operation with HTTP "204 No Content" status code.
  13. The MFAF invokes the Nmfaf\_3caDataManagement\_Notify service operation by sending HTTP POST request message(s) to send the data to all notification endpoints indicated in step 1. Data sent to notification endpoints may be processed and formatted by the MFAF so they conform to delivery requirements for each NF service consumer or notification endpoint.
- NOTE: According to Formatting Instructions provided by the NF service consumer, multiple notifications from a NF can be combined in a single Nmfaf\_3caDataManagement\_Notify so that many notifications from an NF results in fewer notifications (or one notification) to the Data Consumer. Alternatively, a notification can instruct the data notification endpoint to fetch the data from the MFAF.
14. The NF service consumer responds to the Nmfaf\_3caDataManagement\_Notify service operation with HTTP "204 No Content" status code.
  15. The Data Consumer invokes the Nmfaf\_3caDataManagement\_Fetch service operation by sending an HTTP GET request message as described in clause 4.2.2.5 of 3GPP TS 29.574 [15] to fetch the data from the DCCF before an expiry time, if the fetch instruction was received in Nmfaf\_3caDataManagement\_Notify service operation in step 13.
  16. The MFAF responds to the Nmfaf\_3caDataManagement\_Fetch service operation with HTTP "200 OK" status code with the message body containing the NmfafResourceRecord data structure.
  17. When the NF service consumer no longer needs the subscription to the requested data in step 1, it shall invoke the Ndccf\_DataManagement\_Unsubscribe service operation by sending an HTTP DELETE request message as described in clause 4.2.2.3.3 of 3GPP TS 29.574 [15]. The DCCF removes the NF service consumer from the list of NF service consumers that are subscribed for these data.
  18. The DCCF responds to the Ndccf\_DataManagement\_Unsubscribe service operation with HTTP "204 No Content" status code, if the NF service consumer is successfully removed from the list of NF service consumers that are subscribed for these data.
  - 19a. If there are no other NF service consumers subscribed to the data, the DCCF invokes the Nnf\_EventExposure\_Unsubscribe service operation by sending an HTTP DELETE request message to the Data Source, e.g. as described in clause 5.5.2.3 of 3GPP TS 29.503 [22] for the UDM, clause 5.3.2.3 of 3GPP TS 29.518 [18] for the AMF, clause 4.2.4 of 3GPP TS 29.508 [6] for the SMF, clause 4.2.2.3 of 3GPP TS 29.591 [11] for the NEF, or clause 4.2.3 in 3GPP TS 29.517 [12] for the AF.
  - 20a. The Data Source responds to the Nnf\_EventExposure\_Unsubscribe service operation with HTTP "204 No Content" status code, if the data event(s) subscription is successfully removed.
  - 19b. If DCCF determines that no other NF service consumers requiring the historical data from the ADRF, the DCCF may invoke the Ndrf\_DataManagement\_RetrievalUnsubscribe service operation by sending an HTTP DELETE request message to the ADRF as described in clause 4.2.2.7 of 3GPP TS 29.575 [16].

- 20b. The ADRF responds to the Nadrif\_DataManagement\_RetrievalUnsubscribe service operation with HTTP "204 No Content" status code, upon the data retrieval subscription is removed.
- 19c. If DCCF determines that no other NF service consumers require the historical data from the NWDAF, the DCCF may invoke the NnwdaF\_DataManagement\_Unsubscribe service operation by sending an HTTP DELETE request message to the NWDAF as described in clause 4.4.2.3 of 3GPP TS 29.520 [5].
- 20c. The NWDAF responds to the NnwdaF\_DataManagement\_Unsubscribe service operation with HTTP "204 No Content" status code, upon the data subscription is removed.
- 19d. When the DCCF determines that an NF service consumer mapping has to be removed from MFAF, the DCCF invokes the NmfaF\_3daDataManagement\_Deconfigure service operation by sending an HTTP DELETE request message to the MFAF as described in clause 4.2.2.3 of 3GPP TS 29.576 [17].
- 20d. The MFAF responds to the NmfaF\_3daDataManagement\_Deconfigure service operation with HTTP "204 No Content" status code, if the individual resource linked to the delete request is successfully removed.

## 5.6 ML Model provisioning procedures

### 5.6.1 General

The ML Model provisioning procedures allow the NF service consumers (i.e. NWDAF (MTLF+AnLF), NWDAF (AnLF)) to obtain the ML model information on the related Analytics from another NWDAF (i.e. an NWDAF containing MTLF).

### 5.6.2 ML Model Subscribe/Unsubscribe/Notify procedure

The procedure is used by an NF service consumer to subscribe to/unsubscribe from the ML model information on the related Analytics on NWDAF containing MTLF, and also used by the NWDAF containing MTLF to notify the ML model information to the NF service consumer if it subscribed to the ML model information previously.

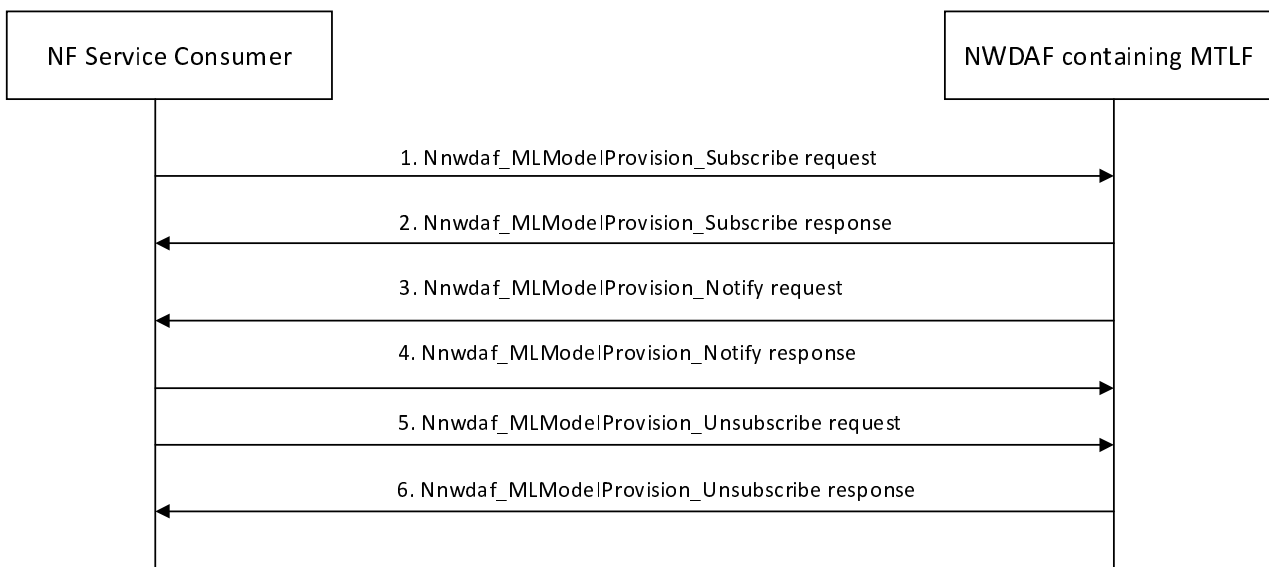

**Figure 5.6.2-1: ML Model Subscribe/Unsubscribe/Notify procedure**

1. In order to subscribe to ML model information, the NF service consumer invokes NnwdaF\_MLModelProvision\_Subscribe service operation by sending an HTTP POST request targeting the resource "NWDAF ML Model Provision Subscriptions". The request shall include the event ID(s) and the notification URI, and may include the event filter information, the target UE information, the expected time interval during which the ML model shall be reported and the expiry time.

In order to modify the existing subscription, the NF service consumer invokes Nnwdaf\_MLModelProvision\_Subscribe service operation by sending an HTTP PUT request with Resource URI of the resource "Individual NWDAF ML Model Provision Subscription".

2. The NWDAF containing MTLF responds to the Nnwdaf\_MLModelProvision\_Subscribe service operation. Upon receipt of the HTTP POST request, if the subscription is accepted to be created, the NWDAF containing MTLF responds to the NF service consumer with "201 Created", and the URI of the created subscription is included in the Location header field.

Upon receipt of the HTTP PUT request, if the subscription is accepted to be updated, the NWDAF containing MTLF responds to the NF service consumer an HTTP "200 OK" with a response body containing a representation of the updated subscription or "204 No Content".

3. If the NWDAF containing MTLF determines that the subscribed ML model information is available, the NWDAF containing MTLF invokes MLModelProvision\_Notify service operation to report the ML model information by sending an HTTP POST request to the NF service consumer identified by the notification URI received during the creation/modification of the subscriptions. The request shall include the event ID, the subscriptionId and the address (e.g. URL or FQDN) of ML Model file, and may include the period of validity that indicates the time period when the provided ML model applies and spatial validity that indicates the area where the provided ML model applies.
4. The NF service consumer responds to the NWDAF containing MTLF with an HTTP "204 No Content" message.
5. In order to unsubscribe from the notification(s) of the ML model information, the NF service consumer invokes Nnwdaf\_MLModelProvision\_Unsubscribe service operation by sending an HTTP DELETE request, which targets the resource "Individual NWDAF ML Model Provision Subscription", to the NWDAF containing MTLF.
6. If the request is accepted, the NWDAF containing MTLF deletes the subscription and responds to the NF service consumer with an HTTP "204 No Content" message.

NOTE: For details of Nnwdaf\_MLModelProvision\_Subscribe/Unsubscribe/Notify service operations refer to 3GPP TS 29.520 [5].

## 5.7 Procedures for Specific Network Data Analytics

### 5.7.1 General

### 5.7.2 Network Slice (Instance) load level Analytics

This procedure is used by the NF to obtain the network slice (instance) load level analytics which are calculated by the NWDAF based on the information collected from the NSACF, NRF, AMF, SMF and/or OAM. If the NF is an AF which is untrusted, the AF will request analytics via the NEF as described in clause 5.2.3.2.

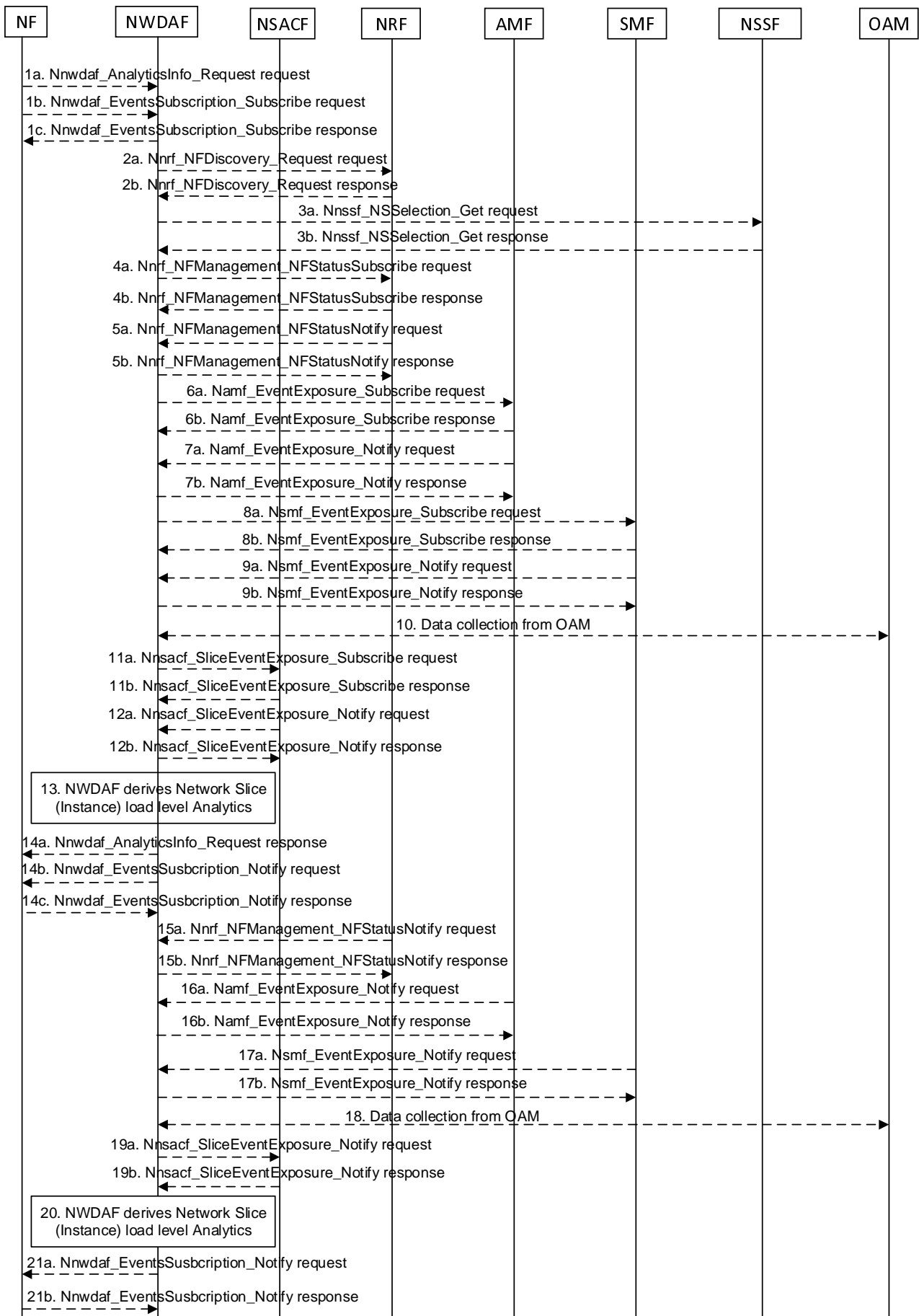

Figure 5.7.2-1: Procedure for Network Slice (Instance) load level Analytics



- 1a. In order to obtain the network slice (instance) load level analytics, the NF may invoke Nnwdaf\_AnalyticsInfo\_Request service operation as described in clause 5.2.3.1.
- 1b-1c. In order to obtain the network slice (instance) load level analytics, the NF may invoke Nnwdaf\_EventsSubscription\_Subscribe service operation as described in clause 5.2.2.1.
- 2a-2b. If the event is set to "LOAD\_LEVEL\_INFORMATION" or "NSI\_LOAD\_LEVEL", the NWDAF invokes Nnrf\_NFDiscovery\_Request service operation as described in clause 5.3.2.2 of 3GPP TS 29.510 [26] to discover the AMF, SMF and NSSF instance(s) relevant to the analytics filters provided in the subscription request. The NRF responds to the NWDAF an HTTP "201 Created" response.
- 3a-3b. (Only for "NSI\_LOAD\_LEVEL")The NWDAF may invoke Nnssf\_NSSelection\_Get service operation as described in clause 5.2.2.2 of 3GPP TS 29.531 [21] to obtain the NSI ID(s) corresponding to the S-NSSAI in the subscription request. The NRF responds to the NWDAF an HTTP "201 Created" response.
- 4a-4b. (Only for "NSI\_LOAD\_LEVEL")The NWDAF may invoke Nnrf\_NFManagement\_NFStatusSubscribe service operation as described in clause 5.2.2.5 of 3GPP TS 29.510 [26] to subscribe to the resource usage information of a network slice instance obtained from its constituent NF instances. The NRF responds to the NWDAF an HTTP "201 Created" response.
- 5a-5b. (Only for "NSI\_LOAD\_LEVEL") If step 4a and step 4b are performed, the NRF may invoke Nnrf\_NFManagement\_NFStatusNotify service operation as described in clause 5.2.2.6 of 3GPP TS 29.510 [26]. The NWDAF responds to the NRF an HTTP "204 No Content" response.
- 6a-6b. The NWDAF may invoke Namf\_EventExposure\_Subscribe service operation as described in clause 5.3.2.2.2 of 3GPP TS 29.518 [18] to subscribe to the notification of individual UE registration/deregistration registered to an S-NSSAI or to an S-NSSAI and NSI ID, or request the total number of UEs served by the AMF per S-NSSAI or per S-NSSAI and NSI ID. The AMF responds to the NWDAF an HTTP "201 Created" response.
- 7a-7b. If step 6a and step 6b are performed, the AMF invokes Namf\_EventExposure\_Notify service operation as described in 3GPP TS 29.518 [18] clause 5.3.2.4. The NWDAF responds to the AMF an HTTP "204 No Content" response.
- 8a-8b. The NWDAF may invoke Nsmf\_EventExposure\_Subscribe service operation by sending an HTTP POST request targeting the resource "SMF Notification Subscriptions" to subscribe to the notification of individual PDU session established or PDU session released in an S-NSSAI or request the total number of PDU Sessions established in an S-NSSAI. The SMF responds to the NWDAF an HTTP "201 Created" response.
- 9a-9b. If step 8a and step 8b are performed, the SMF may invoke Nsmf\_EventExposure\_Notify service operation by sending an HTTP POST request to the NWDAF identified by the notification URI received in step 8a. The NWDAF responds to the SMF an HTTP "204 No Content" response.
10. The NWDAF may invoke "Data collection service" to the OAM to get the mean number of UEs registered as described in clause 5.2.1 of TS 28.552 [27], mean number of PDU sessions established as described in clause 5.3.1 of TS 28.552 [27] and/or the resource usage information of a network slice instance obtained from its constituent NF instances as described in clause 6.2 of TS 28.552 [27]. (Obtaining the resource usage information of a network slice instance is only applicable for "NSI\_LOAD\_LEVEL" event).
- 11a-11b. The NWDAF may invoke Nnsacf\_SliceEventExposure\_Subscribe service operation as described in clause 5.3.2.2 of 3GPP TS 29.536 [20] to request the number of UEs registered to the network slice and/or the number of PDU sessions established to the network slice.
- 12a-12b. The NSACF may invoke Nnsacf\_SliceEventExposure\_Notify service operation as described in clause 5.3.2.4 of 3GPP TS 29.536 [20]. The NWDAF responds to the NSACF an HTTP "204 No Content" response.
13. The NWDAF calculates the network slice (instance) load level analytics based on the data collected from AMF, SMF, NRF, NSACF and/or OAM.
- 14a. If step 1a is performed, the NWDAF responds to the Nnwdaf\_AnalyticsInfo\_Request service operation as described in clause 5.2.3.1.
- 14b-14c. If step 1b and step 1c are performed, the NWDAF invokes Nnwdaf\_EventsSubscription\_Notify service operation as described in clause 5.2.2.1.

15a-15b. The same as step 5a and step 5b.

16a-16b. The same as step 7a and step 7b.

17a-17b. The same as step 9a and step 9b.

18. The same as step 10.

19a-19b. The same as step 12a and step 12b.

20. The same as step 13.

21a-21b. The same as step 14b and step 14c.

NOTE 1: For details of Nsmf\_EventExposure\_Subscribe/Notify service operations refer to 3GPP TS 29.508 [6].

NOTE 2: For details of Nnwdaf\_EventsSubscription\_Subscribe/Unsubscribe/Notify or Nnwdaf\_AnalyticsInfo\_Request service operations refer to 3GPP TS 29.520 [5].

### 5.7.3 Observed Service Experience Analytics

This procedure is used by the NF to obtain the Service Experience analytics which are calculated by the NWDAF based on the information collected from the AMF, SMF, UPF, AF and/or OAM. If the NF is an AF which is untrusted, the AF will request analytics via the NEF as described in clause 5.2.3.2.

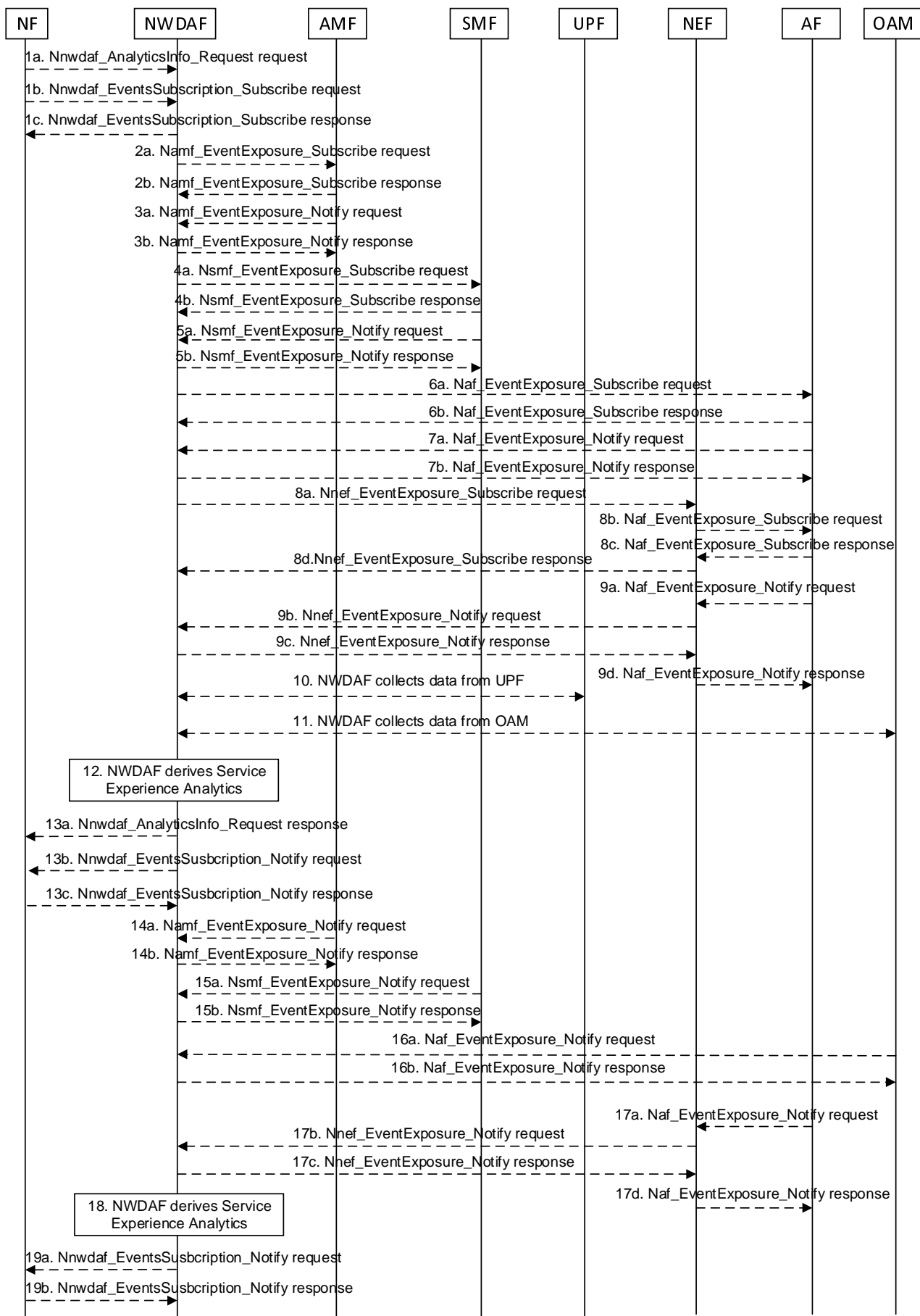

Figure 5.7.3-1: Procedure for Service Experience Analytics

- 1a. In order to obtain the Service Experience analytics, the NF may invoke Nnwdaf\_AnalyticsInfo\_Request service operation as described in clause 5.2.3.1.
- 1b-1c. In order to obtain the Service Experience analytics, the NF may invoke Nnwdaf\_EventsSubscription\_Subscribe service operation as described in clause 5.2.2.1.
- 2a-2b. If the event is set to "SERVICE\_EXPERIENCE", the NWDAF may invoke Namf\_EventExposure\_Subscribe service operation as described in clause 5.3.2.2.2 of 3GPP TS 29.518 [18] to subscribe to the notification of UE ID and UE location. The AMF responds to the NWDAF an HTTP "201 Created" response.
- 3a-3b. If step 2a and step 2b are performed, the AMF invokes Namf\_EventExposure\_Notify service operation as described in 3GPP TS 29.518 [18] clause 5.3.2.4. The NWDAF responds to the AMF an HTTP "204 No Content" response.
- 4a-4b. The NWDAF may invoke Nsmf\_EventExposure\_Subscribe service operation by sending an HTTP POST request targeting the resource "SMF Notification Subscriptions" to subscribe to the notification of QFI, IP filter information, DNAI, UPF information, Application ID, DNN and S-NSSAI. The SMF responds to the NWDAF an HTTP "201 Created" response.
- 5a-5b. If step 4a and step 4b are performed, the SMF may invoke Nsmf\_EventExposure\_Notify service operation by sending an HTTP POST request to the NWDAF identified by the notification URI received in step 4a. The NWDAF responds to the SMF an HTTP "204 No Content" response.
- 6a-6b. If the AF is trusted, the NWDAF may invoke Naf\_EventExposure\_Subscribe service operation by sending an HTTP POST request targeting the resource "Application Event Subscriptions" to request the service data and performance data from AF directly. The AF responds to the NWDAF an HTTP "201 Created" response.
- 7a-7b. If step 6a and step 6b are performed, the AF may invoke Naf\_EventExposure\_Notify service operation by sending an HTTP POST request to the NWDAF identified by the notification URI received in step 6a. The NWDAF responds to the AF an HTTP "204 No Content" response.
- 8a-8d. If the AF is untrusted, the NWDAF may invoke Nnef\_EventExposure\_Subscribe service operation to the NEF by sending an HTTP POST request targeting the resource "Network Exposure Event Subscriptions" and then the NEF invokes Naf\_EventExposure\_Subscribe service operation by sending an HTTP POST request targeting the resource "Application Event Subscriptions". The AF responds to the NEF an HTTP "201 Created" response and then the NEF responds to the NWDAF an HTTP "201 Created" response.
- 9a-9d. If step 8a to step 8d are performed, the AF may invoke Naf\_EventExposure\_Notify service operation by sending an HTTP POST request to the NEF identified by the notification URI received in step 8b and the NEF invokes Nnef\_EventExposure\_Notify service operation by sending an HTTP POST request to the NWDAF identified by the notification URI received in step 8a. The NWDAF responds to the NEF an HTTP "204 No Content" response and then the NEF responds to the AF an HTTP "204 No Content" response.
10. The NWDAF may collect QoS flow bit rate, QoS flow packet delay, packet transmission and packet retransmission information from UPF.

NOTE 1: How NWDAF collects UE communication related data from UPF is not defined in this Release of the specification.

11. The NWDAF may collect Reference Signal Received Power and Reference Signal Received Quality as specified in clause 5.5 of TS 38.331 [33] and clause 5.5.5 of TS 36.331 [34], Signal-to-noise and interference ratio as specified in clause 5.1 of TS 38.215 [35], the mapping information between cell ID and frequency and/or Cell Energy Saving State data as specified in clauses 3.1 and 6.2 of TS 28.310 [36] from OAM.
12. The NWDAF calculates the Service Experience analytics based on the data collected from AMF, SMF, UPF, AF and/or OAM.
- 13a. If step 1a is performed, the NWDAF responds to the Nnwdaf\_AnalyticsInfo\_Request service operation as described in clause 5.2.3.1.
- 13b-13c. If step 1b and step 1c are performed, the NWDAF invokes Nnwdaf\_EventsSubscription\_Notify service operation as described in clause 5.2.2.1.
- 14a-14b. The same as step 3a and step 3b.

15a-15b. The same as step 5a and step 5b.

16a-16b. The same as step 7a and step 7b.

17a-17d. The same as step 9a and step 9b.

18. The same as step 12.

19a-19b. The same as step 13b and step 13c.

NOTE 2: For details of Nsmf\_EventExposure\_Subscribe/Notify service operations refer to 3GPP TS 29.508 [6].

NOTE 3: For details of Nnef\_EventExposure\_Subscribe/Notify service operations refer to 3GPP TS 29.591 [11].

NOTE 4: For details of Naf\_EventExposure\_Subscribe/Notify service operations refer to 3GPP TS 29.517 [12].

## 5.7.4 NF load Analytics

This procedure is used by the NWDAF service consumer (may be an NF, or the OAM) to obtain the NF load analytics which are calculated by the NWDAF based on the information collected from the NRF and/or the OAM, may also collect UE input data via the AF (for the untrusted AF via the NEF). If target NF type is UPF, the NWDAF may collect the information from UPF.

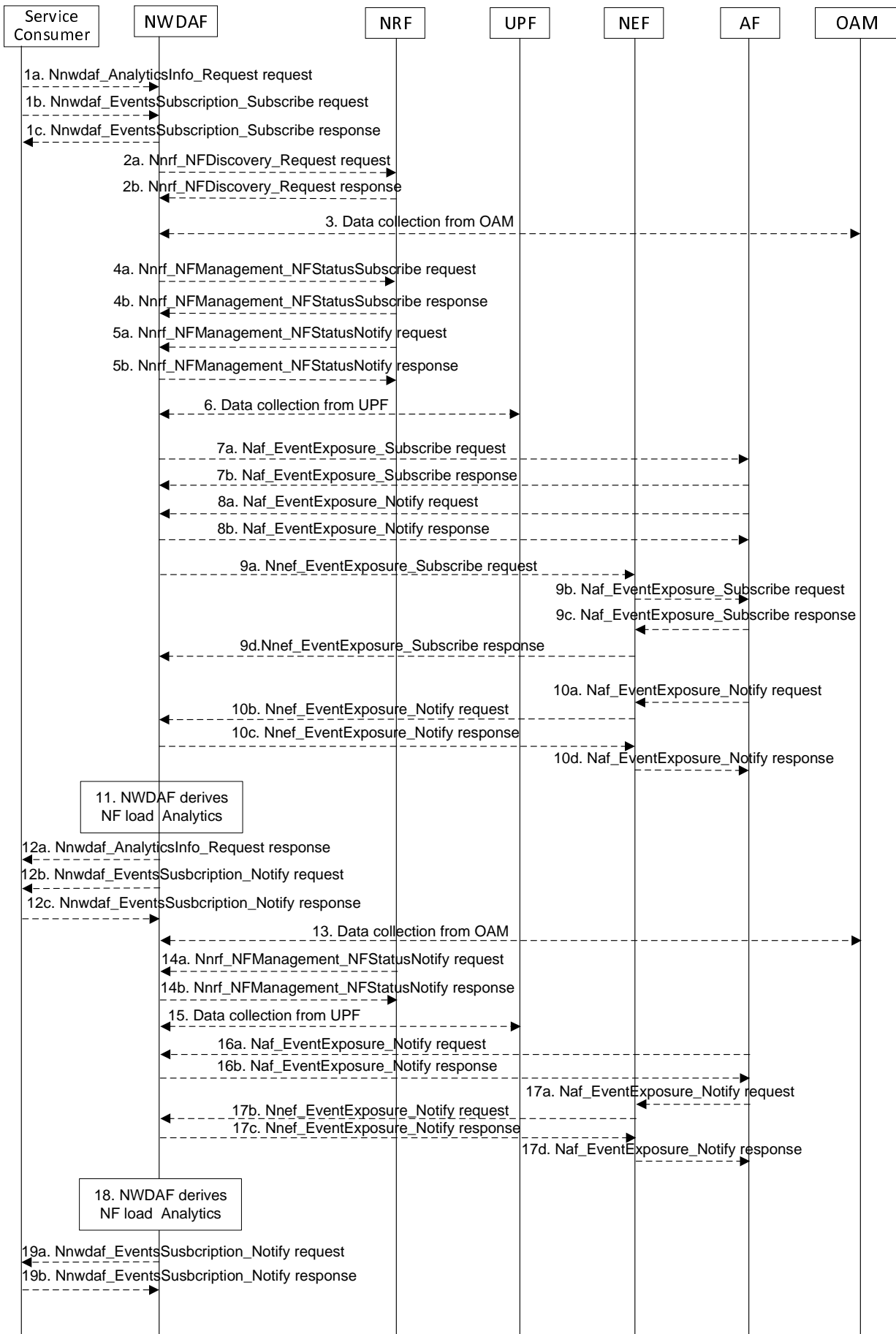

Figure 5.7.4-1: Procedure for NF load Analytics

- 1a. In order to obtain the NF load analytics, the NWDAF service consumer may invoke Nnwdaf\_AnalyticsInfo\_Request service operation as described in clause 5.2.3.1, the requested event is set to "NF\_LOAD" with the supported feature "NfLoad".
  - 1b-1c. In order to obtain the NF load analytics, the NWDAF service consumer may invoke Nnwdaf\_EventsSubscription\_Subscribe service operation as described in clause 5.2.2.1, the subscribed event is set to "NF\_LOAD" with the supported feature "NfLoad".
  - 2a-2b. The NWDAF may invoke Nnrf\_NFDiscovery\_Request service operation as described in clause 5.3.2.2 of 3GPP TS 29.510 [26] for each NF, to obtain the initial NF profile which contains NF status and may contains NF load information. The NRF responds to the NWDAF an HTTP "201 Created" response.
  3. The NWDAF may invoke "Data collection service" to the OAM to get the NF resource usage information as described in clause 5.7 of 3GPP TS 28.552 [27] and/or the NF resource configuration information as described in clause 5.2 of 3GPP TS 28.533 [28]. The NWDAF may also collect the MDT data information for UE as described in 3GPP TS 37.320 [29].
  - 4a-4b. The NWDAF may invoke Nnrf\_NFManagement\_NFStatusSubscribe service operation as described in clause 5.2.2.5 of 3GPP TS 29.510 [26] to subscribe to the NF status and/or NF load information. The NRF responds to the NWDAF an HTTP "201 Created" response.
  - 5a-5b. If step 4a and step 4b are performed, the NRF may invoke Nnrf\_NFManagement\_NFStatusNotify service operation as described in clause 5.2.2.6 of 3GPP TS 29.510 [26]. The NWDAF responds to the NRF an HTTP "204 No Content" response.
  6. If the target NF type is UPF, the NWDAF may collect traffic usage report information from UPF.
- NOTE 1: How the NWDAF collects UPF information is not defined in this release of the specification.
- 7a-7b. If the AF is trusted, the NWDAF may invoke Naf\_EventExposure\_Subscribe service operation to the AF directly by sending an HTTP POST request targeting the resource "Application Event Subscriptions" to collect the Collective Behaviour of UEs. The AF responds to the NWDAF an HTTP "201 Created" response.
  - 8a-8b. If step 7a and step 7b are performed, the AF invokes Naf\_EventExposure\_Notify service operation by sending an HTTP POST request to the NWDAF identified by the notification URI received in step 7a. The NWDAF responds to the AF an HTTP "204 No Content" response.
  - 9a-9d. If the AF is untrusted, the NWDAF may invoke Nnef\_EventExposure\_Subscribe service operation to the NEF by sending an HTTP POST request targeting the resource "Network Exposure Event Subscriptions" and then the NEF invokes Naf\_EventExposure\_Subscribe service operation by sending an HTTP POST request targeting the resource "Application Event Subscriptions" to collect the Collective Behaviour of UEs. The AF responds to the NEF an HTTP "201 Created" response and then the NEF responds to the NWDAF an HTTP "201 Created" response.
  - 10a-10d. If step 9a to step 9d are performed, the AF invokes Naf\_EventExposure\_Notify service operation by sending an HTTP POST request to the NEF identified by the notification URI received in step 9b and the NEF invokes Nnef\_EventExposure\_Notify service operation by sending an HTTP POST request to the NWDAF identified by the notification URI received in step 9a. The NWDAF responds to the NEF an HTTP "204 No Content" response and then the NEF responds to the AF an HTTP "204 No Content" response.
  11. The NWDAF calculates the NF load analytics based on the data collected from NRF, OAM, UPF and/or AF.
  - 12a. If step 1a is performed, the NWDAF responds to the Nnwdaf\_AnalyticsInfo\_Request service operation as described in clause 5.2.3.1.
  - 12b-12c. If step 1b and step 1c are performed, the NWDAF invokes Nnwdaf\_EventsSubscription\_Notify service operation as described in clause 5.2.2.1.
  13. The same as step 3.
  - 14a-14b. The same as step 5a and step 5b.
  15. The same as step 6.
  - 16a-16b. The same as step 8a and step 8b.

17a-17d. The same as step 10a to step 10d.

18. The same as step 11.

19a-19b. The same as step 12b and step 12c.

NOTE 2: For details of Naf\_EventExposure\_Subscribe/Notify service operations refer to 3GPP TS 29.517 [12].

NOTE 3: For details of Nnef\_EventExposure\_Subscribe/Notify service operations refer to 3GPP TS 29.591 [11].

NOTE 4: For details of Nnwdaf\_EventsSubscription\_Subscribe/Unsubscribe/Notify or Nnwdaf\_AnalyticsInfo\_Request service operations refer to 3GPP TS 29.520 [5].

## 5.7.5 Network Performance Analytics

This procedure is used by the NF to obtain the network performance analytics which are calculated by the NWDAF based on the information collected from the AMF, NRF and/or OAM. If the NF is an AF which is untrusted, the AF will request analytics via the NEF as described in clause 5.2.3.2.



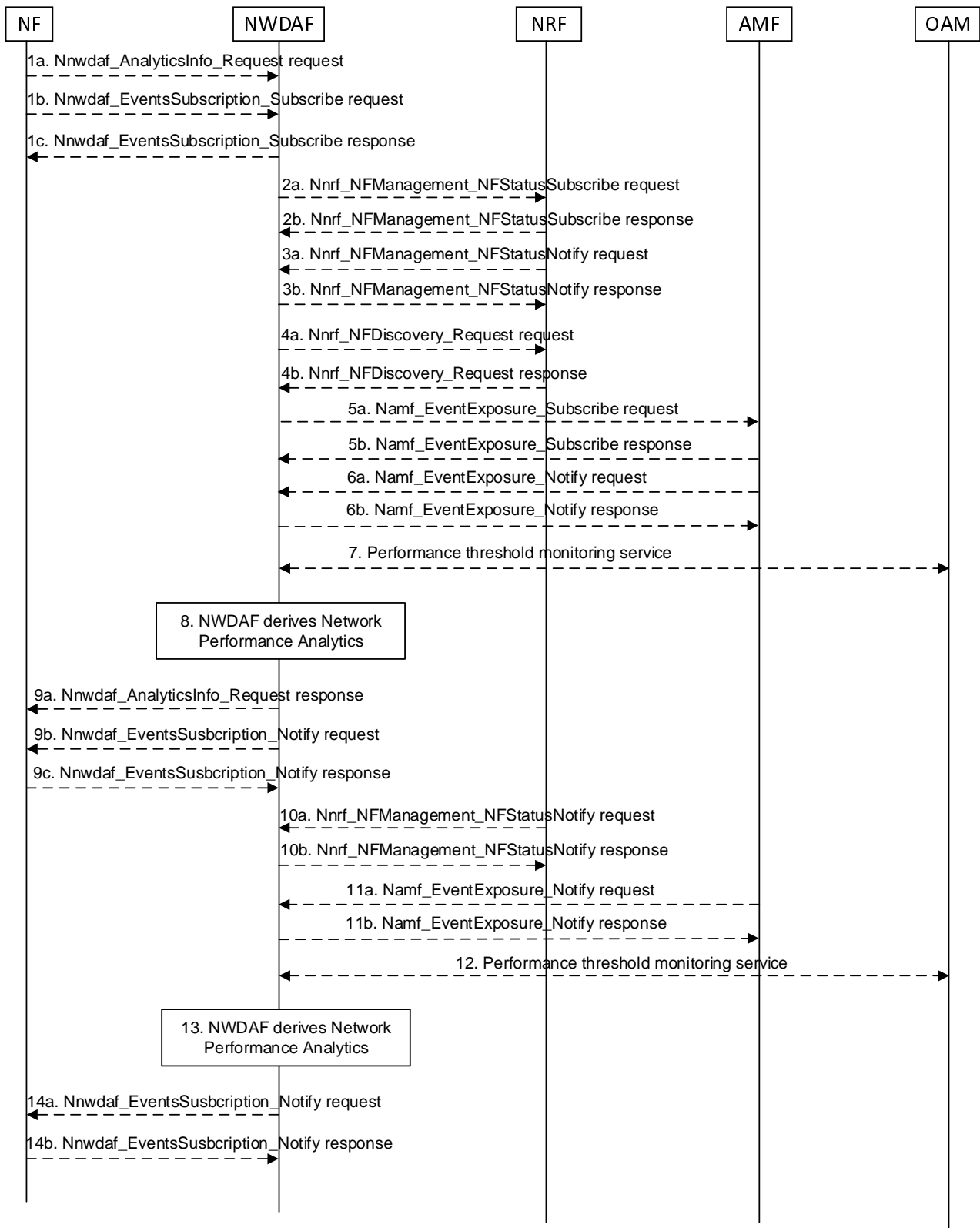

**Figure 5.7.5-1: Procedure for Network Performance Analytics**

1a. In order to obtain the network performance analytics, the NF may invoke Nnwdaf\_AnalyticsInfo\_Request service operation as described in clause 5.2.3.1.

1b-1c. In order to obtain the network performance analytics, the NF may invoke Nnwdaf\_EventsSubscription\_Subscribe service operation as described in clause 5.2.2.1.

- 2a-2b. If the event is set to "NETWORK\_PERFORMANCE", the NWDAF may invoke Nnrf\_NFManagement\_NFStatusSubscribe service operation as described in clause 5.2.2.5 of 3GPP TS 29.510 [26] to subscribe to NF (e.g. SMF, UPF) load and status information. The NRF responds to the NWDAF an HTTP "201 Created" response.
- 3a-3b. If step 2a and step 2b are performed, the NRF may invoke Nnrf\_NFManagement\_NFStatusNotify service operation as described in clause 5.2.2.6 of 3GPP TS 29.510 [26]. The NWDAF responds to the NRF an HTTP "204 No Content" response.
- 4a-4b. If the event is set to "NETWORK\_PERFORMANCE" and the type of network performance is set to "NUM\_OF\_UE", the NWDAF invokes Nnrf\_NFDiscovery\_Request service operation as described in clause 5.3.2.2 of 3GPP TS 29.510 [26] to discover the AMF(s) belonging to the AMF Region(s) that include(s) the Area of Interest. The NRF responds to the NWDAF an HTTP "201 Created" response.
- 5a-5b. The NWDAF may invoke Namf\_EventExposure\_Subscribe service operation as described in clause 5.3.2.2.2 of 3GPP TS 29.518 [18] to collect the number of UEs located in the Area of Interest from AMF. The AMF responds to the NWDAF an HTTP "201 Created" response.
- 6a-6b. If step 5a and step 5b are performed, the AMF invokes Namf\_EventExposure\_Notify service operation as described in 3GPP TS 29.518 [18] clause 5.3.2.4. The NWDAF responds to the AMF an HTTP "204 No Content" response.
7. The NWDAF may invoke "Data collection service" to the OAM to get the status and load information and the performance per Cell Id in the Area of Interest as described in clause 5.1 of TS 28.552 [27].
8. The NWDAF calculates the network performance analytics based on the data collected from AMF, NRF and/or OAM.
- 9a. If step 1a is performed, the NWDAF responds to the Nnwdaf\_AnalyticsInfo\_Request service operation as described in clause 5.2.3.1.
- 9b-9c. If step 1b and step 1c are performed, the NWDAF invokes Nnwdaf\_EventsSubscription\_Notify service operation as described in clause 5.2.2.1.
- 10a-10b. The same as step 3a and step 3b.
- 11a-11b. The same as step 6a and step 6b.
12. The same as step 7.
13. The same as step 8.
- 14a-14b. The same as step 9b and step 9c.

NOTE: For details of Nnwdaf\_EventsSubscription\_Subscribe/Unsubscribe/Notify or Nnwdaf\_AnalyticsInfo\_Request service operations refer to 3GPP TS 29.520 [5].

## 5.7.6 UE Mobility Analytics

This procedure is used by the NF to obtain UE mobility analytics, which is calculated by the NWDAF based on the information collected from the AMF, AF and/or OAM. If the NF is an AF which is untrusted, the AF will request analytics via the NEF as described in clause 5.2.3.2.

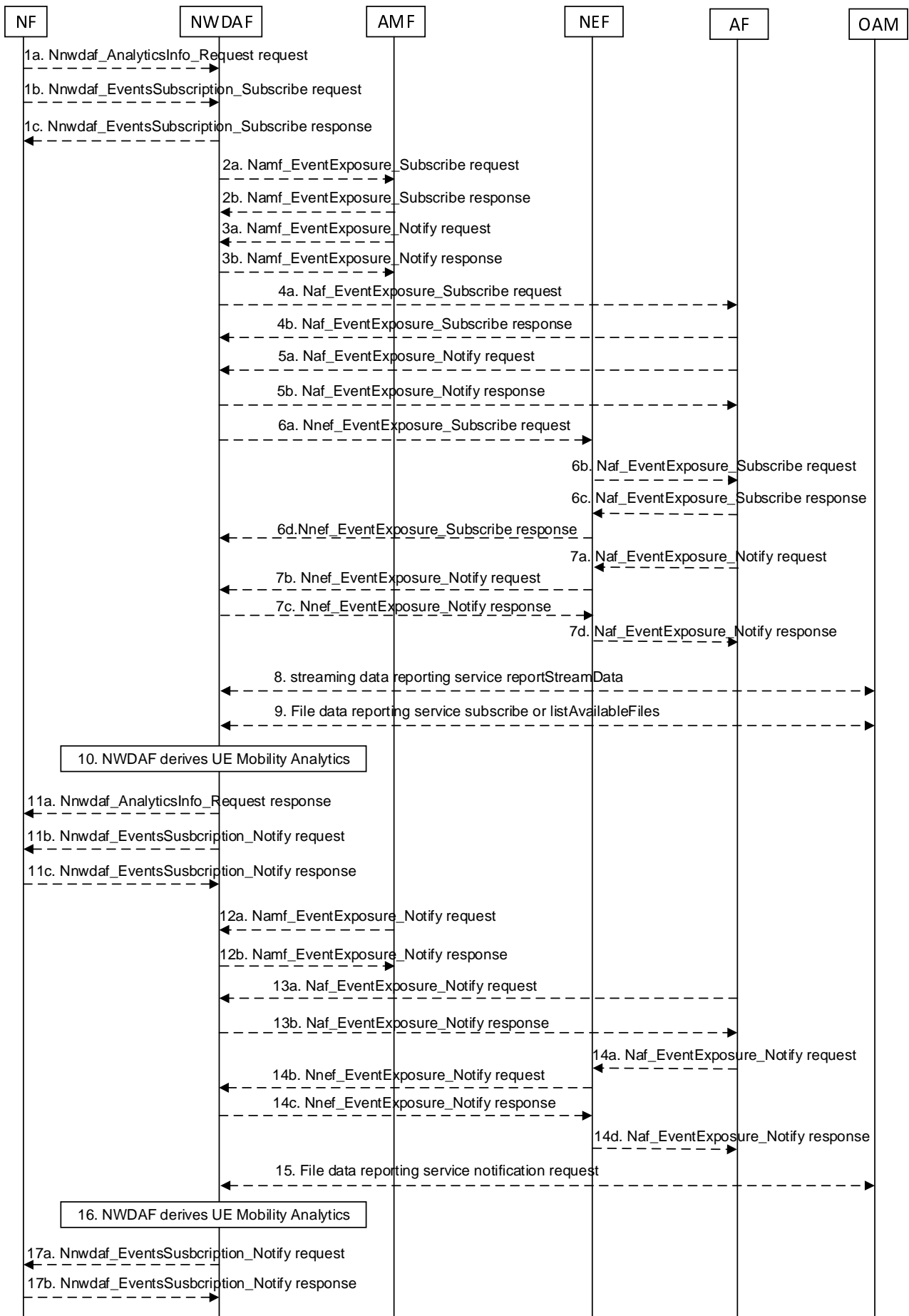

**Figure 5.7.6-1: Procedure for UE Mobility analytics**

- 1a. In order to obtain the UE mobility analytics, the NF may invoke Nnwdaf\_AnalyticsInfo\_Request service operation as described in clause 5.2.3.1.
  - 1b-1c. In order to obtain the UE mobility analytics, the NF may invoke Nnwdaf\_EventsSubscription\_Subscribe service operation as described in clause 5.2.2.1.
  - 2a-2b. The NWDAF may invoke Namf\_EventExposure\_Subscribe service operation as described in clause 5.3.2.2.2 of 3GPP TS 29.518 [18]. This step may be skipped when e.g. the UE mobility information is available. The AMF responds to the NWDAF an HTTP "201 Created" response.
  - 3a-3b. If step 2a and step 2b are performed, the AMF invokes Namf\_EventExposure\_Notify service operation as described in clause 5.3.2.4 of 3GPP TS 29.518 [18]. The NWDAF responds to the AMF an HTTP "204 No Content" response.
  - 4a-4b. If the AF is trusted, the NWDAF may invoke Naf\_EventExposure\_Subscribe service operation to the AF directly by sending an HTTP POST request targeting the resource "Application Event Subscriptions". The AF responds to the NWDAF an HTTP "201 Created" response.
  - 5a-5b. If step 4a and step 4b are performed, the AF invokes Naf\_EventExposure\_Notify service operation by sending an HTTP POST request to the NWDAF identified by the notification URI received in step 4a. The NWDAF responds to the AF an HTTP "204 No Content" response.
  - 6a-6d. If the AF is untrusted, the NWDAF may invoke Nnef\_EventExposure\_Subscribe service operation to the NEF by sending an HTTP POST request targeting the resource "Network Exposure Event Subscriptions" and then the NEF invokes Naf\_EventExposure\_Subscribe service operation by sending an HTTP POST request targeting the resource "Application Event Subscriptions". The AF responds to the NEF an HTTP "201 Created" response and then the NEF responds to the NWDAF an HTTP "201 Created" response.
  - 7a-7d. If step 6a to step 6d are performed, the AF invokes Naf\_EventExposure\_Notify service operation by sending an HTTP POST request to the NEF identified by the notification URI received in step 6b and the NEF invokes Nnef\_EventExposure\_Notify service operation by sending an HTTP POST request to the NWDAF identified by the notification URI received in step 6a. The NWDAF responds to the NEF an HTTP "204 No Content" response and then the NEF responds to the AF an HTTP "204 No Content" response.
  8. The NWDAF may invoke "streaming data reporting service reportStreamData" service operation to the OAM as described in clause 12.5.1.1.5 of 3GPP TS 28.532 [19].
  9. The NWDAF may invoke the "File data reporting service subscribe" service operation to the OAM as described in clause 12.6.1.1.3 of 3GPP TS 28.532 [19] or invoke "File data reporting service listAvailableFiles" service operation to the OAM as described in clause 12.6.1.1.2 of 3GPP TS 28.532 [19].
  10. The NWDAF calculates the requested UE mobility analytics based on the data collected from AMF, AF and/or OAM.
  - 11a. If step 1a is performed, the NWDAF responds to the Nnwdaf\_AnalyticsInfo\_Request service operation as described in clause 5.2.3.1.
  - 11b-11c. If step 1b and step 1c are performed, the NWDAF invokes Nnwdaf\_EventsSubscription\_Notify service operation as described in clause 5.2.2.1.
  - 12a-12b. The same as step 3a and step 3b.
  - 13a-13b. The same as step 5a and step 5b.
  - 14a-14d. The same as step 7a and step 7d.
  15. The same as step 9.
  16. The same as step 10.
  - 17a-17b. The same as step 11b and step 11c.
- NOTE 1: For details of Naf\_EventExposure\_Subscribe/Notify service operations refer to 3GPP TS 29.517 [12].

NOTE 2: For details of Nnef\_EventExposure\_Subscribe/Notify service operations refer to 3GPP TS 29.591 [11].

NOTE 3: For details of Nnwdaf\_EventsSubscription\_Subscribe/Unsubscribe/Notify or Nnwdaf\_AnalyticsInfo\_Request service operations refer to 3GPP TS 29.520 [5].

## 5.7.7 UE Communication Analytics

This procedure is used by the NF to obtain UE communication analytics, which is calculated by the NWDAF based on the information collected from the AMF, SMF and/or AF. If the NF is an AF which is untrusted, the AF will request analytics via the NEF as described in clause 5.2.3.2.

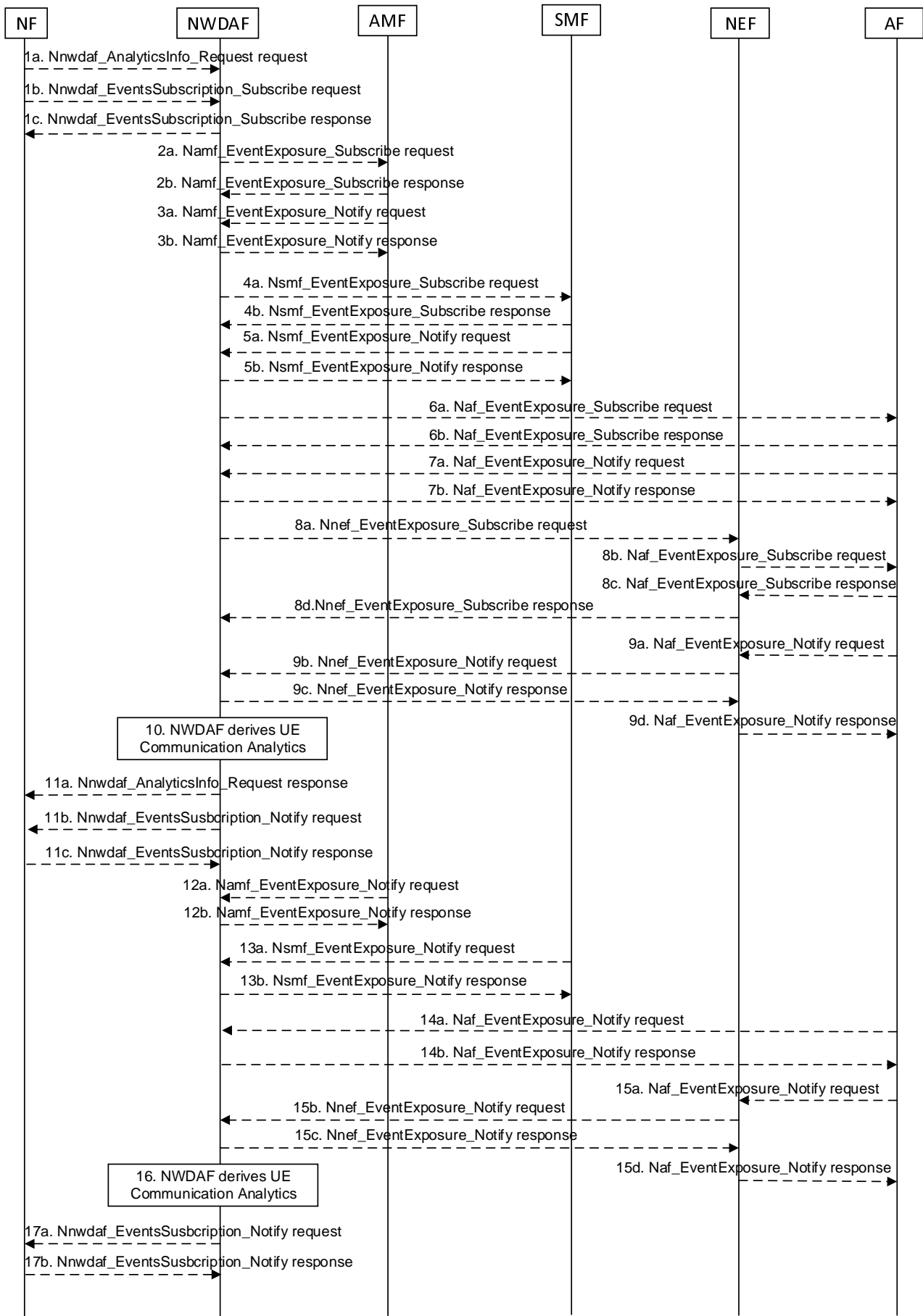

Figure 5.7.7-1: Procedure for UE Communication analytics

- 1a. In order to obtain the UE communication analytics, the NF may invoke Nnwda\_f\_AnalyticsInfo\_Request service operation as described in clause 5.2.3.1.
- 1b-1c. In order to obtain the UE communication analytics, the NF may invoke Nnwda\_f\_EventsSubscription\_Subscribe service operation as described in clause 5.2.2.1.
- 2a-2b. The NWDAF may invoke Namf\_EventExposure\_Subscribe service operation as described in clause 5.3.2.2.2 of 3GPP TS 29.518 [18] to retrieve one or more Type Allocation codes, UE connection management state, UE access behaviour trends and UE location trends from AMF. The AMF responds to the NWDAF an HTTP "201 Created" response.
- 3a-3b. If step 2a and step 2b are performed, the AMF may invoke Namf\_EventExposure\_Notify service operation as described in 3GPP TS 29.518 [18] clause 5.3.2.4. The NWDAF responds to the AMF an HTTP "204 No Content" response.
- 4a-4b. The NWDAF may invoke Nsmf\_EventExposure\_Subscribe service operation by sending an HTTP POST request targeting the resource "SMF Notification Subscriptions" to request the information of the UE and/or N4 session related data to calculate the analytics. The SMF responds to the NWDAF an HTTP "201 Created" response.
- 5a-5b. If step 4a and step 4b are performed, the SMF may invoke Nsmf\_EventExposure\_Notify service operation by sending an HTTP POST request to the NWDAF identified by the notification URI received in step 4a. The NWDAF responds to the SMF an HTTP "204 No Content" response.
- 6a-6b. If the AF is trusted, the NWDAF may invoke Naf\_EventExposure\_Subscribe service operation by sending an HTTP POST request targeting the resource "Application Event Subscriptions" to request the service data from AF directly. The AF responds to the NWDAF an HTTP "201 Created" response.
- 7a-7b. If step 6a and step 6b are performed, the AF may invoke Naf\_EventExposure\_Notify service operation by sending an HTTP POST request to the NWDAF identified by the notification URI received in step 6a. The NWDAF responds to the AF an HTTP "204 No Content" response.
- 8a-8d. If the AF is untrusted, the NWDAF may invoke Nnef\_EventExposure\_Subscribe service operation to the NEF by sending an HTTP POST request targeting the resource "Network Exposure Event Subscriptions" and then the NEF invokes Naf\_EventExposure\_Subscribe service operation by sending an HTTP POST request targeting the resource "Application Event Subscriptions". The AF responds to the NEF an HTTP "201 Created" response and then the NEF responds to the NWDAF an HTTP "201 Created" response.
- 9a-9d. If step 8a to step 8d are performed, the AF may invoke Naf\_EventExposure\_Notify service operation by sending an HTTP POST request to the NEF identified by the notification URI received in step 8b and the NEF invokes Nnef\_EventExposure\_Notify service operation by sending an HTTP POST request to the NWDAF identified by the notification URI received in step 8a. The NWDAF responds to the NEF an HTTP "204 No Content" response and then the NEF responds to the AF an HTTP "204 No Content" response.
10. The NWDAF calculates the requested UE communication analytics based on the data collected from AMF, SMF and/or AF.
- 11a. If step 1a is performed, the NWDAF responds to the Nnwda\_f\_AnalyticsInfo\_Request service operation as described in clause 5.2.3.1.
- 11b-11c. If step 1b and step 1c are performed, the NWDAF may invoke Nnwda\_f\_EventsSubscription\_Notify service operation as described in clause 5.2.2.1.
- 12a-12b. The same as step 3a and step 3b.
- 13a-13b. The same as step 5a and step 5b.
- 14a-14b. The same as step 7a and step 7b.
- 15a-15d. The same as step 9a and step 9d.
16. The same as step 10.
- 17a-17b. The same as step 11b and step 11c.

NOTE 1: For details of Nsmf\_EventExposure\_Subscribe/Notify service operations refer to 3GPP TS 29.508 [6].

NOTE 2: For details of Naf\_EventExposure\_Subscribe/Notify service operations refer to 3GPP TS 29.517 [12].

NOTE 3: For details of Nnef\_EventExposure\_Subscribe/Notify service operations refer to 3GPP TS 29.591 [11].

NOTE 4: For details of Nnwdaf\_EventsSubscription\_Subscribe/Unsubscribe/Notify or Nnwdaf\_AnalyticsInfo\_Request service operations refer to 3GPP TS 29.520 [5].

### 5.7.8 Expected UE behavioural Analytics

This procedure is used by the NF to obtain the expected UE behavioural parameters, which are calculated by the NWDAF based on the information collected from the AMF, SMF, AF and/or OAM. If the NF is an AF which is untrusted, the AF will request analytics via the NEF as described in clause 5.2.3.2.

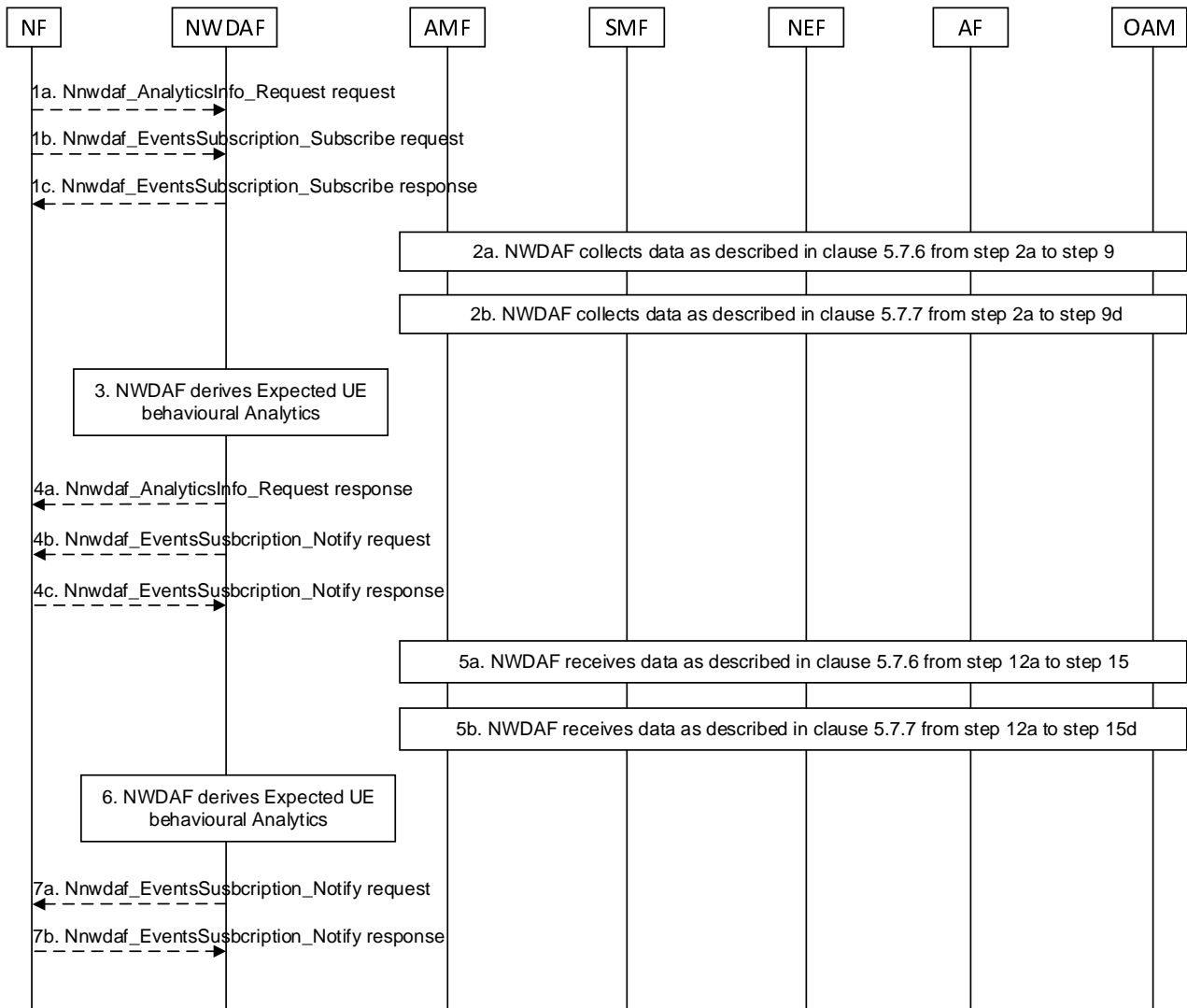

**Figure 5.7.8-1: Procedure for Expected behavioural Analytics**

1a. In order to obtain the expected UE behavioural parameters, the NF may invoke Nnwdaf\_AnalyticsInfo\_Request service operation as described in clause 5.2.3.1.

1b-1c. In order to obtain expected UE behavioural parameters, the NF may invoke Nnwdaf\_EventsSubscription\_Subscribe service operation as described in clause 5.2.2.1.

2a. If the event is set to "UE\_MOBILITY", the NWDAF collects data from AMF, AF and/or OAM as described in clause 5.7.6 from step 2a to step 9.

2b. If the event is set to "UE\_COMM", the NWDAF collects data from AMF, SMF and/or AF as described in clause 5.7.7 from step 2a to step 9d.



- 3. The NWDAF calculates the expected UE behavioural parameters based on the collected data from AMF, SMF, AF and/or OAM.
- 4a. If step 1a is performed, the NWDAF responds to the Nnwdaf\_AnalyticsInfo\_Request service operation as described in clause 5.2.3.1.
- 4b-4c. If step 1b and step 1c are performed, the NWDAF invokes Nnwdaf\_EventsSubscription\_Notify service operation as described in clause 5.2.2.1.
- 5a-5b. The AMF, SMF, AF and/or OAM send the notifications to the NWDAF if it has subscribed to the related events in step 2a or step 2b.
- 6. The same as step 3.
- 7a-7b. The same as step 4b and step 4c.

NOTE: For details of Nnwdaf\_EventsSubscription\_Subscribe/Unsubscribe/Notify or Nnwdaf\_AnalyticsInfo\_Request service operations refer to 3GPP TS 29.520 [5].

### 5.7.9 Abnormal UE behavioural Analytics

This procedure is used by the NF to obtain the abnormal UE behavioural analytics which are calculated by the NWDAF based on the information collected from the AMF, SMF, AF and/or OAM. If the NF is an AF which is untrusted, the AF will request analytics via the NEF as described in clause 5.2.3.2.

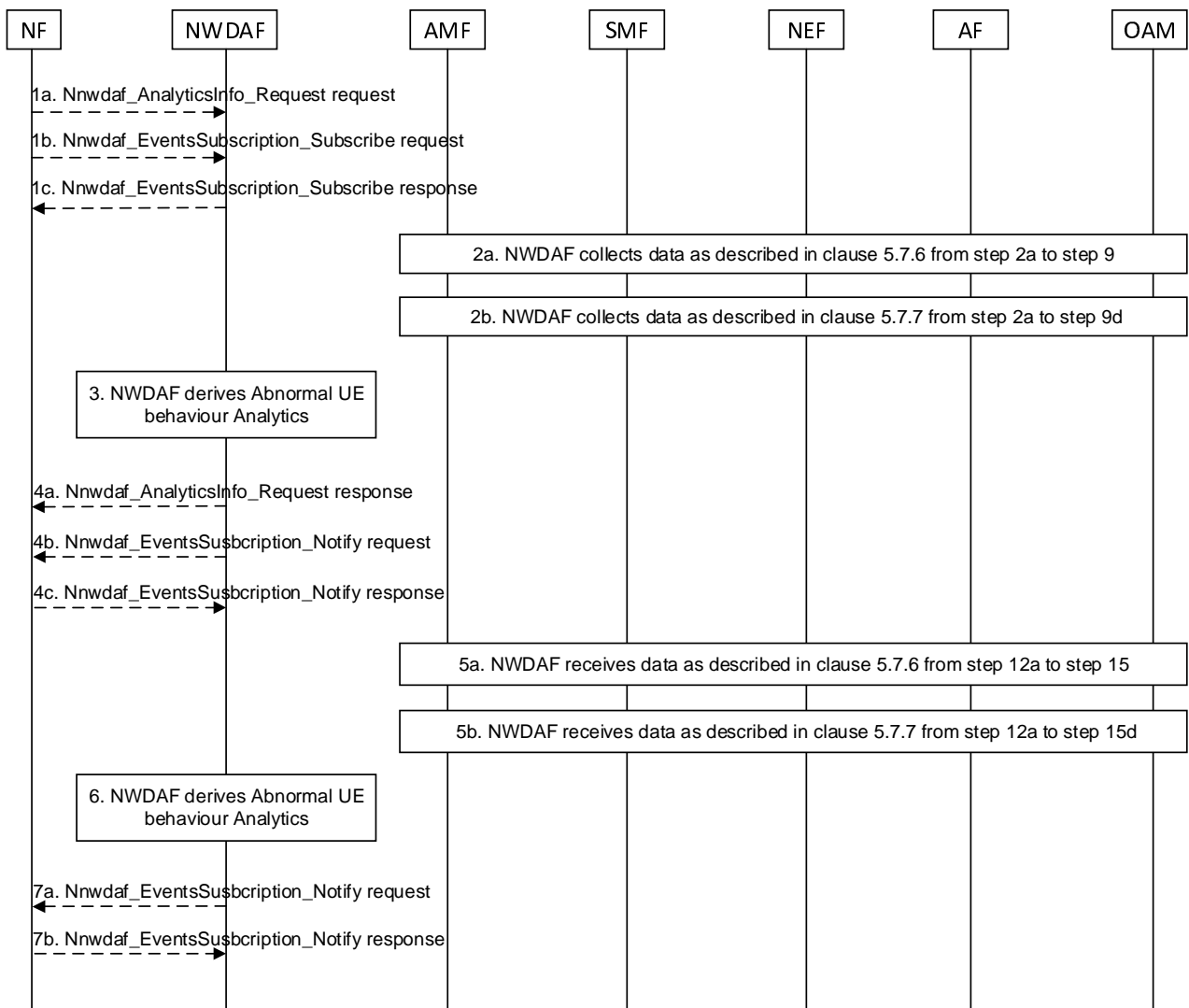

Figure 5.7.9-1: Procedure for Abnormal UE behavioural Analytics

- 1a. In order to obtain the abnormal UE behavioural parameters, the NF may invoke Nnwdaf\_AnalyticsInfo\_Request service operation as described in clause 5.2.3.1.
- 1b-1c. In order to obtain abnormal UE behavioural parameters, the NF may invoke Nnwdaf\_EventsSubscription\_Subscribe service operation as described in clause 5.2.2.1.
- 2a. If the event is set to "ABNORMAL\_BEHAVIOUR" and the expected UE analytics type is set to "MOBILITY" or "MOBILITY\_AND\_COMMUN", or the list of exception IDs includes "UNEXPECTED\_UE\_LOCATION", "PING\_PONG\_ACROSS\_CELLS", "UNEXPECTED\_RADIO\_LINK\_FAILURES", or "UNEXPECTED\_WAKEUP", the NWDAF collects data from AMF, AF and/or OAM as described in clause 5.7.6 from step 2a to step 9.
- 2b. If the event is set to "ABNORMAL\_BEHAVIOUR" and the expected UE analytics type is set to "COMMUN" or "MOBILITY\_AND\_COMMUN", or the list of exception IDs includes "SUSPICION\_OF\_DDOS\_ATTACK", "UNEXPECTED\_LONG\_LIVE\_FLOW", "UNEXPECTED\_LARGE\_RATE\_FLOW", "WRONG\_DESTINATION\_ADDRESS", "TOO\_FREQUENT\_SERVICE\_ACCESS" or "UNEXPECTED\_WAKEUP", the NWDAF collects data from AMF, SMF and/or AF as described in clause 5.7.7 from step 2a to step 9d.
3. The NWDAF calculates the abnormal UE behavioural parameters based on the collected data from AMF, SMF, AF and/or OAM.
- 4a. If step 1a is performed, the NWDAF responds to the Nnwdaf\_AnalyticsInfo\_Request service operation as described in clause 5.2.3.1.
- 4b-4c. If step 1b and step 1c are performed, the NWDAF invokes Nnwdaf\_EventsSubscription\_Notify service operation as described in clause 5.2.2.1.
- 5a-5b. The AMF, SMF, AF and/or OAM send the notifications to the NWDAF if it has subscribed to the related events in step 2a or step 2b.
6. The same as step 3.
- 7a-7b. The same as step 4b and step 4c.

NOTE: For details of Nnwdaf\_EventsSubscription\_Subscribe/Unsubscribe/Notify or Nnwdaf\_AnalyticsInfo\_Request service operations refer to 3GPP TS 29.520 [5].

### 5.7.10 User Data Congestion Analytics

This procedure is used by the NWDAF service consumer (may be an NF e.g. NEF, AF, or PCF) to obtain the User Data Congestion analytics which are calculated by the NWDAF based on the information collected from the AMF, OAM, UPF and/or AF.

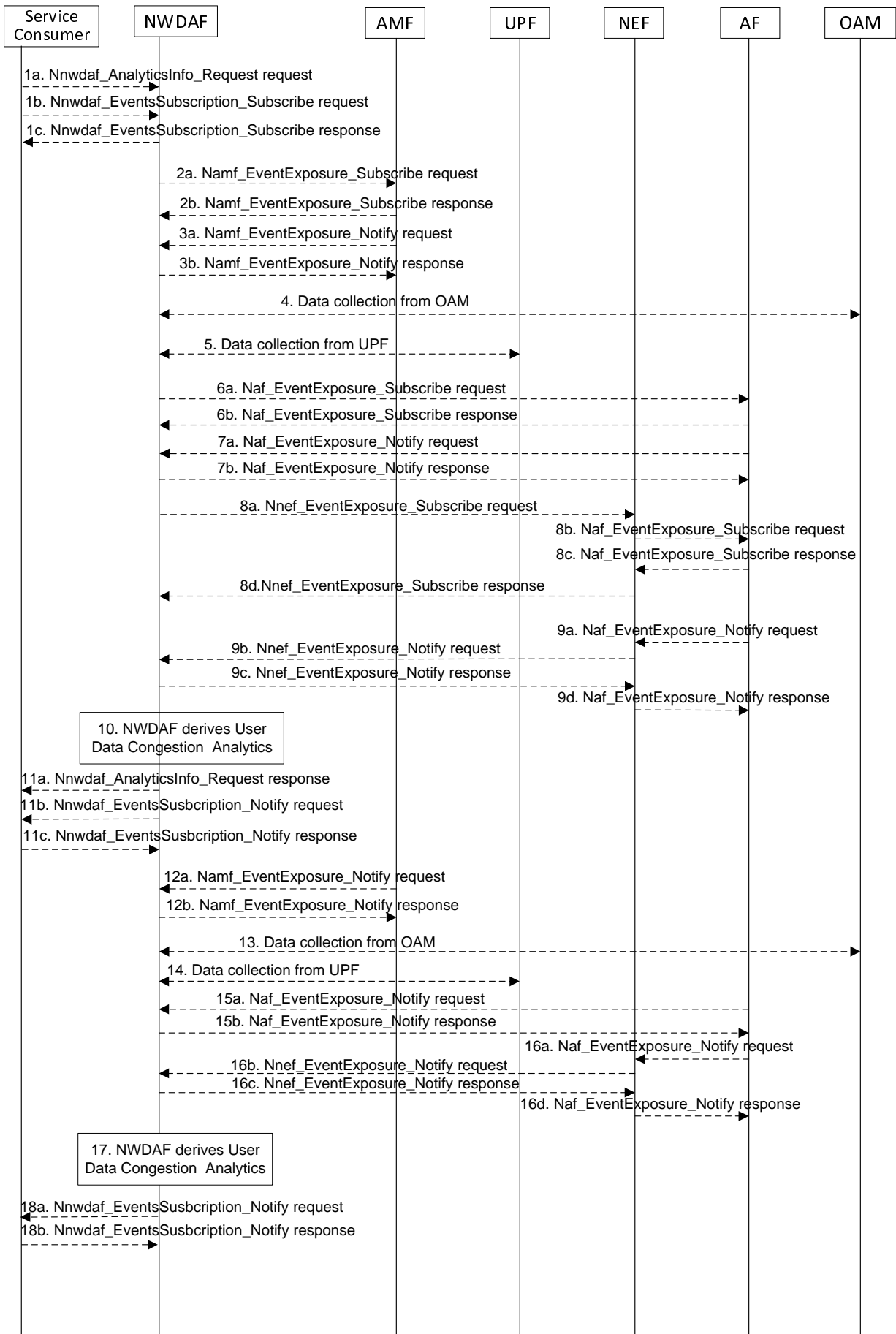

Figure 5.7.10-1: Procedure for User Data Congestion Analytics

- 1a. In order to obtain the User Data Congestion analytics, the NWDAF service consumer may invoke Nnwdaf\_AnalyticsInfo\_Request service operation as described in clause 5.2.3.1, the requested event is set to "USER\_DATA\_CONGESTION" with the supported feature "UserDataCongestion".
- 1b-1c. In order to obtain the User Data Congestion analytics, the NWDAF service consumer may invoke Nnwdaf\_EventsSubscription\_Subscribe service operation as described in clause 5.2.2.1, the subscribed event is set to "USER\_DATA\_CONGESTION" with the supported feature "UserDataCongestion".
- 2a-2b. The NWDAF may invoke Namf\_EventExposure\_Subscribe service operation as described in clause 5.3.2.2.2 of 3GPP TS 29.518 [18] to retrieve the UE location information. The AMF responds to the NWDAF an HTTP "201 Created" response.
- 3a-3b. If step 2a and step 2b are performed, the AMF may invoke Namf\_EventExposure\_Notify service operation as described in 3GPP TS 29.518 [18] clause 5.3.2.4. The NWDAF responds to the AMF an HTTP "204 No Content" response.
4. The NWDAF may invoke "Data collection service" to the OAM to get the Performance Measurements that will be used by the NWDAF to determine congestion levels. Performance Measurements are related to information transfer over the user plane and/or the control plane (e.g. UE Throughput, DRB Setup Management, RRC Connection Number, PDU Session Management, and Radio Resource Utilization as defined in 3GPP TS 28.552 [27]). The NWDAF may obtain measurements by invoking management services that are defined in 3GPP TS 28.532 [19] and 3GPP TS 28.550 [31].
5. The NWDAF may collect data related to User Data Congestion analytics information from UPF.

NOTE 1: How the NWDAF collects UPF information is not defined in this release of the specification.

- 6a-6b. If the AF is trusted, the NWDAF may invoke Naf\_EventExposure\_Subscribe service operation to the AF directly by sending an HTTP POST request targeting the resource "Application Event Subscriptions" to collect the data related to User Data Congestion analytics information. The AF responds to the NWDAF an HTTP "201 Created" response.
- 7a-7b. If step 6a and step 6b are performed, the AF invokes Naf\_EventExposure\_Notify service operation by sending an HTTP POST request to the NWDAF identified by the notification URI received in step 6a. The NWDAF responds to the AF an HTTP "204 No Content" response.
- 8a-8d. If the AF is untrusted, the NWDAF may invoke Nnef\_EventExposure\_Subscribe service operation to the NEF by sending an HTTP POST request targeting the resource "Network Exposure Event Subscriptions" and then the NEF invokes Naf\_EventExposure\_Subscribe service operation by sending an HTTP POST request targeting the resource "Application Event Subscriptions" to collect the data related to User Data Congestion analytics information. The AF responds to the NEF an HTTP "201 Created" response and then the NEF responds to the NWDAF an HTTP "201 Created" response.
- 9a-9d. If step 8a to step 8d are performed, the AF invokes Naf\_EventExposure\_Notify service operation by sending an HTTP POST request to the NEF identified by the notification URI received in step 8b and the NEF invokes Nnef\_EventExposure\_Notify service operation by sending an HTTP POST request to the NWDAF identified by the notification URI received in step 8a. The NWDAF responds to the NEF an HTTP "204 No Content" response and then the NEF responds to the AF an HTTP "204 No Content" response.
10. The NWDAF calculates the User Data Congestion analytics based on the data collected from AMF, OAM, UPF and/or AF.
- 11a. If step 1a is performed, the NWDAF responds to the Nnwdaf\_AnalyticsInfo\_Request service operation as described in clause 5.2.3.1.
- 11b-11c. If step 1b and step 1c are performed, the NWDAF invokes Nnwdaf\_EventsSubscription\_Notify service operation as described in clause 5.2.2.1.
- 12a-12b. The same as step 3a and step 3b.
13. The same as step 4.
14. The same as step 5.
- 15a-15b. The same as step 7a and step 7b.

16a-16d. The same as step 9a to step 9d.

17. The same as step 10.

18a-18b. The same as step 11b and step 11c.

NOTE 2: For details of Naf\_EventExposure\_Subscribe/Notify service operations refer to 3GPP TS 29.517 [12].

NOTE 3: For details of Nnef\_EventExposure\_Subscribe/Notify service operations refer to 3GPP TS 29.591 [11].

NOTE 4: For details of Nnwdaf\_EventsSubscription\_Subscribe/Unsubscribe/Notify or Nnwdaf\_AnalyticsInfo\_Request service operations refer to 3GPP TS 29.520 [5].

## 5.7.11 QoS Sustainability Analytics

This procedure is used by the NWDAF service consumer (maybe an NF, e.g. AF) to obtain the QoS Sustainability analytics which are calculated by the NWDAF based on the information collected from the OAM.

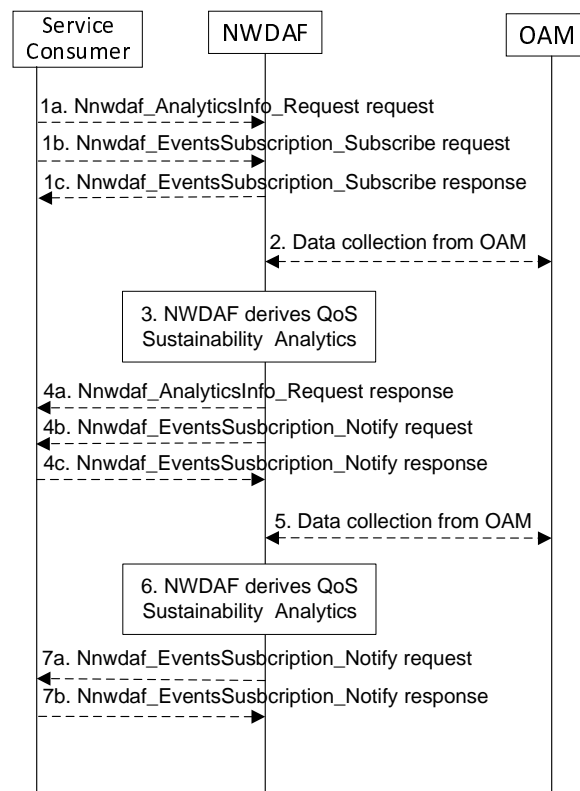

**Figure 5.7.11-1: Procedure for QoS Sustainability Analytics**

- 1a. In order to obtain the QoS sustainability analytics, the NWDAF service consumer may invoke Nnwdaf\_AnalyticsInfo\_Request service operation as described in clause 5.2.3.1, the requested event is sent to "QOS\_SUSTAINABILITY" with the supported feature "QoSSustainability".
- 1b-1c. In order to obtain the QoS sustainability analytics, the NWDAF service consumer may invoke Nnwdaf\_EventsSubscription\_Subscribe service operation as described in clause 5.2.2.1, the subscribed event is set to "QOS\_SUSTAINABILITY" with the supported feature "QoSSustainability".
2. The NWDAF may invoke "Data collection service" to the OAM to get the RAN UE Throughput in clause 6.3.6 of 3GPP TS 28.554 [30] and/or QoS flow Retainability information as described in clause 6.5.1 of 3GPP TS 28.554 [30].
3. The NWDAF calculates the QoS sustainability analytics based on the data collected from OAM.

4a. If step 1a is performed, the NWDAF responds to the Nnwdaf\_AnalyticsInfo\_Request service operation as described in clause 5.2.3.1.

4b-4c. If step 1b and step 1c are performed, the NWDAF invokes Nnwdaf\_EventsSubscription\_Notify service operation as described in clause 5.2.2.1.

5. The same as step 2.

6. The same as step 3.

7a-7b. The same as step 4b and step 4c.

NOTE: For details of Nnwdaf\_EventsSubscription\_Subscribe/Unsubscribe/Notify or Nnwdaf\_AnalyticsInfo\_Request service operations refer to 3GPP TS 29.520 [5].

## 5.7.12 Dispersion Analytics

This procedure is used by the NWDAF service consumer to obtain the dispersion analytics which are calculated by the NWDAF based on the information collected from the AMF, SMF, UPF and/or AF.

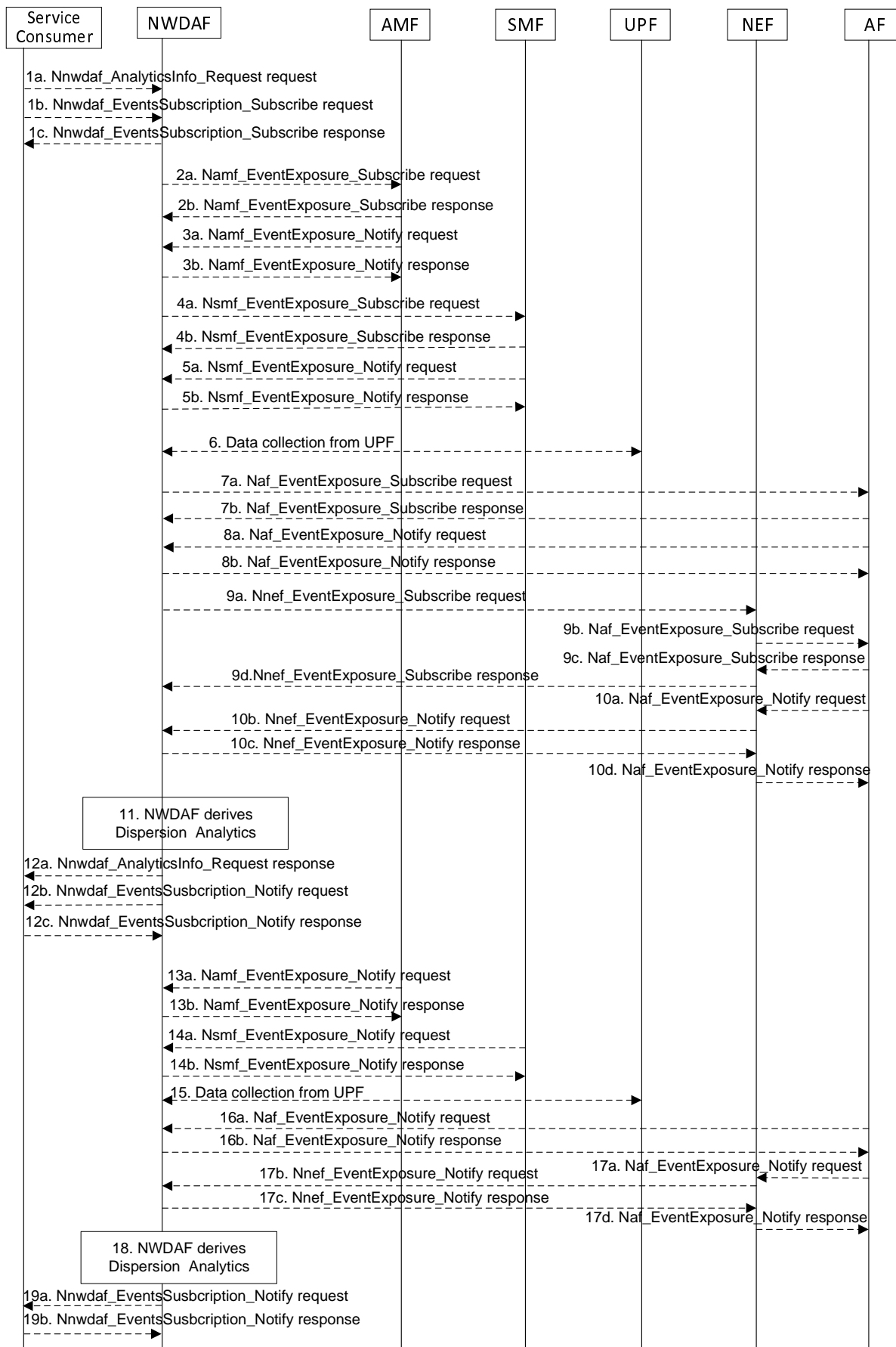

Figure 5.7.12-1: Procedure for Dispersion Analytics

- 1a. In order to obtain the Dispersion analytics, the NWDAF service consumer may invoke Nnwdaf\_AnalyticsInfo\_Request service operation as described in clause 5.2.3.1, the requested event is set to "DISPERSION" with the supported feature "Dispersion".
- 1b-1c. In order to obtain the Dispersion analytics, the NWDAF service consumer may invoke Nnwdaf\_EventsSubscription\_Subscribe service operation as described in clause 5.2.2.1, the subscribed event is set to "DISPERSION" with the supported feature "Dispersion".
- 2a-2b. The NWDAF may invoke Namf\_EventExposure\_Subscribe service operation as described in clause 5.3.2.2.2 of 3GPP TS 29.518 [18] to retrieve the location and/or slice based UE transactions dispersion information. The AMF responds to the NWDAF an HTTP "201 Created" response.
- 3a-3b. If step 2a and step 2b are performed, the AMF may invoke Namf\_EventExposure\_Notify service operation as described in 3GPP TS 29.518 [18] clause 5.3.2.4. The NWDAF responds to the AMF an HTTP "204 No Content" response.
- 4a-4b. The NWDAF may invoke Nsmf\_EventExposure\_Subscribe service operation by sending an HTTP POST request targeting the resource "SMF Notification Subscriptions" to subscribe to the notification of UE transactions dispersion information which may be slice based. The SMF responds to the NWDAF an HTTP "201 Created" response.
- 5a-5b. If step 4a and step 4b are performed, the SMF may invoke Nsmf\_EventExposure\_Notify service operation by sending an HTTP POST request to the NWDAF identified by the notification URI received in step 4a. The NWDAF responds to the SMF an HTTP "204 No Content" response.
6. The NWDAF may collect UE data volume dispersion information from the serving UPF.
- NOTE 1: How the NWDAF collects UPF information is not defined in this release of the specification.
- 7a-7b. If the AF is trusted, the NWDAF may invoke Naf\_EventExposure\_Subscribe service operation to the AF directly by sending an HTTP POST request targeting the resource "Application Event Subscriptions" to collect the UE data volume dispersion information. The AF responds to the NWDAF an HTTP "201 Created" response.
- 8a-8b. If step 7a and step 7b are performed, the AF invokes Naf\_EventExposure\_Notify service operation by sending an HTTP POST request to the NWDAF identified by the notification URI received in step 7a. The NWDAF responds to the AF an HTTP "204 No Content" response.
- 9a-9d. If the AF is untrusted, the NWDAF may invoke Nnef\_EventExposure\_Subscribe service operation to the NEF by sending an HTTP POST request targeting the resource "Network Exposure Event Subscriptions" and then the NEF invokes Naf\_EventExposure\_Subscribe service operation by sending an HTTP POST request targeting the resource "Application Event Subscriptions" to collect the UE data volume dispersion information. The AF responds to the NEF an HTTP "201 Created" response and then the NEF responds to the NWDAF an HTTP "201 Created" response.
- 10a-10d. If step 9a to step 9d are performed, the AF invokes Naf\_EventExposure\_Notify service operation by sending an HTTP POST request to the NEF identified by the notification URI received in step 8b and the NEF invokes Nnef\_EventExposure\_Notify service operation by sending an HTTP POST request to the NWDAF identified by the notification URI received in step 9a. The NWDAF responds to the NEF an HTTP "204 No Content" response and then the NEF responds to the AF an HTTP "204 No Content" response.
11. The NWDAF calculates the Dispersion analytics based on the data collected from AMF, SMF, UPF and/or AF.
- 12a. If step 1a is performed, the NWDAF responds to the Nnwdaf\_AnalyticsInfo\_Request service operation as described in clause 5.2.3.1.
- 12b-12c. If step 1b and step 1c are performed, the NWDAF invokes Nnwdaf\_EventsSubscription\_Notify service operation as described in clause 5.2.2.1.
- 13a-13b. The same as step 3a and step 3b.
- 14a-14b. The same as step 5a and step 5b.
15. The same as step 6.
- 16a-16b. The same as step 8a and step 8b.



17a-17d. The same as step 10a to step 10d.

18. The same as step 11.

19a-19b. The same as step 12b and step 12c.

NOTE 2: For details of Nsmf\_EventExposure\_Subscribe/Notify service operations refer to 3GPP TS 29.508 [6].

NOTE 3: For details of Naf\_EventExposure\_Subscribe/Notify service operations refer to 3GPP TS 29.517 [12].

NOTE 4: For details of Nnef\_EventExposure\_Subscribe/Notify service operations refer to 3GPP TS 29.591 [11].

NOTE 5: For details of Nnwdaf\_EventsSubscription\_Subscribe/Unsubscribe/Notify or Nnwdaf\_AnalyticsInfo\_Request service operations refer to 3GPP TS 29.520 [5].

### 5.7.13 WLAN Performance Analytics

This procedure is used by the NWDAF service consumer to obtain the WLAN performance analytics which are calculated by the NWDAF based on the information collected from the SMF, UPF and/or OAM. If the NF is an AF which is untrusted, the AF will request analytics via the NEF as described in clause 5.2.3.2.

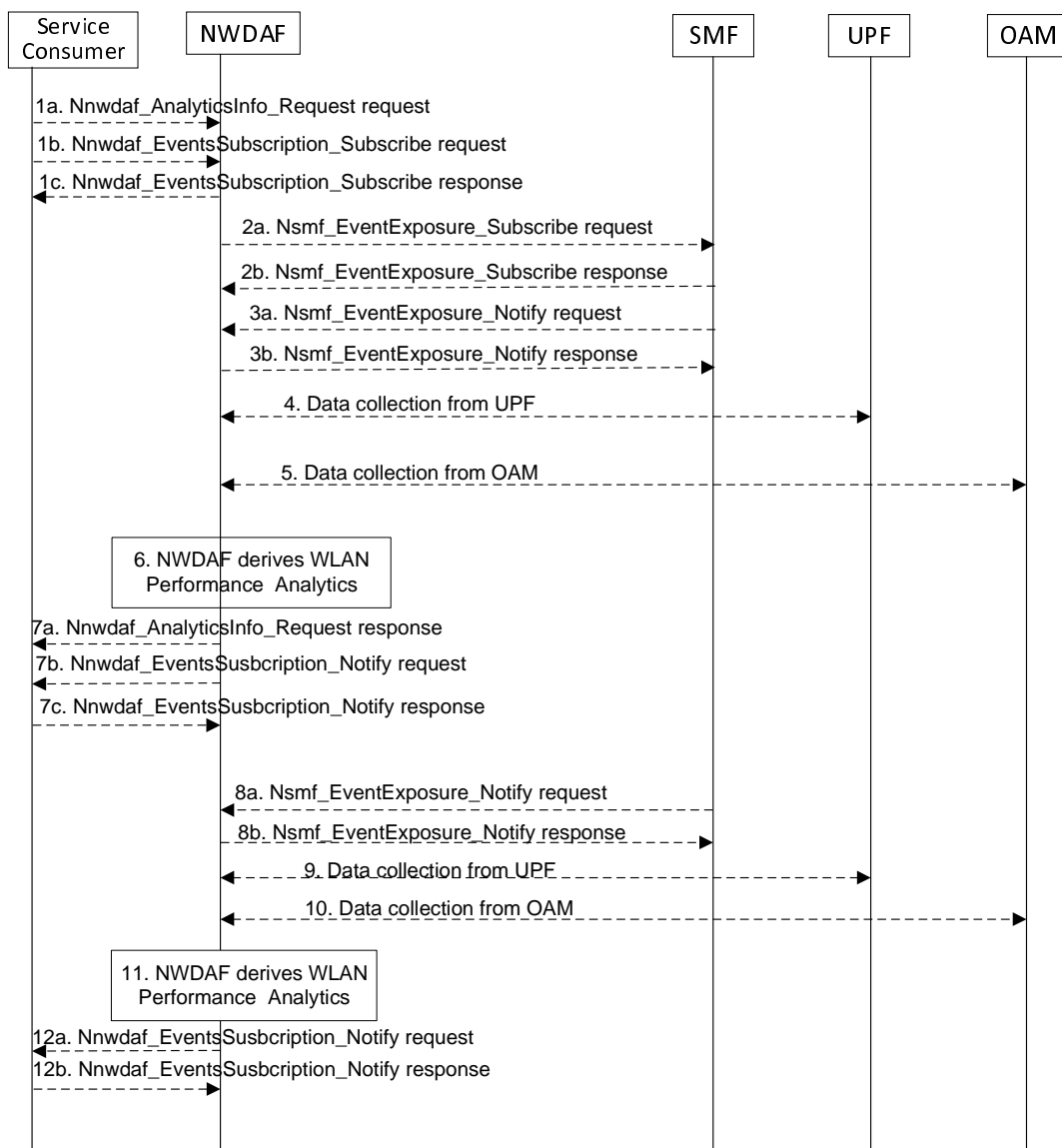

**Figure 5.7.13-1: Procedure for WLAN Performance Analytics**

1a. In order to obtain the WLAN performance analytics, the NWDAF service consumer may invoke Nnwdaf\_AnalyticsInfo\_Request service operation as described in clause 5.2.3.1, the requested event is set to "WLAN\_PERFORMANCE" with the supported feature "WlanPerformance".

1b-1c. In order to obtain the WLAN performance analytics, the NWDAF service consumer may invoke Nnwdaf\_EventsSubscription\_Subscribe service operation as described in clause 5.2.2.1, the subscribed event is set to "WLAN\_PERFORMANCE" with the supported feature "WlanPerformance".

2a-2b. The NWDAF may invoke Nsmf\_EventExposure\_Subscribe service operation by sending an HTTP POST request targeting the resource "SMF Notification Subscriptions" to subscribe to the notification of Information on PDU Session for WLAN. The SMF responds to the NWDAF an HTTP "201 Created" response.

3a-3b. If step 2a and step 2b are performed, the SMF may invoke Nsmf\_EventExposure\_Notify service operation by sending an HTTP POST request to the NWDAF identified by the notification URI received in step 2a. The NWDAF responds to the SMF an HTTP "204 No Content" response.

4. The NWDAF may collect UE communications information for WLAN from the UPF.

NOTE 1: How the NWDAF collects UPF information is not defined in this release of the specification.

5. The NWDAF may collect WLAN measurement results from the OAM. The WLAN measurement data from OAM is collected via MDT and aligned with the WLAN measurement reporting list described in clause 5.1.1.3.3 of TS 37.320 [32].
6. The NWDAF calculates the WLAN performance analytics based on the data collected from SMF, UPF and/or OAM.
- 7a. If step 1a is performed, the NWDAF responds to the Nnwdaf\_AnalyticsInfo\_Request service operation as described in clause 5.2.3.1.
- 7b-7c. If step 1b and step 1c are performed, the NWDAF invokes Nnwdaf\_EventsSubscription\_Notify service operation as described in clause 5.2.2.1.
- 8a-8b. The same as step 3a and step 3b.
9. The same as step 4.
10. The same as step 5.
11. The same as step 6.
- 12a-12b. The same as step 7b and step 7c.

NOTE 2: For details of Nsmf\_EventExposure\_Subscribe/Notify service operations refer to 3GPP TS 29.508 [6].

NOTE 3: For details of Nnwdaf\_EventsSubscription\_Subscribe/Unsubscribe/Notify or Nnwdaf\_AnalyticsInfo\_Request service operations refer to 3GPP TS 29.520 [5].

### 5.7.14 Session Management Congestion Control Experience Analytics

This procedure is used by the NWDAF service consumer e.g. SMF to obtain the Session Management Congestion Control Experience Analytics which are calculated by the NWDAF based on the information collected from the SMF.

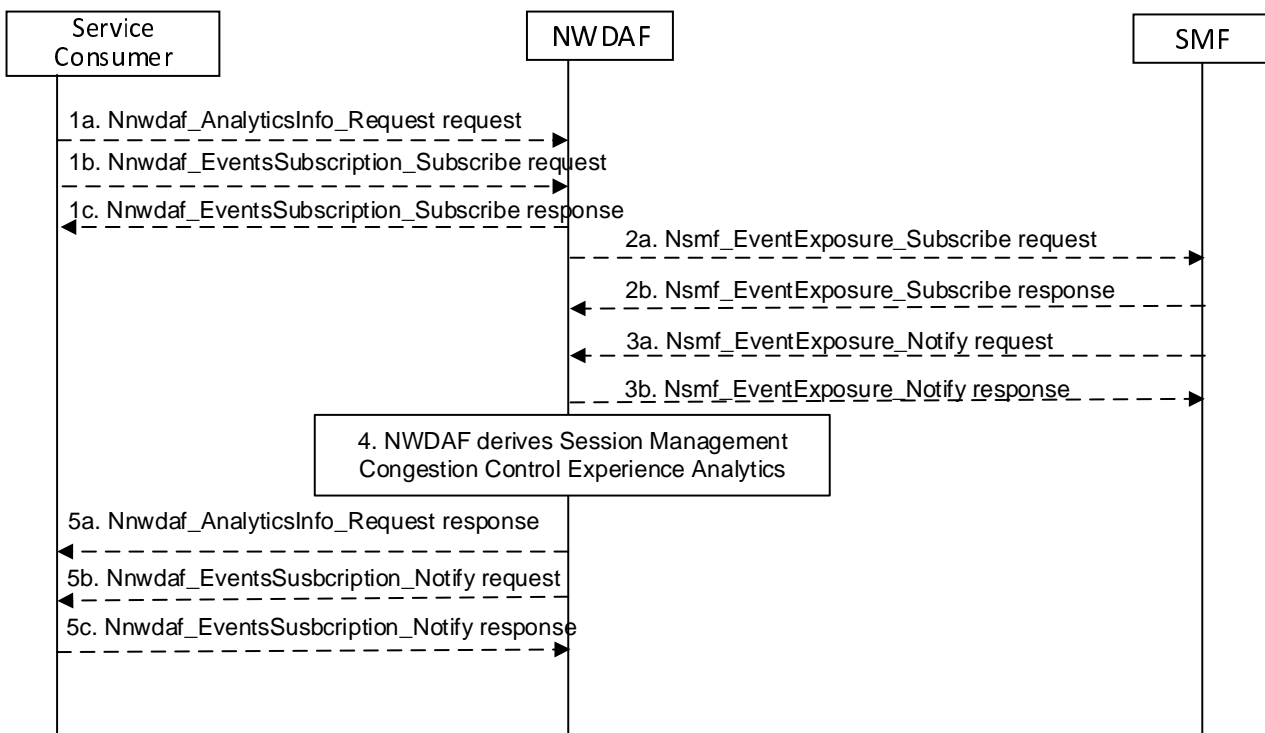

**Figure 5.7.14-1: Procedure for Session Management Congestion Control Experience Analytics**

1a. In order to obtain the SMCCE (Session Management Congestion Control Experience) analytics, the NWDAF service consumer may invoke Nnwdaf\_AnalyticsInfo\_Request service operation as described in clause 5.2.3.1, the requested event is set to "SM\_CONGESTION" with the supported feature "SMCCE".

1b-1c. In order to obtain the SMCCE (Session Management Congestion Control Experience) analytics, the NWDAF service consumer may invoke Nnwdaf\_EventsSubscription\_Subscribe service operation as described in clause 5.2.2.1, the subscribed event is set to "SM\_CONGESTION" with the supported feature "SMCCE".

2a-2b. The NWDAF may invoke Nsmf\_EventExposure\_Subscribe service operation by sending an HTTP POST request targeting the resource "SMF Notification Subscriptions" to subscribe to the notification of Information on UE ID and SMCC experience for PDU Session. The SMF responds to the NWDAF an HTTP "201 Created" response.

3a-3b. If step 2a and step 2b are performed, the SMF may invoke Nsmf\_EventExposure\_Notify service operation by sending an HTTP POST request to the NWDAF identified by the notification URI received in step 2a. The NWDAF responds to the SMF an HTTP "204 No Content" response.

4. The NWDAF calculates the Session Management Congestion Control Experience analytics based on the data collected from SMF.

5a. If step 1a is performed, the NWDAF responds to the Nnwdaf\_AnalyticsInfo\_Request service operation as described in clause 5.2.3.1.

5b-5c. If step 1b and step 1c are performed, the NWDAF invokes Nnwdaf\_EventsSubscription\_Notify service operation as described in clause 5.2.2.1.

NOTE 1: For details of Nsmf\_EventExposure\_Subscribe/Notify service operations refer to 3GPP TS 29.508 [6].

NOTE 2: For details of Nnwdaf\_EventsSubscription\_Subscribe/Unsubscribe/Notify and Nnwdaf\_AnalyticsInfo\_Request service operations refer to 3GPP TS 29.520 [5].

### 5.7.15 Redundant Transmission Experience Analytics

This procedure is used by the NWDAF service consumer (may be an NF e.g. SMF) to obtain the Redundant Transmission Experience Analytics which are calculated by the NWDAF based on the information collected from the AMF, AF, SMF, UPF and/or OAM.

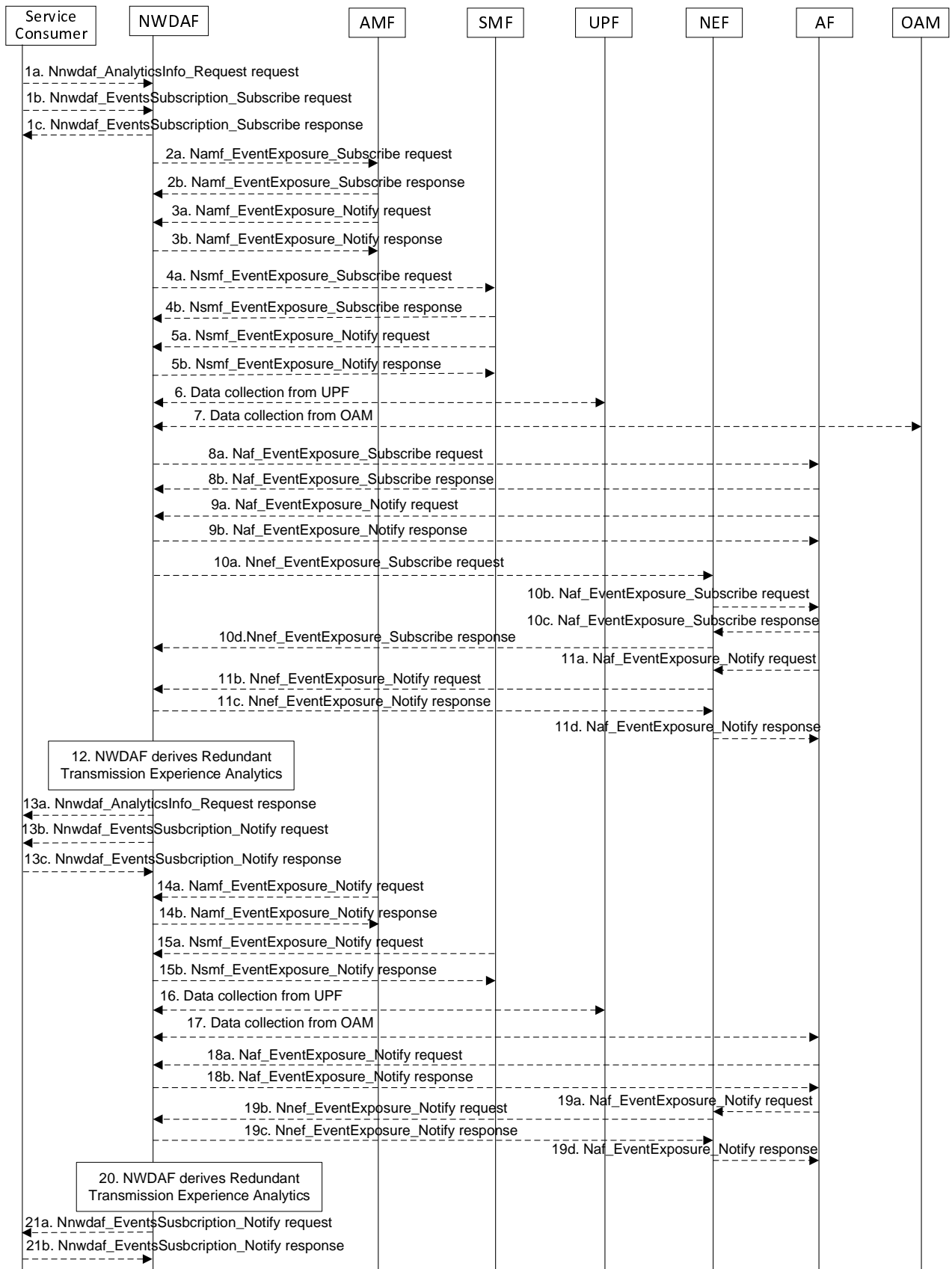

Figure 5.7.15-1: Procedure for Redundant Transmission Experience Analytics

- 1a. In order to obtain the Redundant Transmission Experience Analytics, the NWDAF service consumer may invoke Nnwdaf\_AnalyticsInfo\_Request service operation as described in clause 5.2.3.1, the requested event is set to "RED\_TRANS\_EXP" with the supported feature "RedundantTransmissionExp".
- 1b-1c. In order to obtain the Redundant Transmission Experience Analytics, the NWDAF service consumer may invoke Nnwdaf\_EventsSubscription\_Subscribe service operation as described in clause 5.2.2.1, the subscribed event is set to "RED\_TRANS\_EXP" with the supported feature "RedundantTransmissionExp".
- 2a-2b. The NWDAF may invoke Namf\_EventExposure\_Subscribe service operation as described in clause 5.3.2.2.2 of 3GPP TS 29.518 [18] to retrieve the UE Mobility information. The AMF responds to the NWDAF an HTTP "201 Created" response.
- 3a-3b. If step 2a and step 2b are performed, the AMF may invoke Namf\_EventExposure\_Notify service operation as described in 3GPP TS 29.518 [18] clause 5.3.2.4. The NWDAF responds to the AMF an HTTP "204 No Content" response.
- 4a-4b. The NWDAF may invoke Nsmf\_EventExposure\_Subscribe service operation by sending an HTTP POST request targeting the resource "SMF Notification Subscriptions" to subscribe to the notification of Information related to PDU Session established with redundant transmission. The SMF responds to the NWDAF an HTTP "201 Created" response.
- 5a-5b. If step 4a and step 4b are performed, the SMF may invoke Nsmf\_EventExposure\_Notify service operation by sending an HTTP POST request to the NWDAF identified by the notification URI received in step 4a. The NWDAF responds to the SMF an HTTP "204 No Content" response.
6. The NWDAF may collect data related to packet delay measurement information from UPF, refer to clause 5.4.1 of TS 28.552 [27] for the performance measurement in UPF.
- NOTE 1: How the NWDAF collects UPF information is not defined in this release of the specification.
7. The NWDAF may invoke "Data collection service" to the OAM to get the packet drop and/or packet delay measurement refer to clause 5.1 of TS 28.552 [27] for the performance measurement in NG-RAN.
- 8a-8b. If the AF is trusted, the NWDAF may invoke Naf\_EventExposure\_Subscribe service operation to the AF directly by sending an HTTP POST request targeting the resource "Application Event Subscriptions" to collect the service data related to UE mobility information. The AF responds to the NWDAF an HTTP "201 Created" response.
- 9a-9b. If step 8a and step 8b are performed, the AF invokes Naf\_EventExposure\_Notify service operation by sending an HTTP POST request to the NWDAF identified by the notification URI received in step 8a. The NWDAF responds to the AF an HTTP "204 No Content" response.
- 10a-10d. If the AF is untrusted, the NWDAF may invoke Nnef\_EventExposure\_Subscribe service operation to the NEF by sending an HTTP POST request targeting the resource "Network Exposure Event Subscriptions" and then the NEF invokes Naf\_EventExposure\_Subscribe service operation by sending an HTTP POST request targeting the resource "Application Event Subscriptions" to collect the service data related to UE mobility information. The AF responds to the NEF an HTTP "201 Created" response and then the NEF responds to the NWDAF an HTTP "201 Created" response.
- 11a-11d. If step 10a to step 10d are performed, the AF invokes Naf\_EventExposure\_Notify service operation by sending an HTTP POST request to the NEF identified by the notification URI received in step 10b and the NEF invokes Nnef\_EventExposure\_Notify service operation by sending an HTTP POST request to the NWDAF identified by the notification URI received in step 10a. The NWDAF responds to the NEF an HTTP "204 No Content" response and then the NEF responds to the AF an HTTP "204 No Content" response.
12. The NWDAF calculates the Redundant Transmission Experience Analytics based on the data collected from AMF, AF SMF, UPF and/or OAM.
- 13a. If step 1a is performed, the NWDAF responds to the Nnwdaf\_AnalyticsInfo\_Request service operation as described in clause 5.2.3.1.
- 13b-13c. If step 1b and step 1c are performed, the NWDAF invokes Nnwdaf\_EventsSubscription\_Notify service operation as described in clause 5.2.2.1.
- 14a-14b. The same as step 3a and step 3b.

15a-15b. The same as step 5a and step 5b.

16. The same as step 6.

17. The same as step 7.

18a-18b. The same as step 9a and step 9b.

19a-18d. The same as step 11a and step 11d.

20. The same as step 12.

21a-21b. The same as step 13b and step 13c.

NOTE 2: For details of Naf\_EventExposure\_Subscribe/Notify service operations refer to 3GPP TS 29.517 [12].

NOTE 3: For details of Nsmf\_EventExposure\_Subscribe/Notify service operations refer to 3GPP TS 29.508 [6].

NOTE 4: For details of Nnwdaf\_EventsSubscription\_Subscribe/Unsubscribe/Notify or Nnwdaf\_AnalyticsInfo\_Request service operations refer to 3GPP TS 29.520 [5].

## 5.7.16 DN Performance Analytics

This procedure is used by the NF to obtain DN performance analytics, which is calculated by the NWDAF based on the information collected from the AMF, SMF, AF, UPF and/or OAM. If the NF is an AF which is untrusted, the AF will request analytics via the NEF as described in clause 5.2.3.2.

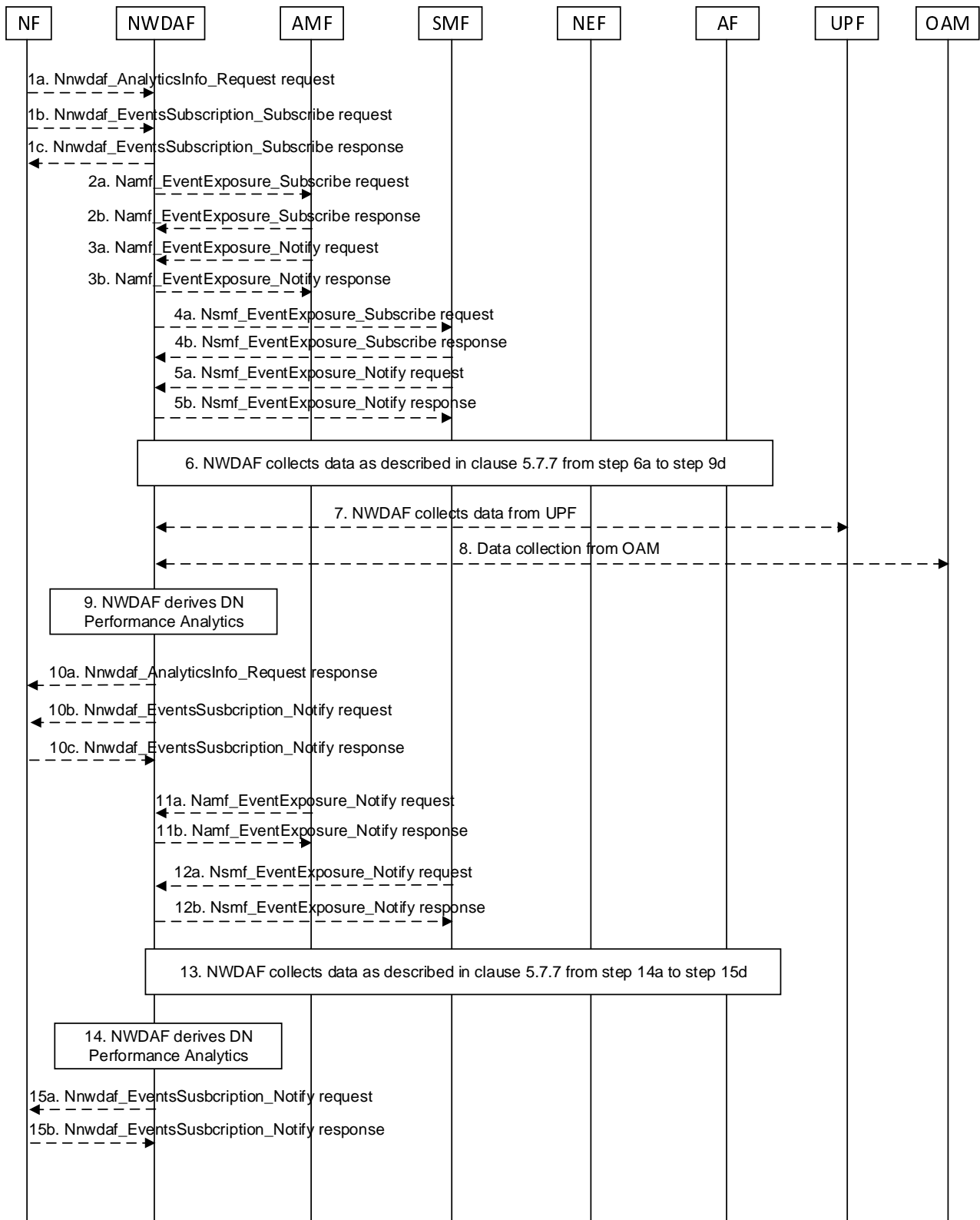

**Figure 5.7.16-1: Procedure for DN Performance Analytics**

1a. In order to obtain the DN performance analytics, the NF may invoke Nnwdaf\_AnalyticsInfo\_Request service operation as described in clause 5.2.3.1.

1b-1c. In order to obtain the DN performance analytics, the NF may invoke Nnwdaf\_EventsSubscription\_Subscribe service operation as described in clause 5.2.2.1.



2a-2b. The NWDAF may invoke Namf\_EventExposure\_Subscribe service operation as described in clause 5.3.2.2.2 of 3GPP TS 29.518 [18] to retrieve the UE location information and SUPI(s) from AMF. The AMF responds to the NWDAF an HTTP "201 Created" response.

3a-3b. If step 2a and step 2b are performed, the AMF may invoke Namf\_EventExposure\_Notify service operation as described in 3GPP TS 29.518 [18] clause 5.3.2.4. The NWDAF responds to the AMF an HTTP "204 No Content" response.

4a-4b. The NWDAF may invoke Nsmf\_EventExposure\_Subscribe service operation by sending an HTTP POST request targeting the resource "SMF Notification Subscriptions" to request DNN, S-NSSAI, application ID, UPF info, DNAI, IP filter information and QFI. The SMF responds to the NWDAF an HTTP "201 Created" response.

5a-5b. If step 4a and step 4b are performed, the SMF may invoke Nsmf\_EventExposure\_Notify service operation by sending an HTTP POST request to the NWDAF identified by the notification URI received in step 4a. The NWDAF responds to the SMF an HTTP "204 No Content" response.

6. The NWDAF may collect performance data from AF as described in clause 5.7.7 from step 6a to step 9d.

7. The NWDAF may collect QoS flow bit rate, QoS flow packet delay, packet transmission and packet retransmission information from UPF.

NOTE 1: How NWDAF collects UE communication related data from UPF is not defined in this Release of the specification.

8. The NWDAF may collect Reference Signal Received Power and Reference Signal Received Quality as specified in clause 5.5 of TS 38.331 [33] and clause 5.5.5 of TS 36.331 [34], Signal-to-noise and interference ratio as specified in clause 5.1 of TS 38.215 [35], the mapping information between cell ID and frequency and Cell Energy Saving State data as specified in clauses 3.1 and 6.2 of TS 28.310 [36] from OAM.

9. The NWDAF calculates the DN performance analytics based on the data collected from AMF, SMF, AF, UPF and/or OAM.

10a. If step 1a is performed, the NWDAF responds to the Nnwdaf\_AnalyticsInfo\_Request service operation as described in clause 5.2.3.1.

10b-10c. If step 1b and step 1c are performed, the NWDAF may invoke Nnwdaf\_EventsSubscription\_Notify service operation as described in clause 5.2.2.1.

11a-11b. The same as step 3a and step 3b.

12a-12b. The same as step 5a and step 5b.

13. The same as step 6.

14. The same as step 9.

15a-15b. The same as step 10b and step 10c.

NOTE 2: For details of Nsmf\_EventExposure\_Subscribe/Notify service operations refer to 3GPP TS 29.508 [6].

NOTE 3: For details of Nnwdaf\_EventsSubscription\_Subscribe/Unsubscribe/Notify or Nnwdaf\_AnalyticsInfo\_Request service operations refer to 3GPP TS 29.520 [5].

## 5.8 Procedures for NWDAF Discovery and Selection

### 5.8.1 General

NWDAF may be deployed in multiple configuration options. Not all these configurations require the same registration, discovery and selection procedures. The discovery and selection may depend on the NWDAF deployment option and the types of analytics it procedures, (i.e., whether it is related to Network Functions or to UEs) or the data that is able to collect from NFs.

## 5.8.2 Procedures related to NRF

### 5.8.2.1 General

### 5.8.2.2 NWDAF Registration in NRF

NWDAF registers in NRF as a regular network function. See TS 29.510 [23] for details.

### 5.8.2.3 Consumer discovery and selection of NWDAF in NRF

A consumer of analytics services may use the NRF for discovering an NWDAF containing AnLF.

If the NWDAF service consumer needs to discover an NWDAF containing AnLF that is able to collect data from particular data sources identified by their NF Set IDs or NF types, the consumer may query NRF with the Nnrf\_NFDiscovery\_NFDiscover service operation, providing the NF Set IDs (serving-nf-set-id attribute) or NF types (serving-nf-type attribute) in the discovery request. See TS 29.510 [23] for details.

## 5.8.3 Procedures related to UDM

### 5.8.3.1 General

### 5.8.3.2 NWDAF containing AnLF Registration/Deregistration in UDM

#### 5.8.3.2.1 NWDAF containing AnLF Registration in UDM

For UE-related analytics, an NWDAF containing AnLF may register in UDM using the Nudm\_UECM\_Register service operation (see TS 29.503 [22] clause 5.3.2.2.8). This is useful especially in scenarios of co-location of the NWDAF containing AnLF with other network functions (e.g., AMF, SMF) and in certain deployment models. Figure 5.8.3.2.1-1 illustrates the signalling flow.

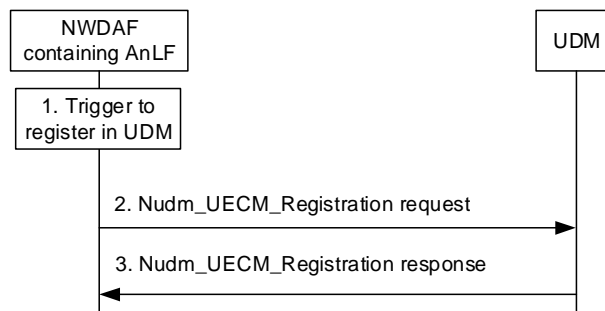
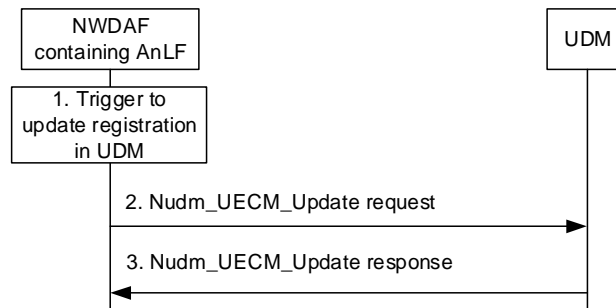

**Figure 5.8.3.2.1-1: NWDAF containing AnLF registration in UDM**

1. NWDAF containing AnLF triggers a registration in UDM, e.g. based on local configuration in the NWDAF containing AnLF, the reception of a new Analytics subscription request, start of collection of UE related data or an OAM configuration action.
2. The NWDAF containing AnLF registers into UDM for the served UE, by sending Nudm\_UECM\_Registration request (UE ID of the served user, NWDAF Instance ID, NF Set ID, Analytics ID(s)).
3. UDM sends a response to NWDAF containing AnLF. A successful response consists of a "200 OK" or "201 Created". If the operation is unsuccessful, UDM responds with proper error response code. See TS 29.503 [22] for details.

### 5.8.3.2.2 NWDAF containing AnLF Update of Registration in UDM

If an NWDAF containing AnLF has previously registered in UDM for one or more analytics IDs for a given UE, the NWDAF containing AnLF may modify the registration at any time. This may be due to, e.g., the NWDAF containing AnLF adds one or more Analytic IDs for the UE, or the NWDAF containing AnLF removes one or more Analytics IDs, but keep registered in UDM for at least one Analytic ID. The NWDAF containing AnLF sends an Nudm\_UECM\_Update service operation (NWDAF registration ID, added or removed Analytics ID(s)), see TS 29.503 [22] clause 5.3.2.6.4. Figure 5.8.3.2.2-1 illustrates the signalling flow.

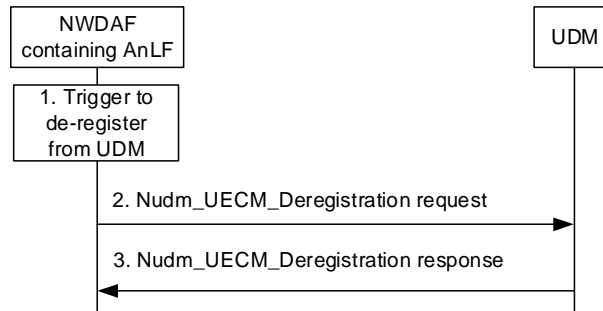

**Figure 5.8.3.2.2-1: NWDAF containing AnLF registration update in UDM**

1. If an NWDAF containing AnLF has previously registered one or more Analytics IDs for a UE in UDM, the NWDAF containing AnLF triggers an update of the registration in UDM, e.g. based on the NWDAF containing AnLF serving the UE of one or more additional Analytic ID(s) or based on the NWDAF containing AnLF not serving the UE for one or more Analytic ID(s) but serving the UE for at least one Analytic ID.
2. The NWDAF containing AnLF updates its registration in UDM for the served UE, by sending Nudm\_UECM\_Update request (NWDAF Registration Id, added or removed Analytic ID(s)).
3. Upon success UDM sends a "204 No Content" response to the NWDAF containing AnLF. If the operation is unsuccessful, UDM responds with proper error response code. See TS 29.503 [22] for details.

### 5.8.3.2.3 NWDAF containing AnLF De-Registration in UDM

If an NWDAF containing AnLF has previously registered in UDM for one or more analytics ID for a given UE, when the NWDAF containing AnLF no longer serves the UE, e.g., it does not collect data for the UE for that Analytics ID or does not keep produce analytic reports or does not keep any data related to the UE, the NWDAF containing AnLF should de-register from UDM by invoking the Nudm\_UECM\_Deregistration service operation (NWDAF registration ID, Analytics ID(s)), see TS 29.503 [22] clause 5.3.2.4.8). Figure 5.8.3.2.3-1 illustrates the signalling flow.

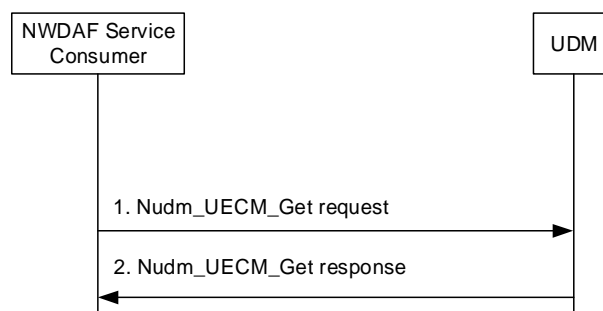

**Figure 5.8.3.2.3-1: NWDAF containing AnLF deregistration from UDM**

1. If an NWDAF containing AnLF has previously registered one or more Analytics IDs for a UE in UDM, the NWDAF containing AnLF triggers a complete deregistration from UDM, e.g. based on the NWDAF containing AnLF not collecting data any longer for the UE, or the NWDAF containing AnLF not producing analytics reports for the UE, or the NWDAF containing AnLF not keeping analytics data for the UE.
2. The NWDAF containing AnLF deregisters from UDM for the served UE, by sending Nudm\_UECM\_Deregistration request (NWDAF Registration Id).
3. UDM sends a "204 No Content" response to the NWDAF containing AnLF. See TS 29.503 [22] for details.

### 5.8.3.3 Consumer discovery and selection of NWDAF containing AnLF in UDM

For UE related analytics, if the NWDAF service consumer needs to discover an NWDAF containing AnLF that is serving or holds data for a UE, the NWDAF serving consumer may query UDM with the target SUPI and the Analytics ID. If the response from UDM indicates multiple candidate NWDAFs, the NWDAF service consumer may, e.g., determine an instance of an NWDAF containing AnLF that has registered in UDM (registrationTime attribute) around the time of interest of the data or analytics, and may also query NRF, as specified in clause 5.8.2.3 in order to determine the capabilities of these NWDAFs and select the most appropriate one. Figure 5.8.3.3-1 illustrates the signalling flow.



**Figure 5.8.3.3-1: Discovery of NWDAF containing AnLF in UDM**

1. The NWDAF service consumer sends an Nudm\_UECM\_Get request to the UDM (UE ID, Analytics ID(s), NF type = NWDAF).
2. Upon success, UDM sends a "200 OK" response to the service consumer including the NWDAF information registered for the UE ID. If the operation is unsuccessful, UDM responds with proper error response code. See TS 29.503 [22] for details.

## 5.8.4 Procedures for PCF learning NWDAF IDs for served UEs

PCF may receive from AMF and SMF the IDs of the NWDAFs containing AnLF that are used by AMF, SMF, and UPF, so that the PCF may select the same NWDAF containing AnLF being used for a specific UE.

When the AMF creates or updates an Access and Mobility Policy Association for a UE, the AMF may include the IDs of the NWDAF containing AnLF that are used by the AMF, along with their Analytic ID(s), in the Npcf\_AMPolicyControl\_Create/Update service operations, as illustrated in Figure 5.8.4-1. See details in TS 29.507 [24].

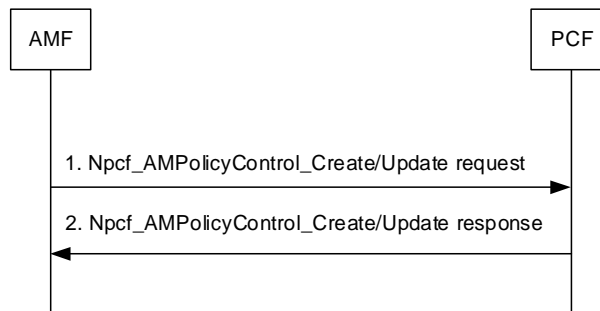

**Figure 5.8.4-1: PCF leaning from AMF NWDAFs containing AnLF**

The PCF may select those NWDAF instances discovered through the Npcf\_AMPolicyControl\_Create/Update request as the ones to use for their associated analytic ID(s) for the UE for which those AM Policy Associations are related to.

When the SMF creates or updates a Session Management Policy Association for a UE, the SMF may include the IDs of the NWDAF containing AnLF that are used by the SMF and UPF, along with their Analytic ID(s), in the Npcf\_SMPolicyControl\_Create/Update service operations, as illustrated in Figure 5.8.4-2. See details in TS 29.512 [25].

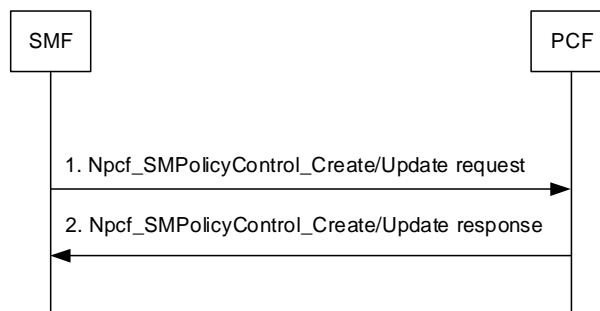

**Figure 5.8.4-2: PCF leaning from SMF and UPF NWDAFs containing AnLF**

The PCF may select those NWDAF instances discovered through the Npcf\_SMPolicyControl\_Create/Update request as the ones to subscribe for their associated analytic ID(s) for the UE for which those SM Policy Associations are related to.

## 5.9 Analytics Data Repository procedures

### 5.9.1 General

The Analytics Data Repository procedures allow the NF service consumers (e.g. NWDAF, DCCF or MFAF) to store, retrieve or delete collected data and analytics in the ADRF.

### 5.9.2 Historical Data and Analytics Storage/Retrieval/Deletion procedure

The procedure is used by an NF service consumer (e.g. NWDAF, DCCF or MFAF) to store, retrieve or delete historical data and/or analytics, i.e. data and/or analytics related to past time period that has been obtained by the consumer.

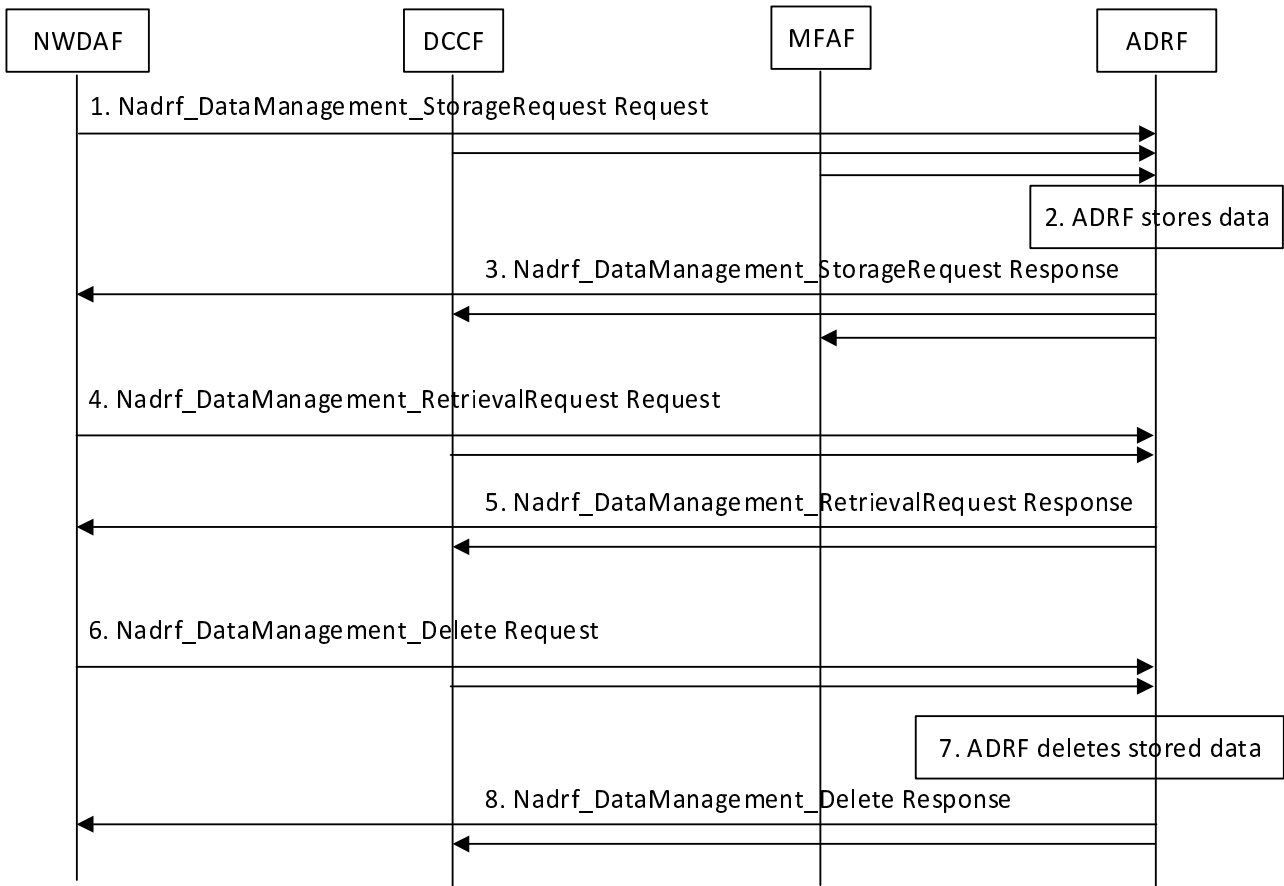

**Figure 5.9.2-1: Historical Data and Analytics storage/deletion procedure**

1. In order to store data or analytics, the NF service consumer invokes Nadrif\_DataManagement\_StorageRequest service operation by sending an HTTP POST request targeting the resource "ADRF Data Store Records" in clause 4.2.2.2 of 3GPP TS 29.575 [16]. The request shall include one of the analytics subscription notification(s), network exposure function event exposure subscription notification(s), application function event exposure subscription notification(s), access and mobility function event exposure subscription notification(s), session management function event exposure subscription notification(s), or unified data management event exposure subscription notification(s).
2. The ADRF stores the data or analytics sent by the consumer. The ADRF may, based on implementation, determines whether the same data or analytics is already stored or being stored based on the information sent in step 1 by the consumer and, if the data or analytics is already stored or being stored in the ADRF, the ADRF decides to not store again the data or analytics sent by the consumer.
3. If the data or analytics is stored, the ADRF sends Nadrif\_DataManagement\_StorageRequest Response message to the consumer with HTTP "201 Created" status code including a representation of the created record.
4. In order to retrieve the stored data or analytics from the ADRF, the NF service consumer shall invoke the Nadrif\_DataManagement\_RetrievalRequest service operation by sending an HTTP GET request targeting the resource "ADRF Data Store Records" as described in clause 4.2.2.5 of 3GPP TS 29.575 [16]. The request shall include fetch correlation identifier(s), or the query parameter value of subscription information. In addition, the start time and stop time during which requested data is collected or is to be collected shall be provided if the request has been performed based on subscription information.
5. If the requested data is found, the ADRF sends Nadrif\_DataManagement\_RetrievalRequest Response message to the consumer with HTTP "200 OK" status code including a representation of the matched record.

6. In order to delete the specified data or analytics from the ADRF, the NF service consumer shall invoke the Ndrf\_DataManagement\_Delete service operation by sending an HTTP DELETE request targeting the resource "Individual ADRF Data Store Record" as described in clause 4.2.2.9 of 3GPP TS 29.575 [16] if the NF service consumer delete the resource including the transaction identifier, or by sending an HTTP POST request including the time window in which the data to be deleted was collected and data or analytics specification.
7. The ADRF deletes the specified stored data or analytics requested by the consumer.
8. If the deletion is successfully processed, the ADRF sends Ndrf\_DataManagement\_Delete Response message to the consumer with HTTP "204 No Content" status code.

### 5.9.3 Historical Data and Analytics Storage via Notifications

The procedure is used by an NF service consumer (e.g. NWDAF, DCCF) to store received notifications in the ADRF.

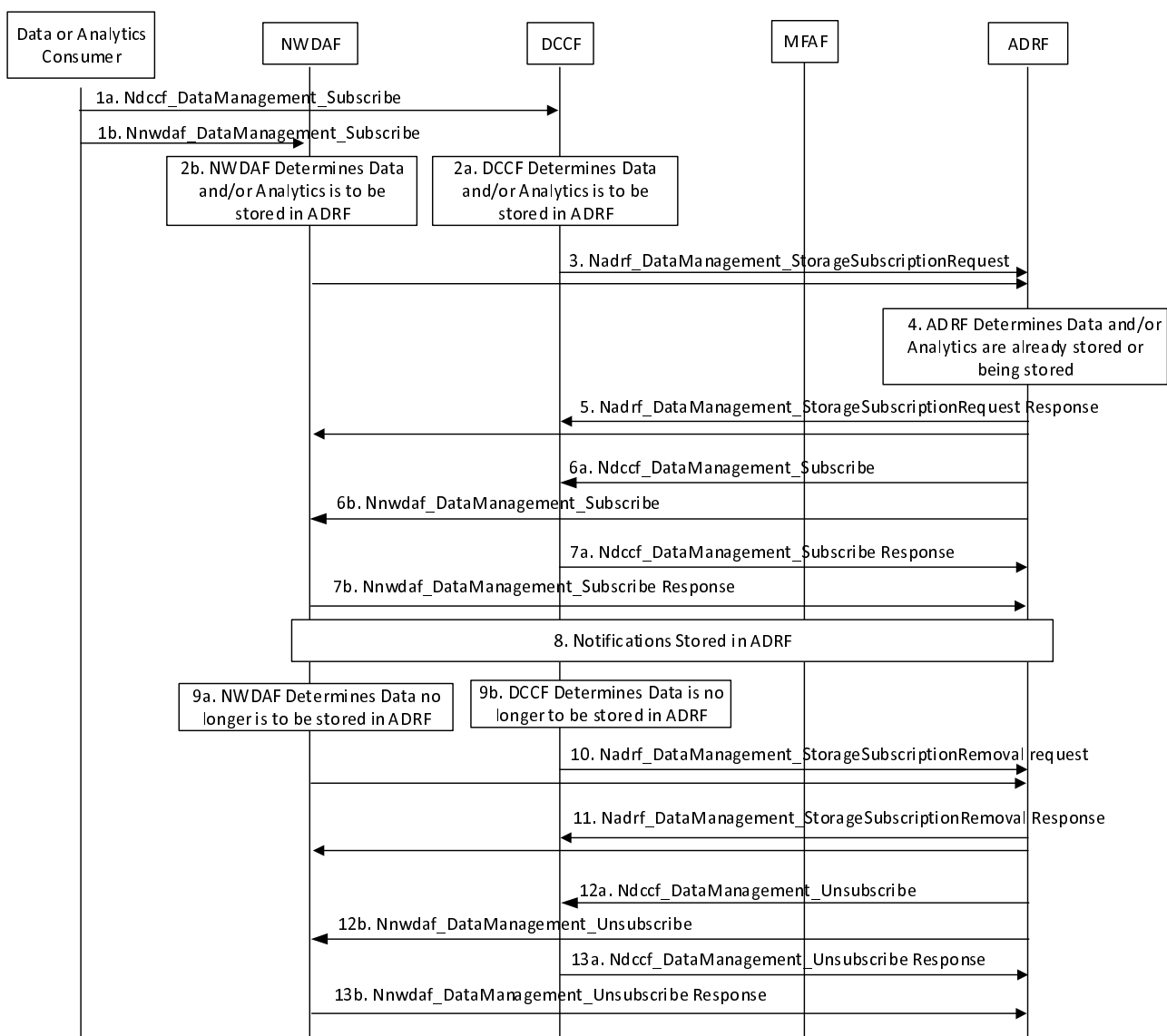

**Figure 5.9.3-1: Historical Data and Analytics storage/deletion procedure**

1-2. Based on provisioning or based on reception of a DataManagement subscription request (e.g. see clause 5.5.3.1), the NF service consumer (e.g. DCCF or NWDAF) determines that notifications are to be stored in the ADRF.

3. The NF service consumer invokes Ndrf\_DataManagement\_StorageSubscriptionRequest service operation by sending an HTTP POST request in clause 4.2.2.3 of 3GPP TS 29.575 [16]. The request shall include one of the analytics subscription information, network exposure function event exposure subscription information, application function event exposure subscription information, access and mobility function event exposure subscription information, session management function event exposure subscription information, or unified data management event exposure subscription information, and one of the target identifiers, and may include the formatting instructions and/or processing instructions.
4. The ADRF may, based on implementation, determines whether the same data or analytics is already stored or being stored based on the information sent in step 3 by the consumer.
5. If the request is successfully processed and accepted, the ADRF sends Ndrf\_DataManagement\_StorageSubscriptionRequest Response message to the consumer with HTTP "200 OK" status code including a transaction reference identifier. If the data and/or analytics is already stored or being stored in the ADRF, the ADRF sends Ndrf\_DataManagement\_StorageSubscriptionRequest Response message to the consumer indicating that data or analytics is stored.
- 6a. ADRF invokes Ndccf\_DataManagement\_Subscribe service operation to subscribe to the DCCF to receive notifications by sending an HTTP POST request message targeting the resource "DCCF Analytics Subscriptions", the HTTP POST message shall include notification endpoint address and a notification correlation ID as defined in clause 5.1.6.2.2 of 3GPP TS 29.574 [15].
- 6b. ADRF invokes NnwdaF\_DataManagement\_Subscribe service operation to subscribe to the NWDAF to receive notifications by sending an HTTP POST request message targeting the resource "NWDAF Data Management Subscriptions", the HTTP POST message shall include notification endpoint address and a notification correlation ID as defined in clause 4.4.2.2 of 3GPP TS 29.520 [5].
- 7a If the Subscription is successfully processed and accepted, the DCCF sends Ndccf\_DataManagement\_Subscribe Response message to the consumer with HTTP "201 Created" status code with the message body containing a representation of the created subscription.
- 7b If the Subscription is successfully processed and accepted, the NWDAF sends NnwdaF\_DataManagement\_Subscribe Response message to the consumer with HTTP "201 Created" status code with the message body containing a representation of the created subscription.
8. The NF service consumer (e.g. DCCF, MFAF or NWDAF) sends Analytics or Data notifications containing the notification correlation ID provided by the ADRF to ADRF notification endpoint address when the historical analytics data are available.

If the NWDAF is the service consumer in step 7, the NWDAF invokes NnwdaF\_DataManagement\_Notify service operation as defined in clause 4.4.2.4 of 3GPP TS 29.520 [5]. The ADRF stores the notifications and responses to the NnwdaF\_DataManagement\_Notify service operation with HTTP "204 No Content" status code.

If the DCCF is used for data collection in step 7, the DCCF invokes Ndccf\_DataManagement\_Notify service operation as defined in clause 4.2.2.4 of 3GPP TS 29.574 [15]. The ADRF stores the notifications and responses to the Ndccf\_DataManagement\_Notify service operation with HTTP "204 No Content" status code.

If the Messaging Framework is used for data collection in step 7, the procedure defined in clause 5.5.3.2 is applicable.

9. The NF service consumer determines that notifications no longer need to be stored in the ADRF.
10. In order to request the ADRF to delete the specified data or analytics subscription, the NF service consumer shall invoke the Ndrf\_DataManagement\_StorageSubscriptionRemoval service operation by sending an HTTP POST request as described in clause 4.2.2.4 of 3GPP TS 29.575 [16], including the transaction reference identifier.
11. If the deletion is successful processed, the ADRF sends Ndrf\_DataManagement\_StorageSubscriptionRemoval Response message with HTTP "204 No Content" status code to the consumer.
- 12a. ADRF invokes Ndccf\_DataManagement\_Unsubscribe service operation to subscribe to the DCCF to receive notifications by sending an HTTP DELETE request message targeting the resource "Individual DCCF Analytics Subscription", the HTTP URI shall include identifier of the existing analytics subscription that is to be deleted as defined in clause 4.2.2.3.2 of 3GPP TS 29.574 [15].



- 12b. ADRF invokes Nnwdaq\_DataManagement\_Unsubscribe service operation to subscribe to the NWDAF to receive notifications by sending an HTTP DELETE request message targeting the resource "Individual NWDAF Data Management Subscription", the HTTP DELETE URI shall include identifier of the existing analytics subscription that is to be deleted as defined in clause 4.4.2.3.2 of 3GPP TS 29.520 [5].
- 13a If the removal of the corresponding subscription is successfully processed and accepted, the DCCF sends Ndcdf\_DataManagement\_Unsubscribe Response message to the consumer with HTTP "204 No Content" status code.
- 13b If the removal of the corresponding subscription is successfully processed and accepted, the NWDAF sends Nnwdaq\_DataManagement\_Unsubscribe Response message to the consumer with HTTP "204 No Content" status code.

## Annex A (informative): Change history

Change history							
Date	Meeting	TDoc	CR	Rev	Cat	Subject/Comment	New version
2021-04	CT3#115e					TS skeleton for TS 29.552.	0.0.0
2021-04	CT3#115e					Inclusion of documents agreed in CT3#115e: C3-212120, C3-212389	0.1.0
2021-05	CT3#116e					Inclusion of document agreed in CT3#116e: C3-213373	0.2.0
2021-08	CT3#117e					Inclusion of document agreed in CT3#117e: C3-214475, C3-214476, C3-214162	0.3.0
2021-10	CT3#118e					Inclusion of document agreed in CT3#118e: C3-215481, C3-215482, C3-215220, C3-215221.	0.4.0
2021-11	CT3#119e					Inclusion of document agreed in CT3#119e: C3-216463, C3-216428, C3-216241, C3-216242, C3-216243, C3-216244, C3-216464	0.5.0
2022-01	CT3#119bis-e					Inclusion of document agreed in CT3#119bis-e: C3-220495, C3-220356, C3-220090, C3-220091, C3-220336, C3-220332, C3-220333, C3-220357, C3-220358, C3-220338.	0.6.0
2022-02	CT3#120e					Inclusion of document agreed in CT3#120e: C3-221470, C3-221477, C3-221481, C3-221622, C3-221623, C3-221624, C3-221625, C3-221591, C3-221285, C3-221680, C3-221296, C3-221683, C3-221685.	0.7.0
2022-03	CT#95e	CP-220158				Presentation to TSG CT for approval	1.0.0
2022-03	CT#95e	CP-220158				Approved by TSG CT	17.0.0
2022-06	CT#96	CP-221132	0001	1	F	Adding "Prepared analytics subscription transfer" signalling flows.	17.1.0
2022-06	CT#96	CP-221131	0002	1	F	Correction Nnwdaf_MLModelProvision Service notification	17.1.0
2022-06	CT#96	CP-221132	0003	1	B	Update procedure for Analytics Exposure via DCCF	17.1.0
2022-06	CT#96	CP-221130	0004	1	B	Update Data Collection Reference Architecture	17.1.0
2022-06	CT#96	CP-221130	0005	1	B	Update Analytics Exposure Reference Architecture	17.1.0
2022-06	CT#96	CP-221130	0006	1	B	Resolve editor's note in Analytics Exposure via DCCF	17.1.0
2022-06	CT#96	CP-221130	0007	1	B	Resolve editor's note in Analytics Exposure via DCCF and MFAF	17.1.0
2022-06	CT#96	CP-221132	0010	1	F	Update Analytics Exposure via DCCF	17.1.0
2022-06	CT#96	CP-221132	0011	1	F	Update Analytics Exposure via DCCF and MFAF	17.1.0
2022-06	CT#96	CP-221133	0012	1	F	Update Analytics context transfer initiated by target NWDAF	17.1.0
2022-06	CT#96	CP-221133	0013	1	F	Update Analytics aggregation with provisioning of Area of Interest	17.1.0
2022-06	CT#96	CP-221132	0014	1	F	Update Data Collection via DCCF	17.1.0
2022-06	CT#96	CP-221132	0015	1	F	Update Data Collection via Messaging Framework	17.1.0
2022-06	CT#96	CP-221132	0016	1	B	SMCCE analytics supports Nnwdaf_EventsSubscription_Subscribe service operation	17.1.0
2022-06	CT#96	CP-221130	0017		B	Remove the redundant description for discovery and selection of NWDAF containing AnLF	17.1.0
2022-06	CT#96	CP-221131	0018	1	B	Introducing the Analytics Data Repository procedures	17.1.0
2022-06	CT#96	CP-221136	0020	1	F	Update of transferring ML model during analytics transfer	17.1.0
2022-06	CT#96	CP-221134	0021		B	Remove the ENs about when the DCCF sends the response to the consumer	17.1.0
2022-06	CT#96	CP-221135	0022	1	B	Update the Analytics context transfer and Analytics Subscription transfer	17.1.0
2022-06	CT#96	CP-221135	0023	1	F	Correction to Analytics context transfer initiated by target NWDAF	17.1.0
2022-09	CT#97e	CP-222103	0025	1	F	Remove EN about using Ndrf_DataManagement_RetrievalRequest in DCCF procedures	17.2.0
2022-09	CT#97e	CP-222102	0026	1	F	Add NSACF to the data source list of the NWDAF	17.2.0
2022-09	CT#97e	CP-222102	0027	1	F	Support prepared analytics subscription transfer	17.2.0
2022-09	CT#97e	CP-222102	0030	1	F	Update the content of Ndrf_DataManagement_RetrievalNotify	17.2.0
2022-12	CT#98e	CP-223173	0031	1	F	User consent corrections in data collection procedures	17.3.0
2022-12	CT#98e	CP-223172	0037		F	Update historical data and analytics storage via Notifications	17.3.0
2023-03	CT#99	CP-230146	0042	2	F	Update for Analytics Exposure via DCCF procedure	17.4.0

---

# History

<b>Document history</b>		
V17.0.0	May 2022	Publication
V17.1.0	July 2022	Publication
V17.2.0	September 2022	Publication
V17.3.0	January 2023	Publication
V17.4.0	April 2023	Publication