

ETSI TS 129 561 V15.3.0 (2019-10)



**5G;
5G System;
Interworking between 5G Network and external Data Networks;
Stage 3
(3GPP TS 29.561 version 15.3.0 Release 15)**



Reference

RTS/TSGC-0329561vf30

Keywords

5G

ETSI

650 Route des Lucioles
F-06921 Sophia Antipolis Cedex - FRANCE

Tel.: +33 4 92 94 42 00 Fax: +33 4 93 65 47 16

Siret N° 348 623 562 00017 - NAF 742 C
Association à but non lucratif enregistrée à la
Sous-Préfecture de Grasse (06) N° 7803/88

Important notice

The present document can be downloaded from:

<http://www.etsi.org/standards-search>

The present document may be made available in electronic versions and/or in print. The content of any electronic and/or print versions of the present document shall not be modified without the prior written authorization of ETSI. In case of any existing or perceived difference in contents between such versions and/or in print, the prevailing version of an ETSI deliverable is the one made publicly available in PDF format at www.etsi.org/deliver.

Users of the present document should be aware that the document may be subject to revision or change of status.

Information on the current status of this and other ETSI documents is available at

<https://portal.etsi.org/TB/ETSIDeliverableStatus.aspx>

If you find errors in the present document, please send your comment to one of the following services:

<https://portal.etsi.org/People/CommiteeSupportStaff.aspx>

Copyright Notification

No part may be reproduced or utilized in any form or by any means, electronic or mechanical, including photocopying and microfilm except as authorized by written permission of ETSI.

The content of the PDF version shall not be modified without the written authorization of ETSI.

The copyright and the foregoing restriction extend to reproduction in all media.

© ETSI 2019.

All rights reserved.

DECT™, **PLUGTESTS™**, **UMTS™** and the ETSI logo are trademarks of ETSI registered for the benefit of its Members.

3GPP™ and **LTE™** are trademarks of ETSI registered for the benefit of its Members and of the 3GPP Organizational Partners.

oneM2M™ logo is a trademark of ETSI registered for the benefit of its Members and of the oneM2M Partners.

GSM® and the GSM logo are trademarks registered and owned by the GSM Association.

Intellectual Property Rights

Essential patents

IPRs essential or potentially essential to normative deliverables may have been declared to ETSI. The information pertaining to these essential IPRs, if any, is publicly available for **ETSI members and non-members**, and can be found in ETSI SR 000 314: "*Intellectual Property Rights (IPRs); Essential, or potentially Essential, IPRs notified to ETSI in respect of ETSI standards*", which is available from the ETSI Secretariat. Latest updates are available on the ETSI Web server (<https://ipr.etsi.org/>).

Pursuant to the ETSI IPR Policy, no investigation, including IPR searches, has been carried out by ETSI. No guarantee can be given as to the existence of other IPRs not referenced in ETSI SR 000 314 (or the updates on the ETSI Web server) which are, or may be, or may become, essential to the present document.

Trademarks

The present document may include trademarks and/or tradenames which are asserted and/or registered by their owners. ETSI claims no ownership of these except for any which are indicated as being the property of ETSI, and conveys no right to use or reproduce any trademark and/or tradename. Mention of those trademarks in the present document does not constitute an endorsement by ETSI of products, services or organizations associated with those trademarks.

Legal Notice

This Technical Specification (TS) has been produced by ETSI 3rd Generation Partnership Project (3GPP).

The present document may refer to technical specifications or reports using their 3GPP identities. These shall be interpreted as being references to the corresponding ETSI deliverables.

The cross reference between 3GPP and ETSI identities can be found under <http://webapp.etsi.org/key/queryform.asp>.

Modal verbs terminology

In the present document "**shall**", "**shall not**", "**should**", "**should not**", "**may**", "**need not**", "**will**", "**will not**", "**can**" and "**cannot**" are to be interpreted as described in clause 3.2 of the [ETSI Drafting Rules](#) (Verbal forms for the expression of provisions).

"**must**" and "**must not**" are **NOT** allowed in ETSI deliverables except when used in direct citation.

Contents

Intellectual Property Rights	2
Legal Notice	2
Modal verbs terminology.....	2
Foreword.....	5
1 Scope	6
2 References	6
3 Definitions and abbreviations.....	7
3.1 Definitions	7
3.2 Abbreviations	8
4 Network Characteristics	8
4.1 Key characteristics of PLMN	8
4.2 Key characteristics of IP Networks	8
4.3 Key characteristics of Ethernet.....	8
5 Interworking Classifications.....	8
5.1 Service Interworking	8
5.2 Network Interworking	8
6 Reference Architecture.....	9
7 Interface to 5G Network services (User Plane).....	9
8 Interworking with DN (IP)	9
8.1 General	9
8.2 DN Interworking Model	9
8.2.1 General.....	9
8.2.2 Access to DN through 5G Network	10
8.2.2.1 Transparent access to DN.....	10
8.2.2.2 IPv4 Non-transparent access to DN	11
8.2.2.3 IPv6 Non-transparent access to DN	12
9 Interworking with DN (Unstructured).....	13
9.1 General	13
9.2 N6 PtP tunnelling based on UDP/IP.....	13
9.3 Other N6 tunnelling mechanism.....	15
10 Interworking with DN (DHCP).....	15
10.1 General	15
10.2 DN interworking Model of SMF for DHCP.....	15
10.2.1 Introduction.....	15
10.2.2 IPv4 Address allocation and IPv4 parameter configuration via DHCPv4	16
10.2.3 IPv6 Prefix allocation via IPv6 stateless address autoconfiguration via DHCPv6	17
10.2.4 IPv6 parameter configuration via stateless DHCPv6.....	19
11 Interworking with DN (RADIUS).....	19
11.1 RADIUS procedures.....	19
11.1.1 RADIUS Authentication and Authorization	19
11.1.2 RADIUS Accounting	20
11.2 Message flows on N6 interface	21
11.2.1 Authentication, Authorization and Accounting procedures	21
11.2.2 Accounting Update	23
11.2.3 DN-AAA initiated QoS flow termination.....	24
11.2.4 DN-AAA initiated re-authorization	25
11.3 List of RADIUS attributes.....	25
11.3.1 General.....	25
11.3.2 Change-of-Authorization Request (optionally sent from DN-AAA server to SMF)	32

11.3.3	Access-Challenge (sent from DN-AAA server to SMF)	33
12	Interworking with DN (Diameter).....	33
12.1	Diameter Procedures	33
12.1.1	Diameter Authentication and Authorization	33
12.1.2	Diameter Accounting.....	34
12.2	Message flows on N6 interface	35
12.2.1	Authentication, Authorization and Accounting procedures	35
12.2.2	Accounting Update	37
12.2.3	DN-AAA initiated QoS flow termination.....	38
12.2.4	DN-AAA initiated re-authorization	38
12.3	N6 specific AVPs	39
12.4	N6 re-used AVPs.....	39
12.4.0	General.....	39
12.4.1	Use of the Supported-Features AVP on the N6 reference point	42
12.5	N6 specific Experimental-Result-Code AVP	43
12.6	N6 Diameter messages	43
12.6.1	General.....	43
12.6.2	DER Command.....	44
12.6.3	DEA Command	45
12.6.4	RAR Command	46
12.6.5	RAA Command	46
13	Interworking with IMS	47
13.1	General	47
13.2	IMS interworking Model.....	47
13.2.1	Introduction.....	47
13.2.2	IMS specific configuration in the SMF.....	47
13.2.3	IMS specific procedures in the SMF	48
13.2.3.1	Provisioning of Signalling Server Address	48
13.2.3.2	Failure of Signalling Server Address	48
14	Interworking with DN (Ethernet).....	48
Annex A (informative): Change history		50
History		51

Foreword

This Technical Specification has been produced by the 3rd Generation Partnership Project (3GPP).

The contents of the present document are subject to continuing work within the TSG and may change following formal TSG approval. Should the TSG modify the contents of the present document, it will be re-released by the TSG with an identifying change of release date and an increase in version number as follows:

Version x.y.z

where:

- x the first digit:
 - 1 presented to TSG for information;
 - 2 presented to TSG for approval;
 - 3 or greater indicates TSG approved document under change control.
- y the second digit is incremented for all changes of substance, i.e. technical enhancements, corrections, updates, etc.
- z the third digit is incremented when editorial only changes have been incorporated in the document.

1 Scope

The present specification defines the stage 3 interworking procedures for 5G Network interworking between PLMN and external DN.

The stage 2 requirements and procedures are contained in 3GPP TS 23.501 [2] and 3GPP TS 23.502 [3].

For interworking between 5G PLMN and external DNs, the present document is valid for both 3GPP accesses and non-3GPP accesses.

2 References

The following documents contain provisions which, through reference in this text, constitute provisions of the present document.

- References are either specific (identified by date of publication, edition number, version number, etc.) or non-specific.
- For a specific reference, subsequent revisions do not apply.
- For a non-specific reference, the latest version applies. In the case of a reference to a 3GPP document (including a GSM document), a non-specific reference implicitly refers to the latest version of that document *in the same Release as the present document*.

- [1] 3GPP TR 21.905: "Vocabulary for 3GPP Specifications".
- [2] 3GPP TS 23.501: "System Architecture for the 5G System; Stage 2".
- [3] 3GPP TS 23.502: "Procedures for the 5G System; Stage 2".
- [4] 3GPP TS 29.281: "General Packet Radio System (GPRS) Tunnelling Protocol User Plane (GTPv1-U)".
- [5] 3GPP TS 29.061: "Interworking between the Public Land Mobile Network (PLMN) supporting packet based services and Packet Data Networks (PDN)".
- [6] IETF RFC 3748: "Extensible Authentication Protocol (EAP)".
- [7] IETF RFC 3579: "RADIUS (Remote Authentication Dial In User Service) Support For Extensible Authentication Protocol (EAP)".
- [8] IETF RFC 2865: "Remote Authentication Dial In User Service (RADIUS)".
- [9] IETF RFC 3162: "RADIUS and IPv6".
- [10] IETF RFC 4818: "RADIUS Delegated-IPv6-Prefix Attribute".
- [11] IETF RFC 5216: "The EAP-TLS Authentication Protocol".
- [12] 3GPP TS 23.228: "IP Multimedia Subsystem (IMS); Stage 2".
- [13] 3GPP TS 24.229: "IP Multimedia Call Control Protocol based on SIP and SDP; Stage 3".
- [14] IETF RFC 2132: "DHCP Options and BOOTP Vendor Extensions".
- [15] IETF RFC 3361: "Dynamic Host Configuration Protocol (DHCP-for-IPv4) Option for Session Initiation Protocol (SIP) Servers".
- [16] IETF RFC 3646: "DNS Configuration options for Dynamic Host Configuration Protocol for IPv6 (DHCPv6)".
- [17] IETF RFC 3319: "Dynamic Host Configuration Protocol (DHCPv6) Options for Session Initiation Protocol (SIP) Servers".

- [18] IETF RFC 2131: "Dynamic Host Configuration Protocol".
- [19] IETF RFC 1542: "Clarification and Extensions for the Bootstrap Protocol".
- [20] IETF RFC 4039: "Rapid Commit Option for the Dynamic Host Configuration Protocol version 4 (DHCPv4)".
- [21] IETF RFC 3315: "Dynamic Host Configuration Protocol for IPv6 (DHCPv6)".
- [22] IETF RFC 3736: "Stateless Dynamic Host Configuration Protocol (DHCP) Service for IPv6".
- [23] IETF RFC 7155: "Diameter Network Access Server Application".
- [24] IETF RFC 6733: "Diameter Base Protocol".
- [25] IETF RFC 4072: "Diameter Extensible Authentication Protocol (EAP) Application".
- [26] IETF RFC 2866: "RADIUS Accounting".
- [27] IETF RFC 5176: "Dynamic Authorization Extensions to Remote Authentication Dial In User Service (RADIUS)".
- [28] 3GPP TS 23.003: "Numbering, addressing and identification".
- [29] IETF RFC 1825: "Security Architecture for the Internet Protocol".
- [30] IETF RFC 1826: "IP Authentication Header".
- [31] IETF RFC 1827: "IP Encapsulating Security Payload (ESP)".
- [32] IETF RFC 4291: "IP Version 6 Addressing Architecture".
- [33] IETF RFC 4861: "Neighbor Discovery for IP Version 6 (IPv6)".
- [34] IETF RFC 4862: "IPv6 Stateless Address Autoconfiguration".
- [35] IETF RFC 1027: "Using ARP to Implement Transparent Subnet Gateways".
- [36] 802.3-2015 - IEEE Standard for Ethernet.
- [37] IETF RFC 5281: "Extensible Authentication Protocol Tunneled Transport Layer Security Authenticated Protocol Version 0 (EAP-TTLSv0)".
- [38] 3GPP TS 23.380: "IMS Restoration Procedures".
- [39] 3GPP TS 29.571: "5G System; Common Data Types for Service Based Interfaces; Stage 3".
- [40] 3GPP TS 29.502: "5G System; Session Management Services; Stage 3".
- [41] 3GPP TS 29.229: "Cx and Dx interfaces based on Diameter protocol; Protocol details".

3 Definitions and abbreviations

3.1 Definitions

For the purposes of the present document, the terms and definitions given in 3GPP TR 21.905 [1] and the following apply. A term defined in the present document takes precedence over the definition of the same term, if any, in 3GPP TR 21.905 [1].

3.2 Abbreviations

For the purposes of the present document, the abbreviations given in 3GPP TR 21.905 [1] and the following apply. An abbreviation defined in the present document takes precedence over the definition of the same abbreviation, if any, in 3GPP TR 21.905 [1].

CSMA/CD	Carrier Sense Multiple Access/Collision Detection
DHCPv4	Dynamic Host Configuration Protocol version 4
DHCPv6	Dynamic Host Configuration Protocol version 6
DN	Data Network
GPSI	Generic Public Subscription Identifier
N3IWF	Non-3GPP InterWorking Function
PtP	Point-to-Point
SFD	Start Frame Delimiter
SMF	Session Management Function
SSC	Session and Service Continuity
UPF	User Plane Function
WAN	Wide Area Network

4 Network Characteristics

4.1 Key characteristics of PLMN

The PLMN is fully defined in the 3GPP technical specifications. The 5G Network related key characteristics are defined in 3GPP TS 23.501 [2].

4.2 Key characteristics of IP Networks

The Internet is a conglomeration of networks utilising a common set of protocols. IP protocols are defined in the relevant IETF RFCs. The networks topologies may be based on LANs (e.g. Ethernet), Point to Point leased lines, PSTN, ISDN, X.25 or WANs using switched technology (e.g. SMDS, ATM).

4.3 Key characteristics of Ethernet

The Ethernet is a family of computer networking technologies commonly used in LAN and is often used to refer to all Carrier Sense Multiple Access/Collision Detection (CSMA/CD) LANs that generally conform to Ethernet Specifications, including IEEE 802.3 [36]. The key characteristics for Ethernet are defined in IEEE 802.3 [36].

5 Interworking Classifications

5.1 Service Interworking

Service interworking is required when the Teleservice at the calling and called terminals are different. No service interworking is specified in this specification.

5.2 Network Interworking

Network interworking is required whenever a PLMN is involved in communications with another network to provide end-to-end communications. The PLMN shall interconnect in a manner consistent with that of a normal Data Network (type defined by the requirements e.g. IP). Interworking appears exactly like that of Data Networks.

6 Reference Architecture

Figure 6-1 shows the access interfaces for the 5G Network. The 5G Network includes both the 3GPP access and the non-3GPP access.

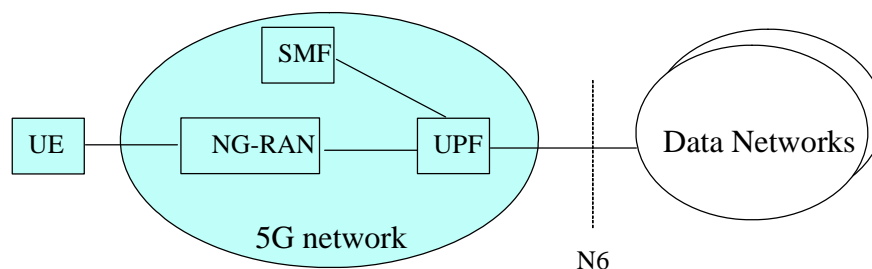

Figure 6-1: Reference Architecture for 5G Network Interworking

7 Interface to 5G Network services (User Plane)

The user plane for 5G Network services is defined in subclause 8.3 of 3GPP TS 23.501 [2] and 3GPP TS 29.281 [4].

8 Interworking with DN (IP)

8.1 General

5GS shall support interworking with DNs based on the Internet Protocol (IP). These interworked networks may be either intranets or the Internet.

8.2 DN Interworking Model

8.2.1 General

When interworking with the IP networks, the 5GS can operate IPv4 and/or IPv6. The interworking point is shown in clause 6.

The UPF for interworking with the IP network is the 5GS access point (see figure 8.2.1-1).

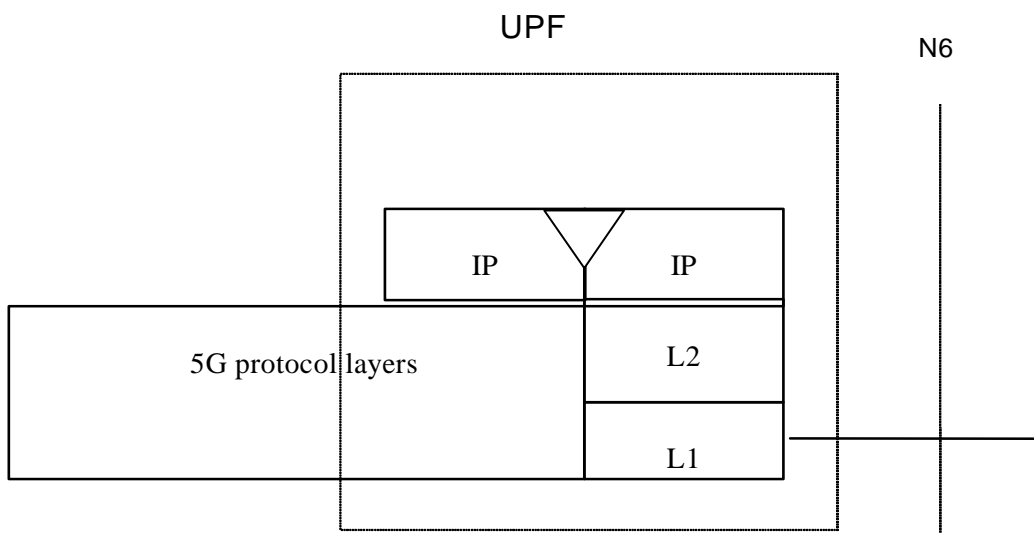

Figure 8.2.1-1: The protocol stacks of UPF for the IP network interworking

Typically, in the IP networks, the interworking with subnetworks is done via IP routers. The N6 reference point is between the UPF and the external IP network. From the external IP network's point of view, the UPF is seen as a normal IP router. The L2 and L1 layers are operator specific.

It is out of the scope of the present document to standardise the router functions and the used protocols in the N6 reference point.

Interworking with user defined ISPs and private/public IP networks is subject to interconnect agreements between the network operators.

8.2.2 Access to DN through 5G Network

8.2.2.1 Transparent access to DN

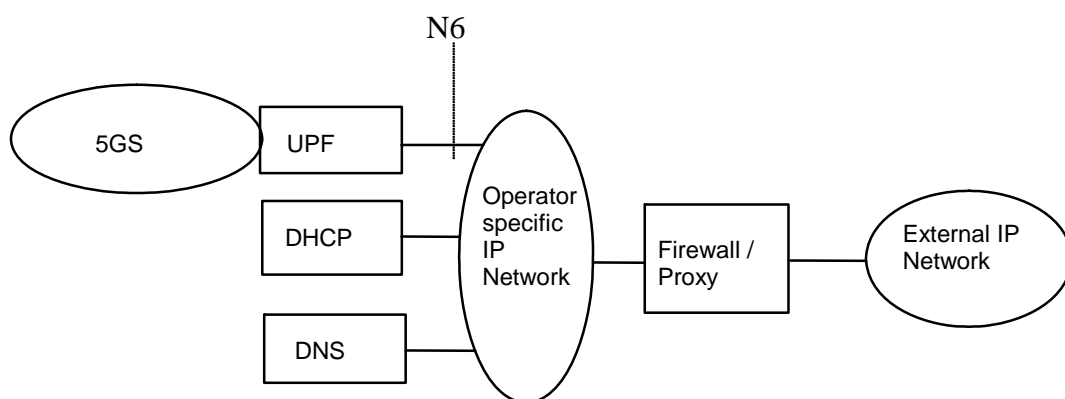

Figure 8.2.2.1-1: Example of the DN Interworking Model, transparent case

In figure 8.2.2.1-1, an example DN interworking model for transparent access to the Internet is provided for an UPF in the 5GS and its N6 reference point.

In transparent access to the Internet case:

- the UE is given an IPv4 address and/or an IPv6 prefix belonging to the operator addressing space. The IPv4 address and/or IPv6 prefix is assigned either at subscription in which case it is a static address or at PDU session establishment in which case it is a dynamic address. This IPv4 address and/or IPv6 prefix if applicable is used for packet forwarding between the Internet and the UPF and within the 5GS. With IPv6, Stateless Address Autoconfiguration shall be used to assign an IPv6 address to the UE. These procedures are as described in the IPv6 non-transparent access case except that the addresses belong to the operator addressing space.

- the UE need not send any authentication request at PDU session establishment procedure and the SMF/UPF need not take any part in the user authentication/authorization process.

The transparent case provides at least a basic ISP service. As a consequence of this it may therefore provide a QoS flow service for a tunnel to a private Intranet. The user level configuration may be carried out between the UE and the intranet, the 5GS is transparent to this procedure. The used protocol stack is depicted in figure 8.2.2.1-2.

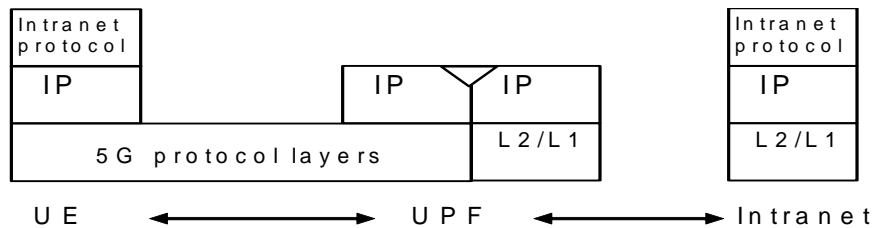

Figure 8.2.2.1-2: Transparent access to an Intranet

The communication between the PLMN and the Intranet may be performed over any network, even an insecure network e.g. the Internet. There is no specific security protocol between the UPF and the Intranet because security is ensured on an end to end basis between the UE and the intranet by the "Intranet Protocol".

User authentication and encryption of user data are done within the "Intranet Protocol" if either of them is needed. This "Intranet Protocol" may also carry private (IP) addresses belonging to the address space of the Intranet.

An example of an "Intranet Protocol" is IPsec (see IETF RFC 1825 [29]). If IPsec is used for this purpose, then IPsec authentication header or security header may be used for user (data) authentication and for the confidentiality of user data (see IETF RFC 1826 [30] and IETF RFC 1827 [31]). In this case private IP tunnelling within public IP takes place.

8.2.2.2 IPv4 Non-transparent access to DN

In this case:

- a static or a dynamic IPv4 address belonging to the Intranet/ISP addressing space is allocated to a UE at PDU session establishment. The methods of allocating IP address to the UE are specified in 3GPP TS 23.501 [2]. The allocated IPv4 address is used for packet forwarding within the UPF and for packet forwarding on the Intranet/ISP;
- as a part of the PDU session establishment, the SMF may request user authentication from an external DN-AAA server (i.e. RADIUS, Diameter) belonging to the Intranet/ISP;
- the IPv4 address allocation to the UE may be performed based on the subscription or a local address pool, which belongs to the Intranet/ISP addressing space, provisioned in the SMF; or via the address allocation servers (i.e. DHCPv4, RADIUS DN-AAA, Diameter DN-AAA) belonging to the Intranet/ISP;
- if requested by the UE at PDU session establishment, the SMF may retrieve the Protocol Configuration Options or IPv4 configuration parameters from a locally provisioned database in SMF and/or from some external server (i.e. DHCPv4, RADIUS DN-AAA, Diameter DN-AAA) belonging to the Intranet/ISP;
- the communication between the 5GS and the Intranet/ISP may be performed over any network, even an insecure network, e.g. the Internet. In case of an insecure connection between the UPF and the Intranet/ISP, there may be a specific security protocol in between. This security protocol is defined by mutual agreement between PLMN operator and Intranet/ISP administrator.

Table 8.2.2.2-1 summarizes the IPv4 address allocation and parameter configuration use cases between the UE and the SMF that may lead the SMF to interwork with the external DHCPv4, DN-AAA servers. For detailed description of the signalling flows between the UE and the SMF, see the references in the table.

Table 8.2.2-1: IPv4 address allocation and parameter configuration use cases

Signalling use cases between UE and SMF	Signalling use cases between SMF and external servers		
	Authentication via RADIUS or Diameter DN-AAA server (clauses 11 or 12) (NOTE 1 and NOTE 2)	IPv4 Address allocation via DHCPv4 or RADIUS or Diameter DN-AAA server (clauses 10, 11 or 12) (NOTE 1 and NOTE 2)	IPv4 parameter configuration via DHCPv4 or RADIUS or Diameter DN-AAA server (clauses 10, 11 or 12) (NOTE 1 and NOTE 2)
(1) IPv4 address allocation and parameter configuration via activation of QoS flow associated with the default QoS rule (2) IPv4 address allocation and parameter configuration via DHCPv4 signalling from UE towards SMF (NOTE 3)	X	X	X
(3) IPv4 address allocation and parameter configuration in untrusted non-3GPP IP access	X	X	X
NOTE 1: When the SMF interworks with AAA servers, the DNN may be configured to interwork with either Diameter DN-AAA or RADIUS DN-AAA server. NOTE 2: If RADIUS DN-AAA or Diameter DN-AAA server is used, the authentication, IPv4 address allocation and parameter configuration signalling may be combined. Similarly, if DHCPv4 server is used for IPv4 address allocation and parameter configuration, the signalling towards the DHCPv4 server may be combined. NOTE 3: If the authentication and authorization procedure towards RADIUS DN-AAA or Diameter DN-AAA is required, it is performed by the SMF before the DHCPv4 signalling when it receives the initial access request (i.e. Nsmf_PDUSession_CreateSMContext).			

8.2.2.3 IPv6 Non-transparent access to DN

When using IPv6 Address Autoconfiguration, the process of setting up the access to an Intranet or ISP involves two signalling phases. The first signalling phase is done in the control plane and consists of the PDU session establishment for 5GS 3GPP or non-3GPP based access, followed by a second signalling phase done in the user plane.

The user plane signalling phase shall be stateless. The stateless procedure, which involves only the UE and the SMF, is described in subclause 10.2.3.

For DNNs that are configured for IPv6 address allocation, the SMF shall only use the Prefix part of the IPv6 address for forwarding of mobile terminated IP packets. The size of the prefix shall be according to the maximum prefix length for a global IPv6 address as specified in the IPv6 Addressing Architecture, see IETF RFC 4291 [32].

The SMF indicates to the UE that Stateless Autoconfiguration shall be performed by sending Router Advertisements as described in subclause 10.2.3 and according to the principles defined in IETF RFC 4861 [33] and IETF RFC 4862 [34].

For UE supporting IPv6, IPv6 Stateless Address Autoconfiguration is mandatory.

In this case, the SMF provides the UE with an IPv6 Prefix belonging to the Intranet/ISP addressing space. A dynamic IPv6 address is given using stateless address autoconfiguration. This IPv6 address is used for packet forwarding within the UPF and for packet forwarding on the Intranet/ISP.

When an SMF receives an initial access request (i.e. Nsmf_PDUSession_CreateSMContext) message, the SMF deduces from local configuration data associated with the DNN:

- The source of IPv6 Prefixes (SMF internal prefix pool, or external address allocation server);
- Any server(s) to be used for address allocation, authentication and/or protocol configuration options retrieval (e.g. IMS related configuration, see 3GPP TS 24.229 [13]);
- The protocol, i.e. RADIUS, Diameter or DHCPv6, to be used with the server(s);
- The communication and security feature needed to communicate with the server(s).

As an example, the SMF may use one of the following options:

- SMF internal Prefix pool for IPv6 prefixes allocation and no authentication;

- SMF internal Prefix pool for IPv6 prefixes allocation and RADIUS for authentication. The RADIUS DN-AAA server responds with either an Access-Accept or an Access-Reject to the RADIUS client in the SMF;
- RADIUS for authentication and IPv6 prefix allocation. The RADIUS DN-AAA server responds with either an Access-Accept or an Access-Reject to the RADIUS client in the SMF.

The SMF includes the IPv6 address composed of a Prefix and an Interface-Identifier in the initial access response (Namf_Communication_N1N2MessageTransfer). The Interface-Identifier may have any value and it does not need to be unique within or across DNNs. It shall however not conflict with the Interface-Identifier that the SMF has selected for its own side of the UE-SMF link. The Prefix assigned by the SMF or the external DN-AAA server shall be globally or site-local unique (see the Note in subclause 11.3 of this document regarding the usage of site-local addresses).

Table 8.2.2.3-1 summarizes the IPv6 prefix allocation and parameter configuration use cases between the UE and the SMF that may lead the SMF to interwork with the external RADIUS DN-AAA, Diameter DN-AAA and DHCPv6 servers. For detailed description of the signalling flows between the UE and the SMF, see the references in the table.

Table 8.2.2.3-1: IPv6 prefix allocation and parameter configuration use cases

Signalling use cases between UE and SMF	Signalling use cases between SMF and external servers		
	Authentication via RADIUS or Diameter DN-AAA server (clauses 11 or 12) (NOTE 1 and NOTE 2)	IPv6 prefix allocation via DHCPv6 or RADIUS or Diameter DN-AAA server (clauses 10, 11 or 12) (NOTE 1 and NOTE 2)	IPv6 parameter configuration via DHCPv6 or RADIUS or Diameter DN-AAA server (clauses 10, 11 or 12) (NOTE 1 and NOTE 2)
(1) IPv6 address allocation and parameter configuration	X	X	X
(2) IPv6 parameter configuration via stateless DHCPv6			
(3) IPv6 address allocation and parameter configuration in untrusted non-3GPP IP access	X	X	X
NOTE 1: When the SMF interworks with DN-AAA servers, the DNN may be configured to interwork with either Diameter DN-AAA or RADIUS DN-AAA server.			
NOTE 2: If RADIUS DN-AAA or Diameter DN-AAA server is used, the authentication, IPv6 prefix allocation and parameter configuration signalling may be combined. Similarly, if DHCPv6 server is used for IPv6 prefix allocation and parameter configuration, the signalling towards the DHCPv6 server may be combined.			

For IPv6 the PDU session establishment phase is followed by an address autoconfiguration phase. IPv6 prefix is delivered to UE in Router Advertisement message from the SMF which acts as an access router, in the process of IPv6 Stateless Address Autoconfiguration as described in subclause 10.2.2. Besides DHCPv6 protocol, the SMF may also use RADIUS or Diameter protocol for the retrieval of an IPv6 prefix from external DN.

9 Interworking with DN (Unstructured)

9.1 General

When support of unstructured PDU type data is provided at the N6 interface, different Point-to-Point (PtP) tunneling techniques may be used. When using PtP tunneling by UDP/IPv6 encapsulation subclause 9.2 below shall be followed. Other techniques as described in subclause 9.3 below may be used.

In the following subclauses, the AS is used as an example for the destination in the external DN.

9.2 N6 PtP tunnelling based on UDP/IP

N6 PtP tunnelling based on UDP/IPv6 may be used to deliver unstructured PDU type data to the AS.

The PtP tunnel is set up by configuration of tunnel parameters in both end of the tunnel. The following parameters are pre-configured in the UPF per DNN:

- the UDP destination port number to use when sending unstructured PDU type data;
- the UDP port number it wants to receive unstructured PDU type data;
- the destination IP address to be used for sending unstructured PDU type data.

The following is pre-configured in the AS:

- the UDP destination port number to use when sending unstructured PDU type data;
- the UDP port number it wants to receive unstructured PDU type data.

NOTE 1: The UPF as well as the AS can use any UDP port numbers not assigned by IANA. The port numbers used need to be aligned between peers.

IP address allocation procedures for the UE (i.e. PDU session) are performed by the SMF as described in subclause 6.3.2, but the IPv6 prefix is not provided to the UE, i.e. Router Advertisements and DHCPv6 are not performed. The SMF assigns a suffix (i.e. IPv6 Interface Identifier) for the PDU session. For the N6 PtP tunnel, the IPv6 prefix allocated for the PDU session plus suffix assigned for the PtP tunnel is used as source address for the uplink data and as destination address for the downlink data.

During the PDU session establishment, the UPF associates the GTP-U tunnel for the PDU session with the N6 PtP tunnel.

The UPF acts as a transparent forwarding node between the UE and the AS.

For uplink delivery, if the uplink data is received from the GTP-U tunnel, the UPF shall forward the received data to the AS over the N6 PtP tunnel associated with the GTP-U tunnel with the destination address of the AS and the configured UDP destination port number for unstructured PDU type data.

For downlink delivery, the AS shall send the data using UDP/IP encapsulation with the IPv6 prefix plus suffix as destination address and the configured UDP destination port number for unstructured PDU type data.

NOTE 2: The UPF decapsulates the received data (i.e. removes the UDP/IPv6 headers) and forwards the data on the GTP-U tunnel identified by the IPv6 prefix of the UE (i.e. PDU session) for delivery to the UE.

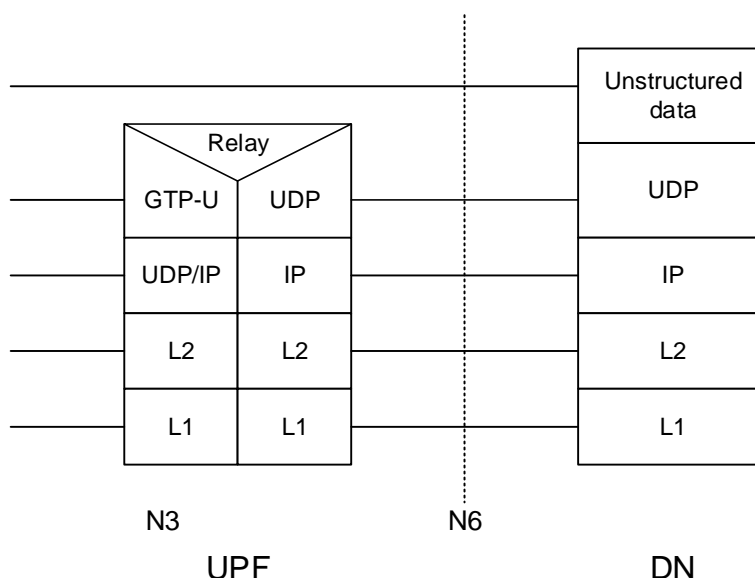

Figure 9.2-1: Protocol configuration for unstructured PDU type data (user plane) using N6 UDP/IPv6 PtP tunneling

9.3 Other N6 tunnelling mechanism

N6 PtP tunnelling mechanisms such as PMIPv6/GRE, L2TP, etc, may be used to deliver unstructured PDU type data to AS. The general handling of such delivery mechanisms is as described below.

A PtP tunnel is established by the UPF towards the AS. Depending on the type of protocol employed on the N6 PtP tunnel, the N6 PtP tunnel setup may be done at the time of PDU Session establishment or at the time of first MO datagram being sent by the UE. The UPF selects the AS based on its configuration (e.g. per DNN, or per PtP tunnel type, etc). However, IP address allocation procedures for the UE (according to subclause 6.3.2) are not performed by the SMF.

NOTE: An AS can be dedicated for handling a specific protocol for unstructured PDU type data.

The UPF acts as a transparent forwarding node between the UE and the AS.

For uplink delivery, the UPF forwards the received data to the AS over the established N6 PtP tunnel.

For downlink delivery, the AS locates the right N6 PtP tunnel for the UE (using information such as UE identifiers in the unstructured PDU type protocol itself, etc) to forward the data. The AS sends the data to UPF over the established N6 PtP tunnel. The UPF in turn sends the data on the GTP-U tunnel identified by the associated N6 PtP tunnel for delivery to the UE.

10 Interworking with DN (DHCP)

10.1 General

In current LAN environments the most commonly used configuration protocol is DHCP (Dynamic Host Configuration Protocol, RFC 2131 [18]) and DHCPv6 (Dynamic Host Configuration Protocol for IPv6, IETF RFC 3315 [21]). It provides a mechanism for passing a large set of configuration parameters to hosts connected to a TCP/IP network (IP address, sub-net mask, domain name, MTU, etc.) in an automatic manner. Moreover, DHCP may assign IP addresses to clients for a finite lease time, allowing for sequential reassignment of addresses to different users.

The lease time is chosen by the administrator of the DHCP server (in the external network), and is therefore out of the scope of the present document.

The 3GPP network may obtain IP address via external DHCP server during the PDU establishment procedure, the SMF acts a DHCP server towards the UE and it acts as a DHCP client towards the external DHCP server.

In the following cases the PDU session associated with the allocated IPv4 address or IPv6 prefix shall be released:

- if the DHCP lease expires;
- if the DHCP renewal is rejected by the DHCP server;
- if the IP address is changed during the renewal process. Usually when the lease is renewed, the IP address remains unchanged. However, if for any reason (e.g. poor configuration of the DHCP server), a different IP address is allocated during the lease renewal process the associated PDU session shall be released.

10.2 DN interworking Model of SMF for DHCP

10.2.1 Introduction

A DHCP client shall be located in the SMF used for interworking with the IP network as illustrated in figure 10.2-1.

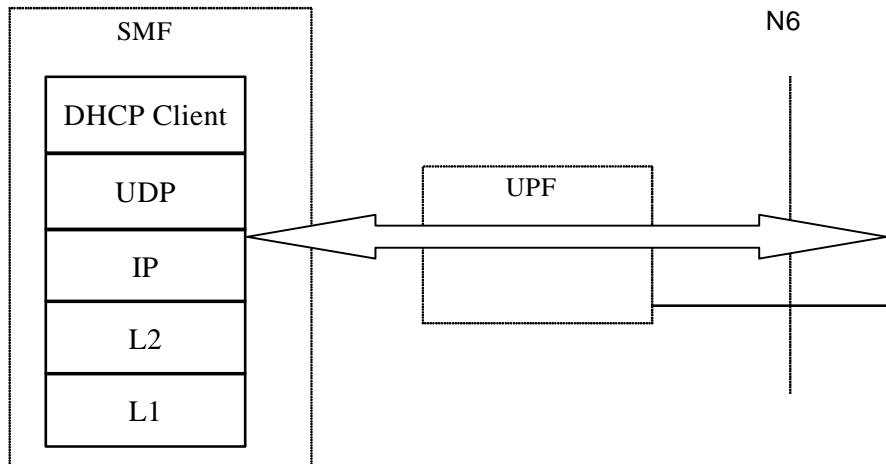

Figure 10.2.1-1: The protocol stacks for the N6 reference point for DHCP

The DHCP client function in the SMF shall be used to allocate IPv4 address or IPv6 prefix to the UE and/or to configure associated parameters via external DHCP servers. The SMF shall have both DHCPv4 and DHCPv6 client functions.

The procedures where the DHCP client function in the SMF is used are further described in 3GPP TS 23.501 [2]. The procedures are IPv4 address allocation and IPv4 parameter configuration via an external DHCPv4 server; IPv6 Prefix allocation via stateless address autoconfiguration; and IPv6 parameter configuration via stateless DHCPv6. These procedures are detailed in the subclauses below.

10.2.2 IPv4 Address allocation and IPv4 parameter configuration via DHCPv4

The UE may obtain the IPv4 address and/or its configuration parameters at or after the initial access signalling (i.e. Nsmf_PDUSession_CreateSMContext) to the 3GPP network. The request for IPv4 address and/or configuration parameters from the UE may trigger the SMF acting as a DHCPv4 client to request the IPv4 address and/or configuration parameters from an external DHCPv4 server and deliver them to the UE. The DHCPv4 functions in the SMF, the UE and the external DHCPv4 server shall be compliant to IETF RFC 2131 [18], IETF RFC 1542 [19] and IETF RFC 4039 [20].

The following system procedure describes the successful IPv4 address allocation and parameter configuration signalling flow between the SMF and the external DHCPv4 server as depicted in figure 10.2.2-1. For a detailed description of the DHCPv4 messages, refer to IETF RFC 2131 [18], IETF RFC 1542 [19] and IETF RFC 4039 [20].

- 1) The DHCPv4 client function in the SMF sends a DHCPDISCOVER as an IP limited broadcast message, i.e. the destination address 255.255.255.255, towards the external DN. If the SMF has the DHCPv4 server IP addresses configured for the DNN, the DHCPDISCOVER shall be send as unicast (or even multicast) to the external DHCPv4 servers.
- 2) Upon receiving the DHCPDISCOVER request message, the external DHCPv4 servers reply by sending a DHCPOFFER message including an offered IP address. Several DHCPOFFER messages may be received by the SMF if multiple DHCPv4 servers respond to the DHCPDISCOVER.
- 3) The DHCPv4 client function in the SMF processes the messages and sends a DHCPREQUEST towards the selected external DHCPv4 server.

NOTE: If the optimized signalling (Rapid Commit Option) is used as per IETF RFC 4039 [20], the messages 2-3 can be eliminated.

- 4) Upon receiving the DHCPREQUEST message, the selected external DHCPv4 server acknowledges the address allocation by sending a DHCPACK containing the lease period (T1), the time-out time (T2) and the

configuration information requested in DHCPREQUEST. The SMF stores the allocated IPv4 address, the lease timers and the configuration parameters. The SMF shall further deliver the IPv4 address and the configuration parameters to the UE by SM NAS message.

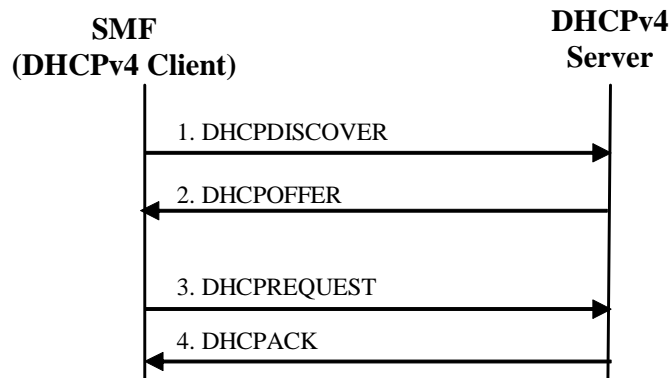

Figure 10.2.2-1: The signalling flow for IPv4 address allocation and parameter configuration using DHCPv4

Figure 10.2.2-2 is a signalling flow for IPv4 address lease renew by using DHCPv4 protocol as specified in IETF RFC 2131 [18].

- 1) The DHCPv4 client function in the SMF sends a unicast DHCPREQUEST towards the external DHCPv4 server to extend the lease period of the allocated IPv4 address.
- 2) The external DHCPv4 server replies with a DHCPACK message confirming the renewed lease and the T1 and T2 timers are restarted.

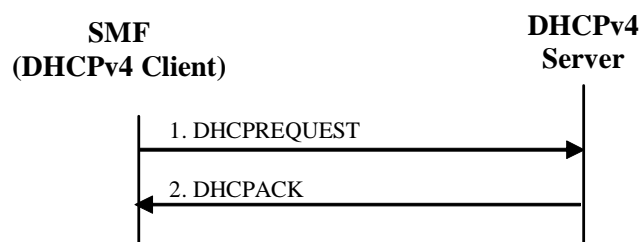

Figure 10.2.2-2: The signalling flow for IPv4 address lease renew using DHCPv4

10.2.3 IPv6 Prefix allocation via IPv6 stateless address autoconfiguration via DHCPv6

When the IPv6 prefix is allocated from the external DN, the SMF is responsible to obtain the IPv6 prefix for external DN, allocate and release the IPv6 prefix. The SMF may use DHCPv6 to obtain the IPv6 prefix from the external DN. In this context, the SMF shall act as a DHCP client as per IETF RFC 3315 [21] towards the external DHCPv6 server.

The SMF may allocate a second IPv6 prefix for routing traffic via a second UPF to enable simultaneous access via remote and local networks or to enable SSC mode 3 (i.e. make-before-break) mobility, as described in subclause 4.3.5.3 of 3GPP TS 23.502 [3].

The following system procedure describes the signalling flows for the IPv6 Stateless Address Autoconfiguration procedures for 5G system. The procedures are based on the descriptions in 3GPP TS 23.501 [2] and 3GPP TS 23.502 [3].

1. UE initiates the PDU Session Establishment procedure, indicating IPv6 address is required.
2. The AMF sends PDU Session Establishment Request in Nsmf_PDUSession_CreateSMContext to the SMF.
3. The SMF may retrieve IPv6 prefix using DHCPv6 mechanism. This procedure is performed when an external DN allocates an IPv6 prefix, the signaling between the SMF and external DN is exchanged via UPF which is omitted in the figure 10.2.3-1.

4. The SMF sends PDU Session Establishment Accept included in Namf_Communication_N1N2MessageTransfer to the AMF. It includes the IPv6 prefix.
5. The AMF sends PDU Session Establishment Accept message to the UE without the IPv6 prefix. The UE shall ignore the IPv6 prefix if it receives it in the message.
6. The UE may send a Router Solicitation to the SMF via the UPF to solicit a Router Advertisement message.
7. The SMF sends a Router Advertisement message to the UE via the UPF, solicited or unsolicited. It shall include an IPv6 prefix in Prefix Information option field of the message. The prefix is the same as the one in the PDU Session Establishment Accept message, if it is provided during the previous PDU Session Establishment procedure.
8. At any time after PDU session establishment, the SMF may trigger the establishment on an alternative route via UPF2 for access to a local data network or for SSC mode 3 mobility.
9. Like step 3, the SMF may retrieve a second IPv6 prefix using DHCPv6 mechanism.
10. The SMF sends a Router Advertisement to the UE via UPF2 to update the UE. Note that this will occur without a Router Solicitation since the UE is unaware of the network's decision to form an alternative Route.
11. Specific to the case of SSC mode 3 mobility, the SMF sends a Router Advertisement to the UE via UPF1 with zero value in the preferred lifetime field and a value in the valid lifetime field according to IETF RFC 4862 [34]. The UE shall update the valid lifetime of the old IPv6 prefix to the signalled value, regardless of the remaining lifetime. The signalled lifetime value indicates how long the SMF is willing to keep the old IPv6 prefix.

NOTE: Alternative routes can be established repeatedly through additional UPFs and old routes can be terminated when required by the SMF. More complex scenarios are not described here for the sake of simplicity.

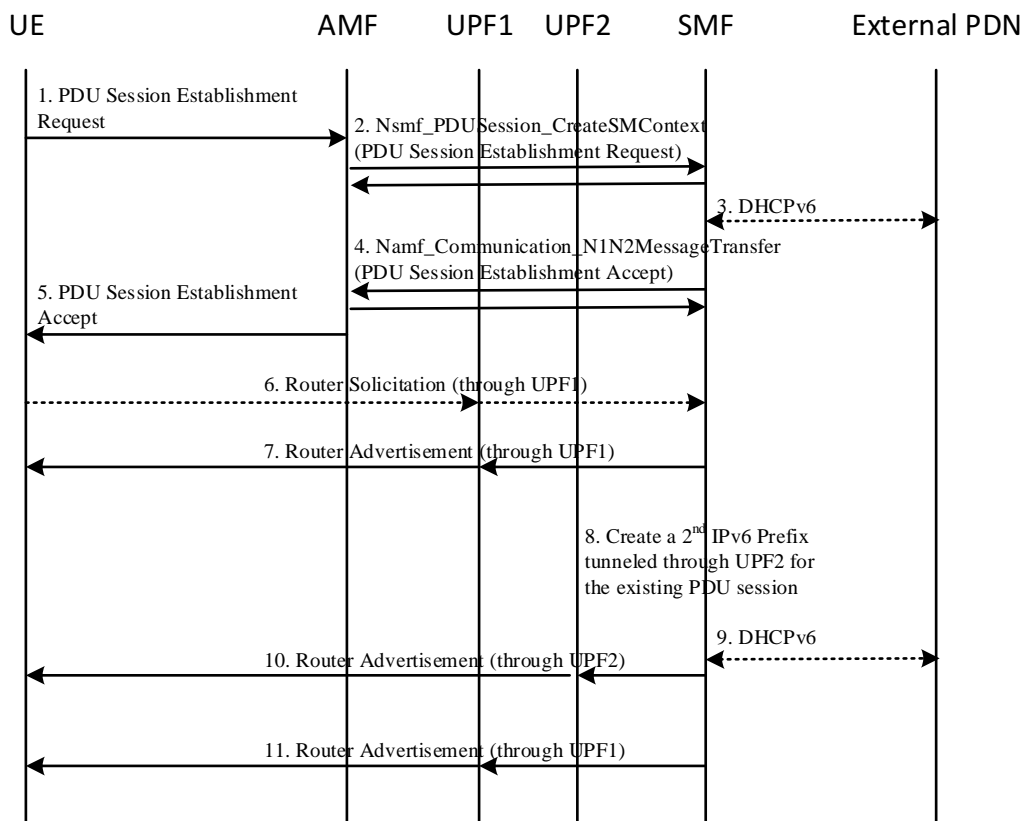

Figure 10.2.3-1: IPv6 Stateless Address Autoconfiguration

10.2.4 IPv6 parameter configuration via stateless DHCPv6

A UE that has obtained an IPv6 address may use stateless DHCP to request other configuration information such as a list of DNS recursive name servers or SIP servers.

For 3GPP networks, when an external DHCPv6 server in a DN is used to obtain the requested parameters, the SMF acts as a DHCPv6 client towards the external DHCPv6 server while acting a DHCPv6 server towards the UE.

The IPv6 parameter configuration via stateless DHCPv6 function in the UE, the SMF and the external DHCPv6 Server shall be compliant to IETF RFC 3736 [22]. The following system procedure describes the signalling flows for the IPv6 parameter configuration via stateless DHCPv6 procedures for 5G system. All messages in the following steps between the UE and the SMF are sent via the UPF.

- 1) A Router Advertisement with the O-flag set, is sent from SMF to UE to indicate to it to retrieve other configuration information.
- 2) The UE sends an INFORMATION-REQUEST message with the IP destination address set to the All_DHCP_Relay_Agents_and_Servers multicast address defined in the DHCPv6 IETF RFC 3315 [21]. The source address shall be the link-local address of the UE. The DHCP relay agent in the SMF shall forward the message.
- 3) DHCP servers receiving the forwarded INFORMATION-REQUEST message, reply by sending a RELAY-REPLY message, with the "Relay Message" option including a REPLY message with the requested configuration parameters.

The UE chooses one of the possibly several REPLY messages and extracts the configuration information.

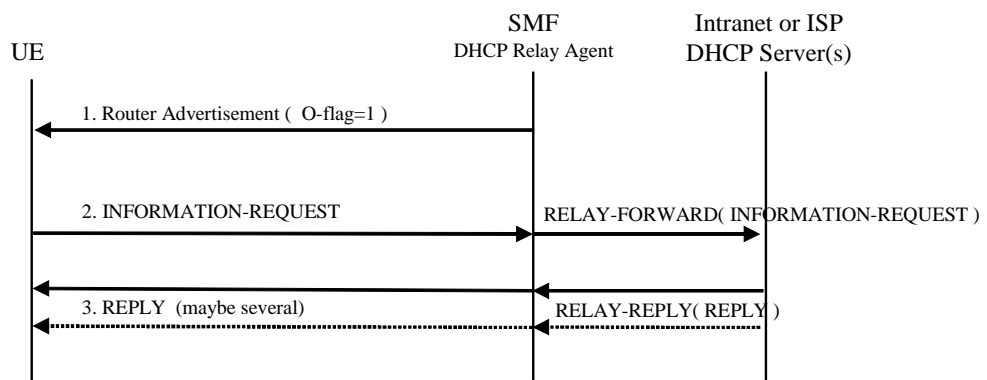

Figure 10.2.4-1: DHCPv6 Other configuration signal flow

11 Interworking with DN (RADIUS)

11.1 RADIUS procedures

11.1.1 RADIUS Authentication and Authorization

RADIUS Authentication and Authorization shall be used according to IETF RFC 2865 [8], IETF RFC 3162 [9] and IETF RFC 4818 [10]. In 5G, multiple authentication methods using Extensible Authentication Protocol (EAP) may be used such as EAP-TLS (see IETF RFC 5216 [11]), EAP-TTLS (see IETF RFC 5281 [37]). The SMF shall implement the RADIUS extension to support EAP as specified in IETF RFC 3579 [7].

The RADIUS client function may reside in an SMF. When the SMF receives an initial access request (i.e. Nsmf_PDUSession_CreateSMContext request with type "Initial request"), the RADIUS client function may send the authentication information to a DN-AAA server, which is identified during the DNN provisioning.

The DN-AAA server performs authentication and authorization. The response (when positive) may contain network information, such as an IPv4 address and/or IPv6 prefix for the user when the SMF is interworking with the DN-AAA server.

The information delivered during the RADIUS authentication can be used to automatically correlate the user identity (e.g. SUPI) to the IPv4 address and/or IPv6 prefix, if applicable, assigned/confirmed by the SMF or the DN-AAA server respectively. The same procedure applies, in case of sending the authentication to a 'proxy' DN-AAA server.

For 5G, RADIUS Authentication is applicable to the initial access request. When the SMF receives an Access-Accept message from the DN-AAA server it shall complete the initial access procedure. If Access-Reject or no response is received, the SMF shall reject the initial access procedure with a suitable cause code.

When DN-AAA server authorizes the PDU Session Establishment, it may send DN authorization data for the established PDU Session to the SMF. The DN authorization data for the established PDU Session may include one or more of the following:

- a reference to a locally configured authorization data in the SMF;
- a reference to retrieve the SM or QoS policy from the PCF;
- a list of allowed MAC addresses (maximum 16) for the Ethernet PDU Session; and
- Session-AMBR for the PDU Session.

SMF policies may require DN authorization without DN authentication. In that case, when contacting the DN-AAA server for authorization, the SMF shall provide the GPSI of the UE if available.

The SMF may also use the RADIUS re-authorization procedure for the purpose of IPv4 address and/or IPv6 prefix allocation to the UE. The use cases that may lead this procedure are:

- IPv4 address and/or IPv6 prefix allocation after UPF selection during PDU session establishment procedure.
- IPv6 prefix allocation during adding additional PDU Session Anchor procedure for IPv6 multi-homing.
- IPv4 address allocation via DHCPv4 procedure after successful PDU session establishment procedure.

When an IPv4 address and/or IPv6 prefix (including any additional IPv6 prefix of IPv6 multi-homing) is (re-)allocated or de-allocated (not causing the PDU session to be released) by using a method not via the DN-AAA server and if the SMF was required by the DN-AAA server to report such change during authentication procedure or by local configuration, the SMF shall, if applicable, use the authentication session that was established before to inform the DN-AAA server by sending RADIUS Access-Request with the latest list of IPv4 address and/or IPv6 prefix(es).

When the SMF is notified by the UPF regarding the UE MAC address change (a new one is detected or a used one is inactive), if the SMF was required by the DN-AAA server to report such change during authentication procedure or by local configuration, the SMF shall, if applicable, use the authentication session that was established before to inform the DN-AAA server by sending RADIUS Access-Request with the latest list of UE MAC addresses in use.

11.1.2 RADIUS Accounting

RADIUS Accounting shall be used according to IETF RFC 2866 [26], IETF RFC 3162 [9] and IETF RFC 4818 [10].

The RADIUS accounting client function may reside in an SMF. The RADIUS accounting client may send information to a DN-AAA server, which is identified during the DNN provisioning. The DN-AAA server may store this information and use it to automatically identify the user. This information can be trusted because the 3GPP network has authenticated the subscriber (i.e. USIM card and possibly other authentication methods).

The SMF may use the RADIUS Accounting-Request Start and Stop messages during QoS flow (e.g. QoS flow associated with the default QoS rule) establishment and termination procedures, respectively.

The use of Accounting-Request STOP and in addition the Accounting ON and Accounting OFF messages may be used to ensure that information stored in the DN-AAA server is synchronised with the SMF information.

If the DN-AAA server is used for IPv4 address and/or IPv6 prefix assignment, then, upon reception of a RADIUS Accounting-Request STOP message for all QoS flows associated to a PDU session defined by DNN and SUPI or GPSI, the DN-AAA server may make the associated IPv4 address and/or IPv6 prefix available for assignment.

When an IPv4 address and/or IPv6 prefix (including any additional IPv6 prefix of IPv6 multi-homing) is (re-)allocated or de-allocated (not causing the PDU session to be released) by using a method not via the DN-AAA server and if the SMF was required by the DN-AAA server to report such change during authentication procedure or by local configuration, the SMF shall, if applicable, use the accounting session that was established before to inform the DN-AAA server by sending RADIUS Accounting-Request Interim-Update with the latest list of IPv4 address and/or IPv6 prefix(es).

When the SMF is notified by the UPF regarding the UE MAC address change (a new one is detected or a used one is inactive), if the SMF was required by the DN-AAA server to report such change during authentication procedure or by local configuration, the SMF shall, if applicable, use the accounting session that was established before to inform the DN-AAA server by sending RADIUS Accounting-Request Interim-Update with the latest list of UE MAC addresses in use.

In order to avoid race conditions, the SMF shall include a 3GPP Vendor-Specific sub-attribute "Session Stop indicator" when it sends the Accounting-Request STOP for the last QoS flow of a PDU session and the PDU session is terminated (i.e. the IPv4 address and/or IPv6 prefix and any associated GTP tunnel can be released). The DN-AAA server shall not assume the PDU session terminated until an Accounting-Request STOP with the Session Stop indicator is received.

11.2 Message flows on N6 interface

11.2.1 Authentication, Authorization and Accounting procedures

When an SMF receives an initial access request (i.e. Nsmf_PDUSession_CreateSMContext request with type "Initial request") message for a given DNN, the SMF may (depending on the configuration for this DNN) send a RADIUS Access-Request message with EAP extension to an DN-AAA server. The DN-AAA server authenticates and authorizes the user by replying with an Access Accept message. Multi-round authentication using the Access-Challenge (sent by DN-AAA) and Access-Request messages may be used. If the DN-AAA server is also responsible for IPv4 address and/or IPv6 prefix allocation, the DN-AAA server shall return the allocated IPv4 address and/or IPv6 prefix in the Access-Accept message.

For re-authentication and re-authorization, the SMF shall send a RADIUS Access-Request message with EAP extension and the DN-AAA shall authenticate and authorize the user by replying with an Access-Accept message. Multi-round authentication using the Access-Challenge (sent by DN-AAA) and Access-Request messages may be used.

The SMF may initiate RADIUS re-authorization procedures for the purpose of IPv4 address and/or IPv6 prefix allocation (or renew the lease). In this case, the SMF shall set the Service-Type attribute to "Authorize Only" and the 3GPP-Allocate-IP-Type subattribute to the type of IP address to be allocated in the Access-Request message sent to the DN-AAA server. If the SMF is using DHCP signalling towards the UE and the DN-AAA server includes the Session-Timeout attribute in the Access-Accept, the SMF may use the Session-Timeout value as the DHCP lease time. The SMF shall not set the DHCP lease time value higher than the Session-Timeout value. The SMF may renew the DHCP lease to the UE without re-authorization towards the DN-AAA server providing that the new lease expiry is no later than the Session-Timeout timer expiry. If the SMF wishes to extend the lease time beyond the current Session-Timeout expiry, it shall initiate a new AAA re-authorization.

Even if the SMF was not involved in user authentication, it may send a RADIUS Accounting-Request (START) message to a DN-AAA server. This message may contain parameters, e.g. the tuple which includes the user ID and IPv4 address and/or IPv6 prefix, to be used by application servers (e.g. WAP gateway) in order to identify the user. This message also indicates to the AAA server that the user session has started. The session is uniquely identified by the Acct-Session-Id that is composed of the Charging ID and the SMF IP address.

If some external applications require RADIUS Accounting-Request (START) information before they can process user packets, then the selected DNN (SMF) may be configured in such a way that the UPF is instructed to drop user data until the Accounting-Response (START) is received from the AAA server. The SMF may wait for the Accounting-Response (START) before sending the final authentication response message in Namf_Communication_N1N2MessageTransfer service operation. The SMF may reject the initial access request if the Accounting-Response (START) is not received. The authentication and accounting servers may be separately configured for each DNN.

For IPv4 PDU type, if IPv4 address is allocated via DHCPv4 signalling between the UE and the DN-AAA after PDU session establishment, the SMF may wait to send the Accounting-Request (START) message until the UE receives its IPv4 address in a DHCPACK.

When the SMF receives a message indicating a QoS flow or PDU session release request and providing a RADIUS Accounting-Request (START) message was sent previously, the SMF shall send a RADIUS Accounting-Request (STOP) message to the DN-AAA server, which indicates the termination of this particular QoS flow or PDU session. The SMF shall immediately send the corresponding response (e.g. Nsmf_PDUSession_UpdateSMContext response) to the AMF, without waiting for an Accounting-Response (STOP) message from the DN-AAA server.

The DN-AAA server shall deallocate the IPv4 address and/or IPv6 prefix initially allocated to the subscriber, if there is no session for the subscriber.

Accounting-Request (ON) and Accounting-Request (OFF) messages may be sent from the SMF to the DN-AAA server to ensure the correct synchronization of the session information in the SMF and the DN-AAA server.

The SMF may send an Accounting-Request (ON) message to the DN-AAA server to indicate that a restart has occurred. The DN-AAA server may then release the associated resources.

Prior to a scheduled restart, the SMF may send Accounting-Request (OFF) message to the DN-AAA server. The DN-AAA server may then release the associated resources.

The following figure 11.2.1-1 is an example message flow to show the procedure of RADIUS Authentication and Accounting between an SMF and a DN-AAA server:

1. UE initiates the PDU Session Establishment procedure, including authentication/authorization information.
2. The AMF sends Nsmf_PDUSession_CreateSMContext Request including the authentication/authorization information to the SMF and the SMF responds to the service operation.

According to the configuration in the SMF, step 6 to step 9 are executed before step 3 if the SMF needs to send an EAP-Request message to the UE.

3. If the N4 session has not been established before, the SMF triggers the N4 Session Establishment procedure to the UPF.
4. The SMF sends the Access-Request message to the DN-AAA via the UPF, the message is forwarded from the SMF to the DN-AAA by the UPF in N4 user plane message.
- 5-10. The DN-AAA responds with the Access-Challenge message to the SMF via the UPF, the message is forwarded from the DN-AAA to the SMF by the UPF in N4 user plane message. The authentication/authorization information is further transferred to UE via Namf_Communication_N1N2MessageTransfer service and NAS SM Transport message. UE responds to the received authentication/authorization data and such information is transferred in NAS SM Transport message and Nsmf_PDUSession_UpdateSMContext service, then finally sent to the DN-AAA by the SMF, via the UPF, in the Access-Request message.

NOTE: Step 5 to step 10 can be repeated depending on the authentication/authorization mechanism used (e.g. EAP-TLS).

11. The SMF receives the final result of authentication/authorization from the DN-AAA in the Access-Accept message, via the UPF.
12. The SMF requests to start accounting by sending the Accounting-Request (START) message to the DN-AAA via the UPF.
13. The SMF proceeds with the PDU session establishment procedure and includes the authentication/authorization information in Namf_Communication_N1N2MessageTransfer service.
14. The DN-AAA responds with the Accounting-Response (START) message. The SMF may wait for the Accounting-Response (START) before sending the Namf_Communication_N1N2MessageTransfer request in step 13.
15. The AMF sends the NAS PDU Session Establishment Request with the authentication/authorization information to the UE.
16. The UE sends a NAS message Deregistration Request to the AMF.
17. The AMF sends Nsmf_PDUSession_ReleaseSMContext Request to the SMF and the SMF responds to the service operation.

18-19. The AMF requests to stop accounting by sending the Accounting-Request (STOP) message to the DN-AAA via the UPF and the DN-AAA responds with the Accounting-Response (STOP) message.

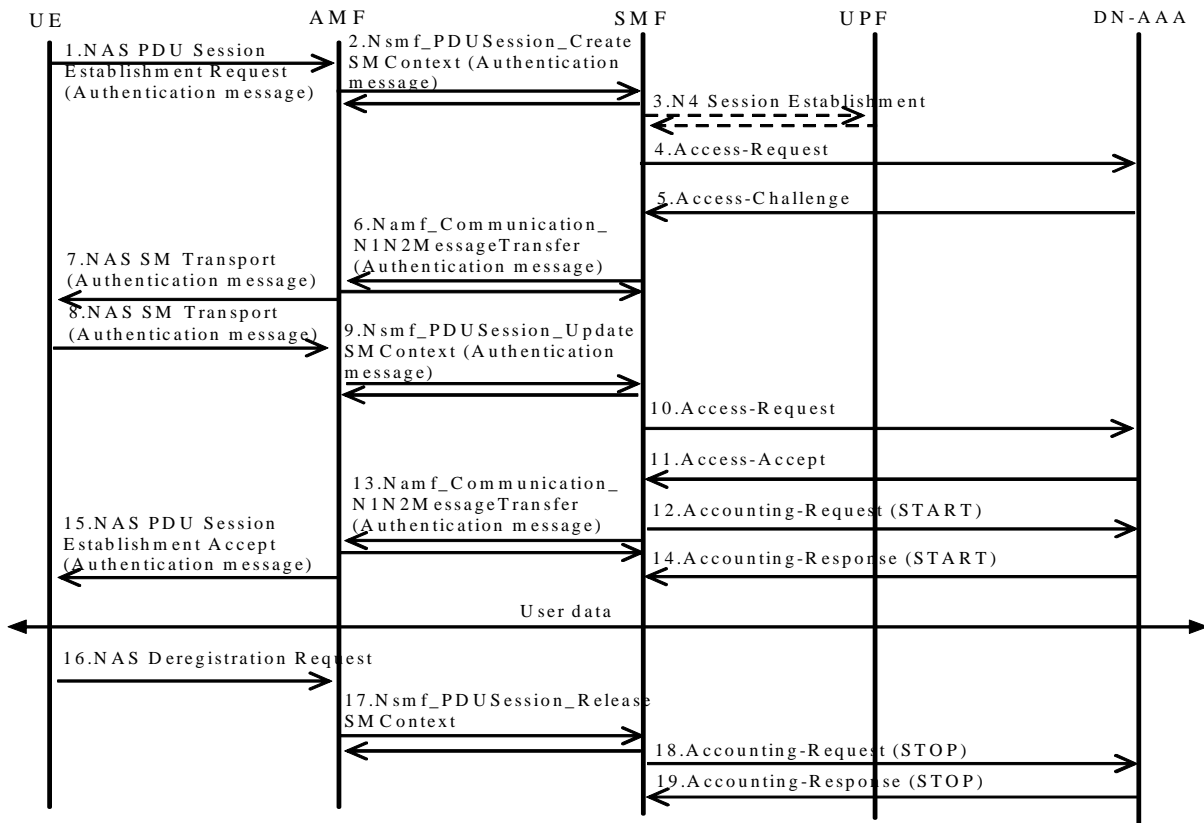

Figure 11.2.1-1: RADIUS Authentication and Accounting example (successful case)

11.2.2 Accounting Update

During the life of a QoS flow some information related to this QoS flow may change. The SMF may send RADIUS Accounting Request Interim-Update to the DN-AAA server upon occurrence of a chargeable event, e.g. RAT change or QoS change. Interim updates are also used when the IPv4 address and/or IPv6 prefix is allocated/released/re-allocated.

When the SMF receives a signalling request (i.e. Nsmf_PDUSession_UpdateSMContext) that indicates the occurrence of one of these chargeable events, the SMF may send an Accounting Request Interim-Update to the DN-AAA server to update the necessary information related to this QoS flow. It is not necessary for the SMF to wait for the RADIUS AccountingResponse message from the DN-AAA server before sending the response for the triggering signalling message (i.e. Namf_Communication_N1N2MessageTransfer). The SMF may delete the QoS flow if the AccountingResponse is not received from the DN-AAA server.

The SMF may also send interim updates at the expiry of an operator configured time limit.

Figure 11.2.2-1 is an example message flow to show the procedure of RADIUS accounting update, messages between the SMF and DN-AAA are forwarded by the UPF in N4 user plane message.

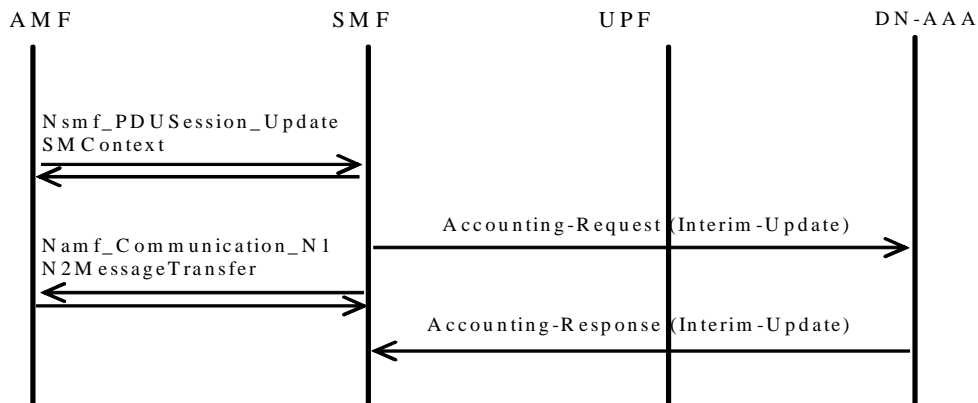

Figure 11.2.2-1: RADIUS accounting update

11.2.3 DN-AAA initiated QoS flow termination

RADIUS is used as the protocol between the SMF and the DN-AAA server or proxy for applications (e.g. MMS) to deliver information related to user session. However some IP applications could need to interwork with the SMF to release the corresponding resource (e.g. terminate a particular QoS flow). For this purpose, the DN-AAA server or proxy may send a RADIUS Disconnect-Request to the SMF. On receipt of the Disconnect-Request from the DN-AAA server, the SMF shall release the corresponding resources and reply with a Disconnect-ACK. If the SMF is unable to release the corresponding resources, it shall reply to the DN-AAA server with a Disconnect-NAK. For more information on RADIUS Disconnect, see IETF RFC 5176 [27]. If the SMF deletes the corresponding QoS flow, it is not necessary for the SMF to wait for the response (i.e. Nsmf_PDUSession_UpdateSMContext) from the AMF before sending the RADIUS Disconnect-ACK to the DN-AAA server.

The Teardown-Indicator in the RADIUS Disconnect Request message indicates to the SMF that all QoS flows for this particular user and sharing the same user session shall be deleted. The QoS flows that belong to the same PDU session are identified by the Acct-Session-Id. The Charging-Id contained in the Acct-Session-Id can be of any IP-CAN bearer of the user. The SMF is able to find out all the related QoS flows sharing the same user session once it has found the exact QoS flow from the Acct-Session-Id. If a user has the same user IP address for different sets of QoS flows towards different networks, only the QoS flows linked to the one identified by the Acct-Session-Id shall be deleted. If the value of Teardown-Indicator is set to "0" or if TI is missing, and if the Acct-Session-Id identifies the QoS flow associated with the default QoS rule, the SMF shall tear down all the QoS flows that share the same user session identified by the Acct-Session-Id.

Figure 11.2.3-1 is an example message flow to show the procedure of DN-AAA initiated QoS flow termination, messages between the SMF and DN-AAA are forwarded by the UPF in N4 user plane message.

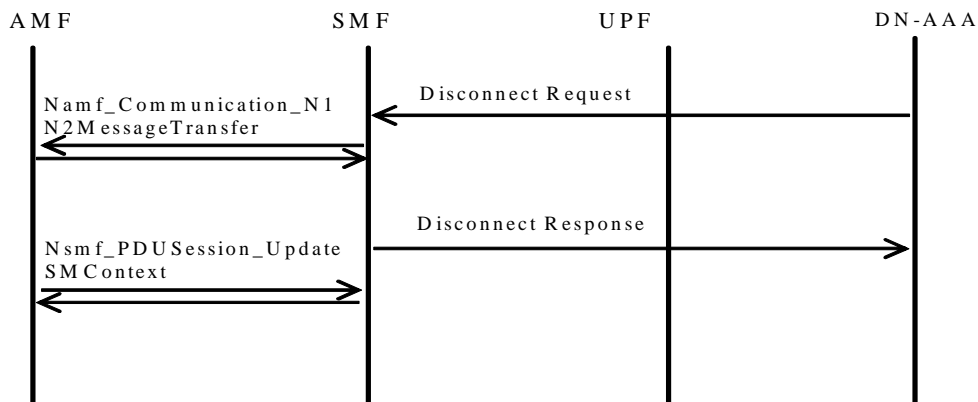

Figure 11.2.3-1: DN-AAA initiated QoS flow termination with RADIUS

11.2.4 DN-AAA initiated re-authorization

Some IP applications could need to interwork with the SMF to update the PDU session authorization attributes. For this purpose, the DN-AAA server or proxy may send a RADIUS CoA-Request to the SMF. On receipt of the CoA-Request from the DN-AAA server, if the service-type value of "Authorize Only" is not included, the SMF shall update the corresponding PDU session authorization attributes and reply with a CoA-ACK; otherwise it shall follow the procedure described in IETF RFC 5176 [27]. DN-AAA may also use CoA procedure to revoke the authorization of a PDU session, or to update the authorization data (e.g. allowed UE MAC addresses).

If the SMF updates/deletes the corresponding PDU session, it is not necessary for the SMF to wait for Nsmf_PDUSession_UpdateSMContext from the AMF before sending the RADIUS CoA-ACK to the DN-AAA server.

Figure 11.2.4-1 is an example message flow to show the procedure of DN-AAA initiated re-authorization, messages between the SMF and DN-AAA are forwarded by the UPF in N4 user plane message.

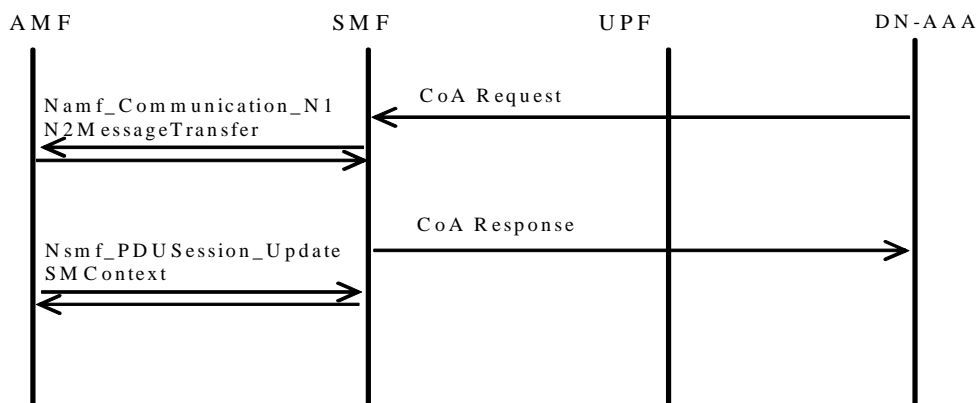

Figure 11.2.4-1: DN-AAA initiated re-authorization with RADIUS

11.3 List of RADIUS attributes

11.3.1 General

RADIUS attributes as defined in subclause 16.4 of 3GPP TS 29.061 [5] are re-used in 5G with the following differences:

- SMF replaces P-GW. GGSN and PPP PDP type related description are not applicable for 5G.
- 5G QoS flow replaces IP-CAN bearer and PDU session replaces IP-CAN session.
- N6 replaces Gi/Sgi and UE replaces MS.
- DNN replaces APN.
- Detailed information needed for 5G compared to 3GPP TS 29.061 [5] is described below.

Table 11.3-1: Additional information needed for 5G compared to the RADIUS attributes defined in 3GPP TS 29.061 [5]

Attr #	Attribute Name	Description	Content	Presence Requirement	Applicable message
79	EAP-Message	This attribute encapsulates EAP message (as defined in IETF RFC 3748 [6]) exchanged between the SMF and DN-AAA, see IETF RFC 3579 [7] for details.	String	Conditional NOTE	Access-Request, Access-Accept, Access-Challenge, Access-Reject, CoA-Request, CoA-ACK, Disconnect-Request, Disconnect-ACK
80	Message-Authenticator	This attribute includes the message authenticator, see IETF RFC 3579 [7] for details.	String	Conditional NOTE	Access-Request, Access-Accept, Access-Challenge, Access-Reject, CoA-Request, CoA-ACK, CoA-NAK Disconnect-Request, Disconnect-ACK, Disconnect-NAK
NOTE: Shall be present if EAP is used.					

Table 11.3-2: Different information needed for 5G compared to the RADIUS VSA defined in subclause 16.4.7 of 3GPP TS 29.061 [5]

Sub-attr #	Sub-attribute Name	Differences
1	3GPP-IMSI	Re-used.
2	3GPP-Charging-Id	Re-used.
3	3GPP-PDP-Type	Re-used. For SMF, this sub-attribute represents PDU session type and only the values "0", "2", "3", "5" and "6" are applicable.
4	3GPP-CG-Address	Re-used.
5	3GPP-GPRS-Negotiated-QoS-Profile	Re-used. For SMF, it uses the format for Release indicator value "15" as defined in 3GPP TS 29.061 [5].
6	3GPP-SGSN-Address	Re-used. It includes AMF IPv4 address.
7	3GPP-GGSN-Address	Re-used. It includes (home) SMF control plane IPv4 address.
8	3GPP-IMSI-MCC-MNC	Re-used.
9	3GPP-GGSN-MCC-MNC	Re-used. MCC and MNC of the network the (home) SMF belongs to.
10	3GPP-NSAPI	Re-used. It identifies QFI with value range 0-255.
11	3GPP-Session-Stop-Indicator	Re-used.
12	3GPP-Selection-Mode	Re-used. SMF maps the selection mode value from the enumeration value of DnnSelectionMode in 3GPP TS 29.502 [40].
13	3GPP-Charging-Characteristics	Re-used.
14	3GPP-CG-Ipv6-Address	Re-used.
15	3GPP-SGSN-Ipv6-Address	Re-used. It includes AMF IPv6 address.
16	3GPP-GGSN-Ipv6-Address	Re-used. It includes (home) SMF control plane IPv6 address.
17	3GPP-Ipv6-DNS-Servers	Re-used.
18	3GPP-SGSN-MCC-MNC	Re-used. MCC and MNC of the network the AMF belongs to
19	3GPP-Tear-down-Indicator	Re-used.
20	3GPP-IMEISV	Re-used.
21	3GPP-RAT-Type	Re-used. For SMF, it uses the sub-attribute definition for P-GW and only the values "3", "7" and "51" are applicable.
22	3GPP-User-Location-Info	Re-used. For SMF, only the values "128", "129", "130", "135" and "136" of Geographic Location Type are applicable.
23	3GPP-MS-TimeZone	Re-used.
24	3GPP-CAMEL-Charging-Info	Not applicable.
25	3GPP-Packet-Filter	Re-used.
26	3GPP-Negotiated-DSCP	Re-used.
27	3GPP-Allocate-IP-Type	Re-used.
28	External-Identifier	Re-used.
29	TWAN-Identifier	Not applicable.
30	3GPP-User-Location-Info-Time	Re-used.
31	3GPP-Secondary-RAT-Usage	Not applicable.
110	3GPP-Notification	Added.
111	3GPP-UE-MAC-Address	Added.
112	3GPP-Authorization-Reference	Added.
113	3GPP-Policy-Reference	Added.
114	3GPP-Session-AMBR	Added.
115	3GPP-NAI	Added.
116	3GPP-Session-AMBR-v2	Added.
117	3GPP-Supported-Features	Added.

NOTE: 5G specific RADIUS VSAs are numbered from 110.

110 – 3GPP-Notification



3GPP Type: 110

Length: 3

Octet 3 is Octet String type.

For bit 1 AUTH,

- if the value of AUTH is set to "1", and there is IPv4 address and/or IPv6 prefix change (not allocated/de-allocated by the DN-AAA itself) and the PDU session is not terminated, the SMF shall send Access-Request message to the DN-AAA with GPSI in Calling-Station-Id or External-Identifier attribute and IP address in:
 - 1) Framed-IP-Address and Framed-Ipv6-Prefix, if both IPv4 address and IPv6 prefix(es) exist for the PDU session; or
 - 2) Framed-IP-Address, if only IPv4 address exists for the PDU session; or
 - 3) Framed-Ipv6-Prefix, if only IPv6 prefix(es) exists for the PDU session.

For Ethernet PDU session, if there is UE MAC address change, the SMF shall send Access-Request message to the DN-AAA with GPSI in Calling-Station-Id or External-Identifier attribute and the complete list of used UE MAC addresses in the 3GPP-UE-MAC-Address attribute.

- if the value is set to "0", the SMF may notify authentication DN-AAA with the UE address and GPSI based on local configuration.

For bit 2 ACC,

- if the value is set to "1", and there is IPv4 address and/or IPv6 prefix change (not allocated/de-allocated by the DN-AAA itself) and the PDU session is not terminated, the SMF shall send Accounting-Request Interim-Update message to the DN-AAA with GPSI in Calling-Station-Id or External-Identifier attribute and IP address in:
 - 1) Framed-IP-Address and Framed-Ipv6-Prefix, if both IPv4 address and IPv6 prefix(es) exist for the PDU session; or
 - 2) Framed-IP-Address, if only IPv4 address exists for the PDU session; or
 - 3) Framed-Ipv6-Prefix, if only IPv6 prefix(es) exists for the PDU session.

For Ethernet PDU session, if there is UE MAC address change, the SMF shall send Accounting-Request Interim-Update message to the DN-AAA with GPSI in Calling-Station-Id or External-Identifier attribute and the complete list of used UE MAC addresses in the 3GPP-UE-MAC-Address attribute.

- if the value is set to "0", the SMF may notify accounting DN-AAA with the UE address and GPSI based on local configuration.

111 – 3GPP-UE-MAC-Address

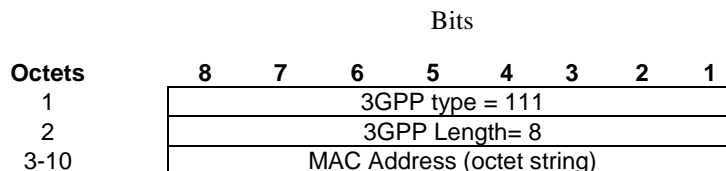

3GPP Type: 111

Length: 8

It is sent from the DN-AAA to authorize UE MAC addresses. Multiple 3GPP-MAC-Address sub-attributes (maximum 16) may be sent in one RADIUS CoA or Access-Accept message. The DN-AAA shall always provide the full list of allowed MAC addresses, and SMF shall replace the existing list with the newly received one. When omitted, there is no restriction and all UE MAC addresses are permitted for the Ethernet PDU session.

When sending from the SMF to the DN-AAA, it indicates UE MAC addresses in use. Multiple 3GPP-MAC-Address sub-attributes may be sent in one RADIUS Access-Request or Accounting-Request Interim-Update message.

MAC address is Octet String type.

112 – 3GPP-Authorization-Reference

Octets	Bits							
	8	7	6	5	4	3	2	1
1	3GPP type = 112							
2	3GPP Length= m							
3-m	Authorization Data Reference (octet string)							

3GPP Type: 112

Length: m

Authorization Data Reference: Octet String. It is sent from the DN-AAA to refer to the local authorization data in the SMF.

113 – 3GPP-Policy-Reference

Octets	Bits							
	8	7	6	5	4	3	2	1
1	3GPP type = 113							
2	3GPP Length= m							
3-m	Policy Data Reference (octet string)							

3GPP Type: 113

Length: m

Policy Data Reference: Octet String. It is sent from the DN-AAA and used by the SMF to retrieve the SM or QoS policy data from the PCF.

114 – 3GPP-Session-AMBR

Octets	Bits							
	8	7	6	5	4	3	2	1
1	3GPP type = 114							
2	3GPP Length= m							
3-m	Session AMBR (octet string)							

3GPP Type: 114

Length: m

Session AMBR: Octet String. It is sent from the DN-AAA to authorize the PDU Session AMBR. The encoding is defined as BitRate in 3GPP TS 29.571 [39].

115 – 3GPP-NAI

Octets	Bits							
	8	7	6	5	4	3	2	1
1	3GPP type = 115							
2	3GPP Length= m							
3-m	NAI (octet string)							

3GPP Type: 115

Length: m

NAI: Octet String. It shall be formatted according to subclause 14.3 of 3GPP TS 23.003 [28] that describes an NAI.

116 – 3GPP-Session-AMBR-v2

Octets	Bits							
	8	7	6	5	4	3	2	1
1	3GPP type = 116							
2	3GPP Length= m							
3	Spare					DL	UL	
4-5	UL Session-AMBR length (octet string)							
6-m	UL Session-AMBR (octet string)							
(m+1)- (m+2)	DL Session-AMBR length (octet string)							
(m+3)-n	DL Session-AMBR (octet string)							

3GPP Type: 116

Length: m

Octet 3 is Octet String type.

Bit 1 UL and bit 2 DL indicate if the corresponding UL and DL Session-AMBR shall be present in a respective field or not. If one of these bits is set to "0", the corresponding field shall not be present at all.

UL/DL Session AMBR: Octet String. It is sent from the DN-AAA to authorize the PDU Session AMBR. The encoding is defined as BitRate in 3GPP TS 29.571 [39].

If the feature eSessionAMBR is supported and if applicable, the DN-AAA shall send this VSA; otherwise, the DN-AAA shall send the VSA 3GPP-Session-AMBR.

117 – 3GPP-Supported-Features

Octets	Bits						
	8	7	6	5	4	3	2
1	3GPP type = 117						
2	3GPP Length= m						
3-6	Vendor ID (octet string)						
7-10	Feature List ID (octet string)						
11-14	Feature List (octet string)						

3GPP Type: 117

Length: m

This VSA may be present in the Access-Request (initial one) message and either the Access-Challenge (initial one) or the Access-Accept message. If present, this VSA informs the destination entity about the features that the origin entity requires to successfully complete the message exchange. The Vendor ID, Feature List ID and Feature List are encoded according to 3GPP TS 29.229 [41]. See clause 12.4.1 for more detailed information regarding the general principle of the feature negotiation with the difference that RADIUS terms replace Diameter terms. The table 12.4.1-1 defines the features applicable to the RADIUS N6 interfaces for the feature lists with a Feature-List-ID of 1.

Table 11.3-3 describes the sub-attributes of the 3GPP Vendor-Specific attribute described above in different RADIUS messages.

Table 11.3-3: List of the 3GPP Vendor-Specific sub-attributes for N6

Sub-attr #	Sub-attribute Name	Description	Presence Requirement	Associated attribute (Location of Sub-attr)	Applicability
110	3GPP-Notification	It includes all notifications that the DN-AAA wants to receive from the SMF.	Optional	Access-Accept	
111	3GPP-UE-MAC-Address	It is sent from the DN-AAA to authorize UE MAC addresses, or it indicates UE MAC addresses in use when sending from the SMF to the DN-AAA.	Optional	Access-Request, Access-Response, Accounting-Request Interim-Update, Change-of-Authorization	
112	3GPP-Authorization-Reference	It is sent from the DN-AAA to refer to the local authorization data in the SMF.	Optional	Access-Accept, Change-of-Authorization	
113	3GPP-Policy-Reference	It is sent from the DN-AAA and used by the SMF to retrieve the SM or QoS policy data from the PCF.	Optional	Access-Accept, Change-of-Authorization	
114	3GPP-Session-AMBR	It is sent from the DN-AAA to authorize the PDU Session AMBR.	Optional	Access-Accept, Change-of-Authorization	
115	3GPP-NAI	The Network Access Identifier identifying the UE.	Optional	Access-Request, Accounting-Request START, Accounting-Request STOP, Accounting-Request Interim-Update	
116	3GPP-Session-AMBR-v2	It is sent from the DN-AAA to authorize the PDU Session AMBR, it includes separate session AMBR for UL and DL.	Optional	Access-Accept, Change-of-Authorization	eSession AMBR
117	3GPP-Supported-Features	It indicates the supported features as specified in clause 12.4.1.	Optional	Access-Request, Access-Accept, Access-Challenge, Accounting-Request START, Accounting-Response START	

RADIUS attributes related to the DN-AAA initiated re-authorization and authentication challenge are described in the following subclauses.

11.3.2 Change-of-Authorization Request (optionally sent from DN-AAA server to SMF)

Table 11.3.2-1 describes the attributes of the Change-of-Authorization Request message. Other RADIUS attributes may be used as defined in IETF RFC 5176 [27].

Table 11.3.2-1: The attributes of the Change-of-Authorization Request message

Attr #	Attribute Name	Description	Content	Presence Requirement
1	User-Name	Username provided by the user (extracted from the PCO field received during PDN connection establishment). If no username is available a generic username, configurable on a per DNN basis, shall be present. If the User-Name has been sent in the Access-Accept message, this user-name shall be used in preference to the above	String	Optional
6	Service-Type	Indicates the type of service for this user.	17 (Authorize Only)	Optional
8	Framed-IP-Address	User IPv4 address	Ipv4	Conditional NOTE 2
30	Called-Station-Id	Identifier for the target network	DNN (UTF-8 encoded characters)	Optional
31	Calling-Station-Id	This attribute is the identifier for the UE, and it shall be configurable on a per DNN basis.	MSISDN in international format according to 3GPP TS 23.003 [28], UTF-8 encoded decimal character. (NOTE 5)	Optional
96	Framed-Interface-Id	User IPv6 Interface Identifier	Ipv6	Conditional NOTE 1 NOTE 2
44	Acct-Session-Id	User session identifier.	SMF IP address (IPv4 or IPv6) and Charging-ID concatenated in a UTF-8 encoded hexadecimal characters.	Mandatory
79	EAP-Message	This attribute encapsulates EAP message (as defined in IETF RFC 3748 [6]) exchanged between the SMF and DN-AAA, see IETF RFC 3579 [7] for details.	String	Conditional NOTE 3
80	Message-Authenticator	This attribute includes the message authenticator, see IETF RFC 3579 [7] for details.	String	Conditional NOTE 3
97	Framed-Ipv6-Prefix	User IPv6 prefix	Ipv6	Conditional NOTE 2
123	Delegated-Ipv6-Prefix	Delegated IPv6 prefix to the user.	Ipv6	Conditional NOTE 4
26/10 415	3GPP Vendor-Specific	Sub-attributes according clause 11.3, the encoding of this attribute is specified in 3GPP TS 29.061 [5].	See clause 11.3	Optional
<p>NOTE 1: Included if the prefix alone is not unique for the user. This may be the case, for example, if a static IPv6 address is assigned.</p> <p>NOTE 2: Either IPv4 or IPv6 address/prefix attribute shall be present. The IP protocol version for end-user and network may be different.</p> <p>NOTE 3: Shall be present if EAP is used.</p> <p>NOTE 4: The delegated IPv6 prefix shall be present if the user was delegated an IPv6 prefix from a local pool.</p> <p>NOTE 5: There are no leading characters in front of the country code.</p>				

11.3.3 Access-Challenge (sent from DN-AAA server to SMF)

Table 11.3.3-1 describes the attributes of the Change-of-Authorization Request message. Other RADIUS attributes may be used as defined in IETF RFC 2865 [8].

Table 11.3.3-1: The attributes of the Access-Challenge message

Attr #	Attribute Name	Description	Content	Presence Requirement
27	Session-Timeout	Indicates the timeout value (in seconds) for the user session	32 bit unsigned Integer	Optional
79	EAP-Message	This attribute encapsulates EAP message (as defined in IETF RFC 3748 [6]) exchanged between the SMF and DN-AAA, see IETF RFC 3579 [7] for details.	String	Conditional NOTE 2
80	Message-Authenticator	This attribute includes the message authenticator, see IETF RFC 3579 [7] for details.	String	Conditional NOTE 2
NOTE 1: Included if the prefix alone is not unique for the user. This may be the case, for example, if a static ipv6 address is assigned.				
NOTE 2: Shall be present if EAP is used.				

12 Interworking with DN (Diameter)

12.1 Diameter Procedures

12.1.1 Diameter Authentication and Authorization

Diameter Authentication and Authorization shall be used according to IETF RFC 7155 [23]. In 5G, multiple authentication methods using Extensible Authentication Protocol (EAP) may be used such as EAP-TLS (see IETF RFC 5216 [11]), EAP-TTLS (see IETF RFC 5281 [37]). The SMF shall support Diameter EAP application as specified in IETF RFC 4072 [25].

The SMF and the DN-AAA shall advertise the support of the Diameter NASREQ and EAP applications by including the value (1 and 5) of the application identifier in the Auth-Application-Id AVP (as specified in IETF RFC 4072 [25]) and the value of the 3GPP (10415) in the Vendor-Id AVP of the Capabilities-Exchange-Request and Capabilities-Exchange-Answer commands as specified in IETF RFC 6733 [24], i.e. as part of the Vendor-Specific-Application-Id AVP.

The Diameter client function may reside in an SMF. When the SMF receives an initial access request (i.e. Nsmf_PDUSession_CreateSMContext request with type "Initial request"), the Diameter client function may send the authentication information to a DN-AAA server, which is identified during the DNN provisioning.

The DN-AAA server performs authentication and authorization. The response (when positive) may contain network information, such as an IPv4 address and/or IPv6 prefix for the user when the SMF is interworking with the DN-AAA server.

The information delivered during the Diameter authentication can be used to automatically correlate the user identity (e.g. SUPI) to the IPv4 address and/or IPv6 prefix, if applicable, assigned/confirmed by the SMF or the DN-AAA server respectively. The same procedure applies, in case of sending the authentication to a 'proxy' DN-AAA server.

For 5G, Diameter Authentication is applicable to the initial access request. When the SMF receives a positive response from the DN-AAA server it shall complete the initial access procedure. If Access-Reject or no response is received, the SMF shall reject the initial access procedure with a suitable cause code.

When DN-AAA server authorizes the PDU Session Establishment, it may send DN authorization data for the established PDU Session to the SMF. The DN authorization data for the established PDU Session may include one or more of the following:

- a reference to a locally configured authorization data in the SMF;
- a reference to retrieve the SM or QoS policy from the PCF;

- a list of allowed MAC addresses (maximum 16) for the Ethernet PDU Session; and
- Session-AMBR for the PDU Session.

SMF policies may require DN authorization without DN authentication. In that case, when contacting the DN-AAA server for authorization, the SMF shall provide the GPSI of the UE if available.

The SMF may also use the Diameter re-authorization procedure for the purpose of IPv4 address and/or IPv6 prefix allocation to the UE. The use cases that may lead this procedure are:

- IPv4 address and/or IPv6 prefix allocation after UPF selection during PDU session establishment procedure.
- IPv6 prefix allocation during adding additional PDU Session Anchor procedure for IPv6 multi-homing.
- IPv4 address allocation via DHCPv4 procedure after successful PDU session establishment procedure.

When an IPv4 address and/or IPv6 prefix (including any additional IPv6 prefix of IPv6 multi-homing) is (re-)allocated or de-allocated (not causing the PDU session to be released) by using a method not via the DN-AAA server and if the SMF was required by the DN-AAA server to report such change during authentication procedure or by local configuration, the SMF shall, if applicable, use the authentication session that was established before to inform the DN-AAA server by sending Diameter DER or AAR with the latest list of IPv4 address and/or IPv6 prefix(es).

When the SMF is notified by the UPF regarding the UE MAC address change (a new one is detected or a used one is inactive), if the SMF was required by the DN-AAA server to report such change during authentication procedure or by local configuration, the SMF shall, if applicable, use the authentication session that was established before to inform the DN-AAA server by sending Diameter DER or AAR with the latest list of UE MAC addresses in use.

12.1.2 Diameter Accounting

Diameter Accounting shall be used according to IETF RFC 7155 [23].

The SMF and the DN-AAA may advertise the support of the Diameter base accounting application by including the value (3) of the application identifier in the Acct-Application-Id AVP and the value of the 3GPP (10415) in the Vendor-Id AVP of the Capabilities-Exchange-Request and Capabilities-Exchange-Answer commands as specified in IETF RFC 6733 [24], i.e. as part of the Vendor-Specific-Application-Id AVP.

The Diameter accounting client function may reside in an SMF. The Diameter accounting client may send information to a DN-AAA server, which is identified during the DNN provisioning. The DN-AAA server may store this information and use it to automatically identify the user. This information can be trusted because the 3GPP network has authenticated the subscriber (i.e. USIM card and possibly other authentication methods).

The SMF may use the Diameter Accounting messages during QoS flow (e.g. QoS flow associated with the default QoS rule) establishment and termination procedures, respectively.

If the DN-AAA server is used for IPv4 address and/or IPv6 prefix assignment, then, upon reception of a Diameter Accounting-Request STOP message for all QoS flows associated to a PDU session defined by DNN and SUPI or GPSI, the DN-AAA server may make the associated IPv4 address and/or IPv6 prefix available for assignment.

When an IPv4 address and/or IPv6 prefix (including any additional IPv6 prefix of IPv6 multi-homing) is (re-)allocated or de-allocated (not causing the PDU session to be released) by using a method not via the DN-AAA server and if the SMF was required by the DN-AAA server to report such change during authentication procedure or by local configuration, the SMF shall, if applicable, use the accounting session that was established before to inform the DN-AAA server by sending Diameter Accounting-Request Interim-Update with the latest list of IPv4 address and/or IPv6 prefix(es).

When the SMF is notified by the UPF regarding the UE MAC address change (a new one is detected or a used one is inactive), if the SMF was required by the DN-AAA server to report such change during authentication procedure or by local configuration, the SMF shall, if applicable, use the accounting session that was established before to inform the DN-AAA server by sending Diameter Accounting-Request Interim-Update with the latest list of UE MAC addresses in use.

12.2 Message flows on N6 interface

12.2.1 Authentication, Authorization and Accounting procedures

When an SMF receives an initial access request (i.e. `Nsmf_PDUSession_CreateSMContext` request with type "Initial request") message for a given DNN, the SMF may (depending on the configuration for this DNN) send a Diameter DER message to a DN-AAA server. The DN-AAA server authenticates and authorizes the user by replying with an DEA message. Multi-round authentication using the DEA and DER messages may be used. If the DN-AAA server is also responsible for IPv4 address and/or IPv6 prefix allocation, the DN-AAA server shall return the allocated IPv4 address and/or IPv6 prefix in the DEA message.

For re-authentication and re-authorization, the SMF shall send a DER message to the DN-AAA server and the DN-AAA server shall authenticate and authorize the user by replying with an DEA message. Multi-round authentication using the DEA and DER messages may be used.

The SMF may initiate Diameter re-authorization procedures for the purpose of IPv4 address and/or IPv6 prefix allocation (or renew the lease). In this case, the SMF shall set the Session-Id to the value used in the initial request, the Auth-Request-Type AVP to "AUTHORIZE_ONLY" and the 3GPP-Allocate-IP-Type AVP to the type of IP address to be allocated in the AA-Request message sent to the AAA server. If the SMF is using DHCP signalling towards the UE and the DN-AAA server includes the Session-Timeout attribute in the Access-Accept, the SMF may use the Session-Timeout value as the DHCP lease time. The SMF shall not set the DHCPv4 lease time value higher than the Session-Timeout value. The SMF may renew the DHCP lease to the UE without re-authorization towards the DN-AAA server providing that the new lease expiry is no later than the Session-Timeout timer expiry. If the SMF wishes to extend the lease time beyond the current Session-Timeout expiry, it shall initiate a new AAA re-authorization.

Even if the SMF was not involved in user authentication, it may send a Diameter Accounting-Request (START) message to a DN-AAA server. If no Diameter session is already open for the same PDU session a Diameter session needs to be activated, otherwise the existing Diameter session is used to send the Accounting-Request (START). If accounting is used per QoS flow, the QFI will identify the particular bearer this accounting message refers to. This message contains parameters, e.g. the tuple which includes the user ID and IPv4 address and/or IPv6 prefix, to be used by application servers (e.g. WAP gateway) in order to identify the user. This message also indicates to the DN-AAA server that the user session has started.

If some external applications require Diameter Accounting-Request (START) information before they can process user packets, then the selected DNN (SMF) may be configured in such a way that the SMF drops user data until an Accounting-Answer (START) indicating success is received from the DN-AAA server. The SMF may wait for the Accounting-Answer (START) before sending the final authentication response message in `Namf_Communication_N1N2MessageTransfer` service operation. The SMF may reject the initial access request if the Accounting-Answer (START) is not received. The authentication and accounting servers may be separately configured for each DNN.

For IPv4 PDU type, if IPv4 address is allocated via DHCPv4 signalling between the UE and the DN-AAA after PDU session establishment, the SMF may wait to send the Accounting-Request START message until the UE receives its IPv4 address in a DHCPACK.

When the SMF receives a message indicating a QoS flow or PDU session release request and providing a Diameter Accounting-Request START message was sent previously, the SMF shall send a Diameter Accounting-Request (STOP) message to the DN-AAA server, which indicates the termination of this particular QoS flow or PDU session. The SMF shall immediately send the corresponding response (e.g. `Nsmf_PDUSession_UpdateSMContext` response) to the AMF, without waiting for an Accounting-Answer (STOP) message from the DN-AAA server.

If the last QoS flow of a PDU session is deactivated, the SMF shall additionally send an STR message to the DN-AAA server. The DN-AAA server shall reply with an STA message and shall deallocate the IPv4 address and/or IPv6 prefix initially allocated to the subscriber.

The following figure 12.2.1-1 is an example message flow to show the procedure of Diameter Authentication and Accounting between an SMF and a DN-AAA server:

1. UE initiates the PDU Session Establishment procedure, including authentication/authorization information.
2. The AMF sends `Nsmf_PDUSession_CreateSMContext` Request including the authentication/authorization information to the SMF and the SMF responds to the service operation.

According to the configuration in the SMF, step 6 to step 9 are executed before step 3 if the SMF needs to send an EAP-Request message to the UE.

3. If the N4 session has not been established before, the SMF triggers the N4 Session Establishment procedure to the UPF.
4. The SMF sends the DER message to the DN-AAA via the UPF, the message is forwarded from the SMF to the DN-AAA by the UPF in N4 user plane message.
- 5-10. The DN-AAA responds with the DEA message to the SMF via the UPF, the message is forwarded from the DN-AAA to the SMF by the UPF in N4 user plane message. The authentication/authorization information is further transferred to UE via Namf_Communication_N1N2MessageTransfer service and NAS SM Transport message. UE responds to the received authentication/authorization data and such information is transferred in NAS SM Transport message and Nsmf_PDUSession_UpdateSMContext service, then finally sent to the DN-AAA by the SMF, via the UPF, in the DER message.

NOTE: Step 5 to step 10 can be repeated depending on the authentication/authorization mechanism used (e.g. EAP-TLS).

11. The SMF receives final result of authentication/authorization from the DN-AAA in the DEA message, via the UPF.
12. The SMF requests to start accounting by sending the Accounting-Request (START) message to the DN-AAA via the UPF.
13. The SMF proceeds with the PDU session establishment procedure and includes the authentication/authorization information in Namf_Communication_N1N2MessageTransfer service.
14. The DN-AAA responds with the Accounting-Response (START) message. The SMF may wait for the Accounting-Response (START) before sending the Namf_Communication_N1N2MessageTransfer request in step 13.
15. The AMF sends the NAS PDU Session Establishment Request with the authentication/authorization information to the UE.
16. The UE sends a NAS message Deregistration Request to the AMF.
17. The AMF sends Nsmf_PDUSession_ReleaseSMContext Request to the SMF and the SMF responds to the service operation.
- 18-19. The AMF requests to stop accounting by sending the Accounting-Request (STOP) message to the DN-AAA via the UPF and the DN-AAA responds with the Accounting-Response (STOP) message.

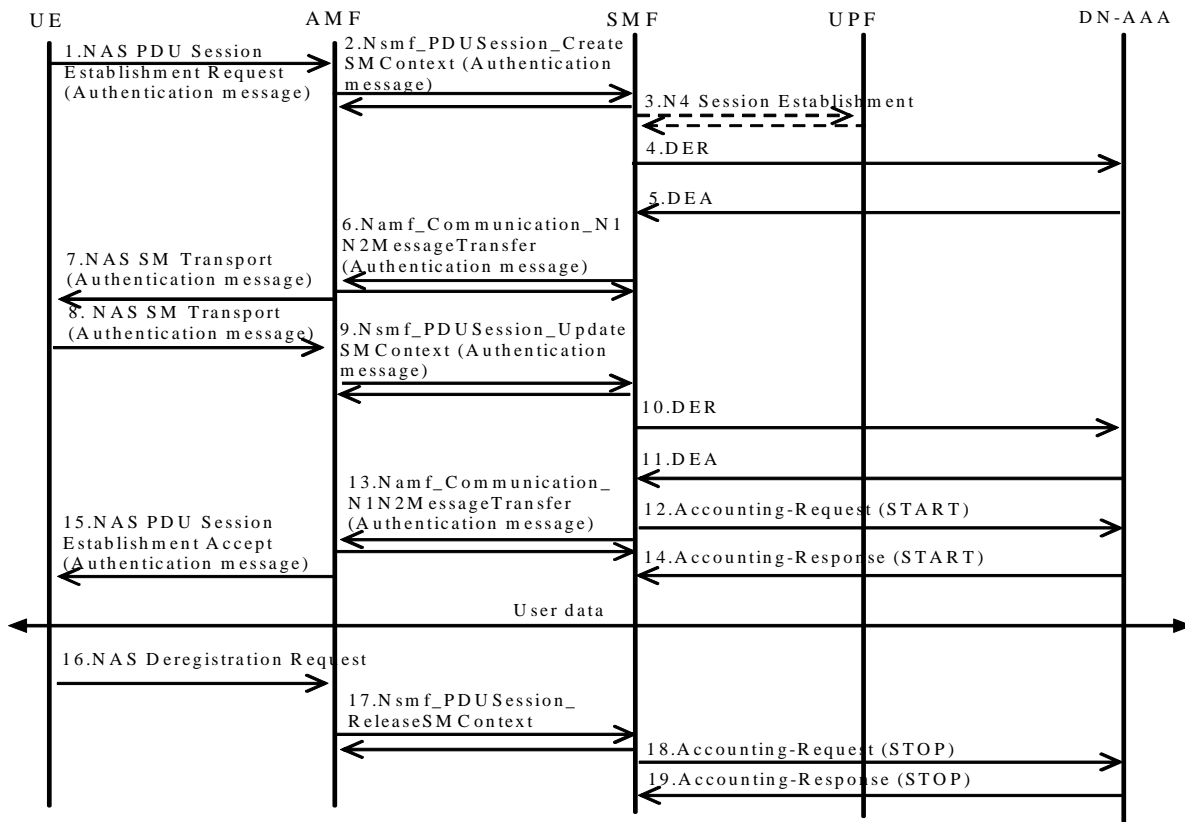

Figure 12.2.1-1: Diameter Authentication and Accounting example (successful case)

12.2.2 Accounting Update

During the life of a QoS flow some information related to this QoS flow may change. The SMF may send an Accounting Request (Interim) to the DN-AAA server upon occurrence of a chargeable event, e.g. RAT change or QoS change. Interim updates are also used when the IPv4 address and/or IPv6 prefix is allocated/released/re-allocated.

When the SMF receives a signalling request (i.e. Nsmf_PDUSession_UpdateSMContext) that indicates the occurrence of one of these chargeable events, the SMF may send an Accounting Request Interim-Update to the DN-AAA server to update the necessary information related to this QoS flow. It is not necessary for the SMF to wait for the Diameter Accounting Answer message from the DN-AAA server before sending the response for the triggering signalling message (i.e. Namf_Communication_N1N2MessageTransfer). The SMF may delete the QoS flow if the Accounting Answer is not received from the DN-AAA server.

The SMF may also send interim updates at the expiry of an operator configured time limit.

Figure 12.2.2-1 is an example message flow to show the procedure of Diameter accounting update, messages between the SMF and DN-AAA are forwarded by the UPF in N4 user plane message.

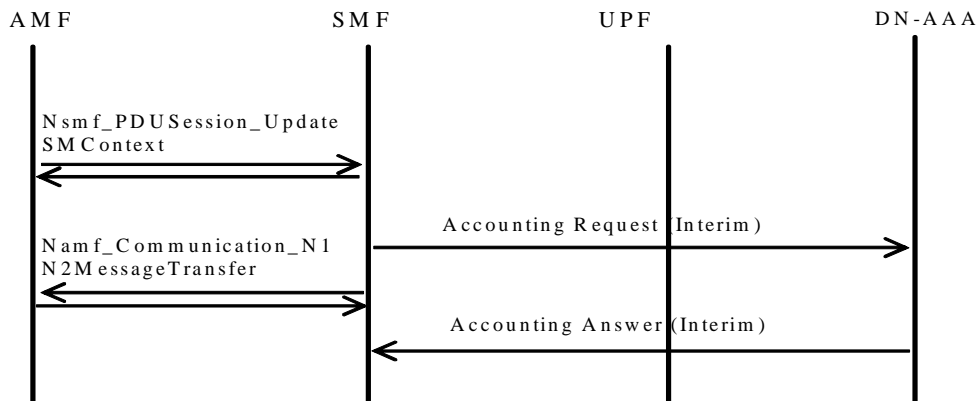

Figure 12.2.2-1: Diameter accounting update

12.2.3 DN-AAA initiated QoS flow termination

Diameter is used as the protocol between the SMF and the DN-AAA server or proxy for applications (e.g. MMS) to deliver information related to user session. However some IP applications could need to interwork with the SMF to release the corresponding resource (e.g. terminate a particular QoS flow). For this purpose, the DN-AAA server or proxy may send a Diameter ASR along with the QoS flow Identifier in 3GPP-NSAPI, if available, to identify the particular QoS flow to be terminated to the SMF. The SMF should react by deleting the corresponding QoS flow and reply with ASA. If the SMF deletes the corresponding QoS flow, it is not necessary for the SMF to wait for the response (i.e. Nsmf_PDUSession_UpdateSMContext) from the AMF before sending the ASA to the DN-AAA server.

The absence of the QoS flow Identifier in the Diameter ASR message indicates to the SMF that all QoS flows for this particular user and sharing the same user session shall be deleted. The QoS flows belonging to the same PDU session are identified by the Diameter Session-Id. If a user has the same user IP address for different sets of QoS flows towards different networks, only the QoS flows linked to the one identified by the Diameter Session-Id shall be deleted.

Figure 12.2.3-1 is an example message flow to show the procedure of DN-AAA initiated QoS flow termination, messages between the SMF and DN-AAA are forwarded by the UPF in N4 user plane message.

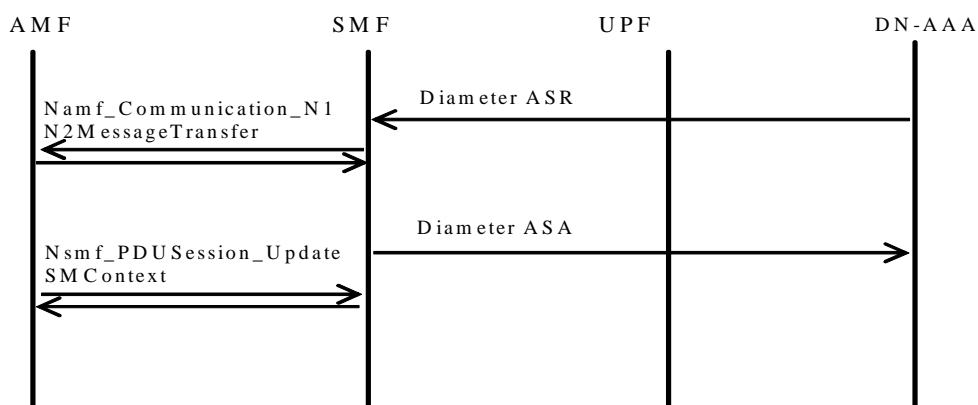

Figure 12.2.3-1: DN-AAA initiated QoS flow termination with Diameter

12.2.4 DN-AAA initiated re-authorization

Some IP applications could need to interwork with the SMF to update the PDU session authorization attributes. For this purpose, the DN-AAA server or proxy may send a Diameter RAR to the SMF. On receipt of the RAR from the DN-AAA server, the SMF shall update the corresponding PDU session authorization attributes and reply with RAA. DN-AAA may also use such procedure to revoke the authorization of a PDU session, or to update the authorization data (e.g. allowed UE MAC addresses).

If the SMF updates/deletes the corresponding PDU session, it is not necessary for the SMF to wait for Nsmf_PDUSession_UpdateSMContext from the AMF before sending the RAA to the DN-AAA server.

Figure 12.2.4-1 is an example message flow to show the procedure of DN-AAA initiated re-authorization, messages between the SMF and DN-AAA are forwarded by the UPF in N4 user plane message.

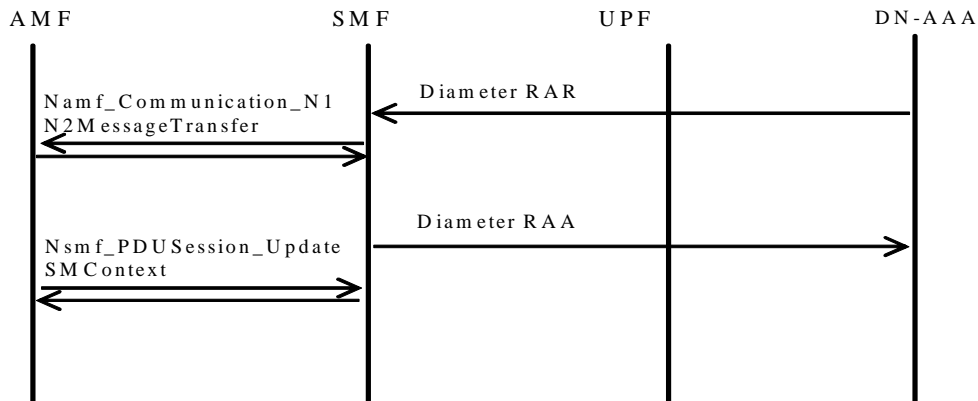

Figure 12.2.4-1: DN-AAA initiated re-authorization with Diameter

12.3 N6 specific AVPs

There is no specific AVP defined in the present release.

12.4 N6 re-used AVPs

12.4.0 General

Table 12.4-1 lists the Diameter AVPs re-used by the N6 reference point from existing Diameter Applications, reference to the respective specifications and a short description of the usage within the N6 reference point.

Table 12.4-1: N6 re-used Diameter AVPs

Attribute Name	AVP Code	Section defined	Value Type (NOTE 2)	AVP Flag rules (NOTE 1)				May Encr.	Appli cabili ty
				Must	May	Should not	Must not		
3GPP-IMSI	1	3GPP TS 29.061 [5] (NOTE 3)	UTF8String	V	P		M	Y	
3GPP-Charging-Id	2	3GPP TS 29.061 [5] (NOTE 3)	OctetString	V	P		M	Y	
3GPP-PDP-Type	3	3GPP TS 29.061 [5] (NOTE 3)	Enumerated	V	P		M	Y	
3GPP-CG-Address	4	3GPP TS 29.061 [5] (NOTE 3)	OctetString	V	P		M	Y	
3GPP-GPRS-Negotiated-QoS-Profile	5	3GPP TS 29.061 [5] (NOTE 3)	UTF8String	V	P		M	Y	
3GPP-SGSN-Address	6	3GPP TS 29.061 [5] (NOTE 3)	OctetString	V	P		M	Y	
3GPP-GGSN-Address	7	3GPP TS 29.061 [5] (NOTE 3)	OctetString	V	P		M	Y	
3GPP-IMSI-MCC-MNC	8	3GPP TS 29.061 [5] (NOTE 3)	UTF8String	V	P		M	Y	
3GPP-GGSN-MCC-MNC	9	3GPP TS 29.061 [5] (NOTE 3)	UTF8String	V	P		M	Y	
3GPP-NSAPI	10	3GPP TS 29.061 [5] (NOTE 3)	OctetString	V	P		M	Y	
3GPP-Selection-Mode	12	3GPP TS 29.061 [5] (NOTE 3)	UTF8String	V	P		M	Y	
3GPP-Charging-Characteristics	13	3GPP TS 29.061 [5] (NOTE 3)	UTF8String	V	P		M	Y	
3GPP-CG-Ipv6-Address	14	3GPP TS 29.061 [5] (NOTE 3)	OctetString	V	P		M	Y	
3GPP-SGSN-Ipv6-Address	15	3GPP TS 29.061 [5] (NOTE 3)	OctetString	V	P		M	Y	
3GPP-GGSN-Ipv6-Address	16	3GPP TS 29.061 [5] (NOTE 3)	OctetString	V	P		M	Y	
3GPP-Ipv6-DNS-Servers	17	3GPP TS 29.061 [5] (NOTE 3)	OctetString	V	P		M	Y	
3GPP-SGSN-MCC-MNC	18	3GPP TS 29.061 [5] (NOTE 3)	UTF8String	V	P		M	Y	
3GPP-IMEISV	20	3GPP TS 29.061 [5] (NOTE 3)	OctetString	V	P		M	Y	
3GPP-RAT-Type	21	3GPP TS 29.061 [5] (NOTE 3)	OctetString	V	P		M	Y	
3GPP-User-Location-Info	22	3GPP TS 29.061 [5] (NOTE 3)	OctetString	V	P		M	Y	
3GPP-MS-TimeZone	23	3GPP TS 29.061 [5] (NOTE 3)	OctetString	V	P		M	Y	
3GPP-Packet-Filter	25	3GPP TS 29.061 [5] (NOTE 3)	OctetString	V	P		M	Y	
3GPP-Negotiated-DSCP	26	3GPP TS 29.061 [5] (NOTE 3)	OctetString	V	P		M	Y	
3GPP-Allocate-IP-Type	27	3GPP TS 29.061 [5] (NOTE 3)	OctetString	V	P		M	Y	
External-Identifier	28	3GPP TS 29.061 [5] (NOTE 3)	OctetString	V	P		M	Y	
3GPP-User-Location-Info-Time	30	3GPP TS 29.061 [5] (NOTE 3)	OctetString	V	P		M	Y	
3GPP-Notification	110	11.3.1	OctetString	V	P		M	Y	
3GPP-UE-MAC-Address	111	11.3.1	OctetString	V	P		M	Y	
3GPP-Authorization-Reference	112	11.3.1	OctetString	V	P		M	Y	

3GPP-Policy-Reference	113	11.3.1	OctetString	V	P		M	Y	
3GPP-Session-AMBR	114	11.3.1	OctetString	V	P		M	Y	
3GPP-NAI	115	11.3.1	OctetString	V	P		M	Y	
3GPP-Session-AMBR-v2	116	11.3.1	OctetString	V	P		M	Y	eSessionAMBR
Supported-Features	628	3GPP TS 29.229 [41]	Grouped	V	M			N	
<p>NOTE 1: The AVP header bit denoted as 'M', indicates whether support of the AVP is required. The AVP header bit denoted as 'V', indicates whether the optional Vendor-ID field is present in the AVP header. For further details, see IETF RFC 6733 [24].</p> <p>NOTE 2: The value types are defined in IETF RFC 6733 [24].</p> <p>NOTE 3: The use of Radius VSA as a Diameter vendor AVP is described in Diameter NASREQ (IETF RFC 7155 [23]) and the P flag may be set.</p>									

NOTE 1: Attribute 3GPP-CAMEL-Charging-Info (24), TWAN-Identifier (29) and 3GPP-Secondary-RAT-Usage (31) are not applicable for 5G in the present specification.

NOTE 2: Table 11.3-2 lists the differences between the RADIUS VSAs used in 5G and the VSAs defined in subclause 16.4.7 of 3GPP TS 29.061 [5].

12.4.1 Use of the Supported-Features AVP on the N6 reference point

The Supported-Features AVP is used during session establishment to inform the destination host about the required and optional features that the origin host supports. The client shall, in the first request in a Diameter session indicate the set of supported features. The server shall, in the first answer within the Diameter session indicate the set of features that it has in common with the client and that the server shall support within the same Diameter session. Any further command messages shall always be compliant with the list of supported features indicated in the Supported-Features AVPs during session establishment. Features that are not advertised as supported shall not be used to construct the command messages for that Diameter session. Unless otherwise stated, the use of the Supported-Features AVP on the N6 reference point shall be compliant with the requirements for dynamic discovery of supported features and associated error handling on the Cx reference point as defined in clause 7.2.1 of 3GPP TS 29.229 [41].

The base functionality for the N6 reference point is the 3GPP Rel-15 standard and a feature is an extension to that functionality. If the origin host does not support any features beyond the base functionality, the Supported-Features AVP may be absent from the N6 commands. As defined in clause 7.1.1 of 3GPP TS 29.229 [41], when extending the application by adding new AVPs for a feature, the new AVPs shall have the M bit cleared and the AVP shall not be defined mandatory in the command ABNF.

As defined in 3GPP TS 29.229 [41], the Supported-Features AVP is of type grouped and contains the Vendor-Id, Feature-List-ID and Feature-List AVPs. On the N6 reference point, the Supported-Features AVP is used to identify features that have been defined by 3GPP and hence, for features defined in this document, the Vendor-Id AVP shall contain the vendor ID of 3GPP (10415). If there are multiple feature lists defined for the N6 reference point, the Feature-List-ID AVP shall differentiate those lists from one another.

On receiving an initial request application message, the destination host shall act as defined in clause 7.2.1 of 3GPP TS 29.229 [41].

Once the SMF and DN-AAA have negotiated the set of supported features during session establishment, the set of common features shall be used during the lifetime of the Diameter session.

The table below defines the features applicable to the N6 interfaces for the feature lists with a Feature-List-ID of 1.

Table 12.4.1-1: Features of Feature-List-ID 1 used in N6

Feature bit	Feature	M/O	Description
0	eSessionAMBR	M	This feature indicates the support of enhanced Session AMBR function. If supported, the DN-AAA authorizes DL and/or UL Session AMBR separately.
Feature bit: The order number of the bit within the Feature-List AVP where the least significant bit is assigned number "0". Feature: A short name that can be used to refer to the bit and to the feature, e.g. "5GC". M/O: Defines if the implementation of the feature is mandatory ("M") or optional ("O") in this 3GPP Release. Description: A clear textual description of the feature.			

12.5 N6 specific Experimental-Result-Code AVP

Diameter Base IETF RFC 6733 [24] defines a number of Result-Code AVP values that are used to report protocol errors and how those are used. Those procedures and values apply for the present specification.

Due to the N6 specific AVPs, new application results can occur and the Experimental-Result AVP is used to transfer the 3GPP-specific result codes. The Experimental-Result AVP is a grouped AVP containing the Vendor-Id AVP set to the value of 3GPP's vendor identifier (10415) and an Experimental-Result-Code AVP.

The following N6 specific Experimental-Result-Code value is defined:

DIAMETER_QOS_FLOW_DELETION_INDICATION (2421)

For SMF this is an indication to the server that the requested 5G QoS flow or PDU session has been deleted.

12.6 N6 Diameter messages

12.6.1 General

This clause describes the N6 Diameter messages.

The relevant AVPs that are of use for the N6 interface are detailed in this subclause. Other Diameter AVPs as defined in IETF RFC 4072 [25] and IETF RFC 7155 [23], even if their AVP flag rules are marked with "M", are not required for being compliant with the current specification.

Diameter messages as defined in subclause 16.4 of 3GPP TS 29.061 [5] are re-used in 5G with the following differences:

- SMF replaces GGSN/P-GW.
- 5G QoS flow replaces IP-CAN/EPS bearer and PDU session replaces IP-CAN session.
- N6 replaces Gi/Sgi.

NOTE: N6 re-used and specific AVPs are specified in subclause 12.3 and subclause 12.4.

- 3GPP-NAI AVP may be included in the AAR and ACR command.
- Multiple 3GPP-UE-MAC-Address AVPs may be included in the AAR and ACR command.
- Acct-Application-Id AVP shall be included in the ACR and ACA command as specified in IETF RFC 7155 [23].
- Additional Diameter messages needed for 5G compared to the 3GPP TS 29.061 [5] are described in the following subclauses.
- Multiple Supported-Features AVPs may be included in the ACR and ACA command.

12.6.2 DER Command

The DER command, defined in IETF RFC 4072 [25], is indicated by the Command-Code field set to 268 and the 'R' bit set in the Command Flags field. It is sent by the SMF to the DN-AAA server upon reception of an initial access request (e.g. Nsmf_PDUSession_CreateSMContext) message for a given DNN to request user authentication and authorization.

The relevant AVPs that are of use for the N6 interface are detailed in the ABNF description below. Other valid AVPs for this command are not used for N6 purposes and should be ignored by the receiver or processed according to the relevant specifications.

The bold marked AVPs in the message format indicate new optional AVPs for N6, or modified existing AVPs.

Message Format:

```
<Diameter-EAP-Request> ::= < Diameter Header: 268, REQ, PXY >
    < Session-Id >
    { Auth-Application-Id }
    { Origin-Host }
    { Origin-Realm }
    { Destination-Realm }
    { Auth-Request-Type }
    [ Destination-Host ]
    [ NAS-Port ]
    [ NAS-Port-Id ]
    [ NAS-Port-Type ]
    [ Origin-State-Id ]
    [ Port-Limit ]
    [ User-Name ]
    { EAP-Payload }
    [ EAP-Key-Name ]
    [ Service-Type ]
    [ Authorization-Lifetime ]
    [ Auth-Grace-Period ]
    [ Auth-Session-State ]
    [ Callback-Number ]
    [ Called-Station-Id ]
    [ Calling-Station-Id ]
    [ Originating-Line-Info ]
    [ Connect-Info ]
    * [ Framed-Compression ]
    [ Framed-Interface-Id ]
    [ Framed-IP-Address ]
    * [ Framed-Ipv6-Prefix ]
    * [ Delegated-Ipv6-Prefix ]
    [ Framed-IP-Netmask ]
    [ Framed-MTU ]
    [ Framed-Protocol ]
    * [ Tunneling ]
    * [ Proxy-Info ]
    * [ Route-Record ]
    [ External-Identifier ]
    [ 3GPP-IMSI ]
    [ 3GPP-NAI ]
    * [ 3GPP-UE-MAC-Address ]
    [ 3GPP-Charging-ID ]
    [ 3GPP-PDP-Type ]
    [ 3GPP-CG-Address ]
    [ 3GPP-GPRS-Negotiated-QoS-Profile ]
    [ 3GPP-SGSN-Address ]
    [ 3GPP-GGSN-Address ]
    [ 3GPP-IMSI-MCC-MNC ]
    [ 3GPP-GGSN-MCC-MNC ]
    [ 3GPP-NSAPI ]
    [ 3GPP-Selection-Mode ]
    [ 3GPP-Charging-Characteristics ]
    [ 3GPP-CG-Ipv6-Address ]
    [ 3GPP-SGSN-Ipv6-Address ]
    [ 3GPP-GGSN-Ipv6-Address ]
    [ 3GPP-SGSN-MCC-MNC ]
    [ 3GPP-User-Location-Info ]
    [ 3GPP-RAT-Type ]
    [ 3GPP-Negotiated-DSCP ]
    [ 3GPP-Allocate-IP-Type ]
    [ TWAN-Identifier ]
    * [ Supported-Features ]
```

* [AVP]

12.6.3 DEA Command

The DEA command, defined in IETF RFC 4072 [25], is indicated by the Command-Code field set to 268 and the 'R' bit cleared in the Command Flags field. It is sent by the DN-AAA server to the SMF in response to the DER command.

The relevant AVPs that are of use for the N6 interface are detailed in the ABNF description below. Other valid AVPs for this command are not used for N6 purposes and should be ignored by the receiver or processed according to the relevant specifications.

The bold marked AVPs in the message format indicate new optional AVPs for N6, or modified existing AVPs.

Message Format:

```
<Diameter-EAP-Answer> ::= < Diameter Header: 268, PXY >
    < Session-Id >
    { Auth-Application-Id }
    { Auth-Request-Type }
    { Result-Code }
    { Origin-Host }
    { Origin-Realm }
    [ User-Name ]
    [ EAP-Payload ]
    [ EAP-Reissued-Payload ]
    [ EAP-Master-Session-Key ]
    [ EAP-Key-Name ]
    [ Multi-Round-Time-Out ]
    [ Accounting-EAP-Auth-Method ]
    [ Service-Type ]
    * [ Class ]
    [ Acct-Interim-Interval ]
    [ Error-Message ]
    [ Error-Reporting-Host ]
    [ Failed-AVP ]
    [ Idle-Timeout ]
    [ Authorization-Lifetime ]
    [ Auth-Grace-Period ]
    [ Auth-Session-State ]
    [ Re-Auth-Request-Type ]
    [ Session-Timeout ]
    * [ Reply-Message ]
    [ Origin-State-Id ]
    * [ Filter-Id ]
    [ Port-Limit ]
    [ Callback-Id ]
    [ Callback-Number ]
    * [ Framed-Compression ]
    [ Framed-Interface-Id ]
    [ Framed-IP-Address ]
    * [ Framed-Ipv6-Prefix ]
    [ Framed-Ipv6-Pool ]
    * [ Framed-Ipv6-Route ]
    * [ Delegated-Ipv6-Prefix ]
    [ Framed-IP-Netmask ]
    * [ Framed-Route ]
    [ Framed-Pool ]
    [ Framed-IPX-Network ]
    [ Framed-MTU ]
    [ Framed-Protocol ]
    [ Framed-Routing ]
    * [ NAS-Filter-Rule ]
    * [ QoS-Filter-Rule ]
    * [ Tunneling ]
    * [ Redirect-Host ]
    [ Redirect-Host-Usage ]
    [ Redirect-Max-Cache-Time ]
    * [ Proxy-Info ]
    * [ External-Identifier ]
    [ 3GPP-Ipv6-DNS-Servers ]
    [ 3GPP-Notification ]
    0*16 [ 3GPP-UE-MAC-Address ]
    [ 3GPP-Authorization-Reference ]
    [ 3GPP-Policy-Reference ]
    [ 3GPP-Session-AMBR ]
    [ 3GPP-Session-AMBR-v2 ]
```

```
* [ Supported-Features ]
* [ AVP ]
```

12.6.4 RAR Command

The RAR command, defined in IETF RFC 7155 [23], is indicated by the Command-Code field set to 258 and the 'R' bit set in the Command Flags field. It is sent by the DN-AAA server to the SMF to initiate re-authorization service.

The relevant AVPs that are of use for the N6 interface are detailed in the ABNF description below. Other valid AVPs for this command are not used for N6 purposes and should be ignored by the receiver or processed according to the relevant specifications.

The bold marked AVPs in the message format indicate new optional AVPs for N6, or modified existing AVPs.

Message Format:

```
<RA-Request> ::= < Diameter Header: 258, REQ, PXY >
    < Session-Id >
    { Origin-Host }
    { Origin-Realm }
    { Destination-Realm }
    [ Destination-Host ]
    { Auth-Application-Id }
    { Re-Auth-Request-Type }
    [ User-Name ]
    [ Origin-State-Id ]
    [ NAS-Port ]
    [ NAS-Port-Id ]
    [ NAS-Port-Type ]
    [ Service-Type ]
    [ Framed-IP-Address ]
    [ Framed-Ipv6-Prefix ]
    [ Framed-Interface-Id ]
    [ Called-Station-Id ]
    [ Calling-Station-Id ]
    [ Originating-Line-Info ]
    [ Acct-Session-Id ]
    * [ Class ]
    [ Reply-Message ]
    * [ Proxy-Info ]
    * [ Route-Record ]
    0*16 [ 3GPP-UE-MAC-Address ]
    [ 3GPP-Authorization-Reference ]
    [ 3GPP-Policy-Reference ]
    [ 3GPP-Session-AMBR ]
    [ 3GPP-Session-AMBR-v2 ]
    * [ AVP ]
```

12.6.5 RAA Command

The RAA command, defined in IETF RFC 7155 [23], is indicated by the Command-Code field set to 258 and the 'R' bit set in the Command Flags field. It is sent by the SMF to the DN-AAA server in response to the RAR command.

The relevant AVPs that are of use for the N6 interface are detailed in the ABNF description below. Other valid AVPs for this command are not used for N6 purposes and should be ignored by the receiver or processed according to the relevant specifications.

Message Format:

```
<RA-Answer> ::= < Diameter Header: 258, PXY >
    < Session-Id >
    { Result-Code }
    { Origin-Host }
    { Origin-Realm }
    [ User-Name ]
    [ Origin-State-Id ]
    [ Error-Message ]
    [ Error-Reporting-Host ]
    [ Failed-AVP ]
    * [ Redirect-Host ]
    [ Redirect-Host-Usage ]
    [ Redirect-Max-Cache-Time ]
    [ Service-Type ]
    [ Idle-Timeout ]
```

```

    [ Authorization-Lifetime ]
    [ Auth-Grace-Period ]
    [ Re-Auth-Request-Type ]
*   [ Class ]
*   [ Reply-Message ]
*   [ Proxy-Info ]
*   [ AVP ]

```

13 Interworking with IMS

13.1 General

Interworking with the IP Multimedia Core Network Subsystem (IMS) puts specific requirements on the SMF.

The SMF shall use the following mechanisms to support the interworking with the IMS:

- the P-CSCF discovery;
- N7 interface for the policy and charging control of QoS flows for IMS media flows; and
- the P-CSCF restoration.

These mechanisms are however not restricted only to the interworking with the IMS and may be used for other services that could benefit from these mechanisms.

If the PDU Session is used for IMS (identified by DNN), the SMF shall not modify the fields Type of Service (IPv4) and Traffic Class (IPv6).

NOTE: The P-CSCF can support paging policy differentiation for different traffic or service types over NG-RAN by marking the fields Type of Service (IPv4) and Traffic Class (IPv6) (see subclause L.3.2.4 of 3GPP TS 24.229 [13]).

13.2 IMS interworking Model

13.2.1 Introduction

The signalling interface between the UE and the P-CSCF is a logical interface, i.e. it uses 5GC as a QoS flow. The Npcf_SMPolicyControl services, offered via N7 interface, are used for network communication between the SMF and the PCF. For a description of the IMS architecture, refer to 3GPP TS 23.228 [12].

13.2.2 IMS specific configuration in the SMF

The SMF shall have a list of preconfigured addresses of signalling servers (the P-CSCF servers). This list shall be provided to the UE at PDU session establishment. It shall be possible to preconfigure the list of preconfigured addresses of signalling servers per DNN.

The SMF/UPF may have the locally preconfigured packet filters, and/or the applicable PCC rules, to be applied on the QoS flow. The packet filters shall filter up-link and down-link packets, and shall only allow traffic to/from the signalling servers and to the DNS and the DHCP servers. It shall be possible to locally preconfigure the packet filters per DNN.

It shall be possible to enable/disable the use of the services offered via N7 interface per DNN.

The SMF shall support IPv4 and/or IPv6 addresses and protocol for IMS signalling and IMS QoS flows.

The methods for the UE to discover the P-CSCF address(es) may vary depending on the access technology that the UE is on. The details of the P-CSCF discovery mechanisms for various accesses are specified in 3GPP TS 23.228 [12] and 3GPP TS 24.229 [13]. The P-CSCF discovery mechanisms are:

- a 5GC procedure for the P-CSCF discovery;
- via DHCP servers i.e. the SMF shall provide the functionality of a DHCP relay agent; and

- if the UE has a P-CSCF FQDN locally configured and request the DNS IP address(es) from the SMF (via 5GC mechanism or DHCP procedures), the SMF shall be able to provide DNS IP address(es) to the UE.

The SMF shall have similar functional support depending on the P-CSCF discovery methods supported by the UE on the access technology. For example, for the UE in 3GPP 5G access network the SMF shall have DHCP server function towards the UE while acting as a DHCP client towards external DHCP server, if the SMF is configured to request DNS and/or P-CSCF IP addresses from the external DHCP servers.

The SMF shall be able to deliver DNS and/or P-CSCF addresses to the UE if requested by the UE via the 5G network or via DHCP procedures using the relevant DHCP options for IPv4/IPv6 DNS and SIP servers (see IETF RFC 2132 [14], IETF RFC 3361 [15], IETF RFC 3646 [16] and IETF RFC 3319 [17]).

On DNNs providing IMS services, the information advertised in Router Advertisements from the SMF to the UEs shall be configured in the same manner as for other DNNs providing IPv6 services except that the "O-flag" shall be set.

The "O-flag" shall be set in IPv6 Router Advertisement messages sent by the SMF for DNNs used for IMS services. This will trigger a DHCP capable UE to start a DHCPv6 session to retrieve server addresses and other configuration parameters. The UE which doesn't support DHCP shall ignore the "O-flag" and shall request the IMS specific configuration (e.g. the P-CSCF address) via other discovery methods supported in the UE (i.e. via locally configured P-CSCF address/FQDN in the UE or via 5G procedure, if applicable).

The SMF shall have configurable policy rules for controlling QoS flows used for signalling.

13.2.3 IMS specific procedures in the SMF

13.2.3.1 Provisioning of Signalling Server Address

At a PDU Session establishment procedure related to the IMS, the SMF shall support the capability to send the P-CSCF address(es) to the UE. The P-CSCF address information is sent by the visited SMF if LBO is used. For Home routed, the P-CSCF address information is sent by the SMF in the HPLMN. The P-CSCF address(es) shall be sent transparently through the AMF, and in case of Home Routed also through the SMF in the VPLMN.

NOTE 1: The SMF is located in the VPLMN if LBO is used.

NOTE 2: Other options to provide the P-CSCF address(es) to the UE as defined in 3GPP TS 23.228 [12] is not excluded.

NOTE 3: A PDU session for IMS is identified by "APN" or "DNN".

13.2.3.2 Failure of Signalling Server Address

If the SMF detects a failure:

- upon receiving the N4 session report from the UPF for the monitored P-CSCF address being used by the UE (as specified in 3GPP TS 23.380 [38], subclause 5.8.3); or
- upon receiving a P-CSCF restoration indication from the UDM or the PCF,

then the SMF shall act as specified in 3GPP TS 23.380 [38], subclause 5.8.

14 Interworking with DN (Ethernet)

When support of Ethernet PDU type data is provided at the N6 interface, the SMF and UPF may support ARP proxying as specified in IETF RFC 1027 [35] and/or IPv6 Neighbour Solicitation Proxying as specified in IETF RFC 4861 [33] functionality. Based on operator configuration, during the PDU session establishment, the SMF may request the UPF acting as the PDU Session Anchor to proxy ARP/IPv6 Neighbour Solicitation or to forward the ARP/IPv6 Neighbour Solicitation traffic from the UPF to the SMF.

Ethernet Preamble, Start Frame Delimiter (SFD) and Frame Check Sequence (FCS) are not sent over 5GS:

- For UL traffic the UE strips the Preamble, SFD and FCS from the Ethernet frame, those fields shall be added by the UPF acting as the PDU Session Anchor.
- For DL traffic the UPF acting as the PDU Session Anchor shall strip the Preamble, SFD and FCS from the Ethernet frame.

IP address is not allocated by the SMF to the UE for this PDU Session. The UPF shall store the MAC addresses, received from the UE, and associate those with the appropriate PDU Session.

NOTE 1: The UE can operate in bridge mode with regard to a LAN it is connecting to the 5GS, thus different MAC addresses can be used as source address of different frames sent UL over a single PDU Session (and destination MAC address of different frames sent DL over the same PDU Session)

NOTE 2: Entities on the LAN connected to the 5GS by the UE can have an IP address allocated by the external DN, but the IP layer is considered as an application layer which is not part of the Ethernet PDU Session.

NOTE 3: In this Release of the specification, only the UE connected to the 5GS is authenticated, not the devices behind such UE.

When a PDU Session of Ethernet PDU type is authorized by a DN, the DN-AAA server may, as part of authorization data, provide the SMF with a list of allowed MAC addresses (maximum 16) for this PDU Session. When such a list has been provided for a PDU Session, the SMF sets corresponding filtering rules in the UPF(s) acting as PDU Session Anchor for the PDU Session and the UPF discards any UL traffic that does not contain any of these MAC addresses as a source address.

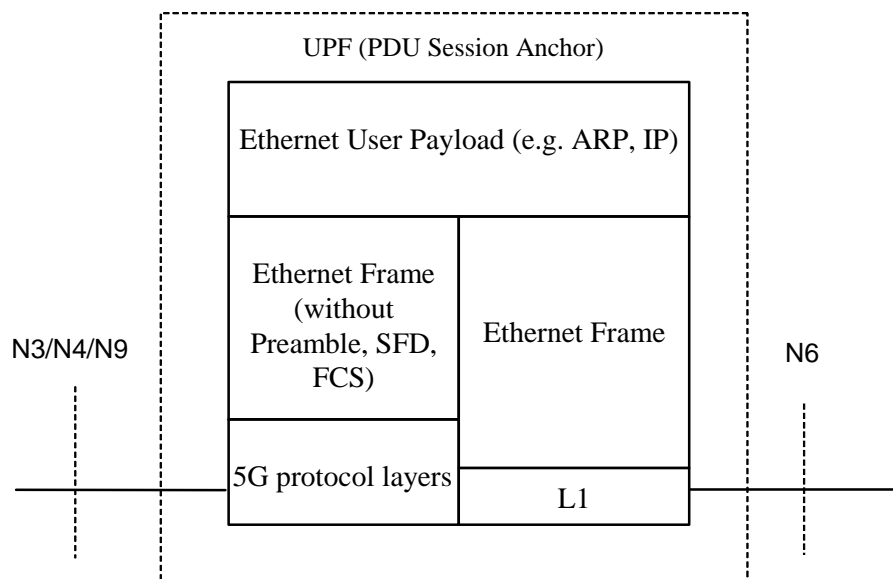

Figure 14-1: Protocol stacks for Ethernet PDU type data (user plane) for N6 reference point

Annex A (informative): Change history

Change history							
Date	TSG #	TSG Doc.	CR	Rev	Cat	Subject/Comment	New
2017-10						TS skeleton of interworking between 5G Network and external Data Networks	0.0.0
2017-11	CT3#92	C3-175380				Update after CT3#92; inclusion of C3-175241, C3-175286, C3-175287, C3-175288, C3-175289.	0.1.0
2017-12	CT3#93	C3-176400				Update after CT3#93; TS number changed to 29.561 and inclusion of C3-176265, C3-176266.	0.2.0
2018-01	CT3#94	C3-180365				Update after CT3#94; inclusion of C3-180264, C3-180126, C3-180348, C3-180129, C3-180130.	0.3.0
2018-03	CT3#95	C3-181371				Update after CT3#95; inclusion of C3-181043, C3-181044, C3-181261, C3-181047, C3-181099.	0.4.0
2018-04	CT3#96	C3-182519				Update after CT3#96; inclusion of C3-182183, C3-182381, C3-182382, C3-182383.	0.5.0
2018-06	CT3#97	C3-183917				Update after CT3#97; inclusion of C3-183308, C3-183309, C3-183310, C3-183318, C3-183319, C3-183717, C3-183321, C3-183325, C3-183326, C3-183327, C3-183729.	0.6.0
2018-06	CT#80	CP-181027				TS sent to plenary for approval	1.0.0
2018-06	CT#80	CP-181027				TS approved by plenary	15.0.0
2018-09	CT#81	CP-182015	0001	2	F	Add multihoming support in IPv6 stateless address autoconfiguration	15.1.0
2018-09	CT#81	CP-182015	0002	1	F	IP address change	15.1.0
2018-09	CT#81	CP-182015	0003	1	F	MAC address change	15.1.0
2018-09	CT#81	CP-182015	0004	-	F	Final result of authentication/authorization from the DN-AAA – Receiving entity	15.1.0
2019-06	CT#84	CP-191188	0006	4	F	Correct session AMBR	15.2.0
2019-09	CT#85	CP-192150	0007		F	3GPP VSA presence for RADIUS	15.3.0
2019-09	CT#85	CP-192150	0011		F	Correct DN-AAA authentication	15.3.0
2019-09	CT#85	CP-192150	0013	1	F	Correct DN-AAA authorization	15.3.0

History

Document history		
V15.0.0	July 2018	Publication
V15.1.0	October 2018	Publication
V15.2.0	July 2019	Publication
V15.3.0	October 2019	Publication