

ETSI TS 129 572 V17.6.0 (2022-10)



**5G;
5G System;
Location Management Services;
Stage 3
(3GPP TS 29.572 version 17.6.0 Release 17)**



Reference

RTS/TSGC-0429572vh60

Keywords

5G

ETSI

650 Route des Lucioles
F-06921 Sophia Antipolis Cedex - FRANCE

Tel.: +33 4 92 94 42 00 Fax: +33 4 93 65 47 16

Siret N° 348 623 562 00017 - APE 7112B
Association à but non lucratif enregistrée à la
Sous-Préfecture de Grasse (06) N° w061004871

Important notice

The present document can be downloaded from:

<http://www.etsi.org/standards-search>

The present document may be made available in electronic versions and/or in print. The content of any electronic and/or print versions of the present document shall not be modified without the prior written authorization of ETSI. In case of any existing or perceived difference in contents between such versions and/or in print, the prevailing version of an ETSI deliverable is the one made publicly available in PDF format at www.etsi.org/deliver.

Users of the present document should be aware that the document may be subject to revision or change of status.

Information on the current status of this and other ETSI documents is available at

<https://portal.etsi.org/TB/ETSIDeliverableStatus.aspx>

If you find errors in the present document, please send your comment to one of the following services:

<https://portal.etsi.org/People/CommitteeSupportStaff.aspx>

If you find a security vulnerability in the present document, please report it through our
Coordinated Vulnerability Disclosure Program:

<https://www.etsi.org/standards/coordinated-vulnerability-disclosure>

Notice of disclaimer & limitation of liability

The information provided in the present deliverable is directed solely to professionals who have the appropriate degree of experience to understand and interpret its content in accordance with generally accepted engineering or other professional standard and applicable regulations.

No recommendation as to products and services or vendors is made or should be implied.

No representation or warranty is made that this deliverable is technically accurate or sufficient or conforms to any law and/or governmental rule and/or regulation and further, no representation or warranty is made of merchantability or fitness for any particular purpose or against infringement of intellectual property rights.

In no event shall ETSI be held liable for loss of profits or any other incidental or consequential damages.

Any software contained in this deliverable is provided "AS IS" with no warranties, express or implied, including but not limited to, the warranties of merchantability, fitness for a particular purpose and non-infringement of intellectual property rights and ETSI shall not be held liable in any event for any damages whatsoever (including, without limitation, damages for loss of profits, business interruption, loss of information, or any other pecuniary loss) arising out of or related to the use of or inability to use the software.

Copyright Notification

No part may be reproduced or utilized in any form or by any means, electronic or mechanical, including photocopying and microfilm except as authorized by written permission of ETSI.

The content of the PDF version shall not be modified without the written authorization of ETSI.

The copyright and the foregoing restriction extend to reproduction in all media.

© ETSI 2022.
All rights reserved.

Intellectual Property Rights

Essential patents

IPRs essential or potentially essential to normative deliverables may have been declared to ETSI. The declarations pertaining to these essential IPRs, if any, are publicly available for **ETSI members and non-members**, and can be found in ETSI SR 000 314: "*Intellectual Property Rights (IPRs); Essential, or potentially Essential, IPRs notified to ETSI in respect of ETSI standards*", which is available from the ETSI Secretariat. Latest updates are available on the ETSI Web server (<https://ipr.etsi.org/>).

Pursuant to the ETSI Directives including the ETSI IPR Policy, no investigation regarding the essentiality of IPRs, including IPR searches, has been carried out by ETSI. No guarantee can be given as to the existence of other IPRs not referenced in ETSI SR 000 314 (or the updates on the ETSI Web server) which are, or may be, or may become, essential to the present document.

Trademarks

The present document may include trademarks and/or tradenames which are asserted and/or registered by their owners. ETSI claims no ownership of these except for any which are indicated as being the property of ETSI, and conveys no right to use or reproduce any trademark and/or tradename. Mention of those trademarks in the present document does not constitute an endorsement by ETSI of products, services or organizations associated with those trademarks.

DECT™, **PLUGTESTS™**, **UMTS™** and the ETSI logo are trademarks of ETSI registered for the benefit of its Members. **3GPP™** and **LTE™** are trademarks of ETSI registered for the benefit of its Members and of the 3GPP Organizational Partners. **oneM2M™** logo is a trademark of ETSI registered for the benefit of its Members and of the oneM2M Partners. **GSM®** and the GSM logo are trademarks registered and owned by the GSM Association.

Legal Notice

This Technical Specification (TS) has been produced by ETSI 3rd Generation Partnership Project (3GPP).

The present document may refer to technical specifications or reports using their 3GPP identities. These shall be interpreted as being references to the corresponding ETSI deliverables.

The cross reference between 3GPP and ETSI identities can be found under <http://webapp.etsi.org/key/queryform.asp>.

Modal verbs terminology

In the present document "**shall**", "**shall not**", "**should**", "**should not**", "**may**", "**need not**", "**will**", "**will not**", "**can**" and "**cannot**" are to be interpreted as described in clause 3.2 of the [ETSI Drafting Rules](#) (Verbal forms for the expression of provisions).

"**must**" and "**must not**" are **NOT** allowed in ETSI deliverables except when used in direct citation.

Contents

Intellectual Property Rights	2
Legal Notice	2
Modal verbs terminology.....	2
Foreword.....	7
1 Scope	9
2 References	9
3 Definitions and abbreviations.....	10
3.1 Definitions	10
3.2 Abbreviations	10
4 Overview	10
5 Services Offered by the LMF.....	11
5.1 Introduction	11
5.2 Nlmf_Location Service	11
5.2.1 Service Description.....	11
5.2.2 Service Operations	11
5.2.2.1 Introduction.....	11
5.2.2.2 DetermineLocation.....	12
5.2.2.2.1 General	12
5.2.2.2.2 Retrieve UE Location	12
5.2.2.2.3 Retrieve UE Location for 5G-MO-LR	12
5.2.2.3 EventNotify	13
5.2.2.3.1 General	13
5.2.2.3.2 Periodic or Triggered Event Notification	13
5.2.2.4 CancelLocation	14
5.2.2.4.1 General	14
5.2.2.4.2 Cancel Periodic or Triggered Location.....	14
5.2.2.5 LocationContextTransfer	15
5.2.2.5.1 General	15
5.2.2.5.2 Transfer Location Context.....	15
5.3 Nlmf_Broadcast Service.....	15
5.3.1 Service Description.....	15
5.3.2 Service Operations	16
5.3.2.1 Introduction.....	16
5.3.2.2 CipheringKeyData.....	16
5.3.2.2.1 General	16
5.3.2.2.2 Request Ciphering Key Information.....	16
5.3.2.2.3 Provide Ciphering Key Information	16
6 API Definitions	17
6.1 Nlmf_Location Service API.....	17
6.1.1 API URI.....	17
6.1.2 Usage of HTTP	18
6.1.2.1 General	18
6.1.2.2 HTTP Standard Headers	18
6.1.2.2.1 General	18
6.1.2.2.2 Content type	18
6.1.2.3 HTTP custom headers	18
6.1.2.3.1 General	18
6.1.2.4 HTTP multipart messages	18
6.1.3 Resources.....	19
6.1.3.1 Overview.....	19
6.1.4 Custom Operations without associated resources	19
6.1.4.1 Overview.....	19

6.1.4.2	Operation: determine-location.....	20
6.1.4.2.1	Description	20
6.1.4.2.2	Operation Definition.....	20
6.1.4.3	Operation: cancel-location	22
6.1.4.3.1	Description	22
6.1.4.3.2	Operation Definition.....	22
6.1.4.4	Operation: location-context-transfer	23
6.1.4.4.1	Description	23
6.1.4.4.2	Operation Definition.....	23
6.1.5	Notifications	24
6.1.5.1	EventNotify.....	25
6.1.5.1.1	Description	25
6.1.5.1.2	Notification Definition	25
6.1.5.1.3	Notification Standard Methods.....	25
6.1.6	Data Model	26
6.1.6.1	General	26
6.1.6.2	Structured data types	30
6.1.6.2.1	Introduction	30
6.1.6.2.2	Type: InputData.....	31
6.1.6.2.3	Type: LocationData	34
6.1.6.2.4	Type: GeographicalCoordinates	36
6.1.6.2.5	Type: GeographicArea	37
6.1.6.2.6	Type: Point	37
6.1.6.2.7	Type: PointUncertaintyCircle.....	37
6.1.6.2.8	Type: PointUncertaintyEllipse	38
6.1.6.2.9	Type: Polygon	38
6.1.6.2.10	Type: PointAltitude	38
6.1.6.2.11	Type: PointAltitudeUncertainty	38
6.1.6.2.12	Type: EllipsoidArc	39
6.1.6.2.13	Type: LocationQoS	39
6.1.6.2.14	Type: CivicAddress.....	40
6.1.6.2.15	Type: PositioningMethodAndUsage	42
6.1.6.2.16	Type: GnssPositioningMethodAndUsage	43
6.1.6.2.17	Type: VelocityEstimate	43
6.1.6.2.18	Type: HorizontalVelocity	43
6.1.6.2.19	Type: HorizontalWithVerticalVelocity	43
6.1.6.2.20	Type: HorizontalVelocityWithUncertainty	44
6.1.6.2.21	Type: HorizontalWithVerticalVelocityAndUncertainty.....	44
6.1.6.2.22	Type: UncertaintyEllipse.....	44
6.1.6.2.23	Type: UeLcsCapability.....	44
6.1.6.2.24	Type: PeriodicEventInfo.....	45
6.1.6.2.25	Type: AreaEventInfo	45
6.1.6.2.26	Type: ReportingArea	45
6.1.6.2.27	Type: MotionEventInfo	46
6.1.6.2.28	Void.....	46
6.1.6.2.29	Type: CancelLocData.....	46
6.1.6.2.30	Type: LocContextData	47
6.1.6.2.31	Type: EventReportMessage.....	47
6.1.6.2.32	Type: EventReportingStatus.....	48
6.1.6.2.33	Type: UELocationInfo.....	48
6.1.6.2.34	Type: EventNotifyData	49
6.1.6.2.35	Type: UeConnectivityState.....	51
6.1.6.2.36	Type: LocalOrigin	51
6.1.6.2.37	Type: RelativeCartesianLocation	52
6.1.6.2.38	Type: Local2dPointUncertaintyEllipse	52
6.1.6.2.39	Type: Local3dPointUncertaintyEllipsoid	52
6.1.6.2.40	Type: UncertaintyEllipsoid.....	53
6.1.6.2.41	Type: LocalArea.....	53
6.1.6.2.42	Type: UeAreaIndication	53
6.1.6.2.43	Type: MinorLocationQoS.....	53
6.1.6.3	Simple data types and enumerations	54
6.1.6.3.1	Introduction	54

6.1.6.3.2	Simple data types.....	54
6.1.6.3.3	Enumeration: ExternalClientType	57
6.1.6.3.4	Enumeration: SupportedGADShapes	57
6.1.6.3.5	Enumeration: ResponseTime.....	57
6.1.6.3.6	Enumeration: PositioningMethod.....	58
6.1.6.3.7	Enumeration: PositioningMode.....	58
6.1.6.3.8	Enumeration: GnssId	59
6.1.6.3.9	Enumeration: Usage	59
6.1.6.3.10	Enumeration: LcsPriority	59
6.1.6.3.11	Enumeration: VelocityRequested	59
6.1.6.3.12	Enumeration: AccuracyFulfilmentIndicator	60
6.1.6.3.13	Enumeration: VerticalDirection	60
6.1.6.3.14	Enumeration: LdrType	60
6.1.6.3.15	Enumeration: ReportingAreaType.....	60
6.1.6.3.16	Enumeration: OccurrenceInfo	60
6.1.6.3.17	Enumeration: ReportingAccessType	61
6.1.6.3.18	Enumeration: EventClass	61
6.1.6.3.19	Enumeration: ReportedEventType	61
6.1.6.3.20	Enumeration: TerminationCause.....	61
6.1.6.3.21	Enumeration: LcsQosClass.....	62
6.1.6.3.22	Enumeration: UeLocationServiceInd	62
6.1.6.4	Binary data	62
6.1.6.4.1	Introduction	62
6.1.6.4.2	LPP Message	62
6.1.7	Error Handling	62
6.1.7.1	General	62
6.1.7.2	Protocol Errors	62
6.1.7.3	Application Errors.....	62
6.1.8	Security	63
6.1.9	Feature Negotiation.....	63
6.1.10	HTTP redirection	64
6.2	Nlmf_Broadcast Service API	64
6.2.1	API URI.....	64
6.2.2	Usage of HTTP	64
6.2.2.1	General	64
6.2.2.2	HTTP Standard Headers	64
6.2.2.2.1	General	64
6.2.2.2.2	Content type	64
6.2.2.3	HTTP custom headers	65
6.2.2.3.1	General	65
6.2.3	Resources	65
6.2.3.1	Overview	65
6.2.4	Custom Operations without associated resources	65
6.2.4.1	Overview	65
6.2.4.4	Operation: cipher-key-data.....	65
6.2.4.4.1	Description	65
6.2.4.4.2	Operation Definition.....	65
6.2.5	Notifications	67
6.2.5.1	CipheringKeyData.....	67
6.2.5.1.1	Description	67
6.2.5.1.2	Notification Definition	67
6.2.5.1.3	Notification Standard Methods.....	67
6.2.6	Data Model	68
6.2.6.1	General	68
6.2.6.2	Structured data types	69
6.2.6.2.1	Introduction	69
6.2.6.2.2	Type: CipheringKeyInfo.....	69
6.2.6.2.3	Type: CipheringKeyResponse	70
6.2.6.2.4	Type: CipheringDataSet	71
6.2.6.2.5	Type: CipheringSetReport.....	76
6.2.6.2.6	Type: CipherRequestData.....	77
6.2.6.2.7	Type: CipherResponseData	77

6.2.6.3	Simple data types and enumerations	77
6.2.6.3.1	Introduction	77
6.2.6.3.2	Simple data types.....	77
6.2.6.3.3	Enumeration: StorageOutcome.....	77
6.2.6.3.4	Enumeration: DataAvailability.....	77
6.2.7	Error Handling	78
6.2.7.1	General	78
6.2.7.2	Protocol Errors	78
6.2.7.3	Application Errors.....	78
6.2.8	Security	78
6.2.9	Feature Negotiation.....	78
6.2.10	HTTP redirection.....	79
Annex A (normative):	OpenAPI specification.....	80
A.1	General	80
A.2	Nlmf_Location API.....	80
A.3	Nlmf_Broadcast API.....	100
Annex B (informative):	Change history	104
History		107

Foreword

This Technical Specification has been produced by the 3rd Generation Partnership Project (3GPP).

The contents of the present document are subject to continuing work within the TSG and may change following formal TSG approval. Should the TSG modify the contents of the present document, it will be re-released by the TSG with an identifying change of release date and an increase in version number as follows:

Version x.y.z

where:

- x the first digit:
 - 1 presented to TSG for information;
 - 2 presented to TSG for approval;
 - 3 or greater indicates TSG approved document under change control.
- y the second digit is incremented for all changes of substance, i.e. technical enhancements, corrections, updates, etc.
- z the third digit is incremented when editorial only changes have been incorporated in the document.

In the present document, modal verbs have the following meanings:

- shall** indicates a mandatory requirement to do something
- shall not** indicates an interdiction (prohibition) to do something

The constructions "shall" and "shall not" are confined to the context of normative provisions, and do not appear in Technical Reports.

The constructions "must" and "must not" are not used as substitutes for "shall" and "shall not". Their use is avoided insofar as possible, and they are not used in a normative context except in a direct citation from an external, referenced, non-3GPP document, or so as to maintain continuity of style when extending or modifying the provisions of such a referenced document.

- should** indicates a recommendation to do something
- should not** indicates a recommendation not to do something
- may** indicates permission to do something
- need not** indicates permission not to do something

The construction "may not" is ambiguous and is not used in normative elements. The unambiguous constructions "might not" or "shall not" are used instead, depending upon the meaning intended.

- can** indicates that something is possible
- cannot** indicates that something is impossible

The constructions "can" and "cannot" are not substitutes for "may" and "need not".

- will** indicates that something is certain or expected to happen as a result of action taken by an agency the behaviour of which is outside the scope of the present document
- will not** indicates that something is certain or expected not to happen as a result of action taken by an agency the behaviour of which is outside the scope of the present document
- might** indicates a likelihood that something will happen as a result of action taken by some agency the behaviour of which is outside the scope of the present document

might not indicates a likelihood that something will not happen as a result of action taken by some agency the behaviour of which is outside the scope of the present document

In addition:

is (or any other verb in the indicative mood) indicates a statement of fact

is not (or any other negative verb in the indicative mood) indicates a statement of fact

The constructions "is" and "is not" do not indicate requirements.

1 Scope

The present document specifies the stage 3 protocol and data model for the Nlmf Service Based Interface. It provides stage 3 protocol definitions and message flows, and specifies the API for each service offered by the LMF.

The 5G System stage 2 architecture and procedures are specified in 3GPP TS 23.501 [2] and 3GPP TS 23.502 [3].

The Technical Realization of the Service Based Architecture and the Principles and Guidelines for Services Definition are specified in 3GPP TS 29.500 [4] and 3GPP TS 29.501 [5].

2 References

The following documents contain provisions which, through reference in this text, constitute provisions of the present document.

- References are either specific (identified by date of publication, edition number, version number, etc.) or non-specific.
- For a specific reference, subsequent revisions do not apply.
- For a non-specific reference, the latest version applies. In the case of a reference to a 3GPP document (including a GSM document), a non-specific reference implicitly refers to the latest version of that document *in the same Release as the present document*.

- [1] 3GPP TR 21.905: "Vocabulary for 3GPP Specifications".
- [2] 3GPP TS 23.501: "System Architecture for the 5G System; Stage 2".
- [3] 3GPP TS 23.502: "Procedures for the 5G System; Stage 2".
- [4] 3GPP TS 29.500: "5G System; Technical Realization of Service Based Architecture; Stage 3".
- [5] 3GPP TS 29.501: "5G System; Principles and Guidelines for Services Definition; Stage 3".
- [6] IETF RFC 4776: "Dynamic Host Configuration Protocol (DHCPv4 and DHCPv6) Option for Civic Addresses Configuration Information".
- [7] IETF RFC 5139: "Revised Civic Location Format for Presence Information Data Format Location Object (PIDF-LO)".
- [8] 3GPP TS 29.571: "5G System; Common Data Types for Service Based Interfaces; Stage 3".
- [9] 3GPP TS 33.501: "Security architecture and procedures for 5G system".
- [10] IETF RFC 6749: "The OAuth 2.0 Authorization Framework".
- [11] 3GPP TS 29.510: "Network Function Repository Services; Stage 3".
- [12] IETF RFC 7540: "Hypertext Transfer Protocol Version 2 (HTTP/2)".
- [13] IETF RFC 8259: "The JavaScript Object Notation (JSON) Data Interchange Format".
- [14] OpenAPI Initiative, "OpenAPI Specification Version 3.0.0", <https://spec.openapis.org/oas/v3.0.0>.
- [15] IETF RFC 7807: "Problem Details for HTTP APIs".
- [16] 3GPP TR 21.900: "Technical Specification Group working methods".
- [17] 3GPP TS 22.071: "Location Services (LCS); Service description; Stage 1".
- [18] 3GPP TS 29.002: "Mobile Application Part (MAP) specification".
- [19] 3GPP TS 23.273: "5G System (5GS) Location Services (LCS); Stage 2".

- [20] 3GPP TS 24.080: "Mobile radio interface layer 3 Supplementary services specification; Formats and coding".
- [21] 3GPP TS 37.355: "LTE Positioning Protocol (LPP)".
- [22] 3GPP TS 24.501: "Non-Access-Stratum (NAS) protocol for 5G System (5GS); Stage 3".
- [23] 3GPP TS 29.518: "Access and Mobility Management Services".
- [24] 3GPP TS 29.171: "Location Services (LCS); LCS Application Protocol (LCS-AP) between the Mobile Management Entity (MME) and Evolved Serving Mobile Location Centre (E-SMLC); SLs interface".
- [25] IETF RFC 4119: "A Presence-based GEOPRIV Location Object Format".
- [26] 3GPP TS 33.256: "Security aspects of Uncrewed Aerial Systems (UAS)".

3 Definitions and abbreviations

3.1 Definitions

For the purposes of the present document, the terms and definitions given in 3GPP TR 21.905 [1] and the following apply. A term defined in the present document takes precedence over the definition of the same term, if any, in 3GPP TR 21.905 [1].

3.2 Abbreviations

For the purposes of the present document, the abbreviations given in 3GPP TR 21.905 [1] and the following apply. An abbreviation defined in the present document takes precedence over the definition of the same abbreviation, if any, in 3GPP TR 21.905 [1].

LDR	Location Deferred Request
LMF	Location Management Function

4 Overview

The Location Management Function (LMF) is the network entity in the 5G Core Network (5GC) supporting the following functionality:

- Supports location determination for a UE.
- Obtains downlink location measurements or a location estimate from the UE.
- Obtains uplink location measurements from the NG RAN.
- Obtains non-UE associated assistance data from the NG RAN.
- Provides broadcast assistance data to UEs and forwards associated ciphering keys to an AMF.

Other functions of an LMF are listed in clause 4.3.8 of 3GPP TS 23.273 [19].

Figure 4-1 provides the reference model (in service based interface representation and in reference point representation), with focus on the LMF:

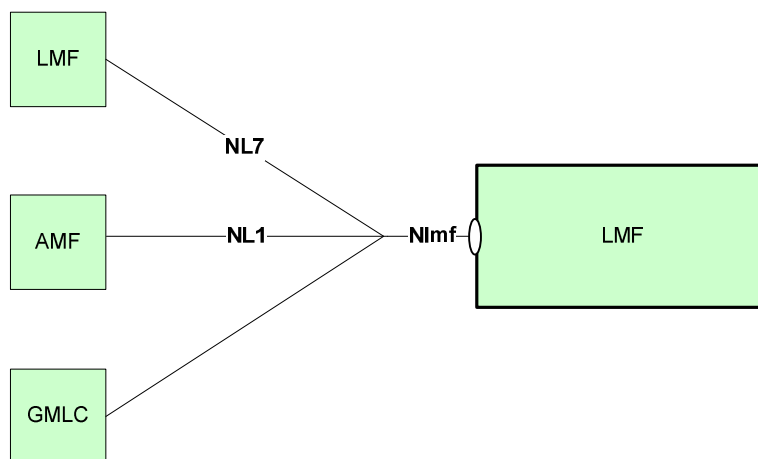

Figure 4-1: Reference model – LMF

5 Services Offered by the LMF

5.1 Introduction

The LMF offers to other NFs the following services:

- Nlmf_Location
- Nlmf_Broadcast

Table 5.1-1 summarizes the corresponding APIs defined for this specification.

Table 5.1-1: API Descriptions

Service Name	Clause	Description	OpenAPI Specification File	apiName	Annex
Nlmf_Location	6.1	LMF Location Service	TS29572_Nlmf_Location.yaml	nlmf-loc	A.2
Nlmf_Broadcast	6.2	LMF Broadcast Service	TS29572_Nlmf_Broadcast.yaml	nlmf-broadcast	A.3

5.2 Nlmf_Location Service

5.2.1 Service Description

The Nlmf_Location service enables an NF to request location determination (current geodetic and optionally local and/or civic location) for a target UE or to request periodic or triggered location for a target UE.

5.2.2 Service Operations

5.2.2.1 Introduction

The service operations defined for the Nlmf_Location service are as follows:

- DetermineLocation: It provides UE location information to the consumer NF.
- EventNotify: It notifies the consumer NF of an event for periodic or triggered location for a target UE.

- CancelLocation: It enables a consumer NF to cancel an ongoing periodic or triggered location for a target UE.
- LocationContextTransfer: It enables a consumer NF to transfer location context information for periodic or triggered location of a target UE to a new LMF.

5.2.2.2 DetermineLocation

5.2.2.2.1 General

The following procedures are defined, using the "DetermineLocation" service operation:

- Retrieve UE Location
- Retrieve UE Location for 5G-MO-LR

5.2.2.2.2 Retrieve UE Location

This procedure allows a consumer NF to request the location information (geodetic location and, optionally, local and/or civic location) for a target UE or to activate periodic or triggered deferred location for a target UE.

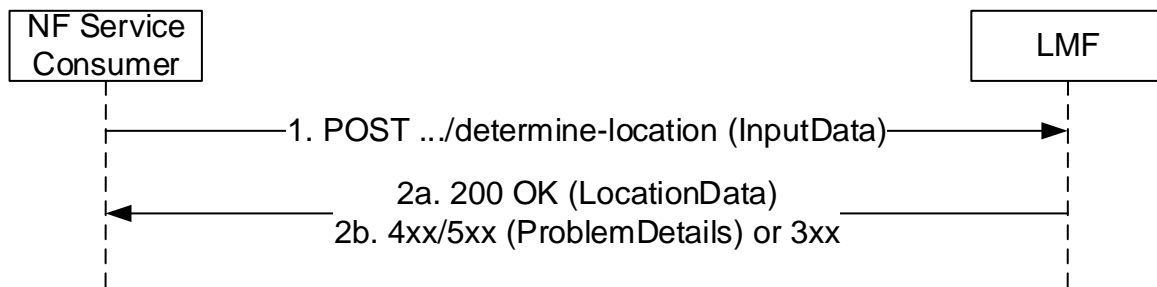

Figure 5.2.2.2.2-1: DetermineLocation Request

1. The NF Service Consumer shall send an HTTP POST request to the resource URI associated with the "determine-location" custom operation. The input parameters for the request (external client type, LCS correlation identifier, serving cell identifier, location QoS, supported GAD shapes, LDR Type, H-GMLC address, LDR Reference, UE connectivity state per access type, TNAP identifier, TWAP identifier, scheduled location time, ...) may be included in the HTTP POST request body;

If UE country or international area needs to be determined, the NF Service Consumer shall include UE country determination indication in the request;

If UE LCS Capability is received in the request indicating LPP is not supported by the UE, the LMF shall not send LPP messages to the UE in subsequent positioning procedures.

- 2a. On success, "200 OK" shall be returned. The response body shall contain the parameters related to the determined position of the UE if any (geodetic position, local location, civic location, positioning methods...);

If the NF service consumer has requested to determine UE country or international area, the LMF shall also include ueAreaInd.

- 2b. On failure or redirection, one of the HTTP status code listed in Table 6.1.4.2.2-2 shall be returned. For a 4xx/5xx response, the message body should contain a ProblemDetails structure with the "cause" attribute set to one of the application error listed in Table 6.1.4.2.2-2.

5.2.2.2.3 Retrieve UE Location for 5G-MO-LR

This procedure allows a consumer NF (i.e. an AMF) to request the location information or location assistance data for a target UE which initiates MO-LR procedure (see 3GPP TS 23.273 [19]).

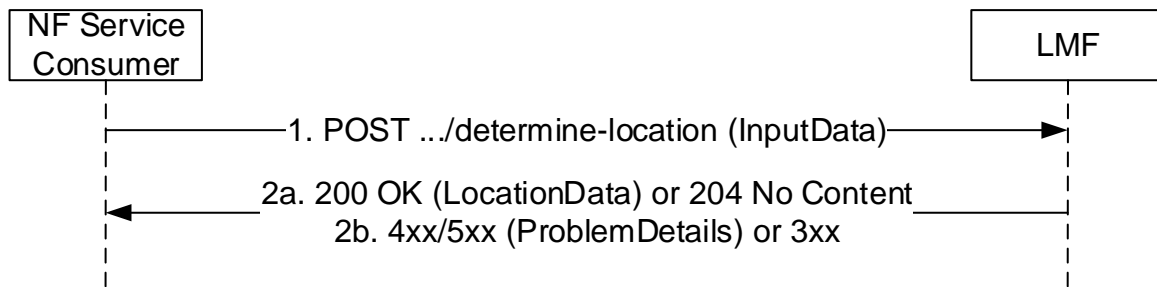

Figure 5.2.2.2.3-1: DetermineLocation Request for 5G-MO-LR

The same requirements in clause 5.2.2.2.2 shall be applied with following modifications:

1. Same as step 1 of figure 5.2.2.2.2-1, the request body shall include the following additional information:
 - The indication received from UE indicating whether a location estimate or location assistance data is required.
 - The LPP messages if received in MO-LR Request from UE
 - UE's subscribed assistance data for 5GC-MO-LR if received from UDM.
- 2a. Same as step 2a of figure 5.2.2.2.2-1 if a consumer NF requests the location information for a target UE. If a NF consumer requests location assistance data for a target UE and LMF has successfully delivered location assistance data to the UE, 204 No Content shall be returned.
- 2b. Same as step 2b of figure 5.2.2.2.2-1.

5.2.2.3 EventNotify

5.2.2.3.1 General

The following procedures are defined, using the "EventNotify" service operation:

- Periodic or Triggered Event Notification

5.2.2.3.2 Periodic or Triggered Event Notification

This procedure notifies the NF Service Consumer (i.e. GMLC) about event information related to periodic or triggered location of a target UE. The notification is delivered to:

- the callback URI of an H-GMLC received (from an AMF) during an earlier DetermineLocation service operation if still available and if the LMF is configured for direct access to the H-GMLC;
- the callback URI of an H-GMLC received (from another LMF) during an earlier LocationContextTransfer service operation if still available and if the LMF is configured for direct access to the H-GMLC;
- the callback URI of an H-GMLC received (from the target UE) in a supplementary services event report if the LMF is configured for direct access to the H-GMLC;

otherwise (if not available),

- the callback URI of a V-GMLC registered in the NRF, if the V-GMLC registered to the NRF with notification endpoints for periodic or triggered event notifications; or

otherwise (if not available),

- the URI of a V-GMLC locally provisioned in the LMF.

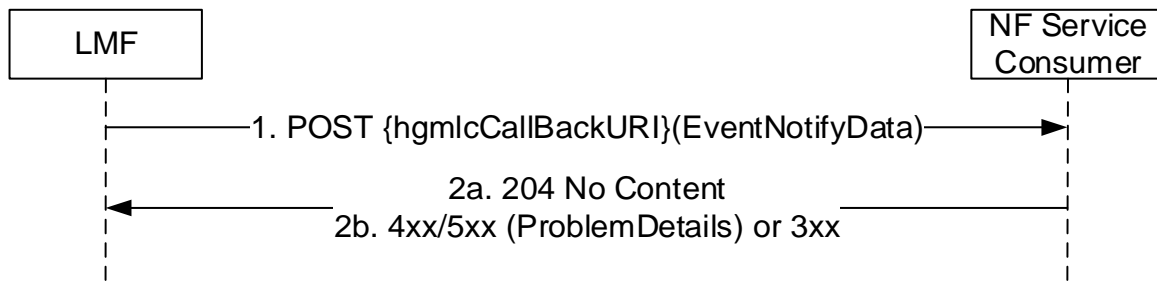

Figure 5.2.2.3.2-1: EventNotify Request

1. The LMF shall send a POST request to the GMLC callback URI determined as described above. The request body shall include a notification correlation ID (LDR reference), the UE identification (SUPI and if available GPSI), the type of event and may include a geodetic location, local location, civic location, position methods used, and other available parameters related to the position if any (e.g. Velocity, Altitude etc.), H-GMLC callback URI (if the NF consumer is a V-GMLC) and serving LMF identification.
- 2a. On success, "204 No content" shall be returned by the NF Service Consumer.
- 2b. On failure or redirection, one of the appropriate HTTP status code listed in Table 6.1.5.1.3.1-2 shall be returned. For a 4xx/5xx response, the message body should contain a ProblemDetails structure indicating appropriate additional error information.

5.2.2.4 CancelLocation

5.2.2.4.1 General

The following procedures are defined, using the "CancelLocation" service operation:

- Cancel Periodic or Triggered Location

5.2.2.4.2 Cancel Periodic or Triggered Location

This procedure allows a consumer NF to cancel periodic or triggered location for a target UE. The cancellation is delivered to a resource URI on the serving LMF identified by the serving LMF identification provided to the consumer NF (i.e. AMF) by a V-GMLC or H-GMLC (see 3GPP TS 23.273 [19]).

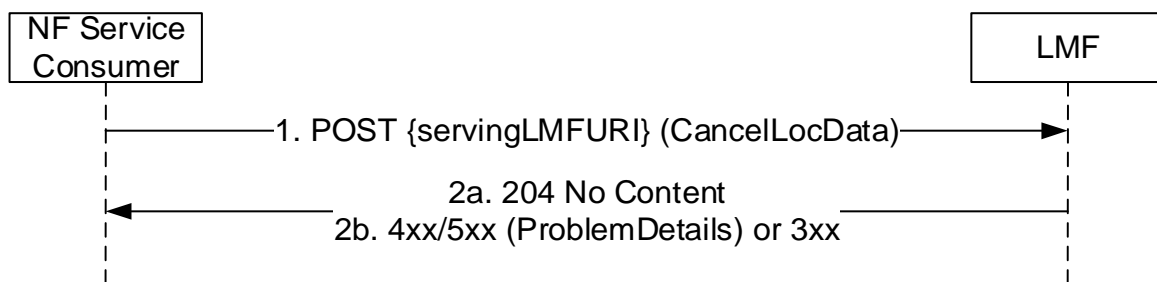

Figure 5.2.2.4.2-1: CancelLocation Request

1. The NF Service Consumer shall send an HTTP POST request to the resource URI of "cancel-location" custom operation on the serving LMF. The request body shall include a notification correlation ID (LDR reference) and an H-GMLC callback URI.
- 2a. On success, "204 No content" shall be returned by the LMF.
- 2b. On failure or redirection, one of the HTTP status code listed in Table 6.1.4.3.2-2 shall be returned. For a 4xx/5xx response, the message body should contain a ProblemDetails structure with the "cause" attribute set to one of the application errors listed in Table 6.1.4.3.2-2.

5.2.2.5 LocationContextTransfer

5.2.2.5.1 General

The following procedures are defined, using the "LocationContextTransfer" service operation:

- Transfer Location Context

5.2.2.5.2 Transfer Location Context

This procedure allows a NF service consumer (e.g. the old LMF) to transfer location context information for periodic or triggered location for a target UE (see clause 6.4 and clause 6.7.2 of 3GPP TS 23.273 [19]). The NF service consumer discovers the service URI of the new LMF by performing a discovery via NRF using:

- the identification of the LMF received (from an AMF) during an earlier Namf_Communication_N1MessageNotify service operation to the consumer NF;

otherwise (if not available),

- the identification of an LMF locally provisioned in the consumer NF.

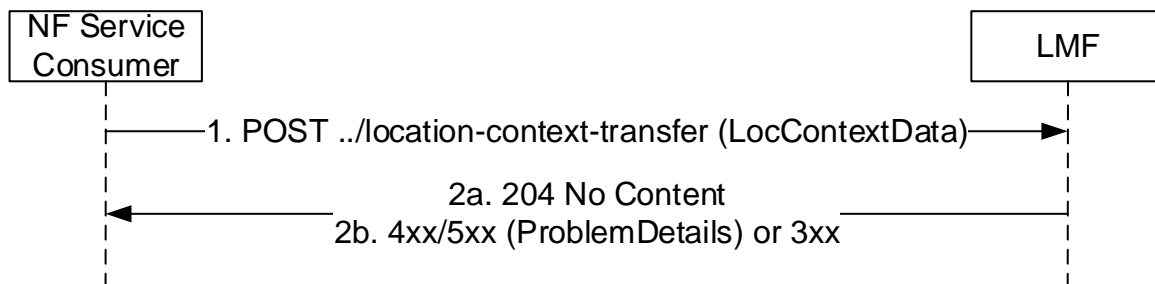

Figure 5.2.2.5.2-1: LocationContextTransfer Request

1. The NF Service Consumer shall send an HTTP POST request to the Custom operation URI ("/location-context-transfer") on the Service URI discovered as described above. The request body shall include an AMF identity, Deferred location type, Deferred location parameters, Notification Target Address (H-GMLC callback URI), Notification Correlation ID (LDR reference), an embedded event report message and may include an event reporting status, UE location information and scheduled location time, and shall include an indication of Control Plane Clot 5GS Optimisation if N1 message is received from the UE with Control Plane Clot 5GS Optimisation.
- 2a. On success, "204 No content" shall be returned by the LMF.
- 2b. On failure or redirection, one of the HTTP status codes listed in Table 6.1.4.4.2-2 shall be returned. For a 4xx/5xx response, the message body should contain a ProblemDetails structure with the "cause" attribute set to one of the application error listed in Table 6.1.4.4.2-2.

5.3 Nlmf_Broadcast Service

5.3.1 Service Description

The Nlmf_Broadcast service enables an NF to obtain ciphering keys and associated parameters applicable to location assistance data that is broadcast to subscribed UEs in ciphered form.

5.3.2 Service Operations

5.3.2.1 Introduction

The service operations defined for the Nlmf_Broadcast service are as follows:

- CipherringKeyData: It provides the cipherring key information to the consumer NF.

5.3.2.2 CipherringKeyData

5.3.2.2.1 General

The following procedures are defined, using the "CipherringKeyData" service operation:

- Request Cipherring Key Information
- Provide Cipherring Key Information

NOTE: The Request Cipherring Key procedure is included in order to provide a valid context in OpenAPI version 3 for the Provide Cipherring Key Information procedure. The Request Cipherring Key procedure is not used for support of cipherring key transfer in 3GPP TS 23.273 [19] and hence need not be supported by an NF Service Consumer or by an LMF.

5.3.2.2.2 Request Cipherring Key Information

This procedure allows a consumer NF to request cipherring key information.

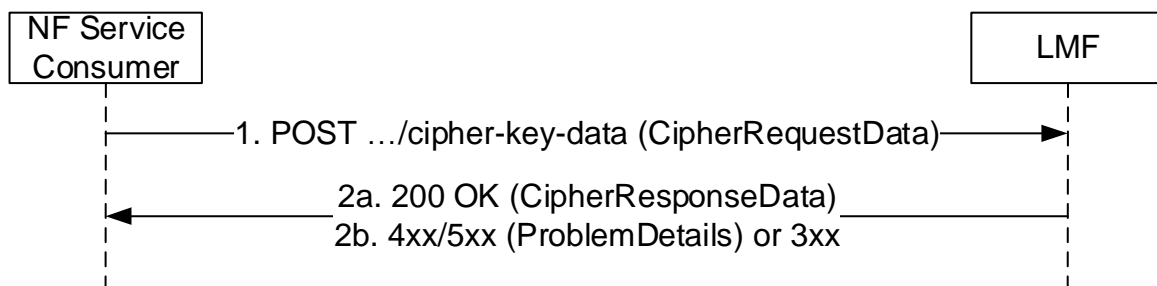

Figure 5.3.2.2.2-1: CipherringKeyData Request

1. The NF Service Consumer shall send an HTTP POST request to the resource URI associated with the "cipher-key-data" custom operation. The request body shall include a notification callback URI.
- 2a. On success, "200 OK" shall be returned. The response body shall indicate whether the LMF has cipherring key data. If the LMF has cipherring key data, the Provide Cipherring Key Information procedure is used to provide the cipherring key data to the NF Service Consumer.
- 2b. On failure or redirection, one of the HTTP status codes listed in Table 6.2.4.4.2-2 shall be returned. For a 4xx/5xx response, the message body shall contain a `ProblemDetails` structure with the "cause" attribute set to one of the application errors listed in Table 6.2.7.3-1.

5.3.2.2.3 Provide Cipherring Key Information

This procedure notifies the NF Service Consumer (i.e. AMF) about updated cipherring key information applicable to broadcast of location assistance data in ciphered form to subscribed UEs. The notification is delivered to:

- the callback URI of an AMF received during an earlier CipherringKeyData request service operation if still available; or
- a callback URI registered in the NRF, if the AMF registered to the NRF with notification endpoints for cipherring key data notifications;

Otherwise (if not available),

- an AMF callback URI locally provisioned in the LMF.

The procedure is invoked by issuing a POST request to the callback URI of the NF Service Consumer. See figure 5.3.2.2.3-1.

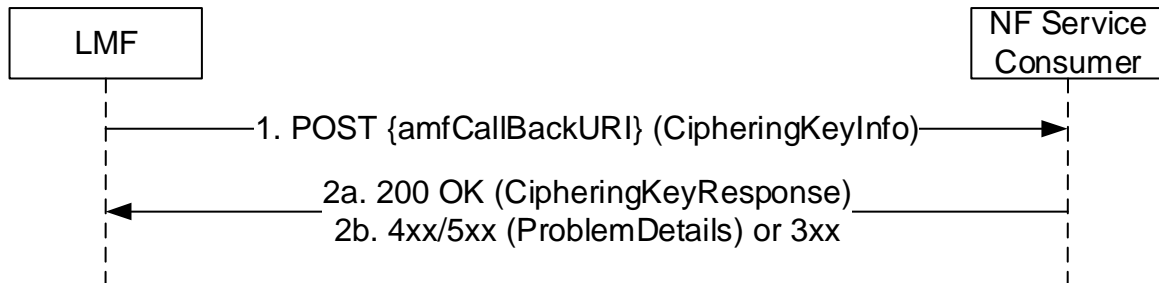

Figure 5.3.2.2.3-1: CipherringKeyData Notify

1. The LMF shall send an HTTP POST request to the callback URI for the NF service consumer determined as described above. The request body shall include one or more cipherring keys and for each cipherring key may include a cipherring key value, cipherring key identifier, validity period and set of applicable types of broadcast assistance data.
- 2a. On success or partial success, "200 OK" shall be returned. The response body shall indicate which cipherring key information was successfully stored by the NF service consumer.
- 2b. On failure or redirection to store any cipherring key information, one of the HTTP status codes listed in table 6.2.5.1.3.1-2 shall be returned. For a 4xx/5xx response, the message body shall contain a ProblemDetails structure with the "cause" attribute set to one of the application errors listed in table 6.2.5.1.3.1-2.

6 API Definitions

6.1 Nlmf_Location Service API

6.1.1 API URI

The Nlmf_Location service shall use the Nlmf_Location API.

The API URI of the Nlmf_Location API shall be:

{apiRoot}/<apiName>/<apiVersion>

The request URI used in HTTP requests from the NF service consumer towards the NF service producer shall have the Resource URI structure defined in clause 4.4.1 of 3GPP TS 29.501 [5], i.e.:

{apiRoot}/<apiName>/<apiVersion>/<apiSpecificResourceUriPart>

with the following components:

- The {apiRoot} shall be set as described in 3GPP TS 29.501 [5].
- The <apiName> shall be "nlmf-loc".
- The <apiVersion> shall be "v1".
- The <apiSpecificResourceUriPart> shall be set as described in clause 6.1.3.

6.1.2 Usage of HTTP

6.1.2.1 General

HTTP/2, as defined in IETF RFC 7540 [12], shall be used as specified in clause 5 of 3GPP TS 29.500 [4].

HTTP/2 shall be transported as specified in clause 5.3 of 3GPP TS 29.500 [4].

HTTP messages and bodies for the Nlmf_Location service shall comply with the OpenAPI [14] specification contained in Annex A.

6.1.2.2 HTTP Standard Headers

6.1.2.2.1 General

6.1.2.2.2 Content type

The following content types shall be supported:

- JSON, as defined in IETF RFC 8259 [13], shall be used as content type of the HTTP bodies specified in the present specification as indicated in clause 5.4 of 3GPP TS 29.500 [4].
- The Problem Details JSON Object (IETF RFC 7807 [15]). The use of the Problem Details JSON object in a HTTP response body shall be signalled by the content type "application/problem+json".

Multipart messages shall also be supported (see clause 6.1.2.4) using the content type "multipart/related", comprising:

- one JSON body part with the "application/json" content type; and
- one or more binary body parts with 3gpp vendor specific content subtypes.

The 3gpp vendor specific content subtypes defined in Table 6.1.2.2.2-1 shall be supported.

Table 6.1.2.2.2-1: 3GPP vendor specific content subtypes

content subtype	Description
vnd.3gpp.lpp	Binary encoded payload, encoding LTE Positioning Protocol (LPP) IEs, as specified in 3GPP TS 37.355 [21].
NOTE:	Using 3GPP vendor content subtypes allows to describe the nature of the opaque payload (e.g. LPP information) without having to rely on metadata in the JSON payload.

See clause 6.1.2.4 for the binary payloads supported in the binary body part of multipart messages.

6.1.2.3 HTTP custom headers

6.1.2.3.1 General

The following HTTP custom headers shall be supported:

- 3gpp-Sbi-Message-Priority: See 3GPP TS 29.500 [4], clause 5.2.3.2.2.

This API does not define any new HTTP custom headers.

6.1.2.4 HTTP multipart messages

HTTP multipart messages shall be supported, to transfer opaque LPP Information, in the following service operations (and HTTP messages):

- DetermineLocation Request (POST);

HTTP multipart messages shall include one JSON body part and one or more binary body parts comprising:

- one LPP payload (see clause 6.1.6.4).

The JSON body part shall be the "root" body part of the multipart message. It shall be encoded as the first body part of the multipart message. The "Start" parameter does not need to be included.

The multipart message shall include a "type" parameter (see IETF RFC 2387 [9]) specifying the media type of the root body part, i.e. "application/json".

NOTE: The "root" body part (or "root" object) is the first body part the application processes when receiving a multipart/related message, see IETF RFC 2387 [9]. The default root is the first body within the multipart/related message. The "Start" parameter indicates the root body part, e.g. when this is not the first body part in the message.

For each binary body part in a HTTP multipart message, the binary body part shall include a Content-ID header (see IETF RFC 2045 [10]), and the JSON body part shall include an attribute, defined with the RefToBinaryData type, that contains the value of the Content-ID header field of the referenced binary body part.

6.1.3 Resources

6.1.3.1 Overview

The structure of the Resource URIs of the Nlmf_Location service is shown in figure 6.1.3.1-1.

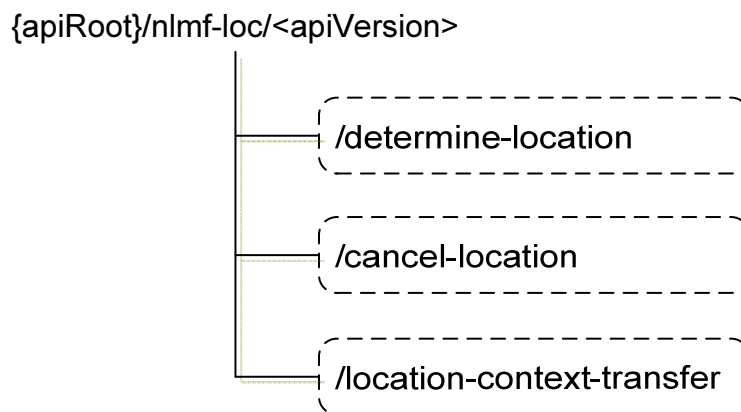

Figure 6.1.3.1-1: Resource URI structure of the Nlmf_Location API

6.1.4 Custom Operations without associated resources

6.1.4.1 Overview

Table 6.1.4.1-1: Custom operations without associated resources

Operation Name	Custom operation URI	Mapped HTTP method	Description (Service Operation)
determine-location	/determine-location	POST	Determine Location
cancel-location	/cancel-location	POST	Cancel Location
location-context-transfer	/location-context-transfer	POST	Transfer Location Context

6.1.4.2 Operation: determine-location

6.1.4.2.1 Description

This clause will describe the custom operation and what it is used for, and the custom operation's URI.

6.1.4.2.2 Operation Definition

This operation shall support the response data structures and response codes specified in tables 6.1.4.2.2-1 and 6.1.4.2.2-2.

Table 6.1.4.2.2-1: Data structures supported by the POST Request Body on this resource

Data type	P	Cardinality	Description
InputData	M	1	Input parameters to the "Determine Location" operation

Table 6.1.4.2.2-2: Data structures supported by the POST Response Body on this resource

Data type	P	Cardinality	Response codes	Description
LocationData	M	1	200 OK	This case represents the successful retrieval of the location of the UE or successful activation of periodic or triggered location in the UE. Upon success, a response body is returned containing the different parameters of the location data if obtained, such as: <ul style="list-style-type: none"> - Geographic Area - Civic Location - Local location, - Positioning methods
n/a			204 No Content	This case represents the successful delivery of location assistance data to the UE, during MO-LR requesting for location assistance data for the UE.
RedirectResponse	O	0..1	307 Temporary Redirect	Temporary redirection. The response shall include a Location header field containing a different URI, or the same URI if a request is redirected to the same target resource via a different SCP. In the former case, the URI shall be an alternative URI of the resource located on an alternative service instance within the same LMF or LMF (service) set.
RedirectResponse	O	0..1	308 Permanent Redirect	Permanent redirection. The response shall include a Location header field containing a different URI, or the same URI if a request is redirected to the same target resource via a different SCP. In the former case, the URI shall be an alternative URI of the resource located on an alternative service instance within the same LMF or LMF (service) set.
ProblemDetails	O	0..1	403 Forbidden	The "cause" attribute may be used to indicate the following application errors: <ul style="list-style-type: none"> - POSITIONING_DENIED - UNSPECIFIED - UNSUPPORTED_BY_UE See table 6.1.7.3-1 for the description of these errors.
ProblemDetails	O	0..1	500 Internal Server Error	The "cause" attribute may be used to indicate the following application error: <ul style="list-style-type: none"> - POSITIONING_FAILED See table 6.1.7.3-1 for the description of these errors.
ProblemDetails	O	0..1	504 Gateway Timeout	The "cause" attribute may be used to indicate the following application error: <ul style="list-style-type: none"> - UNREACHABLE_USER See table 6.1.7.3-1 for the description of this error.
NOTE: The mandatory HTTP error status codes for the POST method listed in Table 5.2.7.1-1 of 3GPP TS 29.500 [4] other than those specified in the table above also apply, with a ProblemDetails data type (see clause 5.2.7 of 3GPP TS 29.500 [4]).				

Table 6.1.4.2.2-3: Headers supported by the 307 Response Code on this resource

Name	Data type	P	Cardinality	Description
Location	string	M	1	An alternative URI of the resource located on an alternative service instance within the same LMF or LMF (service) set. Or the same URI, if a request is redirected to the same target resource via a different SCP.
3gpp-Sbi-Target-Nf-Id	string	O	0..1	Identifier of the target NF (service) instance ID towards which the request is redirected

Table 6.1.4.2.2-4: Headers supported by the 308 Response Code on this resource

Name	Data type	P	Cardinality	Description
Location	string	M	1	An alternative URI of the resource located on an alternative service instance within the same LMF or LMF (service) set. Or the same URI, if a request is redirected to the same target resource via a different SCP.
3gpp-Sbi-Target-Nf-Id	string	O	0..1	Identifier of the target NF (service) instance ID towards which the request is redirected

6.1.4.3 Operation: cancel-location

6.1.4.3.1 Description

This clause describes the custom operation and what it is used for.

6.1.4.3.2 Operation Definition

This operation shall support the request and response data structures and response codes specified in table 6.1.4.3.2-1 and table 6.1.4.3.2-2.

Table 6.1.4.3.2-1: Data structures supported by the POST Request Body on this resource

Data type	P	Cardinality	Description
CancelLocData	M	1	The information used to cancel location.

Table 6.1.4.3.2-2: Data structures supported by the POST Response Body on this resource

Data type	P	Cardinality	Response codes	Description
n/a			204 No Content	This case represents successful cancellation of location.
RedirectResponse	O	0..1	307 Temporary Redirect	Temporary redirection. The response shall include a Location header field containing a different URI, or the same URI if a request is redirected to the same target resource via a different SCP. In the former case, the URI shall be an alternative URI of the resource located on an alternative service instance within the same LMF or LMF (service) set.
RedirectResponse	O	0..1	308 Permanent Redirect	Permanent redirection. The response shall include a Location header field containing a different URI, or the same URI if a request is redirected to the same target resource via a different SCP. In the former case, the URI shall be an alternative URI of the resource located on an alternative service instance within the same LMF or LMF (service) set.
ProblemDetails	O	0..1	403 Forbidden	The "cause" attribute may be used to indicate the following application errors: <ul style="list-style-type: none"> - UNSPECIFIED - LOCATION_SESSION_UNKNOWN See table 6.1.7.3-1 for the description of this error.
NOTE: The mandatory HTTP error status codes for the POST method listed in Table 5.2.7.1-1 of 3GPP TS 29.500 [4] other than those specified in the table above also apply, with a ProblemDetails data type (see clause 5.2.7 of 3GPP TS 29.500 [4]).				

Table 6.1.4.3.2-3: Headers supported by the 307 Response Code on this resource

Name	Data type	P	Cardinality	Description
Location	string	M	1	An alternative URI of the resource located on an alternative service instance within the same LMF or LMF (service) set. Or the same URI, if a request is redirected to the same target resource via a different SCP.
3gpp-Sbi-Target-Nf-Id	string	O	0..1	Identifier of the target NF (service) instance ID towards which the request is redirected

Table 6.1.4.3.2-4: Headers supported by the 308 Response Code on this resource

Name	Data type	P	Cardinality	Description
Location	string	M	1	An alternative URI of the resource located on an alternative service instance within the same LMF or LMF (service) set. Or the same URI, if a request is redirected to the same target resource via a different SCP.
3gpp-Sbi-Target-Nf-Id	string	O	0..1	Identifier of the target NF (service) instance ID towards which the request is redirected

6.1.4.4 Operation: location-context-transfer

6.1.4.4.1 Description

This clause will describe the custom operation and what it is used for.

6.1.4.4.2 Operation Definition

This operation shall support the request and response data structures and response codes specified in table 6.1.4.4.2-1 and table 6.1.4.4.2-2.

Table 6.1.4.4.2-1: Data structures supported by the POST Request Body on this resource

Data type	P	Cardinality	Description
LocContextData	M	1	Input parameters to the "Location Context Transfer" operation

Table 6.1.4.4.2-2: Data structures supported by the POST Response Body on this resource

Data type	P	Cardinality	Response codes	Description
n/a			204 No Content	This case represents successful transfer of the location context.
RedirectResponse	O	0..1	307 Temporary Redirect	Temporary redirection. The response shall include a Location header field containing a different URI, or the same URI if a request is redirected to the same target resource via a different SCP. In the former case, the URI shall be an alternative URI of the resource located on an alternative service instance within the same LMF or LMF (service) set.
RedirectResponse	O	0..1	308 Permanent Redirect	Permanent redirection. The response shall include a Location header field containing a different URI, or the same URI if a request is redirected to the same target resource via a different SCP. In the former case, the URI shall be an alternative URI of the resource located on an alternative service instance within the same LMF or LMF (service) set.
ProblemDetails	O	0..1	403 Forbidden	The "cause" attribute may be used to indicate the following application errors: <ul style="list-style-type: none"> - UNSPECIFIED - LOCATION_TRANSFER_NOT_SUPPORTED - INSUFFICIENT_RESOURCES - EVENT_REPORT_UNRECOGNIZED See table 6.1.7.3-1 for the description of this error.
NOTE: The mandatory HTTP error status codes for the POST method listed in Table 5.2.7.1-1 of 3GPP TS 29.500 [4] other than those specified in the table above also apply, with a ProblemDetails data type (see clause 5.2.7 of 3GPP TS 29.500 [4]).				

Table 6.1.4.4.2-3: Headers supported by the 307 Response Code on this resource

Name	Data type	P	Cardinality	Description
Location	string	M	1	An alternative URI of the resource located on an alternative service instance within the same LMF or LMF (service) set. Or the same URI, if a request is redirected to the same target resource via a different SCP.
3gpp-Sbi-Target-Nf-Id	string	O	0..1	Identifier of the target NF (service) instance ID towards which the request is redirected

Table 6.1.4.4.2-4: Headers supported by the 308 Response Code on this resource

Name	Data type	P	Cardinality	Description
Location	string	M	1	An alternative URI of the resource located on an alternative service instance within the same LMF or LMF (service) set. Or the same URI, if a request is redirected to the same target resource via a different SCP.
3gpp-Sbi-Target-Nf-Id	string	O	0..1	Identifier of the target NF (service) instance ID towards which the request is redirected

6.1.5 Notifications

This clause specifies the notifications provided by the Nlmf_Location service.

Table 6.1.5.1-1: Notifications overview

Notification	Callback URI	HTTP method or custom operation	Description (service operation)
EventNotify	{hgmlcCallbackURI}	POST	

6.1.5.1 EventNotify

6.1.5.1.1 Description

The EventNotify operation is used to notify the occurrence of periodic or triggered location event for a target UE to a consumer NF (e.g. GMLC).

6.1.5.1.2 Notification Definition

Callback URI: {hgmlcCallBackURI}

See clause 5.2.2.1.2 for the description of how the LMF obtains the Callback URI of the NF Service Consumer (e.g. GMLC).

6.1.5.1.3 Notification Standard Methods

6.1.5.1.3.1 POST

This method sends a Location event notify to the NF Service Consumer.

This method shall support the request and response data structures and response codes specified in table 6.1.5.1.3.1-1 and table 6.1.5.1.3.1-2.

Table 6.1.5.1.3.1-1: Data structures supported by the POST Request Body

Data type	P	Cardinality	Description
EventNotifyData	M	1	Input parameters to the "Location Event Notify" operation

Table 6.1.5.1.3.1-2: Data structures supported by the POST Response Body

Data type	P	Cardinality	Response codes	Description
n/a			204 No Content	This case represents successful notification of the event.
RedirectResponse	O	0..1	307 Temporary Redirect	Temporary redirection. The NF service consumer shall generate a Location header field containing a URI pointing to the endpoint of another NF service consumer to which the notification should be sent. If an SCP redirects the message to another SCP then the location header field shall contain the same URI or a different URI pointing to the endpoint of the NF service consumer to which the notification should be sent.
RedirectResponse	O	0..1	308 Permanent Redirect	Permanent redirection. The NF service consumer shall generate a Location header field containing a URI pointing to the endpoint of another NF service consumer to which the notification should be sent. If an SCP redirects the message to another SCP then the location header field shall contain the same URI or a different URI pointing to the endpoint of the NF service consumer to which the notification should be sent.
ProblemDetails	O	0..1	403 Forbidden	The "cause" attribute may be used to indicate the following application errors: - UNSPECIFIED - LOCATION_SESSION_UNKNOWN See table 6.1.7.3-1 for the description of this error.
NOTE: The mandatory HTTP error status codes for the POST method listed in Table 5.2.7.1-1 of 3GPP TS 29.500 [4] other than those specified in the table above also apply, with a ProblemDetails data type (see clause 5.2.7 of 3GPP TS 29.500 [4]).				

Table 6.1.5.1.3.1-3: Headers supported by the 307 Response Code on this resource

Name	Data type	P	Cardinality	Description
Location	string	M	1	A URI pointing to the endpoint of NF service consumer to which the notification should be sent
3gpp-Sbi-Target-Nf-Id	string	O	0..1	Identifier of the target NF (service) instance ID towards which the notification is redirected

Table 6.1.5.1.3.1-4: Headers supported by the 308 Response Code on this resource

Name	Data type	P	Cardinality	Description
Location	string	M	1	A URI pointing to the endpoint of NF service consumer to which the notification should be sent
3gpp-Sbi-Target-Nf-Id	string	O	0..1	Identifier of the target NF (service) instance ID towards which the notification is redirected

6.1.6 Data Model

6.1.6.1 General

This clause specifies the application data model supported by the API.

Table 6.1.6.1-1 specifies the data types defined for the Nlmf_Location service based interface protocol.

Table 6.1.6.1-1: Nlmf_Location specific Data Types

Data type	Clause defined	Description
InputData	6.1.6.2.2	Information within Determine Location Request
LocationData	6.1.6.2.3	Information within Determine Location Response
GeographicalCoordinates	6.1.6.2.4	Geographical coordinates
GeographicArea	6.1.6.2.5	Geographic area specified by different shape
Point	6.1.6.2.6	Ellipsoid Point
PointUncertaintyCircle	6.1.6.2.7	Ellipsoid point with uncertainty circle
PointUncertaintyEllipse	6.1.6.2.8	Ellipsoid point with uncertainty ellipse
Polygon	6.1.6.2.9	Polygon
PointAltitude	6.1.6.2.10	Ellipsoid point with altitude
PointAltitudeUncertainty	6.1.6.2.11	Ellipsoid point with altitude and uncertainty ellipsoid
EllipsoidArc	6.1.6.2.12	Ellipsoid Arc
LocationQoS	6.1.6.2.13	QoS of Location request
CivicAddress	6.1.6.2.14	Indicates a Civic address
PositioningMethodAndUsage	6.1.6.2.15	Indicates the usage of a positioning method
GnssPositioningMethodAndUsage	6.1.6.2.16	Indicates the usage of a Global Navigation Satellite System (GNSS) positioning method
VelocityEstimate	6.1.6.2.17	Velocity estimate
HorizontalVelocity	6.1.6.2.18	Horizontal velocity
HorizontalWithVerticalVelocity	6.1.6.2.19	Horizontal and vertical velocity
HorizontalVelocityWithUncertainty	6.1.6.2.20	Horizontal velocity with speed uncertainty
HorizontalWithVerticalVelocityAndUncertainty	6.1.6.2.21	Horizontal and vertical velocity with speed uncertainty
UncertaintyEllipse	6.1.6.2.22	Ellipse with uncertainty
UeLcsCapability	6.1.6.2.23	Indicates the LCS capability supported by the UE.
PeriodicEventInfo	6.1.6.2.24	Indicates the information of periodic event reporting
AreaEventInfo	6.1.6.2.25	Indicates the information of area based event reporting
ReportingArea	6.1.6.2.26	Indicates an area for event reporting
MotionEventInfo	6.1.6.2.27	Indicates the information of motion based event reporting
CancelLocData	6.1.6.2.29	Information within Cancel Location Request
LocContextData	6.1.6.2.30	Information within Transfer Location Context Request
EventReportMessage	6.1.6.2.31	Indicates an event report message
EventReportingStatus	6.1.6.2.32	Indicates the status of event reporting
UeLocationInfo	6.1.6.2.33	Indicates location information of a UE
EventNotifyData	6.1.6.2.34	Information within Event Notify Request
UeConnectivityState	6.1.6.2.35	Indicates the connectivity state of a UE
LocalOrigin	6.1.6.2.36	Indicates a Local origin in a reference system.
RelativeCartesianLocation	6.1.6.2.37	Relative Cartesian Location
Local2dPointUncertaintyEllipse	6.1.6.2.38	Local 2D point with uncertainty ellipse
Local3dPointUncertaintyEllipsoid	6.1.6.2.39	Local 3D point with uncertainty ellipsoid
UncertaintyEllipsoid	6.1.6.2.40	Ellipsoid with uncertainty
LocalArea	6.1.6.2.41	Local area specified by different shape
UeAreaIndication	6.1.6.2.42	UE area Indication
MinorLocationQoS	6.1.6.2.43	Minor Location QoS
Altitude	6.1.6.3.2	Indicates value of altitude
Angle	6.1.6.3.2	Indicates value of angle
Uncertainty	6.1.6.3.2	Indicates value of uncertainty
Orientation	6.1.6.3.2	Indicates value of orientation angle
Confidence	6.1.6.3.2	Indicates value of confidence
Accuracy	6.1.6.3.2	Indicates value of accuracy
InnerRadius	6.1.6.3.2	Indicates value of the inner radius
CorrelationID	6.1.6.3.2	LCS Correlation ID
AgeOfLocationEstimate	6.1.6.3.2	Indicates value of the age of the location estimate
HorizontalSpeed	6.1.6.3.2	Indicates value of horizontal speed
VerticalSpeed	6.1.6.3.2	Indicates value of vertical speed
SpeedUncertainty	6.1.6.3.2	Indicates value of speed uncertainty
BarometricPressure	6.1.6.3.2	Specifies the measured uncompensated atmospheric pressure

LcsServiceType	6.1.6.3.2	LCS service type
LdrReference	6.1.6.3.2	LDR Reference
ReportingAmount	6.1.6.3.2	Number of required periodic event reports
ReportingInterval	6.1.6.3.2	Event reporting periodic interval
MinimumInterval	6.1.6.3.2	Minimum interval between event reports
MaximumInterval	6.1.6.3.2	Maximum interval between event reports
SamplingInterval	6.1.6.3.2	Maximum time interval between consecutive evaluations by a UE of a trigger event
ReportingDuration	6.1.6.3.2	Maximum duration of event reporting
LinearDistance	6.1.6.3.2	Minimum straight line distance moved by a UE to trigger a motion event report
LMFIdentification	6.1.6.3.2	LMF identification
EventReportCounter	6.1.6.3.2	Number of event reports received from the target UE
EventReportDuration	6.1.6.3.2	Duration of event reporting
UePositioningCapabilities	6.1.6.3.2	Indicates the positioning capabilities supported by the UE.
ExternalClientType	6.1.6.3.3	Indicates types of External Clients
SupportedGADShapes	6.1.6.3.4	Indicates supported GAD shapes
ResponseTime	6.1.6.3.5	Indicates acceptable delay of location request
PositioningMethod	6.1.6.3.6	Indicates supported positioning methods
PositioningMode	6.1.6.3.7	Indicates supported modes used for positioning method
GnssId	6.1.6.3.8	Global Navigation Satellite System (GNSS) ID
Usage	6.1.6.3.9	Indicates usage made of the location measurement
LcsPriority	6.1.6.3.10	Indicates priority of the LCS client
VelocityRequested	6.1.6.3.11	Indicates velocity requirement
AccuracyFulfilmentIndicator	6.1.6.3.12	Indicates fulfilment of requested accuracy
VerticalDirection	6.1.6.3.13	Indicates direction of vertical speed
LdrType	6.1.6.3.14	Indicates LDR types
ReportingAreaType	6.1.6.3.15	Indicates type of event reporting area
OccurrenceInfo	6.1.6.3.16	Specifies occurrence of event reporting
ReportingAccessType	6.1.6.3.17	Specifies access types of event reporting
EventClass	6.1.6.3.18	Specifies event classes
ReportedEventType	6.1.6.3.19	Specifies type of event reporting
TerminationCause	6.1.6.3.20	Specifies causes of event reporting termination
LcsQoSClass	6.1.6.3.21	Specifies LCS QoS class
UeLocationServiceInd	6.1.6.3.22	Specifies location service types requested by UE

Table 6.1.6.1-2 specifies data types re-used by the Nlmf_Location service based interface protocol from other specifications, including a reference to their respective specifications and when needed, a short description of their use within the Nlmf_Location service based interface.

Table 6.1.6.1-2: Nlmf_Location re-used Data Types

Data type	Reference	Comments
Supi	3GPP TS 29.571 [8]	Subscription Permanent Identifier
Pei	3GPP TS 29.571 [8]	Permanent Equipment Identifier
Gpsi	3GPP TS 29.571 [8]	Generic Public Subscription Identifier
Ecgi	3GPP TS 29.571 [8]	E-UTRA Cell Identity
Ncgi	3GPP TS 29.571 [8]	NR Cell Identity
NfnInstanceId	3GPP TS 29.571 [8]	Network Function Instance ID
Uri	3GPP TS 29.571 [8]	Uniform Resource Identifier
RefToBinaryData	3GPP TS 29.571 [8]	Reference to binary data
AccessType	3GPP TS 29.571 [8]	Access type
CmState	3GPP TS 29.518 [23]	Connection Management State
Guami	3GPP TS 29.571 [8]	GUAMI
SupportedFeatures	3GPP TS 29.571 [8]	Supported Features
RedirectResponse	3GPP TS 29.571 [8]	Redirect Response
TwapId	3GPP TS 29.571 [8]	TWAP identifier
TnapId	3GPP TS 29.571 [8]	TNAP identifier
DateTime	3GPP TS 29.571 [8]	Date and Time

6.1.6.2 Structured data types

6.1.6.2.1 Introduction

This clause defines the structures to be used in resource representations.

6.1.6.2.2 Type: InputData

Table 6.1.6.2.2-1: Definition of type InputData

Attribute name	Data type	P	Cardinality	Description	Applicability
externalClientType	ExternalClientType	O	0..1	When present, this IE shall carry the external client type of the requester.	
correlationID	CorrelationID	O	0..1	When present, this IE shall carry the correlation ID of the request.	
amfld	NfInstancelid	O	0..1	Indicates the AMF Instance serving the UE. LMF shall use the AMF Instance to forward LCS related N1/N2 messages to the UE/RAN.	
locationQoS	LocationQoS	O	0..1	When present, this IE shall carry the QoS of the location request.	
supportedGADShapes	array(SupportedGADShapes)	O	1..N	When present, this IE shall carry the GAD shapes supported by the requester.	
supi	Supi	O	0..1	Indicates the SUPI of the target UE.	
pei	Pei	O	0..1	Indicates the PEI of the target UE.	
gpsi	Gpsi	O	0..1	Indicates the GPSI of the target UE.	
ecgi	Ecgi	O	0..1	When present, this IE shall indicate the identifier of the E-UTRAN cell serving the UE or the serving cell identifier of the Primary Cell in the Master RAN Node that is an E-UTRAN node on Dual Connectivity scenarios. (NOTE 2)	
ecgiOnSecondNode	Ecgi	O	0..1	When present, the serving cell identifier of the Primary Cell in the Secondary RAN Node that is an E-UTRAN node when available on Dual Connectivity scenarios. (NOTE 3) (NOTE 4)	
ncgi	Ncgi	O	0..1	When present, this IE shall indicate the identifier of the NR cell serving the UE or the serving cell identifier of the Primary Cell in the Master RAN Node that is a NR node on Dual Connectivity scenarios. (NOTE 2)	
ncgiOnSecondNode	Ncgi	O	0..1	When present, the serving cell identifier of the Primary Cell in the Secondary RAN Node that is a NR node when available on Dual Connectivity scenarios. (NOTE 3) (NOTE 4)	
priority	LcsPriority	O	0..1	When present, this IE shall indicate the priority of the location request.	
velocityRequested	VelocityRequested	O	0..1	When present, this IE shall indicate whether velocity is requested or not.	
ueLcsCap	UeLcsCapability	O	0..1	When present, this IE shall indicate the LCS capability supported by the UE.	
lcsServiceType	LcsServiceType	O	0..1	The LCS service type	
ldrType	LdrType	O	0..1	The type of LDR	
hgmlcCallbackURI	Uri	C	0..1	Callback URI of the H-GMLC It shall be present, if attribute LdrType is present.	
vgmlcAddress	Uri	C	0..1	V-GMLC address that corresponds to the V-GMLC that receives Location Request It shall be present, if attribute LdrType is present and the target UE is in roaming case.	
ldrReference	LdrReference	C	0..1	LDR Reference Number It shall be present, if attribute LdrType is present.	
periodicEventInfo	PeriodicEventInfo	C	0..1	Information for periodic event reporting	
areaEventInfo	AreaEventInfo	C	0..1	Information for area event reporting	
motionEventInfo	MotionEventInfo	C	0..1	Information for motion event reporting	
reportingAccessTypes	array(ReportingAccessType)	O	1..N	Allowed access types for event reporting	
ueConnectivityStates	array(UeConnectivityState)	O	1..N	When present, this IE shall indicate the UE connectivity state per access type	
ueLocationServiceInd	UeLocationServiceInd	C	0..1	If UE sends an MO-LR Request message, this IE shall be present and indicate the request type for a 5GC-MO-LR.	

moAssistanceDataTypes	LcsBroadcastAssistanceTypesData	O	0..1	When present, this IE shall indicate a list of one or more types of location assistance data that UE subscribed.	
lppMessage	RefToBinaryData	C	0..1	If UE includes the first LPP message in MO-LR Request, this IE shall be present and Indicate the binary data of LPP message. (NOTE 5)	
lppMessageExt	array(RefToBinaryData)	C	1..N	If UE includes the additional LPP messages (maximum 3) in MO-LR Request, this IE shall be present and Indicates the binary data of LPP message. (NOTE 5)	
supportedFeatures	SupportedFeatures	C	0..1	This IE shall be present if at least one optional feature defined in clause 6.1.9 is supported.	
uePositioningCap	UePositioningCapabilities	O	0..1	When present, this IE shall indicate the positioning capabilities supported by the UE.	
tnapId	TnapId	O	0..1	When present, this IE shall contain the TNAP Identifier. This IE may be present for non-3GPP access.	
twapId	TwapId	O	0..1	When present, This IE shall contain the TWAP Identifier. This IE may be present for non-3GPP access.	
ueCountryDetInd	boolean	O	0..1	When present, This IE shall contain an indication of determining the country or international area indication where UE is located.	SAT
scheduledLocTime	DateTime	O	0..1	When present, this IE shall contain the scheduled time that the UE needs to be located.	
reliableLocReq	boolean	C	0..1	This IE shall be included with the value "true" to indicate that reliable UE location information is required , as specified in 3GPP TS 33.256 [26] clause 5.3.2. When present, this IE shall be set as following: - true: the reliable UE location information is required - false (default): the reliable UE location information is not required	
<p>NOTE 1: At least one of the attributes defined in this table shall be present in the InputData structure.</p> <p>NOTE 2: Attribute "ecgi" and "ncgi" shall not be present at the same time.</p> <p>NOTE 3: Attribute "ecgiOnSecondNode" and "ncgiOnSecondNode" shall not be present at the same time.</p> <p>NOTE 4: Attribute "ecgiOnSecondNode" or "ncgiOnSecondNode" shall not be present if neither attribute "ecgi" nor "ncgi" is present.</p> <p>NOTE 5: If 3 LPP messages are received, then first LPP message shall be encoded in lppMessage IE and additional 2 LPP messages shall be encoded in lppMessageExt IE.</p>					

6.1.6.2.3 Type: LocationData

Table 6.1.6.2.3-1: Definition of type LocationData

Attribute name	Data type	P	Cardinality	Description	Applicability
locationEstimate	GeographicArea	M	1	For a request for triggered location where location estimates are not required, the location estimate can be based on current serving cell.	
accuracyFulfilmentIndicator	AccuracyFulfilmentIndicator	O	0..1	When present, this IE shall indicate fulfilment of required accuracy.	
ageOfLocationEstimate	AgeOfLocationEstimate	O	0..1	When present, this IE shall indicate age of the location estimate.	
timestampOfLocationEstimate	DateTime	O	0..1	When present, this IE shall indicate the estimated UTC time when the location estimate corresponded to the UE location (i.e. when the location estimate and the actual UE location was the same).	
velocityEstimate	VelocityEstimate	O	0..1	When present, this IE shall indicate velocity estimate.	
civicAddress	CivicAddress	O	0..1	When present, this IE shall indicate a civic address.	
localLocationEstimate	LocalArea	O	0..1	When present, this IE shall indicate a local area in reference system.	
positioningDataList	array(PositioningMethodAndUsage)	O	1..N	When present, this IE shall include a list of data related to positioning methods.	
gnssPositioningDataList	array(GnssPositioningMethodAndUsage)	O	1..N	When present, this IE shall include a list of data related to GNSS positioning methods.	
ecgi	Ecgi	O	0..1	When present, this IE shall indicate the ID of the E-UTRAN cell serving the UE.	
ncgi	Ncgi	O	0..1	When present, this IE shall indicate the ID of the NR cell serving the UE.	
altitude	Altitude	O	0..1	Altitude of the positioning estimate. When the shape used in "locationEstimate" supports conveying the altitude parameter, this IE shall be absent.	
barometricPressure	BarometricPressure	O	0..1	If present, this IE contains the barometric pressure measurement as reported by the target UE.	
servingLMFidentification	LMFidentification	O	0..1	When present, this IE shall indicate the identity of the serving LMF	
uePositioningCap	UePositioningCapabilities	O	0..1	When present, this IE shall indicate the positioning capabilities supported by the UE.	
supportedFeatures	SupportedFeatures	C	0..1	This IE shall be present if at least one optional feature defined in clause 6.1.9 is supported.	

ueAreaInd	UeAreaIndication	O	0..1	<p>When present, this IE shall contain a country or international area indication where UE is located.</p> <p>If UE is outside of the area of any known country, i.e. international area, then the LMF shall provide the International Area Indication without a country.</p>	SAT
achievedQos	MinorLocationQoS	O	0..1	<p>When present, this IE shall contain the achieved Location QoS Accuracy of the estimated location.</p> <p>This IE may be present if the LCS QoS Class required in the request message is "MULTIPLE_QOS".</p> <p>If it's absent, LCS QoS Class required in the request message is "MULTIPLE_QOS" and AccuracyFulfilmentIndicator is "REQUESTED_ACCURACY_FULFILLED", it indicates that the location QoS in the highest priority is achieved.</p>	MUTIQOS

6.1.6.2.4 Type: GeographicalCoordinates

Table 6.1.6.2.4-1: Definition of type GeographicalCoordinates

Attribute name	Data type	P	Cardinality	Description
lon	number	M	1	Longitude (Double-precision float value): Format: double Minimum: -180 Maximum: 180
lat	number	M	1	Latitude (Double-precision float value): Format: double Minimum: -90 Maximum: 90

6.1.6.2.5 Type: GeographicArea

Table 6.1.6.2.5-1: Definition of type GeographicArea as a list of mutually exclusive alternatives

Data type	Cardinality	Discriminator property name	Discriminator mapping	Description
Point	1	shape	POINT	Geographical area consisting of a single point, represented by its longitude and latitude.
PointUncertaintyCircle	1	shape	POINT_UNCERTAINTY_CIRCLE	Geographical area consisting of a point and an uncertainty value.
PointUncertaintyEllipse	1	shape	POINT_UNCERTAINTY_ELLIPSE	Geographical area consisting of a point, plus an uncertainty ellipse and a confidence value.
Polygon	1	shape	POLYGON	Geographical area consisting of a list of points (between 3 to 15 points).
PointAltitude	1	shape	POINT_ALTITUDE	Geographical area consisting of a point and an altitude value.
PointAltitudeUncertainty	1	shape	POINT_ALTITUDE_UNCERTAINTY	Geographical area consisting of a point, an altitude value and an uncertainty value.
EllipsoidArc	1	shape	ELLIPSOID_ARC	Geographical area consisting of an ellipsoid arc.
NOTE: The "anyOf" keyword (instead of "oneOf" keyword which is normally used for mutually exclusive alternatives) is used for GeographicArea type in yaml file to avoid validation failure of OpenAPI. According to current definition, a PointUncertaintyCircle object will always pass the validation with both PointUncertaintyCircle and Point, which fails the qualification of "oneOf" keyword.				

6.1.6.2.6 Type: Point

Table 6.1.6.2.6-1: Definition of type Point

Attribute name	Data type	P	Cardinality	Description
shape	SupportedGADShapes	M	1	It shall take the value "POINT".
point	GeographicalCoordinates	M	1	Indicates a geographic point represented by its longitude and latitude.

6.1.6.2.7 Type: PointUncertaintyCircle

Table 6.1.6.2.7-1: Definition of type PointUncertaintyCircle

Attribute name	Data type	P	Cardinality	Description
shape	SupportedGADShapes	M	1	It shall take the value "POINT_UNCERTAINTY_CIRCLE".
point	GeographicalCoordinates	M	1	Indicates a geographic point represented by its longitude and latitude.
uncertainty	Uncertainty	M	1	Indicates the uncertainty value.

6.1.6.2.8 Type: PointUncertaintyEllipse

Table 6.1.6.2.8-1: Definition of type PointUncertaintyEllipse

Attribute name	Data type	P	Cardinality	Description
shape	SupportedGADShapes	M	1	It shall take the value "POINT_UNCERTAINTY_ELLIPSE".
point	GeographicalCoordinates	M	1	Indicates a geographic point represented by its longitude and latitude.
uncertaintyEllipse	UncertaintyEllipse	M	1	Indicates an uncertainty ellipse.
confidence	Confidence	M	1	Indicates the value of confidence.

6.1.6.2.9 Type: Polygon

Table 6.1.6.2.9-1: Definition of type Polygon

Attribute name	Data type	P	Cardinality	Description
shape	SupportedGADShapes	M	1	It shall take the value "POLYGON".
pointList	array(GeographicalCoordinates)	M	3..15	Array with up to 15 items, where each item is a "point".

6.1.6.2.10 Type: PointAltitude

Table 6.1.6.2.10-1: Definition of type PointAltitude

Attribute name	Data type	P	Cardinality	Description
shape	SupportedGADShapes	M	1	It shall take the value "POINT_ALTITUDE".
point	GeographicalCoordinates	M	1	Indicates a geographic point represented by its longitude and latitude.
altitude	Altitude	M	1	Indicates the value of altitude.

6.1.6.2.11 Type: PointAltitudeUncertainty

Table 6.1.6.2.11-1: Definition of type PointAltitudeUncertainty

Attribute name	Data type	P	Cardinality	Description
shape	SupportedGADShapes	M	1	It shall take the value "POINT_ALTITUDE_UNCERTAINTY".
point	GeographicalCoordinates	M	1	Indicates a geographic point represented by its longitude and latitude.
altitude	Altitude	M	1	Indicates the value of altitude.
uncertaintyEllipse	UncertaintyEllipse	M	1	Indicates the uncertainty ellipse
uncertaintyAltitude	Uncertainty	M	1	Indicates the uncertainty of the altitude.
confidence	Confidence	M	1	Indicates the value of confidence.

6.1.6.2.12 Type: EllipsoidArc

Table 6.1.6.2.12-1: Definition of type EllipsoidArc

Attribute name	Data type	P	Cardinality	Description
shape	SupportedGADShapes	M	1	It shall take the value "ELLIPSOID_ARC".
point	GeographicalCoordinates	M	1	Indicates a geographic point represented by its longitude and latitude.
innerRadius	InnerRadius	M	1	Indicates the value of inner radius of the Ellipsoid Arc.
uncertaintyRadius	Uncertainty	M	1	Indicates the uncertainty radius of the Ellipsoid Arc.
offsetAngle	Angle	M	1	Indicates the offset angle of the Ellipsoid Arc.
includedAngle	Angle	M	1	Indicates the included angle of the Ellipsoid Arc.
confidence	Confidence	M	1	Indicates the value of confidence.

6.1.6.2.13 Type: LocationQoS

Table 6.1.6.2.13-1: Definition of type LocationQoS

Attribute name	Data type	P	Cardinality	Description	Applicability
hAccuracy	Accuracy	O	0..1	Horizontal accuracy	
vAccuracy	Accuracy	O	0..1	Vertical accuracy	
vertRequested	boolean	O	0..1	Vertical accuracy requested (yes/no)	
responseTime	ResponseTime	O	0..1	No delay, Low delay or Delay tolerant	
minorLocQoses	array(MinorLocationQoS)	C	1..2	If present, this IE shall contain a list of MinorLocationQoS in priority order. When the lcsQoSClass sets to "MULTIPLE_QOS", this IE shall be present, and when lcsQoSClass sets to either "BEST_EFFORT" or "ASSURED" this IE shall be absent.	MUTIQOS
lcsQoSClass	LcsQoSClass	C	0..1	LCS QoS Class, see clause 4.1b of 3GPP TS 23.273 [19]. This IE shall be absent if neither hAccuracy nor vAccuracy is included.	

NOTE: If the lcsQoSClass set to "MULTIPLE_QOS", at least one of attributes hAccuracy, vAccuracy shall be present.

6.1.6.2.14 Type: CivicAddress

Table 6.1.6.2.14-1: Definition of type CivicAddress

Attribute name	Data type	P	Cardinality	Description
country	string	M	1	The two-letter ISO 3166 country code in capital ASCII letters, e.g., DE or US IETF RFC 4776 [6]
A1	string	O	0..1	National subdivisions (state, canton, region, province, prefecture) IETF RFC 4776 [6]
A2	string	O	0..1	County, parish, gun (JP), district (IN) IETF RFC 4776 [6]
A3	string	O	0..1	City, township, shi (JP) IETF RFC 4776 [6]
A4	string	O	0..1	City division, borough, city district, ward, chou (JP) IETF RFC 4776 [6]
A5	string	O	0..1	Neighbourhood, block IETF RFC 4776 [6]
A6	string	O	0..1	Group of streets below the neighbourhood level IETF RFC 4776 [6]
PRD	string	O	0..1	Leading street direction IETF RFC 4776 [6]
POD	string	O	0..1	Trailing street suffix IETF RFC 4776 [6]
STS	string	O	0..1	Street suffix or type IETF RFC 4776 [6]
HNO	string	O	0..1	House number IETF RFC 4776 [6]
HNS	string	O	0..1	House number suffix IETF RFC 4776 [6]
LMK	string	O	0..1	Landmark or vanity address IETF RFC 4776 [6]
LOC	string	O	0..1	Additional location information IETF RFC 4776 [6]
NAM	string	O	0..1	Name (residence and office occupant) IETF RFC 4776 [6]
PC	string	O	0..1	Postal/zip code IETF RFC 4776 [6]
BLD	string	O	0..1	Building (structure) IETF RFC 5139 [7]
UNIT	string	O	0..1	Unit (apartment, suite) IETF RFC 5139 [7]
FLR	string	O	0..1	Floor IETF RFC 4776 [6]
ROOM	string	O	0..1	Room IETF RFC 5139 [7]
PLC	string	O	0..1	Place-type IETF RFC 5139 [7]
PCN	string	O	0..1	Postal community name IETF RFC 5139 [7]
POBOX	string	O	0..1	Post office box (P.O. box) IETF RFC 5139 [7]
ADDCODE	string	O	0..1	Additional code IETF RFC 5139 [7]
SEAT	string	O	0..1	Seat (desk, cubicle, workstation) IETF RFC 5139 [7]
RD	string	O	0..1	Primary road or street IETF RFC 5139 [7]
RDSEC	string	O	0..1	Road clause IETF RFC 5139 [7]
RDBR	string	O	0..1	Road branch IETF RFC 5139 [7]
RDSUBBR	string	O	0..1	Road sub-branch IETF RFC 5139 [7]
PRM	string	O	0..1	Road pre-modifier IETF RFC 5139 [7]
POM	string	O	0..1	Road post-modifier IETF RFC 5139 [7]

usageRules	string	O	0..1	When present, this IE shall carry the value of "usage-rules" Element of the PIDL-LO XML document, with UTF-8 encoding. IETF RFC 4119 [25]
method	string	O	0..1	When present, this IE shall contain the method token, carried by the "method" Element of the PIDL-LO XML document. IETF RFC 4119 [25]
providedBy	string	O	0..1	When present, this IE shall carry the value of "provided-by" Element of the PIDL-LO XML document, with UTF-8 encoding. IETF RFC 4119 [25]

EXAMPLE: The above structure follows the same label naming as in the XML schema shown in IETF RFC 5139 [7]. The same example shown in XML in that RFC, in clause 5, would be equivalent to the following JSON document:

```
{
  "country": "AU",
  "A1": "NSW",
  "A3": "Wollongong",
  "A4": "North Wollongong",
  "RD": "Flinders",
  "STS": "Street",
  "RDBR": "Campbell Street",
  "LMK": "Gilligan's Island",
  "LOC": "Corner",
  "NAM": "Video Rental Store",
  "PC": "2500",
  "ROOM": "Westerns and Classics",
  "PLC": "store",
  "POBOX": "Private Box 15"
}
```

6.1.6.2.15 Type: PositioningMethodAndUsage

Table 6.1.6.2.15-1: Definition of type PositioningMethodAndUsage

Attribute name	Data type	P	Cardinality	Description
method	PositioningMethod	M	1	Indicates the related positioning method
mode	PositioningMode	M	1	Indicates the mode of the location measurement from the related positioning method.
usage	Usage	M	1	Indicates the usage of the location measurement from the related positioning method.
methodCode	integer	C	0..1	This IE shall be present when the <i>method</i> IE is with value "NETWORK_SPECIFIC". When present, this IE shall carry the code value of the network specific positioning method in decimal which encodes the binary value "10000 to 11111" (bits 8-4 of " <i>Positioning Method and Usage</i> " IE within " <i>Positioning Data</i> " parameter, as specified in clause 7.4.13 of 3GPP TS 29.171 [24].) Minimum: 16 Maximum: 31

6.1.6.2.16 Type: GnssPositioningMethodAndUsage

Table 6.1.6.2.16-1: Definition of type GnssPositioningMethodAndUsage

Attribute name	Data type	P	Cardinality	Description
mode	PositioningMode	M	1	Indicates the mode of location measurement from the related GNSS positioning method.
gnss	GnssId	M	1	Indicates the related GNSS positioning method
usage	Usage	M	1	Indicates the usage of the location measurement from related GNSS positioning method.

6.1.6.2.17 Type: VelocityEstimate

Table 6.1.6.2.17-1: Definition of type VelocityEstimate as a list of mutually exclusive alternatives

Data type	Cardinality	Description
HorizontalVelocity	1	Velocity estimate including horizontal speed and bearing.
HorizontalWithVerticalVelocity	1	Velocity estimate including horizontal speed and bearing, and also vertical speed and vertical direction.
HorizontalVelocityWithUncertainty	1	Velocity estimate including horizontal speed and bearing; it also includes an uncertainty value.
HorizontalWithVerticalVelocityAndUncertainty	1	Velocity estimate including horizontal speed and bearing, and also vertical speed and vertical direction; it also includes uncertainty value for horizontal and vertical speeds.

6.1.6.2.18 Type: HorizontalVelocity

Table 6.1.6.2.18-1: Definition of type HorizontalVelocity

Attribute name	Data type	P	Cardinality	Description
hSpeed	HorizontalSpeed	M	1	Horizontal speed in kilometres per hour.
bearing	Angle	M	1	Bearing angle in degrees, measured clockwise from North.

6.1.6.2.19 Type: HorizontalWithVerticalVelocity

Table 6.1.6.2.19-1: Definition of type HorizontalWithVerticalVelocity

Attribute name	Data type	P	Cardinality	Description
hSpeed	HorizontalSpeed	M	1	Horizontal speed in kilometres per hour.
bearing	Angle	M	1	Bearing angel in degrees, measured clockwise from North.
vSpeed	VerticalSpeed	M	1	Vertical Seed in kilometres per hour.
vDirection	VerticalDirection	M	1	Vertical Direction: upward or downward.

6.1.6.2.20 Type: HorizontalVelocityWithUncertainty

Table 6.1.6.2.20-1: Definition of type HorizontalVelocityWithUncertainty

Attribute name	Data type	P	Cardinality	Description
hSpeed	HorizontalSpeed	M	1	Speed in kilometres per hour.
bearing	Angle	M	1	Bearing angel in degrees, measured clockwise from North.
uncertainty	SpeedUncertainty	M	1	Uncertainty of horizontal speed in kilometres per hour.

6.1.6.2.21 Type: HorizontalWithVerticalVelocityAndUncertainty

Table 6.1.6.2.21-1: Definition of type HorizontalWithVerticalVelocityAndUncertainty

Attribute name	Data type	P	Cardinality	Description
hspeed	HorizontalSpeed	M	1	Speed in kilometres per hour.
bearing	Angle	M	1	Bearing angel in degrees, measured clockwise from North.
vSpeed	VerticalSpeed	M	1	Vertical Seed in kilometres per hour.
vDirection	VerticalDirection	M	1	Vertical Direction: upwards or downwards.
hUncertainty	SpeedUncertainty	M	1	Uncertainty of horizontal speed in kilometres per hour.
vUncertainty	SpeedUncertainty	M	1	Uncertainty of vertical speed in kilometres per hour.

6.1.6.2.22 Type: UncertaintyEllipse

Table 6.1.6.2.22-1: Definition of type UncertaintyEllipse

Attribute name	Data type	P	Cardinality	Description
semiMajor	Uncertainty	M	1	Indicates the semi-major axis of the uncertainty ellipse.
semiMinor	Uncertainty	M	1	Indicates the semi-minor axis of the uncertainty ellipse.
orientationMajor	Orientation	M	1	Indicates the orientation angle of the major axis.

6.1.6.2.23 Type: UeLcsCapability

Table 6.1.6.2.23-1: Definition of type UeLcsCapability

Attribute name	Data type	P	Cardinality	Description
lppSupport	boolean	O	0..1	Indicates whether the UE supports LPP or not. - true (default): LPP supported by the UE - false: LPP not supported by the UE
ciotOptimisation	boolean	O	0..1	Indicates whether the UE supports and is allowed to use Control Plane CiOT 5GS Optimisation to send an event report for periodic or triggered location or not. Refer to 3GPP TS 23.273 [19] clause 6.7 for more detail. - true: Control Plane CiOT 5GS Optimisation is supported by the UE and allowed - false (default): Control Plane CiOT 5GS Optimisation not supported by the UE or not allowed

6.1.6.2.24 Type: PeriodicEventInfo

Table 6.1.6.2.24-1: Definition of type PeriodicEventInfo

Attribute name	Data type	P	Cardinality	Description
reportingAmount	ReportingAmount	M	1	Number of event reports
reportingInterval	ReportingInterval	M	1	Interval of event reports

NOTE: reportingAmount x reportingInterval shall not exceed 8639999 (99 days, 23 hours, 59 minutes and 59 seconds) for compatibility with OMA MLP and RLP.

6.1.6.2.25 Type: AreaEventInfo

Table 6.1.6.2.25-1: Definition of type AreaEventInfo

Attribute name	Data type	P	Cardinality	Description
areaDefinition	array(ReportingArea)	M	1..250	One or more reporting areas
occurrenceInfo	OccurrenceInfo	O	0..1	One time only report indication
minimumInterval	MinimumInterval	C	0..1	Minimum interval between event reports. This IE shall not be included if occurrenceInfo is present and set to one time event.
maximumInterval	MaximumInterval	C	0..1	Maximum interval between event reports. This IE shall not be included if occurrenceInfo is present and set to one time event.
samplingInterval	SamplingInterval	O	0..1	Maximum time interval between consecutive evaluations by a UE of a trigger event.
reportingDuration	ReportingDuration	O	0..1	Maximum duration of event reporting.
reportingLocationReq	boolean	C	0..1	This IE shall be present and set to true if a location estimate is required for each event report.

6.1.6.2.26 Type: ReportingArea

Table 6.1.6.2.26-1: Definition of type ReportingArea

Attribute name	Data type	P	Cardinality	Description
areaType	ReportingAreaType	M	1	Type of reporting area.
tai	Tai	C	1	TAI for EPS or 5GS. This IE shall be present if the reporting area type is EPS TAI or 5GS TAI.
ecgi	Ecgi	C	1	ECGI. This IE shall be present if the reporting area type is ECGI.
ncgi	Ncgi	C	1	NCGI. This IE shall be present if the reporting area type is NCGI.

NOTE: One of tai, ecgi or ncgi shall be included.

6.1.6.2.27 Type: MotionEventInfo

Table 6.1.6.2.27-1: Definition of type MotionEventInfo

Attribute name	Data type	P	Cardinality	Description
linearDistance	LinearDistance	M	1	Minimum linear (straight line) distance for motion event reports.
occurrenceInfo	OccurrenceInfo	O	0..1	One time only report indication
minimumInterval	MinimumInterval	C	0..1	Minimum interval between event reports. This IE shall not be included if occurrenceInfo is present and set to one time event.
maximumInterval	MaximumInterval	C	0..1	Maximum interval between event reports. This IE shall not be included if occurrenceInfo is present and set to one time event.
samplingInterval	SamplingInterval	O	0..1	Maximum time interval between consecutive evaluations by a UE of a trigger event.
reportingDuration	ReportingDuration	O	0..1	Maximum duration of event reporting.
reportingLocationReq	boolean	C	0..1	This IE shall be present and set to true if a location estimate is required for each event report.

6.1.6.2.28 Void

6.1.6.2.29 Type: CancelLocData

Table 6.1.6.2.29-1: Definition of type CancelLocData

Attribute name	Data type	P	Cardinality	Description
hgmlcCallbackURI	Uri	M	1	Callback URI of the H-GMLC
ldrReference	LdrReference	M	1	LDR Reference
supportedFeatures	SupportedFeatures	C	0..1	This IE shall be present if at least one optional feature defined in clause 6.1.9 is supported.

6.1.6.2.30 Type: LocContextData

Table 6.1.6.2.30-1: Definition of type LocContextData

Attribute name	Data type	P	Cardinality	Description
amfId	NfnInstanceId	M	1	Indicates the AMF Instance serving the UE. LMF shall use the AMF Instance to forward LCS related N1/N2 messages to the UE/RAN.
locationQoS	LocationQoS	C	0..1	This IE shall contain the location QoS if available.
supportedGADShapes	array(SupportedGADShapes)	C	0..N	This IE shall contain the supported GAD shapes if available.
supi	Supi	C	0..1	This IE shall contain the SUPI if available.
gpsi	Gpsi	C	0..1	This IE shall contain the GPSI if available.
ldrType	LdrType	M	1	The type of LDR
hgmlcCallbackURI	Uri	M	1	Callback URI of the H-GMLC
ldrReference	LdrReference	M	1	LDR Reference
periodicEventInfo	PeriodicEventInfo	C	0..1	Information for periodic event reporting
areaEventInfo	AreaEventInfo	C	0..1	Information for area event reporting
motionEventInfo	MotionEventInfo	C	0..1	Information for motion event reporting
eventReportMessage	EventReportMessage	M	1	Contains an embedded event report
eventReportingStatus	EventReportingStatus	O	0..1	Status of event reporting
ueLocationInfo	UELocationInfo	O	0..1	Location information for the target UE
clot5GSOptimisation	boolean	C	0..1	This IE shall be present if it was received from AMF. When present, it shall be set as follows: - true: Control Plane Clot 5GS Optimisation was used and no signalling or data is currently pending for the UE at the AMF. - false (default): Control Plane Clot 5GS Optimisation was not used or signalling or data is currently pending for the UE at the AMF.
ecgi	Ecgi	C	0..1	When present, this IE shall indicate the identifier of the E-UTRAN cell serving the UE. This IE shall be present if it was received from AMF.
ncgi	Ncgi	C	0..1	When present, this IE shall indicate the identifier of the NR cell serving the UE. This IE shall be present if it was received from AMF.
guami	Guami	C	0..1	This IE shall be present if it was received from AMF. When present, it shall contain the GUAMI serving the UE.
supportedFeatures	SupportedFeatures	C	0..1	This IE shall be present if at least one optional feature defined in clause 6.1.9 is supported.
uePositioningCap	UePositioningCapabilities	O	0..1	When present, this IE shall indicate the positioning capabilities supported by the UE.
scheduledLocTime	DateTime	O	0..1	When present, this IE shall contain the scheduled time that the UE needs to be located.
NOTE:	At least one of periodicEventInfo, areaEventInfo or motionEventInfo shall be present in the LocContextData structure.			

6.1.6.2.31 Type: EventReportMessage

Table 6.1.6.2.31-1: Definition of type EventReportMessage

Attribute name	Data type	P	Cardinality	Description
eventClass	EventClass	M	1	This IE shall contain the event class for the message content specified in eventContent.
eventContent	RefToBinaryData	M	1	This IE shall reference the event report binary data corresponding to the eventClass.

6.1.6.2.32 Type: EventReportingStatus

Table 6.1.6.2.32-1: Definition of type EventReportingStatus

Attribute name	Data type	P	Cardinality	Description
eventReportCounter	EventReportCounter	O	0..1	This IE shall contain a count of event reports.
eventReportDuration	EventReportDuration	O	0..1	This IE shall contain the duration of event reporting.

6.1.6.2.33 Type: UELocationInfo

Table 6.1.6.2.33-1: Definition of type UELocationInfo

Attribute name	Data type	P	Cardinality	Description
locationEstimate	GeographicArea	O	0..1	Previous location estimate for the target UE.
ageOfLocationEstimate	AgeOfLocationEstimate	O	0..1	Age of previous location estimate.
timestampOfLocationEstimate	DateTime	O	0..1	When present, this IE shall indicate the estimated UTC time when the location estimate corresponded to the UE location (i.e. when the location estimate and the actual UE location was the same).
velocityEstimate	VelocityEstimate	O	0..1	Previous velocity estimate for the target UE.
ageOfVelocityEstimate	AgeOfLocationEstimate	O	0..1	Age of previous velocity estimate.
timestampOfVelocityEstimate	DateTime	O	0..1	When present, this IE shall indicate the estimated UTC time when the velocity estimate corresponded to the UE velocity (i.e. when the velocity estimate and the actual UE velocity was the same).

6.1.6.2.34 Type: EventNotifyData

Table 6.1.6.2.34-1: Definition of type EventNotifyData

Attribute name	Data type	P	Cardinality	Description	Applicability
reportedEventType	ReportedEventType	M	1	This IE shall contain the type of event being reported.	
supi	Supi	C	0..1	This IE shall contain the SUPI if available.	
gpsi	Gpsi	C	0..1	This IE shall contain the GPSI if available.	
hgmlcCallbackURI	Uri	C	0..1	Callback URI of the H-GMLC (NOTE 1)	
ldrReference	LdrReference	M	1	LDR Reference	
locationEstimate	GeographicArea	O	0..1	If present, this IE shall contain an estimate of the location of the UE in universal coordinates and the accuracy of the estimate.	
ageOfLocationEstimate	AgeOfLocationEstimate	O	0..1	If present, this IE shall contain an indication of how long ago the location estimate was obtained.	
timestampOfLocationEstimate	DateTime	O	0..1	When present, this IE shall indicate the estimated UTC time when the location estimate corresponded to the UE location (i.e. when the location estimate and the actual UE location was the same).	
civicAddress	CivicAddress	O	0..1	If present, this IE shall contain a civic address.	
localLocationEstimate	LocalArea	O	0..1	When present, this IE shall indicate a local area in reference system.	
positioningDataList	array(PositioningMethodAndUsage)	O	1..N	If present, this IE shall indicate the usage of each non-GANSS positioning method that was attempted to determine the location estimate, either successfully or unsuccessfully.	
gnssPositioningDataList	array(GnssPositioningMethodAndUsage)	O	1..N	If present, this IE shall indicate the usage of each GANSS positioning method that was attempted to determine the location estimate, either successfully or unsuccessfully.	
servingLMFIdentification	LMFIdentification	C	0..1	This IE shall be included to identify an LMF which acts as a serving LMF if a serving LMF is used.	
terminationCause	TerminationCause	C	0..1	This IE shall be included if event reporting has been terminated	
velocityEstimate	VelocityEstimate	O	0..1	If present, this IE shall contain an estimate of the velocity of the target UE, composed by horizontal speed, vertical speed, and their respective uncertainty.	
altitude	Altitude	O	0..1	If present, this IE indicates the altitude of the positioning estimate. When the shape used in "locationEstimate" supports conveying the altitude parameter, this IE shall be absent.	

achievedQoS	MinorLocationQoS	O	0..1	<p>When present, this IE shall contain the achieved Location QoS Accuracy of the estimated location.</p> <p>This IE may be present if the required LCS QoS Class in the location request procedure is "MULTIPLE_QOS".</p> <p>If it's absent, the required LCS QoS Class in the location request procedure is "MULTIPLE_QOS" and AccuracyFulfilmentIndicator is "REQUESTED_ACCURACY_FULFILLED", it indicates that the location QoS in the highest priority is achieved.</p>	MUTIQOS
supportedFeatures	SupportedFeatures	C	0..1	This IE shall be present if at least one optional feature defined in clause 6.1.9 is supported.	
NOTE 1: The hgmlcCallbackURI shall be included when the consumer NF is not the H-GMLC.					

6.1.6.2.35 Type: UeConnectivityState

Table 6.1.6.2.35-1: Definition of type UeConnectivityState

Attribute name	Data type	P	Cardinality	Description
accessType	AccessType	M	1	Shall indicate the access type of the UE.
connectivitystate	CmState	O	0..1	When present, it shall indicate the UE connectivity state in the indicated access type.

6.1.6.2.36 Type: LocalOrigin

Table 6.1.6.2.36-1: Definition of type LocalOrigin

Attribute name	Data type	P	Cardinality	Description
coordinateId	string	M	1	This IE defines a known reference point which configured by the PLMN operator
point	GeographicalCoordinates	O	0..1	Indicates a geographic point represented by its longitude and latitude.

6.1.6.2.37 Type: RelativeCartesianLocation

Table 6.1.6.2.37-1: Definition of type RelativeCartesianLocation

Attribute name	Data type	P	Cardinality	Description
x	Float	M	1	Indicates the value (in the unit of meters) on x-axis of the relative location in the cartesian system. Positive value represents easting from reference point (origin).
y	Float	M	1	Indicates the value (in the unit of meters) on y-axis of the relative location in the cartesian system. Positive value represents northing from reference point (origin).
z	Float	O	0..1	Indicates the value (in the unit of meters) on z-axis of the relative location in the cartesian system for a 3D-Point. Positive value represents height above reference point (origin).

6.1.6.2.38 Type: Local2dPointUncertaintyEllipse

Table 6.1.6.2.38-1: Definition of type Local2dPointUncertaintyEllipse

Attribute name	Data type	P	Cardinality	Description
shape	SupportedGADShapes	M	1	It shall take the value "LOCAL_2D_POINT_UNCERTAINTY_ELLIPSE".
localOrigin	LocalOrigin	M	1	Indicates the local origin in the local Cartesian co-ordinates system configured by the PLMN operator.
point	RelativeCartesianLocation	M	1	Indicates a 2D-point (specified by "x" and "y" coordinates) relative to origin in referrece system.
uncertaintyEllipse	UncertaintyEllipse	M	1	Indicates an uncertainty ellipse.
confidence	Confidence	M	1	Indicates the value of confidence.

6.1.6.2.39 Type: Local3dPointUncertaintyEllipsoid

Table 6.1.6.2.39-1: Definition of type Local3dPointUncertaintyEllipsoid

Attribute name	Data type	P	Cardinality	Description
shape	SupportedGADShapes	M	1	It shall take the value "LOCAL_3D_POINT_UNCERTAINTY_ELLIPSOID".
localOrigin	LocalOrigin	M	1	Indicates the local origin in the local Cartesian co-ordinates system configured by the PLMN operator.
point	RelativeCartesianLocation	M	1	Indicates a 3D-point (specified by "x", "y" and "z" coordinates) relative to origin in referrece system.
uncertaintyEllipsoid	UncertaintyEllipsoid	M	1	Indicates the uncertainty ellipsoid
confidence	Confidence	M	1	Indicates the value of confidence.

6.1.6.2.40 Type: UncertaintyEllipsoid

Table 6.1.6.2.40-1: Definition of type UncertaintyEllipsoid

Attribute name	Data type	P	Cardinality	Description
semiMajor	Uncertainty	M	1	Indicates the semi-major axis of the uncertainty ellipsoid.
semiMinor	Uncertainty	M	1	Indicates the semi-minor axis of the uncertainty ellipsoid.
vertical	Uncertainty	M	1	Indicates the vertical axis of the uncertainty ellipsoid.
orientationMajor	Orientation	M	1	Indicates the orientation angle of the major axis.

6.1.6.2.41 Type: LocalArea

Table 6.1.6.2.41-1: Definition of type LocalArea as a list of mutually exclusive alternatives

Data type	Cardinality	Discriminator property name	Discriminator mapping	Description
Local2dPointUncertaintyEllipse	1	shape	LOCAL_2D_POINT_UNCERTAINTY_ELLIPSE	Local area consisting of a point described in 2D local coordinates relative to an origin in a reference system, plus an uncertainty ellipse and a confidence value.
Local3dPointUncertaintyEllipsoid	1	shape	LOCAL_3D_POINT_UNCERTAINTY_ELLIPSOID	Local area consisting of a point described in 3D local coordinates relative to an origin in a reference system, distances r1 (the "semi-major uncertainty"), r2 (the "semi-minor uncertainty") and r3 (the "vertical uncertainty") and an angle of orientation A (the "angle of the major axis").

6.1.6.2.42 Type: UeAreaIndication

Table 6.1.6.2.42-1: Definition of type UeAreaIndication

Attribute name	Data type	P	Cardinality	Description
country	string	C	0..1	This IE shall be present if the country UE located is determined. When present, this IE contains two-letter ISO 3166 country code in capital ASCII letters, e.g., DE or US IETF RFC 4776 [6]
internationalAreaInd	boolean	C	0..1	Indicates international area

NOTE: Either country or internationalAreaInd shall be present.

6.1.6.2.43 Type: MinorLocationQoS

Table 6.1.6.2.43-1: Definition of type MinorLocationQoS

Attribute name	Data type	P	Cardinality	Description
hAccuracy	Accuracy	O	0..1	Horizontal accuracy
vAccuracy	Accuracy	O	0..1	Vertical accuracy

6.1.6.3 Simple data types and enumerations

6.1.6.3.1 Introduction

This clause defines simple data types and enumerations that can be referenced from data structures defined in the previous clauses.

6.1.6.3.2 Simple data types

The simple data types defined in table 6.1.6.3.2-1 shall be supported.

Table 6.1.6.3.2-1: Simple data types

Type Name	Type Definition	Description
Altitude	number	Double-precision float value of the altitude, expressed in meters. Minimum: -32767. Maximum: 32767. Format: double.
Angle	integer	Integer value of the angle, expressed in degrees. Minimum: 0. Maximum: 360.
Uncertainty	number	Float value of uncertainty, expressed in meters. Minimum: 0 Format: float.
Orientation	integer	Integer value of the orientation angle, expressed in degrees. Minimum: 0. Maximum: 180.
Confidence	integer	Integer value of the confidence, expressed in percentage value. Minimum: 0. Maximum: 100.
Accuracy	number	Float value of accuracy, expressed in meters. Minimum: 0 Format: float.
InnerRadius	integer	Integer value of the inner radius, expressed in meters. Minimum: 0. Maximum: 327675. Format: int32.
CorrelationID	string	LCS Correlation ID. The correlation ID shall be of a minimum length of 1 character and maximum length of 255 characters.
AgeOfLocationEstimate	integer	Integer value of the age of the location estimate, expressed in minutes. Minimum: 0. Maximum: 32767.
HorizontalSpeed	number	Float value of horizontal speed, expressed in kilometres per hour. Minimum: 0. Maximum: 2047. Format: float.
VerticalSpeed	number	Float value of horizontal speed, expressed in kilometres per hour. Minimum: 0. Maximum: 255. Format: float.
SpeedUncertainty	number	Float value of speed uncertainty, expressed in kilometres per hour. Minimum: 0. Maximum: 255. Format: float.
BarometricPressure	integer	This IE specifies the measured uncompensated atmospheric pressure in units of Pascal (Pa). Minimum: 30000. Maximum: 115000.
LcsServiceType	integer	The LCS service type as defined in 3GPP TS 22.071 [17] and clause 17.7.8 of 3GPP TS 29.002 [18]. Minimum: 0. Maximum: 127.
LdrReference	string	LDR Reference encoded as a string of hexadecimal characters. The LdrReference shall be of a minimum length of 2 characters and maximum length of 510 characters.
ReportingAmount	integer	Number of required periodic event reports. Minimum: 1. Maximum: 8639999.
ReportingInterval	integer	Event reporting periodic interval in seconds. Minimum: 1. Maximum: 8639999. ReportingInterval x ReportingAmount shall not exceed 8639999.
MinimumInterval	integer	Minimum interval between event reports in seconds. Minimum: 1. Maximum: 32767.
MaximumInterval	integer	Maximum interval between event reports in seconds. Minimum: 1. Maximum: 86400.
SamplingInterval	integer	Maximum time interval between consecutive evaluations by a UE of a trigger event, in seconds. Minimum: 1. Maximum: 3600
ReportingDuration	integer	Maximum duration of event reporting, in seconds. Minimum: 1. Maximum: 8640000.
LinearDistance	integer	The minimum straight line distance moved by a UE to trigger a motion event report, in meters. Minimum: 1. Maximum: 10000.
LMFIdentification	string	The serving LMF identification as defined in 3GPP TS 23.273 [19], encoded as a string of hexadecimal characters.

EventReportCounter	integer	Number of event reports received from the target UE. Minimum: 1. Maximum: 8640000. Note: the current event report is included in the count.
EventReportDuration	integer	Duration of event reporting, in seconds. Minimum: 0. Maximum: 8640000. Note: the duration starts when event reporting is activated in the UE and extends to the current time.
UePositioningCapabilities	Bytes	Positioning capabilities supported by the UE. String with format "byte" as defined in OpenAPI Initiative [14], i.e. base64-encoded characters, encoding the "ProvideCapabilities-r9-IEs" IE as specified in clause 6.3 of 3GPP TS 37.355 [21] (start from octet 1).

6.1.6.3.3 Enumeration: ExternalClientType

The enumeration ExternalClientType represents the different types of clients of the location service.

Table 6.1.6.3.3-1: Enumeration ExternalClientType

Enumeration value	Description
"EMERGENCY_SERVICES"	External client for emergency services
"VALUE_ADDED_SERVICES"	External client for value added services
"PLMN_OPERATOR_SERVICES"	External client for PLMN operator services
"LAWFUL_INTERCEPT_SERVICES"	External client for Lawful Intercept services
"PLMN_OPERATOR_BROADCAST_SERVICES"	External client for PLMN Operator Broadcast services
"PLMN_OPERATOR_OM"	External client for PLMN Operator O&M
"PLMN_OPERATOR_ANONYMOUS_STATISTICS"	External client for PLMN Operator anonymous statistics
"PLMN_OPERATOR_TARGET_MS_SERVICE_SUPPORT"	External client for PLMN Operator target MS service support

6.1.6.3.4 Enumeration: SupportedGADShapes

The enumeration SupportedGADShapes represents the different types, or shapes, of geographic areas supported by the system.

Table 6.1.6.3.4-1: Enumeration SupportedGADShapes

Enumeration value	Description
"POINT"	Ellipsoid Point
"POINT_UNCERTAINTY_CIRCLE"	Ellipsoid point with uncertainty circle
"POINT_UNCERTAINTY_ELLIPSE"	Ellipsoid point with uncertainty ellipse
"POLYGON"	Polygon
"POINT_ALTITUDE"	Ellipsoid point with altitude
"POINT_ALTITUDE_UNCERTAINTY"	Ellipsoid point with altitude and uncertainty ellipsoid
"ELLIPSOID_ARC"	Ellipsoid Arc
"LOCAL_2D_POINT_UNCERTAINTY_ELLIPSE"	Local 2D point with uncertainty ellipse
"LOCAL_3D_POINT_UNCERTAINTY_ELLIPSOID"	Local 3D point with uncertainty ellipsoid

6.1.6.3.5 Enumeration: ResponseTime

The enumeration ResponseTime represents the acceptable delay in the determination of the location of the UE.

Table 6.1.6.3.5-1: Enumeration ResponseTime

Enumeration value	Description
"LOW_DELAY"	Location request is expected with low delay level.
"DELAY_TOLERANT"	Location request is delay tolerant.
"NO_DELAY "	Location request is expected with no delay (NOTE)
NOTE: The value is only used in the interface between GMLC and AF/LCS client via NEF, not further delivered to other NFs in the network. After receiving the enumeration value, the GMLC shall immediately return any location estimate, local location or civic location that it currently has. The GMLC shall return either the Initial or Last Known Location of the Target UE. If no location estimate or Dispatchable Location is available, the GLMC shall return the failure indication and may optionally initiate procedures to obtain a location estimate or Dispatchable Location (e.g. to be available for a later request).	

6.1.6.3.6 Enumeration: PositioningMethod

The enumeration PositioningMethod represents the method used to determine the location of the UE.

Table 6.1.6.3.6-1: Enumeration PositioningMethod

Enumeration value	Description
"CELLID"	Cell ID positioning method
"ECID"	Enhanced cell ID methods based on LTE signals
"OTDOA"	Observed time difference of arrival positioning based on LTE signals
"BAROMETRIC_PRESSURE"	Positioning method based on barometric Pressure Sensor
"WLAN"	WLAN positioning
"BLUETOOTH"	Bluetooth positioning
"MBS"	Terrestrial Beacon System (TBS) positioning based on MBS signals
"MOTION_SENSOR"	Positioning method based on motion Sensor
"DL_TDOA"	Downlink Time Difference of Arrival (DL-TDOA) based on NR signals
"DL_AOD"	Downlink Angle-of-Departure (DL-AoD) based on NR signals
"MULTI-RTT"	Multi-Round Trip Time Positioning (Multi-RTT based on NR signals).
"NR_ECID"	NR enhanced cell ID methods (NR E-CID) based on NR signals.
"UL_TDOA"	Uplink Time Difference of Arrival (UL-TDOA) based on NR signals
"UL_AOA"	Uplink Angle of Arrival (UL-AoA), including the Azimuth of Arrival (A-AoA) and the Zenith of Arrival (Z-AoA) based on NR signals.
"NETWORK_SPECIFIC"	Network specific position methods.

6.1.6.3.7 Enumeration: PositioningMode

The enumeration PositioningMode represents the mode used to determine the location of the UE when a certain positioning method is used.

Table 6.1.6.3.7-1: Enumeration PositioningMode

Enumeration value	Description
"UE_BASED"	UE-based mode
"UE_ASSISTED"	UE-assisted mode
"CONVENTIONAL"	Conventional mode

6.1.6.3.8 Enumeration: GnssId

The enumeration GnssId represents the different GNSS systems.

Table 6.1.6.3.8-1: Enumeration GnssId

Enumeration value	Description
"GPS"	GPS
"GALILEO"	Galileo
"SBAS"	Space Based Augmentation Systems
"MODERNIZED_GPS"	Modernized GPS
"QZSS"	Quasi Zenith Satellite System
"GLONASS"	Global Navigation Satellite System
"BDS"	BeiDou Navigation Satellite System
"NAVIC"	Navigation with Indian Constellation

6.1.6.3.9 Enumeration: Usage

The enumeration Usage represents the type of usage made of the location measurement from the UE.

Table 6.1.6.3.9-1: Enumeration Usage

Enumeration value	Description
"UNSUCCESS"	Not successful
"SUCCESS_RESULTS_NOT_USED"	Successful result not used
"SUCCESS_RESULTS_USED_TO_VERIFY_LOCATION"	Successful result used to verify the location estimate
"SUCCESS_RESULTS_USED_TO_GENERATE_LOCATION"	Successful result used to generate the location estimate
"SUCCESS_METHOD_NOT_DETERMINED"	Successful method not determined

6.1.6.3.10 Enumeration: LcsPriority

The enumeration LcsPriority represents the priority of the LCS client.

Table 6.1.6.3.10-1: Enumeration LcsPriority

Enumeration value	Description
"HIGHEST_PRIORITY"	LCS client with highest priority
"NORMAL_PRIORITY"	LCS client with normal priority

6.1.6.3.11 Enumeration: VelocityRequested

The enumeration VelocityRequested represents the indication of velocity requirement.

Table 6.1.6.3.11-1: Enumeration VelocityRequested

Enumeration value	Description
"VELOCITY_IS_NOT_REQUESTED"	velocity estimate is required
"VELOCITY_IS_REQUESTED"	velocity estimate is not required

6.1.6.3.12 Enumeration: AccuracyFulfilmentIndicator

The enumeration AccuracyFulfilmentIndicator represents whether the requested accuracy was fulfilled or not.

Table 6.1.6.3.12-1: Enumeration AccuracyFulfilmentIndicator

Enumeration value	Description
"REQUESTED_ACCURACY_FULFILLED"	requested accuracy is fulfilled
"REQUESTED_ACCURACY_NOT_FULFILLED"	requested accuracy is not fulfilled

6.1.6.3.13 Enumeration: VerticalDirection

The enumeration VerticalDirection represents the direction (upward/downward) of the vertical speed.

Table 6.1.6.3.13-1: Enumeration VerticalDirection

Enumeration value	Description
"UPWARD"	Vertical speed is upward
"DOWNWARD"	Vertical speed is downward

6.1.6.3.14 Enumeration: LdrType

Table 6.1.6.3.14-1: Enumeration LdrType

Enumeration value	Description
"UE_AVAILABLE"	UE available event
"PERIODIC"	Periodic event
"ENTERING_INTO_AREA"	Entering area event
"LEAVING_FROM_AREA"	Leaving area event
"BEING_INSIDE_AREA"	Being inside area event
"MOTION"	Motion event

6.1.6.3.15 Enumeration: ReportingAreaType

The enumeration ReportingAreaType indicates the type of a reporting area.

Table 6.1.6.3.15-1: Enumeration ReportingAreaType

Enumeration value	Description
"EPS_TRACKING_AREA_IDENTITY"	EPS TAI
"E-UTRAN_CELL_GLOBAL_IDENTIFICATION"	ECGI
"5GS_TRACKING_AREA_IDENTITY"	5GS TAI
"NR_CELL_GLOBAL_IDENTITY"	NCGI

6.1.6.3.16 Enumeration: OccurrenceInfo

The enumeration OccurrenceInfo indicates whether event reporting is one time.

Table 6.1.6.3.16-1: Enumeration AreaType

Enumeration value	Description
"ONE_TIME_EVENT"	Event to be reported one-time only
"MULTIPLE_TIME_EVENT"	Event to be reported multiple times

6.1.6.3.17 Enumeration: ReportingAccessType

The enumeration ReportingAccessType indicates an allowed access type for event reporting.

Table 6.1.6.3.17-1: Enumeration ReportingAccessType

Enumeration value	Description
"NR"	NG Radio access
"EUTRA_CONNECTED_TO_5GC"	E-URTAN access connected to 5GC
"NON_3GPP_CONNECTED_TO_5GC"	Non-3GPP access connected to 5GC
"NR_LEO"	NR (LEO) satellite access
"NR_MEO"	NR (MEO) satellite access
"NR_GEO"	NR (GEO) satellite access
"NR_OTHER_SAT"	NR (OTHERSAT) satellite access

6.1.6.3.18 Enumeration: EventClass

Table 6.1.6.3.18-1: Enumeration EventClass

Enumeration value	Description
"SUPPLEMENTARY_SERVICES"	A supplementary services message containing an argument for an lcs-EventReport operation as defined in 3GPP TS 24.080 [20].

6.1.6.3.19 Enumeration: ReportedEventType

Table 6.1.6.3.19-1: Enumeration ReportedEventType

Enumeration value	Description
"PERIODIC_EVENT"	Periodic reporting event
"ENTERING_AREA_EVENT"	Entering area reporting event
"LEAVING_AREA_EVENT"	Leaving area reporting event
"BEING_INSIDE_AREA_EVENT"	Being inside area reporting event
"MOTION_EVENT"	Motion reporting event
"MAXIMUM_INTERVAL_EXPIRATION_EVENT"	Expiration of maximum reporting interval event
"LOCATION_CANCELLATION_EVENT"	Cancellation of location reporting event

6.1.6.3.20 Enumeration: TerminationCause

Table 6.1.6.3.20-1: Enumeration TerminationCause

Enumeration value	Description
"TERMINATION_BY_UE"	Event reporting terminated by UE
"TERMINATION_BY_NETWORK"	Event reporting terminated by Network
"NORMAL_TERMINATION"	Normal Termination

6.1.6.3.21 Enumeration: LcsQosClass

Table 6.1.6.3.21-1: Enumeration LcsQosClass

Enumeration value	Description
"BEST_EFFORT"	Best Effort Class
"ASSURED"	Assured Class
"MULTIPLE_QOS"	Multiple QoS Class

MULTIQOS

6.1.6.3.22 Enumeration: UeLocationServiceInd

Table 6.1.6.3.22-1: Enumeration UeLocationServiceInd

Enumeration value	Description
"LOCATION_ESTIMATE"	Request location estimate
"LOCATION_ASSISTANCE_DATA"	Request location assistance data

6.1.6.4 Binary data

6.1.6.4.1 Introduction

This clause defines the binary data that shall be supported in a binary body part in an HTTP multipart message (see clauses 6.1.2.2.2 and 6.1.2.4).

6.1.6.4.2 LPP Message

LPP Message shall encode a LPP message as specified in 3GPP TS 37.355 [21], using the vnd.3gpp.lpp content-type.

6.1.7 Error Handling

6.1.7.1 General

HTTP error handling shall be supported as specified in clause 5.2.4 of 3GPP TS 29.500 [4].

6.1.7.2 Protocol Errors

Protocol errors handling shall be supported as specified in clause 5.2.7 of 3GPP TS 29.500 [4].

6.1.7.3 Application Errors

The application errors defined for the Nlmf_Location service are listed in Table 6.1.7.3-1.

Table 6.1.7.3-1: Application errors

Application Error	HTTP status code	Description
POSITIONING_DENIED	403 Forbidden	The positioning procedure was denied.
UNSPECIFIED	403 Forbidden	The request is rejected due to unspecified reasons.
UNSUPPORTED_BY_UE	403 Forbidden	A request for periodic or triggered location is not supported by the UE.
LOCATION_SESSION_UNKNOWN	403 Forbidden	The location context was not found.
LOCATION_TRANSFER_NOT_SUPPORTED	403 Forbidden	Transfer of a location context is not supported
INSUFFICIENT_RESOURCES	403 Forbidden	Insufficient resources for location context transfer
EVENT_REPORT_UNRECOGNIZED	403 Forbidden	The event report is unrecognized or cannot be parsed.
POSITIONING_FAILED	500 Internal Server Error	The positioning procedure failed.
UNREACHABLE_USER	504 Gateway Timeout	The user could not be reached in order to perform positioning procedure.

6.1.8 Security

As indicated in 3GPP TS 33.501 [9], the access to the Nlmf_Location API may be authorized by means of the OAuth2 protocol (see IETF RFC 6749 [10]), using the "Client Credentials" authorization grant, where the NRF (see 3GPP TS 29.510 [11]) plays the role of the authorization server.

If OAuth2 authorization is used, an NF Service Consumer, prior to consuming services offered by the Nlmf_Location API, shall obtain a "token" from the authorization server, by invoking the Access Token Request service, as described in 3GPP TS 29.510 [11], clause 5.4.2.2.

NOTE: When multiple NRFs are deployed in a network, the NRF used as authorization server is the same NRF that the NF Service Consumer used for discovering the Nlmf_Location service.

The Nlmf_Location API defines scopes for OAuth2 authorization as specified in 3GPP TS 33.501 [9]; it defines a single scope consisting on the name of the service (i.e., "nlmf-loc"), and it does not define any additional scopes at resource or operation level.

6.1.9 Feature Negotiation

The optional features in table 6.1.9-1 are defined for the Nlmf_Location API. They shall be negotiated using the extensibility mechanism defined in clause 6.6 of 3GPP TS 29.500 [4].

Table 6.1.9-1: Supported Features

Feature number	Feature Name	M/O	Description
1	ES3XX	M	Extended Support of HTTP 307/308 redirection An NF Service Consumer (e.g. AMF) that supports this feature shall support handling of HTTP 307/308 redirection for any service operation of the Location service. An NF Service Consumer that does not support this feature does only support HTTP redirection as specified for 3GPP Release 15.
2	SAT	O	Satellite Access Support of this feature implies the LMF shall be able to determine the country or International area where UE is located.
3	MUTIQOS	O	Support of Multiple Location QoSes. This feature bit indicates whether the LMF support that more than one Location QoSes during consuming location service are required.

6.1.10 HTTP redirection

An HTTP request may be redirected to a different LMF service instance, within the same LMF or a different LMF of an LMF set, e.g. when an LMF service instance is part of an LMF (service) set or when using indirect communications (see 3GPP TS 29.500 [4]). See also the ES3XX feature in clause 6.1.9.

An SCP that reselects a different LMF producer instance will return the NF Instance ID of the new LMF producer instance in the 3gpp-Sbi-Producer-Id header, as specified in clause 6.10.3.4 of 3GPP TS 29.500 [4].

If an LMF within an LMF set redirects a service request to a different LMF of the set using an 307 Temporary Redirect or 308 Permanent Redirect status code, the identity of the new LMF towards which the service request is redirected shall be indicated in the 3gpp-Sbi-Target-Nf-Id header of the 307 Temporary Redirect or 308 Permanent Redirect response as specified in clause 6.10.9.1 of 3GPP TS 29.500 [4].

6.2 Nlmf_Broadcast Service API

6.2.1 API URI

The Nlmf_Broadcast service shall use the Nlmf_Broadcast API.

The API URI of the Nlmf_Broadcast API shall be:

{apiRoot}/<apiName>/<apiVersion>

The request URI used in HTTP requests from the NF service consumer towards the NF service producer shall have the Resource URI structure defined in clause 4.4.1 of 3GPP TS 29.501 [5], i.e.:

{apiRoot}/<apiName>/<apiVersion>/<apiSpecificResourceUriPart>

with the following components:

- The {apiRoot} shall be set as described in 3GPP TS 29.501 [5].
- The <apiName> shall be "nlmf-broadcast".
- The <apiVersion> shall be "v1".
- The <apiSpecificResourceUriPart> shall be set as described in clause 6.2.3.

6.2.2 Usage of HTTP

6.2.2.1 General

HTTP/2, as defined in IETF RFC 7540 [12], shall be used as specified in clause 5 of 3GPP TS 29.500 [4].

HTTP/2 shall be transported as specified in clause 5.3 of 3GPP TS 29.500 [4].

HTTP messages and bodies for the Nlmf_Location service shall comply with the OpenAPI [14] specification contained in Annex A.

6.2.2.2 HTTP Standard Headers

6.2.2.2.1 General

6.2.2.2.2 Content type

The following content types shall be supported:

- JSON, as defined in IETF RFC 8259 [13], shall be used as content type of the HTTP bodies specified in the present specification as indicated in clause 5.4 of 3GPP TS 29.500 [4].
- The Problem Details JSON Object (IETF RFC 7807 [15]). The use of the Problem Details JSON object in a HTTP response body shall be signalled by the content type "application/problem+json".

6.2.2.3 HTTP custom headers

6.2.2.3.1 General

The following HTTP custom headers shall be supported:

- 3gpp-Sbi-Message-Priority: See 3GPP TS 29.500 [4], clause 5.2.3.2.2.

This API does not define any new HTTP custom headers.

6.2.3 Resources

6.2.3.1 Overview

The structure of the Resource URIs of the Nlmf_Broadcast service is shown in figure 6.2.3.1-1.

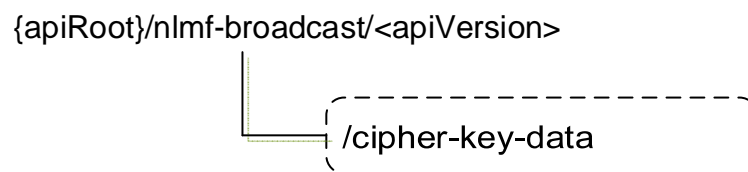

Figure 6.2.3.1-1: Resource URI structure of the Nlmf_Broadcast API

6.2.4 Custom Operations without associated resources

6.2.4.1 Overview

Table 6.2.4.1-1: Custom operations without associated resources

Operation Name	Custom operation URI	Mapped HTTP method	Description
cipher-key-data	/cipher-key-data	POST	Ciphering Key Data

6.2.4.4 Operation: cipher-key-data

6.2.4.4.1 Description

This clause describes the custom operation and what it is used for.

6.2.4.4.2 Operation Definition

This operation shall support the request and response data structures and response codes specified in table 6.2.4.4.2-1 and table 6.2.4.4.2-2.

Table 6.2.4.4.2-1: Data structures supported by the POST Request Body on this resource

Data type	P	Cardinality	Description
CipherRequestData	M	1	Input parameters to the "Ciphering Key Data" operation

Table 6.2.4.4.2-2: Data structures supported by the POST Response Body on this resource

Data type	P	Cardinality	Response codes	Description
CipherResponseData	M	1	200 OK	This case represents a successful request for ciphering key data. Upon success, a response body is returned indicating whether the LMF has ciphering key data. The ciphering key data is returned separately in a CipheringKeyData notification.
RedirectResponse	O	0..1	307 Temporary Redirect	Temporary redirection. The response shall include a Location header field containing a different URI, or the same URI if a request is redirected to the same target resource via a different SCP. In the former case, the URI shall be an alternative URI of the resource located on an alternative service instance within the same LMF or LMF (service) set.
RedirectResponse	O	0..1	308 Permanent Redirect	Permanent redirection. The response shall include a Location header field containing a different URI, or the same URI if a request is redirected to the same target resource via a different SCP. In the former case, the URI shall be an alternative URI of the resource located on an alternative service instance within the same LMF or LMF (service) set.
ProblemDetails	O	0..1	403 Forbidden	The "cause" attribute may be set to one of the following application errors: - UNSPECIFIED - BROADCAST_CIPHERING_KEYS_NOT_SUPPORTED See table 6.2.7.3-1 for the description of this error.
NOTE: The mandatory HTTP error status codes for the POST method listed in Table 5.2.7.1-1 of 3GPP TS 29.500 [4] other than those specified in the table above also apply, with a ProblemDetails data type (see clause 5.2.7 of 3GPP TS 29.500 [4]).				

Table 6.2.4.4.2-3: Headers supported by the 307 Response Code on this resource

Name	Data type	P	Cardinality	Description
Location	string	M	1	An alternative URI of the resource located on an alternative service instance within the same LMF or LMF (service) set. Or the same URI, if a request is redirected to the same target resource via a different SCP.
3gpp-Sbi-Target-Nf-Id	string	O	0..1	Identifier of the target NF (service) instance ID towards which the request is redirected

Table 6.2.4.4.2-4: Headers supported by the 308 Response Code on this resource

Name	Data type	P	Cardinality	Description
Location	string	M	1	An alternative URI of the resource located on an alternative service instance within the same LMF or LMF (service) set. Or the same URI, if a request is redirected to the same target resource via a different SCP.
3gpp-Sbi-Target-Nf-Id	string	O	0..1	Identifier of the target NF (service) instance ID towards which the request is redirected

6.2.5 Notifications

6.2.5.1 CipherringKeyData

6.2.5.1.1 Description

The CipherringKeyData operation is used to notify the occurrence of new cipherring key information to a consumer NF (e.g. AMF).

6.2.5.1.2 Notification Definition

Callback URI: {amfCallbackURI}

See clause 5.3.2.2.2 for the description of how the LMF obtains the Callback URI of the NF Service Consumer (i.e. AMF).

6.2.5.1.3 Notification Standard Methods

6.2.5.1.3.1 POST

This method sends a cipherring key data notify to the NF Service Consumer.

This method shall support the request and response data structures and response codes specified in table 6.2.5.1.3.1-1 and table 6.2.5.1.3.1-2.

Table 6.2.5.1.3.1-1: Data structures supported by the POST Request Body

Data type	P	Cardinality	Description
CipherringKeyInfo	M	1	Input parameters to the "Cipherring Key Data" operation

Table 6.2.5.1.3.1-2: Data structures supported by the POST Response Body

Data type	P	Cardinality	Response codes	Description
CipheringKeyResponse	M	1	200 OK	This case represents successful or partially successful storage of ciphering key information by the service consumer NF. A response body is returned containing the following parameters: - List of Ciphering Set IDs successfully stored - List of Ciphering Set IDs not successfully stored
RedirectResponse	O	0..1	307 Temporary Redirect	Temporary redirection. The NF service consumer shall generate a Location header field containing a URI pointing to the endpoint of another NF service consumer to which the notification should be sent. If an SCP redirects the message to another SCP then the location header field shall contain the same URI or a different URI pointing to the endpoint of the NF service consumer to which the notification should be sent.
RedirectResponse	O	0..1	308 Permanent Redirect	Permanent redirection. The NF service consumer shall generate a Location header field containing a URI pointing to the endpoint of another NF service consumer to which the notification should be sent. If an SCP redirects the message to another SCP then the location header field shall contain the same URI or a different URI pointing to the endpoint of the NF service consumer to which the notification should be sent.
ProblemDetails	O	0..1	403 Forbidden	The "cause" attribute may be set to one of the following application errors: - UNSPECIFIED - UNABLE_TO_STORE_CIPHERING_KEY_DATA See table 6.2.7.3-1 for the description of this error.
NOTE: The mandatory HTTP error status codes for the POST method listed in Table 5.2.7.1-1 of 3GPP TS 29.500 [4] other than those specified in the table above also apply, with a ProblemDetails data type (see clause 5.2.7 of 3GPP TS 29.500 [4]).				

Table 6.2.5.1.3.1-3: Headers supported by the 307 Response Code on this resource

Name	Data type	P	Cardinality	Description
Location	string	M	1	A URI pointing to the endpoint of NF service consumer to which the notification should be sent
3gpp-Sbi-Target-Nf-Id	string	O	0..1	Identifier of the target NF (service) instance ID towards which the notification is redirected

Table 6.2.5.1.3.1-4: Headers supported by the 308 Response Code on this resource

Name	Data type	P	Cardinality	Description
Location	string	M	1	A URI pointing to the endpoint of NF service consumer to which the notification should be sent
3gpp-Sbi-Target-Nf-Id	string	O	0..1	Identifier of the target NF (service) instance ID towards which the notification is redirected

6.2.6 Data Model

6.2.6.1 General

This clause specifies the application data model supported by the API.

Table 6.2.6.1-1 specifies the data types defined for the Nlmf_Broadcast service based interface protocol.

Table 6.2.6.1-1: Nlmf_Broadcast specific Data Types

Data type	Clause defined	Description
CipheringKeyInfo	6.2.6.2.2	Information within Ciphering Key Data Notification request
CipheringKeyResponse	6.2.6.2.3	Information within Ciphering Key Data Notification Response
CipheringDataSet	6.2.6.2.4	Represents a Ciphering Data Set
CipheringSetReport	6.2.6.2.5	Represents a report of Ciphering Data Set storage
CipherRequestData	6.2.6.2.6	Information within Ciphering Key Data request
CipherResponseData	6.2.6.2.7	Information within Ciphering Key Data Response
CipheringSetID	6.2.6.3.2	Ciphering Data Set ID
CipheringKey	6.2.6.3.2	Ciphering Key
C0	6.2.6.3.2	First component of the initial ciphering counter
ValidityDuration	6.2.6.3.2	Validity Duration of the Ciphering Data Set
StorageOutcome	6.2.6.3.3	Indicates the result of Ciphering Data Set storage
DataAvailability	6.2.6.3.4	Indicates availability of ciphering key data at an LMF

Table 6.2.6.1-2 specifies data types re-used by the Nlmf_Broadcast service based interface protocol from other specifications, including a reference to their respective specifications and when needed, a short description of their use within the Nlmf_Broadcast service based interface.

Table 6.2.6.1-2: Nlmf_Broadcast re-used Data Types

Data type	Reference	Comments
Bytes	3GPP TS 29.571 [8]	Binary data encoded as a base64 character string
DateTime	3GPP TS 29.571 [8]	Date and Time
Uri	3GPP TS 29.571 [8]	Uniform Resource Identifier
SupportedFeatures	3GPP TS 29.571 [8]	Supported Features
RedirectResponse	3GPP TS 29.571 [8]	Redirect Response

6.2.6.2 Structured data types

6.2.6.2.1 Introduction

This clause defines the structures to be used in resource representations.

6.2.6.2.2 Type: CipheringKeyInfo

Table 6.2.6.2.2-1: Definition of type CipheringKeyInfo

Attribute name	Data type	P	Cardinality	Description
cipheringData	array(CipheringDataSet)	M	1..N	This IE contains one or more ciphering data sets, where each ciphering data set contains information for one ciphering key.
supportedFeatures	SupportedFeatures	C	0..1	This IE shall be present if at least one optional feature defined in clause 6.2.9 is supported.

6.2.6.2.3 Type: CipheringKeyResponse

Table 6.2.6.2.3-1: Definition of type CipheringKeyResponse

Attribute name	Data type	P	Cardinality	Description
cipheringDataReport	Array(CipheringSetReport)	O	1..N	This IE indicates the ciphering data sets which were successfully stored or not stored. The absence of this IE indicates that all ciphering data sets were successfully stored.

6.2.6.2.4 Type: CipheringDataSet

Table 6.2.6.2.4-1: Definition of type CipheringDataSet

Attribute name	Data type	P	Cardinality	Description
cipheringSetID	CipheringSetID	M	1	Identification of a ciphering data set
cipheringKey	CipheringKey	M	1	A ciphering key value
c0	C0	M	1	First component of the initial ciphering counter as defined in clause 7.4.2 of 3GPP TS 37.355 [21]

ltePosSibTypes	Bytes	O	0..1	<p>This IE contains a bitmap indicating the LTE positioning SIB types for which the ciphering data set is applicable:</p> <ul style="list-style-type: none"> - a bit set to 0 indicates that the ciphering data set is not applicable to the corresponding LTE positioning SIB type - a bit set to 1 indicates that the ciphering data set is applicable to the corresponding LTE positioning SIB type <p>The mapping of the bits to the LTE positioning SIB types is as follows:</p> <ul style="list-style-type: none"> -- bit 8 in the first octet maps to positioning SIB Type 1-1 -- bit 7 in the first octet maps to positioning SIB Type 1-2 -- bit 6 in the first octet maps to positioning SIB Type 1-3 -- bit 5 in the first octet maps to positioning SIB Type 1-4 -- bit 4 in the first octet maps to positioning SIB Type 1-5 -- bit 3 in the first octet maps to positioning SIB Type 1-6 -- bit 2 in the first octet maps to positioning SIB Type 1-7 -- bit 1 in the first octet maps to positioning SIB Type 1-8 -- bit 8 in the second octet maps to positioning SIB Type 2-1 -- bit 7 in the second octet maps to positioning SIB Type 2-2 -- bit 6 in the second octet maps to positioning SIB Type 2-3 -- bit 5 in the second octet maps to positioning SIB Type 2-4 -- bit 4 in the second octet maps to positioning SIB Type 2-5 -- bit 3 in the second octet maps to positioning SIB Type 2-6 -- bit 2 in the second octet maps to positioning SIB Type 2-7 -- bit 1 in the second octet maps to positioning SIB Type 2-8 -- bit 8 in the third octet maps to positioning SIB Type 2-9 -- bit 7 in the third octet maps to positioning SIB Type 2-10 -- bit 6 in the third octet maps to positioning SIB Type 2-11 -- bit 5 in the third octet maps to positioning SIB Type 2-12 -- bit 4 in the third octet maps to positioning SIB Type 2-13 -- bit 3 in the third octet maps to positioning SIB Type 2-14 -- bit 2 in the third octet maps to positioning SIB Type 2-15 -- bit 1 in the third octet maps to positioning SIB Type 2-16 -- bit 8 in the fourth octet maps to
----------------	-------	---	------	---

			<p>positioning SIB Type 2-17</p> <ul style="list-style-type: none"> -- bit 7 in the fourth octet maps to positioning SIB Type 2-18 -- bit 6 in the fourth octet maps to positioning SIB Type 2-19 -- bit 5 in the fourth octet maps to positioning SIB Type 2-20 -- bit 4 in the fourth octet maps to positioning SIB Type 2-21 -- bit 3 in the fourth octet maps to positioning SIB Type 2-22 -- bit 2 in the fourth octet maps to positioning SIB Type 2-23 -- bit 1 in the fourth octet maps to positioning SIB Type 2-24 <ul style="list-style-type: none"> -- bit 8 in the fifth octet maps to positioning SIB Type 2-25 -- bit 7 in the fifth octet maps to positioning SIB Type 3-1 -- bit 6 in the fifth octet maps to positioning SIB Type 4-1 -- bit 5 in the fifth octet maps to positioning SIB Type 5-1 <p>Any unassigned bits are spare and shall be coded as zero. Non-included bits shall be treated as being coded as zero.</p> <p>(NOTE 1)</p>
--	--	--	--

nrPosSibTypes	Bytes	O	0..1	<p>This IE contains a bitmap indicating the NR positioning SIB types for which the ciphering data set is applicable:</p> <ul style="list-style-type: none"> - a bit set to 0 indicates that the ciphering data set is not applicable to the corresponding NR positioning SIB type - a bit set to 1 indicates that the ciphering data set is applicable to the corresponding NR positioning SIB type <p>The mapping of the bits to the NR positioning SIB types is as follows:</p> <ul style="list-style-type: none"> -- bit 8 in the first octet maps to positioning SIB Type 1-1 -- bit 7 in the first octet maps to positioning SIB Type 1-2 -- bit 6 in the first octet maps to positioning SIB Type 1-3 -- bit 5 in the first octet maps to positioning SIB Type 1-4 -- bit 4 in the first octet maps to positioning SIB Type 1-5 -- bit 3 in the first octet maps to positioning SIB Type 1-6 -- bit 2 in the first octet maps to positioning SIB Type 1-7 -- bit 1 in the first octet maps to positioning SIB Type 1-8 -- bit 8 in the second octet maps to positioning SIB Type 2-1 -- bit 7 in the second octet maps to positioning SIB Type 2-2 -- bit 6 in the second octet maps to positioning SIB Type 2-3 -- bit 5 in the second octet maps to positioning SIB Type 2-4 -- bit 4 in the second octet maps to positioning SIB Type 2-5 -- bit 3 in the second octet maps to positioning SIB Type 2-6 -- bit 2 in the second octet maps to positioning SIB Type 2-7 -- bit 1 in the second octet maps to positioning SIB Type 2-8 -- bit 8 in the third octet maps to positioning SIB Type 2-9 -- bit 7 in the third octet maps to positioning SIB Type 2-10 -- bit 6 in the third octet maps to positioning SIB Type 2-11 -- bit 5 in the third octet maps to positioning SIB Type 2-12 -- bit 4 in the third octet maps to positioning SIB Type 2-13 -- bit 3 in the third octet maps to positioning SIB Type 2-14 -- bit 2 in the third octet maps to positioning SIB Type 2-15 -- bit 1 in the third octet maps to positioning SIB Type 2-16 -- bit 8 in the fourth octet maps to positioning SIB Type 2-17
---------------	-------	---	------	---

				<p>-- bit 7 in the fourth octet maps to positioning SIB Type 2-18 -- bit 6 in the fourth octet maps to positioning SIB Type 2-19 -- bit 5 in the fourth octet maps to positioning SIB Type 2-20 -- bit 4 in the fourth octet maps to positioning SIB Type 2-21 -- bit 3 in the fourth octet maps to positioning SIB Type 2-22 -- bit 2 in the fourth octet maps to positioning SIB Type 2-23 -- bit 1 in the fourth octet maps to positioning SIB Type 3-1</p> <p>-- bit 8 in the fifth octet maps to positioning SIB Type 4-1 -- bit 7 in the fifth octet maps to positioning SIB Type 5-1 -- bit 6 in the fifth octet maps to positioning SIB Type 6-1 -- bit 5 in the fifth octet maps to positioning SIB Type 6-2 -- bit 4 in the fifth octet maps to positioning SIB Type 6-3</p> <p>Any unassigned bits are spare and shall be coded as zero. Non-included bits shall be treated as being coded as zero. (NOTE 1)</p>
validityStartTime	DateTime	M	1	This IE contains the UTC time when the ciphering data set becomes valid.
validityDuration	ValidityDuration	M	1	The validity duration of the ciphering data set.
tailList	Bytes	O	0..1	<p>This IE contains the TAIs of the tracking areas for which the ciphering data set is applicable. It is encoded as octets 2 to n of the 5GS tracking area identity list IE specified in clause 9.11.3.9 of 3GPP TS 24.501 [22].</p> <p>If this IE is omitted, the ciphering data set is valid in the entire PLMN.</p>
NOTE 1: At least one of ltesibTypes IE and nrsibTypes IE shall be included.				

6.2.6.2.5 Type: CipheringSetReport

Table 6.2.6.2.5-1: Definition of CipheringSetReport

Attribute name	Data type	P	Cardinality	Description
cipheringSetID	CipheringSetID	M	1	Identification of a ciphering data set
storageOutcome	StorageOutcome	M	1	Indication of whether the ciphering data set was successfully stored or was not stored.

6.2.6.2.6 Type: CipherRequestData

Table 6.2.6.2.6-1: Definition of CipherRequestData

Attribute name	Data type	P	Cardinality	Description
amfCallbackURI	Uri	M	1	Callback URI of the NF Service Consumer
supportedFeatures	SupportedFeatures	C	0..1	This IE shall be present if at least one optional feature defined in clause 6.2.9 is supported.

6.2.6.2.7 Type: CipherResponseData

Table 6.2.6.2.7-1: Definition of CipherResponseData

Attribute name	Data type	P	Cardinality	Description
dataAvailability	DataAvailability	M	1	An indication of whether the LMF currently has ciphering key data applicable to the NF Service Consumer

6.2.6.3 Simple data types and enumerations

6.2.6.3.1 Introduction

This clause defines simple data types and enumerations that can be referenced from data structures defined in the previous clauses.

6.2.6.3.2 Simple data types

The simple data types defined in table 6.2.6.3.2-1 shall be supported.

Table 6.2.6.3.2-1: Simple data types

Type Name	Type Definition	Description
CipheringSetID	integer	The ciphering set ID Minimum = 0. Maximum = 65535
CipheringKey	Bytes	A 128 bit ciphering key encoded as a base64 character string
C0	Bytes	A 128 bit value for C0 encoded as a base64 character string
ValidityDuration	integer	The validity duration in minutes. Minimum = 1. Maximum = 65535

6.2.6.3.3 Enumeration: StorageOutcome

The enumeration StorageOutcome represents the outcome of cipher set data storage at the service consumer NF.

Table 6.2.6.3.3-1: Enumeration StorageOutcome

Enumeration value	Description
"STORAGE_SUCCESSFUL"	Indicates storage of Ciphering Data Set is successful
"STORAGE_FAILED"	Indicates storage of Ciphering Data Set is not successful

6.2.6.3.4 Enumeration: DataAvailability

The enumeration DataAvailability represents the availability of ciphering key data at an LMF.

Table 6.2.6.3.4-1: Enumeration DataAvailability

Enumeration value	Description
"CIPHERING_KEY_DATA_AVAILABLE"	Indicates Ciphering Data Set is available in LMF
CIPHERING_KEY_DATA_NOT_AVAILABLE"	Indicates Ciphering Data Set is not available in LMF

6.2.7 Error Handling

6.2.7.1 General

HTTP error handling shall be supported as specified in clause 5.2.4 of 3GPP TS 29.500 [4].

6.2.7.2 Protocol Errors

Protocol errors handling shall be supported as specified in clause 5.2.7 of 3GPP TS 29.500 [4].

6.2.7.3 Application Errors

The application errors defined for the Nlmf_Broadcast service are listed in table 6.2.7.3-1.

Table 6.2.7.3-1: Application errors

Application Error	HTTP status code	Description
UNSPECIFIED	403 Forbidden	The request is rejected due to unspecified reasons.
UNABLE_TO_STORE_CIPHERING_KEY_DATA	403 Forbidden	The service consumer NF was unable to store ciphering key data.
BROADCAST_CIPHERING_KEYS_NOT_SUPPORTED	403 Forbidden	Ciphering keys for broadcast are not supported.

6.2.8 Security

The Nlmf_Broadcast API does not define service operations for which additional security is needed in this version of the specification.

6.2.9 Feature Negotiation

The optional features in table 6.2.9-1 are defined for the Nlmf_Broadcast API. They shall be negotiated using the extensibility mechanism defined in clause 6.6 of 3GPP TS 29.500 [4].

Table 6.2.9-1: Supported Features

Feature number	Feature Name	M/O	Description
1	ES3XX	M	<p>Extended Support of HTTP 307/308 redirection</p> <p>An NF Service Consumer (e.g. AMF) that supports this feature shall support handling of HTTP 307/308 redirection for any service operation of the Broadcast service. An NF Service Consumer that does not support this feature does only support HTTP redirection as specified for 3GPP Release 15.</p>

6.2.10 HTTP redirection

An HTTP request may be redirected to a different LMF service instance, within the same LMF or a different LMF of an LMF set, e.g. when an LMF service instance is part of an LMF (service) set or when using indirect communications (see 3GPP TS 29.500 [4]). See also the ES3XX feature in clause 6.2.9.

An SCP that reselects a different LMF producer instance will return the NF Instance ID of the new LMF producer instance in the 3gpp-Sbi-Producer-Id header, as specified in clause 6.10.3.4 of 3GPP TS 29.500 [4].

If an LMF within an LMF set redirects a service request to a different LMF of the set using an 307 Temporary Redirect or 308 Permanent Redirect status code, the identity of the new LMF towards which the service request is redirected shall be indicated in the 3gpp-Sbi-Target-Nf-Id header of the 307 Temporary Redirect or 308 Permanent Redirect response as specified in clause 6.10.9.1 of 3GPP TS 29.500 [4].

Annex A (normative): OpenAPI specification

A.1 General

This Annex specifies the formal definition of the Nlmf Service APIs. It consists of an OpenAPI 3.0.0 specification, in YAML format.

This Annex takes precedence when being discrepant to other parts of the specification with respect to the encoding of information elements and methods within the API(s).

NOTE: The semantics and procedures, as well as conditions, e.g. for the applicability and allowed combinations of attributes or values, not expressed in the OpenAPI definitions but defined in other parts of the specification also apply.

Informative copies of the OpenAPI specification files contained in this 3GPP Technical Specification are available on a Git-based repository, that uses the GitLab software version control system (see 3GPP TS 29.501 [5] clause 5.3.1 and 3GPP TR 21.900 [7] clause 5B).

A.2 Nlmf_Location API

openapi: 3.0.0

info:

```
version: '1.2.1'
title: 'LMF Location'
description: |
  LMF Location Service.
  © 2022, 3GPP Organizational Partners (ARIB, ATIS, CCSA, ETSI, TSDSI, TTA, TTC).
  All rights reserved.
```

externalDocs:

```
description: 3GPP TS 29.572 V17.6.0; 5G System; Location Management Services; Stage 3
url: 'https://www.3gpp.org/ftp/Specs/archive/29_series/29.572/'
```

servers:

```
- url: '{apiRoot}/nlmf-loc/v1'
  variables:
    apiRoot:
      default: https://example.com
      description: apiRoot as defined in clause 4.4 of 3GPP TS 29.501
```

security:

```
- {}
- oAuth2ClientCredentials:
  - nlmf-loc
```

paths:

```
/determine-location:
  post:
    summary: Determine Location of an UE
    operationId: DetermineLocation
    tags:
      - Determine Location
    requestBody:
      content:
        application/json:
          schema:
            $ref: '#/components/schemas/InputData'
        multipart/related: # message with binary body part(s)
          schema:
            type: object
            properties: # Request parts
              jsonData:
                $ref: '#/components/schemas/InputData'
              binaryDataLppMessage:
                type: string
```

```

        format: binary
    encoding:
        jsonData:
            contentType: application/json
        binaryDataLppMessage:
            contentType: application/vnd.3gpp.lpp
            headers:
                Content-Id:
                    schema:
                        type: string
        binaryDataLppMessageExt1:
            contentType: application/vnd.3gpp.lpp
            headers:
                Content-Id:
                    schema:
                        type: string
        binaryDataLppMessageExt2:
            contentType: application/vnd.3gpp.lpp
            headers:
                Content-Id:
                    schema:
                        type: string
    required: true
responses:
    '200':
        description: Expected response to a valid request
        content:
            application/json:
                schema:
                    $ref: '#/components/schemas/LocationData'
    '204':
        description: Expected response for MO-LR requesting location assistance data.
    '307':
        $ref: 'TS29571_CommonData.yaml#/components/responses/307'
    '308':
        $ref: 'TS29571_CommonData.yaml#/components/responses/308'
    '400':
        $ref: 'TS29571_CommonData.yaml#/components/responses/400'
    '401':
        $ref: 'TS29571_CommonData.yaml#/components/responses/401'
    '403':
        $ref: 'TS29571_CommonData.yaml#/components/responses/403'
    '404':
        $ref: 'TS29571_CommonData.yaml#/components/responses/404'
    '411':
        $ref: 'TS29571_CommonData.yaml#/components/responses/411'
    '413':
        $ref: 'TS29571_CommonData.yaml#/components/responses/413'
    '415':
        $ref: 'TS29571_CommonData.yaml#/components/responses/415'
    '429':
        $ref: 'TS29571_CommonData.yaml#/components/responses/429'
    '500':
        $ref: 'TS29571_CommonData.yaml#/components/responses/500'
    '503':
        $ref: 'TS29571_CommonData.yaml#/components/responses/503'
    '504':
        $ref: 'TS29571_CommonData.yaml#/components/responses/504'
    default:
        $ref: 'TS29571_CommonData.yaml#/components/responses/default'
callbacks:
    EventNotify:
        '{$request.body#/hgmlcCallbackURI}':
            post:
                requestBody:
                    description: UE Event Notification
                    content:
                        application/json:
                            schema:
                                $ref: '#/components/schemas/EventNotifyData'
responses:
    '204':
        description: Expected response to a valid notification
    '307':
        $ref: 'TS29571_CommonData.yaml#/components/responses/307'
    '308':
        $ref: 'TS29571_CommonData.yaml#/components/responses/308'
    '400':

```

```

    $ref: 'TS29571_CommonData.yaml#/components/responses/400'
  '401':
    $ref: 'TS29571_CommonData.yaml#/components/responses/401'
  '403':
    $ref: 'TS29571_CommonData.yaml#/components/responses/403'
  '404':
    $ref: 'TS29571_CommonData.yaml#/components/responses/404'
  '411':
    $ref: 'TS29571_CommonData.yaml#/components/responses/411'
  '413':
    $ref: 'TS29571_CommonData.yaml#/components/responses/413'
  '415':
    $ref: 'TS29571_CommonData.yaml#/components/responses/415'
  '429':
    $ref: 'TS29571_CommonData.yaml#/components/responses/429'
  '500':
    $ref: 'TS29571_CommonData.yaml#/components/responses/500'
  '503':
    $ref: 'TS29571_CommonData.yaml#/components/responses/503'
  '504':
    $ref: 'TS29571_CommonData.yaml#/components/responses/504'
  default:
    $ref: 'TS29571_CommonData.yaml#/components/responses/default'
/cancel-location:
  post:
    summary: request cancellation of periodic or triggered location
    operationId: CancelLocation
    tags:
      - Cancel Location
    requestBody:
      content:
        application/json:
          schema:
            $ref: '#/components/schemas/CancelLocData'
      required: true
    responses:
      '204':
        description: Expected response to a successful cancellation
      '307':
        $ref: 'TS29571_CommonData.yaml#/components/responses/307'
      '308':
        $ref: 'TS29571_CommonData.yaml#/components/responses/308'
      '400':
        $ref: 'TS29571_CommonData.yaml#/components/responses/400'
      '401':
        $ref: 'TS29571_CommonData.yaml#/components/responses/401'
      '403':
        $ref: 'TS29571_CommonData.yaml#/components/responses/403'
      '404':
        $ref: 'TS29571_CommonData.yaml#/components/responses/404'
      '411':
        $ref: 'TS29571_CommonData.yaml#/components/responses/411'
      '413':
        $ref: 'TS29571_CommonData.yaml#/components/responses/413'
      '415':
        $ref: 'TS29571_CommonData.yaml#/components/responses/415'
      '429':
        $ref: 'TS29571_CommonData.yaml#/components/responses/429'
      '500':
        $ref: 'TS29571_CommonData.yaml#/components/responses/500'
      '503':
        $ref: 'TS29571_CommonData.yaml#/components/responses/503'
      '504':
        $ref: 'TS29571_CommonData.yaml#/components/responses/504'
      default:
        $ref: 'TS29571_CommonData.yaml#/components/responses/default'
/location-context-transfer:
  post:
    summary: transfer context information for periodic or triggered location
    operationId: LocationContextTransfer
    tags:
      - Location Context Transfer
    requestBody:
      content:
        application/json:
          schema:
            $ref: '#/components/schemas/LocContextData'
      required: true

```

```

responses:
  '204':
    description: Expected response to successful location context transfer
  '307':
    $ref: 'TS29571_CommonData.yaml#/components/responses/307'
  '308':
    $ref: 'TS29571_CommonData.yaml#/components/responses/308'
  '400':
    $ref: 'TS29571_CommonData.yaml#/components/responses/400'
  '401':
    $ref: 'TS29571_CommonData.yaml#/components/responses/401'
  '403':
    $ref: 'TS29571_CommonData.yaml#/components/responses/403'
  '404':
    $ref: 'TS29571_CommonData.yaml#/components/responses/404'
  '411':
    $ref: 'TS29571_CommonData.yaml#/components/responses/411'
  '413':
    $ref: 'TS29571_CommonData.yaml#/components/responses/413'
  '415':
    $ref: 'TS29571_CommonData.yaml#/components/responses/415'
  '429':
    $ref: 'TS29571_CommonData.yaml#/components/responses/429'
  '500':
    $ref: 'TS29571_CommonData.yaml#/components/responses/500'
  '503':
    $ref: 'TS29571_CommonData.yaml#/components/responses/503'
  '504':
    $ref: 'TS29571_CommonData.yaml#/components/responses/504'
  default:
    $ref: 'TS29571_CommonData.yaml#/components/responses/default'

```

```

components:
  securitySchemes:
    oAuth2ClientCredentials:
      type: oauth2
      flows:
        clientCredentials:
          tokenUrl: '{nrfApiRoot}/oauth2/token'
          scopes:
            nlmf-loc: Access to the Nlmf_Location API
  schemas:
    #
    # COMPLEX TYPES
    #
    InputData:
      description: Information within Determine Location Request.
      type: object
      not:
        required: [ ecgi, ncgi ]
      properties:
        externalClientType:
          $ref: '#/components/schemas/ExternalClientType'
        correlationID:
          $ref: '#/components/schemas/CorrelationID'
        amfId:
          $ref: 'TS29571_CommonData.yaml#/components/schemas/NfInstanceId'
        locationQoS:
          $ref: '#/components/schemas/LocationQoS'
        supportedGADShapes:
          type: array
          items:
            $ref: '#/components/schemas/SupportedGADShapes'
          minItems: 1
        supi:
          $ref: 'TS29571_CommonData.yaml#/components/schemas/Supi'
        pei:
          $ref: 'TS29571_CommonData.yaml#/components/schemas/Pei'
        gpsi:
          $ref: 'TS29571_CommonData.yaml#/components/schemas/Gpsi'
        ecgi:
          $ref: 'TS29571_CommonData.yaml#/components/schemas/Ecgi'
        ecgiOnSecondNode:
          $ref: 'TS29571_CommonData.yaml#/components/schemas/Ecgi'
        ncgi:
          $ref: 'TS29571_CommonData.yaml#/components/schemas/Ncgi'
        ncgiOnSecondNode:
          $ref: 'TS29571_CommonData.yaml#/components/schemas/Ncgi'

```

```

priority:
  $ref: '#/components/schemas/LcsPriority'
velocityRequested:
  $ref: '#/components/schemas/VelocityRequested'
ueLcsCap:
  $ref: '#/components/schemas/UeLcsCapability'
lcsServiceType:
  $ref: '#/components/schemas/LcsServiceType'
ldrType:
  $ref: '#/components/schemas/LdrType'
hgmlcCallBackURI:
  $ref: 'TS29571_CommonData.yaml#/components/schemas/Uri'
vgmlcAddress:
  $ref: 'TS29571_CommonData.yaml#/components/schemas/Uri'
ldrReference:
  $ref: '#/components/schemas/LdrReference'
periodicEventInfo:
  $ref: '#/components/schemas/PeriodicEventInfo'
areaEventInfo:
  $ref: '#/components/schemas/AreaEventInfo'
motionEventInfo:
  $ref: '#/components/schemas/MotionEventInfo'
reportingAccessTypes:
  type: array
  items:
    $ref: '#/components/schemas/ReportingAccessType'
  minItems: 1
ueConnectivityStates:
  $ref: '#/components/schemas/UeConnectivityState'
ueLocationServiceInd:
  $ref: '#/components/schemas/UeLocationServiceInd'
moAssistanceDataTypes:
  $ref: 'TS29503_Nudm_SDM.yaml#/components/schemas/LcsBroadcastAssistanceTypesData'
lppMessage:
  $ref: 'TS29571_CommonData.yaml#/components/schemas/RefToBinaryData'
lppMessageExt:
  description: Indicates the lpp message extension.
  type: array
  items:
    $ref: 'TS29571_CommonData.yaml#/components/schemas/RefToBinaryData'
  minItems: 1
supportedFeatures:
  $ref: 'TS29571_CommonData.yaml#/components/schemas/SupportedFeatures'
uePositioningCap:
  $ref: '#/components/schemas/UePositioningCapabilities'
tnapId:
  $ref: 'TS29571_CommonData.yaml#/components/schemas/TnapId'
twapId:
  $ref: 'TS29571_CommonData.yaml#/components/schemas/TwapId'
ueCountryDetInd:
  type: boolean
scheduledLocTime:
  $ref: 'TS29571_CommonData.yaml#/components/schemas/DateTime'
reliableLocReq:
  type: boolean
  default: false

LocationData:
  description: Information within Determine Location Response.
  type: object
  required:
    - locationEstimate
  properties:
    locationEstimate:
      $ref: '#/components/schemas/GeographicArea'
    accuracyFulfilmentIndicator:
      $ref: '#/components/schemas/AccuracyFulfilmentIndicator'
    ageOfLocationEstimate:
      $ref: '#/components/schemas/AgeOfLocationEstimate'
    timestampOfLocationEstimate:
      $ref: 'TS29571_CommonData.yaml#/components/schemas/DateTime'
    velocityEstimate:
      $ref: '#/components/schemas/VelocityEstimate'
    civicAddress:
      $ref: '#/components/schemas/CivicAddress'
    localLocationEstimate:
      $ref: '#/components/schemas/LocalArea'
    positioningDataList:

```

```

    type: array
    items:
      $ref: '#/components/schemas/PositioningMethodAndUsage'
    minItems: 1
  gnssPositioningDataList:
    type: array
    items:
      $ref: '#/components/schemas/GnssPositioningMethodAndUsage'
    minItems: 1
  ecgi:
    $ref: 'TS29571_CommonData.yaml#/components/schemas/Ecgi'
  ncgi:
    $ref: 'TS29571_CommonData.yaml#/components/schemas/Ncgi'
  altitude:
    $ref: '#/components/schemas/Altitude'
  barometricPressure:
    $ref: '#/components/schemas/BarometricPressure'
  servingLMFIdentification:
    $ref: '#/components/schemas/LMFIdentification'
  uePositioningCap:
    $ref: '#/components/schemas/UePositioningCapabilities'
  ueAreaInd:
    $ref: '#/components/schemas/UeAreaIndication'
  supportedFeatures:
    $ref: 'TS29571_CommonData.yaml#/components/schemas/SupportedFeatures'
  achievedQos:
    $ref: '#/components/schemas/MinorLocationQoS'

```

GeographicArea:

description: Geographic area specified by different shape.

anyOf:

- \$ref: '#/components/schemas/Point'
- \$ref: '#/components/schemas/PointUncertaintyCircle'
- \$ref: '#/components/schemas/PointUncertaintyEllipse'
- \$ref: '#/components/schemas/Polygon'
- \$ref: '#/components/schemas/PointAltitude'
- \$ref: '#/components/schemas/PointAltitudeUncertainty'
- \$ref: '#/components/schemas/EllipsoidArc'

GADShape:

description: Common base type for GAD shapes.

type: object

required:

- shape

properties:

shape:

\$ref: '#/components/schemas/SupportedGADShapes'

discriminator:

propertyName: shape

mapping:

POINT: '#/components/schemas/Point'

POINT_UNCERTAINTY_CIRCLE: '#/components/schemas/PointUncertaintyCircle'

POINT_UNCERTAINTY_ELLIPSE: '#/components/schemas/PointUncertaintyEllipse'

POLYGON: '#/components/schemas/Polygon'

POINT_ALTITUDE: '#/components/schemas/PointAltitude'

POINT_ALTITUDE_UNCERTAINTY: '#/components/schemas/PointAltitudeUncertainty'

ELLIPSOID_ARC: '#/components/schemas/EllipsoidArc'

LOCAL_2D_POINT_UNCERTAINTY_ELLIPSE: '#/components/schemas/Local2dPointUncertaintyEllipse'

LOCAL_3D_POINT_UNCERTAINTY_ELLIPSOID:

'#/components/schemas/Local3dPointUncertaintyEllipsoid'

Point:

description: Ellipsoid Point.

allOf:

- \$ref: '#/components/schemas/GADShape'

- type: object

required:

- point

properties:

point:

\$ref: '#/components/schemas/GeographicalCoordinates'

PointUncertaintyCircle:

description: Ellipsoid point with uncertainty circle.

allOf:

- \$ref: '#/components/schemas/GADShape'

- type: object

required:

```

    - point
    - uncertainty
  properties:
    point:
      $ref: '#/components/schemas/GeographicalCoordinates'
    uncertainty:
      $ref: '#/components/schemas/Uncertainty'

PointUncertaintyEllipse:
  description: Ellipsoid point with uncertainty ellipse.
  allOf:
    - $ref: '#/components/schemas/GADShape'
    - type: object
      required:
        - point
        - uncertaintyEllipse
        - confidence
      properties:
        point:
          $ref: '#/components/schemas/GeographicalCoordinates'
        uncertaintyEllipse:
          $ref: '#/components/schemas/UncertaintyEllipse'
        confidence:
          $ref: '#/components/schemas/Confidence'

Polygon:
  description: Polygon.
  allOf:
    - $ref: '#/components/schemas/GADShape'
    - type: object
      required:
        - pointList
      properties:
        pointList:
          $ref: '#/components/schemas/PointList'

PointAltitude:
  description: Ellipsoid point with altitude.
  allOf:
    - $ref: '#/components/schemas/GADShape'
    - type: object
      required:
        - point
        - altitude
      properties:
        point:
          $ref: '#/components/schemas/GeographicalCoordinates'
        altitude:
          $ref: '#/components/schemas/Altitude'

PointAltitudeUncertainty:
  description: Ellipsoid point with altitude and uncertainty ellipsoid.
  allOf:
    - $ref: '#/components/schemas/GADShape'
    - type: object
      required:
        - point
        - altitude
        - uncertaintyEllipse
        - uncertaintyAltitude
        - confidence
      properties:
        point:
          $ref: '#/components/schemas/GeographicalCoordinates'
        altitude:
          $ref: '#/components/schemas/Altitude'
        uncertaintyEllipse:
          $ref: '#/components/schemas/UncertaintyEllipse'
        uncertaintyAltitude:
          $ref: '#/components/schemas/Uncertainty'
        confidence:
          $ref: '#/components/schemas/Confidence'

EllipsoidArc:
  description: Ellipsoid Arc.
  allOf:
    - $ref: '#/components/schemas/GADShape'
    - type: object

```

```

required:
- point
- innerRadius
- uncertaintyRadius
- offsetAngle
- includedAngle
- confidence
properties:
point:
  $ref: '#/components/schemas/GeographicalCoordinates'
innerRadius:
  $ref: '#/components/schemas/InnerRadius'
uncertaintyRadius:
  $ref: '#/components/schemas/Uncertainty'
offsetAngle:
  $ref: '#/components/schemas/Angle'
includedAngle:
  $ref: '#/components/schemas/Angle'
confidence:
  $ref: '#/components/schemas/Confidence'

```

```

LocalOrigin:
description: Indicates a Local origin in a reference system
type: object
properties:
coordinateId:
  type: string
point:
  $ref: '#/components/schemas/GeographicalCoordinates'

```

```

RelativeCartesianLocation:
description: Relative Cartesian Location
type: object
required:
- x
- y
properties:
x:
  $ref: 'TS29571_CommonData.yaml#/components/schemas/Float'
y:
  $ref: 'TS29571_CommonData.yaml#/components/schemas/Float'
z:
  $ref: 'TS29571_CommonData.yaml#/components/schemas/Float'

```

```

LocalArea:
description: Local area specified by different shape
oneOf:
- $ref: '#/components/schemas/Local2dPointUncertaintyEllipse'
- $ref: '#/components/schemas/Local3dPointUncertaintyEllipsoid'

```

```

UeAreaIndication:
description: Indicates area (country or international area) where UE is located
type: object
oneOf:
- required:
- country
- required:
- internationalAreaInd
properties:
country:
  description: Indicates country where UE is located
  type: string
internationalAreaInd:
  description: Indicates international area indication if UE is located in international
  type: boolean
  default: false

```

area

```

Local2dPointUncertaintyEllipse:
description: Local 2D point with uncertainty ellipse
allOf:
- $ref: '#/components/schemas/GADShape'
- type: object
  required:
  - localOrigin
  - point
  - uncertaintyEllipse

```



```

    - confidence
  properties:
    localOrigin:
      $ref: '#/components/schemas/LocalOrigin'
    point:
      $ref: '#/components/schemas/RelativeCartesianLocation'
    uncertaintyEllipse:
      $ref: '#/components/schemas/UncertaintyEllipse'
    confidence:
      $ref: '#/components/schemas/Confidence'

Local3dPointUncertaintyEllipsoid:
  description: Local 3D point with uncertainty ellipsoid
  allOf:
    - $ref: '#/components/schemas/GADShape'
    - type: object
      required:
        - localOrigin
        - point
        - uncertaintyEllipsoid
        - confidence
      properties:
        localOrigin:
          $ref: '#/components/schemas/LocalOrigin'
        point:
          $ref: '#/components/schemas/RelativeCartesianLocation'
        uncertaintyEllipsoid:
          $ref: '#/components/schemas/UncertaintyEllipsoid'
        confidence:
          $ref: '#/components/schemas/Confidence'

GeographicalCoordinates:
  description: Geographical coordinates.
  type: object
  required:
    - lon
    - lat
  properties:
    lon:
      type: number
      format: double
      minimum: -180
      maximum: 180
    lat:
      type: number
      format: double
      minimum: -90
      maximum: 90

UncertaintyEllipse:
  description: Ellipse with uncertainty.
  type: object
  required:
    - semiMajor
    - semiMinor
    - orientationMajor
  properties:
    semiMajor:
      $ref: '#/components/schemas/Uncertainty'
    semiMinor:
      $ref: '#/components/schemas/Uncertainty'
    orientationMajor:
      $ref: '#/components/schemas/Orientation'

UncertaintyEllipsoid:
  description: Ellipsoid with uncertainty
  type: object
  required:
    - semiMajor
    - semiMinor
    - vertical
    - orientationMajor
  properties:
    semiMajor:
      $ref: '#/components/schemas/Uncertainty'
    semiMinor:
      $ref: '#/components/schemas/Uncertainty'
    vertical:

```

```

    $ref: '#/components/schemas/Uncertainty'
  orientationMajor:
    $ref: '#/components/schemas/Orientation'

```

```

PointList:
  description: List of points.
  type: array
  items:
    $ref: '#/components/schemas/GeographicalCoordinates'
  minItems: 3
  maxItems: 15

```

```

LocationQoS:
  description: QoS of Location request.
  type: object
  properties:
    hAccuracy:
      $ref: '#/components/schemas/Accuracy'
    vAccuracy:
      $ref: '#/components/schemas/Accuracy'
    verticalRequested:
      type: boolean
    responseTime:
      $ref: '#/components/schemas/ResponseTime'
    minorLocQoses:
      type: array
      items:
        $ref: '#/components/schemas/MinorLocationQoS'
      minItems: 1
      maxItems: 2
    lcsQosClass:
      $ref: '#/components/schemas/LcsQosClass'

```

```

PositioningMethodAndUsage:
  description: Indicates the usage of a positioning method.
  type: object
  required:
    - method
    - mode
    - usage
  properties:
    method:
      $ref: '#/components/schemas/PositioningMethod'
    mode:
      $ref: '#/components/schemas/PositioningMode'
    usage:
      $ref: '#/components/schemas/Usage'
    methodCode:
      type: integer
      minimum: 16
      maximum: 31

```

```

GnssPositioningMethodAndUsage:
  description: Indicates the usage of a Global Navigation Satellite System (GNSS) positioning
  method.
  type: object
  required:
    - mode
    - gnss
    - usage
  properties:
    mode:
      $ref: '#/components/schemas/PositioningMode'
    gnss:
      $ref: '#/components/schemas/GnssId'
    usage:
      $ref: '#/components/schemas/Usage'

```

```

CivicAddress:
  description: Indicates a Civic address.
  type: object
  properties:
    country:
      type: string
    A1:
      type: string
    A2:
      type: string

```

```

A3:
  type: string
A4:
  type: string
A5:
  type: string
A6:
  type: string
PRD:
  type: string
POD:
  type: string
STS:
  type: string
HNO:
  type: string
HNS:
  type: string
LMK:
  type: string
LOC:
  type: string
NAM:
  type: string
PC:
  type: string
BLD:
  type: string
UNIT:
  type: string
FLR:
  type: string
ROOM:
  type: string
PLC:
  type: string
PCN:
  type: string
POBOX:
  type: string
ADDCODE:
  type: string
SEAT:
  type: string
RD:
  type: string
RDSEC:
  type: string
RDBR:
  type: string
RDSUBBR:
  type: string
PRM:
  type: string
POM:
  type: string
usageRules:
  type: string
method:
  type: string
providedBy:
  type: string

VelocityEstimate:
  description: Velocity estimate.
  oneOf:
    - $ref: '#/components/schemas/HorizontalVelocity'
    - $ref: '#/components/schemas/HorizontalWithVerticalVelocity'
    - $ref: '#/components/schemas/HorizontalVelocityWithUncertainty'
    - $ref: '#/components/schemas/HorizontalWithVerticalVelocityAndUncertainty'

HorizontalVelocity:
  description: Horizontal velocity.
  type: object
  required:
    - hSpeed
    - bearing
  properties:

```

```

    hSpeed:
      $ref: '#/components/schemas/HorizontalSpeed'
    bearing:
      $ref: '#/components/schemas/Angle'

HorizontalWithVerticalVelocity:
  description: Horizontal and vertical velocity.
  type: object
  required:
    - hSpeed
    - bearing
    - vSpeed
    - vDirection
  properties:
    hSpeed:
      $ref: '#/components/schemas/HorizontalSpeed'
    bearing:
      $ref: '#/components/schemas/Angle'
    vSpeed:
      $ref: '#/components/schemas/VerticalSpeed'
    vDirection:
      $ref: '#/components/schemas/VerticalDirection'

HorizontalVelocityWithUncertainty:
  description: Horizontal velocity with speed uncertainty.
  type: object
  required:
    - hSpeed
    - bearing
    - hUncertainty
  properties:
    hSpeed:
      $ref: '#/components/schemas/HorizontalSpeed'
    bearing:
      $ref: '#/components/schemas/Angle'
    hUncertainty:
      $ref: '#/components/schemas/SpeedUncertainty'

HorizontalWithVerticalVelocityAndUncertainty:
  description: Horizontal and vertical velocity with speed uncertainty.
  type: object
  required:
    - hSpeed
    - bearing
    - vSpeed
    - vDirection
    - hUncertainty
    - vUncertainty
  properties:
    hSpeed:
      $ref: '#/components/schemas/HorizontalSpeed'
    bearing:
      $ref: '#/components/schemas/Angle'
    vSpeed:
      $ref: '#/components/schemas/VerticalSpeed'
    vDirection:
      $ref: '#/components/schemas/VerticalDirection'
    hUncertainty:
      $ref: '#/components/schemas/SpeedUncertainty'
    vUncertainty:
      $ref: '#/components/schemas/SpeedUncertainty'

UeLcsCapability:
  description: Indicates the LCS capability supported by the UE..
  type: object
  properties:
    lppSupport:
      type: boolean
      default: true
    ciotOptimisation:
      type: boolean
      default: false

PeriodicEventInfo:
  description: Indicates the information of periodic event reporting.
  type: object
  required:
    - reportingAmount

```

```

    - reportingInterval
  properties:
    reportingAmount:
      $ref: '#/components/schemas/ReportingAmount'
    reportingInterval:
      $ref: '#/components/schemas/ReportingInterval'

AreaEventInfo:
  description: Indicates the information of area based event reporting.
  type: object
  required:
    - areaDefinition
  properties:
    areaDefinition:
      type: array
      items:
        $ref: '#/components/schemas/ReportingArea'
      minItems: 1
      maxItems: 250
    occurrenceInfo:
      $ref: '#/components/schemas/OccurrenceInfo'
    minimumInterval:
      $ref: '#/components/schemas/MinimumInterval'
    maximumInterval:
      $ref: '#/components/schemas/MaximumInterval'
    samplingInterval:
      $ref: '#/components/schemas/SamplingInterval'
    reportingDuration:
      $ref: '#/components/schemas/ReportingDuration'
    reportingLocationReq:
      type: boolean
      default: true

ReportingArea:
  description: Indicates an area for event reporting.
  type: object
  required:
    - areaType
  properties:
    areaType:
      $ref: '#/components/schemas/ReportingAreaType'
    tai:
      $ref: 'TS29571_CommonData.yaml#/components/schemas/Tai'
    ecgi:
      $ref: 'TS29571_CommonData.yaml#/components/schemas/Ecgi'
    ncgi:
      $ref: 'TS29571_CommonData.yaml#/components/schemas/Ncgi'

MotionEventInfo:
  description: Indicates the information of motion based event reporting.
  type: object
  required:
    - linearDistance
  properties:
    linearDistance:
      $ref: '#/components/schemas/LinearDistance'
    occurrenceInfo:
      $ref: '#/components/schemas/OccurrenceInfo'
    minimumInterval:
      $ref: '#/components/schemas/MinimumInterval'
    maximumInterval:
      $ref: '#/components/schemas/MaximumInterval'
    samplingInterval:
      $ref: '#/components/schemas/SamplingInterval'
    reportingDuration:
      $ref: '#/components/schemas/ReportingDuration'
    reportingLocationReq:
      type: boolean
      default: true

CancelLocData:
  description: Information within Cancel Location Request.
  type: object
  required:
    - hgmlcCallbackURI
    - ldrReference
  properties:
    hgmlcCallbackURI:

```

```

    $ref: 'TS29571_CommonData.yaml#/components/schemas/Uri'
  ldrReference:
    $ref: '#/components/schemas/LdrReference'
  supportedFeatures:
    $ref: 'TS29571_CommonData.yaml#/components/schemas/SupportedFeatures'

LocContextData:
  description: Information within Transfer Location Context Request.
  type: object
  required:
    - amfId
    - ldrType
    - hgmlcCallbackURI
    - ldrReference
    - eventReportMessage
  properties:
    amfId:
      $ref: 'TS29571_CommonData.yaml#/components/schemas/NfInstanceId'
    locationQoS:
      $ref: '#/components/schemas/LocationQoS'
    supportedGADShapes:
      type: array
      items:
        $ref: '#/components/schemas/SupportedGADShapes'
      minItems: 1
    supi:
      $ref: 'TS29571_CommonData.yaml#/components/schemas/Supi'
    gpsi:
      $ref: 'TS29571_CommonData.yaml#/components/schemas/Gpsi'
    ldrType:
      $ref: '#/components/schemas/LdrType'
    hgmlcCallbackURI:
      $ref: 'TS29571_CommonData.yaml#/components/schemas/Uri'
    ldrReference:
      $ref: '#/components/schemas/LdrReference'
    periodicEventInfo:
      $ref: '#/components/schemas/PeriodicEventInfo'
    areaEventInfo:
      $ref: '#/components/schemas/AreaEventInfo'
    motionEventInfo:
      $ref: '#/components/schemas/MotionEventInfo'
    eventReportMessage:
      $ref: '#/components/schemas/EventReportMessage'
    eventReportingStatus:
      $ref: '#/components/schemas/EventReportingStatus'
    ueLocationInfo:
      $ref: '#/components/schemas/UELocationInfo'
    cIoT5GSOptimisation:
      type: boolean
      default: false
    ecgi:
      $ref: 'TS29571_CommonData.yaml#/components/schemas/Ecgi'
    ncgi:
      $ref: 'TS29571_CommonData.yaml#/components/schemas/Ncgi'
    guami:
      $ref: 'TS29571_CommonData.yaml#/components/schemas/Guami'
    supportedFeatures:
      $ref: 'TS29571_CommonData.yaml#/components/schemas/SupportedFeatures'
    uePositioningCap:
      $ref: '#/components/schemas/UePositioningCapabilities'
    scheduledLocTime:
      $ref: 'TS29571_CommonData.yaml#/components/schemas/DateTime'

EventReportMessage:
  description: Indicates an event report message.
  type: object
  required:
    - eventClass
    - eventContent
  properties:
    eventClass:
      $ref: '#/components/schemas/EventClass'
    eventContent:
      $ref: 'TS29571_CommonData.yaml#/components/schemas/RefToBinaryData'

EventReportingStatus:
  description: Indicates the status of event reporting.
  type: object

```

```

properties:
  eventReportCounter:
    $ref: '#/components/schemas/EventReportCounter'
  eventReportDuration:
    $ref: '#/components/schemas/EventReportDuration'
UELocationInfo:
  description: Indicates location information of a UE.
  type: object
  properties:
    locationEstimate:
      $ref: '#/components/schemas/GeographicArea'
    ageOfLocationEstimate:
      $ref: '#/components/schemas/AgeOfLocationEstimate'
    timestampOfLocationEstimate:
      $ref: 'TS29571_CommonData.yaml#/components/schemas/DateTime'
    velocityEstimate:
      $ref: '#/components/schemas/VelocityEstimate'
    ageOfVelocityEstimate:
      $ref: '#/components/schemas/AgeOfLocationEstimate'
    timestampOfVelocityEstimate:
      $ref: 'TS29571_CommonData.yaml#/components/schemas/DateTime'
EventNotifyData:
  description: Information within Event Notify Request.
  type: object
  required:
    - reportedEventType
    - ldrReference
  properties:
    reportedEventType:
      $ref: '#/components/schemas/ReportedEventType'
    supi:
      $ref: 'TS29571_CommonData.yaml#/components/schemas/Supi'
    gpsi:
      $ref: 'TS29571_CommonData.yaml#/components/schemas/Gpsi'
    hgmlcCallbackURI:
      $ref: 'TS29571_CommonData.yaml#/components/schemas/Uri'
    ldrReference:
      $ref: '#/components/schemas/LdrReference'
    locationEstimate:
      $ref: '#/components/schemas/GeographicArea'
    ageOfLocationEstimate:
      $ref: '#/components/schemas/AgeOfLocationEstimate'
    timestampOfLocationEstimate:
      $ref: 'TS29571_CommonData.yaml#/components/schemas/DateTime'
    civicAddress:
      $ref: '#/components/schemas/CivicAddress'
    localLocationEstimate:
      $ref: '#/components/schemas/LocalArea'
    positioningDataList:
      type: array
      items:
        $ref: '#/components/schemas/PositioningMethodAndUsage'
      minItems: 1
    gnssPositioningDataList:
      type: array
      items:
        $ref: '#/components/schemas/GnssPositioningMethodAndUsage'
      minItems: 1
    servingLMFidentification:
      $ref: '#/components/schemas/LMFIdentification'
    terminationCause:
      $ref: '#/components/schemas/TerminationCause'
    velocityEstimate:
      $ref: '#/components/schemas/VelocityEstimate'
    altitude:
      $ref: '#/components/schemas/Altitude'
    achievedQos:
      $ref: '#/components/schemas/MinorLocationQoS'
    supportedFeatures:
      $ref: 'TS29571_CommonData.yaml#/components/schemas/SupportedFeatures'
UeConnectivityState:
  description: Indicates the connectivity state of a UE.
  type: object
  required:
    - accessType

```

```

    properties:
      accessType:
        $ref: 'TS29571_CommonData.yaml#/components/schemas/AccessType'
      connectivitystate:
        $ref: 'TS29518_Namf_EventExposure.yaml#/components/schemas/CmState'

MinorLocationQoS:
  description: Contain Minor Location QoS.
  type: object
  properties:
    hAccuracy:
      $ref: '#/components/schemas/Accuracy'
    vAccuracy:
      $ref: '#/components/schemas/Accuracy'

#
#
# SIMPLE TYPES
#

Altitude:
  description: Indicates value of altitude.
  type: number
  format: double
  minimum: -32767
  maximum: 32767

Angle:
  description: Indicates value of angle.
  type: integer
  minimum: 0
  maximum: 360

Uncertainty:
  description: Indicates value of uncertainty.
  type: number
  format: float
  minimum: 0

Orientation:
  description: Indicates value of orientation angle.
  type: integer
  minimum: 0
  maximum: 180

Confidence:
  description: Indicates value of confidence.
  type: integer
  minimum: 0
  maximum: 100

Accuracy:
  description: Indicates value of accuracy.
  type: number
  format: float
  minimum: 0

InnerRadius:
  description: Indicates value of the inner radius.
  type: integer
  format: int32
  minimum: 0
  maximum: 327675

CorrelationID:
  description: LCS Correlation ID.
  type: string
  minLength: 1
  maxLength: 255

AgeOfLocationEstimate:
  description: Indicates value of the age of the location estimate.
  type: integer
  minimum: 0
  maximum: 32767

HorizontalSpeed:
  description: Indicates value of horizontal speed.
  type: number

```

format: float
minimum: 0
maximum: 2047

VerticalSpeed:
description: Indicates value of vertical speed.
type: number
format: float
minimum: 0
maximum: 255

SpeedUncertainty:
description: Indicates value of speed uncertainty.
type: number
format: float
minimum: 0
maximum: 255

BarometricPressure:
description: Specifies the measured uncompensated atmospheric pressure.
type: integer
minimum: 30000
maximum: 115000

LcsServiceType:
description: LCS service type.
type: integer
minimum: 0
maximum: 127

LdrReference:
description: LDR Reference.
type: string
minLength: 2
maxLength: 510

ReportingAmount:
description: Number of required periodic event reports.
type: integer
minimum: 1
maximum: 8639999

ReportingInterval:
description: Event reporting periodic interval.
type: integer
minimum: 1
maximum: 8639999

MinimumInterval:
description: Minimum interval between event reports.
type: integer
minimum: 1
maximum: 32767

MaximumInterval:
description: Maximum interval between event reports.
type: integer
minimum: 1
maximum: 86400

SamplingInterval:
description: Maximum time interval between consecutive evaluations by a UE of a trigger event.
type: integer
minimum: 1
maximum: 3600

ReportingDuration:
description: Maximum duration of event reporting.
type: integer
minimum: 1
maximum: 8640000

LinearDistance:
description: Minimum straight line distance moved by a UE to trigger a motion event report.
type: integer
minimum: 1
maximum: 10000

```
LMFIdentification:
  description: LMF identification.
  type: string

EventReportCounter:
  description: Number of event reports received from the target UE.
  type: integer
  minimum: 1
  maximum: 8640000

EventReportDuration:
  description: Duration of event reporting.
  type: integer
  minimum: 1
  maximum: 8640000

UePositioningCapabilities:
  description: Positioning capabilities supported by the UE. A string encoding the
"ProvideCapabilities-r9-IEs" IE as specified in clause 6.3 of 3GPP TS 37.355 (start from octet 1).
  type: string
  format: byte

#
# ENUMS
#
ExternalClientType:
  description: Indicates types of External Clients.
  anyOf:
    - type: string
      enum:
        - EMERGENCY_SERVICES
        - VALUE_ADDED_SERVICES
        - PLMN_OPERATOR_SERVICES
        - LAWFUL_INTERCEPT_SERVICES
        - PLMN_OPERATOR_BROADCAST_SERVICES
        - PLMN_OPERATOR_OM
        - PLMN_OPERATOR_ANONYMOUS_STATISTICS
        - PLMN_OPERATOR_TARGET_MS_SERVICE_SUPPORT
    - type: string

SupportedGADShapes:
  description: Indicates supported GAD shapes.
  anyOf:
    - type: string
      enum:
        - POINT
        - POINT_UNCERTAINTY_CIRCLE
        - POINT_UNCERTAINTY_ELLIPSE
        - POLYGON
        - POINT_ALTITUDE
        - POINT_ALTITUDE_UNCERTAINTY
        - ELLIPSOID_ARC
        - LOCAL_2D_POINT_UNCERTAINTY_ELLIPSE
        - LOCAL_3D_POINT_UNCERTAINTY_ELLIPSOID
    - type: string

ResponseTime:
  description: Indicates acceptable delay of location request.
  anyOf:
    - type: string
      enum:
        - LOW_DELAY
        - DELAY_TOLERANT
        - NO_DELAY
    - type: string

PositioningMethod:
  description: Indicates supported positioning methods.
  anyOf:
    - type: string
      enum:
        - CELLID
        - ECID
        - OTDOA
        - BAROMETRIC_PRESSURE
        - WLAN
        - BLUETOOTH
        - MBS
```

- MOTION_SENSOR
- DL_TDOA
- DL_AOD
- MULTI-RTT
- NR_ECID
- UL_TDOA
- UL_AOA
- NETWORK_SPECIFIC

- type: string

PositioningMode:
description: Indicates supported modes used for positioning method.
anyOf:
- type: string
enum:
- UE_BASED
- UE_ASSISTED
- CONVENTIONAL
- type: string

GnssId:
description: Global Navigation Satellite System (GNSS) ID.
anyOf:
- type: string
enum:
- GPS
- GALILEO
- SBAS
- MODERNIZED_GPS
- QZSS
- GLONASS
- BDS
- NAVIC
- type: string

Usage:
description: Indicates usage made of the location measurement.
anyOf:
- type: string
enum:
- UNSUCCESS
- SUCCESS_RESULTS_NOT_USED
- SUCCESS_RESULTS_USED_TO_VERIFY_LOCATION
- SUCCESS_RESULTS_USED_TO_GENERATE_LOCATION
- SUCCESS_METHOD_NOT_DETERMINED
- type: string

LcsPriority:
description: Indicates priority of the LCS client.
anyOf:
- type: string
enum:
- HIGHEST_PRIORITY
- NORMAL_PRIORITY
- type: string

VelocityRequested:
description: Indicates velocity requirement.
anyOf:
- type: string
enum:
- VELOCITY_IS_NOT_REQUESTED
- VELOCITY_IS_REQUESTED
- type: string

AccuracyFulfilmentIndicator:
description: Indicates fulfilment of requested accuracy.
anyOf:
- type: string
enum:
- REQUESTED_ACCURACY_FULFILLED
- REQUESTED_ACCURACY_NOT_FULFILLED
- type: string

VerticalDirection:
description: Indicates direction of vertical speed.
type: string
enum:

- UPWARD
- DOWNWARD

LdrType:

description: Indicates LDR types.

anyOf:

- type: string
- enum:
 - UE_AVAILABLE
 - PERIODIC
 - ENTERING_INTO_AREA
 - LEAVING_FROM_AREA
 - BEING_INSIDE_AREA
 - MOTION
- type: string

ReportingAreaType:

description: Indicates type of event reporting area.

anyOf:

- type: string
- enum:
 - EPS_TRACKING_AREA_IDENTITY
 - E-UTRAN_CELL_GLOBAL_IDENTIFICATION
 - 5GS_TRACKING_AREA_IDENTITY
 - NR_CELL_GLOBAL_IDENTITY
- type: string

OccurrenceInfo:

description: Specifies occurrence of event reporting.

anyOf:

- type: string
- enum:
 - ONE_TIME_EVENT
 - MULTIPLE_TIME_EVENT
- type: string

ReportingAccessType:

description: Specifies access types of event reporting.

anyOf:

- type: string
- enum:
 - NR
 - EUTRA_CONNECTED_TO_5GC
 - NON_3GPP_CONNECTED_TO_5GC
 - NR_LEO
 - NR_MEO
 - NR_GEO
 - NR_OTHER_SAT
- type: string

EventClass:

description: Specifies event classes.

anyOf:

- type: string
- enum:
 - SUPPLEMENTARY_SERVICES
- type: string

ReportedEventType:

description: Specifies type of event reporting.

anyOf:

- type: string
- enum:
 - PERIODIC_EVENT
 - ENTERING_AREA_EVENT
 - LEAVING_AREA_EVENT
 - BEING_INSIDE_AREA_EVENT
 - MOTION_EVENT
 - MAXIMUM_INTERVAL_EXPIRATION_EVENT
 - LOCATION_CANCELLATION_EVENT
- type: string

TerminationCause:

description: Specifies causes of event reporting termination.

anyOf:

- type: string
- enum:
 - TERMINATION_BY_UE

```

    - TERMINATION_BY_NETWORK
    - NORMAL_TERMINATION
  - type: string

LcsQosClass:
  description: Specifies LCS QoS class.
  anyOf:
    - type: string
      enum:
        - BEST_EFFORT
        - ASSURED
        - MULTIPLE_QOS
    - type: string

UeLocationServiceInd:
  description: Specifies location service types requested by UE.
  anyOf:
    - type: string
      enum:
        - LOCATION_ESTIMATE
        - LOCATION_ASSISTANCE_DATA
    - type: string

```

A.3 Nlmf_Broadcast API

openapi: 3.0.0

```

info:
  version: '1.1.0'
  title: 'LMF Broadcast'
  description: |
    LMF Broadcast Service.
    © 2022, 3GPP Organizational Partners (ARIB, ATIS, CCSA, ETSI, TSDSI, TTA, TTC).
    All rights reserved.

externalDocs:
  description: 3GPP TS 29.572 V17.5.0; 5G System; Location Management Services; Stage 3
  url: 'https://www.3gpp.org/ftp/Specs/archive/29_series/29.572/'

servers:
  - url: '{apiRoot}/nlmf-broadcast/v1'
    variables:
      apiRoot:
        default: https://example.com
        description: apiRoot as defined in clause 4.4 of 3GPP TS 29.501

paths:
  /cipher-key-data:
    post:
      summary: Request ciphering key data
      operationId: CipheringKeyData
      tags:
        - Request Ciphering Key Data
      requestBody:
        content:
          application/json:
            schema:
              $ref: '#/components/schemas/CipherRequestData'
            required: true
      responses:
        '200':
          description: Expected response to a valid request
          content:
            application/json:
              schema:
                $ref: '#/components/schemas/CipherResponseData'
        '307':
          $ref: 'TS29571_CommonData.yaml#/components/responses/307'
        '308':
          $ref: 'TS29571_CommonData.yaml#/components/responses/308'
        '400':
          $ref: 'TS29571_CommonData.yaml#/components/responses/400'
        '401':
          $ref: 'TS29571_CommonData.yaml#/components/responses/401'

```

```

'403':
  $ref: 'TS29571_CommonData.yaml#/components/responses/403'
'404':
  $ref: 'TS29571_CommonData.yaml#/components/responses/404'
'411':
  $ref: 'TS29571_CommonData.yaml#/components/responses/411'
'413':
  $ref: 'TS29571_CommonData.yaml#/components/responses/413'
'415':
  $ref: 'TS29571_CommonData.yaml#/components/responses/415'
'429':
  $ref: 'TS29571_CommonData.yaml#/components/responses/429'
'500':
  $ref: 'TS29571_CommonData.yaml#/components/responses/500'
'503':
  $ref: 'TS29571_CommonData.yaml#/components/responses/503'
'504':
  $ref: 'TS29571_CommonData.yaml#/components/responses/504'
default:
  $ref: 'TS29571_CommonData.yaml#/components/responses/default'
callbacks:
  CipheringKeyData:
    '{$request.body#/amfCallbackURI}':
      post:
        requestBody:
          description: Ciphering Key Data Notification
          content:
            application/json:
              schema:
                $ref: '#/components/schemas/CipheringKeyInfo'
        responses:
          '200':
            description: Expected response to a valid request
            content:
              application/json:
                schema:
                  $ref: '#/components/schemas/CipheringKeyResponse'
          '307':
            $ref: 'TS29571_CommonData.yaml#/components/responses/307'
          '308':
            $ref: 'TS29571_CommonData.yaml#/components/responses/308'
          '400':
            $ref: 'TS29571_CommonData.yaml#/components/responses/400'
          '401':
            $ref: 'TS29571_CommonData.yaml#/components/responses/401'
          '403':
            $ref: 'TS29571_CommonData.yaml#/components/responses/403'
          '404':
            $ref: 'TS29571_CommonData.yaml#/components/responses/404'
          '411':
            $ref: 'TS29571_CommonData.yaml#/components/responses/411'
          '413':
            $ref: 'TS29571_CommonData.yaml#/components/responses/413'
          '415':
            $ref: 'TS29571_CommonData.yaml#/components/responses/415'
          '429':
            $ref: 'TS29571_CommonData.yaml#/components/responses/429'
          '500':
            $ref: 'TS29571_CommonData.yaml#/components/responses/500'
          '503':
            $ref: 'TS29571_CommonData.yaml#/components/responses/503'
          '504':
            $ref: 'TS29571_CommonData.yaml#/components/responses/504'
          default:
            $ref: 'TS29571_CommonData.yaml#/components/responses/default'

components:
  schemas:
#
# COMPLEX TYPES
#
  CipheringKeyInfo:
    description: Information within Ciphering Key Data Notification request.
    type: object
    required:
      - cipheringData
    properties:
      cipheringData:

```

```

    type: array
    items:
      $ref: '#/components/schemas/CipheringDataSet'
    minItems: 1
  supportedFeatures:
    $ref: 'TS29571_CommonData.yaml#/components/schemas/SupportedFeatures'

```

```

CipheringKeyResponse:
  description: Information within Ciphering Key Data Notification Response.
  type: object
  properties:
    cipheringDataReport:
      type: array
      items:
        $ref: '#/components/schemas/CipheringSetReport'
      minItems: 1

```

```

CipheringDataSet:
  description: Represents a Ciphering Data Set.
  type: object
  required:
    - cipheringSetID
    - cipheringKey
    - c0
    - validityStartTime
    - validityDuration
  properties:
    cipheringSetID:
      $ref: '#/components/schemas/CipheringSetID'
    cipheringKey:
      $ref: '#/components/schemas/CipheringKey'
    c0:
      $ref: '#/components/schemas/C0'
    ltePosSibTypes:
      $ref: 'TS29571_CommonData.yaml#/components/schemas/Bytes'
    nrPosSibTypes:
      $ref: 'TS29571_CommonData.yaml#/components/schemas/Bytes'
    validityStartTime:
      $ref: 'TS29571_CommonData.yaml#/components/schemas/DateTime'
    validityDuration:
      $ref: '#/components/schemas/ValidityDuration'
    tailList:
      $ref: 'TS29571_CommonData.yaml#/components/schemas/Bytes'

```

```

CipheringSetReport:
  description: Represents a report of Ciphering Data Set storage.
  type: object
  required:
    - cipheringSetID
    - storageOutcome
  properties:
    cipheringSetID:
      $ref: '#/components/schemas/CipheringSetID'
    storageOutcome:
      $ref: '#/components/schemas/StorageOutcome'

```

```

CipherRequestData:
  description: Information within Ciphering Key Data request.
  type: object
  required:
    - amfCallbackURI
  properties:
    amfCallbackURI:
      $ref: 'TS29571_CommonData.yaml#/components/schemas/Uri'
  supportedFeatures:
    $ref: 'TS29571_CommonData.yaml#/components/schemas/SupportedFeatures'

```

```

CipherResponseData:
  description: Information within Ciphering Key Data Response.
  type: object
  required:
    - dataAvailability
  properties:
    dataAvailability:
      $ref: '#/components/schemas/DataAvailability'

```

```

#
#
# SIMPLE TYPES

```

```
#
CipheringSetID:
  description: Ciphering Data Set Identifier.
  type: integer
  minimum: 0
  maximum: 65535

CipheringKey:
  description: Ciphering Key.
  format: byte
  type: string

CO:
  description: First component of the initial ciphering counter.
  format: byte
  type: string

ValidityDuration:
  description: Validity Duration of the Ciphering Data Set.
  type: integer
  minimum: 1
  maximum: 65535

#
# ENUMS
#
StorageOutcome:
  description: Indicates the result of Ciphering Data Set storage.
  anyOf:
    - type: string
      enum:
        - STORAGE_SUCCESSFUL
        - STORAGE_FAILED

DataAvailability:
  description: Indicates availability of ciphering key data at an LMF.
  anyOf:
    - type: string
      enum:
        - CIPHERING_KEY_DATA_AVAILABLE
        - CIPHERING_KEY_DATA_NOT_AVAILABLE
```

Annex B (informative): Change history

Date	Meeting	TDoc	CR	Rev	Cat	Subject/Comment	New version
2018-01	CT4#82					TS Skeleton agreed in CT4#82	0.0.0
2018-01	CT4#82	C4-181398				Initial draft (C4-181119) Incorporation of agreed pCRs from CT4#82: C4-181121, C4-181233, C4-181234	0.1.0
2018-03	CT4#83	C4-182444				Incorporation of agreed pCRs from CT4#83: C4-182181, C4-182427	0.2.0
2018-03	CT#79	CP-180034				Presented for information	1.0.0
2018-04	CT4#84	C4-183524				Incorporation of agreed pCRs from CT4#84: C4-183184, C4-183363, C4-183510	1.1.0
2018-05	CT4#85	C4-184640				Incorporation of agreed pCRs from CT4#85: C4-184195, C4-184197, C4-184198, C4-184199, C4-184202, C4-184443, C4-184446, C4-184547	1.2.0
2018-06	CT#80	CP-181111				Presented for approval	2.0.0
2018-06	CT#80					Approved in CT#80	15.0.0
2018-09	CT#81	CP-182066	0002	2		Error Cases	15.1.0
2018-09	CT#81	CP-182066	0003	-		Custom Headers	15.1.0
2018-09	CT#81	CP-182066	0004	-		Overall Clean-up	15.1.0
2018-09	CT#81	CP-182066	0005	-		Description of Structured data types	15.1.0
2018-09	CT#81	CP-182066	0006	1		Resource structure presentation	15.1.0
2018-09	CT#81	CP-182066	0007	1		LMF servers clause in OpenAPI	15.1.0
2018-09	CT#81	CP-182066	0008	-		API Version Update	15.1.0
2018-12	CT#82	CP-183025	0010	1	F	Cardinality	15.2.0
2018-12	CT#82	CP-183025	0011	-	F	APIRoot Clarification	15.2.0
2018-12	CT#82	CP-183025	0012	-	F	AMF Id	15.2.0
2018-12	CT#82	CP-183025	0013	-	F	Barometric Pressure in Location Data	15.2.0
2018-12	CT#82	CP-183025	0014	1	F	Clarify Serving Cell in Input Data	15.2.0
2018-12	CT#82	CP-183025	0015	1	F	Oauth2 Corrections	15.2.0
2018-12	CT#82	CP-183025	0016	-	F	API Version	15.2.0
2018-12	CT#82	CP-183179	0017	-	F	ExternalDocs Update	15.2.0
2019-03	CT#83	CP-190030	0018	1	F	OpenAPI Corrections	15.3.0
2019-03	CT#83	CP-190030	0019	1	F	Application Errors	15.3.0
2019-03	CT#83	CP-190030	0020	1	F	Essential Correction to InnerRadius	15.3.0
2019-03	CT#83	CP-190030	0021	1	F	Mandatory Response Codes	15.3.0
2019-03	CT#83	CP-190030	0022	1	F	Essential correction to OpenAPI definition of GeographicArea	15.3.0
2019-03	CT#83	CP-190030	0023	-	F	API version update	15.3.0
2019-06	CT#84	CP-191042	0024	2	F	UE Capabilities	15.4.0
2019-06	CT#84	CP-191042	0025	2	F	Storage of OpenAPI specification files	15.4.0
2019-06	CT#84	CP-191042	0027	1	F	Copyright Note in OpenAPI Spec	15.4.0
2019-06	CT#84	CP-191042	0028	1	F	Major API version	15.4.0
2019-06	CT#84	CP-191042	0030	-	F	Open API Version	15.4.0
2019-09	CT#85	CP-192113	0031	1	F	Missing attribute FLR in Civic Address	16.0.0
2019-09	CT#85	CP-192192	0033	2	B	LMF service operations for a deferred 5GC-MT-LR	16.0.0
2019-09	CT#85	CP-192192	0034	1	B	LMF service operations for a commercial 5GC-MT-LR	16.0.0
2019-09	CT#85	CP-192192	0035	-	F	High Accuracy Support	16.0.0
2019-09	CT#85	CP-192113	0037	1	D	Correct type Polygon	16.0.0
2019-09	CT#85	CP-192120	0039	-	F	3GPP TS 29.572 API version update	16.0.0
2019-12	CT#86	CP-193033	0041	1	A	Motion Sensor Position Method	16.1.0
2019-12	CT#86	CP-193165	0042	3	B	Addition of the LMF Broadcast Service Operations	16.1.0
2019-12	CT#86	CP-193055	0043	1	B	LCS QoS Class	16.1.0
2019-12	CT#86	CP-193036	0045	1	F	ExternalDoc Clause	16.1.0
2019-12	CT#86	CP-193036	0046	1	F	ProblemDetails Optional in Error Response	16.1.0
2019-12	CT#86	CP-193044	0048	-	F	3GPP TS 29.572 API version update	16.1.0
2020-03	CT#87	CP-200039	0049	2	F	Add Corresponding API descriptions in clause 5.1	16.2.0
2020-03	CT#87	CP-200039	0050	2	D	Editorial corrections	16.2.0
2020-03	CT#87	CP-200039	0051	1	F	Correction - formatting consistency	16.2.0
2020-03	CT#87	CP-200018	0052		B	Connectivity state per access type	16.2.0
2020-03	CT#87	CP-200018	0053		B	Primary Cell in the Secondary RAN node	16.2.0
2020-03	CT#87	CP-200052	0055		F	3GPP TS 29.572 Rel16 API External doc update	16.2.0
2020-03	CT#87	CP-200180	0054	4	B	Request Type and embedded LPP message	16.2.0
2020-06	CT#88e	CP-201060	0056	1	F	Add a new Notifications Overview Table	16.3.0
2020-06	CT#88e	CP-201060	0057	1	F	Add custom operation Name	16.3.0
2020-06	CT#88e	CP-201032	0058		F	Location Context Transfer	16.3.0
2020-06	CT#88e	CP-201032	0059	1	B	Network Specific Positioning Methods	16.3.0
2020-06	CT#88e	CP-201032	0060		B	Positioning Methods Support	16.3.0
2020-06	CT#88e	CP-201032	0061	2	F	Storage of YAML files in ETSI Forge	16.3.0
2020-06	CT#88e	CP-201032	0062	1	F	Resolve Editor Notes	16.3.0
2020-06	CT#88e	CP-201032	0063	1	F	LDRreference	16.3.0

2020-06	CT#88e	CP-201032	0065	1	F	Resolution of EN on NR positioning SIBs	16.3.0
2020-06	CT#88e	CP-201032	0068	1	F	Adding ResponseTime enumeration value	16.3.0
2020-06	CT#88e	CP-201060	0069		F	Missing Descriptions	16.3.0
2020-06	CT#88e	CP-201073	0070		F	29.572 Rel-16 API version and External doc update	16.3.0
2020-09	CT#89e	CP-202112	0071	1	F	Optionality of ProblemDetails in TS29.572 cleanup	16.4.0
2020-09	CT#89e	CP-202112	0073	1	F	Adding missing navigation satellite systems for positioning	16.4.0
2020-09	CT#89e	CP-202112	0074	1	F	Including VGMLC address towards LMF when requesting LMF's Location service	16.4.0
2020-09	CT#89e	CP-202112	0075	1	F	Corrections on EventNotify service operation	16.4.0
2020-09	CT#89e	CP-202043	0077	1	F	Correct mismatch on GeographicArea between table and yaml	16.4.0
2020-09	CT#89e	CP-202096	0078	-	F	29.572 Rel-16 API version and External doc update	16.4.0
2020-12	CT#90e	CP-203050	0080	1	F	Essential corrections in clause 5.2.2.4 CancelLocation	16.5.0
2020-12	CT#90e	CP-203050	0081	1	F	Indication of control plane Clot 5GS optimization in LocationContextTransfer	16.5.0
2020-12	CT#90e	CP-203035	0082	1	F	YAML files in 3GPP Forge	16.5.0
2020-12	CT#90e	CP-203036	0085	1	F	29.572 Rel-16 API version and External doc update	16.5.0
2021-03	CT#91e	CP-210041	0087	-	F	Missing PIDL-LO elements in Location Information	17.0.0
2021-03	CT#91e	CP-210037	0088	1	F	HTTP 3xx redirection	17.0.0
2021-03	CT#91e	CP-210034	0089	-	F	Reference change	17.0.0
2021-03	CT#91e	CP-210054	0091	-	F	29.572 Rel-16 API version and External doc update	17.0.0
2021-06	CT#92e	CP-211055	0092	1	F	Resolving Warning in Nlmf_BroadCast API	17.1.0
2021-06	CT#92e	CP-211055	0093		F	Resolving Warning in Nlmf_Location API	17.1.0
2021-06	CT#92e	CP-211026	0094	1	B	Add List of Assistance Data Types for MO-LR	17.1.0
2021-06	CT#92e	CP-211026	0095	3	B	Add Local Coordinates	17.1.0
2021-06	CT#92e	CP-211051	0096		F	OpenAPI Reference	17.1.0
2021-06	CT#92e	CP-211059	0098		A	3xx description correction for SCP	17.1.0
2021-06	CT#92e	CP-211059	0102	1	A	Redirect Response	17.1.0
2021-06	CT#92e	CP-211050	0103		F	29.572 Rel-17 API version and External doc update	17.1.0
2021-09	CT#93e	CP-212034	0105	1	B	Add UE Positioning Capabilities	17.2.0
2021-09	CT#93e	CP-212034	0108	2	B	Support for Area Decision of Satellite Access	17.2.0
2021-09	CT#93e	CP-212034	0109	1	B	LMF Parameters Support for non-3GPP Access	17.2.0
2021-09	CT#93e	CP-212064	0111		A	Encoding of binary attributes in JSON objects	17.2.0
2021-09	CT#93e	CP-212034	0114	1	B	Multiple QoS Class	17.2.0
2021-09	CT#93e	CP-212059	0115		F	29.572 Rel-17 API version and External doc update	17.2.0
2021-12	CT#94e	CP-213096	0118	1	B	Multiple LPP messages	17.3.0
2021-12	CT#94e	CP-213096	0119	1	B	Higher Resolution Timestamp for Location Estimates	17.3.0
2021-12	CT#94e	CP-213096	0120		F	UE Positioning Capabilities Data Type	17.3.0
2021-12	CT#94e	CP-213096	0121	1	B	Update allowed access type for event report	17.3.0
2021-12	CT#94e	CP-213118	0122		F	Resolve OpenAPI Warnings	17.3.0
2021-12	CT#94e	CP-213120	0123		F	307/308 redirection	17.3.0
2021-12	CT#94e	CP-213121	0124		F	29.572 Rel-17 API version and External doc update	17.3.0
2022-03	CT#95e	CP-220034	0128		F	Corrections on the RelativeCartesianLocation	17.4.0
2022-03	CT#95e	CP-220227	0130	1	A	Corrections on attributes	17.4.0
2022-03	CT#95e	CP-220090	0131		F	Update incorrect table number	17.4.0
2022-03	CT#95e	CP-220217	0133		F	29.572 Rel-17 API version and External doc update	17.4.0
2022-06	CT#96	CP-221022	0135	1	B	Schedule location time for LMF	17.5.0
2022-06	CT#96	CP-221022	0136		F	Update the title of RelativeCartesianLocation	17.5.0
2022-06	CT#96	CP-221051	0138		F	29.572 Rel-17 API version and External doc update	17.5.0
2022-09	CT#97	CP-222030	0139	1	F	Alignment on the service name used with template	17.6.0
2022-09	CT#97	CP-222036	0140	1	F	Indication of Network Assisted Positioning method	17.6.0
2022-09	CT#97	CP-222058	0141		F	29.572 Rel-17 API version and External doc update	17.6.0

History

Document history		
V17.4.0	May 2022	Publication
V17.5.0	July 2022	Publication
V17.6.0	October 2022	Publication