

ETSI TS 129 598 V18.6.0 (2024-07)



**5G;
Unstructured data storage services
(3GPP TS 29.598 version 18.6.0 Release 18)**



Reference

RTS/TSGC-0429598vi60

Keywords

5G

ETSI

650 Route des Lucioles
F-06921 Sophia Antipolis Cedex - FRANCE

Tel.: +33 4 92 94 42 00 Fax: +33 4 93 65 47 16

Siret N° 348 623 562 00017 - APE 7112B
Association à but non lucratif enregistrée à la
Sous-Préfecture de Grasse (06) N° w061004871

Important notice

The present document can be downloaded from the
ETSI [Search & Browse Standards application](#).

The present document may be made available in electronic versions and/or in print. The content of any electronic and/or print versions of the present document shall not be modified without the prior written authorization of ETSI. In case of any existing or perceived difference in contents between such versions and/or in print, the prevailing version of an ETSI deliverable is the one made publicly available in PDF format on [ETSI deliver](#).

Users should be aware that the present document may be revised or have its status changed,
this information is available in the [Milestones listing](#).

If you find errors in the present document, please send your comments to
the relevant service listed under [Committee Support Staff](#).

If you find a security vulnerability in the present document, please report it through our
[Coordinated Vulnerability Disclosure \(CVD\)](#) program.

Notice of disclaimer & limitation of liability

The information provided in the present deliverable is directed solely to professionals who have the appropriate degree of experience to understand and interpret its content in accordance with generally accepted engineering or other professional standard and applicable regulations.

No recommendation as to products and services or vendors is made or should be implied.

No representation or warranty is made that this deliverable is technically accurate or sufficient or conforms to any law and/or governmental rule and/or regulation and further, no representation or warranty is made of merchantability or fitness for any particular purpose or against infringement of intellectual property rights.

In no event shall ETSI be held liable for loss of profits or any other incidental or consequential damages.

Any software contained in this deliverable is provided "AS IS" with no warranties, express or implied, including but not limited to, the warranties of merchantability, fitness for a particular purpose and non-infringement of intellectual property rights and ETSI shall not be held liable in any event for any damages whatsoever (including, without limitation, damages for loss of profits, business interruption, loss of information, or any other pecuniary loss) arising out of or related to the use of or inability to use the software.

Copyright Notification

No part may be reproduced or utilized in any form or by any means, electronic or mechanical, including photocopying and microfilm except as authorized by written permission of ETSI.

The content of the PDF version shall not be modified without the written authorization of ETSI.

The copyright and the foregoing restriction extend to reproduction in all media.

© ETSI 2024.
All rights reserved.

Intellectual Property Rights

Essential patents

IPRs essential or potentially essential to normative deliverables may have been declared to ETSI. The declarations pertaining to these essential IPRs, if any, are publicly available for **ETSI members and non-members**, and can be found in ETSI SR 000 314: "*Intellectual Property Rights (IPRs); Essential, or potentially Essential, IPRs notified to ETSI in respect of ETSI standards*", which is available from the ETSI Secretariat. Latest updates are available on the ETSI Web server (<https://ipr.etsi.org/>).

Pursuant to the ETSI Directives including the ETSI IPR Policy, no investigation regarding the essentiality of IPRs, including IPR searches, has been carried out by ETSI. No guarantee can be given as to the existence of other IPRs not referenced in ETSI SR 000 314 (or the updates on the ETSI Web server) which are, or may be, or may become, essential to the present document.

Trademarks

The present document may include trademarks and/or tradenames which are asserted and/or registered by their owners. ETSI claims no ownership of these except for any which are indicated as being the property of ETSI, and conveys no right to use or reproduce any trademark and/or tradename. Mention of those trademarks in the present document does not constitute an endorsement by ETSI of products, services or organizations associated with those trademarks.

DECT™, **PLUGTESTS™**, **UMTS™** and the ETSI logo are trademarks of ETSI registered for the benefit of its Members. **3GPP™** and **LTE™** are trademarks of ETSI registered for the benefit of its Members and of the 3GPP Organizational Partners. **oneM2M™** logo is a trademark of ETSI registered for the benefit of its Members and of the oneM2M Partners. **GSM®** and the GSM logo are trademarks registered and owned by the GSM Association.

Legal Notice

This Technical Specification (TS) has been produced by ETSI 3rd Generation Partnership Project (3GPP).

The present document may refer to technical specifications or reports using their 3GPP identities. These shall be interpreted as being references to the corresponding ETSI deliverables.

The cross reference between 3GPP and ETSI identities can be found under <https://webapp.etsi.org/key/queryform.asp>.

Modal verbs terminology

In the present document "**shall**", "**shall not**", "**should**", "**should not**", "**may**", "**need not**", "**will**", "**will not**", "**can**" and "**cannot**" are to be interpreted as described in clause 3.2 of the [ETSI Drafting Rules](#) (Verbal forms for the expression of provisions).

"**must**" and "**must not**" are **NOT** allowed in ETSI deliverables except when used in direct citation.

Contents

Intellectual Property Rights	2
Legal Notice	2
Modal verbs terminology.....	2
Foreword.....	8
1 Scope	10
2 References	10
3 Definitions of terms, symbols and abbreviations	11
3.1 Terms.....	11
3.2 Symbols.....	11
3.3 Abbreviations	11
4 Overview	11
5 Services offered by the UDSF.....	12
5.1 Introduction	12
5.2 Nudsf_DataRepository Service	12
5.2.1 Service Description.....	12
5.2.2 Service Operations.....	12
5.2.2.1 Introduction.....	12
5.2.2.2 Query.....	13
5.2.2.2.1 General	13
5.2.2.2.2 Record Retrieval.....	13
5.2.2.2.3 Meta Retrieval	13
5.2.2.2.4 Blocks Retrieval	14
5.2.2.2.5 Block Retrieval.....	15
5.2.2.2.6 Search.....	15
5.2.2.2.7 Subscriptions Retrieval.....	16
5.2.2.2.8 Individual Subscription Retrieval	16
5.2.2.2.9 Meta Schema Retrieval.....	17
5.2.2.3 Create	17
5.2.2.3.1 General	17
5.2.2.3.2 Record Create	18
5.2.2.3.3 Block Create	18
5.2.2.3.4 Meta Schema Create.....	19
5.2.2.4 Update	19
5.2.2.4.1 General	19
5.2.2.4.2 Record Update.....	19
5.2.2.4.3 Block Update	20
5.2.2.4.4 Meta Update	21
5.2.2.4.5 Subscription Notification Update	22
5.2.2.4.6 Subscription Notification Update using PUT	22
5.2.2.4.7 Meta Schema Update.....	23
5.2.2.4.8 Record Partial Update.....	23
5.2.2.5 Delete	24
5.2.2.5.1 General	24
5.2.2.5.2 Record Delete	24
5.2.2.5.3 Block Delete	25
5.2.2.5.4 Meta Schema Delete.....	26
5.2.2.5.5 Bulk Records Delete.....	26
5.2.2.6 Notify	27
5.2.2.6.1 General	27
5.2.2.6.2 Record Expiry Notify	27
5.2.2.6.3 Notification due to Data Change	28
5.2.2.6.4 Subscription Expiry Notification.....	28
5.2.2.7 Subscribe.....	28

5.2.2.7.1	General	28
5.2.2.7.2	Subscription to notifications of data change	29
5.2.2.8	Unsubscribe	29
5.2.2.8.1	General	29
5.2.2.8.2	Unsubscription to notifications of data change	29
5.3	Nudsf_Timer Service	30
5.3.1	Service Description	30
5.3.2	Service Operations	30
5.3.2.1	Introduction	30
5.3.2.2	Start	31
5.3.2.2.1	General	31
5.3.2.2.2	Timer Start	31
5.3.2.3	Update	31
5.3.2.3.1	General	31
5.3.2.3.2	Timer Update	31
5.3.2.4	Stop	32
5.3.2.4.1	General	32
5.3.2.4.2	Single Timer Stop	32
5.3.2.4.3	Multiple Timer Stop	32
5.3.2.5	Search	33
5.3.2.5.1	General	33
5.3.2.5.2	Expired Timer Search	33
5.3.2.5.3	Tagged Timer Search	34
5.3.2.6	Notify	34
5.3.2.6.1	General	34
5.3.2.6.2	Timer Expiry Notify	34
6	API Definitions	35
6.1	Nudsf_DataRepository Service API	35
6.1.1	Introduction	35
6.1.2	Usage of HTTP	35
6.1.2.1	General	35
6.1.2.2	HTTP standard headers	35
6.1.2.2.1	General	35
6.1.2.2.2	Content type	35
6.1.2.2.3	Cache-Control	36
6.1.2.2.4	ETag	36
6.1.2.2.5	If-None-Match	36
6.1.2.2.6	If-Match	36
6.1.2.2.7	Last-Modified	36
6.1.2.2.8	If-Modified-Since	36
6.1.2.2.9	When to Use Entity-Tags and Last-Modified Dates	36
6.1.2.2.10	Content-Location	37
6.1.2.3	HTTP custom headers	37
6.1.2.4	HTTP multipart messages	37
6.1.2.4.1	General	37
6.1.2.4.2	Record	37
6.1.2.4.3	BlockCollection	37
6.1.2.4.4	RecordNotification	38
6.1.2.4.5	RecordPatch	38
6.1.3	Resources	39
6.1.3.1	Overview	39
6.1.3.2	Resource: RecordCollection (Collection)	40
6.1.3.2.1	Description	40
6.1.3.2.2	Resource Definition	41
6.1.3.2.3	Resource Standard Methods	41
6.1.3.3	Resource: Record (Document)	43
6.1.3.3.1	Description	43
6.1.3.3.2	Resource Definition	43
6.1.3.3.3	Resource Standard Methods	44
6.1.3.3.3.4	PATCH	47
6.1.3.4	Resource: Meta (Document)	48

6.1.3.4.1	Description	48
6.1.3.4.2	Resource Definition	48
6.1.3.4.3	Resource Standard Methods	48
6.1.3.5	Resource: BlockCollection (Collection)	50
6.1.3.5.1	Description	50
6.1.3.5.2	Resource Definition	50
6.1.3.5.3	Resource Standard Methods	50
6.1.3.6	Resource: Block (Document)	51
6.1.3.6.1	Description	51
6.1.3.6.2	Resource Definition	51
6.1.3.6.3	Resource Standard Methods	51
6.1.3.7	Resource: NotificationSubscriptions	54
6.1.3.7.1	Description	54
6.1.3.7.2	Resource Definition	54
6.1.3.7.3	Standard Methods	54
6.1.3.8	Resource: IndividualNotificationSubscription	55
6.1.3.8.1	Description	55
6.1.3.8.2	Resource Definition	55
6.1.3.8.3	Resource Standard Methods	55
6.1.3.9	Resource: Meta Schema (Document)	58
6.1.3.9.1	Description	58
6.1.3.9.2	Resource Definition	58
6.1.3.9.3	Resource Standard Methods	59
6.1.4	Custom Operations without associated resources	61
6.1.5	Notifications	61
6.1.5.1	General	61
6.1.5.2	Timer Expiry Notification	61
6.1.5.2.1	Description	61
6.1.5.2.2	Target URI	61
6.1.5.2.3	Standard Methods	61
6.1.5.3	Notification due to Data Change	62
6.1.5.3.1	Description	62
6.1.5.3.2	Target URI	62
6.1.5.3.3	Standard Methods	62
6.1.5.4	Subscription Expiry Notification	62
6.1.5.4.1	Description	62
6.1.5.4.2	Target URI	62
6.1.5.4.3	Standard Methods	63
6.1.6	Data Model	63
6.1.6.1	General	63
6.1.6.2	Structured data types	64
6.1.6.2.1	Introduction	64
6.1.6.2.2	Type: RecordSearchResult	65
6.1.6.2.3	Type: RecordMeta	66
6.1.6.2.4	Type: RecordBody	66
6.1.6.2.5	Type: Record	66
6.1.6.2.6	Type: BlockBody	66
6.1.6.2.7	Type: Block	66
6.1.6.2.8	Type: SearchCondition	67
6.1.6.2.9	SearchComparison	67
6.1.6.2.10	Type: NotificationSubscription	68
6.1.6.2.11	Type: RecordNotification	71
6.1.6.2.12	Type: NotificationDescription	71
6.1.6.2.13	Type: SubscriptionFilter	72
6.1.6.2.14	Type: ClientId	72
6.1.6.2.15	Type: MetaSchema	73
6.1.6.2.16	Type: TagType	73
6.1.6.2.17	Type: RecordIdList	73
6.1.6.2.18	Type: NotificationInfo	73
6.1.6.2.19	Type: CountExpression	74
6.1.6.2.20	Type: TagCount	75
6.1.6.2.21	Type: ValueCount	75

6.1.6.2.22	Type: RecordPatch	76
6.1.6.3	Simple data types and enumerations	76
6.1.6.3.1	Introduction	76
6.1.6.3.2	Simple data types.....	76
6.1.6.3.3	Enumeration: ComparisonOperator.....	76
6.1.6.3.4	Enumeration: ConditionOperator	77
6.1.6.3.5	Enumeration: RecordOperation	77
6.1.6.3.6	Enumeration: KeyType	77
6.1.6.3.7	Enumeration: RetrieveRecords.....	77
6.1.6.3.8	Enumeration: TagCountType	78
6.1.6.4	Data types describing alternative data types or combinations of data types	78
6.1.6.4.1	Type: SearchExpression	78
6.1.6.4.2	Type: ExtendedProblemDetails.....	78
6.1.6.4.3	Type: ProblemDetailExtension.....	78
6.1.7	Error Handling	79
6.1.7.1	General	79
6.1.7.2	Protocol Errors	79
6.1.7.3	Application Errors	79
6.1.8	Feature negotiation	79
6.1.9	Security	80
6.2	Nudsf_Timer Service API	81
6.2.1	Introduction.....	81
6.2.2	Usage of HTTP	81
6.2.2.1	General	81
6.2.2.2	HTTP standard headers	81
6.2.2.2.1	General	81
6.2.2.2.2	Content type	82
6.2.2.3	HTTP custom headers	82
6.2.3	Resources	82
6.2.3.1	Overview	82
6.2.3.2	Resource: Timers (Store)	83
6.2.3.2.1	Description	83
6.2.3.2.2	Resource Definition.....	83
6.2.3.2.3	Resource Standard Methods	83
6.2.3.3	Resource: Individual Timer (Document)	85
6.2.3.3.1	Description	85
6.2.3.3.2	Resource Definition.....	85
6.2.3.3.3	Resource Standard Methods	85
6.2.4	Custom Operations without associated resources	87
6.2.5	Notifications	87
6.2.5.1	General	87
6.2.5.2	Timer Expiry Notification.....	88
6.2.5.2.1	Description	88
6.2.5.2.2	Target URI.....	88
6.2.5.2.3	Standard Methods.....	88
6.2.6	Data Model	88
6.2.6.1	General	88
6.2.6.2	Structured data types	89
6.2.6.2.1	Introduction	89
6.2.6.2.2	Type: Timer	89
6.2.6.2.3	Type: TimerIdList	90
6.2.6.3	Simple data types and enumerations	90
6.2.6.3.1	Introduction	90
6.2.6.3.2	Simple data types.....	90
6.2.7	Error Handling	90
6.2.7.1	General	90
6.2.7.2	Protocol Errors	90
6.2.7.3	Application Errors.....	90
6.2.8	Feature negotiation	91
6.2.9	Security	91
Annex A (normative):	OpenAPI specification.....	92

A.1	General	92
A.2	Nudsf_DataRepository API.....	92
A.3	Nudsf_Timer API.....	129
Annex B (informative): Search Examples		137
B.1	Example Search.....	137
B.2	Example AdvancedCounting.....	138
Annex C (informative): HTTP Multipart Examples		141
C.1	General	141
C.2	Example HTTP multipart Record.....	141
C.3	Example HTTP multipart BlockCollection	141
C.4	Example HTTP multipart RecordNotification	142
C.5	Example HTTP multipart RecordPatch.....	142
Annex D (informative): Change history		143
History		146

Foreword

This Technical Specification has been produced by the 3rd Generation Partnership Project (3GPP).

The contents of the present document are subject to continuing work within the TSG and may change following formal TSG approval. Should the TSG modify the contents of the present document, it will be re-released by the TSG with an identifying change of release date and an increase in version number as follows:

Version x.y.z

where:

- x the first digit:
 - 1 presented to TSG for information;
 - 2 presented to TSG for approval;
 - 3 or greater indicates TSG approved document under change control.
- y the second digit is incremented for all changes of substance, i.e. technical enhancements, corrections, updates, etc.
- z the third digit is incremented when editorial only changes have been incorporated in the document.

In the present document, modal verbs have the following meanings:

- shall** indicates a mandatory requirement to do something
- shall not** indicates an interdiction (prohibition) to do something

The constructions "shall" and "shall not" are confined to the context of normative provisions, and do not appear in Technical Reports.

The constructions "must" and "must not" are not used as substitutes for "shall" and "shall not". Their use is avoided insofar as possible, and they are not used in a normative context except in a direct citation from an external, referenced, non-3GPP document, or so as to maintain continuity of style when extending or modifying the provisions of such a referenced document.

- should** indicates a recommendation to do something
- should not** indicates a recommendation not to do something
- may** indicates permission to do something
- need not** indicates permission not to do something

The construction "may not" is ambiguous and is not used in normative elements. The unambiguous constructions "might not" or "shall not" are used instead, depending upon the meaning intended.

- can** indicates that something is possible
- cannot** indicates that something is impossible

The constructions "can" and "cannot" are not substitutes for "may" and "need not".

- will** indicates that something is certain or expected to happen as a result of action taken by an agency the behaviour of which is outside the scope of the present document
- will not** indicates that something is certain or expected not to happen as a result of action taken by an agency the behaviour of which is outside the scope of the present document
- might** indicates a likelihood that something will happen as a result of action taken by some agency the behaviour of which is outside the scope of the present document

might not indicates a likelihood that something will not happen as a result of action taken by some agency the behaviour of which is outside the scope of the present document

In addition:

is (or any other verb in the indicative mood) indicates a statement of fact

is not (or any other negative verb in the indicative mood) indicates a statement of fact

The constructions "is" and "is not" do not indicate requirements.

1 Scope

The present document specifies the stage 3 protocol and data model for the Nudsf Service Based Interface. It provides stage 3 protocol definitions and message flows, and specifies the API for each service offered by the UDSF.

The 5G System stage 2 architecture and procedures are specified in 3GPP TS 23.501 [2] and 3GPP TS 23.502 [3].

The Technical Realization of the Service Based Architecture and the Principles and Guidelines for Services Definition are specified in 3GPP TS 29.500 [4] and 3GPP TS 29.501 [5].

2 References

The following documents contain provisions which, through reference in this text, constitute provisions of the present document.

- References are either specific (identified by date of publication, edition number, version number, etc.) or non-specific.
- For a specific reference, subsequent revisions do not apply.
- For a non-specific reference, the latest version applies. In the case of a reference to a 3GPP document (including a GSM document), a non-specific reference implicitly refers to the latest version of that document *in the same Release as the present document*.

- [1] 3GPP TR 21.905: "Vocabulary for 3GPP Specifications".
- [2] 3GPP TS 23.501: "System Architecture for the 5G System; Stage 2".
- [3] 3GPP TS 23.502: "Procedures for the 5G System; Stage 2".
- [4] 3GPP TS 29.500: "5G System; Technical Realization of Service Based Architecture; Stage 3".
- [5] 3GPP TS 29.501: "5G System; Principles and Guidelines for Services Definition; Stage 3".
- [6] OpenAPI: "OpenAPI Specification Version 3.0.0", <https://spec.openapis.org/oas/v3.0.0>.
- [7] 3GPP TR 21.900: "Technical Specification Group working methods".
- [8] 3GPP TS 33.501: "Security architecture and procedures for 5G system".
- [9] IETF RFC 6749: "The OAuth 2.0 Authorization Framework".
- [10] 3GPP TS 29.510: "5G System; Network Function Repository Services; Stage 3".
- [11] IETF RFC 9113: "HTTP/2".
- [12] IETF RFC 8259: "The JavaScript Object Notation (JSON) Data Interchange Format".
- [13] IETF RFC 9457: "Problem Details for HTTP APIs".
- [14] IETF RFC 6902: "JavaScript Object Notation (JSON) Patch".
- [15] IETF RFC 9110: "HTTP Semantics".
- [16] Void.
- [17] IETF RFC 9111: "HTTP Caching".
- [18] ISO/IEC 14977: "Information technology – Syntactic metalanguage - Extended BNF".
- [19] 3GPP TS 29.571: "5G System; Common Data Types for Service Based Interfaces; Stage 3".
- [20] IETF RFC 2045: "Multipurpose Internet Mail Extensions (MIME) Part One: Format of Internet Message Bodies".

- [21] IETF RFC 2046: "Multipurpose Internet Mail Extensions (MIME) Part Two: Media Types".
- [22] IETF RFC 3986: "Uniform Resource Identifier (URI): Generic Syntax".

3 Definitions of terms, symbols and abbreviations

3.1 Terms

void

3.2 Symbols

void

3.3 Abbreviations

For the purposes of the present document, the abbreviations given in 3GPP TR 21.905 [1] and the following apply. An abbreviation defined in the present document takes precedence over the definition of the same abbreviation, if any, in 3GPP TR 21.905 [1].

5GC	5G Core Network
BNF	Backus–Naur Form
EBNF	Extended BNF
CP	Control Plane
MIME	Multipurpose Internet Mail Extensions
NF	Network Function
UDSF	Unstructured Data Storage Function

4 Overview

The UDSF, as depicted in Figure 4.1-1 below, is described in clause 4.2.5 of 3GPP TS 23.501 [2]. Any of the 5GS NFs can make use of the UDSF to store and retrieve unstructured data, i.e., data that is not defined in 3GPP specifications, and can make use of the UDSF to run timers and get notified on timer expiry. The UDSF is deployed in the same network where the CP NF is located and the same UDSF may be shared by all the NFs in the PLMN to store/retrieve their respective data or an NF may have its own UDSF depending on operator configuration.

NOTE 1: Structured data in this specification refers to data for which the structure is defined in 3GPP specifications. Unstructured data refers to data for which the structure is not defined in 3GPP specifications.

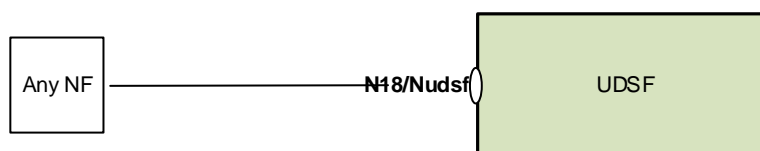

Figure 4.1-1: Reference model – UDSF

5 Services offered by the UDSF

5.1 Introduction

The UDSF offers the following services via the Nudsf service based interface:

- Nudsf_DataRepository Service

NOTE: This service corresponds to the Nudsf_UnstructuredDataManagement service in 3GPP TS 23.501 [2] and 3GPP TS 23.502 [3].

- Nudsf_Timer Service

Table 5.1-1 summarizes the corresponding APIs defined for this specification.

Table 5.1-1: API Descriptions

Service Name	Clause	Description	OpenAPI Specification File	apiName	Annex
Nudsf_DataRepository	6.1	UDSF Data Repository Service	TS29598_Nudsf_DataRepository.yaml	nudsf-dr	A.2
Nudsf_Timer	6.2	UDSF Timer Service	TS29598_Nudsf_Timer.yaml	nudsf-timer	A.3

5.2 Nudsf_DataRepository Service

5.2.1 Service Description

The UDSF is acting as an NF Service Producer. It provides UDSF data repository service to the NF service consumer. Any NF may use the UDSF to store unstructured data.

NOTE 1: Structured data in this specification refers to data for which the structure is defined in 3GPP specifications. Unstructured data refers to data for which the structure is not defined in 3GPP specifications.

5.2.2 Service Operations

5.2.2.1 Introduction

For the Nudsf_DataRepository service, the following service operations are defined:

- Query
- Create
- Update
- Delete
- Notify
- Subscribe
- Unsubscribe

5.2.2.2 Query

5.2.2.2.1 General

The following procedures using the Query service operation are supported:

- Record Retrieval
- Meta Retrieval
- Blocks Retrieval
- Block Retrieval
- Search
- Subscriptions Retrieval
- Individual Subscription Retrieval
- Meta Schema Retrieval

5.2.2.2.2 Record Retrieval

Figure 5.2.2.2.2-1 shows a scenario where the NF service consumer sends a request to the UDSF to retrieve a record that matches the provided recordId and optionally includes the query parameter supported-features.

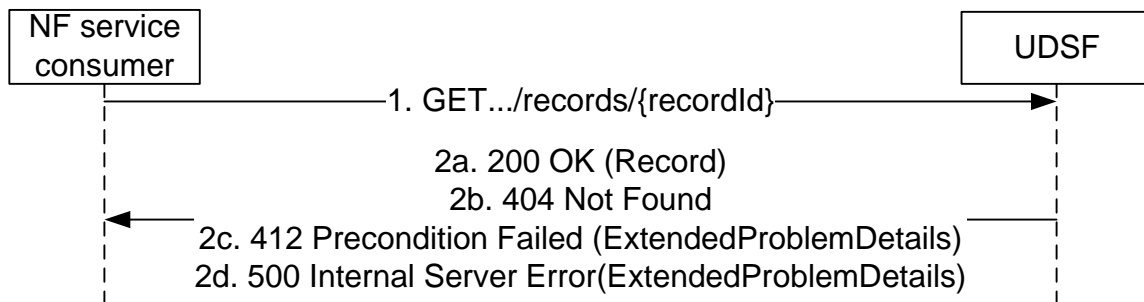

Figure 5.2.2.2.2-1: Requesting a Record

1. The NF service consumer (any NF) sends a GET request to the resource indicated by recordId.
- 2a. On success, the UDSF responds with "200 OK" with the message body containing the record.
- 2b. If the record for the given recordId does not exist in the UDSF, the HTTP status code "404 Not Found" shall be returned optionally including additional error information in the response body (in the ProblemDetails element).
- 2c. If one or more conditions in the given request header fields evaluated to false, the HTTP status code "412 Precondition Failed" shall be returned optionally including additional error information in the response body (in the ExtendedProblemDetails element). The UDSF may include the stored record in the ProblemDetailsExtension.
- 2d. If the request header fields did not include any preconditions (i.e. "if-*"), the HTTP status code "500 Internal Server Error" may be returned optionally including additional error information in the response body (in the ExtendedProblemDetails element). The UDSF may include the stored record in the ProblemDetailsExtension.

On failure, the appropriate HTTP status code indicating the error shall be returned and appropriate additional error information should be returned in the GET response body.

5.2.2.2.3 Meta Retrieval

Figure 5.2.2.2.3-1 shows a scenario where the NF service consumer sends a request to the UDSF to retrieve meta data associated with the provided recordId and optionally includes the query parameter supported-features.

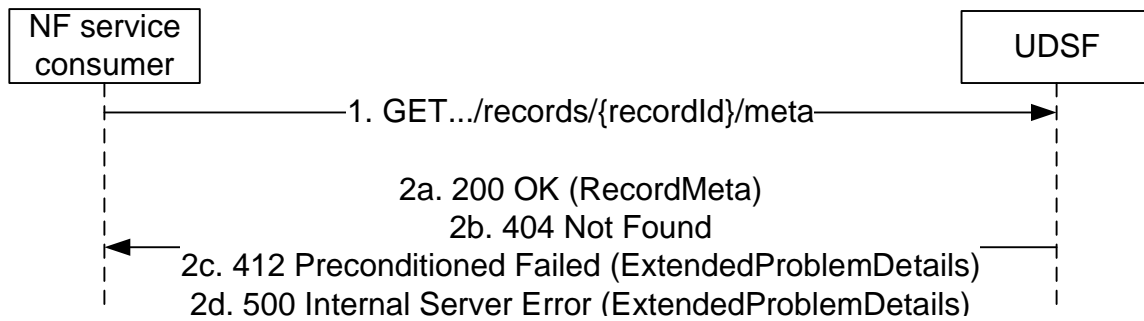

Figure 5.2.2.3-1: Requesting Meta for a Record

1. The NF service consumer (any NF) sends a GET request to the meta resource associated with the record indicated by recordId.
- 2a. On success, the UDSF responds with "200 OK" with the message body containing the RecordMeta.
- 2b. If the record for the given recordId and thus the RecordMeta does not exist in the UDSF, the HTTP status code "404 Not Found" shall be returned optionally including additional error information in the response body (in the ProblemDetails element).
- 2c. If one or more conditions in the given request header fields evaluated to false, the HTTP status code "412 Precondition Failed" shall be returned optionally including additional error information in the response body (in the ExtendedProblemDetails element). The UDSF may include the stored record in the ProblemDetailsExtension.
- 2d. If the request header fields did not include any preconditions (i.e. "if-*"), the HTTP status code "500 Internal Server Error" may be returned optionally including additional error information in the response body (in the ExtendedProblemDetails element). The UDSF may include the stored record in the ProblemDetailsExtension.

On failure, the appropriate HTTP status code indicating the error shall be returned and appropriate additional error information should be returned in the GET response body.

5.2.2.2.4 Blocks Retrieval

Figure 5.2.2.2.4-1 shows a scenario where the NF service consumer sends a request to the UDSF to retrieve (all) the blocks associated with the provided recordId and optionally includes the query parameter supported-features.

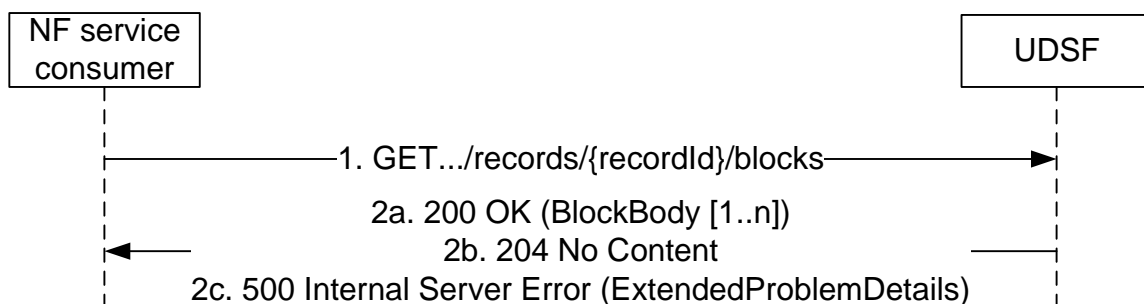

Figure 5.2.2.2.4-1: Requesting Blocks

1. The NF service consumer (any NF) sends a GET request to the resource indicated by recordId.
- 2a. On success, the UDSF responds with "200 OK" with the message body containing the Blocks associated with the record.
- 2b. If a Block for the given recordId does not exist in the UDSF, the HTTP status code "204 No Content" shall be returned.
- 2c. If the request header fields did not include any preconditions (i.e. "if-*"), the HTTP status code "500 Internal Server Error" may be returned optionally including additional error information in the response body (in the ExtendedProblemDetails element). The UDSF may include the stored record in the ProblemDetailsExtension.

On failure, the appropriate HTTP status code indicating the error shall be returned and appropriate additional error information should be returned in the GET response body.

5.2.2.2.5 Block Retrieval

Figure 5.2.2.2.5-1 shows a scenario where the NF service consumer sends a request to the UDSF to retrieve a single block associated with the provided recordId and blockId and optionally includes the query parameter supported-features.

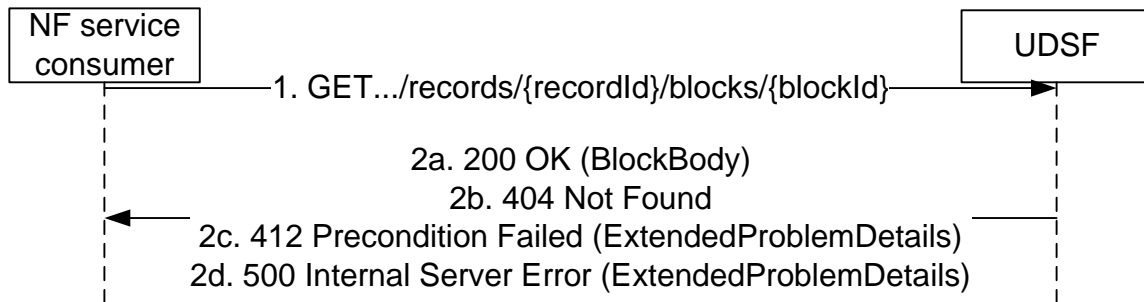

Figure 5.2.2.2.5-1: Requesting a Block

1. The NF service consumer (any NF) sends a GET request to the resource indicated by recordId and blockId.
- 2a. On success, the UDSF responds with "200 OK" with the message body containing the Block associated with the blockId.
- 2b. If the Block for the given recordId and blockId does not exist in the UDSF, the HTTP status code "404 Not Found" shall be returned optionally including additional error information in the response body (in the ProblemDetails element).
- 2c. If one or more conditions in the given request header fields evaluated to false, the "412 Precondition Failed" shall be returned optionally including additional error information in the response body (in the ExtendedProblemDetails element). The UDSF may include the stored record in the ProblemDetailsExtension.
- 2d. If the request header fields did not include any preconditions (i.e. "if-*"), the HTTP status code "500 Internal Server Error" may be returned optionally including additional error information in the response body (in the ExtendedProblemDetails element). The UDSF may include the stored record in the ProblemDetailsExtension.

On failure, the appropriate HTTP status code indicating the error shall be returned and appropriate additional error information should be returned in the GET response body.

5.2.2.2.6 Search

Figure 5.2.2.2.6-1 shows a scenario where the NF service consumer sends a request to the UDSF to search a record that matches the provided search criteria.

The request contains the query parameters filter and optionally supported-features, limit-range, and count-indicator.

- If the CombinedSearchRetrieve feature is supported may contain the query parameters retrieve-records and max-payload-size.
- If the BulkOperations feature is supported, the query parameter filter may contain a list of record IDs identifying the records to be retrieved.
- If the AdvancedCounting feature is supported, the query parameter tag-count-filter may be present instead of filter.

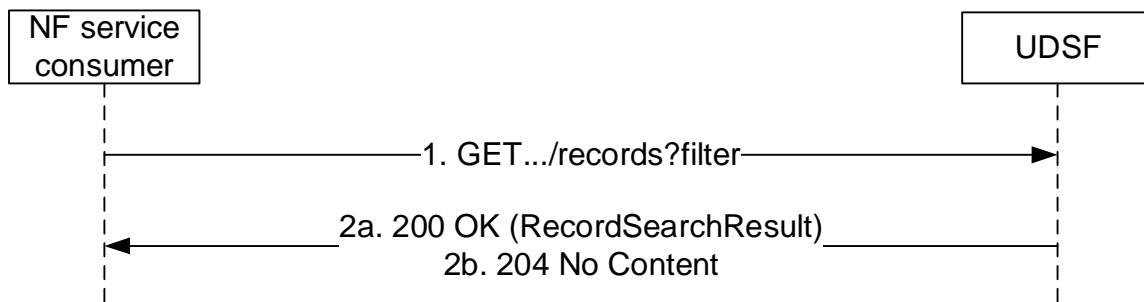

Figure 5.2.2.2.6-1: Searching for Records

1. The NF service consumer (any NF) sends a GET request to the Records resource with the filter query parameter indicating the search criteria.
- 2a. On success, the UDSF responds with "200 OK" with the message body containing the RecordSearchResult.
- 2b. If the UDSF is not able to return any record for the given search criteria, the HTTP status code "204 No Content" shall be returned.

On failure, the appropriate HTTP status code indicating the error shall be returned and appropriate additional error information should be returned in the GET response body.

5.2.2.2.7 Subscriptions Retrieval

Figure 5.2.2.2.7-1 shows a scenario where the NF service consumer sends a request to the UDSF to retrieve all subscriptions associated with the provided storageId and optionally includes the query parameter supported-features and limit-range.

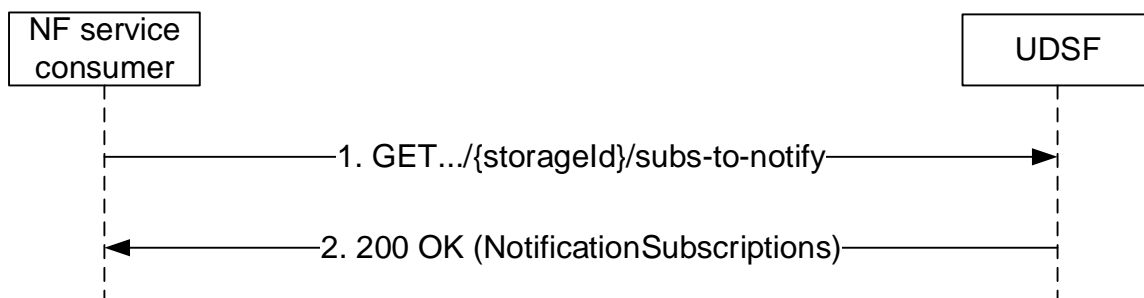

Figure 5.2.2.2.7-1: Requesting Subscriptions

1. The NF service consumer (any NF) sends a GET request to the resource indicated by the storageId.
2. On success, the UDSF responds with "200 OK" with the message body containing the NotificationSubscriptions associated with the storageId (if any).

On failure, the appropriate HTTP status code indicating the error shall be returned and appropriate additional error information should be returned in the GET response body.

5.2.2.2.8 Individual Subscription Retrieval

Figure 5.2.2.2.8-1 shows a scenario where the NF service consumer sends a request to the UDSF to retrieve a subscription associated with the provided storageId and subscriptionId.

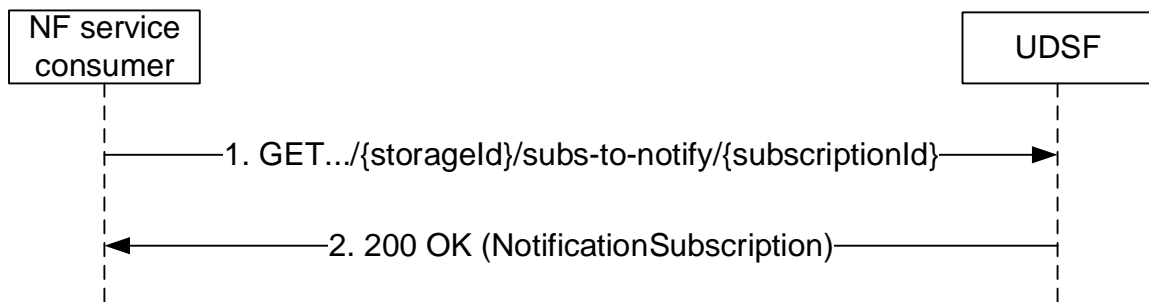

Figure 5.2.2.2.8-1: Requesting an Individual Subscription

1. The NF service consumer (any NF) sends a GET request to the resource indicated by the storageId and the subscriptionId.

2a. On success, the UDSF responds with "200 OK" with the message body containing the NotificationSubscription.

On failure, the appropriate HTTP status code indicating the error shall be returned and appropriate additional error information should be returned in the GET response body.

5.2.2.2.9 Meta Schema Retrieval

Figure 5.2.2.2.9-1 shows a scenario where the NF service consumer sends a request to the UDSF to retrieve a meta schema that matches the provided schemaId and optionally includes the query parameter supported-features.

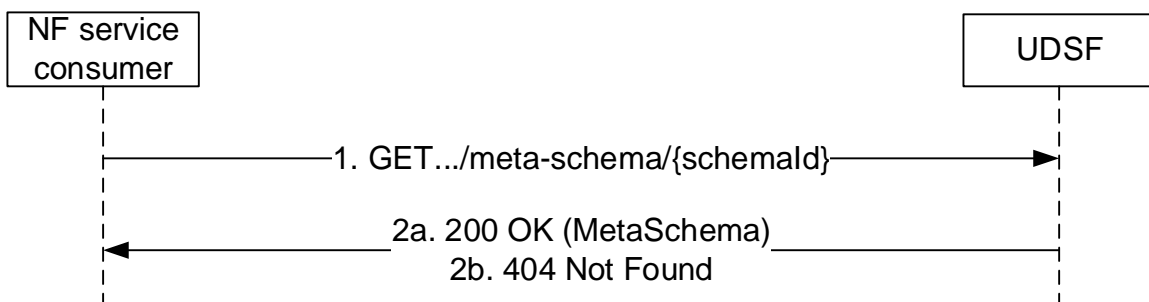

Figure 5.2.2.2.9-1: Requesting a Meta Schema

1. The NF service consumer (any NF) sends a GET request to the resource indicated by schemaId.

2a. On success, the UDSF responds with "200 OK" with the message body containing the meta schema.

2b. If the meta schema for the given schemaId does not exist in the UDSF, the HTTP status code "404 Not Found" shall be returned optionally including additional error information in the response body (in the ProblemDetails element).

On failure, the appropriate HTTP status code indicating the error shall be returned and appropriate additional error information should be returned in the GET response body.

5.2.2.3 Create

5.2.2.3.1 General

The following procedures using the Create service operation are supported:

- Record Create

- Block Create
- Meta Schema Create

5.2.2.3.2 Record Create

Figure 5.2.2.3.2-1 shows a scenario where the NF service consumer sends a request to the UDSF to create a record with the provided recordId.

The request contains the recordId and optionally the query parameters supported-features and get-previous.

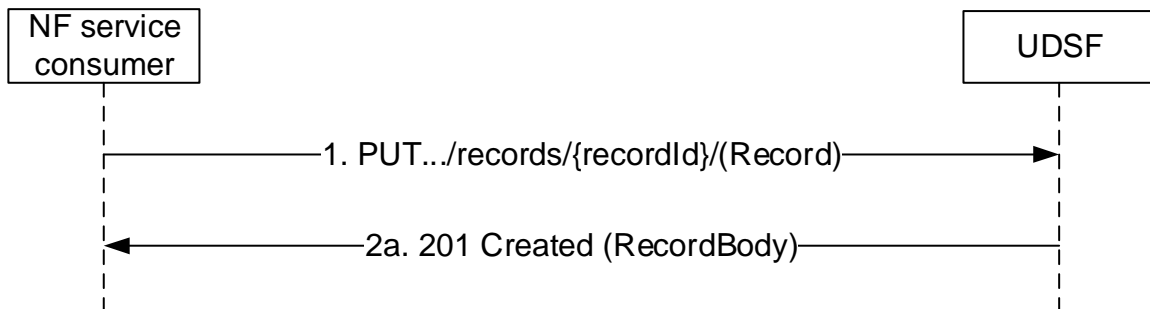

Figure 5.2.2.3.2-1: Create a Record

1. The NF service consumer (any NF) sends a PUT request to create the resource indicated by recordId. The request body contains the meta, zero or more blocks. The record meta information is mandatory and shall be the first part and the remaining parts of the request body (if any) shall be child blocks. If the record meta information is received with record expiry details, UDSF shall create an implicit subscription locally and notify the NF service consumer on record expiry.
- 2a. On success, "201 Created" shall be returned, the content of the PUT response should contain the representation of the created resource, and the "Location" header shall be present and shall contain the URI of the created resource.

On failure, the appropriate HTTP status code indicating the error shall be returned and appropriate additional error information should be returned in the PUT response body.

5.2.2.3.3 Block Create

Figure 5.2.2.3.3-1 shows a scenario where the NF service consumer sends a request to the UDSF to create a block with the provided blockId.

The request contains the blockid and optionally the query parameters supported-features and get-previous.

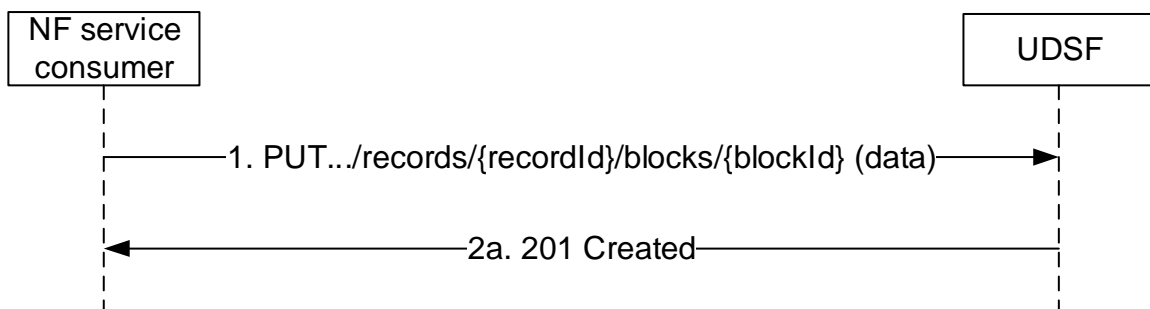

Figure 5.2.2.3.3-1: Create a Block

1. The NF service consumer (any NF) sends a PUT request to create the resource indicated by blockId.

- 2a. On success, "201 Created" shall be returned, the content of the PUT response should contain the representation of the created resource, and the "Location" header shall be present and shall contain the URI of the created resource.

On failure, the appropriate HTTP status code indicating the error shall be returned and appropriate additional error information should be returned in the PUT response body.

5.2.2.3.4 Meta Schema Create

Figure 5.2.2.3.4-1 shows a scenario where the NF service consumer sends a request to the UDSF to create a meta schema with the provided schemaId.

The request contains the schemaId and optionally the query parameters supported-features and get-previous.

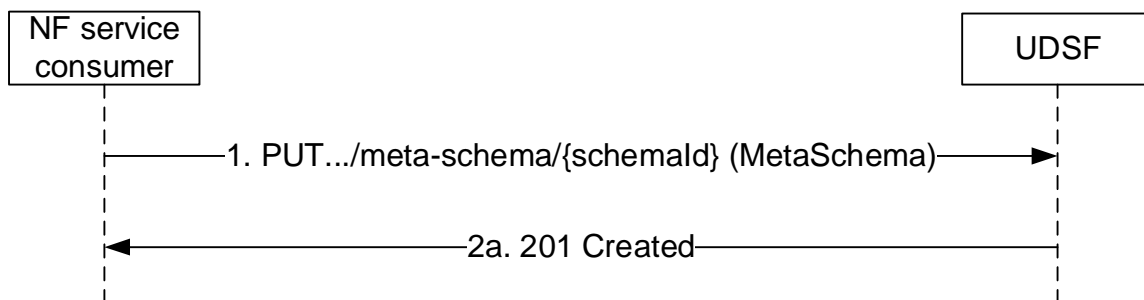

Figure 5.2.2.3.4-1: Create a Meta Schema

1. The NF service consumer (any NF) sends a PUT request to create the resource indicated by schemaId. The request body contains the meta schema.
- 2a. On success, "201 Created" shall be returned, the content of the PUT response should contain the representation of the created resource, and the "Location" header shall be present and shall contain the URI of the created resource.

On failure, the appropriate HTTP status code indicating the error shall be returned and appropriate additional error information should be returned in the PUT response body.

5.2.2.4 Update

5.2.2.4.1 General

The following procedures using the Update service operation are supported:

- Record Update
- Block Update
- Meta Update
- Subscription Notification Update
- Meta Schema Update

5.2.2.4.2 Record Update

Figure 5.2.2.4.2-1 shows a scenario where the NF service consumer sends a request to the UDSF to update a record with the provided recordId.

The request contains the recordId and optionally the query parameters supported-features and get-previous.

The update shall include meta, zero or more blocks. The record meta information shall be the first part and is mandatory and the remaining parts of the body (if any) shall be interpreted as child blocks. Existing record, meta and blocks shall be discarded and the new record, meta and blocks (if any) shall be created.

NOTE: The order of the returned blocks in the response is not guaranteed and can be different from the order used to create them.

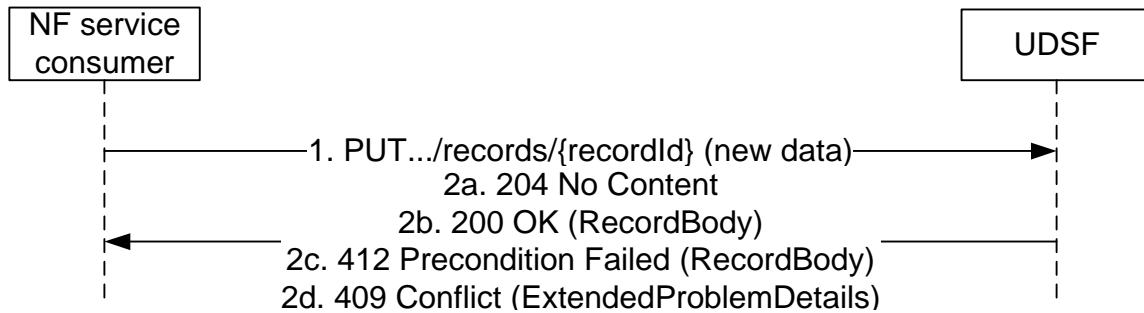

Figure 5.2.2.4.2-1: Update a record

1. The NF service consumer shall send a PUT request to the resource representing the record that is to be updated, and may include meta, zero or more blocks. The record meta information is mandatory and shall be the first part and the remaining parts of the request body (if any) shall be child blocks. An existing record, i.e., meta and blocks shall be discarded and the new record, meta and blocks (if any) shall be created.
- 2a. On success, the UDSF shall respond with "204 No Content" if no record is returned, i.e. the get-previous query parameter was not included in the request.
- 2b. On success, the UDSF shall respond with "200 OK" if a record is returned, i.e. the get-previous query parameter was included in the request, or due to operator's policy, the ttl value in the request exceeded the maximum value allowed.
- 2c. On failure, the UDSF shall respond with "412 Precondition Failed" if one or more conditions given in the request header fields evaluated to false. The RecordBody shall include the stored Record if the get-previous query parameter was included in the request.
- 2d. On failure, the UDSF may respond with "409 Conflict" if the request fields did not include any preconditions (i.e. "if-*"), optionally including additional error information in the response body (in the ExtendedProblemDetails element). The UDSF may include the stored record in the ProblemDetailsExtension.

On failure, the appropriate HTTP status code indicating the error shall be returned and appropriate additional error information should be returned in the PUT response body.

5.2.2.4.3 Block Update

Figure 5.2.2.4.3-1 shows a scenario where the NF service consumer sends a request to the UDSF to update a block with the provided blockId.

The request contains the recordId, blockId and the optional query parameters supported-features, get-previous and the data that is to be updated.

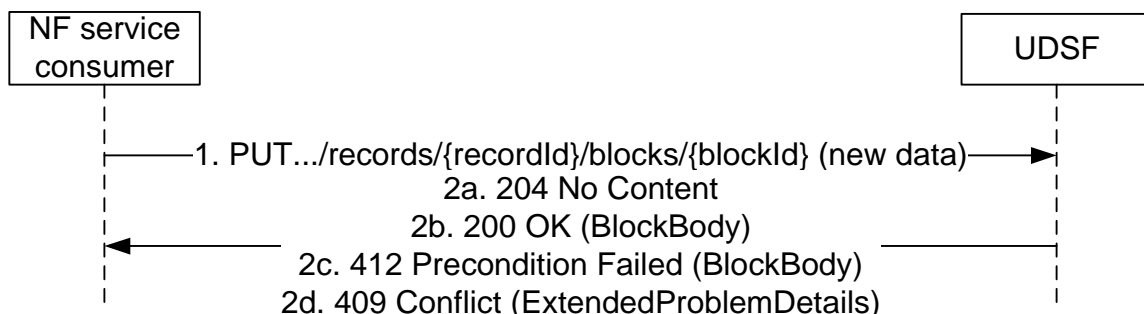

Figure 5.2.2.4.3-1: Update a block

1. The NF service consumer shall send a PUT request to the resource representing the block that is to be updated.

- 2a. On success, the UDSF shall respond with "204 No Content" if no record is returned, i.e. the get-previous query parameter was not included in the request.
- 2b. On success, the UDSF shall respond with "200 OK" if a record is returned, i.e. the get-previous query parameter was included in the request.
- 2c. On failure, the UDSF shall respond with "412 Precondition Failed" if one or more conditions given in the request header fields evaluated to false. The BlockBody shall be included with the stored Block if the get-previous query parameter was included in the request.
- 2d. On failure, the UDSF may respond with "409 Conflict" if the request fields did not include any preconditions (i.e. "if-*"), optionally including additional error information in the response body (in the ExtendedProblemDetails element). The UDSF may include the stored record in the ProblemDetailsExtension.

On failure, the appropriate HTTP status code indicating the error shall be returned and appropriate additional error information should be returned in the PUT response body.

5.2.2.4.4 Meta Update

Figure 5.2.2.4.4-1 shows a scenario where the NF service consumer sends a request to the UDSF to update the meta data associated with the provided recordId and optionally the query parameter supported-features and the data that is to be updated.

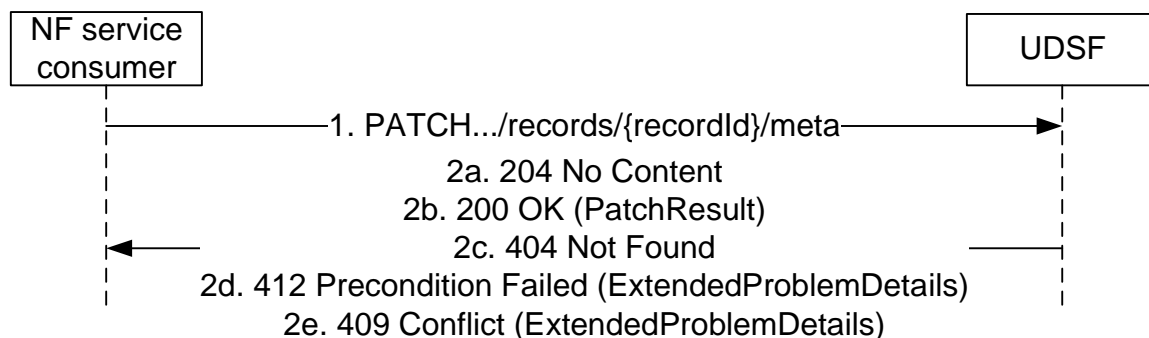

Figure 5.2.2.4.4-1: Update meta

- 1. The NF service consumer shall send a PATCH request to the resource representing the meta of the record.
- 2a. On success, if all the modification instructions in the PATCH request have been implemented, the UDSF shall respond with "204 No Content".
- 2b. On partial success, i.e. if one or more modification instructions have been discarded, "200 OK" with the execution report, shall be returned.
- 2c. On failure, the UDSF shall respond with "404 Not Found" if the record indicated by the recordId and thus the meta does not exist and may shall include the ProblemDetails.
- 2d. On failure, the UDSF shall respond with "412 Precondition Failed" if one or more conditions given in the request header fields evaluated to false, and optionally including additional error information in the response body (in "ExtendedProblemDetails" element). The UDSF may include the meta of the stored record in the ProblemDetailsExtension.
- 2e. On failure, the UDSF may respond with "409 Conflict" if the request fields did not include any preconditions (i.e. "if-*") and optionally including additional error information in the response body (in "ExtendedProblemDetails" element). The UDSF may include the meta of the stored record in the ProblemDetailsExtension.

On failure, the appropriate HTTP status code indicating the error shall be returned and appropriate additional error information should be returned in the PUT response body.

5.2.2.4.5 Subscription Notification Update

Figure 5.2.2.4.5-1 shows a scenario where the NF service consumer sends a request to the UDSF to update the Individual Subscription Notification identified with the storageId and subscriptionId and optionally the query parameter supported-features and the data that is to be updated.

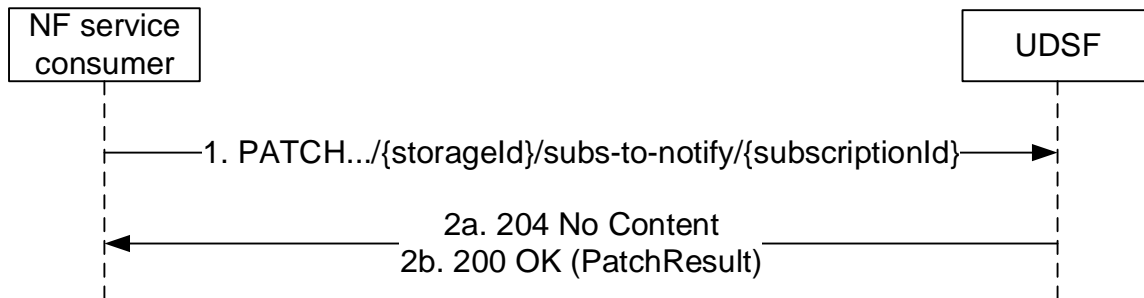

Figure 5.2.2.4.5-1: Update Subscription Notification

1. The NF service consumer shall send a PATCH request to the resource representing the subscriptionId.
- 2a. On success, if all the modification instructions in the PATCH request have been implemented, the UDSF shall respond with "204 No Content".
- 2b. On partial success, i.e. if one or more modification instructions have been discarded, "200 OK" with the execution report, shall be returned.

On failure, the appropriate HTTP status code indicating the error shall be returned and appropriate additional error information should be returned in the PATCH response body.

5.2.2.4.6 Subscription Notification Update using PUT

Figure 5.2.2.4.6-1 shows a scenario where the NF service consumer sends a request to the UDSF to update a subscription to notifications of data change using PUT. The request contains the subscriptionId and the NotificationSubscription and optionally the query parameter supported-features.

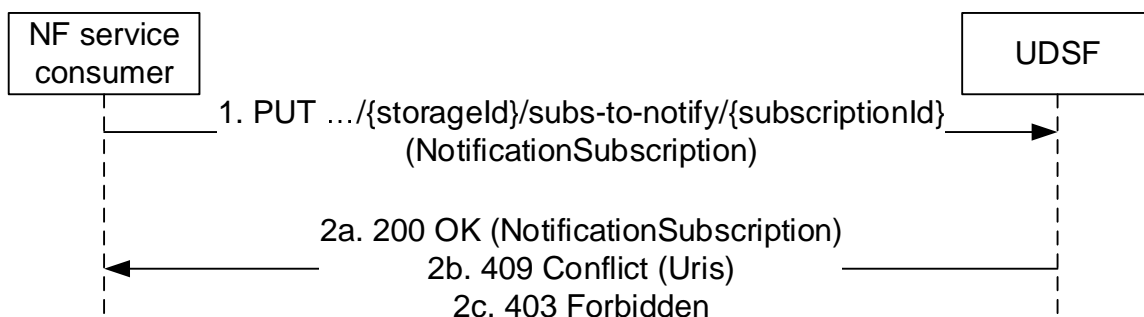

Figure 5.2.2.4.6-1: NF service consumer updates subscription to notifications

1. The NF service consumer sends a PUT request to the NF resource indicated by the storageId and the subscriptionId. The parameter clientId shall be included. If the resource indicated in URI exists and was created by the Client identified by the clientId, the UDSF shall apply the update of the subscription.
- 2a. On success, the UDSF shall respond with "200 OK" and include the updated NotificationSubscription. The expiry attribute of the received NotificationSubscription may indicate a value or a value different from the request, if due to an operator policy, an expiry time is enforced or if the value in the request exceeded a maximum allowed expiry time.
- 2b. On failure, if one or more monitoredResourceUris from the request don't exist in the UDSF, 409 Conflict shall be returned together with the non-existing monitoredResourceUris.

- 2c. On failure, if the service operation cannot be authorized due to e.g. the resource indicated in URI exists but the clientId in the PUT request does not match the clientId of the existing resource, the UDSF shall respond with "403 Forbidden" and optionally including additional error information in the response body (in "ProblemDetails" element).

On failure, the appropriate HTTP status code indicating the error shall be returned and appropriate additional error information should be returned in the PUT response body.

5.2.2.4.7 Meta Schema Update

Figure 5.2.2.4.7-1 shows a scenario where the NF service consumer sends a request to the UDSF to update a meta schema with the provided schemaId.

The request contains the schemaId, the complete new meta schema and optionally the query parameters supported-features and get-previous.

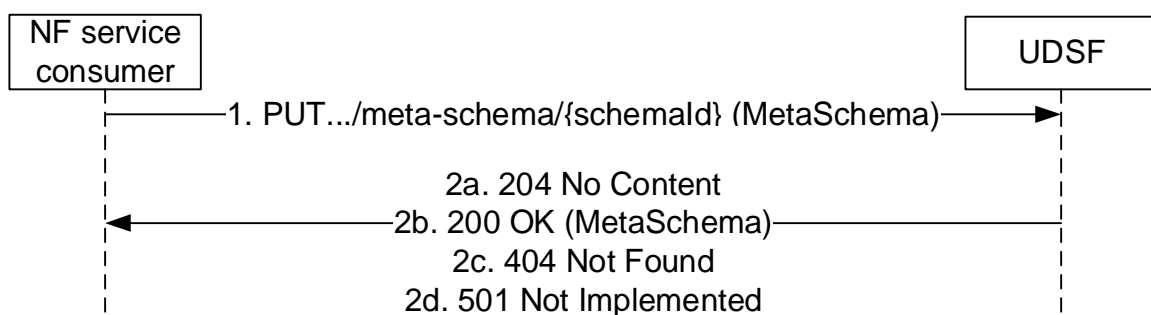

Figure 5.2.2.4.7-1: Update a meta schema

1. The NF service consumer shall send a PUT request to the resource representing the record that is to be updated, the request body shall include the complete new meta schema.
- 2a. On success, the UDSF shall respond with "204 No Content" if no meta schema is returned, i.e. the get-previous query parameter was not included in the request.
- 2b. On success, the UDSF shall respond with "200 OK" if a meta schema is returned, i.e. the get-previous query parameter was included in the request.
- 2c. On failure, the UDSF shall respond with "404 Not Found" if realm or storage does not exist.
- 2d. On failure, the UDSF shall respond with "501 Not Implemented" if meta schema update is not implemented by the UDSF.

On failure, the appropriate HTTP status code indicating the error shall be returned and appropriate additional error information should be returned in the PUT response body.

5.2.2.4.8 Record Partial Update

Figure 5.2.2.4.8-1 shows a scenario where the NF service consumer sends a request to the UDSF to update the parts of a record with the provided recordId and optionally the query parameter supported-features and the data that is to be updated.

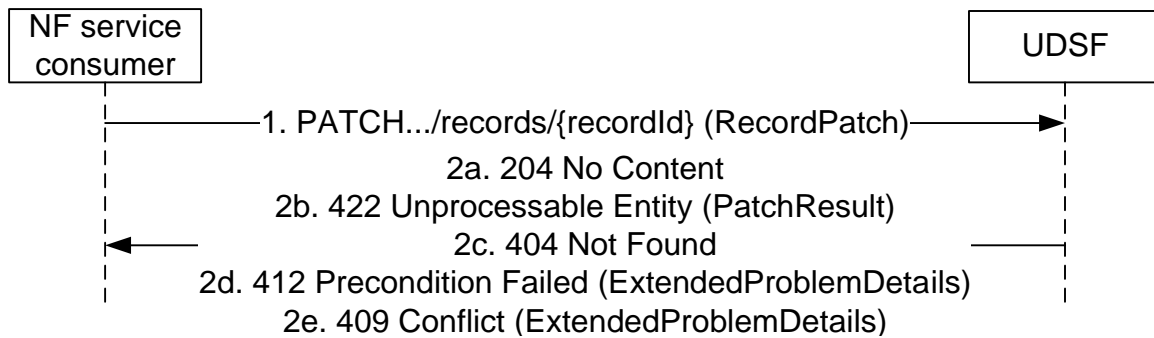

Figure 5.2.2.4.8-1: Update record partially

1. The NF service consumer shall send a PATCH request to the resource representing the record that is to be updated.
- 2a. On success, if all the modification instructions in the PATCH request have been implemented, the UDSF shall respond with "204 No Content".
- 2b. If one or more modification instructions cannot be applied, no changes shall be made to record, the UDSF shall return "422 Unprocessable Entity" with the execution report.
- 2c. If the record for the given recordId does not exist in the UDSF, the HTTP status code "404 Not Found" shall be returned. Additional error information may be included in the response body (in the ProblemDetails element).
- 2d. If one or more conditions in the request header fields evaluated to false, the HTTP status code "412 Precondition Failed" shall be returned. Additional error information may be returned in the response body (in ExtendedProblemDetails element). The UDSF may include the stored record in the ProblemDetailsExtension.
- 2e. If the request header fields did not include any preconditions (i.e. "if-*"), the HTTP status code "409 Conflict" may be returned if request is inservicable due to record being in a bad state. Additional error information may be returned in the response body (in ExtendedProblemDetails element). The UDSF may include the stored record in the ProblemDetailsExtension.

On failure, the appropriate HTTP status code indicating the error shall be returned and appropriate additional error information should be returned in the PATCH response body.

5.2.2.5 Delete

5.2.2.5.1 General

The following procedures using the Delete service operation are supported:

- Record Delete
- Block Delete
- Meta Schema Delete
- Bulk Records Delete

5.2.2.5.2 Record Delete

Figure 5.2.2.5.2-1 shows a scenario where the NF service consumer sends a request to the UDSF to Delete a record with the provided recordId.

The request contains the record id and optionally the query parameters supported-features and get-previous.

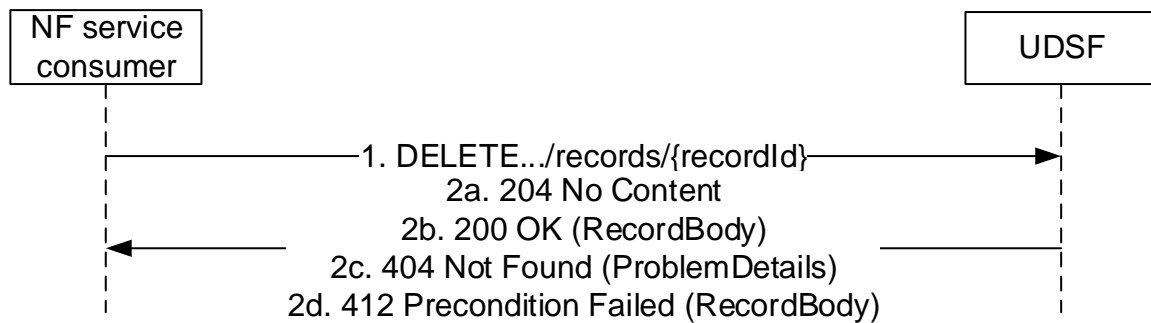

Figure 5.2.2.5.2-1: Delete a record

1. The NF service consumer shall send a DELETE request to the resource representing the record. The UDSF shall delete any resource associated with the resource (meta and block(s)).
- 2a. On success, the UDSF shall respond with "204 No Content" if no record is returned, i.e. the get-previous query parameter was not included in the request.
- 2b. On success, the UDSF shall respond with "200 OK" if a record is returned, i.e. the get-previous query parameter was included in the request.
- 2c. On failure, the UDSF shall respond with "404 Not Found" if the record does not exist and may include the ProblemDetails.
- 2d. On failure, the UDSF shall respond with "412 Precondition Failed" if one or more conditions given in the request header fields evaluated to false and the get-previous query parameter was included in the request. The RecordBody shall be included if the get-previous query parameter was included in the request.

On failure, the appropriate HTTP status code indicating the error shall be returned and appropriate additional error information should be returned in the DELETE response body.

5.2.2.5.3 Block Delete

Figure 5.2.2.5.3-1 shows a scenario where the NF service consumer sends a request to the UDSF to Delete a block with the provided blockId.

The request contains the recordId, blockId and optionally the query parameters supported-features and get-previous.

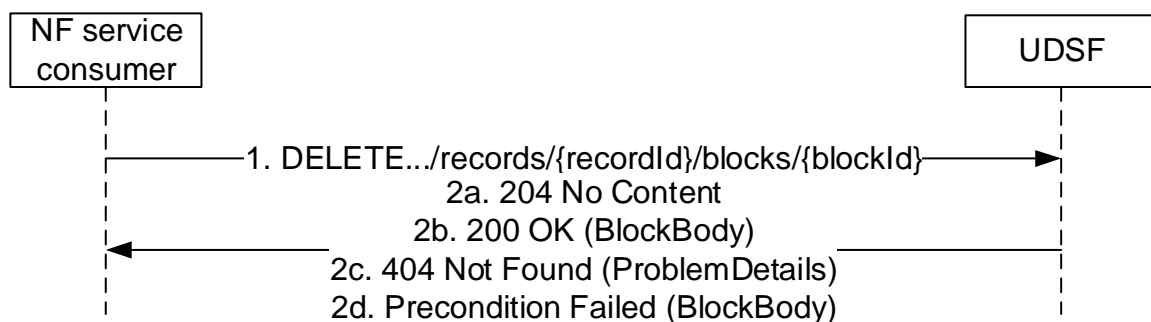

Figure 5.2.2.5.3-1: Delete a block

1. The NF service consumer shall send a DELETE request to the resource representing the block.
- 2a. On success, the UDSF shall respond with "204 No Content" if no block is returned, i.e. the get-previous query parameter was not included in the request.
- 2b. On success, the UDSF shall respond with "200 OK" if a block is returned, i.e. the get-previous query parameter was included in the request.
- 2c. On failure, the UDSF shall respond with "404 Not Found" if the block does not exist and may include the ProblemDetails.

2d. On failure, the UDSF shall respond with "412 Precondition Failed" if one or more conditions given in the request header fields evaluated to false. The BlockBody shall be included if the get-previous query parameter was included in the request.

On failure, the appropriate HTTP status code indicating the error shall be returned and appropriate additional error information should be returned in the DELETE response body.

5.2.2.5.4 Meta Schema Delete

Figure 5.2.2.5.4-1 shows a scenario where the NF service consumer sends a request to the UDSF to Delete a meta schema with the provided schemaId.

The request contains the schemaId and optionally the query parameters supported-features and get-previous.

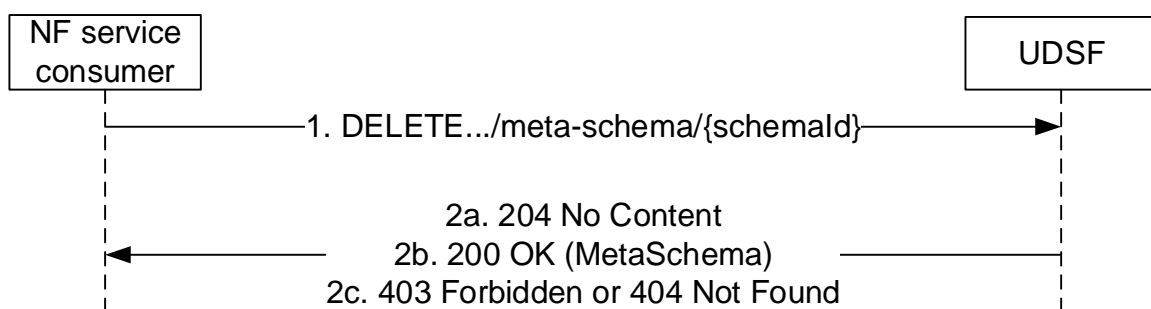

Figure 5.2.2.5.4-1: Delete a meta schema

1. The NF service consumer shall send a DELETE request to the resource representing the meta schema.
- 2a. On success, the UDSF shall respond with "204 No Content" if no meta schema is returned, i.e. the get-previous query parameter was not included in the request.
- 2b. On success, the UDSF shall respond with "200 OK" if a meta schema is returned, i.e. the get-previous query parameter was included in the request.
- 2c. On failure, the UDSF shall respond with "404 Not Found" if the meta schema does not exist or "403 Forbidden" if the meta schema is still referenced by existing records, and may include the ProblemDetails.

On failure, the appropriate HTTP status code indicating the error shall be returned and appropriate additional error information should be returned in the DELETE response body.

5.2.2.5.5 Bulk Records Delete

Figure 5.2.2.5.5-1 shows a scenario where the NF service consumer sends a request to the UDSF to Delete records identified by a filter.

The request contains the query parameter filter and optionally the query parameter supported-features.

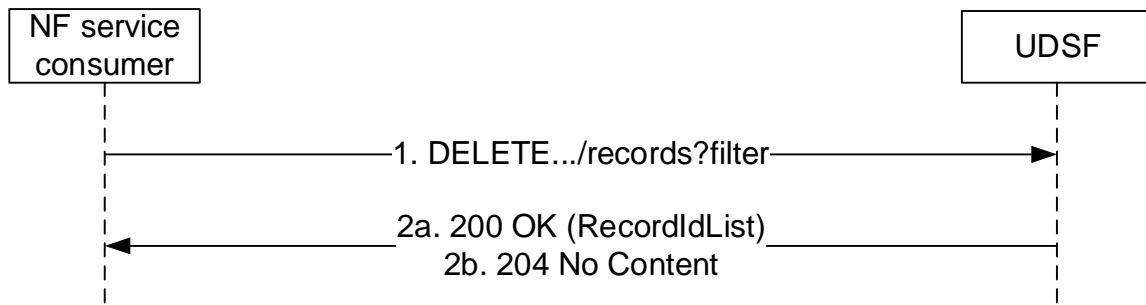

Figure 5.2.2.5.5-1: Delete records matching a filter

1. The NF service consumer shall send a DELETE request to the resource representing the records. The request shall contain a filter query parameter identifying the records to be deleted. The UDSF shall delete any resource associated with the matching records (meta and block(s)). To delete all records and any associated resources the filter query parameter shall consist of SearchComparison with a value of "GTE" for the ComparisonOperator, defined in table 6.1.6.3.3-1.

2a. On success, the UDSF shall respond with "200 OK" with the message body containing the RecordIdList identifying the deleted records.

2b. The UDSF shall respond with "204 No Content" if no records matching the filter could be found.

On failure, the appropriate HTTP status code indicating the error shall be returned and appropriate additional error information should be returned in the DELETE response body.

5.2.2.6 Notify

5.2.2.6.1 General

The following procedures using the Notify service operation are supported:

- Record Expiry Notify
- Notification due to Data Change
- Subscription Expiry Notification

5.2.2.6.2 Record Expiry Notify

Figure 5.2.2.6.2-1 shows a scenario where the UDSF notifies the NF service consumer of the expired record.

The Notify is sent by the UDSF to the NF Service Consumer when the record expires as indicated by the time to live (ttl) attribute of RecordMeta.

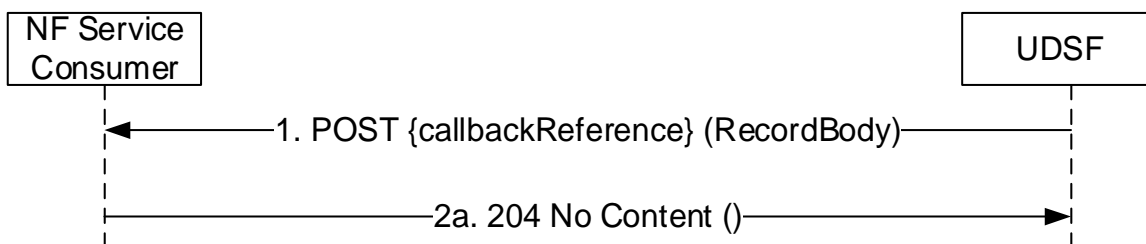

Figure 5.2.2.6.2-1: Record Expiry Notify

1. The UDSF shall send a POST request to the callback URI. The request shall contain the record details.

2a. On success, "204 No content" shall be returned by the NF Service Consumer to UDSF.

On failure, the appropriate HTTP status code indicating the error shall be returned and appropriate additional error information should be returned in the POST response body.

5.2.2.6.3 Notification due to Data Change

Figure 5.2.2.6.3-1 shows a scenario where the UDSF notifies the NF service consumer of a change to data associated with a block or a record triggered by one or more a Subscription to Notification.

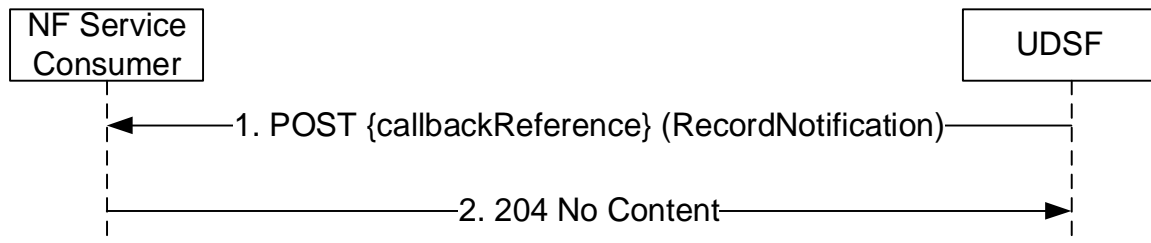

Figure 5.2.2.6.3-1: Notification due to Data Change

1. The UDSF shall send a POST request to the callback URI. The request shall contain the RecordNotification details.
2. On success, "204 No content" shall be returned by the NF Service Consumer to UDSF.

On failure, the appropriate HTTP status code indicating the error shall be returned and appropriate additional error information should be returned in the POST response body.

5.2.2.6.4 Subscription Expiry Notification

Figure 5.2.2.6.4-1 shows a scenario where the UDSF notifies the NF service consumer of an expired subscription to data change.

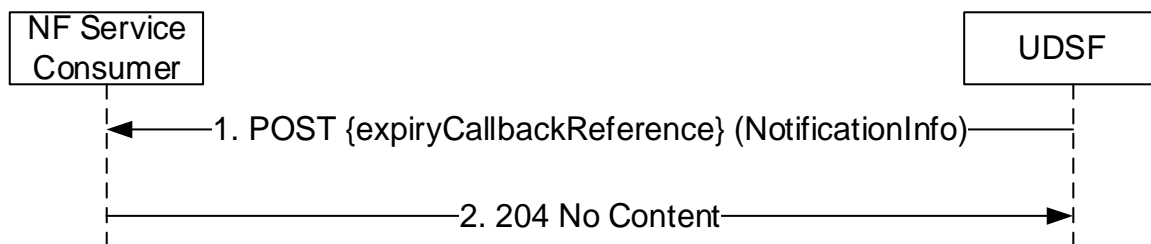

Figure 5.2.2.6.4-1: Subscription Expiry Notification

1. The UDSF shall send a POST request to the expiryCallbackReference URI. The request shall contain the NotificationInfo.
2. On success, "204 No content" shall be returned by the NF Service Consumer to UDSF.

On failure, the appropriate HTTP status code indicating the error shall be returned and appropriate additional error information should be returned in the POST response body.

5.2.2.7 Subscribe

5.2.2.7.1 General

The following procedures using the Subscribe service operation are supported:

- Subscription to notification of data change

5.2.2.7.2 Subscription to notifications of data change

Figure 5.2.2.7.2-1 shows a scenario where the NF service consumer sends a request to the UDSF to subscribe to notifications of data change. The request contains the subscriptionId, the NotificationSubscription and optionally the query parameter supported-features.

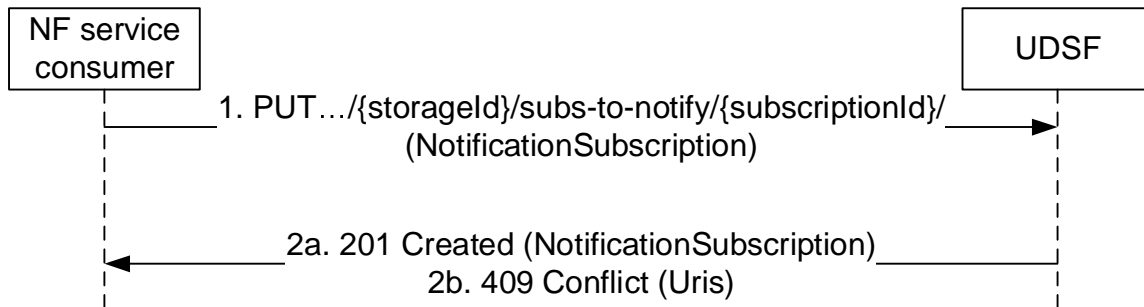

Figure 5.2.2.7.2-1: NF service consumer subscribes to notifications

1. The NF service consumer sends a PUT request to the resource indicated by the storageId and the subscriptionId. The parameter clientId shall be included. If the resource indicated in URI doesn't exist, the UDSF shall trigger the creation of the subscription.
- 2a. On success, the UDSF responds with "201 Created" with the message body containing the NotificationSubscription. The expiry attribute of the received NotificationSubscription may indicate a value or a value different from the request, if due to an operator policy, an expiry time is enforced or if the value in the request exceeded a maximum allowed expiry time.
- 2b. On failure, if one or more monitoredResourceUris from the request don't exist in the UDSF, 409 Conflict shall be returned together with the non-existing monitoredResourceUris.

On failure, the appropriate HTTP status code indicating the error shall be returned and appropriate additional error information should be returned in the PUT response body.

5.2.2.8 Unsubscribe

5.2.2.8.1 General

The following procedures using the Unsubscribe service operation are supported:

- Unsubscription to notification of data change

5.2.2.8.2 Unsubscription to notifications of data change

Figure 5.2.2.8.2-1 shows a scenario where the NF service consumer sends a request to the UDSF to Unsubscribe to notifications of data change. The request contains the subscriptionId, and query parameter client-id, optionally query parameters supported-features and get-previous.

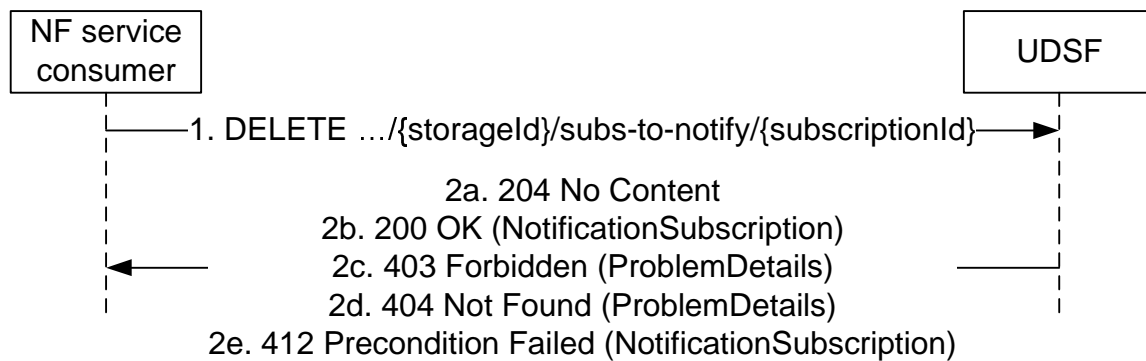

Figure 5.2.2.8.2-1: NF service consumer unsubscribes to notifications

1. The NF service consumer sends a DELETE request to the resource representing the subscription to notification of data change which is indicated by the subscriptionId.
- 2a. On success, the UDSF shall respond with "204 No Content" if an empty response body is returned, i.e. the get-previous query parameter was not included in the request.
- 2b. On success, the UDSF shall respond with "200 OK" with NotificationSubscription containing the NotificationSubscription value before the delete if get-previous was indicated in the request.
- 2c. If the service operation cannot be authorized due to e.g. the client-id query parameter does not match the clientId of the existing resource, the UDSF shall respond with "403 Forbidden" with including additional error information in the response body (in "ProblemDetails" element).
- 2d. If there is no valid subscription to notification of data change which is indicated by the request, the UDSF shall respond with "404 Not Found" with including additional error information in the response body (in "ProblemDetails" element).
- 2e. If one or more conditions given in the request header fields evaluated to false, the UDSF shall respond with "412 Precondition Failed". NotificationSubscription shall be included in the response if get-previous was indicated in the request.

On failure, the appropriate HTTP status code indicating the error shall be returned and appropriate additional error information should be returned in the PUT response body.

5.3 Nudsf_Timer Service

5.3.1 Service Description

The UDSF is acting as an NF Service Producer. It provides UDSF timer service to the NF service consumer. Any NF may use the UDSF to run timers, search for timers, and get notifications on expiry.

5.3.2 Service Operations

5.3.2.1 Introduction

For the Nudsf_Timer service, the following service operations are defined:

- Start
- Update
- Stop
- Search
- Notify

5.3.2.2 Start

5.3.2.2.1 General

The following procedures using the Start service operation are supported:

- Timer Start

5.3.2.2.2 Timer Start

Figure 5.3.2.2.2-1 shows a scenario where the NF service consumer sends a request to the UDSF to start a (new or existing) timer identified by the provided timerId.

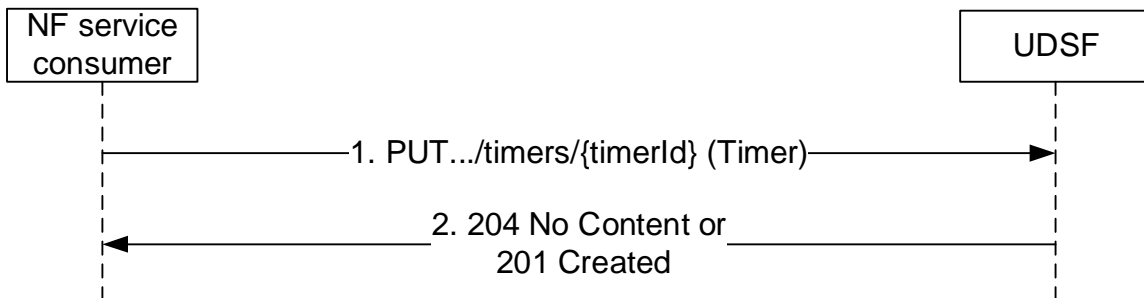

Figure 5.3.2.2.2-1: Starting a Timer

1. The NF service consumer (any NF) sends a PUT request to the resource indicated by timerId.
2. On success, the UDSF responds with "204 No Content" or "201 Created".

On failure, the appropriate HTTP status code indicating the error shall be returned and appropriate additional error information should be returned in the PUT response body.

5.3.2.3 Update

5.3.2.3.1 General

The following procedures using the Update service operation are supported:

- Timer Update

5.3.2.3.2 Timer Update

Figure 5.3.2.3.2-1 shows a scenario where the NF service consumer sends a request to the UDSF to update an existing timer identified by the provided timerId.

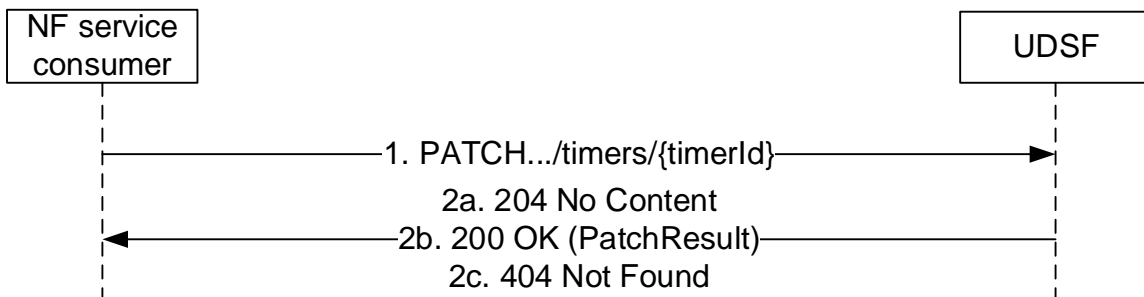

Figure 5.3.2.3.2-1: Modifying a Timer

1. The NF service consumer (any NF) sends a PATCH request to the resource indicated by timerId.

- 2a. On success, if all the modification instructions in the PATCH request have been implemented, the UDSF shall respond with "204 No Content".
- 2b. On partial success, i.e. if one or more modification instructions have been discarded, "200 OK" with the execution report, shall be returned.
- 2c. On failure, the UDSF shall respond with "404 Not Found" if the timer indicated by the timerId does not exist and may include the ProblemDetails.

On failure, the appropriate HTTP status code indicating the error shall be returned and appropriate additional error information should be returned in the PATCH response body.

5.3.2.4 Stop

5.3.2.4.1 General

The following procedures using the Stop service operation are supported:

- Single Timer Stop
- Multiple Timer Stop

5.3.2.4.2 Single Timer Stop

Figure 5.3.2.4.2-1 shows a scenario where the NF service consumer sends a request to the UDSF to stop an existing timer identified by the provided timerId.

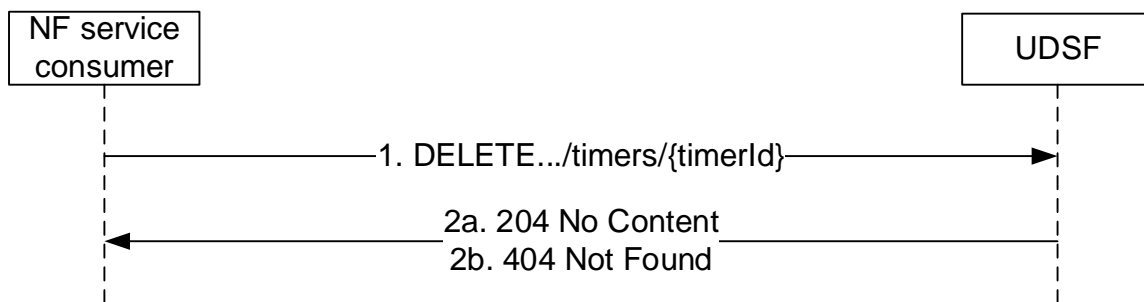

Figure 5.3.2.4.2-1: Stopping a single Timer

1. The NF service consumer (any NF) sends a DELETE request to the resource indicated by timerId.
- 2a. On success, the UDSF shall respond with "204 No Content".
- 2b. On failure, the UDSF shall respond with "404 Not Found" if the timer does not exist and may include the ProblemDetails.

On failure, the appropriate HTTP status code indicating the error shall be returned and appropriate additional error information should be returned in the DELETE response body.

5.3.2.4.3 Multiple Timer Stop

Figure 5.3.2.4.3-1 shows a scenario where the NF service consumer sends a request to the UDSF to stop all timers matching a provided filter.

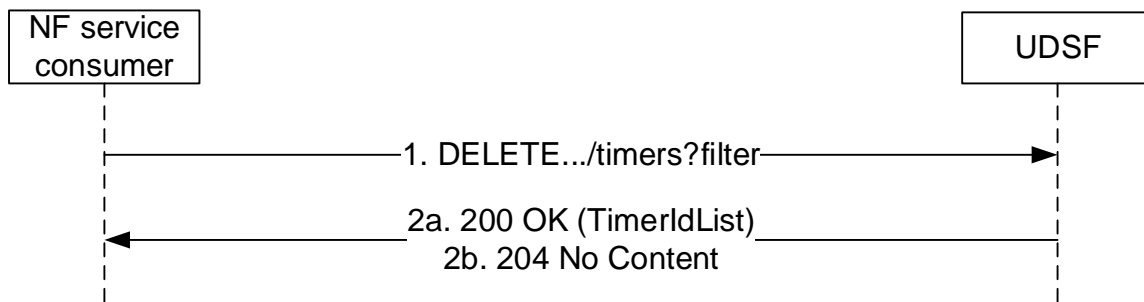

Figure 5.3.2.4.3-1: Stopping multiple Timers

1. The NF service consumer (any NF) sends a DELETE request to the timers resource containing a filter Query Parameter.
- 2a. On success, the UDSF shall respond with "200 OK" with a message body containing the list of stopped timers.
- 2b. The UDSF shall respond with "204 No Content" if no timers matching the filter could be found.

On failure, the appropriate HTTP status code indicating the error shall be returned and appropriate additional error information should be returned in the DELETE response body.

5.3.2.5 Search

5.3.2.5.1 General

The following procedures using the Search service operation are supported:

- Expired Timer Search
- Tagged Timer Search

5.3.2.5.2 Expired Timer Search

Figure 5.3.2.5.2-1 shows a scenario where the NF service consumer sends a request to the UDSF to search for expired timers matching a provided expired-filter.

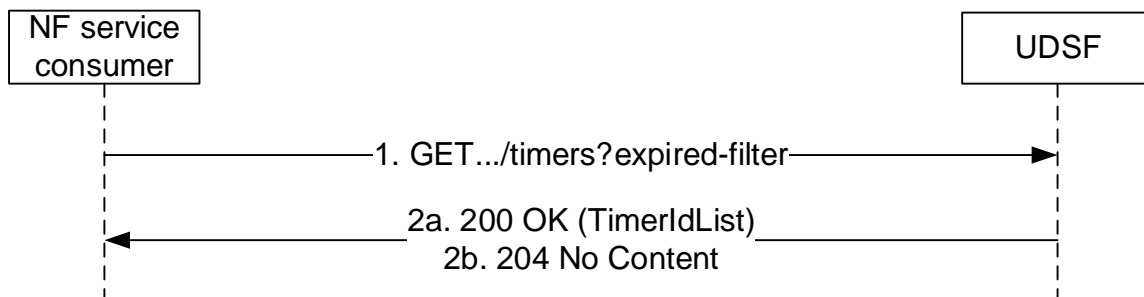

Figure 5.3.2.5.2-1: Searching for expired Timers

1. The NF service consumer (any NF) sends a GET request to the timers resource containing an expired-filter Query Parameter.
- 2a. On success, the UDSF shall respond with "200 OK" with a message body containing the list of expired timers matching the expired-filter.
- 2b. The UDSF shall respond with "204 No Content" if no timers matching the filter could be found.

On failure, the appropriate HTTP status code indicating the error shall be returned and appropriate additional error information should be returned in the GET response body.

5.3.2.5.3 Tagged Timer Search

Figure 5.3.2.5.3-1 shows a scenario where the NF service consumer sends a request to the UDSF to search for tagged timers matching a provided filter.

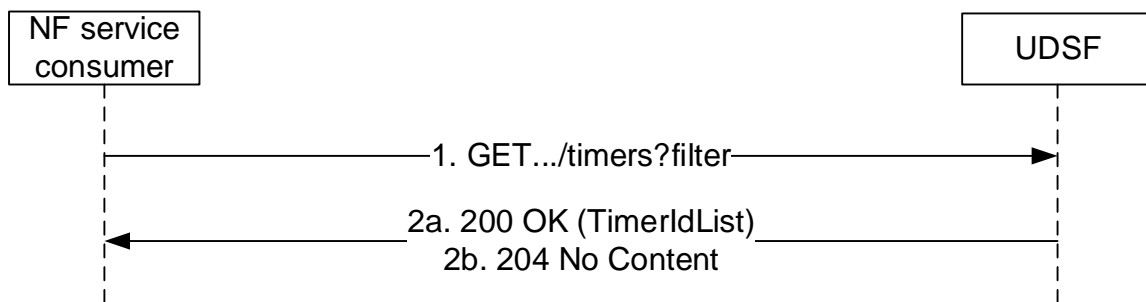

Figure 5.3.2.5.3-1: Searching for tagged Timers

1. The NF service consumer (any NF) sends a GET request to the timers resource containing a filter Query Parameter.
- 2a. On success, the UDSF shall respond with "200 OK" with a message body containing the list of tagged timers matching the filter.
- 2b. The UDSF shall respond with "204 No Content" if no timers matching the filter could be found.

On failure, the appropriate HTTP status code indicating the error shall be returned and appropriate additional error information should be returned in the GET response body.

5.3.2.6 Notify

5.3.2.6.1 General

The following procedures using the Notify service operation are supported:

- Timer Expiry Notify

5.3.2.6.2 Timer Expiry Notify

Figure 5.3.2.6.2-1 shows a scenario where the UDSF notifies the NF service consumer of the expired timer.

The Notify is sent by the UDSF to the NF Service Consumer when the timer expires as indicated by the expires attribute of the Timer.

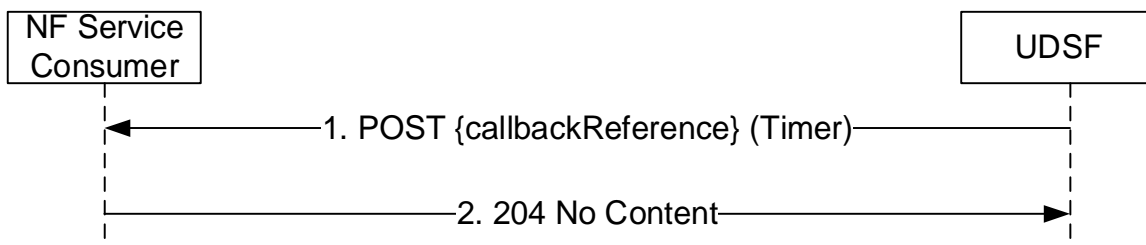

Figure 5.3.2.6.2-1: Timer Expiry Notify

1. The UDSF shall send a POST request to the callback URI. The request shall contain the timer that has expired.
2. On success, "204 No content" shall be returned by the NF Service Consumer to UDSF.

On failure, the appropriate HTTP status code indicating the error shall be returned and appropriate additional error information should be returned in the POST response body.

6 API Definitions

6.1 Nudsf_DataRepository Service API

6.1.1 Introduction

The Nudsf_DataRepository service shall use the Nudsf_DataRepository API.

The API URI of the Nudsf_DataRepository API shall be:

{apiRoot}/<apiName>/<apiVersion>/

The request URI used in HTTP requests from the NF service consumer towards the NF service producer shall have the Resource URI structure defined in clause 4.4.1 of 3GPP TS 29.501 [5], i.e.:

{apiRoot}/<apiName>/<apiVersion>/<apiSpecificResourceUriPart>

with the following components:

- The {apiRoot} shall be set as described in 3GPP TS 29.501 [5].
- The <apiName> shall be "nudsf-dr".
- The <apiVersion> shall be "v1".
- The <apiSpecificResourceUriPart> shall be set as described in clause 6.1.3.

6.1.2 Usage of HTTP

6.1.2.1 General

HTTP/2, IETF RFC 9113 [11], shall be used as specified in clause 5 of 3GPP TS 29.500 [4].

HTTP/2 shall be transported as specified in clause 5.3 of 3GPP TS 29.500 [4].

The OpenAPI [6] specification of HTTP messages and content bodies for the Nudsf_DataRepository API is contained in Annex A.

6.1.2.2 HTTP standard headers

6.1.2.2.1 General

See clause 5.2.2 of 3GPP TS 29.500 [4] for the usage of HTTP standard headers.

6.1.2.2.2 Content type

The following content types shall be supported:

- JSON, IETF RFC 8259 [12], shall be used as content type of the HTTP bodies specified in the present specification as specified in clause 5.4 of 3GPP TS 29.500 [4]. The use of the JSON format shall be signalled by the content type "application/json".
- "Problem Details" JSON object shall be used to indicate additional details of the error in a HTTP response body and shall be signalled by the content type "application/problem+json", as defined in IETF RFC 9457 [13].

- JSON Patch (IETF RFC 6902 [14]). The use of the JSON Patch format in a HTTP request body shall be signalled by the content type "application/json-patch+json".

Multipart messages shall also be supported possibly indicating other content-types as described in clause 6.1.2.4.

6.1.2.2.3 Cache-Control

As described in IETF RFC 9111 [17] clause 5.2, a "Cache-Control" header should be included in HTTP responses carrying a representation of cacheable resources. If it is included, it shall contain a "max-age" value, indicating the amount of time in seconds after which the received response is considered stale.

The "max-age" value shall be configurable by operator policy.

6.1.2.2.4 ETag

As described in IETF RFC 9110 [15] clause 8.8.3, an "ETag" (entity-tag) header should be included in HTTP responses carrying a representation of cacheable or modifiable resources to allow an NF Service Consumer performing a conditional GET request with an "If-None-Match" header or a conditional PUT/PATCH/DELETE request with an "If-Match" header. If it is included, it shall contain a server-generated strong validator, that allows further matching of this value (included in subsequent client requests) with a given resource representation stored in the server or in a cache.

6.1.2.2.5 If-None-Match

As described in IETF RFC 9110 [15] clause 13.1.2, an NF Service Consumer may issue conditional GET or PUT requests towards UDSF by including an "If-None-Match" header in HTTP requests containing one or several entity tags received in previous responses for the same resource.

If the If-None-Match header is included with the PUT method, it shall be used with a value of "*" to prevent the inadvertent modification of an existing representation of the target resource when the client believes that the resource does not have a current representation.

6.1.2.2.6 If-Match

As described in IETF RFC 7232 [15] clause 13.1.1, an NF Service Consumer may issue conditional PUT/PATCH/DELETE request towards UDSF by including an "If-Match" header in HTTP requests containing an entity tag received in previous responses for the same resource.

6.1.2.2.7 Last-Modified

As described in IETF RFC 9110 [15] clause 8.8.2, a "Last-Modified" header should be included in HTTP responses carrying a representation of cacheable resources to allow an NF Service Consumer performing a conditional request with "If-Modified-Since" header.

6.1.2.2.8 If-Modified-Since

As described in IETF RFC 9110 [15] clause 13.1, an NF Service Consumer may issue conditional GET request towards UDSF, by including an "If-Modified-Since" header in HTTP requests.

6.1.2.2.9 When to Use Entity-Tags and Last-Modified Dates

Both "ETag" and "Last-Modified" headers should be sent in the same HTTP response as stated in IETF RFC 9110 [15] clause 15.3.1.

NOTE: "ETag" is a stronger validator than the "Last-Modified" and is preferred.

If the UDSF included an "ETag" header with the resource then a conditional GET request for this resource shall be performed with the "If-None-Match" header, and a PUT/PATCH/DELETE request for this resource shall be performed with the "If-Match" header.

6.1.2.2.10 Content-Location

As described in IETF RFC 9110 [15] clause 8.7, the UDSF shall include the Content-Location header set to the URI of the expired Record when sending a Notification to an NF Consumer.

6.1.2.3 HTTP custom headers

The mandatory HTTP custom header fields specified in clause 5.2.3.2 of 3GPP TS 29.500 [4] shall be applicable.

6.1.2.4 HTTP multipart messages

6.1.2.4.1 General

HTTP multipart messages shall be supported to transfer the opaque Record and Block Information in the following service operations (and HTTP messages):

- Record (PUT/GET/DELETE)
- BlockCollection (GET)
- RecordNotification (POST)
- RecordPatch (PATCH)

NOTE: In the clauses below, this specification deviates in the definition of the Content-Id header from IETF RFC 2045 [20] in that there is no need for the Content-Id to be "world unique", as in this specification the Content-Id is only required to be unique within the context of a Record, BlockCollection, RecordNotification or RecordPatch.

6.1.2.4.2 Record

The Record is encoded as an HTTP multipart message with the multipart/mixed content-type as described in IETF RFC 2046 [21].

The boundary parameter is used to delimit each part (Start of parts to RecordMeta, RecordMeta to Block, Block to Block and Block to End of parts) and shall be set to a value as in accordance with IETF RFC 2046 [21].

The RecordMeta part shall be the first part, and shall always be present. It shall include a Content-Id header that may be set to an unquoted value of "meta" or any other suitable value, for example as described in IETF RFC 2045 [20], the Content-Type (see IETF RFC 2045 [20]) header set to "application/json" and include JSON content for the RecordMeta.

Zero or more Block parts may follow the RecordMeta Part. For each Block part in the HTTP multipart/mixed message, the Block part shall include a Content-Id header identifying the Block with the value of the blockId, a Content-Type (see IETF RFC 2045 [20]) header indicating the MIME type of the Block (any value), e.g. application/octet-stream, application/json or another applicable MIME type and the Content-Transfer-Encoding (see IETF RFC 2045 [20]) header with an appropriate value.

6.1.2.4.3 BlockCollection

The BlockCollection is encoded as an HTTP multipart message with the multipart/parallel content-type as described in IETF RFC 2046 [21].

The boundary parameter is used to delimit each part (Start of parts to Block, Block to Block and Block to End of parts) and shall be set to a value as in accordance with IETF RFC 2046 [21].

For the BlockCollection, zero or more Block parts may be included. For each Block part in the HTTP multipart/parallel message, the Block part shall include a Content-Id header identifying the Block with the value of the blockId, a Content-Type header indicating the MIME type of the Block (any value) e.g. application/octet-stream, application/json or another applicable MIME type and the Content-Transfer-Encoding (see IETF RFC 2045 [20]) header with an appropriate value.

6.1.2.4.4 RecordNotification

The RecordNotification is encoded as an HTTP multipart message with the multipart/mixed content-type as described in IETF RFC 2046 [21].

The boundary parameter is used to delimit each part (Start of parts to RecordNotification, RecordNotification to RecordMeta, RecordMeta to Block, Block to Block and Block to End of parts) and shall be set to a value in accordance with IETF RFC 2046 [21].

The RecordNotification shall be the first part, and shall always be present. It shall include a Content-Id header set to an unquoted value of "meta" or any other suitable value, for example as described in IETF RFC 2045 [20], the Content-Type (see IETF RFC 2045 [20]) header set to "application/json" and include JSON content for the NotificationDescription.

The RecordMeta part shall be the second part, and shall always be present. It shall include a Content-Id header set to an unquoted value of "meta" or any other suitable value, for example as described in IETF RFC 2045 [20], the Content-Type (see IETF RFC 2045 [20]) header set to "application/json" and include JSON content for the RecordMeta.

Zero or more Block parts may follow the RecordMeta Part. For each Block part in the HTTP multipart/mixed message, the Block part shall include a Content-Id header identifying the Block with the value of the blockId, a Content-Type (see IETF RFC 2045 [20]) header indicating the MIME type of the Block (any value), e.g. application/octet-stream, application/json or another applicable MIME type and the Content-Transfer-Encoding (see IETF RFC 2045 [20]) header with an appropriate value.

6.1.2.4.5 RecordPatch

A patch record request shall be a multipart request with content type as "multipart/mixed".

The first part of a multi-part request shall be an array of PatchItems and shall adhere to the JSON document structure defined in IETF RFC 6902 [14]. The Content-Id of the first part shall be "patch" and the content type shall be "application/json-patch+json".

PatchItems shall correspond to meta or blocks. When referring to meta attributes, all paths shall be JSON-Pointer values that start with "/meta". A Path referring to a new or existing block in a PatchItem shall be of the form "/blocks/{blockId}". A value for a block in a PatchItem shall contain the value of the "Content-Id" header that identifies a part in the multipart request. Content of the identified part shall be treated as the value of block in the PatchItem.

6.1.3 Resources

6.1.3.1 Overview

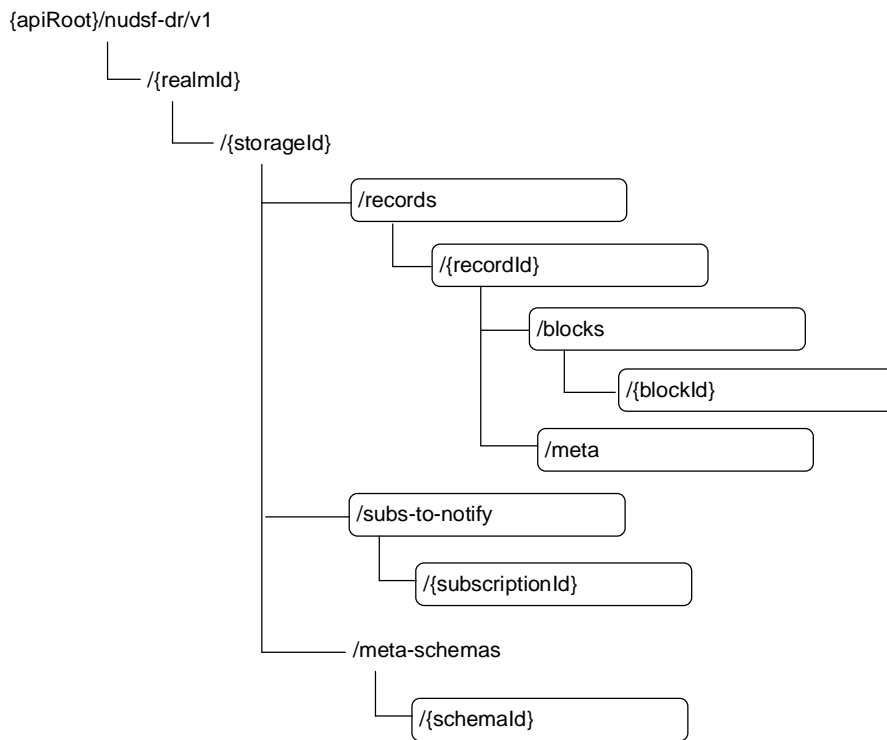

Figure 6.1.3.1-1: Resource URI structure of the nudsf-dr API

Table 6.1.3.1-1 provides an overview of the resources and applicable HTTP methods.

Table 6.1.3.1-1: Resources and methods overview

Resource name	Resource URI	HTTP method or custom operation	Description
RecordCollection (Collection)	/{realmId}/{storageId}/records	GET	Search for records
		DELETE	Delete records
Record (Document)	/{realmId}/{storageId}/records/{recordId}	GET	Retrieve a record
		PUT	Create or update a record
		PATCH	Modify parts of a record
		DELETE	Delete a record
Meta (Document)	/{realmId}/{storageId}/records/{recordId}/meta	GET	Retrieve the meta of a record
		PATCH	Modify the meta of a record
BlockCollection (Collection)	/{realmId}/{storageId}/records/{recordId}/blocks	GET	Retrieve all the blocks of a record
Block (Document)	/{realmId}/{storageId}/records/{recordId}/blocks/{blockId}	GET	Retrieve a block
		PUT	Create or update a block
		DELETE	Delete a block
NotificationSubscriptions (Collection)	/{realmId}/{storageId}/subs-to-notify	GET	Retrieve existing subscriptions
Individual NotificationSubscription (Document)	/{realmId}/{storageId}/subs-to-notify/{subscriptionId}	DELETE	Delete the subscription identified by {subscriptionId}, i.e. unsubscribe to notification for change of data
		PATCH	Update an individual Subscription to notification
		PUT	Create or update a subscription to notification,
		GET	Retrieve an individual Subscription to notification
Meta Schema (Document)	/{realmId}/{storageId}/meta-schemas/{schemald}	GET	Retrieve a Meta Schema
		PUT	Create or update a Meta Schema
		DELETE	Delete a Meta Schema

6.1.3.2 Resource: RecordCollection (Collection)

6.1.3.2.1 Description

This resource represents the collection of records within a storage. It can be used to search for specific records matching specific filter criteria.

6.1.3.2.2 Resource Definition

Resource URI: **{apiRoot}/nudsf-dr/<apiVersion>/{realmId}/{storageId}/records**

This resource shall support the resource URI variables defined in table 6.1.3.2.2-1.

Table 6.1.3.2.2-1: Resource URI variables for this resource

Name	Definition
apiRoot	See clause 6.1.1
realmId	Represents the realm Id.
storageId	Represents the storage Id.

6.1.3.2.3 Resource Standard Methods

6.1.3.2.3.1 GET

This method shall support the URI query parameters specified in table 6.1.3.2.3.1-1.

Table 6.1.3.2.3.1-1: URI query parameters supported by the GET method on this resource

Name	Data type	P	Cardinality	Description	Applicability
supported-features	SupportedFeatures	O	0..1	see 3GPP TS 29.500 [4] clause 6.6	
filter	SearchExpression	C	0..1	The filter criteria for searching the records of the storage. If the tag-count-filter query parameter is included, then this parameter shall not be included.	
limit-range	UInteger	C	0..1	When set, the returned response shall contain at the most the number of record references specified by the parameter value. If the count-indicator parameter is set in the request, this parameter shall be ignored.	
count-indicator	boolean	C	0..1	If this parameter is set, the number of records that matched the criteria shall be returned and no record references shall be returned. If the retrieve-records or tag-count-filter query parameters are included, then this parameter shall not be included.	
retrieve-records	RetrieveRecords	C	0..1	If this parameter is set, the content of records that matched the criteria shall be returned. If the count-indicator is set or the tag count-filter query parameter is included, then this parameter shall not be included.	CombinedSearch Retrieve
max-payload-size	UInteger	O	0..1	Maximum content size (before compression, if any) of the response, expressed in kilo octets. When present, the UDSF shall limit the number of Records or Meta returned in the response so as not to exceed the maximum content size indicated in the request.	CombinedSearch Retrieve
tag-count-filter	map(CountExpression)	C	1..N	The filter criteria for counting the records of the storage. If the tag-count-filter parameter is included, then the filter, count-indicator and retrieve-records parameters shall not be included. The key to the map is a unique string identifying the specific CountExpression.	AdvancedCounting

This method shall support the request data structures specified in table 6.1.3.2.3.1-2 and the response data structures and response codes specified in table 6.1.3.2.3.1-3.

Table 6.1.3.2.3.1-2: Data structures supported by the GET Request Body on this resource

Data type	P	Cardinality	Description
n/a			

Table 6.1.3.2.3.1-3: Data structures supported by the GET Response Body on this resource

Data type	P	Cardinality	Response codes	Description
RecordSearchResult	M	1	200 OK	The search result containing the record references matching the filter.
n/a			204 No Content	The search did not result in any matching record references.
NOTE: The mandatory HTTP error status code for the GET method listed in Table 5.2.7.1-1 of 3GPP TS 29.500 [4] also apply.				

6.1.3.2.3.2 DELETE

This method shall support the URI query parameters specified in table 6.1.3.2.3.2-1.

Table 6.1.3.2.3.2-1: URI query parameters supported by the DELETE method on this resource

Name	Data type	P	Cardinality	Description	Applicability
supported-features	SupportedFeatures	O	0..1	see 3GPP TS 29.500 [4] clause 6.6	
filter	SearchExpression	M	1	The filter criteria for identifying the records to be deleted. To delete all records, the SearchComparison shall use a value of "GTE" for the ComparisonOperator defined in table 6.1.6.3.3-1. The value of the "tag" shall be set to "".	BulkOperations

This method shall support the request data structures specified in table 6.1.3.2.3.2-2 and the response data structures and response codes specified in table 6.1.3.2.3.2-3.

Table 6.1.3.2.3.2-2: Data structures supported by the DELETE Request Body on this resource

Data type	P	Cardinality	Description
n/a			

Table 6.1.3.2.3.2-3: Data structures supported by the DELETE Response Body on this resource

Data type	P	Cardinality	Response codes	Description
n/a			204 No Content	The bulk deletion request did not result in any matching records to be deleted.
RecordIdList	M	1	200 OK	Contains the list of record IDs identifying the deleted records.
NOTE: The mandatory HTTP error status code for the DELETE method listed in Table 5.2.7.1-1 of 3GPP TS 29.500 [4] also apply.				

6.1.3.3 Resource: Record (Document)

6.1.3.3.1 Description

This resource represents a record within a storage.

6.1.3.3.2 Resource Definition

Resource URI: {apiRoot}/nudsf-dr/<apiVersion>/{realmId}/{storageId}/records/{recordId}

This resource shall support the resource URI variables defined in table 6.1.3.3.2-1.

Table 6.1.3.3.2-1: Resource URI variables for this resource

Name	Definition
apiRoot	See clause 6.1.1
realmId	Represents the realm Id where the record is stored
storageId	Represents the storage Id where the record is stored
recordId	Represents the record Id of the record

6.1.3.3.3 Resource Standard Methods

6.1.3.3.3.1 GET

This method shall support the URI query parameters specified in table 6.1.3.3.3.1-1.

Table 6.1.3.3.3.1-1: URI query parameters supported by the GET method on this resource

Name	Data type	P	Cardinality	Description	Applicability
supported-features	SupportedFeatures	O	0..1	see 3GPP TS 29.500 [4] clause 6.6.	

This method shall support the request data structures specified in table 6.1.3.3.3.1-2 and the response data structures and response codes specified in table 6.1.3.3.3.1-3.

Table 6.1.3.3.3.1-2: Data structures supported by the GET Request Body on this resource

Data type	P	Cardinality	Description
n/a			

Table 6.1.3.3.3.1-3: Data structures supported by the GET Response Body on this resource

Data type	P	Cardinality	Response codes	Description
RecordBody	M	1	200 OK	A response body containing the record.
ProblemDetails	O	0..1	404 Not Found	The "cause" attribute may be used to indicate one of the following application errors: -REALM_NOT_FOUND -STORAGE_NOT_FOUND -RECORD_NOT_FOUND
ExtendedProblemDetails	O	0..1	412 Precondition Failed	The "cause" attribute shall be set to the following application error: - INCORRECT_CONDITIONAL_GET_REQUEST The UDSF may include the stored record in the ProblemDetailsExtension.
ExtendedProblemDetails	O	0..1	500 Internal Server Error	The "cause" attribute may be set to the following application error: - DATABASE_INCONSISTENCY The UDSF shall include the stored record in the ProblemDetailsExtension if the cause is "DATABASE_INCONSISTENCY".
NOTE: The mandatory HTTP error status code for the GET method listed in Table 5.2.7.1-1 of 3GPP TS 29.500 [4] also apply.				

6.1.3.3.3.2 PUT

This method shall support the URI query parameters specified in table 6.1.3.3.3.2-1.

Table 6.1.3.3.3.2-1: URI query parameters supported by the PUT method on this resource

Name	Data type	P	Cardinality	Description	Applicability
supported-features	SupportedFeatures	O	0..1	see 3GPP TS 29.500 [4] clause 6.6	
get-previous	boolean	O	0..1	Request to return the previous record content if a record already exists in the targeted storage for the same record identifier.	

When creating or replacing the record, meta and zero or more blocks shall be included. The record meta information shall be the first part and is mandatory. The remaining parts of the body (if any) shall be the blocks to be updated or created. See clause 6.1.2.4 for details on the encoding.

If the operation updates an existing record, then the existing record and its blocks shall be discarded and replaced by the meta and blocks supplied with the request. This also applies to the case when no new blocks are included, i.e. the old blocks (if any) shall be deleted from the record.

This method shall support the request data structures specified in table 6.1.3.3.3.2-2 and the response data structures and response codes specified in table 6.1.3.3.3.2-3.

Table 6.1.3.3.3.2-2: Data structures supported by the PUT Request Body on this resource

Data type	P	Cardinality	Description
Record	M	1	The record that is to be created including meta and zero or more blocks.

Table 6.1.3.3.3.2-3: Data structures supported by the PUT Response Body on this resource

Data type	P	Cardinality	Response codes	Description
RecordBody	M	1	200 OK	Upon successful update of a record, a response body containing the previous record value (if get-previous was indicated in the request, and if one exists) will be returned
RecordBody	O	0..1	201 Created	Upon successful creation of a record, a response body of the created record shall be returned. If due to operator's policy the value of the ttl (if any) in the request exceeded a maximum allowed ttl value with the ttl set to the value applied by the UDSF.
n/a			204 No Content	Upon successful update of a record, an empty response is returned or if no previous record value was requested.
ProblemDetails	O	0..1	403 FORBIDDEN	If the UDSF (based on operator policy), determines to apply a ttl value of the recordMeta different from the ttl value (if any) of the request, the get-previous query-parameter is present in the request and the request applies to a record that already exists in the UDSF, the "cause" attribute shall be set to one of the following application errors: -TTL_VALUE_NOT_ALLOWED
ProblemDetails	O	0..1	404 Not Found	The "cause" attribute may be used to indicate one of the following application errors: -REALM_NOT_FOUND -STORAGE_NOT_FOUND
RecordBody	O	0..1	412 Precondition Failed	If one or more conditions given in the request header fields evaluated to false and get-previous was indicated in the request, the UDSF shall include the RecordBody in the response.
ExtendedProblemDetails	O	0..1	409 Conflict	The "cause" attribute may be set to the following application error: - DATABASE_INCONSISTENCY_PUT_REQUEST The UDSF shall include the stored record in the ProblemDetailsExtension if the cause is "DATABASE_INCONSISTENCY_PUT_REQUEST".
NOTE: The mandatory HTTP error status code for the PUT method listed in Table 5.2.7.1-1 of 3GPP TS 29.500 [4] also apply.				

6.1.3.3.3.3 DELETE

This method shall support the URI query parameters specified in table 6.1.3.3.3.3-1.

Table 6.1.3.3.3.3-1: URI query parameters supported by the DELETE method on this resource

Name	Data type	P	Cardinality	Description	Applicability
supported-features	SupportedFeatures	O	0..1	see 3GPP TS 29.500 [4] clause 6.6	
get-previous	boolean	O	0..1	Request to return the record content if a record exists in the targeted storage for the same record identifier.	

This method shall support the request data structures specified in table 6.1.3.3.3.3-2 and the response data structures and response codes specified in table 6.1.3.3.3.3-3.

Table 6.1.3.3.3.3-2: Data structures supported by the DELETE Request Body on this resource

Data type	P	Cardinality	Description
n/a			

Table 6.1.3.3.3-3: Data structures supported by the DELETE Response Body on this resource

Data type	P	Cardinality	Response codes	Description
RecordBody	O	0..1	200 OK	Upon success, and a response body containing the record value with meta and associated blocks (if any), if get-previous was indicated in the request.
n/a			204 No Content	Upon success and no response body containing the record was requested.
RecordBody	O	0..1	412 Precondition Failed	If one or more conditions given in the request header fields evaluated to false and get-previous was indicated in the request, the UDSF shall include the RecordBody in the response.
ProblemDetails	O	0..1	404 Not Found	The "cause" attribute may be used to indicate one of the following application errors: -REALM_NOT_FOUND -STORAGE_NOT_FOUND -RECORD_NOT_FOUND
NOTE: The mandatory HTTP error status code for the DELETE method listed in Table 5.2.7.1-1 of 3GPP TS 29.500 [4] also apply.				

6.1.3.3.4 PATCH

This method shall support the URI query parameters specified in table 6.1.3.3.4-1. This API is available if the PartialRecordUpdate feature is supported.

Table 6.1.3.3.4-1: URI query parameters supported by the PATCH method on this resource

Name	Data type	P	Cardinality	Description	Applicability
supported-features	SupportedFeatures	O	0..1	see 3GPP TS 29.500 [4] clause 6.6.	

This method shall support the request data structures specified in table 6.1.3.3.4-2 and the response data structures and response codes specified in table 6.1.3.3.4-3.

Table 6.1.3.3.4-2: Data structures supported by the PATCH Request Body on this resource

Data type	P	Cardinality	Description
RecordPatch	M	1	A collection of patch items to apply on the record along with block contents being referred to in patch items.

Table 6.1.3.3.4-3: Data structures supported by the PATCH Response Body on this resource

Data type	P	Cardinality	Response codes	Description
n/a			204 No Content	Upon successful modification, there is no body in the response message.
PatchResult	M	1	422 Unprocessable Entity	If one or more modification instructions cannot be applied, no changes shall be made to record, the execution report is returned.
ProblemDetails	O	0..1	404 Not Found	The "cause" attribute maybe used to indicate one of the following application errors: -REALM_NOT_FOUND -STORAGE_NOT_FOUND -RECORD_NOT_FOUND
ExtendedProblemDetails	O	0..1	412 Precondition Failed	The "cause" attribute shall be set to the following application error: - INCORRECT_CONDITIONAL_GET_REQUEST The UDSF shall include the Record in the ProblemDetailsExtension.
ExtendedProblemDetails	O	0..1	409 Conflict	The "cause" attribute may be set to the following application error: - DATABASE_INCONSISTENCY_PUT_REQUEST The UDSF shall include the Record in the ProblemDetailsExtension if the cause is "DATABASE_INCONSISTENCY_PUT_REQUEST".
NOTE 1: In addition common data structures as listed in table 6.1.7.3-1 are supported.				

6.1.3.4 Resource: Meta (Document)

6.1.3.4.1 Description

This resource represents the meta associated with a record.

6.1.3.4.2 Resource Definition

Resource URI: {apiRoot}/nudsf-dr/<apiVersion>/{realmId}/{storageId}/records/{recordId}/meta

This resource shall support the resource URI variables defined in table 6.1.3.4.2-1.

Table 6.1.3.4.2-1: Resource URI variables for this resource

Name	Definition
apiRoot	See clause 6.1.1
realmId	Represents the realm Id where the record is stored
storageId	Represents the storage Id where the record is stored
recordId	Represents the record Id of the record

6.1.3.4.3 Resource Standard Methods

6.1.3.4.3.1 GET

This method shall support the URI query parameters specified in table 6.1.3.4.3.1-1.

Table 6.1.3.4.3.1-1: URI query parameters supported by the GET method on this resource

Name	Data type	P	Cardinality	Description	Applicability
supported-features	SupportedFeatures	O	0..1	see 3GPP TS 29.500 [4] clause 6.6	

This method shall support the request data structures specified in table 6.1.3.4.3.1-2 and the response data structures and response codes specified in table 6.1.3.4.3.1-3.

Table 6.1.3.4.3.1-2: Data structures supported by the GET Request Body on this resource

Data type	P	Cardinality	Description
n/a			

Table 6.1.3.4.3.1-3: Data structures supported by the GET Response Body on this resource

Data type	P	Cardinality	Response codes	Description
RecordMeta	M	1	200 OK	A response body containing the record meta will be returned.
ProblemDetails	O	0..1	404 Not Found	The "cause" attribute shall be set to one of the following application errors: -REALM_NOT_FOUND -STORAGE_NOT_FOUND -RECORD_NOT_FOUND
Extended ProblemDetails	O	0..1	412 Precondition Failed	The "cause" attribute shall be set to the following application error: - INCORRECT_CONDITIONAL_GET_REQUEST The UDSF shall include the RecordMeta in the ProblemDetailsExtension.
Extended ProblemDetails	O	0..1	500 Internal Server Error	The "cause" attribute may be set to the following application error: - DATABASE_INCONSISTENCY The UDSF shall include the RecordMeta in the ProblemDetailsExtension if the cause is "DATABASE_INCONSISTENCY".
NOTE: The mandatory HTTP error status code for the GET method listed in Table 5.2.7.1-1 of 3GPP TS 29.500 [4] also apply.				

6.1.3.4.3.2 PATCH

This method shall support the URI query parameters specified in table 6.1.3.4.3.2-1.

Table 6.1.3.4.3.2-1: URI query parameters supported by the PATCH method on this resource

Name	Data type	P	Cardinality	Description	Applicability
supported-features	SupportedFeatures	O	0..1	see 3GPP TS 29.500 [4] clause 6.6	

This method shall support the request data structures specified in table 6.1.3.4.3.2-2 and the response data structures and response codes specified in table 6.1.3.4.3.2-3.

Table 6.1.3.4.3.2-2: Data structures supported by the PATCH Request Body on this resource

Data type	P	Cardinality	Description
array(patchItem)	M	1..N	A collection of patch items to apply on the record meta.

Table 6.1.3.4.3.2-3: Data structures supported by the PATCH Response Body on this resource

Data type	P	Cardinality	Response codes	Description
n/a			204 No Content	Upon successful modification, there is no body in the response message. (NOTE 2)
PatchResult	M	1	200 OK	If one or more modification instructions have been discarded, the execution report is returned. (NOTE 2)
ProblemDetails	O	0..1	404 Not Found	The "cause" attribute maybe used to indicate one of the following application errors: -REALM_NOT_FOUND -STORAGE_NOT_FOUND -RECORD_NOT_FOUND
ExtendedProblemDetails	O	0..1	412 Precondition Failed	The "cause" attribute shall be set to the following application error: - INCORRECT_CONDITIONAL_GET_REQUEST The UDSF shall include the RecordMeta in the ProblemDetailsExtension.
ExtendedProblemDetails	O	0..1	409 Conflict	The "cause" attribute may be set to the following application error: - DATABASE_INCONSISTENCY_PUT_REQUEST The UDSF shall include the RecordMeta in the ProblemDetailsExtension if the cause is "DATABASE_INCONSISTENCY_PUT_REQUEST".
NOTE 1: In addition common data structures as listed in table 6.1.7.3-1 are supported.				
NOTE 2: If all the modification instructions in the PATCH request have been implemented, the UDSF shall respond with 204 No Content response; if some of the modification instructions in the PATCH request have been discarded, the UDSF shall respond with PatchResult.				

6.1.3.5 Resource: BlockCollection (Collection)

6.1.3.5.1 Description

This resource represents the collection of blocks of associated with a record.

6.1.3.5.2 Resource Definition

Resource URI: `{apiRoot}/nudsf-dr/<apiVersion>/{realmId}/{storageId}/records/{recordId}/blocks`

This resource shall support the resource URI variables defined in table 6.1.3.5.2-1.

Table 6.1.3.5.2-1: Resource URI variables for this resource

Name	Definition
apiRoot	See clause 6.1.1
realmId	Represents the realm Id where the record is stored
storageId	Represents the storage Id where the record is stored
recordId	Represents the record Id of the record

6.1.3.5.3 Resource Standard Methods

6.1.3.5.3.1 GET

This method shall support the URI query parameters specified in table 6.1.3.5.3.1-1.

Table 6.1.3.5.3.1-1: URI query parameters supported by the GET method on this resource

Name	Data type	P	Cardinality	Description	Applicability
supported-features	SupportedFeatures	O	0..1	see 3GPP TS 29.500 [4] clause 6.6	

This method shall support the request data structures specified in table 6.1.3.5.3.1-2 and the response data structures and response codes specified in table 6.1.3.5.3.1-3.

Table 6.1.3.5.3.1-2: Data structures supported by the GET Request Body on this resource

Data type	P	Cardinality	Description
n/a			

Table 6.1.3.5.3.1-3: Data structures supported by the GET Response Body on this resource

Data type	P	Cardinality	Response codes	Description
array(Block)	M	1..N	200 OK	A response body containing one or more blocks.
n/a			204 No Content	The BlockCollection did not contain any blocks.
NOTE: The mandatory HTTP error status code for the GET method listed in Table 5.2.7.1-1 of 3GPP TS 29.500 [4] also apply.				

6.1.3.6 Resource: Block (Document)

6.1.3.6.1 Description

This resource represents a record within a storage.

6.1.3.6.2 Resource Definition

Resource URI: **{apiRoot}/nudsf-dr/<apiVersion>/{realmId}/{storageId}/records/{recordId}/blocks/{blockId}**

This resource shall support the resource URI variables defined in table 6.1.3.6.2-1.

Table 6.1.3.6.2-1: Resource URI variables for this resource

Name	Definition
apiRoot	See clause 6.1.1
realmId	Represents the realm Id where the record is stored
storageId	Represents the storage Id where the record is stored
recordId	Represents the record Id of the record
blockId	Represents the block Id of the block

6.1.3.6.3 Resource Standard Methods

6.1.3.6.3.1 GET

This method shall support the URI query parameters specified in table 6.1.3.6.3.1-1.

Table 6.1.3.6.3.1-1: URI query parameters supported by the GET method on this resource

Name	Data type	P	Cardinality	Description	Applicability
supported-features	SupportedFeatures	O	0..1	see 3GPP TS 29.500 [4] clause 6.6	

This method shall support the request data structures specified in table 6.1.3.6.3.1-2 and the response data structures and response codes specified in table 6.1.3.6.3.1-3.

Table 6.1.3.6.3.1-2: Data structures supported by the GET Request Body on this resource

Data type	P	Cardinality	Description
n/a			

Table 6.1.3.6.3.1-3: Data structures supported by the GET Response Body on this resource

Data type	P	Cardinality	Response codes	Description
BlockBody	M	1	200 OK	Upon success, a response body containing the requested block is returned.
ProblemDetails	O	0..1	404 Not Found	The "cause" attribute maybe used to indicate one of the following application errors: -REALM_NOT_FOUND -STORAGE_NOT_FOUND -RECORD_NOT_FOUND -BLOCK_NOT_FOUND
ExrendedProblem Details	O	0..1	412 Precondition Failed	The "cause" attribute shall be set to the following application error: - INCORRECT_CONDITIONAL_GET_REQUEST The UDSF shall include the stored record in the ProblemDetailsExtension.
ExtendedProblem Details	O	0..1	500 Internal Server Error	The "cause" attribute may be set to the following application error: - DATABASE_INCONSISTENCY The UDSF shall include the stored record in the ProblemDetailsExtension if the cause is "DATABASE_INCONSISTENCY".
NOTE: The mandatory HTTP error status code for the GET method listed in Table 5.2.7.1-1 of 3GPP TS 29.500 [4] also apply.				

6.1.3.6.3.2 PUT

This method shall support the URI query parameters specified in table 6.1.3.6.3.2-1.

Table 6.1.3.6.3.2-1: URI query parameters supported by the PUT method on this resource

Name	Data type	P	Cardinality	Description	Applicability
supported-features	SupportedFeatures	O	0..1	see 3GPP TS 29.500 [4] clause 6.6	
get-previous	boolean	O	0..1	Request to return the previous block content if a block already exists in the targeted storage for the same block identifier.	

If the operation updates an existing block, then the existing block shall be discarded and replaced by the block supplied with the request.

This method shall support the request data structures specified in table 6.1.3.6.3.2-2 and the response data structures and response codes specified in table 6.1.3.6.3.2-3.

Table 6.1.3.6.3.2-2: Data structures supported by the PUT Request Body on this resource

Data type	P	Cardinality	Description
Block	M	1	The block definition that shall be created. A Content-Type http header can be set to specify the media type of the block's opaque content. If the media-type is not included, the media-type shall be set to application/octet-stream.

Table 6.1.3.6.3.2-3: Data structures supported by the PUT Response Body on this resource

Data type	P	Cardinality	Response codes	Description
BlockBody	M	1	200 OK	Upon successful update of a block, a response body containing the previous record value ((if get-previous was indicated in the request and if one exists) will be returned
n/a			201 Created	Upon successful creation of a record, an empty response shall be returned.
n/a			204 No Content	Upon successful update of a record, an empty response is returned if no previous record value was requested.
ProblemDetails	O	0..1	404 Not Found	The "cause" attribute may be used to indicate one of the following application errors: -REALM_NOT_FOUND -STORAGE_NOT_FOUND -RECORD_NOT_FOUND
BlockBody	O	0..1	412 Precondition Failed	If one or more conditions given in the request header fields evaluated to false and get-previous was indicated in the request, the UDSF shall include the BlockBody in the response.
ExtendedProblemDetails	O	0..1	409 Conflict	The "cause" attribute may be used to indicate the following application error: - DATABASE_INCONSISTENCY_PUT_REQUEST The UDSF shall include the stored record in the ProblemDetailsExtension if the cause is "DATABASE_INCONSISTENCY_PUT_REQUEST".
NOTE: The mandatory HTTP error status code for the PUT method listed in Table 5.2.7.1-1 of 3GPP TS 29.500 [4] also apply.				

6.1.3.6.3.3 DELETE

This method shall support the URI query parameters specified in table 6.1.3.6.3.3-1.

Table 6.1.3.6.3.3-1: URI query parameters supported by the DELETE method on this resource

Name	Data type	P	Cardinality	Description	Applicability
supported-features	SupportedFeatures	O	0..1	see 3GPP TS 29.500 [4] clause 6.6	
get-previous	boolean	O	0..1	Request to return the previous block content (if any).	

This method shall support the request data structures specified in table 6.1.3.6.3.3-2 and the response data structures and response codes specified in table 6.1.3.6.3.3-3.

Table 6.1.3.6.3.3-2: Data structures supported by the DELETE Request Body on this resource

Data type	P	Cardinality	Description
n/a			

Table 6.1.3.6.3.3-3: Data structures supported by the DELETE Response Body on this resource

Data type	P	Cardinality	Response codes	Description
BlockBody	O	0..1	200 OK	Upon success, and a response body containing the block was requested.
n/a			204 No Content	Upon success, and no response body containing the block was requested.
BlockBody	O	0..1	412 Precondition Failed	If one or more conditions given in the request header fields evaluated to false and get-previous was indicated in the request, the UDSF shall include the BlockBody in the response.
ProblemDetails	O	0..1	404 Not Found	The "cause" attribute may be used to indicate one of the following application errors: -REALM_NOT_FOUND -STORAGE_NOT_FOUND -RECORD_NOT_FOUND -BLOCK_NOT_FOUND
NOTE: The mandatory HTTP error status code for the DELETE method listed in Table 5.2.7.1-1 of 3GPP TS 29.500 [4] also apply.				

6.1.3.7 Resource: NotificationSubscriptions

6.1.3.7.1 Description

This resource is used to represent notification subscriptions.

6.1.3.7.2 Resource Definition

Resource URI: {apiRoot}/nudsf-dr/<apiVersion>/{realmId}/{storageId}/subs-to-notify

This resource shall support the resource URI variables defined in table 6.1.3.7.2-1.

Table 6.1.3.7.2-1: Resource URI variables for this resource

Name	Definition
apiRoot	See clause 6.1.1
realmId	Represents the realm Id.
storageId	Represents the storage Id.

6.1.3.7.3 Standard Methods

6.1.3.7.3.2 GET

This method shall support the URI query parameters specified in table 6.1.3.7.3.2-1.

Table 6.1.3.7.3.2-1: URI query parameters supported by the GET method on this resource

Name	Data type	P	Cardinality	Description
supported-features	SupportedFeatures	O	0..1	see 3GPP TS 29.500 [4] clause 6.6
limit-range	UInteger	C	0..1	When set, the returned response shall contain at the most the number of Notification Subscriptions specified by the parameter value.

This method shall support the request data structures specified in table 6.1.3.7.3.2-2 and the response data structures and response codes specified in table 6.1.3.7.3.2-3.

Table 6.1.3.7.3.2-2: Data structures supported by the GET Request Body on this resource

Data type	P	Cardinality	Description
n/a			

Table 6.1.3.7.3.2-3: Data structures supported by the GET Response Body on this resource

Data type	P	Cardinality	Response codes	Description
array(NotificationSubscription)	M	0..N	200 OK	Upon success, a response body containing the individual subscriptions shall be returned.
ProblemDetails	O	0..1	404 NOT FOUND	The "cause" attribute shall be set to one of the following application errors: -REALM_NOT_FOUND -STORAGE_NOT_FOUND
NOTE: The mandatory HTTP error status code for the GET method listed in Table 5.2.7.1-1 of 3GPP TS 29.500 [4] also apply.				

6.1.3.8 Resource: IndividualNotificationSubscription

6.1.3.8.1 Description

This resource is used to represent an individual subscriber data subscriptions to notifications.

6.1.3.8.2 Resource Definition

Resource URI: **{apiRoot}/nudsf-dr/<apiVersion>/{realmId}/{storageId}/subs-to-notify/{subscriptionId}**

This resource shall support the resource URI variables defined in table 6.1.3.8.2-1.

Table 6.1.3.8.2-1: Resource URI variables for this resource

Name	Definition
apiRoot	See clause 6.1.1
realmId	Represents the realm Id.
storageId	Represents the storage Id.
subscriptionId	The subscriptionId identifies an individual NotificationSubscription.

6.1.3.8.3 Resource Standard Methods

6.1.3.8.3.1 DELETE

This method shall support the URI query parameters specified in table 6.1.3.8.3.1-1.

Table 6.1.3.8.3.1-1: URI query parameters supported by the DELETE method on this resource

Name	Data type	P	Cardinality	Description
client-id	ClientId	M	1	The client-id is used by the UDSF to guard against deletion of notification subscriptions that do not belong to the same NF or NFSet.
supported-features	SupportedFeatures	O	0..1	see 3GPP TS 29.500 [4] clause 6.6
get-previous	boolean	O	0..1	Request to return the associated NotificationSubscription if it exist.

This method shall support the request data structures specified in table 6.1.3.8.3.1-2 and the response data structures and response codes specified in table 6.1.3.8.3.1-3.

Table 6.1.3.8.3.1-2: Data structures supported by the DELETE Request Body on this resource

Data type	P	Cardinality	Description
n/a			The request body shall be empty.

Table 6.1.3.8.3.1-3: Data structures supported by the DELETE Response Body on this resource

Data type	P	Cardinality	Response codes	Description
NotificationSubscription	O	0..1	200 OK	Upon successful delete of a NotificationSubscription, a response body containing the NotificationSubscription value before the delete shall be returned if get-previous was indicated in the request.
n/a			204 NO CONTENT	Upon success, an empty response body shall be returned.
ProblemDetails	O	0..1	403 FORBIDDEN	If the client-id query parameter does not match the clientId of the existing resource, 403 FORBIDDEN shall be returned and the "cause" attribute may be used to indicate one of the following application errors: - SUBSCRIPTION_EXISTS
ProblemDetails	O	0..1	404 NOT FOUND	The "cause" attribute shall be set to one of the following application errors: -REALM_NOT_FOUND -STORAGE_NOT_FOUND -SUBSCRIPTION_NOT_FOUND
NotificationSubscription	O	0..1	412 PRECONDITION FAILED	412 PRECONDITION FAILED is returned if one or more conditions given in the request header fields evaluated to false. If get-previous was indicated in the request, the UDSF shall include the NotificationSubscription in the response.
NOTE: The mandatory HTTP error status code for the DELETE method listed in Table 5.2.7.1-1 of 3GPP TS 29.500 [4] also apply.				

6.1.3.8.3.2 PATCH

This method shall support the URI query parameters specified in table 6.1.3.8.3.2-1.

Table 6.1.3.8.3.2-1: URI query parameters supported by the PATCH method on this resource

Name	Data type	P	Cardinality	Description
supported-features	SupportedFeatures	O	0..1	see 3GPP TS 29.500 [4] clause 6.6

This method shall support the request data structures specified in table 6.1.3.8.3.2-2 and the response data structures and response codes specified in table 6.1.3.8.3.2-3.

Table 6.1.3.8.3.2-2: Data structures supported by the PATCH Request Body on this resource

Data type	P	Cardinality	Description
array(PatchItem)	M	1..N	Contains the delta data of the Notification Subscription to be updated.

Table 6.1.3.8.3.2-3: Data structures supported by the PATCH Response Body on this resource

Data type	P	Cardinality	Response codes	Description
n/a			204 NO CONTENT	Upon successful modification, there is no body in the response message. (NOTE 2)
PatchResult	M	1	200 OK	Upon success, the execution report is returned. (NOTE 2)
ProblemDetails	O	0..1	404 NOT FOUND	The "cause" attribute shall be set to one of the following application errors: -REALM_NOT_FOUND -STORAGE_NOT_FOUND -SUBSCRIPTION_NOT_FOUND

NOTE 1: In addition common data structures as listed in table 6.1.7.3-1 are supported.
NOTE 2: If all the modification instructions in the PATCH request have been implemented, the UDSF shall respond with 204 No Content response; if some of the modification instructions in the PATCH request have been discarded, the UDSF shall respond with 200 OK and include the PatchResult.

6.1.3.8.3.3 GET

This method shall support the URI query parameters specified in table 6.1.3.8.3.3-1.

Table 6.1.3.8.3.3-1: URI query parameters supported by the GET method on this resource

Name	Data type	P	Cardinality	Description
supported-features	SupportedFeatures	O	0..1	see 3GPP TS 29.500 [4] clause 6.6.

This method shall support the request data structures specified in table 6.1.3.8.3.3-2 and the response data structures and response codes specified in table 6.1.3.8.3.3-3.

Table 6.1.3.8.3.3-2: Data structures supported by the GET Request Body on this resource

Data type	P	Cardinality	Description
n/a			The request body shall be empty.

Table 6.1.3.8.3.3-3: Data structures supported by the GET Response Body on this resource

Data type	P	Cardinality	Response codes	Description
NotificationSubscription	M	1	200 OK	Upon success, a response body containing the individual subscriptions shall be returned.
ProblemDetails	O	0..1	404 NOT FOUND	The "cause" attribute shall be set to one of the following application errors: -REALM_NOT_FOUND -STORAGE_NOT_FOUND -SUBSCRIPTION_NOT_FOUND

NOTE: The mandatory HTTP error status code for the GET method listed in Table 5.2.7.1-1 of 3GPP TS 29.500 [4] also apply.

6.1.3.8.3.4 PUT

This method shall support the URI query parameters specified in table 6.1.3.8.3.4-1.

Table 6.1.3.8.3.4-1: URI query parameters supported by the PUT method on this resource

Name	Data type	P	Cardinality	Description	Applicability
supported-features	SupportedFeatures	O	0..1	see 3GPP TS 29.500 [4] clause 6.6	

This method shall support the request data structures specified in table 6.1.3.8.3.4-2 and the response data structures and response codes specified in table 6.1.3.8.3.4-3.

Table 6.1.3.8.3.4-2: Data structures supported by the PUT Request Body on this resource

Data type	P	Cardinality	Description
NotificationSubscription	M	1	The Notification Subscription.

Table 6.1.3.8.3.4-3: Data structures supported by the PUT Response Body on this resource

Data type	P	Cardinality	Response codes	Description
NotificationSubscription	M	1	201 CREATED	Upon success, the created NotificationSubscription is returned. The HTTP response shall include a "Location" HTTP header that contains the resource URI of the created resource.
NotificationSubscription	M	1	200 OK	Upon success, the updated NotificationSubscription is returned.
ProblemDetails	O	0..1	404 NOT FOUND	The "cause" attribute shall be set to one of the following application errors: -REALM_NOT_FOUND -STORAGE_NOT_FOUND
ProblemDetails	O	0..1	403 FORBIDDEN	If the clientId of the PUT request does not match the clientId of the existing resource, 403 FORBIDDEN shall be returned and the "cause" attribute may be used to indicate one of the following application errors: - SUBSCRIPTION_EXISTS
array(Uri)	O	1..N	409 CONFLICT	If one or more monitoredResourceUris from the request don't exist in the UDSF, 409 CONFLICT shall be returned together with the non-existing monitoredResourceUris.
NOTE: The mandatory HTTP error status codes for the POST method listed in Table 5.2.7.1-1 of 3GPP TS 29.500 [4] also apply.				

6.1.3.9 Resource: Meta Schema (Document)

6.1.3.9.1 Description

This resource represents a meta schema within a storage.

6.1.3.9.2 Resource Definition

Resource URI: {apiRoot}/nudsf-dr/v1/{realmId}/{storageId}/meta-schemas/{schemaId}

This resource shall support the resource URI variables defined in table 6.1.3.9.2-1.

Table 6.1.3.9.2-1: Resource URI variables for this resource

Name	Definition
apiRoot	See clause 6.1.1
realmId	Represents the realm Id where the schema is stored
storageId	Represents the storage Id where the schema is stored
schemaId	Represents the schema Id of the schema

6.1.3.9.3 Resource Standard Methods

6.1.3.9.3.1 GET

This method shall support the URI query parameters specified in table 6.1.3.9.3.1-1.

Table 6.1.3.9.3.1-1: URI query parameters supported by the GET method on this resource

Name	Data type	P	Cardinality	Description	Applicability
supported-features	SupportedFeatures	O	0..1	see 3GPP TS 29.500 [4] clause 6.6.	Meta Schema

This method shall support the request data structures specified in table 6.1.3.9.3.1-2 and the response data structures and response codes specified in table 6.1.3.9.3.1-3.

Table 6.1.3.9.3.1-2: Data structures supported by the GET Request Body on this resource

Data type	P	Cardinality	Description
n/a			

Table 6.1.3.9.3.1-3: Data structures supported by the GET Response Body on this resource

Data type	P	Cardinality	Response codes	Description
MetaSchema	M	1	200 OK	A response body containing the meta schema.
ProblemDetails	O	0..1	404 Not Found	The "cause" attribute may be used to indicate one of the following application errors: -REALM_NOT_FOUND -STORAGE_NOT_FOUND -SCHEMA_NOT_FOUND
NOTE: The mandatory HTTP error status code for the GET method listed in Table 5.2.7.1-1 of 3GPP TS 29.500 [4] also apply.				

6.1.3.9.3.2 PUT

This method shall support the URI query parameters specified in table 6.1.3.9.3.2-1.

Table 6.1.3.9.3.2-1: URI query parameters supported by the PUT method on this resource

Name	Data type	P	Cardinality	Description	Applicability
supported-features	SupportedFeatures	O	0..1	see 3GPP TS 29.500 [4] clause 6.6	Meta Schema
get-previous	boolean	O	0..1	Request to return the previous meta schema content if the meta schema already exists in the targeted storage for the same schema identifier.	Meta Schema

This method shall support the request data structures specified in table 6.1.3.9.3.2-2 and the response data structures and response codes specified in table 6.1.3.9.3.2-3.

Table 6.1.3.9.3.2-2: Data structures supported by the PUT Request Body on this resource

Data type	P	Cardinality	Description
MetaSchema	M	1	The schema that is to be created/updated.

Table 6.1.3.9.3.2-3: Data structures supported by the PUT Response Body on this resource

Data type	P	Cardinality	Response codes	Description
MetaSchema	M	1	200 OK	Upon successful update of a schema, a response body containing the previous schema value (if get-previous was indicated in the request, and if one exists) will be returned
MetaSchema	M	1	201 Created	Upon successful creation of a schema, a response body of the created schema shall be returned. The HTTP response shall include a "Location" HTTP header that contains the resource URI of the created resource.
n/a			204 No Content	Upon successful update of a schema, an empty response is returned if no previous schema value was requested.
ProblemDetails	O	0..1	404 Not Found	The "cause" attribute may be used to indicate one of the following application errors: -REALM_NOT_FOUND -STORAGE_NOT_FOUND

NOTE: The mandatory HTTP error status code for the PUT method listed in Table 5.2.7.1-1 of 3GPP TS 29.500 [4] also apply.

Table 6.1.3.9.3.2-4: Headers supported by the 201 Response Code on this resource

Name	Data type	P	Cardinality	Description
Location	string	M	1	Contains the URI of the newly created resource, according to the structure: {apiRoot}/nudsf-dr/<apiVersion>/{realmId}/{storageId}/meta-schemas/{schemald}

6.1.3.9.3.3 DELETE

This method shall support the URI query parameters specified in table 6.1.3.9.3.3-1.

Table 6.1.3.9.3.3-1: URI query parameters supported by the DELETE method on this resource

Name	Data type	P	Cardinality	Description	Applicability
supported-features	SupportedFeatures	O	0..1	see 3GPP TS 29.500 [4] clause 6.6	Meta Schema
get-previous	boolean	O	0..1	Request to return the schema content if a schema exists in the targeted storage for the same schema identifier.	Meta Schema

This method shall support the request data structures specified in table 6.1.3.9.3.3-2 and the response data structures and response codes specified in table 6.1.3.9.3.3-3.

Table 6.1.3.9.3.3-2: Data structures supported by the DELETE Request Body on this resource

Data type	P	Cardinality	Description
n/a			

Table 6.1.3.9.3.3-3: Data structures supported by the DELETE Response Body on this resource

Data type	P	Cardinality	Response codes	Description
MetaSchema	O	0..1	200 OK	Upon success, a response body containing the schema value, if get-previous was indicated in the request.
n/a			204 No Content	Upon success, if get-previous was not indicated in the request..
ProblemDetails	O	0..1	404 Not Found	The "cause" attribute may be used to indicate one of the following application errors: -REALM_NOT_FOUND -STORAGE_NOT_FOUND -SCHEMA_NOT_FOUND
NOTE: The mandatory HTTP error status code for the DELETE method listed in Table 5.2.7.1-1 of 3GPP TS 29.500 [4] also apply.				

6.1.4 Custom Operations without associated resources

None.

6.1.5 Notifications

6.1.5.1 General

Notifications shall comply to clause 6.2 of 3GPP TS 29.500 [4] and clause 4.6.2.3 of 3GPP TS 29.501 [5].

6.1.5.2 Timer Expiry Notification

6.1.5.2.1 Description

The Timer Expiry Notification is used by the NF service producer to report to an NF Consumer that the Record has expired as indicated by the ttl attribute (if set) of RecordMeta and if a callbackReference was set in the RecordMeta.

6.1.5.2.2 Target URI

The Callback URI "{callbackReference}" shall be used with the callback URI variables defined in table 6.1.5.2.2-1.

Table 6.1.5.2.2-1: Target URI variables for this resource

Name	Definition
callbackReference	string formatted as URI with the Callback Uri

6.1.5.2.3 Standard Methods

6.1.5.2.3.1 POST

This method shall support the request data structures specified in table 6.1.5.2.3.1-1 and the response data structures and response codes specified in table 6.1.5.2.3.1-1.

Table 6.1.5.2.3.1-2: Data structures supported by the POST Request Body on this resource

Data type	P	Cardinality	Description
RecordBody	M	1	The RecordBody of the record that was deleted.

Table 6.1.5.2.3.1-3: Data structures supported by the POST Response Body on this resource

Data type	P	Cardinality	Response codes	Description
n/a			204 No Content	Upon success, an empty response body shall be returned.
NOTE: The mandatory HTTP error status codes for the POST method listed in Table 5.2.7.1-1 of 3GPP TS 29.500 [4] also apply.				

6.1.5.3 Notification due to Data Change

6.1.5.3.1 Description

The Notification due to Data Change is used by the UDSF to report to an NF Consumer that a Record that is part of a NotificationSubscription has been updated or deleted.

6.1.5.3.2 Target URI

The Callback URI "{callbackReference}" shall be used with the callback URI variables defined in table 6.1.5.3.2-1.

Table 6.1.5.3.2-1: Callback URI variables for this resource

Name	Definition
callbackReference	String formatted as URI with the Callback Uri

6.1.5.3.3 Standard Methods

6.1.5.3.3.1 POST

This method shall support the request data structures specified in table 6.1.5.3.3.1-1 and the response data structures and response codes specified in table 6.1.5.3.3.1-1.

Table 6.1.5.3.3.1-2: Data structures supported by the POST Request Body on this resource

Data type	P	Cardinality	Description
RecordNotification	M	1	The notification with the record information.

Table 6.1.5.3.3.1-3: Data structures supported by the POST Response Body on this resource

Data type	P	Cardinality	Response codes	Description
n/a			204 NO CONTENT	Upon success, an empty response body shall be returned.
NOTE: The mandatory HTTP error status codes for the POST method listed in Table 5.2.7.1-1 of 3GPP TS 29.500 [4] also apply.				

6.1.5.4 Subscription Expiry Notification

6.1.5.4.1 Description

The Subscription Expiry Notification is used by the UDSF to report to an NF Consumer that a Subscription to Notification due to Data Change has expired or is about to expire.

6.1.5.4.2 Target URI

The Callback URI "{expiryCallbackReference}" shall be used with the callback URI variables defined in table 6.1.5.4.2-1.

Table 6.1.5.4.2-1: Callback URI variables for this resource

Name	Definition
expiryCallbackReference	String formatted as URI with the Callback URI

6.1.5.4.3 Standard Methods

6.1.5.4.3.1 POST

This method shall support the request data structures specified in table 6.1.5.4.3.1-1 and the response data structures and response codes specified in table 6.1.5.4.3.1-1.

Table 6.1.5.4.3.1-2: Data structures supported by the POST Request Body on this resource

Data type	P	Cardinality	Description
NotificationInfo	M	1	The notification info with expired subscriptions.

Table 6.1.5.4.3.1-3: Data structures supported by the POST Response Body on this resource

Data type	P	Cardinality	Response codes	Description
n/a			204 No Content	Upon success, an empty response body shall be returned.
NOTE: The mandatory HTTP error status codes for the POST method listed in Table 5.2.7.1-1 of 3GPP TS 29.500 [4] also apply.				

6.1.6 Data Model

6.1.6.1 General

This clause specifies the application data model supported by the API.

Table 6.1.6.1-1 specifies the data types defined for the Nudsf_DataRepository service based interface protocol. For simple data types defined for the Nudsf_DataRepository service API see table 6.1.6.3.2-1.

Table 6.1.6.1-1: Nudsf_DataRepository specific Data Types

Data type	Clause defined	Description	Applicability
RecordSearchResult	6.1.6.2.2	Record Search Result	
RecordMeta	6.1.6.2.3	Record Meta	
RecordBody	6.1.6.2.4	Record Body	
Record	6.1.6.2.5	Record	
BlockBody	6.1.6.2.6	Block Body	
Block	6.1.6.2.7	Block	
SearchCondition	6.1.6.2.8	Search Condition	
SearchComparison	6.1.6.2.9	Search Comparison	
ComparisonOperator	6.1.6.3.3	Comparison Operator	
ConditionOperator	6.1.6.3.4	Condition Operator	
SearchExpression	6.1.6.4.1	Search Expression	
NotificationSubscription	6.1.6.2.10	Notification Subscription	
RecordNotification	6.1.6.2.11	Record Notification	
NotificationDescription	6.1.6.2.12	Notification Description	
SubscriptionFilter	6.1.6.2.13	Subscription Filter	
ClientId	6.1.6.2.14	Client Identity	
MetaSchema	6.1.6.2.15	Meta Schema	Meta Schema
TagType	6.1.6.2.16	Tag Type	Meta Schema
RecordIdList	6.1.6.2.17	List of Record IDs	BulkOperations
NotificationInfo	6.1.6.2.18	Notification Info	
RecordOperation	6.1.6.3.5	Record Operation	
Schemald	6.1.6.3.2	Identifier of a Meta Schema	Meta Schema
KeyType	6.1.6.3.6	Key Type	Meta Schema
RetrieveRecords	6.1.6.3.7	Request to return matching records	CombinedSearchRetrieve
RecordPatch	6.1.6.2.22	Request to patch a record	PartialRecordUpdate

Table 6.1.6.1-2 specifies data types re-used by the Nudsf_DataRepository service based interface protocol from other specifications, including a reference to their respective specifications and when needed, a short description of their use within the Nudsf_DataRepository service based interface.

Table 6.1.6.1-2: Nudsf_DataRepository re-used Data Types

Data type	Reference	Comments	Applicability
SupportedFeatures	3GPP TS 29.571 [19]	see 3GPP TS 29.500 [4] clause 6.6.	
PatchItem	3GPP TS 29.571 [19]	Data structure used for JSON patch.	
PatchResult	3GPP TS 29.571 [19]		
Uri	3GPP TS 29.571 [19]		
DateTime	3GPP TS 29.571 [19]		
NfInstanceId	3GPP TS 29.571 [19]		
NfSetId	3GPP TS 29.571 [19]		

6.1.6.2 Structured data types

6.1.6.2.1 Introduction

This clause defines the structures to be used in resource representations.

6.1.6.2.2 Type: RecordSearchResult

Table 6.1.6.2.2-1: Definition of type RecordSearchResult

Attribute name	Data type	P	Cardinality	Description	Applicability
count	UInteger	M	1	The number of records found by the search. If the tag-count-filter parameter is included, then the count should be set to 0. This attribute should be ignored if the tag-count-filter query parameter was included in the request.	
references	array(Uri)	O	1..N	The Record references found by the search.	
supportedFeatures	SupportedFeatures	O	0..1	See clause 6.1.8	
matchingRecords	map(Record)	C	1..N	This attribute contains the records that match the search filters provided in the request. The key of the map is the recordId. It shall be present if the search request included an instruction to include record content in the response. The map may contain a subset of the matching records in the case where inclusion of more records would result in the content size exceeding the max-payload-size received in the request (if any).	CombinedSearchRetrieve
tagCountResult	map(TagCount)	C	1..N	This attribute contains the result of the advanced counting. The key to the map is the unique identifier used to identify the Advanced Counting map in the GET operation. It shall be present if the tag-count-filter was included in the request.	AdvancedCounting

6.1.6.2.3 Type: RecordMeta

Table 6.1.6.2.3-1: Definition of type RecordMeta

Attribute name	Data type	P	Cardinality	Description	Applicability
tags	map(array(string))	O	1..N(1..M)	A map of tag name/values pairs, where the tag name is a unique string name that is the primary key of the map and is paired with an array of string values.	
ttl	DateTime	O	0..1	ttl refers to the lifetime of the record. After the expiry, the record shall be deleted.	
callbackReference	Uri	O	0..1	The Uri where the NF Service Consumer shall receive notification on the expiry of the Record as indicated by the ttl attribute if desired.	
schemald	Schemald	O	0..1	Id of the MetaSchema to which the tags comply to	Meta Schema

6.1.6.2.4 Type: RecordBody

Table 6.1.6.2.4-1: Definition of type RecordBody

Attribute name	Data type	P	Cardinality	Description	Applicability
record	Record	M	1	The record.	

6.1.6.2.5 Type: Record

Table 6.1.6.2.5-1: Definition of type Record

Attribute name	Data type	P	Cardinality	Description	Applicability
meta	RecordMeta	M	1	The meta of a record.	
blocks	array(Block)	O	1..N	The block(s) (if any) making up the record.	

6.1.6.2.6 Type: BlockBody

Table 6.1.6.2.6-1: Definition of type BlockBody

Attribute name	Data type	P	Cardinality	Description	Applicability
n/a	Block	M	1	The block.	

6.1.6.2.7 Type: Block

Table 6.1.6.2.7-1: Definition of type Block

Attribute name	Data type	P	Cardinality	Description	Applicability
value	Any Type	M	1	The block value of any data type.	

6.1.6.2.8 Type: SearchCondition

Table 6.1.6.2.8-1: Definition of type SearchCondition

Attribute name	Data type	P	Cardinality	Description	Applicability
cond	ConditionOperator	M	1	Logical operator ("AND", "OR" or "NOT")	
units	array(SearchExpression)	M	1..N	For the logical "NOT" operator indicated in the cond attribute, only one member shall be present in the array. For the logical "AND" or "OR" operators indicated in the cond attribute, at least two members shall be present in the array and all the members in the array shall be interpreted as logically concatenated with the logical operator.	
schemald	Schemald	O	0..1	When included, the search is limited to records which have the given schemald value stored in their RecordMeta	Meta Schema

6.1.6.2.9 SearchComparison

Table 6.1.6.2.9-1: Definition of type SearchComparison

Attribute name	Data type	P	Cardinality	Description	Applicability
op	ComparisonOperator	M	1	Comparison operator	
tag	string	M	1	This attribute contains the tag name of an array of strings.	
value	string	M	1	The array of strings indicated in the tag attribute compares to the value of this attribute.	

6.1.6.2.10 Type: NotificationSubscription

Table 6.1.6.2.10-1: Definition of type NotificationSubscription

Attribute name	Data type	P	Cardinality	Description	Applicability
clientId	ClientId	M	1	Identity of the NF or NFSet for which the subscription applies.	
callbackReference	Uri	M	1	Identifies the NF or NF pool where the notification shall be sent.	
expiryCallbackReference	Uri	C	0..1	Identifies the NF or NF pool where the expiry notification shall be sent. Shall be present if the expiryNotification is present.	
expiry	DateTime	C	0..1	This IE shall be included in a subscription response, if, based on operator policy and taking into account the expiry time included in the request, the UDSF needs to include an expiry time. The expiry time, based on operator policy, may indicate a value that is sooner than the NF consumer requested. The absence of this attribute in the subscription response indicates that the subscription does not have an expiry time.	

expiryNotification	UInteger	O	0..1	<p>This attribute when present in the request, indicates to the UDSF that the UDSF shall Notify the NF Consumer about the expiry of the subscription if this capability is supported by the UDSF.</p> <p>-A value of 0 in the subscription request indicates that the UDSF shall notify the NF Consumer upon subscription expiry.</p> <p>-A value greater than 0 in the subscription request, indicates the number of seconds before the expiry of the subscription that the UDSF shall notify the NF Consumer about the expiry.</p> <p>-A value that results in the notification to occur in the past shall be treated the same as a value of 0 was received.</p> <p>A UDSF that supports this capability shall include the attribute in the subscription response and in the Notification, set to the value received in the request (or set to 0 if the notification would occur in the past as described above).</p> <p>For example, if the expiry time in the subscription request indicates a time 100 seconds from now and the expiryNotification indicates 110 seconds, the UDSF shall return a value of 0 in the subscription response, meaning the NF Consumer will be notified upon subscription expiry.</p>	
subFilter	SubscriptionFilter	O	0..1	<p>If not included, the subscription applies to all Create, Delete and Update events of the storage.</p>	
supportedFeatures	SupportedFeatures	O	0..1	<p>Used to negotiate the applicability of optional features</p>	

6.1.6.2.11 Type: RecordNotification

Table 6.1.6.2.11-1: Definition of type RecordNotification

Attribute name	Data type	P	Cardinality	Description	Applicability
descriptor	NotificationDescription	M	1	The block value of any data type.	
meta	RecordMeta	M	1	The meta of a record.	
blocks	array(Block)	O	1..n	The block(s) (if any) making up the record.	

6.1.6.2.12 Type: NotificationDescription

Table 6.1.6.2.12-1: Definition of type NotificationDescription

Attribute name	Data type	P	Cardinality	Description	Applicability
recordRef	Uri	M	1	The reference of the record triggering the Notification.	
operationType	RecordOperation	M	1	The operation type.	
subscriptionId	string	O	0..1	This IE shall contain the subscriptionId that uniquely identifies the subscription to notification within a storage when present.	

6.1.6.2.13 Type: SubscriptionFilter

Table 6.1.6.2.13-1: Definition of type SubscriptionFilter

Attribute name	Data type	P	Cardinality	Description	Applicability
monitoredResourceUris	array(Uri)	O	1..N	A set of URIs that identify the records for which a modification of the representation triggers a notification. The URI shall take the form of either an absolute URI or an absolute-path reference as defined in IETF RFC 3986 [22], also see NOTE 1. The monitored resource shall indicate an existing record. If not present, the subscription is applied to all records within the storage and a modification of the representation of any record within the storage triggers a notification.	
operations	array(RecordOperation)	O	0..3	The operations that shall generate a notification. If the monitoredResourceUris is present, only "UPDATED" and "DELETED" are allowed values, any other value shall be ignored. If the attribute is not present, all applicable operations shall apply to the subscription.	
NOTE 1: The UDSF should handle only the relative-path part (apiSpecificResourceUriPart, see 3GPP TS 29.501 [5] clause 4.4.1) and ignore possible inconsistencies (caused by e.g. an SCP) in the base URI part.					

6.1.6.2.14 Type: ClientId

Table 6.1.6.2.14-1: Definition of type ClientId

Attribute name	Data type	P	Cardinality	Description	Applicability
nfId	NfInstanceId	C	0..1	The NF Instance Id uniquely identifying the NF Consumer. Shall be present if the nfSetId is absent.	
nfSetId	NfSetId	C	0..1	The NF Set Id of the NF Consumer. Shall be present if the nfId is absent.	

6.1.6.2.15 Type: MetaSchema

Table 6.1.6.2.15-1: Definition of type MetaSchema

Attribute name	Data type	P	Cardinality	Description	Applicability
schemald	Schemald	M	1	Id of the schema. Used as reference.	Meta Schema
metaTags	array(TagType)	M	1..N	Array of tag types that describe the schema	Meta Schema

6.1.6.2.16 Type: TagType

Table 6.1.6.2.16-1: Definition of type TagType

Attribute name	Data type	P	Cardinality	Description	Applicability
tagName	string	M	1	Name of the tag. Used as reference. Refers to the unique tag string name that is the primary key of the map and is paired with an array of string values in the RecordMeta tags IE	Meta Schema
keyType	KeyType	M	1	Type of key	Meta Schema
sort	boolean	C	0..1	Shall be present if keyType is "SEARCH_KEY" or "SEARCH_AND_COUNT_KEY" true: indicates that searches based on "GT", "GTE", "LT" and / or "LTE" are expected. false: indicates otherwise	Meta Schema
presence	boolean	O	0..1	true: indicates that presence of the tag is mandatory in the RecordMeta false (default): indicates that presence of the tag is optional in the RecordMeta	Meta Schema

6.1.6.2.17 Type: RecordIdList

Table 6.1.6.2.17-1: Definition of type RecordIdList

Attribute name	Data type	P	Cardinality	Description	Applicability
recordIdList	array(string)	M	1..N	List of Record IDs to be retrieved	BulkOperations

6.1.6.2.18 Type: NotificationInfo

Table 6.1.6.2.18-1: Definition of type NotificationInfo

Attribute name	Data type	P	Cardinality	Description	Applicability
expiredSubscriptions	array(NotificationSubscription)	M	1	An array of one or more expired subscriptions.	

6.1.6.2.19 Type: CountExpression

Table 6.1.6.2.19-1: Definition of type CountExpression

Attribute name	Data type	P	Cardinality	Description	Applicability
tag	string	O	0..1	<p>The name of the tag to be searched for in the record.</p> <p>The tag may be included for TOTAL_COUNT countType.</p> <p>If the "tag" is not included the UDSF shall return the total count of "records" in the storage.</p> <p>The tag shall be included for UNIQUE_COUNT and AGGREGATE_COUNT countTypes.</p>	
countType	TagCountType	M	1	The type of count to be returned.	
filter	SearchExpression	O	0..1	The filter criteria for searching the records of the storage.	

6.1.6.2.20 Type: TagCount

Table 6.1.6.2.20-1: Definition of type TagCount

Attribute name	Data type	P	Cardinality	Description	Applicability
tag	string	C	0..1	<p>The name of the tag counted.</p> <p>If the countType received in the CountExpression is TOTAL_COUNT or UNIQUE_COUNT, then this attribute shall be set to the tag received in the CountExpression.</p> <p>The tag may be included if the countType received in the CountExpression is set to AGGREGATE_COUNT.</p>	
count	UInteger	C	0..1	<p>This attribute contains the unique number of instances of the tag found by the search for countType UNIQUE_COUNT.</p> <p>If the countType received in the CountExpression is TOTAL_COUNT, then this attribute contains the total number of instances of the tag found by the search or the total number of records in the storage.</p> <p>If the countType received in the CountExpression is AGGREGATE_COUNT, then this attribute contains the sum of all the values of the tag.</p>	
valueCount	array(ValueCount)	C	1..N	<p>This attribute contains the count for each value of the tag and shall be included for AGGREGATE countType.</p>	

6.1.6.2.21 Type: ValueCount

Table 6.1.6.2.21-1: Definition of type ValueCount

Attribute name	Data type	P	Cardinality	Description	Applicability
value	string	M	1	The value of the tag counted.	
count	UInteger	M	1	The number of occurrences of the value found.	

6.1.6.2.22 Type: RecordPatch

Table 6.1.6.2.22-1: Definition of type RecordPatch

Attribute name	Data type	P	Cardinality	Description	Applicability
patch	array(PatchItem)	M	1..N	A collection of patch items to apply on the record.	PartialRecordUpdate
blocks	array(Block)	O	1..N	The block(s) (if any) referred to in 1 or more PatchItems	PartialRecordUpdate

6.1.6.3 Simple data types and enumerations

6.1.6.3.1 Introduction

This clause defines simple data types and enumerations that can be referenced from data structures defined in the previous clauses.

6.1.6.3.2 Simple data types

The simple data types defined in table 6.1.6.3.2-1 shall be supported.

Table 6.1.6.3.2-1: Simple data types

Type Name	Type Definition	Description	Applicability
Schemald	string	Id of the schema. Used as reference.	Meta Schema

6.1.6.3.3 Enumeration: ComparisonOperator

The enumeration ComparisonOperator represents the comparison of an array of strings to a string value. The comparison shall be based on lexicographical order. It shall comply with the provisions defined in table 6.1.6.3.3-1.

Table 6.1.6.3.3-1: Enumeration ComparisonOperator

Enumeration value	Description	Applicability
"EQ"	The array contains the string value.	
"NEQ"	The array does not contain the string value.	AdvancedQuery
"GT"	The array contains a string that is greater than the string value.	AdvancedQuery
"GTE"	The array contains a string that is greater than or equal to the string value.	AdvancedQuery
"LT"	The array contains a string that is less than the string value.	AdvancedQuery
"LTE"	The array contains a string that is less than or equal to the string value.	AdvancedQuery

NOTE: It's recommended to use GT/GTE/LT/LTE on single value tags. If not, the logical operator "NOT" applied over the comparison operator "GT" evaluates to "true" if there are no members in the array that are greater than the value.

6.1.6.3.4 Enumeration: ConditionOperator

Table 6.1.6.3.4-1: Enumeration ConditionOperator

Enumeration value	Description	Applicability
"AND"	Logical "AND"	
"OR"	Logical "OR"	
"NOT"	Logical "NOT"	

6.1.6.3.5 Enumeration: RecordOperation

Table 6.1.6.3.5-1: Enumeration RecordOperation

Enumeration value	Description	Applicability
"CREATED"	Indicates a Create record operation	
"UPDATED"	Indicates an Update record operation	
"DELETED"	Indicates a Delete record operation	

6.1.6.3.6 Enumeration: KeyType

Table 6.1.6.3.6-1: Enumeration KeyType

Enumeration value	Description	Applicability
"UNIQUE_KEY"	Tags with this key type may be used for search and will result in no or one matching records.	Meta Schema
"SEARCH_KEY"	Tags with this key type may be used for search and will result in no, one or more matching records.	Meta Schema
"COUNT_KEY"	Tags with this key type may be used for count.	Meta Schema
"SEARCH_AND_COUNT_KEY"	Tags with this key type may be used for search and count.	Meta Schema
"OTHER_TAG"	Tags with this key type may not be used for search or count.	Meta Schema

6.1.6.3.7 Enumeration: RetrieveRecords

Table 6.1.6.3.7-1: Enumeration RetrieveRecords

Enumeration value	Description	Applicability
"ONLY_META"	Only the META of matching records are requested to be included in the RecordSearchResult.	CombinedSearchRetrieve
"META_AND_BLOCKS"	META and BLOCKS of matching records are requested to be included in the RecordSearchResult.	CombinedSearchRetrieve

6.1.6.3.8 Enumeration: TagCountType

Table 6.1.6.3.8-1: Enumeration TagCountType

Enumeration value	Description	Applicability
"AGGREGATE_COUNT"	The count of all values for the specified tag from all records is requested to be returned.	
"UNIQUE_COUNT"	The count of unique values of a tag from records matching the search expression is requested to be returned.	
"TOTAL_COUNT"	If the "tag" is provided in the AdvancedCounting then the count of total values of a tag from records matching the search expression is requested to be returned. Otherwise, the total number of records of the storage is requested to be returned.	

6.1.6.4 Data types describing alternative data types or combinations of data types

6.1.6.4.1 Type: SearchExpression

Table 6.1.6.4.1-1: Definition of type SearchExpression as a list of mutually exclusive alternatives

Data type	Cardinality	Description	Applicability
SearchCondition	1	A search expression with logic operators	AdvancedQuery, AdvancedCounting
SearchComparison	1	A minimum unit of the search expression	
RecordIdList	1	List of Record IDs identifying records to be retrieved	BulkOperations

6.1.6.4.2 Type: ExtendedProblemDetails

This data type is the "ProblemDetails" data type defined in 3GPP TS 29.571 [19] but extended with "ProblemDetailExtension" data type.

Table 6.1.6.4.2-1 Definition of type ExtendedProblemDetails as a list of to be combined data types

Data type	Cardinality	Description	Applicability
ProblemDetails	1	The "ProblemDetails" data structure is specified in clause 5.2.4.1 of 3GPP TS 29.571 [19].	
ProblemDetailsExtension	1	Contains either the stored record or meta of the record associated with the error.	

6.1.6.4.3 Type: ProblemDetailExtension

Table 6.1.6.4.3-1: Definition of type ProblemDetailExtension as a list of mutually exclusive alternatives

Data type	Cardinality	Description	Applicability
Record	0..1	The stored record	
RecordMeta	0..1	The meta of a stored record	

6.1.7 Error Handling

6.1.7.1 General

For the Nudsf_DataRepository API, HTTP error responses shall be supported as specified in clause 4.8 of 3GPP TS 29.501 [5]. Protocol errors and application errors specified in table 5.2.7.2-1 of 3GPP TS 29.500 [4] shall be supported for an HTTP method if the corresponding HTTP status codes are specified as mandatory for that HTTP method in table 5.2.7.1-1 of 3GPP TS 29.500 [4].

In addition, the requirements in the following clauses are applicable for the Nudsf_DataRepository API.

6.1.7.2 Protocol Errors

Protocol errors handling shall be supported as specified in clause 5.2.7 of 3GPP TS 29.500 [4].

6.1.7.3 Application Errors

The application errors defined for the Nudsf_DataRepository service are listed in Table 6.1.7.3-1.

Table 6.1.7.3-1: Application errors

Application Error	HTTP status code	Description
TTL_VALUE_NOT_ALLOWED	403 Forbidden	The ttl value indicated in the request exceeds the maximum value allowed in the UDSF.
SUBSCRIPTION_EXISTS	403 Forbidden	The subscription indicated in the HTTP/2 request is not authorized to be operated.
SCHEMA_IN_USE	403 Forbidden	The schema cannot be deleted as it is still referenced by existing records.
REALM_NOT_FOUND	404 Not Found	The realm indicated in the HTTP/2 request is unavailable in the UDSF.
STORAGE_NOT_FOUND	404 Not Found	The storage indicated in the HTTP/2 request is unavailable in the UDSF.
RECORD_NOT_FOUND	404 Not Found	The record indicated in the HTTP/2 request is unavailable in the UDSF.
BLOCK_NOT_FOUND	404 Not Found	The block indicated in the HTTP/2 request is unavailable in the UDSF.
SUBSCRIPTION_NOT_FOUND	404 Not Found	The subscription indicated in the HTTP/2 request is unavailable in the UDSF.
SCHEMA_NOT_FOUND	404 Not Found	The schema indicated in the HTTP/2 request is unavailable in the UDSF.
DATABASE_INCONSISTENCY_PUT_REQUEST	409 Conflict	Indicates that the request could not be processed because of conflict in the current state of the resource,
INCORRECT_CONDITIONAL_GET_REQUEST	412 Precondition Failed	One or more conditions given in the request header fields evaluated to false when tested in the UDSF.
DATABASE_INCONSISTENCY	500 Internal Server Error	Requested data cannot be returned due to database inconsistency

6.1.8 Feature negotiation

The optional features in table 6.1.8-1 are defined for the Nudsf_DataRepository API. They shall be negotiated using the extensibility mechanism defined in clause 6.6 of 3GPP TS 29.500 [4].

Table 6.1.8-1: Supported Features

Feature number	Feature Name	Description
1	AdvancedQuery	If an NF consumer detects that the UDSF supports the AdvancedQuery feature, it may use values of the ComparisonOperator besides "EQ" and may also use the cond attribute of the SearchCondition. If an NF consumer detects that the UDSF does not support the AdvancedQuery feature, it shall only use a value of "EQ" of the ComparisonOperator and shall not use the cond attribute of the SearchCondition.
2	Meta Schema	This feature supports optimization of UDSF data storage and allows the UDSF to know in advance how data search access by the NF consumer is expected. If the NF consumer detects that the UDSF does not support the Meta Schema feature, it shall not make use of the procedures for storing, updating and deleting Meta Schemas.
3	CombinedSearchRetrieve	This feature supports optimization of search and retrieval of records stored in the UDSF. When searching records (see clause 5.2.2.2.6), consumers supporting this feature can instruct the supporting UDSF to return matching records in addition to the matching records' URIs. If the NF consumer detects that the UDSF does not support the CombinedSearchRetrieve feature, it shall not include the query parameters retrieve-records and max-payload-size in record search requests.
4	BulkOperations	This feature supports optimization for retrieval/deletion of huge number of records identified by a list of record IDs. When the CombinedSearchRetrieve feature has been used to request retrieval of matching records but only a subset of matching records have been received due to maximum content size limitations, the consumers supporting this feature can instruct the supporting UDSF to return remaining records identified by a recordIdList. If the NF consumer detects that the UDSF does not support the BulkOperations feature, it shall not include the RecordIdList in the filter query parameter in record search requests.
5	AdvancedCounting	This feature supports retrieval of aggregate, total and unique tag counts, from the UDSF. When querying for tag counts the user can specify a tag-count-filter query parameter consisting of countType and optional Tag and filter according to which a map tagCount is returned. Refer to B.2 for example. If the NF consumer detects that the UDSF does not support the AdvancedCounting feature, it shall not include the tag-count-filter query parameter in record search requests.
6	PartialRecordUpdate	This feature adds support for PATCH record request to allow partial update to records including Record meta and Blocks.

6.1.9 Security

As indicated in 3GPP TS 33.501 [8] and 3GPP TS 29.500 [4], the access to the Nudsf_DataRepository API may be authorized by means of the OAuth2 protocol (see IETF RFC 6749 [9]), based on local configuration, using the "Client Credentials" authorization grant, where the NRF (see 3GPP TS 29.510 [10]) plays the role of the authorization server.

If OAuth2 is used, an NF Service Consumer, prior to consuming services offered by the <API Name> API, shall obtain a "token" from the authorization server, by invoking the Access Token Request service, as described in 3GPP TS 29.510 [10], clause 5.4.2.2.

NOTE: When multiple NRFs are deployed in a network, the NRF used as authorization server is the same NRF that the NF Service Consumer used for discovering the Nudsf_DataRepository service.

The Nudsf_DataRepository API defines the following scopes for OAuth2 authorization.

Table 6.1.9-1: Oauth2 scopes defined in Nudsf_DR API

Scope	Description
"nudsf-dr"	Access to the Nudsf_DR API
"nudsf-dr:record:read"	Access to read records
"nudsf-dr:record:modify"	Access to update records
"nudsf-dr:record:create"	Access to create records
"nudsf-dr:record-meta:read"	Access to read a record's meta
"nudsf-dr:record-meta:modify"	Access to update a record's meta
"nudsf-dr:block:read"	Access to read blocks
"nudsf-dr:block:create"	Access to create blocks
"nudsf-dr:block:modify"	Access to update blocks
"nudsf-dr:subscription:read"	Access to read subscriptions
"nudsf-dr:subscription:modify"	Access to update subscriptions
"nudsf-dr:subscription:create"	Access to create subscriptions
"nudsf-dr:meta-schema:read"	Access to read meta schema
"nudsf-dr:meta-schema:modify"	Access to update meta schema
"nudsf-dr:meta-schema:create"	Access to create meta schema

6.2 Nudsf_Timer Service API

6.2.1 Introduction

The Nudsf_Timer service shall use the Nudsf_Timer API.

The API URI of the Nudsf_Timer API shall be:

{apiRoot}/<apiName>/<apiVersion>/

The request URI used in HTTP requests from the NF service consumer towards the NF service producer shall have the Resource URI structure defined in clause 4.4.1 of 3GPP TS 29.501 [5], i.e.:

{apiRoot}/<apiName>/<apiVersion>/<apiSpecificResourceUriPart>

with the following components:

- The {apiRoot} shall be set as described in 3GPP TS 29.501 [5].
- The <apiName> shall be "nudsf-timer".
- The <apiVersion> shall be "v1".
- The <apiSpecificResourceUriPart> shall be set as described in clause 6.2.3.

6.2.2 Usage of HTTP

6.2.2.1 General

HTTP/2, IETF RFC 9113 [11], shall be used as specified in clause 5 of 3GPP TS 29.500 [4].

HTTP/2 shall be transported as specified in clause 5.3 of 3GPP TS 29.500 [4].

The OpenAPI [6] specification of HTTP messages and content bodies for the Nudsf_Timer API is contained in Annex A.

6.2.2.2 HTTP standard headers

6.2.2.2.1 General

See clause 5.2.2 of 3GPP TS 29.500 [4] for the usage of HTTP standard headers.

6.2.2.2.2 Content type

The following content types shall be supported:

- JSON, IETF RFC 8259 [12], shall be used as content type of the HTTP bodies specified in the present specification as specified in clause 5.4 of 3GPP TS 29.500 [4]. The use of the JSON format shall be signalled by the content type "application/json".
- "Problem Details" JSON object shall be used to indicate additional details of the error in a HTTP response body and shall be signalled by the content type "application/problem+json", as defined in IETF RFC 9457 [13].
- JSON Patch (IETF RFC 6902 [14]). The use of the JSON Patch format in a HTTP request body shall be signalled by the content type "application/json-patch+json".

6.2.2.3 HTTP custom headers

The mandatory HTTP custom header fields specified in clause 5.2.3.2 of 3GPP TS 29.500 [4] shall be applicable.

6.2.3 Resources

6.2.3.1 Overview

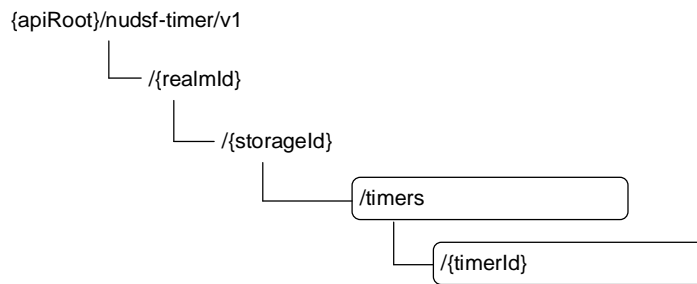

Figure 6.2.3.1-1: Resource URI structure of the nudsf-timer API

Table 6.2.3.1-1 provides an overview of the resources and applicable HTTP methods.

Table 6.2.3.1-1: Resources and methods overview

Resource name	Resource URI	HTTP method or custom operation	Description
Timers (Store)	/{realmId}/{storageId}/timers	GET	Search and retrieve timers matching a filter
		DELETE	Stop (delete) timers matching a filter
Individual Timer (Document)	/{realmId}/{storageId}/timers/{timerId}	PUT	Start (create) or update (replace) a timer
		PATCH	Modify a timer
		DELETE	Stop (delete) a timer
		GET	Retrieve a timer

6.2.3.2 Resource: Timers (Store)

6.2.3.2.1 Description

This resource represents the collection of timers within a storage. It can be used to search for specific timers matching specific filter criteria, and to delete specific timers matching specific filter criteria.

6.2.3.2.2 Resource Definition

Resource URI: **{apiRoot}/nudsf-timer/<apiVersion>/{realmId}/{storageId}/timers**

This resource shall support the resource URI variables defined in table 6.2.3.2.2-1.

Table 6.2.3.2.2-1: Resource URI variables for this resource

Name	Definition
apiRoot	See clause 6.1.1
realmId	Represents the realm Id.
storageId	Represents the storage Id.

6.2.3.2.3 Resource Standard Methods

6.2.3.2.3.1 GET

This method shall support the URI query parameters specified in table 6.2.3.2.3.1-1.

Table 6.2.3.2.3.1-1: URI query parameters supported by the GET method on this resource

Name	Data type	P	Cardinality	Description	Applicability
supported-features	SupportedFeatures	O	0..1	see 3GPP TS 29.500 [4] clause 6.6	
filter	SearchExpression	C	0..1	The filter criteria for searching the timers of the storage. Shall be present if expired-filter is absent; otherwise may be present.	
expired-filter	NullValue	C	0..1	A timer matches the expired-filter if the timer's expiry time is earlier than the current time. Shall be present if filter is absent; otherwise may be present.	
NOTE: If the query parameters filter and expired-filter are both present in the request, the result shall contain all timers that match both query parameters.					

This method shall support the request data structures specified in table 6.2.3.2.3.1-2 and the response data structures and response codes specified in table 6.2.3.2.3.1-3.

Table 6.2.3.2.3.1-2: Data structures supported by the GET Request Body on this resource

Data type	P	Cardinality	Description
n/a			

Table 6.2.3.2.3.1-3: Data structures supported by the GET Response Body on this resource

Data type	P	Cardinality	Response codes	Description
TimerIdList	M	1	200 OK	The search result containing the IDs of timers matching the filter.
n/a			204 No Content	The search did not result in any matching timers.
ProblemDetails	O	0..1	404 NOT FOUND	The "cause" attribute shall be set to one of the following application errors: -REALM_NOT_FOUND -STORAGE_NOT_FOUND
NOTE: The mandatory HTTP error status code for the GET method listed in Table 5.2.7.1-1 of 3GPP TS 29.500 [4] also apply.				

6.2.3.2.3.2 DELETE

This method shall support the URI query parameters specified in table 6.2.3.2.3.2-1.

Table 6.2.3.2.3.2-1: URI query parameters supported by the DELETE method on this resource

Name	Data type	P	Cardinality	Description	Applicability
supported-features	SupportedFeatures	O	0..1	see 3GPP TS 29.500 [4] clause 6.6	
filter	SearchExpression	C	0..1	The filter criteria for identifying the timers of the storage that are to be deleted. Shall be present if expired-filter is absent; otherwise may be present.	
expired-filter	NullValue	C	0..1	Presence of this query parameter indicates that only expired timers are to be deleted. Shall be present if filter is absent; otherwise may be present.	
NOTE: If the query parameters filter and expired-filter are both present in the request, all timers that match both query parameters shall be deleted.					

This method shall support the request data structures specified in table 6.2.3.2.3.2-2 and the response data structures and response codes specified in table 6.2.3.2.3.2-3.

Table 6.2.3.2.3.2-2: Data structures supported by the DELETE Request Body on this resource

Data type	P	Cardinality	Description
n/a			

Table 6.2.3.2.3.2-3: Data structures supported by the DELETE Response Body on this resource

Data type	P	Cardinality	Response codes	Description
TimerIdList	M	1	200 OK	Contains the list of timer IDs identifying the deleted timers.
n/a			204 No Content	The search did not result in any matching timers.
ProblemDetails	O	0..1	404 NOT FOUND	The "cause" attribute shall be set to one of the following application errors: -REALM_NOT_FOUND -STORAGE_NOT_FOUND
NOTE: The mandatory HTTP error status code for the GET method listed in Table 5.2.7.1-1 of 3GPP TS 29.500 [4] also apply.				

6.2.3.3 Resource: Individual Timer (Document)

6.2.3.3.1 Description

This resource represents an individual timer within a storage.

6.2.3.3.2 Resource Definition

Resource URI: **{apiRoot}/nudsf-timer/<apiVersion>/{realmId}/{storageId}/timers/{timerId}**

This resource shall support the resource URI variables defined in table 6.2.3.3.2-1.

Table 6.2.3.3.2-1: Resource URI variables for this resource

Name	Definition
apiRoot	See clause 6.1.1
realmId	Represents the realm Id.
storageId	Represents the storage Id.
timerId	Represents the timer Id.

6.2.3.3.3 Resource Standard Methods

6.2.3.3.3.1 PUT

This method shall support the URI query parameters specified in table 6.2.3.3.3.1-1.

Table 6.2.3.3.3.1-1: URI query parameters supported by the PUT method on this resource

Name	Data type	P	Cardinality	Description	Applicability
supported-features	SupportedFeatures	O	0..1	see 3GPP TS 29.500 [4] clause 6.6	

This method shall support the request data structures specified in table 6.2.3.3.3.1-2 and the response data structures and response codes specified in table 6.2.3.3.3.1-3.

Table 6.2.3.3.3.1-2: Data structures supported by the PUT Request Body on this resource

Data type	P	Cardinality	Description
Timer	M	1	The timer to be created or replaced.

Table 6.2.3.3.3.1-3: Data structures supported by the PUT Response Body on this resource

Data type	P	Cardinality	Response codes	Description
n/a			201 Created	Upon successful creation of a timer, an empty response shall be returned.
n/a			204 No Content	Upon successful replacement of a timer, an empty response shall be returned.
ProblemDetails	O	0..1	404 NOT FOUND	The "cause" attribute shall be set to one of the following application errors: -REALM_NOT_FOUND -STORAGE_NOT_FOUND
NOTE: The mandatory HTTP error status code for the PUT method listed in Table 5.2.7.1-1 of 3GPP TS 29.500 [4] also apply.				

6.2.3.3.3.2 PATCH

This method shall support the URI query parameters specified in table 6.2.3.3.3.2-1.

Table 6.2.3.3.3.2-1: URI query parameters supported by the PATCH method on this resource

Name	Data type	P	Cardinality	Description	Applicability
supported-features	SupportedFeatures	O	0..1	see 3GPP TS 29.500 [4] clause 6.6	

This method shall support the request data structures specified in table 6.2.3.3.3.2-2 and the response data structures and response codes specified in table 6.2.3.3.3.2-3.

Table 6.2.3.3.3.2-2: Data structures supported by the PATCH Request Body on this resource

Data type	P	Cardinality	Description
array(PatchItem)	M	1..N	Contains the delta data of the Timer to be updated.

Table 6.2.3.3.3.2-3: Data structures supported by the PATCH Response Body on this resource

Data type	P	Cardinality	Response codes	Description
n/a			204 No Content	Upon successful modification of a timer, an empty response shall be returned.
PatchResult	M	1	200 OK	Upon success, the execution report is returned. (NOTE 2)
ProblemDetails	O	0..1	404 NOT FOUND	The "cause" attribute shall be set to one of the following application errors: -REALM_NOT_FOUND -STORAGE_NOT_FOUND -TIMER_NOT_FOUND
NOTE 1: In addition common data structures as listed in table 6.1.7.3-1 are supported.				
NOTE 2: If all the modification instructions in the PATCH request have been implemented, the UDSF shall respond with 204 No Content response; if some of the modification instructions in the PATCH request have been discarded, the UDSF shall respond with 200 OK and include the PatchResult.				

6.2.3.3.3.3 DELETE

This method shall support the URI query parameters specified in table 6.2.3.3.3.3-1.

Table 6.2.3.3.3.3-1: URI query parameters supported by the DELETE method on this resource

Name	Data type	P	Cardinality	Description	Applicability
supported-features	SupportedFeatures	O	0..1	see 3GPP TS 29.500 [4] clause 6.6	

This method shall support the request data structures specified in table 6.2.3.3.3.3-2 and the response data structures and response codes specified in table 6.2.3.3.3.3-3.

Table 6.2.3.3.3.3-2: Data structures supported by the DELETE Request Body on this resource

Data type	P	Cardinality	Description
n/a			

Table 6.2.3.3.3-3: Data structures supported by the DELETE Response Body on this resource

Data type	P	Cardinality	Response codes	Description
n/a			204 No Content	Upon successful deletion of a timer, an empty response shall be returned.
ProblemDetails	O	0..1	404 NOT FOUND	The "cause" attribute shall be set to one of the following application errors: -REALM_NOT_FOUND -STORAGE_NOT_FOUND -TIMER_NOT_FOUND
NOTE: The mandatory HTTP error status code for the DELETE method listed in Table 5.2.7.1-1 of 3GPP TS 29.500 [4] also apply.				

6.2.3.3.4 GET

This method shall support the URI query parameters specified in table 6.2.3.3.4-1.

Table 6.2.3.3.4-1: URI query parameters supported by the GET method on this resource

Name	Data type	P	Cardinality	Description	Applicability
supported-features	SupportedFeatures	O	0..1	see 3GPP TS 29.500 [4] clause 6.6	

This method shall support the request data structures specified in table 6.2.3.3.4-2 and the response data structures and response codes specified in table 6.2.3.3.4-3.

Table 6.2.3.3.4-2: Data structures supported by the GET Request Body on this resource

Data type	P	Cardinality	Description
n/a			

Table 6.2.3.3.4-3: Data structures supported by the GET Response Body on this resource

Data type	P	Cardinality	Response codes	Description
Timer	M	1	200 OK	Upon success the timer shall be returned.
ProblemDetails	O	0..1	404 NOT FOUND	The "cause" attribute shall be set to one of the following application errors: -REALM_NOT_FOUND -STORAGE_NOT_FOUND -TIMER_NOT_FOUND
NOTE: The mandatory HTTP error status code for the DELETE method listed in Table 5.2.7.1-1 of 3GPP TS 29.500 [4] also apply.				

6.2.4 Custom Operations without associated resources

None.

6.2.5 Notifications

6.2.5.1 General

Notifications shall comply to clause 6.2 of 3GPP TS 29.500 [4] and clause 4.6.2.3 of 3GPP TS 29.501 [5].

6.2.5.2 Timer Expiry Notification

6.2.5.2.1 Description

The Timer Expiry Notification is used by the NF service producer to report to an NF Consumer that the Timer has expired as indicated by the expires attribute of Timer and if a callbackReference was set in the Timer.

6.2.5.2.2 Target URI

The Callback URI "{callbackReference}" shall be used with the callback URI variables defined in table 6.2.5.2.2-1.

Table 6.2.5.2.2-1: Target URI variables for this resource

Name	Definition
callbackReference	string formatted as URI with the Callback Uri

6.2.5.2.3 Standard Methods

6.2.5.2.3.1 POST

This method shall support the request data structures specified in table 6.2.5.2.3.1-1 and the response data structures and response codes specified in table 6.2.5.2.3.1-1.

Table 6.2.5.2.3.1-2: Data structures supported by the POST Request Body on this resource

Data type	P	Cardinality	Description
Timer	M	1	The timer that expired

Table 6.2.5.2.3.1-3: Data structures supported by the POST Response Body on this resource

Data type	P	Cardinality	Response codes	Description
n/a			204 No Content	Upon success, an empty response body shall be returned.
NOTE: The mandatory HTTP error status codes for the POST method listed in Table 5.2.7.1-1 of 3GPP TS 29.500 [4] also apply.				

6.2.6 Data Model

6.2.6.1 General

This clause specifies the application data model supported by the API.

Table 6.2.6.1-1 specifies the data types defined for the Nudsf_Timer service API. For simple data types defined for the Nudsf_Timer service API see table 6.2.6.3.2-1.

Table 6.2.6.1-1: Nudsf_Timer specific Data Types

Data type	Clause defined	Description	Applicability
Timer	6.2.6.2.2	Timer	

Table 6.2.6.1-2 specifies data types re-used by the Nudsf_Timer service API from other specifications and from other service APIs in current specification, including a reference to the respective specifications and when needed, a short description of their use within the Nudsf_Timer service API.

Table 6.2.6.1-2: Nudsf_Timer re-used Data Types

Data type	Reference	Comments	Applicability
SupportedFeatures	3GPP TS 29.571 [19]	see 3GPP TS 29.500 [4] clause 6.6.	
PatchItem	3GPP TS 29.571 [19]	Data structure used for JSON patch.	
PatchResult	3GPP TS 29.571 [19]		
Uri	3GPP TS 29.571 [19]		
DateTime	3GPP TS 29.571 [19]		
NullValue	3GPP TS 29.571 [19]		
DurationSec	3GPP TS 29.571 [19]		
SearchExpression	6.1.6.4.1	Defined in Nudsf_DataRepository API.	

6.2.6.2 Structured data types

6.2.6.2.1 Introduction

This clause defines the structures to be used in resource representations.

6.2.6.2.2 Type: Timer

Table 6.2.6.2.2-1: Definition of type Timer

Attribute name	Data type	P	Cardinality	Description	Applicability
timerId	TimerId	C	0..1	Identifier of the timer; shall be present in Notification request messages; otherwise shall be absent.	
expires	DateTime	M	1	Point in time of expiry For timer with periodicRepetition it refers to the first time the timer expires.	
metaTags	map(array(string))	O	1..N	A map (list of key-value pairs where tagName serves as key) of tagValue lists.	
callbackReference	Uri	O	0..1	The URI where the NF Service Consumer shall receive notification on the expiry of the Timer. Shall be absent from Notification request messages.	
deleteAfter	UInteger	O	0..1	If specified, the timer resource will be deleted following a period after the (last) expires time of the number of seconds defined by the deleteAfter value. If not specified, the timer shall be deleted immediately after the (last) expires time.	
periodicRepetition	DurationSec	O	0..1	If present, the timer shall be restarted after (each) expiry with the number of seconds defined by the periodicRepetition value, as often as indicated by the repetitionCount attribute.	PeriodicTimer
repetitionCount	UInteger	C	0..1	Shall be present if periodicRepetition is present. It indicates the number of repetitions after first expiry. Minimum value shall be 1.	PeriodicTimer

6.2.6.2.3 Type: TimerIdList

Table 6.2.6.2.3-1: Definition of type TimerIdList

Attribute name	Data type	P	Cardinality	Description	Applicability
timerIds	array(TimerId)	M	1..N	List of Timer IDs	

6.2.6.3 Simple data types and enumerations

6.2.6.3.1 Introduction

This clause defines simple data types and enumerations that can be referenced from data structures defined in the previous clauses.

6.2.6.3.2 Simple data types

The simple data types defined in table 6.2.6.3.2-1 shall be supported.

Table 6.2.6.3.2-1: Simple data types

Type Name	Type Definition	Description	Applicability
TimerId	string	Id of a timer. Used as reference.	

6.2.7 Error Handling

6.2.7.1 General

For the Nudsf_Timer API, HTTP error responses shall be supported as specified in clause 4.8 of 3GPP TS 29.501 [5]. Protocol errors and application errors specified in table 5.2.7.2-1 of 3GPP TS 29.500 [4] shall be supported for an HTTP method if the corresponding HTTP status codes are specified as mandatory for that HTTP method in table 5.2.7.1-1 of 3GPP TS 29.500 [4].

In addition, the requirements in the following clauses are applicable for the Nudsf_Timer API.

6.2.7.2 Protocol Errors

Protocol errors handling shall be supported as specified in clause 5.2.7 of 3GPP TS 29.500 [4].

6.2.7.3 Application Errors

The application errors defined for the Nudsf_Timer service are listed in Table 6.2.7.3-1.

Table 6.2.7.3-1: Application errors

Application Error	HTTP status code	Description
REALM_NOT_FOUND	404 Not Found	The realm indicated in the HTTP/2 request is unavailable in the UDSF.
STORAGE_NOT_FOUND	404 Not Found	The storage indicated in the HTTP/2 request is unavailable in the UDSF.
TIMER_NOT_FOUND	404 Not Found	The Timer indicated in the HTTP/2 request is unavailable in the UDSF.
EXPIRES_VALUE_NOT_ALLOWED	403 Forbidden	The timer could not be started as the expires time is in the past.

6.2.8 Feature negotiation

The optional features in table 6.1.8-1 are defined for the Nudsf_Timer API. They shall be negotiated using the extensibility mechanism defined in clause 6.6 of 3GPP TS 29.500 [4].

Table 6.2.8-1: Supported Features

Feature number	Feature Name	Description
1	PeriodicTimer	Support of periodic timer.

6.2.9 Security

As indicated in 3GPP TS 33.501 [8] and 3GPP TS 29.500 [4], the access to the Nudsf_Timer API may be authorized by means of the OAuth2 protocol (see IETF RFC 6749 [9]), based on local configuration, using the "Client Credentials" authorization grant, where the NRF (see 3GPP TS 29.510 [10]) plays the role of the authorization server.

If OAuth2 is used, an NF Service Consumer, prior to consuming services offered by the Nudsf_Timer API, shall obtain a "token" from the authorization server, by invoking the Access Token Request service, as described in 3GPP TS 29.510 [10], clause 5.4.2.2.

NOTE: When multiple NRFs are deployed in a network, the NRF used as authorization server is the same NRF that the NF Service Consumer used for discovering the Nudsf_Timer service.

The Nudsf_Timer API defines the following scopes for OAuth2 authorization.

Table 6.2.9-1: Oauth2 scopes defined in Nudsf_Timer API

Scope	Description
"nudsf-timer"	Access to the Nudsf_Timer API
"nudsf-timer:timer:read"	Access to read timers
"nudsf-timer:timer:modify"	Access to update timers
"nudsf-timer:timer:create"	Access to create timers

Annex A (normative): OpenAPI specification

A.1 General

This Annex specifies the formal definition of the API(s) defined in the present specification. It consists of OpenAPI 3.0.0 specifications in YAML format.

This Annex takes precedence when being discrepant to other parts of the specification with respect to the encoding of information elements and methods within the API(s).

NOTE: The semantics and procedures, as well as conditions, e.g. for the applicability and allowed combinations of attributes or values, not expressed in the OpenAPI definitions but defined in other parts of the specification also apply.

Informative copies of the OpenAPI specification files contained in this 3GPP Technical Specification are available on a Git-based repository that uses the GitLab software version control system (see 3GPP TS 29.501 [5] clause 5.3.1 and 3GPP TR 21.900 [7] clause 5B).

A.2 Nudsf_DataRepository API

```
openapi: 3.0.0
info:
  title: Nudsf_DataRepository
  version: 1.2.0
  description: |
    Nudsf Data Repository Service.
    © 2024, 3GPP Organizational Partners (ARIB, ATIS, CCSA, ETSI, TSDSI, TTA, TTC).
    All rights reserved.

externalDocs:
  description: 3GPP TS 29.598 UDSF Services, V18.6.0.
  url: 'https://www.3gpp.org/ftp/Specs/archive/29_series/29.598/'

servers:
  - url: '{apiRoot}/nudsf-dr/v1'
    variables:
      apiRoot:
        default: https://example.com
        description: apiRoot as defined in clause 4.4 of 3GPP TS 29.501

security:
  - {}
  - oAuth2ClientCredentials:
    - nudsf-dr

paths:
  /{realmId}/{storageId}/records:
    summary: Access to all Records of a Storage
    description: >
      root of all Records of a Storage
    get:
      summary: Records search with get
      description: Retrieve one or multiple Records based on filter
      operationId: SearchRecord
      tags:
        - Record CRUD
      security:
        - {}
        - oAuth2ClientCredentials:
          - nudsf-dr
        - oAuth2ClientCredentials:
          - nudsf-dr
          - nudsf-dr:record:read
      parameters:
        - name: realmId
```

```

    in: path
    description: Identifier of the Realm
    required: true
    schema:
      type: string
      example: Realm01
  - name: storageId
    in: path
    description: Identifier of the Storage
    required: true
    schema:
      type: string
      example: Storage01
  - name: limit-range
    in: query
    description: The most number of record references to fetch
    schema:
      $ref: 'TS29571_CommonData.yaml#/components/schemas/UInteger'
  - name: filter
    in: query
    description: Query filter using conditions on tags
    content:
      application/json:
        schema:
          $ref: '#/components/schemas/SearchExpression'
  - name: count-indicator
    in: query
    description: >
      Indicates whether the number of records that matched the criteria shall be returned.
    schema:
      type: boolean
      default: false
  - name: supported-features
    in: query
    description: Features required to be supported by the target NF
    schema:
      $ref: 'TS29571_CommonData.yaml#/components/schemas/SupportedFeatures'
  - name: retrieve-records
    in: query
    description: >
      Indicates whether the UDSF is requested to include matching records within the response.
    schema:
      $ref: '#/components/schemas/RetrieveRecords'
  - name: max-payload-size
    in: query
    description: Indicates the number of kilo octets the consumer is prepared to receive
    schema:
      $ref: 'TS29571_CommonData.yaml#/components/schemas/UInteger'
  - name: tag-count-filter
    in: query
    description: Indicates the parameters for advanced counting feature
    schema:
      $ref: '#/components/schemas/CountExpression'
responses:
  '200':
    description: Successful case. Response contains result of the search.
    content:
      application/json:
        schema:
          $ref: '#/components/schemas/RecordSearchResult'
  '204':
    description: >
      The search condition does not match any Record.
  '400':
    $ref: 'TS29571_CommonData.yaml#/components/responses/400'
  '401':
    $ref: 'TS29571_CommonData.yaml#/components/responses/401'
  '403':
    $ref: 'TS29571_CommonData.yaml#/components/responses/403'
  '404':
    $ref: 'TS29571_CommonData.yaml#/components/responses/404'
  '406':
    $ref: 'TS29571_CommonData.yaml#/components/responses/406'
  '429':
    $ref: 'TS29571_CommonData.yaml#/components/responses/429'
  '500':
    $ref: 'TS29571_CommonData.yaml#/components/responses/500'
  '502':

```

```

    $ref: 'TS29571_CommonData.yaml#/components/responses/502'
  '503':
    $ref: 'TS29571_CommonData.yaml#/components/responses/503'
  default:
    $ref: 'TS29571_CommonData.yaml#/components/responses/default'
delete:
  summary: Bulk Deletion of Records
  description: Delete multiple Records based on filter
  operationId: BulkDeleteRecords
  tags:
    - Record CRUD
  security:
    - {}
    - oAuth2ClientCredentials:
      - nudsf-dr
    - oAuth2ClientCredentials:
      - nudsf-dr
      - nudsf-dr:record:modify
  parameters:
    - name: realmId
      in: path
      description: Identifier of the Realm
      required: true
      schema:
        type: string
        example: Realm01
    - name: storageId
      in: path
      description: Identifier of the Storage
      required: true
      schema:
        type: string
        example: Storage01
    - name: filter
      in: query
      required: true
      content:
        application/json:
          schema:
            $ref: '#/components/schemas/SearchExpression'
    - name: supported-features
      in: query
      description: Features required to be supported by the target NF
      schema:
        $ref: 'TS29571_CommonData.yaml#/components/schemas/SupportedFeatures'
responses:
  '200':
    description: Successful case. Response contains RecordIdList.
    content:
      application/json:
        schema:
          $ref: '#/components/schemas/RecordIdList'
  '204':
    description: Successful case.
  '400':
    $ref: 'TS29571_CommonData.yaml#/components/responses/400'
  '401':
    $ref: 'TS29571_CommonData.yaml#/components/responses/401'
  '403':
    $ref: 'TS29571_CommonData.yaml#/components/responses/403'
  '404':
    $ref: 'TS29571_CommonData.yaml#/components/responses/404'
  '406':
    $ref: 'TS29571_CommonData.yaml#/components/responses/406'
  '429':
    $ref: 'TS29571_CommonData.yaml#/components/responses/429'
  '500':
    $ref: 'TS29571_CommonData.yaml#/components/responses/500'
  '502':
    $ref: 'TS29571_CommonData.yaml#/components/responses/502'
  '503':
    $ref: 'TS29571_CommonData.yaml#/components/responses/503'
  default:
    $ref: 'TS29571_CommonData.yaml#/components/responses/default'
/{realmId}/{storageId}/records/{recordId}:
  summary: Access to a specific Record, identified by its RecordId
  description: >

```

```

    Access to a specific Record
get:
  summary: Record access
  description: retrieve one specific Record
  operationId: GetRecord
  tags:
  - Record CRUD
  security:
  - {}
  - oAuth2ClientCredentials:
    - nudsf-dr
  - oAuth2ClientCredentials:
    - nudsf-dr
    - nudsf-dr:record:read
  parameters:
  - name: realmId
    in: path
    description: Identifier of the Realm
    required: true
    schema:
      type: string
      example: Realm01
  - name: storageId
    in: path
    description: Identifier of the Storage
    required: true
    schema:
      type: string
      example: Storage01
  - name: recordId
    in: path
    description: Identifier of the Record
    required: true
    schema:
      type: string
      example: 'UserRecordValue000000001'
  - name: If-None-Match
    in: header
    description: Validator for conditional requests, as described in RFC 9110, 13.1.2
    schema:
      type: string
  - name: If-Modified-Since
    in: header
    description: Validator for conditional requests, as described in RFC 9110, 13.1.3
    schema:
      type: string
  - name: supported-features
    in: query
    description: Features required to be supported by the target NF
    schema:
      $ref: 'TS29571_CommonData.yaml#/components/schemas/SupportedFeatures'
  responses:
    '200': #result ok
      $ref: '#/components/responses/RecordBody'
    '304':
      $ref: '#/components/responses/304'
    '400':
      $ref: 'TS29571_CommonData.yaml#/components/responses/400'
    '401':
      $ref: 'TS29571_CommonData.yaml#/components/responses/401'
    '403':
      $ref: 'TS29571_CommonData.yaml#/components/responses/403'
    '404':
      $ref: 'TS29571_CommonData.yaml#/components/responses/404'
    '406':
      $ref: 'TS29571_CommonData.yaml#/components/responses/406'
    '412':
      $ref: '#/components/responses/412'
    '429':
      $ref: 'TS29571_CommonData.yaml#/components/responses/429'
    '500':
      $ref: '#/components/responses/500'
    '502':
      $ref: 'TS29571_CommonData.yaml#/components/responses/502'
    '503':
      $ref: 'TS29571_CommonData.yaml#/components/responses/503'
  default:
    $ref: 'TS29571_CommonData.yaml#/components/responses/default'

```



```

put:
  summary: Create/Modify Record
  description: Create or Modify a Record with a user provided RecordId
  operationId: CreateOrModifyRecord
  tags:
    - Record CRUD
  security:
    - {}
    - oAuth2ClientCredentials:
      - nudsf-dr
    - oAuth2ClientCredentials:
      - nudsf-dr
      - nudsf-dr:record:create
  parameters:
    - name: realmId
      in: path
      description: Identifier(name) of the Realm
      required: true
      schema:
        type: string
        example: Realm01
    - name: storageId
      in: path
      description: Identifier of the Storage
      required: true
      schema:
        type: string
        example: Storage01
    - name: recordId
      in: path
      description: Identifier of the Record
      required: true
      schema:
        type: string
        example: UserRecordValue000000001
    - name: If-None-Match
      in: header
      description: Validator for conditional requests, as described in RFC 9110, 13.1.2
      schema:
        type: string
    - name: If-Match
      in: header
      description: Record validator for conditional requests, as described in RFC 9110, 13.1.2
      schema:
        type: string
    - name: get-previous
      in: query
      description: Retrieve the Record before update
      required: false
      schema:
        type: boolean
        default: false
    - name: supported-features
      in: query
      description: Features required to be supported by the target NF
      schema:
        $ref: 'TS29571_CommonData.yaml#/components/schemas/SupportedFeatures'
  requestBody:
    $ref: '#/components/requestBodies/RecordBody'
  callbacks:
    recordExpired:
      '{$request.body#/callbackReference}':
        post:
          parameters:
            - name: Content-Location
              in: header
              description: The expired record URI
              schema:
                $ref: 'TS29571_CommonData.yaml#/components/schemas/Uri'
          requestBody:
            $ref: '#/components/requestBodies/RecordBody'
          responses:
            '204':
              description: Callback executed successfully
            '400':
              $ref: 'TS29571_CommonData.yaml#/components/responses/400'
            '401':
              $ref: 'TS29571_CommonData.yaml#/components/responses/401'

```

```

    '403':
      $ref: 'TS29571_CommonData.yaml#/components/responses/403'
    '404':
      $ref: 'TS29571_CommonData.yaml#/components/responses/404'
    '411':
      $ref: 'TS29571_CommonData.yaml#/components/responses/411'
    '413':
      $ref: 'TS29571_CommonData.yaml#/components/responses/413'
    '415':
      $ref: 'TS29571_CommonData.yaml#/components/responses/415'
    '429':
      $ref: 'TS29571_CommonData.yaml#/components/responses/429'
    '500':
      $ref: 'TS29571_CommonData.yaml#/components/responses/500'
    '502':
      $ref: 'TS29571_CommonData.yaml#/components/responses/502'
    '503':
      $ref: 'TS29571_CommonData.yaml#/components/responses/503'
    default:
      $ref: 'TS29571_CommonData.yaml#/components/responses/default'
responses:
  '200' : # Update with return
    $ref: '#/components/responses/RecordBody'
  '201':
    description: >
      Create case. The resource has been successfully created, location header indicates
      the URI of the created Record.
    content:
      multipart/mixed:
        schema:
          $ref: '#/components/schemas/Record'
        encoding:
          meta: # The meta part shall be the first part and is mandatory but can be empty.
            contentType: application/json
            headers:
              Content-Id: # The meta part is identified by the 'meta' Content-Id header.
                schema:
                  type: string
                  required: true
            blocks: # Zero or more block parts may follow the meta part
              contentType: '*/*' # Block parts can be of any type.
              headers:
                Content-Id: # Block identifier is defined by the Content-Id header.
                  schema:
                    type: string
                    required: true
                Content-Transfer-Encoding:
                  schema:
                    type: string
                    required: true
            headers:
              Location:
                $ref: '#/components/headers/Location'
              Cache-Control:
                $ref: '#/components/headers/Cache-Control'
              ETag:
                $ref: '#/components/headers/ETag'
              Last-Modified:
                $ref: '#/components/headers/Last-Modified'
  '204': # Update without return
    description: >
      Update case. The resource has been successfully updated and no
      additional content is included in the response message.
    headers:
      Cache-Control:
        $ref: '#/components/headers/Cache-Control'
      ETag:
        $ref: '#/components/headers/ETag'
      Last-Modified:
        $ref: '#/components/headers/Last-Modified'
  '304':
    $ref: '#/components/responses/304'
  '400':
    $ref: 'TS29571_CommonData.yaml#/components/responses/400'
  '401':
    $ref: 'TS29571_CommonData.yaml#/components/responses/401'
  '403':
    $ref: 'TS29571_CommonData.yaml#/components/responses/403'

```

```

'404':
  $ref: 'TS29571_CommonData.yaml#/components/responses/404'
'408':
  $ref: 'TS29571_CommonData.yaml#/components/responses/408'
'409':
  $ref: '#/components/responses/409'
'411':
  $ref: 'TS29571_CommonData.yaml#/components/responses/411'
'412': # Return Record value if get-previous=true
  $ref: '#/components/responses/RecordBody'
'413':
  $ref: 'TS29571_CommonData.yaml#/components/responses/413'
'415':
  $ref: 'TS29571_CommonData.yaml#/components/responses/415'
'429':
  $ref: 'TS29571_CommonData.yaml#/components/responses/429'
'500':
  $ref: 'TS29571_CommonData.yaml#/components/responses/500'
'502':
  $ref: 'TS29571_CommonData.yaml#/components/responses/502'
'503':
  $ref: 'TS29571_CommonData.yaml#/components/responses/503'
default:
  $ref: 'TS29571_CommonData.yaml#/components/responses/default'

patch:
  summary: Partial update Record
  description: Partial update Record with a user provided RecordId
  operationId: PatchRecord
  tags:
    - Record CRUD
  security:
    - {}
    - oAuth2ClientCredentials:
        - nudsf-dr
    - oAuth2ClientCredentials:
        - nudsf-dr
        - nudsf-dr:record:modify
  parameters:
    - name: realmId
      in: path
      description: Identifier(name) of the Realm
      required: true
      schema:
        type: string
        example: Realm01
    - name: storageId
      in: path
      description: Identifier of the Storage
      required: true
      schema:
        type: string
        example: Storage01
    - name: recordId
      in: path
      description: Identifier of the Record
      required: true
      schema:
        type: string
        example: UserRecordValue000000001
    - name: If-Match
      in: header
      description: Record validator for conditional requests, as described in RFC 7232, 3.2
      schema:
        type: string
    - name: supported-features
      in: query
      description: Features required to be supported by the target NF
      schema:
        $ref: 'TS29571_CommonData.yaml#/components/schemas/SupportedFeatures'
  requestBody:
    $ref: '#/components/requestBodies/RecordPatchBody'
  callbacks:
    recordExpired:
      '{$request.body#/callbackReference}':
        post:
          parameters:
            - name: Content-Location

```

```

      in: header
      description: The expired record URI
      schema:
        $ref: 'TS29571_CommonData.yaml#/components/schemas/Uri'
    requestBody:
      $ref: '#/components/requestBodies/RecordBody'
    responses:
      '204':
        description: Callback executed successfully
      '400':
        $ref: 'TS29571_CommonData.yaml#/components/responses/400'
      '401':
        $ref: 'TS29571_CommonData.yaml#/components/responses/401'
      '403':
        $ref: 'TS29571_CommonData.yaml#/components/responses/403'
      '404':
        $ref: 'TS29571_CommonData.yaml#/components/responses/404'
      '411':
        $ref: 'TS29571_CommonData.yaml#/components/responses/411'
      '413':
        $ref: 'TS29571_CommonData.yaml#/components/responses/413'
      '415':
        $ref: 'TS29571_CommonData.yaml#/components/responses/415'
      '429':
        $ref: 'TS29571_CommonData.yaml#/components/responses/429'
      '500':
        $ref: 'TS29571_CommonData.yaml#/components/responses/500'
      '502':
        $ref: 'TS29571_CommonData.yaml#/components/responses/502'
      '503':
        $ref: 'TS29571_CommonData.yaml#/components/responses/503'
      default:
        $ref: 'TS29571_CommonData.yaml#/components/responses/default'
  responses:
    '204': # Updated successfully
      description: >
        Successful case. The record has been successfully updated and no return is expected.
      headers:
        Cache-Control:
          $ref: '#/components/headers/Cache-Control'
        ETag:
          $ref: '#/components/headers/ETag'
        Last-Modified:
          $ref: '#/components/headers/Last-Modified'
    '304':
      $ref: '#/components/responses/304'
    '400':
      $ref: 'TS29571_CommonData.yaml#/components/responses/400'
    '401':
      $ref: 'TS29571_CommonData.yaml#/components/responses/401'
    '403':
      $ref: 'TS29571_CommonData.yaml#/components/responses/403'
    '404':
      $ref: 'TS29571_CommonData.yaml#/components/responses/404'
    '408':
      $ref: 'TS29571_CommonData.yaml#/components/responses/408'
    '409':
      $ref: '#/components/responses/409'
    '411':
      $ref: 'TS29571_CommonData.yaml#/components/responses/411'
    '412':
      $ref: '#/components/responses/412'
    '413':
      $ref: 'TS29571_CommonData.yaml#/components/responses/413'
    '415':
      $ref: 'TS29571_CommonData.yaml#/components/responses/415'
    '422': # One or more instructions could not be applied. Record is not modified
      description: >
        If one or more modification instructions cannot be applied,
        no changes shall be made to record, the execution report is returned.
      content:
        application/json:
          example:
            schema:
              $ref: 'TS29571_CommonData.yaml#/components/schemas/PatchResult'
    '429':
      $ref: 'TS29571_CommonData.yaml#/components/responses/429'
    '500':

```

```

    $ref: 'TS29571_CommonData.yaml#/components/responses/500'
  '502':
    $ref: 'TS29571_CommonData.yaml#/components/responses/502'
  '503':
    $ref: 'TS29571_CommonData.yaml#/components/responses/503'
  default:
    $ref: 'TS29571_CommonData.yaml#/components/responses/default'

```

delete:

```

summary: Delete a Record with an user provided RecordId
operationId: DeleteRecord
tags:
  - Record CRUD
security:
  - {}
  - oAuth2ClientCredentials:
    - nudsf-dr
  - oAuth2ClientCredentials:
    - nudsf-dr
    - nudsf-dr:record:modify
parameters:
  - name: realmId
    in: path
    description: Identifier(name) of the Realm
    required: true
    schema:
      type: string
      example: Realm01
  - name: storageId
    in: path
    description: Identifier of the Storage
    required: true
    schema:
      type: string
      example: Storage01
  - name: recordId
    in: path
    description: Identifier of the Record
    required: true
    schema:
      type: string
      example: UserRecordValue000000001
  - name: If-Match
    in: header
    description: Record validator for conditional requests, as described in RFC 9110, 13.1.1
    schema:
      type: string
  - name: get-previous
    in: query
    description: Retrieve the Record before delete
    required: false
    schema:
      type: boolean
      default: false
  - name: supported-features
    in: query
    description: Features required to be supported by the target NF
    schema:
      $ref: 'TS29571_CommonData.yaml#/components/schemas/SupportedFeatures'
responses:
  '200':
    $ref: '#/components/responses/RecordBodyDelete'
  '204':
    description: Successful case.
    headers:
      ETag:
        $ref: '#/components/headers/ETag'
      Last-Modified:
        $ref: '#/components/headers/Last-Modified'
  '304':
    $ref: '#/components/responses/304'
  '400':
    $ref: 'TS29571_CommonData.yaml#/components/responses/400'
  '401':
    $ref: 'TS29571_CommonData.yaml#/components/responses/401'
  '403':
    $ref: 'TS29571_CommonData.yaml#/components/responses/403'
  '404':

```

```

    $ref: 'TS29571_CommonData.yaml#/components/responses/404'
  '408':
    $ref: 'TS29571_CommonData.yaml#/components/responses/408'
  '412': # Return return value if get-previous=true
    $ref: '#/components/responses/RecordBody'
  '429':
    $ref: 'TS29571_CommonData.yaml#/components/responses/429'
  '500':
    $ref: 'TS29571_CommonData.yaml#/components/responses/500'
  '502':
    $ref: 'TS29571_CommonData.yaml#/components/responses/502'
  '503':
    $ref: 'TS29571_CommonData.yaml#/components/responses/503'
  default:
    $ref: 'TS29571_CommonData.yaml#/components/responses/default'

/{realmId}/{storageId}/records/{recordId}/meta:
  summary: Access to the meta of a specific Record, identified by its RecordId
  description: >
    Access to the meta of a specific Record
  get:
    summary: Record's meta access
    description: retrieve meta of a specific Record
    operationId: GetMeta
    tags:
      - Record CRUD
    security:
      - {}
      - oAuth2ClientCredentials:
          - nudsf-dr
      - oAuth2ClientCredentials:
          - nudsf-dr
          - nudsf-dr:record-meta:read
    parameters:
      - name: realmId
        in: path
        description: Identifier of the Realm
        required: true
        schema:
          type: string
          example: Realm01
      - name: storageId
        in: path
        description: Identifier of the Storage
        required: true
        schema:
          type: string
          example: Storage01
      - name: recordId
        in: path
        description: Identifier of the Record
        required: true
        schema:
          type: string
          example: 'UserRecordValue000000001'
      - name: If-None-Match
        in: header
        description: Validator for conditional requests, as described in RFC 9110, 13.1.2
        schema:
          type: string
      - name: If-Modified-Since
        in: header
        description: Validator for conditional requests, as described in RFC 9110, 13.1.3
        schema:
          type: string
      - name: supported-features
        in: query
        description: Features required to be supported by the target NF
        schema:
          $ref: 'TS29571_CommonData.yaml#/components/schemas/SupportedFeatures'
    responses:
      '200':
        description: Expected response to a valid request
        headers:
          Cache-Control:
            $ref: '#/components/headers/Cache-Control'
          ETag:
            $ref: '#/components/headers/ETag'

```

```

    Last-Modified:
      $ref: '#/components/headers/Last-Modified'
  content:
    application/json:
      schema:
        $ref: '#/components/schemas/RecordMeta'
'304':
  $ref: '#/components/responses/304'
'400':
  $ref: 'TS29571_CommonData.yaml#/components/responses/400'
'401':
  $ref: 'TS29571_CommonData.yaml#/components/responses/401'
'403':
  $ref: 'TS29571_CommonData.yaml#/components/responses/403'
'404':
  $ref: 'TS29571_CommonData.yaml#/components/responses/404'
'406':
  $ref: 'TS29571_CommonData.yaml#/components/responses/406'
'412':
  $ref: '#/components/responses/412'
'429':
  $ref: 'TS29571_CommonData.yaml#/components/responses/429'
'500':
  $ref: '#/components/responses/500'
'502':
  $ref: 'TS29571_CommonData.yaml#/components/responses/502'
'503':
  $ref: 'TS29571_CommonData.yaml#/components/responses/503'
default:
  $ref: 'TS29571_CommonData.yaml#/components/responses/default'
patch: # patch meta data
  summary: Record's meta update
  description: update meta of a specific Record
  operationId: UpdateMeta
  tags:
    - Record CRUD
  security:
    - {}
    - OAuth2ClientCredentials:
      - nudsf-dr
    - OAuth2ClientCredentials:
      - nudsf-dr
      - nudsf-dr:record-meta:modify
  parameters:
    - name: realmId
      in: path
      description: Identifier of the Realm
      required: true
      schema:
        type: string
        example: Realm01
    - name: storageId
      in: path
      description: Identifier of the Storage
      required: true
      schema:
        type: string
        example: Storage01
    - name: recordId
      in: path
      description: Identifier of the Record
      required: true
      schema:
        type: string
        example: 'UserRecordValue000000001'
    - name: If-Match
      in: header
      description: Record validator for conditional requests, as described in RFC 9110, 13.1.1
      schema:
        type: string
    - name: supported-features
      in: query
      description: Features required to be supported by the target NF
      schema:
        $ref: 'TS29571_CommonData.yaml#/components/schemas/SupportedFeatures'
  requestBody:
    description: Meta data to patch
    content:

```

```

    application/json-patch+json:
      example: ' [{ "op": "replace", "path": "/tags/ueId", "value": "450005" }, { "op":
"remove", "path": "/tags/recordId" } ]'
      schema:
        type: array
        items:
          $ref: 'TS29571_CommonData.yaml#/components/schemas/PatchItem'
        minItems: 1
      required: true
    responses:
      '200':
        description: >
          One or more modification instructions have been discarded,
          the execution report is returned in response PatchResult.
        content:
          application/json:
            example:
              schema:
                $ref: 'TS29571_CommonData.yaml#/components/schemas/PatchResult'
            headers:
              Cache-Control:
                $ref: '#/components/headers/Cache-Control'
              ETag:
                $ref: '#/components/headers/ETag'
              Last-Modified:
                $ref: '#/components/headers/Last-Modified'
      '204':
        description: >
          Successful case. The meta has been successfully updated and no return is expected.
        headers:
          Cache-Control:
            $ref: '#/components/headers/Cache-Control'
          ETag:
            $ref: '#/components/headers/ETag'
          Last-Modified:
            $ref: '#/components/headers/Last-Modified'
      '304':
        $ref: '#/components/responses/304'
      '400':
        $ref: 'TS29571_CommonData.yaml#/components/responses/400'
      '401':
        $ref: 'TS29571_CommonData.yaml#/components/responses/401'
      '403':
        $ref: 'TS29571_CommonData.yaml#/components/responses/403'
      '404':
        $ref: 'TS29571_CommonData.yaml#/components/responses/404'
      '408':
        $ref: 'TS29571_CommonData.yaml#/components/responses/408'
      '409':
        $ref: '#/components/responses/409'
      '411':
        $ref: 'TS29571_CommonData.yaml#/components/responses/411'
      '412':
        $ref: '#/components/responses/412'
      '413':
        $ref: 'TS29571_CommonData.yaml#/components/responses/413'
      '415':
        $ref: 'TS29571_CommonData.yaml#/components/responses/415'
      '429':
        $ref: 'TS29571_CommonData.yaml#/components/responses/429'
      '500':
        $ref: 'TS29571_CommonData.yaml#/components/responses/500'
      '502':
        $ref: 'TS29571_CommonData.yaml#/components/responses/502'
      '503':
        $ref: 'TS29571_CommonData.yaml#/components/responses/503'
      default:
        $ref: 'TS29571_CommonData.yaml#/components/responses/default'

/{realmId}/{storageId}/records/{recordId}/blocks:
  summary: Access to the Blocks of a specific Record, identified by its RecordId
  description: >
    Access to the Blocks of a specific Record
  get:
    summary: Record's Blocks access
    description: retrieve all Blocks of a specific Record
    operationId: GetBlockList
    tags:

```



```

- Block CRUD
security:
- {}
- oAuth2ClientCredentials:
- nudsf-dr
- oAuth2ClientCredentials:
- nudsf-dr
- nudsf-dr:block:read
parameters:
- name: realmId
in: path
description: Identifier of the Realm
required: true
schema:
type: string
example: Realm01
- name: storageId
in: path
description: Identifier of the Storage
required: true
schema:
type: string
example: Storage01
- name: recordId
in: path
description: Identifier of the Record
required: true
schema:
type: string
example: 'UserRecordValue000000001'
- name: supported-features
in: query
description: Features required to be supported by the target NF
schema:
$ref: 'TS29571_CommonData.yaml#/components/schemas/SupportedFeatures'
responses:
'200':
description: Expected response to a successful request
headers:
Cache-Control:
$ref: '#/components/headers/Cache-Control'
ETag:
$ref: '#/components/headers/ETag'
Last-Modified:
$ref: '#/components/headers/Last-Modified'
content:
multipart/parallel:
schema:
type: object
properties:
blocks:
type: array
description: >
an array of Block parts, can be empty
items:
$ref: '#/components/schemas/Block'
encoding:
blocks:
contentType: '*/*' # Block content type can be of any type.
headers:
Content-Id: # Block identifier is defined by the Content-Id header.
schema:
type: string
required: true
Content-Transfer-Encoding:
schema:
type: string
required: true
'204':
description: Successful response, the record contains no blocks
'400':
$ref: 'TS29571_CommonData.yaml#/components/responses/400'
'401':
$ref: 'TS29571_CommonData.yaml#/components/responses/401'
'403':
$ref: 'TS29571_CommonData.yaml#/components/responses/403'
'404':
$ref: 'TS29571_CommonData.yaml#/components/responses/404'

```

```

'406':
  $ref: 'TS29571_CommonData.yaml#/components/responses/406'
'412':
  $ref: '#/components/responses/412'
'429':
  $ref: 'TS29571_CommonData.yaml#/components/responses/429'
'500':
  $ref: '#/components/responses/500'
'502':
  $ref: 'TS29571_CommonData.yaml#/components/responses/502'
'503':
  $ref: 'TS29571_CommonData.yaml#/components/responses/503'
default:
  $ref: 'TS29571_CommonData.yaml#/components/responses/default'

/{realmId}/{storageId}/records/{recordId}/blocks/{blockId}:
summary: Access to a Block of a specific Record, identified by its BlockId
description: >
  Access to a specific Block of a specific Record
get:
summary: Retrieve a specific Block
description: retrieve a specific Block
operationId: GetBlock
tags:
- Block CRUD
security:
- {}
- oAuth2ClientCredentials:
  - nudsf-dr
- oAuth2ClientCredentials:
  - nudsf-dr
  - nudsf-dr:block:read
parameters:
- name: realmId
  in: path
  description: Identifier of the Realm
  required: true
  schema:
    type: string
    example: Realm01
- name: storageId
  in: path
  description: Identifier of the Storage
  required: true
  schema:
    type: string
    example: Storage01
- name: recordId
  in: path
  description: Identifier of the Record
  required: true
  schema:
    type: string
    example: 'UserRecordValue0000000001'
- name: blockId
  in: path
  description: Id of the Block
  required: true
  schema:
    type: string
    example: 'userDefjson01'
- name: If-None-Match
  in: header
  description: Validator for conditional requests, as described in RFC 9110, 13.1.2
  schema:
    type: string
- name: If-Modified-Since
  in: header
  description: Validator for conditional requests, as described in RFC 9110, 13.1.3
  schema:
    type: string
- name: supported-features
  in: query
  description: Features required to be supported by the target NF
  schema:
    $ref: 'TS29571_CommonData.yaml#/components/schemas/SupportedFeatures'
responses:
  '200':

```

```

    $ref: '#/components/responses/BlockBody'
  '304':
    $ref: '#/components/responses/304'
  '400':
    $ref: 'TS29571_CommonData.yaml#/components/responses/400'
  '401':
    $ref: 'TS29571_CommonData.yaml#/components/responses/401'
  '403':
    $ref: 'TS29571_CommonData.yaml#/components/responses/403'
  '404':
    $ref: 'TS29571_CommonData.yaml#/components/responses/404'
  '406':
    $ref: 'TS29571_CommonData.yaml#/components/responses/406'
  '412':
    $ref: '#/components/responses/412'
  '429':
    $ref: 'TS29571_CommonData.yaml#/components/responses/429'
  '500':
    $ref: '#/components/responses/500'
  '502':
    $ref: 'TS29571_CommonData.yaml#/components/responses/502'
  '503':
    $ref: 'TS29571_CommonData.yaml#/components/responses/503'
  default:
    $ref: 'TS29571_CommonData.yaml#/components/responses/default'
put:
  summary: Create or Update a specific Block in a Record.
  description: Create or update a specific Block, related to a Record
  operationId: CreateOrModifyBlock
  tags:
  - Block CRUD
  security:
  - {}
  - oAuth2ClientCredentials:
    - nudsf-dr
  - oAuth2ClientCredentials:
    - nudsf-dr
    - nudsf-dr:block:create
  parameters:
  - name: realmId
    in: path
    description: Identifier of the Realm
    required: true
    schema:
      type: string
      example: Realm01
  - name: storageId
    in: path
    description: Identifier of the Storage
    required: true
    schema:
      type: string
      example: Storage01
  - name: recordId
    in: path
    description: Identifier of the Record
    required: true
    schema:
      type: string
      example: 'UserRecordValue000000001'
  - name: blockId
    in: path
    description: Id of the Block
    required: true
    schema:
      type: string
      example: 'userDefjson01'
  - name: get-previous
    in: query
    description: Retrieve the Block before update
    required: false
    schema:
      type: boolean
      default: false
  - name: If-None-Match
    in: header
    description: Validator for conditional requests, as described in RFC 9110, 13.1.2
    schema:

```

```

    type: string
  - name: If-Match
    in: header
    description: Record validator for conditional requests, as described in RFC 9110, 13.1.1
    schema:
      type: string
  - name: supported-features
    in: query
    description: Features required to be supported by the target NF
    schema:
      $ref: 'TS29571_CommonData.yaml#/components/schemas/SupportedFeatures'
requestBody:
  description: information on the Block to create
  required: true
  content:
    '*/*':
      schema:
        $ref: '#/components/schemas/Block'
responses:
  '200':
    $ref: '#/components/responses/BlockBody'
  '201':
    description: >
      Creation case. The Block has been successfully created.
      Location header indicates the URI of the created Block.
    headers:
      Location:
        $ref: '#/components/headers/Location'
      Cache-Control:
        $ref: '#/components/headers/Cache-Control'
      ETag:
        $ref: '#/components/headers/ETag'
      Last-Modified:
        $ref: '#/components/headers/Last-Modified'
  '204':
    description: >
      Successful case. The resource has been successfully updated.
    headers:
      Cache-Control:
        $ref: '#/components/headers/Cache-Control'
      ETag:
        $ref: '#/components/headers/ETag'
      Last-Modified:
        $ref: '#/components/headers/Last-Modified'
  '400':
    $ref: 'TS29571_CommonData.yaml#/components/responses/400'
  '401':
    $ref: 'TS29571_CommonData.yaml#/components/responses/401'
  '403':
    $ref: 'TS29571_CommonData.yaml#/components/responses/403'
  '404':
    $ref: 'TS29571_CommonData.yaml#/components/responses/404'
  '408':
    $ref: 'TS29571_CommonData.yaml#/components/responses/408'
  '409':
    $ref: '#/components/responses/409'
  '411':
    $ref: 'TS29571_CommonData.yaml#/components/responses/411'
  '412': # Return previous Block value if get-previous=true
    $ref: '#/components/responses/BlockBody'
  '413':
    $ref: 'TS29571_CommonData.yaml#/components/responses/413'
  '415':
    $ref: 'TS29571_CommonData.yaml#/components/responses/415'
  '429':
    $ref: 'TS29571_CommonData.yaml#/components/responses/429'
  '500':
    $ref: 'TS29571_CommonData.yaml#/components/responses/500'
  '502':
    $ref: 'TS29571_CommonData.yaml#/components/responses/502'
  '503':
    $ref: 'TS29571_CommonData.yaml#/components/responses/503'
  default:
    $ref: 'TS29571_CommonData.yaml#/components/responses/default'
delete:
  summary: Delete a specific Block. Then update the Record
  description: delete a specific Block, related to a Record
  operationId: DeleteBlock

```

```

tags:
- Block CRUD
security:
- {}
- oAuth2ClientCredentials:
  - nudsf-dr
- oAuth2ClientCredentials:
  - nudsf-dr
  - nudsf-dr:block:modify
parameters:
- name: realmId
  in: path
  description: Identifier of the Realm
  required: true
  schema:
    type: string
    example: Realm01
- name: storageId
  in: path
  description: Identifier of the Storage
  required: true
  schema:
    type: string
    example: Storage01
- name: recordId
  in: path
  description: Identifier of the Record
  required: true
  schema:
    type: string
    example: 'UserRecordValue000000001'
- name: blockId
  in: path
  description: Id of the Block
  required: true
  schema:
    type: string
    example: 'userDefjson01'
- name: get-previous
  in: query
  description: Retrieve the Block before delete
  required: false
  schema:
    type: boolean
    default: false
- name: If-Match
  in: header
  description: Record validator for conditional requests, as described in RFC 9110, 13.1.1
  schema:
    type: string
- name: supported-features
  in: query
  description: Features required to be supported by the target NF
  schema:
    $ref: 'TS29571_CommonData.yaml#/components/schemas/SupportedFeatures'
responses:
'200':
  $ref: '#/components/responses/BlockBodyDelete'
'204':
  description: >
    Successful case. The Block has been successfully deleted.
  headers:
    ETag:
      $ref: '#/components/headers/ETag'
    Last-Modified:
      $ref: '#/components/headers/Last-Modified'
'400':
  $ref: 'TS29571_CommonData.yaml#/components/responses/400'
'401':
  $ref: 'TS29571_CommonData.yaml#/components/responses/401'
'403':
  $ref: 'TS29571_CommonData.yaml#/components/responses/403'
'404':
  $ref: 'TS29571_CommonData.yaml#/components/responses/404'
'408':
  $ref: 'TS29571_CommonData.yaml#/components/responses/408'
'412': # Return previous Block value if get-previous=true
  $ref: '#/components/responses/BlockBody'

```

```

'429':
  $ref: 'TS29571_CommonData.yaml#/components/responses/429'
'500':
  $ref: 'TS29571_CommonData.yaml#/components/responses/500'
'502':
  $ref: 'TS29571_CommonData.yaml#/components/responses/502'
'503':
  $ref: 'TS29571_CommonData.yaml#/components/responses/503'
default:
  $ref: 'TS29571_CommonData.yaml#/components/responses/default'

/{realmId}/{storageId}/subs-to-notify:
  summary: The notification subscription collection resource
  description: >
    Access to the subscription resource
  get:
    summary: Notification subscription retrieval
    description: retrieve all notification subscriptions of the storage
    operationId: GetNotificationSubscriptions
    tags:
      - NotificationSubscriptions CRUD
    security:
      - {}
      - oAuth2ClientCredentials:
          - nudsf-dr
      - oAuth2ClientCredentials:
          - nudsf-dr
          - nudsf-dr:subscription:read
    parameters:
      - name: realmId
        in: path
        description: Identifier of the Realm
        required: true
        schema:
          type: string
          example: Realm01
      - name: storageId
        in: path
        description: Identifier of the Storage
        required: true
        schema:
          type: string
          example: Storage01
      - name: limit-range
        in: query
        description: The maximum number of NotificationSubscriptions to fetch
        schema:
          $ref: 'TS29571_CommonData.yaml#/components/schemas/Uinteger'
      - name: supported-features
        in: query
        description: Features required to be supported by the target NF
        schema:
          $ref: 'TS29571_CommonData.yaml#/components/schemas/SupportedFeatures'
    responses:
      '200':
        description: Expected response to a valid request
        content:
          application/json:
            schema:
              type: array
              items:
                $ref: '#/components/schemas/NotificationSubscription'
      '304':
        $ref: '#/components/responses/304'
      '400':
        $ref: 'TS29571_CommonData.yaml#/components/responses/400'
      '401':
        $ref: 'TS29571_CommonData.yaml#/components/responses/401'
      '403':
        $ref: 'TS29571_CommonData.yaml#/components/responses/403'
      '404':
        $ref: 'TS29571_CommonData.yaml#/components/responses/404'
      '406':
        $ref: 'TS29571_CommonData.yaml#/components/responses/406'
      '429':
        $ref: 'TS29571_CommonData.yaml#/components/responses/429'
      '500':
        $ref: 'TS29571_CommonData.yaml#/components/responses/500'

```

```

'502':
  $ref: 'TS29571_CommonData.yaml#/components/responses/502'
'503':
  $ref: 'TS29571_CommonData.yaml#/components/responses/503'
default:
  $ref: 'TS29571_CommonData.yaml#/components/responses/default'

/{realmId}/{storageId}/subs-to-notify/{subscriptionId}:
  summary: The notification subscription resource
  description: >
    Access to the subscription resource
  get:
    summary: Notification subscription retrieval
    description: retrieve a single notification subscription of the storage
    operationId: GetNotificationSubscription
    tags:
      - NotificationSubscription CRUD
    security:
      - {}
      - oAuth2ClientCredentials:
          - nudsf-dr
      - oAuth2ClientCredentials:
          - nudsf-dr
          - nudsf-dr:subscription:read
    parameters:
      - name: realmId
        in: path
        description: Identifier of the Realm
        required: true
        schema:
          type: string
          example: Realm01
      - name: storageId
        in: path
        description: Identifier of the Storage
        required: true
        schema:
          type: string
          example: Storage01
      - name: subscriptionId
        in: path
        description: Identifier of the NotificationSubscription
        required: true
        schema:
          type: string
          example: Subscription01
      - name: supported-features
        in: query
        description: Features required to be supported by the target NF
        schema:
          $ref: 'TS29571_CommonData.yaml#/components/schemas/SupportedFeatures'
      - name: If-None-Match
        in: header
        description: Validator for conditional requests, as described in RFC 9110, 13.1.2
        schema:
          type: string
      - name: If-Modified-Since
        in: header
        description: Validator for conditional requests, as described in RFC 9110, 13.1.3
        schema:
          type: string
    responses:
      '200':
        description: Expected response to a valid request
        headers:
          Cache-Control:
            $ref: '#/components/headers/Cache-Control'
          ETag:
            $ref: '#/components/headers/ETag'
          Last-Modified:
            $ref: '#/components/headers/Last-Modified'
        content:
          application/json:
            schema:
              $ref: '#/components/schemas/NotificationSubscription'
      '304':
        $ref: '#/components/responses/304'
      '400':

```

```

    $ref: 'TS29571_CommonData.yaml#/components/responses/400'
  '401':
    $ref: 'TS29571_CommonData.yaml#/components/responses/401'
  '403':
    $ref: 'TS29571_CommonData.yaml#/components/responses/403'
  '404':
    $ref: 'TS29571_CommonData.yaml#/components/responses/404'
  '406':
    $ref: 'TS29571_CommonData.yaml#/components/responses/406'
  '429':
    $ref: 'TS29571_CommonData.yaml#/components/responses/429'
  '500':
    $ref: 'TS29571_CommonData.yaml#/components/responses/500'
  '502':
    $ref: 'TS29571_CommonData.yaml#/components/responses/502'
  '503':
    $ref: 'TS29571_CommonData.yaml#/components/responses/503'
  default:
    $ref: 'TS29571_CommonData.yaml#/components/responses/default'

```

delete:

```

summary: Delete a Notification Subscription of the storage
description: delete a single subscriptions of the storage
operationId: DeleteNotificationSubscription
tags:
- NotificationSubscription CRUD
security:
- {}
- oAuth2ClientCredentials:
  - nudsf-dr
- oAuth2ClientCredentials:
  - nudsf-dr
  - nudsf-dr:subscription:modify
parameters:
- name: realmId
  in: path
  description: Identifier of the Realm
  required: true
  schema:
    type: string
    example: Realm01
- name: storageId
  in: path
  description: Identifier of the Storage
  required: true
  schema:
    type: string
    example: Storage01
- name: subscriptionId
  in: path
  description: Identifier of the NotificationSubscription
  required: true
  schema:
    type: string
    example: Subscription01
- name: client-id
  in: query
  description: Identifies the NF or NFSet
  required: true
  schema:
    $ref: '#/components/schemas/ClientId'
- name: get-previous
  in: query
  description: Retrieve the NotificationSubscription before delete
  required: false
  schema:
    type: boolean
    default: false
- name: If-Match
  in: header
  description: Record validator for conditional requests, as described in RFC 9110, 13.1.1
  schema:
    type: string
- name: supported-features
  in: query
  description: Features required to be supported by the target NF
  schema:
    $ref: 'TS29571_CommonData.yaml#/components/schemas/SupportedFeatures'

```



```

responses:
  '200':
    description: Deleted NotificationSubscription if requested with get-previous
    content:
      application/json:
        schema:
          type: array
          items:
            $ref: '#/components/schemas/NotificationSubscription'
  '204':
    description: >
      Successful case. The SubscriptionNotification has been successfully deleted.
  '400':
    $ref: 'TS29571_CommonData.yaml#/components/responses/400'
  '401':
    $ref: 'TS29571_CommonData.yaml#/components/responses/401'
  '403':
    $ref: 'TS29571_CommonData.yaml#/components/responses/403'
  '404':
    $ref: 'TS29571_CommonData.yaml#/components/responses/404'
  '408':
    $ref: 'TS29571_CommonData.yaml#/components/responses/408'
  '412':
    description: Return previous NotificationSubscription value if get-previous=true
    content:
      application/json:
        schema:
          $ref: '#/components/schemas/NotificationSubscription'
  '429':
    $ref: 'TS29571_CommonData.yaml#/components/responses/429'
  '500':
    $ref: 'TS29571_CommonData.yaml#/components/responses/500'
  '502':
    $ref: 'TS29571_CommonData.yaml#/components/responses/502'
  '503':
    $ref: 'TS29571_CommonData.yaml#/components/responses/503'
  default:
    $ref: 'TS29571_CommonData.yaml#/components/responses/default'

patch: # patch NotificationSubscription data
  summary: NotificationSubscription update
  description: update a specific NotificationSubscription
  operationId: UpdateNotificationSubscription
  tags:
  - NotificationSubscription CRUD
  security:
  - {}
  - oAuth2ClientCredentials:
    - nudsf-dr
  - oAuth2ClientCredentials:
    - nudsf-dr
    - nudsf-dr:subscription:modify
  parameters:
  - name: realmId
    in: path
    description: Identifier of the Realm
    required: true
    schema:
      type: string
      example: Realm01
  - name: storageId
    in: path
    description: Identifier of the Storage
    required: true
    schema:
      type: string
      example: Storage01
  - name: subscriptionId
    in: path
    description: Identifier of the NotificationSubscription
    required: true
    schema:
      type: string
      example: Subscription01
  - name: If-Match
    in: header
    description: Validator for conditional requests, as described in RFC 9110, 13.1.1
    schema:

```

```
    type: string
  - name: supported-features
    in: query
    description: Features required to be supported by the target NF
    schema:
      $ref: 'TS29571_CommonData.yaml#/components/schemas/SupportedFeatures'
  requestBody:
    description: data to patch
    content:
      application/json-patch+json:
        example: 'TBD'
        schema:
          type: array
          items:
            $ref: 'TS29571_CommonData.yaml#/components/schemas/PatchItem'
          minItems: 1
    required: true
  responses:
    '200':
      description: >
        One or more modification instructions have been discarded,
        the execution report is returned in response PatchResult.
      content:
        application/json:
          example:
            schema:
              $ref: 'TS29571_CommonData.yaml#/components/schemas/PatchResult'
      headers:
        Cache-Control:
          $ref: '#/components/headers/Cache-Control'
        ETag:
          $ref: '#/components/headers/ETag'
        Last-Modified:
          $ref: '#/components/headers/Last-Modified'
    '204':
      description: >
        Successful case. The meta has been successfully updated and no return is expected.
      headers:
        Cache-Control:
          $ref: '#/components/headers/Cache-Control'
        ETag:
          $ref: '#/components/headers/ETag'
        Last-Modified:
          $ref: '#/components/headers/Last-Modified'
    '304':
      $ref: '#/components/responses/304'
    '400':
      $ref: 'TS29571_CommonData.yaml#/components/responses/400'
    '401':
      $ref: 'TS29571_CommonData.yaml#/components/responses/401'
    '403':
      $ref: 'TS29571_CommonData.yaml#/components/responses/403'
    '404':
      $ref: 'TS29571_CommonData.yaml#/components/responses/404'
    '408':
      $ref: 'TS29571_CommonData.yaml#/components/responses/408'
    '411':
      $ref: 'TS29571_CommonData.yaml#/components/responses/411'
    '413':
      $ref: 'TS29571_CommonData.yaml#/components/responses/413'
    '415':
      $ref: 'TS29571_CommonData.yaml#/components/responses/415'
    '429':
      $ref: 'TS29571_CommonData.yaml#/components/responses/429'
    '500':
      $ref: 'TS29571_CommonData.yaml#/components/responses/500'
    '502':
      $ref: 'TS29571_CommonData.yaml#/components/responses/502'
    '503':
      $ref: 'TS29571_CommonData.yaml#/components/responses/503'
    default:
      $ref: 'TS29571_CommonData.yaml#/components/responses/default'

put:
  summary: NotificationSubscription Create/Update
  operationId: CreateAndUpdateNotificationSubscription
  tags:
    - NotificationSubscription CRUD
```

```

security:
  - {}
  - oAuth2ClientCredentials:
    - nudsf-dr
  - oAuth2ClientCredentials:
    - nudsf-dr
    - nudsf-dr:subscription:create
parameters:
- name: realmId
  in: path
  description: Identifier of the Realm
  required: true
  schema:
    type: string
    example: Realm01
- name: storageId
  in: path
  description: Identifier of the Storage
  required: true
  schema:
    type: string
    example: Storage01
- name: subscriptionId
  in: path
  description: Identifier of the NotificationSubscription
  required: true
  schema:
    type: string
    example: Subscription01
- name: supported-features
  in: query
  description: Features required to be supported by the target NF
  schema:
    $ref: 'TS29571_CommonData.yaml#/components/schemas/SupportedFeatures'
- name: If-None-Match
  in: header
  description: Validator for conditional requests, as described in RFC 9110, 13.1.2
  schema:
    type: string
- name: If-Match
  in: header
  description: Record validator for conditional requests, as described in RFC 9110, 13.1.1
  schema:
    type: string
requestBody:
  content:
    application/json:
      schema:
        $ref: '#/components/schemas/NotificationSubscription'
      required: true
responses:
  '200' : # Update
    description: Expected response to a valid update request
    content:
      application/json:
        schema:
          $ref: '#/components/schemas/NotificationSubscription'
  '201':
    description: Expected response to a valid create request
    content:
      application/json:
        schema:
          $ref: '#/components/schemas/NotificationSubscription'
headers:
  Location:
    description: >
      'Contains the URI of the newly created resource according to
      the structure: {apiRoot}/nudsf-dr/<apiVersion>/{realmId}/{storageId}
      /subs-to-notify/{subscriptionId}'
    required: true
    schema:
      type: string
  Cache-Control:
    $ref: '#/components/headers/Cache-Control'
  ETag:
    $ref: '#/components/headers/ETag'
  Last-Modified:
    $ref: '#/components/headers/Last-Modified'

```

```

'304':
  $ref: '#/components/responses/304'
'400':
  $ref: 'TS29571_CommonData.yaml#/components/responses/400'
'401':
  $ref: 'TS29571_CommonData.yaml#/components/responses/401'
'403':
  $ref: 'TS29571_CommonData.yaml#/components/responses/403'
'404':
  $ref: 'TS29571_CommonData.yaml#/components/responses/404'
'408':
  $ref: 'TS29571_CommonData.yaml#/components/responses/408'
'409':
  description: Conflict
  content:
    application/json:
      schema:
        type: array
        items:
          $ref: 'TS29571_CommonData.yaml#/components/schemas/Uri'
'411':
  $ref: 'TS29571_CommonData.yaml#/components/responses/411'
'412':
  $ref: 'TS29571_CommonData.yaml#/components/responses/412'
'413':
  $ref: 'TS29571_CommonData.yaml#/components/responses/413'
'415':
  $ref: 'TS29571_CommonData.yaml#/components/responses/415'
'429':
  $ref: 'TS29571_CommonData.yaml#/components/responses/429'
'500':
  $ref: 'TS29571_CommonData.yaml#/components/responses/500'
'502':
  $ref: 'TS29571_CommonData.yaml#/components/responses/502'
'503':
  $ref: 'TS29571_CommonData.yaml#/components/responses/503'
default:
  description: Unexpected error
  content:
    application/problem+json:
      schema:
        $ref: 'TS29571_CommonData.yaml#/components/schemas/ProblemDetails'
callbacks:
  onDataChange:
    '{$request.body#/callbackReference}':
      post:
        requestBody:
          $ref: '#/components/requestBodies/RecordNotificationBody'
        responses:
          '204':
            description: Callback executed successfully
          '400':
            $ref: 'TS29571_CommonData.yaml#/components/responses/400'
          '401':
            $ref: 'TS29571_CommonData.yaml#/components/responses/401'
          '403':
            $ref: 'TS29571_CommonData.yaml#/components/responses/403'
          '404':
            $ref: 'TS29571_CommonData.yaml#/components/responses/404'
          '411':
            $ref: 'TS29571_CommonData.yaml#/components/responses/411'
          '413':
            $ref: 'TS29571_CommonData.yaml#/components/responses/413'
          '415':
            $ref: 'TS29571_CommonData.yaml#/components/responses/415'
          '429':
            $ref: 'TS29571_CommonData.yaml#/components/responses/429'
          '500':
            $ref: 'TS29571_CommonData.yaml#/components/responses/500'
          '502':
            $ref: 'TS29571_CommonData.yaml#/components/responses/502'
          '503':
            $ref: 'TS29571_CommonData.yaml#/components/responses/503'
          default:
            $ref: 'TS29571_CommonData.yaml#/components/responses/default'
  subscriptionExpiryNotification:
    '{$request.body#/expiryCallbackReference}':
      post:

```

```

    requestBody:
      required: true
      content:
        application/json:
          schema:
            $ref: '#/components/schemas/NotificationInfo'
    responses:
      '204':
        description: Successful Notification response
      '400':
        $ref: 'TS29571_CommonData.yaml#/components/responses/400'
      '401':
        $ref: 'TS29571_CommonData.yaml#/components/responses/401'
      '403':
        $ref: 'TS29571_CommonData.yaml#/components/responses/403'
      '404':
        $ref: 'TS29571_CommonData.yaml#/components/responses/404'
      '411':
        $ref: 'TS29571_CommonData.yaml#/components/responses/411'
      '413':
        $ref: 'TS29571_CommonData.yaml#/components/responses/413'
      '415':
        $ref: 'TS29571_CommonData.yaml#/components/responses/415'
      '429':
        $ref: 'TS29571_CommonData.yaml#/components/responses/429'
      '500':
        $ref: 'TS29571_CommonData.yaml#/components/responses/500'
      '502':
        $ref: 'TS29571_CommonData.yaml#/components/responses/502'
      '503':
        $ref: 'TS29571_CommonData.yaml#/components/responses/503'
      default:
        $ref: 'TS29571_CommonData.yaml#/components/responses/default'

/{realmId}/{storageId}/meta-schemas/{schemaId}:
  summary: Access to a specific Meta Schema, identified by its SchemaId
  description: >
    Access to a specific Meta Schema
  get:
    summary: Meta Schema access
    description: retrieve one specific Meta Schema
    operationId: GetMetaSchema
    tags:
      - MetaSchema CRUD
    security:
      - {}
      - OAuth2ClientCredentials:
          - nudsf-dr
      - OAuth2ClientCredentials:
          - nudsf-dr
          - nudsf-dr:meta-schema:read
    parameters:
      - name: realmId
        in: path
        description: Identifier of the Realm
        required: true
        schema:
          type: string
          example: Realm01
      - name: storageId
        in: path
        description: Identifier of the Storage
        required: true
        schema:
          type: string
          example: Storage01
      - name: schemaId
        in: path
        description: Identifier of the Meta Schema
        required: true
        schema:
          $ref: '#/components/schemas/SchemaId'
      - name: If-None-Match
        in: header
        description: Validator for conditional requests, as described in RFC 9110, 13.1.2
        schema:
          type: string
      - name: If-Modified-Since

```

```

    in: header
    description: Validator for conditional requests, as described in RFC 9110, 13.1.3
    schema:
      type: string
  - name: supported-features
    in: query
    description: Features required to be supported by the target NF
    schema:
      $ref: 'TS29571_CommonData.yaml#/components/schemas/SupportedFeatures'
responses:
  '200' : #result ok
    $ref: '#/components/responses/RecordBody'
  '304':
    $ref: '#/components/responses/304'
  '400':
    $ref: 'TS29571_CommonData.yaml#/components/responses/400'
  '401':
    $ref: 'TS29571_CommonData.yaml#/components/responses/401'
  '403':
    $ref: 'TS29571_CommonData.yaml#/components/responses/403'
  '404':
    $ref: 'TS29571_CommonData.yaml#/components/responses/404'
  '406':
    $ref: 'TS29571_CommonData.yaml#/components/responses/406'
  '429':
    $ref: 'TS29571_CommonData.yaml#/components/responses/429'
  '500':
    $ref: 'TS29571_CommonData.yaml#/components/responses/500'
  '502':
    $ref: 'TS29571_CommonData.yaml#/components/responses/502'
  '503':
    $ref: 'TS29571_CommonData.yaml#/components/responses/503'
  default:
    $ref: 'TS29571_CommonData.yaml#/components/responses/default'
put:
  summary: Create/Modify Meta Schema
  description: Create or Modify a Meta Schema with a user provided SchemaId
  operationId: CreateOrModifyMetaSchema
  tags:
    - MetaSchema CRUD
  security:
    - {}
    - oAuth2ClientCredentials:
      - nudsf-dr
    - oAuth2ClientCredentials:
      - nudsf-dr
      - nudsf-dr:meta-schema:create
  parameters:
    - name: realmId
      in: path
      description: Identifier(name) of the Realm
      required: true
      schema:
        type: string
        example: Realm01
    - name: storageId
      in: path
      description: Identifier of the Storage
      required: true
      schema:
        type: string
        example: Storage01
    - name: schemaId
      in: path
      description: Identifier of the Meta Schema
      required: true
      schema:
        $ref: '#/components/schemas/SchemaId'
    - name: If-None-Match
      in: header
      description: Validator for conditional requests, as described in RFC 9110, 13.1.2
      schema:
        type: string
    - name: If-Match
      in: header
      description: Validator for conditional requests, as described in RFC 9110, 13.1.1
      schema:
        type: string

```

```

- name: get-previous
  in: query
  description: Retrieve the Meta Schema before update
  required: false
  schema:
    type: boolean
    default: false
- name: supported-features
  in: query
  description: Features required to be supported by the target NF
  schema:
    $ref: 'TS29571_CommonData.yaml#/components/schemas/SupportedFeatures'
requestBody:
  content:
    application/json:
      schema:
        $ref: '#/components/schemas/MetaSchema'
  required: true
responses:
  '200':
    description: Update with return
    content:
      application/json:
        schema:
          $ref: '#/components/schemas/MetaSchema'
  '201':
    description: >
      Create case. The resource has been successfully created, location header indicates
      the URI of the created Meta Schema.
    content:
      application/json:
        schema:
          $ref: '#/components/schemas/MetaSchema'
    headers:
      Location:
        $ref: '#/components/headers/Location'
      Cache-Control:
        $ref: '#/components/headers/Cache-Control'
      ETag:
        $ref: '#/components/headers/ETag'
      Last-Modified:
        $ref: '#/components/headers/Last-Modified'
  '204': # Update without return
    description: >
      Update case. The resource has been successfully updated and no
      additional content is included in the response message.
    headers:
      Cache-Control:
        $ref: '#/components/headers/Cache-Control'
      ETag:
        $ref: '#/components/headers/ETag'
      Last-Modified:
        $ref: '#/components/headers/Last-Modified'
  '304':
    $ref: '#/components/responses/304'
  '400':
    $ref: 'TS29571_CommonData.yaml#/components/responses/400'
  '401':
    $ref: 'TS29571_CommonData.yaml#/components/responses/401'
  '403':
    $ref: 'TS29571_CommonData.yaml#/components/responses/403'
  '404':
    $ref: 'TS29571_CommonData.yaml#/components/responses/404'
  '408':
    $ref: 'TS29571_CommonData.yaml#/components/responses/408'
  '411':
    $ref: 'TS29571_CommonData.yaml#/components/responses/411'
  '412':
    description: Return Meta Schema value if get-previous=true
    content:
      application/json:
        schema:
          $ref: '#/components/schemas/MetaSchema'
  '413':
    $ref: 'TS29571_CommonData.yaml#/components/responses/413'
  '415':
    $ref: 'TS29571_CommonData.yaml#/components/responses/415'
  '429':

```

```

    $ref: 'TS29571_CommonData.yaml#/components/responses/429'
  '500':
    $ref: 'TS29571_CommonData.yaml#/components/responses/500'
  '501':
    $ref: 'TS29571_CommonData.yaml#/components/responses/501'
  '502':
    $ref: 'TS29571_CommonData.yaml#/components/responses/502'
  '503':
    $ref: 'TS29571_CommonData.yaml#/components/responses/503'
  default:
    $ref: 'TS29571_CommonData.yaml#/components/responses/default'
delete:
  summary: Delete a Meta Schema with an user provided SchemaId
  operationId: DeleteMetaSchema
  tags:
    - MetaSchema CRUD
  security:
    - {}
    - oAuth2ClientCredentials:
      - nudsf-dr
    - oAuth2ClientCredentials:
      - nudsf-dr
      - nudsf-dr:meta-schema:modify
  parameters:
    - name: realmId
      in: path
      description: Identifier(name) of the Realm
      required: true
      schema:
        type: string
        example: Realm01
    - name: storageId
      in: path
      description: Identifier of the Storage
      required: true
      schema:
        type: string
        example: Storage01
    - name: schemaId
      in: path
      description: Identifier of the Meta Schema
      required: true
      schema:
        $ref: '#/components/schemas/SchemaId'
    - name: If-Match
      in: header
      description: Record validator for conditional requests, as described in RFC 9110, 13.1.1
      schema:
        type: string
    - name: get-previous
      in: query
      description: Retrieve the Meta Schema before delete
      required: false
      schema:
        type: boolean
        default: false
    - name: supported-features
      in: query
      description: Features required to be supported by the target NF
      schema:
        $ref: 'TS29571_CommonData.yaml#/components/schemas/SupportedFeatures'
  responses:
    '200':
      description: OK
      content:
        application/json:
          schema:
            $ref: '#/components/schemas/MetaSchema'
    '204':
      description: Successful case.
      headers:
        ETag:
          $ref: '#/components/headers/ETag'
        Last-Modified:
          $ref: '#/components/headers/Last-Modified'
    '304':
      $ref: '#/components/responses/304'
    '400':

```



```

    $ref: 'TS29571_CommonData.yaml#/components/responses/400'
  '401':
    $ref: 'TS29571_CommonData.yaml#/components/responses/401'
  '403':
    $ref: 'TS29571_CommonData.yaml#/components/responses/403'
  '404':
    $ref: 'TS29571_CommonData.yaml#/components/responses/404'
  '408':
    $ref: 'TS29571_CommonData.yaml#/components/responses/408'
  '412':
    description: Return value if get-previous=true
    content:
      application/json:
        schema:
          $ref: '#/components/schemas/MetaSchema'
  '429':
    $ref: 'TS29571_CommonData.yaml#/components/responses/429'
  '500':
    $ref: 'TS29571_CommonData.yaml#/components/responses/500'
  '502':
    $ref: 'TS29571_CommonData.yaml#/components/responses/502'
  '503':
    $ref: 'TS29571_CommonData.yaml#/components/responses/503'
  default:
    $ref: 'TS29571_CommonData.yaml#/components/responses/default'

```

components:

securitySchemes:

oAuth2ClientCredentials:

type: oauth2

flows:

clientCredentials:

tokenUrl: '{nrfApiRoot}/oauth2/token'

scopes:

```

  nudsf-dr: Access to the nudsf-dr API
  nudsf-dr:record:read: Access to read records
  nudsf-dr:record:modify: Access to update records
  nudsf-dr:record:create: Access to create records
  nudsf-dr:record-meta:read: Access to read a record's meta
  nudsf-dr:record-meta:modify: Access to update a record's meta
  nudsf-dr:block:read: Access to read blocks
  nudsf-dr:block:modify: Access to update blocks
  nudsf-dr:block:create: Access to create blocks
  nudsf-dr:subscription:read: Access to read subscriptions
  nudsf-dr:subscription:modify: Access to update subscriptions
  nudsf-dr:subscription:create: Access to create subscriptions
  nudsf-dr:meta-schema:read: Access to read meta schema
  nudsf-dr:meta-schema:modify: Access to update meta schema
  nudsf-dr:meta-schema:create: Access to create meta schema

```

schemas:

RecordSearchResult:

description: Count and collection of Record references matching the providing filter.

type: object

properties:

count: # The total number of elements found.

\$ref: 'TS29571_CommonData.yaml#/components/schemas/UInteger'

references: # The Record references found. If count-indicator is true, no references are sent back.

type: array

items:

\$ref: 'TS29571_CommonData.yaml#/components/schemas/Uri'

minItems: 1

supportedFeatures:

\$ref: 'TS29571_CommonData.yaml#/components/schemas/SupportedFeatures'

matchingRecords:

description: A map (list of key-value pairs where recordId serves as key) of Records

type: object

additionalProperties:

\$ref: '#/components/schemas/Record'

minProperties: 1

tagCountResult:

description: A map of TagCount (list of key-value pairs with unique identifier as key)

type: object

items:

\$ref: '#/components/schemas/TagCount'

example: {"advancedTagCount1": {"tag1": 1}, "advancedTagCount2": {"tag2": 2}}

required:

```

- count
RecordMeta:
  description: Meta data of a Record
  type: object
  properties:
    ttl:
      $ref: 'TS29571_CommonData.yaml#/components/schemas/DateTime'
    callbackReference:
      $ref: 'TS29571_CommonData.yaml#/components/schemas/Uri'
    tags:
      type: object # dictionary type
      description: >
        A dictionary of {"tagName": [ "tagValue", ... ]}. A tag name can be used
        to retrieve a Record. The tagValue are unique.
      additionalProperties:
        type: array
        items:
          type: string
          uniqueItems: true
          minItems: 1
      minProperties: 1
      example: '{"ueId" : [ "455345", "455346" ], "recordId" : [ "1000106" ]}'
    example: >-
      { "tags" : {"ueId" : [ "455345", "455346" ], "recordId" : [ "1000106" ] }}
    schemaId:
      $ref: '#/components/schemas/SchemaId'

Record:
  description: Definition of a Record
  type: object
  properties:
    meta:
      # json representation of the Meta Data
      $ref: '#/components/schemas/RecordMeta'
    blocks:
      # List of multipart data
      type: array
      description: list of opaque Block's in this Record
      items:
        $ref: '#/components/schemas/Block'
      minItems: 1
  required:
    - meta
  example: >-
    {"meta": { "tags" : {"tag1" : ["value1"], "tag2" :["value2"] } }, "blocks": [{"Content-Id":
    "userDefBinaryBlob", "Content-Type": "text/plain", "content": "QmxvY2sgY29udGVudA=="}, {"Content-
    Id": "userDefJsonBlob", "Content-Type": "application/json", "content": {"key": "ftsimpletype-
    999550000000002", "value": "A3E71A78377179B5B91A;imsi-999550000000123"}}]}

RecordPatch:
  description: Definition of a Record Patch
  type: object
  properties:
    patch:
      # json patch as defined in RFC 6902
      type: array
      items:
        $ref: 'TS29571_CommonData.yaml#/components/schemas/PatchItem'
      minItems: 1
    blocks:
      # List of multipart data
      type: array
      description: list of opaque Block's being referred to by PatchItems
      items:
        $ref: '#/components/schemas/Block'
      minItems: 1
  required:
    - patch
  example: >-
    {"patch": [{"op": "add", "path": "/meta/callbackReference", "value": "https://example.com"
    }, {"op": "copy", "from": "/blocks/blockID1", "to": "/blocks/blockID2" }, {"op": "add", "path":
    "/blocks/blockID1", "value": "addedBlock1" }]}, "blocks": [{"Content-Id": "addedBlock1", "Content-
    Type": "text/plain", "content": "QmxvY2sgY29udGVudA=="}]}

RecordIdList:
  description: List of Record IDs
  type: object
  properties:

```

```

recordIdList:
  type: array
  items:
    type: string
  minItems: 1
required:
- recordIdList

```

Block:

description: A Block can be of any type

example: >-

```
"QmxvY2sgY29udGVudA=="
```

NotificationSubscription:

description: Definition of a notification subscription

type: object

properties:

clientId:

\$ref: '#/components/schemas/ClientId'

callbackReference:

\$ref: 'TS29571_CommonData.yaml#/components/schemas/Uri'

expiryCallbackReference:

\$ref: 'TS29571_CommonData.yaml#/components/schemas/Uri'

expiry:

\$ref: 'TS29571_CommonData.yaml#/components/schemas/DateTime'

expiryNotification:

\$ref: 'TS29571_CommonData.yaml#/components/schemas/UInteger'

subFilter:

\$ref: '#/components/schemas/SubscriptionFilter'

supportedFeatures:

\$ref: 'TS29571_CommonData.yaml#/components/schemas/SupportedFeatures'

required:

- clientId
- callbackReference

RecordNotification:

description: Definition of a notification on a record

type: object

properties:

descriptor:

json representation of the notification description

\$ref: '#/components/schemas/NotificationDescription'

meta:

json representation of the Meta Data

\$ref: '#/components/schemas/RecordMeta'

blocks:

List of multipart data

type: array

description: list of opaque Block's in this Record

items:

\$ref: '#/components/schemas/Block'

required:

- descriptor
- meta

example: >-

```

{"descriptor": { "recordRef" : "...", "operationType" : "DELETED"}, "meta": { "tags" :
{"tag1" : ["value1"], "tag2" :["value2"] } }, "blocks": [{"Content-Id": "userDefBinaryBlob",
"Content-Type": "text/plain", "content": "QmxvY2sgY29udGVudA=="}, {"Content-Id": "userDefJsonBlob",
"Content-Type": "application/json", "content": "{\"key\": \"ftsimpletype-99955000000002\", \"value\":
\"A3E71A78377179B5B91A;imsi-999550000000123\"}"}]}

```

NotificationDescription:

description: Description of a record notification

type: object

properties:

recordRef:

\$ref: 'TS29571_CommonData.yaml#/components/schemas/Uri'

operationType:

\$ref: '#/components/schemas/RecordOperation'

subscriptionId:

unique identifier of the NotificationSubscription

type: string

required:

- recordRef
- operationType

example: >-

```
{ "record" : "...", "operationType" : "DELETED" }
```

SubscriptionFilter:

```
description: A subscription filter
type: object
properties:
  monitoredResourceUris:
    type: array
    description: list of resources applicable to the subscription
    items:
      $ref: 'TS29571_CommonData.yaml#/components/schemas/Uri'
    minItems: 1
  operations:
    type: array
    description: list of resources applicable to the subscription
    items:
      $ref: '#/components/schemas/RecordOperation'
    maxItems: 3

ClientId:
description: Defines the identity of the NF Consumer
type: object
properties:
  nfId:
    $ref: 'TS29571_CommonData.yaml#/components/schemas/NfInstanceId'
  nfSetId:
    $ref: 'TS29571_CommonData.yaml#/components/schemas/NfSetId'

RecordOperation:
description: Indicate operation made on a record
anyOf:
- type: string
  enum:
    - CREATED
    - UPDATED
    - DELETED
- type: string

ConditionOperator:
description: TBD
anyOf:
- type: string
  enum:
    - AND
    - OR
    - NOT
- type: string

ComparisonOperator:
description: TBD
anyOf:
- type: string
  enum:
    # Equals
    - EQ
    # Not Equal
    - NEQ
    # Greater Than
    - GT
    # Greater Than or Equal
    - GTE
    # Less Than
    - LT
    # Less Than or Equal
    - LTE
- type: string

CountExpression:
description: >
  A map containing parameters for advanced counting feature with unique key for each request
type: object
properties:
  tag:
    type: string
  countType:
    $ref: '#/components/schemas/TagCountType'
  filter:
    $ref: '#/components/schemas/SearchExpression'
required:
- countType
example:
```

```

    {"advancedTagCount1":{"tag" : "tag1", countType : UNIQUE_COUNT , "filter" : NULL},
    "advancedTagCount2":{"tag" : "tag2", countType : AGGREGATE_COUNT, "filter" : NULL}}

```

```

TagCountType:
  description: Indicate mode of tag count operations
  anyOf:
  - type: string
    enum:
      - UNIQUE_COUNT
      - AGGREGATE_COUNT
      - TOTAL_COUNT
  - type: string

```

```

TagCount:
  description: The TagCount result of a_Advanced Count request
  type: object
  properties:
    tag:
      type: string
    count:
      $ref: 'TS29571_CommonData.yaml#/components/schemas/UInteger'
    valueCount:
      type: array
      items:
        $ref: '#/components/schemas/ValueCount'

```

```

ValueCount:
  description: The AggregateCount map
  type: object
  properties:
    value:
      type: string
    count:
      $ref: 'TS29571_CommonData.yaml#/components/schemas/UInteger'

```

```

SearchExpression:
  description: A logical expression element
  type: object
  oneOf:
    - $ref: '#/components/schemas/SearchCondition'
    - $ref: '#/components/schemas/SearchComparison'
    - $ref: '#/components/schemas/RecordIdList'
  example:
    { "cond": "OR", "units": [ { "op": "EQ", "tag" : "ueId", "value" : "455345" }, { "op": "EQ",
    "tag" : "supi", "value" : "imsi-999559807001001" } ] }

```

```

SearchCondition:
  description: A logical condition
  type: object
  properties:
    cond:
      $ref: '#/components/schemas/ConditionOperator'
    units:
      type: array
      items:
        $ref: '#/components/schemas/SearchExpression'
      minItems: 1
    schemaId:
      $ref: '#/components/schemas/SchemaId'
  required:
    - cond
    - units
  example:
    { "cond": "OR", "units": [ { "op": "EQ", "tag" : "ueId", "value" : "455345" }, { "op": "EQ",
    "tag" : "supi", "value" : "imsi-999559807001001" } ] }

```

```

SearchComparison:
  description: A comparison to apply on tag/values pairs.
  type: object
  properties:
    op:
      $ref: '#/components/schemas/ComparisonOperator'
    tag:
      type: string
    value:
      type: string
  required:
    - op

```

```
- tag
- value
example:
  { "op": "EQ", "tag" : "supi", "value" : "imsi-999559807001001" }

MetaSchema:
  description: Defines the Meta Schema
  type: object
  required:
    - schemaId
    - metaTags
  properties:
    schemaId:
      $ref: '#/components/schemas/SchemaId'
    metaTags:
      type: array
      items:
        $ref: '#/components/schemas/TagType'

TagType:
  description: Defines the Tag Type
  type: object
  required:
    - tagName
    - keyType
  properties:
    tagName:
      type: string
    keyType:
      $ref: '#/components/schemas/KeyType'
    sort:
      type: boolean
      default: false
    presence:
      type: boolean

SchemaId:
  description: Represents the Identifier of a Meta schema.
  type: string

KeyType:
  description: Represents the type of a key.
  anyOf:
    - type: string
      enum:
        - UNIQUE_KEY
        - SEARCH_KEY
        - COUNT_KEY
        - SEARCH_AND_COUNT_KEY
        - OTHER_TAG
    - type: string

RetrieveRecords:
  description: Indicates the data to be retrieved.
  anyOf:
    - type: string
      enum:
        - ONLY_META
        - META_AND_BLOCKS
    - type: string

NotificationInfo:
  type: object
  required:
    - expiredSubscriptions
  properties:
    expiredSubscriptions:
      type: array
      items:
        $ref: '#/components/schemas/NotificationSubscription'
      minItems: 1

ExtendedProblemDetails:
  description: Extending problemDetails
  allOf:
    - $ref: 'TS29571_CommonData.yaml#/components/schemas/ProblemDetails'
    - $ref: '#/components/schemas/ProblemDetailsExtension'
```

```
ProblemDetailsExtension:
  anyOf:
    - $ref: '#/components/schemas/Record'
    - $ref: '#/components/schemas/RecordMeta'

headers:
  Cache-Control:
    description: Cache-Control containing max-age, as described in RFC 9111, 5.2
    schema:
      type: string
  ETag:
    description: Entity Tag, containing a strong validator, as described in RFC 9110, 8.8.3
    schema:
      type: string
  Last-Modified:
    description: Timestamp for last modification of the resource, as described in RFC 9110, 8.8.2
    schema:
      type: string
  Location:
    description: Contains the URI of the newly created resource
    required: true
    schema:
      type: string
  Retry-After:
    description: >
      'Indicates the time the NF Consumer has to wait before making a new request.
      It can be a non-negative integer (decimal number) indicating the number of
      seconds the NF Consumer has to wait before making a new request or an
      HTTP-date after which the AF can retry a new request.'
    schema:
      anyOf:
        - type: integer
        - type: string

requestBodies:
  RecordBody:
    description: >
      The record multipart request body. The meta part shall be the first part
      and is mandatory but can be empty and zero or more block parts may follow the meta part.
    required: true
    content:
      multipart/mixed:
        schema:
          $ref: '#/components/schemas/Record'
        encoding:
          meta: # The meta part shall be the first part and is mandatory but can be empty
            contentType: application/json
            headers:
              Content-Id:
                schema:
                  type: string
                  required: true
          blocks: # 0 or more block parts may follow the meta part
            contentType: '*/*' # Block part can be of any type
            headers:
              Content-Id: # Block identifier is defined by the Content-Id header.
                schema:
                  type: string
                  required: true
              Content-Transfer-Encoding:
                schema:
                  type: string
                  required: true

  RecordPatchBody:
    description: >
      The patch record multipart request body. The patch part shall be the first part
      and is mandatory and zero or more block parts being referred to by patch items
      may follow the patch part.
    required: true
    content:
      multipart/mixed:
        schema:
          $ref: '#/components/schemas/RecordPatch'
        encoding:
          patch: # The patch part shall be the first part
            contentType: application/json-patch+json
            headers:
```

```

    Content-Id:
      schema:
        type: string
        required: true
  blocks: # 0 or more block parts may follow the patch part
  contentType: '*/*' # Block part can be of any type
  headers:
    Content-Id: # Block identifier is defined by the Content-Id header.
      schema:
        type: string
        required: true
    Content-Transfer-Encoding:
      schema:
        type: string
        required: true

RecordNotificationBody:
  description: >
    The record notification multipart request body. The descriptor part shall be the
    first one, followed by record meta part and by zero or more block parts.
  required: true
  content:
    multipart/mixed:
      schema:
        $ref: '#/components/schemas/RecordNotification'
      encoding:
        descriptor: # The descriptor part shall be the first part and is mandatory
          contentType: application/json
          headers:
            Content-Id:
              schema:
                type: string
                required: true
        meta: # The meta part shall be the second part and is mandatory but can be empty
          contentType: application/json
          headers:
            Content-Id:
              schema:
                type: string
                required: true
        blocks: # 0 or more block parts may follow the meta part
          contentType: '*/*' # Block part can be of any type
          headers:
            Content-Id: # Block identifier is defined by the Content-Id header.
              schema:
                type: string
                required: true
            Content-Transfer-Encoding:
              schema:
                type: string
                required: true

responses:
  '304': # Etag response if the value might differ from that sent
    description: Not Modified
    content:
      application/problem+json:
        schema:
          $ref: 'TS29571_CommonData.yaml#/components/schemas/ProblemDetails'
    headers:
      Cache-Control:
        $ref: '#/components/headers/Cache-Control'
      ETag:
        $ref: '#/components/headers/ETag'
      Retry-After:
        $ref: '#/components/headers/Retry-After'

'RecordBody': # Record value with associated headers
  description: >
    - 200 Update. The resource has been successfully updated and previous value
      must be sent in the response message if requested.
    - 200 Get. The resource exists, its value must be sent in the response message
    - 412 Precondition Failed, the previous value must be sent in response message if requested.
  content:
    multipart/mixed:
      schema:
        $ref: '#/components/schemas/Record'
      encoding:

```



```

    meta: # The meta part shall be the first part and is mandatory but can be empty.
    contentType: application/json
    headers:
      Content-Id: # The meta part is identified by the 'meta' Content-Id header.
      schema:
        type: string
        required: true
    blocks: # Zero or more block parts may follow the meta part
    contentType: '*/*' # Block parts can be of any type.
    headers:
      Content-Id: # Block identifier is defined by the Content-Id header.
      schema:
        type: string
        required: true
      Content-Transfer-Encoding:
      schema:
        type: string
        required: true
  headers:
    Cache-Control:
      $ref: '#/components/headers/Cache-Control'
    ETag:
      $ref: '#/components/headers/ETag'
    Last-Modified:
      $ref: '#/components/headers/Last-Modified'
'RecordBodyDelete': # Record value with associated headers
description: >
  - 200 Delete: The resource has been successfully delete and previous value
    must be sent in the response message if requested.
content:
  multipart/mixed:
    schema:
      $ref: '#/components/schemas/Record'
    encoding:
      meta: # The meta part shall be the first par and is mandatory but can be empty.
      contentType: application/json
      headers:
        Content-Id: # The meta part is identified by the Content-Id header.
        schema:
          type: string
          required: true
      blocks: # Zero or more block parts may follow the meta part.
      contentType: '*/*' # Block parts can be of any type.
      headers:
        Content-Id: # Block identifier is defined by the Content-Id header.
        schema:
          type: string
          required: true
        Content-Transfer-Encoding:
        schema:
          type: string
          required: true
    headers:
      ETag:
        $ref: '#/components/headers/ETag'
      Last-Modified:
        $ref: '#/components/headers/Last-Modified'
'BlockBody': # Block value with associated headers
description: >
  - 200 Update: The resource has been successfully updated and previous value
    must be sent in the response message if requested.
  - 200 Get: The resource exists, its value must be sent in the response message
  - 412 Precondition Failed: the previous value must be sent in response message if requested.
content:
  '*/*':
    schema:
      $ref: '#/components/schemas/Block'
  headers:
    Cache-Control:
      $ref: '#/components/headers/Cache-Control'
    ETag:
      $ref: '#/components/headers/ETag'
    Last-Modified:
      $ref: '#/components/headers/Last-Modified'
'BlockBodyDelete': # Block value with associated headers

```

```

description: >
  - 200 Delete: The resource has been successfully delete and previous value
    must be sent in the response message if requested.
content:
  '*/*':
    schema:
      $ref: '#/components/schemas/Block'
headers:
  ETag:
    $ref: '#/components/headers/ETag'
  Last-Modified:
    $ref: '#/components/headers/Last-Modified'

'409':
  description: Conflict
  content:
    application/problem+json:
      schema:
        $ref: '#/components/schemas/ExtendedProblemDetails'
'412':
  description: Precondition Failed
  content:
    application/problem+json:
      schema:
        $ref: '#/components/schemas/ExtendedProblemDetails'
'500':
  description: Internal Server Error
  content:
    application/problem+json:
      schema:
        $ref: '#/components/schemas/ExtendedProblemDetails'

```

A.3 Nudsf_Timer API

```

openapi: 3.0.0
info:
  title: Nudsf_Timer
  version: 1.1.0
  description: |
    Nudsf Timer Service.
    © 2024, 3GPP Organizational Partners (ARIB, ATIS, CCSA, ETSI, TSDSI, TTA, TTC).
    All rights reserved.

externalDocs:
  description: 3GPP TS 29.598 UDSF Services, V18.6.0.
  url: 'https://www.3gpp.org/ftp/Specs/archive/29_series/29.598/'

servers:
  - url: '{apiRoot}/nudsf-timer/v1'
    variables:
      apiRoot:
        default: https://example.com
        description: apiRoot as defined in clause 4.4 of 3GPP TS 29.501

security:
  - {}
  - oAuth2ClientCredentials:
    - nudsf-timer

paths:
  /{realmId}/{storageId}/timers:
    summary: Access to all Timers of a Storage
    description: >
      root of all Timers of a Storage
    get:
      summary: Timers search with get
      description: Retrieve one or multiple TimerIDs based on filter
      operationId: SearchTimer
      tags:
        - Timer Search
      security:
        - {}
        - oAuth2ClientCredentials:
          - nudsf-timer

```

```

- oAuth2ClientCredentials:
  - nudsf-timer
  - nudsf-timer:timer:read
parameters:
- name: realmId
  in: path
  description: Identifier of the Realm
  required: true
  schema:
    type: string
    example: Realm01
- name: storageId
  in: path
  description: Identifier of the Storage
  required: true
  schema:
    type: string
    example: Storage01
- name: filter
  in: query
  description: Query filter using conditions on tags
  content:
    application/json:
      schema:
        $ref: 'TS29598_Nudsf_DataRepository.yaml#/components/schemas/SearchExpression'
- name: expired-filter
  in: query
  description: Used to query for expired timers.
  schema:
    $ref: 'TS29571_CommonData.yaml#/components/schemas/NullValue'
- name: supported-features
  in: query
  description: Features required to be supported by the target NF
  schema:
    $ref: 'TS29571_CommonData.yaml#/components/schemas/SupportedFeatures'
responses:
  '200':
    description: Successful case. Response contains result of the search.
    content:
      application/json:
        schema:
          $ref: '#/components/schemas/TimerIdList'
  '204':
    description: >
      The search condition does not match any Timer.
  '400':
    $ref: 'TS29571_CommonData.yaml#/components/responses/400'
  '401':
    $ref: 'TS29571_CommonData.yaml#/components/responses/401'
  '403':
    $ref: 'TS29571_CommonData.yaml#/components/responses/403'
  '404':
    $ref: 'TS29571_CommonData.yaml#/components/responses/404'
  '406':
    $ref: 'TS29571_CommonData.yaml#/components/responses/406'
  '429':
    $ref: 'TS29571_CommonData.yaml#/components/responses/429'
  '500':
    $ref: 'TS29571_CommonData.yaml#/components/responses/500'
  '502':
    $ref: 'TS29571_CommonData.yaml#/components/responses/502'
  '503':
    $ref: 'TS29571_CommonData.yaml#/components/responses/503'
  default:
    $ref: 'TS29571_CommonData.yaml#/components/responses/default'
delete:
  summary: Delete one or multiple timers based on filter
  operationId: DeleteTimers
  tags:
    - Timers Delete
  security:
    - {}
    - oAuth2ClientCredentials:
      - nudsf-timer
    - oAuth2ClientCredentials:
      - nudsf-timer
      - nudsf-timer:timer:modify
parameters:

```

```

- name: realmId
  in: path
  description: Identifier(name) of the Realm
  required: true
  schema:
    type: string
    example: Realm01
- name: storageId
  in: path
  description: Identifier of the Storage
  required: true
  schema:
    type: string
    example: Storage01
- name: supported-features
  in: query
  description: Features required to be supported by the target NF
  schema:
    $ref: 'TS29571_CommonData.yaml#/components/schemas/SupportedFeatures'
- name: filter
  in: query
  description: A filter that determines the set of timers to be deleted
  content:
    application/json:
      schema:
        $ref: 'TS29598_Nudsf_DataRepository.yaml#/components/schemas/SearchExpression'
- name: expired-filter
  in: query
  description: Presence indicates that only expired timers are to be deleted.
  schema:
    $ref: 'TS29571_CommonData.yaml#/components/schemas/NullValue'
responses:
  '200':
    description: Successful case. Response contains result of the search.
    content:
      application/json:
        schema:
          $ref: '#/components/schemas/TimerIdList'
  '204':
    description: Successful case.
  '400':
    $ref: 'TS29571_CommonData.yaml#/components/responses/400'
  '401':
    $ref: 'TS29571_CommonData.yaml#/components/responses/401'
  '403':
    $ref: 'TS29571_CommonData.yaml#/components/responses/403'
  '404':
    $ref: 'TS29571_CommonData.yaml#/components/responses/404'
  '429':
    $ref: 'TS29571_CommonData.yaml#/components/responses/429'
  '500':
    $ref: 'TS29571_CommonData.yaml#/components/responses/500'
  '502':
    $ref: 'TS29571_CommonData.yaml#/components/responses/502'
  '503':
    $ref: 'TS29571_CommonData.yaml#/components/responses/503'
  default:
    $ref: 'TS29571_CommonData.yaml#/components/responses/default'
/{realmId}/{storageId}/timers/{timerId}:
  summary: Access to a specific Timer, identified by its TimerId
  description: >
    Access to a specific Timer
  put:
    summary: Create/Replace Timer
    description: Create or Modify a Timer with a user provided TimerId
    operationId: CreateOrModifyTimer
    tags:
      - Timer Start
    security:
      - {}
      - OAuth2ClientCredentials:
          - nudsf-timer
      - OAuth2ClientCredentials:
          - nudsf-timer
          - nudsf-timer:timer:create
    parameters:
      - name: realmId

```

```

    in: path
    description: Identifier(name) of the Realm
    required: true
    schema:
      type: string
      example: Realm01
  - name: storageId
    in: path
    description: Identifier of the Storage
    required: true
    schema:
      type: string
      example: Storage01
  - name: timerId
    in: path
    description: Identifier of the Timer
    required: true
    schema:
      $ref: '#/components/schemas/TimerId'
  - name: supported-features
    in: query
    description: Features required to be supported by the target NF
    schema:
      $ref: 'TS29571_CommonData.yaml#/components/schemas/SupportedFeatures'
requestBody:
  content:
    application/json:
      schema:
        $ref: '#/components/schemas/Timer'
    required: true
responses:
  '201':
    description: Timer successfully created
  '204':
    description: Timer successfully replaced
  '400':
    $ref: 'TS29571_CommonData.yaml#/components/responses/400'
  '401':
    $ref: 'TS29571_CommonData.yaml#/components/responses/401'
  '403':
    $ref: 'TS29571_CommonData.yaml#/components/responses/403'
  '404':
    $ref: 'TS29571_CommonData.yaml#/components/responses/404'
  '411':
    $ref: 'TS29571_CommonData.yaml#/components/responses/411'
  '413':
    $ref: 'TS29571_CommonData.yaml#/components/responses/413'
  '415':
    $ref: 'TS29571_CommonData.yaml#/components/responses/415'
  '429':
    $ref: 'TS29571_CommonData.yaml#/components/responses/429'
  '500':
    $ref: 'TS29571_CommonData.yaml#/components/responses/500'
  '502':
    $ref: 'TS29571_CommonData.yaml#/components/responses/502'
  '503':
    $ref: 'TS29571_CommonData.yaml#/components/responses/503'
  default:
    $ref: 'TS29571_CommonData.yaml#/components/responses/default'
callbacks:
  timerExpiry:
    '{$request.body#/callbackReference}':
      post:
        requestBody:
          required: true
          content:
            application/json:
              schema:
                $ref: '#/components/schemas/Timer'
        responses:
          '204':
            description: Callback executed successfully
          '400':
            $ref: 'TS29571_CommonData.yaml#/components/responses/400'
          '401':
            $ref: 'TS29571_CommonData.yaml#/components/responses/401'
          '403':
            $ref: 'TS29571_CommonData.yaml#/components/responses/403'

```

```

    '404':
      $ref: 'TS29571_CommonData.yaml#/components/responses/404'
    '411':
      $ref: 'TS29571_CommonData.yaml#/components/responses/411'
    '413':
      $ref: 'TS29571_CommonData.yaml#/components/responses/413'
    '415':
      $ref: 'TS29571_CommonData.yaml#/components/responses/415'
    '429':
      $ref: 'TS29571_CommonData.yaml#/components/responses/429'
    '500':
      $ref: 'TS29571_CommonData.yaml#/components/responses/500'
    '502':
      $ref: 'TS29571_CommonData.yaml#/components/responses/502'
    '503':
      $ref: 'TS29571_CommonData.yaml#/components/responses/503'
    default:
      $ref: 'TS29571_CommonData.yaml#/components/responses/default'
  patch:
    summary: Timer modification
    description: update a specific Timer
    operationId: UpdateTimer
    tags:
      - Timer Update
    security:
      - {}
      - OAuth2ClientCredentials:
          - nudsf-timer
      - OAuth2ClientCredentials:
          - nudsf-timer
          - nudsf-timer:timer:modify
    parameters:
      - name: realmId
        in: path
        description: Identifier of the Realm
        required: true
        schema:
          type: string
          example: Realm01
      - name: storageId
        in: path
        description: Identifier of the Storage
        required: true
        schema:
          type: string
          example: Storage01
      - name: timerId
        in: path
        description: Identifier of the Timer
        required: true
        schema:
          $ref: '#/components/schemas/TimerId'
      - name: supported-features
        in: query
        description: Features required to be supported by the target NF
        schema:
          $ref: 'TS29571_CommonData.yaml#/components/schemas/SupportedFeatures'
    requestBody:
      description: Timer data to patch
      content:
        application/json-patch+json:
          schema:
            type: array
            items:
              $ref: 'TS29571_CommonData.yaml#/components/schemas/PatchItem'
            minItems: 1
          required: true
    responses:
      '200':
        description: >
          One or more modification instructions have been discarded,
          the execution report is returned in response PatchResult.
        content:
          application/json:
            schema:
              $ref: 'TS29571_CommonData.yaml#/components/schemas/PatchResult'
      '204':
        description: >

```

```

    Successful case. The timer has been successfully updated and no return is expected.
  '400':
    $ref: 'TS29571_CommonData.yaml#/components/responses/400'
  '401':
    $ref: 'TS29571_CommonData.yaml#/components/responses/401'
  '403':
    $ref: 'TS29571_CommonData.yaml#/components/responses/403'
  '404':
    $ref: 'TS29571_CommonData.yaml#/components/responses/404'
  '411':
    $ref: 'TS29571_CommonData.yaml#/components/responses/411'
  '413':
    $ref: 'TS29571_CommonData.yaml#/components/responses/413'
  '415':
    $ref: 'TS29571_CommonData.yaml#/components/responses/415'
  '429':
    $ref: 'TS29571_CommonData.yaml#/components/responses/429'
  '500':
    $ref: 'TS29571_CommonData.yaml#/components/responses/500'
  '502':
    $ref: 'TS29571_CommonData.yaml#/components/responses/502'
  '503':
    $ref: 'TS29571_CommonData.yaml#/components/responses/503'
  default:
    $ref: 'TS29571_CommonData.yaml#/components/responses/default'
delete:
  summary: Delete a Timer with an user provided TimerId
  operationId: DeleteTimer
  tags:
    - Timer Stop
  security:
    - {}
    - oAuth2ClientCredentials:
      - nudsf-timer
    - oAuth2ClientCredentials:
      - nudsf-timer
      - nudsf-timer:timer:modify
  parameters:
    - name: realmId
      in: path
      description: Identifier(name) of the Realm
      required: true
      schema:
        type: string
        example: Realm01
    - name: storageId
      in: path
      description: Identifier of the Storage
      required: true
      schema:
        type: string
        example: Storage01
    - name: timerId
      in: path
      description: Identifier of the Timer
      required: true
      schema:
        $ref: '#/components/schemas/TimerId'
    - name: supported-features
      in: query
      description: Features required to be supported by the target NF
      schema:
        $ref: 'TS29571_CommonData.yaml#/components/schemas/SupportedFeatures'
  responses:
    '204':
      description: Successful case.
    '400':
      $ref: 'TS29571_CommonData.yaml#/components/responses/400'
    '401':
      $ref: 'TS29571_CommonData.yaml#/components/responses/401'
    '403':
      $ref: 'TS29571_CommonData.yaml#/components/responses/403'
    '404':
      $ref: 'TS29571_CommonData.yaml#/components/responses/404'
    '429':
      $ref: 'TS29571_CommonData.yaml#/components/responses/429'
    '500':
      $ref: 'TS29571_CommonData.yaml#/components/responses/500'

```

```

    '502':
      $ref: 'TS29571_CommonData.yaml#/components/responses/502'
    '503':
      $ref: 'TS29571_CommonData.yaml#/components/responses/503'
  default:
    $ref: 'TS29571_CommonData.yaml#/components/responses/default'
get:
  summary: Timer access
  description: retrieve one specific Timer
  operationId: GetTimer
  tags:
  - Timer Get
  security:
  - {}
  - oAuth2ClientCredentials:
    - nudsf-timer
  - oAuth2ClientCredentials:
    - nudsf-timer
    - nudsf-timer:timer:read
  parameters:
  - name: realmId
    in: path
    description: Identifier of the Realm
    required: true
    schema:
      type: string
      example: Realm01
  - name: storageId
    in: path
    description: Identifier of the Storage
    required: true
    schema:
      type: string
      example: Storage01
  - name: timerId
    in: path
    description: Identifier of the Timer
    required: true
    schema:
      $ref: '#/components/schemas/TimerId'
  - name: supported-features
    in: query
    description: Features required to be supported by the target NF
    schema:
      $ref: 'TS29571_CommonData.yaml#/components/schemas/SupportedFeatures'
  responses:
    '200': #result ok
      description: Successful case.
      content:
        application/json:
          schema:
            $ref: '#/components/schemas/Timer'
    '400':
      $ref: 'TS29571_CommonData.yaml#/components/responses/400'
    '401':
      $ref: 'TS29571_CommonData.yaml#/components/responses/401'
    '403':
      $ref: 'TS29571_CommonData.yaml#/components/responses/403'
    '404':
      $ref: 'TS29571_CommonData.yaml#/components/responses/404'
    '406':
      $ref: 'TS29571_CommonData.yaml#/components/responses/406'
    '429':
      $ref: 'TS29571_CommonData.yaml#/components/responses/429'
    '500':
      $ref: 'TS29571_CommonData.yaml#/components/responses/500'
    '502':
      $ref: 'TS29571_CommonData.yaml#/components/responses/502'
    '503':
      $ref: 'TS29571_CommonData.yaml#/components/responses/503'
  default:
    $ref: 'TS29571_CommonData.yaml#/components/responses/default'

components:
  securitySchemes:
    oAuth2ClientCredentials:
      type: oauth2

```



```
flows:
  clientCredentials:
    tokenUrl: '{nrfApiRoot}/oauth2/token'
    scopes:
      nudsf-timer: Access to the nudsf-timer API
      nudsf-timer:timer:read: Access to read timers
      nudsf-timer:timer:modify: Access to update timers
      nudsf-timer:timer:create: Access to create timers

schemas:

# COMPLEX TYPES:

Timer:
  description: Represents a timer.
  type: object
  required:
    - expires
  properties:
    timerId:
      $ref: '#/components/schemas/TimerId'
    expires:
      $ref: 'TS29571_CommonData.yaml#/components/schemas/DateTime'
    metaTags:
      description: >
        A map (list of key-value pairs where a tagName of type string serves as key)
        of tagValue lists
      type: object
      additionalProperties:
        type: array
        items:
          type: string
      minItems: 1
      minProperties: 1
    callbackReference:
      $ref: 'TS29571_CommonData.yaml#/components/schemas/Uri'
    deleteAfter:
      $ref: 'TS29571_CommonData.yaml#/components/schemas/UInteger'
    periodicRepetition:
      $ref: 'TS29571_CommonData.yaml#/components/schemas/DurationSec'
    repetitionCount:
      $ref: 'TS29571_CommonData.yaml#/components/schemas/UInteger'

TimerIdList:
  description: Represents a list of timer IDs.
  type: object
  required:
    - timerIds
  properties:
    timerIds:
      type: array
      items:
        $ref: '#/components/schemas/TimerId'
      minItems: 1

# SIMPLE TYPES:

TimerId:
  description: Represents the identifier of a timer.
  type: string
```

Annex B (informative): Search Examples

B.1 Example Search

The conditional expression is defined by the following Extended Backus-Naur Form (EBNF) [18].

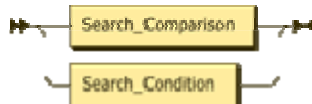

Figure B-1: Search Expression

Search_Expression ::= Search_Comparison | Search_Condition

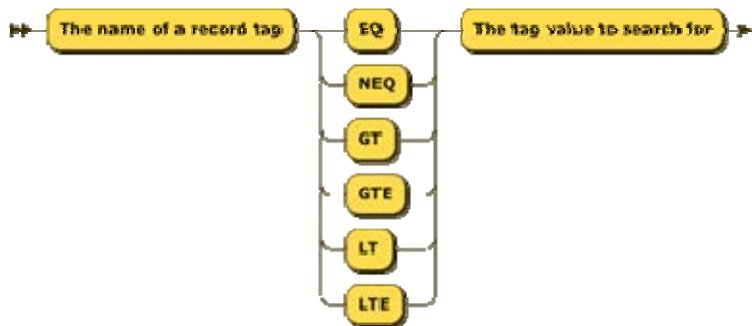

Figure B-2: Search Comparison

Search_Comparison ::= Tag ('EQ' | 'NEQ' | 'GT' | 'GTE' | 'LT' | 'LTE') Value

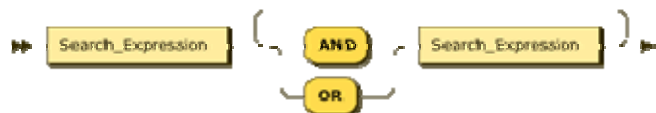

Figure B-3: Search Condition

Search_Condition ::= Search_Expression (('AND' | 'OR') Search_Expression)+



Figure B-4: Search ConditionNot

Search_ConditionNot ::= 'NOT' Search_Expression

Example:

Find all records where the tag "ueId" is equal to "455345" OR the tag "supi" is equal to "imsi-999559807001001":

```
{
  "cond": "OR",
  "units": [
    {
      "op": "EQ",
```

```

    "tag" : "ueId",
    "value" : "455345"
  },
  {
    "op": "EQ",
    "tag" : "supi",
    "value" : "imsi-999559807001001"
  }
]
}

```

B.2 Example AdvancedCounting

Session records:

```
RecordId1/RecordMeta : { "supi": ["imsi-456123000000006"], "dnn":["nrphone"], "qosFlows":["qf1", "qf2"],
"upfNodes":["upfnode1"], "upConnState":"ACTIVATED", "ratType":["NR"]}

```

```
RecordId2/RecordMeta : { "supi": ["imsi-456123000000006 ], "dnn":["ims"], "qosFlows":["qf1", "qf3" ],
"upfNodes":["upfNode1", "upfNode2"], "upConnState":"ACTIVATED", "ratType":["WLAN"]}

```

```
RecordId3/RecordMeta : { "supi": ["imsi-456123000001001 ], "dnn":["nrphone"], "qosFlows":["qf1", "qf2"],
"upfNodes":["upfNode3"], "upConnState":"DEACTIVATED", "ratType":["NR"]}

```

```
RecordId4/RecordMeta : { "supi": ["imsi-456123001032010 ], "dnn":["nrphone"], "qosFlows":["qf1", "qf4"],
"upfNodes":["upfNode4"], "upConnState":"ACTIVATED", "ratType":["NR"]}

```

Example 1: Get Unique count of records with tag= "supi" and upConnState = "ACTIVATED".

Search expression:

```

{
  "advancedTagCount1":
  {
    "tag" : "supi",
    "countType" : "UNIQUE_COUNT",
    "filter" : { "op": "EQ", "tag": "upConnState", "value": "ACTIVATED" }
  }
}

```

Output:

The search found two unique supi in "ACTIVATED" state matching the tag-count-filter.

```
{"advancedTagCount1" : {"supi" : 2}}
```

Example 2: Get Aggregate count of the tag=qosFlow and DNN="nrPhone".

Search expression:

```

{
  "advancedTagCount1":
  {
    "tag" : "qosFlows",
    "countType" : "AGGREGATE_COUNT",
    "filter" : { "op": "EQ", "tag": "dnn", "value": "nrphone" }
  }
}

```

Output:

```
{"advancedTagCount1" : [{"qf1": 2, "qf2":1, "qf4":1 ]]}
```

Example 3: Get Aggregate count for tag=qosFlow across all records

Search Expression:

```
{
  "advancedTagCount1":
  {
    "tag" : "qosFlows",
    "countType" : "AGGREGATE_COUNT",
    "filter" : null
  }
}
```

Output:

```
{"advancedTagCount1": [{"qf1": 4, "qf2":2, "qf3":1, "qf4":1 ]}}
```

Example 4: Get UNIQUE_COUNT of records for tag=supi

Search Expression:

```
{
  "advancedTagCount1":
  {
    "tag" : "supi",
    "countType" : "UNIQUE_COUNT",
    "filter" : null
  }
}
```

Output:

```
{"advancedTagCount1": {"supi" : 3}}
```

Example 5: Request 2 tag counts in one request

- Aggregate count of ratType
- Aggregate count of qosFlows

Search Expression:

```
{
  "advancedTagCount1":
  {
    "tag" : "ratType",
    "countType" : "AGGREGATE_COUNT",
    "filter" : null
  },
  "advancedTagCount2":
  {
    "tag" : "qosFlows",
    "countType" : "AGGREGATE_COUNT",
    "filter" : null
  }
}
```

Output:

```
{"advancedTagCount1": {"NR": 3, "WLAN":1}, "advancedTagCount2": [{"qf1": 4, "qf2":2, "qf3":1, "qf4":1 ]}}
```

Example 6: Total count of number of records with tag="supi"

Search Expression:

```
{
  "advancedTagCount1":
  {
    "tag" : "supi",
    "countType" : "TOTAL_COUNT",
    "filter" : null
  }
}
```

Output:

```
{"advancedTagCount1": {"supi" : 4}}
```

Annex C (informative): HTTP Multipart Examples

C.1 General

This clause provides examples of the HTTP multipart messages. The examples do not aim to be a complete representation of the HTTP message, e.g. additional information or headers can be included.

This Annex is informative and the normative descriptions in this specification prevail over the description in this Annex if there is any difference.

C.2 Example HTTP multipart Record

```
Content-Type: multipart/mixed; boundary=partboundary

--partboundary
Content-Id: meta
Content-Type: application/json; charset=UTF-8

{"tags": { "ueId" : ["455345"], "supi" : ["imsi-999559807001001"] } }
--partboundary

Content-Id: block1
Content-Type: application/json; charset=UTF-8
Content-Transfer-Encoding: binary

{ "firstName": "John", "lastName": "Doe" }
--partboundary

Content-Id: block2
Content-Type: image/png
Content-Transfer-Encoding: binary

<binary representation of png>

--partboundary--'
```

C.3 Example HTTP multipart BlockCollection

```
Content-Type: multipart/parallel; boundary=partboundary

--partboundary
Content-Id: block1
Content-Type: application/json; charset=UTF-8
Content-Transfer-Encoding: binary

{ "firstName": "John", "lastName": "Doe" }
--partboundary

Content-Id: block2
Content-Type: image/png
Content-Transfer-Encoding: base64

iVBORw0KGgoAAAANSUHEUGAAADIAAAACAYAAABUU38AAAAAXNSR0IArs4c6QAAAARnQU1BAACxjwv8YQUAAAAJcEhZcwAADsMAAA7DAcdvqQAAAAdEYVdENyZWw0aW9uIFRpbWUAMjAyMDowMjoyMiAxMTowMT0xNeLkX7MAAAUTSURBVFH7Zn5qFVVVIdv2XsN2qRZzOWUPWnSbHrEwwYapMQKbKCRNJ+GmpEN9EdBhCIVRHMRKYKIWqWYTQpKZzMeZTaHPIipcGyySzN9PvuuyS2h3PvPcW70B/vBx/33DPss/faa6+19ulRKqbdIO7dUfn9X2mXym+e9o0x0FqhJ2yE9+BzeB3+hkZpfzgzjoXe8Bu8C8thGxTSQfAlaPlqzIFm6EpprKvgDdgCvmczfAu/VP47mMOhkKZCdPgPeAgeh58q54I7INQC18PNMAHOH15QRN53G3wPTrsG7oZTYS/QtTXa8TALvoIBUFCXg26zHSZ6oqKTWPMxkBUwGF6F9HzwKzWIh0ItXQve/z6cAbVcXt0KK6HQGH8EWjnVCEg7/DP8mfyvXu9wL+wLQ+AyuB3uhydgBnjf86C16w3EGVoLo8r//oWa4DpwwU7WRQH7dpbl/z/Gj6Fz8DZ87xesBiOglrSCE91HtYfeR+4AG6BtOG/QKukshMfwhL4HFykPq+FD4EX4RnQfTbApeBsRuS/Q9ANz0GDoCzYBXkaQF8A67HqroQjFpZtzFi jIYfk30iVc+EeoZRR4CulKcX4CVwgc8F3SdvHbhW7ZvvrKpdYROkHRUfVbMeSM6JfjbnFNVsMPLkaTgYdp3JPeAtuAhSmdOciaehruF0pfWwFdJOZzFB6jBKRnluHjwHdjiLIdQw7j150vodch35X6k0GeaDalTX89kf4C4oWpWUZ6YfXAFvQ154nQQh/TrvnkBL+/L7wKogTyZEr30Hrqd3QE94ufJ/HDhb/1kOygsVdszFnCY8F6eWznNLMck5a1PAHJanA0h/cDA3gm71FnSptJb5IDpnhMqTITYdQPak6CK6n9Gplk4EQ7MRy2RZV1q6qE6B3TsPy3KK8553sHlAbHuDs3g0uI6sq0y6DjBkFWDUDGaOANDWIE0D+q3rYCacA2k0MBvFAFG0Ba6HMZDVCrDXrVI91t3CCA7eBelAroGHwTVg9DP/eM2c48y5
```

```
Pk6DQrIgzHbQSGEJoRWz2Xw1RPHoArYui4HbScOii16aB1zw2J6RyDRSxtG3Zl0KyAIto1sKK0wJSNxxgJkSwd+Ntgxeyes6SY09w
Fty7WFimsrxY2HlYUwPBoFKo0jUkPgbWOGnHxdlw2q+E7N7jdIi6KcUklsKoe7OJOJITzR7zm7qrdZsbpCJ6BB7tPKyutHEXnbWN
a8b18BG4G9R9qsns64KNumEpzKLTJtIeZMvz+R3ElK05sFR6jZc5UGV21m2yM5Wng8EodxS4YzR66gFutv5ROpAuk9Znh9TO7wBe
sAU6YCGJRGmpt7F6gTNDRBpLoloh94UvQJdrJiJVlJzCwNphiYSQh+KI0Npw9SQGcF0TYeVSuNpvI2B7IClMBSfabwVu9WtbuUq
NifngaEtFqP54Saw9DavnAtuZ61ElegMf8PgEjCxCgdvdtxjvDZVmdhOsagNrljdg5gJzjuleDR/DdLC0sdr1u5glUPThfnjdPT6p
qFxiukfyAl3sFO+BVTZgNeqHAhdjIW+0c35jsiQxETloPxG5c/S6+4+h4PV2sGGCVfmFbrJCVrzero0GsBuyIstx3g07Ll4ER1GFT
/rgbdLA0zplHax67wXLvb7s+48eQsjWsiXxhKl/sww7AjvsiLRRlj416j4qvgd7vueisims+KlHqx7f99q2WGln+xPviOeVALD2
jXqslLwTlVGQ4+/C82oAAAAASUVORK5CYII=
--partboundary--'
```

C.4 Example HTTP multipart RecordNotification

```
Content-Type: multipart/mixed; boundary=partboundary

--partboundary
Content-Id: recordnotification
Content-Type: application/json; charset=UTF-8

{"recordRef" : "...", "operationType" : "DELETED" }

--partboundary

Content-Id: meta
Content-Type: application/json; charset=UTF-8

{"tags": { "ueId" : ["455345"], "supi" : ["imsi-999559807001001"] } }

--partboundary

Content-Id: block1
Content-Type: application/json; charset=UTF-8
Content-Transfer-Encoding: binary

{"firstName": "John", "lastName": "Doe"}

--partboundary

Content-Id: block2
Content-Type: image/png
Content-Transfer-Encoding: binary

<binary representation of png>

--partboundary--'
```

C.5 Example HTTP multipart RecordPatch

```
Content-type: multipart/mixed; boundary=partboundary

--partboundary
Content-Id: patch
Content-Type: application/json-patch+json; charset=UTF-8

{ "op": "add", "path": "/meta/callbackReference", "value": "https://example.com" },
{ "op": "copy", "from": "/blocks/blockID1", "to": "/blocks/blockID2" },
{ "op": "add", "path": "/blocks/blockID1", "value": "addedBlock1" }

--partboundary
Content-Id: addedBlock1
Content-Type: image/png
Content-Transfer-Encoding: binary

<binary representation of png>

--partboundary--'
```

Annex D (informative): Change history

Change history							
Date	Meeting	TDoc	CR	Rev	Cat	Subject/Comment	New version
2019-11	CT4#94	C4-195489				Initial Draft.	0.1.0
2020-03	CT4#96	C4-200359 C4-200360 C4-200584 C4-200585 C4-200586 C4-200654 C4-200905 C4-200920 C4-201226 C4-201230 C4-201235 C4-201236 C4-201237				Implementation of pCRs agreed at CT4#96.	0.2.0
2020-03	CT#87e	CP-200066				TS presented for information and approval	1.0.0
2020-03	CT#87e					Approved at CT#87e	16.0.0
2020-06	CT#88e	CP-201175	0001	4	B	Subscribe To Notify	16.1.0
2020-06	CT#88e	CP-201041	0002		C	Removal of Editor's Note	16.1.0
2020-06	CT#88e	CP-201041	0003		C	Add supportedFeatures to RecordSearchResult	16.1.0
2020-06	CT#88e	CP-201041	0004		F	SearchExpression	16.1.0
2020-06	CT#88e	CP-201041	0006	1	F	Miscellaneous Corrections	16.1.0
2020-06	CT#88e	CP-201041	0007	1	B	Storage of YAML files in ETSI Forge	16.1.0
2020-06	CT#88e	CP-201041	0008		F	204 missing in OpenAPI	16.1.0
2020-06	CT#88e	CP-201073	0009		F	Rel-16 API version and External doc update	16.1.0
2020-09	CT#89e	CP-202116	0010		F	Optionality of ProblemDetails in TS29.598 cleanup	16.2.0
2020-12	CT#90e	CP-203052	0011	1	F	Misc corrections	16.3.0
2020-12	CT#90e	CP-203035	0012		F	Removal of the reference to ETSI Forge	16.3.0
2020-12	CT#90e	CP-203052	0013	1	F	Corrections on Subscription and Notification	16.3.0
2020-12	CT#90e	CP-203052	0014	1	F	Corrections on yaml of Nudsf_DataRepository OpenAPI	16.3.0
2020-12	CT#90e	CP-203052	0015	1	F	Define Unsubscription to notifications service operation	16.3.0
2020-12	CT#90e	CP-203052	0016	1	F	Incorrect data type	16.3.0
2020-12	CT#90e	CP-203052	0018		F	Resource URI problems clean up	16.3.0
2020-12	CT#90e	CP-203018	0019	3	B	Meta Schema	17.0.0
2020-12	CT#90e	CP-203055	0022		F	29.598 Rel-17 API version and External doc update	17.0.0
2021-03	CT#91e	CP-210039	0024	1	A	Removal of paging parameters	17.1.0
2021-03	CT#91e	CP-210039	0026	1	A	BlockId clarification	17.1.0
2021-03	CT#91e	CP-210034	0027	1	F	OpenAPI Reference	17.1.0
2021-03	CT#91e	CP-210090	0028	2	B	Nudsf_Timer Service	17.1.0
2021-03	CT#91e	CP-210029	0029		F	29.598 Rel-17 API version and External doc update	17.1.0
2021-06	CT#92e	CP-211028	0031		F	metaTags cardinality in type Timer	17.2.0
2021-06	CT#92e	CP-211028	0032		F	Adding some missing description fields to data type definitions in OpenAPI specification files of the Nudsf_DataRepository API	17.2.0
2021-06	CT#92e	CP-211028	0033		F	Adding some missing description fields to data type definitions in OpenAPI specification files of the Nudsf_Timer API	17.2.0
2021-06	CT#92e	CP-211065	0035		A	Nested cardinality R17	17.2.0
2021-06	CT#92e	CP-211065	0037	1	A	Monitored Resource URI	17.2.0
2021-06	CT#92e	CP-211061	0039		A	Content-ID	17.2.0
2021-06	CT#92e	CP-211050	0040		F	29.598 Rel-17 API version and External doc update	17.2.0
2021-09	CT#93e	CP-212026	0042		B	Combined Search and Retrieval	17.3.0
2021-09	CT#93e	CP-212067	0044		A	Removal of enum	17.3.0
2021-09	CT#93e	CP-212059	0045		F	29.598 Rel-17 API version and External doc update	17.3.0
2021-12	CT#94e	CP-213087	0047	2	B	Subscription Expiry Notification	17.4.0
2021-12	CT#94e	CP-213086	0048	1	B	Support of Bulk Operations	17.4.0
2021-12	CT#94e	CP-213133	0050	2	F	Content-id	17.4.0
2021-12	CT#94e	CP-213121	0051		F	29.598 Rel-17 API version and External doc update	17.4.0
2022-03	CT#95e	CP-220024	0052		F	Query parameter formatting	17.5.0
2022-03	CT#95e	CP-220066	0053		F	29.598 Rel-17 API version and External doc update	17.5.0
2022-06	CT#96	CP-221051	0054		F	29.598 Rel-17 API version and External doc update	17.6.0
2022-12	CT#98	CP-223065	0057	1	F	Removing editor's notes from Rel-17	17.7.0
2022-12	CT#98	CP-223028	0056	1	F	Missing Mandatory Status Codes in OpenAPI	18.0.0
2022-12	CT#98	CP-223033	0058		F	29.598 Rel-18 API version and External doc update	18.0.0
2023-03	CT#99	CP-230208	0059	3	F	Introducing Advanced Tag Counting	18.1.0
2023-03	CT#99	CP-230071	0060		F	29.598 Rel-18 API version and External doc update	18.1.0

2023-06	CT#100	CP-231025	0061		B	OAuth2 scopes in the Nudsf APIs	18.2.0
2023-06	CT#100	CP-231028	0063	2	F	Clarification: Delete all records	18.2.0
2023-06	CT#100	CP-231070	0064		F	29.598 Rel-18 API version and External doc update	18.2.0
2023-09	CT#101	CP-232033	0065	2	F	Correction: Unsubscribe service operation	18.3.0
2023-09	CT#101	CP-232153	0066	3	F	UDSF Error Handling	18.3.0
2023-09	CT#101	CP-232060	0067		F	29.598 Rel-18 API version and External doc update	18.3.0
2023-12	CT#102	CP-233029	0068	1	B	Periodic Timer	18.4.0
2023-12	CT#102	CP-233028	0069		F	Update and replace obsoleted HTTP RFCs	18.4.0
2023-12	CT#102	CP-233031	0070		F	Replacing obsoleted HTTP RFC 7807 with 9457	18.4.0
2023-12	CT#102	CP-233060	0071		F	29.598 Rel-18 API version and External doc update	18.4.0
2024-03	CT#103	CP-240028	0072	1	B	Partial Record Update	18.5.0
2024-03	CT#103	CP-240056	0073		F	29.598 Rel-18 API version and External doc update	18.5.0
2024-06	CT#104	CP-241319	0074	1	F	Callbacks	18.6.0
2024-06	CT#104	CP-241050	0075	2	F	Style Corrections and OpenAPI corrections of Nudsf API	18.6.0
2024-06	CT#104	CP-241050	0076	1	F	Clarifying the self-references and editorial corrections	18.6.0
2024-06	CT#104	CP-241069	0079		A	Corrections to OpenAPI	18.6.0
2024-06	CT#104	CP-241052	0080		F	29.598 Rel-18 API version and External doc update	18.6.0

History

Document history		
V18.5.0	May 2024	Publication
V18.6.0	July 2024	Publication