

ETSI TS 129 673 V16.3.0 (2021-01)



**LTE;
5G;
5G System;
UE radio capability management services;
Stage 3
(3GPP TS 29.673 version 16.3.0 Release 16)**



Reference

RTS/TSGC-0429673vg30

Keywords

5G,LTE

ETSI

650 Route des Lucioles
F-06921 Sophia Antipolis Cedex - FRANCE

Tel.: +33 4 92 94 42 00 Fax: +33 4 93 65 47 16

Siret N° 348 623 562 00017 - NAF 742 C
Association à but non lucratif enregistrée à la
Sous-Préfecture de Grasse (06) N° 7803/88

Important notice

The present document can be downloaded from:

<http://www.etsi.org/standards-search>

The present document may be made available in electronic versions and/or in print. The content of any electronic and/or print versions of the present document shall not be modified without the prior written authorization of ETSI. In case of any existing or perceived difference in contents between such versions and/or in print, the prevailing version of an ETSI deliverable is the one made publicly available in PDF format at www.etsi.org/deliver.

Users of the present document should be aware that the document may be subject to revision or change of status.

Information on the current status of this and other ETSI documents is available at

<https://portal.etsi.org/TB/ETSIDeliverableStatus.aspx>

If you find errors in the present document, please send your comment to one of the following services:

<https://portal.etsi.org/People/CommiteeSupportStaff.aspx>

Copyright Notification

No part may be reproduced or utilized in any form or by any means, electronic or mechanical, including photocopying and microfilm except as authorized by written permission of ETSI.

The content of the PDF version shall not be modified without the written authorization of ETSI.

The copyright and the foregoing restriction extend to reproduction in all media.

© ETSI 2021.

All rights reserved.

DECT™, **PLUGTESTS™**, **UMTS™** and the ETSI logo are trademarks of ETSI registered for the benefit of its Members.

3GPP™ and **LTE™** are trademarks of ETSI registered for the benefit of its Members and of the 3GPP Organizational Partners.

oneM2M™ logo is a trademark of ETSI registered for the benefit of its Members and of the oneM2M Partners.

GSM® and the GSM logo are trademarks registered and owned by the GSM Association.

Intellectual Property Rights

Essential patents

IPRs essential or potentially essential to normative deliverables may have been declared to ETSI. The information pertaining to these essential IPRs, if any, is publicly available for **ETSI members and non-members**, and can be found in ETSI SR 000 314: "*Intellectual Property Rights (IPRs); Essential, or potentially Essential, IPRs notified to ETSI in respect of ETSI standards*", which is available from the ETSI Secretariat. Latest updates are available on the ETSI Web server (<https://ipr.etsi.org/>).

Pursuant to the ETSI IPR Policy, no investigation, including IPR searches, has been carried out by ETSI. No guarantee can be given as to the existence of other IPRs not referenced in ETSI SR 000 314 (or the updates on the ETSI Web server) which are, or may be, or may become, essential to the present document.

Trademarks

The present document may include trademarks and/or tradenames which are asserted and/or registered by their owners. ETSI claims no ownership of these except for any which are indicated as being the property of ETSI, and conveys no right to use or reproduce any trademark and/or tradename. Mention of those trademarks in the present document does not constitute an endorsement by ETSI of products, services or organizations associated with those trademarks.

Legal Notice

This Technical Specification (TS) has been produced by ETSI 3rd Generation Partnership Project (3GPP).

The present document may refer to technical specifications or reports using their 3GPP identities. These shall be interpreted as being references to the corresponding ETSI deliverables.

The cross reference between 3GPP and ETSI identities can be found under <http://webapp.etsi.org/key/queryform.asp>.

Modal verbs terminology

In the present document "**shall**", "**shall not**", "**should**", "**should not**", "**may**", "**need not**", "**will**", "**will not**", "**can**" and "**cannot**" are to be interpreted as described in clause 3.2 of the [ETSI Drafting Rules](#) (Verbal forms for the expression of provisions).

"**must**" and "**must not**" are **NOT** allowed in ETSI deliverables except when used in direct citation.

Contents

Intellectual Property Rights	2
Legal Notice	2
Modal verbs terminology.....	2
Foreword.....	5
1 Scope	7
2 References	7
3 Definitions of terms, symbols and abbreviations	8
3.1 Terms.....	8
3.2 Symbols.....	8
3.3 Abbreviations	8
4 Overview	8
4.1 Introduction	8
5 Services offered by the UCMF.....	9
5.1 Introduction	9
5.2 Ncmf_UECapabilityManagement Service	9
5.2.1 Service Description.....	9
5.2.2 Service Operations.....	10
5.2.2.1 Introduction.....	10
5.2.2.2 Service Operation Resolve	10
5.2.2.2.1 General	10
5.2.2.2.2 Retrieve a Dictionary Entry.....	11
5.2.2.3 Service Operation Assign.....	11
5.2.2.4 Service Operation Subscribe	12
5.2.2.4.1 General	12
5.2.2.5 Unsubscribe.....	13
5.2.2.5.1 General	13
5.2.2.6 Notify	13
5.2.2.6.1 General	13
6 API Definitions	14
6.1 Ncmf_UECapabilityManagement Service API.....	14
6.1.1 Introduction.....	14
6.1.2 Usage of HTTP	14
6.1.2.1 General	14
6.1.2.2 HTTP standard headers	14
6.1.2.2.1 General	14
6.1.2.2.2 Content type	14
6.1.2.3 HTTP custom headers	15
6.1.2.4 HTTP multipart messages	15
6.1.3 Resources.....	16
6.1.3.1 Overview.....	16
6.1.3.2 Resource: Dictionary Entries	17
6.1.3.2.1 Description	17
6.1.3.2.2 Resource Definition.....	17
6.1.3.2.3 Resource Standard Methods	17
6.1.3.2.3.1 GET.....	17
6.1.3.2.3.2 POST.....	18
6.1.3.2.4 Resource Custom Operations	18
6.1.3.3 Resource: Individual Dictionary Entry.....	18
6.1.3.3.1 Description	18
6.1.3.3.2 Resource Definition.....	19
6.1.3.3.3 Resource Standard Methods	19
6.1.3.3.3.1 GET.....	19

6.1.3.4	Resource: Subscriptions collection	20
6.1.3.4.1	Description	20
6.1.3.4.2	Resource Definition	20
6.1.3.4.3	Resource Standard Methods	20
6.1.3.4.3.1	POST	20
6.1.3.4.4	Resource Custom Operations	20
6.1.3.5	Resource: Individual subscription	21
6.1.3.5.1	Description	21
6.1.3.5.2	Resource Definition	21
6.1.3.5.3	Resource Standard Methods	21
6.1.3.5.3.2	DELETE	21
6.1.3.5.4	Resource Custom Operations	22
6.1.4	Custom Operations without associated resources	22
6.1.5	Notifications	22
6.1.5.1	General	22
6.1.5.2	UCMF Notification	22
6.1.5.2.1	Description	22
6.1.5.2.2	Target URI	22
6.1.5.2.3	Standard Methods	22
6.1.5.2.3.1	POST	22
6.1.6	Data Model	23
6.1.6.1	General	23
6.1.6.2	Structured data types	23
6.1.6.2.1	Introduction	23
6.1.6.2.2	Type: DicEntryData	24
6.1.6.2.3	Type: DicEntryCreateData	24
6.1.6.2.4	Type: DicEntryCreatedData	24
6.1.6.2.5	Type: UeRadioCapald	25
6.1.6.2.6	Type: CreateSubscription	25
6.1.6.2.7	Type: CreatedSubscription	25
6.1.6.2.8	Type: UcmfNotification	26
6.1.6.2.9	Type: ManAssOpRequestlist	26
6.1.6.3	Simple data types and enumerations	26
6.1.6.3.1	Introduction	26
6.1.6.3.2	Simple data types	26
6.1.6.3.3	Enumeration: EventType	27
6.1.6.3.4	Enumeration: RacFormat	27
6.1.6.4	Data types describing alternative data types or combinations of data types	27
6.1.6.5	Binary data	27
6.1.6.5.2	UE Radio Capability Information	27
6.1.7	Error Handling	28
6.1.7.1	General	28
6.1.7.2	Protocol Errors	28
6.1.7.3	Application Errors	28
6.1.8	Feature negotiation	28
6.1.9	Security	28
Annex A (normative):	OpenAPI specification	29
A.1	General	29
A.2	Nucmf_UECapabilityManagement API	29
Annex B (informative):	Change history	36
History		37

Foreword

This Technical Specification has been produced by the 3rd Generation Partnership Project (3GPP).

The contents of the present document are subject to continuing work within the TSG and may change following formal TSG approval. Should the TSG modify the contents of the present document, it will be re-released by the TSG with an identifying change of release date and an increase in version number as follows:

Version x.y.z

where:

- x the first digit:
 - 1 presented to TSG for information;
 - 2 presented to TSG for approval;
 - 3 or greater indicates TSG approved document under change control.
- y the second digit is incremented for all changes of substance, i.e. technical enhancements, corrections, updates, etc.
- z the third digit is incremented when editorial only changes have been incorporated in the document.

In the present document, modal verbs have the following meanings:

- shall** indicates a mandatory requirement to do something
- shall not** indicates an interdiction (prohibition) to do something

The constructions "shall" and "shall not" are confined to the context of normative provisions, and do not appear in Technical Reports.

The constructions "must" and "must not" are not used as substitutes for "shall" and "shall not". Their use is avoided insofar as possible, and they are not used in a normative context except in a direct citation from an external, referenced, non-3GPP document, or so as to maintain continuity of style when extending or modifying the provisions of such a referenced document.

- should** indicates a recommendation to do something
- should not** indicates a recommendation not to do something
- may** indicates permission to do something
- need not** indicates permission not to do something

The construction "may not" is ambiguous and is not used in normative elements. The unambiguous constructions "might not" or "shall not" are used instead, depending upon the meaning intended.

- can** indicates that something is possible
- cannot** indicates that something is impossible

The constructions "can" and "cannot" are not substitutes for "may" and "need not".

- will** indicates that something is certain or expected to happen as a result of action taken by an agency the behaviour of which is outside the scope of the present document
- will not** indicates that something is certain or expected not to happen as a result of action taken by an agency the behaviour of which is outside the scope of the present document
- might** indicates a likelihood that something will happen as a result of action taken by some agency the behaviour of which is outside the scope of the present document

might not indicates a likelihood that something will not happen as a result of action taken by some agency the behaviour of which is outside the scope of the present document

In addition:

is (or any other verb in the indicative mood) indicates a statement of fact

is not (or any other negative verb in the indicative mood) indicates a statement of fact

The constructions "is" and "is not" do not indicate requirements.

1 Scope

The present document specifies the stage 3 protocol and data model for the Ncnmf Service Based Interface. It provides stage 3 protocol definitions and message flows, and specifies the API for each service offered by the Ncnmf.

The 5G System stage 2 architecture and procedures are specified in 3GPP TS 23.501 [2] and 3GPP TS 23.502 [3].

The Technical Realization of the Service Based Architecture and the Principles and Guidelines for Services Definition are specified in 3GPP TS 29.500 [4] and 3GPP TS 29.501 [5].

2 References

The following documents contain provisions which, through reference in this text, constitute provisions of the present document.

- References are either specific (identified by date of publication, edition number, version number, etc.) or non-specific.
- For a specific reference, subsequent revisions do not apply.
- For a non-specific reference, the latest version applies. In the case of a reference to a 3GPP document (including a GSM document), a non-specific reference implicitly refers to the latest version of that document *in the same Release as the present document*.

- [1] 3GPP TR 21.905: "Vocabulary for 3GPP Specifications".
- [2] 3GPP TS 23.501: "System Architecture for the 5G System; Stage 2".
- [3] 3GPP TS 23.502: "Procedures for the 5G System; Stage 2".
- [4] 3GPP TS 29.500: "5G System; Technical Realization of Service Based Architecture; Stage 3".
- [5] 3GPP TS 29.501: "5G System; Principles and Guidelines for Services Definition; Stage 3".
- [6] OpenAPI: "OpenAPI 3.0.0 Specification", <https://github.com/OAI/OpenAPI-Specification/blob/master/versions/3.0.0.md>.
- [7] 3GPP TR 21.900: "Technical Specification Group working methods".
- [8] 3GPP TS 33.501: "Security architecture and procedures for 5G system".
- [9] IETF RFC 6749: "The OAuth 2.0 Authorization Framework".
- [10] 3GPP TS 29.510: "5G System; Network Function Repository Services; Stage 3".
- [11] IETF RFC 7540: "Hypertext Transfer Protocol Version 2 (HTTP/2)".
- [12] IETF RFC 8259: "The JavaScript Object Notation (JSON) Data Interchange Format".
- [13] IETF RFC 7807: "Problem Details for HTTP APIs".
- [14] 3GPP TS 29.571: "5G System; Common Data Types for Service Based Interfaces; Stage 3".
- [15] 3GPP TS 38.413: "NG Radio Access Network (NG-RAN); NG Application Protocol (NGAP)".
- [16] 3GPP TS 29.274: "3GPP Evolved Packet System (EPS); Evolved General Packet Radio Service (GPRS) Tunnelling Protocol for Control plane (GTPv2-C); Stage 3".
- [17] 3GPP TS 36.413: "Evolved Universal Terrestrial Radio Access Network (E-UTRAN); S1 Application Protocol (S1AP)"

3 Definitions of terms, symbols and abbreviations

3.1 Terms

void

3.2 Symbols

void

3.3 Abbreviations

For the purposes of the present document, the abbreviations given in 3GPP TR 21.905 [1] and the following apply. An abbreviation defined in the present document takes precedence over the definition of the same abbreviation, if any, in 3GPP TR 21.905 [1].

MME	Mobility Management Entity
UCMF	UE radio Capability Management Function

4 Overview

4.1 Introduction

Within the 5GC, the UCMF offers services to the NF (e.g. AMF and MME) via the Nucmf service based interface (see 3GPP TS 23.501 [2] and 3GPP TS 23.502 [3]).

Figure 4.1-1 provides the reference model (in service based interface representation and in reference point representation), with focus on the UCMF and the scope of the present specification.

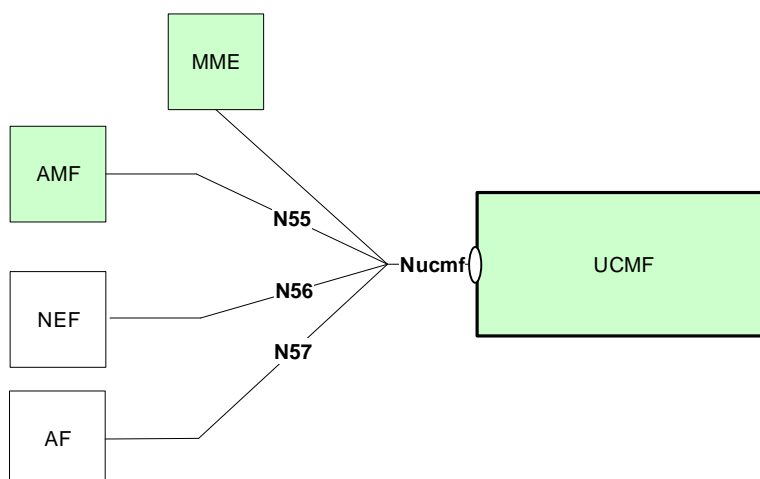

Figure 4.1-1: Reference model – UCMF

The functionalities supported by the UCMF are listed in clause 6.2.5 of 3GPP TS 23.501 [2].

5 Services offered by the UCMF

5.1 Introduction

The UCMF supports the following services.

Table 5.1-1: NF Services provided by UCMF

Service Name	Description	Example Consumer
Nucmf_UECapabilityManagement	<p>Allows the NF consumer to resolve UE Radio Capability ID (either Manufacturer-assigned or PLMN-assigned) into the corresponding UE radio access capability.</p> <p>Allows the NF consumer to obtain a PLMN-assigned UE Radio Capability ID for a specific UE radio access capability.</p> <p>Allows the NF consumer to subscribe or unsubscribe for notifications of UCMF dictionary entries.</p> <p>Allows the NF consumer to be notified about creation and deletion of UCMF dictionary entries.</p>	AMF, MME

5.2 Nucmf_UECapabilityManagement Service

5.2.1 Service Description

The Nucmf_UECapabilityManagement service operates on the dictionary entries for the mapping between UE Radio Capability ID and UE Radio Access Capability Information. The service operations exposed by this service allow service consumer NF, e.g. an AMF:

- to retrieve UE radio access capability information with a UE Radio Capability ID (either Manufacturer-assigned or PLMN-assigned);
- to obtain a PLMN-assigned UE Radio Capability ID for a specific UE radio access capability information;
- to subscribe or unsubscribe for notifications of UCMF dictionary entries;
- to be notified about creation and deletion of UCMF dictionary entries;

The Nucmf_UECapabilityManagement service supports the following service operations;

Table 5.2.1-1: Service operations supported by the Nucmf_UECapabilityManagement service

Service Operations	Description	Operation Semantics	Example Consumer(s)
Resolve	Retrieve UE radio access capability information from the dictionary entry identified by the UE Radio Capability ID (either Manufacturer-assigned or PLMN-assigned)	Request/Response	AMF, MME
Assign	Request to assign a UE Radio Capability ID by providing the UE Radio Capability Information. See 3GPP TS 23.502 clause 5.2.18.3.2.	Request/Response	AMF, MME
Subscribe	Subscribe for notifications of UCMF dictionary entries.	Subscribe/Notify	AMF, MME
Unsubscribe	Unsubscribe for notifications of UCMF dictionary entries.	Subscribe/Notify	AMF, MME
Notify	To be notified about creation and deletion of UCMF dictionary entries.	Subscribe/Notify	AMF, MME

5.2.2 Service Operations

5.2.2.1 Introduction

See Table 5.2.1-1 for an overview of the service operations supported by the Nucmf_UECapabilityManagement service.

5.2.2.2 Service Operation Resolve

5.2.2.2.1 General

The Resolve service operation shall be used to retrieve UE Radio Access Capability Information from a dictionary entry stored in the UCMF, by a NF service consumer, e.g. an AMF, when:

- it has received an unknown UE Radio Capability ID, which is either Manufacturer-assigned or PLMN-assigned;

The NF Service Consumer (e.g. AMF) shall retrieve UE Radio Access Capability Information by using the HTTP GET method as shown in Figure 5.2.2.2.1-1.

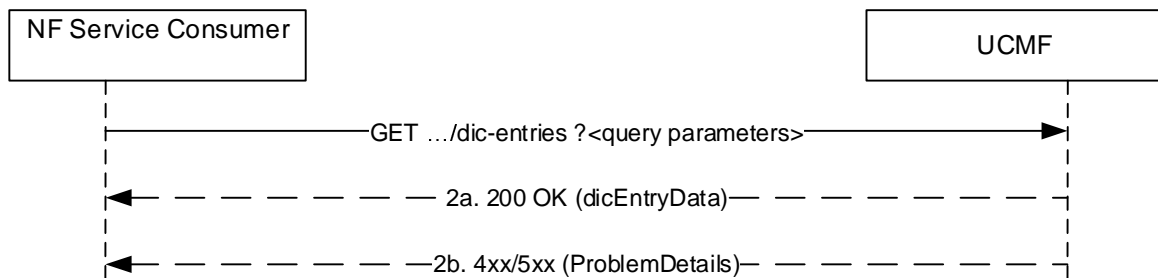

Figure: 5.2.2.2.1-1 Retrieve UE Radio Access Capability Information

1. The NF Service Consumer, e.g. an AMF, shall send an HTTP GET request to the resource URI Dictionary Entries collection resource. The query parameters are a Manufacturer-assigned or a PLMN-assigned UE Radio Capability ID, and the Coding format (e.g. 5GS or EPS) in which UE Radio Access Capability Information needs to be provided.
- 2a. On success, "200 OK" shall be returned. The response body shall contain UE Radio Access Capability Information in the requested Coding format stored in the dictionary entry that is matching the UE Radio Capability ID in query, and may contain a PLMN-assigned UE Radio Capability ID if the query parameter is a Manufacturer-assigned UE Radio Capability ID and if the PLMN-assigned UE Radio Capability ID mechanism is used in the network.

2b. On failure, one of the HTTP status code listed in Table 6.1.3.3.3.2-3 shall be returned. For a 4xx/5xx response, the message body may contain a ProblemDetails structure with the "cause" attribute set to one of the application errors listed in Table 6.1.3.3.3.2-2, where applicable.

5.2.2.2.2 Retrieve a Dictionary Entry

The Resolve service operation may be used to retrieve a dictionary entry stored in the UCMF, by a NF service consumer, e.g. an AMF, when it has the Dictionary Entry ID available.

The NF Service Consumer (e.g. AMF) shall retrieve a Dictionary Entry by using the HTTP GET method as shown in Figure 5.2.2.2.1-1.

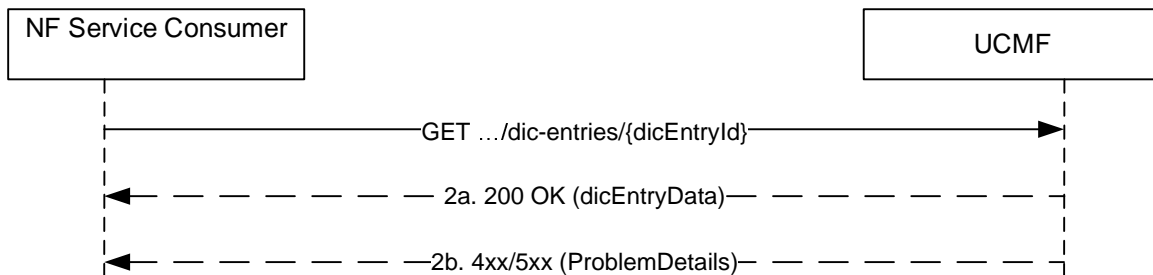

Figure 5.2.2.2.1-1 Retrieve a dictionary entry

1. The NF Service Consumer, e.g. an AMF, shall send an HTTP GET request to an individual Dictionary Entry resource. The query parameter is the Coding Format (e.g. 5GS or EPS) in which UE Radio Access Capability Information needs to be provided.
- 2a. On success, "200 OK" shall be returned. The response body shall the dictionary entry information for the given Dictionary Entry ID.
- 2b. On failure, one of the HTTP status code listed in Table 6.1.3.3.3.2-3 shall be returned. For a 4xx/5xx response, the message body may contain a ProblemDetails structure with the "cause" attribute set to one of the application errors listed in Table 6.1.3.3.3.2-3, where applicable.

5.2.2.3 Service Operation Assign

The Assign service operation shall be used by the service consumer NF (e.g. AMF) to obtain a PLMN-assigned UE Radio Capability ID from the UCMF for a specific UE radio access capability information. The UCMF shall create a new dictionary entry and assign a PLMN-assigned UE Radio Capability ID unless such dictionary entry already exists and a PLMN-assigned UE Radio Capability ID has already been assigned to the given UE radio access capability information in the UCMF. The NF service consumer, e.g. an AMF, may consume the service by providing the UE Radio Access Capability Information retrieved from the UE, and Type Allocation Code of PEI of the UE, e.g. when it hasn't received any UE Radio Capability ID.

The NF Service Consumer (e.g. AMF) shall obtain the PLMN Assigned UE Radio Capability ID by using the HTTP POST method as shown in Figure 5.2.2.3.1-1.

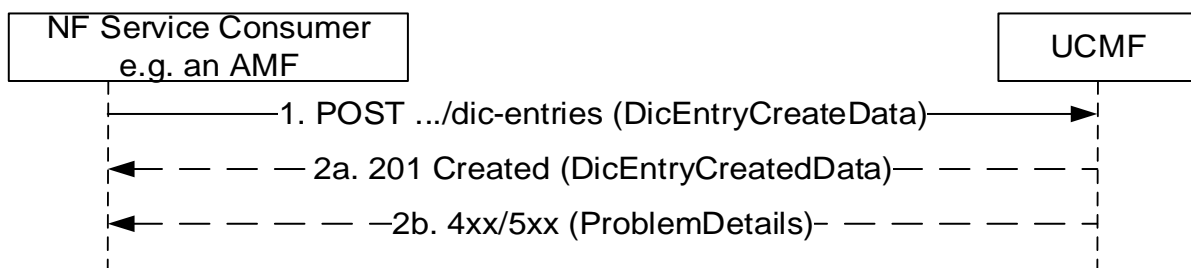

Figure 5.2.2.3-1 Create a dictionary entry

1. The NF Service Consumer shall send a POST request to the resource representing the Dictionary Entries collection resource of the UCMF. The payload body of the POST request shall contain:
 - the UE Radio Access Capability Information for the current radio configuration of the UE in 5GS format, or EPS format, or both the formats;
 - the Type Allocation Code of the PEI of the UE.
- 2a. On success, the UCMF shall check whether for the provided input a dictionary entry already exists and a PLMN Assigned UE Radio Capability ID has already been assigned. If so "201 Created" shall be returned, the payload body of the POST response shall contain already assigned PLMN Assigned UE Radio Capability ID included in DicEntryCreatedData and the "Location" header shall be present and shall contain the URI of the already existing resource. Otherwise a new dictionary entry shall be created and "201 Created" shall be returned, the payload body of the POST response shall contain the newly assigned PLMN Assigned UE Radio Capability ID included in DicEntryCreatedData and the "Location" header shall be present and shall contain the URI of the newly created resource.
- 2b. On failure, one of the HTTP status code listed in Table 6.1.3.2.3.2-3 shall be returned. For a 4xx/5xx response, the message body may contain a ProblemDetails structure with the "cause" attribute set to one of the application errors listed in Table 6.1.3.3.2-2, where applicable. A UCMF configured to operate in Mode of Operation A (3GPPP TS 23.501, Clause 5.4.4.1a) shall reject the operation if the request does not contain UE Radio Access Capability Information in both the formats and the UCMF is not able to find match of the received UE Radio Access Capability Information in its database.

5.2.2.4 Service Operation Subscribe

5.2.2.4.1 General

The Subscribe service operation shall be used by a NF Service Consumer, e.g. an AMF, to create a subscription in the UCMF, to get notifications for one or more new dictionary entries creation or for the deletion of one or more PLMN Assigned UE Radio Capability IDs.

The NF Service Consumer shall request to create a new subscription by using HTTP method POST with URI of the subscriptions collection, see clause 6.1.3.4. A `ucmfNotificationUri` shall be provided in the `CreateSubscription` to be used by the UCMF to send notifications later. See Figure 5.2.2.4.1-1.

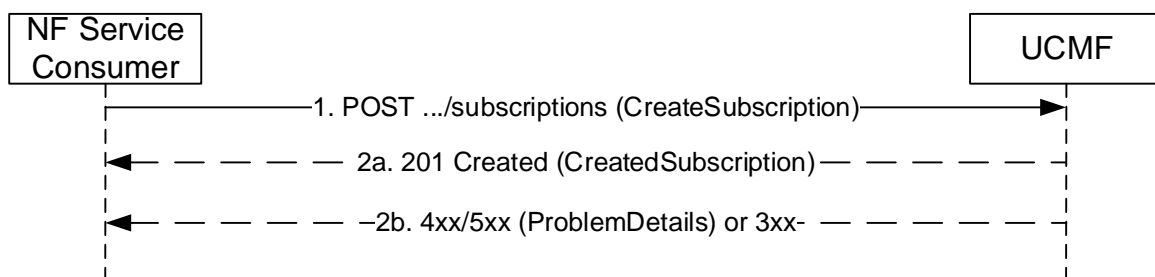

Figure 5.2.2.4.1-1 Create a subscription

1. The NF Service Consumer shall send a POST request to create a subscription resource in the UCMF. The payload body of the POST request shall contain a representation of the individual subscription resource to be created. The request may contain an expiry time, suggested by the NF Service Consumer as a hint, representing the time upto which the subscription is desired to be kept active and the time after which the subscribed event(s) shall stop generating report.
- 2a. On success, the request is accepted, the UCMF shall include a HTTP Location header to provide the location of a newly created resource (subscription) together with the status code 201 indicating the requested resource is created in the response message. The UCMF may also include the highest dictionary entry ID which has been allocated.

The response, based on operator policy and taking into account the expiry time included in the request, may contain the expiry time, as determined by the UCMF, after which the subscription becomes invalid. Once the subscription expires, if the NF Service Consumer wants to keep receiving notifications, it shall create a new

subscription in the UCMF. The UCMF shall not provide the same expiry time for many subscriptions in order to avoid all of them expiring and recreating the subscription at the same time. If the expiry time is not included in the response, the NF Service Consumer shall consider the subscription to be valid without an expiry time.

- 2b. On failure or redirection, one of the HTTP status code listed in Table 6.1.3.4.3.1-3 shall be returned. For a 4xx/5xx response, the message body may contain a ProblemDetails structure with the "cause" attribute set to one of the application errors listed in Table 6.1.3.4.3.1-3.

5.2.2.5 Unsubscribe

5.2.2.5.1 General

The Unsubscribe service operation is used by a NF Service Consumer, e.g. AMF, towards the UCMF, to remove an existing subscription previously created by itself at the UCMF.

The NF Service Consumer shall unsubscribe to the subscription by using HTTP method DELETE with the URI of the individual subscription resource (see clause 6.1.3.5) to be deleted. See Figure 5.2.2.5.1-1.

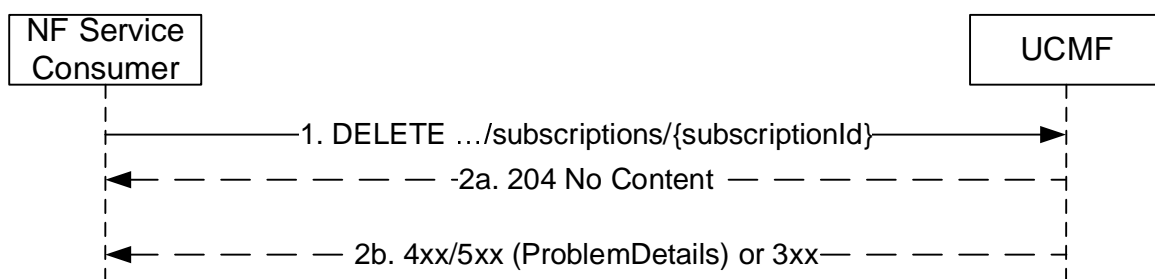

Figure 5.2.2.5.1-1 Unsubscribe a subscription

1. The NF Service Consumer shall send a DELETE request to delete an existing subscription resource in the UCMF.
- 2a. On success, the request is accepted, the UCMF shall reply with the status code 204 indicating the resource identified by subscription ID is successfully deleted in the response message.
- 2b. On failure or redirection, one of the HTTP status code listed in Table 6.1.3.5.3.2-3 shall be returned. For a 4xx/5xx response, the message body may contain a ProblemDetails structure with the "cause" attribute set to one of the application error listed in Table 6.1.3.5.3.2-3.

5.2.2.6 Notify

5.2.2.6.1 General

The Notify service operation is used by the UCMF, to send a notification, towards the notification URI, when certain event included in the subscription has taken place.

The UCMF shall use the HTTP method POST, using the notification URI received in the subscription creation as specified in clause 5.2.2.4.1. See Figure 5.2.2.6.1-1.

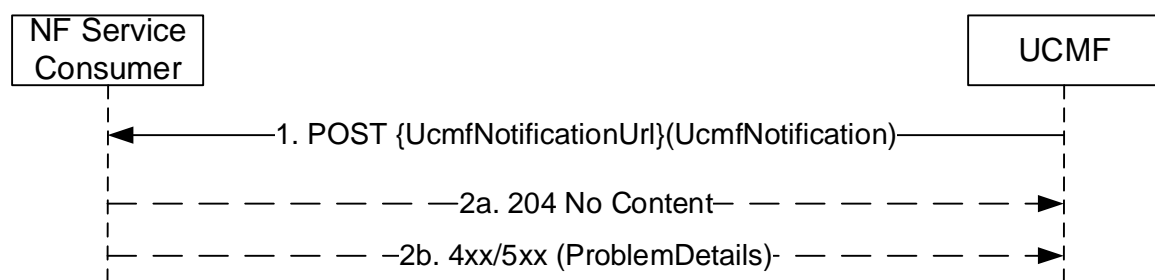

Figure 5.2.2.6.1-1 Notify

1. The AMF shall send a POST request to send a notification.
- 2a. On success, "204 No content" shall be returned by the NF Service Consumer.
- 2b. On failure, the appropriate HTTP status code (e.g. "403 Forbidden") indicating the error shall be returned and appropriate additional error information should be returned.

6 API Definitions

6.1 Nucmf_UECapabilityManagement Service API

6.1.1 Introduction

The Nucmf_UECapabilityManagement service shall use the Nucmf_UECapabilityManagement API.

The API URI of the Nucmf_UECapabilityManagement API shall be:

{apiRoot}/<apiName>/<apiVersion>/

The request URI used in HTTP requests from the NF service consumer towards the NF service producer shall have the Resource URI structure defined in clause 4.4.1 of 3GPP TS 29.501 [5], i.e.:

{apiRoot}/<apiName>/<apiVersion>/<apiSpecificResourceUriPart>

with the following components:

- The {apiRoot} shall be set as described in 3GPP TS 29.501 [5].
- The <apiName> shall be "nucmf-uecm".
- The <apiVersion> shall be "v1".
- The <apiSpecificResourceUriPart> shall be set as described in clause 5.3.

6.1.2 Usage of HTTP

6.1.2.1 General

HTTP/2, IETF RFC 7540 [11], shall be used as specified in clause 5 of 3GPP TS 29.500 [4].

HTTP/2 shall be transported as specified in clause 5.3 of 3GPP TS 29.500 [4].

The OpenAPI [6] specification of HTTP messages and content bodies for the <API Name> API is contained in Annex A.

6.1.2.2 HTTP standard headers

6.1.2.2.1 General

See clause 5.2.2 of 3GPP TS 29.500 [4] for the usage of HTTP standard headers.

6.1.2.2.2 Content type

JSON, IETF RFC 8259 [12], shall be used as content type of the HTTP bodies specified in the present specification as specified in clause 5.4 of 3GPP TS 29.500 [4]. The use of the JSON format shall be signalled by the content type "application/json".

"Problem Details" JSON object shall be used to indicate additional details of the error in a HTTP response body and shall be signalled by the content type "application/problem+json", as defined in IETF RFC 7807 [13].

Multipart messages shall also be supported (see clause 6.1.2.4) using the content type "multipart/related", comprising:

- one JSON body part with the "application/json" content type; and
- one or more binary body parts with 3gpp vendor specific content subtypes.

The 3gpp vendor specific content subtypes defined in Table 6.1.2.2-1 shall be supported.

Table 6.1.2.2-1: 3GPP vendor specific content subtypes

content subtype	Description
vnd.3gpp.ngap	Binary encoded payload, encoding NG Application Protocol (NGAP) IEs, as specified in clause 9.3 of 3GPP TS 38.413 [15] (ASN.1 encoded).
vnd.3gpp.s1ap	Binary encoded payload, encoding S1 Application Protocol (S1AP) IEs, as specified in clause 9.2 of 3GPP TS 36.413 [17] (ASN.1 encoded).
NOTE:	Using 3GPP vendor content subtypes allows to describe the nature of the opaque payload (e.g. NGAP or 5GS NAS information) without having to rely on metadata in the JSON payload.

See clause 6.1.2.4 for the binary payloads supported in the binary body part of multipart messages.

6.1.2.3 HTTP custom headers

The mandatory HTTP custom header fields specified in clause 5.2.3.2 of 3GPP TS 29.500 [4] shall be applicable.

6.1.2.4 HTTP multipart messages

HTTP multipart messages shall be supported to transfer opaque UE Radio Access Capability Information, in the following service operations (and HTTP messages):

- Resolve Response (GET Response);
- Assign Request (POST);

HTTP multipart message shall include one JSON body part and one or two binary body parts comprising the OCTET STRING of UE Radio Capability IE (i.e. excluding the IEI, Criticality and octet string length indicator, see also Annex B of 3GPP TS 29.274 [16]) as specified in clause 9.3.1.74 of 3GPP TS 38.413 [15] and clause 9.2.1.27 of 3GPP TS 36.413 [17].

The JSON body part shall be the "root" body part of the multipart message. It shall be encoded as the first body part of the multipart message. The "Start" parameter does not need to be included.

The multipart message shall include a "type" parameter (see IETF RFC 2387 [10]) specifying the media type of the root body part, i.e. "application/json".

- NOTE: The "root" body part (or "root" object) is the first body part the application processes when receiving a multipart/related message, see IETF RFC 2387 [10]. The default root is the first body within the multipart/related message. The "Start" parameter indicates the root body part, e.g. when this is not the first body part in the message.

For each binary body part in a HTTP multipart message, the binary body part shall include a Content-ID header (see IETF RFC 2045 [12]), and the JSON body part shall include an attribute, defined with the RefToBinaryData type, that contains the value of the Content-ID header field of the referenced binary body part.

6.1.3 Resources

6.1.3.1 Overview

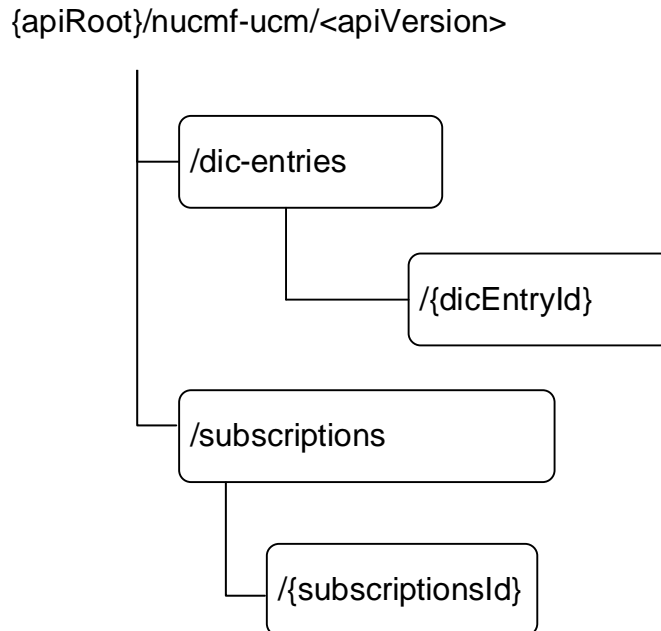

Figure 6.1.3.1-1: Resource URI structure of the Nucmf_UECapabilityManagement API

Table 6.1.3.1-1 provides an overview of the resources and applicable HTTP methods.

Table 6.1.3.1-1: Resources and methods overview

Resource name	Resource URI	HTTP method or custom operation	Description
Dictionary Entries collection	/dic-entries	POST	Nucmf_UECapabilityManagement_Assign
		GET	Nucmf_UECapabilityManagement_Resolve
Individual Dictionary Entry	/dic-entries/{dicEntryId}	GET	Nucmf_UECapabilityManagement_Resolve
Subscriptions collection	/subscriptions	POST	Nucmf_UECapabilityManagement_Subscribe
Individual subscription	/subscriptions/{subscriptionId}	DELETE	Nucmf_UECapabilityManagement_Unsubscribe

6.1.3.2 Resource: Dictionary Entries

6.1.3.2.1 Description

This resource represents the collection of the individual dictionary entries created in the UCMF, where each individual dictionary entry includes the mapping information between UE Radio Capability ID and UE Radio Access Capability Information, Type Allocation Code and Software version of a PEI.

This resource is modelled with the Collection resource archetype (see clause C.2 of 3GPP TS 29.501 [5]).

6.1.3.2.2 Resource Definition

Resource URI: **{apiRoot}/nucmf-ucm/<apiVersion>/dic-entries**

This resource shall support the resource URI variables defined in table 6.1.3.2.2-1.

Table 6.1.3.2.2-1: Resource URI variables for this resource

Name	Definition
apiRoot	See clause 6.1.1
apiVersion	See clause 6.1.1

6.1.3.2.3 Resource Standard Methods

6.1.3.2.3.1 GET

This operation retrieves the UE Radio Access Capability Information from a dictionary entry stored in the UCMF, by querying with a Manufacturer-assigned or PLMN-assigned UE Radio Capability ID, or the TAC and the SVN as part of the IMEI/IMEISV of the UE.

This method shall support the URI query parameters specified in table 6.1.3.2.3.1-1.

Table 6.1.3.2.3.1-1: URI query parameters supported by the GET method on this resource

Name	Data type	P	Cardinality	Description	Applicability
ue-radio-capa-id	UeRadioCapalid	M	1	PLMN assigned or Manufacturer assigned UE Radio Capability ID used to retrieve a dictionary entry.	
rac-format	RacFormat	C	0..1	Coding format in which UE Radio Access Capability Information needs to be provided. See the clause 6.1.6.3.4.	

This method shall support the request data structures specified in table 6.1.3.2.3.1-2 and the response data structures and response codes specified in table 6.1.3.2.3.1-3.

Table 6.1.3.2.3.1-2: Data structures supported by the GET Request Body on this resource

Data type	P	Cardinality	Description
n/a			

Table 6.1.3.2.3.1-3: Data structures supported by the GET Response Body on this resource

Data type	P	Cardinality	Response codes	Description
DicEntryData	M	1	200 OK	The response body contains a dictionary entry that is matching the querying parameter.
ProblemDetails	O	0..1	400 Bad Request	The response body contains the error reason of the request message.
ProblemDetails	O	0..1	404 Not Found	The "cause" attribute may be used to indicate the following application error: - NO_DICTIONARY_ENTRY_FOUND - OUT_DATED_VERSION_ID_IN_RAC_ID See table 6.1.7.3-1 for the description of this error.
NOTE: The mandatory HTTP error status code for the GET method listed in Table 5.2.7.1-1 of 3GPP TS 29.500 [4] also apply, with response body containing an object of ProblemDetails data type (see clause 5.2.7 of 3GPP TS 29.500 [4]).				

6.1.3.2.3.2 POST

This method creates an individual dictionary entry resource in the UCMF unless such dictionary entry already exists.

This method shall support the URI query parameters specified in table 6.1.3.2.3.2-1.

Table 6.1.3.2.3.2-1: URI query parameters supported by the POST method on this resource

Name	Data type	P	Cardinality	Description
n/a				

This method shall support the request data structures specified in table 6.1.3.2.3.2-2 and the response data structures and response codes specified in table 6.1.3.2.3.2-3.

Table 6.1.3.2.3.2-2: Data structures supported by the POST Request Body on this resource

Data type	P	Cardinality	Description
DicEntryCreateData	M	1	Contains UE Radio Access Capability Information and type Allocation Code.

Table 6.1.3.2.3.2-3: Data structures supported by the POST Response Body on this resource

Data type	P	Cardinality	Response codes	Description
DicEntryCreatedData	M	1	201 Created	The response body contains the assigned UE Radio Capability ID.
ProblemDetails	O	0..1	400 Bad Request	The response body contains the error reason of the request message.
NOTE: The mandatory HTTP error status code for the POST method listed in Table 5.2.7.1-1 of 3GPP TS 29.500 [4] also apply.				

6.1.3.2.4 Resource Custom Operations

None.

6.1.3.3 Resource: Individual Dictionary Entry

6.1.3.3.1 Description

This resource represents an individual Dictionary Entry for the mapping information between UE Radio Capability ID(s) and UE Radio Access Capability information, identified by the Dictionary Entry ID.

This resource is modelled as the Document resource archetype (see clause C.1 of 3GPP TS 29.501 [5]).

6.1.3.3.2 Resource Definition

Resource URI: {apiRoot}/nucmf-ucm/<apiVersion>/dic-entries/{dicEntryId}

This resource shall support the resource URI variables defined in table 6.1.3.3.2-1.

Table 6.1.3.3.2-1: Resource URI variables for this resource

Name	Definition
apiRoot	See clause 6.1.1
apiVersion	See clause 6.1.1.
dicEntryId	Integer with range 1-4294967295.

6.1.3.3.3 Resource Standard Methods

6.1.3.3.3.1 GET

This operation retrieves an individual dictionary entry resource for the mapping information between UE Radio Capability ID(s) and UE Radio Access Capability information, stored in the UCMF, identified by the dicEntryId.

This method shall support the URI query parameters specified in table 6.1.3.2.3.1-1.

Table 6.1.3.3.3.1-1: URI query parameters supported by the GET method on this resource

Name	Data type	P	Cardinality	Description	Applicability
rac-format	RacFormat	C	0..1	Coding format in which UE Radio Access Capability Information needs to be provided. See the clause 6.1.6.3.4.	

This method shall support the request data structures specified in table 6.1.3.2.3.1-2 and the response data structures and response codes specified in table 6.1.3.2.3.1-3.

Table 6.1.3.2.3.1-2: Data structures supported by the GET Request Body on this resource

Data type	P	Cardinality	Description
n/a			

Table 6.1.3.2.3.1-3: Data structures supported by the GET Response Body on this resource

Data type	P	Cardinality	Response codes	Description
DicEntryData	M	1	200 OK	The response body contains a dictionary entry for the given Dictionary Entry ID.
ProblemDetails	O	0..1	404 Not Found	The "cause" attribute may be used to indicate the following application error: - NO_DICTIONARY_ENTRY_FOUND See table 6.1.7.3-1 for the description of this error.
NOTE: The mandatory HTTP error status code for the GET method listed in Table 5.2.7.1-1 of 3GPP TS 29.500 [4] also apply, with response body containing an object of ProblemDetails data type (see clause 5.2.7 of 3GPP TS 29.500 [4]).				

6.1.3.4 Resource: Subscriptions collection

6.1.3.4.1 Description

This resource represents a collection of subscriptions in the UCMF, created by NF service consumers of Nucmf_UECapabilityManagement service.

This resource is modelled as the Collection resource archetype (see clause C.2 of 3GPP TS 29.501 [5]).

6.1.3.4.2 Resource Definition

Resource URI: {apiRoot}/nucmf-ucm/<apiVersion>/subscriptions

This resource shall support the resource URI variables defined in table 6.1.3.4.2-1.

Table 6.1.3.4.2-1: Resource URI variables for this resource

Name	Definition
apiRoot	See clause 6.1.1
apiVersion	See clause 6.1.1.

6.1.3.4.3 Resource Standard Methods

6.1.3.4.3.1 POST

This method shall support the URI query parameters specified in table 6.1.3.4.3.1-1.

Table 6.1.3.4.3.1-1: URI query parameters supported by the POST method on this resource

Name	Data type	P	Cardinality	Description
n/a				

This method shall support the request data structures specified in table 6.1.3.4.3.1-2 and the response data structures and response codes specified in table 6.1.3.4.3.1-3.

Table 6.1.3.4.3.1-2: Data structures supported by the POST Request Body on this resource

Data type	P	Cardinality	Description
CreateSubscription	M	1	The Subscription to be created by a NF Service consumer, e.g. an AMF.

Table 6.1.3.4.3.1-3: Data structures supported by the POST Response Body on this resource

Data type	P	Cardinality	Response codes	Description
CreatedSubscription	M	1	201 Created	Represents successful creation of a Subscription in the UCMF
ProblemDetails	O	0..1	400 Bad Request	The response body contains the error reason of the request message.
NOTE: The mandatory HTTP error status code for the POST method listed in Table 5.2.7.1-1 of 3GPP TS 29.500 [4] also apply, with response body containing an object of ProblemDetails data type (see clause 5.2.7 of 3GPP TS 29.500 [4]).				

6.1.3.4.4 Resource Custom Operations

None.

6.1.3.5 Resource: Individual subscription

6.1.3.5.1 Description

This resource represents an individual of subscription in the UCMF, created earlier by a NF Service Consumer of Nucmf_UECapabilityManagement service.

This resource is modelled as the Document resource archetype (see clause C.1 of 3GPP TS 29.501 [5]).

6.1.3.5.2 Resource Definition

Resource URI: {apiRoot}/nucmf-ucm/<apiVersion>/subscriptions/{subscriptionId}

This resource shall support the resource URI variables defined in table 6.1.3.5.2-1.

Table 6.1.3.5.2-1: Resource URI variables for this resource

Name	Definition
apiRoot	See clause 6.1.1
apiVersion	See clause 6.1.1.
subscriptionId	String identifies an individual subscription in the UCMF.

6.1.3.5.3 Resource Standard Methods

6.1.3.5.3.2 DELETE

This method shall support the URI query parameters specified in table 6.1.3.5.3.2-1.

Table 6.1.3.5.3.2-1: URI query parameters supported by the DELETE method on this resource

Name	Data type	P	Cardinality	Description
n/a				

This method shall support the request data structures specified in table 6.1.3.5.3.2-2 and the response data structures and response codes specified in table 6.1.3.5.3.2-3.

Table 6.1.3.5.3.2-2: Data structures supported by the DELETE Request Body on this resource

Data type	P	Cardinality	Description
n/a			

Table 6.1.3.5.3.2-3: Data structures supported by the DELETE Response Body on this resource

Data type	P	Cardinality	Response codes	Description
n/a			204 No Content	
ProblemDetails	O	0..1	404 Not Found	Indicates the modification of subscription has failed due to application error. The "cause" attribute may be used to indicate the following application error: - SUBSCRIPTION_NOT_FOUND.
NOTE: The mandatory HTTP error status code for the DELETE method listed in Table 5.2.7.1-1 of 3GPP TS 29.500 [4] also apply, with response body containing an object of ProblemDetails data type (see clause 5.2.7 of 3GPP TS 29.500 [4]).				

6.1.3.5.4 Resource Custom Operations

None.

6.1.4 Custom Operations without associated resources

None.

6.1.5 Notifications

6.1.5.1 General

Notifications shall comply to clause 6.2 of 3GPP TS 29.500 [4] and clause 4.6.2.3 of 3GPP TS 29.501 [5].

6.1.5.2 UCMF Notification

6.1.5.2.1 Description

The UCMF Notification is used by the UCMF to report one or several observed Events to a NF service consumer that has subscribed to such Notifications via the Individual Notification Subscription Resource.

6.1.5.2.2 Target URI

The Callback URI "{ucmfNotificationUri}" shall be used with the callback URI variables defined in table 6.1.5.2.2-1.

Table 6.1.5.2.2-1: Callback URI variables for this resource

Name	Definition
ucmfNotificationUri	String formatted as URI with the UCMF Callback Uri

6.1.5.2.3 Standard Methods

6.1.5.2.3.1 POST

This method shall support the request data structures specified in table 6.1.5.2.3.1-1 and the response data structures and response codes specified in table 6.1.5.2.3.1-1.

Table 6.1.5.2.3.1-2: Data structures supported by the POST Request Body on this resource

Data type	P	Cardinality	Description
UcmfNotification	M	1	Represents the notification to be delivered

Table 6.1.5.2.3.1-3: Data structures supported by the POST Response Body on this resource

Data type	P	Cardinality	Response codes	Description
n/a			204 No Content	
NOTE: The mandatory HTTP error status codes for the POST method listed in Table 5.2.7.1-1 of 3GPP TS 29.500 [4] also apply.				

6.1.6 Data Model

6.1.6.1 General

This clause specifies the application data model supported by the API.

Table 6.1.6.1-1 specifies the data types defined for the Nucmf_UECapabilityManagement service based interface protocol.

Table 6.1.6.1-1: Nucmf_UECapabilityManagement specific Data Types

Data type	Clause defined	Description	Applicability
DicEntryData	6.1.6.2.2		
DicEntryCreateData	6.1.6.2.3		
DicEntryCreatedData	6.1.6.2.4		
UeRadioCapId	6.1.6.2.5		
CreateSubscription	6.1.6.2.6		
CreatedSubscription	6.1.6.2.7		
UcmfNotification	6.1.6.2.8		
ManAssOpRequestlist	6.1.6.2.9		
RacFormat	6.1.6.3.4		

Table 6.1.6.1-2 specifies data types re-used by the Nucmf_UECapabilityManagement service based interface protocol from other specifications, including a reference to their respective specifications and when needed, a short description of their use within the N_{<NF>} service based interface.

Table 6.1.6.1-2: Nucmf_UECapabilityManagement re-used Data Types

Data type	Reference	Comments	Applicability
PlmnAssiUeRadioCapId	3GPP TS 29.571 [14]		
ManAssiUeRadioCapId	3GPP TS 29.571 [14]		
TypeAllocationCode	3GPP TS 29.571 [14]		
NflInstancelId	3GPP TS 29.571 [14]		
DateTime	3GPP TS 29.571 [14]		

6.1.6.2 Structured data types

6.1.6.2.1 Introduction

This clause defines the structures to be used in resource representations.

6.1.6.2.2 Type: DicEntryData

Table 6.1.6.2.2-1: Definition of type DicEntryData

Attribute name	Data type	P	Cardinality	Description
dicEntryId	DicEntryId	C	0..1	Identifier of the Dictionary Entry
plmnAssiUeRadioCapId	PlmnAssiUeRadioCapId	C	0..1	This IE shall include a PLMN Assigned UE Radio Capability ID if allocated in the dictionary entry.
manAssiUeRadioCapId	ManAssiUeRadioCapId	C	0..1	This IE shall include a Manufacturer Assigned UE Radio Capability ID if available in the dictionary entry.
typeAllocationCode	TypeAllocationCode	M	1	This IE shall contain the Type Allocation Code in corresponding to the UE Radio Access Capability in the dictionary entry.
ueRadioCapability5GS	RefToBinaryData	C	0..1	This IE shall be included to contain the UE Radio Access Capability Information encoded either as OCTET STRING of UE Radio Capability IE as specified in clause 9.3.1.74 of 3GPP TS 38.413 [15], when the message is sent to AMF, otherwise it may be included.
ueRadioCapabilityEPS	RefToBinaryData	C	0..1	This IE shall be included to contain the UE Radio Access Capability Information encoded as OCTET STRING of UE Radio Capability IE as specified in clause 9.2.1.27 of 3GPP TS 36.413 [x], when the message is sent to MME, otherwise it may be included.
NOTE: The information in the dictionary entry which is included as the query parameter(s) or URI variable in the request message shall not be present.				

6.1.6.2.3 Type: DicEntryCreateData

Table 6.1.6.2.3-1: Definition of type DicEntryCreateData

Attribute name	Data type	P	Cardinality	Description
typeAllocationCode	TypeAllocationCode	M	1	This IE shall contain the Type Allocation Code in corresponding to the UE Radio Access Capability in the dictionary entry.
ueRadioCapability5GS	RefToBinaryData	C	0..1	This IE shall be included to contain the UE Radio Access Capability Information encoded as OCTET STRING of UE Radio Capability IE specified in clause 9.3.1.74 of 3GPP TS 38.413 [15].
ueRadioCapabilityEPS	RefToBinaryData	C	0..1	This IE shall be included to contain the UE Radio Access Capability Information encoded as OCTET STRING of UE Radio Capability IE specified in clause 9.2.1.27 of 3GPP TS 36.413 [17]. (NOTE)
NOTE: At least one of ueRadioCapability5GS or ueRadioCapabilityEPS shall be present.				

6.1.6.2.4 Type: DicEntryCreatedData

Table 6.1.6.2.4-1: Definition of type DicEntryCreatedData

Attribute name	Data type	P	Cardinality	Description
plmnAssiUeRadioCapId	PlmnAssiUeRadioCapId	M	1	This IE shall include a PLMN Assigned UE Radio Capability ID if allocated.

6.1.6.2.5 Type: UeRadioCapIId

Table 6.1.6.2.5-1: Definition of type UeRadioCapIId

Attribute name	Data type	P	Cardinality	Description
plmnAssiUeRadioCapIId	PlmnAssiUeRadioCapIId	C	0..1	This IE shall include a PLMN Assigned UE Radio Capability ID. (NOTE)
manAssiUeRadioCapIId	ManAssiUeRadioCapIId	C	0..1	This IE shall include a Manufacturer Assigned UE Radio Capability ID. (NOTE)
NOTE: Only one of plmnAssiUeRadioCapIId and manAssiUeRadioCapIId shall be present during retrieving UE Radio Access Capability Information. (See clause 6.1.3.2.3.1)				

6.1.6.2.6 Type: CreateSubscription

Table 6.1.6.2.6-1: Definition of type CreateSubscription

Attribute name	Data type	P	Cardinality	Description
nflId	NflInstancelId	C	0..1	This IE shall contain the NF Instance ID of the service consumer, e.g. an AMF, if it is available.
ucmfNotificationUri	Uri	M	1	This IE shall contain the callback URI on which the subscribed events shall be notified.
suggestedExpires	DateTime	O	0..1	If present, indicates the point in time at which the subscription expires, which is suggested by the service consumer.

6.1.6.2.7 Type: CreatedSubscription

Table 6.1.6.2.7-1: Definition of type CreatedSubscription

Attribute name	Data type	P	Cardinality	Description
dicEntryId	DicEntryId	M	1	This IE shall contain the highest DicEntryId has been allocated in the UCMF.
confirmedExpires	DateTime	O	0..1	If present, indicates the point in time at which the subscription expires, which is confirmed by the service producer.

6.2.6.2.8 Type: UcmfNotification

Table 6.2.6.2.8-1: Definition of type UcmfNotification

Attribute name	Data type	P	Cardinality	Description
dicEntryId	DicEntryId	M	1	This IE shall contain the highest DicEntryId has been allocated in the UCMF.
eventType	EventType	M	1	This IE shall contain the different events type included in the notification.
manAssOpRequestlist	ManAssOpRequestlist	C	0..1	This IE shall be present to contain the Manufacturer Assigned operation requested list which includes a list of PLMN Assigned UE Radio Capability IDs or a list of TACs if the event type indicates the deletion of one or more PLMN Assigned UE Radio Capability IDs as specified in 3GPP TS 23.501 [2].
versionId	UInteger	O	0..1	UInteger with the range between 0 and 255. This IE may be present if eventType indicates to notify a new version id of PLMN Assigned UE Radio Capability Id(s).

6.2.6.2.9 Type: ManAssOpRequestlist

Table 6.2.6.2.9-1: Definition of type DelPlmnAssiUeRadioCapIdData

Attribute name	Data type	P	Cardinality	Description
plmnAssiUeRadioCapId	array(PlmnAssiUeRadioCapId)	C	0..N	This IE shall contain one or more PLMN Assigned UE Radio Capability IDs to be deleted. (NOTE) The UCMF shall always provide a complete list of PLMN Assigned UE Radio Capability IDs to enable the AMF to overwrite the existing list.
typeAllocationCode	array (TypeAllocationCode)	C	0..N	This IE shall contain one or more Type Allocation Code in corresponding to the PLMN Assigned UE Radio Capability IDs to be deleted. (NOTE) The UCMF shall always provide a complete list of Type Allocation Codes to enable the AMF to overwrite the existing list.

NOTE: Either plmnAssiUeRadioCapId or typeAllocationCode shall be present, not for both.

6.1.6.3 Simple data types and enumerations

6.1.6.3.1 Introduction

This clause defines simple data types and enumerations that can be referenced from data structures defined in the previous clauses.

6.1.6.3.2 Simple data types

The simple data types defined in table 6.1.6.3.2-1 shall be supported.

Table 6.1.6.3.2-1: Simple data types

Type Name	Type Definition	Description	Applicability
DicEntryId	Integer	integer with range 1-4294967295.	

6.1.6.3.3 Enumeration: EventType

The enumeration EventType represents different type of events included in a notification from the UCMF. It shall comply with the provisions defined in table 6.1.5.3.3-1.

Table 6.1.6.3.3-1: Enumeration EventType

Enumeration value	Description	Applicability
"CREATION_OF_DICTIONARY_ENTRY"	New dictionary entries are created in the UCMF.	
"DELETION_OF_PLMN_ASSIGNED_IDS"	One or more PLMN-assigned UE Radio Capability IDs are deleted.	
"NEW_VERSION_ID_OF_PLMN_ASSIGNED_IDS"	Notify a new version id of PLMN Assigned UE Radio Capability Id(s).	

6.1.6.3.4 Enumeration: RacFormat

The enumeration RacFormat represents the encoding type of the UE's Radio Access Capability Information.

Table 6.1.6.3.4-1: Enumeration racFormat

Enumeration value	Description	Applicability
"5GS"	This value indicates UE Radio Access Capability Information shall be encoded as OCTET STRING of UE Radio Capability IE specified in clause 9.3.1.74 of 3GPP TS 38.413 [15].	
"EPS"	This value indicates UE Radio Access Capability Information shall be encoded as OCTET STRING of UE Radio Capability IE specified in clause 9.2.1.27 of 3GPP TS 36.413 [17].	

6.1.6.4 Data types describing alternative data types or combinations of data types

None.

6.1.6.5 Binary data

6.1.6.5.1 Introduction

This clause defines the binary data that shall be supported in a binary body part in an HTTP multipart message (see clauses 6.1.2.2.2 and 6.1.2.4).

6.1.6.5.2 UE Radio Capability Information

UeRadioCapability5GS shall be encoded with the OCTET STRING of UE Radio Capability IE (i.e. excluding the IEI, Criticality and octet string length indicator, see also Annex B of 3GPP TS 29.274 [16]) as specified in clause 9.3.1.74 of 3GPP TS 38.413 [15], using the vnd.3gpp.ngap content-type.

UeRadioCapabilityEPS shall be encoded with the OCTET STRING of UE Radio Capability IE (i.e. excluding the IEI, Criticality and octet string length indicator, see also Annex B of 3GPP TS 29.274 [16]) as specified in clause 9.2.1.27 of 3GPP TS 36.413 [17], using the vnd.3gpp.s1ap content-type.

6.1.7 Error Handling

6.1.7.1 General

For the Nucmf_UECapabilityManagement API, HTTP error responses shall be supported as specified in clause 4.8 of 3GPP TS 29.501 [5]. Protocol errors and application errors specified in table 5.2.7.2-1 of 3GPP TS 29.500 [4] shall be supported for an HTTP method if the corresponding HTTP status codes are specified as mandatory for that HTTP method in table 5.2.7.1-1 of 3GPP TS 29.500 [4].

In addition, the requirements in the following clauses are applicable for the Nucmf_UECapabilityManagement API.

6.1.7.2 Protocol Errors

No specific procedures for the Nucmf_UECapabilityManagement service are specified.

6.1.7.3 Application Errors

The application errors defined for the Nucmf_UECapabilityManagement service are listed in Table 6.1.7.3-1.

Table 6.1.7.3-1: Application errors

Application Error	HTTP status code	Description
NO_DICTIONARY_ENTRY_FOUND	404	There is no dictionary entry matching the UE Radio Capability ID in query.
OUT_DATED_VERSION_ID_IN_RAC_ID	404	The version id in the requested PLMN Assigned UE Radio Capability Id is out-dated.

6.1.8 Feature negotiation

The optional features in table 6.1.8-1 are defined for the Nucmf_UECapabilityManagement API. They shall be negotiated using the extensibility mechanism defined in clause 6.6 of 3GPP TS 29.500 [4].

Table 6.1.8-1: Supported Features

Feature number	Feature Name	Description

6.1.9 Security

As indicated in 3GPP TS 33.501 [8] and 3GPP TS 29.500 [4], the access to the Nucmf_UECapabilityManagement API may be authorized by means of the OAuth2 protocol (see IETF RFC 6749 [9]), based on local configuration, using the "Client Credentials" authorization grant, where the NRF (see 3GPP TS 29.510 [10]) plays the role of the authorization server.

If OAuth2 is used, an NF Service Consumer, prior to consuming services offered by the Nucmf_UECapabilityManagement API, shall obtain a "token" from the authorization server, by invoking the Access Token Request service, as described in 3GPP TS 29.510 [10], clause 5.4.2.2.

NOTE: When multiple NRFs are deployed in a network, the NRF used as authorization server is the same NRF that the NF Service Consumer used for discovering the Nucmf_UECapabilityManagement service.

The Nucmf_UECapabilityManagement API defines a single scope "nucmf_uecapabilitymanagement" for the entire service, and it does not define any additional scopes at resource or operation level.

Annex A (normative):OpenAPI specification

A.1 General

This Annex specifies the formal definition of the API(s) defined in the present specification. It consists of OpenAPI 3.0.0 specifications in YAML format.

This Annex takes precedence when being discrepant to other parts of the specification with respect to the encoding of information elements and methods within the API(s).

NOTE : The semantics and procedures, as well as conditions, e.g. for the applicability and allowed combinations of attributes or values, not expressed in the OpenAPI definitions but defined in other parts of the specification also apply.

Informative copies of the OpenAPI specification files contained in this 3GPP Technical Specification are available on a Git-based repository hosted in ETSI Forge, that uses the GitLab software version control system (see 3GPP TS 29.501 [5] clause 5.3.1 and 3GPP TR 21.900 [7] clause 5B).

A.2 Nucmf_UECapabilityManagement API

```

openapi: 3.0.0

info:
  title: Nucmf_UECapabilityManagement
  version: 1.0.2
  description: |
    Nucmf_UECapabilityManagement Service.
    © 2020, 3GPP Organizational Partners (ARIB, ATIS, CCSA, ETSI, TSDSI, TTA, TTC).
    All rights reserved.

externalDocs:
  description: 3GPP TS 29.673 V16.3.0; 5G System; UE Radio Capability Management Services
  url: http://www.3gpp.org/ftp/Specs/archive/29_series/29.673/

servers:
  - url: '{apiRoot}/nucmf-uecm/v1'
    variables:
      apiRoot:
        default: https://example.com
        description: apiRoot as defined in clause 4.4 of 3GPP TS 29.501

security:
  - {}
  - oAuth2ClientCredentials:
    - nucmf-uecm

paths:
  /dic-entries:
    get:
      summary: retrieve a dictionary entry matching query parameters
      operationId: RetrieveDictionaryEntry
      tags:
        - Dictionary Entry (Store)
      parameters:
        - name: ue-radio-capability-id
          in: query
          required: true
          description: UE Radio Capability ID, either PLMN Assigned or Manufacturer Assigned
          schema:
            $ref: '#/components/schemas/UeRadioCapaId'
        - name: rac-format
          in: query
          description: Encoding format of RAC Info
          schema:
            $ref: '#/components/schemas/RacFormat'
      responses:
        '200':
          description: Expected response to a valid request
  
```

```

content:
  multipart/related: # message with binary body part(s)
  schema:
    type: object
    properties: # Request parts
      jsonData:
        $ref: '#/components/schemas/DicEntryData'
      binaryDataUeRadioCapability5GS:
        type: string
        format: binary
      binaryDataUeRadioCapabilityEPS:
        type: string
        format: binary
  encoding:
    jsonData:
      contentType: application/json
    binaryDataUeRadioCapability5GS:
      contentType: application/vnd.3gpp.ngap
    headers:
      Content-Id:
        schema:
          type: string
    binaryDataUeRadioCapabilityEPS:
      contentType: application/vnd.3gpp.slap
    headers:
      Content-Id:
        schema:
          type: string
'400':
  $ref: 'TS29571_CommonData.yaml#/components/responses/400'
'401':
  $ref: 'TS29571_CommonData.yaml#/components/responses/401'
'403':
  $ref: 'TS29571_CommonData.yaml#/components/responses/403'
'404':
  $ref: 'TS29571_CommonData.yaml#/components/responses/404'
'406':
  $ref: 'TS29571_CommonData.yaml#/components/responses/406'
'411':
  $ref: 'TS29571_CommonData.yaml#/components/responses/411'
'413':
  $ref: 'TS29571_CommonData.yaml#/components/responses/413'
'415':
  $ref: 'TS29571_CommonData.yaml#/components/responses/415'
'429':
  $ref: 'TS29571_CommonData.yaml#/components/responses/429'
'500':
  $ref: 'TS29571_CommonData.yaml#/components/responses/500'
'501':
  $ref: 'TS29571_CommonData.yaml#/components/responses/501'
'503':
  $ref: 'TS29571_CommonData.yaml#/components/responses/503'
default:
  $ref: 'TS29571_CommonData.yaml#/components/responses/default'

```

```

post:
  summary: Create a dictionary entry in the UCMF
  tags:
    - a dictionary entry (Document)
  operationId: CreateDictionaryEntry
  requestBody:
    content:
      multipart/related: # message with binary body part(s)
      schema:
        type: object
        properties: # Request parts
          jsonData:
            $ref: '#/components/schemas/DicEntryCreateData'
          binaryDataUeRadioCapability5GS:
            type: string
            format: binary
          binaryDataUeRadioCapabilityEPS:
            type: string
            format: binary
      encoding:
        jsonData:
          contentType: application/json
        binaryDataUeRadioCapability5GS:

```

```

        contentType: application/vnd.3gpp.ngap
        headers:
          Content-Id:
            schema:
              type: string
        binaryDataUeRadioCapabilityEPS:
          contentType: application/vnd.3gpp.slap
          headers:
            Content-Id:
              schema:
                type: string
      required: true
    responses:
      '201':
        description: Dictionary Created
        headers:
          Location:
            description: 'Contains the URI of the newly created resource, according to the
structure: {apiRoot}/nucmf-uecm/<apiVersion>/dic-entries/{dicEntryId}'
            required: true
            schema:
              type: string
        content:
          application/json:
            schema:
              $ref: '#/components/schemas/DicEntryCreatedData'
      '400':
        $ref: 'TS29571_CommonData.yaml#/components/responses/400'
      '403':
        $ref: 'TS29571_CommonData.yaml#/components/responses/403'
      '411':
        $ref: 'TS29571_CommonData.yaml#/components/responses/411'
      '413':
        $ref: 'TS29571_CommonData.yaml#/components/responses/413'
      '415':
        $ref: 'TS29571_CommonData.yaml#/components/responses/415'
      '429':
        $ref: 'TS29571_CommonData.yaml#/components/responses/429'
      '500':
        $ref: 'TS29571_CommonData.yaml#/components/responses/500'
      '501':
        $ref: 'TS29571_CommonData.yaml#/components/responses/501'
      '503':
        $ref: 'TS29571_CommonData.yaml#/components/responses/503'
      default:
        $ref: 'TS29571_CommonData.yaml#/components/responses/default'

/dic-entries/{dicEntryId}:
  get:
    summary: Get an individual dictionary entry via dicEntryId
    operationId: GetDicEntry
    tags:
      - dic Entry Id (Document)
    parameters:
      - name: dicEntryId
        in: path
        description: the ID of a dictionary entry in the UCMF
        required: true
        schema:
          $ref: '#/components/schemas/DicEntryId'
      - name: rac-format
        in: query
        description: Encoding format of of RAC Info
        schema:
          $ref: '#/components/schemas/RacFormat'
    responses:
      '200':
        description: Expected response to a valid request
        content:
          application/json:
            schema:
              $ref: '#/components/schemas/DicEntryData'
      '400':
        $ref: 'TS29571_CommonData.yaml#/components/responses/400'
      '401':
        $ref: 'TS29571_CommonData.yaml#/components/responses/401'
      '403':
        $ref: 'TS29571_CommonData.yaml#/components/responses/403'

```



```

'404':
  $ref: 'TS29571_CommonData.yaml#/components/responses/404'
'406':
  $ref: 'TS29571_CommonData.yaml#/components/responses/406'
'411':
  $ref: 'TS29571_CommonData.yaml#/components/responses/411'
'413':
  $ref: 'TS29571_CommonData.yaml#/components/responses/413'
'415':
  $ref: 'TS29571_CommonData.yaml#/components/responses/415'
'429':
  $ref: 'TS29571_CommonData.yaml#/components/responses/429'
'500':
  $ref: 'TS29571_CommonData.yaml#/components/responses/500'
'501':
  $ref: 'TS29571_CommonData.yaml#/components/responses/501'
'503':
  $ref: 'TS29571_CommonData.yaml#/components/responses/503'
default:
  $ref: 'TS29571_CommonData.yaml#/components/responses/default'

/subscriptions:
  post:
    summary: Nucmf_UECapabilityManagement Subscribe service Operation
    operationId: CreateIndividualSubscription
    tags:
      - Subscriptions (Collection)
    requestBody:
      required: true
      content:
        application/json:
          schema:
            $ref: '#/components/schemas/CreateSubscription'
    responses:
      '201':
        description: Success
        content:
          application/json:
            schema:
              $ref: '#/components/schemas/CreatedSubscription'
        headers:
          Location:
            description: 'Contains the URI of the newly created resource, according to the
structure: {apiRoot}/nucmf-uecm/<apiVersion>/subscriptions/{subscriptionId}'
            required: true
            schema:
              type: string
      '400':
        $ref: 'TS29571_CommonData.yaml#/components/responses/400'
      '401':
        $ref: 'TS29571_CommonData.yaml#/components/responses/401'
      '403':
        $ref: 'TS29571_CommonData.yaml#/components/responses/403'
      '404':
        $ref: 'TS29571_CommonData.yaml#/components/responses/404'
      '411':
        $ref: 'TS29571_CommonData.yaml#/components/responses/411'
      '413':
        $ref: 'TS29571_CommonData.yaml#/components/responses/413'
      '415':
        $ref: 'TS29571_CommonData.yaml#/components/responses/415'
      '429':
        $ref: 'TS29571_CommonData.yaml#/components/responses/429'
      '500':
        $ref: 'TS29571_CommonData.yaml#/components/responses/500'
      '503':
        $ref: 'TS29571_CommonData.yaml#/components/responses/503'
      default:
        $ref: 'TS29571_CommonData.yaml#/components/responses/default'
    callbacks:
      myNotification:
        '{$request.body#/ucmfNotificationUri}':
          post:
            requestBody:
              required: true
              content:
                application/json:

```

```

        schema:
          $ref: '#/components/schemas/UcmfNotification'
      responses:
        '204':
          description: No Content, Notification was succesfull
        '400':
          $ref: 'TS29571_CommonData.yaml#/components/responses/400'
        '401':
          $ref: 'TS29571_CommonData.yaml#/components/responses/401'
        '403':
          $ref: 'TS29571_CommonData.yaml#/components/responses/403'
        '404':
          $ref: 'TS29571_CommonData.yaml#/components/responses/404'
        '411':
          $ref: 'TS29571_CommonData.yaml#/components/responses/411'
        '413':
          $ref: 'TS29571_CommonData.yaml#/components/responses/413'
        '415':
          $ref: 'TS29571_CommonData.yaml#/components/responses/415'
        '429':
          $ref: 'TS29571_CommonData.yaml#/components/responses/429'
        '500':
          $ref: 'TS29571_CommonData.yaml#/components/responses/500'
        '503':
          $ref: 'TS29571_CommonData.yaml#/components/responses/503'
        default:
          $ref: 'TS29571_CommonData.yaml#/components/responses/default'

/subscriptions/{subscriptionId}:
  delete:
    summary: unsubscribe from notifications
    operationId: DeleteIndividualSubcription
    tags:
      - IndividualSubscription (Document)
    parameters:
      - name: subscriptionId
        in: path
        description: Event Subscription ID
        required: true
        schema:
          type: string
    responses:
      '204':
        description: No Content. Resource was succesfully deleted
      '400':
        $ref: 'TS29571_CommonData.yaml#/components/responses/400'
      '401':
        $ref: 'TS29571_CommonData.yaml#/components/responses/401'
      '403':
        $ref: 'TS29571_CommonData.yaml#/components/responses/403'
      '404':
        $ref: 'TS29571_CommonData.yaml#/components/responses/404'
      '429':
        $ref: 'TS29571_CommonData.yaml#/components/responses/429'
      '500':
        $ref: 'TS29571_CommonData.yaml#/components/responses/500'
      '503':
        $ref: 'TS29571_CommonData.yaml#/components/responses/503'
      default:
        $ref: 'TS29571_CommonData.yaml#/components/responses/default'

components:
  securitySchemes:
    oAuth2ClientCredentials:
      type: oauth2
      flows:
        clientCredentials:
          tokenUrl: '{nrfApiRoot}/oauth2/token'
          scopes:
            nucmf-uecm: Access to the Nucmf_UECapabilityManagement API

schemas:
  DicEntryData:
    type: object
    required:
      - typeAllocationCode
    properties:

```

```

dicEntryId:
  $ref: '#/components/schemas/DicEntryId'
typeAllocationCode:
  $ref: 'TS29571_CommonData.yaml#/components/schemas/TypeAllocationCode'
plmnAssiUeRadioCapId:
  $ref: 'TS29571_CommonData.yaml#/components/schemas/PlmnAssiUeRadioCapId'
manAssiUeRadioCapId:
  $ref: 'TS29571_CommonData.yaml#/components/schemas/ManAssiUeRadioCapId'
ueRadioCapability5GS:
  $ref: 'TS29571_CommonData.yaml#/components/schemas/RefToBinaryData'
ueRadioCapabilityEPS:
  $ref: 'TS29571_CommonData.yaml#/components/schemas/RefToBinaryData'

DicEntryCreateData:
  type: object
  required:
    - typeAllocationCode
  properties:
    typeAllocationCode:
      $ref: 'TS29571_CommonData.yaml#/components/schemas/TypeAllocationCode'
    ueRadioCapability5GS:
      $ref: 'TS29571_CommonData.yaml#/components/schemas/RefToBinaryData'
    ueRadioCapabilityEPS:
      $ref: 'TS29571_CommonData.yaml#/components/schemas/RefToBinaryData'

DicEntryCreatedData:
  type: object
  required:
    - plmnAssiUeRadioCapId
  properties:
    plmnAssiUeRadioCapId:
      $ref: 'TS29571_CommonData.yaml#/components/schemas/PlmnAssiUeRadioCapId'

UeRadioCapaId:
  type: object
  properties:
    plmnAssiUeRadioCapId:
      $ref: 'TS29571_CommonData.yaml#/components/schemas/PlmnAssiUeRadioCapId'
    manAssiUeRadioCapId:
      $ref: 'TS29571_CommonData.yaml#/components/schemas/ManAssiUeRadioCapId'

CreateSubscription:
  type: object
  required:
    - ucmfNotificationUri
  properties:
    nfId:
      $ref: 'TS29571_CommonData.yaml#/components/schemas/NfInstanceId'
    ucmfNotificationUri:
      $ref: 'TS29571_CommonData.yaml#/components/schemas/Uri'
    suggestedExpires:
      $ref: 'TS29571_CommonData.yaml#/components/schemas/DateTime'

CreatedSubscription:
  type: object
  required:
    - dicEntryId
  properties:
    dicEntryId:
      $ref: '#/components/schemas/DicEntryId'
    confirmedExpires:
      $ref: 'TS29571_CommonData.yaml#/components/schemas/DateTime'

UcmfNotification:
  type: object
  required:
    - dicEntryId
    - eventType
  properties:
    dicEntryId:
      $ref: '#/components/schemas/DicEntryId'
    eventType:
      $ref: '#/components/schemas/EventType'
    manAssOpRequestlist:
      $ref: '#/components/schemas/manAssOpRequestlist'
    minItems: 1

```

```
    versionId:
      $ref: 'TS29571_CommonData.yaml#/components/schemas/UInteger'

manAssOpRequestlist:
  type: object
  oneOf:
    - required: [plmnAssiUeRadioCapId]
    - required: [typeAllocationCod]
  properties:
    plmnAssiUeRadioCapId:
      type: array
      items:
        $ref: 'TS29571_CommonData.yaml#/components/schemas/PlmnAssiUeRadioCapId'
      minItems: 1
    typeAllocationCode:
      type: array
      items:
        $ref: 'TS29571_CommonData.yaml#/components/schemas/TypeAllocationCode'

#
# SIMPLE DATA TYPES
#
DicEntryId:
  type: integer
  minimum: 0
  maximum: 4294967295

#
# ENUMERATIONS
#

EventType:
  anyOf:
    - type: string
      enum:
        - CREATION_OF_DICTIONARY_ENTRY
        - DELETION_OF_PLMN_ASSIGNED_IDS
        - NEW_VERSION_ID_OF_PLMN_ASSIGNED_IDS
    - type: string

RacFormat:
  anyOf:
    - type: string
      enum:
        - 5GS
        - EPS
    - type: string
```

Annex B (informative): Change history

Change history							
Date	Meeting	TDoc	CR	Re v	Cat	Subject/Comment	New version
2019-09	CT4#93	C4-193849				Initial draft	0.1.0
2019-10	CT4#94	C4-194356				Subscribe, Unsubscribe and Notify	0.2.0
2019-10	CT4#94	C4-194357				Individual dictionary entry resource	0.2.0
2019-11	CT4#95	C4-195436				Data type and openAPI related to Resolve, Assign	0.3.0
2019-11	CT4#95	C4-195438				Data type and openAPI related to (un)Subscribe/Notify	0.3.0
2019-12	CT#86	CP-193069				TS presented for information	1.0.0
2020-03	CT4#96e	C4-200622				UcmfNotification for deletion	1.1.0
2020-03	CT4#96e	C4-200623				Other alignment with stage 2 requirements	1.1.0
2020-03	CT#87e	CP-200067				TS presented for approval	2.0.0
2020-03	CT#87e					Approved at CT#87e	16.0.0
2020-06	CT#88e	CP-201279	0001	2	B	Multiple RAC Coding Format Support in RACS Operation	16.1.0
2020-06	CT#88e	CP-201035	0003		F	Storage of YAML files in ETSI Forge	16.1.0
2020-06	CT#88e	CP-201035	0004		B	New application error at receiving out-dated UE RAC-ID	16.1.0
2020-06	CT#88e	CP-201035	0005	1	B	Populating New Version Id via Notification	16.1.0
2020-06	CT#88e	CP-201187	0006		F	3GPP TS 29.673 API version update Rel-16	16.1.0
2020-09	CT#89e	CP-202108	0007		F	DicEntryId in DicEntryData	16.2.0
2020-09	CT#89e	CP-202108	0008		F	UE Radio Capability ID retrieval	16.2.0
2020-09	CT#89e	CP-202108	0009		F	Optionality of ProblemDetails in TS29.673 cleanup	16.2.0
2020-09	CT#89e	CP-202096	0010		F	29.673 Rel-16 API version and External doc update	16.2.0
2020-12	CT#90e	CP-203047	0011	1	F	TAC is mandatory in DicEntryData	16.3.0
2020-12	CT#90e	CP-203036	0012			29.673 Rel-16 API version and External doc update	16.3.0

History

Document history		
V16.1.0	July 2020	Publication
V16.2.0	November 2020	Publication
V16.3.0	January 2021	Publication