

ETSI TS 131 111 V16.8.0 (2023-04)



**Digital cellular telecommunications system (Phase 2+) (GSM);
Universal Mobile Telecommunications System (UMTS);
LTE;
5G;
Universal Subscriber Identity Module (USIM)
Application Toolkit (USAT)
(3GPP TS 31.111 version 16.8.0 Release 16)**



Reference

RTS/TSGC-0631111vg80

Keywords

5G,GSM,LTE,UMTS

ETSI

650 Route des Lucioles
F-06921 Sophia Antipolis Cedex - FRANCE

Tel.: +33 4 92 94 42 00 Fax: +33 4 93 65 47 16

Siret N° 348 623 562 00017 - APE 7112B
Association à but non lucratif enregistrée à la
Sous-Préfecture de Grasse (06) N° w061004871

Important notice

The present document can be downloaded from:

<https://www.etsi.org/standards-search>

The present document may be made available in electronic versions and/or in print. The content of any electronic and/or print versions of the present document shall not be modified without the prior written authorization of ETSI. In case of any existing or perceived difference in contents between such versions and/or in print, the prevailing version of an ETSI deliverable is the one made publicly available in PDF format at www.etsi.org/deliver.

Users of the present document should be aware that the document may be subject to revision or change of status.

Information on the current status of this and other ETSI documents is available at

<https://portal.etsi.org/TB/ETSIDeliverableStatus.aspx>

If you find errors in the present document, please send your comment to one of the following services:

<https://portal.etsi.org/People/CommitteeSupportStaff.aspx>

If you find a security vulnerability in the present document, please report it through our
Coordinated Vulnerability Disclosure Program:

<https://www.etsi.org/standards/coordinated-vulnerability-disclosure>

Notice of disclaimer & limitation of liability

The information provided in the present deliverable is directed solely to professionals who have the appropriate degree of experience to understand and interpret its content in accordance with generally accepted engineering or other professional standard and applicable regulations.

No recommendation as to products and services or vendors is made or should be implied.

No representation or warranty is made that this deliverable is technically accurate or sufficient or conforms to any law and/or governmental rule and/or regulation and further, no representation or warranty is made of merchantability or fitness for any particular purpose or against infringement of intellectual property rights.

In no event shall ETSI be held liable for loss of profits or any other incidental or consequential damages.

Any software contained in this deliverable is provided "AS IS" with no warranties, express or implied, including but not limited to, the warranties of merchantability, fitness for a particular purpose and non-infringement of intellectual property rights and ETSI shall not be held liable in any event for any damages whatsoever (including, without limitation, damages for loss of profits, business interruption, loss of information, or any other pecuniary loss) arising out of or related to the use of or inability to use the software.

Copyright Notification

No part may be reproduced or utilized in any form or by any means, electronic or mechanical, including photocopying and microfilm except as authorized by written permission of ETSI.

The content of the PDF version shall not be modified without the written authorization of ETSI.

The copyright and the foregoing restriction extend to reproduction in all media.

© ETSI 2023.
All rights reserved.

Intellectual Property Rights

Essential patents

IPRs essential or potentially essential to normative deliverables may have been declared to ETSI. The declarations pertaining to these essential IPRs, if any, are publicly available for **ETSI members and non-members**, and can be found in ETSI SR 000 314: "*Intellectual Property Rights (IPRs); Essential, or potentially Essential, IPRs notified to ETSI in respect of ETSI standards*", which is available from the ETSI Secretariat. Latest updates are available on the ETSI Web server (<https://ipr.etsi.org/>).

Pursuant to the ETSI Directives including the ETSI IPR Policy, no investigation regarding the essentiality of IPRs, including IPR searches, has been carried out by ETSI. No guarantee can be given as to the existence of other IPRs not referenced in ETSI SR 000 314 (or the updates on the ETSI Web server) which are, or may be, or may become, essential to the present document.

Trademarks

The present document may include trademarks and/or tradenames which are asserted and/or registered by their owners. ETSI claims no ownership of these except for any which are indicated as being the property of ETSI, and conveys no right to use or reproduce any trademark and/or tradename. Mention of those trademarks in the present document does not constitute an endorsement by ETSI of products, services or organizations associated with those trademarks.

DECT™, **PLUGTESTS™**, **UMTS™** and the ETSI logo are trademarks of ETSI registered for the benefit of its Members. **3GPP™** and **LTE™** are trademarks of ETSI registered for the benefit of its Members and of the 3GPP Organizational Partners. **oneM2M™** logo is a trademark of ETSI registered for the benefit of its Members and of the oneM2M Partners. **GSM®** and the GSM logo are trademarks registered and owned by the GSM Association.

Legal Notice

This Technical Specification (TS) has been produced by ETSI 3rd Generation Partnership Project (3GPP).

The present document may refer to technical specifications or reports using their 3GPP identities. These shall be interpreted as being references to the corresponding ETSI deliverables.

The cross reference between 3GPP and ETSI identities can be found under <https://webapp.etsi.org/key/queryform.asp>.

Modal verbs terminology

In the present document "**shall**", "**shall not**", "**should**", "**should not**", "**may**", "**need not**", "**will**", "**will not**", "**can**" and "**cannot**" are to be interpreted as described in clause 3.2 of the [ETSI Drafting Rules](#) (Verbal forms for the expression of provisions).

"**must**" and "**must not**" are **NOT** allowed in ETSI deliverables except when used in direct citation.

Contents

Intellectual Property Rights	2
Legal Notice	2
Modal verbs terminology.....	2
Foreword.....	12
1 Scope	14
2 References	14
3 Definitions, abbreviations and symbols	17
3.1 Definitions	17
3.2 Abbreviations	17
3.3 Symbols.....	18
4 Overview of USAT	18
4.1 Profile Download	18
4.2 Proactive UICC	18
4.3 Data download to UICC	19
4.4 Menu selection	19
4.5 Call control by USIM	19
4.6 MO Short Message control by USIM.....	19
4.7 Event download.....	19
4.8 Security	19
4.9 Multiple card	20
4.10 Timer Expiration	20
4.11 Bearer Independent Protocol	20
4.12 Description of the access technology indicator mechanism	20
4.13 Description of the network search mode mechanism	20
4.14 Geographical location discovery	20
4.15 Operation in reduced USAT capable terminals	20
4.16 Tag allocation guidelines.....	20
4.17 USAT over the AT interface	20
4.18 USAT facilities provided by eCAT clients.....	21
4.19 Negotiation of Poll Interval	21
4.20 ProSe usage information reporting.....	21
5 Profile download	21
5.1 Procedure.....	21
5.2 Structure and coding of TERMINAL PROFILE.....	21
5.3 Definition of display parameters in Profile download.....	27
6 Proactive UICC	27
6.1 Introduction	27
6.2 Identification of ME support	27
6.3 General procedure	27
6.4 Proactive UICC commands and procedures.....	28
6.4.1 DISPLAY TEXT	28
6.4.2 GET INKEY	28
6.4.3 GET INPUT.....	28
6.4.4 MORE TIME	28
6.4.5 PLAY TONE	28
6.4.6 POLL INTERVAL	28
6.4.7 REFRESH.....	28
6.4.7.1 EF _{IMSI} changing procedure	28
6.4.7.2 Generic Bootstrapping Procedure Request.....	29
6.4.7.3 EF _{UICCIARI} changing procedure	29
6.4.7.4 Steering of roaming and steering of roaming for I-WLAN procedure	29
6.4.7.5 Steering of roaming via NAS messages	29

6.4.7.6	Routing Indicator Data update via NAS messages.....	29
6.4.8	SET UP MENU	29
6.4.9	SELECT ITEM.....	30
6.4.10	SEND SHORT MESSAGE	30
6.4.11	SEND SS	30
6.4.12	SEND USSD.....	31
6.4.12.1	MMI Mode.....	31
6.4.12.2	Application Mode	32
6.4.13	SET UP CALL.....	33
6.4.14	POLLING OFF	34
6.4.15	PROVIDE LOCAL INFORMATION.....	34
6.4.16	SET UP EVENT LIST.....	36
6.4.17	PERFORM CARD APDU	37
6.4.18	POWER OFF CARD	37
6.4.19	POWER ON CARD.....	37
6.4.20	GET READER STATUS.....	37
6.4.21	TIMER MANAGEMENT	37
6.4.22	SET UP IDLE MODE TEXT	37
6.4.23	RUN AT COMMAND	37
6.4.24	SEND DTMF.....	37
6.4.25	LANGUAGE NOTIFICATION	37
6.4.26	LAUNCH BROWSER	37
6.4.27	OPEN CHANNEL.....	37
6.4.27.1	OPEN CHANNEL related to CS bearer.....	37
6.4.27.2	OPEN CHANNEL related to GPRS/UTRAN packet service/E-UTRAN/NG-RAN	38
6.4.27.3	OPEN CHANNEL related to local bearer.....	38
6.4.27.4	OPEN CHANNEL related to Default (network) Bearer	38
6.4.27.5	OPEN CHANNEL related to (I-)WLAN bearer	39
6.4.27.6	OPEN CHANNEL related to Terminal Server Mode	40
6.4.27.7	OPEN CHANNEL related to UICC Server Mode	40
6.4.27.8	OPEN CHANNEL for IMS	40
6.4.28	CLOSE CHANNEL.....	41
6.4.29	RECEIVE DATA	41
6.4.30	SEND DATA.....	41
6.4.31	GET CHANNEL STATUS	41
6.4.32	SERVICE SEARCH	41
6.4.33	GET SERVICE INFORMATION	41
6.4.34	DECLARE SERVICE	41
6.4.35	RETRIEVE MULTIMEDIA MESSAGE.....	41
6.4.36	SUBMIT MULTIMEDIA MESSAGE.....	41
6.4.37	DISPLAY MULTIMEDIA MESSAGE	41
6.4.38	SET FRAMES	41
6.4.39	GET FRAME STATUS.....	42
6.4.40	Geographical Location Request.....	42
6.4.41	ACTIVATE	43
6.4.42	CONTACTLESS STATE CHANGED	43
6.4.43	COMMAND CONTAINER	43
6.4.44	ENCAPSULATED SESSION CONTROL	43
6.5	Common elements in proactive UICC commands	43
6.5.1	Command number	43
6.5.2	Device identities	43
6.5.3	Alpha identifier	43
6.5.4	Icon identifiers	43
6.5.5	Text attribute.....	43
6.5.6	Frame identifier	43
6.6	Structure of proactive UICC commands	43
6.6.1	DISPLAY TEXT	43
6.6.2	GET INKEY	44
6.6.3	GET INPUT.....	44
6.6.4	MORE TIME	44
6.6.5	PLAY TONE	44
6.6.6	POLL INTERVAL	44

6.6.7	SET-UP MENU	44
6.6.8	SELECT ITEM.....	44
6.6.9	SEND SHORT MESSAGE	44
6.6.10	SEND SS	45
6.6.11	SEND USSD.....	45
6.6.12	SET UP CALL.....	45
6.6.13	REFRESH.....	46
6.6.14	POLLING OFF.....	46
6.6.15	PROVIDE LOCAL INFORMATION	46
6.6.16	SET UP EVENT LIST.....	47
6.6.17	PERFORM CARD APDU	47
6.6.18	POWER OFF CARD.....	47
6.6.19	POWER ON CARD.....	47
6.6.20	GET READER STATUS.....	47
6.6.21	TIMER MANAGEMENT	47
6.6.22	SET UP IDLE MODE TEXT	47
6.6.23	RUN AT COMMAND	47
6.6.24	SEND DTMF COMMAND.....	47
6.6.25	LANGUAGE NOTIFICATION	47
6.6.26	LAUNCH BROWSER	47
6.6.27	OPEN CHANNEL.....	47
6.6.27.1	OPEN CHANNEL related to (I-)WLAN Bearer.....	48
6.6.27.2	OPEN CHANNEL for IMS	48
6.6.28	CLOSE CHANNEL.....	49
6.6.29	RECEIVE DATA	49
6.6.30	SEND DATA.....	49
6.6.31	GET CHANNEL STATUS	49
6.6.32	SERVICE SEARCH	49
6.6.33	GET SERVICE INFORMATION	49
6.6.34	DECLARE SERVICE	49
6.6.35	RETRIEVE MULTIMEDIA MESSAGE.....	49
6.6.36	SUBMIT MULTIMEDIA MESSAGE.....	49
6.6.37	DISPLAY MULTIMEDIA MESSAGE	49
6.6.38	SET FRAMES	49
6.6.39	GET FRAMES STATUS.....	49
6.6.40	Geographical Location Request.....	50
6.6.41	ACTIVATE	50
6.6.42	CONTACTLESS STATE CHANGED	50
6.6.43	COMMAND CONTAINER	50
6.6.44	ENCAPSULATED SESSION CONTROL	50
6.7	Command results.....	50
6.8	Structure of TERMINAL RESPONSE.....	51
6.8.0	Overall structure of TERMINAL RESPONSE.....	51
6.8.1	Command details	53
6.8.2	Device identities	53
6.8.3	Result	53
6.8.4	Duration	53
6.8.5	Text string.....	53
6.8.6	Item identifier	53
6.8.7	Local information	53
6.8.8	Call control requested action	54
6.8.9	Result data object 2.....	54
6.8.10	Card reader status	54
6.8.11	Card ATR	54
6.8.12	R-APDU	54
6.8.13	Timer identifier.....	54
6.8.14	Timer value.....	54
6.8.15	AT Response.....	55
6.8.16	Text string 2.....	55
6.8.17	Channel data	55
6.8.18	Channel status.....	55
6.8.19	Channel data length	55

6.8.20	Bearer description	55
6.8.21	Buffer size	55
6.8.22	Total Display Duration	55
6.8.23	Service Availability	55
6.8.24	Service Record	55
6.8.25	Other address (local address)	55
6.8.26	Frames Information	55
6.9	Proactive UICC session and ME display interaction	55
6.10	Handling of unknown, unforeseen and erroneous messages	56
6.11	Proactive commands versus possible Terminal response	56
7	ENVELOPE Commands	57
7.1	Data download to UICC	57
7.1.1	SMS-PP data download	57
7.1.1.1	Procedure	57
7.1.1.1a	Procedure for SMS-PP data download via REGISTRATION ACCEPT or DL NAS TRANSPORT messages	58
7.1.1.2	Structure of ENVELOPE (SMS-PP DOWNLOAD)	58
7.1.2	Cell Broadcast data download	59
7.1.2.1	Procedure	59
7.1.2.2	Structure of ENVELOPE (CELL BROADCAST DOWNLOAD)	60
7.2	Menu Selection	60
7.3	Call Control and MO SMS control by USIM	61
7.3.1	Call Control by USIM	61
7.3.1.1	Procedure for mobile originated calls	61
7.3.1.2	Procedure for Supplementary Services and USSD	62
7.3.1.3	Indication to be given to the user	63
7.3.1.4	Interaction with Fixed Dialling Number	64
7.3.1.5	Support of Barred Dialling Number (BDN) service	64
7.3.1.6	Structure of ENVELOPE (CALL CONTROL)	64
7.3.1.7	Procedure for PDP Context Activation	67
7.3.1.8	Procedure for EPS PDN connection Activation	68
7.3.1.9	Procedure for IMS communications establishment	69
7.3.1.10	Procedure for PDU session establishment	69
7.3.2	MO Short Message Control by USIM	70
7.3.2.1	Description	70
7.3.2.2	Structure of ENVELOPE (MO SHORT MESSAGE CONTROL)	70
7.3.2.3	Indication to be given to the user	71
7.3.2.4	Interaction with Fixed Dialling Number	71
7.4	Timer Expiration	72
7.5	Event download	72
7.5.1	(I-)WLAN Access status event	72
7.5.1.1	Procedure	72
7.5.1.2	Structure of ENVELOPE (EVENT DOWNLOAD – (I-)WLAN Access Status)	72
7.5.1A	MT Call event	73
7.5.1A.1	Procedure	73
7.5.1A.2	Structure of ENVELOPE (EVENT DOWNLOAD - MT call)	73
7.5.2	Network Rejection event	74
7.5.2.1	Procedure	74
7.5.2.2	Structure of ENVELOPE (EVENT DOWNLOAD – Network Rejection)	74
7.5.2A	Call connected event	75
7.5.2A.1	Procedure	75
7.5.2A.2	Structure of ENVELOPE (EVENT DOWNLOAD - call connected)	75
7.5.3	CSG Cell Selection event	76
7.5.3.1	Procedure	76
7.5.3.2	Structure of ENVELOPE (EVENT DOWNLOAD – CSG Cell Selection)	76
7.5.3A	Call disconnected event	77
7.5.3A.1	Procedure	77
7.5.3A.2	Structure of ENVELOPE (EVENT DOWNLOAD - call disconnected)	77
7.5.4	Location status event	78
7.5.5	User activity event	78
7.5.6	Idle screen available event	78

7.5.7	Card reader status event	78
7.5.8	Language selection event	78
7.5.9	Browser termination event	78
7.5.10	Data available event	78
7.5.11	Channel status event	78
7.5.12	Access Technology Change Event	78
7.5.13	Display parameters changed event	79
7.5.14	Local Connection event	79
7.5.15	Network Search Mode Change Event	79
7.5.16	Browsing status event	79
7.5.17	Frames Information changed event	79
7.5.18	HCI connectivity event	79
7.5.19	Contactless state request	79
7.5.20	Incoming IMS Data event	79
7.5.20.1	Procedure	79
7.5.20.2	Structure of ENVELOPE (EVENT DOWNLOAD – Incoming IMS Data)	79
7.5.21	IMS Registration Event	80
7.5.21.1	Procedure	80
7.5.21.2	Structure of ENVELOPE (EVENT DOWNLOAD – IMS Registration)	80
7.5.22	Profile Container	81
7.5.23	Envelope Container	81
7.5.24	Poll Interval Negotiation	81
7.5.25	Data Connection Status Change Event	81
7.5.25.1	Procedure	81
7.5.25.2	Structure of ENVELOPE (EVENT DOWNLOAD – Data Connection Status Change)	81
7.6	USSD Data Download	82
7.6.1	Procedure	82
7.6.2	Structure of ENVELOPE (USSD Data Download)	83
7.7	MMS Transfer Status	83
7.8	MMS notification download	83
7.9	Terminal Applications	84
7.10	Geographical Location Reporting	84
7.10.1	Procedure	84
7.10.2	Structure of ENVELOPE (Geographical Location Reporting)	84
7.11	Void	85
7.12	ProSe usage information reporting	85
7.12.1	Procedure	85
7.12.2	Structure of ENVELOPE (ProSe Report)	85
8	COMPREHENSION-TLV data objects	86
8.1	Address	86
8.2	Alpha identifier	86
8.3	Subaddress	86
8.4	Capability configuration parameters	86
8.5	Cell Broadcast Page	86
8.6	Command details	86
8.7	Device identities	87
8.8	Duration	87
8.9	Item	88
8.10	Item identifier	88
8.11	Response length	88
8.12	Result	88
8.12.1	Additional information for SEND SS	88
8.12.2	Additional information for ME problem	89
8.12.3	Additional information for network problem	89
8.12.4	Additional information for SS problem	89
8.12.5	Additional information for SMS problem	89
8.12.6	Not used	89
8.12.7	Additional information for USSD problem	89
8.12.8	Additional information for interaction with call control or MO SM control	90
8.12.9	Additional information for MultipleCard commands	90
8.12.10	Additional information for launch browser problem	90

8.12.11	Additional information for Bearer Independent Protocol	90
8.12.12	Additional information for Frames commands	90
8.12.13	Additional information for SUBMIT and RETRIEVE MULTIMEDIA MESSAGE	90
8.13	SMS TPDU	90
8.14	SS string	91
8.15	Text string	91
8.16	Tone.....	91
8.17	USSD string.....	91
8.18	File List	91
8.19	Location Information.....	92
8.19.1	Location Information for GERAN.....	92
8.19.2	Location Information for UTRAN.....	92
8.19.3	Location Information for E-UTRAN	92
8.19.4	Location Information for NG-RAN	93
8.19.5	Location Information when no surrounding macrocell is detected	93
8.20	IMEI.....	93
8.21	Help Request	93
8.22	Network Measurement Results.....	93
8.23	Default Text.....	96
8.24	Items Next Action Indicator	96
8.25	Event list.....	96
8.26	Cause	96
8.27	Location status.....	97
8.28	Transaction identifier	97
8.29	BCCH channel list.....	97
8.30	Call control requested action	98
8.31	Icon Identifier.....	98
8.32	Item Icon Identifier list.....	99
8.33	Card reader status	99
8.34	Card ATR	99
8.35	C-APDU	99
8.36	R-APDU	99
8.37	Timer identifier	99
8.38	Timer value	99
8.39	Date-Time and Time zone	99
8.40	AT Command	99
8.41	AT Response	100
8.42	BC Repeat indicator	100
8.43	Immediate response	100
8.44	DTMF string.....	100
8.45	Language	100
8.46	Timing Advance	100
8.47	Browser Identity	101
8.48	URL.....	101
8.49	Bearer	101
8.50	Provisioning File Reference	101
8.51	Browser Termination Cause	101
8.52	Bearer description.....	101
8.52.0	Structure of Bearer description	101
8.52.1	Bearer parameters for CSD.....	102
8.52.2	Bearer parameters for GPRS / UTRAN Packet Service / E-UTRAN / NG-RAN	102
8.52.3	Bearer parameters for UTRAN Packet Service with extended parameters / HSDPA / E-UTRAN / NG-RAN.....	103
8.52.4	Bearer parameters for (I-)WLAN	104
8.52.5	Bearer parameters for E-UTRAN / NG-RAN / mapped UTRAN packet service.....	104
8.52.6	Bearer parameters for NG-RAN	105
8.53	Channel data	105
8.54	Channel data length	105
8.55	Buffer size	105
8.56	Channel status	105
8.57	Card reader identifier.....	106
8.58	Other Address.....	106

8.59	UICC/ME interface transport level	106
8.60	AID.....	106
8.61	Network Access Name	106
8.62	Access Technology.....	106
8.63	Display parameters	106
8.64	Service Record	107
8.65	Device Filter.....	107
8.66	Service Search	107
8.67	Attribute Information	107
8.68	Service Availability	107
8.69	Remote Entity Address.....	107
8.70	Text Attribute	107
8.71	Item Text Attribute List.....	107
8.72	PDP context Activation parameters.....	107
8.73	UTRAN/E-UTRAN/NG-RAN Measurement Qualifier	108
8.74	Multimedia Message Reference	108
8.75	Multimedia Message Identifier.....	108
8.76	Multimedia Message Transfer status	108
8.77	MM Content Identifier	108
8.78	Multimedia Message Notification	108
8.79	Last Envelope.....	108
8.80	Frames Layout.....	109
8.81	Frames Information	109
8.82	Frames identifier	109
8.83	I-WLAN Identifier	109
8.84	(I-)WLAN Access Status.....	109
8.85	IMEISV	109
8.86	Network search mode.....	109
8.87	Battery State	109
8.88	Browsing status	110
8.89	Registry application data	110
8.90	PLMNwAcT List.....	110
8.91	Routing Area Identification	110
8.92	Update/Attach/Registration Type	110
8.93	Rejection Cause Code	111
8.94	Geographical Location Parameters.....	112
8.95	GAD shapes.....	114
8.96	NMEA sentence	114
8.97	PLMN List.....	115
8.98	EPS PDN connection activation parameters	115
8.99	Tracking Area Identification	115
8.100	CSG ID list identifier	116
8.101	CSG cell selection status	116
8.102	CSG ID.....	117
8.103	HNB name.....	117
8.104	Activate descriptor	117
8.105	Broadcast Network information	117
8.106	Contactless state request.....	117
8.107	Contactless functionality state	118
8.108	IMS URI.....	118
8.109	Extended registry application data	118
8.110	IARI.....	118
8.111	IMPU List.....	118
8.112	IMS status code	119
8.113	eCAT client profile.....	119
8.114	eCAT client identity	119
8.115	Encapsulated envelope type	119
8.116	Void.....	119
8.117	Void.....	119
8.118	PLMN ID.....	119
8.119	E-UTRAN Inter-frequency Network Measurement Results	119
8.120	Call control result	120

8.121	eCAT sequence number	120
8.122	Encrypted TLV list	120
8.123	MAC	120
8.124	SA template	120
8.125	CAT service list	120
8.126	Refresh enforcement policy	120
8.127	DNS Server Address	120
8.128	ProSe Report Data	121
8.129	SSID	121
8.130	BSSID	121
8.131	HESSID	121
8.132	Media Type	121
8.133	IMS call disconnection cause	122
8.134	E-UTRAN Primary Timing Advance Information	122
8.135	URI truncated	123
8.136	Extended Rejection Cause Code	123
8.137	Data connection status	123
8.138	Data connection type	123
8.139	(E/5G)SM cause	124
8.140	IP address list	124
8.141	Surrounding macrocells	125
8.142	PDP/PDN/PDU type	125
8.143	PDU Session Establishment parameters	126
8.144	NG-RAN Primary Timing Advance Information	126
8.145	Slices information	126
9	Tag values	127
9.1	BER-TLV tags in ME to UICC direction	127
9.2	BER-TLV tags in UICC TO ME direction	127
9.3	COMPREHENSION-TLV tags in both directions	128
9.4	Type of Command and Next Action Indicator	130
10	Allowed Type of command and Device identity combinations	130
11	Security requirements	130
Annex A (normative):	Support of USAT by Mobile Equipment	131
Annex B (informative):	Example of DISPLAY TEXT Proactive UICC Command	133
Annex C (normative):	Structure of USAT communications	134
Annex D (informative):	ME display in proactive UICC session	135
Annex E (informative):	Help information feature processing	136
Annex F (informative):	Monitoring of events	137
Annex G (normative):	Support of Multiple Card Operation	138
Annex H (informative):	Multiple Card proactive command examples	139
Annex I (informative):	Bearer independent protocol proactive command examples	140
Annex J (informative):	WAP References	141
Annex K (informative):	Use of USAT Bearer independent protocol for local links Bluetooth case	142
Annex L (informative):	Bluetooth Service Discovery protocol	143
Annex M (informative):	Use of USAT Bearer independent protocol for local links, server case ..	144
Annex N (informative):	USSD information flow between the Network, the ME and the UICC ...	145

N.1	MMI Mode	145
N.2	Application Mode.....	147
N.3	USSD Data Download.....	149
Annex O (informative):	Geographical location information discovery information flow between the ME and the UICC.....	150
Annex P (normative):	Support of USAT by Terminals with reduced feature capabilities.....	151
Annex Q (normative):	Default routing for USAT over AT interface	152
Q.0	3GPP-specific facilities.....	152
Q.1	Default routing mechanism	152
Q.2	Combination rules for terminal profiles	153
Annex R (informative):	UICC access to IMS, command flow examples.....	154
R.1	Discovery of the UICC's IARI and IMS Registration.....	154
R.2	Notification of Incoming IMS data	155
R.3	UICC originating a SIP message.....	156
Annex S (normative):	3GPP PS data off and Bearer Independent Protocol.....	157
Annex T (informative):	Data Connection Status change event, command flow examples.....	158
T.1	Introduction	158
T.2	Success activation of PDP/PDN/PDU request flow example	158
T.3	Rejected activation of PDP/PDN/PDU request flow example	159
T.4	PDP/PDN/PDU Data connection deactivated flow example	160
Annex U (informative):	Change History	163
History		170

Foreword

This Technical Specification has been produced by the 3rd Generation Partnership Project (3GPP).

The contents of the present document are subject to continuing work within the TSG and may change following formal TSG approval. Should the TSG modify the contents of the present document, it will be re-released by the TSG with an identifying change of release date and an increase in version number as follows:

Version x.y.z

where:

- x the first digit:
 - 1 presented to TSG for information;
 - 2 presented to TSG for approval;
 - 3 or greater indicates TSG approved document under change control.
- y the second digit is incremented for all changes of substance, i.e. technical enhancements, corrections, updates, etc.
- z the third digit is incremented when editorial only changes have been incorporated in the document.

In the present document, modal verbs have the following meanings:

- shall** indicates a mandatory requirement to do something
- shall not** indicates an interdiction (prohibition) to do something

The constructions "shall" and "shall not" are confined to the context of normative provisions, and do not appear in Technical Reports.

The constructions "must" and "must not" are not used as substitutes for "shall" and "shall not". Their use is avoided insofar as possible, and they are not used in a normative context except in a direct citation from an external, referenced, non-3GPP document, or so as to maintain continuity of style when extending or modifying the provisions of such a referenced document.

- should** indicates a recommendation to do something
- should not** indicates a recommendation not to do something
- may** indicates permission to do something
- need not** indicates permission not to do something

The construction "may not" is ambiguous and is not used in normative elements. The unambiguous constructions "might not" or "shall not" are used instead, depending upon the meaning intended.

- can** indicates that something is possible
- cannot** indicates that something is impossible

The constructions "can" and "cannot" are not substitutes for "may" and "need not".

- will** indicates that something is certain or expected to happen as a result of action taken by an agency the behaviour of which is outside the scope of the present document
- will not** indicates that something is certain or expected not to happen as a result of action taken by an agency the behaviour of which is outside the scope of the present document
- might** indicates a likelihood that something will happen as a result of action taken by some agency the behaviour of which is outside the scope of the present document

might not indicates a likelihood that something will not happen as a result of action taken by some agency the behaviour of which is outside the scope of the present document

In addition:

is (or any other verb in the indicative mood) indicates a statement of fact

is not (or any other negative verb in the indicative mood) indicates a statement of fact

The constructions "is" and "is not" do not indicate requirements.

1 Scope

The present document defines the interface between the UICC and the Mobile Equipment (ME), and mandatory ME procedures, specifically for "USIM Application Toolkit".

The present document refers in its majority to the ETSI TS 102 223 [32], which describes the generic aspects of application toolkits within the UICC.

USAT is a set of commands and procedures for use during 3GPP network operation phase, in addition to those defined in TS 31.101 [13].

Specifying the interface is to ensure interoperability between a UICC and an ME independently of the respective manufacturers and operators.

The present document defines for:

- the commands;
- the application protocol;
- the mandatory requirements on the UICC and ME for each procedure.

The present document does not specify any aspects related to the administrative management phase. Any internal technical realization of either the UICC or the ME are only specified where these reflect over the interface. The present document does not specify any of the security algorithms which may be used.

For the avoidance of doubt, references to clauses of ETSI TS 102 223 [32] include all the clauses of that clause, unless specifically mentioned.

The target specification ETSI TS 102 223 [32] contains material that is outside of the scope of 3GPP requirements and the present document indicates which parts are in the scope and which are not.

A 3GPP ME may support functionality that is not required by 3GPP, but the requirements to do so are outside of the scope of 3GPP.

2 References

The following documents contain provisions which, through reference in this text, constitute provisions of the present document.

- References are either specific (identified by date of publication, edition number, version number, etc.) or non-specific.
- For a specific reference, subsequent revisions do not apply.
- For a non-specific reference, the latest version applies. In the case of a reference to a 3GPP document (including a GSM document), a non-specific reference implicitly refers to the latest version of that document in the same Release as the present document.

- [1] 3GPP TS 22.002: "Circuit Bearer Services (BS) supported by a Public Land Mobile Network (PLMN)".
- [2] 3GPP TS 22.030: "Man-Machine Interface (MMI) of the User Equipment (UE)".
- [3] 3GPP TS 22.042: "Network Identity and Time Zone (NITZ); Service description; Stage 1".
- [4] 3GPP TS 23.038: "Alphabets and language-specific information".
- [5] 3GPP TS 23.040: "Technical realization of the Short Message Service (SMS)".
- [6] 3GPP TS 23.041: "Technical realization of Cell Broadcast Service (CBS)".
- [7] 3GPP TS 23.122: "Non-Access Stratum functions related to Mobile Station (MS) in idle mode".

- [8] 3GPP TS 24.007: "Mobile radio interface signalling layer 3; General aspects".
- [9] 3GPP TS 24.008: "Mobile radio interface layer 3 specification; Core network protocols; Stage 3".
- [10] 3GPP TS 24.011: "Point-to-Point (PP) Short Message Service (SMS) support on mobile radio interface".
- [11] 3GPP TS 24.080: "Mobile radio layer 3 supplementary services specification; Formats and coding".
- [12] 3GPP TS 27.007: "AT command set for User Equipment (UE)".
- [13] 3GPP TS 31.101: "UICC-terminal interface; Physical and logical characteristics".
- [14] 3GPP TS 31.102: "Characteristics of the USIM application".
- [15] Void.
- [16] Void.
- [17] Void.
- [18] Void.
- [19] Void.
- [20] Void.
- [21] Void.
- [22] 3GPP TS 22.001: "Principles of circuit telecommunication services supported by a Public Land Mobile Network (PLMN)".
- [23] Void.
- [24] Void.
- [25] Void.
- [26] Void.
- [27] 3GPP TS 44.018: "Mobile radio interface Layer 3 specification; Radio Resource Control Protocol".
- [28] Void.
- [29] Void.
- [30] 3GPP TS 23.003: "Numbering, addressing and identification".
- [31] Void.
- [32] ETSI TS 102 223 V15.2.0: "Smart Cards; Card Application Toolkit".
- [33] 3GPP TR 21.905: "Vocabulary for 3GPP specifications".
- [34] 3GPP TS 22.101: "Service aspects; Service principles".
- [35] 3GPP TS 25.401: "UTRAN overall description".
- [36] 3GPP TS 25.413: "UTRAN Iu interface RANAP signalling".
- [37] 3GPP TS 24.090: "Unstructured Supplementary Service Data (USSD) - Stage 3".
- [38] 3GPP TS 25.331: "Radio Resource Control (RRC) Protocol Specification".
- [39] 3GPP TS 25.133: "Requirements for support of radio resource management".
- [40] Void.

- [41] 3GPP TS 31.115: "Secured packet structure for the (U)SIM Toolkit applications".
- [42] 3GPP TS 24.234 Release 12: "3GPP System to WLAN Interworking; UE to Network protocols; Stage 3".
- [43] ETSI TS 101 220: "Smart Cards; ETSI numbering system for telecommunication application providers".
- [44] 3GPP TS 23.032: "Universal Geographical Area Description (GAD)".
- [45] IEC 61162-1: "Maritime navigation and radio communication equipment and systems – Digital interfaces".
- [46] 3GPP TS 24.301: "Non-Access-Stratum (NAS) protocol for Evolved Packet Systems (EPS): Stage 3".
- [47] 3GPP TS 23.203: "Policy and charging control architecture".
- [48] 3GPP TS 36.401: "Evolved Universal Terrestrial Radio Access Network (E-UTRAN); Architecture description".
- [49] 3GPP TS 36.331: "Evolved Universal Terrestrial Radio Access (E-UTRA); Radio Resource Control (RRC); Protocol specification".
- [50] 3GPP TS 36.133: " Evolved Universal Terrestrial Radio Access (E-UTRA); Requirements for support of radio resource management".
- [51] 3GPP TS 31.116: "Remote APDU Structure for (U)SIM Toolkit applications".
- [52] 3GPP TS 24.229 "IP multimedia call control protocol based on SIP and SDP; stage 3"
- [53] IETF RFC 3261: "SIP: Session Initiation Protocol".
- [54] IETF RFC 3629 (2003): "UTF-8, a transformation format of ISO 10646".
- [55] IETF RFC 3680 (2004): "A Session Initiation Protocol (SIP) Event Package for Registrations".
- [56] 3GPP TS 31.104: "Characteristics of the Hosting Party Subscription Identity Module (HPSIM) application"
- [57] 3GPP TS 32.582: "Telecommunications management; Home Node B (HNB) Operations, Administration, Maintenance and Provisioning (OAM&P); Information model for Type 1 interface HNB to HNB Management System (HMS)".
- [58] 3GPP TS 32.592: "Telecommunications management; Home Node B (HeNB) Operations, Administration, Maintenance and Provisioning (OAM&P); Information model for Type 1 interface HeNB to HeNB Management System (HeMS)".
- [59] 3GPP TS 25.304: "User Equipment (UE) procedures in idle mode and procedures for cell reselection in connected mode".
- [60] 3GPP TS 36.304: "Evolved Universal Terrestrial Radio Access (E-UTRA); User Equipment (UE) procedures in idle mode".
- [61] 3GPP TS 24.334: "Proximity-services (ProSe) User Equipment (UE) to ProSe function protocol aspects; Stage 3".
- [62] 3GPP TS 31.103: "Characteristics of the IP Multimedia Services Identity Module (ISIM) application".
- [63] 3GPP TS 24.302: "Access to the 3GPP Evolved Packet Core (EPC) via non-3GPP access networks; Stage 3".
- [64] IEEE Std 802.11™-2012: "Part 11: Wireless LAN Medium Access Control (MAC) and Physical Layer (PHY) Specifications".
- [65] 3GPP TS 24.341: "Support of SMS over IP networks; Stage 3".

- [66] 3GPP TS 36.211: "Evolved Universal Terrestrial Radio Access (E-UTRA); Physical channels and modulation".
- [67] 3GPP TS 22.011: "Service accessibility"
- [68] 3GPP TS 24.368: "Non-Access Stratum (NAS) configuration Management Object (MO)"
- [69] 3GPP TS 38.413: "NG-RAN; NG Application Protocol (NGAP)"
- [70] 3GPP TS 24.501: "Non-Access-Stratum (NAS) protocol for 5G System (5GS); Stage 3".
- [71] 3GPP TS 38.331: "NR; Radio Resource Control (RRC) protocol specification".
- [72] 3GPP TS 38.133: "NR; Requirements for support of radio resource management".
- [73] 3GPP TS 38.211: "NR; Physical channels and modulation".
- [74] 3GPP TS 23.501: "System architecture for the 5G System (5GS); Stage 2".

3 Definitions, abbreviations and symbols

3.1 Definitions

For the purposes of the present document, the terms and definitions given in ETSI TS 102 223 [32] clause 3.1 and TR 21.905 [33] apply.

Within the context of the present document, the term "terminal" used in ETSI TS 102 223 [32] refers to the Mobile Equipment (ME).

Within the context of the present document, the term "NAA" used in ETSI TS 102 223 [32] refers to the USIM.

Within the context of the present document, the term "CAT" used in ETSI TS 102 223 [32] refers to the USAT.

Within the context of the present document, the following terms and definitions given in 3GPP TS 22.011 [67] apply:

3GPP PS data off
3GPP PS data off exempt service

3.2 Abbreviations

For the purpose of the present document, the abbreviations given in ETSI TS 102 223 [32] and TR 21.905 [33] and the following apply:

5GS	5G System
ADN	Abbreviated Dialling Number
BCCH	Broadcast Control Channel
BSSID	Basic Service Set Identifier
CB	Cell Broadcast
CBMID	Cell Broadcast Message Identifier
CSG	Closed Subscriber Group
DNN	Data Network Name
EGPRS	EDGE General Packet Radio Service
EPS	Evolved Packet System
E-UTRAN	Evolved Universal Terrestrial Radio Access Network
FDN	Fixed Dialling Number
GGSN	Gateway GPRS Support Node
GPRS	General Packet Radio Service
GSM	Global System for Mobile communications
H(e)NB	Home Node B or Home evolved Node B
HESSID	Homogenous Extended Service Set Identifier

HPSIM	Hosting Party Subscription Identity Module
HSDPA	High Speed Downlink Packet Access
IARI	IMS Application Reference Identifier
IMPU	IMS Public User Identity
MM	Multimedia Message
MMS	Multimedia Messaging Service
MMI	Man Machine Interface
NA	No Audio-alerting capability
ND	No Display capability
NG-RAN	Next Generation – Radio Access Network
NK	No Keypad capability
NL	No support of multiple Languages
NR	New Radio
NS	No Speech-call capability
NSSAI	Network Slice Selection Assistance Information
PDN	Packet Data Network
PDP	Packet Data Protocol, e.g., Ip or X25 or PPP
PDU	Protocol Data Unit
ProSe	Proximity-based Services
PS	Packet Switched
RFU	Reserved for Future Use
SD	Slice Differentiator
S-NSSAI	Single Network Slice Selection Assistance Information
SS	Supplementary Service
SSC	Supplementary Service Control string
SSID	Service Set Identifier
SST	Slice/Service Type
USAT	USIM Application Toolkit
USIM	Universal Subscriber Identity Module
USSD	Unstructured Supplementary Service Data
WSID	WLAN Specific Identifier

3.3 Symbols

For the purposes of the present document, the following symbols apply:

'0' to '9' and 'A' to 'F' The sixteen hexadecimal digits.

4 Overview of USAT

The USAT provides mechanisms which allow applications, existing in the UICC, to interact and operate with any ME which supports the specific mechanism(s) required by the application.

The following mechanisms have been defined. These mechanisms are dependent upon the commands and protocols relevant to USAT in TS 31.101 [13].

4.1 Profile Download

Profile downloading provides a mechanism for the ME to tell the UICC what it is capable of.

4.2 Proactive UICC

Proactive UICC gives a mechanism whereby the UICC can initiate actions to be taken by the ME. The supported functions are specified in clause 6.4.

For each command involved in the dialog with the user, a help information may be available, either for each item of a list of items proposed to the user, or with each command requesting a response from the user. If a proactive command

involved in the dialog with the user indicates the availability of the help feature, the support of this feature is optional for the terminal.

4.3 Data download to UICC

Data downloading to the UICC uses either dedicated commands (the transport mechanisms of SMS point-to-point and Cell Broadcast) or the Bearer independent protocol. Transferral of information over the UICC-ME interface uses the ENVELOPE command.

4.4 Menu selection

See ETSI TS 102 223 [32] clause 4.4.

4.5 Call control by USIM

When this service is activated by the USIM, all dialled digit strings, supplementary service control strings and USSD strings, PDP context parameters, PDN connection parameters, PDU session establishment parameters or IMS communications parameters are first passed to a USIM application before the ME sets up the call, the supplementary service operation or the USSD operation, establishes the PDP context, the PDN connection, the PDU session or initiates IMS communications. The ME shall also pass to the USIM application at the same time its current serving cell. The USIM application has the ability to allow, bar or modify the call, the supplementary service operation or, the USSD operation, PDP context activation, PDN connection activation, PDU session establishment or IMS communication set up by another context activation. The USIM application also has the ability to replace a call request, a supplementary service operation or a USSD operation by another call request or supplementary service operation or USSD operation.

EXAMPLE: A call request can be replaced by a supplementary service operation or a USSD operation, and vice-versa.

4.6 MO Short Message control by USIM

When this service is activated by the USIM, all MO short messages are first passed to the USIM application before the ME sends the short message. The ME shall also pass to the USIM application at the same time its current serving cell. The USIM application shall have the ability to allow the sending, bar the sending or modify the destination address of the short message before sending it.

4.7 Event download

In addition to the set of events defined in ETSI TS 102 223 [32] clause 4.7, the following event may also be reported to the UICC:

- Network Rejection
- CSG cell selection (if class "q" is supported)
- Incoming IMS Data (if classes "e" and "t" are supported)
- IMS Registration (if classes "e" and "t" are supported)
- Data Connection Status Change (if class "e" is supported)

4.8 Security

See ETSI TS 102 223 [32] clause 4.8.

4.9 Multiple card

See ETSI TS 102 223 [32] clause 4.9.

4.10 Timer Expiration

See ETSI TS 102 223 [32] clause 4.10.

4.11 Bearer Independent Protocol

See ETSI TS 102 223 [32] clause 4.11.

4.12 Description of the access technology indicator mechanism

See ETSI TS 102 223 [32] clause 4.12.

4.13 Description of the network search mode mechanism

See ETSI TS 102 223 [32] clause 4.14.

4.14 Geographical location discovery

The proactive command Geographical Location Request and the envelope command Geographical Location Reporting allows the UICC to request and receive the current geographical location information from the ME when the ME is equipped with a positioning feature and it is enabled (e.g. autonomous GPS, Assisted GPS or Assisted GNSS).

4.15 Operation in reduced USAT capable terminals

This specification takes into account terminal types corresponding to the following capabilities:

- no display capability
- no keypad available
- no audio alerting capability
- no speech call capability
- no support of multiple languages.

These terminal types are used to identify which USAT features are not available for each type of reduced functionality.

Note: Terminal types details are in Annex P.

4.16 Tag allocation guidelines

See ETSI TS 102 223 [32] clause 4.13.

4.17 USAT over the AT interface

See ETSI TS 102 223 [32] clause 4.16.

4.18 USAT facilities provided by eCAT clients

Not required by 3GPP.

4.19 Negotiation of Poll Interval

See ETSI TS 102 223 [32] clause 4.18.

4.20 ProSe usage information reporting

When the UICC supports the ProSe usage information reporting functionality, the ProSe-enabled Public Safety UE stores in the UICC the information to provide information necessary for composing of charging events related to the ProSe direct communication. The UICC is responsible for communicating those reports to the ProSe Function CTF (ADF) using BIP mechanism.

5 Profile download

5.1 Procedure

The profile download instruction is sent by the ME to the UICC as part of the UICC initialization procedure. The UICC initialization procedure is specified in TS 31.101 [13]. If class "s" is supported, the profile download instruction is sent also every time the TE accessing USAT functionalities over the AT interface is connected or disconnected or changes its profile. If the terminal supports class "s" the profile download instruction shall combine capabilities supported by the MT and the TE according to Annex Q.

If the UICC indicates the support of "Additional TERMINAL PROFILE after UICC activation" in its USIM Service Table, the ME shall handle the profile download procedure as specified in ETSI TS 102 223 [32] clause 5.1.

If the UICC does not indicate the support of "Additional TERMINAL PROFILE after UICC activation" in its USIM Service Table, the profile download instruction shall only be sent by the ME to the UICC as part of the UICC initialization procedure. However, if a USIM initialisation procedure is performed due to a refresh proactive command, the USIM initialisation procedure may also include a profile download.

The profile(s) sent by the ME shall state the facilities relevant to USAT that are supported by the ME.

5.2 Structure and coding of TERMINAL PROFILE

Direction: ME to UICC.

The command header is specified in TS 31.101 [13].

Command parameters/data:

Description	Clause	M/O/C	Length
Profile	-	M	lgth

- Profile:

Contents:

- The list of USAT facilities that are supported by the ME.

Coding:

- 1 bit is used to code each facility:
 - bit = 1: facility supported by ME.

- bit = 0: facility not supported by ME.

NOTE: several bits may need to be set to 1 for the support of the same facility. This is because of backward compatibility with SAT: several options existed in SAT for a given facility, and they are mandatory in USAT when this facility is supported.

First byte (Download):

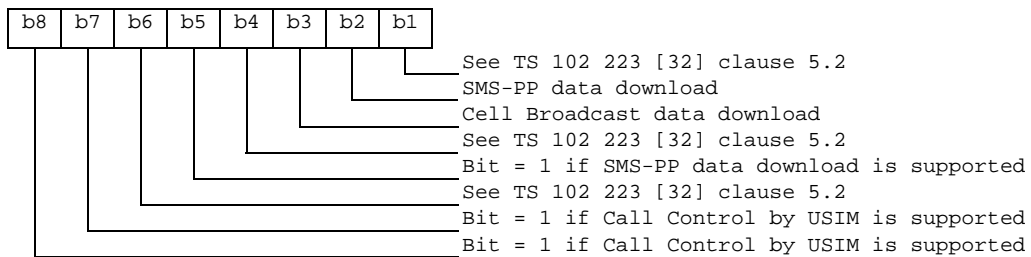

Second byte (Other):

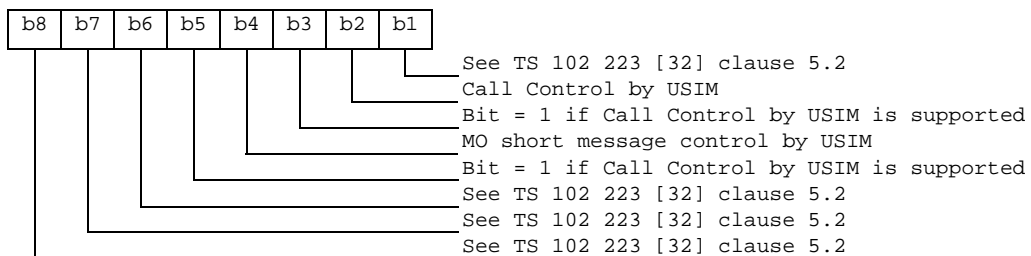

Third byte (Proactive UICC):

- See ETSI TS 102 223 [32] clause 5.2.

Fourth byte (Proactive UICC):

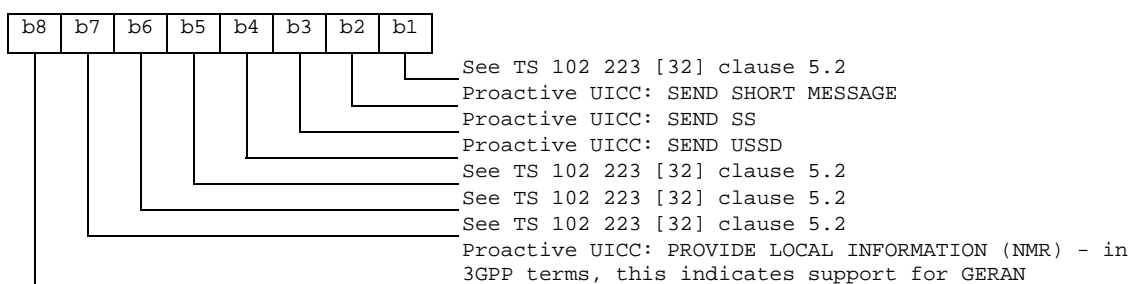

Fifth byte (Event driven information):

- See ETSI TS 102 223 [32] clause 5.2.

Sixth byte (Event driven information extensions):

- See ETSI TS 102 223 [32] clause 5.2.

Seventh byte (Multiple card proactive commands) for class "a":

- See ETSI TS 102 223 [32] clause 5.2.

Eighth byte (Proactive UICC):

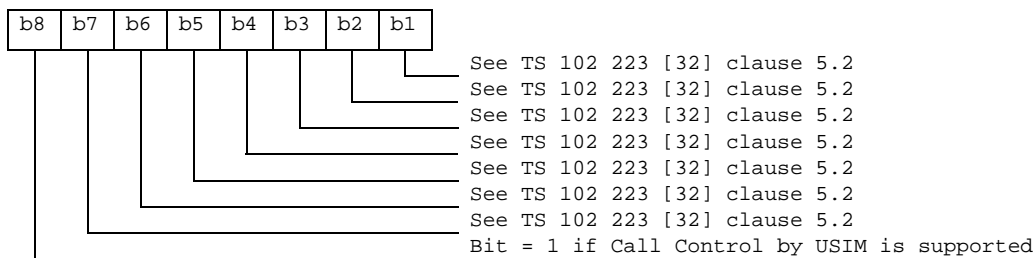

Ninth byte:

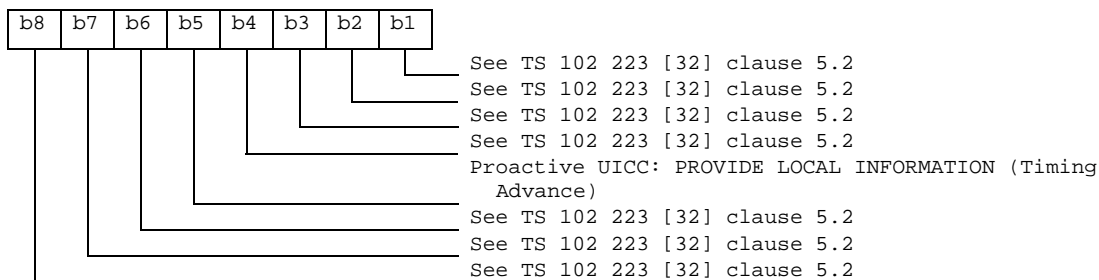

Tenth byte (Soft keys support) for class "d":

- See ETSI TS 102 223 [32] clause 5.2.

Eleventh byte: (Soft keys information):

- See ETSI TS 102 223 [32] clause 5.2.

Twelfth byte (Bearer Independent protocol proactive commands) for class "e":

- See ETSI TS 102 223 [32] clause 5.2.

Thirteenth byte (Bearer Independent protocol supported bearers) for class "e":

- See ETSI TS 102 223 [32] clause 5.2.

Fourteenth byte: (Screen height):

- See ETSI TS 102 223 [32] clause 5.2.

Fifteenth byte: (Screen width):

- See ETSI TS 102 223 [32] clause 5.2.

Sixteenth byte: (Screen effects):

- See ETSI TS 102 223 [32] clause 5.2.

Seventeenth byte (Bearer independent protocol supported transport interface/bearers) for class "e":

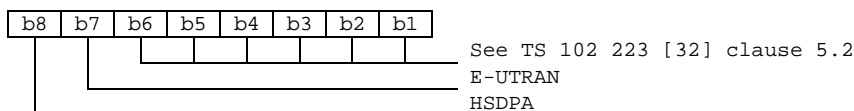

Eighteenth byte:

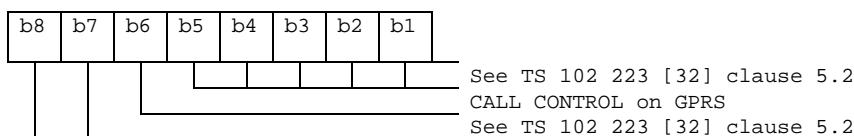

Nineteenth byte: (reserved for TIA/EIA-136 facilities):

- See ETSI TS 102 223 [32] clause 5.2.

Twentieth byte: (reserved for TIA/EIA/IS-820 facilities):

- See ETSI TS 102 223 [32] clause 5.2.

Twenty-first byte (Extended Launch Browser Capability) for class "c":

- See ETSI TS 102 223 [32] clause 5.2.

Twenty second byte:

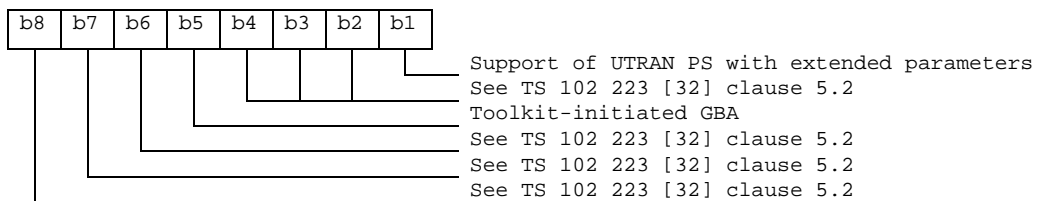

Twenty third byte:

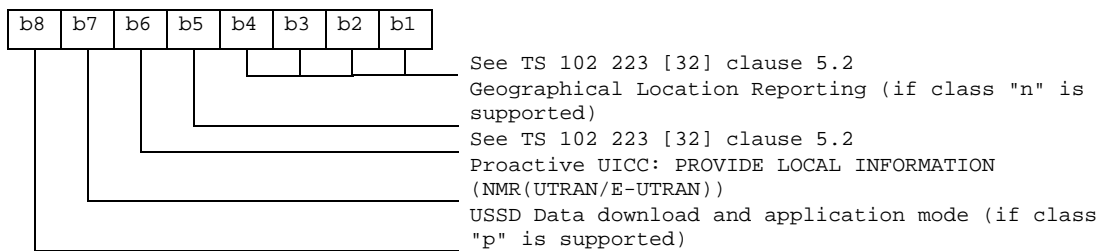

Twenty fourth byte for class "i":

- See ETSI TS 102 223 [32] clause 5.2.

Twenty-fifth byte (Event driven information extensions):

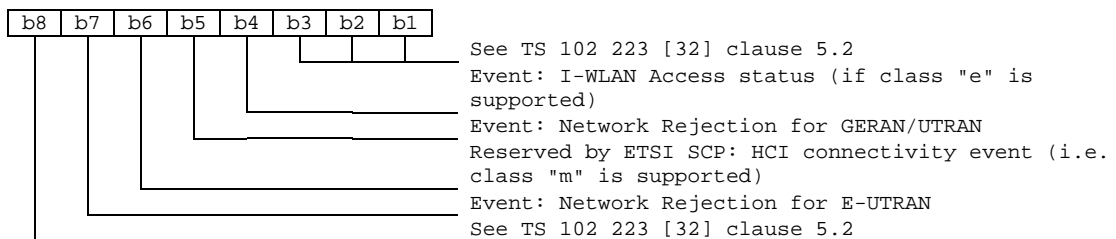

Twenty-sixth byte (Event driven information extensions):

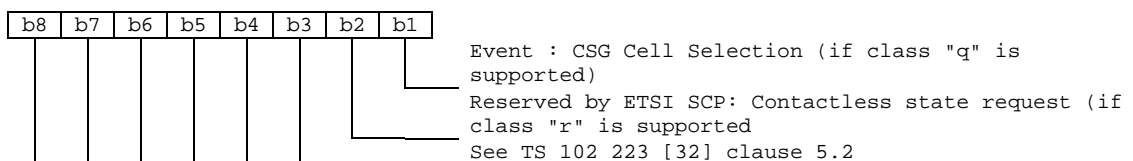

Twenty-seventh byte (Event driven information extensions):

- See ETSI TS 102 223 [32] clause 5.2.

Twenty-eighth byte (Text attributes):

- See ETSI TS 102 223 [32] clause 5.2.

Twenty-ninth byte (Text attributes):

- See ETSI TS 102 223 [32] clause 5.2.

Thirtieth byte:

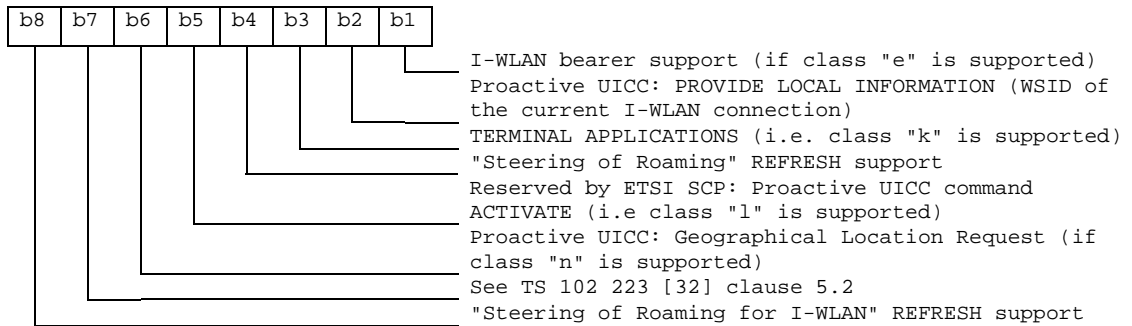

Thirty-first byte:

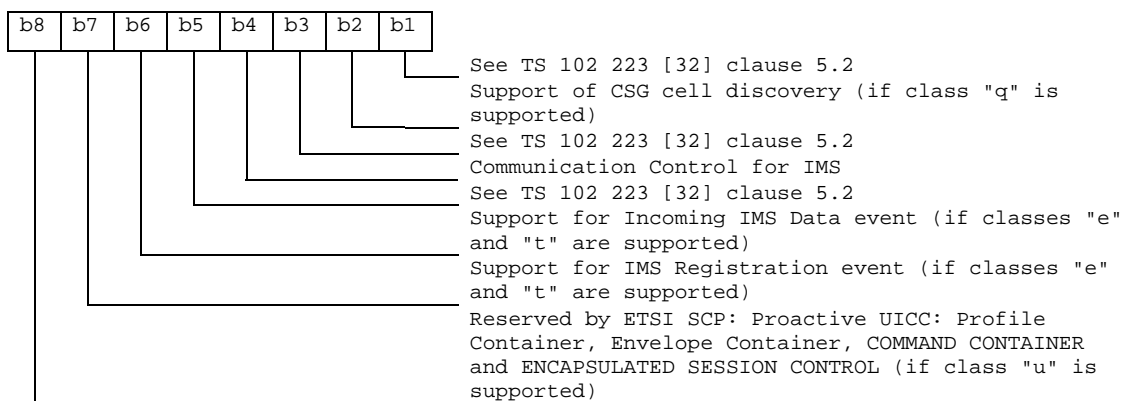

Thirty-second byte:

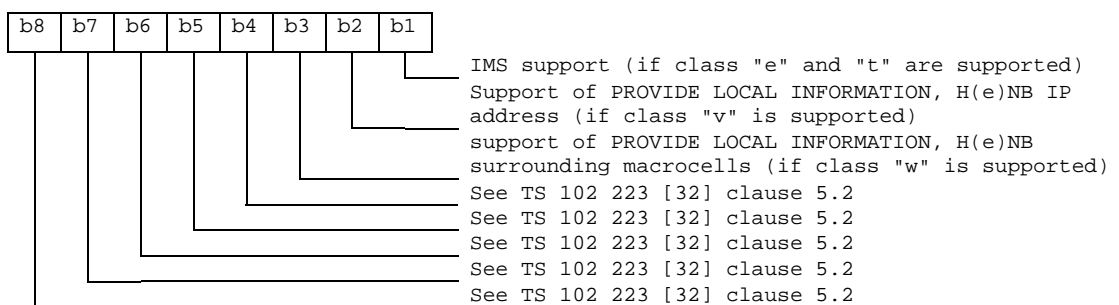

Thirty-third byte:

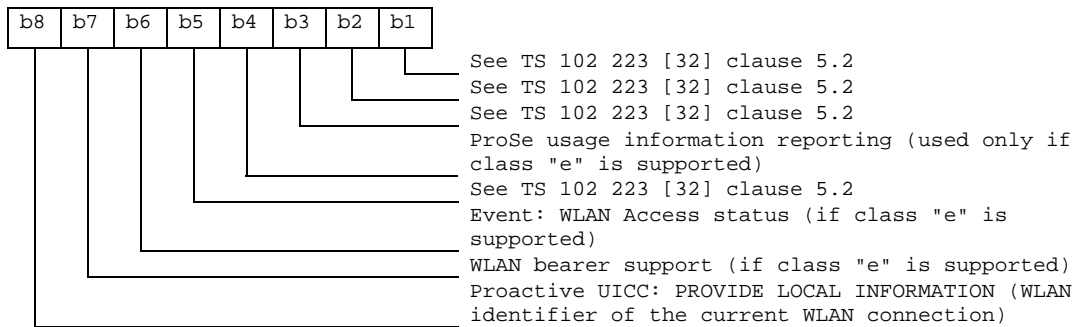

Thirty-fourth byte:

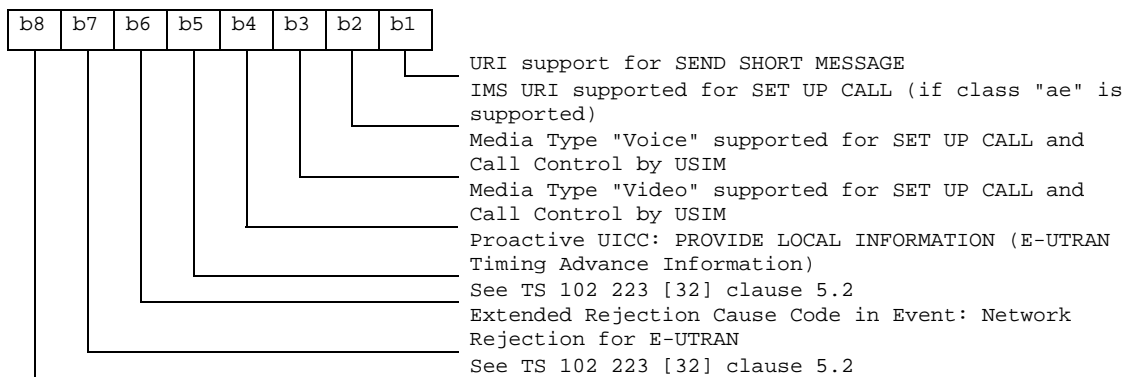

Thirty-fifth byte:

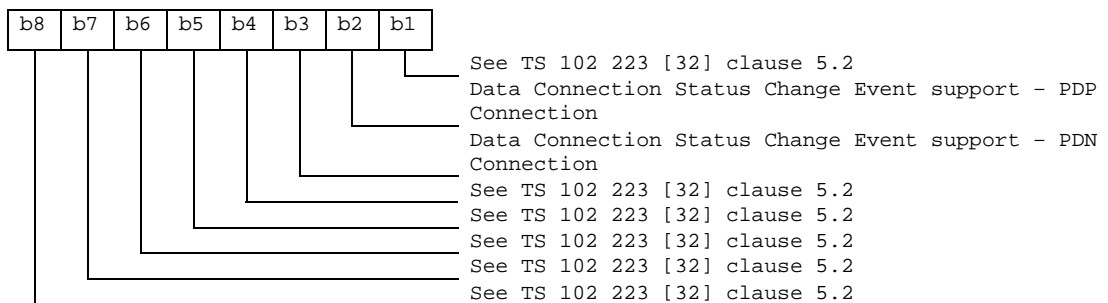

Thirty sixth byte:

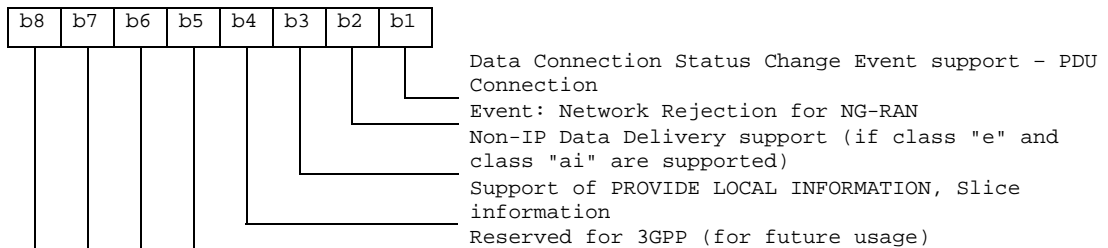

Thirty seventh byte:

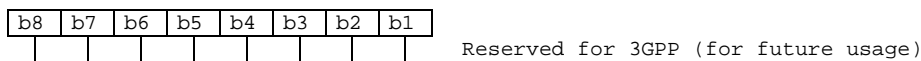

Thirty eighth byte:

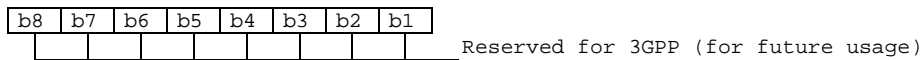

Thirty ninth byte:

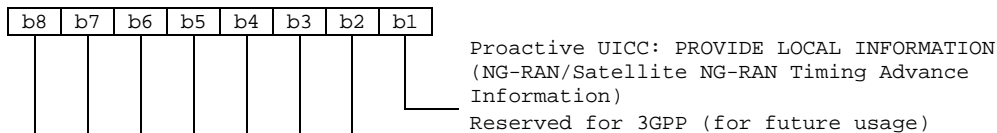

Subsequent bytes:

- See ETSI TS 102 223 [32] clause 5.2.

Response parameters/data:

- None.

5.3 Definition of display parameters in Profile download

See ETSI TS 102 223 [32] clause 5.3.

6 Proactive UICC

6.1 Introduction

TS 31.101 [13] defines the communication protocols between the ME and the UICC, and defines a mechanism to transport "proactive" commands using these protocols. Details about how this mechanism is used for USAT are defined in TS 102 223 [32] clause 6.1. The supported proactive commands are specified in clause 6.4. of the present document.

If the UICC issues an instruction to the ME to initiate a Mobile Originated transaction (e.g. SEND SMS, SEND SS, SEND USSD or SEND DTMF), then unless explicitly stated elsewhere in the present document or in TS 31.101 [13], the content supplied by the UICC for onward transmission by the ME shall not be altered by the ME.

6.2 Identification of ME support

See ETSI TS 102 223 [32] clause 6.2.

6.3 General procedure

See ETSI TS 102 223 [32] clause 6.3.

6.4 Proactive UICC commands and procedures

6.4.1 DISPLAY TEXT

See ETSI TS 102 223 [32] clause 6.4.1.

6.4.2 GET INKEY

See ETSI TS 102 223 [32] clause 6.4.2.

6.4.3 GET INPUT

See ETSI TS 102 223 [32] clause 6.4.3.

6.4.4 MORE TIME

See ETSI TS 102 223 [32] clause 6.4.4.

6.4.5 PLAY TONE

See ETSI TS 102 223 [32] clause 6.4.5.

NOTE: Some supervisory tones are optional for mobile equipment (see TS 22.001 [22]).

6.4.6 POLL INTERVAL

See ETSI TS 102 223 [32] clause 6.4.6.

6.4.7 REFRESH

See ETSI TS 102 223 [32] clause 6.4.7 except for:

- "eUICC Profile State Change" and "Application Update" which are not required by 3GPP;
- "3G Session Reset" and "Steering of Roaming" which are defined as follows.

3G Session Reset:

This mode causes the ME to reset the 3G session, in accordance with the 3G session reset procedure defined in TS 31.102 [14]. Subsequently, the ME performs the "USIM Initialization and File Change Notification" procedure and the MM Restart procedure as defined in TS 23.122 [7].

Steering of Roaming:

This mode triggers a steering of roaming procedure as defined in TS 23.122 [7] or a steering of roaming for I-WLAN procedure as defined in TS 24.234 [42].

6.4.7.1 EF_{IMSI} changing procedure

When an EF_{IMSI} is changed via Data Download or a USAT application and a REFRESH command is issued by the UICC the following rules apply to the UICC and ME:

- USIM Initialization. This command shall not be used if an EF_{IMSI} is changed, as the behaviour of the UE is unpredictable;
- File Change Notification. This command shall not be used if an EF_{IMSI} is changed, as the behaviour of the UE is unpredictable;
- USIM Initialization and File Change Notification. This command shall not be used if an EF_{IMSI} is changed, as the behaviour of the UE is unpredictable;

- USIM Initialization and Full File Change Notification. This command shall not be used if an EF_{IMSI} is changed, as the behaviour of the UE is unpredictable;
- UICC Reset. Normal UICC Reset procedure is carried out;
- USIM Application Reset. Normal USIM Application Reset procedure is carried out;
- 3G Session Reset. Normal 3G Session Reset procedure is carried out.

If an EF_{IMSI} is to be updated, neither EF_{IMSI}, EF_{PSLOCI}, EF_{EPSLOCI}, EF_{LOCI}, EF_{5GS3GPPOCI} nor EF_{5GSN3GPPOCI} shall be updated in the UICC before the 3G session termination procedure has been completed by the ME.

6.4.7.2 Generic Bootstrapping Procedure Request

If Toolkit-initiated GBA is supported by the ME, as indicated in the TERMINAL PROFILE, then the following applies:

When the UICC issues a REFRESH command implying a File Change Notification on EF_{GBABP} (GBA Bootstrapping parameters) under ADF USIM or ADF ISIM the ME shall perform a GBA bootstrapping procedure (as defined in TS 31.102 [14] or TS 31.103 [62]).

This procedure applies to REFRESH command only in the following modes: USIM File Change Notification; USIM Initialization and File Change Notification; and 3G Session Reset.

6.4.7.3 EF_{UICCIARI} changing procedure

When an EF_{UICCIARI} is changed in either the USIM or the ISIM via Data Download or a USAT application and a REFRESH command is issued by the UICC the following rule applies to the ME:

The ME shall read the updated list of IARIs associated with active applications installed on the UICC and follow the procedures defined in TS 24.229 [52].

6.4.7.4 Steering of roaming and steering of roaming for I-WLAN procedure

The steering of roaming procedures defined in TS 23.122 [7] and in TS 24.234 [42] might take a long time. In order to avoid blocking the Toolkit interface, the ME shall send the TERMINAL RESPONSE (Command performed successfully) immediately after starting the steering of roaming procedure, without waiting for its completion. The ME shall send TERMINAL RESPONSE (ME unable to process command or other appropriate code) in case it fails to start the steering of roaming procedure.

6.4.7.5 Steering of roaming via NAS messages

When the ME receives an SOR transparent container, as specified in 3GPP TS 24.501 [70] clause 9.11.3.51, via a REGISTRATION ACCEPT message (see 3GPP TS 23.122 [7] Annex C.2) or via a DL NAS TRANSPORT message (see 3GPP TS 23.122 [7] Annex C.3), with the indication that the transparent container shall be forwarded to the USIM using SMS-PP data download, and the integrity check of the message was successful, the ME shall pass the transparent container to the USIM by using the procedure for SMS-PP data download via REGISTRATION ACCEPT or DL NAS TRANSPORT messages as described in clause 7.1.1.1a

6.4.7.6 Routing Indicator Data update via NAS messages

When the ME receives a secure packet in a UE parameters update data set with UE parameters update data set type set to Routing Indicator update data as specified in 3GPP TS 24.501 [70] clause 9.11.3.53A, via a DL NAS TRANSPORT message, and the integrity check of the message was successful, the ME shall pass the transparent container to the USIM by using the procedure for SMS-PP data download via DL NAS TRANSPORT messages as described in clause 7.1.1.1a. Upon successfully processing the Routing Indicator data from the secure packet on the UICC, the UICC shall issue a File Change Notification REFRESH.

6.4.8 SET UP MENU

See ETSI TS 102 223 [32] clause 6.4.8.

6.4.9 SELECT ITEM

See ETSI TS 102 223 [32] clause 6.4.9.

6.4.10 SEND SHORT MESSAGE

This command requests the ME to send a short message.

Two types are defined in ETSI TS 102 223 [32] clause 6.4.10 and apply as follows within the context of the present document:

- a short message to be sent to the network in an SMS-SUBMIT message, or an SMS-COMMAND message, where the user data can be passed transparently;
- a short message to be sent to the network in an SMS-SUBMIT message where the text needs to be packed by the ME.

Where the text has been packed, the text string provided by the UICC shall not be longer than 160 characters. It shall use the SMS default 7-bit coded alphabet, packed into 8-bit octets, in accordance with TS 23.038 [4]. The data coding indication contained in the Data Coding Scheme byte shall be "default alphabet". The text length (which is part of the SMS TPDU) given by the UICC shall state the number of 7-bit characters in the text string. The command details shall indicate "packing not required".

8-bit data Short Messages may be sent by the UICC. The command shall indicate packing not required. The data coding indication contained in the Data Coding Scheme byte shall be "8 bit". The string shall not be longer than 140 bytes, and the length (in SMS TPDU) shall state the number of bytes in the string.

If UCS2 is supported by the ME, 16-bit data Short Messages may be sent by the UICC. The text string provided by the UICC shall not be longer than 70 characters. It shall use the 16-bit UCS2 alphabet format, in accordance with TS 23.038 [4]. The text length (which is part of the SMS TPDU) given by the UICC shall state the number of 16-bit characters in the text string. The command details shall indicate "packing not required".

SMS commands may be sent by the UICC. These shall count as packed text message. The SMS TPDU from the UICC shall indicate SMS-COMMAND. The command details shall indicate "packing not required".

Where packing by the ME is required, the text string provided by the UICC shall not be longer than 160 characters. It shall use the SMS default 7-bit coded alphabet as defined in TS 23.038 [4] with bit 8 set to 0. The text length given by the UICC shall state the number of characters in the text string. The ME shall pack the text string and modify the Data Coding Scheme byte to "default alphabet" in accordance with TS 23.038 [4] before submitting the message to the network.

Optionally, the UICC may include in this command an alpha identifier. See ETSI TS 102 223 [32] clause 6.4.10 for the use of this alpha identifier.

If the ME is capable of SMS-MO, then it shall send the data as a Short Message TPDU to the destination address. The ME shall give the result to the UICC using TERMINAL RESPONSE (indicating successful or unsuccessful transmission of the Short Message) after receiving an SMS RP-ACK or RP-Error from the network. If an alpha identifier was provided by the UICC, the ME should not give any information to the user at the reception of SMS RP-ACK or RP-Error.

If the Short Message TPDU is unsuccessfully received by the network (e.g. the reception of a CP-ERROR), the ME shall inform the UICC using TERMINAL RESPONSE (network currently unable to process command). If a null alpha identifier was provided by the UICC, the ME should not give any information to the user at the unsuccessful network reception.

6.4.11 SEND SS

Upon receiving this command, the ME shall decide if it is able to execute the command. Examples are given below, but the list is not exhaustive:

- if the command is rejected because the ME is busy on an SS transaction, the ME informs the UICC using TERMINAL RESPONSE (ME unable to process command - currently busy on SS transaction);

- if the command is rejected because the ME is busy on a USSD transaction, the ME shall inform the UICC using TERMINAL RESPONSE (ME unable to process command - currently busy on USSD transaction);
- if the command is rejected because the ME does not support that Supplementary Service, the ME informs the UICC using TERMINAL RESPONSE (Command beyond ME's capabilities).

If the ME is able to send the SS request, the ME shall:

- send the SS request immediately, without need to alert the user first;
- optionally, the UICC may include in this command an alpha-identifier. The use of this alpha-identifier by the ME is described below:
 - if the alpha identifier is provided by the UICC and is not a null data object, the ME shall use it to inform the user. This is also an indication that the ME should not give any other information to the user on the fact that the ME is sending a SS request. If an icon is provided by the UICC, the icon indicated in the command may be used by the ME to inform the user, in addition to, or instead of the alpha identifier, as indicated with the icon qualifier (see clause 6.5.4);
 - if the alpha identifier is provided by the UICC and is a null data object (i.e. length = '00' and no value part), this is an indication that the ME should not give any information to the user on the fact that the ME is sending an SS request;
 - if the alpha identifier is not provided by the UICC, the ME may give information to the user concerning what is happening.
- once an SS Return Result message not containing an error has been received from the network, the ME shall inform the UICC that the command has been successfully executed, using TERMINAL RESPONSE. This command shall include the contents of SS Return Result as additional data. If a null alpha identifier was provided by the UICC, the ME should not give any information to the user at the reception of an SS Return Result message;
- if the command is rejected because the network cannot support or is not allowing the Supplementary Service request, the ME informs the UICC using TERMINAL RESPONSE (SS Return Result error code). If a null alpha identifier was provided by the UICC, the ME should not give any information to the user at the reception of a SS Return Result message;
- if the SS request is unsuccessfully received by the network, the ME shall inform the UICC using TERMINAL RESPONSE (network currently unable to process command), and not retry to send the request. If a null alpha identifier was provided by the UICC, the ME should not give any information to the user at the reception of a SS Return Result message.

A terminal of type ND shall ignore any alpha identifier provided together with this command. The terminal shall respond with "command performed successfully" upon successful completion of the command. A terminal of type ND shall also ignore any icon provided together with this command. The terminal shall respond with "command performed successfully but requested icon could not be displayed" upon successful completion of the command.

If the ME supports the Outgoing Call Information service, the ME shall not store in EF_{OCI} the supplementary service control string sent by the UICC in this command.

The supplementary service control string included in the SEND SS proactive command shall not be checked against those of the FDN list, even if the Fixed Dialling Number service is enabled.

6.4.12 SEND USSD

6.4.12.1 MMI Mode

Upon receiving this command, the ME shall decide if it is able to execute the command. Examples are given below, but the list is not exhaustive:

- if the command is rejected because the ME is busy on a USSD transaction, the ME informs the UICC using TERMINAL RESPONSE (ME unable to process command - currently busy on USSD transaction);

- if the command is rejected because the ME is busy on a SS transaction, the ME informs the UICC using TERMINAL RESPONSE (ME unable to process command - currently busy on SS transaction).

If the ME is able to send the USSD request, the ME shall:

- send the USSD immediately, without need to alert the user first;
- optionally, the UICC may include in this command an alpha-identifier. The use of this alpha-identifier by the ME is described below:
 - if the alpha identifier is provided by the UICC and is not a null data object, the ME shall use it to inform the user. This is also an indication that the ME should not give any other information to the user on the fact that the ME is sending a USSD request. If an icon is provided by the UICC, the icon indicated in the command may be used by the ME to inform the user, in addition to, or instead of the alpha identifier, as indicated with the icon qualifier (see clause 6.5.4);
 - if the alpha identifier is provided by the UICC and is a null data object (i.e. length = '00' and no value part), this is an indication that the ME should not give any information to the user on the fact that the ME is sending a USSD request;
 - if the alpha identifier is not provided by the UICC, the ME may give information to the user concerning what is happening.

A terminal of type ND shall ignore any alpha identifier provided together with this command. The terminal shall respond with "command performed successfully" upon successful completion of the command. A terminal of type ND shall also ignore any icon provided together with this command. The terminal shall respond with "command performed successfully but requested icon could not be displayed" upon successful completion of the command.

- once the USSD transaction is initiated, a dialogue between the network and the user may occur which involves the MMI of the ME. If an alpha identifier was initially provided by the UICC, this alpha identifier may be discarded during this dialogue;
- once a RELEASE COMPLETE message containing the USSD Return Result message not containing an error has been received from the network, the ME shall inform the UICC that the command has been successfully executed, using TERMINAL RESPONSE. This command shall include the text contained in the USSD Return Result in a Text String data object. If a null alpha identifier was provided by the UICC, the ME should not give any information to the user at the reception of a USSD Return Result message;
- if the UE clears the transaction by sending a RELEASE COMPLETE upon request of the user, the ME shall inform the UICC using TERMINAL RESPONSE (USSD transaction terminated by user);
- if the USSD operation is rejected because the network cannot support or is not allowing mobile initiated USSD, the ME informs the UICC using TERMINAL RESPONSE (USSD Return Result error code). If a null alpha identifier was provided by the UICC, the ME should not give any information to the user at the reception of a USSD Return Result message;
- if the USSD request is unsuccessfully received by the network, the ME shall inform the UICC using TERMINAL RESPONSE (network currently unable to process command), and not retry to send the request. If a null alpha identifier was provided by the UICC, the ME should not give any information to the user at the reception of a USSD Return Result message.

6.4.12.2 Application Mode

This clause applies if class "p" is supported.

A USSD is considered as Application Mode (Send USSD used for the transport of Data to the network) if the service "data download via USSD and USSD application mode" is allocated and activated in the USIM Service Table (see TS 31.102 [14]) and the DCS coding within the USSD string TLV is set to 8 bit data.

Upon receiving this command, the ME shall decide if it is able to execute the command. Examples are given below, but the list is not exhaustive:

- if the command is rejected because the ME is busy on a USSD transaction, the ME informs the UICC using TERMINAL RESPONSE (ME unable to process command - currently busy on USSD transaction);

- if the command is rejected because the ME is busy on a SS transaction, the ME informs the UICC using TERMINAL RESPONSE (ME unable to process command - currently busy on SS transaction).

If the ME is able to send the USSD request then the ME shall:

- send the USSD immediately, without need to alert the user first;
- optionally, the UICC may include in this command an alpha-identifier. The use of this alpha-identifier by the ME is described below:
 - if the alpha identifier is provided by the UICC and is not a null data object, the ME shall use it to inform the user. This is also an indication that the ME should not give any other information to the user on the fact that the ME is sending a USSD request. If an icon is provided by the UICC, the icon indicated in the command may be used by the ME to inform the user, in addition to, or instead of the alpha identifier, as indicated with the icon qualifier (see clause 6.5.4);
 - if the alpha identifier is provided by the UICC and is a null data object (i.e. length = '00' and no value part), this is an indication that the ME should not give any information to the user on the fact that the ME is sending a USSD request;
 - if the alpha identifier is not provided by the UICC, the ME may give information to the user concerning what is happening.
- once a FACILITY (including RELEASE COMPLETE) message containing a USSD Request message has been received from the network, the ME shall inform the UICC that the network requests more information, using the command ENVELOPE (USSD Data Download). This command shall include the text contained in the USSD Request in a Text String data object. If a null alpha identifier was provided by the UICC, the ME should not give any information to the user at the reception of a USSD Request message.

A terminal of type ND shall ignore any alpha identifier provided together with this command. The terminal shall respond with "command performed successfully" upon successful completion of the command. A terminal of type ND shall also ignore any icon provided together with this command. The terminal shall respond with "command performed successfully but requested icon could not be displayed" upon successful completion of the command.

6.4.13 SET UP CALL

This command is issued by the UICC to request a call set up. The procedure is defined in ETSI TS 102 223 [32] clause 6.4.13, except when stated otherwise in the present document.

The UICC may request the use of an automatic redial mechanism according to TS 22.001 [22]

In addition to the rules given in ETSI TS 102 223 [32] clause 6.4.13 the following applies:

- If the UICC supplies a number stored in EF_{ECC}, this shall not result in an emergency call.

Upon receiving this command, the ME shall decide if it is able to execute the command. Examples are given below, but the list is not exhaustive:

- if the command is rejected because the ME is busy on another call, the ME informs the UICC using TERMINAL RESPONSE (ME unable to process command - currently busy on call);
- if the command is rejected because the ME is busy on a SS transaction, the ME informs the UICC using TERMINAL RESPONSE (ME unable to process command - currently busy on SS transaction);
- if the command is rejected because the ME cannot support Call Hold, or because the ME does not support the capability configuration parameters requested by the UICC, the ME informs the UICC using TERMINAL RESPONSE (Command beyond ME's capabilities);
- if the command is rejected because the network cannot support or is not allowing Call Hold of a multi party call, the ME informs the UICC using TERMINAL RESPONSE (SS Return Result error code);
- if the command is rejected because the network cannot support or is not allowing Call Hold of a single call, the ME informs the UICC using TERMINAL RESPONSE (Network currently unable to process command).

If the ME supports the Outgoing Call Information service, the ME shall not store in EF_{OCT} and in EF_{OCT} the call set-up details (called party number and associated parameters) sent by the UICC in this command.

6.4.14 POLLING OFF

See ETSI TS 102 223 [32] clause 6.4.14.

6.4.15 PROVIDE LOCAL INFORMATION

This command requests the ME to send current local information to the UICC. At present, this information is restricted to:

- location information: the mobile country code (MCC), mobile network code (MNC), location area code/tracking area code (LAC/TAC) and cell ID of the current serving cell;

NOTE: For UTRAN the cell ID returned in terminal response is the last known cell ID which may not be the current serving cell, when the ME is on a dedicated channel.

- the IMEI or IMEISV of the ME;
- the Network Measurement Results (and the BCCH channel list if connected to GERAN);
- the current date, time and time zone;
- the current ME language setting;
- the Timing Advance, suitable for GERAN,E-UTRAN and NG-RAN
- the current access technology;
- the current network search mode;
- the charge state of the battery (if class "g" is supported);
- the WSID of the current I-WLAN connection;
- the WLAN identifier of the current WLAN connection;
- the CSG ID list and corresponding HNB names (if available in the broadcasted information to the ME) of detected CSG or Hybrid cells in the Allowed CSG list or the Operator CSG list (if class "q" is supported);
- the H(e)NB IP address. (if class "v" is supported);
- the list of location information for surrounding macrocells (if class "w" is supported);
- the list of slice(s) information.

The above information can be requested only if supported by the ME as indicated in the TERMINAL PROFILE.

The ME shall return the requested local information within a TERMINAL RESPONSE.

Where location information or Network Measurement Results has been requested and no service is currently available, then the ME shall return TERMINAL RESPONSE (ME currently unable to process command - no service).

Where location information or Network Measurement Results has been requested and the ME is on limited service (e.g. emergency calls only), the ME shall return the data requested in the TERMINAL RESPONSE with the general result (Limited Service).

Where Network Measurement Results has been requested and the ME is connected to a different access technology to the one requested (e.g. UTRAN Measurement Qualifier included when ME is connected to a GERAN), then the ME shall return TERMINAL RESPONSE (ME currently unable to process command - no service).

Network Measurement Results are available on a per access technology basis and indicated as such in the Terminal Profile.

Network Measurement Results for a GERAN:

If the NMR are requested and a call is in progress, the value of all the returned parameters provided by the ME in the response to the command will be valid. The NMR returned when a call is in progress from Mes supporting multiband operation, shall be according to the value of the multiband reporting parameter as defined in TS 44.018 [27]. If a call is not in progress (i.e. ME is in idle mode) some of the returned parameters (e.g. RXQUAL) may be invalid. In idle mode, Mes supporting multiband operation shall ignore the value of the multiband reporting parameter and the NMR returned shall be as defined in TS 44.018 [27] when the multiband reporting parameter equals zero.

NOTE 1: When in idle mode, the only information element on which it is possible to rely on is the RXLEV-FULL-SERVING-CELL, which contains the value of the received signal strength on the BCCH of the current serving cell.

NOTE 2: Network Measurement Results are defined in TS 44.018 [27] as Measurement Results.

The BCCH channel list is only available if the ME is connected to a GERAN.

Network Measurement Results for a UTRAN:

The USIM request for measurement information shall not trigger any measurement activities in ME in addition to those requested by UTRAN.

The ME shall only report measurement results that are valid according to the current RRC state or the UTRAN configuration requested.

NOTE 3: The returned parameters provided by the ME, in the response to the command, are subject to the ME capability, currently used radio configuration, current RRC state and the UTRAN configuration requested as defined in the TS 25.331 [38].

NOTE 4: Network Measurement Results are defined in TS 25.331 [38] as the MEASUREMENT REPORT message.

Network Measurement Results for a E-UTRAN:

The USIM request for measurement information shall not trigger any measurement activities in ME in addition to those requested by E-UTRAN.

The ME shall only report measurement results that are valid according to the current RRC state or the E-UTRAN configuration requested.

NOTE 5: The returned parameters provided by the ME, in the response to the command, are subject to the ME capability, currently used radio configuration, current RRC state and the E-UTRAN configuration requested as defined in the TS 36.331 [49].

NOTE 6: Network Measurement Results are defined in TS 36.331 [49] as the *MeasurementReport* message.

Network Measurement Results for a NG-RAN:

The USIM request for measurement information shall not trigger any measurement activities in ME in addition to those requested by NG-RAN.

The ME shall only report measurement results that are valid according to the current RRC state or the NG-RAN configuration requested.

NOTE 7: The returned parameters provided by the ME, in the response to the command, are subject to the ME capability, currently used radio configuration, current RRC state and the NG-RAN configuration requested as defined in the TS 38.331 [71].

NOTE 8: Network Measurement Results are defined in TS 38.331 [71] as the *MeasurementReport* message.

The ME shall return the current date and time as set by the user. An ME of type NK or type ND may return the date and time received from the network with the NITZ feature (see TS 22.042 [3]), if this is available. If available, the ME shall also return the time zone known from the network with the NITZ feature (see TS 22.042 [3]). If the time zone information is not available, the ME shall return 'FF' for this element.

If language setting is requested, the ME shall return the currently used language.

Timing advance is available if the ME is connected to a GERAN, E-UTRAN or NG-RAN. If the Timing Advance is requested, the ME shall return the timing advance value that was received from the BTS, eNodeB or gNodeB during the last active dedicated connection (e.g. for call or SMS). Timing advance is defined for GERAN in TS 44.018 [27], for E-UTRAN in 3GPP TS 36.211 [66] and for NG-RAN in 3GPP TS 38.211 [73]. An ME supporting the Timing Advance feature shall be able to store the last value of timing advance. In addition to the timing advance value, the ME shall return its current status (i.e. ME is in idle mode or not) in order for the application to be aware of potential misinterpretation of the timing advance value. Caution should be taken if using the Timing Advance value for distance measurement as reflections from the external environment (buildings etc.) may affect the accuracy.

If the access technology is requested, the ME shall return the current access technology that the ME is using.

The WSID or the WLAN identifier is only available if the ME is connected to a I-WLAN or a WLAN respectively. If the WSID or the WLAN identifier is requested, the ME shall return the WSID or the WLAN identifier respectively of the currently connected I-WLAN or a WLAN respectively. Where a WSID or the WLAN identifier has been requested and no I-WLAN or WLAN respectively is currently connected, then the ME shall return TERMINAL RESPONSE (ME currently unable to process command - no service).

When CSG ID list is requested, the ME shall return the CSG ID list and the corresponding HNB name (if available in the broadcasted information to the ME). If the CSG ID list has been requested, and the ME is currently not camped on a CSG or Hybrid cell, the ME shall return TERMINAL RESPONSE (ME currently not able to process command – no service).

The proactive command PROVIDE LOCAL INFORMATION – H(e)NB IP address is issued on the H(e)NB-HPSIM interface, see TS 31.104 [56].

When the IP address is requested, the H(e)NB shall return the IP address reported to H(e)MS and/or HNB-GW for location verification based on IP address (which may be a local IP address). If no such IP address is available to the H(e)NB, the H(e)NB shall return TERMINAL RESPONSE (ME currently not able to process command – no service). If several such IP addresses are available, the H(e)NB provides all of them to the UICC.

The proactive command PROVIDE LOCAL INFORMATION – H(e)NB surrounding macrocell is issued on the H(e)NB-HPSIM interface, see TS 31.104 [56].

When the list of surrounding macrocells is requested, the H(e)NB shall provide the list of location information for detected macrocells.

- For the HNB, all cell information contained in: intra-frequency neighbor list, inter-frequency neighbor list, inter-RAT neighbor list, that are reported to the HMS, see TS 32.582 [57] sec 6.1.1.
- For the HeNB, all cell information contained in: LTE cell neighbor list, UMTS cell neighbor list, GSM cell neighbor list, that are reported to the HeMS, see TS 32.592 [58] sec 6.1.15.

Location information contains the mobile country code (MCC), mobile network code (MNC), location area code/tracking area code (LAC/TAC) and cell ID. The list of surrounding macrocells is provided for all access technologies supported by the H(e)NB, up to the limit of the TERMINAL RESPONSE APDU command size.

NOTE 9: the HPSIM request for H(e)NB surrounding macrocell does not trigger a network scan; the H(e)NB reports available information to the HPSIM.

When the list of slice(s) information is requested, the Serving PLMN S-NSSAIs list shall be returned.

An S-NSSAI, as specified in 3GPP TS 23.003 [30], is comprised of,:

- A Slice/Service type (SST)
- A Slice Differentiator (SD)

6.4.16 SET UP EVENT LIST

See ETSI TS 102 223 [32] clause 6.4.16.

6.4.17 PERFORM CARD APDU

See ETSI TS 102 223 [32] clause 6.4.17.

6.4.18 POWER OFF CARD

See ETSI TS 102 223 [32] clause 6.4.18.

6.4.19 POWER ON CARD

See ETSI TS 102 223 [32] clause 6.4.19.

6.4.20 GET READER STATUS

See ETSI TS 102 223 [32] clause 6.4.20.

6.4.21 TIMER MANAGEMENT

See ETSI TS 102 223 [32] clause 6.4.21.

6.4.22 SET UP IDLE MODE TEXT

See ETSI TS 102 223 [32] clause 6.4.22.

6.4.23 RUN AT COMMAND

See ETSI TS 102 223 [32] clause 6.4.23.

6.4.24 SEND DTMF

See ETSI TS 102 223 [32] clause 6.4.24.

6.4.25 LANGUAGE NOTIFICATION

See ETSI TS 102 223 [32] clause 6.4.25.

6.4.26 LAUNCH BROWSER

This command is used to request a browser inside a browser-enabled ME to interpret the content corresponding to a URL. See ETSI TS 102 223 [32] clause 6.4.26.

Upon receiving this command, the ME shall decide if it is able to execute the command. In addition to the examples given in ETSI TS 102 223 [32] clause 6.4.26 the following example applies:

- if the command is rejected because the ME is busy on a SS transaction, the ME informs the UICC using TERMINAL RESPONSE (ME unable to process command - ME currently unable to process command);

6.4.27 OPEN CHANNEL

6.4.27.1 OPEN CHANNEL related to CS bearer

This command is issued by the UICC to request a channel opening. The procedure is defined in ETSI TS 102 223 [32] clause 6.4.27.1, except when stated otherwise in the present document.

The UICC may request the use of an automatic reconnection mechanism according to TS 22.001 [22].

Upon receiving this command, the ME shall decide if it is able to execute the command. In addition to the examples given in ETSI TS 102 223 [32] clause 6.4.27.1 the following example applies:

- if the command is rejected because the ME is busy on a SS transaction, the ME informs the UICC using TERMINAL RESPONSE (ME unable to process command - currently busy on SS transaction). The operation is aborted.

The "Bearer description" provided in the command gives recommended values for parameters that the ME should use to establish the data link. However if the ME or network does not support these values, the ME selects the most appropriate values.

6.4.27.2 OPEN CHANNEL related to GPRS/UTRAN packet service/E-UTRAN/NG-RAN

The procedures defined in ETSI TS 102 223 [32] clause 6.4.27.2 apply, understanding that:

- "packet data service" means GPRS, UTRAN packet service, E-UTRAN or NG-RAN,
- "activation of packet data service" means activation of a PDP context or EPS PDN connection or PDU session.

The UICC provides to the terminal a list of parameters necessary to activate a packet data service. The UICC has three ways to indicate to the ME the QoS it requires:

- either use a Bearer Description called "Bearer description for GPRS/UTRAN Packet Service/E-UTRAN", which is valid for GPRS, UTRAN packet service and E-UTRAN
- or use a Bearer Description called "Bearer description for UTRAN Packet Service with extended parameters and HSDPA" which is valid for a UTRAN packet service, HSDPA and E-UTRAN.
- or use a Bearer Description called "Bearer description for E-UTRAN and mapped UTRAN packet service", which is valid for UTRAN packet service and E-UTRAN.

For NG-RAN, Quality of Service parameters are not applicable

Upon receiving this command, the ME shall decide if it is able to execute the command.

If the 3GPP PS data off status is "active", and the UE is not configured with indication that Bearer Independent Protocol is a 3GPP PS data off exempt service (see Annex S), then the ME shall send the TERMINAL RESPONSE (ME currently unable to process command) immediately. The operation is aborted.

In addition to the examples given in ETSI TS 102 223 [32] clause 6.4.27.2 the following example applies:

- if the command is rejected because the ME is busy on an SS transaction and unable to activate a PDP context in parallel with this SS transaction, the ME informs the UICC using TERMINAL RESPONSE (ME unable to process command - currently busy on SS transaction). The operation is aborted.

The "Bearer description" provided in the command gives recommended values for parameters that the ME should use to establish the data link. However if the ME or network does not support these values, the ME selects the most appropriate values.

If class "ai" is supported, the "Bearer description" provided in the command shall indicate a Non-IP PDP Type in order to establish a Non-IP data link. The UICC shall provide the Network Access Name data object.

6.4.27.3 OPEN CHANNEL related to local bearer

See ETSI TS 102 223 [32] clause 6.4.27.3.

6.4.27.4 OPEN CHANNEL related to Default (network) Bearer

See ETSI TS 102 223 [32] clause 6.4.27.4.

Additionally, if the 3GPP PS data off status is "active", and the UE is not configured with indication that Bearer Independent Protocol is a 3GPP PS data off exempt service (see Annex S), then the ME shall send the TERMINAL RESPONSE (ME currently unable to process command) immediately. The operation is aborted.

If class "ai" is supported, the "Bearer description" provided in the command shall indicate Non-IP PDP Type in order to establish a Non-IP data link. The UICC shall provide the Network Access Name data object.

6.4.27.5 OPEN CHANNEL related to (I-)WLAN bearer

This clause applies if class "e" is supported.

Upon receiving this command, the ME shall decide if it is able to execute the command. The UICC shall indicate whether the ME should establish the link immediately, in background mode or upon receiving the first transmitted data (on demand).

The UICC provides to the ME a list of parameters necessary to activate a (I-)WLAN service.

The ME shall attempt at least one (I-)WLAN service activation.

Upon receiving this command, the ME shall decide if it is able to execute the command. Examples are given below, but the list is not exhaustive:

- if immediate or background (I-)WLAN service activation is requested and the ME is unable to set-up a channel using the exact parameters provided by the UICC, the ME sets up the channel according to TS 24.234 [42] for a I-WLAN service activation or according to TS 24.302 [63] for a WLAN service activation and informs the UICC of the I-WLAN identifier or the WLAN identifier respectively and the modified parameters using TERMINAL RESPONSE (Command performed with modification);
- if immediate (I-)WLAN service activation is requested and the ME is unable to activate the I-WLAN service with the network using the exact parameters provided by the UICC, the ME informs the UICC using TERMINAL RESPONSE (Network currently unable to process command). The operation is aborted;
- if background mode (I-)WLAN service activation is requested and the ME is unable to activate the I-WLAN service with the network using the exact parameters provided by the UICC, the ME informs the UICC using a channel status event (link not established - no further info). The operation is aborted;
- if the command is rejected because the ME has no channel left with the requested bearer capabilities, the ME informs the UICC using TERMINAL RESPONSE (Bearer independent protocol error). The operation is aborted;
- if the user does not accept the channel set-up, the ME informs the UICC using TERMINAL RESPONSE (User did not accept the proactive command). The operation is aborted;
- if the user has indicated the need to end the proactive UICC session, the ME informs the UICC using TERMINAL RESPONSE (Proactive UICC session terminated by the user). The operation is aborted;
- if background mode (I-)WLAN service activation is requested, the ME allocates buffers, starts activation of (I-)WLAN service, informs the UICC and reports the channel identifier immediately using TERMINAL RESPONSE (Command performed successfully). At the end of activation, the ME shall send a channel status event (link established or link not established - no further info).

The ME shall inform the UICC that the command has been successfully executed using TERMINAL RESPONSE:

- if immediate (I-)WLAN service activation is requested, the ME allocates buffers, activates the (I-)WLAN service and informs the UICC and reports the channel identifier using TERMINAL RESPONSE (Command performed successfully);
- if on demand (I-)WLAN service activation is requested, the ME allocates buffers, informs the UICC and reports the channel identifier using TERMINAL RESPONSE (Command performed successfully).

If the ME is able to set up the channel on the serving network, the ME shall then enter the confirmation phase described hereafter; optionally, the UICC may include in this command an alpha-identifier. The use of this alpha-identifier by the ME is described below:

- if the alpha identifier is provided by the UICC and is not a null data object, the ME shall use it during the user confirmation phase. This is also an indication that the ME should not give any other information to the user during the user confirmation phase. If an icon is provided by the UICC, the icon indicated in the command may

be used by the terminal to inform the user, in addition to, or instead of the alpha identifier, as indicated with the icon qualifier (see clause 6.5.4);

- if the alpha identifier is provided by the UICC and is a null data object (i.e. length = '00' and no value part), this is an indication that the ME should not give any information to the user or ask for user confirmation;
- if the alpha identifier is not provided by the UICC, the ME may give information to the user;

A terminal of type ND shall ignore any alpha identifier provided together with this command. The terminal shall respond with "command performed successfully" upon successful completion of the command. A terminal of type ND shall also ignore any icon provided together with this command. The terminal shall respond with "command performed successfully but requested icon could not be displayed" upon successful completion of the command.

- if the user doesn't reject the channel, the ME shall then set up a channel. A terminal of type NK or type ND may not alert the user and may open the channel without explicit confirmation by the user;
- if the user does not accept the channel or rejects the channel, then the ME informs the UICC using TERMINAL RESPONSE (user did not accept the proactive command). The operation is aborted;
- if the user has indicated the need to end the proactive UICC session, the ME shall send a TERMINAL RESPONSE with (Proactive UICC session terminated by the user) result value;
- optionally, during packet data service activation, the ME can give some audible or display indication concerning what is happening;
- if the user stops the (I-)WLAN service activation attempt before a result is received from the network, the ME informs the UICC using TERMINAL RESPONSE (user cleared down call before connection or network release).

6.4.27.6 OPEN CHANNEL related to Terminal Server Mode

See ETSI TS 102 223 [32] clause 6.4.27.6.

6.4.27.7 OPEN CHANNEL related to UICC Server Mode

See ETSI TS 102 223 [32] clause 6.4.27.5.

6.4.27.8 OPEN CHANNEL for IMS

The following applies if classes "e" and "t" are supported.

After a successful registration to IMS specified in TS 24.229 [52] and after the ME has informed the UICC of this successful registration, the UICC may attempt to open a channel to communicate with the IMS.

The UICC will include in the OPEN CHANNEL for IMS command the IARI representing an active application installed on the UICC. This IARI shall be known to the ME and populated in the EF_{UICCIARI} as specified in TS 31.102 [14].

The ME shall encapsulate all subsequent SIP communications intended for the IMS application running on the UICC. The ME shall decapsulate all subsequent messages received from the IMS application running on the UICC. Once the application is no longer available for SIP communications the UICC shall send the CLOSE CHANNEL command for the current channel ID.

If network conditions changed after a successful IMS registration, upon receiving this command, the ME shall decide if it is able to execute the command. If the ME is unable to process the command (the list is not exhaustive)

- if the command is unable to proceed due to the absence of an active IMS PDP/PDN context, the ME shall inform the UICC using the TERMINAL RESPONSE (network currently unable to process command) upon receipt of this failure cause, the UICC shall wait until the next IMS registration event before sending another OPEN CHANNEL for IMS command to the ME.

- if the command is unable to proceed due to the inability to contact IMS, the ME shall inform the UICC using the TERMINAL RESPONSE (network currently unable to process command) upon receipt of this failure cause, the UICC shall wait until the next IMS registration event before sending another OPEN CHANNEL for IMS command to the ME.
- If the command is unable to proceed because there is no channel available, the ME shall inform the UICC using the TERMINAL RESPONSE (Bearer Independent Protocol error - no channel available).

The ME shall inform the UICC that the command has been successfully executed using TERMINAL RESPONSE (Command performed successfully)

6.4.28 CLOSE CHANNEL

ETSI TS 102 223 [32] clause 6.4.28 applies, with the following addition.

In case of OPEN CHANNEL for IMS, the UICC shall send a CLOSE CHANNEL command to close the BIP channel at the end of the SIP dialog.

6.4.29 RECEIVE DATA

See ETSI TS 102 223 [32] clause 6.4.29.

6.4.30 SEND DATA

See ETSI TS 102 223 [32] clause 6.4.30.

6.4.31 GET CHANNEL STATUS

See ETSI TS 102 223 [32] clause 6.4.31.

6.4.32 SERVICE SEARCH

See ETSI TS 102 223 [32] clause 6.4.32.

6.4.33 GET SERVICE INFORMATION

See ETSI TS 102 223 [32] clause 6.4.33.

6.4.34 DECLARE SERVICE

See ETSI TS 102 223 [32] clause 6.4.34.

6.4.35 RETRIEVE MULTIMEDIA MESSAGE

See ETSI TS 102 223 [32] clause 6.4.37.

6.4.36 SUBMIT MULTIMEDIA MESSAGE

See ETSI TS 102 223 [32] clause 6.4.38.

6.4.37 DISPLAY MULTIMEDIA MESSAGE

See ETSI TS 102 223 [32] clause 6.4.39.

6.4.38 SET FRAMES

See ETSI TS 102 223 [32] clause 6.4.35.

6.4.39 GET FRAME STATUS

See ETSI TS 102 223 [32] clause 6.4.36.

6.4.40 Geographical Location Request

This clause applies if class "n" is supported.

This command requests an ME that is equipped with a positioning feature to report the location information of the ME within a specified quality of service.

As the determination of the geographical location information may take some time, the geographical location information report is sent by the ME to the UICC using the command ENVELOPE (Geographical Location Reporting). The ME reporting can be performed either in the format of GAD shapes defined in TS 23.032 [44] or in the format of NMEA sentences defined in IEC 61162-1 [45].

The horizontal coordinates represent the minimum set of information to be sent to the UICC (i.e. latitude and longitude). The UICC may request additional geographical location information (i.e. vertical coordinate and velocity). The UICC may request a preferred quality of service (e.g. preferred accuracy, preferred maximum response time). However if the ME does not support the requested preferred parameters, the ME selects the most appropriate quality of service parameters.

Upon receiving this command, the ME shall decide if it is able to execute the command. Examples are given below, but the list is not exhaustive:

- if the command is rejected because the ME is not equipped with a positioning feature, the ME informs the UICC using TERMINAL RESPONSE (Command beyond ME's capabilities);
- if the command is rejected because the ME is currently unable to get the location information (e.g. due to lack of GPS coverage or due to a deactivated GPS receiver), the ME shall inform the UICC using TERMINAL RESPONSE (ME currently unable to process command);

If the ME is able to attempt to retrieve the geographical location information, the ME shall:

- inform the UICC that the command has been successfully executed, using TERMINAL RESPONSE.
 - 1) - once the requested location information is available, the ME shall send this information to the UICC using the command ENVELOPE (Geographical Location Reporting).
- optionally, the UICC may include in this command an alpha-identifier. The use of this alpha-identifier by the ME is described below:
 - if the alpha identifier is provided by the UICC and is not a null data object, the ME shall use it to inform the user. This is also an indication that the ME should not give any other information to the user on the fact that the ME is processing the location information request for the UICC. If an icon is provided by the UICC, the icon indicated in the command may be used by the ME to inform the user, in addition to, or instead of the alpha identifier, as indicated with the icon qualifier (see clause 6.5.4);
 - if the alpha identifier is provided by the UICC and is a null data object (i.e. length = '00' and no value part), this is an indication that the ME should not give any information to the user on the fact that the ME is determining the location information for the UICC;
 - 1) A terminal of type ND shall ignore any alpha identifier provided together with this command. The terminal shall respond with "command performed successfully" upon successful completion of the command. A terminal of type ND shall also ignore any icon provided together with this command. The terminal shall respond with "command performed successfully but requested icon could not be displayed" upon successful completion of the command.
 - a) - if the alpha identifier is not provided by the UICC, the ME may give information to the user concerning what is happening.

If the ME receives a "Geographical Location Request" command during the processing of a previous "Geographical Location Request" command (i.e. after the reception of a location request and before sending the "Geographical Location Reporting" ENVELOPE command), the latest location request shall be ignored.

6.4.41 ACTIVATE

Not required by 3GPP.

6.4.42 CONTACTLESS STATE CHANGED

Not required by 3GPP.

6.4.43 COMMAND CONTAINER

Not required by 3GPP.

6.4.44 ENCAPSULATED SESSION CONTROL

Not required by 3GPP.

6.5 Common elements in proactive UICC commands

See ETSI TS 102 223 [32] clause 6.5.

6.5.1 Command number

See ETSI TS 102 223 [32] clause 6.5.1.

6.5.2 Device identities

See ETSI TS 102 223 [32] clause 6.5.2.

6.5.3 Alpha identifier

See ETSI TS 102 223 [32] clause 6.5.3.

6.5.4 Icon identifiers

The display of icons is optional for the terminal on a per command basis, see ETSI TS 102 223 [32] clause 6.5.4.

6.5.5 Text attribute

See ETSI TS 102 223 [32] clause 6.5.5.

6.5.6 Frame identifier

See ETSI TS 102 223 [32] clause 6.5.6.

6.6 Structure of proactive UICC commands

The general structure of proactive UICC commands using TLV objects is described in annex C.

6.6.1 DISPLAY TEXT

See ETSI TS 102 223 [32] clause 6.6.1.

6.6.2 GET INKEY

See ETSI TS 102 223 [32] clause 6.6.2.

6.6.3 GET INPUT

See ETSI TS 102 223 [32] clause 6.6.3.

6.6.4 MORE TIME

See ETSI TS 102 223 [32] clause 6.6.4.

6.6.5 PLAY TONE

See ETSI TS 102 223 [32] clause 6.6.5.

6.6.6 POLL INTERVAL

See ETSI TS 102 223 [32] clause 6.6.6.

6.6.7 SET-UP MENU

See ETSI TS 102 223 [32] clause 6.6.7.

6.6.8 SELECT ITEM

See ETSI TS 102 223 [32] clause 6.6.8.

6.6.9 SEND SHORT MESSAGE

Description	Clause	M/O/C	Min	Length
Proactive UICC command Tag	9.2	M	Y	1
Length (A+B+C+D+E+F+G+H)	-	M	Y	1 or 2
Command details	8.6	M	Y	A
Device identities	8.7	M	Y	B
Alpha identifier	8.2	O	N	C
Address data object 1	8.1 or 8.108	O	N	D
SMS TPDU (SMS-SUBMIT or SMS-COMMAND)	8.13	M	Y	E
Icon identifier	8.31	O	N	F
Text attribute	8.70	C	N	G
Frame Identifier	8.82	O	N	H
Address data object 2	8.108	C	N	I

The address data object holds the RP_Destination_Address of the Service Centre. If no RP_Destination_Address is transferred, then the ME shall insert the default Service Centre address.

The address data object 1 may optionally hold the Public Service Identity of the SM-SC in URI format that the ME shall use to submit the SMS over IP as defined in 3GPP TS 24.341 [65].

In case Address data object 1 holds a Public Service Identity, the address data object 2 shall be present and holds the URI of the receiver of the short message. If the address data object 2 is present, the ME shall use the address data object 2 to submit the SMS over IP as defined in 3GPP TS 24.341 [65] clause 5.3.1.4.2.

When Address data object 2 is present, the UICC shall set the TP_Destination_Address field in the SMS TPDU to the dummy MSISDN value as specified in 24.341 [65].

The Text attribute applies to the Alpha Identifier. It may be present only if the Alpha Identifier is present.

6.6.10 SEND SS

Description	Clause	M/O/C	Min	Length
Proactive UICC command Tag	9.2	M	Y	1
Length (A+B+C+D+E+F+G)	-	M	Y	1 or 2
Command details	8.6	M	Y	A
Device identities	8.7	M	Y	B
Alpha identifier	8.2	O	N	C
SS string	8.14	M	Y	D
Icon identifier	8.31	O	N	E
Text attribute	8.70	C	N	F
Frame Identifier	8.82	O	N	G

The Text attribute applies to the Alpha Identifier. It may be present only if the Alpha Identifier is present.

6.6.11 SEND USSD

Description	Clause	M/O/C	Min	Length
Proactive UICC command Tag	9.2	M	Y	1
Length (A+B+C+D+E+F+G)	-	M	Y	1 or 2
Command details	8.6	M	Y	A
Device identities	8.7	M	Y	B
Alpha identifier	8.2	O	N	C
USSD String	8.17	M	Y	D
Icon identifier	8.31	O	N	E
Text attribute	8.70	C	N	F
Frame Identifier	8.82	O	N	G

The Text attribute applies to the Alpha Identifier. It may be present only if the Alpha Identifier is present.

6.6.12 SET UP CALL

Description	Clause	M/O/C	Min	Length
Proactive UICC command Tag	9.2	M	Y	1
Length (A+B+C+D+E+F+G+H+I+J+K+L+M+N)	-	M	Y	1 or 2
Command details	8.6	M	Y	A
Device identities	8.7	M	Y	B
Alpha identifier (user confirmation phase)	8.2	O	N	C
Address or IMS URI	8.1 or 8.108	M	Y	D
Capability configuration parameters	8.4	O	N	E
Subaddress	8.3	O	N	F
Duration	8.8	O	N	G
Icon identifier (user confirmation phase)	8.31	O	N	H
Alpha identifier (call set up phase)	8.2	O	N	I
Icon identifier (call set up phase)	8.31	O	N	J
Text Attribute (user confirmation phase)	8.72	C	N	K
Text Attribute (call set up phase)	8.72	C	N	L
Frame Identifier	8.80	O	N	M
Media Type	8.132	O	N	N

If the capability configuration parameters are not present, the ME shall assume the call is a speech call.

If the subaddress is not present, the ME shall not provide a called party subaddress to the network.

If the duration is not present, the UICC imposes no restrictions on the ME of the maximum duration of redials.

The Text Attribute (user confirmation phase) applies to the Alpha Identifier (user confirmation phase). The Text Attribute (call set up phase) applies to the Alpha identifier (call set up call phase). One Text Attribute may be present only if at least one Alpha Identifier is present. Both Text Attributes may be present only if both Alpha Identifiers are present. If only one Text Attribute data object is present, it shall apply to the first or unique Alpha identifier present in the command.

The IMS URI data object holds the SIP URI or tel URI, as defined in TS 24.229 [52], of the called party (if class "ae" is supported).

When the Media Type data object is present, it indicates the type of media the ME shall use, if supported by the ME to set up the communication. If the ME is unable to set up the call as requested, it shall return an error code reflecting the cause of the error. For example, in case of failure due to network constraints, the error code "Access Technology unable to process command" shall be used.

6.6.13 REFRESH

For all REFRESH modes except "Steering of Roaming", see ETSI TS 102 223 [32] clause 6.6.13.

For "Steering of Roaming":

Description	Clause	M/O/C	Min	Length
Proactive UICC command Tag	9.2	M	Y	1
Length (A+B+C+D+E+F+G+H)	-	M	Y	1 or 2
Command details	8.6	M	Y	A
Device identities	8.7	M	Y	B
Alpha identifier	8.2	O	N	C
Icon identifier	8.31	O	N	D
Text Attribute	8.70	C	N	E
Frame Identifier	8.82	O	N	F
PLMNwAct List	8.90	C (see Note 1)	N	G
PLMN List	8.97	C (see Note 2)	N	H
Note 1: This parameter is required in case of steering of roaming (according to TS 23.122 [7]).				
Note 2: This parameter is required in case of steering of roaming for I-WLAN (according to TS 24.234 [42]).				

The Text attribute applies to the Alpha Identifier. It may be present only if the Alpha Identifier is present.

6.6.14 POLLING OFF

See ETSI TS 102 223 [32] clause 6.6.14.

6.6.15 PROVIDE LOCAL INFORMATION

Description	Clause	M/O/C	Min	Length
Proactive UICC command Tag	9.2	M	Y	1
Length (A+B+C)	-	M	Y	1 or 2
Command details	8.6	M	Y	A
Device Identities	8.7	M	Y	B
UTRAN/E-UTRAN/NG-RAN Measurement Qualifier	8.73	C	N	C

UTRAN/E-UTRAN/NG-RAN Measurement Qualifier: This data object applies when the Command Qualifier in Command details is set to indicate "Network Measurement results". It shall be included to indicate to the ME that "Network Measurement Results for a UTRAN" or "Network Measurement Results for a E-UTRAN" or "Network Measurement Results for a NG-RAN" is required. It shall be excluded to indicate to the ME that "Network Measurement Results for a GERAN" is required. It shall only be included/excluded if the ME has indicated that it supports the implied access technology via the respective Terminal Profile setting.

6.6.16 SET UP EVENT LIST

See ETSI TS 102 223 [32] clause 6.6.16.

6.6.17 PERFORM CARD APDU

See ETSI TS 102 223 [32] clause 6.6.17.

6.6.18 POWER OFF CARD

See ETSI TS 102 223 [32] clause 6.6.18.

6.6.19 POWER ON CARD

See ETSI TS 102 223 [32] clause 6.6.19.

6.6.20 GET READER STATUS

See ETSI TS 102 223 [32] clause 6.6.20.

6.6.21 TIMER MANAGEMENT

See ETSI TS 102 223 [32] clause 6.6.21.

6.6.22 SET UP IDLE MODE TEXT

See ETSI TS 102 223 [32] clause 6.6.22.

6.6.23 RUN AT COMMAND

See ETSI TS 102 223 [32] clause 6.6.23.

6.6.24 SEND DTMF COMMAND

See ETSI TS 102 223 [32] clause 6.6.24.

6.6.25 LANGUAGE NOTIFICATION

See ETSI TS 102 223 [32] clause 6.6.25.

6.6.26 LAUNCH BROWSER

See ETSI TS 102 223 [32] clause 6.6.26.

6.6.27 OPEN CHANNEL

The structure of the OPEN CHANNEL command is defined in ETSI TS 102 223 [32] clause 6.6.27. , with the addition of the following:

6.6.27.1 OPEN CHANNEL related to (I-)WLAN Bearer

Description	Clause	M/O/C	Min	Length
Proactive UICC command Tag	9.2	M	Y	1
Length (A+B+C+D+E+F+G+H+I+J+K+L)	-	M	Y	1 or 2
Command details	8.6	M	Y	A
Device identities	8.7	M	Y	B
Alpha identifier	8.2	O	N	C
Icon identifier	8.31	O	N	D
Bearer description	8.52	M	Y	E
Buffer size	8.55	M	Y	F
I-WLAN Identifier	8.83	O	N	G
Other address (local address)	8.58	O	N	H
UICC/terminal interface transport level	8.59	O	N	I
Data destination address	8.58	C	Y	J
Text Attribute	8.72	C	N	K
Frame Identifier	8.82	O	N	L

When OPEN CHANNEL is related to I-WLAN bearer:

- The I-WLAN Identifier may be requested.
- If the parameter is not present, the ME shall select the I-WLAN according to TS 24.234 [42] using the Automatic PLMN Selection Mode Procedure.

When OPEN CHANNEL is related to WLAN bearer, the ME shall select the WLAN according to TS 24.302 [63] using the automatic mode WLAN selection procedure and ignore the I-WLAN Identifier, if provided.

The local address parameter provides information to the ME necessary to identify the local device. If the parameter is present and length is not null, it provides an IP address that identifies the USAT application in the address area applicable to the PDN. If local address length is null, dynamic local address allocation is required for the USAT application. If parameter is not present, the ME may use the ME default local address configuration.

If the UICC/ME interface transport level is present in the command, then the ME shall provide the requested transport layer protocols under the channel and shall use this object containing a set of parameters required to make the transport connection. The data that is exchanged at the UICC/ME interface in the RECEIVE DATA/SEND DATA commands are SDUs. When the USAT application sends an SDU, the transport layer within the ME is in charge to add the transport header to the SDU in order to build the Transport-PDU. When the USAT application requests to receive an SDU, the transport layer within the ME is in charge to remove the transport header of the Transport-PDU, and to forward the SDU to the USAT. If the parameter is not present, the UICC/ME interface is the bearer level (serial link or packet link), and the USAT application is in charge of the network and transport layer.

The Data destination address is the end point destination address of sent data. This data destination address is requested when a UICC/ME interface transport is present, otherwise it is ignored. The data destination address is a data network address (e.g. IP address).

Text Attribute applies to the Alpha Identifier. It may be present only if the Alpha Identifier is present.

6.6.27.2 OPEN CHANNEL for IMS

Description	Clause	M/O/C	Min	Length
Proactive UICC command Tag	9.2	M	Y	1
Length (A+B+C+D)	-	M	Y	1 or 2
Command details	8.6	M	Y	A
Device identities	8.7	M	Y	B
Buffer size	8.55	M	Y	C
IARI	8.110	M	Y	D

6.6.28 CLOSE CHANNEL

See ETSI TS 102 223 [32] clause 6.6.28.

6.6.29 RECEIVE DATA

See ETSI TS 102 223 [32] clause 6.6.29.

6.6.30 SEND DATA

See ETSI TS 102 223 [32] clause 6.6.30.

6.6.31 GET CHANNEL STATUS

See ETSI TS 102 223 [32] clause 6.6.31.

6.6.32 SERVICE SEARCH

See ETSI TS 102 223 [32] clause 6.6.32.

6.6.33 GET SERVICE INFORMATION

See ETSI TS 102 223 [32] clause 6.6.33.

6.6.34 DECLARE SERVICE

See ETSI TS 102 223 [32] clause 6.6.34.

6.6.35 RETRIEVE MULTIMEDIA MESSAGE

See ETSI TS 102 223 [32] clause 6.6.37.

6.6.36 SUBMIT MULTIMEDIA MESSAGE

See ETSI TS 102 223 [32] clause 6.6.38.

6.6.37 DISPLAY MULTIMEDIA MESSAGE

See ETSI TS 102 223 [32] clause 6.6.39.

6.6.38 SET FRAMES

See ETSI TS 102 223 [32] clause 6.6.35.

6.6.39 GET FRAMES STATUS

See ETSI TS 102 223 [32] clause 6.6.36.

6.6.40 Geographical Location Request

Description	Clause	M/O/C	Min	Length
Proactive UICC command Tag	9.2	M	Y	1
Length (A+B+C+D+E)	-	M	Y	1 or 2
Command details	8.6	M	Y	A
Device Identities	8.7	M	Y	B
Alpha identifier	8.2	O	N	C
Icon identifier	8.31	O	N	D
Geographical Location Parameters	8.94	M	N	E

6.6.41 ACTIVATE

Not required by 3GPP.

6.6.42 CONTACTLESS STATE CHANGED

Not required by 3GPP.

6.6.43 COMMAND CONTAINER

Not required by 3GPP.

6.6.44 ENCAPSULATED SESSION CONTROL

Not required by 3GPP.

6.7 Command results

Once the ME has made its attempt to execute a proactive command from the UICC, the ME shall inform the UICC of the success or otherwise of that command, by using TERMINAL RESPONSE.

This procedure is defined in ETSI TS 102 223 [32] clause 6.7, and applies here except for the following statements.

Temporary problems are defined as:

- ME is currently unable to process the command. Specific causes for this are listed in ETSI TS 102 223 [32] clause 6.7; in addition to these, the following causes may be returned within the USAT context:
 - ME currently busy on SS transaction;
 - ME currently busy on USSD operation;
 - access control class barred on serving network;
- if none of these can be made to apply, a "no cause can be given" value can be used;
- network is currently unable to process the command. Within the USAT context, specific cause values are the cause values given by the network, as defined in TS 24.008 [9];
- in some proactive commands, the ME is required to solicit and receive approval of the user before executing the proactive command. In the case that the user does not give approval for the execution of the proactive command, it shall not be executed by the ME and the terminal response "user did not accept the proactive command" shall be returned by the ME to the UICC;
- the user cleared down the call, before the call connected (CONNECT received from network, as defined in TS 24.008 [9]) or before the network released the call;

- action in contradiction with the current timer state. This is where the UICC requests an action for a timer to be taken by the ME and the state of the timer does not allow that action;
- interaction with call control by USIM, temporary problem. This is sent by the ME to indicate that call control modified the type of request indicated in the proactive command, and that the action requested by call control encounters a temporary problem.

Permanent problems are defined as in ETSI TS 102 223 [32] clause 6.7, with the addition of:

- SS Return Error. This is given to the UICC when the network returns a SS error in response to a previous SS command. Specific cause values are the same as given by the network in the Return Error message;
- USSD Return Error. This is given to the UICC when the network returns a USSD error in response to a previous USSD command. Specific cause values are the same as given by the network in a Return Error message;
- SMS RP-ERROR. This is given to the UICC when the network returns an error in response to the ME trying to send a short message. Specific cause values are the same as the cause value of RP-Cause in an RP-ERROR message;
- interaction with MO short message control by USIM, permanent problem. This is sent by the ME to indicate that:

MO short message control by USIM does not allow the action corresponding to the proactive command; or

MO short message control by USIM has modified the type of request indicated in the proactive command and that the action requested by call control encounters a permanent problem.

6.8 Structure of TERMINAL RESPONSE

6.8.0 Overall structure of TERMINAL RESPONSE

Direction: ME to UICC.

The command header is specified in TS 31.101 [13]. Length (A+B+ ... +AE) is indicated by P3 of the header.

Command parameters/data.

Description	Clause	M/O/C	Min	Length
Command details	8.6	M	Y	A
Device identities	8.7	M	N	B
Result	8.12	M	Y	C
Duration (only required in response to a POLL INTERVAL proactive command)	8.8	C	N	D
Text string (only required in response to a GET INKEY or GET INPUT or SEND USSD proactive command)	8.15	C	N	E
Item identifier (only required in response to SELECT ITEM proactive command)	8.10	C	N	F
Local information (only required in response to PROVIDE LOCAL INFORMATION proactive command)	8.19, 8.20, 8.29, 8.39, 8.45, 8.46, 8.62, 8.83, 8.85, 8.86, 8.87, 8.100, 8.129, 8.130, 8.131, 8.134, 8.140, 8.141, 8.144	C	N	G
Local information (only required in response to PROVIDE LOCAL INFORMATION (Network Measurement Results) proactive command)	8.22, 8.119	C	N	AB or AB ₀ + ... + AB _n
Local information (only required in response to PROVIDE LOCAL INFORMATION	8.58	C	N	AC or AC ₀ + ... + AC _n

Description	Clause	M/O/C	Min	Length
(H(e)NB IP address request) proactive command)				
Local information (only required in response to PROVIDE LOCAL INFORMATION (list of surrounding macrocells) proactive command)	8.19, 8.62	C	N	AD or AD ₀ + ... + AD _n
Call control requested action (only required if call control by USIM has modified a proactive command SET UP CALL, SEND SS or SEND USSD in another type of request).	8.30	C	N	H
Result data object 2 (only required if call control by USIM has modified a proactive command SET UP CALL, SEND SS or SEND USSD in another type of request).	8.12	C	N	I
Card reader status (only required in response to GET READER STATUS command). According to the requested information, one Card reader status object for each card interface reported, or one Card reader identifier object is required..	8.33, 8.57	C	N	J ₀ + ... + J _n or J
Card ATR (only required in response to POWER ON CARD).	8.34	C	N	K
R-APDU (only required in response to PERFORM CARD APDU).	8.36	C	N	L
Timer identifier (only required in response to a TIMER MANAGEMENT proactive command)	8.37	C	N	M
Timer value (only required in response to a TIMER MANAGEMENT proactive command)	8.38	C	N	N
AT Response (only required in response to RUN AT COMMAND proactive command)	8.41	C	N	P
Text string2 (only required if call control by USIM has modified the proactive command SET UP CALL or SEND SS into a USSD request)	8.15	C	N	Q
Channel data (only required in response to RECEIVE DATA)	8.53	C	N	R
Channel status (only required in response to GET CHANNEL STATUS or OPEN CHANNEL proactive command)	8.56	C	N	S ₀ + ... + S _n
Channel data length (only required in response to RECEIVE DATA or SEND DATA proactive command)	8.54	C	N	T
Bearer description (only required in response to OPEN CHANNEL proactive command)	8.52	C	N	U
Buffer size (only required in response to OPEN CHANNEL proactive command)	8.55	C	N	V
Total display duration (only required in response to a GET INKEY proactive command)	8.8	C	N	W
Service availability (only required in response to SERVICE SEARCH proactive command)	8.68	C	N	X
Service record (only required in response to GET SERVICE INFORMATION proactive command)	8.64	C	N	Y
Other address (local address) (only required in response to OPEN CHANNEL proactive command with dynamic local address request)	8.58	C	N	Z
Frames Information (only required in response to SET FRAMES or GET FRAMES STATUS proactive commands)	8.81	C	N	AA
Slices Information (only required in response to PROVIDE LOCAL INFORMATION (list of slice(s) information) proactive command)	8.145	C	N	AE or AE ₀ + ... + AE _n

Specific rules apply for the coding of the TERMINAL RESPONSE, see ETSI TS 102 223 [32] clause 6.8.

Response parameters/data: None.

6.8.1 Command details

See ETSI TS 102 223 [32] clause 6.8.1.

6.8.2 Device identities

See ETSI TS 102 223 [32] clause 6.8.2.

6.8.3 Result

See ETSI TS 102 223 [32] clause 6.8.3.

6.8.4 Duration

See ETSI TS 102 223 [32] clause 6.8.4.

6.8.5 Text string

ETSI TS 102 223 [32] clause 6.8.5 applies, with the addition of the following procedure.

When the ME issues a successful TERMINAL RESPONSE for a SEND USSD command, it shall supply the text returned within the Return Result message from the network, no matter what type of string was returned.

6.8.6 Item identifier

See ETSI TS 102 223 [32] clause 6.8.6.

6.8.7 Local information

For Local Information values defined in clause 8.6 then ETSI TS 102 223 [32] clause 6.8.7 applies, with the addition of the following procedures:

- Where the UICC has requested the Network Measurement Results, the TERMINAL RESPONSE shall contain
 - for GERAN: The NMR data object and the BCCH channel list data object
 - for UTRAN: The Network Measurement Results are coded as the MEASUREMENT REPORT message as defined in TS 25.331 [38].
 - for E-UTRAN: The Network Measurement Results are coded as the *MeasurementReport* message defined in TS 36.331 [49]
 - for NG-RAN: The Network Measurement Results are coded as the *MeasurementReport* message defined in TS 38.331 [71]
- Where the UICC has requested the Network Measurement Results for multiple access technologies, TERMINAL RESPONSE shall contain the Access Technology data object listing all current access technologies, followed by one NMR data object and one BCCH channel list data object for each current access technology in the same sequence. The BCCH channel list data object shall immediately follow the NMR data object, even if not supported by a network access technology. If no NMR data or no BCCH channel list is available for an access technology, the respective data object shall have length zero.
- Where the UICC has requested the Timing Advance, the TERMINAL RESPONSE shall contain the Timing Advance data object if supported by the network access technology.

- Where the UICC has requested the WLAN Specific Identifier, the TERMINAL RESPONSE shall contain the WSID of the current I-WLAN connection.
- Where the UICC has requested the WLAN Identifier, the TERMINAL RESPONSE shall contain the SSID, the BSSID when available, and the HESSID when available, of the current WLAN connection.
- Where the UICC has requested the CSG ID list Identifier, the TERMINAL RESPONSE shall contain the CSG ID list and the corresponding HNB name (if available in the broadcasted information to the ME) of the detected CSG or Hybrid cells in the Allowed CSG list or the Operator CSG list. (if class "q" is supported)
- Where the UICC has requested the H(e)NB IP address, the TERMINAL RESPONSE shall contain the list of all IP addresses available on the H(e)NB-network interface, as a sequence of "Other Address" Data Objects in the TERMINAL RESPONSE. (if class "v" is supported)
- Where the UICC has requested the list of surrounding macrocells, the TERMINAL RESPONSE shall contain, for all supported access technologies, the Access Technology data object listing all current access technologies, followed by one location information data object for each current access technology in the same sequence, up to the limit of the TERMINAL RESPONSE APDU command size. If no location information is available for an access technology, the respective data object shall have length zero. (if class "w" is supported).
- Where the UICC has requested the list of slice(s) information, the TERMINAL RESPONSE shall contain the slices information data object listing all slice(s) information, up to the limit of the TERMINAL RESPONSE APDU command size. If no slice information is available, the respective data object shall have length zero.

6.8.8 Call control requested action

When the ME issues a TERMINAL RESPONSE for a proactive command SET UP CALL, SEND SS or SEND USSD which has been modified by call control by USIM in another type of request, it shall supply the response data given in response to the ENVELOPE (CALL CONTROL).

6.8.9 Result data object 2

When the ME issues a TERMINAL RESPONSE for a proactive command SET UP CALL, SEND SS or SEND USSD which has been modified by call control by USIM in another type of request, it shall supply the Result data object it would have supplied for the proactive command equivalent to the action requested by call control, and given in the Call control request data element.

6.8.10 Card reader status

See ETSI TS 102 223 [32] clause 6.8.10.

6.8.11 Card ATR

See ETSI TS 102 223 [32] clause 6.8.11.

6.8.12 R-APDU

See ETSI TS 102 223 [32] clause 6.8.12.

6.8.13 Timer identifier

See ETSI TS 102 223 [32] clause 6.8.13.

6.8.14 Timer value

See ETSI TS 102 223 [32] clause 6.8.14.

6.8.15 AT Response

See ETSI TS 102 223 [32] clause 6.8.15.

6.8.16 Text string 2

When the ME issues a successful TERMINAL RESPONSE for a proactive command SET UP CALL or SEND SS which has been modified by "call control" by USIM into a USSD request ('05' result value), it shall supply the Text string 2. The Text string 2 shall contain the text returned within the Return Result message from the network for the USSD response. Text string 2 is equivalent to the Text string in the Terminal Response to a SEND USSD command.

6.8.17 Channel data

See ETSI TS 102 223 [32] clause 6.8.17.

6.8.18 Channel status

See ETSI TS 102 223 [32] clause 6.8.18.

6.8.19 Channel data length

See ETSI TS 102 223 [32] clause 6.8.19.

6.8.20 Bearer description

See ETSI TS 102 223 [32] clause 6.8.20.

6.8.21 Buffer size

See ETSI TS 102 223 [32] clause 6.8.21.

6.8.22 Total Display Duration

See ETSI TS 102 223 [32] clause 6.8.22.

6.8.23 Service Availability

See ETSI TS 102 223 [32] clause 6.8.23.

6.8.24 Service Record

See ETSI TS 102 223 [32] clause 6.8.24.

6.8.25 Other address (local address)

See ETSI TS 102 223 [32] clause 6.8.25.

6.8.26 Frames Information

See ETSI TS 102 223 [32] clause 6.8.26.

6.9 Proactive UICC session and ME display interaction

See ETSI TS 102 223 [32] clause 6.9.

6.10 Handling of unknown, unforeseen and erroneous messages

See ETSI TS 102 223 [32] clause 6.10.

6.11 Proactive commands versus possible Terminal response

Table 6.1 shows for each proactive command the possible terminal response returned (marked by a "•" character), in addition to those defined in ETSI TS 102 223 [32] clause 6.11.

The commands "COMMAND CONTAINER" and "ENCAPSULATED SESSION CONTROL" listed in ETSI TS 102 223 [32] are not required by 3GPP.

Table 6.1: Proactive commands versus possible terminal response

TERMINAL RESPONSE		PROACTIVE COMMAND							
		SET UP CALL	SEND SS	SEND USSD	SEND SMS	Geographical Location Request			
		'10'	'11'	'12'	'13'	'16'			
00	Command performed successfully	•	•	•	•	•			
01	Command performed with partial comprehension	•	•	•	•	•			
02	Command performed, with missing information	•	•	•	•	•			
03	REFRESH performed with additional Efs read								
04	Command performed successfully, but requested icon could not be displayed	•	•	•	•	•			
05	Command performed, but modified by call control by USIM	•		•					
06	Command performed successfully, limited service								
07	Command performed with modification								
08	REFRESH performed but indicated USIM was not active								
09	Command performed successfully, tone not played								
10	Proactive UICC session terminated by the user	•							
11	Backward move in the proactive UICC session requested by the user								
12	No response from user					•			
13	Help information required by the user								
14	USSD or SS Transaction terminated by user	•	•	•					
15	Reserved for 3GPP (for future usage)								
16	Reserved for 3GPP (for future usage)								
20	ME currently unable to process command	•	•	•	•	•			
21	Network currently unable to process command	•	•	•	•	•			
22	User did not accept the proactive command	•				•			
23	User cleared down call before connection or network release	•							
24	Action in contradiction with the current timer state								
25	Interaction with call control by USIM, temporary problem	•	•	•					
26	Launch browser generic error								
27	MMS Temporary Problem								
28	Reserved for 3GPP (for future usage)								
29	Reserved for 3GPP (for future usage)								
30	Command beyond Mes capabilities	•	•	•	•	•			
31	Command type not understood by ME	•	•	•	•	•			
32	Command data not understood by ME	•	•	•	•	•			
33	Command number not known by ME	•	•	•	•	•			
34	SS Return Error	•	•						
35	SMS RPERROR				•				
36	Error, required values are missing	•	•	•	•	•			
37	USSD return error			•					
38	Multiple Card command error								
39	Interaction with call/SM control by USIM, permanent problem	•	•	•	•				
3A	Bearer Independent Protocol error								

		PROACTIVE COMMAND								
		SET UP CALL	SEND SS	SEND USSD	SEND SMS	Geographical Location Request				
TERMINAL RESPONSE		'10'	'11'	'12'	'13'	'16'				
3B	Access Technology unable to process command									
3C	Frames error	•	•	•	•					
3D	MMS Error									
3E	Reserved for 3GPP (for future usage)									
3F	Reserved for 3GPP (for future usage)									

7 ENVELOPE Commands

7.1 Data download to UICC

7.1.1 SMS-PP data download

7.1.1.1 Procedure

If the service "data download via SMS Point-to-point" is allocated and activated in the USIM Service Table (see TS 31.102 [14]), then the ME shall follow the procedure below:

- when the ME receives a Short Message with:
 - protocol identifier = SIM data download; and
 - data coding scheme = class 2 message; or
- when the ME receives a Short Message with:
 - protocol identifier=ANSI-136 R-DATA (see TS 23.040 [5]); and
 - data coding scheme = class 2 message, and the ME chooses not to handle the message (e.g. Mes not supporting EGPRS over TIA/EIA-136 do not need to handle the message).
- then the ME shall pass the message transparently to the UICC using the ENVELOPE (SMS-PP DOWNLOAD) command as defined below;
- the ME shall not display the message, or alert the user of a short message waiting;
- the ME shall wait for an acknowledgement from the UICC;
- When receiving a secured Command Packet (as specified in TS 31.115 [41]) requesting a Proof of Receipt (PoR), the UICC shall verify the authenticity of the sender. If the authentication of the sender fails, no further processing related to the Proof of Receipt shall take place.
- if the UICC responds with '90 00' or '6F XX' or '62 XX' or '63 XX', the ME shall acknowledge the receipt of the short message to the network using an RP-ACK message. The response data from the UICC will be supplied by the ME in the TP-User-Data element of the RP-ACK message it will send back to the network (see TS 23.040 [5] and TS 24.011 [10]). The values of protocol identifier and data coding scheme in RP-ACK shall be as in the original message;
- if the UICC responds with '93 00', the ME shall either retry the command or send back an RP-ERROR message to the network with the TP-FCS value indicating 'SIM Application Toolkit Busy' (see TS 23.040 [5]).

If the service "data download via SMS-PP" is not available in the USIM Service Table, and the ME receives a Short Message with the protocol identifier = SIM data download and data coding scheme = class 2 message, then the ME shall store the message in EF_{SMS} in accordance with TS 31.102 [14].

7.1.1.1a Procedure for SMS-PP data download via REGISTRATION ACCEPT or DL NAS TRANSPORT messages

If the service "data download via SMS Point-to-point" is allocated and activated in the USIM Service Table (see 3GPP TS 31.102 [14]), then the ME shall follow the procedure below:

- when the ME receives a:
 - REGISTRATION ACCEPT message or a DL NAS TRANSPORT message that includes an SOR transparent container information element with list type with value "0"= secure packet; or
 - DL NAS TRANSPORT message that includes a UE parameters update transparent container containing a UE parameters update data set with UE parameters update data set type with value "1"=Routing Indicator update data
- containing a secured packet constructed as a single SMS-Deliver TPDU or concatenation of several SMS-Deliver TDUs (as specified in 3GPP TS 23.040 [5]) with:
 - protocol identifier = SIM data download; and
 - data coding scheme = class 2 message
- and the integrity check of the message was successful
- then the ME shall pass the message(s) transparently to the UICC using the ENVELOPE (SMS-PP DOWNLOAD) command as defined in clause 7.1.1.2;
- the ME shall not display or alert the user
- the secure packet is coded as a Command Packet formatted as Short Message Point to Point (as specified in 3GPP TS 31.115 [41])

NOTE: The command packet should not request a Proof of Receipt (PoR)

7.1.1.2 Structure of ENVELOPE (SMS-PP DOWNLOAD)

Direction: ME to UICC.

The command header is specified in TS 31.101 [13].

Command parameters/data.

Description	Clause	M/O/C	Min	Length
SMS-PP download tag	9.1	M	Y	1
Length (A+B+C+D+E)	-	M	Y	1 or 2
Device identities	8.7	M	Y	A
Address	8.1 or 8.108	C(see note2)	N(see note1)	B
URI truncated	8.135	C	N	C
SMS TPDU (SMS-DELIVER)	8.13	M	Y	D
Originating Address	8.108	C	N (see note1)	E
NOTE1: The UICC shall be able to manage the situation when the address field is not present, in order to ensure backwards compatibility with previous releases of this specification.				
NOTE2: The address data object shall not be present when SMS-PP data download is transporting SOR transparent container information element received from REGISTRATION ACCEPT or DL NAS TRANSPORT message as such message does not contain the address of a service center.				

- Device identities: the ME shall set the device identities to:
 - source: Network;
 - destination: UICC.
- Address: The address data object holds the RP_Originating_Address of the Service Centre (TS-Service-Centre-Address), as defined in 3GPP TS 24.011 [10]. If the USIM or the ISIM Service Table indicates URI support for SMS-PP DOWNLOAD, then this address data object may contain the Public Service Identity of the Service Center. If the URI is longer than the maximum length that can be transmitted to the UICC, then the URI shall be truncated to the maximum length that can be transmitted to the UICC and the request shall contain a URI truncated tag.
- Originating Address: If the USIM or the ISIM Service Table indicates URI support for SMS-PP DOWNLOAD, then the Originating Address data object may be present and contain the Public Identity (IMPU) of the sender of the short message. If the URI is longer than the maximum length that can be transmitted to the UICC, then the Originating Address data object shall not be sent.

Response parameters/data.

It is permissible for the UICC not to provide response data. If the UICC provides response data, the following data is returned.

Byte(s)	Description	Length
1-X (X≤128)	UICC Acknowledgement	X

7.1.2 Cell Broadcast data download

7.1.2.1 Procedure

If the service "data download via SMS-CB" is available in the USIM Service Table (see TS 31.102 [14]), then the ME shall follow the procedure below:

- when the ME receives a new Cell Broadcast message, the ME shall compare the message identifier of the Cell Broadcast message with the message identifiers contained in EF_{CBMID};
- In the case of a GSM Cell Broadcast message, if the message identifier is found in EF_{CBMID}, the cell broadcast page is passed to the UICC using the ENVELOPE (CELL BROADCAST DOWNLOAD) command, defined below. The ME shall not display the message;
- In the case of a UMTS Cell Broadcast message, if the message identifier is found in EF_{CBMID}, the ME shall deconstruct the UMTS Cell Broadcast message Parameter into its Cell Broadcast pages, and reconstruct each page in the format of the GSM Cell Broadcast Message Parameter, as described below, and according to the definition of the Cell Broadcast message structure in TS 23.041[6]:
 - 1) From the Number-of-Pages byte of the UMTS message, the ME shall obtain the number of Cell Broadcast pages to be constructed.
 - 2) For each page the ME shall reconstruct GSM Cell Broadcast Page header as follows:
 - The 2-byte Serial Number of the UMTS message shall be mapped to the reconstructed GSM message Serial Number.
 - The 2-byte Message ID of the UMTS message shall be mapped to the reconstructed GSM message Message ID.
 - The 1-byte Data Coding Scheme of the UMTS message shall be mapped to the reconstructed GSM message Data Coding Scheme.
 - The 1-byte Number-Of-Pages of the UMTS message in combination with the current page's sequence number (based on the order of the pages in the UMTS message) shall be formatted into the reconstructed GSM message Page Parameter byte, as described in TS 23.041[6].

- The respective 82 byte CBS-Message-Information-Page shall be mapped to the reconstructed GSM message content.

Table: Cell Broadcast Message Parameter Element mapping

Network – ME (UMTS Cell Broadcast Message)	ME-USAT interface (GSM Cell Broadcast Message Format)
Message ID	Message ID
Serial Number	Serial Number
Data Coding Scheme	Data Coding Scheme
Number-Of –Pages	Page Parameter (Note)
CBS-Message-Information-Page	Content of Message

NOTE: The Page Parameter byte is constructed from the total number of pages as indicated in the UMTS CB message, in combination with the current page's sequence number (based on the order of the pages in the UMTS message).

- Each of the resulting pages shall then be passed to the UICC using the ENVELOPE (CELL BROADCAST DOWNLOAD) command, defined below. The ME shall not display the message;
- if the message identifier of the incoming cell broadcast message is not found in EFCBMID, then the ME shall determine if the message should be displayed, by following the procedures in TS 23.041 [6] and TS 31.102 [14].
- if the UICC responds with '93 00', the ME shall consider that the Cell Broadcast page has not been delivered successfully. The ME may retry to deliver the same Cell Broadcast page.

The ME shall identify new cell broadcast pages by their message identifier, serial number and page values.

7.1.2.2 Structure of ENVELOPE (CELL BROADCAST DOWNLOAD)

Direction: ME to UICC.

The command header is specified in TS 31.101 [13].

Command parameters/data.

Description	Clause	M/O/C	Min	Length
Cell Broadcast Download tag	9.1	M	Y	1
Length (A+B)	-	M	Y	1 or 2
Device identities	8.7	M	Y	A
Cell Broadcast page	8.5	M	Y	B

- Device identities: the ME shall set the device identities to:
 - source: Network;
 - destination: UICC.

Response parameters/data: None for this type of ENVELOPE command.

7.2 Menu Selection

See ETSI TS 102 223 [32] clause 7.2.

If the UICC responds with '93 00', the ME shall not re-issue this particular envelope.

7.3 Call Control and MO SMS control by USIM

7.3.1 Call Control by USIM

7.3.1.1 Procedure for mobile originated calls

If the service "call control" is available in the USIM Service Table (see TS 31.102 [14]), then the ME shall follow the procedure described in ETSI TS 102 223 [32] clause 7.3.1.1 with the additional rules listed here:

- when the user is dialling "112" or an emergency call code stored in EF_{ECC} , the ME shall set up an emergency call instead of passing the call set-up details to the UICC;
- if the UICC provides response data, then in addition to the response data listed by ETSI TS 102 223 [32] clause 7.3.1.6, the response data from the UICC may indicate to the ME to send instead a supplementary service or USSD operation using the data supplied by the UICC. It is then mandatory for the ME to perform the supplementary service or USSD operation in accordance with the data from the UICC, if it is within the ME's capabilities to do so. If the UICC requires a supplementary service or USSD operation that is beyond the ME's capabilities, then the ME shall not perform the supplementary service or USSD operation at all.
- If, as a result of the procedure, the UICC supplies a number stored in EF_{ECC} , this shall not result in an emergency call.

This procedure is applicable also in the case where the call is originated over IMS and the service "communication control for IMS by USIM" is not available in the USIM Service Table (see TS 31.102 [14]). If the call is originated over IMS and the service "communication control for IMS by USIM" is available in the USIM Service Table, only the procedure for IMS communications establishment (clause 7.3.1.9) shall be used.

In the case where the initial call set-up request results from a proactive command SET UP CALL:

- if the call control result is "not allowed", the ME shall inform the UICC using TERMINAL RESPONSE "interaction with call control by USIM or MO short message control by USIM, permanent problem; action not allowed";
- if the call set-up request is changed by call control in a supplementary service or USSD operation, and if the supplementary service or USSD operation is within the ME's capabilities, then the ME shall send this request to the network. The ME shall then send back a TERMINAL RESPONSE to the SET UP CALL command at the same time it would have done for the proactive command equivalent to the action requested by call control (i.e. SEND SS or SEND USSD). However, in that case, the TERMINAL RESPONSE shall contain the response data given in the response to ENVELOPE (CALL CONTROL) and a second Result TLV identical to the one given in response to the proactive command equivalent to the action requested by call control (i.e. SEND SS or SEND USSD). The mapping between the general result in the first Result TLV and the general result in the second Result TLV is given below:

the general result "command performed, but modified by call control by USIM" shall be given in the first Result TLV if the general result of the second Result TLV is '0X' or '1X';

the general result "interaction with call control by USIM, temporary problem" shall be given in the first Result TLV if the general result of the second Result TLV is '2X';

the general result "interaction with call control by USIM or MO short message control by USIM, permanent problem" shall be given in the first Result TLV if the general result of the second Result TLV is '3X';

- if the call set-up request is changed by call control into a supplementary service or USSD operation, and if the supplementary service or USSD operation is beyond the ME's capabilities, then the ME shall send back a TERMINAL RESPONSE to the SET UP CALL command, without performing the supplementary service or USSD operation at all. In that case, the TERMINAL RESPONSE shall contain the response data given in the response to ENVELOPE (CALL CONTROL) and a second Result TLV identical to the one given in response to the proactive command equivalent to the action requested by call control (i.e. SEND SS or SEND USSD). The mapping between the general result in the first Result TLV and the general result in the second Result TLV is given below:

the general result "interaction with call control by USIM or MO short message control by USIM, permanent problem" shall be given in the first Result TLV, and the general result "command beyond ME's capabilities" shall be given in the second Result TLV.

The ME shall then follow the call set-up procedure defined in TS 24.008 [9] or the supplementary service or USSD operation procedure defined in TS 24.080 [11].

7.3.1.2 Procedure for Supplementary Services and USSD

If the service "call control" is available in the USIM Service Table (see TS 31.102 [14]), then for all supplementary service and USSD operations (including those resulting from a SEND SS or SEND USSD proactive UICC command), the ME shall first pass the supplementary service or USSD control string (corresponding to the supplementary service or USSD operation and coded as defined in TS 22.030 [2], even if this SS or USSD operation has been performed via a specific menu of the ME) to the UICC, using the ENVELOPE (CALL CONTROL) command defined below. The ME shall also pass to the UICC in the ENVELOPE (CALL CONTROL) command the current serving cell.

The UICC shall respond in the same way as for mobile originated calls. The ME shall interpret the response as follows:

- if the UICC responds with '90 00', the ME shall send the supplementary service or USSD operation with the information as sent to the UICC;
- if the UICC responds with any status code indicating an error, the ME shall not send the supplementary service or USSD;
- if the UICC responds with '93 00', the ME shall not send the supplementary service or USSD operation and may retry the command;
- if the UICC provides response data, then the response data from the UICC shall indicate to the ME whether to send the supplementary service or USSD operation as proposed, not send the SS or USSD operation, send the SS or USSD operation using the data supplied by the UICC, or instead set up a call using the data supplied by the UICC. It is mandatory for the ME to perform the supplementary service or USSD operation or the call set-up request in accordance with the data from the UICC, if it is within the ME's capabilities to do so. If the UICC requires a call set-up or supplementary service or USSD operation that is beyond the ME's capabilities (e.g. the UICC maps a USSD operation to a data call, and the ME does not support data calls), then the ME shall not perform the call set-up request or supplementary service or USSD operation at all.

In the case where the initial SS or USSD request results from a proactive command SEND SS or SEND USSD:

- if the call control result is "not allowed", the ME shall inform the UICC using TERMINAL RESPONSE ("interaction with call control by USIM or MO short message control by USIM, permanent problem; action not allowed");
- if the SS or USSD request is changed by call control in a call set-up request, then the ME shall set up the call using the data given by the UICC, if it is within the ME's capabilities to do so. If the UICC requires a call set-up that is beyond the ME's capabilities (e.g. the UICC maps a USSD operation to a data call, and the ME does not support data calls), then the ME shall not set up the call at all. The ME shall send back a TERMINAL RESPONSE to the initial proactive command at the same time it would have done for the proactive command equivalent to the action requested by call control (i.e. SET UP CALL). However, in that case, the TERMINAL RESPONSE shall contain the response data given in the response to ENVELOPE (CALL CONTROL) and a second Result TLV identical to the one given in response to the proactive command equivalent to the action requested by call control (i.e. SET UP CALL). The mapping between the general result in the first Result TLV and the general result in the second Result TLV is the same as the one described in clause 7.3.1.1.

If the ME supports the Outgoing Call Information service, the ME shall update EF_{OCI} with the supplementary service or USSD control string corresponding to the initial user request.

The ME shall then follow the supplementary service or USSD operation procedure defined in TS 24.080 [11] or the call set-up procedure defined in TS 24.008 [9].

7.3.1.3 Indication to be given to the user

The UICC may optionally include an alpha-identifier in the response data to the ENVELOPE (CALL CONTROL) message, in order to inform the user at the time the response is received by the ME. The use of this alpha identifier by the ME is described below:

- if the UICC responds with "allowed, no modification", then:
 - if the alpha identifier is provided by the UICC and is not a null data object, the ME shall use it to inform the user during the PDP/PDN context activation, PDU session establishment or call set-up;
 - if the alpha identifier is provided by the UICC and is a null data object (i.e. length = '00' and no value part), this is an indication that the ME should not modify the display corresponding to the initial user request;
 - if the alpha identifier is not provided by the UICC, the ME may give information to the user concerning what is happening;
- if the UICC responds with "not allowed", then:
 - if the alpha identifier is provided by the UICC and is not a null data object, the ME shall use it to inform the user. This is also an indication that the ME should not give any other information to the user on the reason of the barring;
 - if the alpha identifier is provided by the UICC and is a null data object (i.e. length = '00' and no value part), the ME may give information to the user concerning what is happening;
 - if the alpha identifier is not provided by the UICC, the ME may give information to the user concerning what is happening.
- if the UICC responds with "allowed, with modifications", and the modified request is within the ME's capabilities, then:
 - if the alpha identifier is provided by the UICC and is not a null data object, the ME shall use it to inform the user. The ME shall then not display the destination address or SS string given by the UICC. This is also an indication that the ME should not give any other information to the user on the changes made by the UICC to the initial user request;
 - if the alpha identifier is provided by the UICC and is a null data object (i.e. length = '00' and no value part), this is an indication that the ME should not give any information to the user on the changes made by the UICC to the initial user request. The ME shall not display the destination address or SS string given by the UICC. The ME should not modify the display corresponding to the initial user request;
 - if the alpha identifier is not provided by the UICC, the ME may indicate to the user that the initial user request has been changed.
- if the UICC responds with "allowed, with modifications" to a user-initiated request (i.e. a request not initiated by a proactive command), and the modified user request is beyond the ME's capabilities, then the ME may give information to the user on the modified request and the fact that the modified request is beyond the ME's capabilities, optionally using the alpha identifier, if one is provided by the UICC;
- if the UICC responds with "allowed, with modifications" to a request by a proactive command SET UP CALL, SEND SS, SEND USSD or OPEN CHANNEL where GPRS is selected, and the modified request is beyond the ME's capabilities, then the ME shall not give any information to the user on the fact that the modified request is beyond the ME's capabilities, and shall give a TERMINAL RESPONSE to the proactive command (i.e. SET UP CALL, SEND SS, SEND USSD or OPEN CHANNEL) as detailed in clauses 7.3.1.1, 7.3.1.2 and 7.3.1.3. The responsibility to inform the user in this case lies with the UICC application which sent the proactive command.

A terminal of type ND shall ignore any alpha identifier provided together with the response data to the ENVELOPE (CALL CONTROL) message.

7.3.1.4 Interaction with Fixed Dialling Number

The procedure defined in ETSI TS 102 223 [32] clause 7.3.1.4 for calls applies. In addition, it shall apply in the same way for supplementary service operations, the supplementary service control string being checked as if it was a called number.

The ME shall check the number (or the supplementary service control string) in accordance with TS 22.101 [34].

When the called address is an IMS URI, the ME shall check the destination address using the FDN stored in EF_{FDNURI} , in addition to the EF_{FDN} entries, following the same principle as defined in the Fixed Dialling Number description in TS 22.101 [34] applied to URIs, and as described in TS 31.102[14] clause 4.2.97.

7.3.1.5 Support of Barred Dialling Number (BDN) service

The procedure defined in ETSI TS 102 223 [32] clause 7.3.1.5 for calls applies. In addition, it shall apply in the same way for supplementary service operations, the supplementary service control string being checked as if it was a called number.

The ME shall check the number (or the supplementary service control string) in accordance with TS 22.101 [34].

When the called address is an IMS URI, the ME shall check the destination address using the BDN stored in EF_{BDNURI} , in addition to the EF_{BDN} entries, following the same principle as defined in the Barring Dialling Number description in TS 22.101 [34] applied to URIs, and as described in TS 31.102[14] clause 4.2.98.

7.3.1.6 Structure of ENVELOPE (CALL CONTROL)

Direction: ME to UICC.

The command header is specified in TS 31.101 [13].

Command parameters/data.

Description	Clause	M/O/C	Min	Length
Call control tag	9.1	M	Y	1
Length (A+B+C+D+E+F+G+H)	-	M	Y	1 or 2
Device identities	8.7	M	Y	A
Address or SS string or USSD string or PDP context activation parameters or EPS PDN connection activation parameters or IMS URI or PDU session establishment parameters	8.1, 8.14 or 8.17 or 8.72 or 8.98 or 8.108 or 8.143	M	Y	B
Capability configuration parameters 1	8.4	O	N	C
Subaddress	8.3	O	N	D
Location information	8.19	C	N	E
Capability configuration parameters 2	8.4	O	N	F
Media Type	8.132	C	N	G
URI truncated	8.135	C	N	H

- Device identities: the ME shall set the device identities to:

source: ME;

destination: UICC.

- Address or SS string or USSD string or PDP context activation parameters or EPS PDN connection activation parameters or IMS URI or PDU session establishment parameters: only one data object shall be sent to the UICC:

for a call set-up, the address data object is used and holds the Called Party Number, as defined in TS 24.008 [9], to which the ME is proposing setting up the call;

for a supplementary service, the SS string data object is used and holds the corresponding supplementary service;

for a USSD operation, the USSD string data object is used and holds the corresponding USSD control string;

USIM Applications and MEs should take into account that early implementations of USAT use the SS string data object for coding of USSD control strings (instead of the USSD string data object). This behaviour is only possible for USSD control strings consisting of digits (0-9,*,#). The UICC can identify MEs having this early implementation by evaluating the indication "USSD string data object supported in Call Control" in the TERMINAL PROFILE. The ME can identify USIMs having this early implementation by evaluating the indication "USSD string data object supported in Call Control" in the USIM Service Table.

For a PDP context activation, the Activate PDP context request parameters are used, as defined in TS 24.008 [9]. Except for the following parameters:

- Requested QoS;
- Access Point Name; and
- Protocol configuration options,

the UICC should not modify any other parameters included in the ACTIVATE PDP CONTEXT REQUEST message as defined in TS 24.008 [9] to avoid that the UE sends a value of any of these parameters that is not compliant to TS 24.008 [9];

for an EPS PDN connection activation, the PDN Connectivity Request parameters are used, as defined in TS 24.301 [46]. Except for the following parameters:

- Access Point Name; and
- Protocol configuration options,

the UICC should not modify any other parameters included in the PDN CONNECTIVITY REQUEST message as defined in TS 24.301 [46] to avoid that the UE sends a value of any of these parameters that is not compliant to TS 24.301 [46];

for an IMS communication establishment, the IMS Request-URI field is used and the IMS URI data object holds the SIP URI or tel URI, as defined in TS 24.229[52], to which the ME is proposing setting up the communication. If the URI is longer than the maximum length that can be transmitted to the UICC, then the URI shall be truncated to the maximum length that can be transmitted to the UICC and the request shall contain a URI truncated tag.

for a PDU session establishment, the PDU Session Establishment Request parameters are used, as defined in TS 24.501 [70]. Except for the following parameters:

- SM PDU DN request container; and
- operator specific parameters in Extended Protocol configuration options,

the UICC should not modify any other parameters included in the PDU SESSION ESTABLISHMENT REQUEST message as defined in TS 24.501 [70] to avoid that the UE sends a value of any of these parameters that is not compliant to TS 24.501 [70].

- Capability configuration parameters: Only used for a call set-up, this contains the Bearer capabilities that the ME is proposing to send to the network. The first capability configuration parameters corresponds to the bearer capability 1 information element of a mobile originating SETUP message, as defined in TS 24.008 [9]. The second capability configuration parameters correspond to the bearer capability 2 information element of a mobile originating SETUP message, as defined in TS 24.008 [9]. If no capability configuration parameters are present, this shall indicate a speech call.
- Subaddress: Only used for a call set-up, this contains the called party subaddress that the ME is proposing to send to the network. If one is not present, this shall indicate that the ME is proposing not to send this information element to the network.
- Location information: This data object contains the identification (MCC, MNC, LAC/TAC, Cell Identity) of the current serving cell of the UE. The comprehension required flag of this data object in this command shall be set to '0'. This data object shall be present if the call is performed over GERAN, UTRAN, E-UTRAN or NG-RAN.

- Media Type: This data object indicates the type of media the ME is proposing using to set up the communication. If the type of media to be used by the ME is one of those listed in the Terminal Profile and if the "Media Type support" service is allocated and activated in the USIM or ISIM Service Table, the Media Type data object shall be present.
- URI truncated: This data object indicates that the URI in the request was truncated because too long to be transmitted to the UICC.

Response parameters/data.

It is permissible for the UICC to provide no response data, by responding with SW1/SW2 = '90 00'. If the UICC does not provide any response data, then this shall have the same meaning as "allowed, no modification".

Description	Clause	M/O/C	Min	Length
Call control result	-	M	Y	1
Length (A+B+C+D+E+F+G)	-	M	Y	1 or 2
Address or SS string or USSD string or PDP context activation parameters or EPS PDN connection activation parameters or IMS URI or PDU session establishment parameters	8.1, 8.14 or 8.17 or 8.72 or 8.98 or 8.108 or 8.143	O	N	A
Capability configuration parameters 1	8.4	O	N	B
Subaddress	8.3	O	N	C
Alpha identifier	8.2	O	N	D
BC repeat indicator	8.42	C	N	E
Capability configuration parameters 2	8.4	O	N	F
Media Type	8.132	O	N	G

- Call control result:

Contents:

- The command that the UICC gives to the ME concerning whether to allow, bar or modify the proposed call (or supplementary service operation);

Coding:

- '00' = Allowed, no modification;
 - '01' = Not allowed;
 - '02' = Allowed with modifications.
- Address or SS string or USSD string or PDP context/EPS PDN connection activation parameters or IMS URI or PDU session establishment parameters: Only one data object may be included if the UICC requests the call (or supplementary service or USSD operation or PDP context/EPS PDN connection activation or IMS communication establishment or PDU session establishment parameters) details to be modified:

for a call set-up, if the address data object is not present, then the ME shall assume the Dialling number is not to be modified;

if the SS string data object or address data object is present and the ME receives wild values according to TS 31.102 [14], then the ME shall not process the command.

For a supplementary service, if the SS string data object is not present, then the ME shall assume that SS is not to be modified;

for a USSD operation, if the USSD string data object is not present, then the ME shall assume that the USSD operation is not to be modified;

for a PDP context activation, if the PDP context activation parameters object is not present, then the ME shall assume that the PDP context activation is not to be modified;

for an EPS PDN connection activation, if the EPS PDN connection activation parameters object is not present, then the ME shall assume that the EPS PDN connection activation is not to be modified;

for an IMS communication establishment, if the IMS URI data object is not present, then the ME shall assume that neither the SIP URI nor the tel URI are to be modified.

for a PDU session establishment, if the PDU session establishment parameters object is not present, then the ME shall assume that the PDU session establishment is not to be modified.

- Capability configuration parameters: Only used for a call set-up, this data object is only required if the USIM application requests the call details to be modified. The first capability configuration parameters corresponds to the bearer capability 1 information element of a mobile originating SETUP message, as defined in TS 24.008 [9]. The second capability configuration parameters corresponds to the bearer capability 2 information element of a mobile originating SETUP message, as defined in TS 24.008 [9]. If the capability configuration parameters are not present, then the ME shall assume the parameters are not to be modified.
- Subaddress: Only used for a call set-up, this data object is only required if the USIM application requests the call details to be modified. If the subaddress is not present, then the ME shall assume the called party subaddress is not to be modified. If the subaddress supplied by the USIM application is a null data object, then the ME shall not provide a called party subaddress to the network. A null data object shall have length = '00' and no value part.
- Alpha identifier: this data object is only required if the UICC requests a particular indication to be given to the user. The handling of this data object by the ME is described in clause 7.3.1.3. The comprehension required flag of this data object shall be set to '0'.
- BC repeat indicator: indicates how the associated bearers shall be interpreted. The change of bearer occurs on a network event. This BC repeat indicator is conditioned to the presence of the second capability configuration parameters and is coded as defined in TS 24.008 [9].
- Media Type: this data object is only required if the UICC requests the media type of the call to be modified. If the Media Type is not present then the ME shall assume the media type of the call is not to be modified.

It is mandatory for the UICC to provide at least one of the optional data objects if it has set the Call control result to "allowed with modifications".

7.3.1.7 Procedure for PDP Context Activation

If the service "call control on GPRS by USIM" is available in the USIM Service Table (see TS 31.102 [14]), then for all PDP Context activation (including those resulting from a OPEN CHANNEL proactive UICC command where GPRS is selected), the ME shall first pass the corresponding Activate PDP Context message (see TS 24.008 [9]) to the UICC, using the ENVELOPE (CALL CONTROL) command defined below. The ME shall also pass to the UICC in the ENVELOPE (CALL CONTROL) command the current serving cell.

When the ME performs an emergency PDP context activation, the ME shall not send the ENVELOPE (CALL CONTROL) command to the UICC.

The UICC shall respond in the same way as for mobile originated calls. The ME shall interpret the response as follows:

- if the UICC responds with '90 00', the ME shall send the Activate PDP Context message with the information as sent to the UICC;
- if the UICC responds with '93 00', the ME shall not the Activate PDP Context message and may retry the command;
- if the UICC provides response data, then the response data from the UICC shall indicate to the ME whether to send the Activate PDP Context message as proposed, not send the Activate PDP Context message or send the Activate PDP Context message using the data supplied by the UICC. It is mandatory for the ME to perform the PDP Context Activation in accordance with the data from the UICC, if it is within the ME's capabilities to do so. If the UICC requires PDP Context Activation that is beyond the ME's capabilities, then the ME shall not perform PDP Context Activation at all.

In the case where the initial PDP Context Activation request results from a proactive command OPEN CHANNEL where GPRS is selected:

- if the call control result is "not allowed", the ME shall inform the UICC using TERMINAL RESPONSE ("interaction with call control by USIM or MO short message control by USIM, permanent problem; action not allowed");
- if the PDP Context Activation data is changed by call control, then the ME shall activate the PDP context using the data given by the UICC, if it is within the ME's capabilities to do so. If the UICC requires a PDP Context Activation that is beyond the ME's capabilities (e.g. the UICC requests a QoS that the ME cannot handle), then the ME shall not activate the PDP context at all.

7.3.1.8 Procedure for EPS PDN connection Activation

If the service "call control on EPS PDN connection by USIM" is available in the USIM Service Table (see TS 31.102 [14]), then for all EPS PDN connection activation (including those resulting from a OPEN CHANNEL proactive UICC command where E-UTRAN is selected), the ME shall first pass the corresponding PDN Connectivity Request message (see TS 24.301 [46]) to the UICC, using the ENVELOPE (CALL CONTROL) command defined above. The ME shall also pass to the UICC in the ENVELOPE (CALL CONTROL) command the current serving cell.

When the ME performs an emergency EPS PDN connection activation, the ME shall not send the ENVELOPE (CALL CONTROL) command to the UICC.

The UICC shall respond in the same way as for mobile originated calls. The ME shall interpret the response as follows:

- if the UICC responds with '90 00', the ME shall send the PDN Connectivity Request message with the information as sent to the UICC;
- if the UICC responds with '93 00', the ME shall not send the PDN Connectivity Request message and may retry the command;
- if the UICC provides response data, then the response data from the UICC shall indicate to the ME whether to send the PDN Connectivity Request message as proposed, not send the PDN Connectivity Request message or send the PDN Connectivity Request message using the data supplied by the UICC. It is mandatory for the ME to perform the EPS PDN Connection Activation in accordance with the data from the UICC, if it is within the ME's capabilities to do so. If the UICC requires EPS PDN Connection Activation that is beyond the ME's capabilities, then the ME shall not perform EPS PDN Connection Activation at all.

In the case where the initial PDN Connectivity Request results from a proactive command OPEN CHANNEL where E-UTRAN is selected:

- if the call control result is "not allowed", the ME shall inform the UICC using TERMINAL RESPONSE ("interaction with call control by USIM or MO short message control by USIM, permanent problem; action not allowed");
- if the EPS PDN Connection Activation data is changed by call control, then the ME shall activate the EPS PDN Connection using the data given by the UICC, if it is within the ME's capabilities to do so. If the UICC requires a EPS PDN Connection Activation that is beyond the ME's capabilities, then the ME shall not activate the EPS PDN Connection at all.

7.3.1.9 Procedure for IMS communications establishment

If the service "communication control for IMS by USIM" is available in the USIM Service Table (see TS 31.102 [14]), then for all IMS communication establishment, the ME shall first pass the corresponding IMS Request-URI contained in SIP INVITE message (see TS24.229 [52]) to the UICC, using the ENVELOPE (CALL CONTROL) command defined above. The ME shall also pass to the UICC in the ENVELOPE (CALL CONTROL) command the current serving cell if the IMS communication is established over GERAN, UTRAN, E-UTRAN or NG-RAN. If the type of media to be used by the ME is one of those listed in the Terminal Profile and if the "Media Type support" service is allocated and activated in the USIM or ISIM Service Table, the ME shall pass to the UICC in the ENVELOPE (CALL CONTROL) command the media type of the SIP communication session it is setting up.

This procedure replaces the call control by USIM using the Address TLV (clause 8.1) when the call is originated over IMS and the service "communication control for IMS by USIM" is available in the USIM Service Table (see TS 31.102 [14]).

When the ME detects that an IMS emergency call is being initiated, the ME shall set up an emergency call without sending the ENVELOPE (CALL CONTROL) command to the UICC.

The UICC shall respond in the same way as for mobile originated communications. The ME shall interpret the response as follows:

- if the UICC responds with '90 00', the ME shall send the SIP INVITE message with the information as sent to the UICC;
- if the UICC responds with '93 00', the ME shall not send SIP INVITE message and may retry the command;
- if the UICC provides response data, then the response data from the UICC shall indicate to the ME whether to send the SIP INVITE message as proposed, not send the SIP INVITE message or send the SIP INVITE message using the IMS-Request URI supplied by the UICC. It is mandatory for the ME to perform the SIP INVITE request in accordance with the data from the UICC, if it is within the ME's capabilities to do so. If the UICC requires SIP INVITE request that is beyond the ME's capabilities, then the ME shall not send SIP INVITE request at all.

7.3.1.10 Procedure for PDU session establishment

If the service "call control on PDU session by USIM" is available in the USIM Service Table (see TS 31.102 [14]), then for all PDU session establishment (including those resulting from a OPEN CHANNEL proactive UICC command where NG-RAN is selected), the ME shall first pass the corresponding PDU Session Establishment Request message (see TS 24.501 [70]) to the UICC, using the ENVELOPE (CALL CONTROL) command defined above. The ME shall also pass to the UICC in the ENVELOPE (CALL CONTROL) command the current serving cell.

When the ME performs an emergency PDU session establishment, the ME shall not send the ENVELOPE (CALL CONTROL) command to the UICC.

The UICC shall respond in the same way as for mobile originated calls. The ME shall interpret the response as follows:

- if the UICC responds with '90 00', the ME shall send the PDU Session Establishment Request message with the information as sent to the UICC;
- if the UICC responds with '93 00', the ME shall not send the PDU Session Establishment Request message and may retry the command;
- if the UICC provides response data, then the response data from the UICC shall indicate to the ME whether to send the PDU Session Establishment Request message as proposed, not send the PDU Session Establishment Request message or send the PDU Session Establishment Request message using the data supplied by the UICC. It is mandatory for the ME to perform the PDU session establishment in accordance with the data from the UICC, if it is within the ME's capabilities to do so. If the UICC requires PDU session establishment that is beyond the ME's capabilities, then the ME shall not perform PDU session establishment at all.

In the case where the initial PDU Session Establishment Request results from a proactive command OPEN CHANNEL where NG-RAN is selected:

- if the call control result is "not allowed", the ME shall inform the UICC using TERMINAL RESPONSE ("interaction with call control by USIM or MO short message control by USIM, permanent problem; action not allowed");
- if the PDU session establishment data is changed by call control, then the ME shall establish the PDU session using the data given by the UICC, if it is within the ME's capabilities to do so. If the UICC requires a PDU session establishment that is beyond the ME's capabilities, then the ME shall not establish the PDU session at all.

7.3.2 MO Short Message Control by USIM

7.3.2.1 Description

If the service "MO Short Message Control" is available in the USIM Service Table (see TS 31.102 [14]), then the ME shall follow the procedure below:

- for all MO short message attempts (even those resulting from a SEND SM proactive UICC command), the ME shall first pass the RP_destination_address of the service centre and the TP_Destination_Address to the UICC, using the ENVELOPE (MO SHORT MESSAGE CONTROL) command defined below. The ME shall also pass to the UICC in the ENVELOPE (MO SHORT MESSAGE CONTROL) command the current serving cell;
- if the UICC responds with '90 00', the ME shall send the short message with the addresses unchanged;
- if the UICC responds with any other status code indicating an error, the ME shall not send the short message;
- if the UICC responds with '93 00', the ME shall not send the short message and may retry the command;
- if the UICC provides response data, then the response data from the UICC shall indicate to the ME whether to send the short message as proposed, not send the short message or send a short message using the data supplied by the UICC. It is mandatory for the ME to perform the MO short message request in accordance with the data from the UICC.

The ME shall then follow the MO Short Message procedure defined in TS 24.011 [10].

In the case where the initial MO short message request results from a proactive command SEND SHORT MESSAGE, if the MO short message control result is "not allowed", the ME shall inform the UICC using TERMINAL RESPONSE, "interaction with call control by USIM or MO short message control by USIM, permanent problem; action not allowed".

7.3.2.2 Structure of ENVELOPE (MO SHORT MESSAGE CONTROL)

Direction: ME to UICC.

The command header is specified in TS 31.101 [13].

Command parameters/data.

Description	Clause	M/O/C	Min	Length
MO Short Message control tag	9.1	M	Y	1
Length (A+B+C+D)	-	M	Y	1 or 2
Device identities	8.7	M	Y	A
Address data object 1	8.1 or 8.108	M	Y	B
Address data object 2	8.1 or 8.108	M	Y	C
Location information	8.19	C	Y	D

- Device identities: the ME shall set the device identities to:
source: ME;
destination: UICC.
- Address data object 1: this address data object 1 contains the RP_Destination_Address of the Service Centre to which the ME is proposing to send the short message. If the USIM or the ISIM Service Table indicates URI

support for MO SHORT MESSAGE CONTROL, then the address data object 1 may contain the Public Service Identity of the SM-SC to which the ME is proposing to send the short message. The type of address data object shall not be modified.

- Address data object 2: this address data object 2 contains the TP_Destination_Address to which the ME is proposing to send the short message. If the USIM or the ISIM Service Table indicates URI support for MO SHORT MESSAGE CONTROL, then the address data object 2 may contain the Public Identity (IMPU) of the receiver to which the ME is proposing to send the short message. The type of address data object shall not be modified.
- Location information: this data object contains the identification (MCC, MNC, LAC/TAC, Cell Identity) of the current serving cell of the UE. This data object shall be present if the short message is sent over GERAN, UTRAN, E-UTRAN or NG-RAN.

Response parameters/data.

It is permissible for the UICC to provide no response data, by responding with SW1/SW2 = '90 00'. If the UICC does not provide any response data, then this shall have the same meaning as "allowed, no modification".

Description	Clause	M/O/C	Min	Length
MO short message control result	-	M	Y	1
Length (A+B+C)	-	M	Y	1 or 2
Address data object 1	8.1 or 8.108	O (see note)	N	A
Address data object 2	8.1 or 8.108	O (see note)	N	B
Alpha identifier	8.2	O	N	C
NOTE: The UICC shall provide the two optional address data objects if it has set the MO Short Message control result to "allowed with modifications".				

- MO Short Message control result:

Contents:

- The command that the UICC gives to the ME concerning whether to allow, bar or modify the proposed short message;

Coding:

- '00' = Allowed, no modification;
- '01' = Not allowed;
- '02' = Allowed with modifications.
- if the ME receives wild values according to TS 31.102 [14] in either the Address data object 1 or Address data object 2, then the ME shall not process the command.
- Alpha identifier: this data object is only required if the UICC requests a particular indication to be given to the user. The handling of this data object by the ME is described in clause 7.3.2.3.

7.3.2.3 Indication to be given to the user

The UICC may optionally include an alpha-identifier in the response data to the ENVELOPE (MO SHORT MESSAGE CONTROL) message, in order to inform the user at the time the response is received by the ME. The use of this alpha identifier by the ME is identical to the one described in clause 7.3.1.3 relative to call control by USIM.

7.3.2.4 Interaction with Fixed Dialling Number

It is permissible for the Fixed Dialling Number service to be enabled (see TS 31.102 [14]) at the same time as MO Short Message Control is available (in the USIM Service Table). If FDN is enabled, the ME shall follow the procedure for Call Control (see clause 7.3.1.4), where the number or called address (i.e. IMS URI) in the procedure refers to both the SMS destination address and the SMSC address.

7.4 Timer Expiration

See ETSI TS 102 223 [32] clause 7.4.

7.5 Event download

See ETSI TS 102 223 [32] clause 7.5.

Regarding all the call events, the following equivalences shall apply:

- the "call setup message" is the SETUP message as defined in TS 24.008 [09];
- the "call connect message" is the CONNECT message as defined in TS 24.008 [09];
- the "disconnect messages" are the DISCONNECT, RELEASE, RELEASE COMPLETE messages as defined in TS 24.008 [09];
- the "NULL state" is the CC-U0 state as defined in TS 24.008 [09].

Regarding the location status event, the following equivalence shall apply:

- the "idle" state is the MM-IDLE state as defined in TS 24.008 [09] for GERAN/UTRAN, the EMM-IDLE state as defined in TS 24.301 [46] for E-UTRAN and 5GMM-IDLE state as defined in TS 24.501 [70] for NG-RAN.

Where events occur and the UICC responds with '93 00', the ME shall retry to deliver the event download messages to the UICC.

7.5.1 (I-)WLAN Access status event

7.5.1.1 Procedure

If the (I-)WLAN Access Status event is part of the current event list (as set up by the last SET UP EVENT LIST command, see clause 6.4.16), then, when the terminal detects a change in its current I-WLAN access or WLAN access respectively the terminal shall inform the UICC that this has occurred, by using the ENVELOPE (EVENT DOWNLOAD – (I-)WLAN Access Status) command as defined in clause 7.5.1.2.

7.5.1.2 Structure of ENVELOPE (EVENT DOWNLOAD – (I-)WLAN Access Status)

Direction: terminal to UICC.

The command header is specified in TS 31.101 [13].

Command parameters/data.

Description	Clause	M/O	Min	Length
Event download tag	9.1	M	Y	1
Length (A+B+C)	-	M	Y	1 or 2
Event list	8.25	M	Y	A
Device identities	8.7	M	Y	B
(I-)WLAN Access Status	8.84	M	Y	C

Event list: the Event list data object shall contain only one event (value part of length 1 byte), and terminal shall set the event to:

(I-)WLAN Access Status.

Device identities: the terminal shall set the device identities to:

source: terminal;

destination: UICC.

(I-)WLAN Access Status: this data object shall contain the (I-)WLAN Access status of the terminal.

Response parameters/data: None for this type of ENVELOPE command.

7.5.1A MT Call event

7.5.1A.1 Procedure

If the MT call event is part of the current event list (as set up by the last SET UP EVENT LIST command, see clause 6.4.16), then when the ME receives an incoming call setup message, the ME shall inform the UICC that this has occurred, by using the ENVELOPE (EVENT DOWNLOAD - MT call) command as defined in clause 7.5.1A.2.

7.5.1A.2 Structure of ENVELOPE (EVENT DOWNLOAD - MT call)

Direction: ME to UICC.

The command header is specified in TS 31.101 [13].

Command parameters/data.

Description	Clause	M/O/C	Min	Length
Event download tag	9.1	M	Y	1
Length (A+B+C+D+E+F+G+H)	-	M	Y	1 or 2
Event list	8.25	M	Y	A
Device identities	8.7	M	Y	B
Transaction identifier	8.28	M	N	C
Address	8.1	C	N	D
Subaddress	8.3	C	N	E
IMS URI	8.108	C	N	F
Media Type	8.132	C	N	G
URI truncated	8.135	C	N	H

Event list: the event list object shall contain only one event (value part of length 1 byte), and ME shall set the event to:

- MT call.

Device identities: the ME shall set the device identities to:

- source: network;
- destination: UICC.

Transaction identifier: the transaction identifier data object shall contain one transaction identifier, and this shall be the Transaction Identifier as defined in clause 8.28.

Address: the address data object holds the Calling Party number received by the ME in the call setup message. If the Calling Party number is included in the call setup message, the ME shall include the Address object. Otherwise the ME shall not include the Address object.

Subaddress: The Subaddress data object holds the Calling Party Subaddress as received by the ME in the call setup message. If the Calling Party Subaddress is included in the call setup message, the ME shall include the Subaddress object, otherwise the terminal shall not include the Subaddress object.

IMS URI: The IMS URI data object is a SIP or TEL URI of the Calling Party received by the ME in the call setup message. This data object will be present only if the "URI support by UICC" Service is present in the USIM or the ISIM Service Table. The IMS URI data object shall contain the SIP URI or tel URI indicated in the P-Asserted-Identity field as defined in TS 24.229 [52]. In case the P-Asserted-Identity field is missing the SIP URI or tel URI indicated in the From header field shall be used. If the URI is longer than the maximum length that can be transmitted to the UICC, then the URI shall be truncated to the maximum length that can be transmitted to the UICC and the request shall contain a URI truncated tag.

Media Type: The Media Type indicates the type of media of the incoming call session and shall be coded as defined in clause 8.132. The Media Type data object shall be present, if the "Media Type support" service is allocated and activated in the USIM or ISIM Service Table.

Response parameters/data:

- none.

7.5.2 Network Rejection event

7.5.2.1 Procedure

If the Network Rejection event is part of the current event list (as set up by the last SET UP EVENT LIST command, see ETSI TS 102 223 [32] clause 6.4.16), then, in the case of GERAN/UTRAN if the terminal receives a LOCATION UPDATING REJECT message or a GPRS ATTACH REJECT message or a ROUTING AREA UPDATE REJECT message (as defined in TS 24.008 [9]) or in the case of E-UTRAN if the terminal receives an EMM ATTACH REJECT message or TRACKING AREA UPDATE REJECT message (as defined in TS 24.301 [46]), or in the case of NG-RAN if the terminal receives a REGISTRATION REJECT message (as defined in TS 24.501 [70]), the terminal shall inform the UICC that this has occurred, by using the ENVELOPE (EVENT DOWNLOAD – Network Rejection Event) command as defined below.

7.5.2.2 Structure of ENVELOPE (EVENT DOWNLOAD – Network Rejection)

Direction: ME to UICC.

The command header is specified in TS 31.101 [13].

Command parameters/data.

Description	Clause	M/O	Min	Length
Event download tag	9.1	M	Y	1
Length (A+B+C+D+E+F+G+H+I)	-	M	Y	1
Event list	8.25	M	Y	A
Device identities	8.7	M	Y	B
Location Information	8.19	C	N	C
Routing Area Identification	8.91	C	N	D
Tracking Area Identification	8.99	C	N	E
Access Technology	8.62	M	Y	F
Update/Attach/Registration Type	8.92	M	Y	G
Rejection Cause Code	8.93	M	Y	H
Extended Rejection Cause Code	8.136	C	N	I

- Event list: the Event list data object shall contain only one event (value part of length 1 byte), and terminal shall set the event to:
 - Network Rejection Event.
- Device identities: the terminal shall set the device identities to:
 - source: Network;
 - destination: UICC.
- Location information: This data object shall only be present when the ME receives a LOCATION UPDATING REJECT message, and shall contain the identification (MCC, MNC, and LAC) of the rejecting network.
- Routing Area Identification: This data object shall only be present when the ME receives a GPRS ATTACH REJECT message or a ROUTING AREA UPDATE REJECT message and shall contain the identification (MCC, MNC, LAC and RAC) of the rejecting network.

- Tracking Area Identification: This data object shall only be present when the ME receives an EMM ATTACH REJECT or a TRACKING AREA UPDATE REJECT or a REGISTRATION REJECT message and shall contain the identification (MCC, MNC and TAC) of the rejecting network.
- Access Technology: This data object shall contain the access technology of the rejecting network.
- Update/Attach/Registration Type: This data object contains the location updating or attach or update or EPS attach or EPS update or 5GS registration type that was used in the LOCATION UPDATING REQUEST or GPRS ATTACH REQUEST or ROUTING AREA UPDATE REQUEST or EMM ATTACH REQUEST or TRACKING AREA UPDATE REQUEST or REGISTRATION REQUEST message.
- Rejection Cause Code: This data object contains the cause code value that was received in the LOCATION UPDATING REJECT or GPRS ATTACH REJECT or ROUTING AREA UPDATE REJECT or EMM ATTACH REJECT or TRACKING AREA UPDATE REJECT or REGISTRATION REJECT message.
- Extended Rejection Cause Code: This data object contains the extended cause code value that was received in the EMM ATTACH REJECT or TRACKING AREA UPDATE REJECT message.

Response parameters/data: None for this type of ENVELOPE command.

7.5.2A Call connected event

7.5.2A.1 Procedure

See ETSI TS 102 223 [32] clause 7.5.2.1.

7.5.2A.2 Structure of ENVELOPE (EVENT DOWNLOAD - call connected)

Direction: ME to UICC.

The command header is specified in TS 31.101 [13].

Command parameters/data.

Description	Clause	M/O/C	Min	Length
Event download tag	9.1	M	Y	1
Length (A+B+C+D)	-	M	Y	1 or 2
Event list	8.25	M	Y	A
Device identities	8.7	M	Y	B
Transaction identifier	8.28	M	Y	C
Media Type	8.132	O	N	D

Event list: the event list object shall contain only one event (value part of length 1 byte), and the ME shall set the event to:

- call connected.

Device identities:

- in the case of connecting at the near end (an MT call), the ME shall set the device identities to:
 - source: ME;
 - destination: UICC.
- in the case of connecting at the far end (an MO call), the ME shall set the device identities to:
 - source: network;
 - destination: UICC.

Transaction identifier: the Transaction identifier data object shall contain one transaction identifier.

Media Type: The Media Type indicates the type of media of the call session and shall be coded as defined in clause 8.132. The Media Type data object shall be present, if the "Media Type support" service is allocated and activated in the USIM or ISIM Service Table.

Response parameters/data:

- none.

7.5.3 CSG Cell Selection event

The following clause applies if class "q" is supported

7.5.3.1 Procedure

If the CSG Cell Selection event is part of the current event list (as set up by the last SET UP EVENT LIST command, see ETSI TS 102.223 [32]), then, when the ME detects a change in its current CSG or Hybrid cell selection status, the ME shall inform the UICC that it has occurred, using ENVELOPE (EVENT DOWNLOAD – CSG Cell Selection) as defined below.

7.5.3.2 Structure of ENVELOPE (EVENT DOWNLOAD – CSG Cell Selection)

Direction : ME to UICC

The command header is specified in TS 31.101 [13]

Command parameters/data

Description	Clause	M/O	Min	Length
Event download tag	9.1	M	Y	1
Length (A+B+C+D+E+F+G)	-	M	Y	1
Event list	8.25	M	Y	A
Device identities	8.7	M	Y	B
Access Technology	8.62	C	Y	C
CSG cell selection status	8.101	M	Y	D
CSG ID	8.102	C	N	E
HNB name	8.103	C	N	F
PLMN ID	8.118	O	N	G

- Event list: the Event list data object shall contain only one event (value part of length 1 byte), and terminal shall set the event to:
 - CSG Cell Selection.
- Device identities: the terminal shall set the device identities to:
 - source: Network;
 - destination: UICC.
- Access Technology: This data object shall contain the access technology of the current serving cell. If the device is not camping on any cell, this data object shall not be present.
- CSG cell selection status: this data object shall contain CSG or Hybrid cell selection status. The ME should send the event indicating that it is not camped on a CSG or Hybrid cell only after a previous event that indicated that UE was camped on a CSG or Hybrid cell.
- CSG ID: If the UE is camping on a CSG or Hybrid cell in the Allowed CSG list or the Operator CSG list, this data object shall be present, and shall contain CSG id of the current serving CSG or Hybrid cell. In all other cases this data object shall not be present.
- HNB name: If the UE is camping on a CSG or Hybrid cell in the Allowed CSG list or the Operator CSG list and the HNB name of the cell is available in the broadcasted information to the ME, this data object shall be present, and

shall contain the broadcasted HNB name of the current serving CSG or Hybrid cell. In all other cases this data object shall not be present.

- PLMN ID: If the UE is camping on a CSG or Hybrid cell that is listed in the Allowed CSG list or the Operator CSG list, this data object may be present, and, if present, shall contain the PLMN identity of the current serving CSG or Hybrid cell.

Response parameters/data: None for this type of ENVELOPE command.

7.5.3A Call disconnected event

7.5.3A.1 Procedure

See ETSI TS 102 223 [32] clause 7.5.3.1.

7.5.3A.2 Structure of ENVELOPE (EVENT DOWNLOAD - call disconnected)

Direction: ME to UICC.

The command header is specified in TS 31.101 [13].

Command parameters/data.

Description	Clause	M/O/C	Min	Length
Event download tag	9.1	M	Y	1
Length (A+B+C+D+E+F)	-	M	Y	1 or 2
Event list	8.25	M	Y	A
Device identities	8.7	M	Y	B
Transaction identifier	8.28	M	Y	C
Cause	8.26	O	N	D
Media Type	8.132	C	N	E
IMS call disconnection cause	8.133	O	N	F

Event list: the event list object shall contain only one event (value part of length 1 byte), and the ME shall set the event to:

- call disconnected.

Device identities:

- in the case of "near end" disconnection, the ME shall set the device identities to:
 - source: ME;
 - destination: UICC.
- in the case of "far end" disconnection, the ME shall set the device identities to:
 - source: network;
 - destination: UICC.

Transaction identifier: the transaction identifier data object shall contain a list of the transaction identifiers for each of the calls being disconnected.

Cause: the cause shall reflect the cause information element sent or received in the disconnect message triggering the ENVELOPE command. If the cause information element was not present in the message, or the cause data object shall not be included. In the case of a radio link timeout, the cause data object shall be included, with a value part of zero length.

Media Type: The Media Type indicates the type of media of the call session and shall be coded as defined in clause 8.132. The Media Type data object shall be present if the "Media Type support" service is allocated and activated in the USIM or ISIM Service Table.

IMS call disconnection cause: The IMS call disconnection cause shall reflect the Reason header field in the SIP message triggering the ENVELOPE command. If the Reason header field is not present in the SIP message, the IMS call disconnection cause data object shall not be included. The cause and corresponding protocol shall not be present in the ENVELOPE command within a corresponding IMS call disconnection cause data object if the "IMS call disconnection cause" service is neither allocated and activated in the USIM nor ISIM Service Table.

Response parameters/data:

- none.

7.5.4 Location status event

See ETSI TS 102 223 [32] clause 7.5.4.

If a location status is already available in the UE when the UICC supplies an event list with location status event (by using the SET UP EVENT LIST command), the ME shall immediately send the ENVELOPE (EVENT DOWNLOAD - location status) command (after the TERMINAL RESPONSE), providing the Location status and the Location information.

7.5.5 User activity event

See ETSI TS 102 223 [32] clause 7.5.5.

7.5.6 Idle screen available event

See ETSI TS 102 223 [32] clause 7.5.6.

7.5.7 Card reader status event

See ETSI TS 102 223 [32] clause 7.5.7.

7.5.8 Language selection event

See ETSI TS 102 223 [32] clause 7.5.8.

7.5.9 Browser termination event

See ETSI TS 102 223 [32] clause 7.5.9.

7.5.10 Data available event

See ETSI TS 102 223 [32] clause 7.5.10.

7.5.11 Channel status event

See ETSI TS 102 223 [32] clause 7.5.11.

7.5.12 Access Technology Change Event

See ETSI TS 102 223 [32] clause 7.5.12.

If an access technology is already available in the UE when the UICC supplies an event list with Access Technology Change event (by using the SET UP EVENT LIST command), the ME shall immediately send the ENVELOPE (EVENT DOWNLOAD - Access Technology Change) command (after the TERMINAL RESPONSE), providing the Access Technology.

7.5.13 Display parameters changed event

See ETSI TS 102 223 [32] clause 7.5.13.

7.5.14 Local Connection event

See ETSI TS 102 223 [32] clause 7.5.14.

7.5.15 Network Search Mode Change Event

See ETSI TS 102 223 [32] clause 7.5.15.

7.5.16 Browsing status event

See ETSI TS 102 223 [32] clause 7.5.16.

7.5.17 Frames Information changed event

See ETSI TS 102 223 [32] clause 7.5.17.

7.5.18 HCI connectivity event

Not required by 3GPP.

7.5.19 Contactless state request

Not required by 3GPP.

7.5.20 Incoming IMS Data event

The following clauses apply if classes "e" and "t" are supported.

7.5.20.1 Procedure

If the Incoming IMS data event is part of the current event list (as set up by the last SET UP EVENT LIST command, see ETSI TS 102 223 [32]), then, in the case of an incoming IMS message to an IARI (see TS 24.229 [52]) associated to an application installed on the UICC and no open channel is available for IMS communication, see 3GPP TS 31.102 [14], the terminal shall inform the UICC that this has occurred, by using the ENVELOPE (EVENT DOWNLOAD – Incoming IMS data) command as defined below.

7.5.20.2 Structure of ENVELOPE (EVENT DOWNLOAD – Incoming IMS Data)

Direction : ME to UICC

The command header is specified in TS 31.101 [13]

Command parameters/data

Description	Clause	M/O	Min	Length
Event download tag	9.1	M	Y	1
Length (A+B+C)	-	M	Y	1 or 2
Event list	8.25	M	Y	A
Device identities	8.7	M	Y	B
IARI	8.110	M	Y	C

- Event list: the Event list data object shall contain only one event (value part of length 1 byte), and terminal shall set the event to:

- Incoming IMS Data event.
- Device identities: the terminal shall set the device identities to:
 - source: Network;
 - destination: UICC.
- IARI: This data object contains the IARI included in the Accept-Contact (see TS 24.229 [52]) header field of the incoming SIP INVITE IMS message destined for the UICC.

Response parameters/data: None for this type of ENVELOPE command.

7.5.21 IMS Registration Event

The following clauses apply if classes "e" and "t" are supported.

7.5.21.1 Procedure

If the IMS Registration event is part of the current event list (as set up by the last SET UP EVENT LIST command, see ETSI TS 102 223 [32]) and the SIP REGISTER message contains the IARIs defined in EF-UICCIARI, then, upon receiving the 200 OK (see 3GPP TS 24.229 [52]) message in response to the SIP REGISTER message (see 3GPP TS 24.229 [52]) or upon receiving any status code (see 3GPP TS 24.229 [52]) indicating a failure in response to the SIP REGISTER message, the terminal shall inform the UICC that this event has occurred, by using the ENVELOPE (EVENT DOWNLOAD – IMS Registration) command as defined below.

7.5.21.2 Structure of ENVELOPE (EVENT DOWNLOAD – IMS Registration)

Direction : ME to UICC

The command header is specified in TS 31.101 [13]

Command parameters/data

Description	Clause	M/O/C	Min	Length
Event download tag	9.1	M	Y	1
Length (A+B+C+D)	-	M	Y	1 or 2
Event list	8.25	M	Y	A
Device identities	8.7	M	Y	B
IMPU list	8.111	C	Y	C
IMS status code	8.112	C	Y	D

- Event list: the Event list data object shall contain only one event (value part of length 1 byte), and terminal shall set the event to:
 - IMS Registration Event.
- Device identities: the terminal shall set the device identities to:
 - source: Network;
 - destination: UICC.
- IMPU list: This data object shall contain the list of IMPUs built from the URIs from the aor (address of record) attributes for which within the same registration element at least one of the ME's contact URIs has the status "active" (see RFC 3680 [55]) received in the registration event package (see 3GPP TS 24.229 [52]) of the SIP NOTIFY request. This data object shall only be present in the case of a successful registration. If the network indicates, using the SIP NOTIFY request containing the registration event package, that there are no aor attributes that for which within the same registration element at least one of the ME's contact URIs has the status "active" then the ME shall send an empty list of IMPUs to the UICC.

- Status Code: This data object shall contain the Status-code (see 3GPP TS 24.229 [52]) received from the IMS network in response to a SIP REGISTER message. This data object shall only be present to indicate that a failure occurred during an IMS registration.

Response parameters/data: None for this type of ENVELOPE command.

7.5.22 Profile Container

Not required by 3GPP.

7.5.23 Envelope Container

Not required by 3GPP.

7.5.24 Poll Interval Negotiation

See ETSI TS 102 223 [32] clause 7.5.22.

7.5.25 Data Connection Status Change Event

7.5.25.1 Procedure

This and the following clauses apply if class "e" is supported.

If the Data Connection Status Change event is part of the current event list (as set up by the last SET UP EVENT LIST command, see clause 8.25 of this document), then, upon detection by the ME of a change in the data connection status, the terminal shall inform the UICC that this event has occurred, by using the ENVELOPE (EVENT DOWNLOAD – Data Connection Status Change) command as defined below.

7.5.25.2 Structure of ENVELOPE (EVENT DOWNLOAD – Data Connection Status Change)

Direction: ME to UICC

The command header is specified in TS 31.101 [13].

Command parameters/data

Description	Clause	M/O/C	Min	Length
Event download tag	9.1	M	Y	1
Length (A+B+C+D+E+F+G+H+I+J+K+L)	-	M	Y	1 or 2
Event list	8.25	M	Y	A
Device identities	8.7	M	Y	B
Data connection status	8.137	M	Y	C
Data connection type	8.138	M	Y	D
(E/5G)SM cause	8.139	C	Y	E
Transaction identifier	8.28	M	Y	F
Date-Time and Time zone	8.39	C	Y	G
Location Information	8.19	C	Y	H
Access Technology	8.62	C	Y	I
Location status	8.27	M	Y	J
Network Access Name	8.61	C	Y	K
PDP/PDN/PDU type	8.142	C	Y	L

- Event list: the Event list data object shall contain only one event (value part of length 1 byte), and the ME shall set the event to:
 - Data Connection Status Change.
- Device identities: the terminal shall set the device identities to:

- source: Network for network originated messages. ME for ME originated messages;
- destination: UICC.
- Data connection status: This data object shall contain the status of the data connection.
- Data connection type: This data object shall contain the type of data connection.
- (E/5G)SM cause: If an (E/5G)SM cause is available, this data object shall contain either the SM cause as defined in 3GPP TS 24.008 [9] or the ESM cause as defined in 3GPP TS 24.301 [46], or the 5GSM cause as defined in 3GPP TS 24.501 [70].
- Transaction identifier: The Transaction identifier data object shall contain one transaction identifier as defined in clause 8.28.
- Date-Time and Time zone: If the date-time and time zone information is available in the ME, this data object is mandatory and shall contain the Date-Time and Time zone at the ME detected moment of occurrence of the event.
- Location Information: This data object contains the identification (MCC, MNC, LAC/TAC, Cell Identity) of the current serving cell of the UE. The comprehension required flag of this data object in this command shall be set to '0'. This data object shall be present if the data connection is performed over GERAN, UTRAN, E-UTRAN or NG-RAN.
- Access Technology: This data object shall contain the access technology of the rejecting or accepting network.
- Location Status: This data object indicates the current service state of the terminal.
- Network Access Name: This data object shall contain the Access Point Name value present in the Activate PDP context request (for a PDP context activation, as defined in TS 24.008 [9]) or the PDN connectivity request (for an EPS PDN connection activation, as defined in TS 24.301 [46]), or it shall contain the Data Network Name value present in the UL NAS TRANSPORT message for PDU Session Establishment request, as defined TS 24.501 [70]. It is present only when Data connection status is either successful or rejected.
- PDP/PDN/PDU type: This data object shall contain the PDP/PDN/PDU type requested in the Activate PDP context request (for a PDP context activation, as defined in TS 24.008 [9]) or the PDN connectivity request (for an EPS PDN connection activation, as defined in TS 24.301 [46]), or the PDU Session Establishment request (as defined in TS 24.501 [70]). It is present only when Data connection status is either successful or rejected.

Response parameters/data: None for this type of ENVELOPE command.

7.6 USSD Data Download

This clause applies if class "p" is supported.

7.6.1 Procedure

If the service "data download via USSD and USSD application mode" is allocated and activated in the USIM Service Table (see TS 31.102 [14]), then the ME shall follow the procedure below:

- When the ME receives a USSD packet it shall pass the message transparently to the USIM using the ENVELOPE (USSD DOWNLOAD) if the Data Coding Scheme of the USSD message (as defined for the CBS Data Coding Scheme in TS 23.038 [4]) indicate the USIM as the target (Bit 0 set to 0 and Bit 1 set to 1):
 - The ME shall wait for an acknowledgement from the USIM:
 - if the UICC responds with '90 00', the ME shall acknowledge the receipt of USSD message to the network using a FACILITY message. The ME will supply the response data from the UICC in the USSD String of the return result component of the FACILITY message it will send back to the network (see TS 24.090 [37]). The alphabet and language indicators shall be those used in the original message.
 - if the USIM responds with '93 00', the ME shall either retry the command or send back a FACILITY message to the network. The ME will supply the status word followed by the response data from the UICC in the USSD String of the return result component of the FACILITY message it will send back to

the network (see TS 24.090 [37]). The alphabet and language indicators shall be those used in the original message.

- if the UICC responds with '62 XX' or '63 XX', the ME shall acknowledge the receipt of the USSD message to the network using a FACILITY message. The ME will supply the status word followed by the response data from the UICC in the USSD String of the return result component of the FACILITY message it will send back to the network (see TS 24.090 [37]). The alphabet and language indicators shall be those used in the original message.

If the service "data download via USSD and USSD application mode " is not allocated and activated in the USIM Service Table, and the ME receives a USSD message with a Data Coding Scheme indicating that the destination is the card (as defined above), the ME shall return a FACILITY message to the network. The ME will supply the status word '6D 00' (i.e. Instruction code not supported or invalid) in the USSD String of the return result component of the FACILITY message it will send back to the network (see TS 24.090 [37]). The alphabet and language indicators shall be those used in the original message.

7.6.2 Structure of ENVELOPE (USSD Data Download)

Direction: ME to UICC

The command header is specified in TS 31.101 [13].

Command parameters/data:

Description	Clause	M/O	Min	Length
USSD Download tag	9.1	M	Y	1
Length (A+B)	-	M	Y	1 or 2
Device identities	8.7	M	Y	A
USSD string	8.17	M	Y	B

- Device identities: the ME shall set the device identities to:

Source: Network

Destination: UICC

Response parameters/data:

It is permissible for the UICC not to provide response data. If the UICC provides response data, the following data is returned.

Byte(s)	Description	Length
1-X (X≤182)	UICC response	X

7.7 MMS Transfer Status

See ETSI TS 102 223 [32] clause 7.6.

7.8 MMS notification download

See ETSI TS 102 223 [32].

Considering the addressing mechanism to the UICC indicated in ETSI TS 102 223 [32] clause 7.7, the UICC shall be targeted using the following application identifier: "uicc.3gpp.org".

7.9 Terminal Applications

See ETSI TS 102 223 [32] clause 7.8.

7.10 Geographical Location Reporting

7.10.1 Procedure

This clause applies if class "n" is supported.

If the ME has processed the proactive command "Geographical Location Request" successfully, then the ME shall send the ENVELOPE (Geographical Location Reporting).

It is acceptable for the ME to send the envelope even if the requested accuracy has not been achieved.

Note: some GAD Shapes contain the actual accuracy.

If positioning data cannot be provided, the envelope command shall neither include the GAD shape TLV nor the NMEA-sentence TLV.

If positioning data can be provided, the envelope command shall include either a GAD shape TLV or a NMEA-sentence TLV. The information sent by the ME is deemed fresh.

7.10.2 Structure of ENVELOPE (Geographical Location Reporting)

Direction: ME to UICC.

The command header is specified in TS 31.101 [13].

Command parameters/data.

Description	Clause	M/O/C	Min	Length
Geographical Location Reporting tag	9.1	M	Y	1
Length (A+B+C)	-	M	Y	1 or 2
Device identities	8.7	M	Y	A
GAD shape	8.95	C	N	B
NMEA sentence	8.96	C	N	C

- Device identities: the ME shall set the device identities to:
 - source: ME;
 - destination: UICC.
- GAD shape: This data object contains the location information.
- NMEA sentence: This data object contains the location information.

Response parameters/data: None for this type of ENVELOPE command.

7.11 Void

7.12 ProSe usage information reporting

7.12.1 Procedure

If the service "ProSe Usage Information Reporting configuration" and service "UICC ProSe Direct Communication usage information reporting" are allocated and activated in the ProSe Service Table (see TS 31.102 [14]), then a ProSe-enabled Public Safety ME that supports "ProSe usage information reporting" shall store the ProSe usage information to be sent over the PC3ch interface (see 3GPP TS 24.334 [61]) in the UICC. This is performed using the ENVELOPE (ProSe Report).

A UICC supporting the "ProSe usage information reporting" shall also support BIP. The UICC is responsible to transmit the collected reports to the ProSe Function CTF (ADF) using BIP mechanism, following the same procedure described in TS 24.334 [61] clause 10.3.1 and using the communication security described in TS 24.334 [61] clause 4.1. The address of the ProSe Function CTF (ADF) is available in the EF_{PROSE_UICC} (see TS 31.102 [14]).

The UICC shall store the received ProSe usage information until a USAGE_INFORMATION_REPORT_LIST_RESPONSE is received with transaction ID set to the value of the transaction ID included in the USAGE_INFORMATION_REPORT_LIST message.

If one envelope is not enough to transmit all the information (i.e. the ProSe usage information is more than 243 bytes), the information shall be split into several ENVELOPE (ProSe Report). The final envelope is indicated by containing a Last Envelope TLV. Intermediate envelopes shall not contain this TLV.

If one envelope is enough to transmit the information, this envelope shall contain a Last Envelope TLV.

NOTE: If the usage information report list sending procedure is unsuccessfully completed, the USIM behaviour is according to what is specified for the UE in 3GPP TS 24.334 [61], clause 10.3.2.1.6.

7.12.2 Structure of ENVELOPE (ProSe Report)

Direction: ME to UICC.

The command header is specified in TS 31.101 [13].

Command parameters/data.

Description	Clause	M/O/C	Min	Length
ProSe Report tag	9.1	M	Y	1
Length (A+B+C)	-	M	Y	1 or 2
Device identities	8.7	M	Y	A
ProSe Report	8.128	M	Y	B
Last Envelope	8.79	C	N	C

- Device identities: the ME shall set the device identities to:
 - source: ME;
 - destination: UICC.
- ProSe Report Data: This data object contains the ProSe Report.
- Last Envelope: Indicates that the last information concerning the ProSe Report has been sent.

Response parameters/data: None for this type of ENVELOPE command.

The UICC may respond with status word '69 82' if the PIN verification has not been performed successfully.

NOTE: The handling of the case where the USIM cannot process the ENVELOPE command (e.g. when there is not enough memory for storing a ProSe Report) is implementation-specific.

8 COMPREHENSION-TLV data objects

The coding of the TLV objects is as described in ETSI TS 102 223 [32] clause 8, except when stated otherwise in the present document.

8.1 Address

See ETSI TS 102 223 [32] clause 8.1.

8.2 Alpha identifier

See ETSI TS 102 223 [32] clause 8.2.

8.3 Subaddress

See ETSI TS 102 223 [32] clause 8.3.

8.4 Capability configuration parameters

Byte(s)	Description	Length
1	Capability configuration parameters tag	1
2 to (Y-1)+2	Length (X)	Y
(Y-1)+3 to (Y-1)+X+2	Capability configuration parameters	X

Capability configuration parameters are coded as for EF_{CCP}. If it is being provided by the UICC, the UICC shall supply all information required to complete the Bearer Capability Information Element in the Call Set-up message (see TS 24.008 [9]). Any unused bytes at the end of the value part shall be coded 'FF'.

See TS 31.102 [14] for the coding of all Efs.

NOTE: The second byte of this TLV contains the Length of the TLV and the third byte contains the Length of the bearer capability contents, followed by the actual contents.

8.5 Cell Broadcast Page

Byte(s)	Description	Length
1	Cell Broadcast page tag	1
2	Length = '58' (88 decimal)	1
3 - 90	Cell Broadcast page	88

The Cell Broadcast page is formatted in the same way as the GSM Cell Broadcast Message Parameter, as described in TS 23.041 [6].

8.6 Command details

The content and the coding of the Command Details TLV object is defined in ETSI TS 102 223 [32] clause 8.6, except for the following.

The coding of the Command Qualifier is defined for the following commands:

- SEND SS:

this byte is RFU.

- SEND USSD:

this byte is RFU.

- PROVIDE LOCAL INFORMATION.

The following additional values are defined:

'00' = Location Information (MCC, MNC, LAC/TAC, Cell Identity and Extended Cell Identity).

'02' = Network Measurement results.

'05' = Timing Advance.

'0C' = current WSID.

'11' = CSG ID list and corresponding HNB name.

'12' = H(e)NB IP address.

'13' = H(e)NB surrounding macrocells.

'14' = current WLAN identifier.

'15' = slices information.

'16' to '19' = reserved for 3GPP (for future usage)

The following values do not apply

'07' = Reserved by ETSI (ESN)

'0B' = Reserved by ETSI (MEID)

- REFRESH. The following additional values are defined:

'07' = Steering of Roaming as defined in TS 23.122 [7].

'08' = Steering of Roaming for I-WLAN as defined in TS 24.234 [42].

- Geographical Location Request:

this byte is RFU.

- OPEN CHANNEL related to CS bearer, GPRS/UTRAN packet service/E-UTRAN/NG-RAN, local bearer, Default (network) bearer, I-WLAN bearer, WLAN bearer, Terminal Server Mode, UICC Server Mode:

- As defined in ETSI TS 102 223 [32]

- OPEN CHANNEL for IMS:

this byte is RFU.

8.7 Device identities

See ETSI TS 102 223 [32] clause 8.7.

8.8 Duration

See ETSI TS 102 223 [32] clause 8.8.

8.9 Item

See ETSI TS 102 223 [32] clause 8.9.

8.10 Item identifier

See ETSI TS 102 223 [32] clause 8.10.

8.11 Response length

See ETSI TS 102 223 [32] clause 8.11.

8.12 Result

For the general result byte coding the following values are defined in addition to or replacement of those in ETSI TS 102 223 [32] clause 8.12:

- '14' = USSD or SS transaction terminated by the user
- '34' = SS Return Error;
- '35' = SMS RP-ERROR;
- '37' = USSD Return Error;
- '39' = Interaction with call control by USIM or MO short message control by USIM, permanent problem;

In addition, the following values are reserved for 3GPP for future usage:

- '15' = reserved for 3GPP (for future usage);
- '16' = reserved for 3GPP (for future usage);
- '28' = reserved for 3GPP (for future usage);
- '29' = reserved for 3GPP (for future usage);
- '3E' = reserved for 3GPP (for future usage);
- '3F' = reserved for 3GPP (for future usage);

Additional information:

Contents:

- For the general result "Command performed successfully", some proactive commands require additional information in the command result. This is defined in the clauses below. For the general result values '20', '21', '34', '35', '37', and '39', it is mandatory for the ME to provide a specific cause value as additional information, as defined in the clauses below. For other values, see ETSI TS 102 223 [32] clause 8.12.

8.12.1 Additional information for SEND SS

When the ME issues a successful general result for a SEND SS proactive command, it shall also include the Operation Code and Parameters included in the Return Result component from the network, as additional information.

The first byte of the additional information shall be the SS Return Result Operation code, as defined in TS 24.080 [11].

The rest of the additional information shall be the SS Return Result Parameters, as defined in TS 24.080 [11].

8.12.2 Additional information for ME problem

For the general result "ME currently unable to process command", it is mandatory for the ME to provide additional information, the first byte of which to be as defined in ETSI TS 102 223 [32] clause 8.12.2, with the addition of the following value:

- '03' = ME currently busy on SS transaction;
- '08' = ME currently busy on USSD transaction.

8.12.3 Additional information for network problem

For the general result "network currently unable to process command", it is mandatory for the ME to provide additional information. The first byte shall be the cause value of the Cause information element returned by the network (as defined in TS 24.008 [9]). Bit 8 shall be set to '1'. One further value is defined:

- '00' = No specific cause can be given.

All other values shall be interpreted by the UICC as '00'. The coding '00' shall only be used by the ME if no others apply.

8.12.4 Additional information for SS problem

For the general result "SS Return Error", it is mandatory for the ME to provide additional information. The first byte shall be the error value given in the Facility (Return Error) information element returned by the network (as defined in TS 24.080 [11]). One further value is defined:

- '00' = No specific cause can be given.

All other values shall be interpreted by the UICC as '00'. The coding '00' shall only be used by the ME if no others apply.

8.12.5 Additional information for SMS problem

For the general result "SMS RP-ERROR", it is mandatory for the ME to provide additional information. The first byte shall be the cause value given in the RP-Cause element of the RP-ERROR message returned by the network (as defined in TS 24.011 [10]), with bit 8 = 0. One further value is defined:

- '00' = No specific cause can be given.

All other values shall be interpreted by the UICC as '00'. Specific cause '00' shall only be used by the ME if no others apply.

8.12.6 Not used

8.12.7 Additional information for USSD problem

For the general result "USSD Return Error", the ME shall provide additional information. The first byte shall be the error value given in the Facility (Return Error) information element returned by the network (as defined in TS 24.080 [11]). One further value is defined:

- '00' = No specific cause can be given.

All other values shall be interpreted by the UICC as '00'.

The coding '00' shall only be used by the ME if no others apply.

8.12.8 Additional information for interaction with call control or MO SM control

For the general result "interaction with call control by USIM or MO short message control by USIM, permanent problem", it is mandatory for the ME to provide additional information, the first byte of which to be as defined below:

- '00' = No specific cause can be given;
- '01' = Action not allowed;
- '02' = The type of request has changed.

All other values shall be interpreted by the UICC as '00'. The coding '00' shall only be used by the ME if no others apply.

8.12.9 Additional information for MultipleCard commands

See ETSI TS 102 223 [32] clause 8.12.9.

8.12.10 Additional information for launch browser problem

See ETSI TS 102 223 [32] clause 8.12.10.

8.12.11 Additional information for Bearer Independent Protocol

See ETSI TS 102 223 [32] clause 8.12.11.

8.12.12 Additional information for Frames commands

See ETSI TS 102 223 [32] clause 8.12.12.

8.12.13 Additional information for SUBMIT and RETRIEVE MULTIMEDIA MESSAGE

See ETSI TS 102 223 [32] clause 8.12.13.

8.13 SMS TPDU

Byte(s)	Description	Length
1	SMS TPDU tag	1
2 to (Y-1)+2	Length (X)	Y
(Y-1)+3 to (Y-1)+X+2	SMS TPDU	X

The TPDU is formatted as described in TS 23.040 [5].

Where the TPDU is being sent from the UICC to the ME (to be forwarded to the network), and where it includes a TP-Message-Reference which is to be incremented by the ME for every outgoing message, the TP-Message-Reference as provided by the UICC need not be the valid value. TP-Message-Reference shall be checked and corrected by the ME to the value described in TS 23.040 [5].

8.14 SS string

Byte(s)	Description	Length
1	SS string tag	1
2 to (Y-1)+2	Length (X)	Y
(Y-1)+3	TON and NPI	1
(Y-1)+4 to (Y-1)+X+2	SS or USSD string	X - 1

TON/NPI and SS or USSD control string are coded as for EF_{ADN} , where the ADN record relates to a Supplementary Service Control string. See TS 31.102 [14] for the coding of EF_{ADN} .

8.15 Text string

Content and coding is defined ETSI TS 102 223 [32] clause 8.15, with the following requirement:

Data coding scheme is coded as for SMS Data coding scheme defined in TS 23.038 [4]. Parts of the data coding scheme other than the character set indication shall be ignored.

8.16 Tone

See ETSI TS 102 223 [32] clause 8.16.

NOTE: Standard supervisory tones for 3G are specified in TS 22.001 [22].

8.17 USSD string

Byte(s)	Description	Length
1	USSD string tag	1
2 to (Y-1)+2	Length (X)	Y
(Y-1)+3	Data coding scheme	1
(Y-1)+4 to (Y-1)+X+2	USSD string	X-1

The Data coding scheme is coded as for Cell Broadcast defined in TS 23.038 [4]. The coding of the USSD string is defined in TS 22.030 [2].

NOTE 1: The MMI mode uses a 7 bit character set, the Application mode uses a 8 bit character set.

NOTE2: The DCS is set to 0x96 to indicate that the USSD string is formatted according to TS 31.115 [41].

8.18 File List

See ETSI TS 102 223 [32] clause 8.18.

8.19 Location Information

8.19.1 Location Information for GERAN

Byte(s)	Description	Length
1	Location Information tag	1
2	Length = '07' or '05' (see Note)	1
3 – 5	Mobile Country & Network Codes (MCC & MNC)	3
6 – 7	Location Area Code (LAC)	2
8 – 9	Cell Identity Value (Cell ID) (see Note)	2
NOTE: When this object is used in the Network Rejection event download, the Cell Identity Value (Cell ID) field shall not be present and the length field shall be set to '05'.		

The Mobile Country Code (MCC), the Mobile Network Code (MNC) and the Location Area Code (LAC) are coded as in TS 24.008 [9].

For GERAN, the Cell Identity Value is coded as in TS 24.008 [9].

8.19.2 Location Information for UTRAN

Byte(s)	Description	Length
1	Location Information tag	1
2	Length = '09' or '05' (see Note)	1
3 – 5	Mobile Country & Network Codes (MCC & MNC)	3
6 – 7	Location Area Code (LAC)	2
8 – 9	Cell Identity Value (Cell ID) (see Note)	2
10 – 11	Extended Cell identity Value (see Note)	2
NOTE: When this object is used in the Network Rejection event download, the Cell Identity Value (Cell ID) and Extended Cell identity Value fields shall not be present and the length field shall be set to '05'.		

The Mobile Country Code (MCC), the Mobile Network Code (MNC) and the Location Area Code (LAC) are coded as in TS 24.008 [9].

Only the C-id part of the UC-id is returned in the Cell Identity Value (i.e. the 16 least significant bits of the UC-id), as defined in TS 25.401 [35] and TS 25.413 [36].

The Extended Cell identity Value is coded as the RNC-id part of the UC-id, as defined in TS 25.401 [35] and TS 25.413 [36]. It is left padded with zeros (this means that byte 10 contains the 4 most significant bits of the RNC-id value, and byte 11 contains the 8 least significant bits of the RNC-id value).

8.19.3 Location Information for E-UTRAN

Byte(s)	Description	Length
1	Location Information tag	1
2	Length = '09' or '05' (see Note)	1
3 – 5	Mobile Country & Network Codes (MCC & MNC)	3
6 – 7	Tracking Area Code (TAC)	2
8 – 11	E-UTRAN Cell Identifier (ECI) (see Note)	4
NOTE: When this object is used in the Network Rejection event download, the E-UTRAN Cell Identifier (ECI) field shall not be present and the length field shall be set to '05'.		

The Mobile Country Code (MCC), the Mobile Network Code (MNC) is coded as in TS 24.008 [9].

The Tracking Area Code (TAC) for E-UTRAN is coded in 2 bytes as specified in TS 24.301 [46].

The E-UTRAN Cell Identifier (ECI) is coded as defined in TS 36.401 [48]. ECI has a length of 28 bits. The most significant bit of ECI is coded on the most significant bit of byte 8. The least significant bit of ECI is coded on the 4th bit of byte 11. The 4 least significant bits of byte 11 shall be set to 1.

8.19.4 Location Information for NG-RAN

Byte(s)	Description	Length
1	Location Information tag	1
2	Length = '0B' or '03' (see Note)	1
3 – 5	Mobile Country & Network Codes (MCC & MNC)	3
6 – 8	Tracking Area Code (TAC) (see Note)	3
9 – 13	NR Cell Identifier (NCI) (see Note)	5
NOTE:	When this object is used in the Network Rejection event download, the Tracking Area Code (TAC) and the NR Cell Identifier (NCI) fields shall not be present and the length field shall be set to '03'.	

The Mobile Country Code (MCC), the Mobile Network Code (MNC) is coded as in TS 24.008 [9].

The Tracking Area Code (TAC) for NG-RAN is coded in 3 bytes as specified in TS 24.501 [70]. The most significant bit of TAC is coded on the most significant bit of byte 6. The least significant bit of TAC is coded on the least significant bit of byte 8.

NR Cell Identifier (NCI) Value is coded on 36 bits as referenced in TS 38.413 [69] clause 9.3.1.7. The most significant bit of NCI is coded on the most significant bit of byte 9. The least significant bit of NCI is coded on the 4th bit of byte 13. The 4 least significant bits of byte 13 shall be set to 1.

8.19.5 Location Information when no surrounding macrocell is detected

When PROVIDE LOCAL INFORMATION with command qualifier '13' is used and no surrounding macrocell is detected for an Access Technology, a location information data object with length set to '00' shall be present.

Byte(s)	Description	Length
1	Location Information tag	1
2	Length = '00'	1

8.20 IMEI

See ETSI TS 102 223 [32] clause 8.20.

8.21 Help Request

See ETSI TS 102 223 [32] clause 8.21.

8.22 Network Measurement Results

Byte(s)	Description	Length
1	Network Measurement Results tag	1
2	Length (X) of bytes following	1
3 – to X+2	Network Measurement Results	X

For GERAN: The Network Measurement Results are coded as for the Measurement Results information element in TS 44.018 [27], starting at octet 2 (the IEI is removed, as this information is duplicated by the data object tag). The Length shall be set to '10' (16 decimal).

For UTRAN: The Network Measurement Results are coded as for the "MeasurementReport" information element as defined in the ASN.1 description of TS 25.331 [38], according to the following:

- The "Measurement identity" field in the MEASUREMENT REPORT shall be set to the value '1'.
- If "intra-frequency measurements" are requested by USIM, the ME shall, in the MEASUREMENT REPORT, include IE "Intra-frequency measured results list" in IE "Measured Results". The ME shall report CPICH Ec/No, CPICH RSCP and pathloss for the up to 6 strongest (highest Ec/No value) intra-frequency cells, if available in the ME according to TS 25.331 [38] and TS 25.133 [39].
- If "inter-frequency measurements" are requested by USIM, the ME shall, in the MEASUREMENT REPORT, include IE "inter-frequency measured results list" in IE "Measured Results". The ME shall report CPICH Ec/No, CPICH RSCP and pathloss for the up to 6 strongest (highest Ec/No value) inter-frequency cells per monitored frequency, if available in the ME according to TS 25.331 [38] and TS 25.133 [39].
- If "inter-RAT (GERAN) measurements" are requested by USIM, the ME shall, in the MEASUREMENT REPORT, include IE "inter-RAT measured results list" in IE "Measured Results". The ME shall report GSM carrier RSSI for up to 8 strongest (highest RSSI value) inter-RAT GERAN cells (identified by the BCCH ARFCN), if available in the ME according to TS 25.331 [38] and TS 25.133 [50].
- If "inter-RAT (E-UTRAN)" are requested by USIM, the ME shall, in the MEASUREMENT REPORT, include IE "E-UTRA measured results". The ME shall report RSRP and RSRQ for the up to 4 strongest (highest RSRQ value) inter-RAT E-UTRAN cells per monitored frequency, if available in the ME according to TS 25.331 [38] and TS 25.133 [39].
- All other optional fields in the *MeasurementReport* shall be set to be absent.

For E-UTRAN:

Intra-frequency & inter-RAT (GERAN): the Network Measurement Results are coded as for the *MeasurementReport* information element as defined in the ASN.1 description of TS 36.331 [49], according to the following:

- The "measId" field in the "measResults" shall be set to the value '1'.
- the ME shall include IE "measResultServCell" with RSRP and RSRQ of the serving cell.
- If "intra-frequency measurements" are requested by USIM, the ME shall, in the *MeasurementReport*, include IE "measResultListEUTRA" in IE "measResults". The ME shall report RSRP, RSRQ, Physical Cell ID and IE "cgi-Info" for the up to 8 strongest (highest RSRQ value) intra-frequency cells, if available in the ME according to TS 36.331 [49] and TS 36.133 [50].
- If "inter-RAT (GERAN) measurements" are requested by USIM, the ME shall, in the *MeasurementReport*, include IE "measResultListGERAN" in IE "measResults". The ME shall report GERAN carrier RSSI and Physical Cell ID for the up to 8 strongest (highest RSSI value) inter-RAT GERAN cells (identified by the BCCH ARFCN) and IE "cgi-Info", if available in the ME according to TS 36.331 [49] and TS 36.133 [50].
- All other optional fields in the *MeasurementReport* shall be set to be absent.

Inter-frequency & inter-RAT (UTRAN): the ME can send more than one Network Measurement Results TLV object, each containing the results of one frequency. Each Network Measurement Results shall include 2 bytes with the frequency value coded as the ARFCN-ValueEUTRA for inter-frequency measurements or as the ARFCN-ValueUTRA for inter-RAT (UTRAN) measurements as defined in TS 36.331 [49], followed by the *MeasurementReport* information element as defined in the ASN.1 description of TS 36.331 [49], according to the following:

- The "measId" field in the "measResults" shall be set to the value '1'.
- the ME shall include IE "measResultServCell" with RSRP and RSRQ of the serving cell.
- If "inter-frequency measurements" are requested by the USIM, the ME shall, in the *MeasurementReport*, include IE "measResultListEUTRA" in IE "measResults". The ME shall report RSRP, RSRQ, Physical Cell ID and IE "cgi-Info" for the up to 8 strongest (highest RSRQ value) inter-frequency cells per monitored frequency, if available in the ME according to TS 36.331 [49] and TS 36.133 [50].

- If "inter-RAT (UTRAN) measurements" are requested by the USIM, the ME shall, in the *MeasurementReport*, include IE "measResultListUTRA" in IE "measResults". The ME shall report CPICH Ec/No, CPICH RSCP, Physical Cell ID and IE "cgi-Info" for the up to 8 strongest (highest Ec/No value) inter-RAT UTRAN cells per monitored frequency, if available in the ME according to TS 36.331 [49] and TS 36.133 [50].
- All other optional fields in the *MeasurementReport* shall be set to be absent.

For inter-frequency measurement results with EARFCN that exceeds maxEARFCN, the ME shall use the E-UTRAN Inter-frequency Network Measurement Results TLV objects if the service "extended EARFCN" is available in the USIM Service Table (see TS 31.102 [14]) or not include them otherwise.

Inter-RAT (NR): the ME can send more than one Network Measurement Results TLV object, each containing the results of one frequency. Each Network Measurement Results shall include 4 bytes containing the frequency value coded as the ARFCN-ValueNR for inter-RAT (NR) measurements as defined in TS 36.331 [49], where the least significant byte of the frequency value is stored in the least significant byte of this 4 byte field and the unused bytes of these 4 byte field are set to 0, followed by the *MeasurementReport* information element as defined in the ASN.1 description of TS 36.331 [49], according to the following:

- The "measId" field in the "measResults" shall be set to the value '1'.
- the ME shall include IE "measResultServCell" with RSRP and RSRQ of the serving cell.
- If "inter-RAT (NR) measurements" are requested by the USIM, the ME shall, in the *MeasurementReport*, include IE "measResultNeighCellListNR" in IE "measResults". The ME shall report Physical Cell ID, related RSRP,RSRQ and SINR for the up to 8 strongest inter-RAT NR cells per monitored frequency, if available in the ME according to TS 36.331 [49] and TS 36.133 [50].
- All other optional fields in the *MeasurementReport* shall be set to be absent.

For NG-RAN:

Intra-frequency : the Network Measurement Results are coded as for the *MeasurementReport* information element as defined in the ASN.1 description of TS 38.331 [71], according to the following:

- The "measId" field in the "measResults" shall be set to the value '1'.
- the ME shall include IE "measResultServingCell" with RSRP,RSRQ and the available SINR of the serving cell.
- If "intra-frequency measurements" are requested by USIM, the ME shall, in the *MeasurementReport*, include IE "MeasResultListNR" in IE "measResults". The ME shall report Physical Cell ID,related RSRP,RSRQ,SINR and IE "cgi-Info" for the up to 8 strongest intra-frequency cells, if available in the ME according to TS 38.331 [71] and TS 38.133 [72].
- All other optional fields in the *MeasurementReport* shall be set to be absent.

Inter-frequency and inter-RAT (E-UTRAN): the ME can send more than one Network Measurement Results TLV object, each containing the results of one frequency. Each Network Measurement Results shall include 3 bytes containing the frequency value coded as the ARFCN-ValueNR for Inter-frequency measurements or as the ARFCN-ValueEUTRA for inter-RAT (E-UTRAN) measurements as defined in TS 38.331[71].the Network Measurement Results are coded as for the *MeasurementReport* information element as defined in the ASN.1 description of TS 38.331 [71], according to the following:

- The "measId" field in the "measResults" shall be set to the value '1'.
- the ME shall include IE "measResultServingCell" with RSRP,RSRQ and the available SINR of the serving cell.
- If "inter-frequency measurements" are requested by USIM, the ME shall, in the *MeasurementReport*, include IE "MeasResultListNR" in IE "measResults". The ME shall report Physical Cell ID,related RSRP,RSRQ,SINR and IE "cgi-Info" for the up to 8 strongest inter-frequency cells per monitored frequency, if available in the ME according to TS 38.331 [71] and TS 38.133 [72].
- If "inter-RAT (E-UTRAN)" are requested by the USIM, the ME shall, in the *MeasurementReport*, include IE "measResultListEUTRA" in IE "measResults". The ME shall report RSRP, RSRQ, SINR,Physical Cell ID

and IE "cgi-Info" for the up to 8 strongest inter-RAT E-UTRAN cells per monitored frequency, if available in the ME according to TS 38.331 [71] and TS 38.133 [72].

- All other optional fields in the *MeasurementReport* shall be set to be absent.

8.23 Default Text

See ETSI TS 102 223 [32] clause 8.23.

8.24 Items Next Action Indicator

See ETSI TS 102 223 [32] clause 8.24.

8.25 Event list

For the event list byte coding, the following value are defined in addition to those in ETSI TS 102 223 [32] clause 8.25:

- '11' = (I-)WLAN Access Status.
- '12' = Network Rejection
- '15' = CSG cell selection
- '17' = IMS Registration
- '18' = Incoming IMS data
- '1D' = Data Connection Status Change

In addition, the following events are reserved for 3GPP for future usage:

- '1E' = reserved for 3GPP (for future usage);
- '1F' = reserved for 3GPP (for future usage);
- '20' = reserved for 3GPP (for future usage);
- '21' = reserved for 3GPP (for future usage);
- '22' = reserved for 3GPP (for future usage);

8.26 Cause

Byte(s)	Description	Length
1	Cause tag	1
2	Length (X) of bytes following. $X=0$, or $2 \leq X \leq 30$.	1
3 to X+2	Cause	X

The Cause data object is coded as for the Cause call control information element in TS 24.008 [9], starting at octet 3 (the IEI and Length information are removed, as this information is duplicated by the data object tag and length).

Radio Link Timeout is indicated by the Cause data object having a value part of zero length (only the Tag and Length components are sent).

8.27 Location status

See ETSI TS 102 223 [32] clause 8.27.

8.28 Transaction identifier

Byte(s)	Description	Length
1	Transaction identifier tag	1
2	Length (X) of bytes following	1
3 to X+2	Transaction identifier list	X

- Transaction identifier list:

Contents:

- A list of transaction identifiers, of variable length. Each byte in the list defines a transaction identifier. Each transaction identifier shall not appear more than once within the list;

Coding:

- Each byte in the transaction identifier list shall be coded as defined below:

bits 1 to 4 = RFU;

bits 5 to 7 = TI value;

bit 8 = TI flag.

If the terminal supports IMS:

- TI value is an identifier generated by the terminal to uniquely identify the call, regardless of the bearer of the call.
- TI flag is:
 - Call connected event: "1"
 - MT Call event: "0"
 - Call disconnected event: "0" if caller disconnects the call, "1" otherwise

If the terminal does not support IMS:

- Call connected event: Transaction Identifier in the corresponding call connect message
- MT Call event: Transaction Identifier in the corresponding call setup message from the network
- Call disconnected event: Transaction Identifier in the corresponding disconnect message triggering the ENVELOPE command, or in case of radio link failure, the Transaction Identifier as in an ME initiated disconnect message.
- TI value and TI flag are coded as defined in TS 24.007 [8].

In case of Data Connection Status Change event, the transaction identifier is encoded as:

- TI value is an identifier generated by the terminal to uniquely identify the PDP or PDN or PDU data connection, regardless of the bearer of the connection.
- TI flag is always 0 in this data connection transaction identifier.

8.29 BCCH channel list

This information is only available when the ME is connected to a GSM access network.

Byte(s)	Description	Length
1	BCCH channel list tag	1
2	Length (X) of bytes following	1
3 to X+2	BCCH channel list	X

- BCCH channel list:

Contents:

- The list of absolute RF channels for BCCH carriers, as known by the ME from the SYSTEM INFORMATION messages. The BCCH channel list is composed of one to three BCCH channel sub lists, each sub list is derived from the set of frequencies defined by reference neighbour cells description information element or elements. In the latter case the set is the union of the different subsets defined by the neighbour cells description information elements (see TS 44.018 [27]). The length of the BCCH channel list field depends on the length of the received BCCH channel list derived from the different SYSTEM INFORMATION messages to be considered.

Coding:

- Each ARFCN is represented by 10 bits. Spare bit(s) are to be filled with 0.

	Bit 8	Bit 7	Bit 6	Bit 5	Bit 4	Bit 3	Bit 2	Bit 1
Byte 1	ARFCN#1 (high part)							
Byte 2	ARFCN#1 (low part)				ARFCN#2 (high part)			
Byte 3	ARFCN#2 (low part)				ARFCN#3 (high part)			
...	...							
Byte X-1	ARFCN#m-1 (low part)				ARFCN#m (high part)			
Byte X	ARFCN#m (low part)						Spare bit (0)	Spare bit (0)

8.30 Call control requested action

Byte(s)	Description	Length
1	Call control requested action tag	1
2 to (Y-1)+2	Length (X)	Y
(Y-1)+3 to (Y-1)+X+2	Call control requested action	X

- Call control requested action:

Contents:

- The action given in response to the ENVELOPE (CALL CONTROL). It may contain, in the same order as given by the UICC, the address or SS string, the capability configuration parameters, the called party sub-address and the alpha identifier, or the IMS Request-URI;

Coding:

- As described in clause 7.3.1.6, starting with the first optional element given in the response data to the ENVELOPE (CALL CONTROL).

8.31 Icon Identifier

See ETSI TS 102 223 [32] clause 8.31.

8.32 Item Icon Identifier list

See ETSI TS 102 223 [32] clause 8.32.

8.33 Card reader status

See ETSI TS 102 223 [32] clause 8.33.

8.34 Card ATR

See ETSI TS 102 223 [32] clause 8.34.

8.35 C-APDU

See ETSI TS 102 223 [32] clause 8.35.

8.36 R-APDU

See ETSI TS 102 223 [32] clause 8.36.

8.37 Timer identifier

See ETSI TS 102 223 [32] clause 8.37.

8.38 Timer value

See ETSI TS 102 223 [32] clause 8.38.

8.39 Date-Time and Time zone

See ETSI TS 102 223 [32] clause 8.39.

NOTE: coding is as for the Time Zone and Time information element in TS 24.008 [9], starting at octet 2.

8.40 AT Command

Byte(s)	Description	Length
1	AT Command tag	1
2 to (Y-1)+2	Length (X)	Y
(Y-1)+3 to (Y-1)+3+X-1	AT Command string	X

Contents:

- The AT Command string is structured exactly as the AT Command line as defined in TS 27.007 [12], which may contain single or concatenated AT commands.

8.41 AT Response

Byte(s)	Description	Length
1	AT Response tag	1
2 to (Y-1)+2	Length (X)	Y
(Y-1)+3 to (Y-1)+3+X-1	AT Response string	X

Contents:

- The AT Response string is structured exactly as the response to a command line as defined in TS 27.007 [12], which may contain single or concatenated responses appropriate to the issued AT command.
- If the AT Response string is longer than the maximum length capable of being transmitted to the UICC then the AT Response string shall be truncated to this length by the ME.

8.42 BC Repeat indicator

Byte(s)	Description	Length
1	BC repeat indicator tag	1
2	Length = '01'	1
3	BC repeat indicator values	1

Contents & coding:

- The BC repeat indicator is structured exactly as defined in 3GPP TS 24.008 [09].

8.43 Immediate response

See ETSI TS 102 223 [32] clause 8.43.

8.44 DTMF string

See ETSI TS 102 223 [32] clause 8.44.

8.45 Language

See ETSI TS 102 223 [32] clause 8.45.

8.46 Timing Advance

This information is only available when the ME is connected to a GSM access network.

Byte(s)	Description	Length
1	Timing Advance tag	1
2	Length = '02'	1
3	ME Status	1
4	Timing Advance	1

Coding of ME status:

- '00' = ME is in the idle state;
- '01' = ME is not in idle state;

- '02' to 'FF' = reserved values.

The Timing Advance is coded as for the Timing Advance information element in TS 44.018 [27], starting at octet 2 (the IEI is removed, as this information is duplicated by the data object tag).

8.47 Browser Identity

See ETSI TS 102 223 [32] clause 8.37.

8.48 URL

See ETSI TS 102 223 [32] clause 8.48.

8.49 Bearer

Byte(s)	Description	Length
1	Bearer tag	1
2 to (Y + 1)	Length (X)	Y
(Y+2) to (Y + X + 1)	List of bearers in order of priority requested	X

The ME shall use this list to choose which bearers are allowed in order of priority.

Coding of the bearers:

- '00' = SMS;
- '01' = CSD;
- '02' = USSD;
- '03' = GPRS/UTRAN packet service/E-UTRAN/NG-RAN;
- '04' to 'FF' = RFU.

8.50 Provisioning File Reference

See ETSI TS 102 223 [32] clause 8.50.

8.51 Browser Termination Cause

See ETSI TS 102 223 [32] clause 8.51.

8.52 Bearer description

8.52.0 Structure of Bearer description

Byte(s)	Description	Length
1	Bearer description tag	1
2	Length (X+1)	1
3	Bearer type	1
4 to (3+X)	Bearer parameters	X

- Bearer Type coding: in addition to the values defined in ETSI TS 102 223 [32], the following are defined:
'01' = CSD;

'02' = GPRS / UTRAN packet service / E-UTRAN / NG-RAN.

'09' = UTRAN packet service with extended parameters / HSDPA / E-UTRAN / NG-RAN.

'0A' = (I-)WLAN.

'0B' = E-UTRAN / NG-RAN / mapped UTRAN packet service.

'0C' = NG-RAN

'0D' and '0E' = reserved for 3GPP (for future usage)

- Bearer parameters coding: see the following clauses.

8.52.1 Bearer parameters for CSD

Contents: parameters specific to the bearer.

In this case X=3.

NOTE: The default values of the subparameters are manufacturer specific since they depend on the purpose of the device and data services provided by it. Not all combinations and values of these subparameters are supported by GSM (see TS 22.002 [1]).

Coding:

- The following values are as defined in the TS 27.007 [12] for the select service bearer type "+CBST" extended command. They are coded in hexadecimal.

Coding of Byte 4:

- Data rate: same as the "speed" subparameter defined in TS 27.007 [12].

Coding of byte 5:

- Bearer service: same as the "name" subparameter defined in TS 27.007 [12].

Coding of Byte 6:

- Connection element: same as the "ce" subparameter defined in TS 27.007 [12].

8.52.2 Bearer parameters for GPRS / UTRAN Packet Service / E-UTRAN / NG-RAN

Contents: parameters describing the Quality of Service (QoS) and the type of PDP. This is an element of the PDP context. These parameters can be used for 3GPP network packet service.

In this case X=6.

Coding:

- The following values are as defined in the TS 27.007 [12], for the "+CGQREQ" extended command. They are coded in hexadecimal.

Coding of Byte 4:

- Precedence class: same as the "precedence" subparameter, defined in TS 27.007 [12].

Coding of Byte 5:

- Delay class: same as the "delay" subparameter, defined in TS 27.007 [12].

Coding of Byte 6:

- Reliability class: same as the "reliability" subparameter, defined in TS 27.007 [12].

Coding of Byte 7:

- Peak throughput class: same as the "peak" subparameter, defined in TS 27.007 [12].

Coding of Byte 8:

- Mean throughput class: same as the "mean" subparameter, defined in TS 27.007 [12].

Coding of Byte 9:

- Packet data protocol type (PDP type):
 - '02' = IP (Internet Protocol, IETF STD 5);
 - '07' = Non-IP (Transfer of Non-IP data to external packet data network);
 - all other values are reserved.

NOTE 1: The mapping between the UTRAN and E-UTRAN QoS parameters are defined in TS 23.203 [47].

NOTE 2: For NG-RAN, QoS parameters are not applicable.

8.52.3 Bearer parameters for UTRAN Packet Service with extended parameters / HSDPA / E-UTRAN / NG-RAN

Contents: parameters describing the Quality of Service (QoS) and the type of PDP. This is an element of the PDP context.

In this case X=17.

Coding:

- The following values are as defined in the TS 27.007 [12], for the "+CGEQREQ" extended command. They are coded in hexadecimal.

Coding of Byte 4:

- Traffic class: same as the "Traffic class" subparameter, defined in TS 27.007 [12].

Coding of Byte 5 and 6:

- Maximum bitrate UL: same as the "Maximum bitrate UL" subparameter, defined in TS 27.007 [12]. The ME shall fill all octets with 'FF' in case the value exceeds the maximum that can be represented.

Coding of Byte 7 and 8:

- Maximum bitrate DL: same as the "Maximum bitrate DL" subparameter, defined in TS 27.007 [12]. The ME shall fill all octets with 'FF' in case the value exceeds the maximum that can be represented.

Coding of Byte 9 and 10:

- Guaranteed bitrate UL: same as the "Guaranteed bitrate UL" subparameter, defined in TS 27.007 [12]. The ME shall fill all octets with 'FF' in case the value exceeds the maximum that can be represented.

Coding of Byte 11 and 12:

- Guaranteed bitrate DL: same as the "Guaranteed bitrate DL" subparameter, defined in TS 27.007 [12]. The ME shall fill all octets with 'FF' in case the value exceeds the maximum that can be represented.

Coding of Byte 13:

- Delivery order: same as the "Delivery order" subparameter, defined in TS 27.007 [12].

Coding of Byte 14:

- Maximum SDU size: same as the "Maximum SDU size" subparameter, defined in TS 24.008 [9].

Coding of Byte 15:

- SDU error ratio: same as the "SDU error ratio" subparameter, defined in TS 24.008 [9], coded in the first 4 bits. The 4 most significant bits shall be set to 0.

Coding of Byte 16:

- Residual bit error ratio: same as the "Residual bit error ratio" subparameter, defined in TS 24.008 [9], coded in the first 4 bits. The 4 most significant bits shall be set to 0.

Coding of Byte 17:

- Delivery of erroneous SDUs: same as the "Delivery of erroneous SDUs" subparameter, defined in TS 27.007 [12].

Coding of Byte 18:

- Transfer delay: same as the "Transfer delay" subparameter, defined in TS 24.008 [9], coded in the first 6 bits. The 2 most significant bits shall be set to 0.

Coding of Byte 19:

- Traffic handling priority: same as the "Traffic handling priority" subparameter, defined in TS 27.007 [12].

Coding of Byte 20:

- PDP_type: same as the "PDP type" subparameter, defined in TS 24.008 [9] for ETSI or IETF allocated address.

NOTE 1: HSDPA parameters and UTRAN Packet Service parameters are the same except for the maximum bitrate DL and the guaranteed bitrate DL, which can be higher for HSDPA (see TS 24.008 [9]).

NOTE 2: The mapping between the UTRAN and E-UTRAN QoS parameters are defined in TS 23.203 [47].

NOTE 3: For NG-RAN, QoS parameters are not applicable.

8.52.4 Bearer parameters for (I-)WLAN

Content: parameters specific to the bearer. RFU.

In this case X=0

8.52.5 Bearer parameters for E-UTRAN / NG-RAN / mapped UTRAN packet service

Contents: parameters describing the Quality of Service (QoS) and the type of PDP. This is an element of the PDP context.

In this case X=2 or X=6 or X=10 or X=14, depending on the size of the "EPS quality of service" information element and the resource type (GBR or non-GBR).

In case of a non-GBR QCI, the QoS octets in the "EPS quality of service" information element are ignored by the UE, as specified in TS 24.301 [46]. In this case, the UE shall use X=2, passing only the QCI value.

Coding of Byte 4 to Byte X+2:

Byte 4 same as "octet 3" of the "EPS quality of service" information element, defined in TS 24.301 [46].

For a GBR QCI each subsequent Byte shall be present only if the corresponding next octet in the "EPS quality of service" information element is present. The coding of the corresponding bytes shall be the same.

Coding of Byte X+3:

- PDP_type: same as the "PDP type" subparameter, defined in TS 24.008 [9] for ETSI or IETF allocated address.

NOTE 1: the UICC should handle the cases with X > 14 gracefully, ignoring additional octets.

NOTE 2: For NG-RAN, QoS parameters are not applicable.

8.52.6 Bearer parameters for NG-RAN

Contents: parameters describing the type of PDU session. This is an element of the PDU session context.

When the ME has successfully established PDU session it shall include this Bearer parameter in the TERMINAL RESPONSE to inform the USIM.

The Bearer parameters for NR shall contain the PDU session type.

Length:

- 1 to X Bytes

Coding:

- Coding of Byte 4:

PDU session type: same as the "PDU session type", defined in Figure 9.11.4.11.1 of TS 24.501 [70].

- Coding of further Bytes:

RFU

8.53 Channel data

See ETSI TS 102 223 [32] clause 8.53.

8.54 Channel data length

See ETSI TS 102 223 [32] clause 8.54.

8.55 Buffer size

See ETSI TS 102 223 [32] clause 8.55.

8.56 Channel status

ETSI TS 102 223 [32] clause 8.56 applies, with the following addition.

In case of an OPEN CHANNEL for IMS, the coding is as follows:

Coding :

- byte 3 :
 - Bit 1 to 3 : Channel identifier 1 to 7;
Channel identifier 0 means "no channel available".
 - Bit 4 to 7 : RFU
 - Bit 8 : 0 = BIP channel not established;
1 = BIP channel established.

- byte 4:
 - '00' = No further info can be given;
 - '01' = Not used;

'02' = Not used;

'03' = Not used;

'04' = Not used;

'05' = Link dropped (network failure or user cancellation);

all other values are reserved.

8.57 Card reader identifier

See ETSI TS 102 223 [32] clause 8.57.

8.58 Other Address

See ETSI TS 102 223 [32] clause 8.58.

8.59 UICC/ME interface transport level

See ETSI TS 102 223 [32] clause 8.59.

8.60 AID

See ETSI TS 102 223 [32] clause 8.60.

8.61 Network Access Name

Byte(s)	Description	Length
1	Network Access Name tag	1
2	Length (X)	1
3 to 3+X-1	Network Access Name	X

Content:

- The Network Access Name is used to identify the Gateway entity (GGSN) or a Packet Data Network Gateway (PDN-GW) or a User Plane Function (UPF), which provides interworking with an external packet data network. For GPRS, UTRAN packet service and E-UTRAN, the Network Access Name is an APN. For NG-RAN, the Network Access Name is a DNN (which is coded same as an APN).

Coding:

- As defined in TS 23.003 [30].

8.62 Access Technology

See ETSI TS 102 223 [32] clause 8.61.

8.63 Display parameters

See ETSI TS 102 223 [32] clause 8.62.

8.64 Service Record

See ETSI TS 102 223 [32] clause 8.63.

8.65 Device Filter

See ETSI TS 102 223 [32] clause 8.64.

8.66 Service Search

See ETSI TS 102 223 [32] clause 8.65.

8.67 Attribute Information

See ETSI TS 102 223 [32] clause 8.66.

8.68 Service Availability

See ETSI TS 102 223 [32] clause 8.67.

8.69 Remote Entity Address

See ETSI TS 102 223 [32] clause 8.68.

8.70 Text Attribute

See ETSI TS 102 223 [32] clause 8.72.

8.71 Item Text Attribute List

See ETSI TS 102 223 [32] clause 8.73.

8.72 PDP context Activation parameters

Byte(s)	Description	Length
1	PDP context Activation parameters tag	1
2 to (Y+1)	Length (X)	Y
(Y+2) to (Y+X+1)	PDP context Activation parameters	X

The PDP context Activation parameters are coded as the ACTIVATE PDP CONTEXT REQUEST message, refer to TS 24.008 [9].

NOTE: If the "Protocol configuration options" in the ACTIVATE PDP CONTEXT REQUEST message is too large (i.e. greater than 229-L, where L is the sum of the length of the Requested QoS Information Element, the Requested PDP address Information Element, and the Access point name Information Element), the ME may decide not to include the "Protocol configuration options" and any subsequent information elements of the ACTIVATE PDP CONTEXT REQUEST message inside the "PDP context Activation parameters".

8.73 UTRAN/E-UTRAN/NG-RAN Measurement Qualifier

This information is only available when the ME is connected to a UTRAN or an E-UTRAN or NG-RAN.

Byte(s)	Description	Length
1	UTRAN/E-UTRAN/NG-RAN Measurement Qualifier tag	1
2	Length (1)	1
3	UTRAN/E-UTRAN/NG-RAN Measurement Qualifier	1

UTRAN/E-UTRAN/NG-RAN Measurement Qualifier

Contents: Qualifier specific to the UTRAN/E-UTRAN/NG-RAN NMR

Coding

'01'	UTRAN Intra-frequency measurements
'02'	UTRAN Inter-frequency measurements
'03'	UTRAN Inter-RAT (GERAN) measurements
'04'	UTRAN Inter-RAT (E-UTRAN) measurements
'05'	E-UTRAN Intra-frequency measurements
'06'	E-UTRAN Inter-frequency measurements
'07'	E-UTRAN Inter-RAT (GERAN) measurements
'08'	E-UTRAN Inter-RAT (UTRAN) measurements
'09'	E-UTRAN Inter-RAT (NR) measurements
'0A'	NG-RAN Intra-frequency measurements
'0B'	NG-RAN Inter-frequency measurements
'0C'	NG-RAN Inter-RAT (E-UTRAN) measurements

All other values are reserved

8.74 Multimedia Message Reference

See ETSI TS 102 223 [32] clause 8.82.

8.75 Multimedia Message Identifier

See ETSI TS 102 223 [32] clause 8.83.

8.76 Multimedia Message Transfer status

See ETSI TS 102 223 [32] clause 8.84.

8.77 MM Content Identifier

In addition to ETSI TS 102 223 [32] clause 8.85, the codinf of the MM Content Data Object tag is done according to TS 31.102[14].

8.78 Multimedia Message Notification

See ETSI TS 102 223 [32] clause 8.86.

8.79 Last Envelope

See ETSI TS 102 223 [32] clause 8.87.

8.80 Frames Layout

See ETSI TS 102 223 [32] clause 8.78.

8.81 Frames Information

See ETSI TS 102 223 [32] clause 8.79.

8.82 Frames identifier

See ETSI TS 102 223 [32] clause 8.80.

8.83 I-WLAN Identifier

Byte(s)	Description	Length
1	I-WLAN Identifier tag	1
2	Length (X)	1
3 to (2+X)	WSID value	X

The WSID Value is coded as the WLAN Specific Identifier (WSID) defined in TS 24.234 [42].

8.84 (I-)WLAN Access Status

Byte(s)	Description	Length
1	(I-)WLAN Access Status tag	1
2	Length (1)	1
3	Access status	1

Coding of Access status:

- '00' = No current (I-)WLAN coverage;
- '01' = (I-)WLAN coverage available, no current connection;
- '02' = (I-)WLAN coverage available, connection on-going;
- '03' to 'FF' = reserved values.

8.85 IMEISV

See ETSI TS 102 223 [32] clause 8.74.

8.86 Network search mode

See ETSI TS 102 223 [32] clause 8.75.

8.87 Battery State

See ETSI TS 102 223 [32] clause 8.76.

8.88 Browsing status

See ETSI TS 102 223 [32] clause 8.77.

8.89 Registry application data

See ETSI TS 102 223 [32] clause 8.88.

8.90 PLMNwAcT List

Byte(s)	Description	Length
1	PLMNwAcT List tag	1
2	Length (5n)	1
3 to 5	1 st PLMN Identifier(highest priority)	3
6 to 7	1 st PLMN Access Technology Identifier	2
:	:	
(5n-2) to (5n)	n th PLMN Identifier (lowest priority)	3
(5n+1) to (5n+2)	n th PLMN Access Technology Identifier	2

Coding of PLMN Identifier:

As for PLMN within EF_{PLMNwAcT} in TS 31.102 [14].

Coding of PLMN Access Technology Identifier:

As for Access Technology Identifier within EF_{PLMNwAcT} in TS 31.102 [14].

8.91 Routing Area Identification

Byte(s)	Description	Length
1	Routing Area Information Tag	1
2	Length	1
3 - 5	Mobile Country & Network Codes (MCC & MNC)	3
6 - 7	Location Area Code (LAC)	2
8	Routing Area code (RAC)	1

When present, this object shall contain the Routing Area Identification information of rejecting network. The RAI is coded in the same manner as the value part of the Routing Area Identification information element as specified in TS 24.008 [9].

8.92 Update/Attach/Registration Type

Byte(s)	Description	Length
1	Update/Attach/Registration Type Tag	1
2	Length	1
3	Update/Attach/Registration Type	1

Contents:

- In the case of GERAN/UTRAN, the terminal shall use this information as a mechanism to indicate to the UICC the location updating type that was sent in the LOCATION UPDATING REQUEST message or the attach type that was sent in the GPRS ATTACH REQUEST message or the update type that was sent in the ROUTING AREA UPDATING REQUEST message, as specified in TS 24.008 [9].
- In the case of E-UTRAN, the terminal shall use this information as a mechanism to indicate to the UICC the EPS attach type that was sent in the EMM ATTACH REQUEST message or the EPS update type that was sent in the TRACKING AREA UPDATE REQUEST message, as specified in TS 24.301 [46].

- In the case of NG-RAN, the terminal shall use this information as a mechanism to indicate to the UICC the 5GS registration type that was sent in the REGISTRATION REQUEST message, as specified in TS 24.501 [70].

Coding:

- '00' = "Normal Location Updating" in the case of a LOCATION UPDATING REQUEST message;
- '01' = "Periodic Updating" in the case of a LOCATION UPDATING REQUEST message;
- '02' = "IMSI Attach" in the case of a LOCATION UPDATING REQUEST message;
- '03' = "GPRS Attach" in the case of a GPRS ATTACH REQUEST message;
- '04' = "Combined GPRS/IMSI Attach" in the case of a GPRS ATTACH REQUEST message;
- '05' = "RA Updating" in the case of a ROUTING AREA UPDATE REQUEST message;
- '06' = "Combined RA/LA Updating" in the case of a ROUTING AREA UPDATE REQUEST message;
- '07' = "Combined RA/LA Updating with IMSI Attach" in the case of a ROUTING AREA UPDATE REQUEST message;
- '08' = "Periodic Updating" in the case of a ROUTING AREA UPDATE REQUEST message;
- '09' = "EPS Attach" in the case of an EMM ATTACH REQUEST message;
- '0A' = "Combined EPS/IMSI Attach" in the case of an EMM ATTACH REQUEST message;
- '0B' = "TA updating" in the case of an EMM TRACKING AREA UPDATE REQUEST message;
- '0C' = "Combined TA/LA updating" in the case of an EMM TRACKING AREA UPDATE REQUEST message;
- '0D' = "Combined TA/LA updating with IMSI attach" in the case of an EMM TRACKING AREA UPDATE REQUEST message;
- '0E' = "Periodic updating" in the case of an EMM TRACKING AREA UPDATE REQUEST message;
- '0F' = "Initial Registration" in the case of a 5GMM REGISTRATION REQUEST message;
- '10' = "Mobility Registration updating" in the case of a 5GMM REGISTRATION REQUEST message;
- '11' = "Periodic Registration updating" in the case of a 5GMM REGISTRATION REQUEST message;
- All other values are reserved for future use

8.93 Rejection Cause Code

Byte(s)	Description	Length
1	Rejection Cause Code Tag	1
2	Length	1
3	Rejection Cause Code	1

For GERAN/UTRAN, in the case of a LOCATION UPDATING REJECT message, this object shall contain the Reject Cause as received in the LOCATION UPDATING REJECT message. The Reject Cause is coded in the same manner as the value part of the Reject Cause information element as specified in TS 24.008 [9].

For GERAN/UTRAN, in the case of a GPRS ATTACH REJECT message or a ROUTING AREA UPDATE REJECT message, this object shall contain the GMM Cause as received in the GPRS ATTACH REJECT message or ROUTING AREA UPDATE REJECT message. The GMM Cause is coded in the same manner as the value part of the GMM Cause information element as specified in TS 24.008 [9].

For E-UTRAN, in the case of an EMM ATTACH REJECT message or an EMM TRACKING AREA UPDATE REJECT message, this object shall contain the EMM Cause as received in the EMM ATTACH REJECT message or

EMM TRACKING AREA UPDATE REJECT message. The EMM Cause is coded in the same manner as the value part of the EMM Cause information element as specified in TS 24.301 [46].

For NG-RAN, in the case of a 5GMM REGISTRATION REJECT message, this object shall contain the 5GMM Cause as received in the 5GMM REGISTRATION REJECT message. The 5GMM Cause is coded in the same manner as the value part of the 5GMM Cause information element as specified in TS 24.501 [70].

8.94 Geographical Location Parameters

Byte(s)	Description	Length
1	Geographical Location Parameters Tag	1
2	Length	1
3	Horizontal accuracy	1
4	Vertical coordinate	1
5	Velocity	1
6	Preferred GAD shapes	1
7	Preferred NMEA sentences	1
8	Preferred Maximum Response Time	1

Horizontal accuracy:

Contents:

- the preferred horizontal accuracy.

Coding:

- '81': horizontal accuracy not specified / best effort;
- 'xx' where '00' ≤ 'xx' ≤ '7F': 'xx' represents the uncertainty for longitude and latitude as described in TS 23.032 [44]. A value in this range may be specified in the parameters of the "Geographical Location Request" command. The horizontal location error should be less than the error indicated by the horizontal accuracy with 67% confidence.
- All other values are reserved.

Vertical coordinate:

Contents:

- indicates if the vertical coordinate (altitude) is requested and potentially indicate the preferred vertical coordinate accuracy.

Coding:

- '80': vertical coordinate is not requested (i.e. 2D location fix is acceptable);
- '81': vertical coordinate is requested, (i.e. 3D location fix is preferred) but accuracy is not specified (best effort);
- 'xx' where '00' ≤ 'xx' ≤ '7F': vertical coordinate is requested and 'xx' represents the altitude uncertainty as described in TS 23.032 [44]. A value in this range may be specified in the parameters of the "Geographical Location Request" command. The vertical location error should be less than the error indicated by the vertical accuracy with 67% confidence.
- All other values are reserved.

Velocity:

Contents:

- indicates if a velocity and a velocity uncertainty are requested. When a velocity type or an uncertainty are requested, the corresponding bit shall be set to 1. Otherwise the bit is set to 0. If b1 is set to zero, b2, b3 and b4 shall be ignored. If b2 is set to zero, b4 shall be ignored.

Coding:

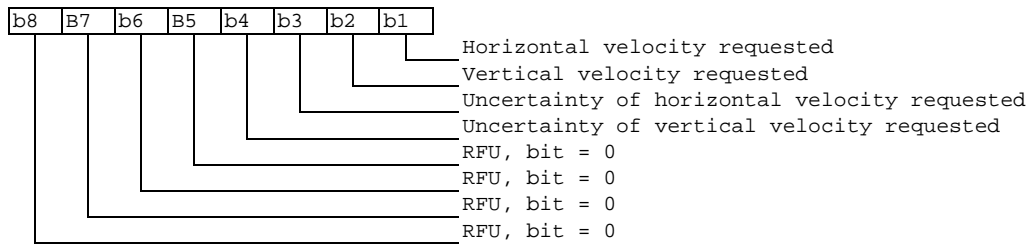

Preferred GAD shapes:

Contents:

- the preferred GAD shape(s). When a GAD shape is indicated as "preferred", the corresponding bit shall be set to 1. Otherwise the bit is set to 0. The UICC application should be capable of extracting the needed information from all GAD shapes indicated in the bit map below.

Coding:

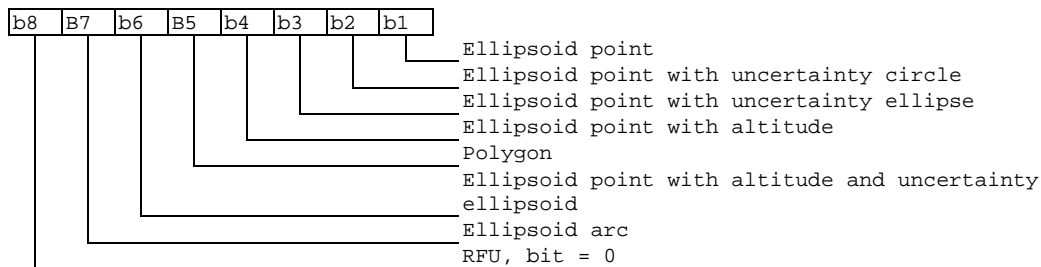

Preferred NMEA sentences:

Contents:

- the preferred NMEA sentence(s). When a NMEA sentence is indicated as "preferred", the corresponding bit shall be set to 1. Otherwise the bit is set to 0. The UICC application should be capable of extracting the needed information from all NMEA sentences indicated in the bit map below.

Coding:

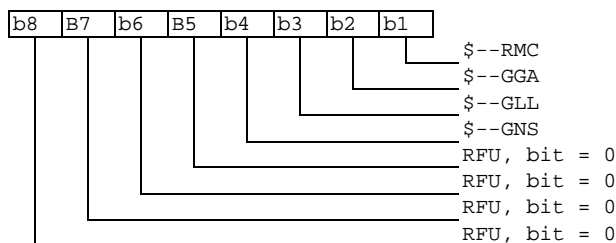

Preferred Maximum Response Time:

Contents:

- indicates the preferred maximum response time. This hint may be used by the ME to make trade-offs between requirements for positioning accuracy and response time.

Coding:

- 'xx' where '02' ≤ 'xx' ≤ '07': 2^{xx} represents the preferred maximum response time in seconds.
- All other values are reserved;

8.95 GAD shapes

Byte(s)	Description	Length
1	GAD shapes Tag	1
2	Length	1
3	Length of GAD shape	1
4 to X+3	GAD shape	X
X+4	Length of Velocity	1
X+5 to X+Y+4	Velocity	Y

Length of GAD shape:

Contents:

- the length of the GAD shape.

Coding:

- binary.

GAD shape:

Contents:

- universal geographical area description shape.

Coding:

- shape encoded as described in TS 23.032 [44] with the first byte of the shape (i.e. octet 1 containing the type shape) encoded on byte 4.

Length of Velocity:

Contents:

- the length of the velocity. This byte shall be set to '00' when the Velocity is not available.

Coding:

- binary.

Velocity:

Contents:

- velocity.

Coding:

- velocity encoded as described in TS 23.032 [44] with the first byte of the velocity (i.e. octet 1 containing the velocity shape) encoded on byte X+5.

8.96 NMEA sentence

Byte(s)	Description	Length
1	NMEA sentence Tag	1
2	Length	1
3 to X+2	NMEA sentence	X

NMEA sentence:

Contents:

- NMEA sentence as defined in IEC 61162-1 [45]. The ME should use one of the Preferred NMEA sentences indicated in the "Geographical Location Parameters" by the UICC. Otherwise, one of the NMEA sentences listed in clause 8.94 shall be used.

Coding:

ASCII;

8.97 PLMN List

Byte(s)	Description	Length
1	PLMN List tag	1
2	Length (3n)	1
3 to 5	1 st PLMN Identifier(highest priority)	3
:	:	
(3n) to (3n+2)	nth PLMN Identifier (lowest priority)	3

Coding of PLMN Identifier:

As for PLMN within EF_{OPLMNWLAN} in TS 31.102 [14].

8.98 EPS PDN connection activation parameters

Byte(s)	Description	Length
1	EPS PDN connection Activation parameters tag	1
2 to (Y+1)	Length (X)	Y
(Y+2) to (Y+X+1)	EPS PDN connection Activation parameters	X

The EPS PDN connection Activation parameters are coded as the PDN CONNECTIVITY REQUEST message, refer to TS 24.301 [46].

NOTE: If the "Protocol configuration options" in the PDN CONNECTIVITY REQUEST message is too large (i.e. greater than 229-L, where L is the length of the Access point name Information Element), the ME may decide not to include the "Protocol configuration options" and any subsequent information elements of the PDN CONNECTIVITY REQUEST message inside the "EPS PDN connection Activation parameters".

8.99 Tracking Area Identification

Byte(s)	Description	Length
1	Tracking Area Identification Tag	1
2	Length	1
3 - 5	Mobile Country & Network Codes (MCC & MNC)	3
6 - X	Tracking Area Code (TAC) (See NOTE)	X - 5

NOTE: TAC is coded in 2 bytes for E-UTRAN and in 3 bytes for NG-RAN

This object shall contain the Tracking Area Identification information of rejecting network (i.e. MCC, MNC and TAC). The value part of this object is coded in the same manner as the value part of the Tracking Area Identity information element as specified in TS 24.301 [46] for E-UTRAN, or as the value part of the Tracking Area Identity information element as specified in TS 24.501 [70] for NG-RAN.

8.100 CSG ID list identifier

Byte(s)	Description	Length
1	CSG ID list Identifier tag	1
2 to 1+Y	Length	Y
(Y+2) to (Y+X+1)	CSG ID List	X (X>1)

CSG ID List:

Description	Value	M/O	Length (bytes)
PLMN Tag	'80'	M	1
Length	A	M	1
PLMN	--	M	A
CSG ID and Name Tag	'81'	M	1
Length	B	M	1
CSG ID and Name	-	M	B

The CSG ID List TLV object shall contain one PLMN TLV object, Tag '80', followed by at least one CSG ID and Name TLV, Tag '81'. The CSG ID List TLV object can contain more than one PLMN TLV objects. Each CSG ID and Name TLV belongs to the previous PLMN.

Coding of PLMN object (Tag '80'):

Content:

Mobile Country Code (MCC) followed by the Mobile Network Code (MNC).

Coding:

according to TS 24.008 [9].

Coding of CSG ID and name (Tag '81'):

Content:

CSG ID and HNB Name

Coding:

1 to 4	CSG ID	M	4 bytes
5 to B	HNB Name	M	B-4 bytes

CSG ID: as in EF_{ACSGL}, in TS 31.102 [14].

HNB Name: as for HNB name in EF_{HNB} in TS 31.102 [14].

8.101 CSG cell selection status

Byte(s)	Description	Length
1	CSG cell selection status tag	1
2	Length	1
3	CSG cell selection status	2

Coding of CSG cell selection status:

Byte 1 : general information

- '00' = not camped on a CSG or Hybrid cell in the Allowed CSG list or the Operator CSG list
- '01' = camped on a CSG or Hybrid cell of the Operator CSG list or Allowed CSG list

- other values are RFU

Byte 2 : additional information

This byte may contain additional information. If additional information is present, bit b1 shall be set to 1. If b1 is set to 0, this byte shall be ignored.

Bits b7 and b8 indicate the CSG selection mechanism used; see TS 25.304 [59] and TS 36.304 [60].

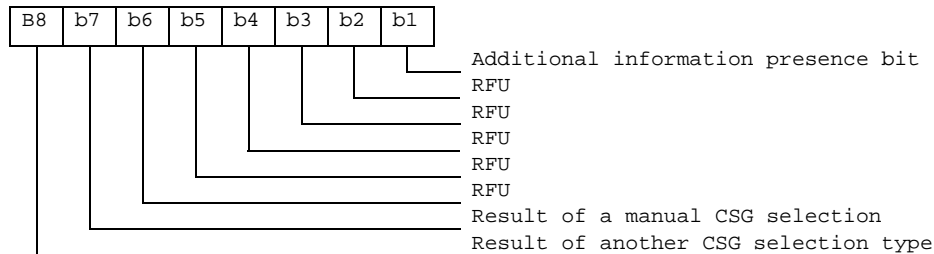

8.102 CSG ID

Byte(s)	Description	Length
1	CSG ID tag	1
2	Length	1
3 to X+2	CSG ID	X

Coding of CSG ID:

As for CSG ID in EF_{ACSGL} , in TS 31.102 [14]

8.103 HNB name

Byte(s)	Description	Length
1	HNB name tag	1
2	Length	1
3 to 2+X	HNB name	X

Coding of HNB name:

As for HNB name in $EF_{HNBName}$ in TS 31.102 [14]

8.104 Activate descriptor

Not required by 3GPP.

8.105 Broadcast Network information

Not required by 3GPP.

8.106 Contactless state request

Not required by 3GPP.

8.107 Contactless functionality state

Not required by 3GPP.

8.108 IMS URI

Byte(s)	Description	Length
1	IMS URI Tag	1
2 to (Y+1)	Length	Y
(Y+2) to (Y+X+1)	IMS URI (IMPU)	X

Content :

IMS URI shall take the form of IMPU, which is SIP URI or tel URI, as defined in TS 24.229 [52]

Coding of IMS URI

As defined in TS 24.229 [52]

8.109 Extended registry application data

See ETSI TS 102 223 [32] clause 8.93.

8.110 IARI

Byte(s)	Description	Length
1	IARI Tag	1
2 to (Y+1)	Length	Y
(Y+2) to (Y+X+1)	IARI value	X
NOTE: X>0		

Coding:

- IARI value shall be coded as specified in TS 24.229 [52].

8.111 IMPU List

Byte(s)	Description	Length
1	IMPU List Tag	1
2 to (Y+1)	Length	Y
Y+2	URI TLV tag	1
(Y+3) to (Y+Z+2)	URI TLV length	Z
..	:	...
...

Coding:

- For contents and syntax of URI TLV data object values see IETF RFC 3261 [53]. The URI shall be encoded to an octet string according to UTF-8 encoding rules as specified in IETF RFC 3629 [54]. The tag value of the URI TLV data object shall be '80'.

8.112 IMS status code

Byte(s)	Description	Length
1	IMS Status-code Tag	1
2	Length	1
3 to X+2	IMS Status-code	X
NOTE: X>0		

Content

- IMS status code as specified in 3GPP TS 24.229 [52]

Coding:

- Sequence of digits in ASCII format.

8.113 eCAT client profile

Not required by 3GPP.

8.114 eCAT client identity

Not required by 3GPP.

8.115 Encapsulated envelope type

Not required by 3GPP.

8.116 Void

8.117 Void

8.118 PLMN ID

Byte(s)	Description	Length
1	PLMN Identity Tag	1
2	Length	1
3 to 5	PLMN identity	3

PLMN ID TLV object shall contain PLMN identity Tag followed by Length and PLMN identity, containing Mobile Country Code (MCC) and Mobile Network Code (MNC), coded according to TS 24.008 [9].

8.119 E-UTRAN Inter-frequency Network Measurement Results

Byte(s)	Description	Length
1	E-UTRAN Inter-frequency Network Measurement Results tag	1
2	Length (X) of bytes following	1
3 – 6	Frequency value	4
7 – to X+6	Measurement Report information	X

The ME can send more than one E-UTRAN Inter-frequency Network Measurement Results TLV object, each containing the results of one frequency. This TLV object shall be used only if the service "extended EARFCN" is available in the USIM Service Table (see TS 31.102 [14]).

The frequency value shall be coded as the ARFCN-ValueEUTRA-v9e0 as defined in TS 36.331 [49].

The Measurement Report information shall be coded as *MeasurementReport* information element defined in the ASN.1 description of TS 36.331 [49], according to the following:

- The "measId" field in the "measResults" shall be set to the value '1'.
- the ME shall include IE "measResultServCell" with RSRP and RSRQ of the serving cell.
- the ME shall, in the *MeasurementReport*, include IE "measResultListEUTRA" in IE "Measured Results". The ME shall report RSRP, RSRQ, Physical Cell ID and IE "cgi-Info" for the up to 6 strongest (highest RSRQ value) inter-frequency cells per monitored frequency, if available in the ME according to TS 36.331 [49] and TS 36.133 [50].
- All other optional fields in the *MeasurementReport* shall be set to be absent.

8.120 Call control result

Not required by 3GPP.

8.121 eCAT sequence number

Not required by 3GPP.

8.122 Encrypted TLV list

Not required by 3GPP.

8.123 MAC

Not required by 3GPP.

8.124 SA template

1) Not required by 3GPP.

8.125 CAT service list

Not required by 3GPP.

8.126 Refresh enforcement policy

See ETSI TS 102 223 [32] clause 8.103.

8.127 DNS Server Address

See ETSI TS 102 223 [32] clause 8.104.

8.128 ProSe Report Data

Byte(s)	Description	Length
1	ProSe Report Data Tag	1
2 to (X+1)	Length	X (1 or 2)
X+2 to X+1+Y	ProSe Report Data	Y

Contents:

- Contains the ProSe Report

Coding:

- Coded according to the XML schema defined in TS 24.334 [61] with <prose-pc3ch-message> element as the root element and one <USAGE_INFORMATION_REPORT_LIST> element inside it.

8.129 SSID

Byte(s)	Description	Length
1	SSID tag	1
2	Length (X)	1
3 to (2+X)	SSID Value	X ≤ 32

The SSID value is coded as specified for the SSID field in IEEE 802.11 [64].

8.130 BSSID

Byte(s)	Description	Length
1	BSSID tag	1
2	Length = '06'	1
3 to 8	BSSID value	6

The BSSID value is coded as specified for the BSSID field in IEEE 802.11 [64].

8.131 HESSID

Byte(s)	Description	Length
1	HESSID tag	1
2	Length = '06'	1
3 to 8	HESSID value	6

The HESSID value is coded as specified for the HESSID field in IEEE 802.11 [64].

8.132 Media Type

The Media Type data element indicates the media type of the communication.

Byte(s)	Description	Length
1	Media type tag	1
2	Length = '01'	1
3	Media type value	1

Coding:

- The Media type value is coded as a bitmap

First byte (conversational communication):

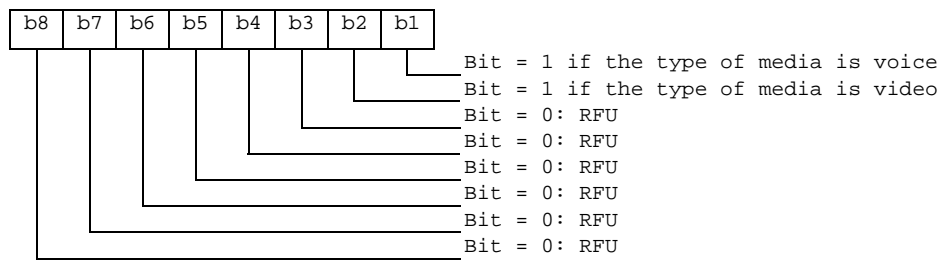

8.133 IMS call disconnection cause

Byte(s)	Description	Length
1	IMS cause tag	1
2	Length = '03'	1
3	Protocol	1
4 to 5	Cause	2

Protocol is the value of the protocol header field parameter in the Reason header field of the SIP message triggering the call disconnect event. It is coded on 1 byte as follows:

- '01' for SIP
- '02' for Q.850
- Other values are RFU

Cause is the value of the cause header field parameter in the Reason header field of the SIP message triggering the call disconnect event. It is coded as 2-bytes integer, e.g. a value of "603" translates to '025B'.

8.134 E-UTRAN Primary Timing Advance Information

Byte(s)	Description	Length
1	E-UTRAN Timing Advance tag	1
2	Length = '03'	1
3	ME Status	1
4 - 5	E-UTRAN Primary Timing Advance value	2

Coding of ME status:

- '00' = ME is in the idle state;
- '01' = ME is not in idle state;
- '02' to 'FF' = reserved values.

The E-UTRAN Primary Timing Advance value is equal to the total "Timing offset between uplink and downlink radio frames at the UE, expressed in units of Ts" (Basic time unit), as defined in TS 36.211 [66].

If the ME has never been in E-UTRAN RRC connected mode on the current cell, the value of the E-UTRAN Primary Timing Advance shall be set to 'FF FF'.

8.135 URI truncated

Byte(s)	Description	Length
1	URI truncated tag	1
2	Length = '0'	1

8.136 Extended Rejection Cause Code

Byte(s)	Description	Length
1	Extended Rejection Cause Code Tag	1
2	Length	1
3	Extended Rejection Cause Code	1

For E-UTRAN, in the case of an EMM ATTACH REJECT message or an EMM TRACKING AREA UPDATE REJECT message, if the Extended EMM Cause is available, then this object shall contain the Extended EMM Cause as received in the EMM ATTACH REJECT message or EMM TRACKING AREA UPDATE REJECT message. The Extended EMM Cause is coded in the same manner as the value part of the Extended EMM Cause information element as specified in TS 24.301 [46].

8.137 Data connection status

This data object shall contain the result of the PDP request procedure, PDN request procedure or PDU establishment procedure as defined in 3GPP TS 24.008 [9] for GERAN & UTRAN, 3GPP TS 24.301 [46] for E-UTRAN or 3GPP TS 24.501 [70] for NG-RAN.

Byte(s)	Description	Length
1	Data connection status tag	1
2	Length = '01'	1
3	Data connection status value	1

Data connection status value coding:

- '00' = Data connection successful; Successful means accepted by the network and completed by the device.
- '01' = Data connection rejected;
- '02' = Data connection dropped or deactivated.
- Other values RFU

8.138 Data connection type

This data object shall contain the type of procedure, PDP request procedure, PDN request procedure or PDU establishment procedure, as defined in 3GPP TS 24.008 [9] for GERAN & UTRAN, 3GPP TS 24.301 [46] for E-UTRAN or 3GPP TS 24.501 [70] for NG-RAN.

Byte(s)	Description	Length
1	Data connection type tag	1
2	Length = '01'	1
3	Data connection type	1

Data connection type coding:

- '00' = PDP connection
- '01' = PDN connection

- '02' = PDU connection
- Other values RFU

8.139 (E/5G)SM cause

This data object shall contain the value of the SM cause for PDP as defined in 3GPP TS 24.008 [9] for GERAN & UTRAN, the ESM Cause for PDN as defined in 3GPP TS 24.301 [46] for E-UTRAN or the 5GSM Cause for PDU as defined in 3GPP TS 24.501 [70] for NG-RAN.

Byte(s)	Description	Length
1	(E/5G)SM cause tag	1
2	Length = '01'	1
3	(E/5G)SM cause value	1

(E/5G)SM cause value coding:

For PDP procedures:

The coding of the cause is defined in 3GPP TS 24.008 [9]

- If the data connection (i.e. request procedure) is accepted, (E/5G)SM cause value is the SM cause value contained in the message for PS session management (i.e. ACTIVATE PDP CONTEXT ACCEPT message) coded as in TS 24.008 [9] clause 10.5.6.6a;
- If the data connection (i.e. request procedure) fails or is deactivated, (E/5G)SM cause value is the SM cause value contained in the messages for PS session management (i.e. ACTIVATE PDP CONTEXT REJECT message or REQUEST PDP CONTEXT ACTIVATION REJECT message or the DEACTIVATE PDP CONTEXT REQUEST message) and is coded as in TS 24.008 [9] clause 10.5.6.6.

For PDN procedures:

The coding of the cause is defined in 3GPP TS 24.301 [46].

- If the data connection (i.e. request procedure) fails or is deactivated, (E/5G)SM cause value is the ESM cause value contained in the message types for EPS session management (ie. in the PDN CONNECTIVITY REJECT message or ACTIVATE DEFAULT EPS BEARER CONTEXT REJECT message or the DEACTIVATE EPS BEARER CONTEXT REQUEST message) and is coded as in TS 24.301 [46] clause 9.9.4.4.

For PDU procedures:

The coding of the cause is defined in 3GPP TS 24.501 [70].

- If the data connection (i.e. request procedure) fails or is deactivated/released, (E/5G)SM cause value is the 5GSM cause value contained in the message types for 5GS session management (ie. in the PDU SESSION ESTABLISHMENT REJECT message or in the PDU SESSION RELEASE REQUEST message) and is coded as in TS 24.501 [70] clause 9.11.4.2.

8.140 IP address list

Byte(s)	Description	Length
1	IP address list Tag	1
2	Length	1
3 to (2+X)	Other address TLV object(s)	X

Content :

- List of IP addresses on the H(e)NB-network interface.

Coding:

- coding of Other address : see clause 8.58.

8.141 Surrounding macrocells

Byte(s)	Description	Length
1	Surrounding macrocell list Tag	1
2	Length	1
3 to 5	Access Technology TLV object(s)	3
6 to 6+X	Location information TLV object(s)	X

Content :

- List of surrounding macrocells, per access technology

Coding:

- coding of Access Technology : see clause 8.62.
- coding of Location Information : see clause 8.19.

8.142 PDP/PDN/PDU type

This data object shall contain the PDP, PDN or PDU Session type, as defined in 3GPP TS 24.008 [9] for GERAN and UTRAN, in 3GPP TS 24.301 [46] for E-UTRAN or in 3GPP TS 24.501 [70] for NG-RAN.

Byte(s)	Description	Length
1	PDP/PDN/PDU type tag (see Note)	1
2	Length = '01'	1
3	PDP/PDN type or PDU Session type	1
NOTE: Interpretation of the type depends on the value for the Access Technology (see clause 8.62)		

PDP/PDN type coding:

- '00' = IPv4
- '01' = IPv6
- '03' = IPv4v6
- '04' = PPP
- '05' = non IP

All other values are RFU.

PDU Session type coding:

- '00' = IPv4
- '01' = IPv6
- '03' = IPv4v6
- '04' = Unstructured
- '05' = Ethernet

All other values are RFU.

8.143 PDU Session Establishment parameters

Byte(s)	Description	Length
1	PDU Session Establishment parameters tag	1
2 to (Y+1)	Length (Z+X)	Y
(Y+2) to (Y+Z+1)	DNN	Z
(Y+Z+2) to (Y+Z+X+1)	PDU Session Establishment parameters	X

The DNN is coded as specified in TS 24.501 [70] clause 9.11.2.1B.

The PDU Session Establishment parameters are coded as the PDU SESSION ESTABLISHMENT REQUEST message as specified in TS 24.501 [70].

NOTE: If the "SM PDU DN request container" in the PDU SESSION ESTABLISHMENT REQUEST message is too large (i.e. greater than $207-Z$, where Z is the length of the DNN Information Element), the ME may decide not to include the "SM PDU DN request container" and any subsequent information elements of the PDU SESSION ESTABLISHMENT REQUEST message inside the "PDU Session Establishment parameters". If the "Extended protocol configuration options" in the PDU SESSION ESTABLISHMENT REQUEST message is too large (i.e. greater than $207-Z-L$, where Z is the length of the DNN Information Element, L is the length of the "SM PDU DN request container", and $L \leq (207-Z)$), the ME may decide not to include the "Extended protocol configuration options" inside the "PDU Session Establishment parameters".

8.144 NG-RAN Primary Timing Advance Information

Byte(s)	Description	Length
1	NG-RAN Timing Advance tag	1
2	Length = '04'	1
3	ME Status	1
4 - 6	NG-RAN Primary Timing Advance value	3

Coding of ME status:

- '00' = ME is in the idle state;
- '01' = ME is in inactive state;
- '02' = ME is in connect state;
- '03' to 'FF' = reserved values.

The NG-RAN Primary Timing Advance value is equal to the total "Timing offset between uplink and downlink radio frames at the UE, expressed in units of T_s " (Basic time unit), as defined in TS 38.211 [73].

If the ME has never been in NG-RAN RRC connected mode on the current cell, the value of the NG-RAN Primary Timing Advance shall be set to 'FF FF FF'.

8.145 Slices information

This data object contain a list of slice information.

Each slice information element is a S-NSSAI as specified in 3GPP TS 23.003 [30].

Byte(s)	Description	Length	M/O/C
1	Slices information tag	1	M
2	Length ($X = 1 + 4n$) of bytes following	1	M
3	Number of Served S-NSSAIs (n)	1	M
4 to 7	Served S-NSSAI 1 – SST + SD	4	C (see Note)
	C (see Note)
($X - 1$) to ($X + 2$)	Served S-NSSAI n - SST + SD	4	C (see Note)
NOTE : if no Served S-NSSAI is available, this field is not present			

Number of Served S-NSSAIs

- Contents:

- Value set to 0 if no Served S-NSSAI is available else this is the number of Served S-NSSAI that will be described in the following list.

Served S-NSSAI

- Coding:

S-NSSAI shall be coded on 32 bits.

- As specified in TS 23.003 [30], SD reserved value "no SD value associated with the SST" defined as hexadecimal FFFFFFFF shall be used to pad value to 32 bits

9 Tag values

This clause specifies the tag values used to identify the BER-TLV and COMPREHENSION-TLV data objects used in the present document, in addition to those defined in ETSI TS 101 220 [43].

9.1 BER-TLV tags in ME to UICC direction

Description	Length of tag	Value
SMS-PP download tag	1	'D1'
Cell Broadcast download tag	1	'D2'
MO Short message control tag	1	'D5'
USSD download tag	1	'D9'
Geographical Location Reporting tag	1	'DD'
ProSe Report tag	1	'DF'
Reserved for 3GPP (for future usage)	1	'E0'
Reserved for 3GPP (for future usage)	1	'E1'
Reserved for 3GPP (for future usage)	1	'E2'
Reserved for 3GPP (for future usage)	1	'E3'

9.2 BER-TLV tags in UICC TO ME direction

No additional tag is defined.

9.3 COMPREHENSION-TLV tags in both directions

Description	Length of tag	Tag value, bits 1-7 (Range: '01' - '7E')	Tag (CR and Tag value)	Reassign (see NOTE)
SS string tag	1	'09'	'09' or '89'	yes
BSSID tag				
PLMN ID tag	1	'09'	'09' or '89'	yes
E-UTRAN Timing Advance tag				
USSD string tag	1	'0A'	'0A' or '8A'	yes
HESSID tag				
SMS TPDU tag	1	'0B'	'0B' or '8B'	yes
PDP/PDN/PDU type tag				
Cell Broadcast page tag	1	'0C'	'0C' or '8C'	yes
PDU session establishment parameters tag				
Cause tag	1	'1A'	'1A' or '9A'	yes
BCCH channel list tag				
Data connection status tag	1	'1D'	'1D' or '9D'	yes
BC Repeat Indicator tag				
Data connection type tag	1	'2A'	'2A' or 'AA'	yes
Timing Advance tag				
(E/5G)SM cause tag	1	'2E'	'2E' or 'AE'	yes
PDP context Activation parameters tag				
Surrounding macrocells tag	1	'52'	'52' or 'D2'	yes
UTRAN/E-UTRAN/NG-RAN Measurement Qualifier tag				
IP address list tag	1	'69'	'69' or 'E9'	yes
I-WLAN Identifier tag				
SSID tag	1	'4A'	'4A' or 'CA'	yes
(I-)WLAN Access Status tag				
PLMNwAcT List tag	1	'4B'	'4B' or 'CB'	yes
PLMNwAcT List tag				
Routing Area Information tag	1	'72'	'72' or 'F2'	yes
URI truncated				
Update/Attach Type tag	1	'73'	'73' or 'F3'	yes
ProSe Report Data Tag				
Rejection Cause Code tag	1	'74'	'74' or 'F4'	yes
Geographical Location Parameters tag				
IARI tag	1	'75'	'75' or 'F5'	yes
GAD shapes tag				
IMPU list tag	1	'76'	'76' or 'F6'	yes
NMEA sentence tag				
IMS Status-Code tag	1	'77'	'77' or 'F7'	yes
PLMN List tag				
E-UTRAN Inter-frequency Network Measurement Results tag	1	'78'	'78' or 'F8'	yes
EPS PDN connection Activation parameters tag				
Tracking Area Identification tag	1	'79'	'79' or 'F9'	yes
CSG ID list tag				
Media type tag	1	'7D'	'7D' or 'FD'	yes
CSG cell selection status tag				
IMS call disconnection cause tag	1	'7E'	'7E' or 'FE'	yes
CSG ID tag				
Slice information tag	1	'55'	'55' or 'D5'	yes
HNB name tag				
Extended rejection cause code tag	1	'56'	'56' or 'D6'	yes
IMS URI tag				
NG-RAN Primary Timing Advance Information	1	'57'	'57' or 'D7'	yes
	1	'31'	'31' or 'B1'	yes

NOTE: Starting from Release 10, tag values are assigned in a context specific manner, i.e. the same tag value can be used for different data objects, provided that the object can be uniquely identified from the context of the proactive command or ENVELOPE command in which it is used.
The column "Reassign" indicates whether it is expected that a tag can be reassigned in a context specific manner (yes), whether that is not recommended (NR) because of potential future conflicts or if this shall not be done (no).

9.4 Type of Command and Next Action Indicator

The table below shows the values which shall be used for Type of Command coding (see clause 8.6) and Next Action Indicator coding (see clause 8.24) in addition to those defined in ETSI TS 102 223 [32] clause 9.4.

Value	Name	used for Type of Command coding	used for Next Action Indicator coding
'11'	SEND SS	X	X
'12'	SEND USSD	X	X
'16'	Geographical Location Request	X	
'75'	reserved for 3GPP (for future usage)	not available	not available
'76'	reserved for 3GPP (for future usage)	not available	not available
'77'	reserved for 3GPP (for future usage)	not available	not available
'78'	reserved for 3GPP (for future usage)	not available	not available

10 Allowed Type of command and Device identity combinations

Only certain types of commands can be issued with certain device identities. These combinations are defined below, in addition to ETSI TS 102 223 [32] clause 10.

Command description	Source	Destination
CELL BROADCAST DOWNLOAD	Network	UICC
MO SHORT MESSAGE CONTROL	ME	UICC
SEND SS	UICC	Network
SEND USSD	UICC	Network
(I-)WLAN Access Status	ME	UICC
Network Rejection	Network	UICC
Geographical Location Request	UICC	ME

11 Security requirements

TS 31.115 [41] and TS 31.116 [51] specify standardized methods of securing the content of application messages. If it is necessary to secure application messaging to Toolkit applications, then TS 31.115 [41] and TS 31.116 [51] may be used.

Annex A (normative): Support of USAT by Mobile Equipment

Support of USAT is optional for Mobile Equipment. However, if an ME states conformance with a specific 3GPP release, it is mandatory for the ME to support all functions of that release, with the exception of the functions:

- "Alpha identifier in REFRESH command supported by terminal";
- "Event Language Selection";
- "Proactive UICC: PROVIDE LOCAL INFORMATION (language)"; and
- "Proactive UICC: LANGUAGE NOTIFICATION".

The support of USAT implies the support of CAT (ETSI TS 102 223 [32]).

The support of letter classes, which specify mainly ME hardware dependent features, is optional for the ME and may supplement the USAT functionality described in the present document. If an ME states conformance to a letter class, it is mandatory to support all functions within the respective letter class.

The table below indicates the commands and functions of the optional letter classes.

Letter classes	Command/function description
a to m	See TS 102 223 [32]. Class "e" also includes the Event Download: Data Connection Status Change Event.
n	Proactive command: Geographical Location Request Envelope command: Geographical Location Reporting
o	See TS 102 223 [32]
p	USSD Data download in application mode
q	Proactive command : Provide Local Information (CSG cell discovery) Event download : CSG cell selection
r	See TS 102 223 [32]
s	See TS 102 223 [32]
t	Event download: Incoming IMS Data Event download: IMS Registration Proactive command : OPEN CHANNEL for IMS
u	See TS 102 223 [32]
v	Proactive command : Provide Local Information (H(e)NB IP address)
w	Proactive command : Provide Local Information (H(e)NB surrounding macrocells)
x	Security for Profile Container, Envelope Container, COMMAND CONTAINER and ENCAPSULATED SESSION CONTROL (reserved by ETSI SCP – not needed by 3GPP)
y	Envelope command: Service List Retrieval (reserved by ETSI SCP – not needed by 3GPP)
z	Indication of subsequent link with same Network Access Name in CLOSE CHANNEL. See TS 102 223 [32]
aa	DNS server address request for OPEN CHANNEL. See TS 102 223 [32]
ab	Proactive command: LAUNCH BROWSER. See TS 102 223 [32]
ac	Extended Launch Browser Capability Event download: Browser termination event Event download: Browsing status event. See TS 102 223 [32]
ad	Event download: Poll Interval Negotiation. See TS 102 223 [32]
ae	URI support for SET UP CALL proactive command
af	Proactive Command: REFRESH with "Application Update" mode. See TS 102 223 [32]
ag	Reserved for 3GPP (for future usage)
ah	Reserved for 3GPP (for future usage)
ai	Non-IP Data Delivery support over BIP
aj	Reserved for 3GPP (for future usage)
ak	Proactive command: eUICC OPERATION. See TS 102 223 [32]

Annex B (informative): Example of DISPLAY TEXT Proactive UICC Command

See ETSI TS 102 223 [32] Annex B.

Annex C (normative): Structure of USAT communications

See ETSI TS 102 223 [32] Annex C.

Annex D (informative): ME display in proactive UICC session

See ETSI TS 102 223 [32] Annex D.

Annex E (informative): Help information feature processing

See ETSI TS 102 223 [32] Annex E.

Annex F (informative): Monitoring of events

In addition to ETSI TS 102 223 [32] Annex F. , the following is defined:

Event	Continuously reported	Reported once
(I-)WLAN Access Status	X	
Network Rejection	X	
CSG cell selection	X	

Annex G (normative): Support of Multiple Card Operation

See ETSI TS 102 223 [32] Annex G.

Annex H (informative): Multiple Card proactive command examples

See ETSI TS 102 223 [32] Annex H.

Annex I (informative): Bearer independent protocol proactive command examples

See ETSI TS 102 223 [32] Annex I.

Annex J (informative): WAP References

See ETSI TS 102 223 [32] Annex J.

Annex K (informative): Use of USAT Bearer independent protocol for local links Bluetooth case

See ETSI TS 102 223 [32] Annex K.

Annex L (informative): Bluetooth Service Discovery protocol

See ETSI TS 102 223 [32] Annex L.

Annex M (informative): Use of USAT Bearer independent protocol for local links, server case

See ETSI TS 102 223 [32] Annex M.

Annex N (informative): USSD information flow between the Network, the ME and the UICC

N.1 MMI Mode

Mobile initiated USSD operation, Nentwork does not request further information

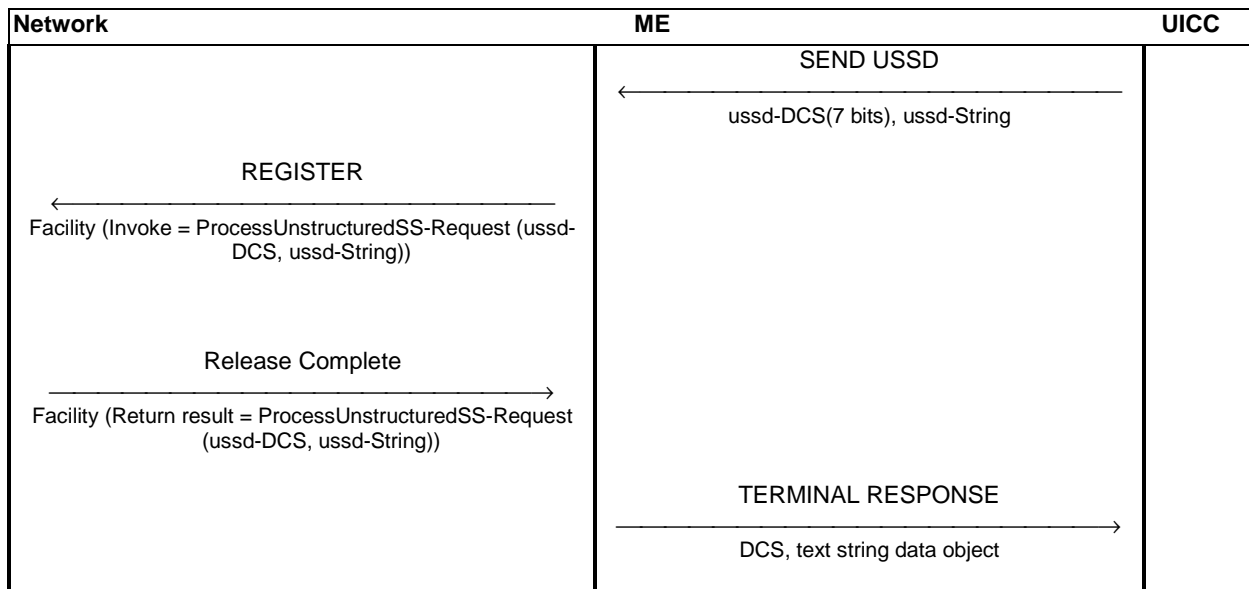

Figure N.1

Mobile initiated USSD operation, Network requests further information

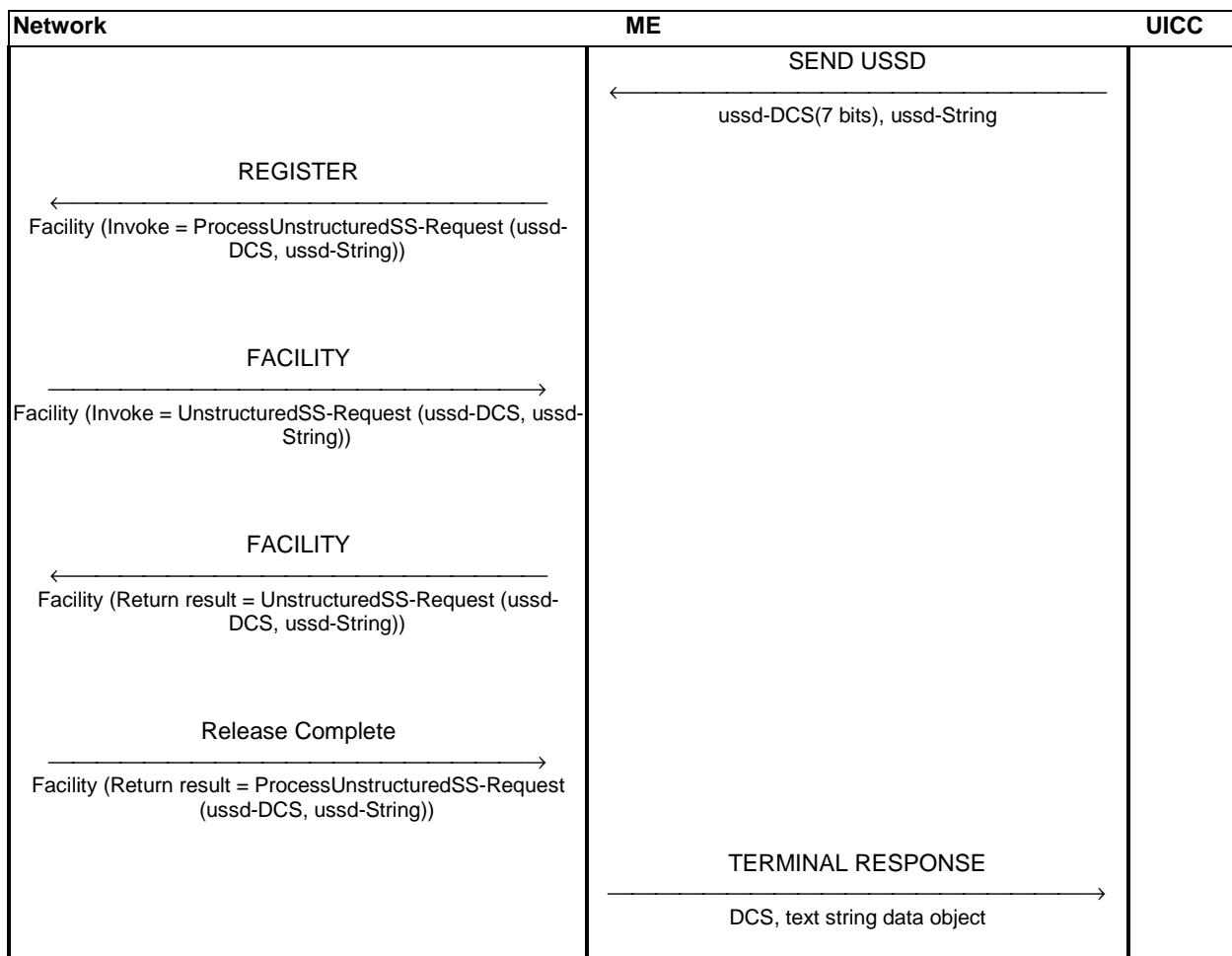

Figure N.2

N.2 Application Mode

Mobile initiated USSD operation, Network does not request further information

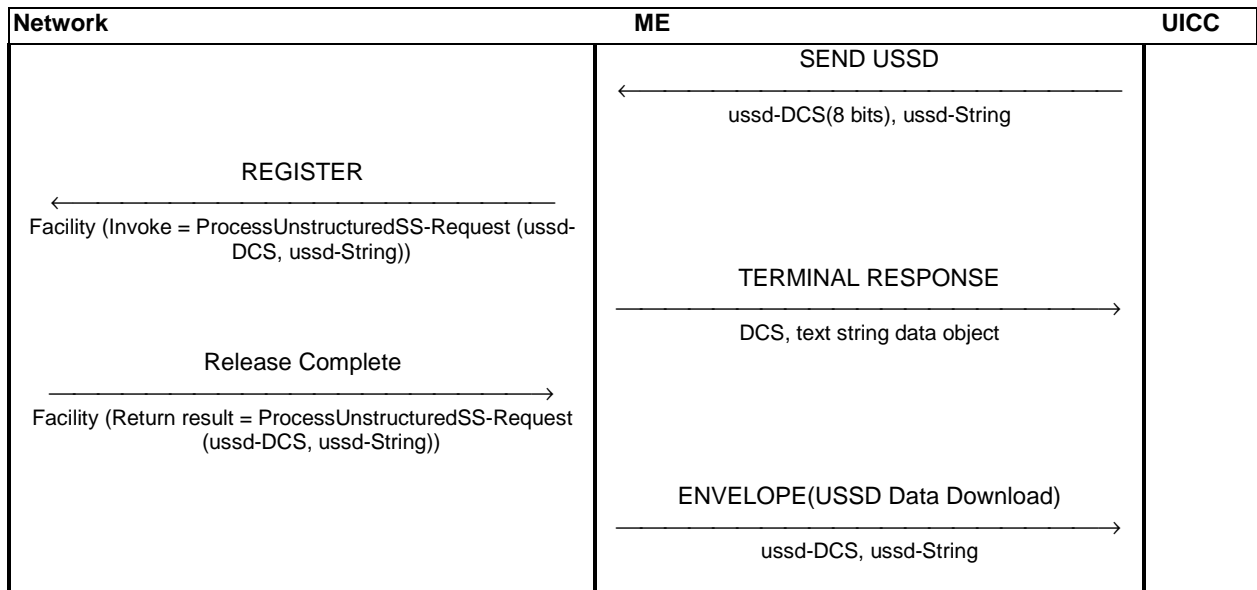

Figure N.3

Mobile initiated USSD operation, Network requests further information

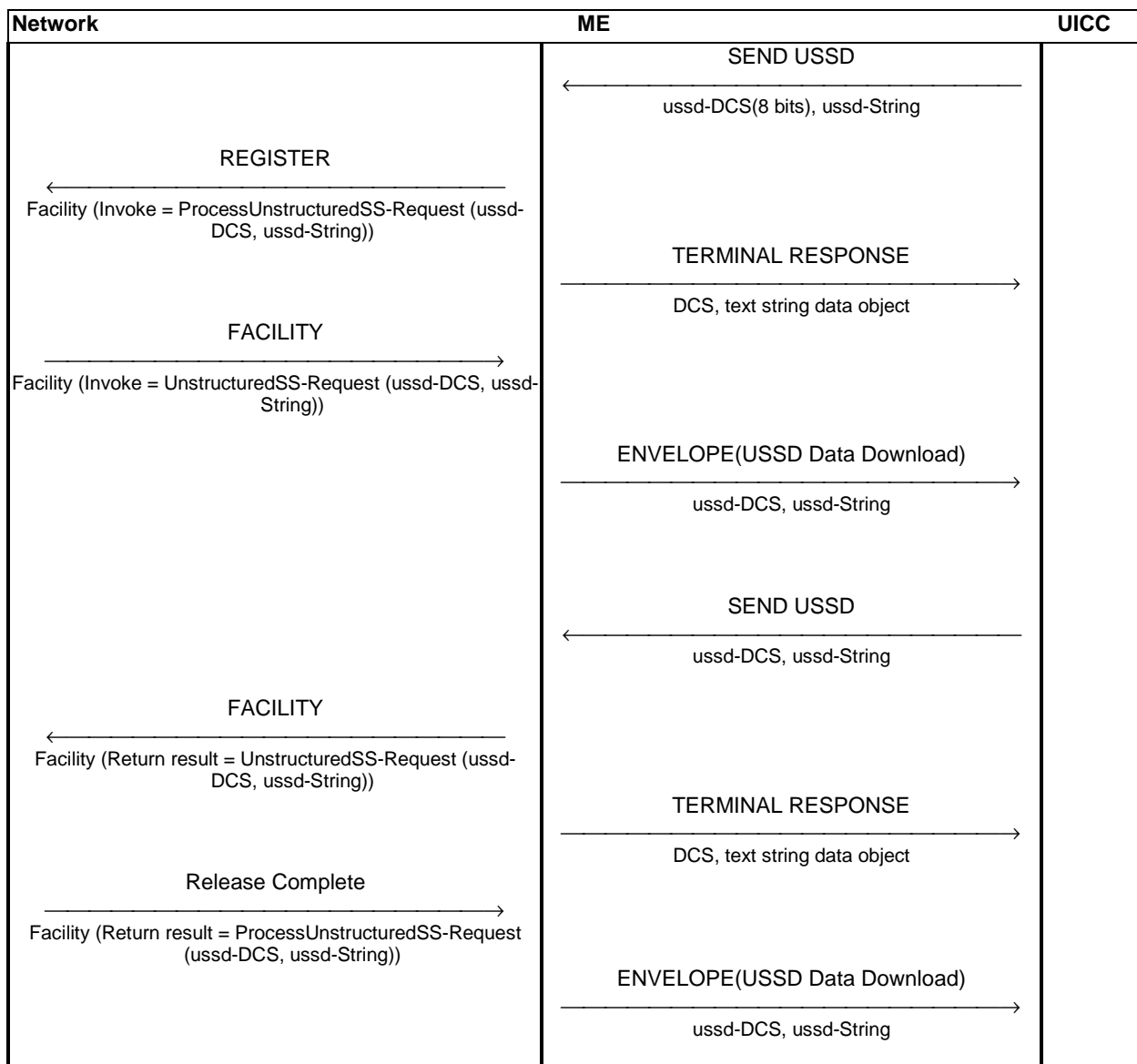

Figure N.4

N.3 USSD Data Download

Network initiated USSD operation

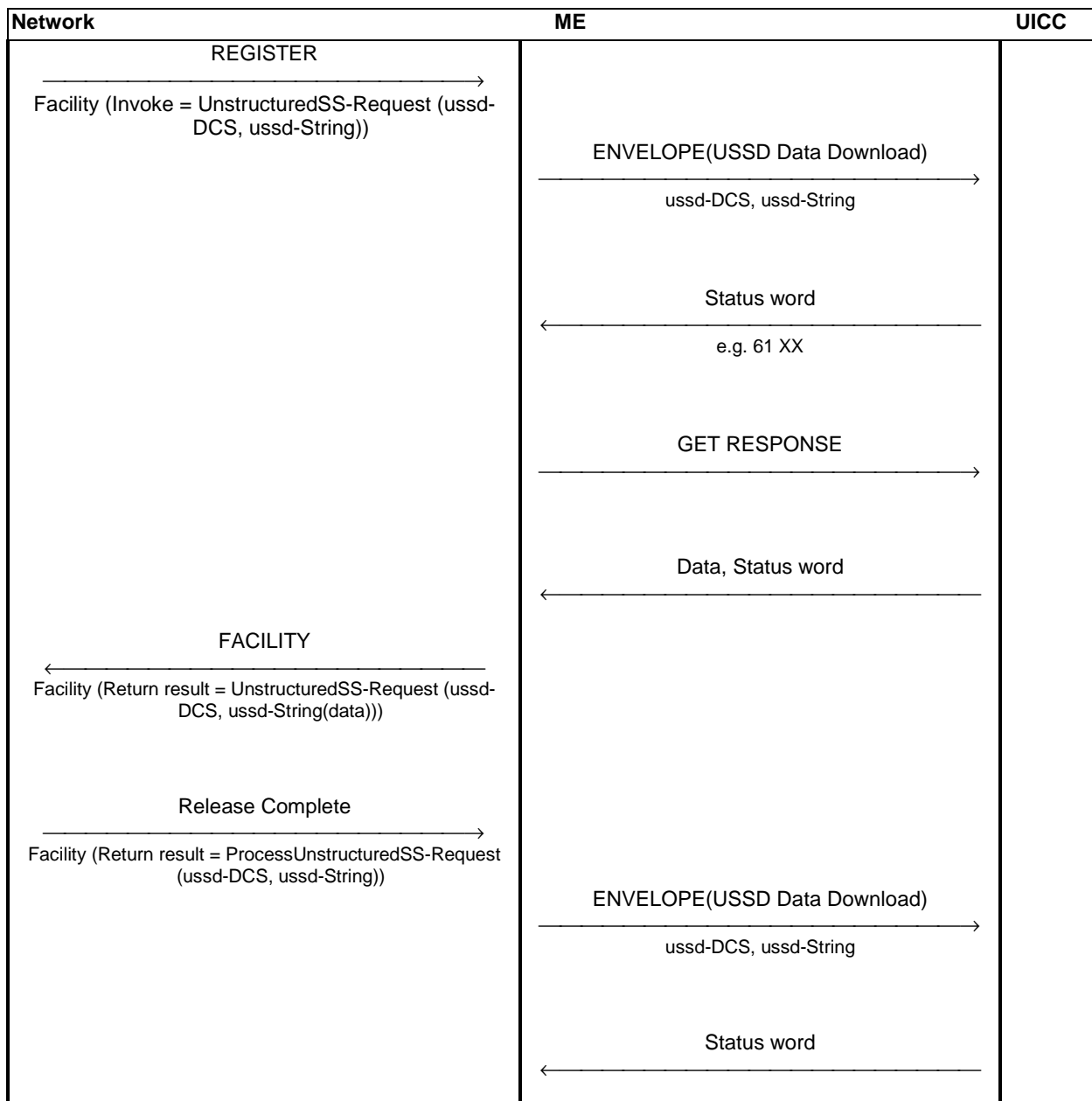

Figure N.5

Annex O (informative): Geographical location information discovery information flow between the ME and the UICC

The ME accepts the parameters provided by the UICC

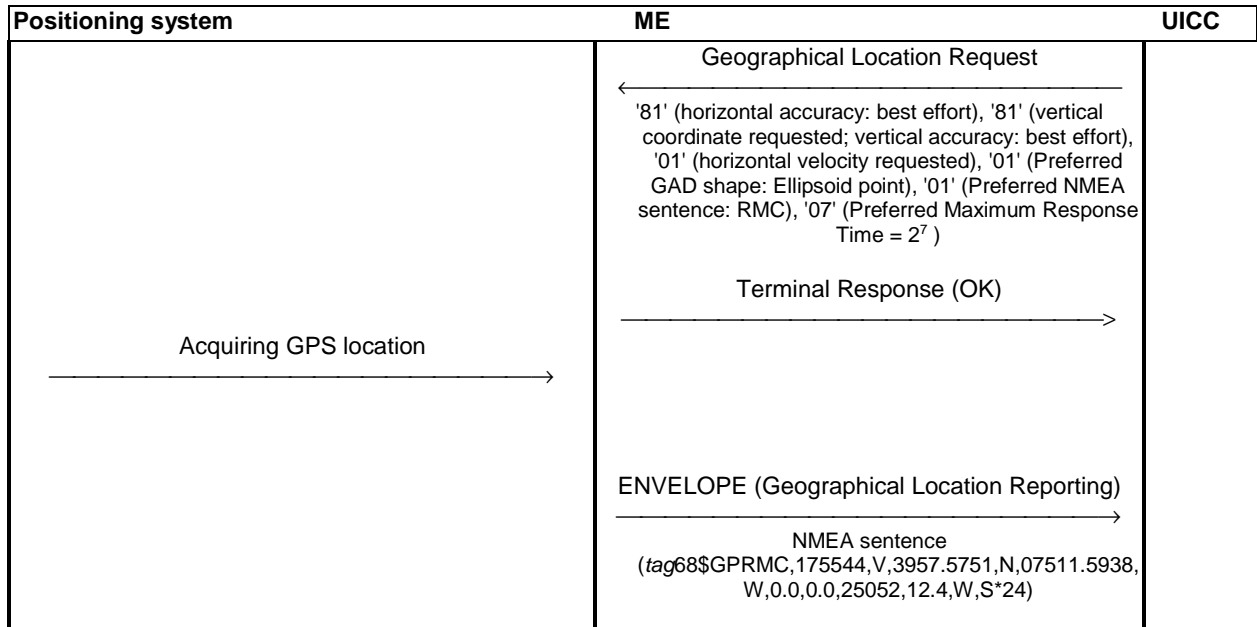

Figure O.1

Annex P (normative): Support of USAT by Terminals with reduced feature capabilities.

See ETSI TS 102 223 [32] Annex S except for USAT-specific commands which are defined as follows.

Table P.1 provides the applicability of USAT-specific envelope commands for the different terminal types.

Table P.2 provides an overview of USAT-specific affected commands.

Table P.1: Envelope applicability table

Envelope	ND type	NK type	NA type	NS type	NL type
SMS-PP data download					
Cell Broadcast data download					
Call Control by USIM	Note 2				
MO Short Message Control by USIM	Note 2				
EVENT DOWNLOAD - (I-)WLAN Access status					
EVENT DOWNLOAD - Network Rejection					
USSD Data Download					
Geographical Location Reporting					
ProSe Report					
Note 1: "O" means proactive command is optional, No indication means that the proactive command is fully applicable.					
Note 2: If an alpha identifier is provided by the UICC in the response, it shall be ignored by the terminal.					

Table P.2: Overview of affected commands

Command	ND type	NK type	NA type	NS type	NL type
SEND SS	partial				
SEND USSD - MMI Mode	partial				
SEND USSD - Application Mode	partial				
OPEN CHANNEL related to (I-)WLAN bearer	partial				
Geographical Location Request	partial				
Note: "O" means support of this command is optional, "partial" means parts of the command are affected. No indication means that the proactive command is fully applicable.					

Annex Q (normative): Default routing for USAT over AT interface

Q.0 3GPP-specific facilities

The provisions of ETSI TS 102 223 [32] Annex T apply with the extensions given below.

In addition to the facilities given in ETSI TS 102 223 [32], the facilities given in table Q.1 may be supported by multiple entities at the same time.

Table Q.1: Additional facilities that may be supported by multiple entities

Facility	Remarks
Proactive UICC: REFRESH	
Proactive UICC: SET UP EVENT LIST	
Event: Data available	Note 2
Event: Channel status	Note 2
Event: Local connection	Note 2
Proactive UICC: OPEN CHANNEL	Note 1
Proactive UICC: CLOSE CHANNEL	Note 2
Proactive UICC: RECEIVE DATA	Note 2
Proactive UICC: SEND DATA	Note 2
Proactive UICC: GET CHANNEL STATUS	Note 2
Proactive UICC: SERVICE SEARCH	Note 2
Proactive UICC: GET SERVICE INFORMATION	Note 2
Proactive UICC: DECLARE SERVICE	Note 2
Number of channels supported by terminal	Note 3
TCP, UICC in client mode, remote connection	Note 2
UDP, UICC in client mode, remote connection	Note 2
Note 1: Uniqueness is provided by means of the bearer type. Note 2: Uniqueness is provided by means of the channel identifier. Note 3: The total number of channels supported shall be sum of the respective number of supported channels by each entity, limited to a maximum of 7.	

The list of facilities given in ETSI TS 102 223 [32] that can be provided by the MT only shall be considered a default list that applies if EF_{UFC} does not exist (see TS 31.102 [14]). If EF_{UFC} exists, the list coded in this file applies. However, the facilities below are inherent to MT operation and shall be considered MT only even if not indicated so in EF_{UFC}.

- PROVIDE LOCAL INFORMATION (MCC, MNC, LAC/TAC, Cell Identity and Extended Cell Identity)
- PROVIDE LOCAL INFORMATION (NMR)
- POLL INTERVAL
- POLLING OFF
- PROVIDE LOCAL INFORMATION (IMEI)
- PROVIDE LOCAL INFORMATION (IMEISV)
- PROVIDE LOCAL INFORMATION (Search Mode change)
- PROVIDE LOCAL INFORMATION (NMR(UTRAN/E-UTRAN))

Q.1 Default routing mechanism

In addition to the mechanism defined in ETSI TS 102 223 [32], the MT shall route USAT commands as follows:

- SET UP EVENT LIST shall be routed to all entities supporting the command, each containing only the events supported by the entity, even if the list is empty (which allows for proper deregistration of events set up earlier). For the TERMINAL RESPONSE to the UICC, the responses from the MT and the TE have to be combined as follows:
 - The MT shall check if it is able to set up the events it supports itself. If the MT is currently unable to process command or if the set up of the events would fail, the MT shall send this result in the TERMINAL RESPONSE without forwarding the command to the TE.
 - If the MT is capable of setting up the MT events, the list of TE events shall be forwarded to the TE and the TE shall send its TERMINAL RESPONSE.
 - If the TE command was successful, the MT shall set up its events and report that the command was performed in the TERMINAL RESPONSE. If the MT or the TE or both have performed the command with partial comprehension or with missing information, this shall be reflected in the TERMINAL RESPONSE; if one reported partial comprehension and the other missing information, the MT response takes precedence.
 - If the TE reports that it is currently unable to process command or the command failed, the MT shall report this in the TERMINAL RESPONSE.
- REFRESH shall be routed to all entities supporting the command to inform them about modified Efs; only the MT shall perform other activities indicated in the command (e.g. UICC reset). For the TERMINAL RESPONSE to the UICC, the responses from the MT and the TE have to be combined as follows:
 - The MT shall check if it is able to perform the REFRESH. If the MT is currently unable to process the command or the command would fail, the MT shall send this result in the TERMINAL RESPONSE without forwarding the command to the TE.
 - If the MT is capable of performing the REFRESH, the command shall be forwarded to the TE and the TE shall send its TERMINAL RESPONSE, but if there is a refresh action to be performed by the MT (e.g. USIM initialisation), the MT shall send its response to the TE's TERMINAL RESPONSE only after the refresh action has started to avoid that the TE tries to access the UICC before the refresh action.
 - If the TE command was successful, the MT shall perform the REFRESH and report that the command was performed in the TERMINAL RESPONSE. If the MT or the TE have performed the command with a limitation (partial comprehension, missing information, additional Efs read, requested icon could not be displayed or USIM/ISIM was not active) this shall be reflected in the TERMINAL RESPONSE; if both reported different limitations, the MT response takes precedence.
 - If the TE reports that it is currently unable to process command or the command failed, the MT shall report this in the TERMINAL RESPONSE.
- OPEN CHANNEL shall be routed according to the indicated bearer type. To avoid conflicts in channel identifier assignment, the MT shall replace the destination device identity by an available channel identifier and the entity providing the bearer type shall use this channel identifier in its response.
- Subsequent BIP commands shall be routed according to the channel identifier.

Q.2 Combination rules for terminal profiles

In addition to the mechanism defined in ETSI TS 102 223 [32], the MT shall proceed as follows when combining the MT and TE profiles:

- Number of channels supported by terminal for BIP: Here the indicated numbers of the different entities shall be added and the sum, limited to a maximum of 7, shall be provided in the combined terminal profile.

Annex R (informative): UICC access to IMS, command flow examples

This annex applies if class "e" and "t" are supported.

The flowcharts provided in this annex are illustrative examples. The listing of commands is not exhaustive and the timing/order of commands may differ. All SIP requests and responses received by the ME within the SIP dialog established by the SIP INVITE request are sent to the UICC.

R.1 Discovery of the UICC's IARI and IMS Registration

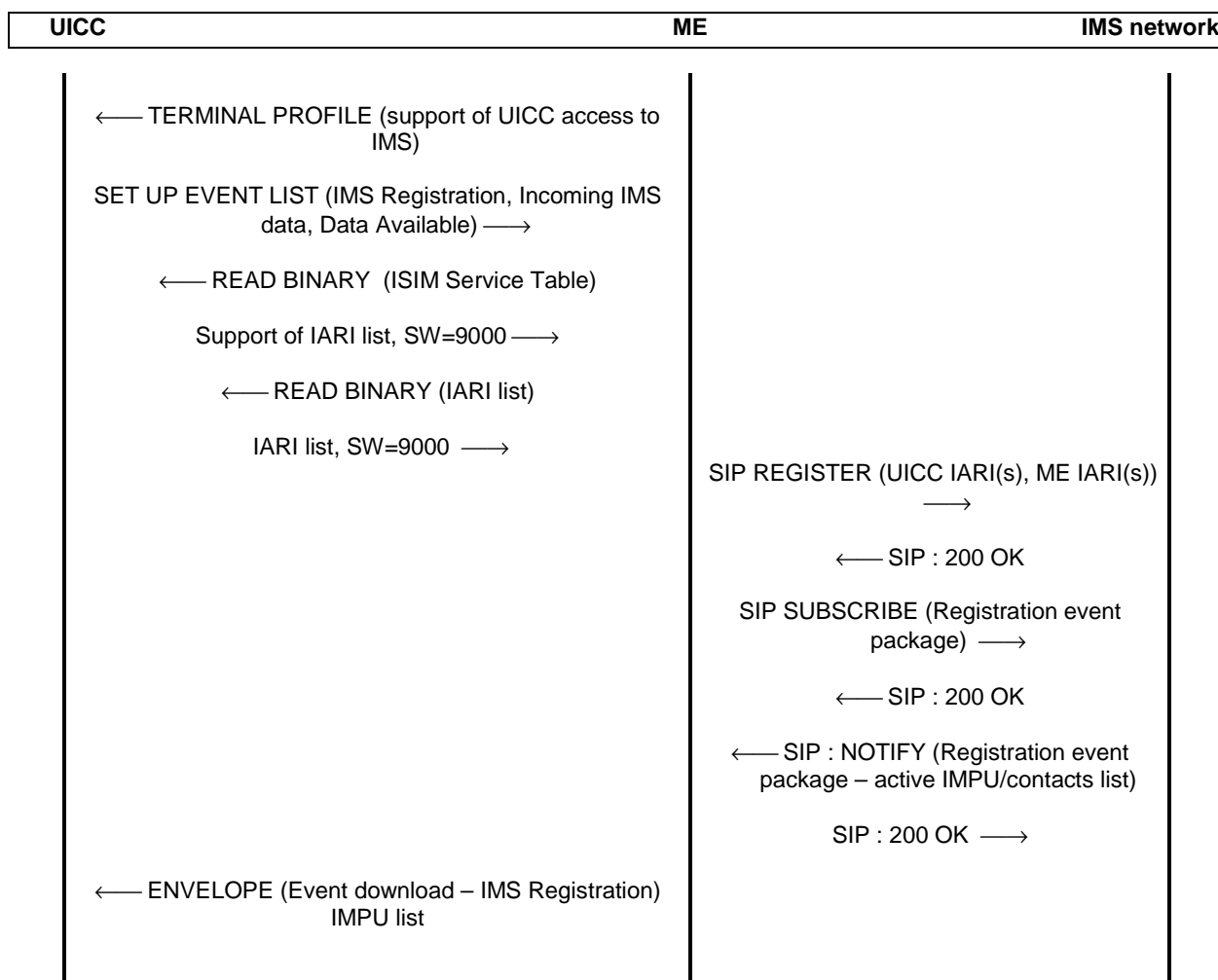

Figure R.1

If the ISIM is present, the list of IARIs associated with active applications installed on the UICC is located in the ISIM. Otherwise, the list of IARIs associated with active applications installed on the UICC is located in the USIM. The case where the ISIM is supported is shown in the command flow.

The ME will register the IARI(s) associated with active applications installed on the UICC and the IARI(s) of applications installed in the ME. The ME does not need to wait for SET UP EVENT LIST command to register to IMS. Therefore it is recommended that the UICC sends the SET UP EVENT LIST as soon as possible to avoid the case where the ME registers to the IMS network before the UICC can be informed of this.

Since the IMS Registration and Incoming IMS data events may occur at anytime, it is assumed that the UICC will keep monitoring both events.

R.2 Notification of Incoming IMS data

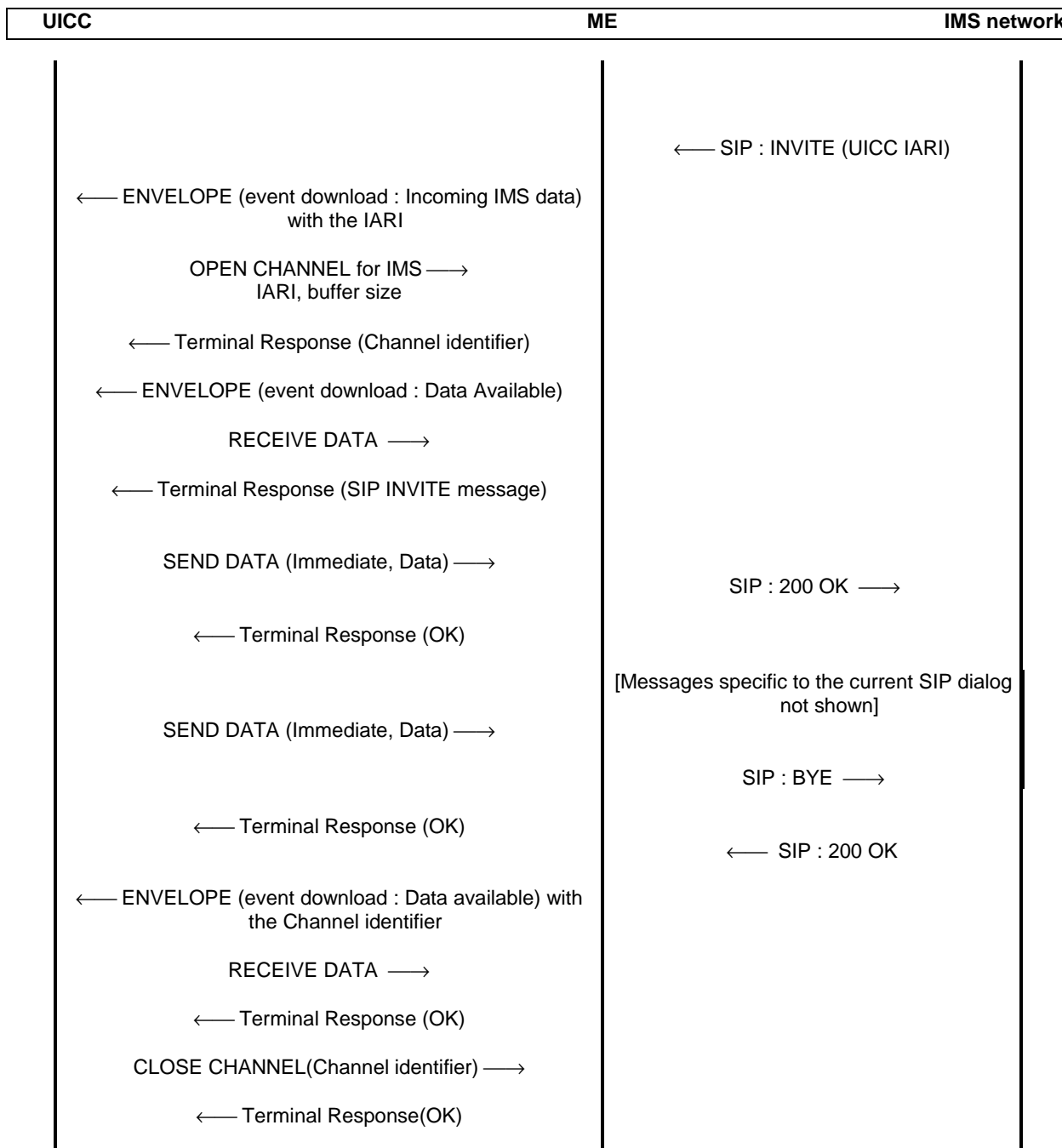

Figure R.2

When an incoming SIP message is received, the ME checks the IARI to see if the destination application resides on ME or on the UICC. If the IARI is associated with an active application installed on the UICC and there is not any channel to the UICC associated with that IARI, the ME informs the UICC with an ENVELOPE Incoming IMS data event command. The UICC sends an Open Channel for IMS proactive command upon reception of this ENVELOPE command. At end of the SIP dialog, the UICC closes the channel to free resources.

This flowchart occurs after a successful IMS registration is completed and the UICC is registered to the Incoming IMS data event. Otherwise the ME discards the incoming SIP INVITE message.

R.3 UICC originating a SIP message

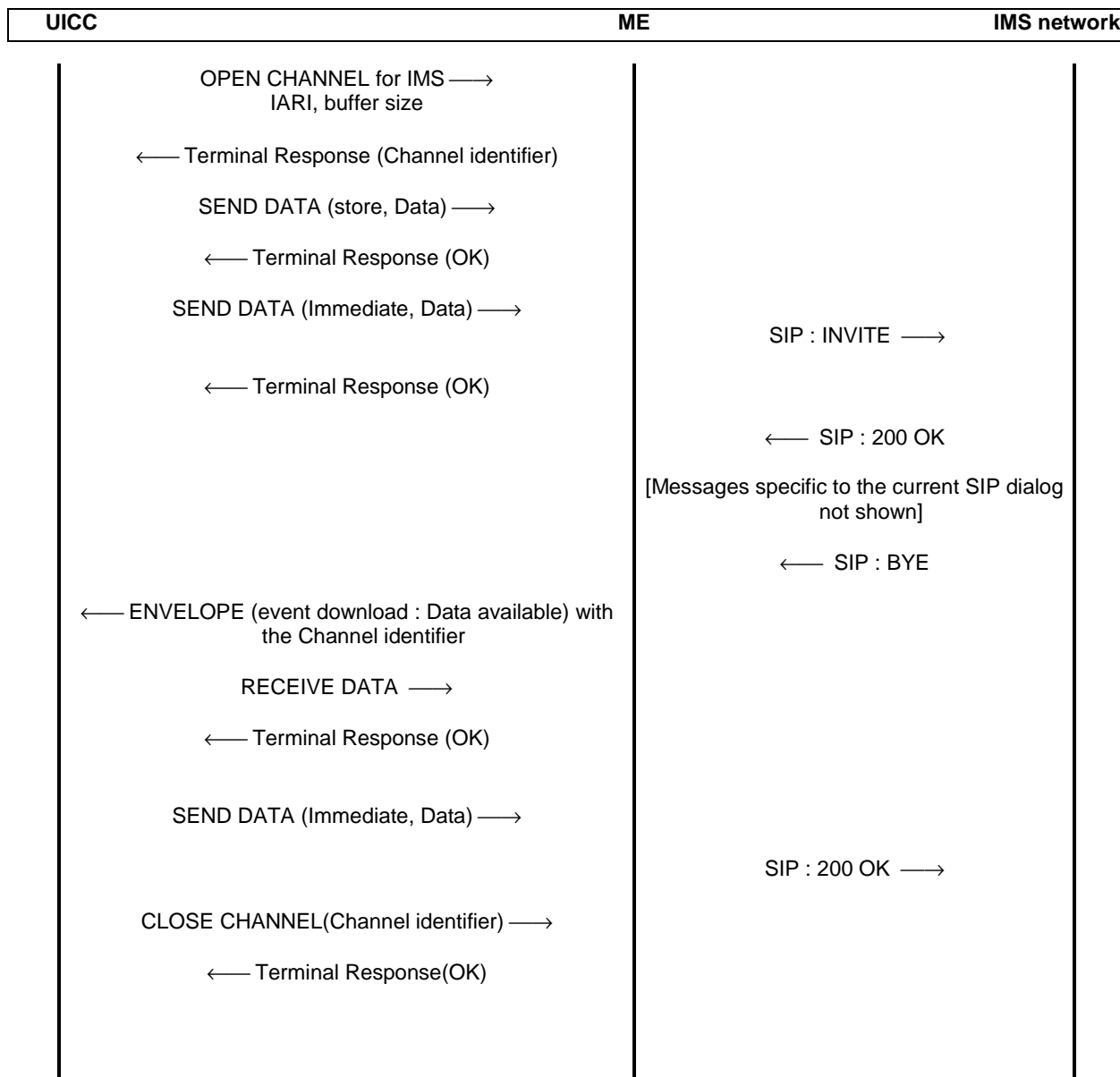

Figure R.3

The UICC will close the channel at the end of the SIP dialog.

Annex S (normative): 3GPP PS data off and Bearer Independent Protocol

This annex applies if class "e" is supported.

The UE may support the 3GPP PS data off.

If the UE supports the 3GPP PS data off, the UE may be configured with an indication whether the Bearer Independent Protocol is a 3GPP PS data off exempt service using one or more of the following methods:

- the Bearer Independent Protocol indication of the EF_{3GPPPSDATAOFF} file described in 3GPP TS 31.102 [14];
- the 3GPP_PS_data_off/Bearer_independent_protocol node of 3GPP TS 24.368 [68].

If the UE is configured with both the BIP_exempt node of 3GPP TS 24.368 [68] and the Bearer Independent Protocol indication of the EF_{3GPPPSDATAOFF} file described in 3GPP TS 31.102 [14], then the Bearer Independent Protocol indication of the EF_{3GPPPSDATAOFF} file shall take precedence.

Annex T (informative): Data Connection Status change event, command flow examples

T.1 Introduction

This annex applies if class "e" is supported.

The flowcharts provided in this annex are illustrative examples. The listing of commands is not exhaustive and the timing/order of commands may differ. They are illustrating how after a completion of PDP, PDN or PDU procedure, initiated by Network or by the ME, a new Data connection status change event is sent to the UICC.

T.2 Success activation of PDP/PDN/PDU request flow example

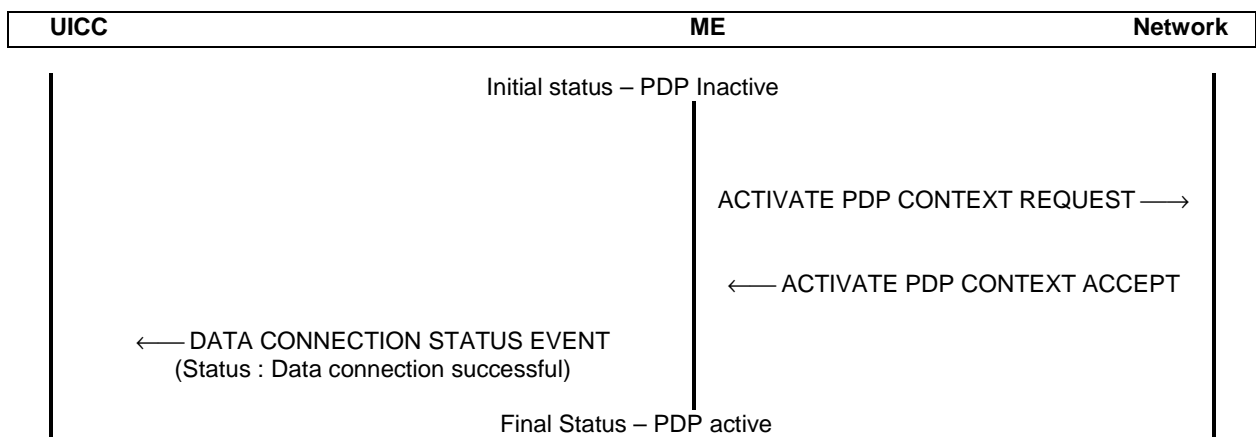

Figure T.2.1 Successful PDP context activation procedure

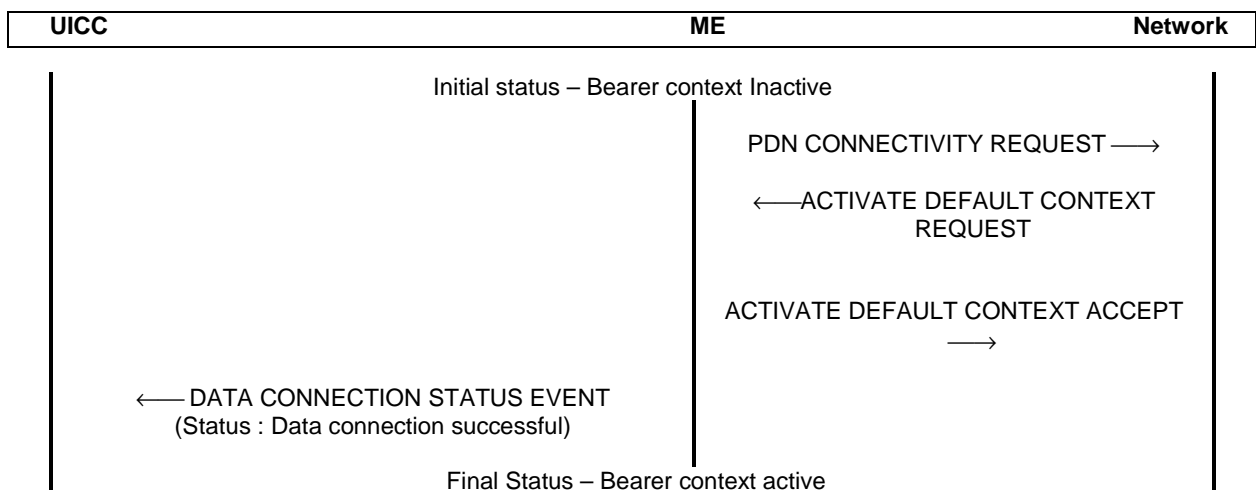

Figure T.2.2 Successful PDN context activation procedure

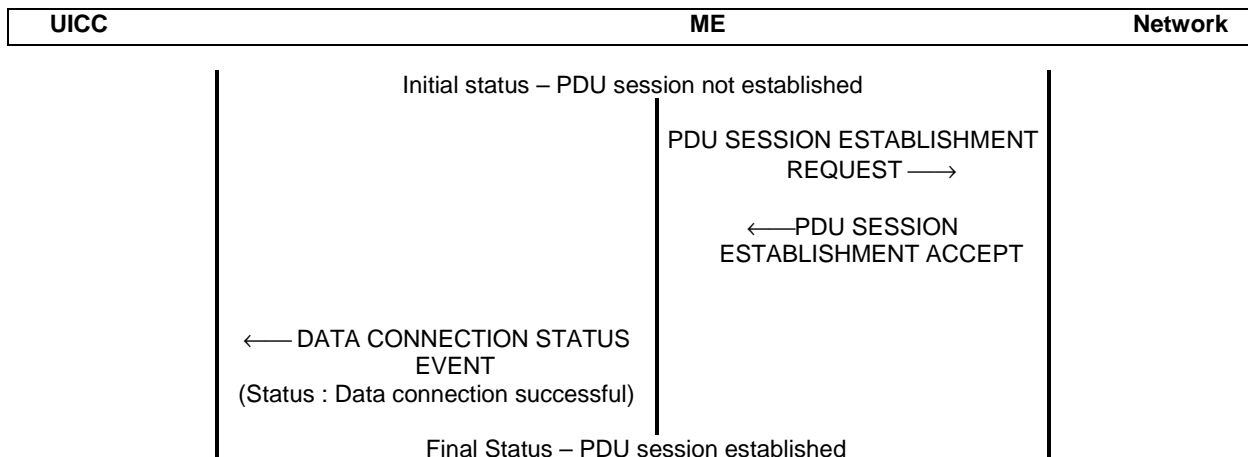

Figure T.2.3 Successful PDU session establishment procedure

T.3 Rejected activation of PDP/PDN/PDU request flow example

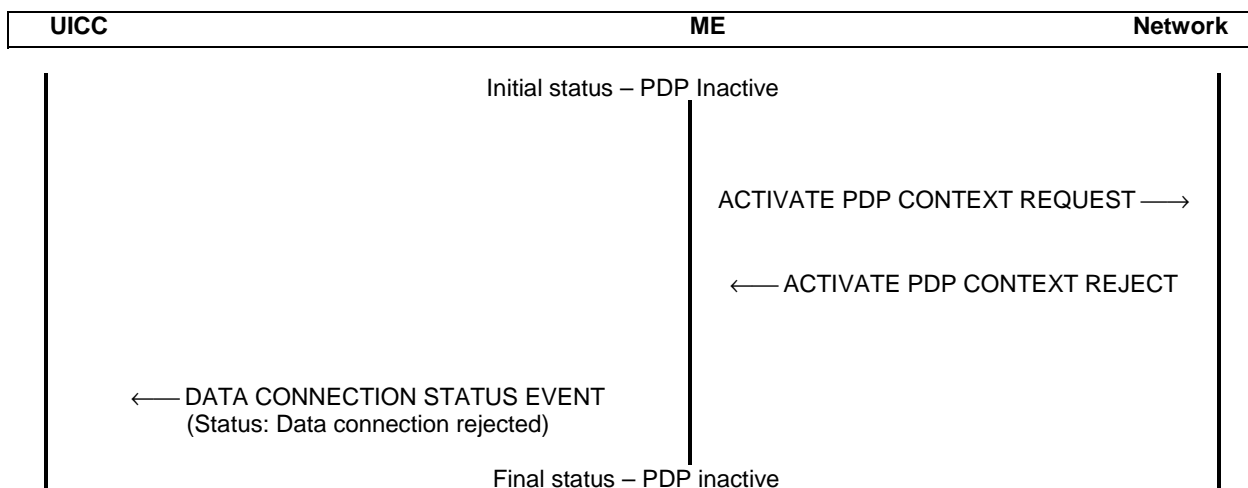
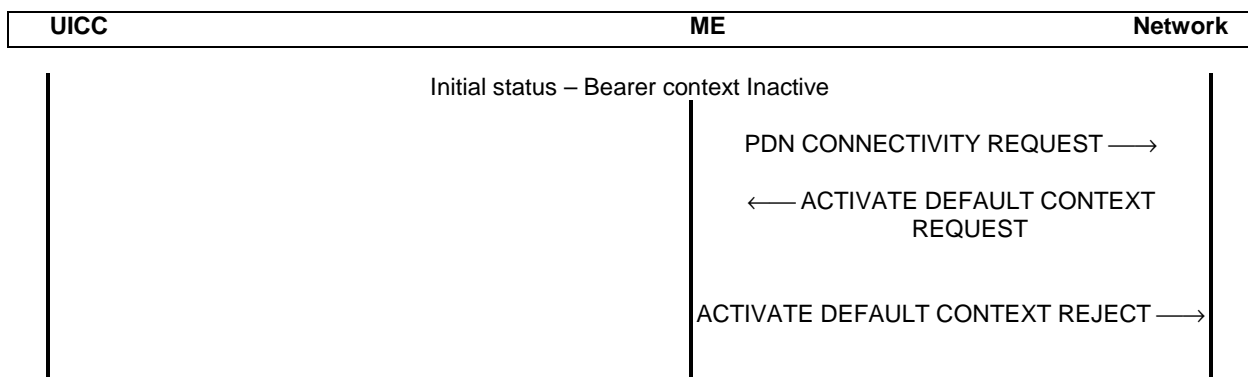

Figure T.3.1 Rejected PDP context activation procedure when initiated by the ME



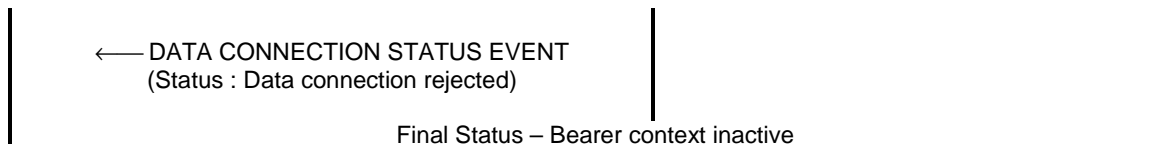

Figure T.3.2 Rejected PDN context activation procedure when initiated by the ME

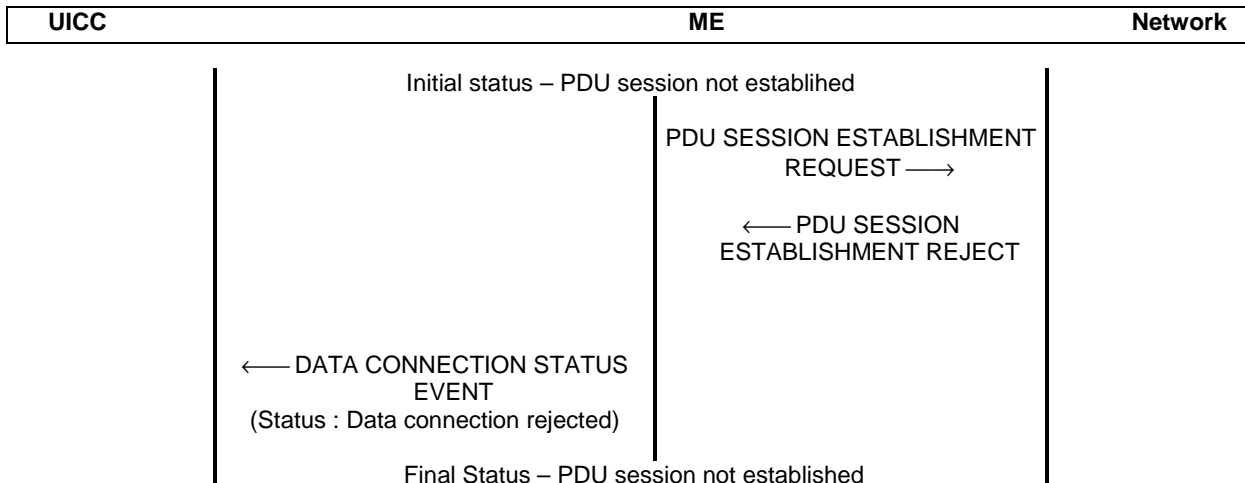

Figure T.3.3 Rejected PDU session establishment procedure when initiated by the ME

T.4 PDP/PDN/PDU Data connection deactivated flow example

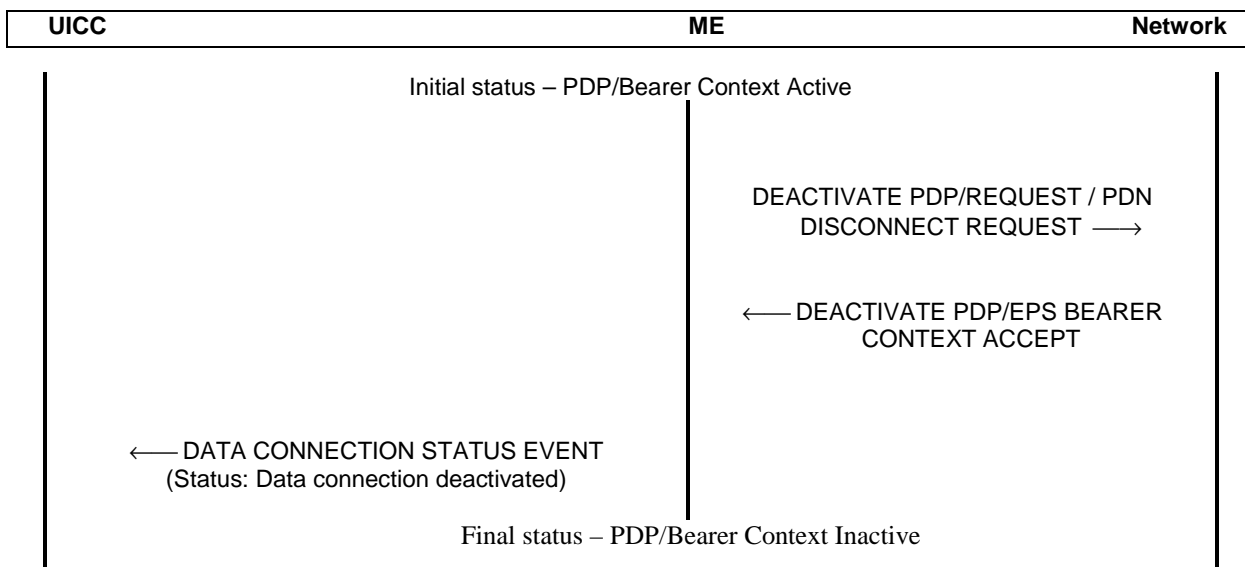

Figure T.4.1 MS Initiated PDP/PDN context deactivation procedure

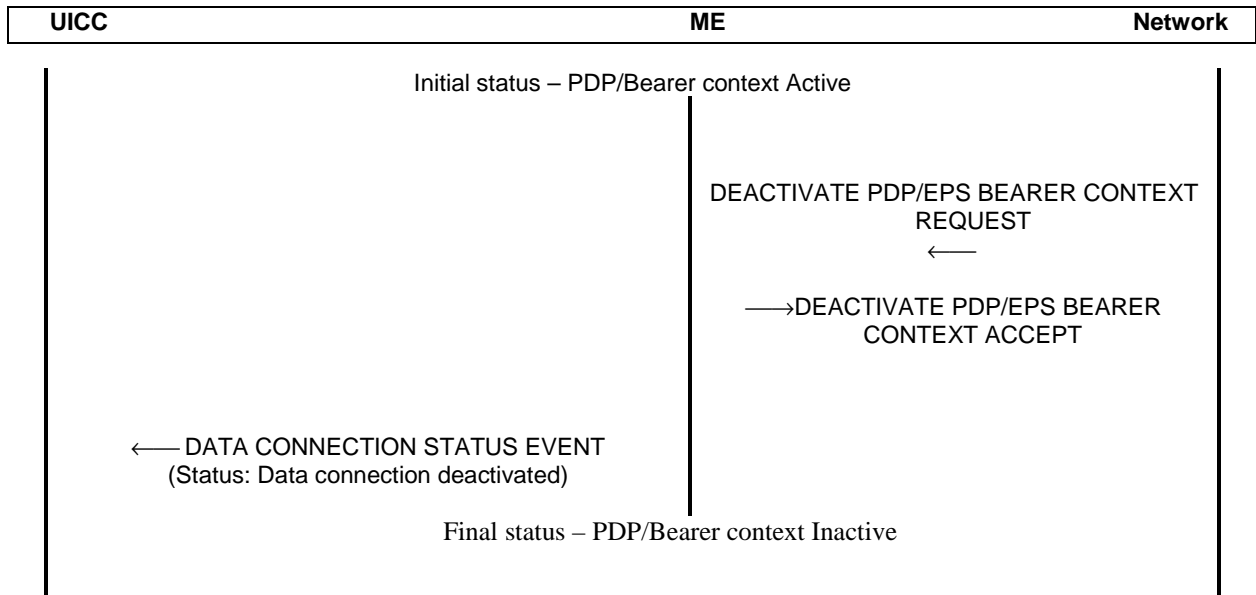

Figure T.4.2 Network Initiated PDP/PDN context deactivation procedure

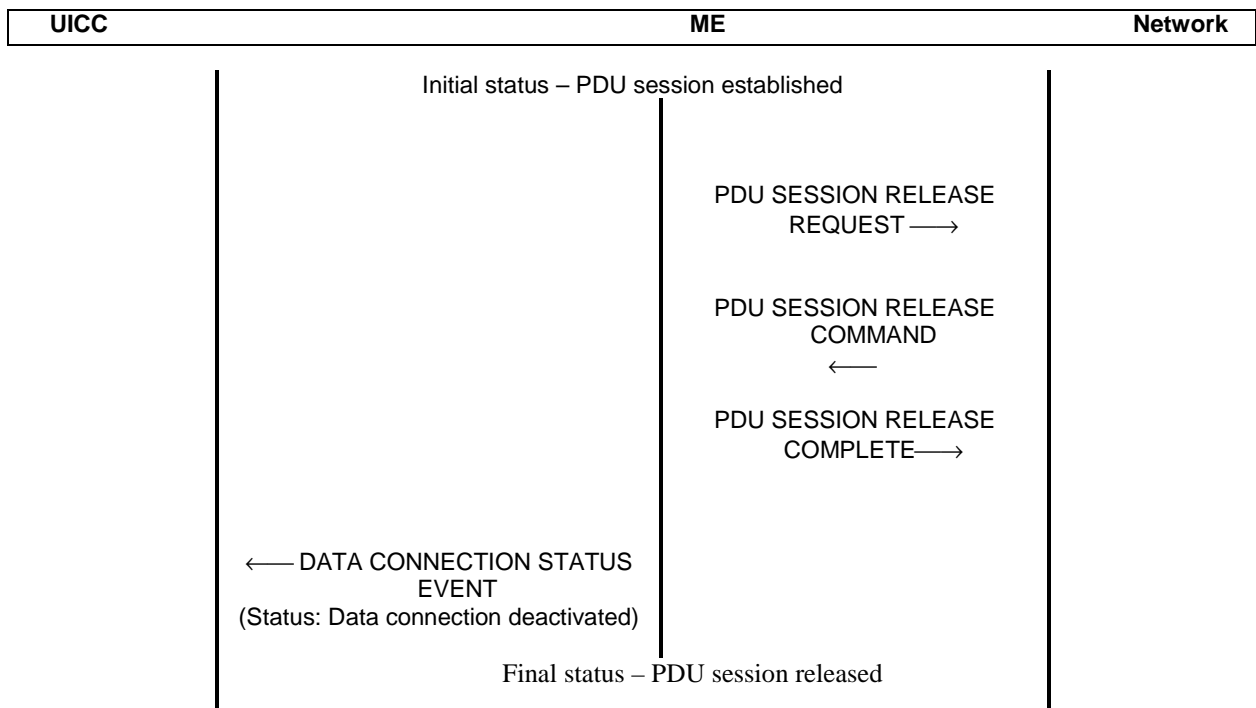
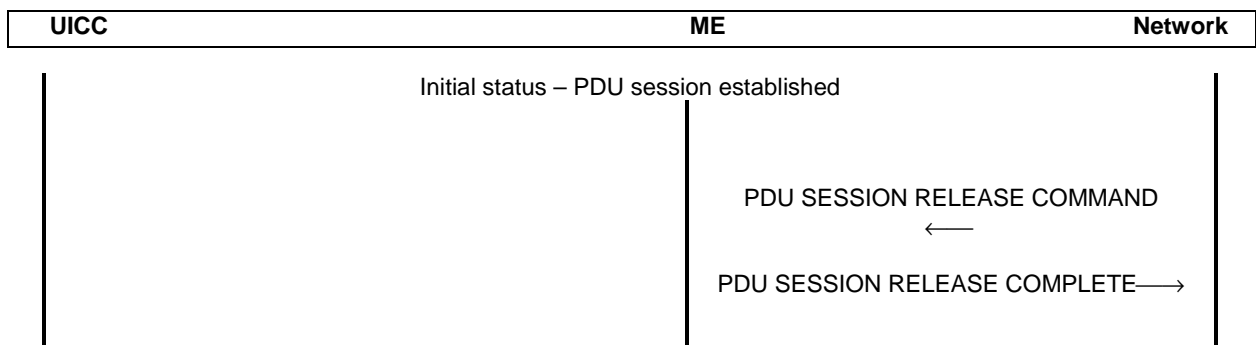

Figure T.4.3 MS Initiated PDU session release procedure



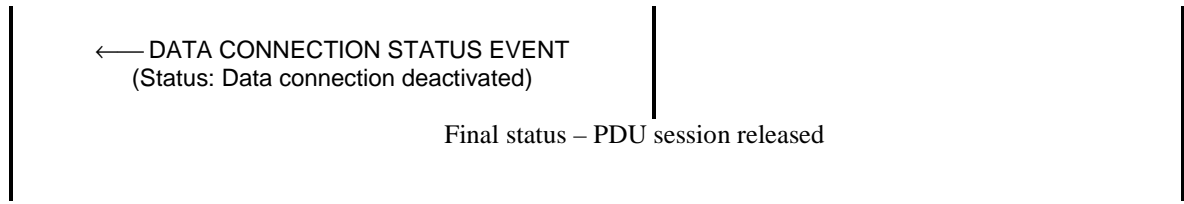

Figure T.4.4 Network Initiated PDU session release procedure

Annex U (informative): Change History

Date	TSG TD#	TSG	CR	Rev	Cat	Subject/Comment	New
CT-28	CP-050141		144	-	F	Clarification on the coding of the DCS field for USSD data download	7.0.0
CT-29	CP-050341		149	-	F	Transfer MMS commands to SCP	7.1.0
CT-30	CP-050500		152	-	A	Missing data objects concerning Frames	7.2.0
CT-30	CP-050500		150	-	A	Correction of the length of Bearer parameters for UTRAN Packet Service	7.2.0
CT-30	CP-050497		153	-	B	Extension of BIP bearers with I-WLAN	7.2.0
CT-31	CP-060019		155	-	A	Corrections to align TS 31.111 with ETSI TS 102 223 and ETSI TS 101 220	7.3.0
CT-31	CP-060019		157	-	A	Introduction of HSDPA in BIP	7.3.0
CT-31	CP-060024		158	-	D	Editorial corrections	7.3.0
CT-31	CP-060024		159	-	F	Alignment with SCP specifications	7.3.0
CT-31	CP-060157		161	-	A	Correction on "USIM Service table" in data SMS-PP download	7.3.0
CT-32	CP-060244		0162	-	F	Incorrect Service Table referenced	7.4.0
CT-33	CP-060476		0167	-	A	UTRAN NMR encoding and Local Information clarifications	7.5.0
CT-35	CP-070060		0169	1	A	Removal of re-introduced text for Call Control User indication	7.6.0
CT-36	CP-070300		0176	2	F	Correction of possible Terminal Responses to the Send SMS command	7.7.0
CT-36	CP-070300		0181	2	F	Addition of missing Frame Identifiers to proactive commands	7.7.0
CT-36	CP-070300		0184	-	F	Correction for the general results "SS Return Error" and "USSD Return Error"	7.7.0
CT-37	CP-070616		0185	1	F	Incomplete Launch Application command definition	7.8.0
CT-37	CP-070612		0187	-	A	Correction to UTRAN Network Measurement Results	7.8.0
CT-37	CP-070661		0188	5	B	Steering of Roaming Refresh Command	7.8.0
CT-38	CP-070842		0190	5	B	Addition of EVENT: Network Rejection	8.0.0
CT-39	CP-080169		0191	-	F	Correction to RAC in Event : Network Rejection	8.1.0
-----	-----		-----	----	----	Numbering of clauses corrected	8.1.1
CT-40	CP-080386		0193	2	F	Explicit definition of Provide Local Information values	8.2.0
CT-41	CP-080658		0196	4	B	Introduction of a geographical location discovery mechanism in the USIM Toolkit	8.3.0
CT-41	CP-080586		0197	-	F	Correction of a missing closing parenthesis in 31.111 8.19.	8.3.0
CT-42	CP-080903		0198	3	B	I-WLAN Steering of Roaming Refresh Command	8.4.0
CT-42	CP-080908		0199	1	F	Correct Geographical Location Request Terminal response value	8.4.0
-----	-----		-----	----	----	Upgrade to copyright, keywords and logo for LTE	8.4.0
CT-43	CP-090188		201	2	B	Support of EPS in USAT: BIP, Provide Local Information, Call control	8.5.0
CT-43	CP-090188		207	1	B	Definition of the "idle" state in Event Download (Location Status) to include E-UTRAN	8.5.0
CT-43	CP-090190		206	1	A	Downgrade of Data download via USSD and USSD application mode	8.5.0
CT-43	CP-090197		203	-	F	Correction of formatting error in Terminal Profile and in clause titles	8.5.0
CT-43	CP-090240		200	1	B	Support of EPS in Network Rejection Event	8.5.0
CT-43	CP-090242		202	1	F	Reduced USAT capable terminals	8.5.0
						Correction to history table version entries ex CT-43.	8.5.1
CT-43	CP-090455		209	1	A	Correction to OPEN CHANNEL	8.6.0
CT-43	CP-090456		212	-	F	NMEA sentence reference	8.6.0

Date	TSG TD#	TSG	CR	Rev	Cat	Subject/Comment	New
CT-43	CP-090452		213	1	F	IMSI changing procedure	8.6.0
CT-43	CP-090456		214	-	F	Network Rejection Event for GERAN/UTRAN	8.6.0
CT-43	CP-090452		215	1	F	Support of E-UTRAN in Provide Local Information for NMR	8.6.0
CT-45	CP-090716		225	-	A	Correction of an open reference and clarification of display icon	8.7.0
CT-45	CP-090715		226	-	F	Correction of missing reference to 3GPP specification	8.7.0
CT-46	CP-090994		220	2	B	Discovery of surrounding CSG cells	9.0.0
CT-46	CP-090994		227	1	B	CSG cell selection event	9.0.0
CT-47	CP-100186		235	-	F	Completion of implementation of CR 0227 (tag values)	9.1.0
CT-47	CP-100186		236	-	F	Correction of erroneous use of the "H(e)NB" term	9.1.0
CT-47	CP-100181		231	2	A	ETSI SCP references correction	9.1.0
CT-48	CP-100392		0243	1	F	Update of the specification and of references to SCP specifications	9.2.0
CP-48	CP-100393		0240	1	A	Correction to security requirement references	9.2.0
CP-48	CP-100393		0248	1	A	Correction of TERMINAL RESPONSE	9.2.0
CP-49	CP-100596		0254	-	F	HNB name corrections	9.3.0
CP-49	CP-100595		0257	-	D	Editorial correction in Comprehension-TLV Tag list	10.0.0
CP-50	CP-100828		0272	1	A	Reference update and restoration of the Terminal Profile's bytes with letter class	10.1.0
CP-50	CP-100828		0271	1	A	Essential corrections to NMR and UTRAN/E-UTRAN Measurement Qualifier	10.1.0
CP-50	CP-100825		0270	2	B	Communication control for IMS	10.1.0
CP-50	CP-100841		0274	-	A	Clarification on EVENT DOWNLOAD - CSG cell selection	10.1.0
CP-51	CP-110239		0275	1	B	Rules for multiple entities providing USAT facilities	10.2.0
CP-51	CP-110243		0276	1	C	Addition of Direct Communication Channel for BIP terminal server mode	10.2.0
CP-51	CP-110238		0279	1	B	Introduction of the IARI based Incoming IMS Data event	10.2.0
CP-51	CP-110238		0280	1	B	Introduction of ME behaviour during a REFRESH of EF_UICCIARI	10.2.0
CP-51	CP-110238		0281	-	B	Introduction of the IARI based IMS Registration event	10.2.0
CP-51	CP-110298		0282	4	B	Introduction the IARI based Open Channel command	10.2.0
CP-51	CP-110243		0290	1	C	Enable Re-assignment of tag values	10.2.0
CP-51	CP-110217		0292	-	A	Essential corrections to the CSG cell selection status event and command PROVIDE LOCAL INFORMATION related to CSG	10.2.0
CP-52	CP-110530		0291	2	F	Essential correction on the length size for the IMS Registration Event envelope command	10.3.0
CP-52	CP-110530		0292	2	F	Correction to IMS Registration event letter class	10.3.0
CP-52	CP-110530		0294	3	F	Reservation of a bit in Terminal profile for Open Channel for IMS	10.3.0
CP-52	CP-110499		0296	2	A	Removal of the mandatory Home eNodeB name support in USAT	10.3.0
CP-53	CP-110596		0297	2	F	Corrections to IMS Registration Event and Open Channel for IMS USAT commands	10.4.0
CP-54	CP-110901		0300	1	F	Essential correction to call control by USIM using IMS Request-URI parameter	10.5.0
CP-54	CP-110901		0304	1	F	Alignment with ETSI TS 102 223 regarding eCAT	10.5.0
CP-54	CP-110901		0303	1	F	Correction of USAT over AT commands	10.5.0
CP-54	CP-110901		0301	2	A	Essential correction to call control by USIM using IMS Request-URI parameter	11.0.0
CP-54	CP-110900		0299	2	C	Definition of procedures for Steering of Roaming	11.0.0

Date	TSG TD#	TSG	CR	Rev	Cat	Subject/Comment	New
CP-55	CP-120146		0313	1	A	Update of reference to ETSI TS 102 223	10.6.0
CP-55	CP-120147		0317		A	Correction to channel status data object	10.6.0
CP-56	CP-120387		321	1	A	Correction of bearer parameters for E-UTRAN / mapped UTRAN packet service	10.7.0
CP-56	CP-120388		322	1	D	Deletion of COMPREHENSION-TLV tag value from 3GPP specification	10.7.0
CP-56	CP-120388		324	1	D	Correction in the Geographical location information discovery information flow between the ME and the UICC	10.7.0
CP-56	CP-120406		315	3	B	Addition of Provide local information, H(e)NB IP address	10.7.0
CP-56	CP-120406		316	4	B	Addition of Provide local information, H(e)NB surrounding macrocells	10.7.0
CP-57	CP-120624		0328		A	Correction of length of CSG ID	11.3.0
CP-57	CP-120624		0331	1	A	Correction of CSG ID list identifier	11.3.0
CP-57	CP-120624		0334	1	A	Changes in ENVELOPE (EVENT DOWNLOAD - CSG Cell Selection)	11.3.0
CP-57	CP-120625		0344	1	A	Clarification of the use of the Incoming IMS Data event	11.3.0
CP-57	CP-120623		0349	2	C	Enhancements to the security of the SMS OTA download mechanisms	11.3.0
CP-57	CP-120626		0338	1	D	Correction to reference for 'OPEN CHANNEL related to UICC Server Mode'	11.3.0
CP-58	CP-120871		0348	2	A	Essential correction on NMR in E-UTRAN	11.4.0
CP-58	CP-120871		0353	1	A	Call control for emergency PDN	11.4.0
CP-58	CP-120871		0356	2	A	Correction of padding for ECI in Location Information	11.4.0
CP-58	CP-120872		0359	1	A	Essential correction on CSG reselection	11.4.0
CP-58	CP-120873		0350		F	Location Information for call control	11.4.0
CP-59	CP-130146		0363	1	F	Update of reference to ETSI TS 102 223 specification	11.5.0
CP-60	CP-130364		0364		F	Location Information for MO Short Message Control	11.6.0
CP-60	CP-130365		0367		A	Clarification on the IMS Registration Event	11.6.0
CP-60	CP-130366		0365	2	D	Optional fields in MO Short Message control response	12.0.0
CP-60	CP-130366		0368	1	D	Correction in call control by USIM text	12.0.0
CP-61	CP-130534		0370	1	C	PLMN ID to "CSG Cell Selection" ENVELOPE COMMAND	12.1.0
CP-62	CP-130787		0381	1	A	Essential correction for IMS emergency call in call control by USIM	12.2.0
CP-62	CP-130788		0377	1	A	Correction for call control for IMS communications by USIM	12.2.0
CP-63	CP-140164		0391		A	Correction of location information in case of call control for IMS	12.3.0
CP-63	CP-140165		0398		D	Correction of editorial errors in TS 31.111	12.3.0
CP-63	CP-140166		0388	1	A	Essential correction to default routing for USAT over AT interface references	12.3.0
CP-63	CP-140167		0395	1	A	Essential correction in communication control for IMS by USIM	12.3.0
CP-63	CP-140168		0392	1	B	Addition of POLL INTERVAL ENVELOPE command	12.3.0
CP-63	CP-140169		0399		A	Change PROVIDE LOCAL INFORMATION procedure for HPSIM	12.3.0
CP-64	CP-140422		0401	2	F	Coding of PDP type in the Bearer parameters	12.4.0
CP-64	CP-140422		0406		F	Introduction of BCCH and Timing Advance Local Information	12.4.0
CP-64	CP-140425		0396	4	B	URI support in MT Call event	12.4.0
CP-64	CP-140425		0400	1	B	Modification to TI value	12.4.0
CP-64	CP-140427		0404	1	F	E-UTRAN inter-frequency measurements that exceeds maxEARFCN	12.4.0

Date	TSG TD#	TSG	CR	Rev	Cat	Subject/Comment	New
CP-65	CP-140702		0384	3	A	Essential corrections for MTC on PDP / EPS PDN context activation	12.5.0
CP-65	CP-140700		0408	1	C	Reference ETSI Specifications for the POLL INTERVAL Negotiation procedure	12.5.0
CP-65	CP-140707		0407		D	Removal of references to EF _{LND}	12.5.0
CP-65	CP-140707		0409	1	C	Update of reference to ETSI TS 102 223	12.5.0
CP-66	CP-140958		0410	1	F	Description of Transaction Identifier for terminals not supporting IMS	12.6.0
CP-66	CP-140960		0413	1	F	Update of reference to ETSI TS 102 223 V11.3.0	12.6.0
CP-66	CP-140959		0416	1	F	Correction of COMPREHENSION-TLV data objects list	12.6.0
CP-67	CP-150158		0420	2	B	ENVELOPE for ProSe usage information reporting	12.7.0
CP-67	CP-150159		0425	2	F	Essential correction to the value of the Transaction Identifier in Call disconnect event	12.7.0
CP-67	CP-150159		0426		F	Update of reference to ETSI TS 102 223	12.7.0
CP-68	CP-150388		0427		F	Support for toolkit initiated GBA bootstrap using refresh on ISIM	12.8.0
CP-68	CP-150388		0428	1	F	Update of tags allocated by ETSI SCP	12.8.0
CP-68	CP-150380		0432		A	Correction of PDP context activation parameters	12.8.0
CP-68	CP-150388		0433	1	F	URI support by USAT clarification on the interactions with FDN_URI and BDN_URI	12.8.0
CP-68	CP-150388		0437	1	F	Update of reference to ETSI TS 102 223	12.8.0
CP-68	CP-150394		0424	6	B	WLAN Bearer alignment of USAT	13.0.0
CP-68	CP-150381		0434	2	B	URI support by USAT SMS related features	13.0.0
CP-68	CP-150386		0429	3	C	Removal of mandatory clause	13.0.0
CP-68	CP-150394		0435	2	B	Enhanced IMS Call Control	13.0.0
CP-69	CP-150563		0436	3	B	Alignment of Provide Local Information for Timing Advance to E-UTRAN radio technology	13.1.0
						Hole in CR numbering between 437 and 626	
CP-69	CP-150563		0627		F	Correction to Bearer parameters for UTRAN and EUTRAN	13.1.0
CP-70	CP-150831		0629	1	A	Handling of a too long IMS URI	13.2.0
CP-70	CP-150827		0630	1	C	Condition to send Location status and access technology change events	13.2.0
CP-71	CP-160142		0631	1	B	Handling of long URI for IMS call control	13.3.0
CP-71	CP-160144		0632		B	Handling of long URI for MT Call event	13.3.0
CP-72	CP-160348		0635	1	A	Correction / clarification of ProSe usage information reporting	13.4.0
CP-73	CP-160549		0636	1	B	Adding of Extended EMM Cause to the EVENT DOWNLOAD – Network Rejection	13.4.0
CP-74	CP-160787		0644		A	Location Information for MO Short Message Control	14.1.0
CP-74	CP-160788		0652		A	Update of reference to ETSI TS 102 223	14.1.0
CP-74	CP-160788		0654		A	Correction of I-WLAN specification references	14.1.0
CP-74	CP-160790		0648	1	A	Essential Correction to Envelope(ProSe Report) for access control	14.1.0
CP-74	CP-160789		0653		D	Clarification of the encoding of the IMS Status Code	14.1.0
CP-74	CP-160789		0638	4	B	URI support by USAT SMS-PP-Download	14.1.0
CP-74	CP-160790		0649	1	D	Error handling by USIM in ProSe usage information reporting procedure	14.1.0
CP-74	CP-160790		0650	2	D	Clarification of Envelope(ProSe Report) for error handling	14.1.0
CP-75	CP-170212		0655	1	B	3GPP PS Data Off and BIP	14.2.0

Date	TSG TD#	TSG	CR	Rev	Cat	Subject/Comment	New
CP-75	CP-170213		0656	6	B	New Event Download for Data Connection Status	14.2.0
CP-76	CP-171165		0658	-	A	Essential correction for the Timing Advance for E-UTRAN	14.3.0
CP-76	CP-171166		0663	-	F	Corrections for the Event Download for Data Connection Status	14.3.0
CP-77	CP-172064		0664	1	D	Fixed wrong implementation of CR 0315, CR 0316 and CR 0655	14.4.0
CP-77	CP-172064		0664a	1	F	Update of reference to TS 102 223	14.4.0
CP-77	CP-172064		0665	1	F	Date and time for MTC devices	14.4.0
CP-77	CP-172064		0667	1	F	New class for URI support in the SET UP CALL	14.4.0
CP-78	CP-173143		0671	1	B	Definition of values reserved by ETSI SCP for 3GPP usage	14.5.0
CP-78	CP-173143		0672	2	B	Support of Non-IP Data Delivery by ME	14.5.0
CP79	CP-180134		0673	1	B	Enhance Location Information object for NG-RAN Cell Identity	15.1.0
CP-79	CP-180134		0674	1	B	Enhance Bearer object in Toolkit spec to accommodate 5GS	15.1.0
CP-80	CP-181152		0677	1	A	Make Date and Time field conditional in Data Connection Status Change event in 31.111.	15.1.0
CP-80	CP-181152		0679	1	A	Remove ambiguity in Location Status Event and Access Tech Event related text in 31.111.	15.1.0
CP-80	CP-181155		0680	2	B	Update the UICC Toolkit Data Connection Status Change Event for 5GS	15.3.0
CP-80	CP-181155		0681	1	B	Update the UICC Toolkit Network Reject Event for 5GS	15.3.0
CP-80	CP-181155		0682	2	B	5G support for the OPEN CHANNEL command	15.3.0
CP-80	CP-181155		0683	2	B	Call Control update for PDU sessions	15.3.0
CP-80	CP-181155		0686	4	B	5G support for the OPEN CHANNEL command	15.3.0
						Wrong Specification Numbering	15.3.1
2018-09	CP-182185		0684	4	B	Network Measurement Report update for NR	15.4.0
2018-09	CP-182185		0687	2	B	Update the version number of ETSI TS 102223 to latest	15.4.0
2018-09	CP-182185		0689	4	B	Update the UICC Toolkit Data Connection Status Change Event for 5GS	15.4.0
2018-09	CP-182184		0690	2	A	Overview clause of Call control by USIM missing PDN related overview.	15.4.0
2018-09	CP-182185		0691	2	B	Enhance Location Information object to accommodate 3 byte TAC for 5GS.	15.4.0
2018-09	CP-182185		0692	4	D	Correction to Annex U	15.4.0
2018-09	CP-182185		0693	3	B	SMS-PP Data download procedure to support SoR using 5G NAS	15.4.0
2018-09	CP-182185		0694	1	B	Fix implementation error for USIM Call Control procedure and allow updating only the operator specific ePCOs.	15.4.0
2018-09	CP-182189		0695	1	F	Correct implementation error for terminal profile bits for non-IP data delivery	15.4.0
2018-09	CP-182185		0705	-	B	Addition of DNN object in PDU session establishment parameters	15.4.0
2018-12	CP-183185		0706	3	C	Enable procedure for update of Routing ID data in the UICC, as triggered by the UDM.	15.5.0
2018-12	CP-183185		0707	1	F	5G Call Control by USIM shall take into account SM PDU DN container length.	15.5.0
2018-12	CP-183185		0708	-	F	Change NR ARFCN length in NMR from 3 to 4 to be future proof.	15.5.0
2018-12	CP-183185		0710	1	F	Correction to CALL CONTROL command for PDU session establishment	15.5.0
2018-12	CP-183185		0711	1	F	Correction due to incorrect TS 24.501 clause referred	15.5.0
2018-12	CP-183185		0713	1	F	Correction to address data field in SMS-PP DOWNLOAD command	15.5.0
2019-03	CP-190047		0716	-	F	Align Routing Indicator data update procedure with CT1 referring to data as data set.	15.6.0
2019-03	CP-190047		0717	2	C	Update Routing Indicator data update procedure to indicate REFRESH type.	15.6.0

Date	TSG TD#	TSG	CR	Rev	Cat	Subject/Comment	New
2019-03	CP-190046		0718	-	F	Correction of specification version in Annex U	15.6.0
2019-03	CP-190044		0721	-	F	Correction of the reference used in cl. 8.143	15.6.0
2019-03	CP-190046		0720	-	A	Update Annex A to align with letter classes allocated by ETSI SCP	15.6.0
2019-09	CP-192014		0723	1	F	Update reference to Rel-15 version of ETSI TS 102.223 in 3GPP TS 31.111	15.7.0
2019-12	CP-193076		0726	1	F	Specify the 'data connection type' in command parameters/data definition in clause 7.5.25.2.	15.8.0
2020-03	CP-200087		0725	6	F	Correction to Bearer Description data object	16.0.0
2020-03	CP-200087		0727	2	B	Introducing Network Measurement Results for NG-RAN	16.0.0
2020-03	CP-200087		0729	2		Alignment of Provide Local Information for Timing Advance to NG-RAN radio technology	16.0.0
2020-03	CP-200087		0730	-	B	PROVIDE LOCAL INFORMATION to get Slice(s) information	16.0.0
2020-06	CP-201154		0732	7	A	Update the scope of 31.111 to cover 2/5G aspects	16.1.0
2020-06	CP-201154		0735	1	A	Essential correction to network measurement results for E-UTRAN	16.1.0
2020-06	CP-201154		0737	3	A	Update the Network Rejection event and Update/Attach/Registration Type	16.1.0
2020-06	CP-201141		0734	1	D	Make more clear that the value part of the Tracking Area Identity information element specified in TS 24.501 is for NG-RAN.	16.1.0
2020-09	CP-202137		0740	-	F	Update of routing indicator, TAC and update/attach	16.2.0
2020-09	CP-202137		0743	-	F	Missing tags in clause 9.3	16.2.0
2020-09	CP-202137		0744	-	F	Correction on the coding of PDU session Type from Bearer description for NG-RAN	16.2.0
2020-12	CP-203088		0747	-	F	Correction to 8.22 Network Measurement Result (Rel 16)	16.3.0
2020-12	CP-203089		0746	2	F	Update Measurement Qualifier for NGRAN	16.3.0
2021-03	CP-210079		0750	-	A	Address parameter not present for SoR use case on ENVELOPE PP-DD command	16.4.0
2021-12	CP-213165	CT#94	0754		F	Correction of ENVELOPE commands	16.5.0
2022-03	CP-220131	CT#95	0763	-	F	Reallocation of TAG VALUE for 'NG-RAN Primary Timing Advance Information'	16.6.0
2022-03	CP-220131	CT#95	0767	1	F	Correction of byte usage in clause 5.2	16.6.0
2022-12	CP-223076	CT#98e	0778	2	A	Update for the procedure of SMS-PP data download via REGISTRATION ACCEPT or DL NAS TRANSPORT messages.	16.7.0
2022-12	CP-223078	CT#98e	0780	3	F	31.111 corrections Rel-16 to TERMINAL PROFILE bits name and TERMINAL RESPONSE command length and Slice information length	16.7.0
2023-03	CP-233100	CT#99	0784	-	A	Update of 5G EFs for EFIMSI changing procedure in Rel-16	16.8.0

History

Document history		
V16.1.0	July 2020	Publication
V16.2.0	November 2020	Publication
V16.3.0	January 2021	Publication
V16.4.0	April 2021	Publication
V16.5.0	January 2022	Publication
V16.6.0	April 2022	Publication
V16.7.0	January 2023	Publication
V16.8.0	April 2023	Publication