

# ETSI TS 132 260 V6.6.0 (2006-06)

---

*Technical Specification*

**Universal Mobile Telecommunications System (UMTS);  
Telecommunication management;  
Charging management;  
IP Multimedia Subsystem (IMS) charging  
(3GPP TS 32.260 version 6.6.0 Release 6)**

---



---

**Reference**

RTS/TSGS-0532260v660

---

**Keywords**

UMTS

**ETSI**

650 Route des Lucioles  
F-06921 Sophia Antipolis Cedex - FRANCE

---

Tel.: +33 4 92 94 42 00 Fax: +33 4 93 65 47 16

Siret N° 348 623 562 00017 - NAF 742 C  
Association à but non lucratif enregistrée à la  
Sous-Préfecture de Grasse (06) N° 7803/88

---

**Important notice**

---

Individual copies of the present document can be downloaded from:

<http://www.etsi.org>

The present document may be made available in more than one electronic version or in print. In any case of existing or perceived difference in contents between such versions, the reference version is the Portable Document Format (PDF). In case of dispute, the reference shall be the printing on ETSI printers of the PDF version kept on a specific network drive within ETSI Secretariat.

Users of the present document should be aware that the document may be subject to revision or change of status. Information on the current status of this and other ETSI documents is available at

<http://portal.etsi.org/tb/status/status.asp>

If you find errors in the present document, please send your comment to one of the following services:

[http://portal.etsi.org/chaicor/ETSI\\_support.asp](http://portal.etsi.org/chaicor/ETSI_support.asp)

---

**Copyright Notification**

---

No part may be reproduced except as authorized by written permission.  
The copyright and the foregoing restriction extend to reproduction in all media.

© European Telecommunications Standards Institute 2006.  
All rights reserved.

**DECT**<sup>TM</sup>, **PLUGTESTS**<sup>TM</sup> and **UMTS**<sup>TM</sup> are Trade Marks of ETSI registered for the benefit of its Members.  
**TIPHON**<sup>TM</sup> and the **TIPHON logo** are Trade Marks currently being registered by ETSI for the benefit of its Members.  
**3GPP**<sup>TM</sup> is a Trade Mark of ETSI registered for the benefit of its Members and of the 3GPP Organizational Partners.

---

## Intellectual Property Rights

IPRs essential or potentially essential to the present document may have been declared to ETSI. The information pertaining to these essential IPRs, if any, is publicly available for **ETSI members and non-members**, and can be found in ETSI SR 000 314: "*Intellectual Property Rights (IPRs); Essential, or potentially Essential, IPRs notified to ETSI in respect of ETSI standards*", which is available from the ETSI Secretariat. Latest updates are available on the ETSI Web server (<http://webapp.etsi.org/IPR/home.asp>).

Pursuant to the ETSI IPR Policy, no investigation, including IPR searches, has been carried out by ETSI. No guarantee can be given as to the existence of other IPRs not referenced in ETSI SR 000 314 (or the updates on the ETSI Web server) which are, or may be, or may become, essential to the present document.

---

## Foreword

This Technical Specification (TS) has been produced by ETSI 3rd Generation Partnership Project (3GPP).

The present document may refer to technical specifications or reports using their 3GPP identities, UMTS identities or GSM identities. These should be interpreted as being references to the corresponding ETSI deliverables.

The cross reference between GSM, UMTS, 3GPP and ETSI identities can be found under <http://webapp.etsi.org/key/queryform.asp>.

# Contents

Intellectual Property Rights .....	2
Foreword.....	2
Foreword.....	5
1 Scope .....	6
2 References .....	6
3 Definitions, symbols and abbreviations .....	8
3.1 Definitions .....	8
3.2 Abbreviations .....	9
3.3 Symbols.....	9
4 Architecture Considerations .....	10
4.1 High level IP Multimedia Subsystem (IMS) architecture .....	10
4.2 IMS offline charging architecture.....	11
4.3 IMS online charging architecture .....	11
5 Charging Principles .....	12
5.1 IMS Charging Principles .....	12
5.1.2 IMS Charging Correlation .....	12
5.1.2.1 Basic Principles for IMS Domain Correlation .....	12
5.1.2.2 IMS Charging Identifier (ICID) .....	12
5.1.2.3 Access network charging identifier.....	13
5.1.2.4 Inter Operator Identifier (IOI).....	13
5.1.2.5 Application Charging Identifier (ACID).....	13
5.2 IMS Offline Charging Principles.....	13
5.2.1 Basic Principles .....	13
5.2.2 Diameter Message Flows and Types .....	15
5.2.2.1 Message Flows - Successful Cases and Scenarios .....	15
5.2.2.1.1 Session Establishment - Mobile Origination .....	15
5.2.2.1.2 Session Establishment - Mobile Termination.....	16
5.2.2.1.3 Mid-Session Procedures .....	17
5.2.2.1.4 Session Release - Mobile Initiated .....	18
5.2.2.1.5 Session-Unrelated Procedures .....	19
5.2.2.1.6 Session Establishment - PSTN Initiated.....	20
5.2.2.1.7 Session Establishment - IMS Initiated.....	21
5.2.2.1.8 Session Release - PSTN Initiated .....	22
5.2.2.1.9 Session Release - IMS Initiated.....	23
5.2.2.1.10 Multi-Party Call.....	23
5.2.2.1.11 AS Related Procedures - AS Acting as a Redirect Server .....	26
5.2.2.1.12 AS Related Procedures - AS Acting as a Voice Mail Server.....	27
5.2.2.2 Message Flows - Error Cases and Scenarios.....	28
5.2.2.2.1 Session Related SIP Procedures- Reception of SIP error messages .....	28
5.2.2.2.2 Session Related SIP Procedures - SIP session failure .....	28
5.2.2.2.3 Session Unrelated SIP procedures .....	28
5.2.2.2.4 CDF Connection Failure.....	28
5.2.2.2.5 No Reply from CDF .....	28
5.2.2.2.6 Duplicate Detection .....	28
5.2.2.2.7 CDF Detected Failure.....	29
5.2.3 CDR generation .....	29
5.2.4 GTP" record transfer flows .....	29
5.2.5 Bi CDR file transfer .....	29
5.3 IMS Online Charging Scenarios.....	29
5.3.1 Basic Principles .....	29
5.3.2 Diameter Message Flows and Types .....	30
5.3.2.1 Immediate Event Charging (IEC).....	30
5.3.2.1.1 Message Flows - Successful Cases and Scenarios.....	31

5.3.2.1.2	Message Flows - Error Cases and Scenarios .....	31
5.3.2.2	Event Charging with Unit Reservation (ECUR) and Session Charging with Unit Reservation (SCUR) .....	31
5.3.2.2.1	Message Flows - Successful Cases and Scenarios.....	32
5.3.2.2.1.2	Expiration of Reservation Validity .....	32
5.3.2.2.2	Message Flows - Error Cases and Scenarios .....	32
6	Definition of charging information .....	33
6.1	Data description for IMS offline charging .....	33
6.1.1	Rf Message contents .....	33
6.1.1.1	Charging Data-Request Message.....	33
6.1.1.2	Charging Data Response Message.....	34
6.1.2	GTP" message contents .....	34
6.1.3	CDR Description on the Bi Interface.....	34
6.1.3.1	CDR Field Types .....	34
6.1.3.2	CDR Triggers.....	35
6.1.3.2.1	Session Related CDRs.....	35
6.1.3.2.2	Session Unrelated CDRs .....	35
6.1.3.3	S-CSCF CDR Content.....	36
6.1.3.4	P-CSCF CDR Content.....	38
6.1.3.5	I-CSCF CDR Content .....	40
6.1.3.6	MRFC CDR Content.....	41
6.1.3.7	MGCF CDR Content.....	43
6.1.3.8	BGCF CDR Content .....	45
6.1.3.9	SIP AS CDR Content.....	47
6.2	Data description for IMS online charging .....	48
6.2.1	Ro message contents.....	48
6.2.1.1	Debit and Reserve Units Request Message .....	49
6.2.1.2	Debit and Reserve Units Response Message.....	49
6.3	IMS Charging Specific Parameters .....	50
6.3.1	Definition of IMS charging information.....	50
6.3.1.1	IMS charging information assignment for Service Information .....	50
6.3.1.2	Definition of the IMS Information.....	50
6.3.2	Detailed Message Format for offline charging .....	51
6.3.3	Detailed Message Format for online charging .....	53
6.3.4	Formal IMS charging parameter description .....	55
6.3.4.1	IMS charging information for CDRs .....	55
6.3.4.2	IMS charging information for charging events .....	55
<b>Annex A (informative):</b>	<b>Void .....</b>	<b>56</b>
<b>Annex B (informative):</b>	<b>Bibliography.....</b>	<b>57</b>
<b>Annex C (informative):</b>	<b>Change history .....</b>	<b>58</b>
History .....		59

---

# Foreword

This Technical Specification has been produced by the 3<sup>rd</sup> Generation Partnership Project (3GPP).

The contents of the present document are subject to continuing work within the TSG and may change following formal TSG approval. Should the TSG modify the contents of the present document, it will be re-released by the TSG with an identifying change of release date and an increase in version number as follows:

Version x.y.z

where:

- x the first digit:
  - 1 presented to TSG for information;
  - 2 presented to TSG for approval;
  - 3 or greater indicates TSG approved document under change control.
- y the second digit is incremented for all changes of substance, i.e. technical enhancements, corrections, updates, etc.
- z the third digit is incremented when editorial only changes have been incorporated in the document.

---

# 1 Scope

The present document is part of a series of documents that specify charging functionality and charging management in GSM/UMTS networks. The GSM/UMTS core network charging architecture and principles are specified in document TS 32.240 [1], which provides an umbrella for other charging management documents that specify

- the content of the CDRs per domain and subsystem (offline charging),
- the content of real-time charging events per domain / subsystem (online charging);
- the functionality of online and offline charging for those domains and subsystems;
- the interfaces that are used in the charging framework to transfer the charging information (i.e. CDRs or charging events)

The complete document structure for these TSs is defined in TS 32.240 [1].

The present document specifies the Offline and Online Charging description for the IP Multimedia Subsystem (IMS), based on the functional descriptions of the IMS in 3GPP TS 23.228 [200]. This charging description includes the offline and online charging architecture and scenarios specific to IMS, as well as the mapping of common 3GPP charging architecture specified in TS 32.240 [1] onto IMS. It further specifies the structure and content of the CDRs for offline charging, and the charging events for online charging. The present document is related to other 3GPP charging TSs as follows:

- The common 3GPP charging architecture is specified in TS 32.240 [1];
- The parameters, abstract syntax and encoding rules for these CDR types are specified in TS 32.298 [51].
- A transaction based mechanism for the transfer of CDRs within the network is specified in TS 32.295 [54].
- The file based mechanism used to transfer the CDRs from the network to the operator's billing domain (e.g. the billing system or a mediation device) is specified in TS 32.297 [52].
- The 3GPP Diameter application that is used for IMS offline and online charging is specified in TS 32.299 [50].

All terms, definitions and abbreviations used in the present document, that are common across 3GPP TSs, are defined in the 3GPP Vocabulary, TR 21.905 [100]. Those that are common across charging management in GSM/UMTS domains, services or subsystems are provided in the umbrella document TS 32.240 [1] and are copied into clause 3 of the present document for ease of reading. Finally, those items that are specific to the present document are defined exclusively in the present document.

Furthermore, requirements that govern the charging work are specified in 3GPP TS 22.115 [102].

---

# 2 References

The following documents contain provisions, which, through reference in this text, constitute provisions of the present document.

- References are either specific (identified by date of publication, edition number, version number, etc.) or non-specific.
- For a specific reference, subsequent revisions do not apply.
- For a non-specific reference, the latest version applies. In the case of a reference to a 3GPP document (including a GSM document), a non-specific reference implicitly refers to the latest version of that document *in the same Release as the present document*.

[1] 3GPP TS 32.240: "Telecommunication management; Charging management; Charging architecture and principles".

[2]-[10] Void.

- [11] 3GPP TS 32.251: "Telecommunication management; Charging management; Packet Switched (PS) domain charging".
- [12]-[49] Void.
- [50] 3GPP TS 32.299: "Telecommunication management; Charging management; Diameter charging application
- [51] 3GPP TS 32.298: "Telecommunication management; Charging management; Charging Data Record (CDR) parameter description
- [52] 3GPP TS 32.297: "Telecommunication management; Charging management; Charging Data Records (CDR) file format and transfer
- [53] Void.
- [54] 3GPP TS 32.295: "Telecommunication management; Charging management; Charging Data Record (CDR) transfer".
- [55]-[99] Void.
- [100] 3GPP TR 21.905: "Vocabulary for 3GPP Specifications".
- [101]-[102] Void.
- [103] 3GPP TS 23.002: "Network Architecture".
- [104]-[199] Void.
- [200] 3GPP TS 22.228: "IMS Stage 1".
- [201] 3GPP TS 23.228: " Functional stage 2 description of IMS".
- [202] 3GPP TS 24.228: "Signalling flows for the IP multimedia call control based on SIP and SDP, Stage 3'
- [203] 3GPP TS 23.218: "IP Multimedia (IM) session handling; IM call model; Stage 2".
- [204] 3GPP TS 24.229: "Internet Protocol (IP) multimedia call control protocol based on Session Initiation Protocol (SIP) and Session Description Protocol (SDP); Stage 3".
- [205] 3GPP TS 29.229: "Cx and Dx Interfaces based on the Diameter protocol; Protocol Details".
- [206]-[299] Void.
- [300]-[399] Void.
- [400] Void.
- [401] IETF RFC 3588 (2003): 'diameter base protocol".
- [402] IETF RFC 4006: 'Diameter Credit Control Application".
- [403] IETF RFC 2806: "URLs for Telephone Calls".
- [404] IETF RFC 3261: "SIP: Session Initiation Protocol".
- [405] IETF RFC 2486: "The Network Access Identifier".
- [406] RFC 3455 (January 2003): "Private Header (P-Header) Extensions to the Session Initiation Protocol (SIP) for the 3rd-Generation Partnership Project (3GPP)".



---

## 3 Definitions, symbols and abbreviations

### 3.1 Definitions

For the purposes of the present document, the following terms and definitions given in 3GPP TR 21.905 [50], 3GPP TS 32.240 [1], and the following apply:

**billing:** function whereby CDRs generated by the charging function are transformed into bills requiring payment.

**Billing Domain:** Part of the operator network, which is outside the core network that receives and processes charging information from the core network charging functions. It includes functions that can provide billing mediation and billing end applications.

**CDR field Categories:** the CDR fields are defined in the present document. They are divided into the following categories:

- **Mandatory:** field that shall be present in the CDR.
- **Conditional:** field that shall be present in a CDR if certain conditions are met.
- **Operator Provisionable: Mandatory:** A field that operators have provisioned to be included in the CDR for all conditions.
- **Operator Provisionable: Conditional:** A field that operators have provisioned to be included in the CDR if certain conditions are met.

**chargeable event:** activity utilizing telecommunications network infrastructure and related services for:

- user to user communication (e.g. a single call, a data communication session or a short message); or
- user to network communication (e.g. service profile administration); or
- inter-network communication (e.g. transferring calls, signalling, or short messages); or
- mobility (e.g. roaming or inter-system handover); and
- that the network operator wants to charge for.

**charged party:** user involved in a chargeable event that has to pay parts or the whole charges of the chargeable event, or a third party paying the charges caused by one or all users involved in the chargeable event, or a network operator.

**charging:** function whereby information related to a chargeable event is formatted and transferred in order to make it possible to determine usage for which the charged party may be billed.

**Charging Data Record (CDR):** record generated by a network element for the purpose of billing a subscriber for the provided service. It includes fields identifying the user, the session and the network elements as well as information on the network resources and services used to support a subscriber session. In the traditional circuit domain, CDR has been used to denote "Call Detail Record", which is subsumed by "Charging Data Record" hereafter.

**charging function:** entity inside the core network domain, subsystem or service that is involved in charging for that domain, subsystem or service.

**offline charging:** charging mechanism where charging information **does not** affect, in real-time, the service rendered

**online charging:** charging mechanism where charging information can affect, in real-time, the service rendered and therefore a direct interaction of the charging mechanism with session/service control is required

**partial CDR:** CDR that provides information on part of a subscriber session. A long session may be covered by several partial CDRs. Two formats are considered for Partial CDRs. One that contains all of the necessary fields; the second has a reduced format.

## 3.2 Abbreviations

For the purposes of the present document, the following abbreviations apply:

ABNF	Augmented Backus-Naur Form
ACA	Accounting Answer
ACR	Accounting Request
AS	Application Server
AVP	Attribute Value Pair
B2BUA	Back-to-Back User Agent
BGCF	Breakout Gateway Control Function
BS	Billing System
CCA	Credit Control Answer
CCF	Charging Collection Function
CCR	Credit Control Request
CDF	Charging Data Function
CDR	Charging Data Record
CGF	Charging Gateway Function
CPCF	Content Provider Charging Function
ECF	Event Charging Function
ECUR	Event Charging with Unit Reservation
CSCF	Call Session Control Function (I-Interrogating; P-Proxy; and S-Serving)
IEC	Immediate Event Charging
IMS	IP Multimedia Subsystem
IMS-GWF	IMS Gateway Function
ISC	IMS Service Control
MGCF	Media Gateway Control Function
MRFC	Media Resource Function Controller
MRFP	Multimedia Resource Function Processor
OCS	Online Charging System
SCCF	Subscriber Content Charging Function
SCUR	Session Charging with Unit Reservation
SDP	Session Description Protocol
SIP	Session Initiation Protocol
UA	User Agent
UE	User Equipment

## 3.3 Symbols

For the purposes of the present document, the following symbols apply:

Bi	Reference point for the CDR file transfer from the IMS CGF to the BD.
Ga	Reference point for CDR transfer between a CDF and CGF.
Rf	Offline Charging Reference Point between an IMS Network Entity or an AS and CDF
Ro	Online Charging Reference Point between an AS or MRFC and IMS-GWF and the OCS

# 4 Architecture Considerations

## 4.1 High level IP Multimedia Subsystem (IMS) architecture

Figure 4.1 depicts the logical IMS architecture, as described in 3GPP TS 23.002 [103]

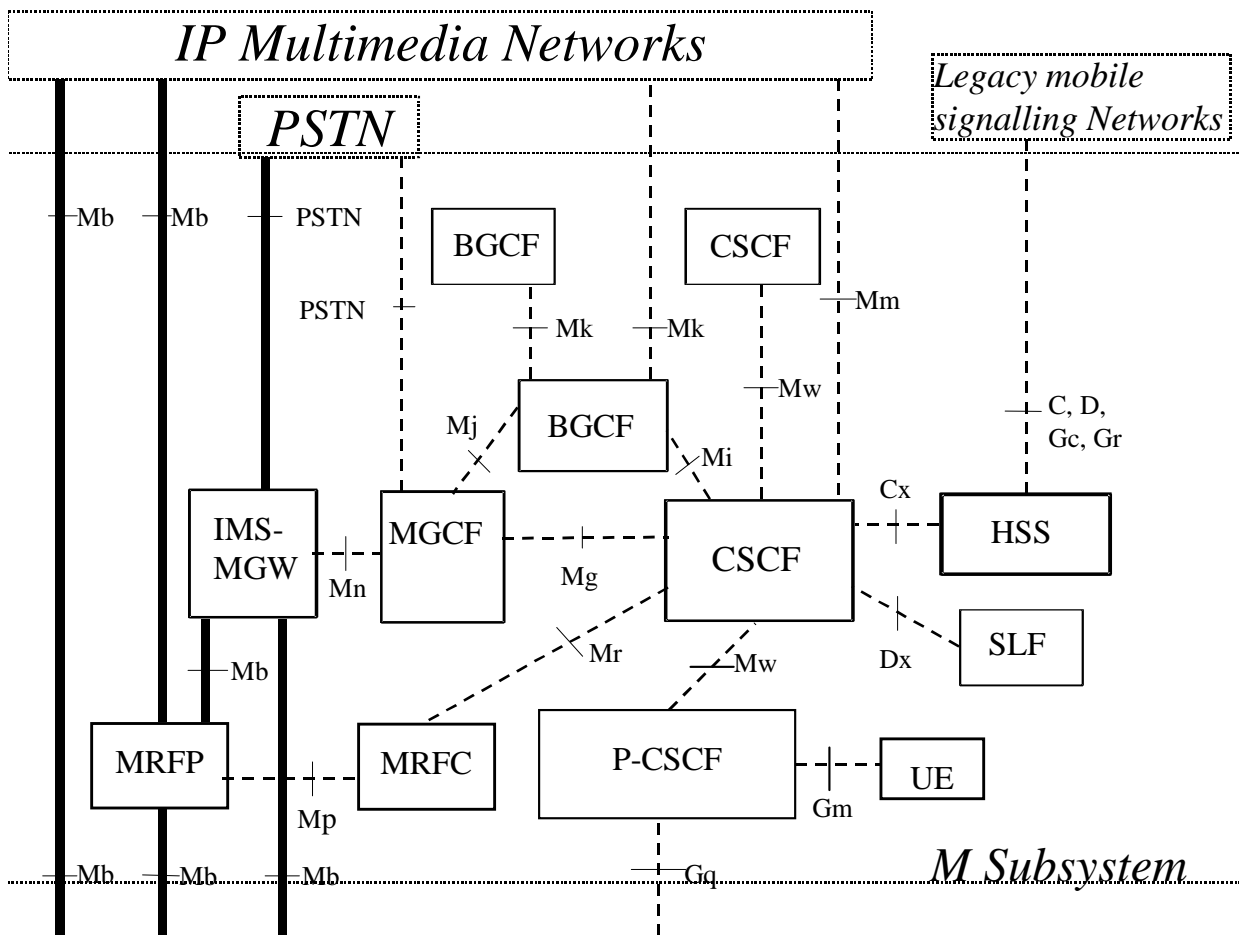

Figure 4.1: IMS logical architecture

## 4.2 IMS offline charging architecture

The architecture for IMS offline charging is described in the following figure. The Rf interface is described in clause 6.1.1 and Bi in clause 6.1.2.

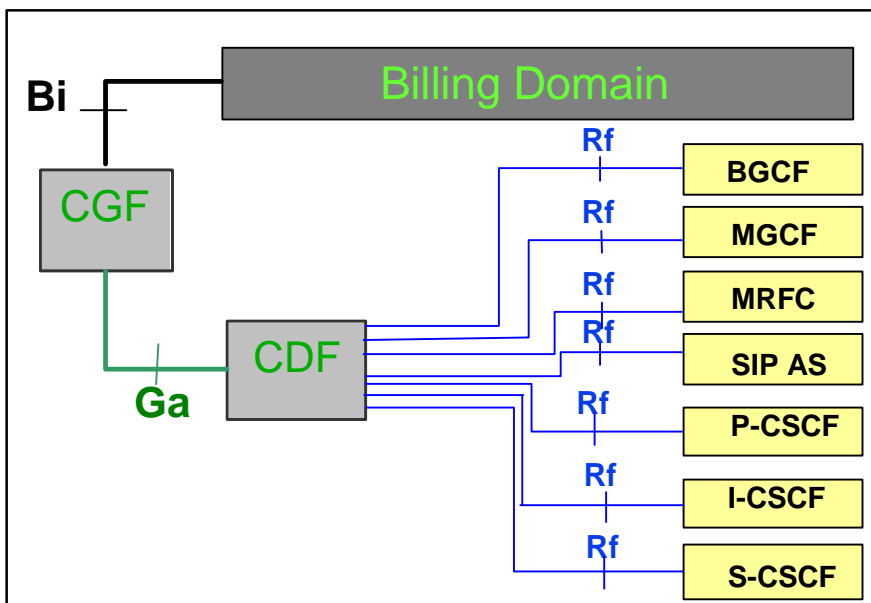

Figure 4.2: IMS offline charging architecture

NOTE: The combination of the CDF/CGF corresponds to the 3GPP Rel-5 CCF.

## 4.3 IMS online charging architecture

The architecture for IMS online charging is described in the following figure. The Ro interface is described in clause 6.2 and ISC in TS 23.228 [201].

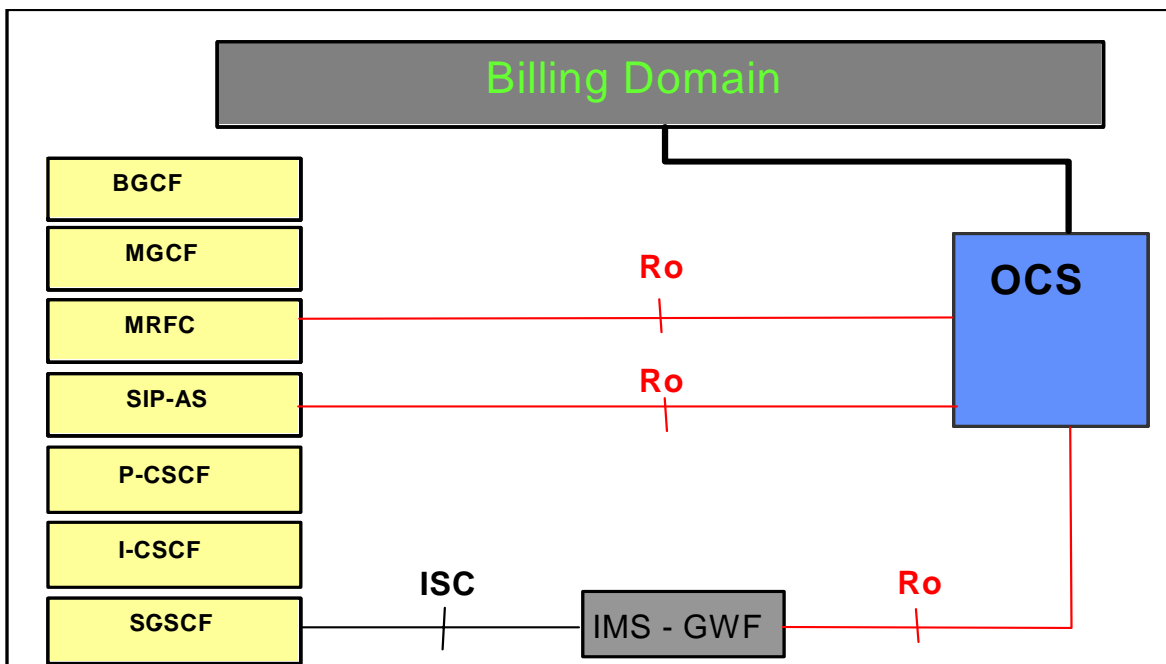

Figure 4.3: IMS online charging Architecture

---

## 5 Charging Principles

### 5.1 IMS Charging Principles

The AS and MRFC are able to distinguish whether to apply offline or online charging, i.e. whether to send charging information over the Rf interface to the CDF or over the Ro interface to the OCS, which includes ECF and SCF as described in chapter 4.3 (or to use both). The decision of which interface to use is based on the information (CDF and/or OCS address) the AS/MRFC receives in the SIP signalling and the system configuration as provisioned by the operator. If the AS/MRFC only receive the CDF address and do not receive an OCS address then they use only the Rf interface. If only the OCS address was provided then they use only the Ro interface. In cases where both CDF and OCS addresses are provided it is possible to use both interfaces simultaneously.

However, operators may overrule the addresses received via the SIP signalling and use their own configured rules instead. Operators may configure locally on the AS/MRFC an OCS and/or CDF address. The choice of whether the IMS network elements use locally configured addresses or the addresses received by SIP signalling, and the decision on which interface(s) to use, is left for operator configuration.

All other IMS network elements (S-CSCF, P-CSCF, I-CSCF, BGCF and MGCF) apply offline charging via the Rf interface using the CDF address as received via SIP signalling or the locally configured CDF address in the IMS network element. The S-CSCF supports online charging using:

- the ISC interface, i.e. if the application server addressed over ISC is the IMS Gateway Function, or
- the Ro interface directly instead of the ISC, if the IMS Gateway Function is integrated within the S-CSCF.

The offline and online charging function addresses transferred in SIP signalling are encoded in the P-Charging-Function-Addresses as defined in TS 24.229 [204] and RFC 3455 [406]. The P-Charging-Function-Addresses header contains the following parameters: CCF (i.e. CDF) and ECF (i.e. OCS).

#### 5.1.2 IMS Charging Correlation

##### 5.1.2.1 Basic Principles for IMS Domain Correlation

The IMS charging correlation information is encoded in the SIP P-Charging-Vector header as defined in the following sub clauses. The P-Charging-Vector header contains the following parameters: ICID, access network charging identifier and IOI.

General correlation mechanisms are defined in TS 32.240 [1], and further details about the usage of P-Charging-Vector are defined in TS 24.229 [204] and RFC 3455 [406].

##### 5.1.2.2 IMS Charging Identifier (ICID)

The IMS domain correlation is based on IMS Charging Identifier (ICID) shared between IMS network elements involved with the same session/transaction. With ICID it is possible to correlate session/transaction related charging data generated in different IMS elements (i.e. x-CSCFs, ASs"). The ICID is included in all SIP methods, if the P-Charging-Vector header is present, and transferred through originating and terminating side nodes, except to UE.

The value of the ICID parameter is identical with the 'icid-value' parameter defined in TS 24.229 [204]. The 'icid-value' is a mandatory part of the P-Charging-Vector and coded as a text-based UTF-8 charset (as are all SIP messages). For further information regarding the composition and usage of the P-Charging-Vector refer to [204] and RFC 3455 [406].

The ICID value is globally unique across all 3GPP IMS networks for a time period of at least one month, implying that neither the node that generated this ICID nor any other IMS network element reuse this value before the uniqueness period expires. The one month minimum uniqueness period counts from the time of release of the ICID, i.e. the ICID value no longer being used. This can be achieved by using node specific information, e.g. high-granularity time information and / or topology / location information. The exact method how to achieve the uniqueness requirement is an implementation issue.

At each SIP session unrelated method, both initial and subsequent (e.g., REGISTER, NOTIFY, MESSAGE etc.), a new, session unrelated ICID is generated at the first IMS network element that processes the method. This ICID value is contained in the SIP request and response of that SIP transaction and must be valid for the duration of the transaction.

At each SIP session establishment a new, session specific ICID is generated at the first IMS network element that processes the session-initiating SIP INVITE message. This ICID is then used in all subsequent SIP messages for that session (e.g., 200 OK, (re-)INVITE, BYE etc.) until the session is terminated.

### 5.1.2.3 Access network charging identifier

The access network charging identifier is the media flow level data shared among the IMS network elements for one side of the session (either the originating or terminating side). This information is used to correlate the access network charging data with the IMS charging data. GPRS charging information (GGSN identifier and PDP context information) is an example of access network charging identifier. The access network charging identifier is populated in the P-Charging-Vector using the access-network-charging-info parameter. For further information regarding the composition and usage of the access-network-charging-info parameter refer to TS 24.229[204] and RFC 3455 [406].

### 5.1.2.4 Inter Operator Identifier (IOI)

The IOI identifies both originating and terminating networks involved in a session/transaction. The IOI may be generated from each side of session/transaction to identify the home networks associated with each side. The orig-ioi and term-ioi parameters of P-Charging-Vector represent the originating and terminating operator identifiers. For further information regarding the composition and usage of the orig-ioi and term-ioi parameters refer to TS 24.229[204] and RFC 3455 [406].

### 5.1.2.5 Application Charging Identifier (ACID)

< If ACID will be accepted, the same kind of description than for ICID should be included here, i.e. more general than in Annex B >

## 5.2 IMS Offline Charging Principles

### 5.2.1 Basic Principles

The offline charging functionality is based on the IMS network nodes reporting accounting information upon reception of various SIP methods or ISUP messages, as most of the accounting relevant information is contained in these messages. This reporting is achieved by sending Diameter *Accounting Requests* (ACR) [Start, Interim, Stop and Event] from the IMS network elements to the CDF.

The Diameter client uses ACR Start, Interim and Stop in procedures related to successful SIP sessions. It uses ACR Events for unsuccessful SIP sessions and for session unrelated procedures. Further details are specified in the tables below and in clause 5.2.2.

It is operator configurable in the nodes for which SIP method or ISUP messages an *Accounting Request* is sent. Table 5.2.1.1 describes all possible ACRs that might be sent from a P-CSCF, I-CSCF, S-CSCF, MGCF or BGCF. A list of node specific ACRs, along with the AVPs to be included are detailed in TS 32.299 [50].

The ACRs to be sent from a MRFC are described in table 5.2.1.2.

It is configurable for the operators to enable or disable the generation of an ACR message by the IMS node in response to a particular "Triggering SIP Method /ISUP Message". However, for those table entries marked with \*, the operator can enable or disable the ACR message based on whether or not the SIP (Re) Invite message that is replied to by the "Triggering SIP Method /ISUP Message" carried piggybacked user data.

**Table 5.2.1.1: Accounting Request Messages Triggered by SIP Methods or ISUP Messages for all IMS nodes except for MRFC and AS**

Diameter Message	Triggering SIP Method /ISUP Message
ACR [Start]	SIP 200 OK acknowledging an initial SIP INVITE (see note 2) ISUP:ANM (applicable for the MGCF)
ACR [Interim]	SIP 200 OK acknowledging a SIP RE-INVITE or SIP UPDATE [e.g. change in media components] (see note 2) Expiration of AVP [Acct-Interim-Interval] (see note 2)
ACR [Stop]	SIP BYE message (both normal and abnormal session termination cases) (see note 2) ISUP:REL (applicable for the MGCF) Deregistration (see note 1 and note 2)
ACR [Event]	SIP 200 OK acknowledging non-session related SIP messages, which are: SIP NOTIFY (see note 2) SIP MESSAGE SIP REGISTER SIP SUBSCRIBE SIP PUBLISH SIP 202 Accepted acknowledging a SIP REFER or any other method SIP Final Response 2xx (except SIP 200 OK) SIP Final/Redirection Response 3xx SIP Final Response (4xx, 5xx or 6xx), indicating an unsuccessful SIP session set-up SIP Final Response (4xx, 5xx or 6xx), indicating an unsuccessful session-unrelated procedure SIP CANCEL, indicating abortion of a SIP session set-up (see note 2) I-CSCF completing a Cx Query that was issued in response to a SIP INVITE
NOTE 1: SIP SUBSCRIBE with the field "Expires" set to 0 means unsubscribe. SIP REGISTER with its "Expires" header field or "Expires" parameter equal to 0 or local deregistration due to expiry means Deregistration (see 3GPP TS 24.229 [204]).	
NOTE 2: (only for I-CSCF): This trigger may only occur if I-CSCF is acting in THIG mode.	

**Table 5.2.1.2: Accounting Request Messages Triggered by SIP Methods for the MRFC**

Diameter Message	Triggering SIP Method
ACR [Start]	SIP 200 OK acknowledging an SIP INVITE for initiating a multimedia ad hoc conferencing session
ACR [Interim]	SIP ACK acknowledging a SIP INVITE to connect an UE to the conferencing session Expiration of AVP [Acct-Interim-Interval]
ACR [Stop]	SIP BYE message
ACR [Event]	SIP Final/Redirection Response 3xx SIP Final Response with error codes 4xx, 5xx or 6xx indicating termination of an ongoing session SIP CANCEL, indicating abortion of a SIP session set-up

## 5.2.2 Diameter Message Flows and Types

The flows described in the present document specify the charging communications between IMS entities and the charging functions for different charging scenarios. The SIP messages and Diameter transactions associated with these charging scenarios are shown primarily for general information and to illustrate the charging triggers. They are not intended to be exhaustive of all the SIP message flows discussed in TS 24.228 [200] and they depend on the Diameter Accounting Requests triggers configured by the operator.

### 5.2.2.1 Message Flows - Successful Cases and Scenarios

#### 5.2.2.1.1 Session Establishment - Mobile Origination

The following figure shows the Diameter transactions that are required between CSCF and CDF during session establishment originated by a UE.

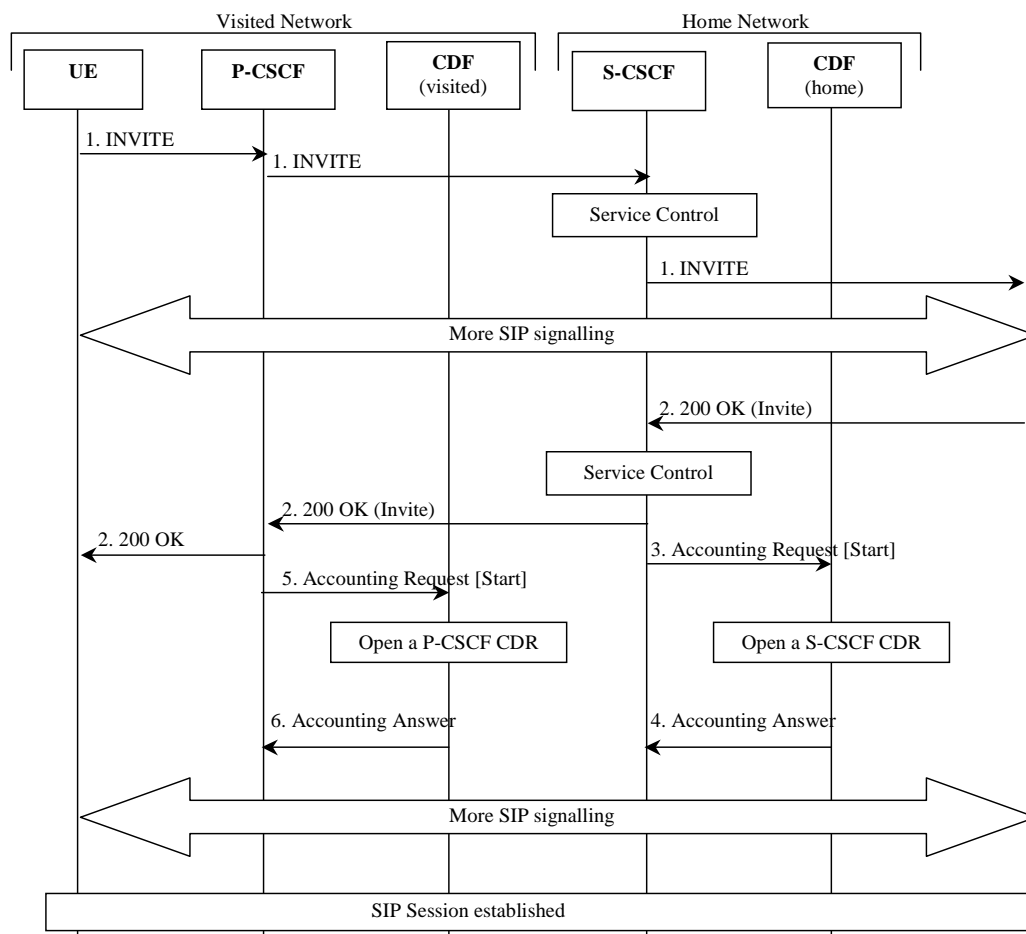

**Figure : Message Sequence Chart for Session Establishment (Mobile Origination)**

1. The session is initiated.
2. The destination party answers and a final response are received.
3. Upon reception of the final response, the S-CSCF sends an *Accounting-Request* with *Accounting-Record-Type* indicating START\_RECORD to record start of a user session and start of a media component in the S-CSCF CDR.
4. The CDF acknowledges the reception of the data and opens an S-CSCF CDR.
5. Same as 3, but for P-CSCF.
6. Same as 4, but creating a P-CSCF CDR.



5.2.2.1.2 Session Establishment - Mobile Termination

The following figure shows the Diameter transactions that are required between CSCF and CDF during a session establishment that is terminated to a mobile. The I-CSCF is only involved in the INVITE transaction.

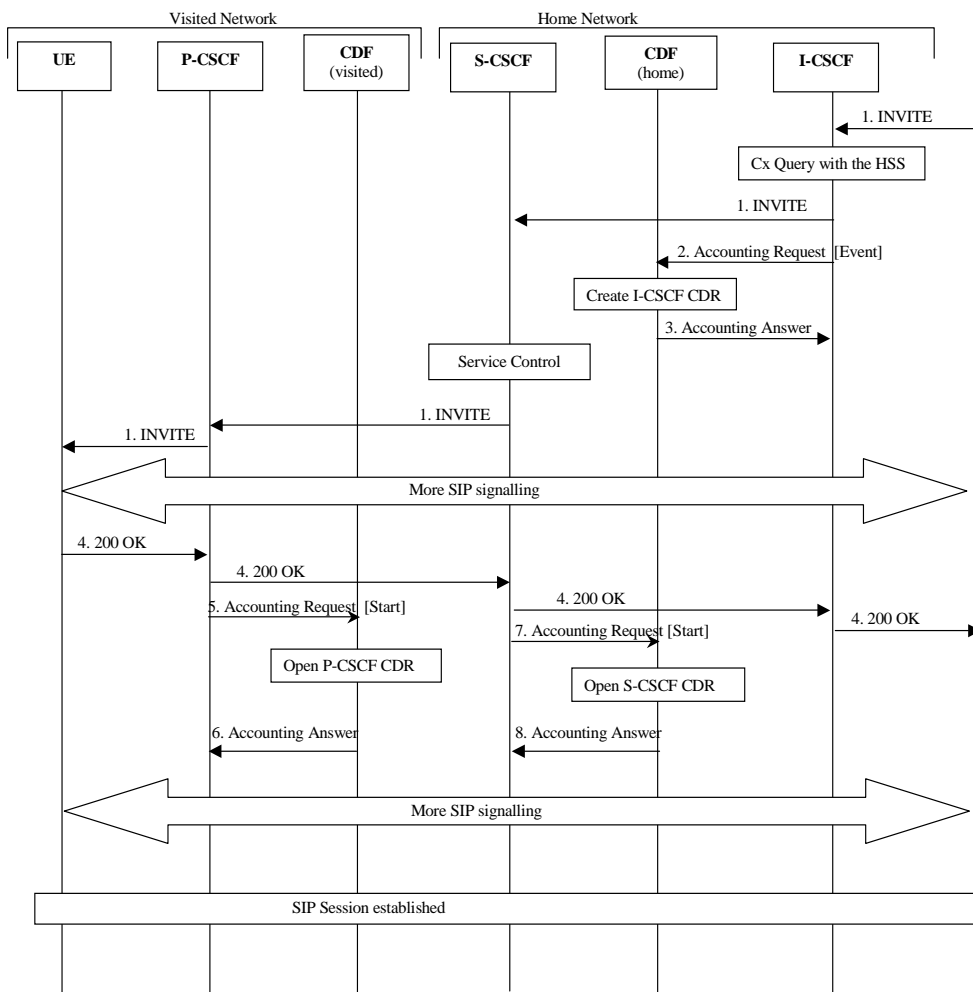

Figure : Message Sequence Chart for Session Establishment (Mobile Termination)

- 1. The session is initiated.
- 2. Upon completing a Cx query the I-CSCF sends an *Accounting Request* with the *Accounting-Record-Type* set to EVENT.
- 3. The CDF acknowledges the data received and creates an I-CSCF CDR.
- 4. The destination party answers and a final response are sent.
- 5. - 8. These steps are identical to the corresponding steps described in clause 5.2.2.1.1.

5.2.2.1.3 Mid-Session Procedures

The following figure shows the Diameter transactions that are required between CSCF and CDF when a UE generates a SIP (Re-)INVITE or SIP UPDATE in mid-session, e.g. in order to modify media component(s), or when the hold and resume procedure is executed.

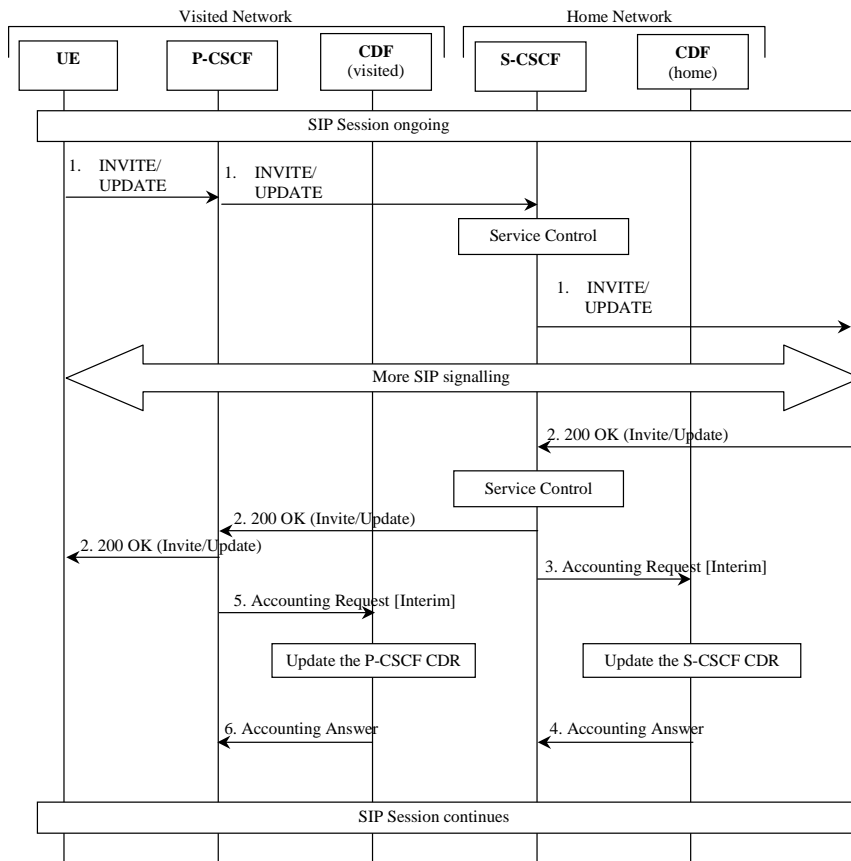
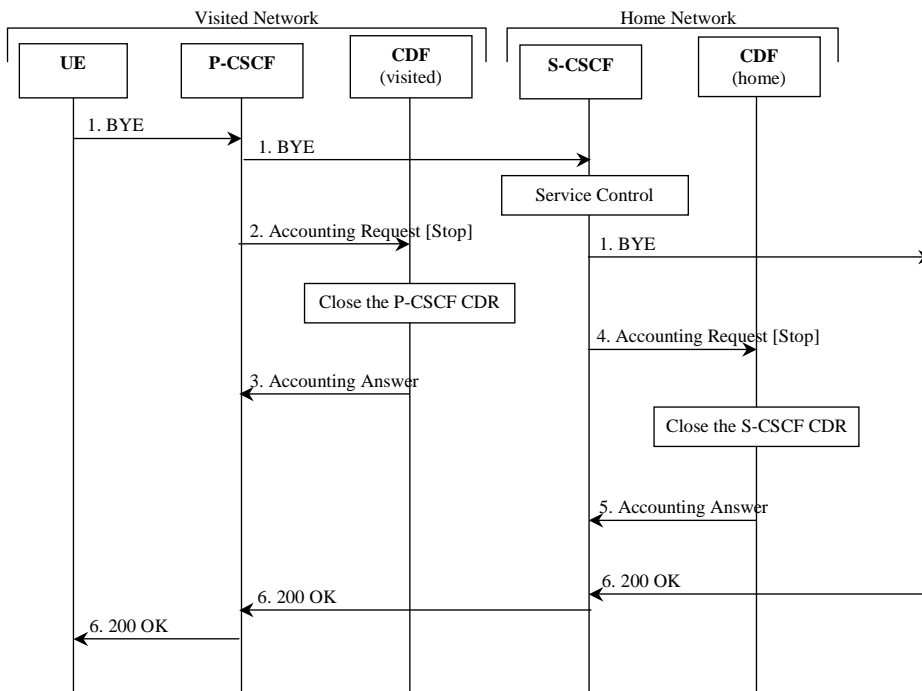

Figure : Message Sequence Chart for Media Modification

1. Modified media information is received from the subscriber.
2. The destination party acknowledges the media modification.
3. At modification of a media, the S-CSCF sends *Accounting-Request* with *Accounting-Record-Type* indicating INTERIM\_RECORD to record modification of a media component in the S-CSCF CDR.
4. The CDF acknowledges the reception of the data and updates the S-CSCF CDR.
5. Same as 3, but for P-CSCF.
6. Same as 4, updating the P-CSCF CDR.

5.2.2.1.4 Session Release - Mobile Initiated

The following figure shows the Diameter transactions that are required between CSCF and CDF for a session release that is initiated by the UE.



**Figure : Message Sequence Chart for Session Release**

1. The session is released.
2. At session termination the P-CSCF sends *Accounting-Request* with *Accounting-Record-Type* indicating STOP\_RECORD to record stop of a session and stop of a media component in the P-CSCF CDR.
3. The CDF acknowledges the reception of the data and closes the P-CSCF CDR.
4. Same as 2, but for S-CSCF.
5. Same as 3, closing the S-CSCF CDR.
6. The release is acknowledged.

5.2.2.1.5 Session-Unrelated Procedures

The following figure shows the Diameter transactions that are required between CSCF and CDF for session-unrelated IMS procedures, i.e. those that relate to the Diameter ACR [Event], as listed in Table 5.2.1.1.

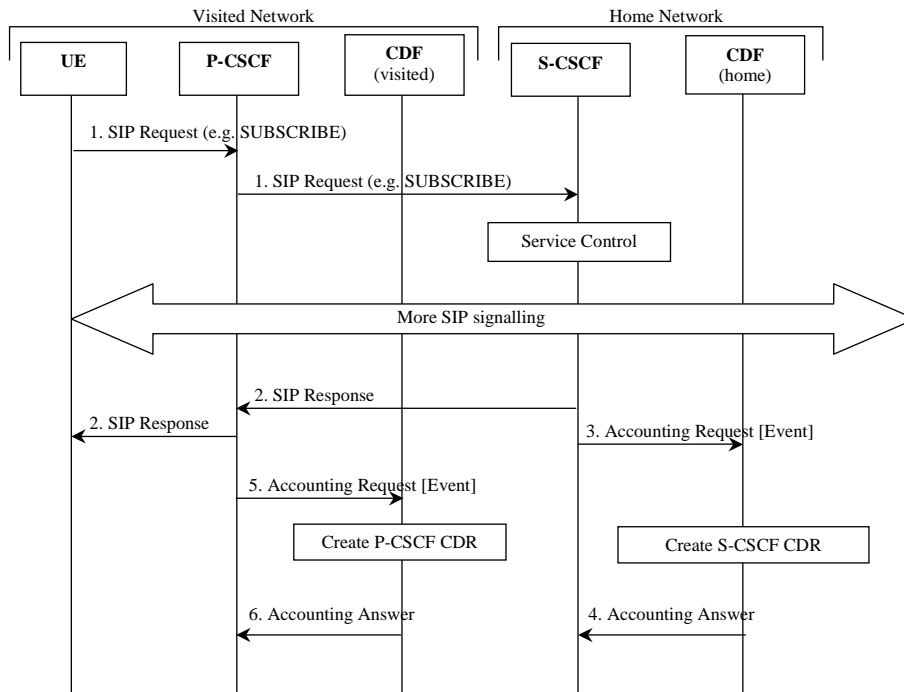

Figure : Message Sequence Chart for Session-Unrelated Procedure

1. The P-CSCF receives a "SIP Request" (e.g. SUBSCRIBE) from the subscriber.
2. The "SIP Request" is acknowledged by the "SIP Response" as follows:
  - in the successful case, a 200 OK message is returned;
  - in case of failure an appropriate SIP error message is returned.

Depending on the used SIP method, there might be additional signalling between steps 1 and 2.

3. After the completion of the procedure, the S-CSCF sends *Accounting-Request* with *Accounting-Record-Type* indicating *EVENT\_RECORD* to record transaction specific information in the S-CSCF CDR.
4. The CDF acknowledges the reception of the data and produces an S-CSCF CDR.
5. Same as 3, but for P-CSCF.
6. Same as 4, creating a P-CSCF CDR.

### 5.2.2.1.6 Session Establishment - PSTN Initiated

The following figure shows the Diameter transactions that are required between MGCF and CDF during session establishment initiated from the PSTN side.

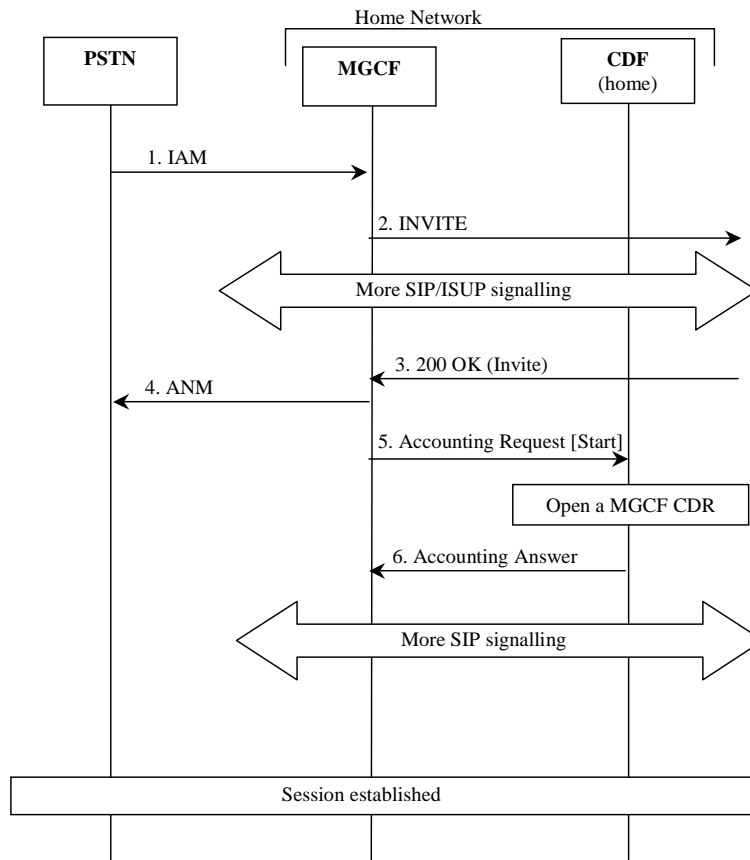

**Figure : Message Sequence Chart for Session Establishment (PSTN Initiated)**

1. The session is originated from the PSTN.
2. The session setup is triggered in the IMS.
3. The destination party answers and a final response are received.
4. MGCF forwards an answer message to the PSTN.
5. Upon reception of the final response, the MGCF sends an *Accounting-Request* with *Accounting-Record-Type* indicating *START\_RECORD* to record start of a user session and start of a media component in the MGCF CDR.
6. The CDF acknowledges the reception of the data and opens a MGCF CDR.

5.2.2.1.7 Session Establishment - IMS Initiated

The following figure shows the Diameter transactions that are required between BGCF, MGCF and CDF during session establishment initiated from the IMS side.

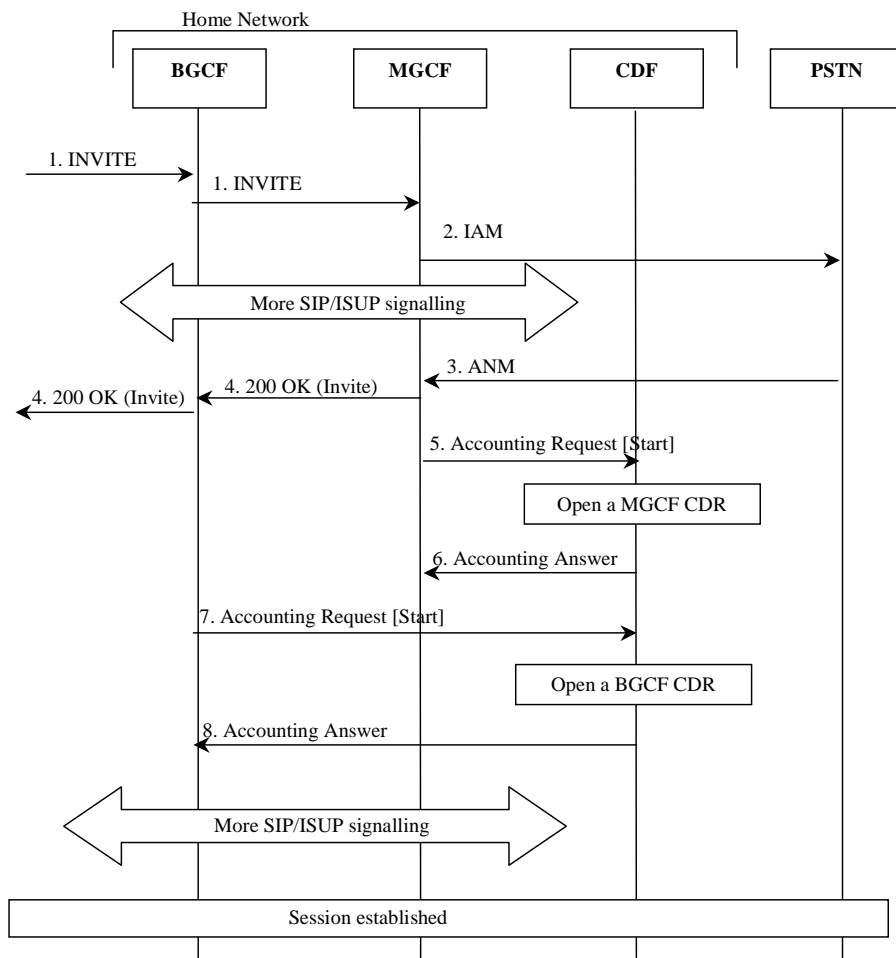

Figure : Message Sequence Chart for Session Establishment (IMS Initiated)

1. The session is originated from the IMS.
2. A session towards PSTN is established.
3. The destination party answers and an answer message are received.
4. A final response message is sent to the session originator.
5. Upon reception of the answer message, the MGCF sends an *Accounting-Request* with *Accounting-Record-Type* indicating *START\_RECORD* to record start of a user session and start of a media component in the MGCF CDR.
6. The CDF acknowledges the reception of the data and opens a MGCF CDR.
7. Upon reception of the 200 OK message, the BGCF sends an *Accounting-Request* with *Accounting-Record-Type* indicating *START\_RECORD* to record start of a user session and start of a media component in the BGCF CDR.
8. The CDF acknowledges the reception of the data and opens a BGCF CDR.

5.2.2.1.8 Session Release - PSTN Initiated

The following figure shows the Diameter transactions that are required between BGCF, MGCF and CDF during a PSTN initiated session release. The BGCF is only involved if the session had been initiated from the IMS side.

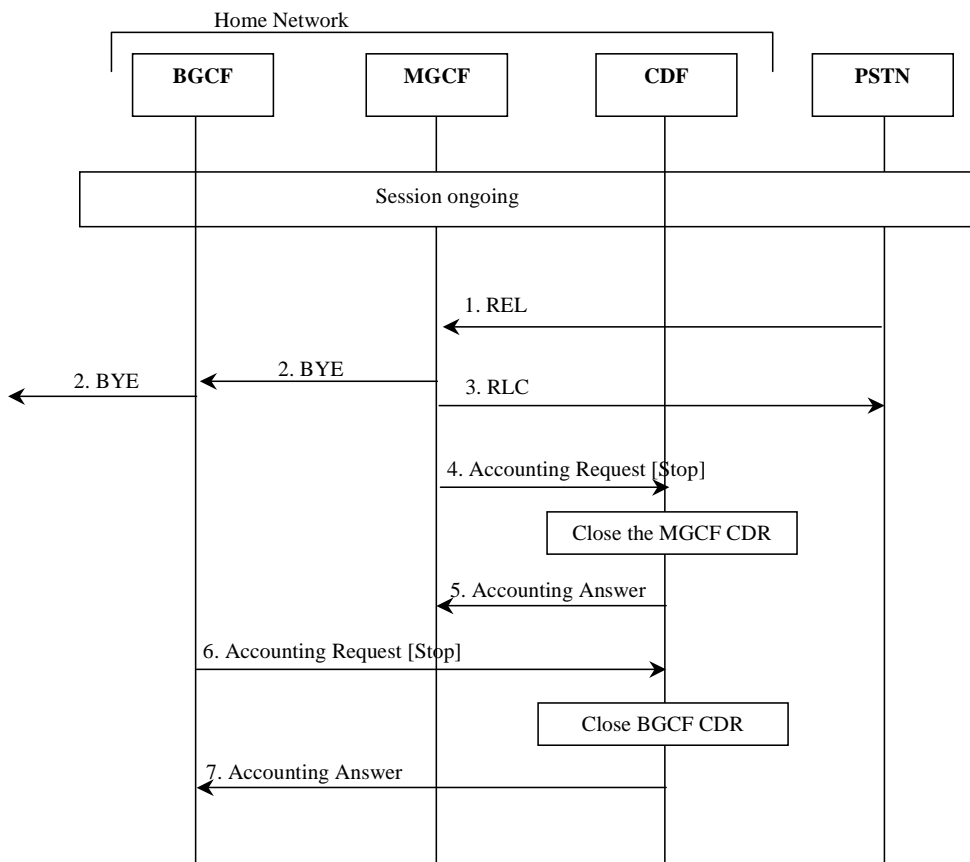

Figure : Message Sequence Chart for Session Release (PSTN initiated)

1. The session release is initiated from PSTN.
2. Session release continues within IMS.
3. The reception of the release message is acknowledged.
4. Upon reception of the release message, the MGCF sends an *Accounting-Request* with *Accounting-Record-Type* indicating STOP\_RECORD to record stop of a session in the MGCF CDR.
5. The CDF acknowledges the reception of the data and closes the MGCF CDR.
6. Same as 4, but for BGCF.
7. Same as 5, but for BGCF.

### 5.2.2.1.9 Session Release - IMS Initiated

The following figure shows the Diameter transactions that are required between BGCF, MGCF and CDF during a IMS initiated session release.

The BGCF is only involved if the session had been initiated from the IMS side.

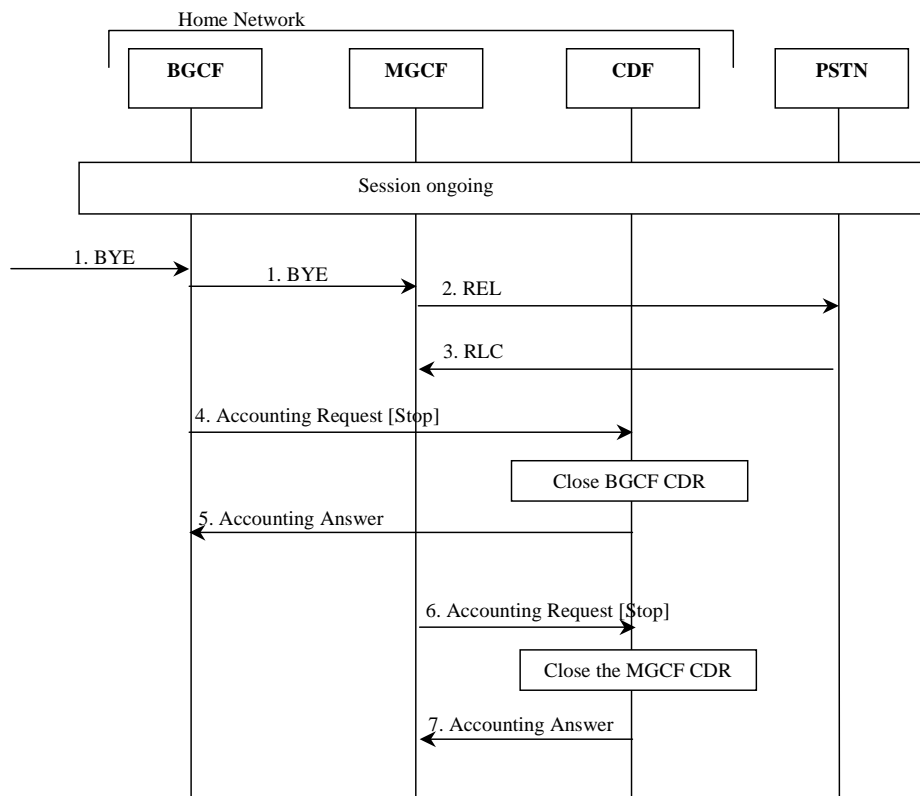

**Figure : Message Sequence Chart for Session Release (IMS initiated)**

1. The session release is initiated from the IMS side.
2. A release message is sent towards PSTN.
3. The acknowledgement of the release message is received from PSTN.
4. Upon reception of the BYE message, the BGCF sends an *Accounting-Request* with *Accounting-Record-Type* indicating STOP\_RECORD to record stop of a session in the BGCF CDR.
5. The CDF acknowledges the reception of the data and closes the BGCF CDR.
6. Same as 4, but for MGCF.
7. Same as 5, but for MGCF.

### 5.2.2.1.10 Multi-Party Call

The following figure shows the establishment of an ad hoc conference (multiparty call). An AS (acting as B2BUA) performs third party call control with the MRFC, where the S-CSCF is in the signalling path. The Application Server that is in control of the ad hoc conference is aware of the MRFC capabilities.

**NOTE:** Only accounting information sent from the MRFC is shown in detail in the figure. The SIP messages are for illustrative purpose only.



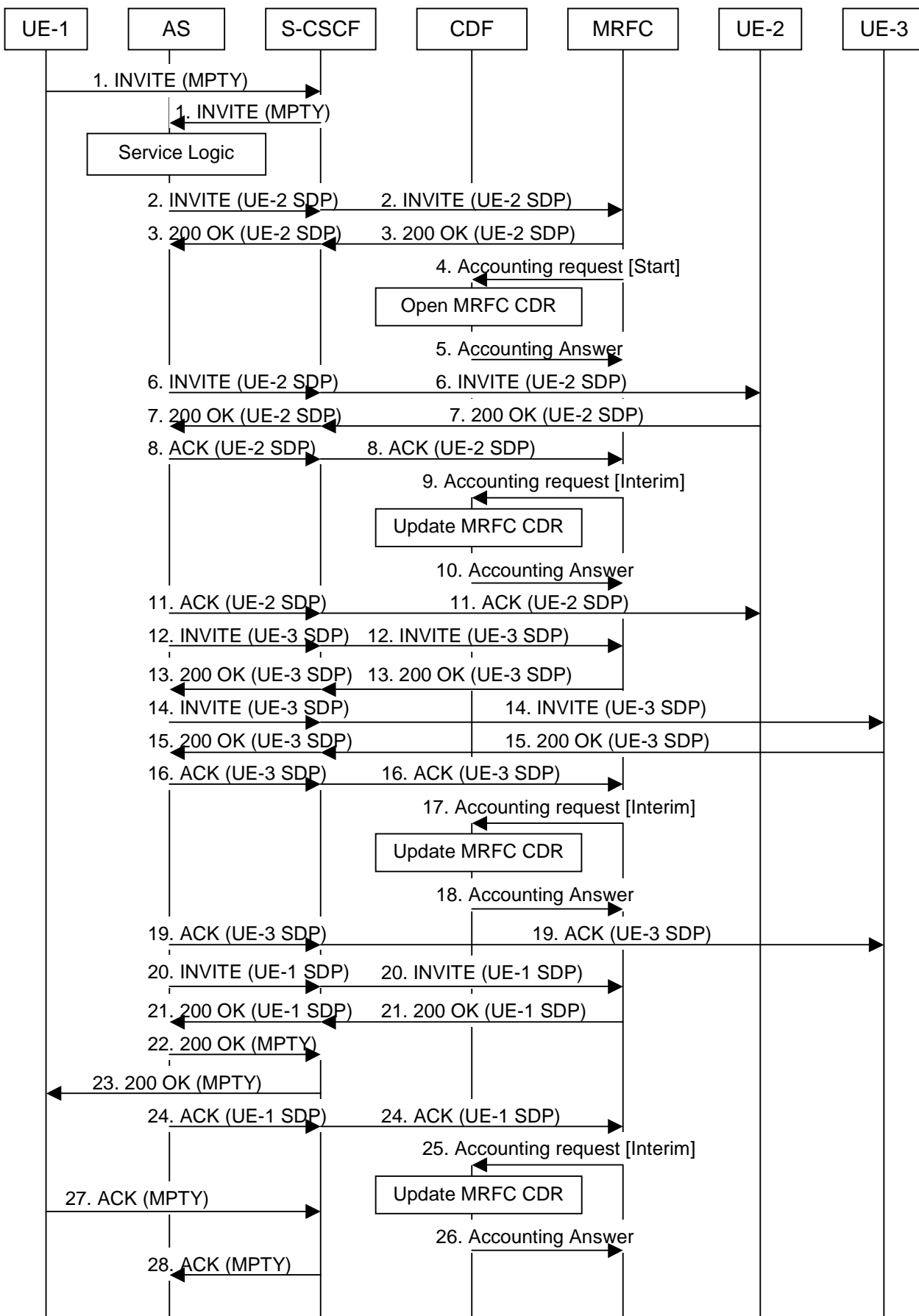

**Figure : Message Sequence Chart for Multi-Party Call Establishment in MRFC**

1. Sessions exist between UE-1 and UE-2, and between UE-1 and UE-3. A request is received from UE-1 for putting all parties together to a multi-party call.
2. - 3. Request and acknowledgement to initiate multi-party call. MRFC assigns a conference-ID that is used by the AS in subsequent interactions with the MRFC in INVITE messages connecting other endpoints (see TS 23.228 [201]). Path establishment between AS and MRFC for UE-2.
4. At start of session establishment the MRFC sends an *Accounting-Request* with *Accounting-Record-Type* indicating START\_RECORD to record start of multi-party call in the MRFC CDR.
5. The CDF acknowledges the reception of the data and creates the MRFC CDR. 'Calling Party Address', 'Service Request Time Stamp', 'Service ID' (holding the conference-ID) etc. are included in the MRFC CDR.
- 6 - 7. Path establishment between UE-2 and AS. Same ICID is used as for the path between AS and MRFC for UE-2 (step 2. - 3.).
8. Acknowledgement of path between AS and MRFC for UE-2.
9. The MRFC may send an *Accounting-Request* with *Accounting-Record-Type* indicating INTERIM\_RECORD to report that UE-2 has been connected to the multi-party call.
10. The CDF acknowledges the reception of the data and includes UE-2 in the field 'Application Provided Called Parties' of the MRFC CDR.
11. Acknowledgement of path between AS and UE-2. Now a path between UE-2 and MRFP via AS is established.
- 12 -13.. Request and acknowledgement to establish path between AS and MRFC for UE-3.
14. -15. Path establishment between UE-3 and AS. Same ICID is used as for the path between AS and MRFC for UE-3 (step 12. - 13.).
16. Acknowledgement of path between AS and MRFC for UE-3.
17. The MRFC may send an *Accounting-Request* with *Accounting-Record-Type* indicating INTERIM\_RECORD to report that UE-3 has been connected to the multi-party call.
18. The CDF acknowledges the reception of the data and includes UE-3 in a new field 'Application Provided Called Parties' of the MRFC CDR.
19. Acknowledgement of path between AS and UE-3.
- 20 - 21. Request and acknowledgement to establish path between AS and MRFC for UE-1. Same ICID is used as for the path between UE-1 and AS (step 1.).
- 22 - 23. Request for multi-party conference with UE-2 and UE-3 is acknowledged to UE 1. Implicit acknowledgement of path UE-1 to AS.
24. Acknowledgement of path between AS and MRFC for UE-1.
25. The MRFC may send an *Accounting-Request* with *Accounting-Record-Type* indicating INTERIM\_RECORD to report that UE-1 has been connected to the multi-party call.
26. The CDF acknowledges the reception of the data and includes the field 'Service Delivery Start Time Stamp' into the MRFC CDR.
- 27 -28. UE-1 acknowledges the multi-party call session establishment.

NOTE: It is in the responsibility of the AS to terminate the sessions existing at the beginning of the multi-party call establishment between UE-1 and UE-2 and between UE-1 and UE-3 (see step 1.) in case of successful multi-party call establishment. This is not shown in the diagram above.

5.2.2.1.11 AS Related Procedures - AS Acting as a Redirect Server

Application servers may support a multitude of services which are not specified in 3GPP standards. Therefore it is not possible to standardise charging flows and procedures for those services. However, for all such services, the AS may apply either Event Charging, where ACR [Event] messages are generated, or Session Charging, using ACR [Start, Stop and Interim]. The following clauses depict one example for each of the two scenarios. The first procedure, AS acting as a Redirect Server, depicts the "event" case, while the second procedure, AS acting as a Voice Mail Server, depicts the "session" case.

The following figure shows the case where an Application Server acts as a Redirect Server. In the figure below, UE-1 sets up a session towards UE-2 but due to Call Forwarding functionality located in the AS, a new number (to UE-3) is returned to UE-1. Finally UE-1 sets up the session towards UE-3.

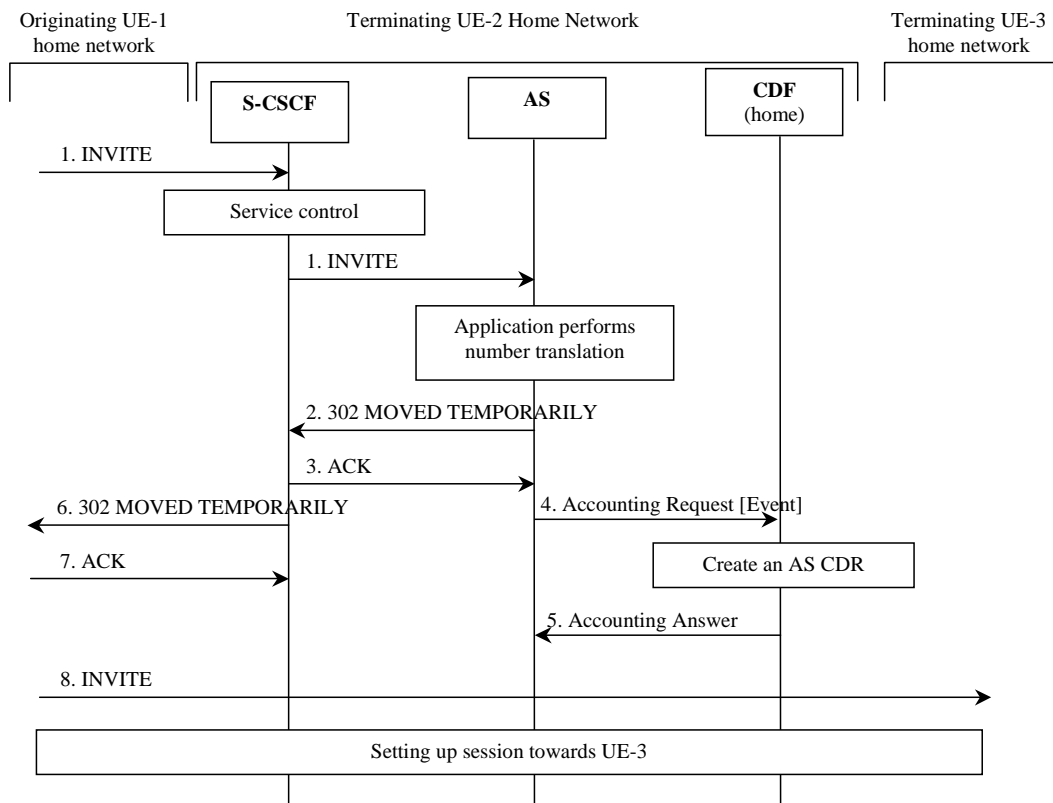
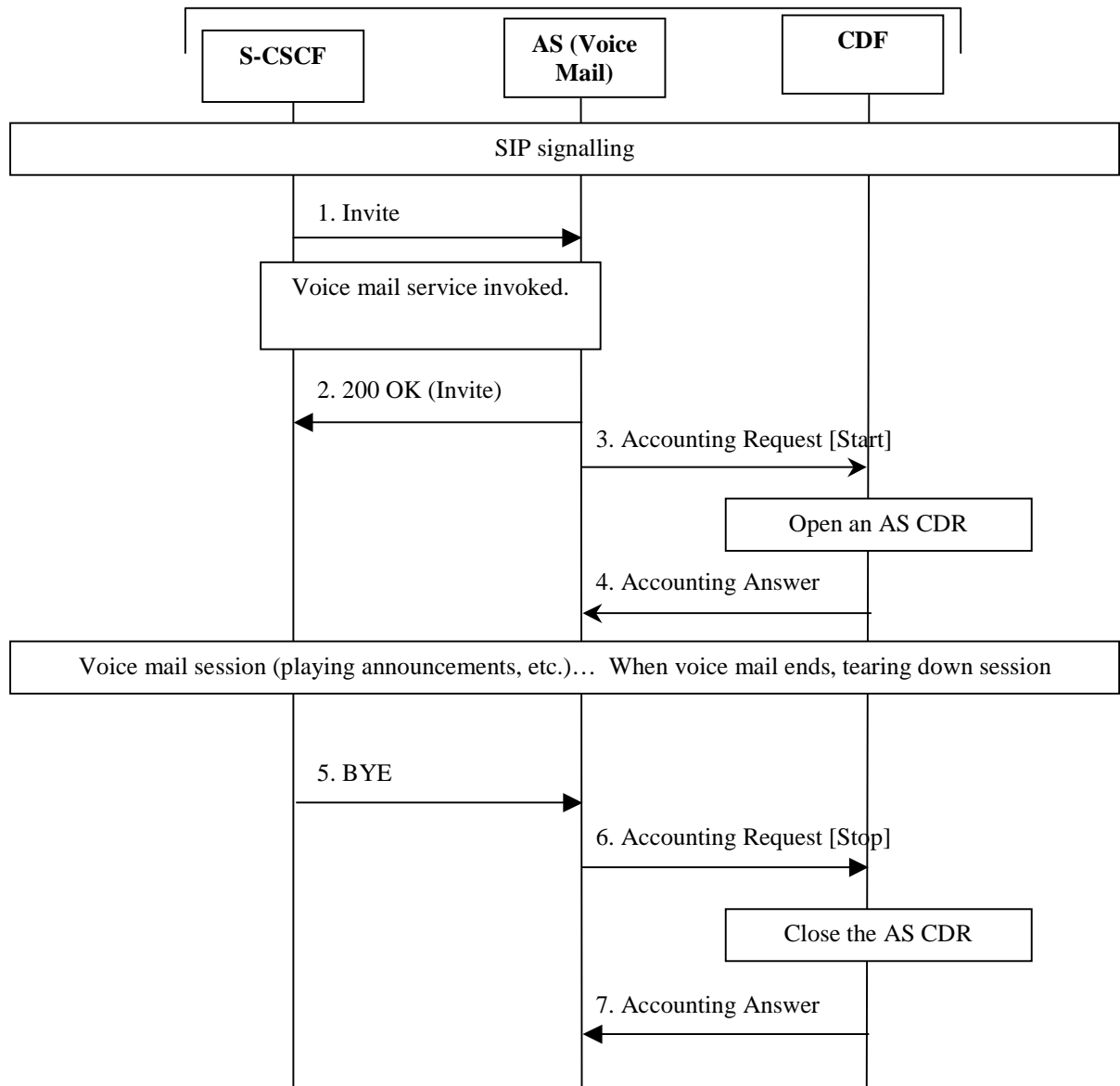

Figure : Message Sequence Chart for AS Acting as a Redirect Server

- 1. Sessions initiated by UE-1 towards UE-2.
- 2. - 3. Response indicating that session should be redirected towards another number (UE-3).
- 4. After successful service execution, the AS sends *Accounting-Request* with *Accounting-Record-Type* indicating *EVENT\_RECORD* to record service specific information in the AS CDR.
- 5. The CDF acknowledges the reception of the data and creates the AS CDR.
- 6-7. Response indicating that session should be redirected towards another number (UE-3).
- 8. Session is initiated by UE-1 towards UE-3.

## 5.2.2.1.12 AS Related Procedures - AS Acting as a Voice Mail Server

The following figure shows the case where an Application Server acts as a Voice Mail Server. S-CSCF invokes the AS acting as Voice Mail Server according to procedure as defined in TS 23.218 [203].



**Figure : Message Sequence Chart for AS Acting as a Mail Server**

1. AS receives the INVITE from the S-CSCF.
2. AS acknowledges the initiated Voice Mail session by issuing a 200 OK in response to the INVITE.
3. AS sends *Accounting-Request* with *Accounting-Record-Type* indicating START\_RECORD to record start of a voice mail session.
4. The CDF acknowledges the reception of the *Accounting-Request* with *Accounting-Record-Type* indicating START\_RECORD and opens a AS CDR.
5. Voice mail session release is initiated.
6. Upon reception of release message AS sends an *Accounting-Request* with *Accounting-Record-Type* indicating STOP\_RECORD to record stop of a session in the AS CDR.
7. The CDF acknowledges the reception of the data and closes the AS CDR.

### 5.2.2.2 Message Flows - Error Cases and Scenarios

This clause describes various error cases and how these should be handled. The error cases are grouped into the following categories:

- Failure in SIP Related Procedures:
  - Session Related Error Scenarios;
  - Session Unrelated Error Scenarios.
- Errors in Diameter (Accounting) Related Procedures.

#### 5.2.2.2.1 Session Related SIP Procedures- Reception of SIP error messages

A SIP session is closed abnormally by the reception of a BYE message indicating the reason for such termination.

In this case, an ACR [Stop] message that includes an appropriate error indication is sent.

#### 5.2.2.2.2 Session Related SIP Procedures - SIP session failure

All nodes involved in the SIP session are expected to exercise some kind of session supervision. In case a node detects an error in the SIP session, such as a timeout or the occurrence of an invalid SIP message that results in the inability to maintain the session, this IMS node will generate a BYE message towards both ends of the connection.

The node that sent the BYE to trigger session termination identifies the cause of the failure in the ACR [Stop] towards the CDF. All other nodes, i.e. those that receive the BYE, are not aware of an error, and therefore they treat this situation as any normal SIP session termination.

#### 5.2.2.2.3 Session Unrelated SIP procedures

As described in clause 5.1.2.1.2, a session unrelated SIP procedure may either be completed with the reception of a 200OK, or a SIP error message. If the latter occurs, i.e. there is a failure in the procedure, the ACR [Event] sent towards the CDF includes an appropriate error indication.

#### 5.2.2.2.4 CDF Connection Failure

When the connection towards the primary CDF is broken, the process of sending accounting information should continue towards a secondary CDF (if such a CDF is configured). For further CDF connection failure functionality, see clause "*Transport Failure Detection*" in IETF RFC 3588 [401].

If no CDF is reachable the network element may buffer the generated accounting data in non-volatile memory. Once the CDF connection is working again, all accounting messages stored in the buffer is sent to the CDF, in the order they were stored in the buffer.

#### 5.2.2.2.5 No Reply from CDF

In case an IMS node does not receive an ACA in reply to an ACR, it may repeat the ACR message. The waiting time until a repetition is sent, and the maximum number of repetitions are both configurable by the operator. When the maximum number of repetitions is reached and still no ACA reply has been received, the IMS node executes the CDF connection failure procedure as specified above.

If retransmitted ACRs are sent, they are marked with the T-flag as described in IETF RFC 3588 [401] , in order to allow duplicate detection in the CDF, as specified in the next clause.

#### 5.2.2.2.6 Duplicate Detection

A Diameter client marks possible duplicate request messages (e.g. retransmission due to the link failover process) with the T-flag as described in IETF RFC 3588 [401].

If the CDF receives a message that is marked as retransmitted and this message was already received, then it discards the duplicate message. However, if the original of the re-transmitted message was not yet received, it is the information

in the marked message that is taken into account when generating the CDR. The CDRs are marked if information from duplicated message(s) is used.

#### 5.2.2.2.7 CDF Detected Failure

The CDF closes a CDR when it detects that expected Diameter ACRs for a particular SIP session have not been received for a period of time. The exact behaviour of the CDF is operator configurable.

### 5.2.3 CDR generation

**Editor's Note:** FFS

### 5.2.4 GTP" record transfer flows

GTP" is not used between CDF and CGF in IP Multimedia subsystem, because CDF and CGF are combined into CCF (see clause 4).

Text should be copied from the middle tear template section.

### 5.2.5 Bi CDR file transfer

**Editor's Note:** FFS

## 5.3 IMS Online Charging Scenarios

### 5.3.1 Basic Principles

IMS online charging uses the Credit Control application that is specified in 3GPP Rel-6 TS 32.299 [50].

Three cases for online charging are distinguished:

- Immediate Event Charging (IEC); and
- Event Charging with Unit Reservation (ECUR), and
- Session Charging with Unit Reservation (SCUR)

Both stage 2 and stage 3 mechanisms for the three cases for online charging are detailed in TS 32.299 [50].

In the case of Immediate Event Charging (IEC), granting units to the IMS network element is performed in a single operation that also includes the deduction of the corresponding monetary units from the subscriber's account. The charging process is controlled by the corresponding credit control request which is sent for a given credit control event.

In contrast, Event Charging with Unit Reservation (ECUR) also includes the process of requesting, reserving, releasing and returning unused units for events. The deduction of the corresponding monetary units then occurs upon conclusion of the ECUR transaction. In this case, the credit control request is used to control the credit control session.

Session Charging with Unit Reservation (SCUR) is used for credit control of sessions. SCUR also includes the process of requesting, reserving, releasing and returning unused units for sessions, and the deduction of the corresponding monetary units. During a SIP session there can be repeated execution of unit reservation and debit operations as specified in TS 32.299 [50].

The IMS network element may apply IEC, where CCR Event messages are generated, or ECUR, using CCR Initial, and Termination or SCUR. The decision whether to apply IEC, ECUR or SCUR is based on the service and/or operator's policy.

The CTF uses CCR Initial, Update, Terminate in procedures related to successful SIP sessions. It uses CCR Events for unsuccessful SIP sessions and for session unrelated procedures. Further details are specified in the tables below.

It is operator configurable in the nodes for which SIP method a *Credit Control Request* is sent. The table below describes all possible CCRs that might be sent from a S-CSCF.

It is configurable for the operators to enable or disable the generation of a CCR message by the IMS node in response to a particular "Triggering SIP Method".

**Table 5.3.1: Credit Control Request Messages Triggered by SIP Methods for IMS-GWF**

Diameter Message	Triggering SIP Method
CCR [Initial]	SIP INVITE (SCUR)
	SIP NOTIFY (ECUR)
	SIP MESSAGE (ECUR)
	SIP REGISTER (ECUR)
	SIP SUBSCRIBE (ECUR)
	SIP REFER (ECUR)
	SIP PUBLISH (ECUR)
CCR [Update]	SIP 200 OK acknowledging a SIP INVITE, RE-INVITE or SIP UPDATE [e.g. change in media components] (SCUR)
	RE-INVITE or SIP UPDATE [e.g. change in media components] (SCUR)
	Expiration of quota, Validity time expiry or other authorization triggers (quota threshold reached, ...). (SCUR)
CCR [Terminate]	SIP BYE message (both normal and abnormal session termination cases) (SCUR)
	SIP 200 OK acknowledging non-session related SIP messages (ECUR)
	Aborting a SIP session set-up procedure, using an internal trigger, or a SIP CANCEL.(SCUR/ECUR)
	Deregistration (see NOTE) (SCUR/ECUR)
	SIP Final Response 2xx (including 202 response to REFER, except SIP 200 OK) (ECUR)
	SIP Final/Redirection Response 3xx (SCUR/ECUR)
	SIP Final Response (4xx, 5xx or 6xx), indicating an unsuccessful SIP session set-up procedure (SCUR)
SIP Final Response (4xx, 5xx or 6xx), indicating an unsuccessful session-unrelated procedure (ECUR)	
CCR [Event]	SIP NOTIFY (IEC)
	SIP MESSAGE (IEC)
	SIP REGISTER (IEC)
	SIP SUBSCRIBE (IEC)
	SIP REFER (IEC)
	SIP PUBLISH (IEC)
	SIP Final Response (4xx, 5xx or 6xx), indicating an unsuccessful session-unrelated procedure (IEC)
NOTE :	SIP SUBSCRIBE with the field "Expires" set to 0 means unsubscribe. SIP REGISTER with its "Expires" header field or "Expires" parameter equal to 0 or local deregistration due to expiry means Deregistration (see 3GPP TS 24.229 [204]).

**Editors Note: Triggers for AS and MRFC are FFS.**

NOTE: To the extent possible alignment with the IETF RFC 4006 [402] is planned.

## 5.3.2 Diameter Message Flows and Types

This clause describes the message flows for the event charging procedures on the Ro interface.

### 5.3.2.1 Immediate Event Charging (IEC)

This clause provides the details of the "Debit Units" operation specified in TS 32.299 [50].

### 5.3.2.1.1 Message Flows - Successful Cases and Scenarios

#### 5.3.2.1.1.1 IEC – Debit Units Operation

The transactions that are required on the Ro interface in order to perform IEC with Debit Units operations are carried out as described in TS 32.299 [50] where 'CTF' refers to IMS network element. The Debit Units operation may alternatively be carried out prior to, concurrently with or after service/content delivery. The IMS network element must ensure that the requested service execution is successful, when this scenario is used.

**Editor's Note: Must be aligned with TS 32.299 [50].**

### 5.3.2.1.2 Message Flows - Error Cases and Scenarios

This clause describes various error cases and how these should be handled.

The failure handling behaviour is locally configurable in the IMS network element. If the *Direct-Debiting-Failure-Handling* AVP is not used, the locally configured values are used instead.

#### 5.3.2.1.2.1 Reception of SIP Error Messages

If SIP errors in SIP response (4xx, 5xx or 6xx) occur during service delivery, as defined in TS 24.228 [202] and TS 23.218 [203], it is up to the IMS network element to determine to what extent the service was delivered before the error occurred and act appropriately with respect to charging. This may imply that no units at all (or no more units) are debited.

#### 5.3.2.1.2.2 Debit Units Operation Failure

This case comprises situations where either no, or an erroneous response, is received from the ECF. The 'no response' case is detected by the IMS network element when the connection supervision timer Tx expires (IETF RFC 4006 [402]) before a response *Credit-Control-Answer* (CCA) is received. The case of receiving an erroneous response implies that the IMS network element receives a *Credit-Control-Answer* (CCA), which it is unable to process, while Tx is running. The failure handling complies with the failure procedures for "Direct Debiting" scenario described in IETF RFC 4006 [402].

#### 5.3.2.1.2.3 Duplicate Detection

The detection of duplicate request is needed and must be enabled. To speed up and simplify as much as possible the duplicate detection, the all-against-all record checking should be avoided and just those records marked as potential duplicates need to be checked against other received requests (within a reasonable time window) by the receiver entity.

The IMS network element marks the request messages that are retransmitted after a link failover as possible duplicates with the T-flag as described in [201]. For optimized performance, uniqueness checking against other received requests is only necessary for those records marked with the T-flag received within a reasonable time window. This focused check is based on the inspection of the *Session-Id* and *CC-Request-Number* AVP pairs.

### 5.3.2.2 Event Charging with Unit Reservation (ECUR) and Session Charging with Unit Reservation (SCUR)

This clause provides the details of the "Reserve Units" and "Debit Units" operation specified in TS 32.299 [50].



### 5.3.2.2.1 Message Flows - Successful Cases and Scenarios

#### 5.3.2.2.1.1 ECUR and SCUR - Reserve Units and Debit Units Operations

The transactions that are required on the Ro interface in order to perform ECUR/SCUR with Reserve Units and Debit Units operations is carried out as described in TS 32.299 [50] where 'CTF' refers to an IMS network element. Multiple replications of both of these operations are possible.

#### 5.3.2.2.1.2 Expiration of Reservation Validity

This clause defines how reserved units are returned, if not used, within a reasonable time. It should be possible that both the reservation and SIP sessions are cancelled or only the reservation is cancelled without removing the SIP session.

### 5.3.2.2.2 Message Flows - Error Cases and Scenarios

This clause describes various error cases and how these should be handled.

The failure handling behaviour is locally configurable in the IMS network element. If *Credit-Control-Failure-Handling* AVP is not used, the locally configured values are used instead.

#### 5.3.2.2.2.1 Reception of SIP Error Messages

If SIP errors occur during service delivery, as defined in [202] and [203], it is up to the IMS network element to determine to what extent the service was delivered before the error occurred and act appropriately with respect to charging. This may imply that no units at all (or no more units) are reserved or debited.

#### 5.3.2.2.2.2 Reserve Units and Debit Units Operation Failure

This case comprises of OCS connection failure, and/or receiving error responses from the OCS.

The IMS network element detects an OCS connection failure when the timer Tx expires (IETF RFC 4006 [402]) or a transport failure is detected as defined in IETF RFC 3588 [401]. The OCS also has the capability to detect failures when the timer Ts (IETF RFC 3588 [401]) expires. The OCS should indicate the cause of failure by setting the appropriate result code as defined in IETF RFC 3588 [401] and IETF RFC 4006 [402]. In any case, the failure handling of IMS network element and OCS complies with the failure procedures for session based credit control scenario described in IETF RFC 4006 [402].

#### 5.3.2.2.2.3 Duplicate Detection

For credit control duplicate detection is performed only for possible duplicate event requests related to IEC as mentioned in clause 5.3.2.1.2.3, as retransmission of ECUR/SCUR related credit control requests is not allowed.

#### 5.3.2.2.2.4 Aborted Session Setup

If a trigger occurs during session establishment to release a session during the establishment procedure, the IMS Network Element shall initiate procedures to cancel the session establishment as defined in TS 24.229 [204]. On completion of the cancellation procedure, the IMS Network Element shall close the credit-control session (for SCUR and ECUR) indicating an appropriate cause code.

## 6 Definition of charging information

### 6.1 Data description for IMS offline charging

#### 6.1.1 Rf Message contents

The IMS nodes generate accounting information that can be transferred from the CTF to the CDF. For this purpose, IMS offline charging utilises the *Charging Data Transfer* that is specified in the 3GPP accounting application described in TS 32.299 [50].

The *Charging Data Transfer* operation employs the *Charging Data Request* and *Charging Data Response* messages. The following table describes the use of these messages for offline charging.

**Table 6.1.1: Offline Charging Messages Reference Table**

Command-Name	Source	Destination
<i>Charging Data Request</i>	S-CSCF, I-CSCF, P-CSCF, MRFC, MGCF, BGCF, AS	CDF
<i>Charging Data Response</i>	CDF	S-CSCF, I-CSCF, P-CSCF, MRFC, MGCF, BGCF, AS

#### 6.1.1.1 Charging Data-Request Message

The following table illustrates the basic structure of a Diameter *Charging Data-Request* message as used for IMS offline charging.

**Table 6.1.1.1: Charging Data Request Message Contents**

Field	Category	Description
Session Identifier	M	Described in 32.299 [50]
Originator Host	M	Described in 32.299 [50]
Originator Domain	M	Described in 32.299 [50]
Destination Domain	M	Described in 32.299 [50]
Operation Type	M	Described in 32.299 [50]
Operation Number	M	Described in 32.299 [50]
Operation Identifier	O <sub>M</sub>	The field corresponds to the unique operation identification.
User Name	O <sub>C</sub>	The field contains the Private User Identity [201].
Operation Interval	O <sub>C</sub>	TBD
Origination State	O <sub>C</sub>	TBD
Origination Timestamp	O <sub>C</sub>	This field contains the time when the operation is requested.
Proxy Information	O <sub>C</sub>	This field contains the parameter of the proxy.
Route Information	O <sub>C</sub>	This field contains the parameter of the route.
Service Information	O <sub>M</sub>	This field holds the 3GPP specific IMS parameter, described in 6.3.

### 6.1.1.2 Charging Data Response Message

The following table illustrates the basic structure of a Diameter *Charging Data Response* message as used for IMS offline charging.

**Table 6.1.1.2: Charging Data Response Message Contents**

Field	Category	Description
Session Identifier	M	This field identifies the operation session.
Operation Result	M	This field identifies the result of the operation.
Originator Host	M	This field contains the identification of the source point of the operation and the realm of the operation originator.
Originator Domain	M	This field contains the realm of the operation originator.
Operation Type	M	This field defines the transfer type: event for event based charging and start, interim, stop for session based charging.
Operation Number	M	This field contains the sequence number of the transferred messages.
Operation Identifier	O <sub>M</sub>	The field corresponds to the unique operation identification.
User Name	O <sub>C</sub>	The field contains the Private User Identity [201].
Operation Interval	O <sub>C</sub>	TBD
Origination State	O <sub>C</sub>	TBD
Origination Timestamp	O <sub>C</sub>	This field contains the time when the operation is requested.
Proxy Information	O <sub>C</sub>	This field contains the parameter of the proxy.

## 6.1.2 GTP" message contents

GTP" is used between CDF and CGF in IP Multimedia subsystem.

Use text from middle tear template

## 6.1.3 CDR Description on the Bi Interface

### 6.1.3.1 CDR Field Types

The following Standard CDR content and format are considered:

S-CSCF-CDR generated based on information from the S-CSCF.

I-CSCF-CDR generated based on information from the I-CSCF.

P-CSCF-CDR generated based on information from the P-CSCF.

BGCF-CDR generated based on information from the BGCF.

MGCF-CDR generated based on information from the MGCF.

MRFC-CDR generated based on information from the MRFC.

AS-CDR generated based on information from the AS.

The content of each CDR type is defined in the tables in clauses 6.1.3.3 to 6.1.3.9. For each CDR type the field definition includes the field name, category and description. The detailed field descriptions are provided in TS 32.298 [51].

**Editor's Note:** Equipment vendors shall be able to provide all of the fields listed in the CDR content table in order to claim compliance with the present document. However, since CDR processing and transport consume network resources, operators may opt to eliminate some of the fields that are not essential for their operation.

**Editors note:** Rephrase the above paragraph and ref. to 32.240

The CDF provides the CDRs at the Bi interface in the format and encoding described in TS 32.298 [51]. Additional CDR formats and contents may be available at the interface to the billing system to meet the requirements of the billing system, these are outside of the scope of 3GPP standardisation.

## 6.1.3.2 CDR Triggers

### 6.1.3.2.1 Session Related CDRs

Reflecting the usage of multimedia sessions IMS CDRs are generated by the CDF on a per session level. In the scope of the present document the term "session" refers always to a SIP session. The coherent media components are reflected inside the session CDRs with a media component container comprising of all the information necessary for the description of a media component.

Accounting information for SIP sessions is transferred from the CTF involved in the session to the CDF using Charging Data Request Start, Interim and Stop messages. A session CDR is opened in the CDF upon reception of a Charging Data Request [Start] message. Partial CDRs may be generated upon reception of a Charging Data Request [Interim] message, which is sent by the network entity towards the CDF due to a session modification procedure (i.e. change in media). Session CDRs are updated, or partial CDRs are generated upon reception of a Charging Data Request [Interim] message, which is sent by the network entity due to expiration of the Charging Data Interim Interval. The CDF closes the final session CDR upon reception of a Charging Data Request [Stop] message, which indicates that the SIP session is terminated. Further details on triggers for the generation of IMS CDRs are specified in [1].

Accounting information for unsuccessful session set-up attempts may be sent by the CTF to the CDF employing the Charging Data Request [Event] message. The behaviour of the CDF upon receiving Charging Data Request [Event] messages is specified in clause 6.1.3.2.2.

### 6.1.3.2.2 Session Unrelated CDRs

To reflect chargeable events not directly related to a session the CDF may generate CDRs upon the occurrence of session unrelated SIP procedures, such as registration respectively de-registration events. Accounting information for SIP session-unrelated procedures is transferred from the IMS nodes involved in the procedure to the CDF using Charging Data Request [Event] messages. Session unrelated CDRs are created in the CDF in a "one-off" action based on the information contained in the Charging Data Request [Event] message. One session unrelated CDR is created in the CDF for each Charging Data Request [Event] message received, whereas the creation of partial CDRs is not applicable for session unrelated CDRs. The cases for which the IMS nodes send Charging Data Request [Event] messages are listed per SIP procedure in table 5.2.1.1 and table 5.2.1.2.

Further details on triggers for the generation of IMS CDRs are specified in clause 5.2.2.

## 6.1.3.3 S-CSCF CDR Content

The detailed description of the field is provided in TS 32.298 [51].

Table 6.1.3.3: Charging Data of S-CSCF CDR

Field	Category	Description
Record Type	M	Identifies the type of record. The parameter is derived from the Node functionality parameter.
Retransmission	O <sub>C</sub>	This parameter, when present, indicates that information from retransmitted Charging Data Requests has been used in this CDR
SIP Method	O <sub>C</sub>	Specifies the SIP-method for which the CDR is generated. Only available in session unrelated cases. This parameter corresponds to Event Type parameter.
Role of Node	O <sub>M</sub>	This field indicates the role of the S-CSCF.
Node Address	O <sub>M</sub>	This item holds the address of the node providing the information for the CDR. This may either be the IP address or the FQDN of the IMS node generating the accounting data.
Session ID	O <sub>M</sub>	The Session identification. For a SIP session the Session-ID contains the SIP Call ID as defined in the Session Initiation Protocol RFC 3261 [404].
List Of Calling Party Address	O <sub>M</sub>	The address or addresses (Public User ID or Public Service ID) of the party requesting a service or initiating a session.
List of Associated URI	O <sub>C</sub>	The list of non-barred public user identities (SIP URIs and/or TEL URIs) associated to the public user identity under registration.
Called Party Address	O <sub>M</sub>	For SIP transactions, except for registration, this field holds the address of the party (Public User ID or Public Service ID) to whom the SIP transaction is posted. For registration transactions, this field holds the Public User ID under registration.
Requested Party Address	O <sub>C</sub>	For SIP transactions this field holds the address of the party (Public User ID or Public Service ID) to whom the SIP transaction was originally posted. This field is only present if different from the Called Party Address parameter.
List of Called Asserted Identity	O <sub>C</sub>	The address or addresses of the final asserted identities. Present if the final asserted identities are available in the SIP 2xx response.
Private User ID	O <sub>M</sub>	Holds the used Network Access Identifier of the served party according to RFC2486 [405].
Service Request Time Stamp	O <sub>M</sub>	This field contains the time stamp, which indicates the time at which the service was requested.
Service Delivery Start Time Stamp	O <sub>M</sub>	This field holds the time stamp reflecting either: successful session set-up, a delivery unrelated service, an unsuccessful session set-up and an unsuccessful session unrelated request.
Service Delivery End Time Stamp	O <sub>C</sub>	This field records the time at which the service delivery was terminated. It is Present only in SIP session related case.
Record Opening Time	O <sub>C</sub>	A time stamp reflecting the time the CDF opened this record. Present only in SIP session related case.
Record Closure Time	O <sub>M</sub>	A Time stamp reflecting the time the CDF closed the record.
Application Servers Information	O <sub>C</sub>	This a grouped CDR field containing the fields: 'Application Server Involved' and 'Application Provided Called Parties'.
Application Servers Involved	O <sub>C</sub>	Holds the ASs (if any) identified by the SIP URIs.
Application Provided Called Parties	O <sub>C</sub>	Holds a list of the Called Party Address(es), if the address(es) are determined by an AS (SIP URI, E.164...).
List of Inter Operator Identifiers	O <sub>C</sub>	Holds the identification of the home network (originating and terminating) if exchanged via SIP signalling, as recorded in the P-Charging-Vector header. This grouped field may occur several times in one CDR.
Originating IOI	O <sub>C</sub>	This parameter corresponds to Orig-IOI header of the P-Charging-Vector defined in TS 24.229 [204].
Terminating IOI	O <sub>C</sub>	This parameter corresponds to Term-IOI header of the P-Charging-Vector defined in TS 24.229 [204].
Local Record Sequence Number	O <sub>M</sub>	This field includes a unique record number created by S-CSCF. The number is allocated sequentially for each partial CDR (or whole CDR) including all CDR types. The number is unique within the CDF.

Field	Category	Description
Record Sequence Number	O <sub>C</sub>	This field contains a running sequence number employed to link the partial records generated by the CDF for a particular session.
Cause For Record Closing	O <sub>M</sub>	This field contains a reason for the close of the CDR.
Incomplete CDR Indication	O <sub>C</sub>	This field provides additional diagnostics when the CDF detects missing Charging Data Requests.
IMS Charging Identifier	O <sub>M</sub>	This parameter holds the IMS charging identifier (ICID) as generated by the IMS node for the SIP session.
List of SDP Media Components	O <sub>C</sub>	This is a grouped field which may occur several times in one CDR. The first occurrence describes the initial SIP session negotiation whilst the other would stem from session re-negotiations.  The field is present only in a SIP session related case.
SDP Session Description	O <sub>C</sub>	Holds the Session portion of the SDP data exchanged between the User Agents if available in the SIP transaction.
SIP Request Timestamp	O <sub>M</sub>	This parameter contains the time of the SIP Request (usually a (Re)Invite).
SIP Response Timestamp	O <sub>M</sub>	This parameter contains the time of the response to the SIP Request (usually a 200 OK).
SDP Media Components	O <sub>M</sub>	This is a grouped field comprising several sub-fields associated with one media component. Since several media components may exist for a session in parallel these sub-fields may occur several times.
SDP Media Name	O <sub>M</sub>	This field holds the name of the media as available in the SDP data.
SDP Media Description	O <sub>M</sub>	This field holds the attributes of the media as available in the SDP data.
GPRS Charging ID	O <sub>M</sub>	This parameter holds the GPRS charging ID (GCID) which is generated by the GGSN for a GPRS PDP context.
Media Initiator Flag	O <sub>C</sub>	This field indicates if the called party has requested the session modification and it is present only if the initiator was the called party.
GGSN Address	O <sub>C</sub>	This parameter holds the control plane IP address of the GGSN that handles one or more media component(s) of an IMS session.
Service Reason Return Code	O <sub>M</sub>	This parameter provides the returned SIP status code for the service request for the successful and failure case,
List of Message Bodies	O <sub>C</sub>	This grouped field comprising several sub-fields describing the data that may be conveyed end-to-end in the body of a SIP message. Since several message bodies may be exchanged via SIP-signalling, this grouped field may occur several times.
Content-Type	O <sub>C</sub>	This sub-field of Message Bodies holds the MIME type of the message body, Examples are: application/zip, image/gif, audio/mpeg, etc.
Content-Disposition	O <sub>C</sub>	This sub-field of Message Bodies holds the content disposition of the message body inside the SIP signalling, Content-disposition header field equal to 'render', indicates that 'the body part should be displayed or otherwise rendered to the user'. Content disposition values are: session, render, inline, icon, alert, attachment, etc.
Content-Length	O <sub>C</sub>	This sub-field of Message Bodies holds the size of the data of a message body in bytes.
Originator	O <sub>C</sub>	This sub-field of the "List of Message Bodies" indicates the originating party of the message body.
Record Extensions	O <sub>C</sub>	A set of operator/manufacture specific extensions to the record, conditioned upon existence of an extension.

## 6.1.3.4 P-CSCF CDR Content

The detailed description of the field is provided in TS 32.298 [51].

**Table 6.1.3.4: Charging Data of P-CSCF CDR**

Field	Category	Description
Record Type	M	Identifies the type of record. The parameter is derived from the Node functionality parameter.
Retransmission	O <sub>C</sub>	This parameter, when present, indicates that information from retransmitted Charging Data Requests has been used in this CDR.
SIP Method	O <sub>C</sub>	Specifies the SIP-method for which the CDR is generated. Only available in session unrelated cases.
Role of Node	O <sub>M</sub>	This fields indicates the role of the P-CSCF.
Node Address	O <sub>M</sub>	This item holds the address of the node providing the information for the CDR. This may either be the IP address or the FQDN of the IMS node generating the accounting data.
Session ID	O <sub>M</sub>	The Session identification. For a SIP session the Session-ID contains the SIP Call ID as defined in the Session Initiation Protocol RFC 3261 [404].
List Of Calling Party Address	O <sub>M</sub>	The address (Public User ID or Public Service ID) of the party requesting a service or initiating a session. Note: For P-CSCF, only one address is present
List of Associated URI	O <sub>C</sub>	The list of non-barred public user identities (SIP URIs and/or TEL URIs) associated to the public user identity under registration.
Called Party Address	O <sub>M</sub>	In the context of an end-to-end SIP transaction this field holds the address of the party (Public User ID) to whom the SIP transaction is posted.
Served Party IP Address	O <sub>M</sub>	This field contains the IP address of either the calling or called party, depending on whether the P-CSCF is in touch with the calling or called network.
Service Request Time Stamp	O <sub>M</sub>	This field contains the time stamp, which indicates the time at which the service was requested.
Service Delivery Start Time Stamp	O <sub>M</sub>	This field holds the time stamp reflecting either: successful session set-up, a delivery unrelated service, an unsuccessful session set-up and an unsuccessful session unrelated request.
Service Delivery End Time Stamp	O <sub>C</sub>	This field records the time at which the service delivery was terminated. It is Present only in SIP session related case. Present with Charging Data Request [Stop].
Record Opening Time	O <sub>C</sub>	A time stamp reflecting the time the CDF opened this record. Present only in SIP session related case.
Record Closure Time	O <sub>M</sub>	A Time stamp reflecting the time the CDF closed the record.
Inter Operator Identifiers	O <sub>C</sub>	Holds the identification of the home network (originating and terminating) if exchanged via SIP signalling, as recorded in the <i>P-Charging-Vector header</i> .
Originating IOI	O <sub>C</sub>	This parameter corresponds to Orig-IOI header of the P-Charging-Vector defined in TS 24.229 [204].
Terminating IOI	O <sub>C</sub>	This parameter corresponds to Term-IOI header of the P-Charging-Vector defined in TS 24.229 [204].
Local Record Sequence Number	O <sub>M</sub>	This field includes a unique record number created by this node. The number is allocated sequentially for each partial CDR (or whole CDR) including all CDR types. The number is unique within the CDF.
Record Sequence Number	O <sub>C</sub>	This field contains a running sequence number employed to link the partial records generated by the CDF for a particular session.
Cause For Record Closing	O <sub>M</sub>	This field contains a reason for the close of the CDR.
Incomplete CDR Indication	O <sub>C</sub>	This field provides additional diagnostics when the CDF detects missing Charging Data Requests.
IMS Charging Identifier	O <sub>M</sub>	This parameter holds the IMS charging identifier (ICID) as generated by the IMS node for the SIP session.
List of SDP Media Components	O <sub>C</sub>	This is a grouped field which may occur several times in one CDR. The first occurrence describes the initial session negotiation whilst the other would stem from session re-negotiations.  The field is present only in a SIP session related case.
SDP Session Description	O <sub>C</sub>	Holds the Session portion of the SDP data exchanged between the User Agents if available in the SIP transaction.

Field	Category	Description
SIP Request Timestamp	O <sub>M</sub>	This parameter contains the time of the SIP Request (usually a (Re)Invite). This parameter corresponds to SIP Request Timestamp in Charging Data Request [Interim].
SIP Response Timestamp	O <sub>M</sub>	This parameter contains the time of the response to the SIP Request (usually a 200 OK). This parameter corresponds to SIP Response Timestamp in Charging Data Request [Interim].
SDP Media Components	O <sub>M</sub>	This is a grouped field comprising several sub-fields associated with one media component. Since several media components may exist for a session in parallel these sub-fields may occur several times.
SDP Media Name	O <sub>M</sub>	This field holds the name of the media as available in the SDP data. This parameter corresponds to SDP-Media-Name.
SDP Media Description	O <sub>M</sub>	This field holds the attributes of the media as available in the SDP data. This parameter corresponds to SDP-Media-Description.
GPRS Charging ID	O <sub>M</sub>	This parameter holds the GPRS charging ID (GCID) which is generated by the GGSN for a GPRS PDP context.
Authorised QoS	O <sub>C</sub>	Authorised QoS as defined in TS 23.207 [7] / TS 29.207 [8] and applied via the Go interface.
Media Initiator Flag	O <sub>C</sub>	This field indicates if the called party has requested the session modification and it is present only if the initiator was the called party.
GGSN Address	O <sub>C</sub>	This parameter holds the control plane IP address of the GGSN that handles one or more media component(s) of a IMS session.
Service Reason Return Code	O <sub>M</sub>	This parameter provides the returned SIP status code for the service request for the successful and failure case,
List of Message Bodies	O <sub>C</sub>	This grouped field comprising several sub-fields describing the data that may be conveyed end-to-end in the body of a SIP message. Since several message bodies may be exchanged via SIP-signalling, this grouped field may occur several times.
Content-Type	O <sub>C</sub>	This sub-field of Message Bodies holds the MIME type of the message body, Examples are: application/zip, image/gif, audio/mpeg, etc.
Content-Disposition	O <sub>C</sub>	This sub-field of Message Bodies holds the content disposition of the message body inside the SIP signalling, Content-disposition header field equal to 'render', indicates that 'the body part should be displayed or otherwise rendered to the user'. Content disposition values are: session, render, inline, icon, alert, attachment, etc.
Content-Length	O <sub>C</sub>	This sub-field of Message Bodies holds the size of the data of a message body in bytes.
Originator	O <sub>C</sub>	This sub-field of the "List of Message Bodies" indicates the originating party of the message body.
Record Extensions	O <sub>C</sub>	A set of operator/manufacture specific extensions to the record, conditioned upon existence of an extension.



### 6.1.3.5 I-CSCF CDR Content

The detailed description of the field is provided in TS 32.298 [51].

**Table 6.1.3.5: Charging Data of I-CSCF CDR**

Field	Category	Description
Record Type	M	Identifies the type of record. The parameter is derived from the Node functionality parameter.
Retransmission	O <sub>C</sub>	This parameter, when present, indicates that information from retransmitted Charging Data Requests has been used in this CDR
SIP Method	O <sub>C</sub>	Specifies the SIP-method for which the CDR is generated. Only available in session unrelated cases.
Role of Node	O <sub>M</sub>	This fields indicates the role of the I-CSCF.
Node Address	O <sub>M</sub>	This item holds the address of the node providing the information for the CDR. This may either be the IP address or the FQDN of the IMS node generating the accounting data.
Session ID	O <sub>M</sub>	The Session identification. For a SIP session the Session-ID contains the SIP Call ID as defined in the Session Initiation Protocol RFC 3261 [404].
List Of Calling Party Address	O <sub>M</sub>	The address or addresses (Public User ID or Public Service ID) of the party requesting a service or initiating a session.
List of Associated URI	O <sub>C</sub>	The list of non-barred public user identities (SIP URIs and/or TEL URIs) associated to the public user identity under registration.
Called Party Address	O <sub>M</sub>	In the context of an end-to-end SIP transaction this field holds the address of the party (Public User ID) to whom the SIP transaction is posted.
Service Request Time Stamp	O <sub>M</sub>	This field contains the time stamp, which indicates the time at which the service was requested. This parameter corresponds to SIP Request Timestamp. Present with Charging Data Request [Event].
Inter Operator Identifiers	O <sub>C</sub>	Holds the identification of the home network (originating and terminating) if exchanged via SIP signalling, as recorded in the <i>P-Charging-Vector header</i> .
Originating IOI	O <sub>C</sub>	This parameter corresponds to Orig-IOI header of the P-Charging-Vector defined in TS 24.229 [204].
Terminating IOI	O <sub>C</sub>	This parameter corresponds to Term-IOI header of the P-Charging-Vector defined in TS 24.229 [204].
Local Record Sequence Number	O <sub>M</sub>	This field includes a unique record number created by this node. The number is allocated sequentially for each partial CDR (or whole CDR) including all CDR types. The number is unique within the CDF.
Cause For Record Closing	O <sub>M</sub>	This field contains a reason for the close of the CDR.
Incomplete CDR Indication	O <sub>C</sub>	This field provides additional diagnostics when the CDF detects missing Charging Data Requests.
S-CSCF Information	O <sub>C</sub>	This field contains Information related to the serving CSCF, e.g. the S-CSCF capabilities upon registration event or the S-CSCF address upon the session establishment event.
IMS Charging Identifier	O <sub>M</sub>	This parameter holds the IMS charging identifier (ICID) as generated by the IMS node for the SIP session.
Service Reason Return Code	O <sub>M</sub>	This parameter provides the returned SIP status code for the service request for the successful and failure case,
Record Extensions	O <sub>C</sub>	A set of operator/manufacturer specific extensions to the record, conditioned upon existence of an extension.

## 6.1.3.6 MRFC CDR Content

The detailed description of the field is provided in TS 32.298 [51].

**Table 6.1.3.6: Charging Data of MRFC CDR**

Field	Category	Description
Record Type	M	Identifies the type of record. The parameter is derived from the Node functionality parameter.
Retransmission	O <sub>C</sub>	This parameter, when present, indicates that information from retransmitted Charging Data Requests has been used in this CDR.
SIP Method	O <sub>C</sub>	Specifies the SIP-method for which the CDR is generated. Only available in session unrelated cases.
Role of Node	O <sub>M</sub>	This field indicates the role of the MRFC.
Node Address	O <sub>M</sub>	This item holds the address of the node providing the information for the CDR. This may either be the IP address or the FQDN of the IMS node generating the accounting data.
Session ID	O <sub>M</sub>	The Session identification. For a SIP session the Session-ID contains the SIP Call ID as defined in the Session Initiation Protocol RFC 3261 [404].
Service ID	O <sub>M</sub>	This field identifies the service the MRFC is hosting. For conferences the conference ID is used here.
List Of Calling Party Address	O <sub>M</sub>	The address or addresses (Public User ID or Public Service ID) of the party requesting a service or initiating a session.
Called Party Address	O <sub>C</sub>	For SIP transactions, except for registration, this field holds the address of the party (Public User ID or Public Service ID) to whom the SIP transaction is posted. For registration transactions, this field holds the Public User ID under registration.
Requested Party Address	O <sub>C</sub>	For SIP transactions this field holds the address of the party (Public User ID or Public Service ID) to whom the SIP transaction was originally posted. This field is only present if different from the Called Party Address parameter.
List of Called Asserted Identity	O <sub>C</sub>	The address or addresses of the final asserted identities. Present if the final asserted identities are available in the SIP 2xx response.
Service Request Time Stamp	O <sub>M</sub>	This field contains the time stamp which indicates the time at which the service was requested. This parameter corresponds to SIP Request Timestamp. Present with Charging Data Request [Start] and Charging Data Request [Event].
Service Delivery Start Time Stamp	O <sub>M</sub>	This field holds the time stamp reflecting either: successful session set-up, a delivery unrelated service, an unsuccessful session set-up and an unsuccessful session unrelated request. This parameter corresponds to SIP Response Timestamp. Present with Charging Data Request [Start] and Charging Data Request [EVENT].
Service Delivery End Time Stamp	O <sub>C</sub>	This field records the time at which the service delivery was terminated. It is Present only in SIP session related case. This parameter corresponds to SIP Request Timestamp. Present with Charging Data Request [Stop].
Record Opening Time	O <sub>C</sub>	A time stamp reflecting the time the CDF opened this record. Present only in SIP session related case.
Record Closure Time	O <sub>M</sub>	A Time stamp reflecting the time the CDF closed the record.
Application Servers Information	O <sub>C</sub>	This is a grouped CDR field containing the fields: 'Application Server Involved' and 'Application Provided Called Parties'.
Application Servers Involved	O <sub>C</sub>	Holds the ASs (if any) identified by the SIP URIs.
Application Provided Called Parties	O <sub>C</sub>	Holds a list of the Called Party Address(es), if the address(es) are determined by an AS (SIP URI, E.164...).
Inter Operator Identifiers	O <sub>C</sub>	Holds the identification of the home network (originating and terminating) if exchanged via SIP signalling, as recorded in the <i>P-Charging-Vector header</i> .
Originating IOI	O <sub>C</sub>	This parameter corresponds to Orig-IOI header of the P-Charging-Vector defined in TS 24.229 [204].
Terminating IOI	O <sub>C</sub>	This parameter corresponds to Term-IOI header of the P-Charging-Vector defined in TS 24.229 [204].

Field	Category	Description
Local Record Sequence Number	O <sub>M</sub>	This field includes a unique record number created by this node. The number is allocated sequentially for each partial CDR (or whole CDR) including all CDR types. The number is unique within the CDF.
Record Sequence Number	O <sub>C</sub>	This field contains a running sequence number employed to link the partial records generated by the CDF for a particular session.
Cause For Record Closing	O <sub>M</sub>	This field contains a reason for the close of the CDR.
Incomplete CDR Indication	O <sub>C</sub>	This field provides additional diagnostics when the CDF detects missing Charging Data Requests.
IMS Charging Identifier	O <sub>M</sub>	This parameter holds the IMS charging identifier (ICID) as generated by the IMS node for the SIP session.
List of SDP Media Components	O <sub>C</sub>	This is a grouped field which may occur several times in one CDR. The first occurrence describes the initial session negotiation whilst the other would stem from session re-negotiations. The field is present only in a SIP session related case
SDP Session Description	O <sub>C</sub>	Holds the Session portion of the SDP data exchanged between the User Agents if available in the SIP transaction.
SIP Request Timestamp	O <sub>M</sub>	This parameter contains the time of the SIP Request (usually a (Re)Invite). This parameter corresponds to SIP Request Timestamp in the Charging Data Request [Interim].
SIP Response Timestamp	O <sub>M</sub>	This parameter contains the time of the response to the SIP Request (usually a 200 OK). This parameter corresponds to SIP Response Timestamp In the Charging Data Request [Interim].
SDP Media Components	O <sub>M</sub>	This is a grouped field comprising several sub-fields associated with one media component. Since several media components may exist for a session in parallel these sub-fields may occur several times.
SDP Media Name	O <sub>M</sub>	This field holds the name of the media as available in the SDP data. This parameter corresponds to SDP-Media-Name.
SDP Media Description	O <sub>M</sub>	This field holds the attributes of the media as available in the SDP data.
GPRS Charging ID	O <sub>M</sub>	This parameter holds the GPRS charging ID (GCID) which is generated by the GGSN for a GPRS PDP context.
Media Initiator Flag	O <sub>C</sub>	This field indicates if the called party has requested the session modification and it is present only if the initiator was the called party.
GGSN Address	O <sub>C</sub>	This parameter holds the control plane IP address of the GGSN that handles one or more media component(s) of a IMS session.
Service Reason Return Code	O <sub>M</sub>	This parameter provides the returned SIP status code for the service request for the successful and failure case,
Record Extensions	O <sub>C</sub>	A set of operator/manufacture specific extensions to the record, conditioned upon existence of an extension.

## 6.1.3.7 MGCF CDR Content

The detailed description of the field is provided in TS 32.298 [51].

**Table 6.1.3.7: Charging Data of MGCF CDR**

Field	Category	Description
Record Type	M	Identifies the type of record. The parameter is derived from the Node functionality parameter.
Retransmission	O <sub>C</sub>	This parameter, when present, indicates that information from retransmitted Charging Data Requests has been used in this CDR
SIP Method	O <sub>C</sub>	Specifies the SIP-method for which the CDR is generated. Only available in session unrelated cases.
Role of Node	O <sub>M</sub>	This field indicates the role of the MGCF.
Node Address	O <sub>M</sub>	This item holds the address of the node providing the information for the CDR. This may either be the IP address or the FQDN of the IMS node generating the accounting data.
Session ID	O <sub>M</sub>	The Session identification. For a SIP session the Session-ID contains the SIP Call ID as defined in the Session Initiation Protocol RFC 3261 [404].
List Of Calling Party Address	O <sub>M</sub>	The address or addresses (Public User ID or Public Service ID) of the party requesting a service or initiating a session.
Called Party Address	O <sub>M</sub>	In the context of an end-to-end SIP transaction this field holds the address of the party (Public User ID) to whom the SIP transaction is posted.
Service Request Time Stamp	O <sub>M</sub>	This field contains the time stamp which indicates the time at which the service was requested. This parameter corresponds to SIP Request Timestamp. Present with Charging Data Request [Start] and Charging Data Request [Event].
Service Delivery Start Time Stamp	O <sub>M</sub>	This field holds the time stamp reflecting either: successful session set-up, a delivery unrelated service, an unsuccessful session set-up and an unsuccessful session unrelated request. This parameter corresponds to SIP Response Timestamp. Present with Charging Data Request [Start] and Charging Data Request [Event].
Service Delivery End Time Stamp	O <sub>C</sub>	This field records the time at which the service delivery was terminated. It is Present only in SIP session related case. This parameter corresponds to SIP Request Timestamp. Present with Charging Data Request [Stop].
Record Opening Time	O <sub>C</sub>	A time stamp reflecting the time the CDF opened this record. Present only in SIP session related case.
Record Closure Time	O <sub>M</sub>	A Time stamp reflecting the time the CDF closed the record.
Inter Operator Identifiers	O <sub>C</sub>	Holds the identification of the home network (originating and terminating) if exchanged via SIP signalling, as recorded in the <i>P-Charging-Vector header</i> .
Originating IOI	O <sub>C</sub>	This parameter corresponds to Orig-IOI header of the P-Charging-Vector defined in TS 24.229 [204].
Terminating IOI	O <sub>C</sub>	This parameter corresponds to Term-IOI header of the P-Charging-Vector defined in TS 24.229 [204].
Local Record Sequence Number	O <sub>M</sub>	This field includes a unique record number created by this node. The number is allocated sequentially for each partial CDR (or whole CDR) including all CDR types. The number is unique within the CDF.
Record Sequence Number	O <sub>C</sub>	This field contains a running sequence number employed to link the partial records generated by the CDF for a particular session.
Cause For Record Closing	O <sub>M</sub>	This field contains a reason for the close of the CDR.
Incomplete CDR Indication	O <sub>C</sub>	This field provides additional diagnostics when the CDF detects missing Charging Data Requests.
IMS Charging Identifier	O <sub>M</sub>	This parameter holds the IMS charging identifier (ICID) as generated by the IMS node for the SIP session.
List of SDP Media Components	O <sub>C</sub>	This is a grouped field which may occur several times in one CDR. The first occurrence describes the initial session negotiation whilst the other would stem from session re-negotiations. The field is present only in a SIP session related case.
SDP Session Description	O <sub>C</sub>	Holds the Session portion of the SDP data exchanged between the User Agents if available in the SIP transaction.
SIP Request Timestamp	O <sub>M</sub>	This parameter contains the time of the SIP Request (usually a (Re)Invite). This parameter corresponds to SIP Request Timestamp in Charging Data Request [Interim].

Field	Category	Description
SIP Response Timestamp	O <sub>M</sub>	This parameter contains the time of the response to the SIP Request (usually a 200 OK). This parameter corresponds to SIP Response Timestamp in Charging Data Request [Interim].
SDP Media Components	O <sub>M</sub>	This is a grouped field comprising several sub-fields associated with one media component. Since several media components may exist for a session in parallel these sub-fields may occur several times.
SDP Media Name	O <sub>M</sub>	This field holds the name of the media as available in the SDP data. This parameter corresponds to SDP-Media-Name.
SDP Media Description	O <sub>M</sub>	This field holds the attributes of the media as available in the SDP data.
GPRS Charging ID	O <sub>M</sub>	This parameter holds the GPRS charging ID (GCID) which is generated by the GGSN for a GPRS PDP context.
Media Initiator Flag	O <sub>C</sub>	This field indicates if the called party has requested the session modification and it is present only if the initiator was the called party.
Service Reason Return Code	O <sub>M</sub>	This parameter provides the returned SIP status code for the service request for the successful and failure case.
Trunk Group ID Incoming/Outgoing	O <sub>M</sub>	Contains the outgoing trunk group ID for an outgoing session/call or the incoming trunk group ID for an incoming session/call.
Bearer Service	O <sub>M</sub>	Holds the used bearer service for the PSTN leg.
Record Extensions	O <sub>C</sub>	A set of operator/manufacture specific extensions to the record, conditioned upon existence of an extension.

## 6.1.3.8 BGCF CDR Content

The detailed description of the field is provided in TS 32.298 [51].

Table 6.1.3.8: Charging Data of BGCF CDR

Field	Category	Description
Record Type	M	Identifies the type of record. The parameter is derived from the Node functionality parameter.
Retransmission	O <sub>C</sub>	This parameter, when present, indicates that information from retransmitted Charging Data Requests has been used in this CDR.
SIP Method	O <sub>C</sub>	Specifies the SIP-method for which the CDR is generated. Only available in session unrelated cases.
Role of Node	O <sub>M</sub>	This field indicates the role of the BGCF.
Node Address	O <sub>M</sub>	This item holds the address of the node providing the information for the CDR. This may either be the IP address or the FQDN of the IMS node generating the accounting data.
Session ID	O <sub>M</sub>	The Session identification. For a SIP session the Session-ID contains the SIP Call ID as defined in the Session Initiation Protocol RFC 3261 [404].
List Of Calling Party Address	O <sub>M</sub>	The address or addresses (Public User ID or Public Service ID) of the party requesting a service or initiating a session.
Called Party Address	O <sub>M</sub>	In the context of an end-to-end SIP transaction this field holds the address of the party (Public User ID) to whom the SIP transaction is posted.
Service Request Time Stamp	O <sub>M</sub>	This field contains the time stamp which indicates the time at which the service was requested. This parameter corresponds to SIP Request Timestamp. Present with Charging Data Request [Start] and Charging Data Request [Event].
Service Delivery Start Time Stamp	O <sub>M</sub>	This field holds the time stamp reflecting either: successful session set-up, a delivery unrelated service, an unsuccessful session set-up and an unsuccessful session unrelated request. This parameter corresponds to SIP Response Timestamp. Present with Charging Data Request [Start] and Charging Data Request [Event].
Service Delivery End Time Stamp	O <sub>C</sub>	This field records the time at which the service delivery was terminated. It is Present only in SIP session related case. This parameter corresponds to SIP Request Timestamp. Present with Charging Data Request [Stop].
Record Opening Time	O <sub>C</sub>	A time stamp reflecting the time the CDF opened this record. Present only in SIP session related case.
Record Closure Time	O <sub>M</sub>	A Time stamp reflecting the time the CDF closed the record
Inter Operator Identifiers	O <sub>C</sub>	Holds the identification of the home network (originating and terminating) if exchanged via SIP signalling, as recorded in the <i>P-Charging-Vector header</i> .
Originating IOI	O <sub>C</sub>	This parameter corresponds to Orig-IOI header of the P-Charging-Vector defined in TS 24.229 [204].
Terminating IOI	O <sub>C</sub>	This parameter corresponds to Term-IOI header of the P-Charging-Vector defined in TS 24.229 [204].
Local Record Sequence Number	O <sub>M</sub>	This field includes a unique record number created by this node. The number is allocated sequentially for each partial CDR (or whole CDR) including all CDR types. The number is unique within the CDF.
Record Sequence Number	O <sub>C</sub>	This field contains a running sequence number employed to link the partial records generated by the CDF for a particular session.
Cause For Record Closing	O <sub>M</sub>	This field contains a reason for the close of the CDR.
Incomplete CDR Indication	O <sub>C</sub>	This field provides additional diagnostics when the CDF detects missing Charging Data Requests.
IMS Charging Identifier	O <sub>M</sub>	This parameter holds the IMS charging identifier (ICID) as generated by the IMS node for the SIP session.
List of SDP Media Components	O <sub>C</sub>	This is a grouped field which may occur several times in one CDR. The first occurrence describes the initial session negotiation whilst the other would stem from session re-negotiations. The field is present only in a SIP session related case.
SDP Session Description	O <sub>C</sub>	Holds the Session portion of the SDP data exchanged between the User Agents if available in the SIP transaction.

Field	Category	Description
SIP Request Timestamp	O <sub>M</sub>	This parameter contains the time of the SIP Request (usually a (Re)Invite). This parameter corresponds to SIP Request Timestamp in Charging Data Request [Interim].
SIP Response Timestamp	O <sub>M</sub>	This parameter contains the time of the response to the SIP Request (usually a 200 OK). This parameter corresponds to SIP Response Timestamp in Charging Data Request [Interim].
SDP Media Components	O <sub>M</sub>	This is a grouped field comprising several sub-fields associated with one media component. Since several media components may exist for a session in parallel these sub-fields may occur several times.
SDP Media Name	O <sub>M</sub>	This field holds the name of the media as available in the SDP data.
SDP Media Description	O <sub>M</sub>	This field holds the attributes of the media as available in the SDP data.
GPRS Charging ID	O <sub>M</sub>	This parameter holds the GPRS charging ID (GCID) which is generated by the GGSN for a GPRS PDP context.
Media Initiator Flag	O <sub>C</sub>	This field indicates if the called party has requested the session modification and it is present only if the initiator was the called party.
Service Reason Return Code	O <sub>M</sub>	This parameter provides the returned SIP status code for the service request for the successful and failure case,
Record Extensions	O <sub>C</sub>	A set of operator/manufacture specific extensions to the record, conditioned upon existence of an extension.

## 6.1.3.9 SIP AS CDR Content

The detailed description of the field is provided in TS 32.298 [51].

**Table 6.1.3.9: Charging Data of AS CDR**

Field	Category	Description
Record Type	M	Identifies the type of record. The parameter is derived from the Node functionality parameter.
Retransmission	O <sub>C</sub>	This parameter, when present, indicates that information from retransmitted Charging Data Requests has been used in this CDR
SIP Method	O <sub>C</sub>	Specifies the SIP-method for which the CDR is generated. Only available in session unrelated cases.
Role of Node	O <sub>M</sub>	This fields indicates the role of the AS.
Node Address	O <sub>M</sub>	This item holds the address of the node providing the information for the CDR. This may either be the IP address or the FQDN of the IMS node generating the accounting data.
Session ID	O <sub>M</sub>	The Session identification. For a SIP session the Session-ID contains the SIP Call ID as defined in the Session Initiation Protocol RFC 3261 [404].
List Of Calling Party Address	O <sub>M</sub>	The address or addresses (Public User ID or Public Service ID) of the party requesting a service or initiating a session.
Called Party Address	O <sub>M</sub>	For SIP transactions, except for registration, this field holds the address of the party (Public User ID or Public Service ID) to whom the SIP transaction is posted. For registration transactions, this field holds the Public User ID under registration.
Requested Party Address	O <sub>C</sub>	For SIP transactions this field holds the address of the party (Public User ID or Public Service ID) to whom the SIP transaction was originally posted. This field is only present if different from the Called Party Address parameter.
List of Called Asserted Identity	O <sub>C</sub>	The address or addresses of the final asserted identities. Present if the final asserted identities are available in the SIP 2xx response.
Service Request Time Stamp	O <sub>M</sub>	This field contains the time stamp which indicates the time at which the service was requested. This parameter corresponds to SIP Request Timestamp. Present with Charging Data Request [Start] and Charging Data Request [Event].
Service Delivery Start Time Stamp	O <sub>M</sub>	This field holds the time stamp reflecting either: successful session set-up, a delivery unrelated service, an unsuccessful session set-up and an unsuccessful session unrelated request. This parameter corresponds to SIP Response Timestamp. Present with Charging Data Request [Start] and Charging Data Request [Event].
Service Delivery End Time Stamp	O <sub>C</sub>	This field records the time at which the service delivery was terminated. It is Present only in SIP session related case. This parameter corresponds to SIP Request Timestamp. Present with Charging Data Request [Stop].
Record Opening Time	O <sub>C</sub>	A time stamp reflecting the time the CDF opened this record. Present only in SIP session related case.
Record Closure Time	O <sub>M</sub>	A Time stamp reflecting the time the CDF closed the record.
Inter Operator Identifiers	O <sub>C</sub>	Holds the identification of the home network (originating and terminating) if exchanged via SIP signalling, as recorded in the <i>P-Charging-Vector header</i> .
Originating IOI	O <sub>C</sub>	This parameter corresponds to Orig-IOI header of the P-Charging-Vector defined in TS 24.229 [204].
Terminating IOI	O <sub>C</sub>	This parameter corresponds to Term-IOI header of the P-Charging-Vector defined in TS 24.229 [204].
Local Record Sequence Number	O <sub>M</sub>	This field includes a unique record number created by this node. The number is allocated sequentially for each partial CDR (or whole CDR) including all CDR types. The number is unique within the CDF.
Record Sequence Number	O <sub>C</sub>	This field contains a running sequence number employed to link the partial records generated by the CDF for a particular session.
Cause For Record Closing	O <sub>M</sub>	This field contains a reason for the close of the CDR.
Incomplete CDR Indication	O <sub>C</sub>	This field provides additional diagnostics when the CDF detects missing Charging Data Requests.
IMS Charging Identifier	O <sub>M</sub>	This parameter holds the IMS charging identifier (ICID) as generated by the IMS node for the SIP session.



Field	Category	Description
List of SDP Media Components	O <sub>C</sub>	This is a grouped field which may occur several times in one CDR. The first occurrence describes the initial session negotiation whilst the other would stem from session re-negotiations. The field is present only in a SIP session related case.
SDP Session Description	O <sub>C</sub>	Holds the Session portion of the SDP data exchanged between the User Agents if available in the SIP transaction.
SIP Request Timestamp	O <sub>M</sub>	This parameter contains the time of the SIP Request (usually a (Re)Invite). This parameter corresponds to SIP Request Timestamp in Charging Data Request [Interim].
SIP Response Timestamp	O <sub>M</sub>	This parameter contains the time of the response to the SIP Request (usually a 200 OK). This parameter corresponds to SIP Response Timestamp in Charging Data Request [Interim].
SDP Media Components	O <sub>M</sub>	This is a grouped field comprising several sub-fields associated with one media component. Since several media components may exist for a session in parallel these sub-fields may occur several times.
SDP Media Name	O <sub>M</sub>	This field holds the name of the media as available in the SDP data.
SDP Media Description	O <sub>M</sub>	This field holds the attributes of the media as available in the SDP data.
GPRS Charging ID	O <sub>M</sub>	This parameter holds the GPRS charging ID (GCID) which is generated by the GGSN for a GPRS PDP context.
Media Initiator Flag	O <sub>C</sub>	This field indicates if the called party has requested the session modification and it is present only if the initiator was the called party.
GGSN Address	O <sub>C</sub>	This parameter holds the control plane IP address of the GGSN that handles one or more media component(s) of a IMS session.
Service Reason Return Code	O <sub>M</sub>	This parameter provides the returned SIP status code for the service request for the successful and failure case,
Service Specific Data	O <sub>C</sub>	This field contains service specific data.
List of Message Bodies	O <sub>C</sub>	This grouped field comprising several sub-fields describing the data that may be conveyed end-to-end in the body of a SIP message. Since several message bodies may be exchanged via SIP-signalling, this grouped field may occur several times.
Content-Type	O <sub>C</sub>	This sub-field of Message Bodies holds the MIME type of the message body, Examples are: application/zip, image/gif, audio/mpeg, etc.
Content-Disposition	O <sub>C</sub>	This sub-field of Message Bodies holds the content disposition of the message body inside the SIP signalling, Content-disposition header field equal to 'render', indicates that 'the body part should be displayed or otherwise rendered to the user'. Content disposition values are : session, render, inline, icon, alert, attachment, etc.
Content-Length	O <sub>C</sub>	This sub-field of Message Bodies holds the size of the data of a message body in bytes.
Originator	O <sub>C</sub>	This sub-field of the "List of Message Bodies" indicates the originating party of the message body.
Record Extensions	O <sub>C</sub>	A set of operator/manufacture specific extensions to the record, conditioned upon existence of an extension.

## 6.2 Data description for IMS online charging

### 6.2.1 Ro message contents

The IMS nodes generate debit and reserve units information that can be transferred from the CTF to the OCF. For this purpose, IMS online charging utilises the *Debit Units and Reserve Units* procedure that is specified in the 3GPP debit unit operation in TS 32.299 [50].

The *Debit and reserve units* procedure employs the *Debit and Reserve Units Request* and *Debit and Reserve Units Response* messages. Table 6.2.1 describes the use of these messages in IMS online charging.

**Table 6.2.1: Online Charging Messages Reference Table**

Command-Name	Source	Destination
Debit and Reserve Units Request	MRFC, AS, IMS-GWF	OCS
Debit and Reserve Units Response	OCS	MRFC, AS, IMS-GWF

### 6.2.1.1 Debit and Reserve Units Request Message

Table 6.2.1.1 illustrates the basic structure of a *Debit and Reserve Units Request* message from the CTF in MRFC and AS and the IMS-GWF as used for IMS online charging.

**Table 6.2.1.1: Debit and reserve units Request Message Contents**

Field	Category	Description
Session Identifier	M	Described in 32.299 [50]
Originator Host	M	Described in 32.299 [50]
Originator Domain	M	Described in 32.299 [50]
Destination Domain	M	Described in 32.299 [50]
Operation Identifier	M	Described in 32.299 [50]
Operation Token	M	Described in 32.299 [50]
Operation Type	M	Described in 32.299 [50]
Operation Number	M	Described in 32.299 [50]
Destination Host	O <sub>C</sub>	Described in 32.299 [50]
User Name	O <sub>C</sub>	The field contains the Private User Identity [201]
Origination State	O <sub>C</sub>	Described in 32.299 [50]
Origination Timestamp	O <sub>C</sub>	Described in 32.299 [50]
Subscriber Identifier	O <sub>M</sub>	This field contains the identification of the mobile subscriber (i.e. MSISDN or SIP-URI) that uses the requested service.
Termination Cause	O <sub>C</sub>	Described in 32.299 [50]
Requested Action	O <sub>C</sub>	Described in 32.299 [50]
Multiple Operation	O <sub>M</sub>	Described in 32.299 [50]
Multiple Unit Operation	O <sub>M</sub>	Described in 32.299 [50]
Subscriber Equipment Number	O <sub>C</sub>	Described in 32.299 [50]
Proxy Information	O <sub>C</sub>	Described in 32.299 [50]
Route Information	O <sub>C</sub>	Described in 32.299 [50]
Service Information	O <sub>M</sub>	This field holds additional 3GPP service specific parameter: - IMS Information, - PS Information
Extended Information	O <sub>C</sub>	This field holds the network/manufacture specific extensions.

### 6.2.1.2 Debit and Reserve Units Response Message

Table 6.2.1.2 illustrates the basic structure of a Debit and Reserve Units Response message as used for IMS charging. This message is always used by the OCS as specified below, independent of the receiving IMS node and the operation type that is being replied to.

**Table 6.2.1.2: Debit and Reserve Units Response Message Contents for MRFC, AS and IMS-GWF**

Field	Category	Description
Session Identifier	M	Described in 32.299 [50]
Operation Result	M	Described in 32.299 [50]
Originator Host	M	Described in 32.299 [50]
Originator Domain	M	Described in 32.299 [50]
Operation Identifier	M	Described in 32.299 [50]
Operation Type	M	Described in 32.299 [50]
Operation Number	M	Described in 32.299 [50]
Operation Failover	O <sub>C</sub>	Described in 32.299 [50]
Multiple Unit Operation	O <sub>M</sub>	Described in 32.299 [50]
Operation Failure Action	O <sub>C</sub>	Described in 32.299 [50]
Redirection Host	O <sub>C</sub>	Described in 32.299 [50]
Redirection Host Usage	O <sub>C</sub>	Described in 32.299 [50]
Redirection Cache Time	O <sub>C</sub>	Described in 32.299 [50]
Proxy Information	O <sub>C</sub>	Described in 32.299 [50]
Route Information	O <sub>C</sub>	Described in 32.299 [50]
Failed parameter	O <sub>C</sub>	Described in 32.299 [50]
Service Information	O <sub>C</sub>	This field holds additional 3GPP service specific parameter: - IMS Information, - PS Information

Field	Category	Description
Extended Information	O <sub>C</sub>	This field holds the network/manufacture specific extensions.

## 6.3 IMS Charging Specific Parameters

### 6.3.1 Definition of IMS charging information

The IMS Information parameter used for IMS charging is provided in the Service Information parameter.

#### 6.3.1.1 IMS charging information assignment for Service Information

The components in the Service Information that are use for IMS charging can be found in Table 6.3.1.1.

**Table 6.3.1.1: Service Information used for IMS Charging**

Field	Category	Description	Provided by IMS NE
Service Information	O <sub>M</sub>	This is a structured field and holds the 3GPP specific parameter as defined in TS 32.299 [50]. For IMS Charging the IMS Information is used.	All
IMS Information	O <sub>M</sub>	This is a structured field and holds the IMS specific parameters. The details are defined in clause 6.3.1.2.	All
PS Information	O <sub>C</sub>	This is a structured field and holds PS specific parameters. The complete structure is defined in TS 32.251 [11].	Not in I-CSCF
GGSN Address	O <sub>C</sub>	This field holds the IP-address of the GGSN that generated the GPRS Charging ID, as described in [1].	Not in I-CSCF, MGCF, BGCF
User Location Info	O <sub>C</sub>	Used as define in the cgi-3GPP or UTRAN-Cell-ID-3GPP extension of the P-Access-Network-Info header.	I-CSCF, S-CSCF, P-CSCF

#### 6.3.1.2 Definition of the IMS Information

IMS specific charging information is provided within the IMS Information. The fields of the IMS Information which are different covered in several IMS network nodes are indicated by the node specific type.

The detailed structure of the IMS Information can be found in table 6.3.1.2.

**Table 6.3.1.2: Structure of the IMS Information**

Field	Category	Description	Provided by IMS NE
Event Type	O <sub>C</sub>	This field holds the content of the "Event" header.	All
Node Functionality	M	This field contains the function of the node.	All
Role of Node	O <sub>M</sub>	This field specifies the role of the AS/CSCF.	All
User Session ID	O <sub>M</sub>	This field holds the session identifier. For a SIP session the <i>Session-ID</i> contains the SIP Call ID.	All
Calling Party Address	O <sub>M</sub>	This field holds the address (SIP URI or TEL URI)URI of the party (Public User Identity or Public Service Identity) initiating a session or requesting a service.	All
Called Party Address	O <sub>M</sub>	For SIP transactions, except for registration, this field holds the address of the party (Public User ID or Public Service ID) to whom the SIP transaction is posted. For registration transactions, this field holds the Public User ID under registration.	All

Field	Category	Description	Provided by IMS NE
Requested Party Address	O <sub>C</sub>	For SIP transactions this field holds the address of the party (Public User ID or Public Service ID) to whom the SIP transaction was originally posted. This field is only present if different from the Called Party Address parameter.	S-CSCF and AS/MRFC
Called Asserted Identity	O <sub>C</sub>	The address of the final asserted identity. Present if the final asserted identity is available in the SIP 2xx response.	S-CSCF and AS/MRFC
Associated URI	O <sub>C</sub>	This field holds a non-barred public user identity (SIP URI or TEL URI) associated to the public user identity under registration.	S-CSCF, P-CSCF, I-CSCF
Time Stamps	O <sub>M</sub>	This field holds the time of the SIP REQUEST and the time of the response to the SIP REQUEST.	All
Application Server Information	O <sub>C</sub>	This field holds the SIP URI(s) of the AS(s) addressed during the session and the called party number (SIP URI, E.164), if an application server determines it.	S-CSCF and MRFC
Inter Operator Identifier	O <sub>C</sub>	This field holds the identification of the network neighbours (originating and terminating) as exchanged via SIP signalling if available.	All
IMS Charging Identifier	O <sub>M</sub>	This field holds the IMS Charging Identifier (ICID) as generated by a IMS node for a SIP session.	All
SDP Session Description	O <sub>C</sub>	This field holds the content of an "attribute-line" (i=, c=, b=, k=, a=, etc.) related to a session.	Not in I-CSCF
SDP Media Component	O <sub>C</sub>	This is a grouped field comprising several sub-fields associated with one media component. Since several media components may exist for a session in parallel these sub-fields may occur several times.	Not in I-CSCF
Served Party IP Address	O <sub>C</sub>	This field holds the IP address of either the calling or called party, depending on whether the P-CSCF is in touch with the calling or the called party.	P-CSCF
Server Capabilities	O <sub>C</sub>	This field contains the server capabilities as described in 3GPP TS 29.229 [205].	I-CSCF
Trunk Group ID	O <sub>C</sub>	This field identifies the incoming and outgoing PSTN legs.	MGCF
Bearer Service	O <sub>C</sub>	This field holds the used bearer service for the PSTN leg.	MGCF
Service Id	O <sub>C</sub>	This field identifies the service the MRFC is hosting. For conferences the conference ID is used as the value of this parameter.	MRFC
Service Specific Data	O <sub>C</sub>	This field contains service specific data if and as provided by an Application Server.	AS
Message Bodies	O <sub>C</sub>	This field holds information about the Message body, Content-Type, Content-Length, Content-Disposition and Originator if available.	P-CSCF, S-CSCF, MGCF and AS
Cause Code	O <sub>C</sub>	This field contains the cause value.	All

### 6.3.2 Detailed Message Format for offline charging

The following chapter specifies per Operation Type the charging data that are sent by each of the IMS network elements:

- S-CSCF
- P-CSCF
- CSCF
- MRFC
- MGCF
- BGCF
- AS

The Operation Types are listed in the following order: S (start)/I (interim)/S (stop)/E (event). Therefore, when all Operation Types are possible it is marked as SISE. If only some Operation Types are allowed for a node, only the appropriate letters are used (i.e. SIS or E) as indicated in the table heading. The omission of an Operation Type for a particular field is marked with "-" (i.e. SI-E). Also, when an entire field is not allowed in a node the entire cell is marked as "-".

Table 6.3.2.1 illustrates the basic structure of the supported fields in the Charging Data Request message for IMS offline charging.

**Table 6.3.2.1 : Supported fields in Charging Data Request Message**

Field	Node Type	S-CSCF	P-CSCF	I-CSCF	MRFC	MGCF	BGCF	AS
	Supported Operation Types	S/I/S/E	S/I/S/E	E	S/I/S	S/I/S/E	S/I/S/E	S/I/S/E
Session Identifier		SISE	SISE	E	SIS	SISE	SISE	SISE
Originator Node		SISE	SISE	E	SIS	SISE	SISE	SISE
Originator Domain		SISE	SISE	E	SIS	SISE	SISE	SISE
Destination Domain		SISE	SISE	E	SIS	SISE	SISE	SISE
Operation Type		SISE	SISE	E	SIS	SISE	SISE	SISE
Operation Number		SISE	SISE	E	SIS	SISE	SISE	SISE
Operation Identifier		SISE	SISE	E	SIS	SISE	SISE	SISE
User Name		SISE	SISE	E	SIS	SISE	SISE	SISE
Operation Interval		SISE	SISE	E	SIS	SISE	SISE	SISE
Origination State		SISE	SISE	E	SIS	SISE	SISE	SISE
Origination Timestamp		SISE	SISE	E	SIS	SISE	SISE	SISE
Proxy Information		SISE	SISE	E	SIS	SISE	SISE	SISE
Route Information		SISE	SISE	E	SIS	SISE	SISE	SISE
<b>Service Information with PS and IMS Information</b>								
Event Type		SISE	SISE	E	SIS	SISE	SISE	SISE
Role of Node		SISE	SISE	E	SIS	SISE	SISE	SISE
Node Functionality		SISE	SISE	E	SIS	SISE	SISE	SISE
User Session Id		SISE	SISE	E	SIS	SISE	SISE	SISE
Calling Party Address		SISE	SISE	E	SIS	SISE	SISE	SISE
Called Party Address		SISE	SISE	E	SIS	SISE	SISE	SISE
Requested Party Address		S--E	-	-	S--	-	-	S--E
Called Asserted Identity		S--E	-	-	S--	-	-	S--E
Associated URI		---E	---E	E	-	-	-	-
Time stamps (see note 3)		SISE	SISE	E	SIS	SISE	SISE	SISE
Application server Information (see note 1)		SISE	-	-	SIS	-	-	-
Inter Operator Identifiers (see note 1)		SISE	SISE	E	SIS	SISE	SISE	SISE
IMS Charging Identifier		SISE	SISE	E	SIS	SISE	SISE	SISE
SDP Session Description		SI--	SI--	-	SI--	SI--	SI--	SI--
SDP Media Component		SI--	SI--	-	SI--	SI--	SI--	SI--
GGSN Address		SI--	SI--	-	SI--	SI--	SI--	SI--
Served Party (see note 1)		-	SISE	-	-	-	-	-
Authorized QoS (see note 1)		-	SI--	-	-	-	-	-
Server Capabilities (see note 1)		-	-	E	-	-	-	-
Trunk Group ID (see note 1)		-	-	-	-	SISE	-	-
Bearer Service (see note 1)		-	-	-	-	SISE	-	-
Service Id (see note 1)		-	-	-	SIS	-	-	-
Service Specific Data (see note 1)		-	-	-	-	-	-	SISE
Message Bodies (see note 2)		SISE	SISE	-	-	SISE	-	SISE
Cause Code		--SE	--SE	E	--S	--SE	--SE	--SE
NOTE 1: Only present if available in the CTF of the IMS node.								
NOTE 2: Present only if Messages Bodies is included in the SIP message that triggered the Charging Data Request.								
NOTE 3: Only present if ACR is triggered on a SIP message (e.g. SIP INVITE, SIP UPDATE).								

Table 6.3.2.2 illustrates the basic structure of the supported fields in the Charging Data Response message for IMS offline charging.

**Table 6.3.2.2 : Supported fields in Charging Data Response Message**

Field	Node Type	S-CSCF	P-CSCF	I-CSCF	MRFC	MGCF	BGCF	AS
	Supported Operation Types	S/I/S/E	S/I/S/E	E	S/I/S	S/I/S/E	S/I/S/E	S/I/S/E
Session Identifier		SISE	SISE	E	SIS	SISE	SISE	SISE
Originator Node		SISE	SISE	E	SIS	SISE	SISE	SISE
Originator Domain		SISE	SISE	E	SIS	SISE	SISE	SISE
Destination Domain		SISE	SISE	E	SIS	SISE	SISE	SISE
Operation Type		SISE	SISE	E	SIS	SISE	SISE	SISE
Operation Number		SISE	SISE	E	SIS	SISE	SISE	SISE
Operation Identifier		SISE	SISE	E	SIS	SISE	SISE	SISE
User Name		SISE	SISE	E	SIS	SISE	SISE	SISE
Operation Interval		SISE	SISE	E	SIS	SISE	SISE	SISE
Origination State		SISE	SISE	E	SIS	SISE	SISE	SISE
Origination Timestamp		SISE	SISE	E	SIS	SISE	SISE	SISE
Proxy Information		SISE	SISE	E	SIS	SISE	SISE	SISE
Route Information		SISE	SISE	E	SIS	SISE	SISE	SISE

### 6.3.3 Detailed Message Format for online charging

The following table specifies per Operation type the charging data that are sent by each of the IMS network elements:

- MRFC
- IMS-GWF
- AS

The Operation types are listed in the following order: I (initial)/U (update)/T (terminate)/E (event). Therefore, when all Operation types are possible it is marked as IUTE. If only some Operation types are allowed for a node, only the appropriate letters are used (i.e. IUT or E) as indicated in the table heading. The omission of an Operation type for a particular field is marked with "-" (i.e. IU-E). Also, when an entire field is not allowed in a node the entire cell is marked as "-".

Note that not for all structured fields the individual field members are listed in the table. Detailed descriptions of the fields are provided in TS 32.299 [50].

Table 6.3.3.1 illustrates the basic structure of the supported fields in the Debit and Reserve Units Request for IMS online charging.

**Table 6.3.3.1: Supported fields in *Debit and Reserve Units Request* Message**

Field	Node Type	IMS-GWF	MRFC	AS
	Supported Operation Types	I/U/T/E	I/U/T/E	I/U/T/E
Session Identifier		IUTE	IUTE	IUTE
Originator Host		IUTE	IUTE	IUTE
Originator Domain		IUTE	IUTE	IUTE
Destination Domain		IUTE	IUTE	IUTE
Operation Identifier		IUTE	IUTE	IUTE
Operation Token		IUTE	IUTE	IUTE
Operation Type		IUTE	IUTE	IUTE
Operation Number		IUTE	IUTE	IUTE
Destination Host		IUTE	IUTE	IUTE
User Name		IUTE	IUTE	IUTE
Origination State		IUTE	IUTE	IUTE
Origination Timestamp		IUTE	IUTE	IUTE
Subscriber Identifier		IUTE	IUTE	IUTE
Termination Cause		—T-	—T-	—T-
Requested Action		IUTE	IUTE	IUTE
Multiple Operation		IU-E	IU-E	IU-E
Multiple Unit Operation		IU-E	IU-E	IU-E
Service Units Requested		IU-E	IU-E	IU-E
Action Requested		---E	---E	---E
Service Units Used		-UT-	-UT-	-UT-
Subscriber Equipment Number		IUTE	IUTE	IUTE
Proxy Information		IUTE	IUTE	IUTE
Route Information		IUTE	IUTE	IUTE
Extended Information		IUTE	IUTE	IUTE
<b>Service Information with PS and IMS Information</b>				
Event Type		IUTE	IUTE	IUTE
Role Of Node		IUTE	IUTE	IUTE
Node Functionality		IUTE	IUTE	IUTE
User Session Id		IUTE	IUTE	IUTE
Calling Party Address		IUTE	IUTE	IUTE
Called Party Address		IUTE	IUTE	IUTE
Requested Party Address		I--E	I--E	I--E
Called Asserted Identity		-UTE	-UTE	-UTE
Associated URI		--TE	-	-
Application Server Information		IUTE	IUTE	-
Inter Operator Identifier		IUTE	IUTE	IUTE
IMS Charging Identifier		IUTE	IUTE	IUTE
SDP Session Description		IU--	IU--	IU--
SDP Media Component		IU--	IU-	IU--
GGSN Address		IU--	IU-	IU--
Served Party		-	-	-
Server Capabilities		-	-	-
Trunk Group ID		-	-	-
Bearer Service		-	-	-
Service Id		-	IUT	-
Service Specific Data		-	-	-
Messages Bodies		IUTE	-	IUTE
Cause Code		--TE	--T	--TE

Table 6.3.3.2 illustrates the basic structure of the supported fields in the Debit and Reserve Units Response for IMS online charging.

**Table 6.3.3.2: Supported fields in *Debit and Reserve Units Response* Message**

Field	Node Type	IMS-GWF	MRFC	AS
	Supported Operation Types	I/U/T/E	I/U/T/E	I/U/T/E
Session Identifier		IUTE	IUTE	IUTE
Operation Result		IUTE	IUTE	IUTE
Originator Host		IUTE	IUTE	IUTE
Originator Domain		IUTE	IUTE	IUTE
Operation Identifier		IUTE	IUTE	IUTE
Operation Type		IUTE	IUTE	IUTE
Operation Number		IUTE	IUTE	IUTE
Operation Failover		IUTE	IUTE	IUTE
Multiple Unit Operation		IUTE	IUTE	IUTE
Operation Failure Action		-	-	-
Redirection Host		-	-	-
Redirection Host Usage		-	-	-
Redirection Cache Time		-	-	-
Proxy Information		-	-	-
Route Information		-	-	-
Failed parameter		-	-	-
Extended Information		IUTE	IUTE	IUTE

## 6.3.4 Formal IMS charging parameter description

### 6.3.4.1 IMS charging information for CDRs

The detailed definitions, abstract syntax and encoding of the IMS CDR parameters are specified in TS 32.298 [51].

### 6.3.4.2 IMS charging information for charging events

The detailed charging event parameter definitions are specified in 3GPP TS 32.299 [50].



Annex A (informative):  
Void

---

## Annex B (informative): Bibliography

### a) **The 3GPP charging specifications**

- 3GPP TS 32.250: "Telecommunication management; Charging management; Circuit Switched (CS) domain charging".
- 3GPP TS 32.252: "Telecommunication management; Charging management; Wireless Local Area Network (WLAN) charging".
- 3GPP TS 32.270: "Telecommunication management; Charging management; Multimedia Messaging Service (MMS) charging".
- 3GPP TS 32.271: "Telecommunication management; Charging management; Location Services (LCS) charging".
- 3GPP TS 32.296: "Telecommunication management; Charging management; Online Charging System (OCS) applications and interfaces".

### b) **Common 3GPP specifications**

- 3GPP TS 22.101: "Service aspects; Service Principles".
- 3GPP TS 22.115 "Service aspects; Charging and Billing".
- 3GPP TS 23.003: "Numbering, addressing and identification".
- 3GPP TS 27.001: "General on Terminal Adaptation Functions (TAF) for Mobile Stations (MS)".

### c) **other Domain and Service specific 3GPP / ETSI specifications**

-

### d) **Relevant ITU Recommendations**

- ITU-T Recommendation D.93: "Charging and accounting in the international land mobile telephone service (provided via cellular radio systems)".
- ITU-T Recommendation E.164: "The international public telecommunication numbering plan".
- ITU-T Recommendation Q.767: "Application of the ISDN user part of CCITT signalling System No.7 for international ISDN interconnections".
- ITU-T Recommendation X.25: "Interface between Data Terminal Equipment (DTE) and Data Circuit-terminating Equipment (DCE) for terminals operating in the packet mode and connected to public data networks by dedicated circuit".
- ITU-T Recommendation X.121: "International numbering plan for public data networks".

### e) **Relevant IETF RFCs**

- IETF RFC 959 (1985): "File Transfer Protocol".

## Annex C (informative): Change history

Change history								
Date	TSG #	TSG Doc.	CR	Rev	Subject/Comment	Cat	Old	New
Mar 2004	SA_23	SP-040144	--	--	Submitted to TSG SA#23 for Information	--	1.0.0	
Dec 2004	SA_26	SP-040777	--	--	Submitted to TSG SA#26 for Approval	--	2.0.0	6.0.0
Mar 2005	SA_27	SP-050030	0001	--	Correction of missing Service Specific Data AVP (Attribute Value Pair)	A	6.0.0	6.1.0
Mar 2005	SA_27	SP-050030	0002	--	Correction of criteria for the presence of the GPRS charging ID in the IMS CDRs - Align with SA2's TS 23.228	A	6.0.0	6.1.0
Mar 2005	SA_27	SP-050030	0003	--	Correction of Table 5.2.1.1: 'addition of reporting of 2xx/3xx events'	F	6.0.0	6.1.0
Jun 2005	SA_28	SP-050276	0004	--	Correction to scope	F	6.1.0	6.2.0
Jun 2005	SA_28	SP-050276	0005	--	Correction to references	F	6.1.0	6.2.0
Jun 2005	SA_28	SP-050276	0005	--	Correction to references	F	6.1.0	6.2.0
Sep 2005	SA_29	SP-050437	0006	--	Remove GGSN Address from the I-CSCF CDR	F	6.2.0	6.3.0
Sep 2005	SA_29	SP-050437	0007	--	Correct service delivery "Start" and "End" time stamps	F	6.2.0	6.3.0
Sep 2005	SA_29	SP-050437	0009	--	Correct handling of 3xx response	F	6.2.0	6.3.0
Dec 2005	SA_30	SP-050698	0011	--	Correct Diameter parts - Align with TS 32.299	F	6.3.0	6.4.0
Dec 2005	SA_30	SP-050698	0012	--	Add missing 'DEREGISTER' to the currently identified triggers	F	6.3.0	6.4.0
Mar 2006	SA_31	SP-060081	0013	--	Correction to Inter Operator Identifier (IOI) occurrences in S-CSCF CDR	F	6.4.0	6.5.0
Mar 2006	SA_31	SP-060080	0014	--	Correction of ACR-CDR generation conditions - Align with IETF RFC 3515	F	6.4.0	6.5.0
Mar 2006	SA_31	SP-060082	0015	--	Removal of ACID (Application Charging ID) - not relevant for Rel-6	F	6.4.0	6.5.0
Mar 2006	SA_31	SP-060081	0016	--	Correction of User-Name AVP - Align with 32.299	F	6.4.0	6.5.0
Mar 2006	SA_31	SP-060082	0017	--	Corrections of online charging (Ro) triggers	F	6.4.0	6.5.0
Mar 2006	SA_31	SP-060082	0018	--	Correction to List of Session Description Protocol (SDP) Media Components parameter in IMS CDRs	F	6.4.0	6.5.0
Mar 2006	SA_31	SP-060082	0019	--	Correction of List of Session Description Protocol (SDP) Media Components parameter in IMS CDRs	F	6.4.0	6.5.0
Mar 2006	SA_31	SP-060081	0020	--	Correction of SIP timestamps	F	6.4.0	6.5.0
Jun 2006	SA_32	SP-060241	0021	--	Correction on IMS charging information	F	6.5.0	6.6.0
Jun 2006	SA_32	SP-060241	0022	--	Correction to Calling Party ID	F	6.5.0	6.6.0
Jun 2006	SA_32	SP-060241	0023	--	Implicit registration: Add 'list of associated URI' parameter to the IMS charging information - Align with SA2's 23.228 IMS Stage 2	F	6.5.0	6.6.0
Jun 2006	SA_32	SP-060241	0024	--	Correction on handling of aborted session setups - Align with 24.229	F	6.5.0	6.6.0
Jun 2006	SA_32	SP-060241	0025	--	Removal of GGSN Address	F	6.5.0	6.6.0
Jun 2006	SA_32	SP-060417	0026	1	Correction to Called Party Address in IMS Charging	F	6.5.0	6.6.0

---

## History

<b>Document history</b>		
V6.0.0	December 2004	Publication
V6.1.0	March 2005	Publication
V6.2.0	June 2005	Publication
V6.3.0	September 2005	Publication
V6.4.0	December 2005	Publication
V6.5.0	March 2006	Publication
V6.6.0	June 2006	Publication