

ETSI TS 132 260 V14.3.0 (2017-10)



**Digital cellular telecommunications system (Phase 2+) (GSM);
Universal Mobile Telecommunications System (UMTS);
LTE;
Telecommunication management;
Charging management;
IP Multimedia Subsystem (IMS) charging
(3GPP TS 32.260 version 14.3.0 Release 14)**



Reference

RTS/TSGS-0532260ve30

Keywords

GSM,LTE,UMTS

ETSI

650 Route des Lucioles
F-06921 Sophia Antipolis Cedex - FRANCE

Tel.: +33 4 92 94 42 00 Fax: +33 4 93 65 47 16

Siret N° 348 623 562 00017 - NAF 742 C
Association à but non lucratif enregistrée à la
Sous-Préfecture de Grasse (06) N° 7803/88

Important notice

The present document can be downloaded from:

<http://www.etsi.org/standards-search>

The present document may be made available in electronic versions and/or in print. The content of any electronic and/or print versions of the present document shall not be modified without the prior written authorization of ETSI. In case of any existing or perceived difference in contents between such versions and/or in print, the only prevailing document is the print of the Portable Document Format (PDF) version kept on a specific network drive within ETSI Secretariat.

Users of the present document should be aware that the document may be subject to revision or change of status.

Information on the current status of this and other ETSI documents is available at

<https://portal.etsi.org/TB/ETSIDeliverableStatus.aspx>

If you find errors in the present document, please send your comment to one of the following services:

<https://portal.etsi.org/People/CommiteeSupportStaff.aspx>

Copyright Notification

No part may be reproduced or utilized in any form or by any means, electronic or mechanical, including photocopying and microfilm except as authorized by written permission of ETSI.

The content of the PDF version shall not be modified without the written authorization of ETSI.

The copyright and the foregoing restriction extend to reproduction in all media.

© ETSI 2017.

All rights reserved.

DECT™, **PLUGTESTS™**, **UMTS™** and the ETSI logo are trademarks of ETSI registered for the benefit of its Members.

3GPP™ and **LTE™** are trademarks of ETSI registered for the benefit of its Members and of the 3GPP Organizational Partners.

oneM2M logo is protected for the benefit of its Members.

GSM® and the GSM logo are trademarks registered and owned by the GSM Association.

Intellectual Property Rights

IPRs essential or potentially essential to the present document may have been declared to ETSI. The information pertaining to these essential IPRs, if any, is publicly available for **ETSI members and non-members**, and can be found in ETSI SR 000 314: *"Intellectual Property Rights (IPRs); Essential, or potentially Essential, IPRs notified to ETSI in respect of ETSI standards"*, which is available from the ETSI Secretariat. Latest updates are available on the ETSI Web server (<https://ipr.etsi.org>).

Pursuant to the ETSI IPR Policy, no investigation, including IPR searches, has been carried out by ETSI. No guarantee can be given as to the existence of other IPRs not referenced in ETSI SR 000 314 (or the updates on the ETSI Web server) which are, or may be, or may become, essential to the present document.

Foreword

This Technical Specification (TS) has been produced by ETSI 3rd Generation Partnership Project (3GPP).

The present document may refer to technical specifications or reports using their 3GPP identities, UMTS identities or GSM identities. These should be interpreted as being references to the corresponding ETSI deliverables.

The cross reference between GSM, UMTS, 3GPP and ETSI identities can be found under <http://webapp.etsi.org/key/queryform.asp>.

Modal verbs terminology

In the present document "**shall**", "**shall not**", "**should**", "**should not**", "**may**", "**need not**", "**will**", "**will not**", "**can**" and "**cannot**" are to be interpreted as described in clause 3.2 of the [ETSI Drafting Rules](#) (Verbal forms for the expression of provisions).

"**must**" and "**must not**" are **NOT** allowed in ETSI deliverables except when used in direct citation.

Contents

Intellectual Property Rights	2
Foreword.....	2
Modal verbs terminology.....	2
Foreword.....	7
1 Scope	8
2 References	9
3 Definitions, symbols and abbreviations	12
3.1 Definitions	12
3.2 Symbols.....	12
3.3 Abbreviations	12
4 Architecture considerations	14
4.1 High level IMS architecture	14
4.2 IMS offline charging architecture.....	15
4.3 IMS online charging architecture	16
5 Charging principles	17
5.1 IMS charging principles	17
5.1.0 Introduction.....	17
5.1.1 IMS charging applicability	17
5.1.2 IMS charging correlation	17
5.1.2.1 Basic principles for IMS domain correlation	17
5.1.2.2 IMS Charging Identifier	18
5.1.2.2A Related ICID	18
5.1.2.3 Access network charging identifier.....	18
5.1.2.4 Inter Operator Identifier	18
5.1.2.5 Void.....	19
5.1.2.6 IMS visited network identifier	19
5.1.2.7 Loopback-indication	19
5.1.2.8 Functional Entity (FE) Identifier.....	19
5.1.3 SDP handling	19
5.1.4 Trigger conditions.....	19
5.1.5 IMS support of real-time tariff transfer.....	20
5.1.6 Served user identification	20
5.1.7 Single charging session from AS/ATCF acting as B2BUA.....	21
5.1.8 Charging support for roaming architecture for voice over IMS with local breakout	22
5.1.8A Charging support for roaming architecture for voice over IMS with home routed traffic	22
5.1.9 Charging support for Network provided Location information	24
5.1.9A Charging support for IMS transit scenarios	24
5.1.10 Charging support for TRF.....	24
5.1.11 Charging support for IMS service continuity	24
5.1.12 IMS support of OCS-provided announcements	25
5.1.13 Charging support of UE location(s) and TimeZone(s).....	25
5.2 IMS offline charging principles.....	27
5.2.1 Basic principles.....	27
5.2.2 Message flows and types	28
5.2.2.0 Introduction.....	28
5.2.2.1 Message flows - successful cases and scenarios	28
5.2.2.1.1 Session establishment - mobile origination	28
5.2.2.1.2 Session establishment - mobile termination	32
5.2.2.1.3 Mid-session procedures	33
5.2.2.1.4 Session release - mobile initiated	35
5.2.2.1.5 Session-unrelated procedures	37
5.2.2.1.6 Session establishment - PSTN initiated	38
5.2.2.1.7 Session establishment - IMS initiated.....	39

5.2.2.1.8	Session release - PSTN initiated.....	40
5.2.2.1.9	Session release - IMS initiated	41
5.2.2.1.10	Multi-Party call.....	42
5.2.2.1.11	AS related procedures - AS acting as a redirect server.....	45
5.2.2.1.12	AS related procedures - AS acting as a voice mail server	46
5.2.2.1.13	AS Related Procedures - AS Acting as a SCC AS	47
5.2.2.1.13.0	Introduction.....	47
5.2.2.1.13.1	UE originating call (PS only or CS only).....	47
5.2.2.1.13.2	UE originating call (PS and CS combined origination)	49
5.2.2.1.13.3	UE terminating call (PS only or CS only).....	52
5.2.2.1.13.4	UE terminating call (PS and CS combined origination)	54
5.2.2.1.13.5	Session transfer from PS to CS	57
5.2.2.1.13.6	Session transfer from CS to PS	59
5.2.2.1.13.7	Session transfer from PS to (CS+PS).....	61
5.2.2.1.13.8	Session transfer from (CS+PS) to PS.....	64
5.2.2.1.13.9	IMS emergency session transfer from PS to CS	67
5.2.2.1.13.10	Inter-UE transfer triggered by target UE without collaborative session establishment	68
5.2.2.1.14	Initiating alternate charged party call	72
5.2.2.1.15	Session establishment via IBCF to S-CSCF - IMS initiated.....	74
5.2.2.1.16	AS related procedures - AS acting as a MMTel AS	75
5.2.2.1.17	Session establishment via IBCF to a third party AS providing tariff information in real time (RTTI)	75
5.2.2.1.18	Third party AS providing tariff information in real time (RTTI) during the session.....	76
5.2.2.1.19	Support of Optimal Media Routing (OMR)	77
5.2.2.1.19.0	Introduction.....	77
5.2.2.1.19.1	IMS-ALG related procedures for OMR – Session establishment and IMS-ALG bypasses its local GW	78
5.2.2.1.19.2	IMS-ALG related procedures for OMR – session establishment and alternate IP realm is selected	81
5.2.2.1.19.3	IMS-ALG related procedures for OMR – mid-session procedure	83
5.2.2.1.19.4	IMS-ALG related procedures for OMR – transcoding	84
5.2.2.1.19.4.0	Introduction	84
5.2.2.1.19.4.1	IMS-ALG Related Procedures for OMR – transcoder provided by IMS-ALG.....	84
5.2.2.1.19.4.2	IMS-ALG related procedures for OMR – transcoder offered by IMS-ALG but not selected.....	86
5.2.2.1.20	AS acting as a B2BUA – single charging session	88
5.2.2.1.21	Session establishment for roaming architecture for voice over IMS with local breakout	90
5.2.2.1.22	Service continuity using ATCF	92
5.2.2.1.22.0	Introduction.....	92
5.2.2.1.22.1	UE originating call (CS only) through ATCF.....	92
5.2.2.1.22.1A	UE originating call (PS only) through ATCF	94
5.2.2.1.22.2	UE terminating call (CS only) through ATCF.....	94
5.2.2.1.22.2A	UE terminating call (PS only) through ATCF	96
5.2.2.1.22.3	UE session transfer PS to CS using ATCF	97
5.2.2.1.22.4	UE session transfer CS to PS using ATCF	98
5.2.2.2	Message flows - error cases and scenarios	100
5.2.2.2.0	Introduction	100
5.2.2.2.1	Session related SIP procedures- reception of SIP error messages	100
5.2.2.2.2	Session related SIP procedures - SIP session failure	100
5.2.2.2.3	Session unrelated SIP procedures.....	101
5.2.2.2.4	CDF connection failure	101
5.2.2.2.5	No reply from CDF	101
5.2.2.2.6	Duplicate detection.....	101
5.2.2.2.7	CDF detected failure.....	101
5.2.3	CDR generation	101
5.2.4	GTP' record transfer flows	101
5.2.5	Bi CDR file transfer	101
5.3	IMS online charging scenarios	101
5.3.1	Basic principles.....	101
5.3.2	Message flows and types	104
5.3.2.0	Introduction.....	104
5.3.2.1	Immediate Event Charging (IEC)	104

5.3.2.1.0	Introduction	104
5.3.2.1.1	Message flows - successful cases and scenarios.....	104
5.3.2.1.1.1	IEC – Debit Units operation	104
5.3.2.1.1.2	Scenarios.....	105
5.3.2.1.2	Message flows - error cases and scenarios	105
5.3.2.1.2.0	Introduction.....	105
5.3.2.1.2.1	Reception of SIP error messages	106
5.3.2.1.2.2	Debit Units operation failure.....	106
5.3.2.1.2.3	Duplicate detection	106
5.3.2.2	Event Charging with Unit Reservation (ECUR) and Session Charging with Unit Reservation (SCUR)	106
5.3.2.2.0	General	106
5.3.2.2.1	Message flows - successful cases and scenarios.....	106
5.3.2.2.1.1	ECUR and SCUR - Reserve / Debit Units operations	106
5.3.2.2.1.2	Expiration of reservation validity	106
5.3.2.2.1.3	Scenarios.....	107
5.3.2.2.1.3.0	Introduction	107
5.3.2.2.1.3.1	Session related procedures (SCUR)	108
5.3.2.2.1.3.2	Session unrelated procedures (ECUR)	118
5.3.2.2.2	Message flows - error cases and scenarios	120
5.3.2.2.2.0	Introduction.....	120
5.3.2.2.2.1	Reception of SIP error messages	120
5.3.2.2.2.2	Debit / Reserve Units operation failure.....	120
5.3.2.2.2.3	Duplicate detection	120
5.3.2.2.2.4	Aborted session setup	120
5.3.2.3	IMS service termination by OCS	120
5.3.2.3.0	Introduction	120
5.3.2.3.1	Triggers on Ro interface which imply the termination of the IMS service	120
5.3.2.3.2	Indication to the UE of the reason for IMS service release	121
6	Definition of charging information	122
6.1	Data description for IMS offline charging	122
6.1.1	Rf message contents.....	122
6.1.1.0	Introduction.....	122
6.1.1.1	Charging Data Request message	122
6.1.1.2	Charging Data Response message.....	123
6.1.2	GTP' message contents	123
6.1.3	CDR description on the Bi interface	123
6.1.3.1	CDR content description	123
6.1.3.2	CDR triggers	124
6.1.3.2.1	Session related CDRs	124
6.1.3.2.2	Session unrelated CDRs	124
6.1.3.3	S-CSCF CDR content	125
6.1.3.4	P-CSCF CDR content	130
6.1.3.5	I-CSCF CDR content	135
6.1.3.6	MRFC CDR content.....	138
6.1.3.7	MGCF CDR content	142
6.1.3.8	BGCF CDR content	146
6.1.3.9	SIP AS CDR content.....	149
6.1.3.10	IBCF CDR content.....	155
6.1.3.11	E-CSCF CDR content	160
6.1.3.12	TRF CDR content	164
6.1.3.13	ATCF CDR content.....	168
6.1.3.14	TF CDR content	173
6.2	Data description for IMS online charging	177
6.2.1	Ro message contents.....	177
6.2.1.0	Introduction.....	177
6.2.1.1	Debit / Reserve Units Request message.....	178
6.2.1.2	Debit / Reserve Units Response message.....	179
6.3	IMS charging specific parameters	180
6.3.1	Definition of IMS charging information.....	180
6.3.1.0	General.....	180

6.3.1.1	IMS charging information assignment for Service Information	180
6.3.1.2	Definition of the IMS Information	180
6.3.2	Detailed message format for offline charging.....	184
6.3.3	Detailed message format for online charging	188
6.3.4	Formal IMS charging parameter description	191
6.3.4.1	IMS charging information for CDRs	191
6.3.4.2	IMS charging information for charging events	191
Annex A (informative): Bibliography.....		192
Annex B (informative): Message flows for service termination by OCS.....		193
B.0	General	193
B.1	Scenario 1 - session related (SCUR): service termination on reception of an initial SIP INVITE request	193
B.2	Scenario 2 - session related (SCUR): service termination triggered after an early SIP dialog is established	194
B.3	Scenario 3 - session related (SCUR): service termination triggered after a confirmed SIP dialog is established	197
B.4	Scenario 4 - session unrelated (ECUR): service termination on reception of an initial non-INVITE SIP request	200
B.5	Scenario 5 - session unrelated (IEC): service termination on reception of an initial non-INVITE SIP request.....	201
Annex C (informative): Change history		202
History		206

Foreword

This Technical Specification has been produced by the 3rd Generation Partnership Project (3GPP).

The contents of the present document are subject to continuing work within the TSG and may change following formal TSG approval. Should the TSG modify the contents of the present document, it will be re-released by the TSG with an identifying change of release date and an increase in version number as follows:

Version x.y.z

where:

- x the first digit:
 - 1 presented to TSG for information;
 - 2 presented to TSG for approval;
 - 3 or greater indicates TSG approved document under change control.
- y the second digit is incremented for all changes of substance, i.e. technical enhancements, corrections, updates, etc.
- z the third digit is incremented when editorial only changes have been incorporated in the document.

1 Scope

The present document is part of a series of Technical Specifications (TSs) that specify charging functionality and charging management in GSM/UMTS networks. The GSM/UMTS core network charging architecture and principles are specified in document TS 32.240 [1], which provides an umbrella for other charging management documents that specify:

- the content of the CDRs per domain and subsystem (offline charging),
- the content of real-time charging events per domain / subsystem (online charging);
- the functionality of online and offline charging for those domains and subsystems;
- the interfaces that are used in the charging framework to transfer the charging information (i.e. CDRs or charging events).

The complete document structure for these TSs is defined in TS 32.240 [1].

The present document specifies the offline and online charging description for the IP Multimedia Subsystem (IMS), based on the functional descriptions of the IMS in TS 23.228 [200]. This charging description includes the offline and online charging architecture and scenarios specific to IMS, as well as the mapping of common 3GPP charging architecture specified in TS 32.240 [1] onto IMS. It further specifies the structure and content of the CDRs for offline charging, and the charging events for online charging. The present document is related to other 3GPP charging TSs as follows:

- The common 3GPP charging architecture is specified in TS 32.240 [1];
- The parameters, abstract syntax and encoding rules for these CDR types are specified in TS 32.298 [51].
- A transaction based mechanism for the transfer of CDRs within the network is specified in TS 32.295 [54].
- The file based mechanism used to transfer the CDRs from the network to the operator's billing domain (e.g. the billing system or a mediation device) is specified in TS 32.297 [52].
- The 3GPP Diameter application that is used for IMS offline and online charging is specified in TS 32.299 [50].

All terms, definitions and abbreviations used in the present document, that are common across 3GPP TSs, are defined in the 3GPP Vocabulary, TR 21.905 [100]. Those that are common across charging management in GSM/UMTS domains, services or subsystems are provided in the umbrella document TS 32.240 [1] and are copied into clause 3 of the present document for ease of reading. Finally, those items that are specific to the present document are defined exclusively in the present document.

Furthermore, requirements that govern the charging work are specified in TS 22.115 [101].

2 References

The following documents contain provisions, which, through reference in this text, constitute provisions of the present document.

- References are either specific (identified by date of publication, edition number, version number, etc.) or non-specific.
- For a specific reference, subsequent revisions do not apply.
- For a non-specific reference, the latest version applies. In the case of a reference to a 3GPP document (including a GSM document), a non-specific reference implicitly refers to the latest version of that document *in the same Release as the present document*.

- [1] 3GPP TS 32.240: "Telecommunication management; Charging management; Charging architecture and principles".
- [2] Void.
- [3] - [10] Void.
- [11] 3GPP TS 32.251: "Telecommunication management; Charging management; Packet Switched (PS) domain charging".
- [12] - [34] Void.
- [35] 3GPP TS 32.275: "Telecommunication management; Charging management; MultiMedia Telephony (MMTel) charging".
- [36] 3GPP TS 32.276: "Telecommunication management; Charging management; Voice Call Service (VCS) charging".
- [37] - [39] Void.
- [40] 3GPP TS 32.280: "Telecommunication management; Charging management; Advice of Charge (AoC) service".
- [41] 3GPP TS 32.281: "Telecommunication management; Charging management; Announcement service".
- [42] - [49] Void.
- [50] 3GPP TS 32.299: "Telecommunication management; Charging management; Diameter charging application".
- [51] 3GPP TS 32.298: "Telecommunication management; Charging management; Charging Data Record (CDR) parameter description".
- [52] 3GPP TS 32.297: "Telecommunication management; Charging management; Charging Data Records (CDR) file format and transfer".
- [53] Void.
- [54] 3GPP TS 32.295: "Telecommunication management; Charging management; Charging Data Record (CDR) transfer".
- [55] - [99] Void.
- [100] 3GPP TR 21.905: "Vocabulary for 3GPP Specifications".
- [101] 3GPP TS 22.115: "Service aspects; Charging and billing".
- [102] Void.
- [103] 3GPP TS 23.002: "Network architecture".

- [104] 3GPP TS 23.003: "Numbering, addressing and identification".
- [105] - [199] Void.
- [200] 3GPP TS 22.228: "Service requirements for the Internet Protocol (IP) multimedia core network subsystem (IMS); Stage 1".
- [201] 3GPP TS 23.228: "IP Multimedia Subsystem (IMS); Stage 2".
- [202] 3GPP TS 24.228: "Signalling flows for the IP multimedia call control based on Session Initiation Protocol (SIP) and Session Description Protocol (SDP); Stage 3".
- [203] 3GPP TS 23.218: "IP Multimedia (IM) session handling; IM call model; Stage 2".
- [204] 3GPP TS 24.229: "IP multimedia call control protocol based on Session Initiation Protocol (SIP) and Session Description Protocol (SDP); Stage 3".
- [205] 3GPP TS 29.229: "Cx and Dx interfaces based on the Diameter protocol; Protocol details".
- [206] 3GPP TS 29.658: "SIP Transfer of IP Multimedia Service Tariff Information; Protocol specification".
- [207] 3GPP TS 33.203: "3G security; Access security for IP-based services".
- [208] 3GPP TS 33.210: "3G security; Network Domain Security (NDS); IP network layer security".
- [209] 3GPP TS 33.310: "Network Domain Security (NDS); Authentication Framework (AF)".
- [210] 3GPP TS 24.292: "IP Multimedia (IM) Core Network (CN) subsystem Centralized Services (ICS); Stage 3".
- [211] 3GPP TS 29.079: "Optimal media routing within the IP Multimedia Subsystem (IMS); Stage 3".
- [212] 3GPP TS 23.167: "IP Multimedia Subsystem (IMS) emergency sessions".
- [213] 3GPP TS 23.203: "Policy and charging control architecture".
- [214] 3GPP TS 29.214: "Policy and charging control over Rx reference point".
- [215] 3GPP TS 29.328: "IP Multimedia (IM) Subsystem Sh Interface; Signalling flows and message contents".
- [216] 3GPP TS 23.237: "IP Multimedia Subsystem (IMS) Service Continuity; Stage 2".
- [217] 3GPP TS 24.237: "IP Multimedia (IM) Core Network (CN) subsystem IP Multimedia Subsystem (IMS) service continuity; Stage 3".
- [218] 3GPP TS 24.337: "IP Multimedia Subsystem (IMS) inter-UE transfer; Stage 3".
- [219] 3GPP TS 23.292: "IP Multimedia Subsystem (IMS) centralized services; Stage 2".
- [220] 3GPP TS 24.628: "Common Basic Communication procedures using IP Multimedia (IM) Core Network (CN) subsystem; Protocol specification".
- [221] – [299] Void.
- [300] - [399] Void.
- [400] Void.
- [401] Void.
- [402] IETF RFC 4006 (2005): "Diameter Credit-Control Application".
- [403] IETF RFC 2806 (2000): "URLs for Telephone Calls".
- [404] IETF RFC 3261 (2002): "SIP: Session Initiation Protocol".

- [405] IETF RFC 2486 (1999): "The Network Access Identifier".
- [406] IETF RFC 7315 (2014): "Private Header (P-Header) Extensions to the Session Initiation Protocol (SIP) for the 3rd-Generation Partnership Project (3GPP)".
- [407] Void.
- [408] Void.

3 Definitions, symbols and abbreviations

3.1 Definitions

For the purposes of the present document, the following terms and definitions given in TR 21.905 [100], TS 32.240 [1], and the following apply. A term defined in the present document takes precedence over the definition of the same term, if any, in TR 21.905 [100].

billing: function whereby CDRs generated by the charging function are transformed into bills requiring payment.

Billing Domain: Part of the operator network, which is outside the core network that receives and processes charging information from the core network charging functions. It includes functions that can provide billing mediation and billing end applications.

charged party: user involved in a chargeable event that has to pay parts or the whole charges of the chargeable event, or a third party paying the charges caused by one or all users involved in the chargeable event, or a network operator.

charging: function whereby information related to a chargeable event is formatted and transferred in order to make it possible to determine usage for which the charged party may be billed.

Charging Data Record (CDR): record generated by a Network Element for the purpose of billing a subscriber for the provided service. It includes fields identifying the user, the session and the Network Elements as well as information on the network resources and services used to support a subscriber session. In the traditional circuit domain, CDR has been used to denote "Call Detail Record", which is subsumed by "Charging Data Record" hereafter.

charging function: entity inside the core network domain, subsystem or service that is involved in charging for that domain, subsystem or service.

offline charging: charging mechanism where charging information **does not** affect, in real-time, the service rendered

online charging: charging mechanism where charging information can affect, in real-time, the service rendered and therefore a direct interaction of the charging mechanism with session/service control is required

partial CDR: CDR that provides information on part of a subscriber session. A long session may be covered by several partial CDRs. Two formats are considered for Partial CDRs. One that contains all of the necessary fields; the second has a reduced format.

3.2 Symbols

For the purposes of the present document, the following symbols apply:

Bi	Reference point for the CDR file transfer from the IMS CGF to the BD.
Ga	Reference point for CDR transfer between a CDF and CGF.
Rf	Offline Charging Reference Point between an IMS Network Entity or an AS and CDF
Ro	Online Charging Reference Point between an AS or MRFC and IMS-GWF and the OCS

3.3 Abbreviations

For the purposes of the present document, the abbreviations given in TR 21.905 [100] and the following apply. An abbreviation defined in the present document takes precedence over the definition of the same abbreviation, if any, in TR 21.905 [100].

ABNF	Augmented Backus-Naur Form
ACA	Accounting-Answer
ACR	Accounting-Request
AS	Application Server
ATCF	Access Transfer Control Function
ATGW	Access Transfer Gateway

AVP	Attribute Value Pair
B2BUA	Back-to-Back User Agent
BGCF	Breakout Gateway Control Function
BS	Billing System
CCA	Credit-Control-Answer
CCF	Charging Collection Function
CCR	Credit-Control-Request
CDF	Charging Data Function
CDIV	Communication Diversion
CDR	Charging Data Record
CGF	Charging Gateway Function
CONF	Conference
CPCF	Content Provider Charging Function
CSCF	Call Session Control Function (I-Interrogating; P-Proxy; and S-Serving)
EATF	Emergency Access Transfer Function
ECF	Event Charging Function
ECUR	Event Charging with Unit Reservation
IBCF	Interconnect Border Control Function
IEC	Immediate Event Charging
IMS	IP Multimedia Subsystem
IMS-AGW	IMS Access Media Gateway
IMS-ALG	IMS - Application Level Gateway
IMS-GWF	IMS Gateway Function
IOI	Inter Operator Identifier
ISC	IMS Service Control
MGCF	Media Gateway Control Function
MMTel	MultiMedia Telephony
MRFC	Media Resource Function Controller
NNI	Network to Network Interface
MRFP	Multimedia Resource Function Processor
NetLoc	Network provided Location information
OCS	Online Charging System
OMR	Optimal Media Routing
RTTI	Real-time Transfer of Tariff Information
SCCF	Subscriber Content Charging Function
SCUR	Session Charging with Unit Reservation
SDP	Session Description Protocol
SIP	Session Initiation Protocol
TF	Transit Functions
TIP	Terminating Identity Presentation
TIR	Terminating Identity Restriction
TRF	Transit and Roaming Function
TrGW	Transition GateWay
UA	User Agent
UE	User Equipment
VCC	Voice Call Continuity
VCS	Voice Call Service
VDN	VCC Domain transfer Number

4 Architecture considerations

4.1 High level IMS architecture

Figure 4.1.1 depicts the logical IMS architecture, as described in TS 23.002 [103]

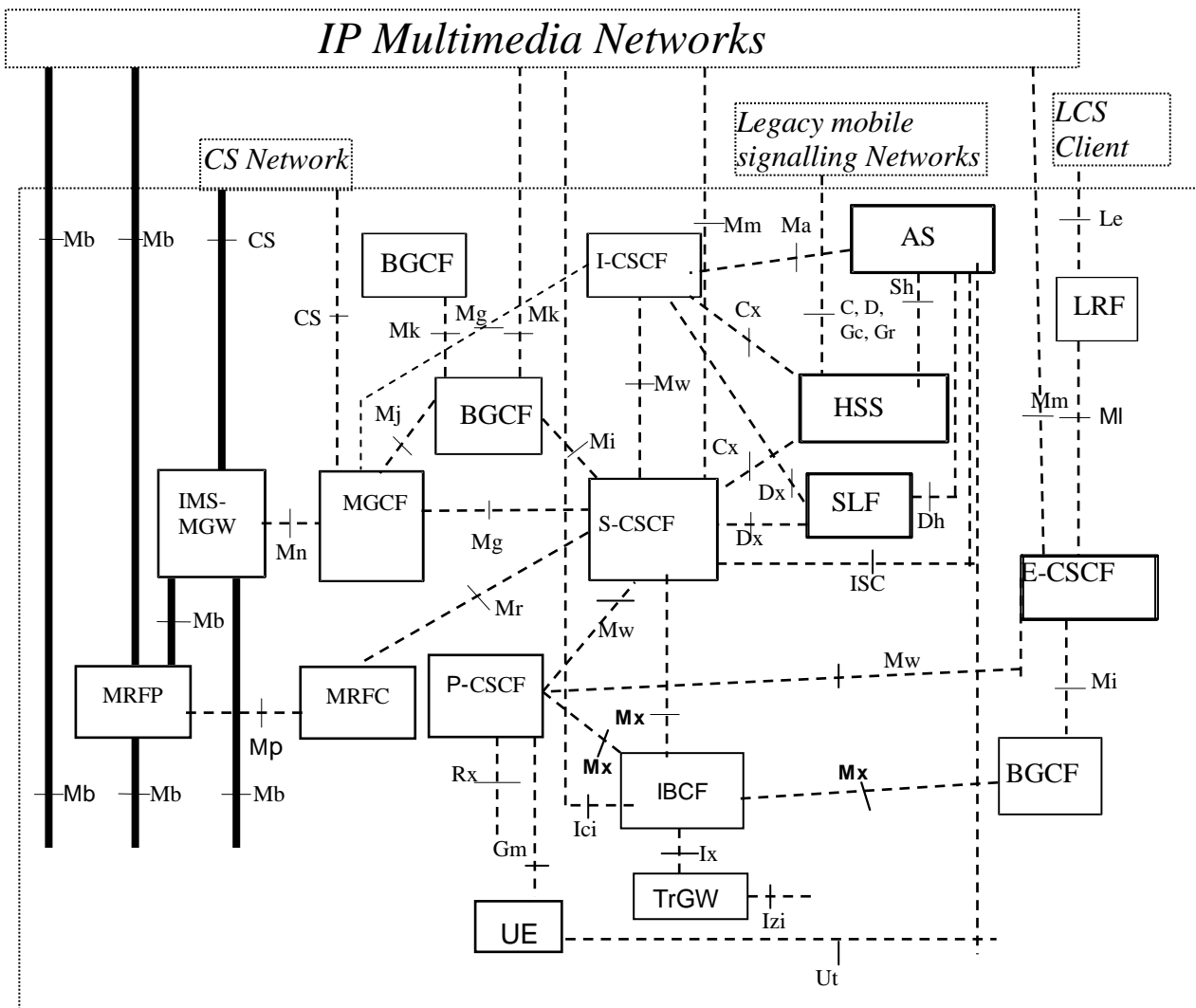

Figure 4.1.1: IMS logical architecture

4.2 IMS offline charging architecture

The architecture for IMS offline charging is described in the following figure 4.2.1. The Rf interface is described in clause 6.1.1 and Bi in clause 6.1.2.

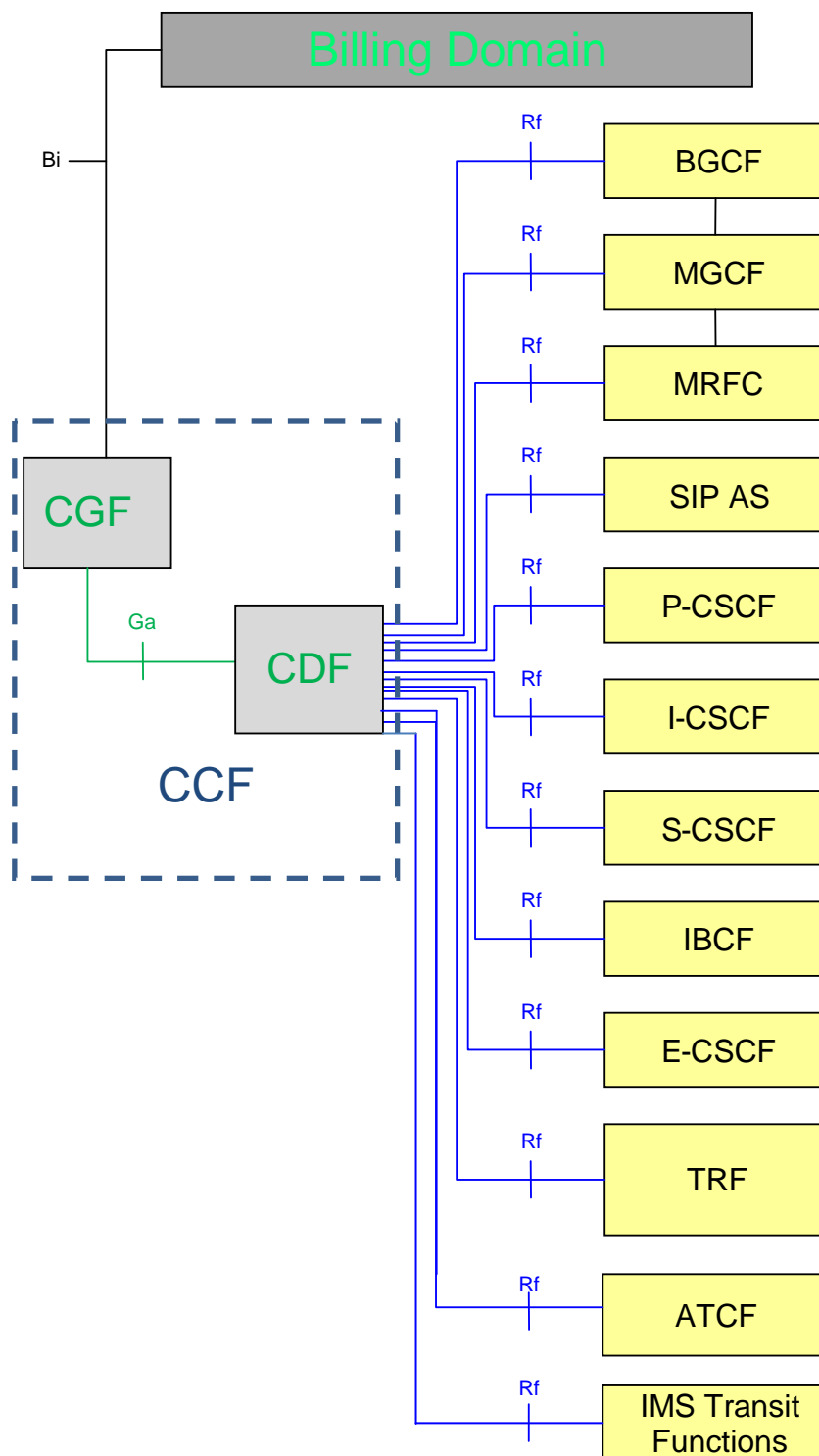

Figure 4.2.1: IMS offline charging architecture

4.3 IMS online charging architecture

The architecture for IMS online charging is described in the following figure 4.3.1. The Ro interface is described in clause 6.2 and ISC in TS 23.228 [201].

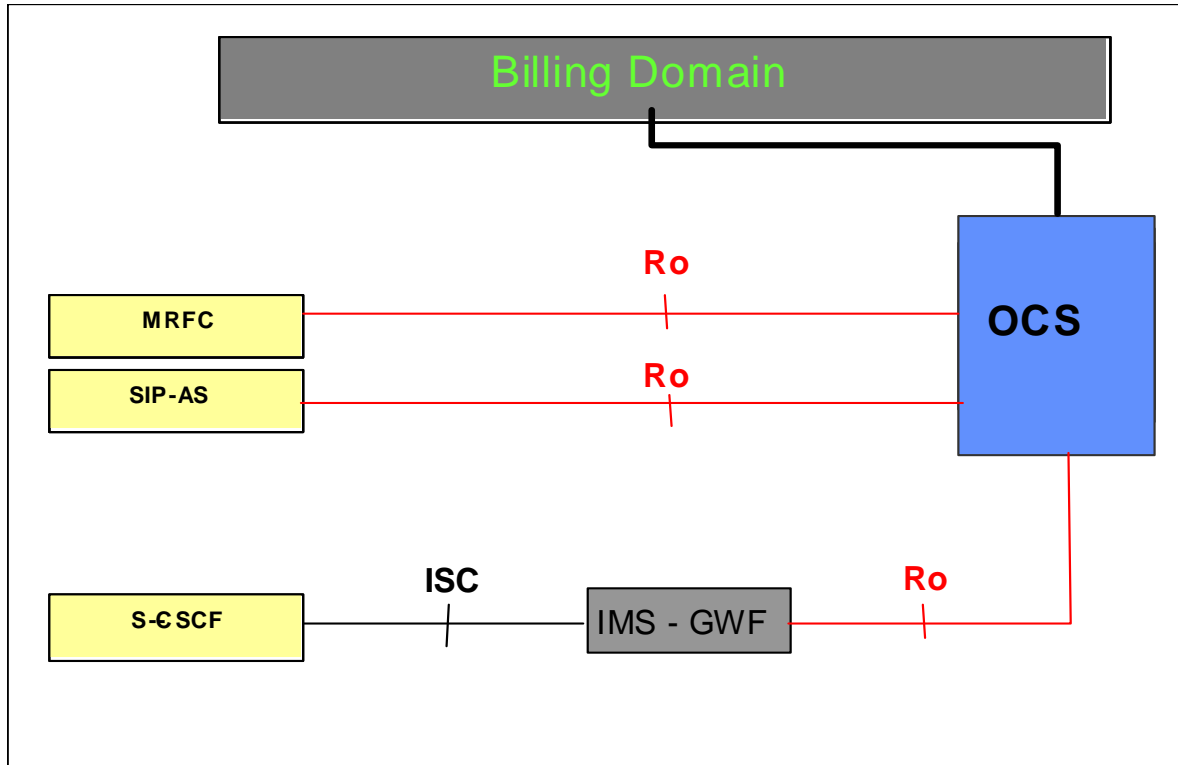

Figure 4.3.1: IMS online charging architecture

5 Charging principles

5.1 IMS charging principles

5.1.0 Introduction

The IMS Network Elements shall maintain the integrity of all received or created charging-related information when forwarding the information to the offline and online charging systems, whatever the length of the value of any particular parameter is. For example, the IMS Charging Identifier (ICID) may be generated by one IMS Network Element (e.g. the P-CSCF) and forwarded to another IMS Network Element (e.g. the S-CSCF). Both may generate charging information and ensure that the data integrity is maintained, in order to make possible correlation based on the ICID.

5.1.1 IMS charging applicability

The AS and MRFC are able to distinguish whether to apply offline or online charging, i.e. whether to send charging information over the Rf interface to the CDF or over the Ro interface to the OCS, which includes ECF and SCF as described in clause 4.3 (or to use both). The decision of which interface to use is based on the information (CDF and/or OCS address) the AS/MRFC receives in the SIP signalling and the system configuration as provisioned by the operator. If the AS/MRFC only receive the CDF address and do not receive an OCS address then they use only the Rf interface. If only the OCS address was provided then they use only the Ro interface. In cases where both CDF and OCS addresses are provided it is possible to use both interfaces simultaneously.

However, operators may overrule the addresses received via the SIP signalling and use their own configured rules instead. Operators may configure locally on the AS/MRFC an OCS and/or CDF address. The choice of whether the IMS Network Elements use locally configured addresses or the addresses received by SIP signalling, and the decision on which interface(s) to use, is left for operator configuration.

All other IMS Network Elements (S-CSCF, P-CSCF, I-CSCF, BGCF, IBCF, and MGCF) apply offline charging via the Rf interface using the CDF address as received via SIP signalling or the locally configured CDF address in the IMS Network Element. The S-CSCF supports online charging using:

the ISC interface, i.e. if the Application Server addressed over ISC is the IMS Gateway Function, or

the Ro interface directly instead of the ISC, if the IMS Gateway Function is integrated within the S-CSCF.

The offline and online charging function addresses transferred in SIP signalling are encoded in the P-Charging-Function-Addresses as defined in TS 24.229 [204] and RFC 7315 [406]. The P-Charging-Function-Addresses header contains the following parameters: CCF (i.e. CDF) and ECF (i.e. OCS).

5.1.2 IMS charging correlation

5.1.2.1 Basic principles for IMS domain correlation

The IMS charging correlation information is encoded in the SIP P-Charging-Vector header as defined in the following sub clauses. The P-Charging-Vector header contains the following parameters: ICID, access network charging identifier and IOI.

The loopback-indication parameter identify when loopback apply.

General correlation mechanisms are defined in TS 32.240 [1], and further details about the usage of P-Charging-Vector are defined in TS 24.229 [204], TS 24.292 [210], and IETF RFC 7315 [406].

The enhanced MSC server for ICS charging in this specification refers the MSC server which performs IMS registration, as defined in TS 23.292 [219]. The enhanced MSC server for SRVCC charging in this specification refers the MSC server defined in TS 24.237 [217].

5.1.2.2 IMS Charging Identifier

The IMS domain correlation is based on IMS Charging Identifier (ICID) shared between IMS Network Elements involved with the same session/transaction. With ICID it is possible to correlate session/transaction related charging data generated in different IMS elements (i.e. x-CSCFs, ASs'). The ICID is included in all SIP methods, if the P-Charging-Vector header is present, and transferred through originating and terminating side nodes, except to UE.

The value of the ICID parameter is identical with the 'icid-value' parameter defined in TS 24.229 [204]. The 'icid-value' is a mandatory part of the P-Charging-Vector and coded as a text-based UTF-8 charset (as are all SIP messages). For further information regarding the composition and usage of the P-Charging-Vector refer to [204] and RFC 7315 [406].

The ICID value is globally unique across all 3GPP IMS networks for a time period of at least one month, implying that neither the node that generated this ICID nor any other IMS Network Element reuse this value before the uniqueness period expires. The one month minimum uniqueness period counts from the time of release of the ICID, i.e. the ICID value no longer being used. This can be achieved by using node specific information, e.g. high-granularity time information and / or topology / location information. The exact method how to achieve the uniqueness requirement is an implementation issue.

At each SIP session unrelated method, both initial and subsequent (e.g. SIP REGISTER, SIP NOTIFY, SIP MESSAGE etc.), a new, session unrelated ICID is generated at the first IMS Network Element that processes the method. This ICID value is contained in the SIP request and SIP response of that SIP transaction and must be valid for the duration of the transaction.

At each SIP session establishment a new, session specific ICID is generated at the first IMS Network Element that processes the session-initiating SIP INVITE message. Enhanced MSC server will generate an ICID for ICS and SRVCC originated calls as described in TS 24.229 [204]. This ICID is then used in all subsequent SIP messages for that session (e.g., SIP 200 OK, SIP (RE-)INVITE, SIP BYE etc.) until the session is terminated.

5.1.2.2A Related ICID

During the process of SRVCC access transfer, the Enhanced MSC server or the P-CSCF generates an ICID for the target access leg. For the purpose of charging correlation between the source access leg and the target access leg when the user is roaming the SCC AS and the ATCF includes the ICID used on the source access leg as the Related ICID for the target access leg as described in TS 24.229 [204]. Alternatively, when OneChargingSession is applied in the SCC AS and the ATCF, the ICID of the original access leg is preserved in the AS/ATCF CDR for the whole duration of the session, and the Related ICID contains the ICID used on the target access leg.

This Related ICID is sent in the 1xx and 2xx responses to the initial SIP INVITE as described in TS 24.237 [217].

5.1.2.3 Access network charging identifier

The access network charging identifier is the media flow level data shared among the IMS Network Elements for one side of the session (either the originating or terminating side). This information is used to correlate the access network charging data with the IMS charging data.

The access network is identified by bearer specific correlation identifier, e.g. for Packet Switched Access (GGSN address and PDP context Identifier) or Fixed Broadband Access (Multimedia Charging Identifier). The access network charging identifier is populated in the P-Charging-Vector using the access-network-charging-info parameter. For further information regarding the composition and usage of the access-network-charging-info parameter refer to TS 24.229[204] and RFC 7315 [406].

5.1.2.4 Inter Operator Identifier

The Inter Operator Identifier (IOI) identifies originating, terminating and transit networks involved in a session/transaction. The IOI may be generated from each side of session/transaction to identify the home networks associated with each side. The Orig-IOI and Term-IOI parameters of P-Charging-Vector represent the originating and terminating operator identifiers.

For interconnection scenarios in multi operator environments where one or more transit operators are between the originating and terminating operator, a list of Transit-IOI values may occur additionally to identify involved transit operators. Due to operator policy, a transit operator may also hide his identity by adding a void value. Addition and deletion of Transit-IOI values are operator configurable. For further information regarding the composition and usage of the parameters refer to TS 24.229[204], TS 24.292 [210], and IETF RFC 7315 [406].

NOTE: No transit networks are expected between the S-CSCF and a 3rd party Application Server triggered by the initial filter criteria in the S-CSCF.

5.1.2.5 Void

5.1.2.6 IMS visited network identifier

The IMS visited network identifier identifies the visited network involved in a session/transaction. The IMS visited network identifier is available in the SIP P-Visited-Network-ID header of the SIP REGISTER, with the value according to 3GPP TS 24.229 [204], and should be used for all charging events associated with the user.- For the roaming architecture for voice over IMS with local breakout, the value of IMS visited network identifier is a pre-provisioned string that identifies the network of the P-CSCF at the home network.

- For the roaming architecture for voice over IMS with home routed traffic, IMS visited network identifier is a string that identifies the visited network of the UE including an indication that the P-CSCF is located in the home network.

5.1.2.7 Loopback-indication

During the loopback the TRF will set the Loopback-indication parameter to identify when loopback applies. When the TRF receives responses to initial or subsequent requests from the terminating side, the TRF inserts in the P-Charging-Vector header field, if present, the "loopback-indication" header field parameter to the outgoing response.

5.1.2.8 Functional Entity (FE) Identifier

The FE Identifier contains one or more:

- IM CN subsystem functional entity address, and/or
- AS address and the corresponding application identifier

As defined in TS 32.240 [1] clause 5.3.4.4.2 the functional entity address is included when the IM CN subsystem functional entity does create charging information for the related CDR of this IM CN subsystem functional entity. As defined in TS 32.240 [1] clause 5.3.4.4.3 for AS hosting several applications the same AS address can appear several times, each accompanied with a different application identifier based on the application executed by the AS.

Values in SIP requests shall be ignored. The FE-Identifier exchange via SIP signalling is defined in TS 24.229 [210].

5.1.3 SDP handling

SDP information on SIP can have two different meanings; SDP offer or SDP answer. This is captured in the charging information by a SDP-type parameter that indicates if the SDP Media Component is an SDP offer or SDP answer. SDP offers can be sent by either the calling or called party and the Media Initiator Flag identifies who sent the first SDP offer in a SDP negotiation. SDP can be negotiated more than once in an SIP INVITE or SIP RE-INVITE dialog.

Each occurrence of the List of SDP Media Components in the corresponding CDRs may include either SDP offer or SDP answer. For the first negotiation, the SDP answer defines which media are used in the session, therefore it shall be recorded in case of successful session setup. Additionally the corresponding SDP offer may be recorded. In case of unsuccessful session setup the SDP offer may be recorded, if available.

When session re-negotiations occur, multiple occurrences of List of SDP Media Components may be used to include a series of SDP negotiations in which each occurrence holds an SDP offer or SDP answer as for the first SDP negotiation.

5.1.4 Trigger conditions

This clause contains the details for trigger conditions listed in table 5.2.1.1 for offline charging messages (Charging Data Request and Charging Data Response) and table 5.3.1.1 for online charging messages (Debit / Reserve Units Request and Debit / Reserve Response) triggered by SIP methods or ISUP messages for all IMS nodes except for MRFC and AS.

The I-CSCF and BGCF, which need not be present in the signalling path for subsequent requests after the first SIP INVITE, do not support session based charging using Charging Data Request [Start, Interim, and Stop]. In these (and only in these) IMS Network Elements, successful session set-up completion triggers Charging Data Request [Event]. Use of session based charging when the I-CSCF or the BGCF is call stateful is not described in this release.

The initial registration, user-initiated re-registration, and user-initiated de-registration chargeable events relate to SIP REGISTER to trigger Charging Data Request[Event] / Debit / Reserve Units Requests, while network-initiated deregistration event relates to SIP NOTIFY to trigger Charging Data Request[Event] / Debit / Reserve Units Requests provided that subscription to registration events has been applied (see TS 24.229 [204]).

If at the time when the SIP 200 OK is received only the SDP offer is available, the CTF may trigger Charging Data Request[Start] immediately (subsequent SIP ACK containing the SDP answer triggers Charging Data Request[Interim]) or may trigger Charging Data Request[Start] once the SIP ACK has been received. The precise behaviour shall depend on operator policy.

If capturing the last user location information and/or UE Time Zone of one specific party (originating or terminating) at session release is required by operator (e.g. for legal purpose), and such information is not available at the time the SIP BYE is received, the CTF shall delay the Charging Data Request[Stop] until the reception of SIP 200 OK acknowledging the SIP BYE. Otherwise, the CTF shall trigger Charging Data Request[Stop] once the SIP BYE request has been received.

If capturing the last user location information and/or UE Time Zone of one specific party (originating or terminating) at session release is required by operator (e.g. for legal purpose), and such information is not available at the time the SIP BYE is received, the CTF shall delay the Debit / Reserve Units Request [Terminate] until the reception of SIP 200 OK acknowledging the SIP BYE. Otherwise, the CTF shall trigger Debit / Reserve Units Request [Terminate] once the SIP BYE request has been received. In any case, the granted quota shall not be used once the SIP BYE is received.

5.1.5 IMS support of real-time tariff transfer

The TS 29.658 [206] describes the Real-time Transfer of Tariff Information (RTTI) in SIP. The RTTI may be supported for the requested service (e.g. tariff information of a value added service residing in the called network or in a specific AS).

According to the procedures described in the TS 29.658 [206], tariff information may be included in the content body of the following SIP messages: 1xx provisional response or SIP 200 OK at session setup, mid-dialog requests or responses. The following IMS Network Elements, IBCF, MGCF, S-CSCF and AS may pass tariff information and record the tariff information in the corresponding CDRs for IMS offline charging. For online charging, the AS and the IMS-GWF may send charging information related to the content body of RTTI message over Ro interface to the OCS.

The following security mechanisms shall be used for RTTI:

- IBCF shall accept RTTI information only from trusted IMS networks and filter out RTTI information from non trusted IMS networks.
- If RTTI information has to be sent over unsecure domain networks, the security of the domains interconnection shall rely on Network Domain Security specifications: TS 33.210 [208] and TS 33.310 [209].
- The S-CSCF responsible for the handling of RTTI messages shall follow the common IMS security specification TS 33.203 [207] to protect against malicious UE that try to bypass the P-CSCF.

5.1.6 Served user identification

Subscriber Identifier is an Information Element used in both online and offline charging information to identify the served user for the specific leg of an IMS session. A list of Subscription Id(s) for IMS CDR shall contain the Public user Id(s) for the served user.

In the case when the served user is obtained from the P-Header P-Served-User (can be available in P-CSCF, S-CSCF and AS) then it shall also be used as Subscription-Id in both online and offline charging.

The Subscriber Equipment Number field contains the identification of the mobile device (e.g. IMEI) that the subscriber is using.

An Instance Id is defined as a URN generated by the device that uniquely identifies a specific device amongst all other devices (fixed or mobile). The Instance Id is transported in the sip.instance feature tag in the Contact header of a SIP request associated with the served user.

5.1.7 Single charging session from AS/ATCF acting as B2BUA

When a session-initiating SIP INVITE message is received by an AS/ATCF, this AS/ATCF, per application logic needs, acting as a B2BUA, may decide ICID for the outgoing dialog to be the same as received or different.

In case the same ICID is preserved between incoming and outgoing dialog by the AS/ATCF acting as a B2BUA, a single charging session for both dialogs can be created by this AS/ATCF. This option, referred-to as "OneChargingSession" in the different descriptions, is applicable per Operator configuration.

5.1.8 Charging support for roaming architecture for voice over IMS with local breakout

The roaming architecture for voice over IMS with local breakout is described in the TS 23.228 [201]. The corresponding Charging principles are defined in the TS 32.240 [1]. In the present document, charging support for the Transit and Roaming Function (TRF) requisite for roaming architecture for voice over IMS with local breakout is rendered by presuming collocation or standalone.

Figure 5.1.8.1 shows an example for possible signalling and media flows in a roaming architecture for voice over IMS with local breakout.

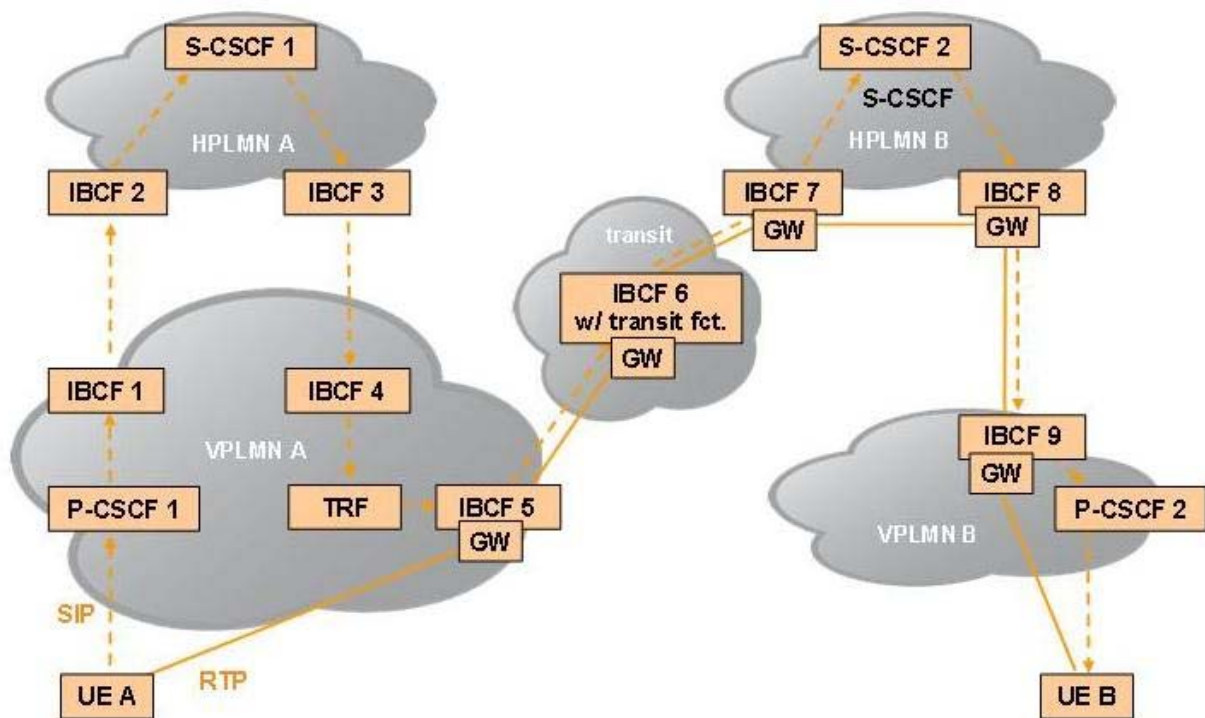

Figure 5.1.8.1: Signalling and media flows in a roaming architecture for voice over IMS with vocal breakout (example)

5.1.8A Charging support for roaming architecture for voice over IMS with home routed traffic

The charging principle of roaming architecture for voice over IMS with home routed traffic is described in TS 32.240 [1].

In LBO roaming model where P-CSCF is located in VPLMN, the home network determines the serving PLMN of the UE from the location of the P-CSCF during initial IMS Registration, using the P-CSCF network identifier.

In deployments without IMS-level roaming interfaces where P-CSCF is located in HPLMN, the home network determines the serving PLMN of the UE using procedure defined in TS 23.228 [201], where P-CSCF requests the PCRF to report the PLMN identifier where the UE is currently located. The received PLMN ID information is then forwarded in the SIP REGISTER request. Figure 5.1.8A.1 shows an example for possible signalling and media flows in a Roaming Architecture for Voice over IMS with home routed traffic.

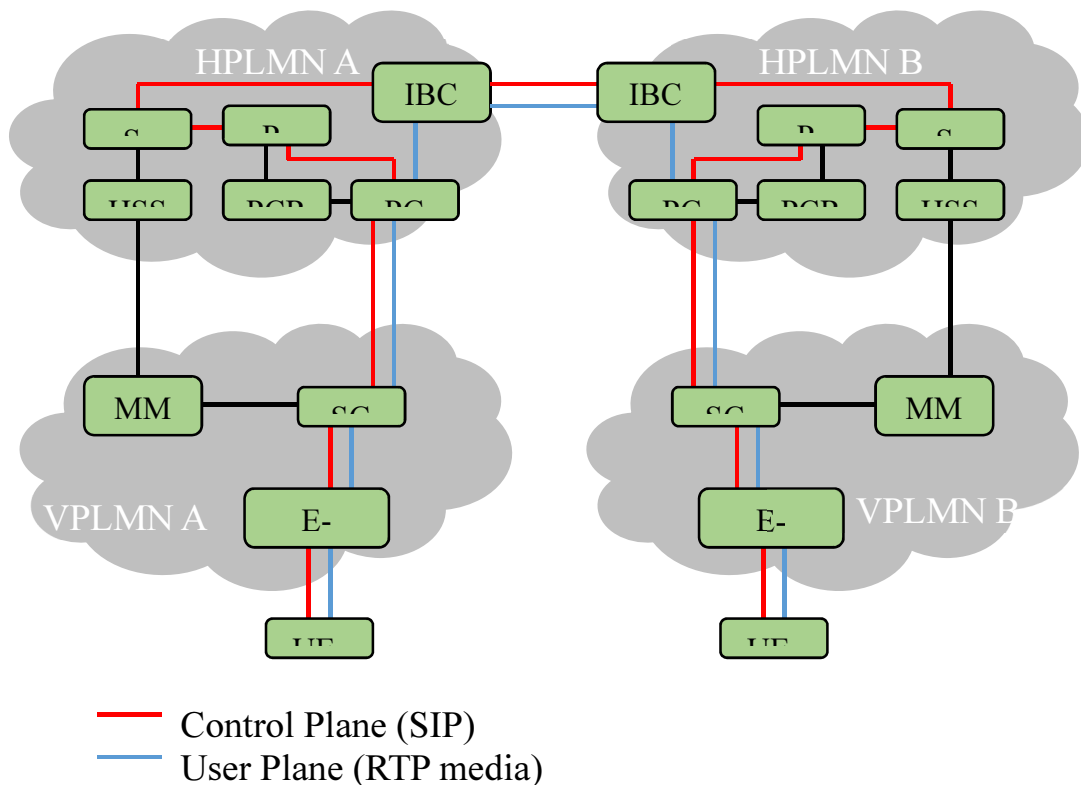

Figure 5.1.8A.1: Signalling and media flows in a Roaming Architecture for Voice over IMS with home routed traffic (Example)

5.1.9 Charging support for Network provided Location information

The Network provided Location information (NetLoc) is described in the TS 23.228 [201] and for emergency service request using PCC-based solutions for the UE location in mobile networks in TS 23.167 [212].

In some scenarios, an AS can also detect emergency service and obtain the UE location using HSS-based solutions in TS 23.167 [212].

Based on operator policies and the availability of the user location information and/or UE Time Zone from the access network, the solution ensures that relevant SIP messages contain the correct or up to date information about the user location information, and/or UE Time Zone provided by the access network and currently used by the UE.

For the 3GPP access networks, the P-CSCF can retrieve user location information and/or UE Time Zone related to the access network currently used by the UE using PCC mechanisms, as specified in TS 23.203 [213] and TS 29.214 [214]. In some scenarios, an AS can also obtain location information using HSS-based solutions in TS 29.328 [215].

For fixed networks, the P-CSCF is aware of the network provided location information through signalling with the NASS.

As specified in TS 24.229 [204], clause 7.2A.4.3, the network provided location information is transported in the SIP P-Access-Network-Info header with an "np" parameter and indicates details of where the UE is currently located (i.e. SAI, TAI, RAI, CGI, ECGI or access-specific user location information) as defined in TS 23.228 [214].

In the defined CDRs, the network provided location information available when the CDR is opened, for 3GPP accesses is directly available in the User Location Info field and also available in the Access Network Information or Additional Access Network Information fields. For non-3GPP accesses, the network provided location information available when the CDR is opened, shall be available in either the Access Network Information or Additional Access Network Information fields

NOTE 1: In a node that receives two PANI headers, in Rel-11, the operator determined which PANI header (i.e., network-provided or UE-provided) would be included in the Access Network Information field. For backward compatibility, for an operator that deployed the Rel-11 capability the other PANI header should be included in the Additional Access Network Information field.

NOTE 2: In a node that receives two PANI headers for an operator first deploying this capability in Rel-12, it is recommended that the network-provided PANI header be included in the Access Network Information field and a UE-provided PANI header be included in the Additional Access Network Information field.

In case terminating VoLTE UE attached to an MSC Server not enhanced for ICS, AS is able to retrieve CS location information (i.e. VLR Number and MSC Address) via Sh interface from HSS in TS 29.328 [215] which can be recorded in AS CDR.

5.1.9A Charging support for IMS transit scenarios

The IMS transit network scenarios are described in the TS 23.228 [201] and may require additional functionalities provided by the IMS Transit Functions (TF). When residing in a stand-alone entity, the IMS TF may apply offline charging. Applicable fields for the IMS TF are in table 6.3.2.1.

5.1.10 Charging support for TRF

In order to support traffic for the Roaming Architecture for Voice over IMS with Local Breakout, IMS TF are enhanced with additional routing functionality, both combined in a Transit and Roaming Function (TRF and defined in TS 23.228 [201]). Depending on the transit operator configuration, these functions might reside in a stand-alone entity or be collocated with an existing IMS Network Element.

When residing in a stand-alone entity, the TRF may apply offline charging.

When collocated with an existing IMS Network Element, charging information for the TRF is combined with charging information of the corresponding IMS Network Element. Applicable fields are in table 6.3.2.1.

5.1.11 Charging support for IMS service continuity

The charging requirements for IMS service continuity using AS and ATCF are specified in TS 23.237 [216].

Inter-UE transfer provides the capability of transferring the communication sessions with multiple media across different UEs and is part of Service Continuity (SC) as described in TS 23.237 [216]. For inter-UE transfer shall an AS implement the role of an SCC AS according to TS 24.337 [218].

A complete session can be transferred from one UE to another with or without establishing a collaborative session as defined in TS 23.237 [216] and TS 24.337 [218]. The SCC AS is able to serve an inter-UE transfer request initiated by the target UE without the establishment of a collaborative session regardless of the access technology used by either of the involved UEs.

For a consistent representation of the various access transfers specified in TS 23.237 [216] and TS 24.337 [218] in offline and online charging of the AS and in offline charging of the ATCF the Access Transfer Type parameter provides information on the used access technologies, e.g. PS to CS, CS to PS, PS to PS or CS to CS. The Inter-UE Transfer parameter indicates whether the access transfer was done between two UEs provided by the SCC AS as defined in TS 24.337 [218]. These parameters together, show the type of access transfer in detail, and are reported together with UE identification (i.e. Subscriber Equipment Number and/or Instance Id), Access Network Information and potentially Additional Access Network Information and Cellular Network Information available along the session transfer procedure.

Subsequently, the Requested Party Address parameter holds addresses related to session transfer if available: For SIP transactions, the address of the party (Public User ID or Public Service ID) to whom the SIP transaction was originally posted. For PS to CS transfer, the Session Transfer Number for Single Radio Voice Call Continuity (STN-SR) as described in TS 23.237 [216]. For CS to PS transfer, the Session Transfer Identifier for CS to PS Single Radio Voice Call Continuity (STI-SR) as described in TS 23.237 [216].

5.1.12 IMS support of OCS-provided announcements

During an IMS online charging session, the OCS may utilize the Announcement service specified in TS 32.281 [41] to request the IMS-GWF or AS to render video or audio announcements to a subscriber involved in an IMS session.

5.1.13 Charging support of UE location(s) and TimeZone(s)

As specified in TS 24.229 [204], clause 7.2A.4.3, and in RFC 7315 [406], details of the UE location and Timezone are transported in the SIP P-Access-Network-Info header, which is conveyed in SIP signalling through IMS Nodes. Consequently UE location and TimeZone changes are addressed under SIP P-Access-Network-Info header changes.

The SIP P-Access-Network-Info header includes either UE-provided location, either Network-Provided location, both are subject to change independently during an IMS session. Any available UE-provided and Network-Provided locations are received by IMS Nodes in every SIP requests and responses, and transported in two P-Access-Network-Info headers when both are available. The charging support for Network-Provided location is described in clause 5.1.9.

As specified in TS 24.229 [204], clause 7.2.15.3, when a User Agent (UA) supporting one or more cellular radio access technology (e.g. E-UTRAN) is using a non-cellular IP-CAN to access the IM CN subsystem, details of the radio cell identity of the cellular radio access network on which the UE most recently camped are transported in the SIP Cellular-Network-Info header, which is conveyed in SIP signalling through IMS Nodes.

When Charging Data Request [Start/ Interim/Stop] are triggered for SIP session-related procedures, based on principles described in clause 5.2.1, any available SIP P-Access-Network-Info and SIP Cellular-Network-Info header(s) shall be reported to the CDF, using Access Network Information, Additional Access Network Information and Cellular Network Information IEs. The received IEs shall be included by the CDF:

- in Access Network Information, Additional Access Network Information and Cellular Network Information fields of IMS CDRs, upon Charging Data Request [Start] from IMS Nodes.
- in the List of Access Network Info Change field of IMS CDRs, upon reception of Charging Data Request [Interim, Stop] from IMS Nodes, only for SIP P-Access-Network-Info and SIP Cellular-Network-Info header(s) identified as changed.

When Debit / Reserve Units Request [Initial/ Update/Terminate] are triggered for SIP session-related procedures, based on principles described in clause 5.3.1, any available SIP P-Access-Network-Info and SIP Cellular-Network-Info header(s) shall be reported, using Access Network Information, Additional Access Network Information and Cellular Network Information IEs.

As specified in clause 5.1.11, during IMS service continuity transfer procedure, the Access Network Information, Additional Access Network Information and Cellular Network Information shall be provided by the AS and ATCF together with transfer parameters, using Access Transfer Information IE, in offline and online charging.

5.2 IMS offline charging principles

5.2.1 Basic principles

The offline charging functionality is based on the IMS network nodes reporting accounting information upon reception of various SIP methods or ISUP messages, as most of the accounting relevant information is contained in these messages. This reporting is achieved by sending Charging Data Request [Start, Interim, Stop and Event] from the IMS Network Elements to the CDF.

The charging client uses Charging Data Request[Start, Interim and Stop] in procedures related to successful SIP sessions. It uses Charging Data Request[Event]s for unsuccessful SIP sessions and for session unrelated procedures. Further details are specified in the tables below and in clause 5.2.2.

It is operator configurable in the nodes for which SIP method or ISUP messages an Charging Data Request is sent. Table 5.2.1.1 describes all possible Charging Data Requests that might be sent from a P-CSCF, I-CSCF, S-CSCF, IBCF, MGCF or BGCF. A list of node specific Charging Data Requests, along with the AVPs to be included are detailed in TS 32.299 [50].

The Charging Data Requests to be sent from a MRFC are described in table 5.2.1.2.

It is configurable for the operators to enable or disable the generation of an Charging Data Request message by the IMS node in response to a particular "Triggering SIP Method /ISUP Message".

Table 5.2.1.1: Charging Data Request messages triggered by SIP methods or ISUP messages for all IMS nodes except for MRFC and AS

Message	Triggering SIP method /ISUP message
Charging Data Request [Start]	SIP 2xx acknowledging an initial SIP INVITE
	SIP ACK acknowledging an initial SIP INVITE
	ISUP:ANM (applicable for the MGCF)
Charging Data Request [Interim]	SIP 2xx acknowledging a SIP RE-INVITE or SIP UPDATE [e.g. change in media components, terminating identity change]
	SIP ACK acknowledging an initial SIP INVITE or a SIP RE-INVITE
	Expiration of Interim Interval
	SIP 1xx provisional response, mid-dialog requests, mid-dialog responses and SIP INFO embedding RTTI XML body (applicable for the S-CSCF and IBCF).
	ISUP charging ASE (applicable for the MGCF).
Charging Data Request [Stop]	SIP response (4xx, 5xx or 6xx), indicating an unsuccessful SIP RE-INVITE or SIP UPDATE
	SIP BYE message (both normal and abnormal session termination cases)
	SIP 2xx acknowledging a SIP BYE message (only when last user location information of originating/terminating party is required by operator for legal purpose)
Charging Data Request [Event]	ISUP:REL (applicable for the MGCF)
	SIP 2xx acknowledging non-session related SIP messages, which are:
	SIP NOTIFY
	SIP MESSAGE
	SIP REGISTER
	SIP SUBSCRIBE
	SIP PUBLISH
	SIP REFER
	SIP 2xx acknowledging an initial SIP INVITE (BGCF and I-CSCF only)
	SIP Final/Redirection Response 3xx
	SIP Final Response (4xx, 5xx or 6xx), indicating an unsuccessful SIP session set-up
SIP Final Response (4xx, 5xx or 6xx), indicating an unsuccessful session-unrelated procedure	
SIP CANCEL, indicating abortion of a SIP session set-up	

Table 5.2.1.2: Charging Data Request messages triggered by SIP methods for the MRFC

Message	Triggering SIP method
Charging Data Request [Start]	SIP 2xx acknowledging an SIP INVITE for initiating a multimedia ad hoc conferencing session
Charging Data Request [Interim]	SIP ACK acknowledging a SIP INVITE to connect an UE to the conferencing session
	SIP RE-INVITE (see Note 1)
	SIP BYE (see Note 2)
Charging Data Request [Stop]	Expiration of Interim Interval
	SIP BYE message (see Note 3)
	SIP CANCEL (see Note 3)
	SIP Final Response with error codes 4xx, 5xx or 6xx indicating termination of an ongoing session (see Note 3)
NOTE 1: This trigger only applies to a user joining an ongoing conferencing session	
NOTE 2: This trigger only applies to a user leaving an ongoing conferencing session	
NOTE 3: This trigger only applies if this causes the ongoing conferencing session to terminate	

5.2.2 Message flows and types

5.2.2.0 Introduction

The flows described in the present document specify the charging communications between IMS entities and the charging functions for different charging scenarios. The SIP messages and Charging Data transactions associated with these charging scenarios are shown primarily for general information and to illustrate the charging triggers. They are not intended to be exhaustive of all the SIP message flows discussed in TS 24.228 [200] and they depend on the Charging Data Requests triggers configured by the operator.

5.2.2.1 Message flows - successful cases and scenarios

5.2.2.1.1 Session establishment - mobile origination

Figure 5.2.2.1.1.1 to figure 5.2.2.1.1.3 show the Charging Data transactions that are required between CSCF and CDF during session establishment originated by a UE.

Figures 5.2.2.1.1.1-5.2.2.1.1.3 below are illustrated in LBO roaming model where P-CSCF and CDF are located in VPLMN. The same figures are applicable for deployment of voice over IMS with home routed traffic, where P-CSCF is located in HPLMN, with the exception that the HPLMN CDF is used.

Scenario 1: Successful session establishment

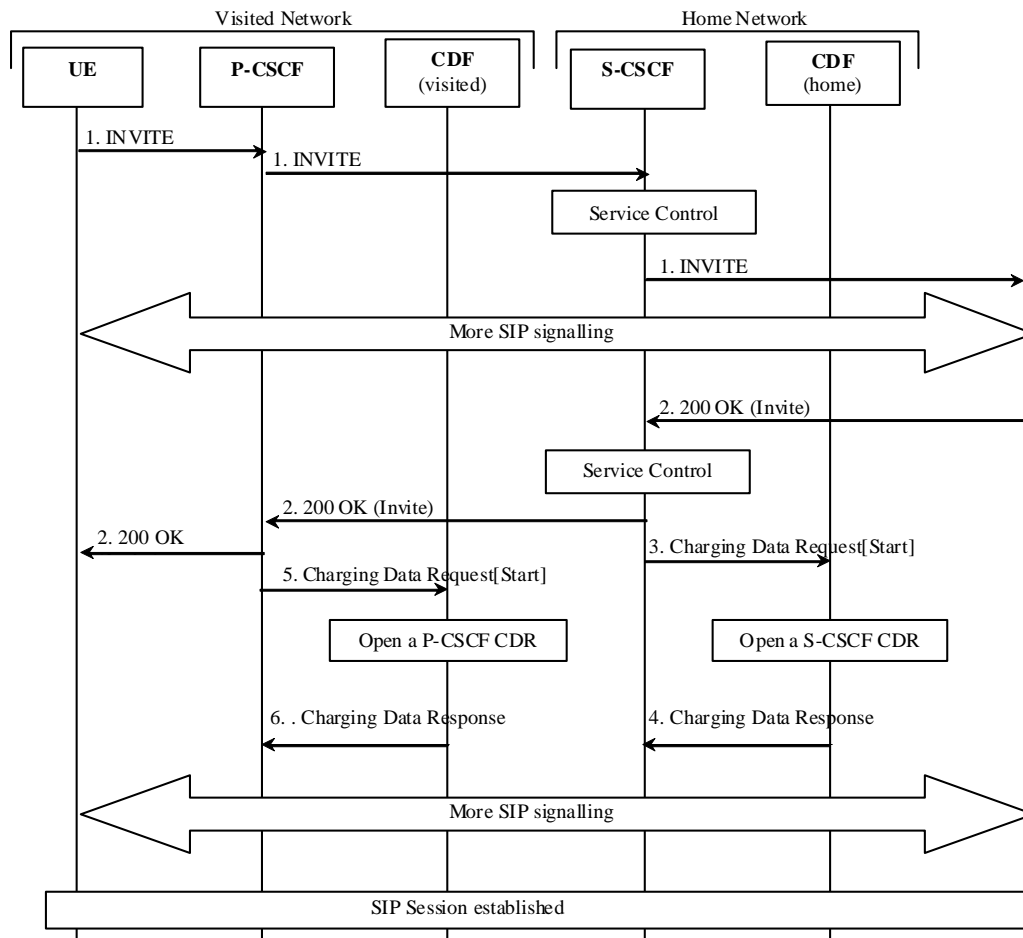

Figure 5.2.2.1.1.1: Message sequence chart for session establishment (mobile origination)

1. The session is initiated.
2. The destination party answers and a final response are received.
3. Upon reception of the final response, the S-CSCF sends an Charging Data Request[Start] to record start of a user session and start of a media component in the S-CSCF CDR.
4. The CDF acknowledges the reception of the data and opens an S-CSCF CDR.
5. Same as 3, but for P-CSCF.
6. Same as 4, but creating a P-CSCF CDR.

Scenario 2: Successful session establishment with late SDP answer (SIP 200 OK triggering Charging Data Request)

Figure 5.2.2.1.1.2 shows the Charging Data transactions that are required between CSCF and CDF during session establishment originated by a UE.

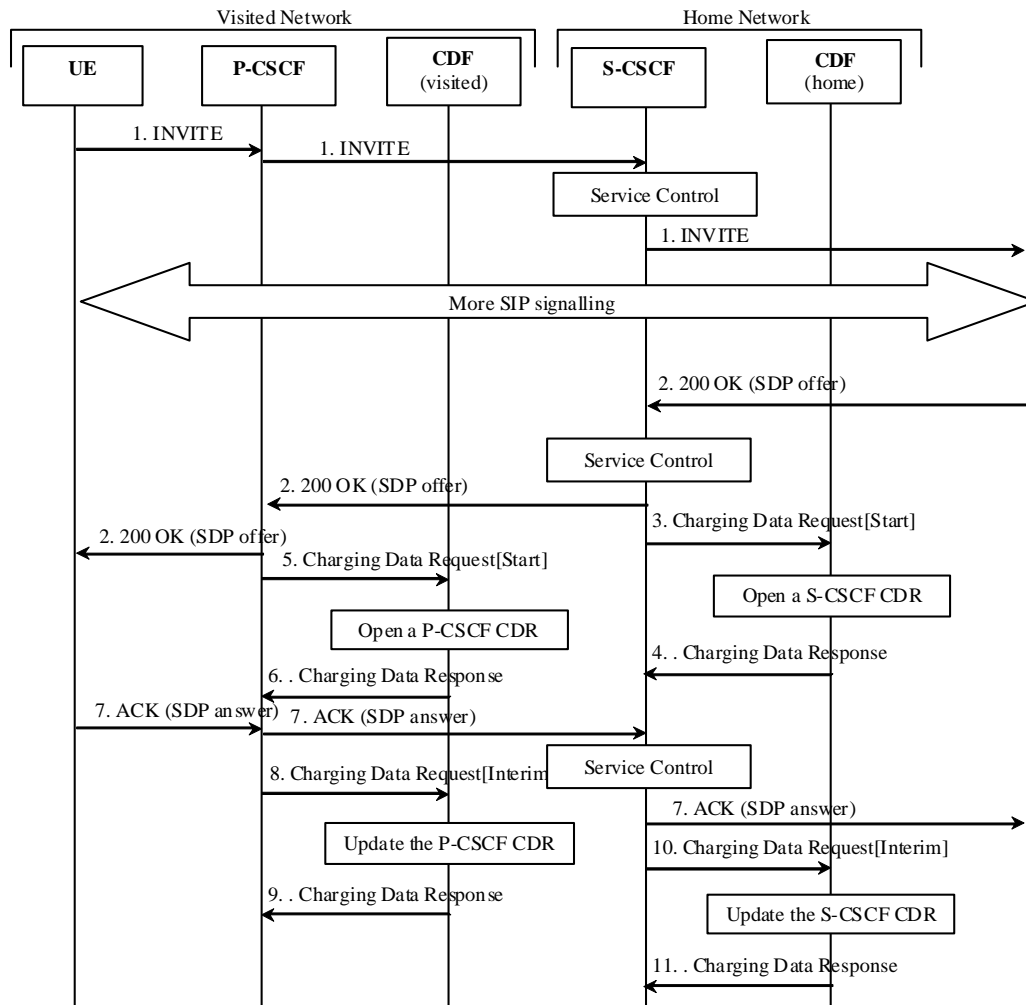

Figure 5.2.2.1.1.2: Message sequence chart for session establishment (SIP 200 OK triggering Charging Data Request) - mobile origination

1. The session is initiated.
2. The destination party answers and a response are received.
3. Upon reception of the SIP 200 OK, the S-CSCF sends an Charging Data Request[Start] to record start of a user session and start of a media component in the S-CSCF CDR.
4. The CDF acknowledges the reception of the data and opens an S-CSCF CDR.
5. Same as 3, but for P-CSCF.
6. Same as 4, but creating a P-CSCF CDR.
7. - 11. These steps are identical to steps 3. -7. of scenario 2 described in clause 5.2.2.1.3.

Scenario 3: Successful session establishment with late SDP answer (SIP ACK triggering Charging Data Request)

Figure 5.2.2.1.1.3 shows the Charging Data transactions that are required between CSCF and CDF during session establishment originated by a UE.

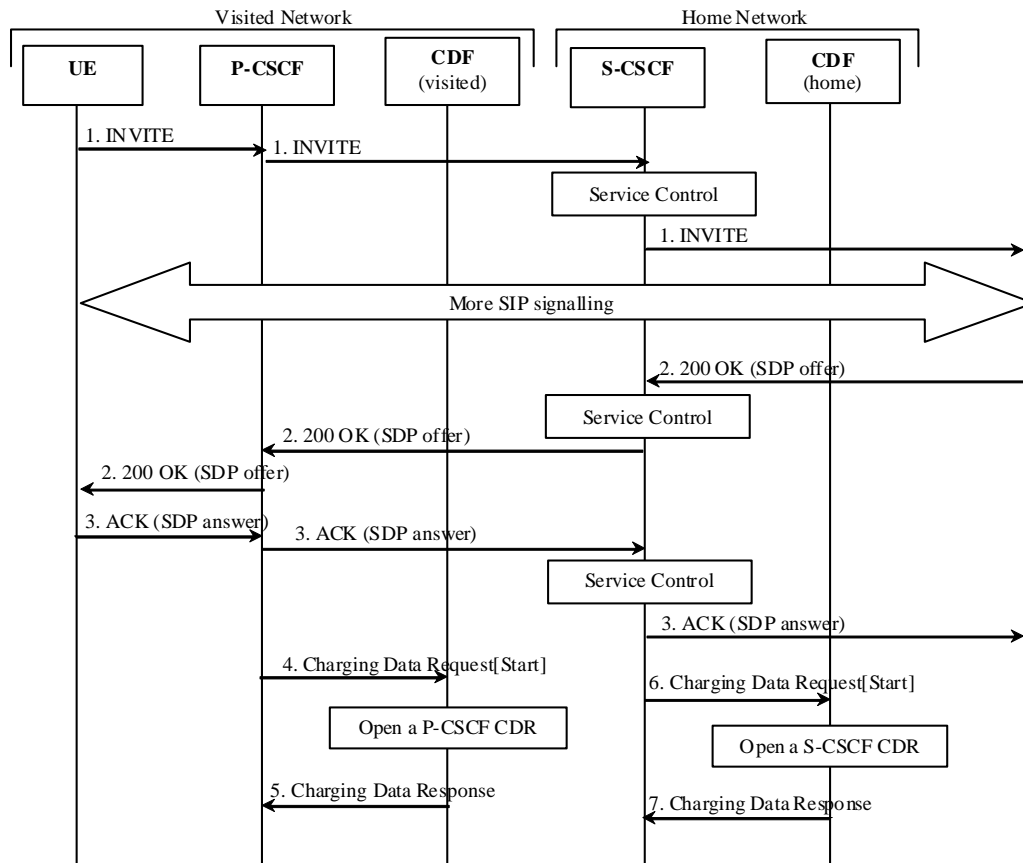

Figure 5.2.2.1.1.3: Message sequence chart for session establishment (SIP ACK triggering Charging Data Request) - mobile origination

1. The session is initiated.
2. The destination party answers and a final response are received. If the final response includes a SDP offer only, then the CSCF shall wait for the SIP ACK.
3. The SIP ACK including the SDP answer is received.
4. Upon reception of the SIP ACK, the P-CSCF sends an Charging Data Request[Start] to record start of a user session and start of a media component in the P-CSCF CDR.
5. The CDF acknowledges the reception of the data and opens an P-CSCF CDR.
6. Same as 4, but for S-CSCF.
7. Same as 5, but creating a S-CSCF CDR.

5.2.2.1.2 Session establishment - mobile termination

Figure 5.2.2.1.2.1 shows the Charging Data transactions that are required between CSCF and CDF during a session establishment that is terminated to a mobile. The I-CSCF is only involved in the SIP INVITE transaction.

Figure 5.2.2.1.2.1 below is illustrated in LBO roaming model where P-CSCF and CDF are located in VPLMN. The same figure is applicable for deployment of voice over IMS with home routed traffic, where P-CSCF is located in HPLMN, with the exception that the HPLMN CDF is used.

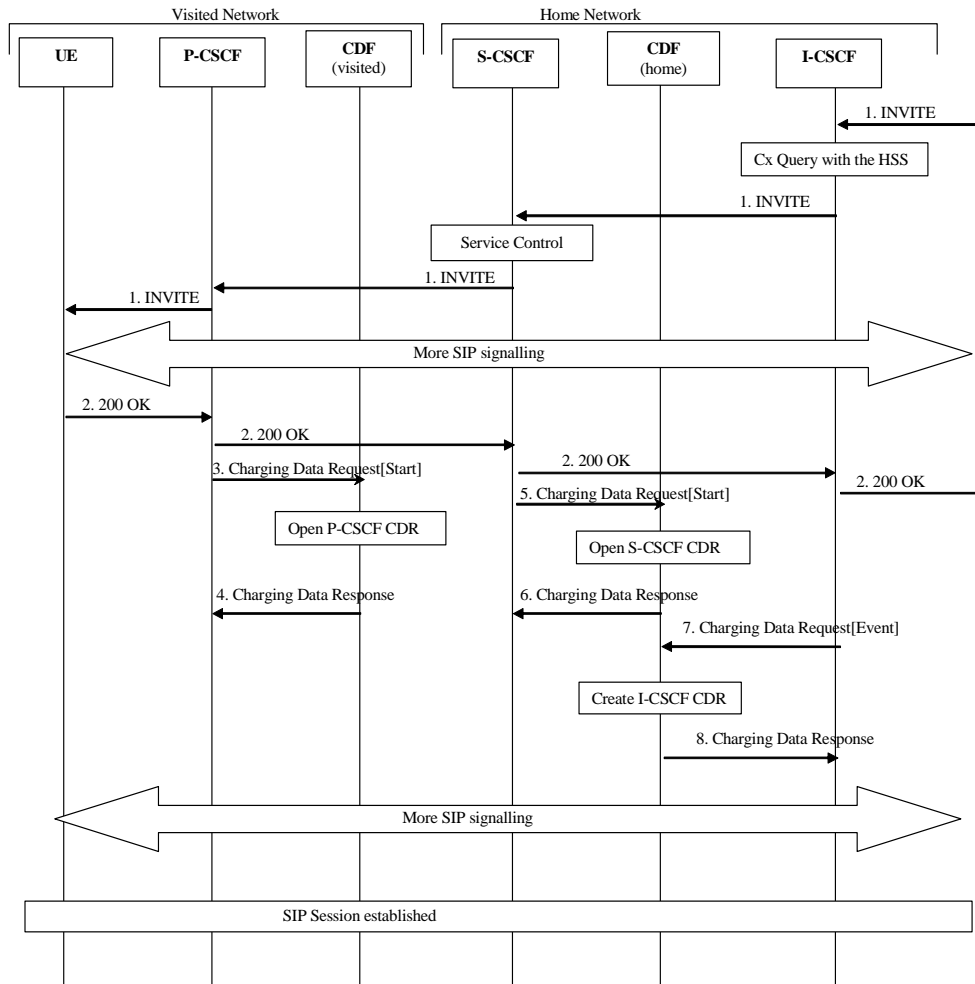

Figure 5.2.2.1.2.1: Message sequence chart for session establishment (mobile termination)

1. The session is initiated.
2. The destination party answers and a final response are sent.
3. - 6. These steps are identical to the corresponding steps described in clause 5.2.2.1.1.
7. Upon reception of the SIP 200 OK, the I-CSCF sends an Charging Data Request[Event].
8. The CDF acknowledges the data received and creates an I-CSCF CDR.

5.2.2.1.3 Mid-session procedures

Figure 5.2.2.1.3.1 shows the Charging Data transactions that are required between CSCF and CDF when a UE generates a SIP (RE-)INVITE or SIP UPDATE in mid-session, e.g. in order to modify media component(s), or when the hold and resume procedure is executed.

Figures 5.2.2.1.3.1-5.2.2.1.3.2 below are illustrated in LBO roaming model where P-CSCF and CDF are located in VPLMN. The same figures are applicable for deployment of voice over IMS with home routed traffic, where P-CSCF is located in HPLMN, with the exception that the HPLMN CDF is used.

Scenario 1: Mid-session procedures

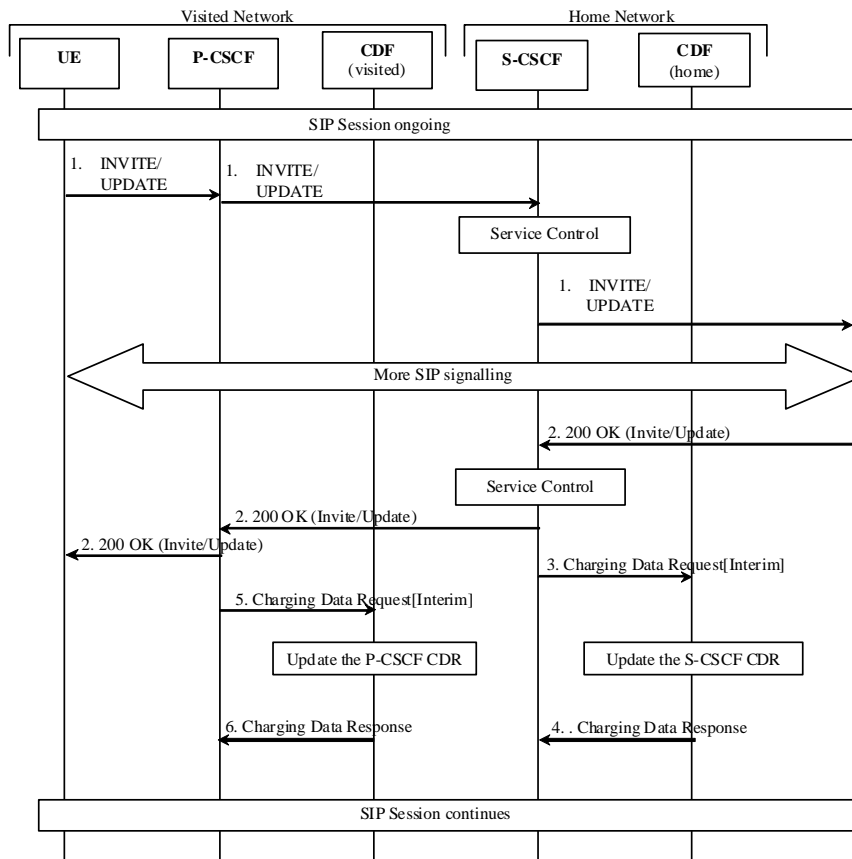

Figure 5.2.2.1.3.1: Message sequence chart for media modification

1. Modified media information is received from the subscriber.
2. The destination party acknowledges the media modification.
3. At modification of a media, the S-CSCF sends Charging Data Request[Interim] to record modification of a media component in the S-CSCF CDR.
4. The CDF acknowledges the reception of the data and updates the S-CSCF CDR.
5. Same as 3, but for P-CSCF.
6. Same as 4, updating the P-CSCF CDR.

Scenario 2 : Mid-session procedures with late SDP answer (SIP ACK triggering Charging Data Request)

Figure 5.2.2.1.3.2 shows the Charging Data transactions that are required between CSCF and CDF when a UE generates a SIP (RE-)INVITE or SIP UPDATE in mid-session, e.g. in order to modify media component(s), or when the hold and resume procedure is executed.

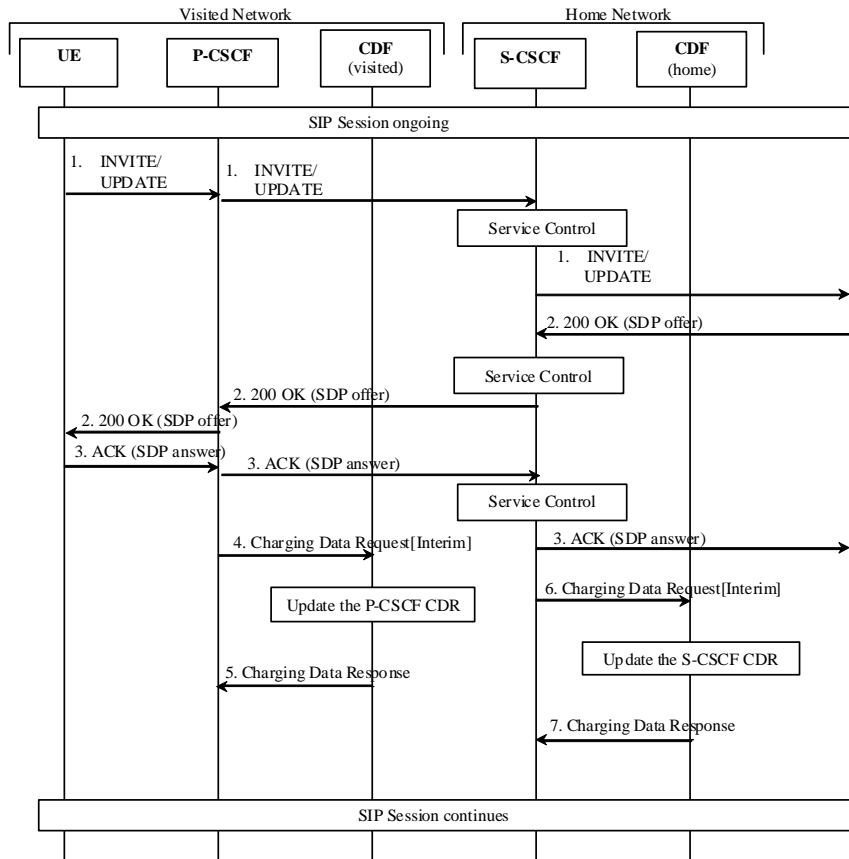

Figure 5.2.2.1.3.2: Message sequence chart for media modification (SIP ACK triggering Charging Data Request)

1. The UE generates a SIP RE-INVITE or SIP UPDATE in mid-session.
2. The destination party replies with a response including a SDP offer. If the final response includes a SDP offer only, then the CSCF shall wait for the SIP ACK.
3. The SIP ACK including the SDP answer is received.
4. At modification of a media, the P-CSCF sends Charging Data Request[Interim] to record modification of a media component in the P-CSCF CDR.
5. The CDF acknowledges the reception of the data and updates the P-CSCF CDR.
6. Same as 4, but for S-CSCF.
7. Same as 5, updating the S-CSCF CDR.

5.2.2.1.4 Session release - mobile initiated

Figures 5.2.2.1.4.1 to 5.2.2.1.4.2 show the Charging Data transactions that are required between CSCF and CDF for a session release that is initiated by the UE.

Figures 5.2.2.1.4.1-5.2.2.1.4.2 below are illustrated in LBO roaming model where P-CSCF and CDF are located in VPLMN. The same figures are applicable for deployment of voice over IMS with home routed traffic, where P-CSCF is located in HPLMN, with the exception that the HPLMN CDF is used.

Scenario 1: Successful session release (SIP BYE triggering Charging Data Request)

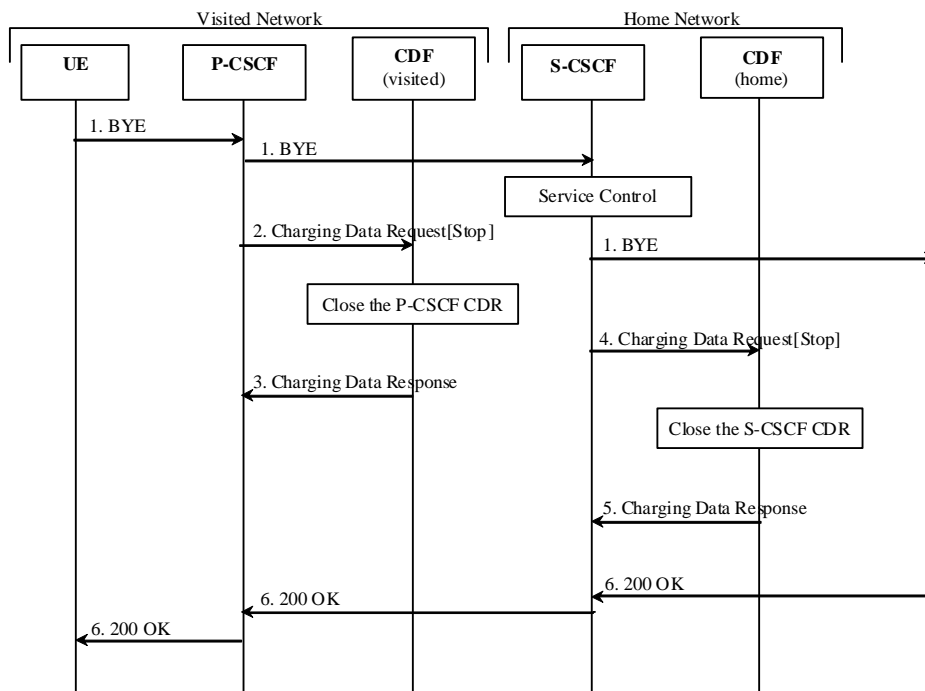

Figure 5.2.2.1.4.1: Message sequence chart for session release (SIP BYE triggering Charging Data Request)

1. The session is released.
2. At session termination the P-CSCF sends Charging Data Request[Stop] to record stop of a session and stop of a media component in the P-CSCF CDR.
3. The CDF acknowledges the reception of the data and closes the P-CSCF CDR.
4. Same as 2, but for S-CSCF.
5. Same as 3, closing the S-CSCF CDR.
6. The release is acknowledged.

Scenario 2: Successful session release (SIP 200 OK triggering Charging Data Request)

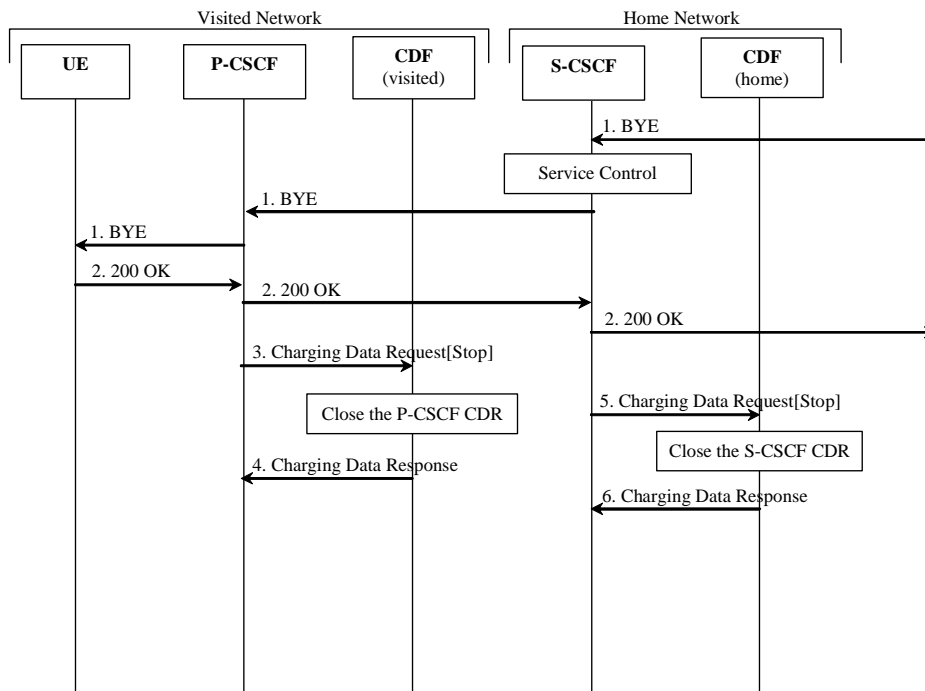

Figure 5.2.2.1.4.2: Message sequence chart for session release (SIP 200 OK triggering Charging Data Request)

1. The session is released.
2. The release is acknowledged.
3. At acknowledgement of SIP session termination and, if required, Rx session termination, the P-CSCF sends Charging Data Request[Stop] to record stop of a session and stop of a media component and information from the acknowledgement message (e.g. user location retrieved as per Annex A.10.5 of TS 29.214[214]) in the P-CSCF CDR. Reported charging information must rely on the time when SIP BYE message is received and not when the corresponding acknowledgement is received.
4. The CDF acknowledges the reception of the data and closes the P-CSCF CDR.
5. Same as 3, but for S-CSCF.
6. Same as 4, closing the S-CSCF CDR.

5.2.2.1.5 Session-unrelated procedures

Figure 5.2.2.1.5.1 shows the Charging Data transactions that are required between CSCF and CDF for session-unrelated IMS procedures, i.e. those that relate to the Charging Data Request [Event], as listed in table 5.2.1.1.

Figure 5.2.2.1.5.1 below is illustrated in LBO roaming model where P-CSCF and CDF are located in VPLMN. The same figure is applicable for deployment of voice over IMS with home routed traffic, where P-CSCF is located in HPLMN, with the exception that the HPLMN CDF is used.

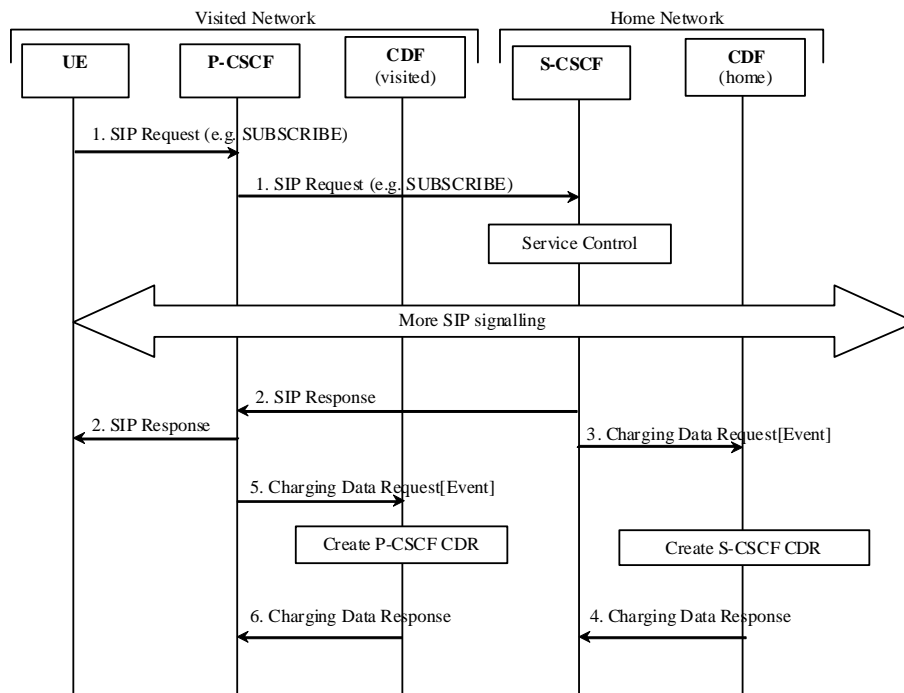

Figure 5.2.2.1.5.1: Message sequence chart for session-unrelated procedure

1. The P-CSCF receives a "SIP request" (e.g. SUBSCRIBE) from the subscriber.
2. The "SIP Request" is acknowledged by the "SIP response" as follows:
 - in the successful case, a SIP 200 OK message is returned;
 - in case of failure an appropriate SIP error message is returned.

Depending on the used SIP method, there might be additional signalling between steps 1 and 2.

3. After the completion of the procedure, the S-CSCF sends Charging Data Request[Event] to record transaction specific information in the S-CSCF CDR.
4. The CDF acknowledges the reception of the data and produces an S-CSCF CDR.
5. Same as 3, but for P-CSCF.
6. Same as 4, creating a P-CSCF CDR.

5.2.2.1.6 Session establishment - PSTN initiated

Figure 5.2.2.1.6.1 shows the Charging Data transactions that are required between MGCF and CDF during session establishment initiated from the PSTN side.

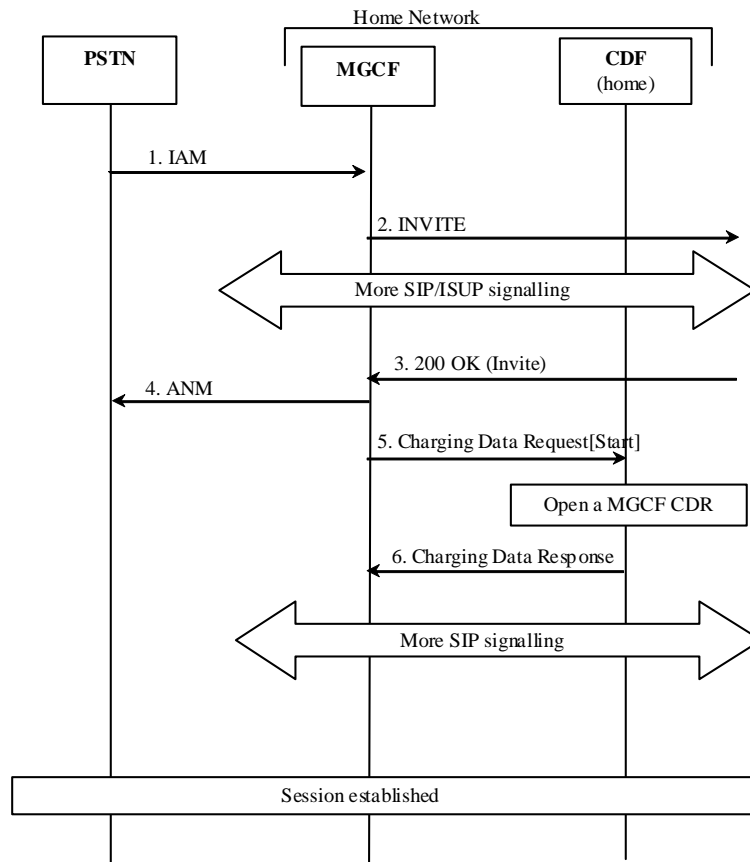

Figure 5.2.2.1.6.1: Message sequence chart for session establishment (PSTN initiated)

1. The session is originated from the PSTN.
2. The session setup is triggered in the IMS.
3. The destination party answers and a final response are received.
4. MGCF forwards an answer message to the PSTN.
5. Upon reception of the final response, the MGCF sends an Charging Data Request[Start] to record start of a user session and start of a media component in the MGCF CDR.
6. The CDF acknowledges the reception of the data and opens a MGCF CDR.

5.2.2.1.7 Session establishment - IMS initiated

Figure 5.2.2.1.7.1 shows the Charging Data transactions that are required between BGCF, MGCF and CDF during session establishment initiated from the IMS side.

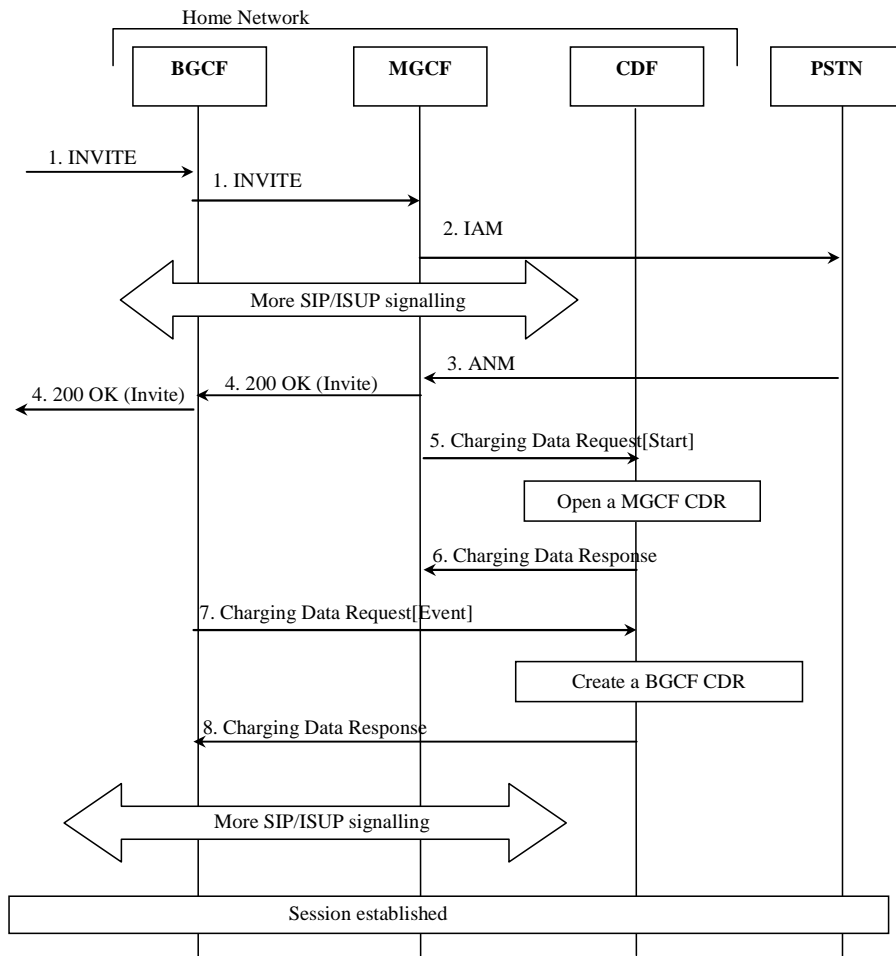

Figure 5.2.2.1.7.1: Message sequence chart for session establishment (IMS initiated)

1. The session is originated from the IMS.
2. A session towards PSTN is established.
3. The destination party answers and an answer message are received.
4. A final response message is sent to the session originator.
5. Upon reception of the answer message, the MGCF sends an Charging Data Request[Start] to record start of a user session and start of a media component in the MGCF CDR.
6. The CDF acknowledges the reception of the data and opens a MGCF CDR.
7. Upon reception of the SIP 200 OK message, the BGCF sends an Charging Data Request[Event] to record start of a user session and start of a media component in the BGCF CDR.
8. The CDF acknowledges the reception of the data and creates a BGCF CDR.

5.2.2.1.8 Session release - PSTN initiated

Figure 5.2.2.1.8.1 shows the Charging Data transactions that are required between MGCF and CDF during a PSTN initiated session release.

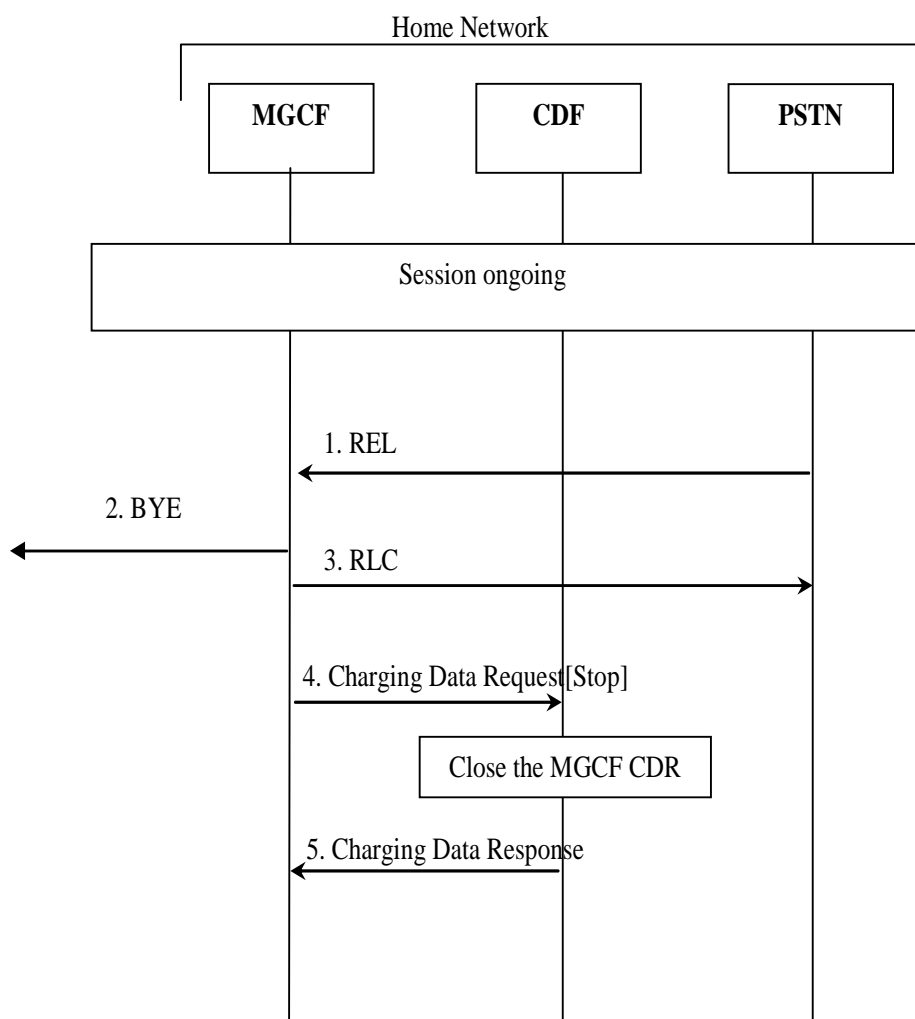

Figure 5.2.2.1.8.1: Message sequence chart for session release (PSTN initiated)

1. The session release is initiated from PSTN.
2. Session release continues within IMS.
3. The reception of the release message is acknowledged.
4. Upon reception of the release message, the MGCF sends an Charging Data Request[Stop] to record stop of a session in the MGCF CDR.
5. The CDF acknowledges the reception of the data and closes the MGCF CDR.

5.2.2.1.9 Session release - IMS initiated

Figure 5.2.2.1.9.1 shows the Charging Data transactions that are required between MGCF and CDF during an IMS initiated session release.

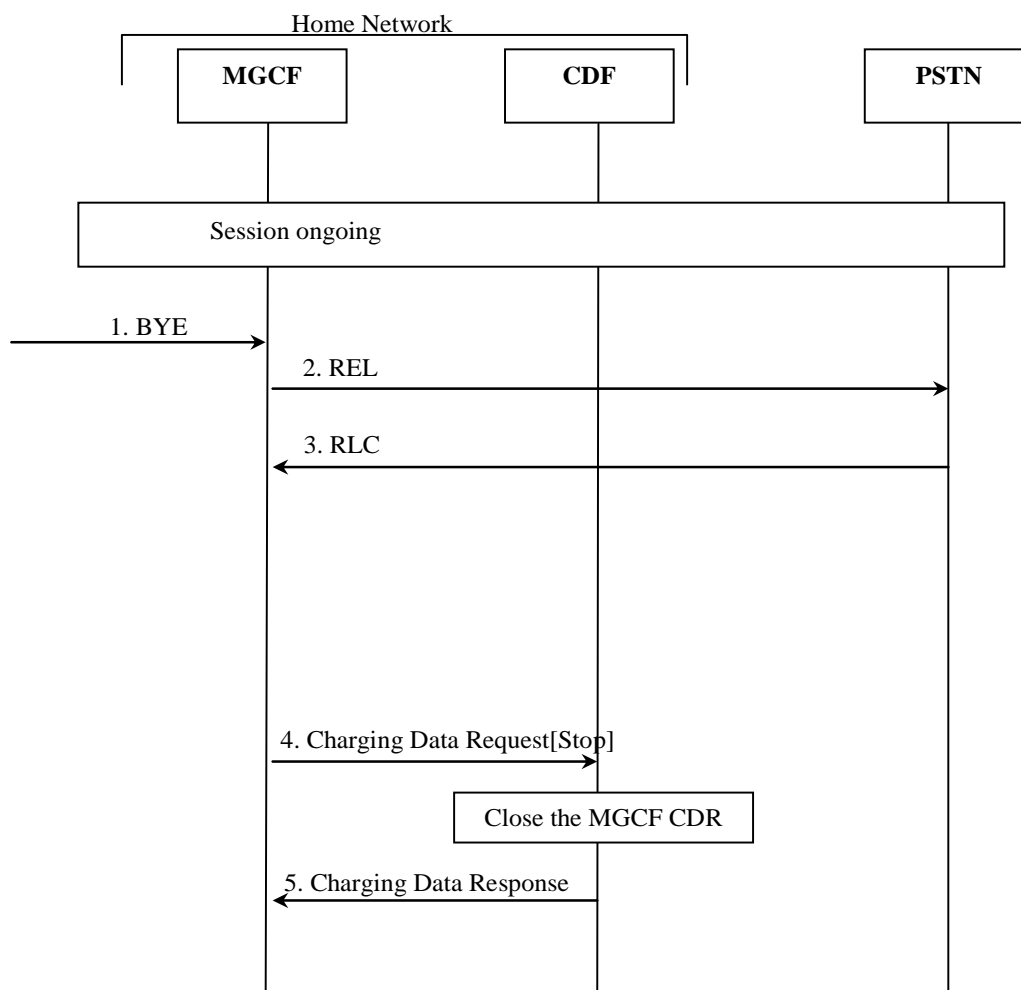

Figure 5.2.2.1.9.1: Message sequence chart for session release (IMS initiated)

1. The session release is initiated from the IMS side.
2. A release message is sent towards PSTN.
3. The acknowledgement of the release message is received from PSTN.
4. Upon reception of the SIP BYE message the MGCF sends an Charging Data Request[Stop] to record stop of a session in the MGCF CDR.
5. The CDF acknowledges the reception of the data and closes the MGCF CDR.

5.2.2.1.10 Multi-Party call

Figure 5.2.2.1.10.1 shows the establishment of an ad hoc conference (multiparty call). An AS (acting as B2BUA) performs third party call control with the MRFC, where the S-CSCF is in the signalling path. The AS that is in control of the ad hoc conference is aware of the MRFC capabilities. Note that only accounting information sent from the MRFC is shown in detail in figure 5.2.2.1.10.1. The SIP messages are for illustrative purpose only.

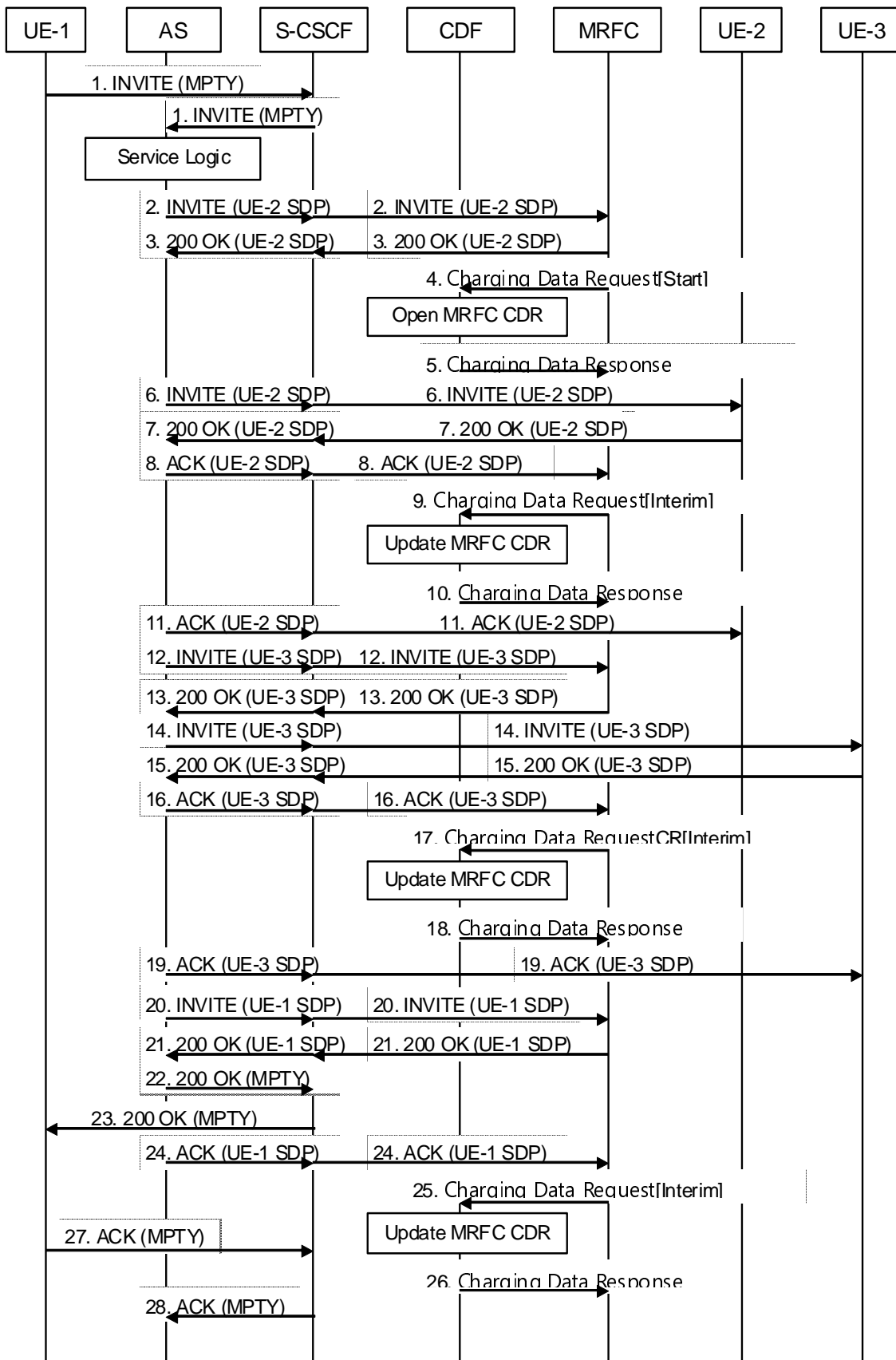

Figure 5.2.2.1.10.1: Message sequence chart for Multi-Party call establishment in MRFC

1. Sessions exist between UE-1 and UE-2, and between UE-1 and UE-3. A request is received from UE-1 for putting all parties together to a multi-party call.
2. - 3. Request and acknowledgement to initiate multi-party call. MRFC assigns a conference-ID that is used by the AS in subsequent interactions with the MRFC in SIP INVITE messages connecting other endpoints (see TS 23.228 [201]). Path establishment between AS and MRFC for UE-2.
4. At start of session establishment the MRFC sends an Charging Data Request[Start] to record start of multi-party call in the MRFC CDR
5. The CDF acknowledges the reception of the data and creates the MRFC CDR. 'Calling Party Address', 'Service Request Time Stamp', 'Service ID' (holding the conference-ID) etc. are included in the MRFC CDR
- 6 - 7. Path establishment between UE-2 and AS. Same ICID is used as for the path between AS and MRFC for UE-2 (step 2. - 3.).
8. Acknowledgement of path between AS and MRFC for UE-2.
9. The MRFC may send an Charging Data Request[Interim] to report that UE-2 has been connected to the multi-party call.
10. The CDF acknowledges the reception of the data and includes UE-2 in the field 'Application Provided Called Parties' of the MRFC CDR.
11. Acknowledgement of path between AS and UE-2. Now a path between UE-2 and MRFP via AS is established.
- 12 -13. Request and acknowledgement to establish path between AS and MRFC for UE-3.
14. -15. Path establishment between UE-3 and AS. Same ICID is used as for the path between AS and MRFC for UE-3 (step 12. - 13.).
16. Acknowledgement of path between AS and MRFC for UE-3.
17. The MRFC may send an Charging Data Request[Interim] to report that UE-3 has been connected to the multi-party call.
18. The CDF acknowledges the reception of the data and includes UE-3 in a new field 'Application Provided Called Parties' of the MRFC CDR.
19. Acknowledgement of path between AS and UE-3.
- 20 - 21. Request and acknowledgement to establish path between AS and MRFC for UE-1. Same ICID is used as for the path between UE-1 and AS (step 1.).
- 22 - 23. Request for multi-party conference with UE-2 and UE-3 is acknowledged to UE 1. Implicit acknowledgement of path UE-1 to AS.
24. Acknowledgement of path between AS and MRFC for UE-1.
25. The MRFC may send an Charging Data Request[Interim] to report that UE-1 has been connected to the Multi-Party call.
26. The CDF acknowledges the reception of the data and includes the field 'Service Delivery Start Time Stamp' into the MRFC CDR.
27. - 28. UE-1 acknowledges the multi-party call session establishment.

NOTE: It is in the responsibility of the AS to terminate the sessions existing at the beginning of the multi-party call establishment between UE-1 and UE-2 and between UE-1 and UE-3 (see step 1.) in case of successful multi-party call establishment. This is not shown in the diagram above.

5.2.2.1.11 AS related procedures - AS acting as a redirect server

ASs may support a multitude of services which are not specified in 3GPP standards. Therefore it is not possible to standardise charging flows and procedures for those services. However, for all such services, the AS may apply either Event Charging, where Charging Data Request [Event] messages are generated, or Session Charging, using Charging Data Request [Start, Stop and Interim]. The following clauses depict one example for each of the two scenarios. The first procedure, AS acting as a redirect server, depicts the "event" case, while the second procedure, AS acting as a Voice Mail Server, depicts the "session" case.

Figure 5.2.2.1.11.1 shows the case where an AS acts as a redirect server. In the figure below, UE-1 sets up a session towards UE-2 but due to Call Forwarding functionality located in the AS, a new number (to UE-3) is returned to UE-1. Finally UE-1 sets up the session towards UE-3.

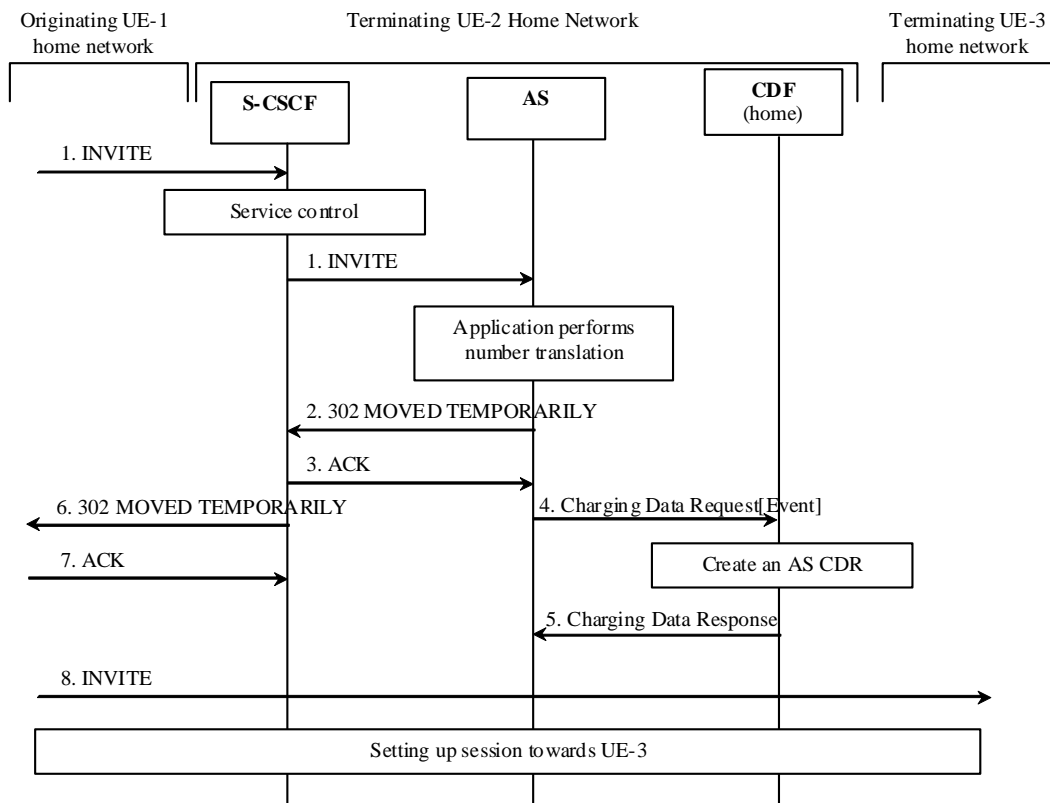

Figure 5.2.2.1.11.1: Message sequence chart for AS acting as a redirect server

1. Sessions initiated by UE-1 towards UE-2.
2. - 3. Response indicating that session should be redirected towards another number (UE-3).
4. After successful service execution, the AS sends Charging Data Request[Event] to record service specific information in the AS CDR.
5. The CDF acknowledges the reception of the data and creates the AS CDR.
- 6-7. Response indicating that session should be redirected towards another number (UE-3).
8. Session is initiated by UE-1 towards UE-3.

5.2.2.1.12 AS related procedures - AS acting as a voice mail server

Figure 5.2.2.1.12.1 shows the case where an AS acts as a voice mail server. S-CSCF invokes the AS acting as Voice Mail Server according to procedure as defined in TS 23.218 [203].

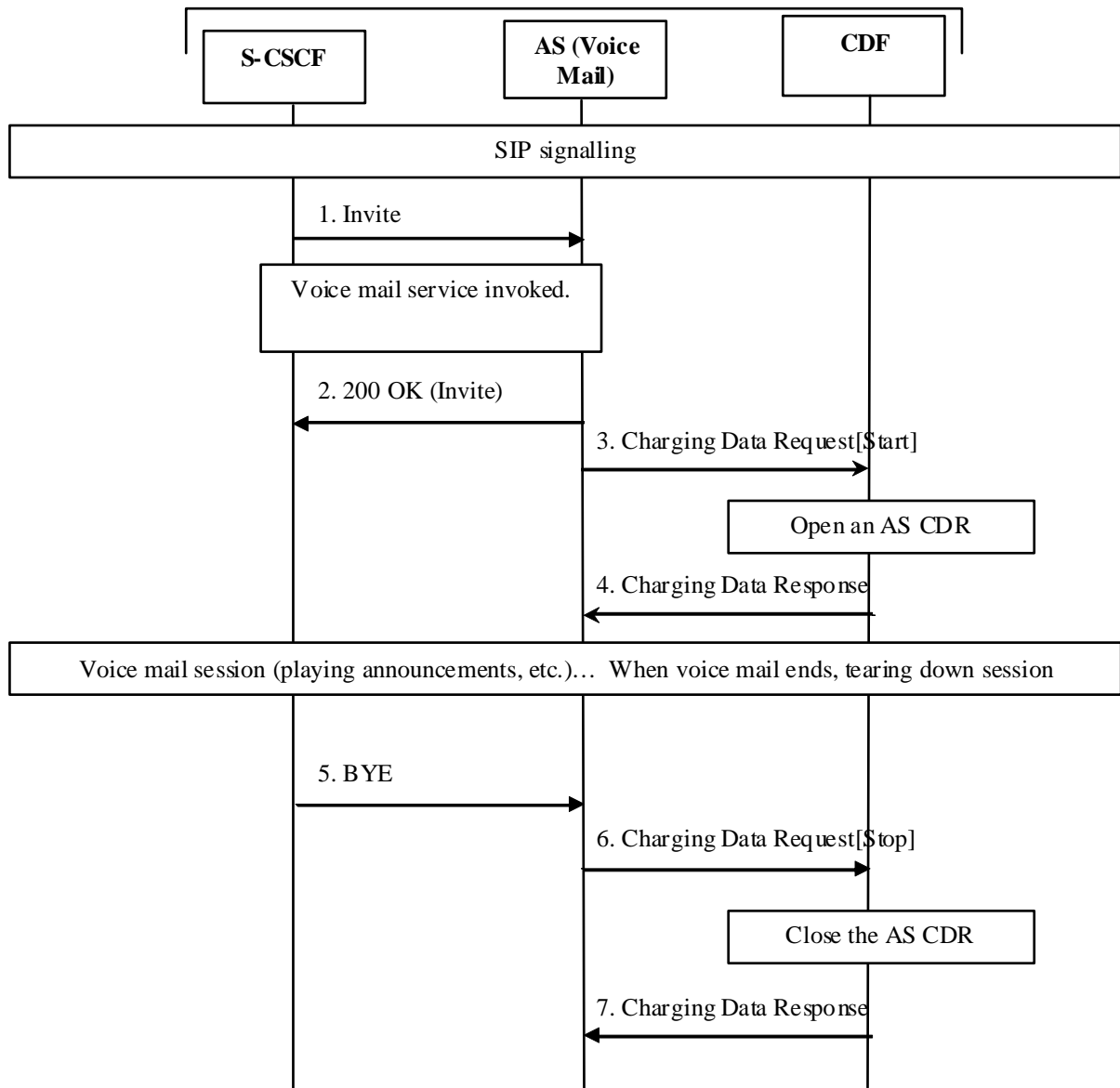

Figure 5.2.2.1.12.1: Message sequence chart for AS acting as a mail server

1. AS receives the SIP INVITE from the S-CSCF.
2. AS acknowledges the initiated Voice Mail session by issuing a SIP 200 OK in response to the SIP INVITE.
3. AS sends Charging Data Request[Start] to record start of a voice mail session.
4. The CDF acknowledges the reception of the Charging Data Request[Start] and opens an AS CDR.
5. Voice mail session release is initiated.
6. Upon reception of release message AS sends an Charging Data Request[Stop] to record stop of a session in the AS CDR.
7. The CDF acknowledges the reception of the data and closes the AS CDR.

5.2.2.1.13 AS Related Procedures - AS Acting as a SCC AS

5.2.2.1.13.0 Introduction

Service continuity using SCC AS call flows with alternative "OneChargingSession" option reflected in the different flows description, i.e. a single charging session from SCC AS.

5.2.2.1.13.1 UE originating call (PS only or CS only)

In the flow figure 5.2.2.1.13.1.1, Call-ID #1 is for access leg and Call-ID #2 is for remote leg.

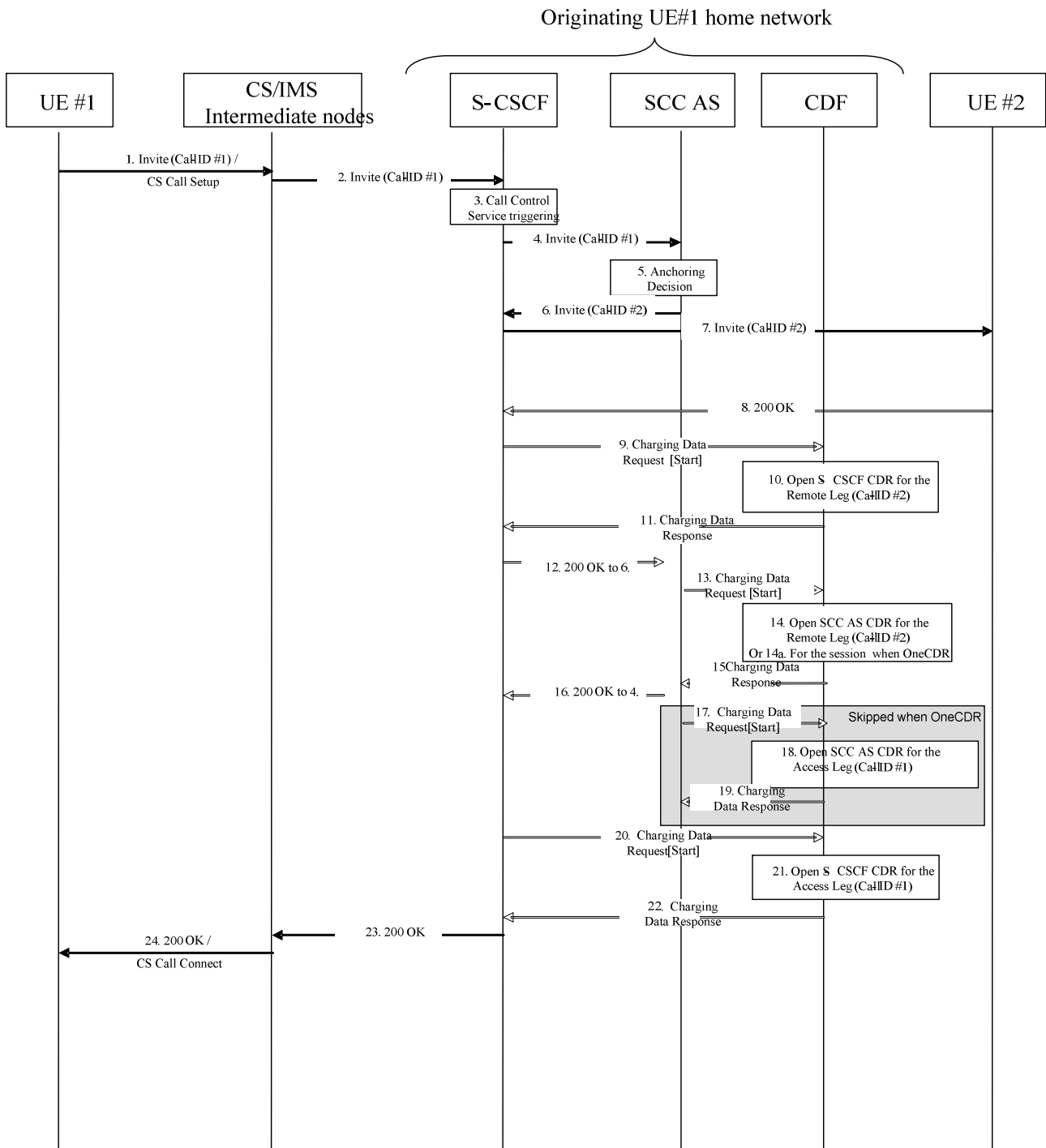

Figure 5.2.2.1.13.1.1: Message sequence chart UE originating call

1. The SCC session is initiated (an SIP INVITE for IMS, a call setup for CS).
2. After processing at CS/PS intermediate nodes, the resulting SIP INVITE is sent to the S-CSCF
3. The S-CSCF validates the service profile, and invokes any appropriate service logic required for this user.
4. The S-CSCF forwards the SIP INVITE request message to the SCC AS, according to the service origination logic defined by initial Filter Criteria (iFC) in the subscriber profile of the HSS.
5. The SCC call is anchored at the SCC AS in the home IMS Domain upon reception of the SIP Invite (Call-ID# 1).

- 6-7. The S-CSCF forwards the SIP INVITE request message to the terminating network (Call-ID #2).
8. The response SIP 200 OK is transmitted to the S-CSCF in the Originating network.
9. Upon reception of the final response, the S-CSCF in the originating network sends a Charging Data Request[Start] to record SCC call routing and start of a user session/media component in the S-CSCF CDR.
- 10-11. The CDF from the Originating network opens a S-CSCF CDR related to the Remote leg and acknowledges the reception of the data.
12. Same as 8 but for SCC AS (Remote leg)
13. Same as 9 but for the SCC AS (Remote leg)
- 14-15. Same as 10-11 but opening a SCC AS CDR related to the Remote leg
- 13-14a-15. Alternatively, when "OneChargingSession", the SCC AS sends a Charging Data Request[Start] to record SCC call routing and start of a user session/media components in the SCC AS CDR for the IMS session (ICID) with access leg and remote leg. The CDF opens a SCC AS CDR related to the IMS session, and acknowledges the reception of the data.
16. Same as 8 but for S-CSCF AS (Access leg)
17. Same as 9 but for the SCC AS (Access leg) .
- 18-19. Same as 10-11 but opening a SCC AS CDR (Access leg).
Steps 17 to 19 are not applicable for the "OneChargingSession" option.
20. Same as 9 but for the S-CSCF (Access leg)
- 21-22. Same as 10-11 but opening a S-CSCF CDR (Access leg)
23. The final response to SIP Invite (Call ID #1) is transmitted.
24. The session is set up with CS or PS media.

For IMS Emergency session over PS, the same flow applies in the UE serving Network, between the E-CSCF (instead of S-CSCF) and the EATF (Emergency Access Transfer Function, instead of SCC AS), with E-CSCF and EATF CDRs opened for access and remote legs.

EATF (acting as a B2BUA) performs third party call control and is considered as an AS for the charging description.

5.2.2.1.13.2 UE originating call (PS and CS combined origination)

In the flow figure 5.2.2.1.13.2.1, Call-ID #1 is for PS access leg, Call-ID #1' for CS access leg and Call-ID #2 for remote leg.

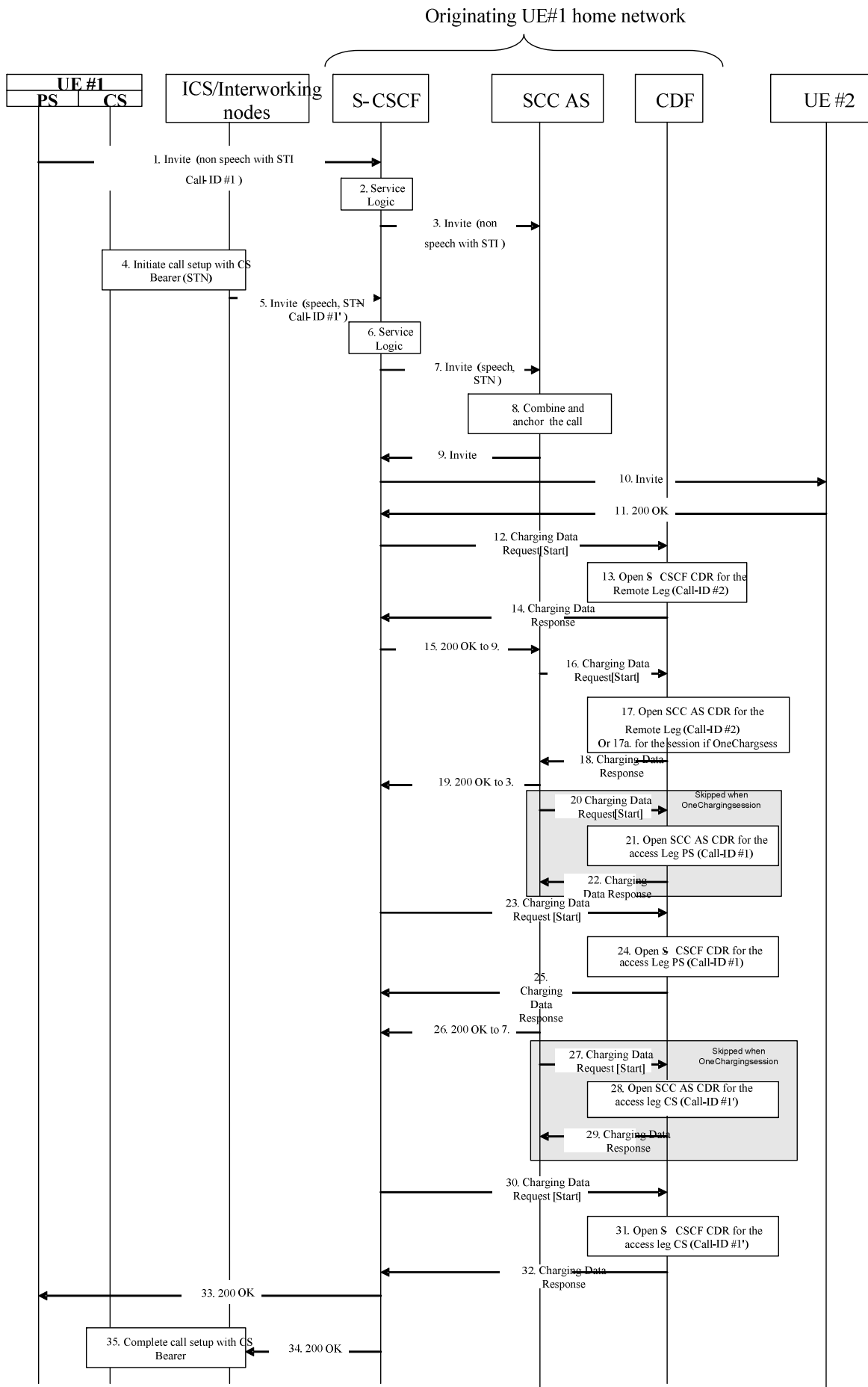

Figure 5.2.2.1.13.2.1: Message sequence chart UE originating call

1. UE-1 wants to initiate a multimedia session with UE-2 with speech components carried on CS bearers and non-speech components carried on PS bearers. Therefore the multimedia session is split into two parts, each one corresponding to a separate access leg. UE-1 initiates the establishment of the first access leg by sending an SIP INVITE request with non-speech media components. The SIP INVITE contains STI information indicating that a second access leg (with the speech component) will be originated from the CS domain.
2. The S-CSCF executes any service logic as appropriate.
3. The S-CSCF sends the SIP INVITE to the SCC AS. The SCC AS identifies that this access leg has to be correlated to a subsequent access leg based on the STI information in the SIP INVITE.
4. UE-1 request to set up call with CS bearer. The called party number is set to an identifier such as a PSI DN, which is used to indicate to the SCC AS that this access leg is to be combined with a PS leg. The DN is either statically configured on the UE or assigned to the UE by the network upon IMS Registration.
5. After processing at ICS/Interworking nodes, the resulting SIP INVITE is sent to the S-CSCF.
6. The S-CSCF executes any service logic as appropriate.
7. The S-CSCF sends the SIP INVITE to the SCC AS. The SCC AS identifies that this CS leg has to be correlated to a PS leg based on the iFC in the SIP INVITE.
8. After the SCC AS receives both the SIP INVITE requests in step 3 and in step 7, the SCC AS identifies that they are part of the same multimedia session and combines the two access legs of the session by checking the caller's identity and anchor the combined session.
- 9-10. The SCC AS sends SIP INVITE to the remote end point for combined session establishment.
11. The SIP 200 OK response is transmitted to the S-CSCF in the Originating network.
12. Upon reception of the final response, the S-CSCF in the originating network sends an Charging Data Request[Start] to record SCC call routing and start of a user session/media component in the S-CSCF CDR.
- 13-14. The CDF from the Originating network opens an S-CSCF CDR related to the Remote leg and acknowledges the reception of the data.
15. Same as 11 but for SCC AS (Remote leg)
16. Same as 12 but for the SCC AS (Remote leg)
- 17-18. Same as 13-14 but opening a SCC AS CDR related to the Remote leg
- 16-17a-18 Alternatively, when "OneChargingSession", the SCC AS sends an Charging Data Request[Start] to record start of the SCC AS CDR for the IMS session (ICID) with the CS access leg, PS access leg and the Remote leg. The CDF opens a SCC AS CDR related to the IMS session, and acknowledges the reception of the data.
19. Same as 11 but for S-CSCF (Access leg)
20. Same as 12 but for the SCC AS (Access leg)
- 21-22. Same as 13-14 but opening a SCC AS CDR for the PS access leg.
Steps 20 to 22 are not applicable for the "OneChargingSession" option.
23. Same as 12 but for the S-CSCF (Access leg)
- 24-25. Same as 13-14 but opening a S-CSCF CDR for the PS access leg.
26. Same as 11 but for S-CSCF AS (Access leg).
27. Same as 12 but for the SCC AS (Access leg).

28-29. Same as 13-14 but opening a SCC AS CDR for the CS access leg.

Steps 27 to 29 are not applicable for the "OneChargingSession" option.

29. Same as 12 but for the S-CSCF (Access leg)

30-31. Same as 13-14 but opening a S-CSCF CDR for the CS access leg.

32. The final SIP 200 OK response is sent to the UE #1

33. The SIP 200 OK response is sent to the ICS intermediate nodes.

34. The completion of the CS call bearer is done.

5.2.2.1.13.3 UE terminating call (PS only or CS only)

In the flow figure 5.2.2.1.13.3.1, Call-ID #1 is for PS access leg and Call-ID #2 for remote leg.

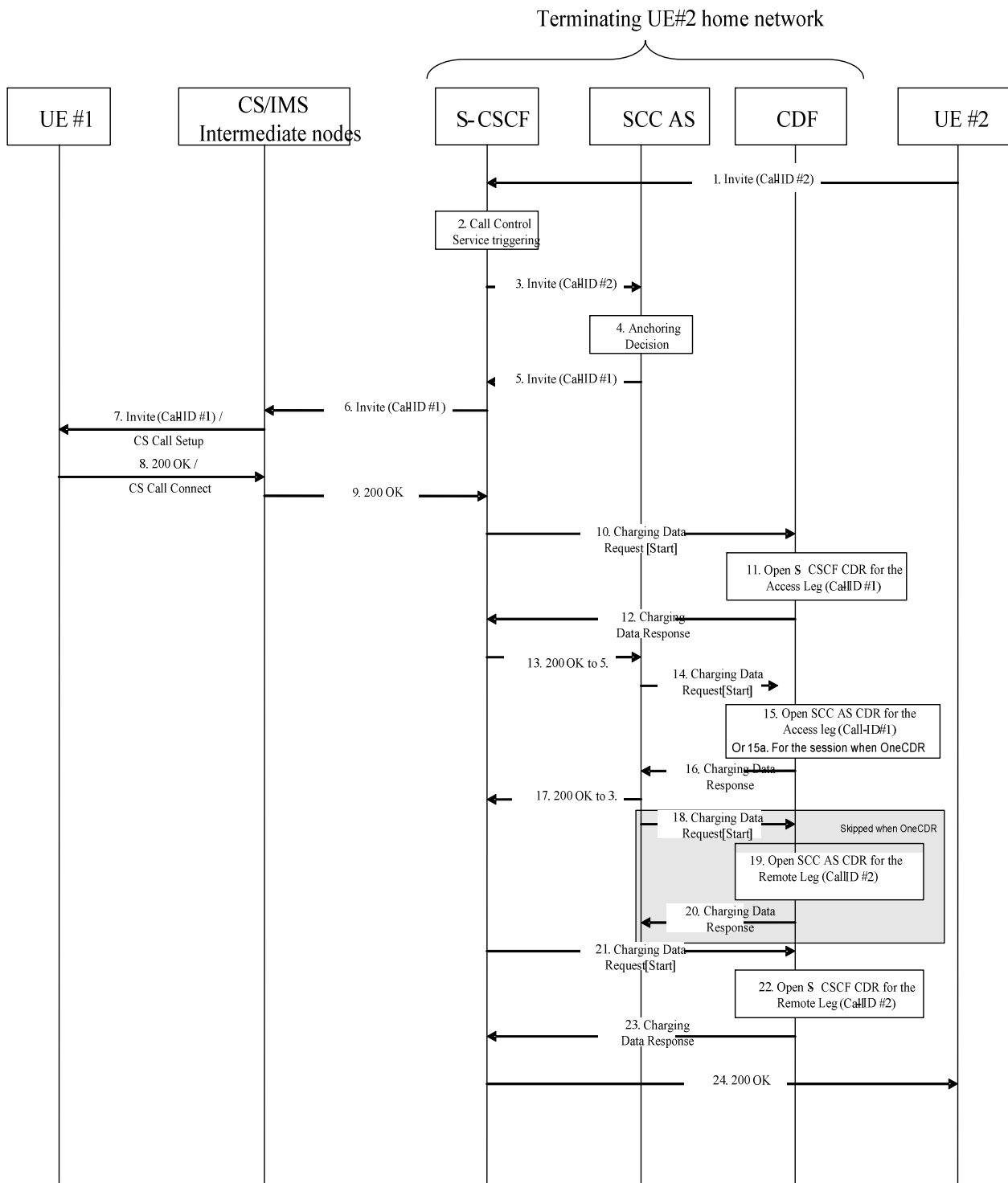

Figure 5.2.2.1.13.3.1: Message sequence chart UE terminating call

1. The SCC session is initiated by UE #2 sending an SIP INVITE to S-CSCF.
2. The S-CSCF validates the service profile, and invokes any appropriate service logic required for this user.
3. The S-CSCF forwards the SIP INVITE request message to the SCC AS, according to the service origination logic defined by initial Filter Criteria (iFC) in the subscriber profile of the HSS.
4. The SCC call is anchored at the SCC AS in the home IMS Domain upon reception of the SIP INVITE (Call ID #2).

- 5-6-7. The S-CSCF forwards the SIP INVITE request message to the terminating network (Call ID #1). After processing at CS/PS intermediate nodes, the resulting message is sent to UE #1.
8. The response SIP 200 OK is transmitted to CS/PS intermediate nodes.
9. After processing at CS/PS intermediate nodes, the SIP 200 OK message is sent to S-CSCF.
10. Upon reception of the final response, the S-CSCF in the originating network sends an Charging Data Request[Start] to record SCC call routing and start of a user session/media component in the S-CSCF CDR.
- 11-12. The CDF from the Originating network opens an S-CSCF CDR related to the Access leg and acknowledges the reception of the data.
13. Same as 9 but for SCC AS (Access leg)
14. Same as 10 but for the SCC AS (Access leg)
- 15-16. Same as 11-12 but opening a SCC AS CDR related to the Access leg
- 14-15a-16. Alternatively, when "OneChargingSession", the SCC AS sends an Charging Data Request[Start] to record SCC call routing and start of a user session/media components in the SCC AS CDR for the IMS session (ICID) with access leg and remote leg. The CDF opens a SCC AS CDR related to the IMS session and acknowledges the reception of the data.
17. Same as 9 but for SCC AS (Remote leg)
18. Same as 10 but for the SCC AS (Remote leg) .
- 19-20. Same as 11-12 but opening a SCC AS CDR (Remote leg).
- Steps 18 to 20 are not applicable for the "OneChargingSession" option.
21. Same as 10 but for the S-CSCF (Remote leg)
- 22-23. Same as 11-12 but opening a S-CSCF CDR (Remote leg)
24. The final response to SIP INVITE (Call ID #2) is transmitted.

5.2.2.1.13.4 UE terminating call (PS and CS combined origination)

In the flow figure 5.2.2.1.13.4.1, Call-ID #1 is for PS access leg, Call-ID #1' for CS access leg and Call-ID #2 for remote leg.

Terminating UE#2 home network

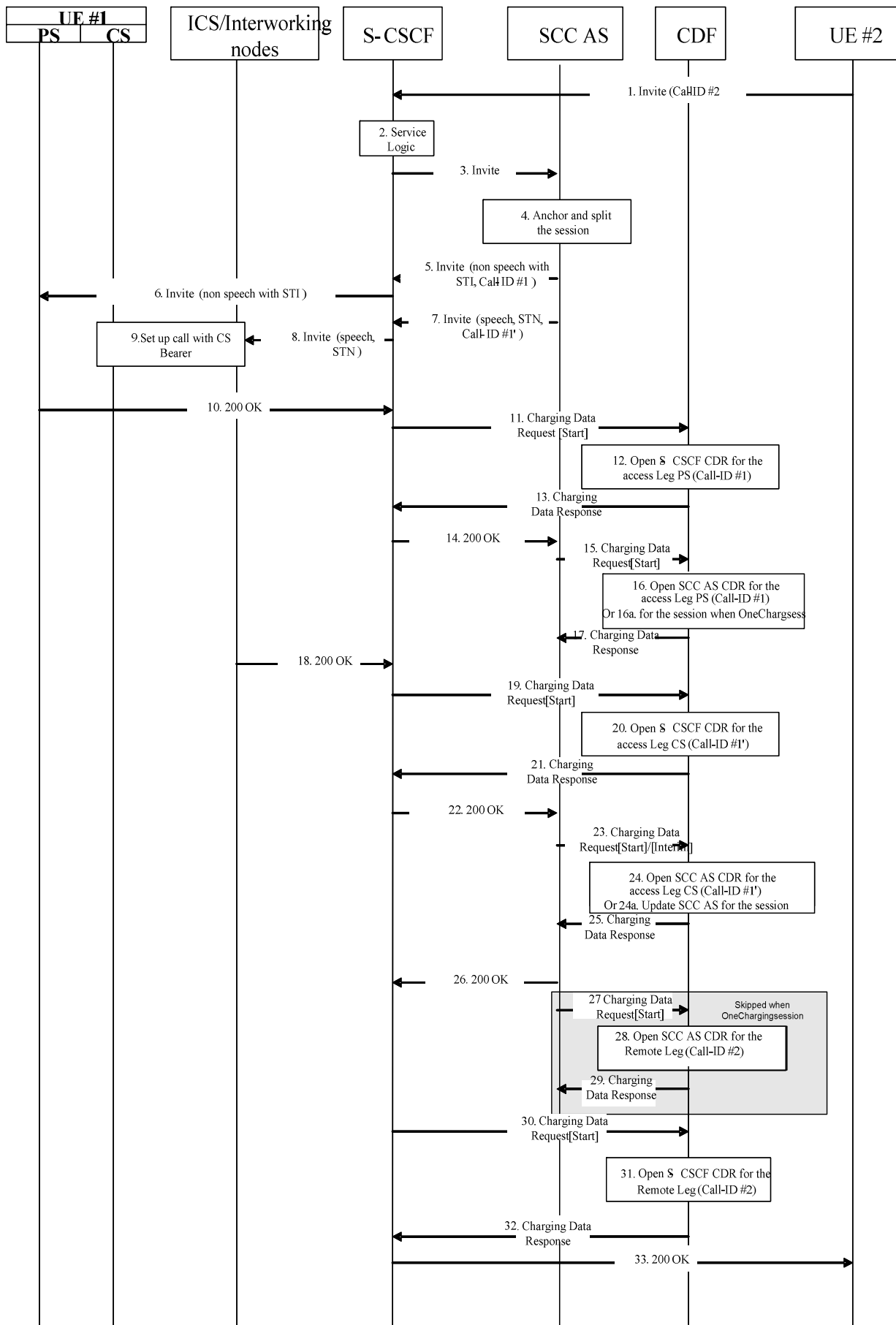

Figure 5.2.2.1.13.4.1: Message sequence chart UE terminating call

1. UE-2 sends SIP INVITE to UE-1 to establish a session with both speech and non-speech components.
2. The S-CSCF executes any service logic as appropriate.
3. The S-CSCF sends the SIP INVITE to the SCC AS. The SCC AS identifies that this access leg has to be correlated to a subsequent access leg based on the ST information in the SIP INVITE.
4. The session is anchored at the SCC AS. Based on operator policy and on information indicating that UE-1 is accessible over both the PS and CS domains, the SCC AS decides to split the session over PS and CS domains. This behaviour is similar to the behaviour of a CSI AS specified in TS 23.279.
- 5-6. The SCC AS sends SIP INVITE for the non-speech part of the session. The SIP INVITE contains STI information indicating that the speech component will be established from the CS domain.
- 7-8. The SCC AS sends SIP INVITE for the speech part of the session and the S-CSCF forwards the SIP INVITE to the ICS/Interworking nodes.
9. The ICS/Interworking nodes set up call to UE-1 with CS bearer.
- 10-18. A 200 OK response is sent to the S-CSCF. The speech and non-speech part of the session is established.
11. Upon reception of the response, the S-CSCF in the originating network sends an Charging Data Request[Start] to record SCC call routing and start of a user session/media component in the S-CSCF CDR.
- 12-13. The CDF from the Originating network opens an S-CSCF CDR related to the PS Access leg and acknowledges the reception of the data.
14. Same as 10 but for SCC AS (Access leg)
15. Same as 11 but for the SCC AS (Access leg)
- 16-17. Same as 12-13 but opening a SCC AS CDR related to the PS Access leg.
 - 15-16a-17. Alternatively, when "OneChargingSession", the SCC AS sends an Charging Data Request[Start] to record start of the SCC AS CDR for the IMS session (ICID) with the PS access leg and the Remote leg. The CDF opens the SCC AS CDR related to the IMS session and acknowledges the reception of the data.
19. Upon reception of the response, the S-CSCF in the originating network sends an Charging Data Request[Start] to record SCC call routing and start of a user session/media component in the S-CSCF CDR.
- 20-21. The CDF from the Originating network opens an S-CSCF CDR related to the CS Access leg and acknowledges the reception of the data.
22. Same as 10 but for SCC AS (Access leg)
23. Same as 11 but for the SCC AS (Access leg)
- 24-25. Same as 12-13 but opening a SCC AS CDR related to the CS Access leg.
 - 23-24a-25. Alternatively, when "OneChargingSession", the SCC AS sends an Charging Data Request[Interim] to record modification of the SCC AS CDR for the IMS session (ICID) with the CS access leg. The CDF updates the SCC AS CDR related to the IMS session and acknowledges the reception of the data.
26. Same as 10 but for S-CSCF (Remote leg)
27. Same as 11 but for the SCC AS (Remote leg)
- 28-29. Same as 12-13 but opening a SCC AS CDR for the Remote leg.

Steps 27 to 29 are not applicable for the "OneChargingSession" option.
30. Same as 11 but for the S-CSCF (Remote leg)
- 31-32. Same as 12-13 but opening a S-CSCF CDR for the Remote leg.

33. The SIP 200 OK response is sent to the UE #2.

5.2.2.1.13.5 Session transfer from PS to CS

In the flow figure 5.2.2.1.13.5.1, Call-ID #1 is for PS access leg, Call-ID #1' for CS access leg and Call-ID #2 for remote leg.

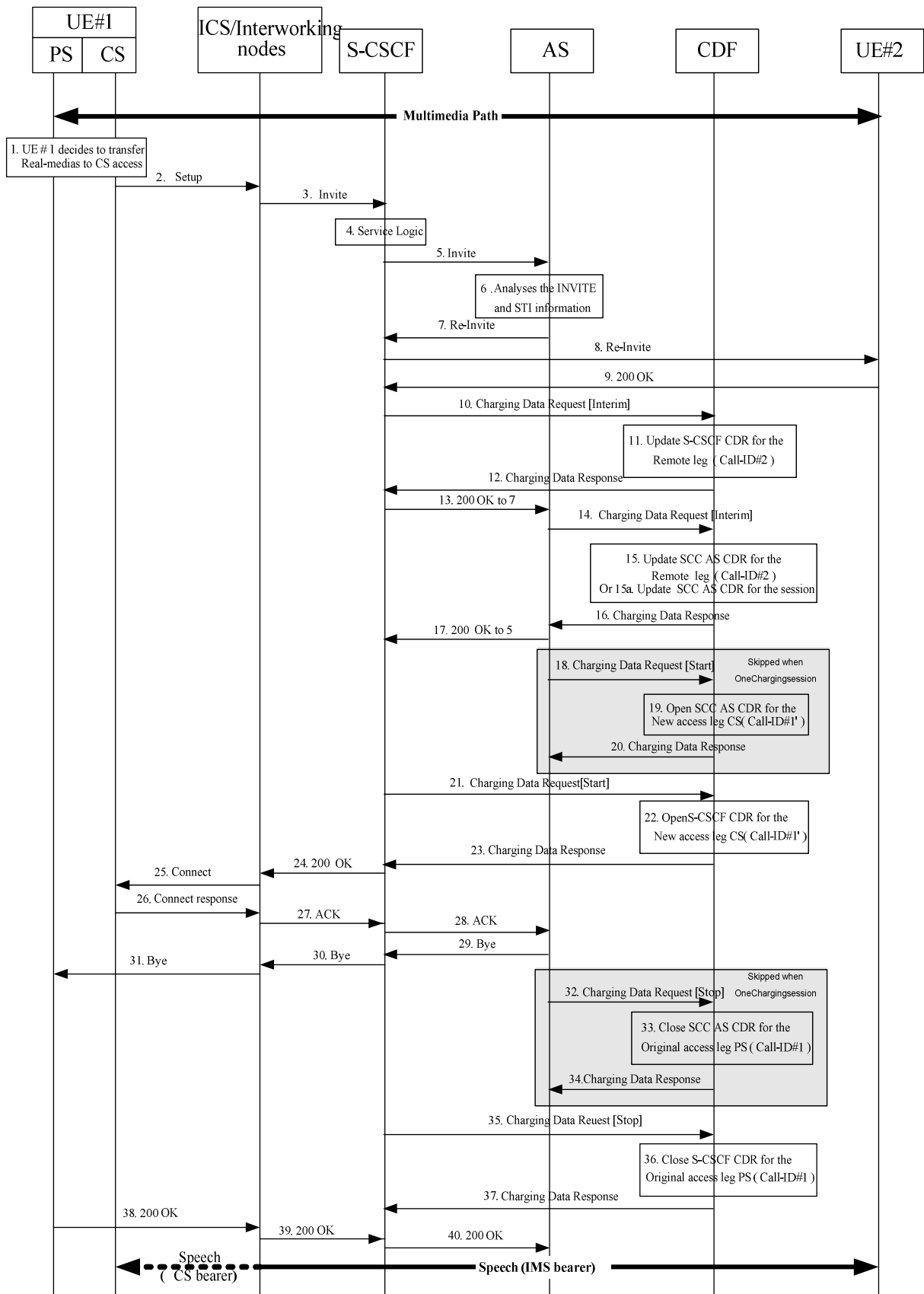

Figure 5.2.2.1.13.5.1: Message sequence chart UE domain transfer PS access to CS access

The user is engaged in an active multimedia session with UE-2 via PS access.

1-2. UE-1 originates a multimedia call in the CS domain including the STN information to request the real time media transfer to CS access.

3. The ICS intermediate Nodes convert the request into IMS SIP format and then forward the converted request to the S-CSCF.
4. The S-CSCF invokes the SCC Application as the first AS of any ASs that need to remain in the path of the call after session transfer.
5. The S-CSCF forwards the SIP INVITE to the SCC Application over the ISC interface.
- 6 The SCC AS analyses the SIP INVITE to derive that the SIP INVITE is a request to transfer a multimedia session with video and voice media components to the PS domain.
- 7-9. The SCC AS sends a SIP RE-INVITE to the Remote UE to update the media components of the previous dialog. Remote UE answers by a SIP 200 OK message.
- 10-12. At Remote Leg update the S-CSCF in the originating network sends Charging Data Request[Interim] to record update of a session in the S-CSCF CDR.
13. The S-CSCF answers to the SIP INVITE message in 7.
- 14-16. At Remote Leg update the SCC AS sends Charging Data Request[Interim] to record update of a session in the SCC AS CDR.
- 14-15a-16. Alternatively, when "OneChargingSession", the SCC AS sends an Charging Data Request[Interim] to record modification of SCC AS CDR for the IMS session (ICID) with the new legs configuration (Remote leg and new CS access leg).The CDF updates the SCC AS CDR related to the IMS session and acknowledges the reception of the data.
17. The SCC AS answers to the SIP INVITE message in 5.18-20. Upon generation of the SIP 200 OK response, the SCC AS in the home IMS of the originating SCC user sends an Charging Data Request[Start] to record start of a user session in the SCC AS-CDR for Call-ID #1'. The CDF from the originating network opens an AS CDR and acknowledges the reception of the data.

Steps 18 to 20 are not applicable for the "OneChargingSession" option.
- 21-23. Upon generation of the SIP 200 OK response, the S-CSCF in the home IMS of the originating SCC user sends an Charging Data Request[Start] to record start of a user session in the S-CSCF-CDR for Call-ID #1'. The CDF from the originating network opens an S-CSCF CDR and acknowledges the reception of the data.
24. The SIP 200 OK response is sent by the S-CSCF.
25. The SIP 200 OK response is converted by the ICS/Interworking nodes in CS format.
- 26-28. The UE #1 acknowledges by sending an ACK message to the SCC AS.
- 29-31. The SCC Application sends BYE request to release the old access leg.
- 32-34. At session termination the SCC AS sends Charging Data Request[Stop] to record stop of a session and stop of a media component in the SCC AS CDR. This CDR may be generated with special handling. One example of special handling is to zero rate the IMS resource usage for the Access leg establishment.

Steps 32 to 34 are not applicable for the "OneChargingSession" option.
- 35-37. The S-CSCF in the originating network sends Charging Data Request[Stop] for closing the S-CSCF CDR related to the initial Access leg. This CDR may be generated with special handling. One example of special handling is to zero rate the IMS resource usage for Access leg establishment. This can be performed using the correlation mechanism with the SCC AS CDR for Access leg.
- 38-40. The UE-1 acknowledges the release of old access leg.

5.2.2.1.13.6 Session transfer from CS to PS

In the flow figure 5.2.2.1.13.6.1, Call-ID #1 is for PS access leg, Call-ID #1' for CS access leg and Call-ID #2 for remote leg.

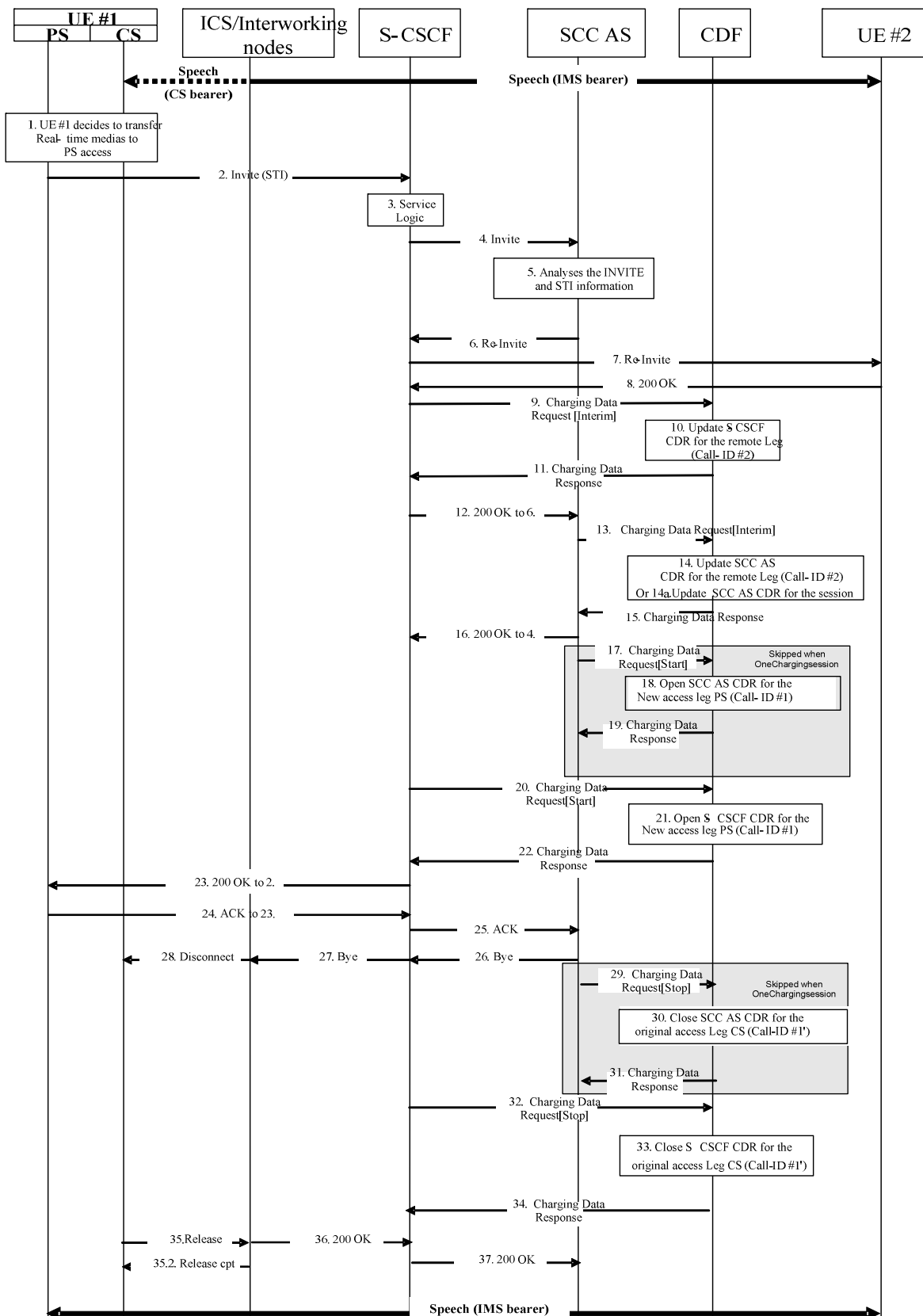

Figure 5.2.2.1.13.6.1: Message sequence chart UE domain transfer CS access to PS access

The user is engaged in an active multimedia session with UE-2 via CS access.

1. UE-1 originates a call in the PS domain including the STI to request the multimedia session transfer to PS access in conjunction with CS access.
2. The session establishment request is routed to the S-CSCF by the P-CSCF.
3. The S-CSCF invokes the SCC Application as the first AS of any ASs that need to remain in the path of the call after session transfer.
4. The S-CSCF forwards the SIP INVITE to the SCC Application over the ISC interface.
5. The SCC Application analyses the SIP INVITE to derive that the SIP INVITE is a request to transfer a multimedia session with video and voice media components to the PS domain.
- 6-8. The SCC AS sends a SIP RE-INVITE to the Remote UE to update the media components of the previous dialog. Remote UE answers by a SIP 200 OK message.
- 9-11. At Access Leg update the S-CSCF in the originating network sends Charging Data Request[Interim] to record update of a session in the S-CSCF CDR.
12. The S-CSCF answers to the SIP INVITE message in 6.
- 13-15. At Access Leg update the SCC AS sends Charging Data Request[Interim] to record update of a session in the SCC AS CDR.
- 13-14a-15. Alternatively, when "OneChargingSession", the SCC AS sends an Charging Data Request[Interim] to record modification of SCC AS CDR for the IMS session (ICID) with the new legs configuration (Remote leg and new PS access leg).The CDF updates the SCC AS CDR related to the IMS session and acknowledges the reception of the data.
16. The SCC AS answers to the SIP INVITE message in 4.
- 17-19. Upon generation of the final response, the SCC AS in the home IMS of the originating SCC user sends an Charging Data Request[Start] to record start of a user session in the SCC AS-CDR. The CDF from the originating network opens an AS CDR and acknowledges the reception of the data.

Steps 17 to 19 are not applicable for the "OneChargingSession" option.
- 20-22. Upon generation of the final response, the S-CSCF in the home IMS of the originating SCC user sends an Charging Data Request[Start] to record start of a user session in the S-CSCF-CDR. The CDF from the originating network opens an S-CSCF CDR and acknowledges the reception of the data.
23. The S-CSCF answers to the SIP INVITE message in 2.
- 24-25. The SIP 200 OK is acknowledged.
- 26-28. The SCC Application sends BYE request to release the old access leg. 29-31 The SCC AS sends Charging Data Request[Stop] for closing the SCC AS CDR related to the original Access leg. The CDF updates the SCC AS CDR related to the IMS session and acknowledges the reception of the data

Steps 29 to 31 are not applicable for the "OneChargingSession" option.
- 32-34. The S-CSCF sends Charging Data Request[Stop] for closing the S-CSCF CDR related to the original Access leg. This CDR may be generated with special handling. One example of special handling is to zero rate the IMS resource usage for Access leg establishment. This can be performed using the correlation mechanism with the SCC AS CDR for Access leg.
- 35-37. The UE-1 acknowledges the release of old access leg.

5.2.2.1.13.7 Session transfer from PS to (CS+PS)

In the flow figure 5.2.2.1.13.7.1, Call-ID #1 is for PS2 access leg, Call-ID #1' for PS1 access leg, Call-ID #1" for CS access leg and Call-ID #2 for remote leg.

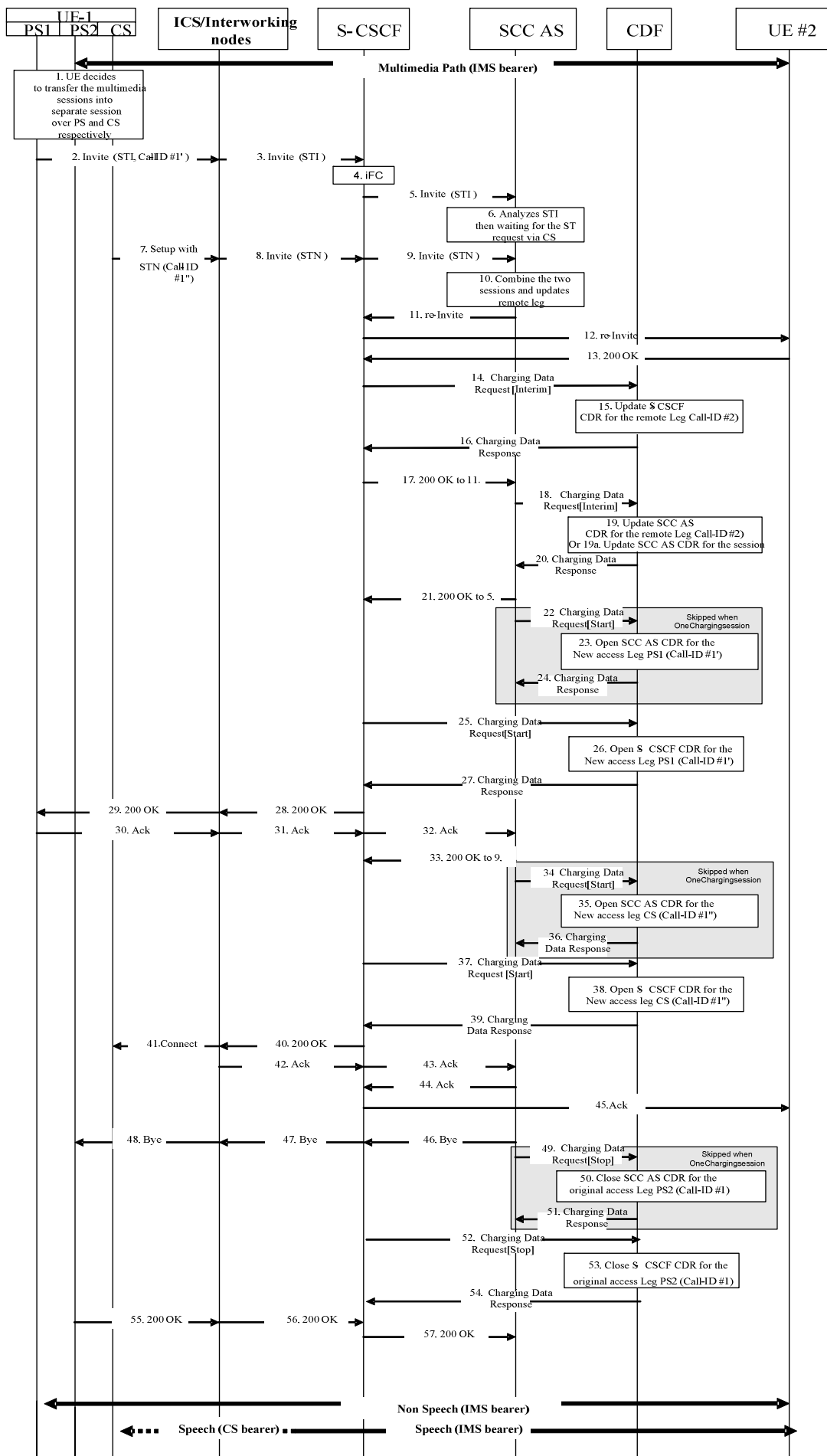

Figure 5.2.2.1.13.7.1: Message sequence chart UE domain transfer PS2 access to PS1 and CS access.

- 1-2. UE-1 originates a call in the PS1 domain including the STI to request the multimedia session transfer to PS1 access in conjunction with CS access.
3. The session establishment request is routed to the S-CSCF by the P-CSCF.
4. The S-CSCF invokes the SCC Application as the first AS of any ASs that need to remain in the path of the call after session transfer.
5. The S-CSCF forwards the SIP INVITE to the SCC Application over the ISC interface.
6. The SCC Application analyses the STI and decides to wait for the session transfer request in CS access.
7. UE-1 origins a CS call including STN to indicate to the network that this is a session transfer request.
8. The ICS intermediate Nodes convert the request into IMS SIP format and then forward the converted request to the S-CSCF.
9. The S-CSCF forwards the SIP INVITE to the SCC Application over the ISC interface.
10. The SCC Application correlates the two requests and decides to update the remote leg.
- 11-13. The SCC AS sends a SIP RE-INVITE to the Remote UE to modify the media components of the existing dialog identified in the REFER request.
The SIP RE-INVITE proposes new SDP parameters based on the parameters received from UE-2 in step 6. When the Remote UE receives the new media parameters, it returns an answer and starts the reception/transmission of these media components.
- 14-16. At Access Leg update the S-CSCF in the originating network sends Charging Data Request[Interim] to record update of a session in the S-CSCF CDR.
17. The S-CSCF answers to the SIP INVITE message in 11.
- 18-20. At Access Leg update the SCC AS sends Charging Data Request[Interim] to record update of a session in the SCC AS CDR
- 18-19a-20. Alternatively, when "OneChargingSession", the SCC AS sends an Charging Data Request[Interim] to record modification of SCC AS CDR for the IMS session (ICID) with the new PS access leg, new CS access leg and Remote leg.
The CDF updates the SCC AS CDR related to the IMS session and acknowledges the reception of the data.
21. The S-CSCF answers to the SIP INVITE message in 5.
- 22-24. Upon generation of the final response, the SCC AS in the home IMS of the originating SCC user sends an Charging Data Request[Start] to record start of a user session in the SCC AS-CDR for Call-ID #1'.
The CDF from the originating network opens an AS CDR and acknowledges the reception of the data.

Steps 22 to 24 are not applicable for the "OneChargingSession" option.
- 25-27. Upon generation of the final response, the S-CSCF in the home IMS of the originating SCC user sends an Charging Data Request[Start] to record start of a user session in the S-CSCF-CDR for Call-ID #1'. The CDF from the originating network opens an S-CSCF CDR and acknowledges the reception of the data.
- 28-29. The S-CSCF accepts session continuity message from the Remote UE by sending a SIP 200 OK response (for the PS1 INVITE message).
- 30-32. UE-1 sends an ACK response to the SCC AS.
33. The S-CSCF answers to the SIP INVITE message in 9.

34-36. Upon generation of the final response, the SCC AS in the home IMS of the originating SCC user sends an Charging Data Request[Start] to record start of a user session in the SCC AS-CDR for Call-ID #1". The CDF from the originating network opens an AS CDR and acknowledges the reception of the data.

Steps 34 to 36 are not applicable for the "OneChargingSession" option.

37-39. Upon generation of the final response, the S-CSCF in the home IMS of the originating SCC user sends an Charging Data Request[Start] to record start of a user session in the S-CSCF-CDR for Call-ID #1". The CDF from the originating network opens an S-CSCF CDR and acknowledges the reception of the data.

40-41. The S-CSCF accepts session continuity message from the Remote UE by sending a SIP 200 OK response (for the CS INVITE message).

42-44. UE-1 sends an ACK response to the S-CSCF.

45. Once acknowledgment has been received for the both leg, the ACK message is sent to the remote UE.

46-48. The SCC Application initiates to release the old access leg.

49-51. The SCC AS sends Charging Data Request[Stop] for closing the SCC AS CDR related to the original Access leg. The CDF updates the SCC AS CDR related to the IMS session and acknowledges the reception of the data.

Steps 49 to 51 are not applicable for the "OneChargingSession" option.

52-54. The S-CSCF sends Charging Data Request[Stop] for closing the S-CSCF CDR related to the original Access leg. This CDR may be generated with special handling. One example of special handling is to zero rate the IMS resource usage for Access leg establishment. This can be performed using the correlation mechanism with the SCC AS CDR for Access leg.

55-56. The UE answers by a SIP 200 OK message to the S-CSCF.

57. The S-CSCF sends a SIP 200 OK message to the SCC AS the releasing of the old access leg.

5.2.2.1.13.8 Session transfer from (CS+PS) to PS

In the flow figure 5.2.2.1.13.8.1, Call-ID #1 is for PS2 access leg, Call-ID #1' for CS access leg, Call-ID #1" for PS1 access leg and Call-ID #2 for remote leg.

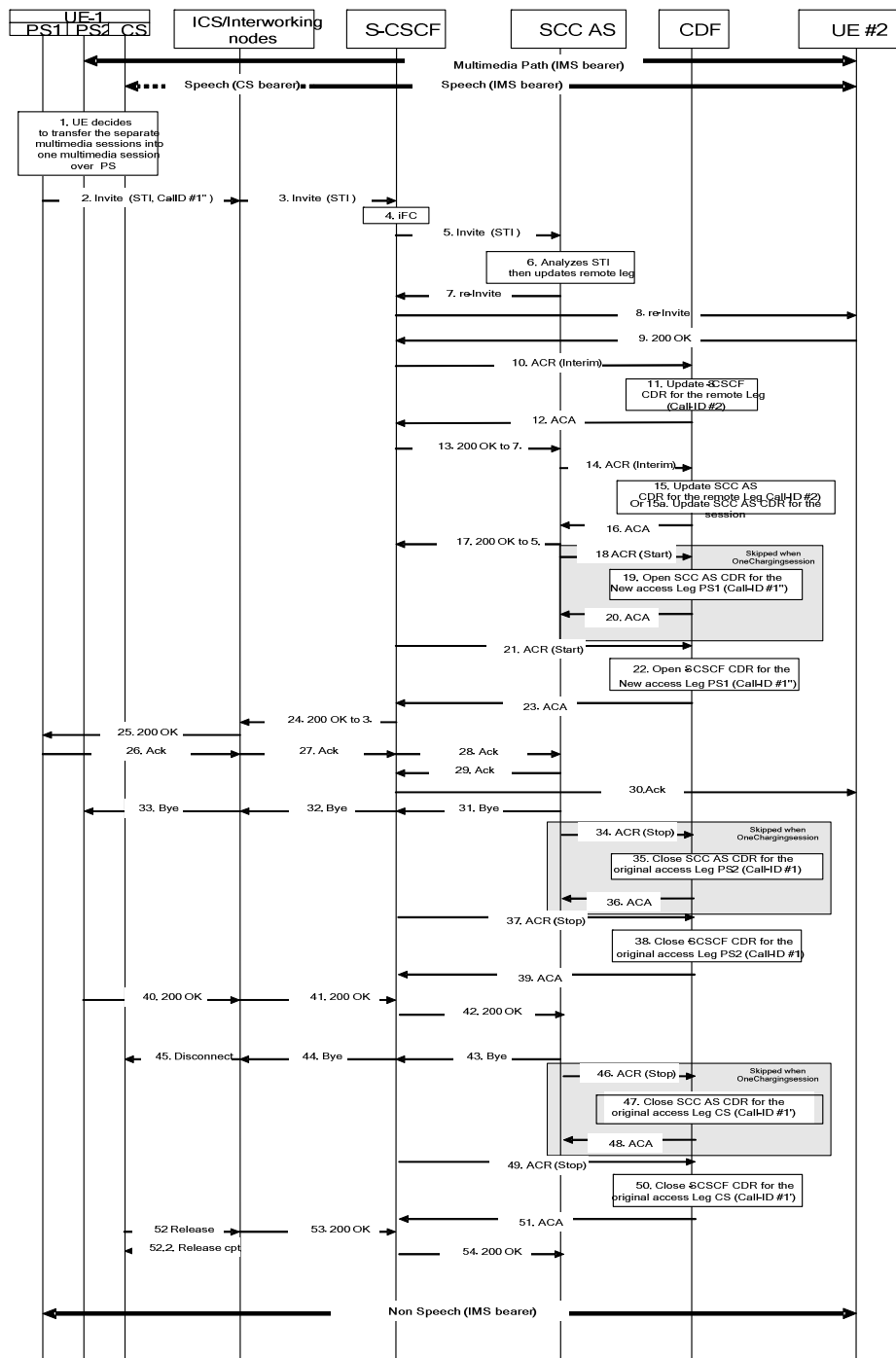

Figure 5.2.2.1.13.8.1: Message sequence chart UE domain transfer PS2 access and CS access to PS1 access

- 1-2. UE-1 originates a call in the PS1 domain including the STI to request the multimedia session transfer to PS1 access.
3. The session establishment request is routed to the S-CSCF by the P-CSCF.
4. The S-CSCF invokes the SCC Application as the first AS of any ASs that need to remain in the path of the call after session transfer.
5. The S-CSCF forwards the SIP INVITE to the SCC Application over the ISC interface.
6. The SCC Application analyses the STI and decides to update the Remote leg.

7-9. The SCC AS sends a SIP RE-INVITE to the Remote UE to modify the media components of the existing dialog identified in the REFER request.

The SIP RE-INVITE proposes new SDP parameters based on the parameters received from UE-2 in step 6. When the Remote UE receives the new media parameters, it returns an answer and starts the reception/transmission of these media components.

10-12. At Access Leg update the S-CSCF in the originating network sends Charging Data Request[Interim] to record update of a session in the S-CSCF CDR.

13. The S-CSCF answers to the SIP INVITE message in step 7.

14-16. At Access Leg update the SCC AS sends Charging Data Request[Interim] to record update of a session in the SCC AS CDR.

14-15a-16. Alternatively, when "OneChargingSession", the SCC AS sends an Charging Data Request[Interim] to record modification of SCC AS CDR for the IMS session (ICID) with remote leg and new PS access leg. The CDF updates the SCC AS CDR related to the IMS session and acknowledges the reception of the data.

17. The SCC AS answers to the SIP INVITE message in step 5.

18-20. Upon generation of the final response, the SCC AS in the home IMS of the originating SCC user sends an Charging Data Request[Start] to record start of a user session in the SCC AS-CDR. The CDF from the originating network opens an AS CDR and acknowledges the reception of the data.

Steps 18 to 19 are not applicable for the "OneChargingSession" option.

21-23. Upon generation of the final response, the S-CSCF in the home IMS of the originating SCC user sends an Charging Data Request[Start] to record start of a user session in the S-CSCF-CDR. The CDF from the originating network opens an S-CSCF CDR and acknowledges the reception of the data.

24. The S-CSCF answers to the SIP INVITE message in step 3.

25. The SIP 200 OK message is sent to UE #1.

26-30. UE-1 sends an ACK response to the S-CSCF. The ACK message is sent to the remote UE.

31-33. The source Access Leg 2(which is one of the Access Legs previously established over PS2) is released by the SCC Application in this example, however the UE-1 may initiate to release the source Access Leg 2.

34-36. The SCC AS sends Charging Data Request[Stop] for closing the SCC AS CDR related to the original Access leg. The CDF updates the SCC AS CDR related to the IMS session and acknowledges the reception of the data.

Steps 34 to 36 are not applicable for the "OneChargingSession" option.

37-39. The S-CSCF sends Charging Data Request[Stop] for closing the S-CSCF CDR related to the original PS Access leg. This CDR may be generated with special handling. One example of special handling is to zero rate the IMS resource usage for Access leg establishment. This can be performed using the correlation mechanism with the SCC AS CDR for PS Access leg.

40-42. The UE-1 answers to the BYE message in step 33.

43-45. The SCC Application initiates to release the old access leg via CS access in this example, however the UE-1 may initiate to release the source Access Leg.

46-48. The SCC AS sends Charging Data Request[Stop] for closing the SCC AS CDR related to the original CS Access leg. The CDF updates the SCC AS CDR related to the IMS session and acknowledges the reception of the data.

Steps 46 to 48 are not applicable for the "OneChargingSession" option.

49-51. The S-CSCF sends Charging Data Request[Stop] for closing the S-CSCF CDR related to the original CS Access leg. This CDR may be generated with special handling. One example of special handling is to zero rate the IMS resource usage for Access leg establishment. This can be performed using the correlation mechanism with the SCC AS CDR for CS Access leg.

52-54. The UE-1 answers to the BYE message in step 43.

5.2.2.1.13.9 IMS emergency session transfer from PS to CS

In the flow figure 5.2.2.1.13.9.1, Call-ID #1 is for PS access leg, Call-ID #1' for CS access leg and Call-ID #2 for remote leg.

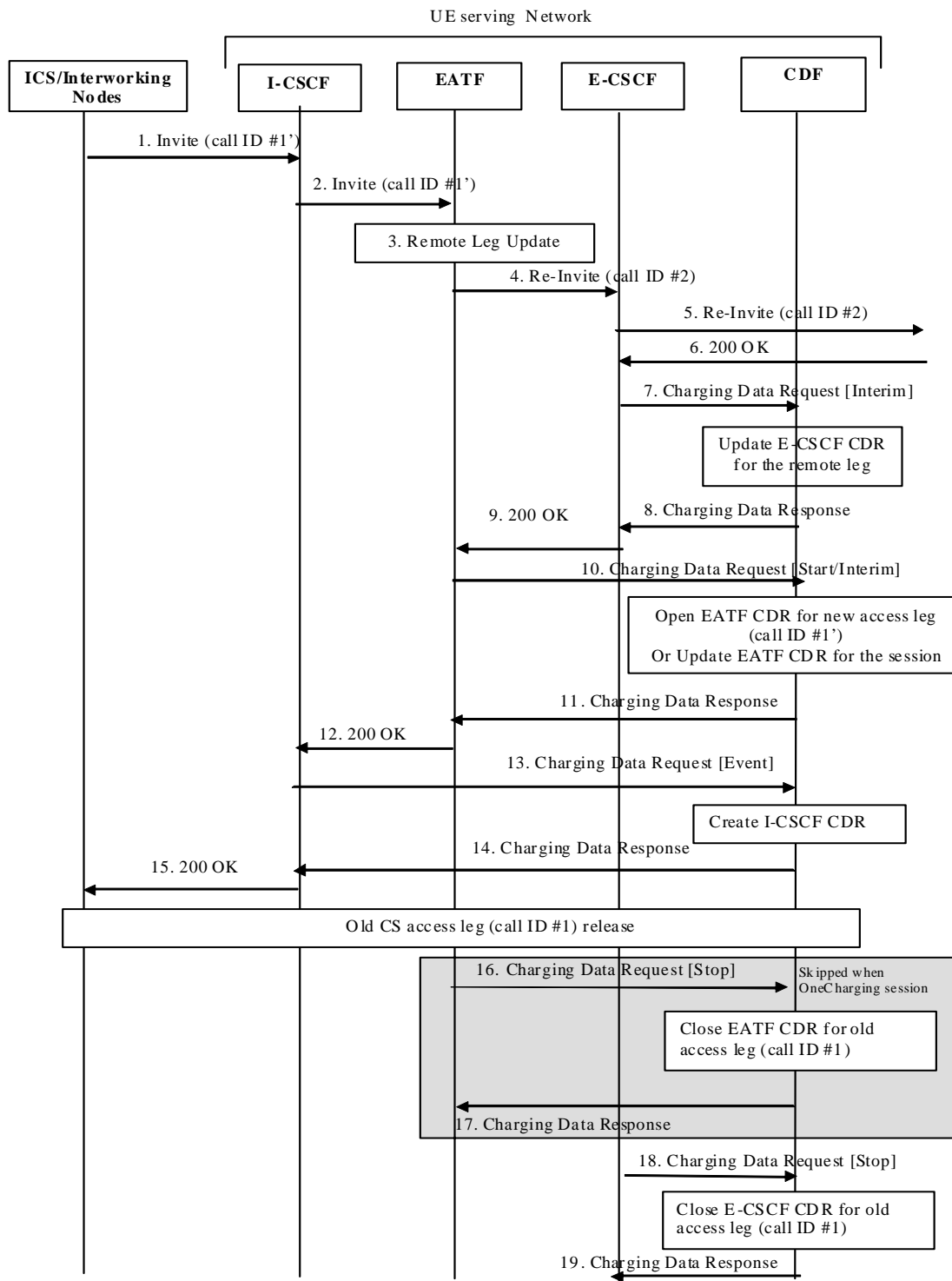

Figure 5.2.2.1.13.9.1: Message sequence chart UE domain transfer PS access to CS access for IMS emergency session.

1-2. UE originates an IMS emergency session transfer towards EATF via I-CSCF.

3. From the received INVITE analysis, the EATF derives a request for transfer of the existing IMS emergency session to the CS domain, and proceeds with switch of access leg communicating with the Remote Leg from Old PS Access Leg to new CS Access Leg.
- 4-5. The EATF performs the Remote Leg update by sending the SIP RE-INVITE request towards the remote end via E-CSCF.
- 6-8 Upon receipt of the SIP 200 OK response, the E-CSCF sends an Charging Data Request[Interim] to record update of the E-CSCF CDR for remote leg Call-ID #2.
- 9-11 Upon receipt of the SIP 200 OK response, the EATF sends an Charging Data Request[Start] to record start of an EATF CDR for new access leg Call-ID #1'. Alternatively, when "OneChargingSession", the EATF sends an Charging Data Request[Interim] to record modification of EATF CDR for the IMS session (ICID) with new CS access leg. The CDF updates the EATR CDR related to the IMS session and acknowledges the reception of the data.
- 12-14 Upon receipt of the SIP 200 OK response, the I-CSCF sends an Charging Data Request[Event] to create an I-CSCF CDR for new access leg Call-ID #1'.
15. The SIP 200 OK response is sent towards the UE via ICS/Interworking nodes.
- 16-17 Upon release of old access leg, the EATF sends an Charging Data Request[Stop] to record stop of the EATF CDR for old access leg Call-ID #1.

Steps 16 to 17 are not applicable for the "OneChargingSession" option.
- 18-19 Upon release of old access leg, the E-CSCF sends an Charging Data Request[Stop] to record stop of the E-CSCF CDR for old access leg Call-ID #1.

EATF (acting as a B2BUA) performs third party call control and is considered as an AS for the charging description.

5.2.2.1.13.10 Inter-UE transfer triggered by target UE without collaborative session establishment

In the flow figure 5.2.2.1.13.10-1, Call-ID #1 is for source access leg, Call-ID #1' for target access leg and Call-ID #2 for remote leg.

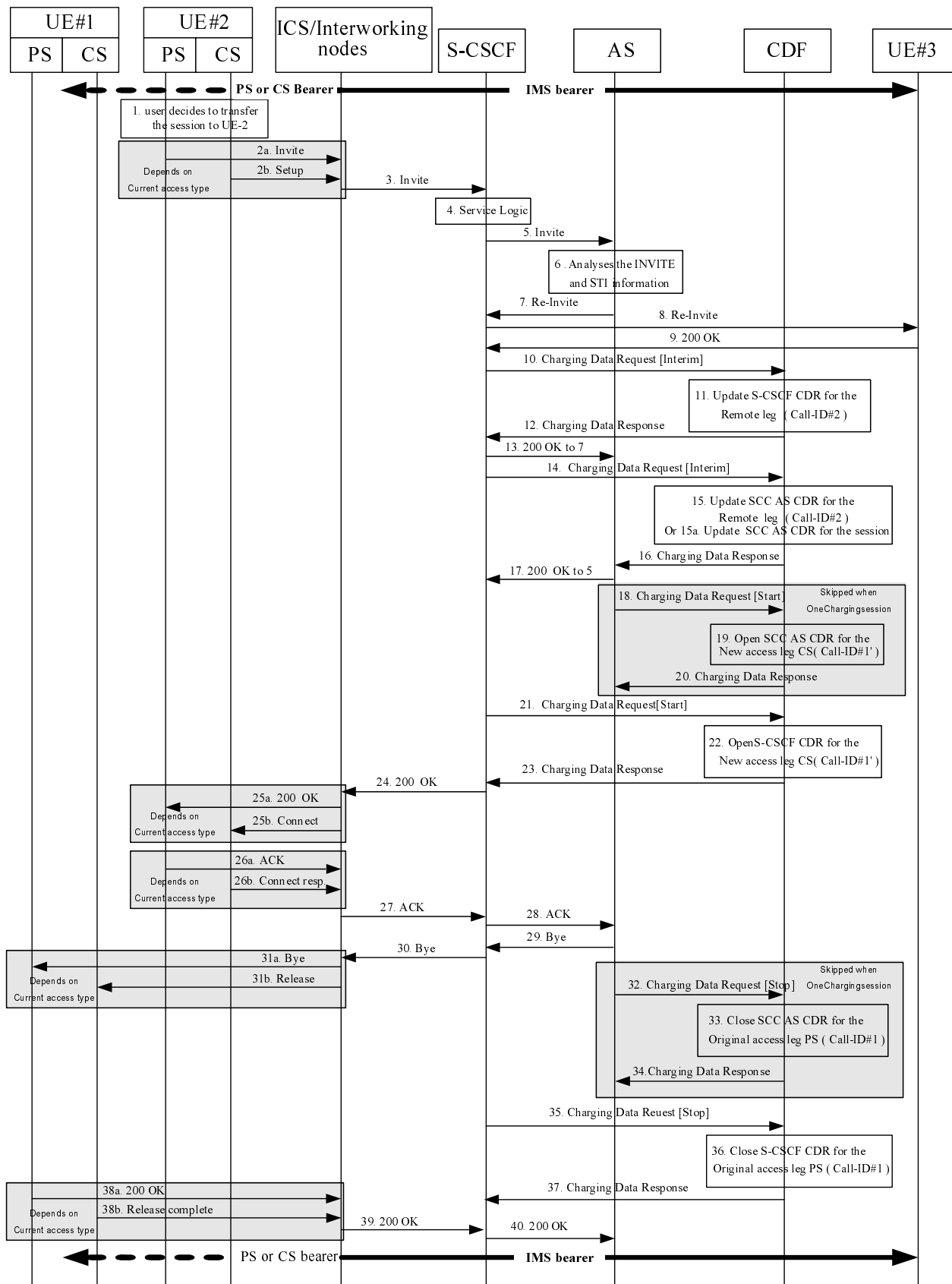

Figure 5.2.2.1.13.10-1 Message sequence chart Inter-UE transfer triggered by target UE without collaborative session establishment

The user is engaged in an active call session with UE#2 via either PS or CS access. UE#2 is having either PS or CS access (or both).

1. The user decides to transfer the session to UE#2, therefore initiates a call with UE#2 in its current (PS or CS) domain including the STN information to request the transfer of the session to UE#2.
- 2a. UE#2 originates a call in PS domain including the STN information to initiate Inter-UE transfer
- 2b. UE#2 originates a call in CS domain including the STN information (Inter-UE STN number) to initiate Inter-UE transfer. The ICS intermediate Nodes convert the request into IMS SIP format.
3. The request is forwarded to the S-CSCF.
4. The S-CSCF invokes the SCC Application as the first AS of any ASs that need to remain in the path of the call after session transfer.
5. The S-CSCF forwards the SIP INVITE to the SCC Application over the ISC interface.
- 6 The SCC AS analyses the SIP INVITE to derive that the SIP INVITE is a request to transfer a session from UE#1 to UE#2.
- 7-9. The SCC AS sends a SIP Re-INVITE to the Remote UE to update the media components of the previous dialog. Remote UE answers by a SIP 200 OK message.
- 10-12. At Remote Leg update the S-CSCF in the originating network sends Charging Data Request[Interim] to record update of a session in the S-CSCF CDR.
13. The S-CSCF answers to the SIP INVITE message in 7.
- 14-16. At Remote Leg update the SCC AS sends Charging Data Request[Interim] to record update of a session in the SCC AS CDR.
- 14-15a-16. Alternatively, when "OneChargingSession", the SCC AS sends an Charging Data Request[Interim] to record modification of SCC AS CDR for the IMS session (ICID) with the new legs configuration (Remote leg and new CS access leg).The CDF updates the SCC AS CDR related to the IMS session and acknowledges the reception of the data.
17. The SCC AS answers to the SIP INVITE message in 5.18-20. Upon generation of the SIP 200 OK response, the SCC AS in the home IMS of the originating SCC user sends an Charging Data Request[Start] to record start of a user session in the SCC AS-CDR for Call-ID #1'. The CDF from the originating network opens an AS CDR and acknowledges the reception of the data.

Steps 18 to 20 are not applicable for the "OneChargingSession" option.
- 21-23. Upon generation of the SIP 200 OK response, the S-CSCF in the home IMS of the originating SCC user sends an Charging Data Request[Start] to record start of a user session in the S-CSCF-CDR for Call-ID #1'. The CDF from the originating network opens an S-CSCF CDR and acknowledges the reception of the data.
24. The SIP 200 OK response is sent by the S-CSCF.
- 25a. The SIP 200 OK response is forwarded to UE#2.
- 25b. The SIP 200 OK response is converted by the ICS/Interworking nodes in CS format and sent to UE#2.
- 26a. UE#2 acknowledges the SIP 200 OK message.
- 26b. UE#2 acknowledges the Connect message.
- 27-28. The acknowledge from UE#2 is forwarded to the SCC AS.

29-30. The SCC application sends SIP BYE request to release the old access leg.
- 31a. The SIP BYE is forwarded to UE#1.
- 31b. The BYE is converted by the ICS/Interworking nodes in CS format and sent to UE#1.
- 32-34. At session termination the SCC AS sends Charging Data Request[Stop] to record stop of a session and stop of a media component in the SCC AS CDR. This CDR may be generated with special handling. One example of special handling is to zero rate the IMS resource usage for the Access leg establishment.

Steps 32 to 34 are not applicable for the "OneChargingSession" option.

35-37. The S-CSCF in the originating network sends Charging Data Request[Stop] for closing the S-CSCF CDR related to the initial Access leg. This CDR may be generated with special handling. One example of special handling is to zero rate the IMS resource usage for Access leg establishment. This can be performed using the correlation mechanism with the SCC AS CDR for Access leg.

38a. UE#1 acknowledges the release of old access leg in PS domain.

38b. UE#1 acknowledges the release of old access leg in CS domain. The ICS intermediate nodes convert the acknowledge into IMS SIP format.

39-40. The acknowledge of the release of old access leg is forwarded to the AS.

5.2.2.1.14 Initiating alternate charged party call

Figure 5.2.2.1.14.1 shows the case where a call with an alternate charged party is successfully initiated.

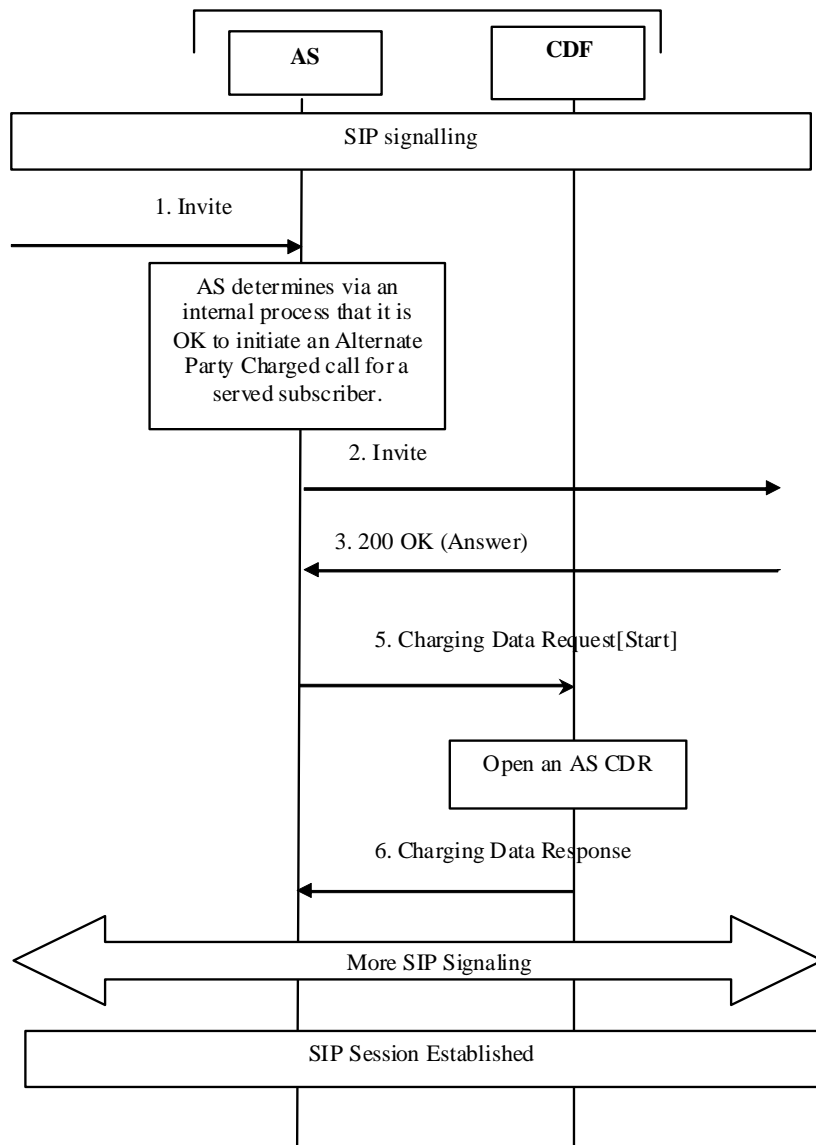

Figure 5.2.2.1.14.1: Successful Initiation of alternate party charging

1. The AS receives a SIP INVITE.
2. After determining that alternate charged party is supported, the AS initiates an Invite with an "Alternate Party Identity" for charging. The method for determination of the alternate charged party includes accessing subscriber data and doing a security assessment.
3. The terminating side issues a SIP 200 OK (Answer), to AS.
4. The AS sends a SIP 200 OK.
5. The AS sends an Charging Data Request[Start] to the CDF.

6. The CDF opens a CDR with the Subscription-ID for the Alternate Charged Party and sends an Charging Data Response to the AS.
7. The session is established.

5.2.2.1.15 Session establishment via IBCF to S-CSCF - IMS initiated

Figure 5.2.2.1.15.1 shows the Charging Data transactions that are required between IBCF, S-CSCF and CDF in each IMS network during session establishment.

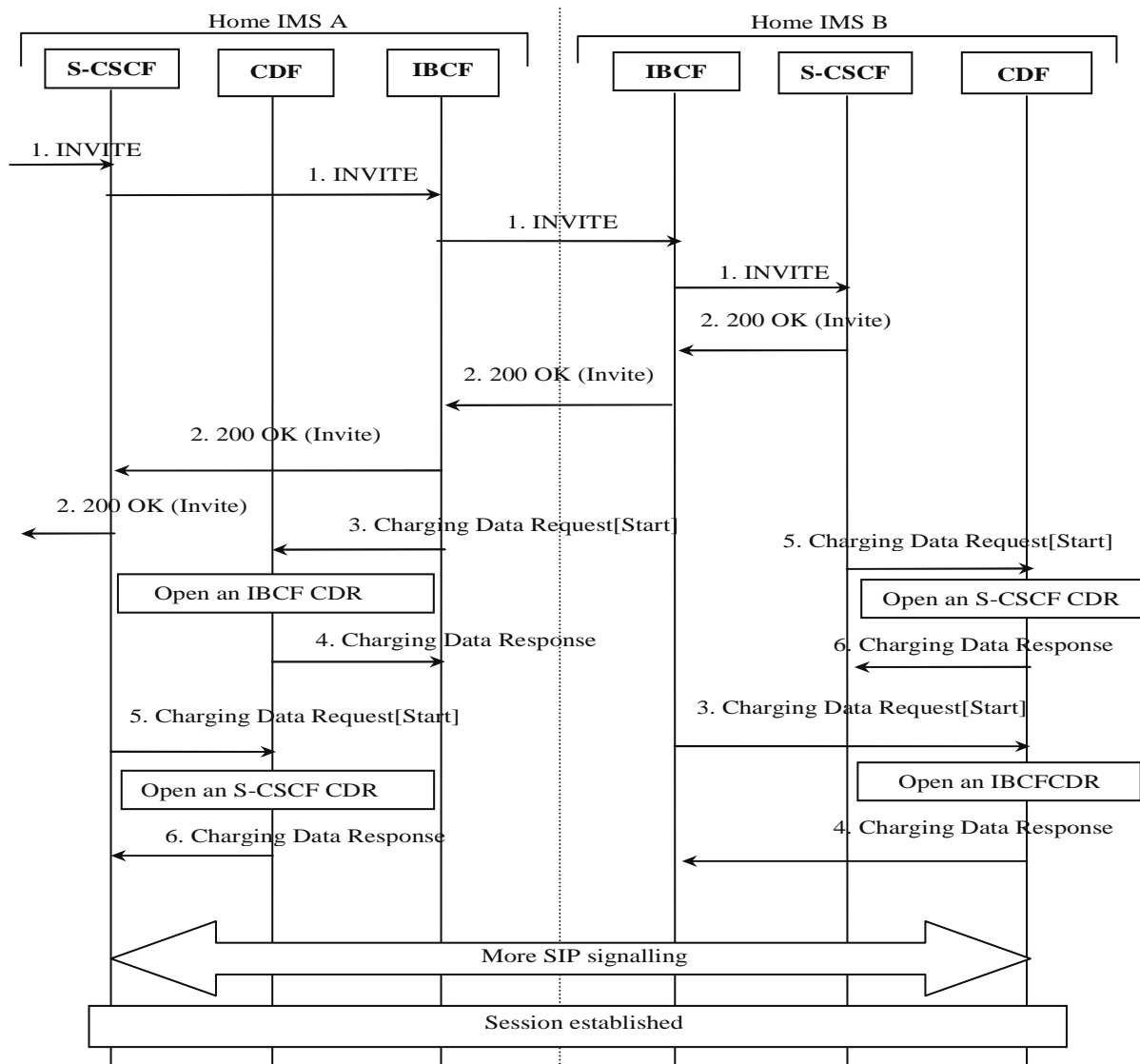

Figure 5.2.2.1.15.1: Message sequence chart for IMS initiated session establishment via IBCF

1. The session is originated in Home IMS A, and an SIP INVITE is sent through to Home IMS B via IBCFs.
2. All of the IMS network entities respond with successful SIP 200 OK to the SIP INVITE.
3. Upon reception of the answer message, the IBCFs send an Charging Data Request[Start] in each IMS to record start of a user session and start of a media component in the IBCF and CDRs.
4. The CDF in each IMS acknowledges the reception of the data and opens an IBCF CDR.
5. Upon reception of the answer message, the S-CSCFs send an Charging Data Request[Start] in each IMS to record start of a user session and start of a media component in the and S-CSCF.
6. The CDF in each IMS acknowledges the reception of the data and opens an S-CSCF CDR.
7. The session is established.

5.2.2.1.16 AS related procedures - AS acting as a MMTel AS.

For details on charging at AS acting as an MMTel server, providing service such as CDIV, CONF and TIP/TIR, see the TS 32.275 [35].

5.2.2.1.17 Session establishment via IBCF to a third party AS providing tariff information in real time (RTTI)

Figure 5.2.2.1.17.1 shows the Charging Data transactions that are required between S-CSCF, IBCF and CDF, in each IMS network, during session establishment. It represents a charging interconnect scenario where the third party AS (located in another network) provides e.g. value-added service and real time tariff information according to TS 29.658 [206].

Editor's Note: The interconnect scenario between IMS network and PSTN (involving MGCF rather than IBCF) is FFS.

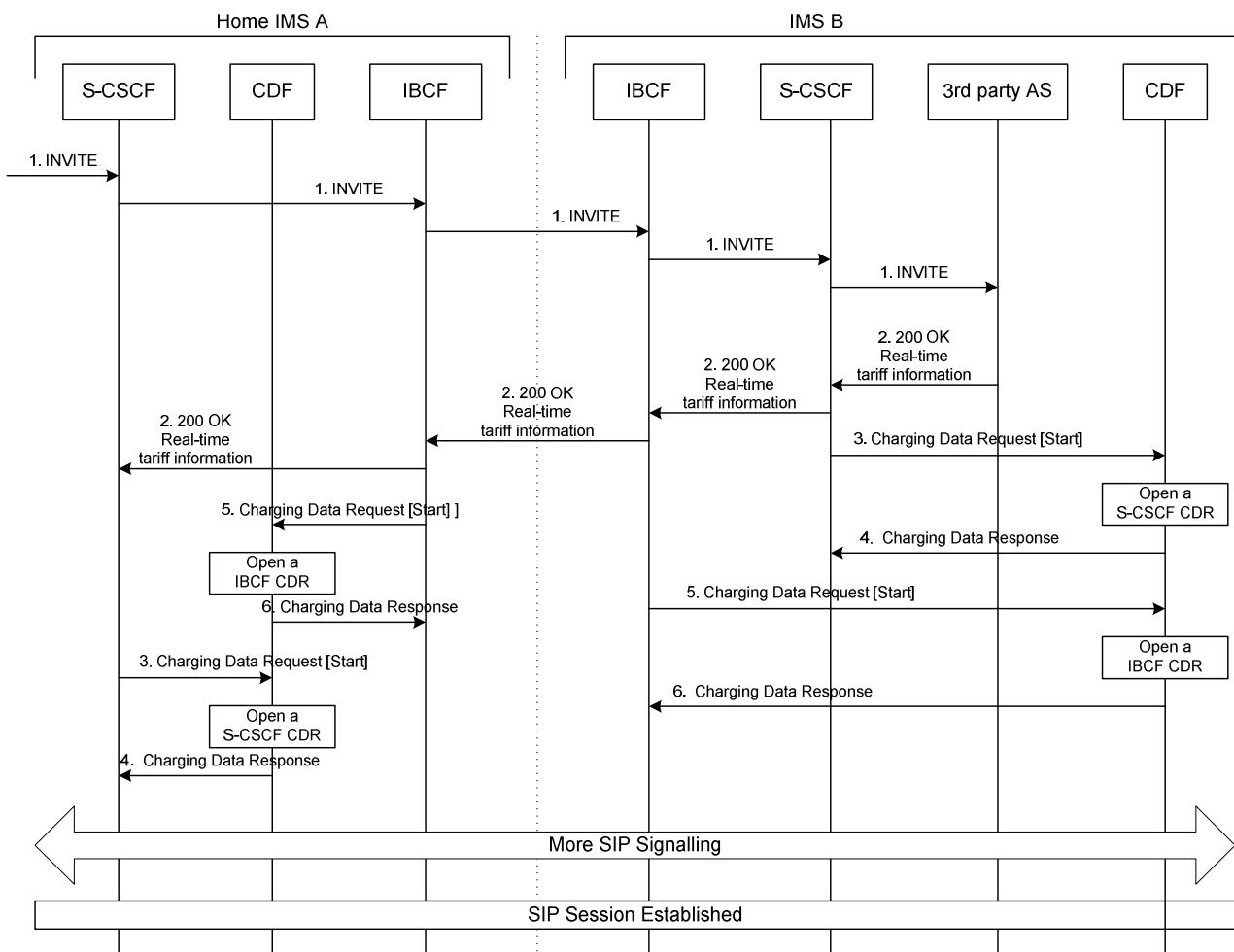

Figure 5.2.2.1.17.1: Message sequence chart for IMS initiated session establishment with a 3rd party AS providing Real-Time Tariff Information (RTTI)

1. The session is initiated.
2. The destination (third party AS) answers with successful SIP 200 OK to the SIP INVITE. The third party AS includes a real time tariff information within the SIP 200OK response.
3. Upon reception of the final response, the S-CSCF sends an Charging Data Request[Start] to record start of a user session and start of a media component in the S-CSCF.

- 4 The CDF in each IMS network acknowledges the reception of the data and opens an S-CSCF CDR.
5. Upon reception of the SIP 200 OK message, the IBCFs send an Charging Data Request[Start] in each IMS to record start of a user session and start of a media component in the IBCF.
- 6 The CDF in each IMS acknowledges the reception of the data and opens an IBCF CDR.

5.2.2.1.18 Third party AS providing tariff information in real time (RTTI) during the session

Figure 5.2.2.1.18.1 shows the Charging Data transactions that are required between S-CSCF, IBCF and CDF, in each IMS network, when a third party AS (located in another network) involved in the session provides e.g. value-added service and real time tariff information according to TS 29.658 [206] during the session.

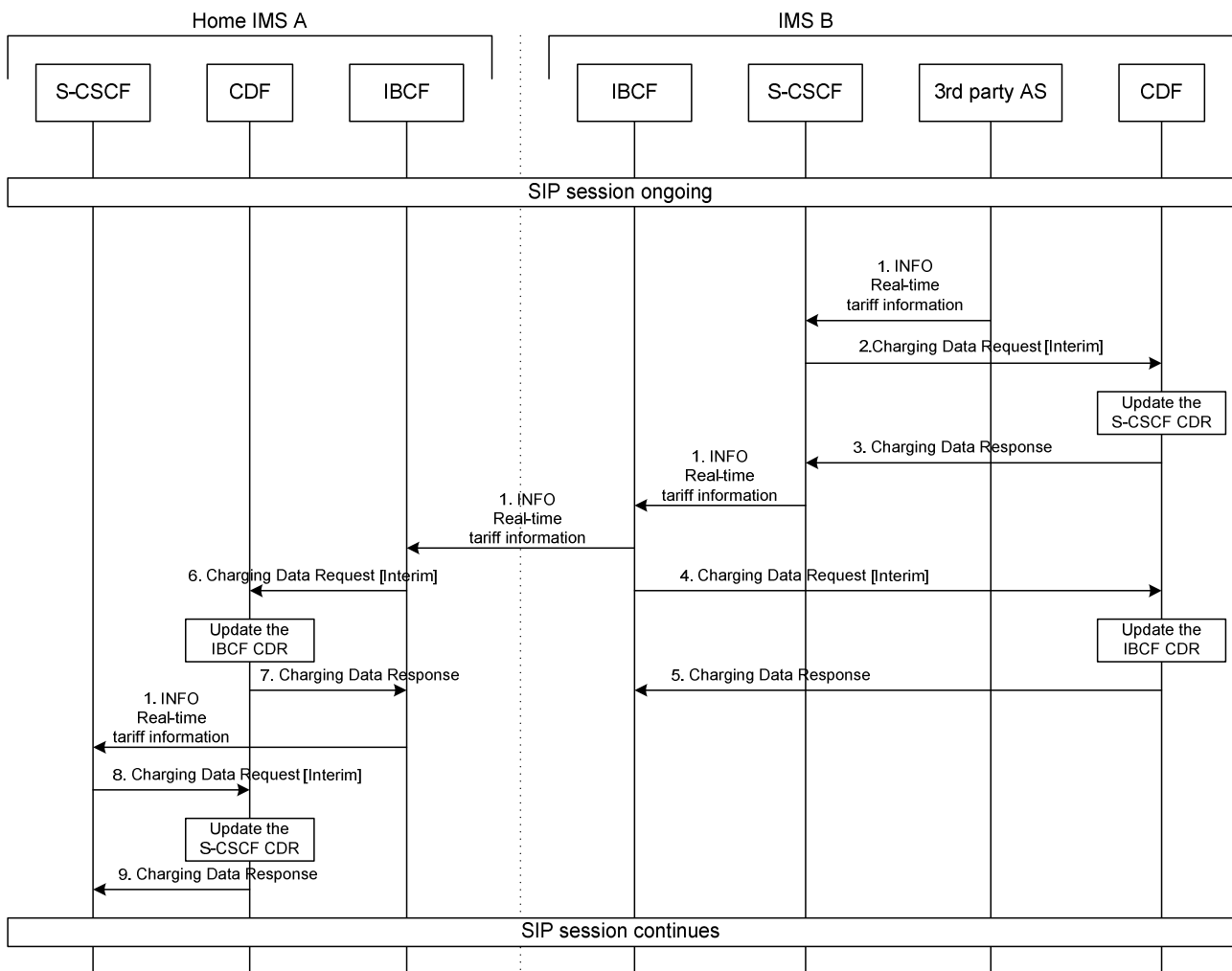

Figure 5.2.2.1.18.1: Message sequence chart for third party AS providing tariff information in real time (RTTI) during the session

1. The third party AS includes an RTTI within a SIP INFO and sends the message to the originating party.
2. Upon reception of the SIP INFO embedding RTTI, the S-CSCF sends an Charging Data Request[Interim] to record tariff information in the CDR.
3. The CDF acknowledges the reception of the data and updates the S-CSCF CDR.
4. Upon reception of the SIP INFO embedding RTTI, the IBCF sends an Charging Data Request[Interim] to record tariff information in the CDR.
5. The CDF acknowledges the reception of the data and updates the IBCF-CDR.

6. Upon reception of the SIP INFO embedding RTTI, the IBCF sends an Charging Data Request[Interim] to record tariff information in the CDR.
7. The CDF acknowledges the reception of the data and updates the IBCF-CDR.
8. Upon reception of the SIP INFO embedding RTTI, the S-CSCF sends an Charging Data Request[Interim] to record tariff information in the CDR.
9. The CDF acknowledges the reception of the data and updates the S-CSCF CDR.

5.2.2.1.19 Support of Optimal Media Routing (OMR)

5.2.2.1.19.0 Introduction

Optimal Media Routing (OMR) relies on IMS-ALG function enhancement, used by some IMS Nodes as described in TS 23.228 [201] Annex Q, when performing media functions at transport level such as firewall or NAT, or application level such as transcoding. The purpose of OMR is to identify and remove unnecessary media functions from the media path for each media stream associated to a session. The OMR procedures are applicable to the following IMS entities having IMS-ALG function used in a B2BUA mode:

- P-CSCF for support of NAT for signalling and media (with IMS-ALG/IMS-AGW model as described in TS 23.228 [201] Annex G);
- IBCF for border Control Functions towards other IMS/SIP Networks (with IBCF/TrGW model as described in TS 23.228 [201] Annex I);
- Any AS performing as a B2BUA controlling media resources.

Although the different TS 23.228 [201] scenarios mainly address the IBCF/TrGW, they are also applicable to P-CSCF/IMS-AGW, except for transcoding function which relates to IBCF only. Consequently, in the different flows, the "GW" stands for TrGW or IMS-AGW, according to the situation.

The following flows focus on one IMS Node behaviour, embedding such IMS-ALG function supporting OMR, when involved in some of OMR scenarios described in TS 23.228 [201] Annex Q.

Each media line of the same session can be applied with separate OMR decision (i.e. different optimised paths), however, for simplification, only one media is assumed in the following call flows.

In the Figure, the "Originating side" may be an Originating UA or another IMS-ALG in the same IMS Network, or another IMS Network, and the "Destination side" may be a Terminating UA or another IMS-ALG in the same IMS Network, or another IMS Network.

5.2.2.1.19.1 IMS-ALG related procedures for OMR – Session establishment and IMS-ALG bypasses its local GW

Figure 5.2.2.1.19.1.1 shows the session establishment with SDP offer/answer exchange from Originating side towards a Destination side, traversing an IMS Network Node including IMS-ALG function supporting OMR, and OMR results in IMS-ALG bypasses its local GW.

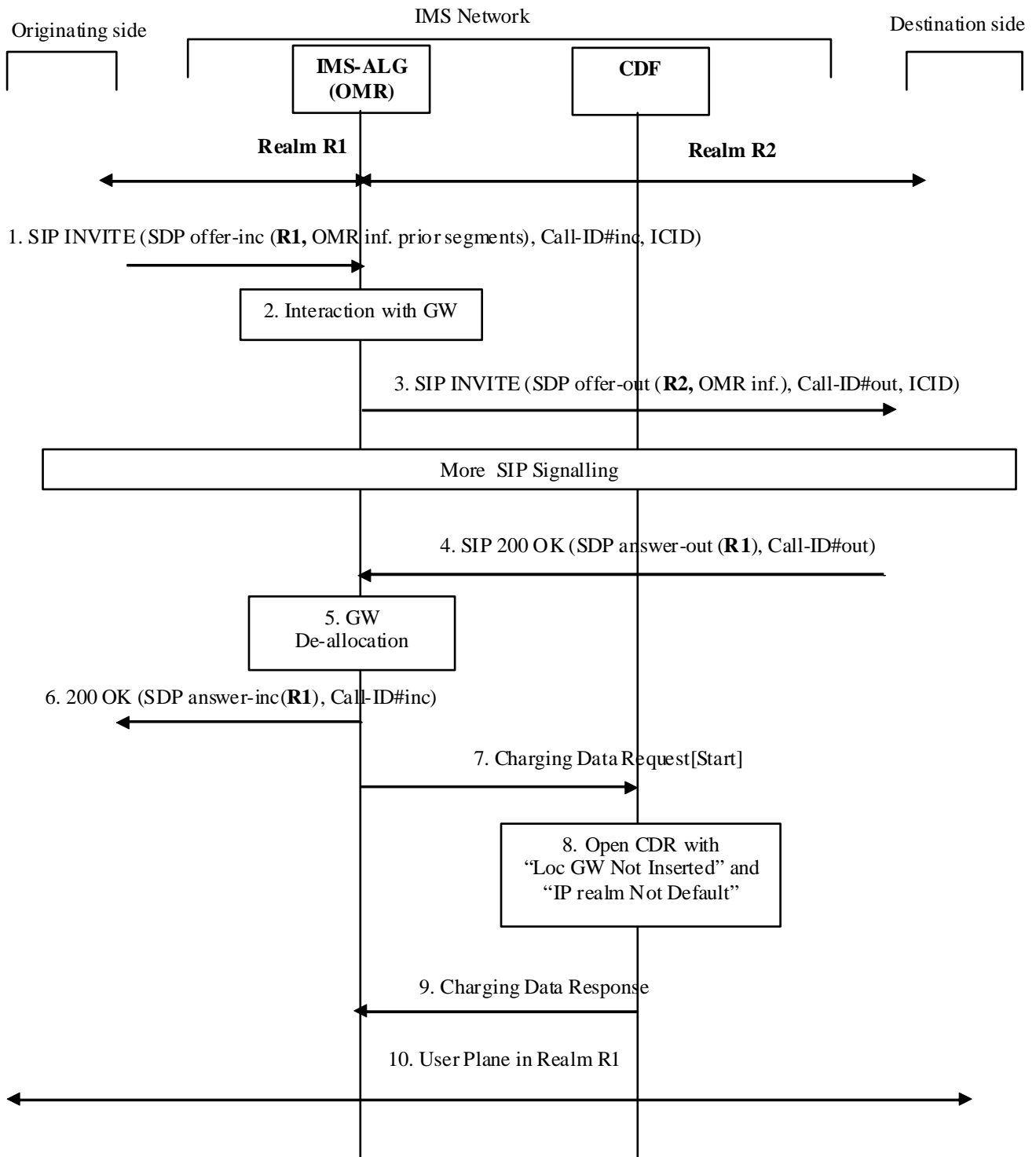

Figure 5.2.2.1.19.1.-1: Message sequence chart for session establishment with IMS-ALG supporting OMR and IMS-ALG bypasses its local GW due to OMR process.

1. IMS-ALG receives an SIP INVITE with SDP offer-inc (call-ID#-inc) from Originating side, containing the transport address allocated in realm R1 by the Originating side for the media on incoming leg, and potential OMR information from prior user plane segments.
2. IMS-ALG determines the outgoing IP realm (R2) is different from the incoming IP realm (R1) and interacts with a GW in order to allocate a local transport address for the media on outgoing leg, in realm R2.
3. IMS-ALG generates SIP INVITE towards Destination side (call-ID#-out), with a new SDP offer-out including such local transport address, and also OMR extensions (for the segment locally handled, along with those received from prior user plane segments) for further OMR decisions.

4. The destination side answers with SIP 200 OK and SDP answer-out, with the transport address allocated by the destination side for the media on outgoing leg, as result of OMR processing (based on OMR information provided in step 3). This transport address is in realm R1, thus identifying the local GW to be bypassed (i.e. same IP realm as in step 1), and also identifying use of a different IP realm from the default one (i.e. R2).
5. The Local GW is de-allocated (release of resource allocated in step 2 in realm R2).
6. IMS-ALG forwards the SDP answer-inc for the media on incoming leg, with this transport address received in step 4.
7. IMS-ALG sends Charging Data Request[Start] to record start of session with "Local GW Not Inserted" and "IP realm Not Default" indications for the media.
- 8-9. The CDF opens a session CDR for the IMS Node and acknowledges the reception of the data.
10. A user plane connection is now established in realm R1 without GW insertion for the media.

5.2.2.1.19.2 IMS-ALG related procedures for OMR – session establishment and alternate IP realm is selected

Figure 5.2.2.1.19.2.1 shows the session establishment with SDP offer/answer exchange from Originating side towards Destination side, traversing an IMS Network Node including IMS-ALG function supporting OMR, and OMR results in alternate IP realm selection (i.e. not the default IP realm) for the media.

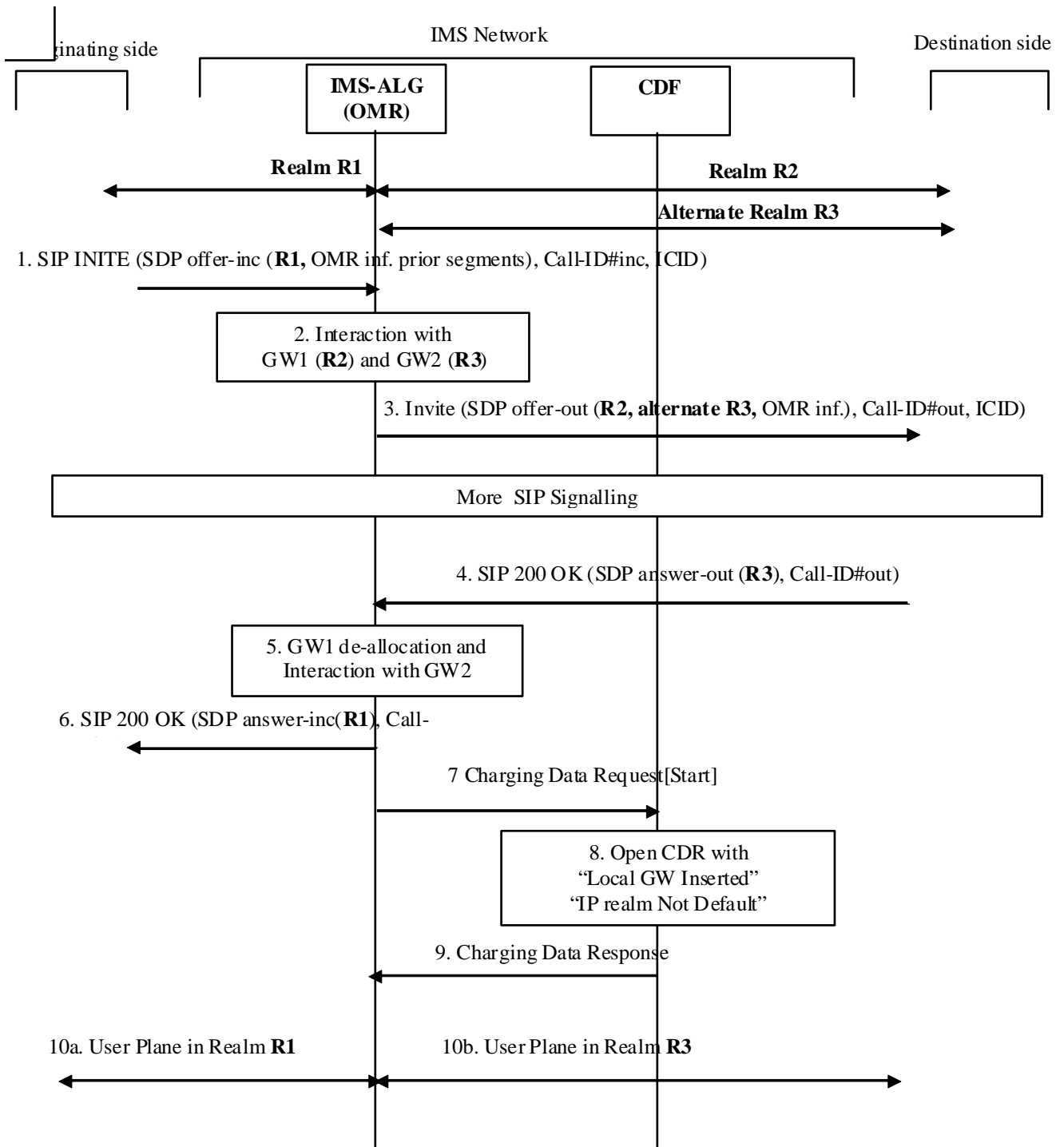

Figure 5.2.2.1.19.2.1: Message sequence chart for session establishment with IMS-ALG supporting OMR, and alternate realm is selected due to OMR process.

1. IMS-ALG receives an SIP INVITE with SDP offer-inc (call-ID#-inc) from Originating side, containing the transport address allocated in realm R1 by the Originating side for the media on incoming leg, and potential OMR information from prior user plane segments.

2. IMS-ALG determines the outgoing IP realm (R2) is different from the incoming IP realm (R1) and interacts with a GW1 in order to allocate a local transport address for the media on outgoing leg, in realm R2. IMS-ALG additionally interacts with GW2 in order to allocate an alternate local transport address for the media in realm R3.
3. IMS-ALG generates SIP INVITE towards Destination side (call-ID#-out), with a new SDP offer-out including such local transport addresses, and also OMR extensions (for the segment locally handled, along with those received from prior user plane segments) for further OMR decisions.
4. The destination side answers with SIP 200 OK and SDP answer-out, with the transport address allocated by the destination side for the media on outgoing leg, as result of OMR processing (based on OMR information provided in step 3). This transport address is in realm R3, thus identifying the local GW2 to be retained, and also identifying use of a different IP realm from the default one (i.e. R2).
5. The GW1 is de-allocated (release of resource allocated in step 2 for realm R2), and interaction occurs with GW2 to maintain the user plane connection via R3.
6. IMS-ALG1 forwards the SDP answer-inc, with the transport address allocated by the GW2 in realm R1, for the media on incoming leg.
7. IMS-ALG sends Charging Data Request[Start] to record start of session with "Local GW Inserted" and "IP realm Not Default" indications for the media.
- 8-9. The CDF opens a session CDR for the IMS Node and acknowledges the reception of the data.
- 10a-b. A user plane connection is now established in realm R1 up to the GW2, and in realm R3 from the GW2 for the media.

5.2.2.1.19.3 IMS-ALG related procedures for OMR – mid-session procedure

Figure 5.2.2.1.19.3.1 shows a scenario when a new SDP offer/answer exchange due to UE generating a SIP (RE-)INVITE or SIP UPDATE in mid-session in order to add a media component , and the OMR procedures is processed for this new media, with same situation as in clause 5.2.2.1.19.1 (IMS-ALG bypasses its local GW).

This scenario also applies for situations where a (RE-)INVITE or a SIP UPDATE is issued for updating a media and the OMR procedures is processed again, changing the established media path.

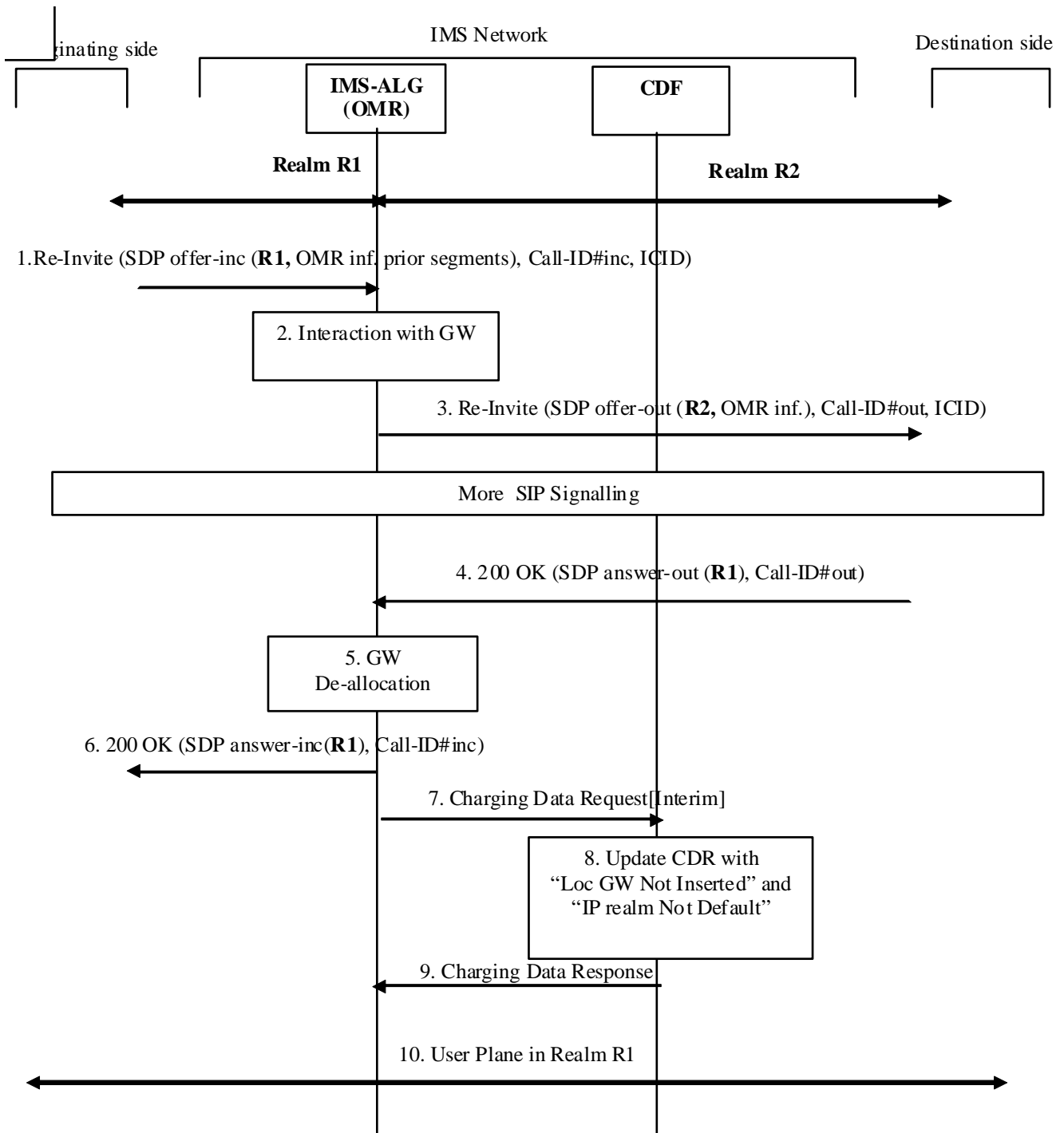

Figure 5.2.2.1.19.3.1: Message sequence chart for mid-session procedure with IMS-ALG supporting OMR, IMS-ALG bypasses its GW due to OMR process for the added media.

The same steps described in clause 5.2.2.1.19.1 apply, with following exceptions:

- 1 and 3. A SIP RE-INVITE instead of SIP INVITE

7. IMS-ALG sends Charging Data Request[Interim] to record update of session with "Local GW Not Inserted" and "IP realm Not Default" indications for the media.

8-9. The CDF updates the session CDR for the IMS Node and acknowledges the reception of the data.

5.2.2.1.19.4 IMS-ALG related procedures for OMR – transcoding

5.2.2.1.19.4.0 Introduction

As described in TS 23.228 [201] Annex Q, transcoding is also part of OMR process.

The following flows 5.2.2.1.19.4.1 show session establishment with SDP offer/answer exchange from Originating side towards a Destination side, traversing an IMS Network Node including IMS-ALG function supporting OMR with transcoder inserted by this IMS node.

Although transcoding aspect is part of the same SDP offer/answer different exchanges described in clause 5.2.2.1.19.1 to clause 5.2.2.1.19.3, therefore combined in OMR process, it is reflected here through dedicated flows for simplification.

These procedures apply to IBCF/TrGW only.

5.2.2.1.19.4.1 IMS-ALG Related Procedures for OMR – transcoder provided by IMS-ALG

The flow in figure 5.2.2.1.19.4.1.1 describes the situation where IMS-ALG allocates a transcoder for offering an additional transcoding option, and this transcoder is selected.

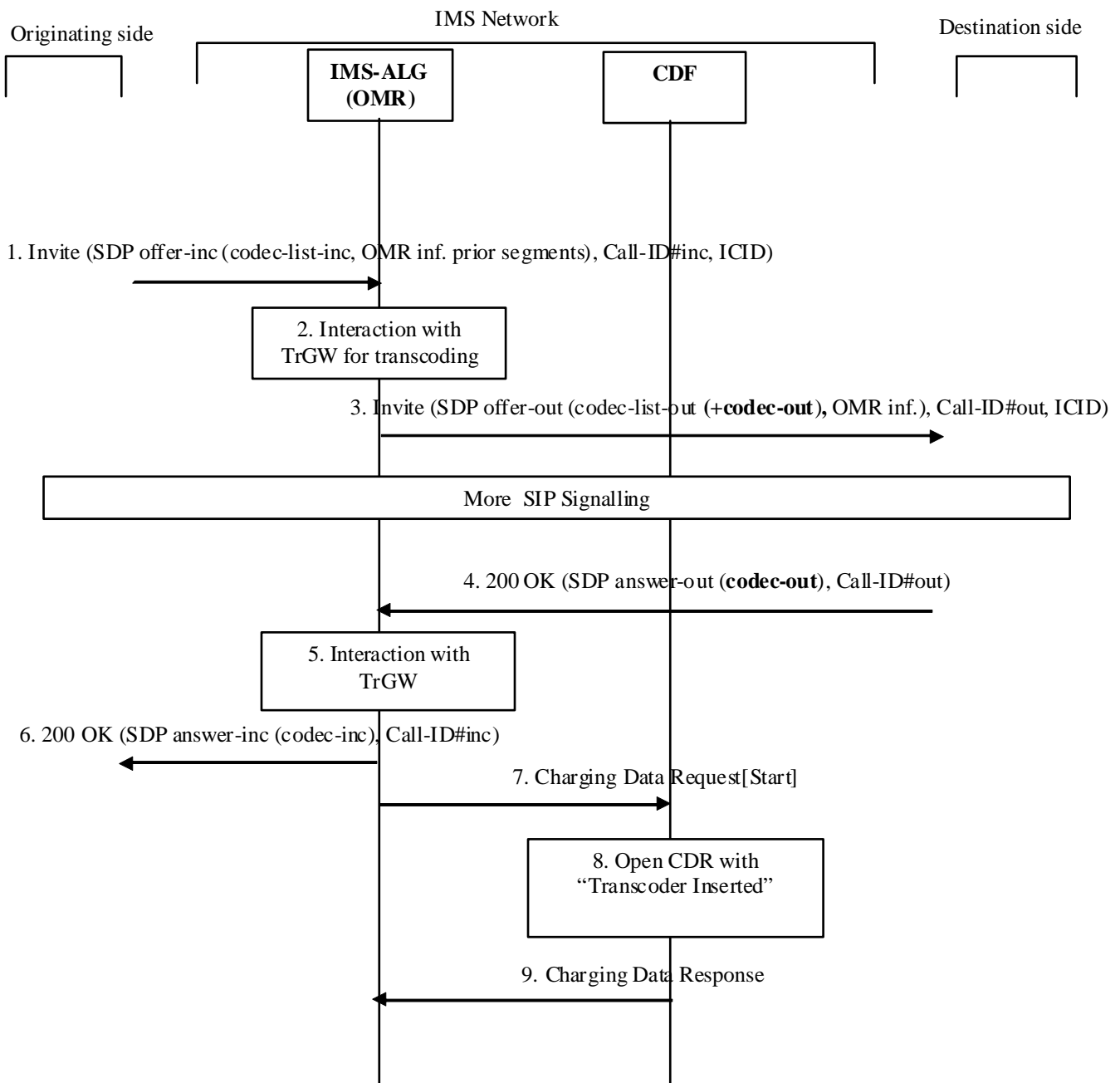

Figure 5.2.2.1.19.4.1.1: Message sequence chart for Session establishment with transcoder offered by IMS-ALG is inserted

1. IMS-ALG receives an SIP INVITE with SDP offer-inc (call-ID#-inc) from Originating side, containing a codec-list-inc in the SDP offer, and potential OMR information from prior user plane segments based on an Operator's configuration.
2. IMS-ALG interacts with TrGW for transcoder allocation for the purpose of offering an additional codec "codec-out".
 3. IMS-ALG generates INVITE towards Destination side (call-ID#-out), the SDP offer-out containing the new codec-list-out (i.e. codec-list-inc enriched with "codec-out"), and also OMR extensions (for transcoding options associated to different segments).
4. The destination side answers with SIP 200 OK and SDP answer-out with the selected codec which is the additional one offered by IMS-ALG (i.e. codec-out).

5. Interaction occurs with TrGW for media configuration with codec-out for the outgoing leg and with codec-inc for the incoming leg (codec-inc is selected by IBCF from the codec-list-inc received in step 1).
6. IMS-ALG forwards the SDP answer-inc for the incoming leg, with this codec-inc.
7. IMS-ALG sends Charging Data Request[Start] to record start of session with "Transcoder Inserted" indication for the media.
- 8-9. The CDF opens a session CDR for the IMS Node and acknowledges the reception of the data.

5.2.2.1.19.4.2 IMS-ALG related procedures for OMR – transcoder offered by IMS-ALG but not selected

The flow in figure 5.2.2.1.19.4.2.1 describes the situation where IMS-ALG allocates a transcoder for offering an additional transcoding option, and this transcoder is not selected.

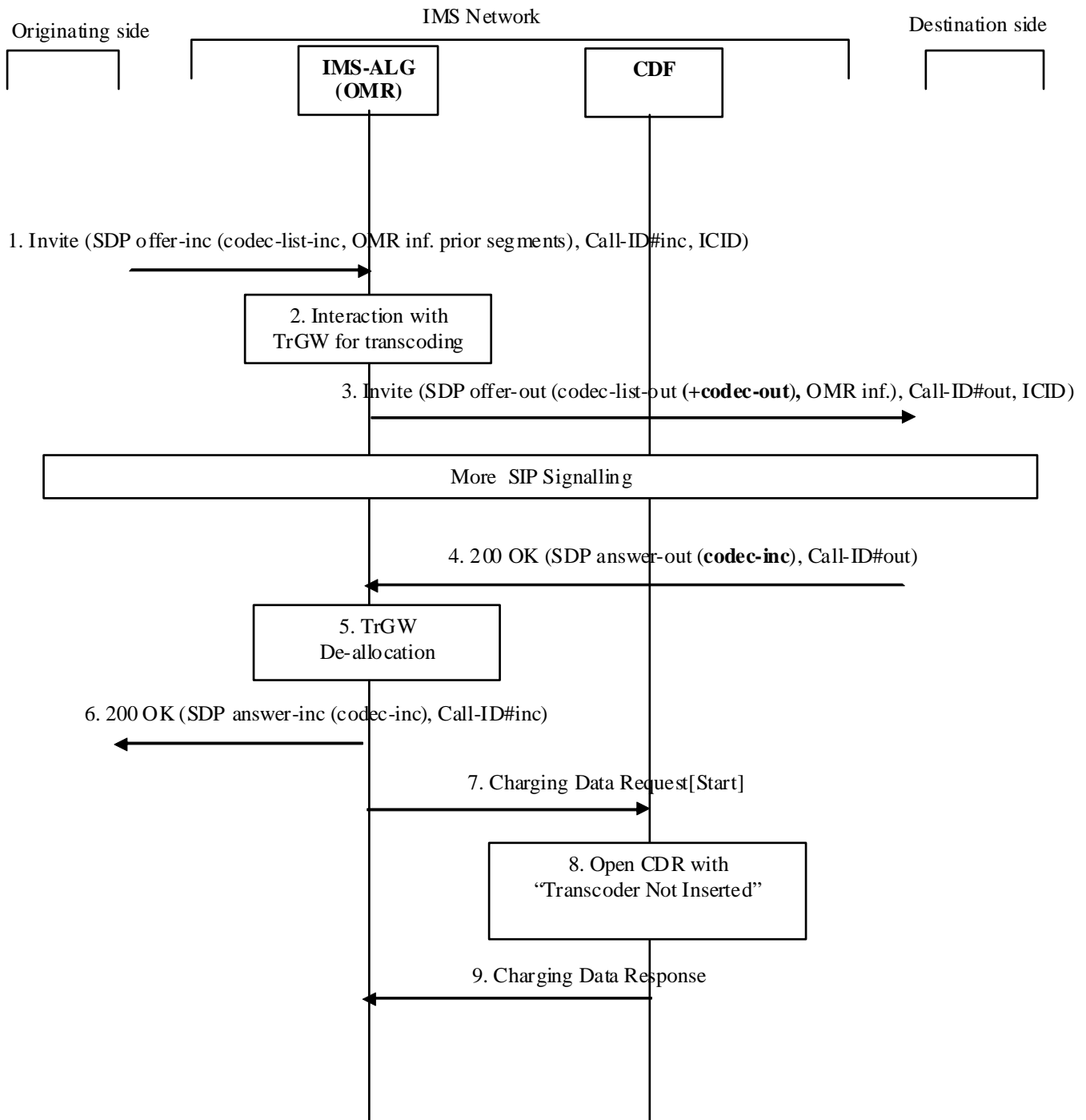

Figure 5.2.2.1.19.4.2.1: Message sequence chart for session establishment with transcoder offered by IMS-ALG is not selected

1. IMS-ALG receives an SIP INVITE with SDP offer-inc (call-ID#-inc) from Originating side, containing a codec-list-inc in the SDP offer, and potential OMR information from prior user plane segments, based on an Operator's configuration.
2. IMS-ALG interacts with TrGW for transcoder allocation for the purpose of offering additional codec "codec-out".
3. IMS-ALG generates SIP INVITE towards Destination side (call-ID#-out), the SDP offer-out containing the new codec-list-out (i.e. codec-list-inc enriched with "codec-out"), and also OMR extensions (for transcoding options associated to different segments).

4. The destination side answers with SIP 200 OK and SDP answer-out with the selected codec (codec-inc), belonging to the codec-list-inc received in step 1 (original offer).
5. Therefore, transcoding is not needed, and TrGW is de-allocated.
6. IMS-ALG forwards the SDP answer-inc for the incoming leg, with this codec-inc.
7. IMS-ALG sends Charging Data Request[Start] to record start of session with "Transcoder Not Inserted" indication for the media.
- 8-9. The CDF opens a session CDR for the IMS Node and acknowledges the reception of the data.

5.2.2.1.20 AS acting as a B2BUA – single charging session

Figure 5.2.2.1.20.1 shows the case where an AS acts as a B2BUA, and a single offline charging session is created for the established dialogs ("OneChargingSession" option)

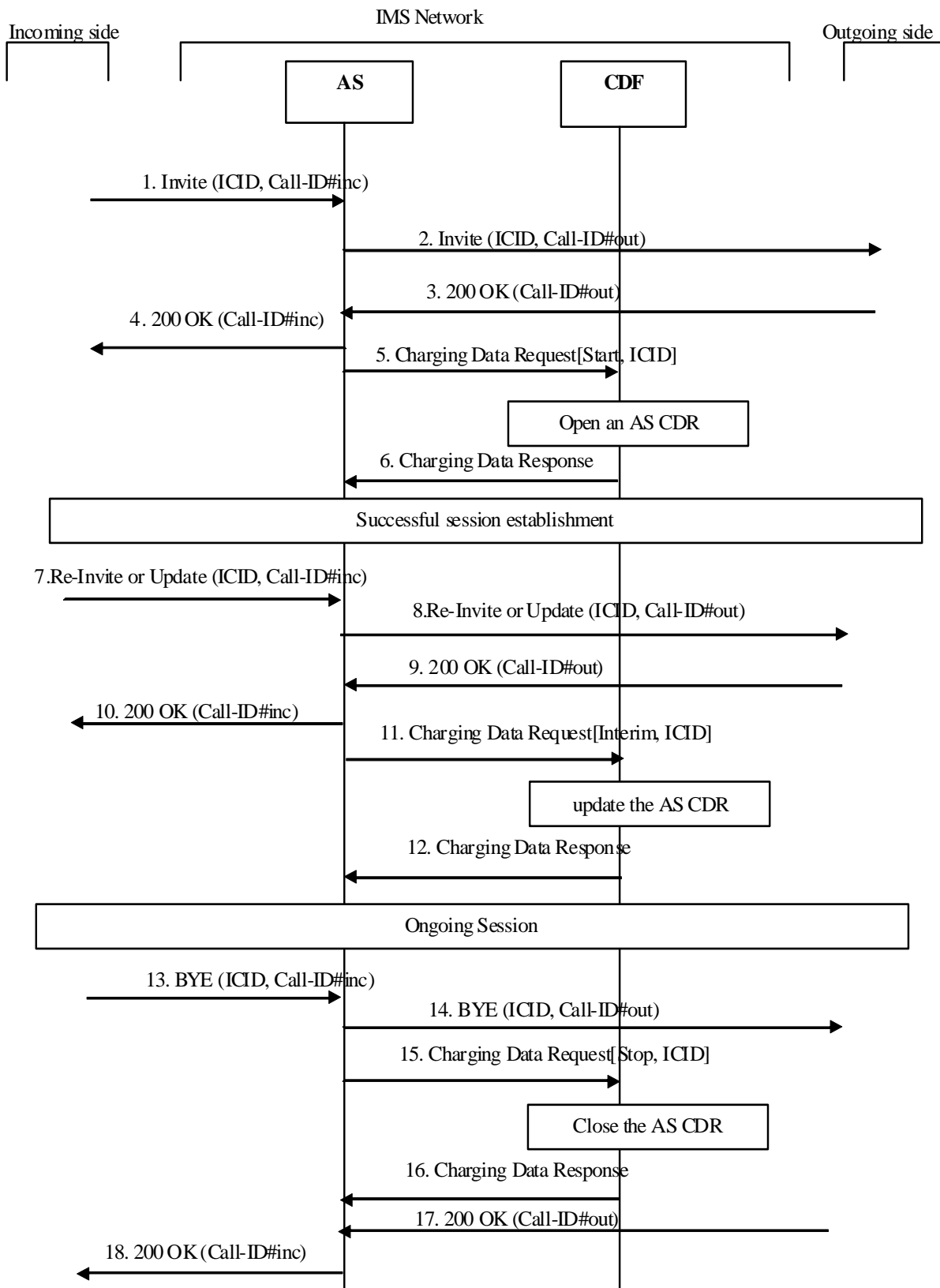

Figure 5.2.2.1.20.1: Message sequence chart for AS acting as a B2BUA with single charging session

1. AS receives the SIP INVITE from Incoming side (Call-ID#inc) containing ICID.

2. AS acting as a B2BUA generates SIP INVITE towards Outgoing side (Call-ID#out) with the same ICID as received in step 1.
3. SIP 200 OK is received in response to the SIP INVITE (Call-ID#out).
4. SIP 200 OK is sent in response to the SIP INVITE (Call-ID#inc).
5. AS sends Charging Data Request[Start] to record start of a session, provided with ICID and information associated to both Call-ID#inc and Call-ID#out.
6. The CDF acknowledges the reception of the Charging Data Request[Start] and opens a AS CDR.
7. AS receives a mid-session (e.g. in order to modify media component(s)) SIP RE-INVITE or SIP UPDATE from Incoming side (Call-ID#inc) for the IMS session (ICID).
8. AS generates SIP RE-INVITE or SIP UPDATE towards Outgoing side (Call-ID#out)
- 9-10. AS sends SIP 200 OK (Call-ID#inc) towards Incoming side, when SIP 200 OK (Call-ID#out) response is received from Outgoing side.
11. AS sends an Charging Data Request[Interim] to record changes associated to Call-ID#inc or/and Call-ID#out (e.g. changed media component(s)) in the AS CDR for the IMS session (ICID).
12. The CDF acknowledges the reception of the data and updates the AS CDR.
13. AS receives BYE from Incoming side (Call-ID#inc)
14. AS sends BYE towards Outgoing side (Call-ID#out)
15. AS sends an Charging Data Request[Stop] to record stop of a session in the AS CDR for the IMS session (ICID).
16. The CDF acknowledges the reception of the data and closes the AS CDR.
- 17-18. AS sends SIP 200 OK (Call-ID#inc) towards Incoming side, when SIP 200 OK (Call-ID#out) response is received from Outgoing side.

5.2.2.1.21 Session establishment for roaming architecture for voice over IMS with local breakout

Figure 5.2.2.1.21.1 shows the Charging Data transactions initiated by the P-CSCF, S-CSCF, IBCF, and TRF towards the CDF that are required for a roaming architecture for voice over IMS with local breakout in each IMS network during session establishment. This example pertains to the flow in Annex M.3.1.3 in TS 23.228 [201] in which loopback and OMR procedures are applied between the visited network and the home network serving UE A.

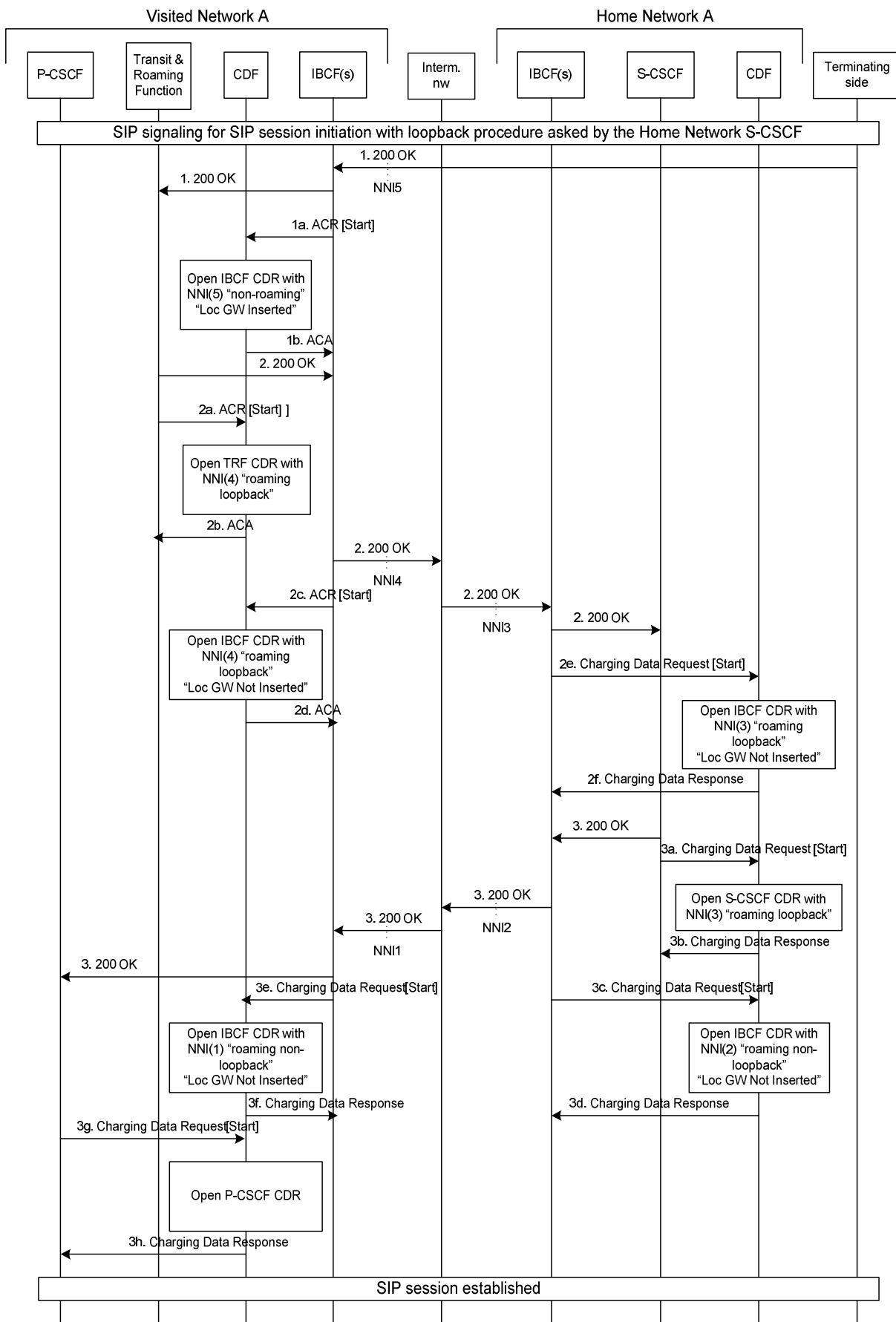

Figure 5.2.2.1.21.1: Message sequence chart for roaming architecture for voice over IMS with local breakout with "VPLMN routing" and TRF

1. The session initiation is acknowledged by the SIP 200 OK by the termination side and received by the IBCF in the Visited Network A.
 - 1a. IBCF sends Charging Data Request[Start] to record start of session with "Local GW Inserted" indication and with information on the non-roaming NNI 5 used for interconnection towards the terminating network.
 - 1b. The CDF acknowledges the reception of the data and opens an IBCF CDR.
2. The Visited Network A TRF performs the loopback procedure and the session acknowledgement is routed towards the Home network through an IBCF.
 - 2a. TRF sends Charging Data Request[Start] to record start of session and indicating loopback routing from the roaming NNI.
 - 2b. The CDF acknowledges the reception of the data and opens a TRF CDR.
 - 2c. IBCF sends Charging Data Request[Start] to record start of session with "Local GW Not Inserted" indication and with information on the roaming NNI 4 interconnecting to the intermediate network for the loopback path.
 - 2d. The CDF acknowledges the reception of the data and opens an IBCF CDR.
 - 2e. IBCF sends Charging Data Request[Start] to record start of session with "Local GW Not Inserted" indication and with information on the roaming NNI 3 interconnecting to the intermediate network for the loopback path.
 - 2f. The CDF acknowledges the reception of the data and opens an IBCF CDR.
3. The S-CSCF in the Home Network A routes the session acknowledgement towards the Visited Network A through an IBCF.
 - 3a. S-CSCF sends Charging Data Request[Start] to record start of session and indicating loopback routing to the roaming NNI.
 - 3b. The CDF acknowledges the reception of the data and opens an IBCF CDR.
 - 3c. IBCF sends Charging Data Request[Start] to record start of session with "Local GW Not Inserted" indication and with information on the roaming NNI 2 interconnecting to the intermediate network for the non-loopback path.
 - 3d. The CDF acknowledges the reception of the data and opens an IBCF CDR.
 - 3e. IBCF sends Charging Data Request[Start] to record start of session with "Local GW Not Inserted" indication and with information on the roaming NNI 1 interconnecting to the intermediate network for the non-loopback path.
 - 3f. The CDF acknowledges the reception of the data and opens an IBCF CDR.
 - 3g. P-CSCF sends Charging Data Request[Start] to record start of session.
 - 3h. The CDF acknowledges the reception of the data and opens an IBCF CDR.

5.2.2.1.22 Service continuity using ATCF

5.2.2.1.22.0 Introduction

Service continuity using ATCF call flows with alternative "OneChargingSession" option reflected in the different flows description, i.e. a single charging session from ATCF.

5.2.2.1.22.1 UE originating call (CS only) through ATCF

In the flow figure 5.2.2.1.22.1.1, Call-ID #1 is for serving leg and Call-ID #2 is for home leg of CS access leg.

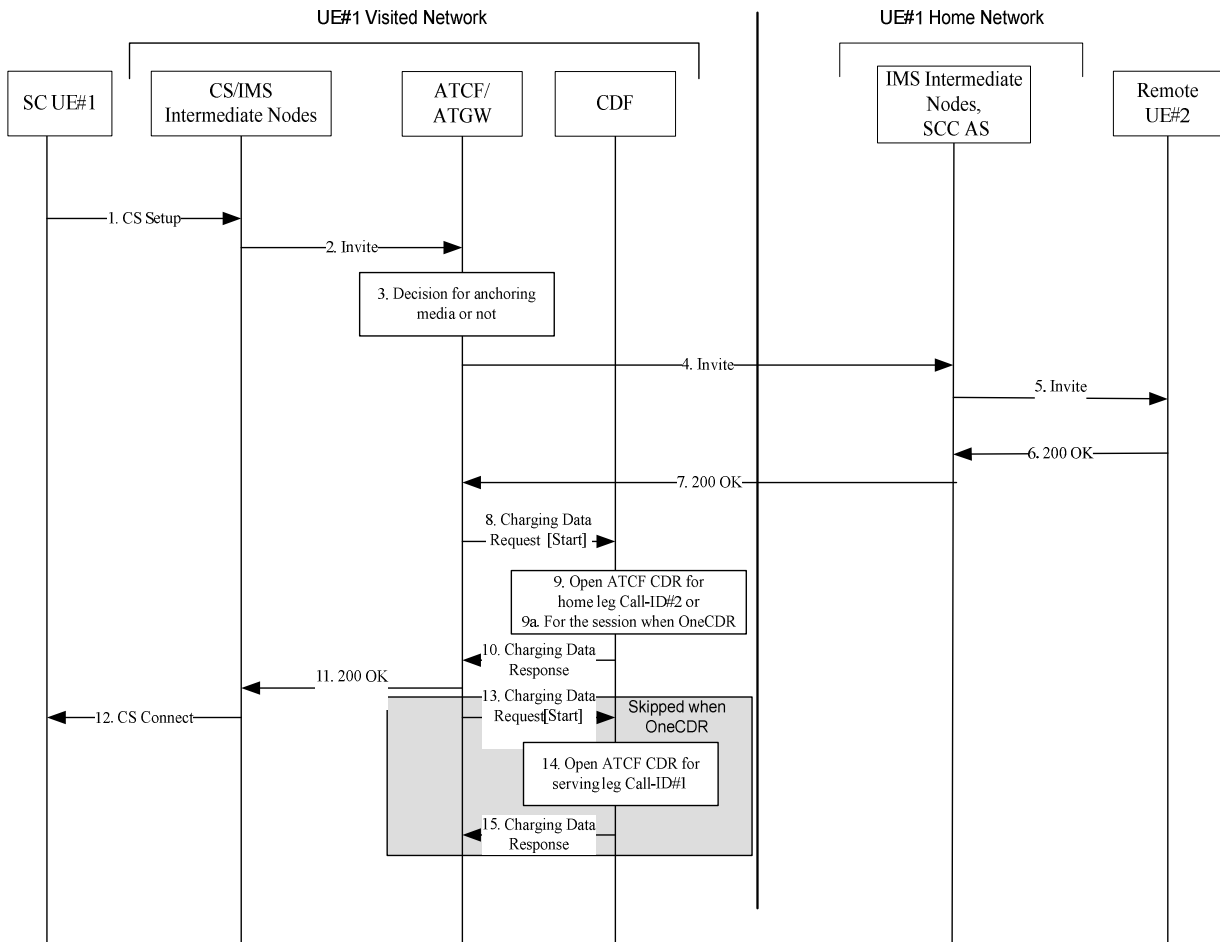

Figure 5.2.2.1.22.1.1: Message sequence chart UE originating call (CS only) through ATCF

1. The SCC session is initiated by UE#1 sending a Call Setup.
 2. After processing at CS/PS intermediate nodes, the resulting SIP INVITE goes through the ATCF in the UE#1 serving network.
 3. The ATCF may decide whether to anchor the media session, and allocate if needed, ATGW resources to it.
 4. The ATCF create an SIP INVITE request message and send it to the UE#1 Home Network SCC AS.
 5. The call setup proceeds and is routed to the remote UE-2.
 - 6-7. On response SIP 200 OK from the remote UE#2, response SIP 200 OK is transmitted to UE#1 serving network.
 8. Upon reception of the final response, the ATCF sends an Charging Data Request[Start] to record start of a user session/media component in the ATCF CDR for the IMS session.
 - 9-10. The CDF from the Serving network opens an ATCF CDR for the home leg (Call-ID#2) and acknowledges the reception of the data.
 - 9a-10. Alternatively, when "OneChargingSession", the CDF opens an ATCF CDR related to the IMS session, with serving leg and home leg, and acknowledges the reception of the data.
 - 11-12. The final response to SIP INVIT (Call ID #1) is transmitted.
 - 13-15. Same as 8-9-10 but opening a ATCF CDR for the serving leg (Call-ID#1).
- Steps 13 to 15 are not applicable for the "OneChargingSession" option.

5.2.2.1.22.1A UE originating call (PS only) through ATCF

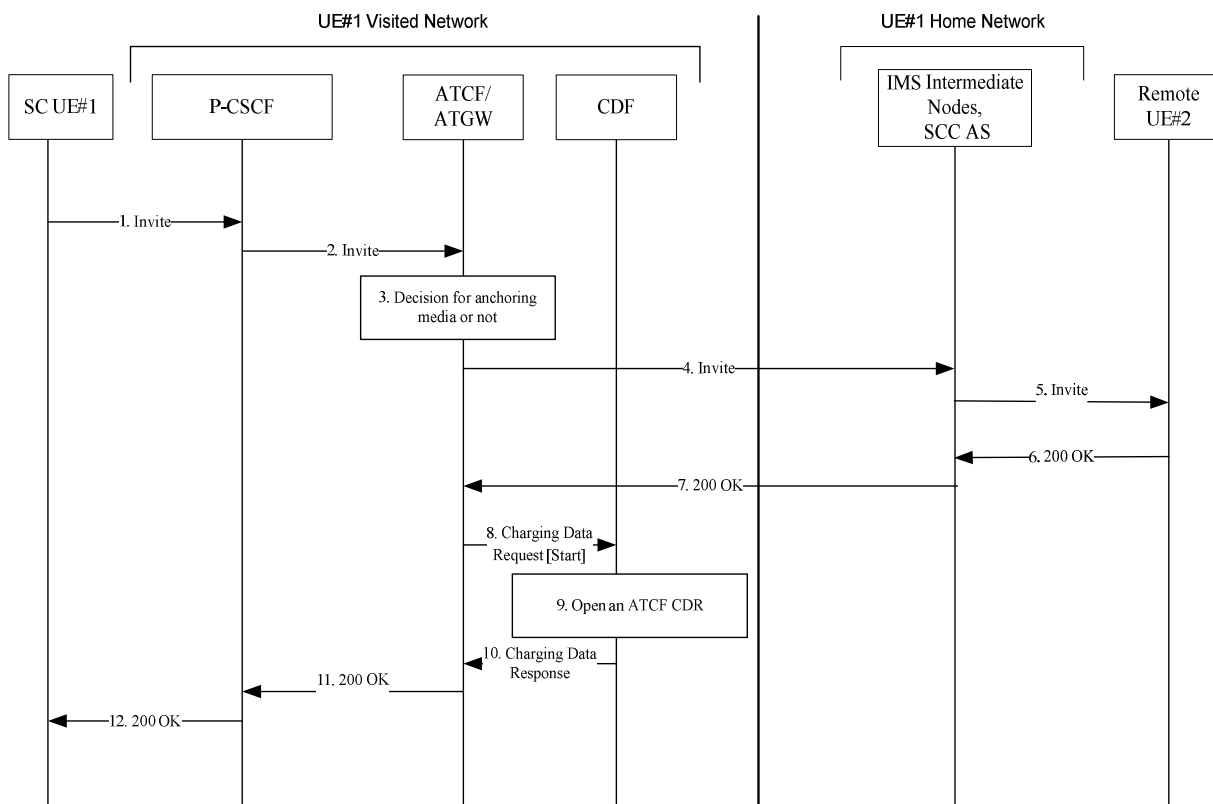

Figure 5.2.2.1.22.1A.1: Message sequence chart UE originating call (PS only) through ATCF

1. The SCC session is initiated by UE#1 sending an SIP INVITE.
2. After processing at P-CSCF, the resulting SIP INVITE goes through the ATCF in the UE#1 Visited Network.
3. The ATCF may decide whether to anchor the media session, and allocate if needed, ATGW resources to it.
4. The ATCF forwards the SIP INVITE request message to the UE#1 Home Network SCC AS.
5. The call setup proceeds and is routed to the remote UE#2.
- 6-7 On response SIP 200 OK from the remote UE#2, response SIP 200 OK is transmitted to UE#1 Visited Network.
8. Upon reception of the final response, the ATCF sends an Charging Data Request[Start] to record start of a user session/media component in the ATCF CDR for the IMS session.
- 9-10. The CDF from UE#1 Visited Network opens an ATCF CDR and acknowledges the reception of the data.
- 11-12. The final response to SIP INVITE is transmitted.

5.2.2.1.22.2 UE terminating call (CS only) through ATCF

In the flow figure 5.2.2.1.22.2.1, Call-ID #1 is for serving leg and Call-ID #2 is for home leg.

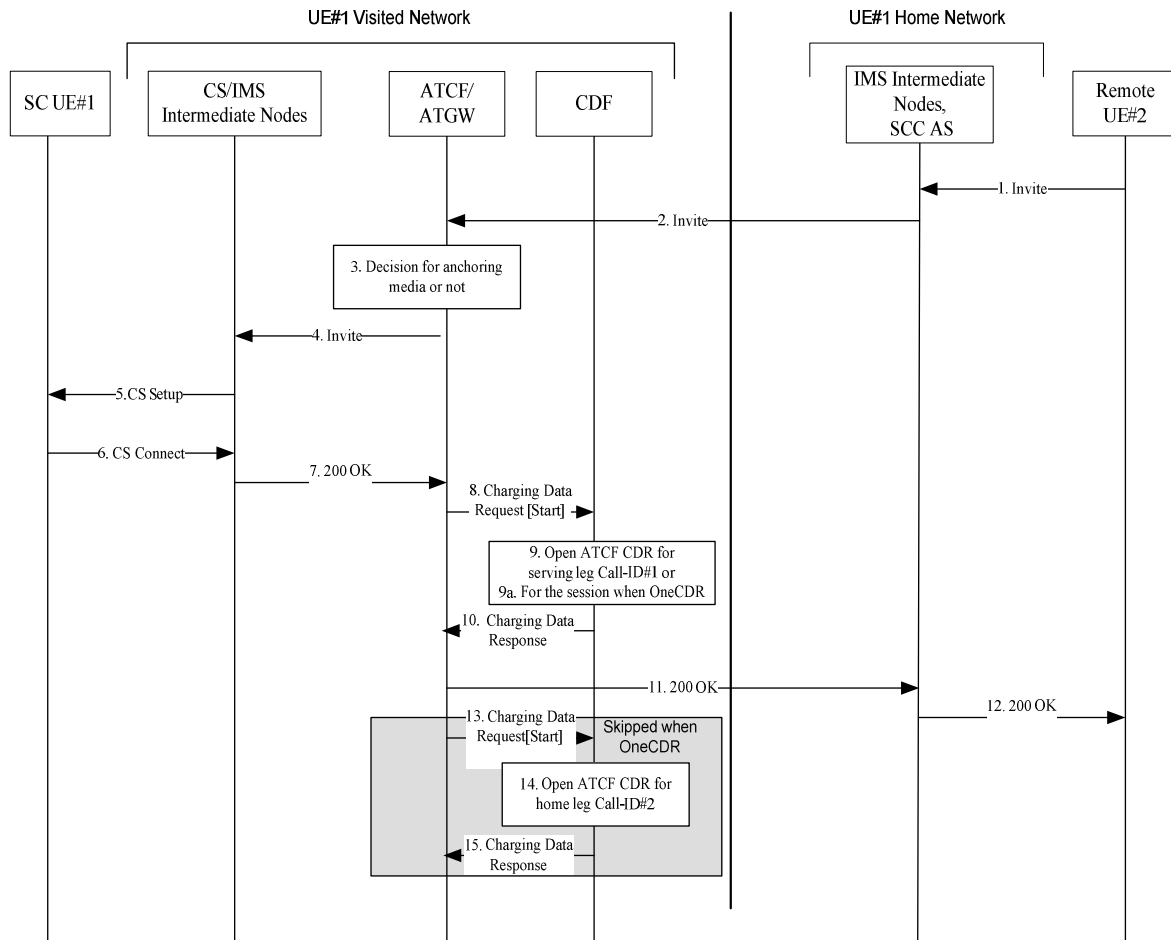

Figure 5.2.2.1.22.2.1: Message sequence chart UE terminating call (CS only) through ATCF

1. The SCC session is initiated by UE #2 sending an SIP INVITE towards UE-1.
2. The call setup proceeds and is routed to the UE-1.
3. The ATCF may decide whether to anchor the media session, and allocate if needed, ATGW resources to it.
4. The ATCF create an SIP INVITE request message and send it to the CS/PS intermediate nodes.
5. After processing at CS/PS intermediate nodes, the resulting message is sent to UE #1.
6. The response is transmitted to CS/PS intermediate nodes.
7. After processing at CS/PS intermediate nodes, the SIP 200 OK message is sent to ATCF.
8. Upon reception of the final response, the ATCF in the terminating network sends an Charging Data Request[Start] to record start of a user session/media component in the ATCF CDR.
- 9-10. The CDF from the Terminating serving network opens an ATCF CDR for the serving leg (Call ID #1) and acknowledges the reception of the data.
- 9a-10 Alternatively, when "OneChargingSession", the CDF opens a ATCF CDR related to the IMS session (ICID) with serving leg and home leg, and acknowledges the reception of the data.
- 11-12. The final response to SIP INVITE (Call ID #2) is transmitted.
- 13-15. Same as 8-9-10 but for the home leg (Call ID #2).

Steps 13 to 15 are not applicable for the "OneChargingSession" option.

5.2.2.1.22.2A UE terminating call (PS only) through ATCF

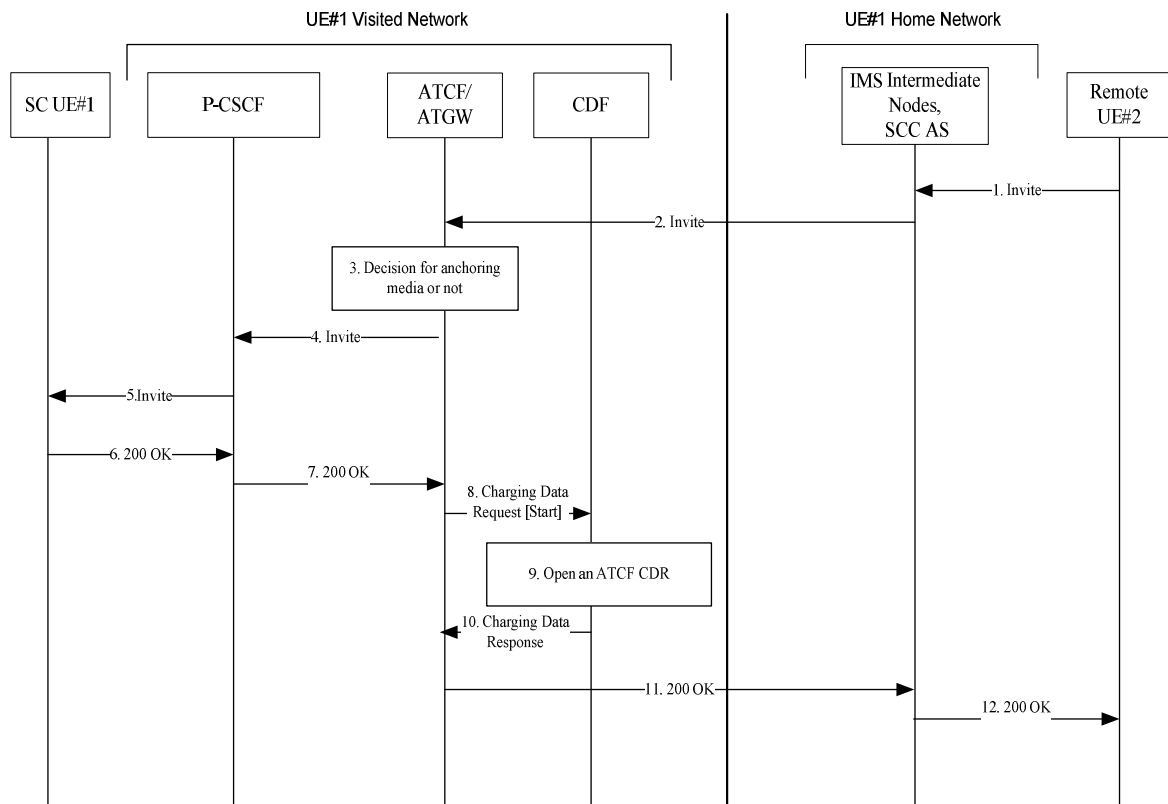

Figure 5.2.2.1.22.2A.1: Message sequence chart UE terminating call (PS only) through ATCF

1. The SCC session is initiated by UE #2 sending an SIP INVITE towards UE#1.
2. The call setup proceeds and is routed to the UE#1.
3. The ATCF may decide whether to anchor the media session, and allocate if needed, ATGW resources to it.
4. The ATCF forwards the SIP INVITE request message to the P-CSCF.
5. After processing at P-CSCF, the resulting message is sent to UE #1.
6. The response is transmitted to P-CSCF.
7. After processing at P-CSCF, the SIP 200 OK is sent to ATCF.
8. Upon reception of the final response, the ATCF sends an Charging Data Request[Start] to record start of a user session/media component in the ATCF CDR.
- 9-10. The CDF from UE#1 Visited Network opens an ATCF CDR and acknowledges the reception of the data.
- 11-12. The final response to SIP INVITE is transmitted.

5.2.2.1.22.3 UE session transfer PS to CS using ATCF

In the flow figure 5.2.2.1.22.3.1, Call-ID #1 is for PS access leg, Call-ID #1' for serving leg of CS access leg and Call-ID #2' for home leg of CS access leg.

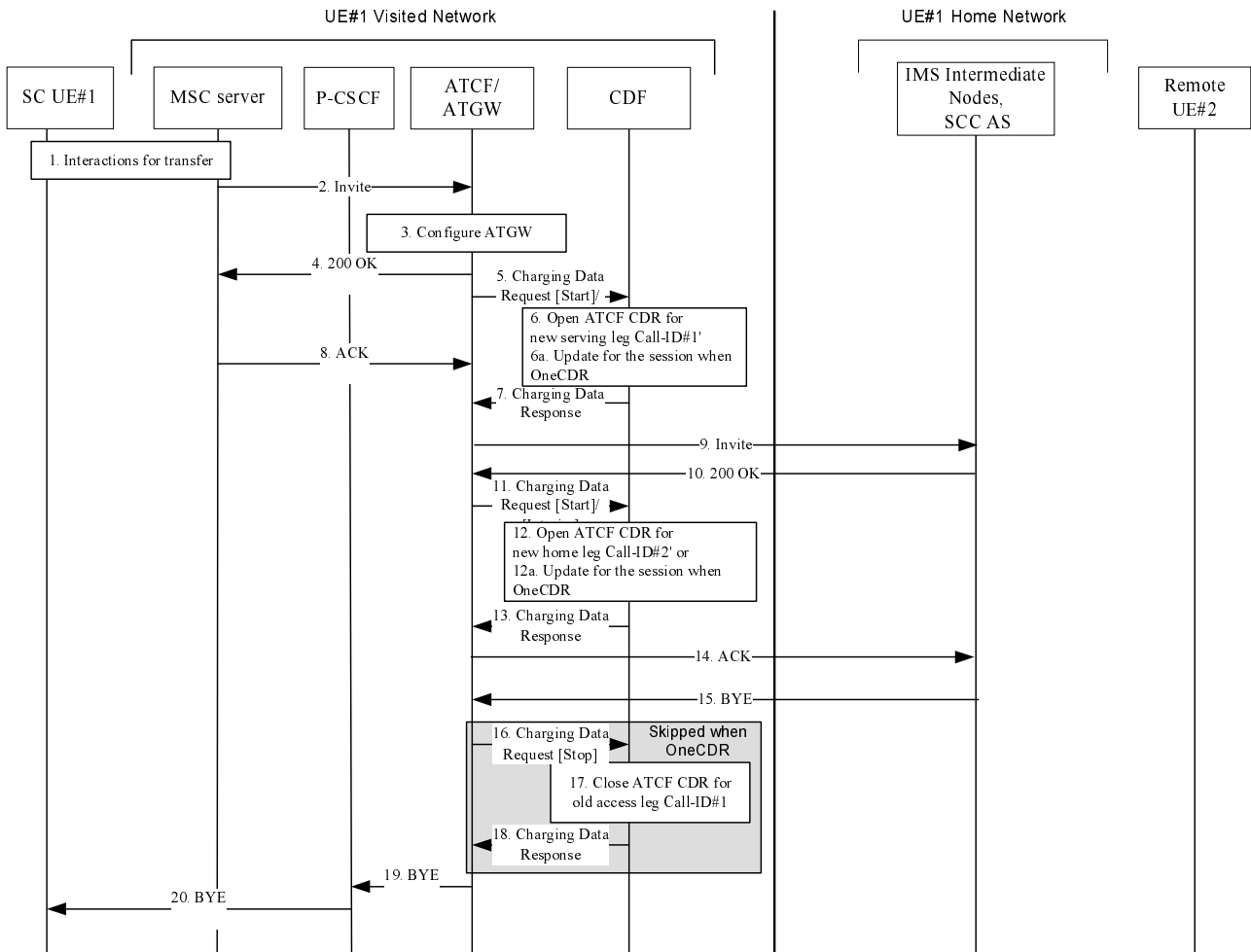

Figure 5.2.2.1.22.3.1: Message sequence chart UE session transfer PS to CS using ATCF

1. UE has an ongoing session under PS with media anchored in ATGW, and interactions between UE, RAN, MME/SGSN and MSC take place for session transfer to CS.
2. MSC server sends the resulting SIP INVITE towards the ATCF in the UE#1 serving network.
3. The media session is anchored in ATGW: the ATCF updates the ATGW with new CS access leg resource.
4. The ATCF sends SIP 200 OK answer to MSC server for switching the media path.
- 5-7. the ATCF sends an Charging Data Request[Start] to record start of a user session/media component in the ATCF CDR for the serving leg of new CS access leg.
- 5-6a-7. Alternatively, when "OneChargingSession", the ATCF sends an Charging Data Request[Interim] to record modification of the ATCF CDR with the serving leg of new CS access leg. The CDF updates ATCF CDR related to the IMS session, with new serving leg, and acknowledges the reception of the data.
8. ACK from MSC server to ATCF
9. The ATCF creates and sends a SIP INVITE request via a new dialog to the SCC AS for indicating the transfer has taken place.

10. The SCC AS sends a SIP 200 OK confirmation response to the ATCF containing SDP answer stored during the original session establishment procedure.
 - 11-13. The ATCF sends an Charging Data Request[Start] to record start of a user session/media component in the ATCF CDR for home leg of new CS access leg.
 - 11-12a-13 Alternatively, when "OneChargingSession", the ATCF sends an Charging Data Request[Interim] to record modification of the ATCF CDR with the home leg of new CS access leg. The CDF updates ATCF CDR related to the IMS session, with new home leg, and acknowledges the reception of the data.
 14. The ATCF acknowledges the SIP 200 OK.
 - 15, 19-20 The SCC AS terminates the old PS access leg, by sending a SIP BYE request.
 - 16-18. The ATCF sends an Charging Data Request[Stop] to close the ATCF CDR for the old PS access leg (conducted for both serving and home leg of the old PS access leg if flow 5.2.2.1.22.4 precedes for the same session).
- Steps 16 to 18 are not applicable for the "OneChargingSession" option.

5.2.2.1.22.4 UE session transfer CS to PS using ATCF

In the flow figure 5.2.2.1.22.4.1, Call-ID#1 for serving leg of old CS access leg and Call-ID#2 for home leg of old CS access leg, Call-ID#1' is for serving leg of new PS access leg, and Call-ID#2' is for home leg of new PS access leg.

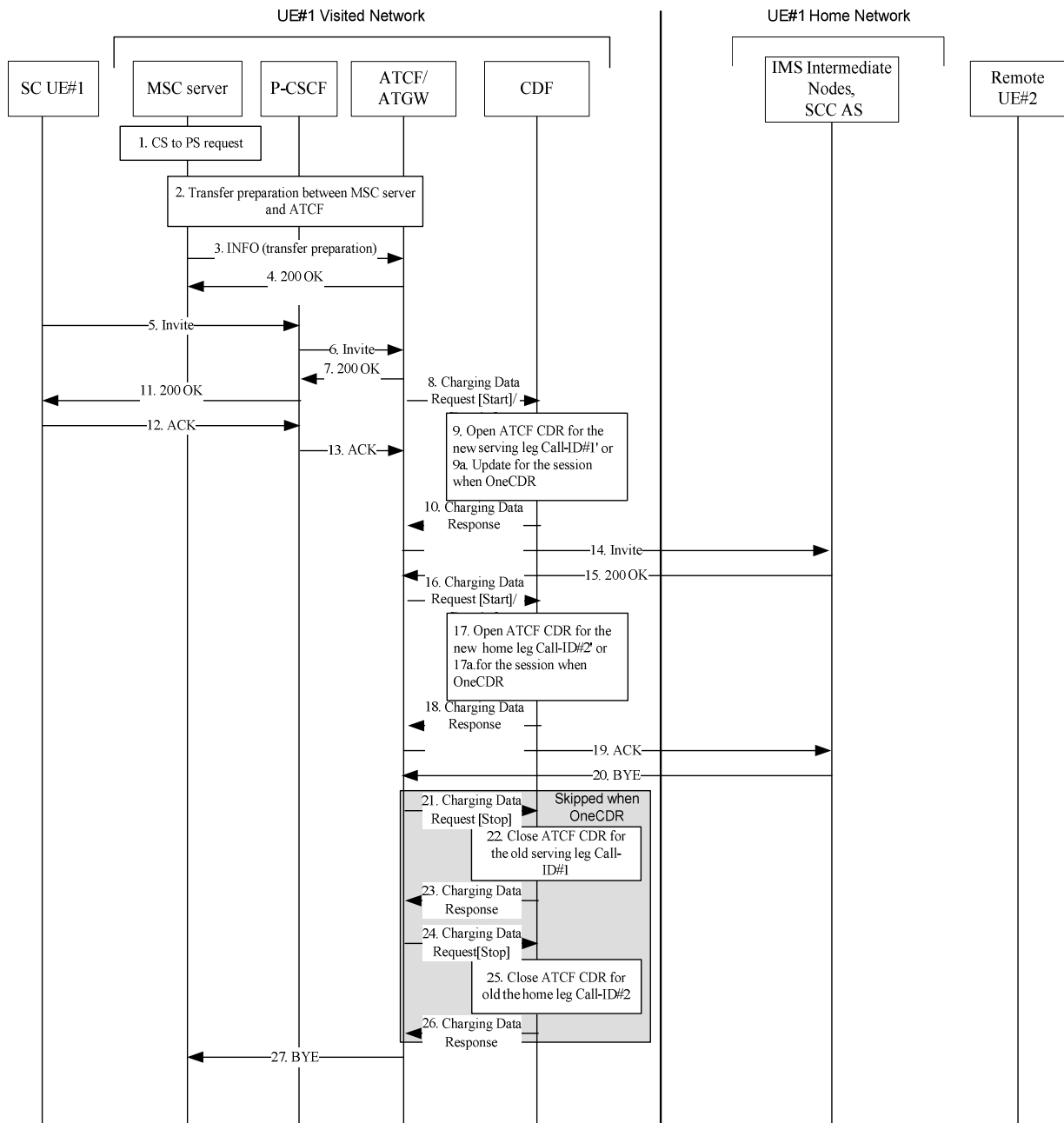

Figure 5.2.2.1.22.4.1: Message sequence chart UE session transfer CS to PS using ATCF

1. UE has an ongoing session under CS with media anchored in ATGW, and interactions between UE, RAN, MME/SGSN and MSC take place for session transfer to PS.
2. Transfer preparation procedure between MSC server and ATCF, the MSC interacts with UE for handover.
3. The MSC server sends a SIP INFO request containing a session transfer preparation to the ATCF to instruct the ATCF that media should be switched to the new access leg.
4. The ATCF sends SIP 200 OK answer to MSC server for switching the media path.
- 5-6. UE A sends an SIP INVITE request towards the ATCF to move the session control to the PS access.
- 7-11. The ATCF sends a SIP 200 OK response to the UE.
- 8-10. The ATCF sends an Charging Data Request[Start] to record start of a user session in the ATCF CDR for the serving leg of the new PS access leg.

8-9a -10. Alternatively, when "OneChargingSession", the ATCF sends an Charging Data Request[Interim] to record modification of the ATCF CDR with the serving leg of new PS access leg. The CDF updates ATCF CDR related to the IMS session, with new serving leg, and acknowledges the reception of the data.

12-13. UE acknowledges the SIP 200 OK.

14. The ATCF creates and sends SIP INVITE request via a new dialog to the SCC AS for indicating the transfer has taken place.

15. The SCC AS sends a SIP 200 OK confirmation response to the ATCF containing SDP answer stored during the original session establishment procedure.

16-18. The ATCF sends an Charging Data Request[Start] to record start of a user session in the ATCF CDR for the home leg of the new PS access leg.

16-17a -18. Alternatively, when "OneChargingSession" , the ATCF sends an Charging Data Request[Interim] to record modification of the ATCF CDR with the home leg of new PS access leg. The CDF updates ATCF CDR related to the IMS session, with new home leg, and acknowledges the reception of the data.

20, 27 The SCC AS terminates the old CS access leg, by sending a SIP BYE request.

21-23. The ATCF sends an Charging Data Request[Stop] to close the ATCF CDR for the serving leg of old CS access leg.

24-26. The ATCF sends an Charging Data Request[Stop] to close the ATCF CDR for the home leg of old CS access leg.

Steps 21 to 26 are not applicable for the "OneChargingSession" option.

5.2.2.2 Message flows - error cases and scenarios

5.2.2.2.0 Introduction

This clause describes various error cases and how these should be handled. The error cases are grouped into the following categories:

- Failure in SIP related procedures:
 - Session related error scenarios;
 - Session unrelated error scenarios.
- Errors in Charging Data Transfer related procedures.

5.2.2.2.1 Session related SIP procedures- reception of SIP error messages

A SIP session is closed abnormally by the reception of a SIP BYE message indicating the reason for such termination.

In this case, an Charging Data Request[Stop] message that includes an appropriate error indication is sent.

5.2.2.2.2 Session related SIP procedures - SIP session failure

All nodes involved in the SIP session are expected to exercise some kind of session supervision. In case a node detects an error in the SIP session, such as a timeout or the occurrence of an invalid SIP message that results in the inability to maintain the session, this IMS node will generate a SIP BYE message towards both ends of the connection.

The node that sent the BYE to trigger session termination identifies the cause of the failure in the Charging Data Request [Stop] towards the CDF. All other nodes, i.e. those that receive the SIP BYE, are not aware of an error, and therefore they treat this situation as any normal SIP session termination.

5.2.2.2.3 Session unrelated SIP procedures

As described in clause 5.1.2.1.2, a session unrelated SIP procedure may either be completed with the reception of a SIP 200 OK, or a SIP error message. If the latter occurs, i.e. there is a failure in the procedure, the Charging Data Request[Event] sent towards the CDF includes an appropriate error indication.

5.2.2.2.4 CDF connection failure

The CDF connection failure mechanism is specified in TS 32.299 [50] clause 6.1.3.1.

5.2.2.2.5 No reply from CDF

The mechanism when no reply from CDF, is specified in TS 32.299 [50] clause 6.1.3.2.

5.2.2.2.6 Duplicate detection

The duplicate detection mechanism is specified in TS 32.299 [50] clause 6.1.3.3.

5.2.2.2.7 CDF detected failure

The CDF detected failure mechanism on expected Charging Data Requests for a particular SIP session is specified in TS 32.299 [50] clause 6.1.3.4.

5.2.3 CDR generation

Editor's Note: FFS

5.2.4 GTP' record transfer flows

GTP' is not used between CDF and CGF for IMS offline charging because CDF and CGF are combined into CCF (see clause 4.2).

NOTE: Vendors may nevertheless implement a separate CDF and CGF for IMS offline charging. In this case, it is recommended that the approach chosen conforms to the principles and protocol applications specified in TS 32.295 [54].

5.2.5 Bi CDR file transfer

The CGF will receive charging events from each AS involved in a SIP dialog. This may result in multiple CDRs, some of these CDRs may be redundant for billing purposes. When preparing these CDRs for the BD, the CGF may elect not to send some CDRs or may perform consolidation before transfer based on the operator's configuration.

5.3 IMS online charging scenarios

5.3.1 Basic principles

IMS online charging uses the Credit-Control application that is specified in TS 32.299 [50].

Three cases for online charging are distinguished:

- Immediate Event Charging (IEC); and
- Event Charging with Unit Reservation (ECUR), and
- Session Charging with Unit Reservation (SCUR).

Both stage 2 and stage 3 mechanisms for the three cases for online charging are detailed in TS 32.299 [50].

In the case of Immediate Event Charging (IEC), granting units to the IMS Network Element is performed in a single operation that also includes the deduction of the corresponding monetary units from the subscriber's account. The charging process is controlled by the corresponding Debit UnitsRequest which is sent for a given Credit-Control event.

In contrast, Event Charging with Unit Reservation (ECUR) also includes the process of requesting, reserving, releasing and returning unused units for events. The deduction of the corresponding monetary units then occurs upon conclusion of the ECUR transaction. In this case, the Debit / Reserve Units Request is used to control the Credit-Control session.

Session Charging with Unit Reservation (SCUR) is used for Credit-Control of sessions. SCUR also includes the process of requesting, reserving, releasing and returning unused units for sessions, and the deduction of the corresponding monetary units. During a SIP session there can be repeated execution of unit reservation and debit operations as specified in TS 32.299 [50].

The IMS Network Element may apply IEC, where Debit UnitsRequest[Event] messages are generated, or ECUR, using Reserve Units Request[Initial] and Debit Units Request[Terminate] or SCUR. The decision whether to apply IEC, ECUR or SCUR is based on the service and/or operator's policy.

The CTF uses Debit / Reserve Units Request[Initial, Update, Terminate] in procedures related to successful SIP sessions. It uses Debit Units Request[Event] or Reserve Units Request[Event or Initial, Terminate] depending on whether IEC or ECUR/SCUR applies) for unsuccessful SIP sessions and for session unrelated procedures. Further details are specified in the tables below.

It is operator configurable in the nodes for which SIP method a Debit / Reserve Units Request is sent. The table below describes all possible Debit / Reserve Units Requests that might be sent from an IMS GWF or an MRFC or an AS.

It is configurable for the operators to enable or disable the generation of a Debit / Reserve Units Request message by the IMS node in response to a particular "Triggering SIP Method".

Table 5.3.1.1: Debit / Reserve Units Request messages triggered by SIP methods for IMS-GWF or AS

Message	Triggering SIP Method
Debit / Reserve Units Request [Initial]	SIP INVITE (SCUR)
	SIP NOTIFY (ECUR)
	SIP MESSAGE (ECUR)
	SIP REGISTER (ECUR)
	SIP SUBSCRIBE (ECUR)
	SIP REFER (ECUR)
	SIP PUBLISH (ECUR)
Reserve Units Request [Update]	SIP 2xx acknowledging a SIP INVITE, RE-INVITE or SIP UPDATE [e.g. change in media components] (SCUR)
	RE-INVITE or SIP UPDATE [e.g. change in media components, terminating identity change] (SCUR)
	Expiration of quota, Validity time expiry or other authorization triggers (quota threshold reached, ...). (SCUR)
	Any SIP message (except those triggering a Debit / Reserve Units Request[Initial] or those not covered by the above triggers for Reserve Units Request[Update] conveying a SDP offer or its associated SDP answer before SIP session establishment (SCUR)
	SIP 1xx provisional response, mid-dialog requests, mid-dialog responses and SIP INFO embedding RTTI XML body
SIP response (4xx, 5xx or 6xx), indicating an unsuccessful SIP RE-INVITE or SIP UPDATE (SCUR)	
Debit / Reserve Units Request [Terminate]	SIP BYE message (both normal and abnormal session termination cases) (SCUR)
	SIP 2xx acknowledging a SIP BYE message (only when last user location information of originating/ terminating party is required by operator for legal purpose).
	SIP 2xx acknowledging non-session related SIP messages (ECUR)
	Aborting a SIP session set-up procedure, using an internal trigger, or a SIP CANCEL.(SCUR/ECUR)
	Deregistration (SCUR/ECUR)
	SIP Final/Redirection Response 3xx (SCUR/ECUR)
	SIP Final Response (4xx, 5xx or 6xx), indicating an unsuccessful SIP session set-up procedure (SCUR)
SIP Final Response (4xx, 5xx or 6xx), indicating an unsuccessful session-unrelated procedure (ECUR)	
Debit Units Request [Event]	SIP NOTIFY (IEC)
	SIP MESSAGE (IEC)
	SIP REGISTER (IEC)
	SIP SUBSCRIBE (IEC)
	SIP REFER (IEC)
	SIP PUBLISH (IEC)
	SIP Final Response (4xx, 5xx or 6xx), indicating an unsuccessful session-unrelated procedure (IEC)

Table 5.3.1.2: Debit / Reserve Units Request messages triggered by SIP methods for MRFC

Message	Triggering SIP Method
Debit / Reserve Units Request [Initial]	SIP INVITE(SCUR) for initiating a multimedia ad hoc conferencing session
Reserve Units Request [Update]	SIP RE-INVITE or SIP UPDATE[e.g. change in media components](SCUR)
	SIP BYE message Expiration of quota, Validity time expiry or other authorization triggers (quota threshold reached, ...). (SCUR)
Debit / Reserve Units Request [Terminate]	SIP BYE message(both normal and abnormal session termination cases)(SCUR)
	SIP Final Response with error codes 4xx, 5xx or 6xx indicating termination of an ongoing session(SCUR) SIP CANCEL(SCUR)

5.3.2 Message flows and types

5.3.2.0 Introduction

This clause describes the message flows for the event charging procedures on the Ro interface. The IMS functions providing online charging *via* the Ro interface are the S-CSCF with IMS GWF, the AS and the MRFC.

NOTE: The following sub-clauses only show the scenarios of the S-CSCF with IMS-GWF case and the AS case. The scenarios of the MRFC are FFS.

5.3.2.1 Immediate Event Charging (IEC)

5.3.2.1.0 Introduction

This clause provides the details of the "Debit Units" operation specified in TS 32.299 [50].

5.3.2.1.1 Message flows - successful cases and scenarios

5.3.2.1.1.1 IEC – Debit Units operation

The transactions that are required on the Ro interface in order to perform IEC with Debit Units operations are carried out as described in TS 32.299 [50] where CTF refers to IMS Network Element. The Debit Units operation may alternatively be carried out prior to, concurrently with or after service/content delivery. The IMS Network Element must ensure that the requested service execution is successful, when this scenario is used.

Editor's Note: Must be aligned with TS 32.299 [50].

5.3.2.1.1.2 Scenarios

Figure 5.3.2.1.1.2.1 shows the Debit Units transactions that are required between the IMS-GWF/AS and the OCS for session-unrelated IMS procedures, i.e. those that relate to the Debit Units Request[Event], as listed in table 5.3.1.1.

SIP messages and Charging Data transactions associated with these charging scenarios are shown primarily for general information and to illustrate the charging triggers. They are not intended to be exhaustive and depend on the Debit Units Request triggers configured by the operator.

Scenario 1: Successful session unrelated case

NOTE: The Debit Units operation is carried out prior to service/content delivery.

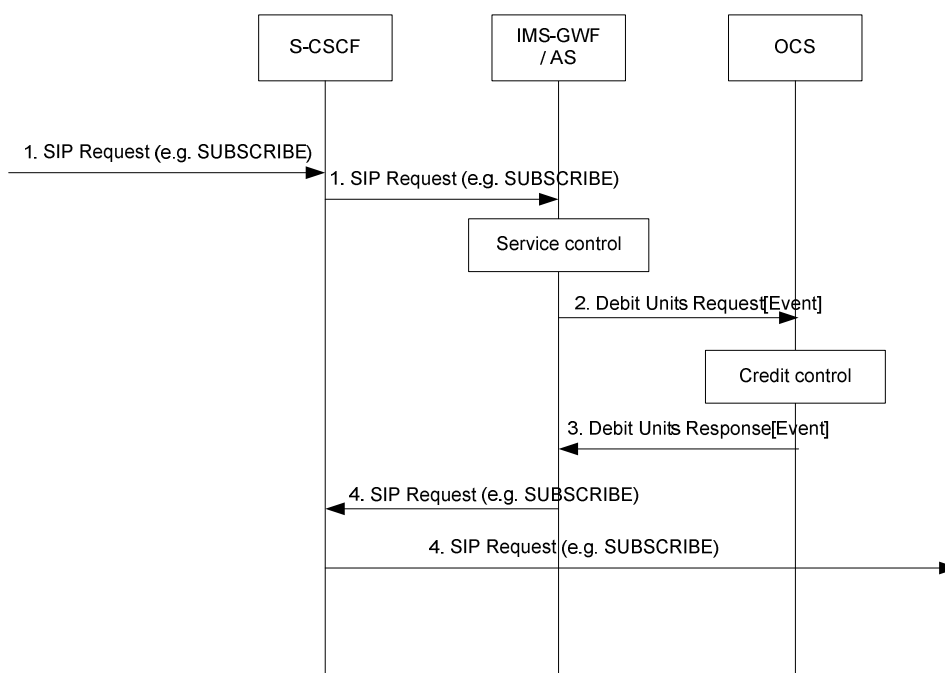

Figure 5.3.2.1.1.2.1: Message sequence chart for session-unrelated procedure

- 1) A session unrelated SIP request (e.g. SUBSCRIBE) is received in the S-CSCF. The S-CSCF forwards this request to the IMS-GWF/AS.
- 2) The IMS-GWF/AS sends a Debit Units Request[Event] to the OCS, requesting units in order to provide the service.
- 3) The OCS sends the Debit Units Response to acknowledge the Debit Units Request, granting the requested units.
- 4) The IMS-GWF/AS and the S-CSCF forward the SIP request.

5.3.2.1.2 Message flows - error cases and scenarios

5.3.2.1.2.0 Introduction

This clause describes various error cases and how these should be handled.

The failure handling behaviour is locally configurable in the IMS Network Element. If the *Direct-Debiting-Failure-Handling* AVP is not used, the locally configured values are used instead.

5.3.2.1.2.1 Reception of SIP error messages

If SIP errors in SIP response (4xx, 5xx or 6xx) occur during service delivery, as defined in TS 24.228 [202] and TS 23.218 [203], it is up to the IMS Network Element to determine to what extent the service was delivered before the error occurred and act appropriately with respect to charging. This may imply that no units at all (or no more units) are debited.

5.3.2.1.2.2 Debit Units operation failure

This case comprises situations where either no, or an erroneous response, is received from the OCS. The "no response" case is detected by the IMS Network Element when the connection supervision timer Tx expires (IETF RFC 4006 [402]) before a Debit / Reserve Units Response is received. The case of receiving an erroneous response implies that the IMS Network Element receives a Debit / Reserve Units Response, which it is unable to process, while Tx is running. The failure handling complies with the failure procedures for "Direct Debiting" scenario described in IETF RFC 4006 [402].

5.3.2.1.2.3 Duplicate detection

The detection of duplicate request is needed and must be enabled. To speed up and simplify as much as possible the duplicate detection, the all-against-all record checking should be avoided and just those records marked as potential duplicates need to be checked against other received requests (within a reasonable time window) by the receiver entity.

The IMS Network Element marks the request messages that are retransmitted after a link failover as possible duplicates with the T-flag as described in TS 23.228 [201]. For optimized performance, uniqueness checking against other received requests is only necessary for those records marked with the T-flag received within a reasonable time window. This focused check is based on the inspection of the *Session-Id* and *CC-Request-Number* AVP pairs.

5.3.2.2 Event Charging with Unit Reservation (ECUR) and Session Charging with Unit Reservation (SCUR)

5.3.2.2.0 General

This clause provides the details of the "Reserve Units" and "Debit Units" operation specified in TS 32.299 [50].

5.3.2.2.1 Message flows - successful cases and scenarios

5.3.2.2.1.1 ECUR and SCUR - Reserve / Debit Units operations

The transactions that are required on the Ro interface in order to perform ECUR/SCUR with Reserve / Debit Units operations is carried out as described in TS 32.299 [50] where CTF refers to an IMS Network Element. Multiple replications of both of these operations are possible.

5.3.2.2.1.2 Expiration of reservation validity

This clause defines how reserved units are returned, if not used, within a reasonable time. It should be possible that both, reservation and SIP sessions are cancelled or only the reservation is cancelled without removing the SIP session.

5.3.2.2.1.3 Scenarios

5.3.2.2.1.3.0 Introduction

The following figures show the Reserve Units transactions that are required between the IMS-GWF/AS and the OCS for session-related and session-unrelated IMS procedures.

The SIP messages and Charging Data transactions associated with these charging scenarios are shown primarily for general information and to illustrate the charging triggers. They are not intended to be exhaustive and they depend on the Reserve Units Request triggers configured by the operator.

All of the scenarios depict originating sessions only.

5.3.2.2.1.3.1 Session related procedures (SCUR)

Scenario 1: Successful session establishment

Figure 5.3.2.2.1.3.1.1 shows the Reserve Units transactions that are required in the IMS-GWF/AS during a SIP session establishment.

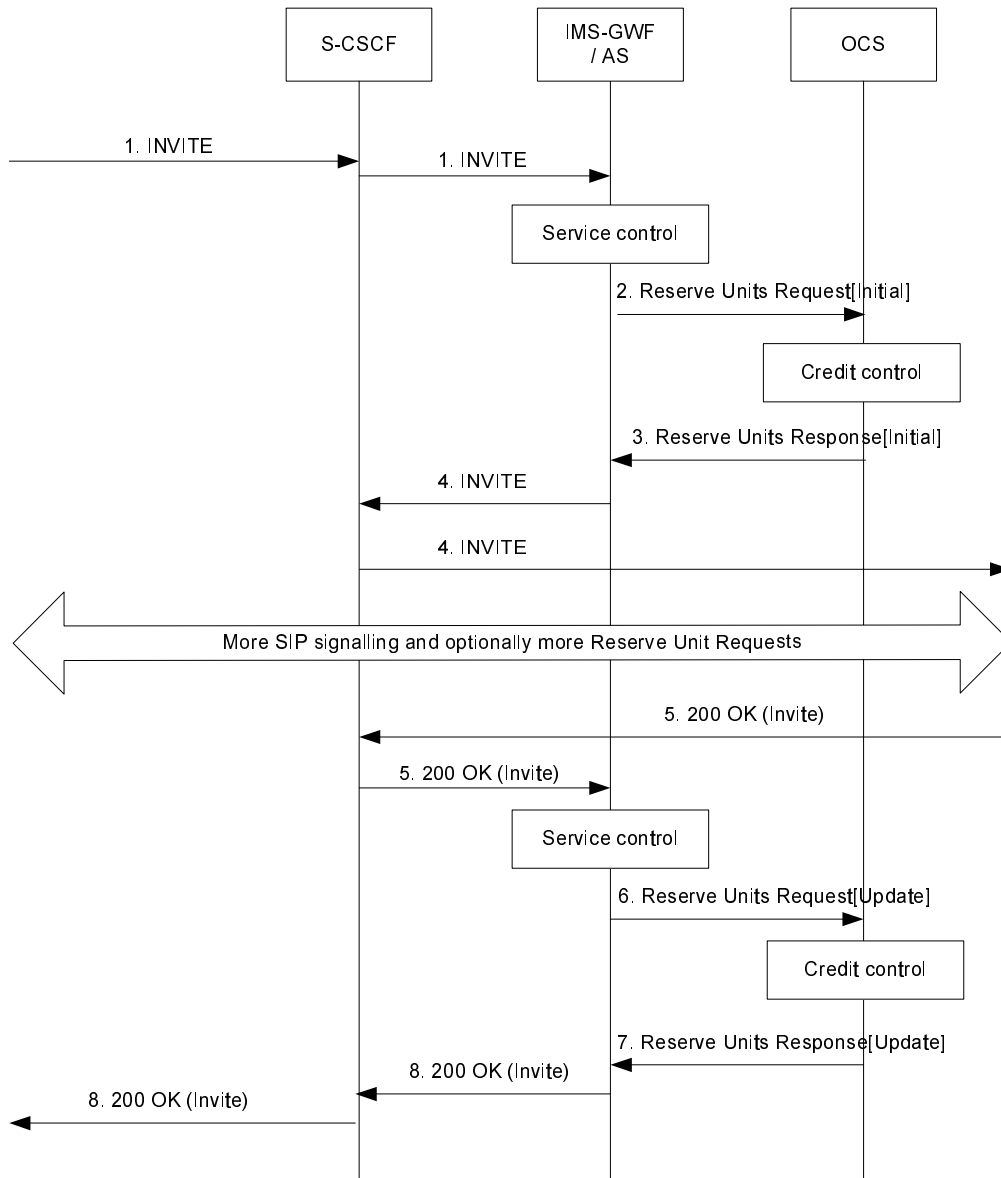

Figure 5.3.2.2.1.3.1.1: Message sequence chart for successful session establishment

- 1) An initial SIP Invite Request is received in the S-CSCF. This request is forwarded to the IMS-GWF/AS.
- 2) The IMS-GWF/AS sends a Reserve Units Request[Initial] to the OCS requesting service units. The online Credit-Control session is initiated.
- 3) The OCS grants units in the Reserve Units Response.
- 4) The IMS-GWF/AS and S-CSCF forward the initial SIP INVITE.
- 5) A final response is received in the IMS-GWF/AS.

- 6) If the trigger is active, the SIP 200 OK answer triggers a Reserve Units Request[Update] in the IMS-GWF/AS in order to update the Credit-Control session. New service units are requested. Also the used service units (if any) are reported.
- 7) The OCS sends the Reserve Units Response to acknowledge the Reserve Units Request. New service units are granted.
- 8) The final answer is forwarded.

Scenario 2: Successful session establishment with early media negotiation

Figure 5.3.2.2.1.3.1.2 shows the Charging Data transactions that are required in the IMS-GWF/AS during a SIP session establishment in which SDP negotiation is completed before a final response to the initial SIP INVITE is exchanged.

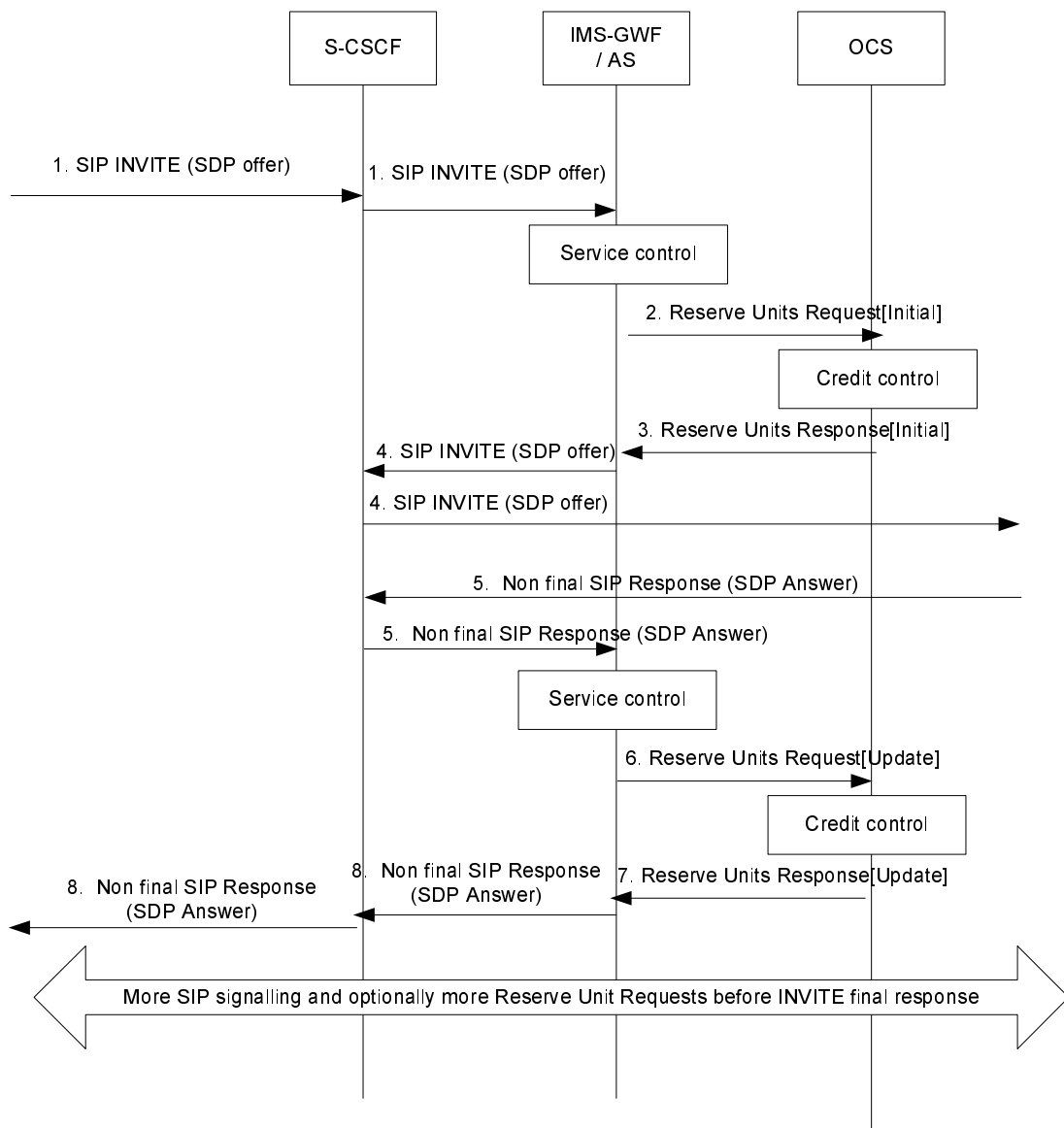

Figure 5.3.2.2.1.3.1.2: Message sequence chart for session establishment with early media negotiation

- 1) An initial SDP offer is conveyed in a SIP INVITE message. The SIP INVITE message received in the S-CSCF is forwarded to the IMS-GWF/AS.
- 2) In this example, the SDP offer is conveyed in a SIP request which implies the start of the online Credit-Control session towards the OCS. The IMS-GWF/AS sends a Reserve Units Request[Initial] to the OCS requesting service units. The online Credit-Control session is initiated.
- 3) The OCS grants units in the Reserve Units Response.
- 4) The IMS-GWF/AS and S-CSCF forward the SIP request conveying the SDP offer.
- 5) A non-final SIP message (e.g. a provisional reliable response) conveying an SDP answer is received in the IMS-GWF/AS.
- 6) The received SDP answer triggers a Reserve Units Request[Update] in order to update the session. New service units are requested. Also the used service units (if any) are reported.

- 7) The OCS sends the Reserve Units Response to acknowledge the Reserve Units Request. New service units are granted.
- 8) The SDP answer is forwarded.

Scenario 3: Mid-session procedures

Figure 5.3.2.2.1.3.1.3 shows the Charging Data transactions that are required in the IMS-GWF/AS when receiving a SIP RE-INVITE in mid-session, e.g. in order to modify media component(s), or when the hold and resume procedure is executed.

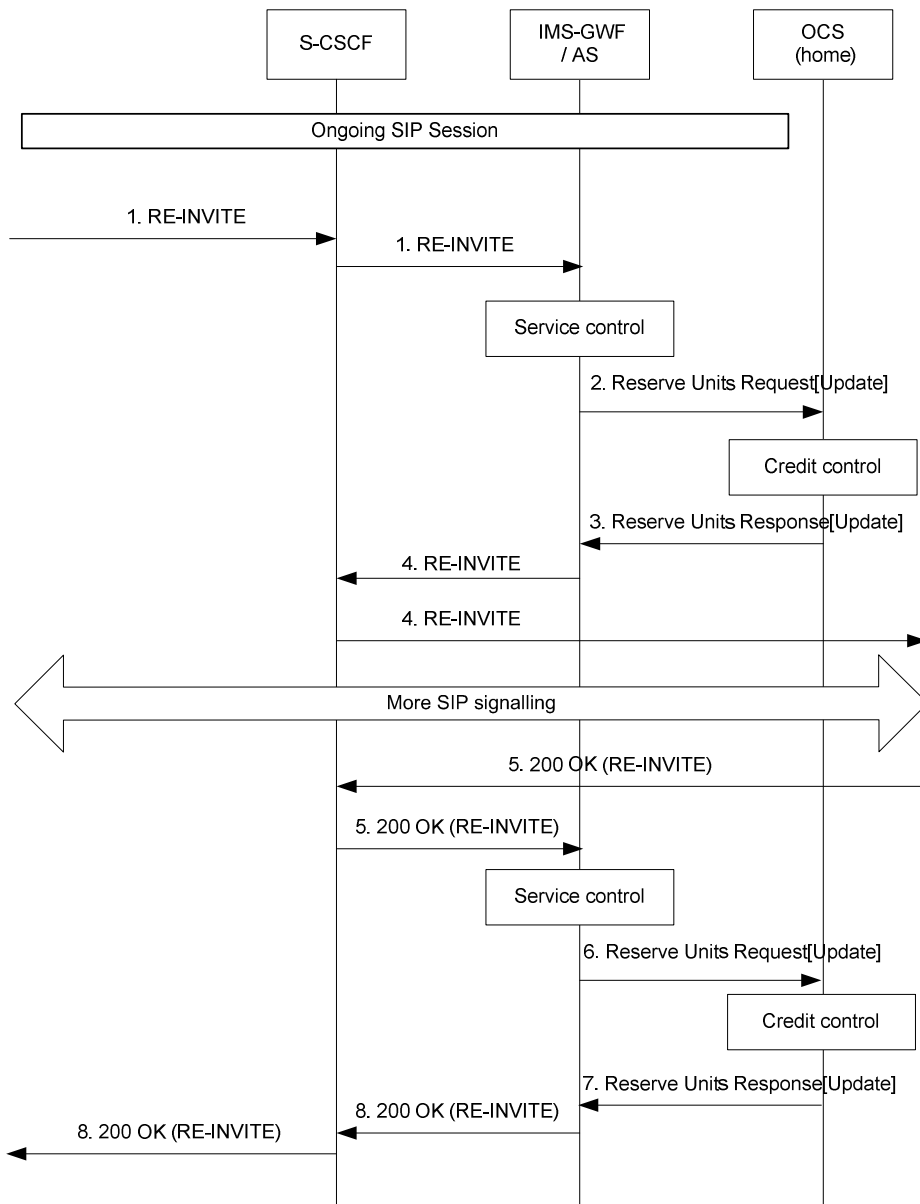

Figure 5.3.2.2.1.3.1.3: Message sequence chart for mid-session procedures

- 1) A SIP RE-INVITE request is received in the S-CSCF. This request is forwarded to the IMS-GWF/AS.
- 2) Upon receiving the SIP RE-INVITE request, the IMS-GWF/AS sends a Reserve Units Request[Update] to update the previously initiated session. New service units are requested. The used service units (if any) are also reported.
- 3) The OCS grants new service units in the Reserve Units Response.
- 4) The RE-INVITE request is forwarded.
- 5) The RE-INVITE request is acknowledged with a SIP 200 OK.

- 6) If the trigger is active, the IMS-GWF/AS sends a Reserve Units Request[Update] to the OCS to update the session. New service units are requested. The used service units (if any) are also reported.
- 7) The OCS grants new service units in the Reserve Units Response.
- 8) The SIP 200 OK message is forwarded.

Scenario 4: Session release

Figure 5.3.2.2.1.3.1.4 shows the Debit / Reserve Units operation that are required in the IMS-GWF/AS for a session release scenario with SIP BYE triggering online Credit-Control session termination.

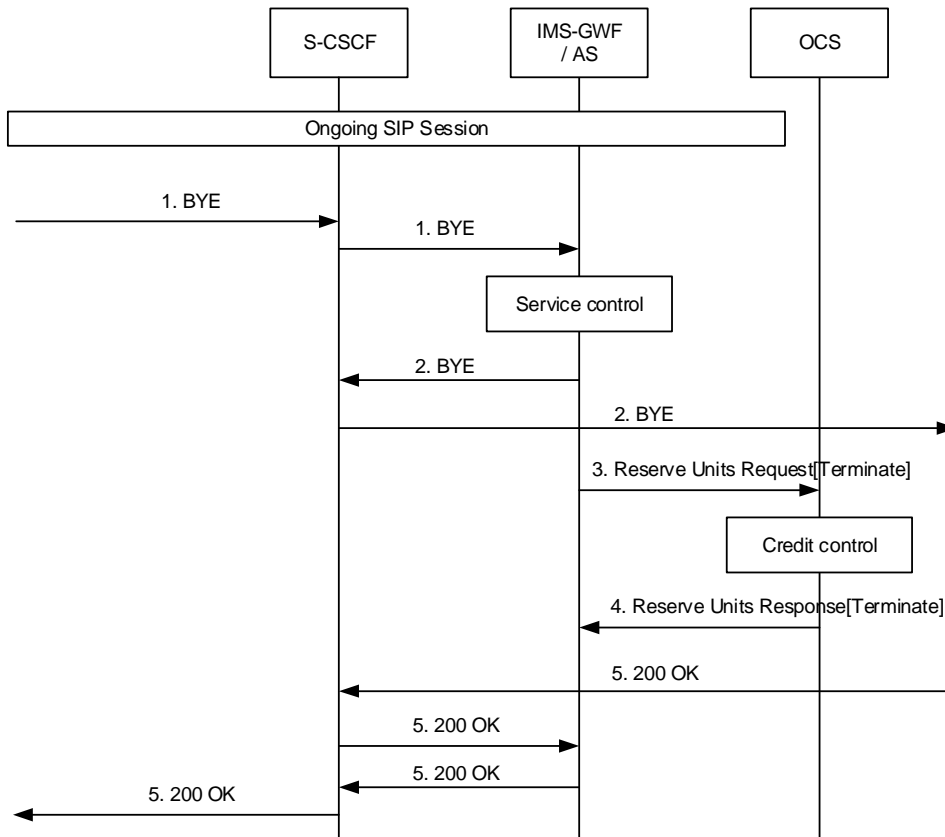

Figure 5.3.2.2.1.3.1.4: Message sequence chart for session release (SIP BYE triggering Credit-Control session termination).

- 1) A SIP session is released by sending a SIP BYE message. The S-CSCF forwards this message to the IMS-GWF/AS.
- 2) Upon receiving the SIP BYE message, the IMS-GWF/AS forwards the SIP BYE request to the UE.
- 3) In case there is an ongoing online control session, the IMS-GWF/AS sends a Reserve Units Request[Terminate] reporting the used granted units.
- 4) The OCS sends a Reserve Units Response. The online Credit-Control session is terminated.
- 5) The final answer to the SIP BYE message is forwarded.

Figure 5.3.2.2.1.3.1.4A shows the Debit / Reserve Units operation that are required in the IMS-GWF/AS for a session release scenario with SIP 200 OK triggering online Credit-Control session termination.

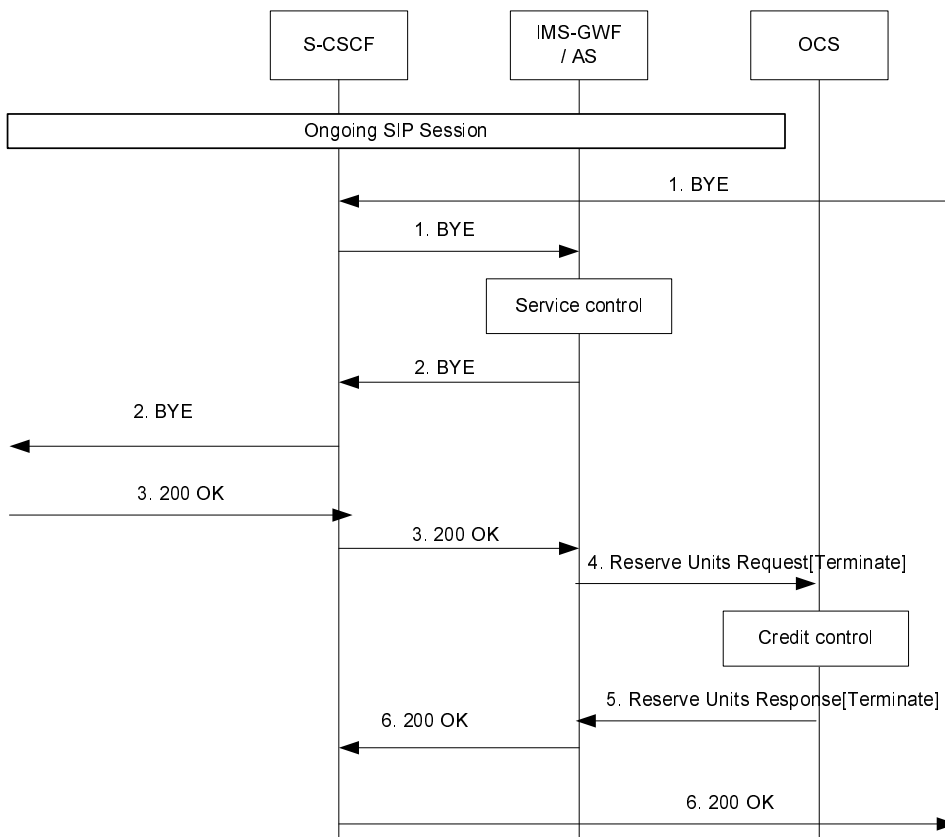

Figure 5.3.2.2.1.3.1.4A: Message sequence chart for session release (SIP 200 OK triggering Credit-Control session termination).

- 1) A SIP session is released by receiving a SIP BYE message. The S-CSCF forwards this message to the IMS-GWF/AS.
- 2) Upon receiving the SIP BYE message, the IMS-GWF/AS forwards the SIP BYE request to the UE. In case there is an ongoing online control session, and the IMS-GWF/AS is configured to wait for SIP 200 OK acknowledging SIP BYE, the counter of used granted units is stopped.
- 3) The release is acknowledged by SIP 200 OK forwarded to the IMS-GWF/AS by the S-CSCF.
- 4) In case there is an ongoing online control session, the IMS-GWF/AS sends a Reserve Units Request [Terminate] reporting charging information (e.g. user location received in SIP 200 OK) together with the used granted units.
- 5) The OCS sends a Reserve Units Response. The online Credit-Control session is terminated.
- 6) The final SIP 200 OK answer to the SIP BYE message is forwarded.

Scenario 5: Successful session establishment with reception of RTTI message

Figure 5.3.2.2.1.3.1.5 shows the Debit / Reserve Units operation that are required in the IMS-GWF/AS during a SIP session establishment when RTTI message is received embedded in the SIP 200 OK.

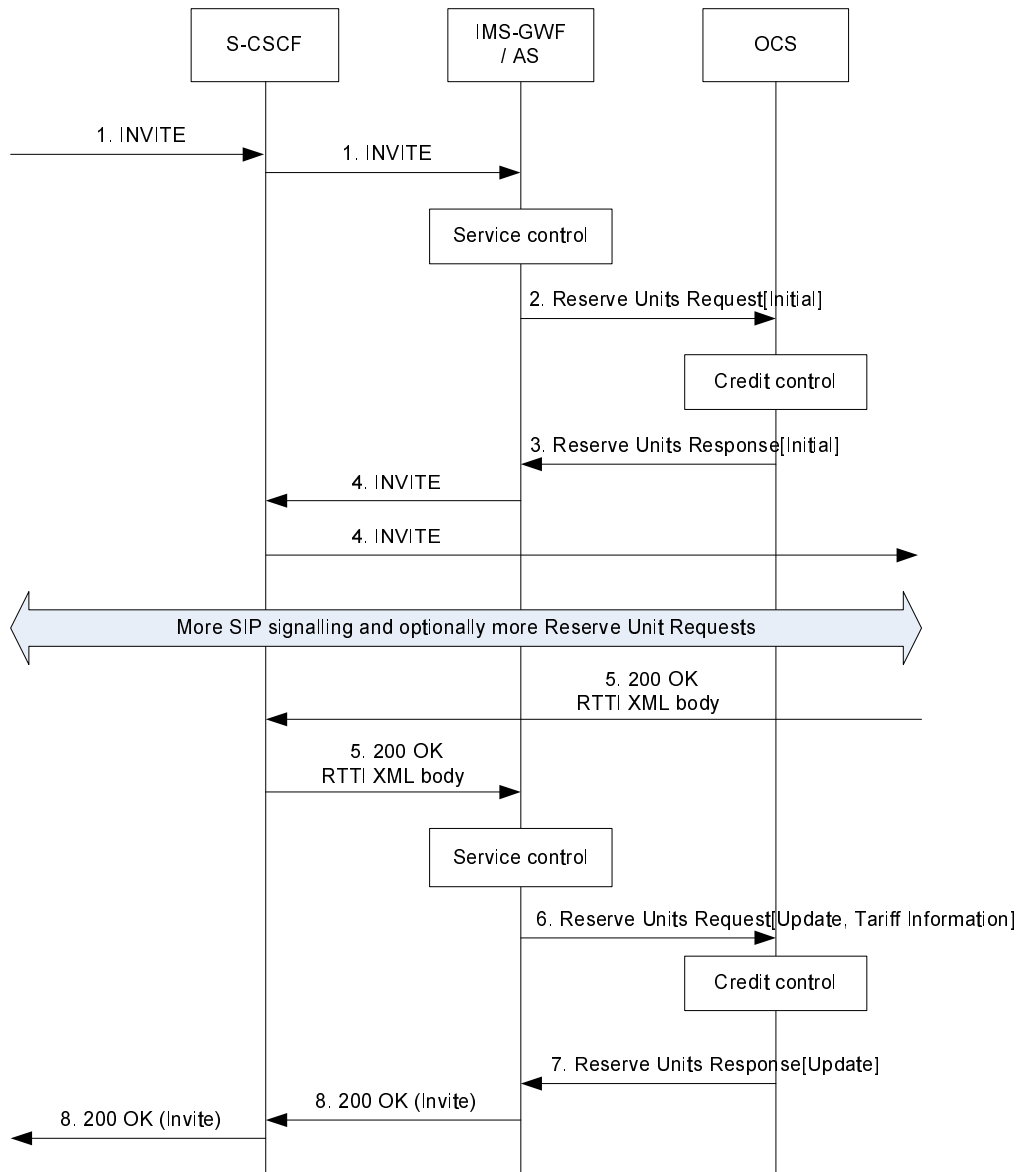

Figure 5.3.2.2.1.3.1.5: Message sequence chart for successful session establishment with reception of RTTI message

- 1) An initial SIP INVITE request is received in the S-CSCF. This request is forwarded to the IMS-GWF/AS.
- 2) The IMS-GWF/AS sends a Reserve Units Request[Initial] to the OCS requesting service units. The online Credit-Control session is initiated.
- 3) The OCS grants units in the Reserve Units Response.
- 4) The IMS-GWF/AS and S-CSCF forward the initial SIP INVITE.
- 5) A final response is received in the IMS-GWF/AS, which embeds a RTTI XML body.
- 6) If the trigger is active, the SIP 200 OK answer triggers a Reserve Units Request[Update] in the IMS-GWF/AS in order to update the session and take into account the RTTI XML body within the SIP 200 OK (see NOTE). New service units are requested. Also the used service units (if any) are reported.

- 7) The OCS sends the Reserve Units Response to acknowledge the Reserve Units Request. New service units are granted.
- 8) The final answer is forwarded.

NOTE: The mapping of RTTI XML body on Tariff Information structure is described in TS 32.280 [36].

5.3.2.2.1.3.2 Session unrelated procedures (ECUR)

Scenario 1: Successful session unrelated procedure

Figure 5.3.2.2.1.3.2.1 shows the Debit / Reserve Units operation that are required in the IMS-GWF/AS for a session unrelated procedure.

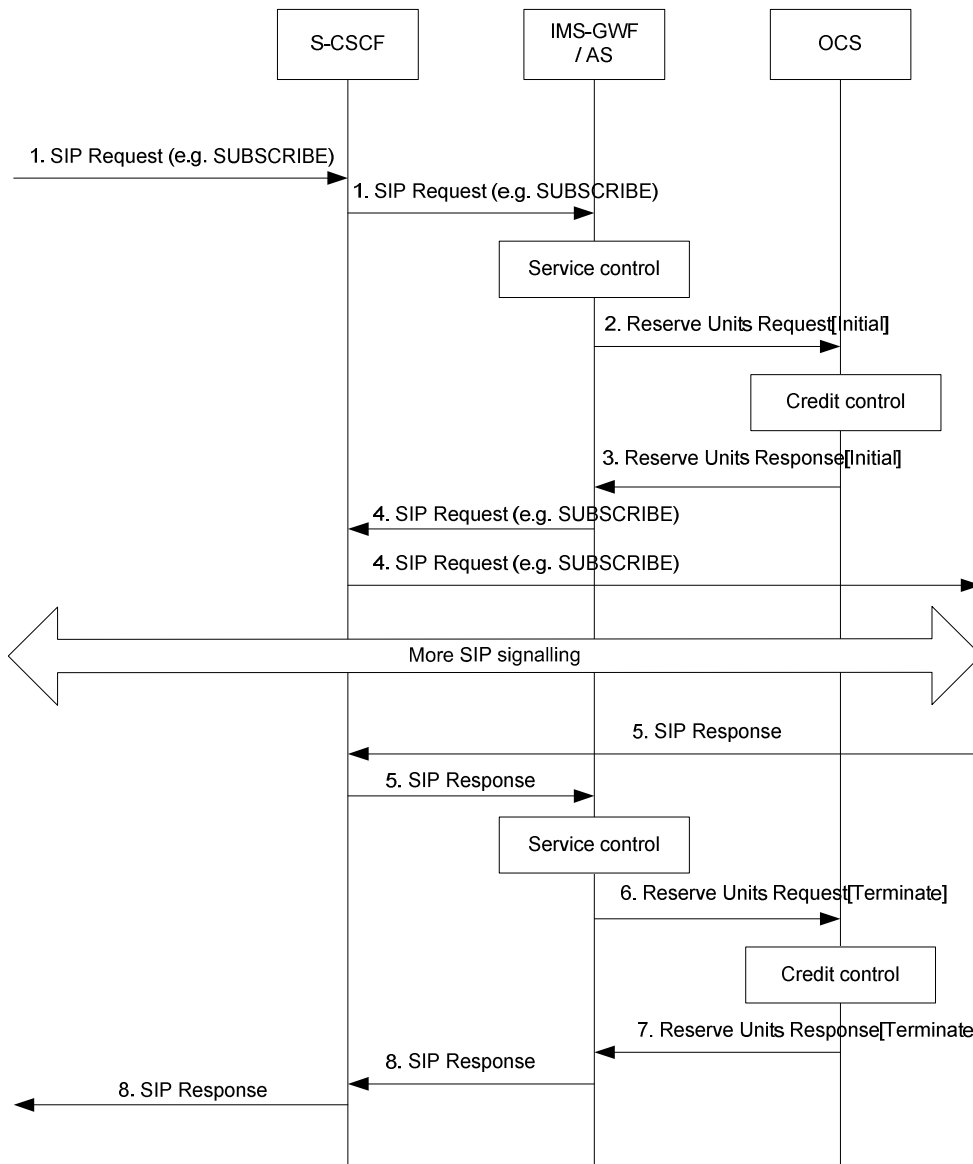

Figure 5.3.2.2.1.3.2.1: Message sequence chart for session-unrelated procedures

- 1) A session unrelated SIP request (e.g. SIP SUBSCRIBE) is received in the S-CSCF. The S-CSCF forwards this request to the IMS-GWF/AS.
- 2) The IMS-GWF/AS sends a Reserve Units Request[Initial] to initiate a Credit-Control session. Service units are requested to the OCS.
- 3) The OCS grants service units in the Reserve Units Response.
- 4) The IMS-GWF/AS and the S-CSCF forward the SIP request
- 5) Depending on the used SIP method, there might be additional signalling between steps 4 and 5.
- 6) The SIP request is acknowledged by a SIP response.

- 7) The IMS-GWF/AS sends a Debit Units Request[Terminate] to the OCS. It also reports the used granted units.
- 8) The OCS sends a Debit Units Response to acknowledge the Debit Units Request. The online session is terminated.
- 9) The IMS-GWF/AS and S-CSCF forward the SIP response.

5.3.2.2.2 Message flows - error cases and scenarios

5.3.2.2.2.0 Introduction

This clause describes various error cases and how these should be handled.

The failure handling behaviour is locally configurable in the IMS Network Element. If *Credit-Control-Failure-Handling* AVP is not used, the locally configured values are used instead.

5.3.2.2.2.1 Reception of SIP error messages

If SIP errors occur during service delivery, as defined in [202] and [203], it is up to the IMS Network Element to determine to what extent the service was delivered before the error occurred and act appropriately with respect to charging. This may imply that no units at all (or no more units) are reserved or debited.

5.3.2.2.2.2 Debit / Reserve Units operation failure

The Debit / Reserve Units operation failure mechanism is specified in TS 32.299 [50] clause 6.3.6.2.

5.3.2.2.2.3 Duplicate detection

For Debit / Reserve Units operation duplicate detection is performed only for possible duplicate event requests related to IEC as mentioned in clause 5.3.2.1.2.3, as retransmission of ECUR/SCUR related Debit / Reserve Units Requests is not allowed.

5.3.2.2.2.4 Aborted session setup

If a trigger occurs during session establishment to release a session during the establishment procedure, the IMS Network Element shall initiate procedures to cancel the session establishment as defined in TS 24.229 [204]. On completion of the cancellation procedure, the IMS Network Element shall close the credit-control session (for SCUR and ECUR) indicating an appropriate cause code.

5.3.2.3 IMS service termination by OCS

5.3.2.3.0 Introduction

Annex B describes several scenarios related to IMS service termination.

NOTE: The annex B only shows the scenario of the S-CSCF with IMS-GWF case.

For IMS session related scenarios charged by means of SCUR in the IMS-GWF, service termination shall imply the rejection of a request for IMS session establishment or the release of an established session that is possibly associated to an online charging session.

For IMS session unrelated scenarios charged by means of ECUR in the IMS-GWF, Service Termination shall imply the rejection of the SIP method triggering the Reserve Units Request as defined in TS 32.299 [50].

For IMS session unrelated scenarios charged by means of IEC prior to service/content delivery in the IMS-GWF, service termination shall imply the rejection of the SIP method triggering the Debit Units Request as defined in TS 32.299 [50].

5.3.2.3.1 Triggers on Ro interface which imply the termination of the IMS service

The procedures in Ro interface which may trigger the IMS Service termination are the following:

- Reception of an unsuccessful Operation Result different from DIAMETER_CREDIT_CONTROL_NOT_APPLICABLE (TS 32.299 [50]) in the Debit / Reserve Units Response message.
- Reception of an unsuccessful Result Code different from DIAMETER_CREDIT_CONTROL_NOT_APPLICABLE (TS 32.299 [50]) within the multiple units operation

in the Debit / Reserve Units Response message when only one instance of the multiple units operation field is used.

- Execution of the termination action procedure as defined in TS 32.299 [50] when only one instance of the Multiple Unit Operation field is used.
- Execution of the failure handling procedures when the Failure Action is set to 'Terminate' or 'Retry & Terminate'.

Reception in the IMS-GWF of an Abort-Session-Request message from OCS.

In case either a Final-Unit-Indication or an erroneous Result-Code at multiple units operation level trigger the IMS service termination and the charging is based on ECUR or SCUR, the IMS-GWF shall close the online session by sending a Debit Units and Reserve Units operation of Type 'Terminate'.

Refer to TS 32.299 [50] for a detailed description of these procedures.

5.3.2.3.2 Indication to the UE of the reason for IMS service release

As a result of service termination triggering in IMS-GWF, the IMS service shall be denied to end-users. The network should provide an indication to UEs of the reason the service has been released or rejected. The procedure shall depend on:

- The charged party.

The network should provide UEs with an indication of the reason the service has been released or rejected.

However, this reason shall depend on whether the UE is the charged party or not. The premise is that only the charged party should know that the IMS service is being rejected / released because of OCS interaction.

- IMS specific protocol issues as defined in TS 24.229 [204].

A) In this scenario, the Response Code of the SIP response shall indicate the server understood the request but is refusing to fulfil it and that this request should not be repeated. The SIP response may include additional information about the cause to reject/release the IMS service. The presence of this additional error information in the response shall be operator configurable.

The additional information included in the SIP response may contain a SIP URI. The UE may treat the SIP URI as if it were a Contact in a redirect and generate a new SIP INVITE, resulting, for example, in a recorded announcement session being established. If announcement information is present in the Debit / Reserve Units Response message then a SIP URI should not be provided in the SIP response for redirection purposes.

B) The IMS-GWF generates a SIP request (e.g. SIP BYE or SIP CANCEL) as a result of the IMS Service Termination procedure:

In this scenario, the IMS-GWF may include a 'Reason' field in the request which provides additional information about the cause to reject/release the IMS service. The presence of this additional information in the request shall be operator configurable.

In both scenarios, it shall also be operator configurable both per SIP method and per Originating/Terminating side, the content of the additional error information sent to the UEs. This error information shall also be configurable based on the procedure in Ro interface which has triggered the release/rejection of the IMS service according to clause 5.3.2.3.1. In particular when the service termination is triggered by the reception of an unsuccessful operation result (different from DIAMETER_CREDIT_CONTROL_NOT_APPLICABLE as defined in TS 32.299 [50]) in the Debit / Reserve Units Response message or the reception of an unsuccessful Result Code (different from DIAMETER_CREDIT_CONTROL_NOT_APPLICABLE as defined in TS 32.299 [50]) within the multiple units operation in the Debit / Reserve Units Response message, the additional error information/reason shall also be configurable based on the Result Code received through Ro interface.

6 Definition of charging information

6.1 Data description for IMS offline charging

6.1.1 Rf message contents

6.1.1.0 Introduction

The IMS nodes generate accounting information that can be transferred from the CTF to the CDF. For this purpose, IMS offline charging utilises the Charging Data Transfer that is specified in the 3GPP accounting application described in TS 32.299 [50].

The Charging Data Transfer operation employs the Charging Data Request and Charging Data Response messages. Table 6.1.1.0.1 describes the use of these messages for offline charging.

Table 6.1.1.0.1: Offline charging messages reference table

Message	Source	Destination
<i>Charging Data Request</i>	S-CSCF, I-CSCF, P-CSCF, MRFC, MGCF, BGCF, IBCF, AS, E-CSCF, TF, TRF, ATCF	CDF
<i>Charging Data Response</i>	CDF	S-CSCF, I-CSCF, P-CSCF, MRFC, MGCF, BGCF, IBCF, AS, E-CSCF, TF, TRF, ATCF

The tables in the subsequent parts of this clause describes the Information Elements (IE) used in the charging data messages and the category in table are used according to the charging data configuration defined in clause 5.4 of TS 32.240 [1].

6.1.1.1 Charging Data Request message

Table 6.1.1.1.1 illustrates the basic structure of a Charging Data Request message as used for IMS offline charging.

Table 6.1.1.1.1: Charging Data Request message contents

Information Element	Category	Description
Session Identifier	M	Described in 32.299 [50]
Originator Host	M	Described in 32.299 [50]
Originator Domain	M	Described in 32.299 [50]
Destination Domain	M	Described in 32.299 [50]
Operation Type	M	Described in 32.299 [50]
Operation Number	M	Described in 32.299 [50]
Operation Identifier	O _M	The field corresponds to the unique operation identification.
User Name	O _C	This field contains the Private User Identity defined in TS 23.003 [104].
Destination Host	O _C	Described in 32.299 [50]
Operation Interval	O _C	This field contains the requested time interval between Charging Data Request operations.
Origination State	O _C	TBD
Origination Timestamp	O _C	This field contains the time when the operation is requested.
Proxy Information	O _C	This field contains the parameter of the proxy.
Route Information	O _C	This field contains the parameter of the route.
Operation Token	O _M	This field identifies the domain, subsystem, or service and release.
Service Information	O _M	This field holds the IMS charging specific parameters, described in clause 6.3.

6.1.1.2 Charging Data Response message

Table 6.1.1.2.1 illustrates the basic structure of a Charging Data Response message as used for IMS offline charging.

Table 6.1.1.2.1: Charging Data Response message contents

Information Element	Category	Description
Session Identifier	M	This field identifies the operation session.
Operation Result	M	This field identifies the result of the operation.
Originator Host	M	This field contains the identification of the source point of the operation and the realm of the operation originator.
Originator Domain	M	This field contains the realm of the operation originator.
Operation Type	M	This field defines the transfer type: event for event based charging and start, interim, stop for session based charging.
Operation Number	M	This field contains the sequence number of the transferred messages.
Operation Identifier	O _M	The field corresponds to the unique operation identification.
User Name	O _C	The field contains the Private User Identity defined in TS 23.003 [104].
Operation Interval	O _C	This field contains the requested time interval between Charging Data Request operations.
Origination State	O _C	TBD
Origination Timestamp	O _C	This field contains the time when the operation is requested.
Proxy Information	O _C	This field contains the parameter of the proxy.

6.1.2 GTP' message contents

Not applicable. Refer to clause 5.2.4 for further information.

6.1.3 CDR description on the Bi interface

6.1.3.1 CDR content description

The following standard CDR content and format are considered:

- S-CSCF-CDR generated based on information from the S-CSCF
- I-CSCF-CDR generated based on information from the I-CSCF
- P-CSCF-CDR generated based on information from the P-CSCF
- BGCF-CDR generated based on information from the BGCF
- IBCF-CDR generated based on information from the IBCF
- MGCF-CDR generated based on information from the MGCF
- MRFC-CDR generated based on information from the MRFC
- AS-CDR generated based on information from the AS
- E-CSCF-CDR generated based on information from the E-CSCF
- TF-CDR generated based on information from the IMS TF
- TRF-CDR generated based on information from the TRF
- ATCF-CDR generated based on information from the ATCF

The content of each CDR type is defined in the tables in clauses 6.1.3.3 to 6.14.3.1. For each CDR type the field definition includes the CDR parameter ("field name"), category and description. The categories in the tables are used according to the charging data configuration defined in clause 5.4 of TS 32.240 [1].

Editor's Note: Equipment vendors shall be able to provide all of the fields listed in the CDR content table in order to claim compliance with the present document. However, since CDR processing and transport consume network resources, operators may opt to eliminate some of the fields that are not essential for their operation.

The CDF provides the CDRs at the Bi interface in the format and encoding described in TS 32.298 [51]. Additional CDR formats and contents may be available at the interface to the billing system to meet the requirements of the billing system, these are outside of the scope of 3GPP standardisation.

6.1.3.2 CDR triggers

6.1.3.2.1 Session related CDRs

Reflecting the usage of multimedia sessions IMS CDRs are generated by the CDF on a per session level. In the scope of the present document the term "session" refers always to a SIP session. The coherent media components are reflected inside the session CDRs with a media component container comprising of all the information necessary for the description of a media component.

Accounting information for SIP sessions is transferred from the CTF involved in the session to the CDF using Charging Data Request[Start, Interim and Stop] messages. A session CDR is opened in the CDF upon reception of a Charging Data Request[Start] message. Partial CDRs may be generated upon reception of a Charging Data Request[Interim] message, which is sent by the network entity towards the CDF due to a session modification procedure (i.e. change in media). Session CDRs are updated, or partial CDRs are generated upon reception of a Charging Data Request[Interim] message, which is sent by the network entity due to expiration of the Charging Data Interim Interval. The CDF closes the final session CDR upon reception of a Charging Data Request[Stop] message, which indicates that the SIP session is terminated. Further details on triggers for the generation of IMS CDRs are specified in [1].

Accounting information for unsuccessful session set-up attempts may be sent by the CTF to the CDF employing the Charging Data Request[Event] message. The behaviour of the CDF upon receiving Charging Data Request [Event] messages is specified in clause 6.1.3.2.2.

6.1.3.2.2 Session unrelated CDRs

To reflect chargeable events not directly related to a session the CDF may generate CDRs upon the occurrence of session unrelated SIP procedures, such as registration respectively de-registration events. Accounting information for SIP session-unrelated procedures is transferred from the IMS nodes involved in the procedure to the CDF using Charging Data Request[Event] messages. Session unrelated CDRs are created in the CDF in a "one-off" action based on the information contained in the Charging Data Request[Event] message. One session unrelated CDR is created in the CDF for each Charging Data Request[Event] message received, whereas the creation of partial CDRs is not applicable for session unrelated CDRs. The cases for which the IMS nodes send Charging Data Request[Event] messages are listed per SIP procedure in table 5.2.1.1 and table 5.2.1.2.

Further details on triggers for the generation of IMS CDRs are specified in clause 5.2.2.

6.1.3.3 S-CSCF CDR content

The detailed description of the field is provided in TS 32.298 [51].

Table 6.1.3.3.1: Charging data of S-CSCF CDR

Field	Category	Description
Record Type	M	Identifies the type of record. The parameter is derived from the Node functionality parameter.
Retransmission	O _C	This parameter, when present, indicates that information from retransmitted Charging Data Requests has been used in this CDR
SIP Method	O _C	Specifies the SIP-method for which the CDR is generated. Only available in session unrelated cases.
Event	O _C	This field identifies the SIP event package to which the SIP request is referred.
Expires Information	O _C	This field indicates the validity time of either the SIP message or its content, depending on the SIP method.
Role of Node	O _M	This field indicates whether the S-CSCF is serving the Originating or the Terminating party.
Node Address	O _M	This item holds the address of the node providing the information for the CDR. This may either be the IP address or the FQDN of the IMS node generating the accounting data.
Session ID	O _M	The Session identification. For a SIP session the Session-ID contains the SIP Call ID as defined in the Session Initiation Protocol RFC 3261 [404].
Session Priority	O _C	The field contains the priority of the session.
List Of Calling Party Address	O _M	The address or addresses (Public User ID or Public Service ID) of the party requesting a service or initiating a session. In the case of no P-Asserted-Identify is known, this list shall include one item with the value "unknown".
List of Associated URI	O _C	The list of non-barred public user identities (SIP URIs and/or Tel URIs) associated to the public user identity under registration.
Called Party Address	O _M	For SIP transactions, except for registration, this field holds the address of the party (Public User ID or Public Service ID) to whom the SIP transaction is posted. For registration transactions, this field holds the Public User ID under registration.
Requested Party Address	O _C	For SIP transactions this field holds the address of the party (Public User ID or Public Service ID) to whom the SIP transaction was originally posted. This field is only present if different from the Called Party Address parameter.
Number Portability routing information	O _C	This field includes information on number portability after DNS/ENUM request from S-CSCF in the calling user's home network.
Carrier Select routing information	O _C	This field includes information on carrier select after DNS/ENUM request from S-CSCF in the calling user's home network.
List of Called Asserted Identity	O _C	The address or addresses of the final asserted identities. Present if the final asserted identities are available in the SIP 2xx response.
List of Called Identity Changes	O _C	List of terminating identity address changes and associated timestamps.
Called Identity Change Time Stamp	O _C	Timestamp of SIP UPDATE or SIP RE-INVITE with changed terminating identity information.
Called Identity	O _C	Changed terminating identity information received in a SIP UPDATE or SIP RE-INVITE.
Private User ID	O _C	This field holds the private user identity of the served party defined in TS 23.003 [104] , if available.
List of Subscription Id	O _M	Holds the public user identities of the served user
Service Request Time Stamp	O _M	This field contains the time stamp, which indicates the time at which the service was requested.
Service Request Time Stamp Fraction	O _M	This parameter contains the milliseconds fraction in relation to the Service Request Time Stamp.
Service Delivery Start Time Stamp	O _M	This field holds the time stamp reflecting either: successful session set-up, a delivery unrelated service, an unsuccessful session set-up and an unsuccessful session unrelated request.
Service Delivery Start Time Stamp Fraction	O _M	This parameter contains the milliseconds fraction in relation to the Service Delivery Start Time Stamp.
Service Delivery End Time Stamp	O _C	This field records the time at which the service delivery was terminated. It is Present only in SIP session related case.
Service Delivery End Time Stamp Fraction	O _C	This parameter contains the milliseconds fraction in relation to the Service Delivery End Time Stamp.
Record Opening Time	O _C	A time stamp reflecting the time the CDF opened this record. Present only in SIP session related case.
Record Closure Time	O _M	A Time stamp reflecting the time the CDF closed the record.
Application Servers Information	O _C	This a grouped CDR field containing the fields: "Application Server Involved" and "Application Provided Called Parties".
Application Servers Involved	O _C	Holds the ASs (if any) identified by the SIP URIs.
Application Provided Called Parties	O _C	Holds a list of the Called Party Address(es), if the address(es) are determined by an AS (SIP URI, E.164...).
Status	O _C	Holds the abnormal status information of specific ASs (if any) when AS(s) respond 4xx/5xx or time out to S-CSCF during an IMS session.

Field	Category	Description
List of Inter Operator Identifiers	O _C	Holds the identification of the home network (originating and terminating) if exchanged via SIP signalling, as recorded in the P-Charging-Vector header. This grouped field may occur several times in one CDR.
Originating IOI	O _C	This parameter corresponds to Orig-IOI header of the P-Charging-Vector defined in TS 24.229 [204].
Terminating IOI	O _C	This parameter corresponds to Term-IOI header of the P-Charging-Vector defined in TS 24.229 [204].
Transit IOI List	O _C	This parameter corresponds to Transit-IOI List of the P-Charging-Vector defined in TS 24.229 [204]. This field may occur several times in one CDR. Each occurrence represents transit IOI values received from the path inbound to or outbound from the S-CSCF.
Local Record Sequence Number	O _M	This field includes a unique record number created by S-CSCF. The number is allocated sequentially for each partial CDR (or whole CDR) including all CDR types. The number is unique within the CDF.
Record Sequence Number	O _C	This field contains a running sequence number employed to link the partial records generated by the CDF for a particular session.
Cause For Record Closing	O _M	This field contains a reason for the close of the CDR.
Incomplete CDR Indication	O _C	This field provides additional diagnostics when the CDF detects missing Charging Data Requests.
IMS Charging Identifier	O _M	This parameter holds the IMS charging identifier (ICID) as generated by the IMS node for the SIP session.
List of Early SDP Media Components	O _C	This is a grouped field which may occur several times in one CDR. This field shall not be present if no media components are set to active before the final SIP session answer to the initial SIP Invite is received. This field can be present in either session or event CDRs.
SDP Session Description	O _C	Holds the Session portion of SDP data exchanged in the above mentioned scenario, if available.
SDP Type	O _M	This parameter indicates if the SDP media component is an SDP offer or SDP answer.
SDP Offer Timestamp	O _M	This parameter contains the time of the SIP request which conveys the SDP offer.
SDP Answer Timestamp	O _M	This parameter contains the time of the response to the SIP request which conveys the SDP answer.
SDP Media Components	O _M	This is a grouped field comprising several sub-fields associated with one media component. Since several media components may exist for a session in parallel these sub-fields may occur several times.
SDP Media Name	O _M	This field holds the name of the media as available in the SDP data.
SDP Media Description	O _M	This field holds the attributes of the media as available in the SDP data.
Access Correlation ID	O _C	This parameter holds the charging identifier from the access network, consisting of either GPRS charging ID (GCID) which is generated by the GGSN for a GPRS PDP context, Charging Id which is generated by P-GW for IP-CAN bearer or the Access Network Charging Identifier Value which is generated by another type of access network. It is present only if received from the access network when PCC architecture is implemented.
Media Initiator Flag	O _C	This field indicates if the called party has requested the session modification and it is present only if the initiator was the called party.
List of SDP Media Components	O _C	This is a grouped field which may occur several times in one CDR. The field is present only in a SIP session related case.
SDP Session Description	O _C	Holds the Session portion of the SDP data exchanged between the User Agents if available in the SIP transaction.
SDP Type	O _M	This parameter indicates if the SDP media component is an SDP offer or SDP answer.
SIP Request Timestamp	O _C	This parameter contains the time of the SIP request (usually a (RE-)INVITE).
SIP Response Timestamp	O _C	This parameter contains appropriately the time of SIP 200 OK acknowledging an SIP INVITE or of SIP ACK including an SDP answer.
SIP Request Timestamp Fraction	O _C	This parameter contains the milliseconds fraction in relation to the SIP Request Timestamp.
SIP Response Timestamp Fraction	O _C	This parameter contains the milliseconds fraction in relation to the SIP Response Timestamp.
SDP Media Components	O _M	This is a grouped field comprising several sub-fields associated with one media component. Since several media components may exist for a session in parallel these sub-fields may occur several times.
SDP Media Name	O _M	This field holds the name of the media as available in the SDP data.
SDP Media Description	O _M	This field holds the attributes of the media as available in the SDP data.

Field	Category	Description
Access Correlation ID	O _C	This parameter holds the charging identifier from the access network, consisting of either GPRS charging ID (GCID) which is generated by the GGSN for a GPRS PDP context, Charging Id which is generated by P-GW for IP-CAN bearer or the Access Network Charging Identifier Value which is generated by another type of access network. It is present only if received from the access network when PCC architecture is implemented.
Media Initiator Flag	O _C	This field indicates if the called party has requested the session modification and it is present only if the initiator was the called party.
GGSN Address	O _C	This parameter holds the control plane IP address of the GGSN that handles one or more media component(s) of an IMS session.
Service Reason Return Code	O _M	This parameter provides the returned SIP status code for the service request for the successful and failure case,
List Of Reason Header	O _C	This parameter contains the list of SIP reason headers included in BYE or CANCEL method terminating the service, Reliability of this information is not guaranteed if the SIP or CANCEL is originated outside of the trust domain which is determined by the Operator on a "per parameter basis".
List of Message Bodies	O _C	This grouped field comprising several sub-fields describing the data that may be conveyed end-to-end in the body of a SIP message. Since several message bodies may be exchanged via SIP-signalling, this grouped field may occur several times.
Content-Type	O _M	This sub-field of Message Bodies holds the MIME type of the message body, Examples are: application/zip, image/gif, audio/mpeg, etc.
Content-Disposition	O _C	This sub-field of Message Bodies holds the content disposition of the message body inside the SIP signalling, Content-disposition header field equal to "render", indicates that "the body part should be displayed or otherwise rendered to the user". Content disposition values are: session, render, inline, icon, alert, attachment, etc.
Content-Length	O _M	This sub-field of Message Bodies holds the size of the data of a message body in bytes.
Originator	O _C	This sub-field of the "List of Message Bodies" indicates the originating party of the message body.
Access Network Information	O _C	This field contains the content of one SIP P-header "P-Access-Network-Info", available in the IMS Node when charging session starts, if available.
Additional Access Network Information	O _C	This field contains the content of an additional SIP P-header "P-Access-Network-Info", available in the IMS Node as additional location when charging session starts, if available.
Cellular Network Information	O _C	This field contains the content of one SIP "Cellular-Network-Info" header, when the UE supporting one or more cellular radio access technologies but using a non-cellular IP-CAN, such as untrusted WLAN access, provides this header field to relay information to its service provider about the radio cell identity of the cellular radio access network on which the UE most recently camped.
List of Access Network Info Change	O _C	This field is a list of grouped field describing the subsequent SIP P-header "P-Access-Network-Info" changes.
Access Network Information	O _C	This field holds the content of the SIP P-header "P-Access-Network-Info", when changed from the previous one.
Additional Access Network Information	O _C	This field holds the content of additional SIP P-header "P-Access-Network-Info" when changed from the previous one, if available.
Cellular Network Information	O _C	This field contains the content of one SIP "Cellular-Network-Info" header, when the UE supporting one or more cellular radio access technologies but using a non-cellular IP-CAN, such as untrusted WLAN access, provides this header field to relay information to its service provider about the radio cell identity of the cellular radio access network on which the UE most recently camped. This field is applicable when changed from the previous one, if available.
Access Change Time	O _C	This field contains the time at which the changed user location information was acquired.
Service Context Id	O _M	Holds the context information to which the CDR belongs. The information is obtained from the Operation Token of the Charging Data Request message.
IMS Communication Service ID	O _C	This field contains the IMS communication service identifier if received in the P-Asserted-Service header in the SIP request.
Online Charging Flag	O _C	This field indicates the Online Charging Request was sent based on the provided ECF address from the SIP P-header "P-Charging-Function-Addresses". NOTE: No proof that online charging action has been taken
Real Time Tariff Information	O _C	This field holds the tariff/add-on charge received.

Field	Category	Description
User Location Info	O _C	This field contains the network provided location information for 3GPP accesses, available in the IMS Node when charging session starts, if available.
MS Time Zone	O _C	This field indicates the offset between universal time and local time in steps of 15 minutes of where the MS currently resides.
NNI Information	O _C	This grouped field holds information about the NNI used for interconnection and roaming on the loopback routing path. It is present only if "VPLMN routing" is applied in a Roaming Architecture for Voice over IMS with Local breakout.
NNI Type	O _C	This field indicates usage of the roaming NNI for loopback routing, i.e. S-CSCF performed the loopback decision.
From Address	O _M	Contains the information from the SIP From header.
IMS Emergency Indication	O _C	This field indicates the registration is an emergency registration or the IMS session is an IMS emergency session, and is present only for emergency cases.
IMS Visited Network Identifier	O _C	Contains the information from the SIP P-Visited-Network-ID header received in a REGISTER request.
SIP Route header received	O _C	Contains the information in the topmost route header in a received initial SIP INVITE or non-session related SIP MESSAGE request prior to triggering of any ASs. This field is present only for requests from the served user.
SIP Route header transmitted	O _C	Contains the information in the route header representing the destination in a transmitted SIP INVITE or non-session related SIP MESSAGE request following triggering of all application servers. This field is present for requests toward the served user and for requests from the served user when "VPLMN routing" is applied in a Roaming Architecture for Voice over IMS with Local breakout.
Subscriber Equipment Number	O _C	This field contains the identification of the mobile device (e.g. IMEI) that the subscriber is using.
Instance Id	O _C	This field uniquely identifies the device (fixed or mobile) of the served user.
Record Extensions	O _C	A set of operator/manufacture specific extensions to the record, conditioned upon existence of an extension.
FE Identifier List	O _C	This parameter corresponds to FE Identifier List of the P-Charging-Vector defined in TS 24.229 [204]. This element contains one or more IM CN subsystem functional entity addresses and/or AS and application identifiers where the IM CN subsystem functional entity does create charging information for the related CDR of this IM CN subsystem functional entity.

6.1.3.4 P-CSCF CDR content

The detailed description of the field is provided in TS 32.298 [51].

Table 6.1.3.4.1: Charging data of P-CSCF CDR

Field	Category	Description
Record Type	M	Identifies the type of record. The parameter is derived from the Node functionality parameter.
Retransmission	O _C	This parameter, when present, indicates that information from retransmitted Charging Data Requests has been used in this CDR.
SIP Method	O _C	Specifies the SIP-method for which the CDR is generated. Only available in session unrelated cases.
Event	O _C	This field identifies the SIP event package to which the SIP request is referred.
Expires Information	O _C	This field indicates the validity time of either the SIP message or its content, depending on the SIP method.
Role of Node	O _M	This field indicates whether the P-CSCF is serving the Originating or the Terminating party.
Node Address	O _M	This item holds the address of the node providing the information for the CDR. This may either be the IP address or the FQDN of the IMS node generating the accounting data.
Session ID	O _M	The Session identification. For a SIP session the Session-ID contains the SIP Call ID as defined in the Session Initiation Protocol RFC 3261 [404].
Session Priority	O _C	The field contains the priority of the session.
List Of Calling Party Address	O _M	The address (Public User ID or Public Service ID) of the party requesting a service or initiating a session. In the case of no P-Asserted-Identify is known, this list shall include one item with the value "unknown" Note: For P-CSCF, only one address is present
List of Associated URI	O _C	The list of non-barred public user identities (SIP URIs and/or Tel URIs) associated to the public user identity under registration.
Called Party Address	O _M	In the context of an end-to-end SIP transaction this field holds the address of the party (Public User ID) to whom the SIP transaction is posted. For emergency calls, this parameter could contain an URN.
List of Called Asserted Identity	O _C	The address or addresses of the final asserted identities. Present if the final asserted identities are available in the SIP 2xx response.
List of Called Identity Changes	O _C	List of terminating identity address changes and associated timestamps.
Called Identity Change Time Stamp	O _C	Timestamp of SIP UPDATE or SIP RE-INVITE with changed terminating identity information.
Called Identity	O _C	Changed terminating identity information received in a SIP UPDATE or SIP RE-INVITE.
Served Party IP Address	O _M	This field contains the IP address of either the calling or called party, depending on whether the P-CSCF is in touch with the calling or called network.
Private User ID	O _C	This field holds the private user identity of the served party defined in TS 23.003 [104], if available.
List of Subscription Id	O _M	Holds the public user identities of the served user.
Service Request Time Stamp	O _M	This field contains the time stamp, which indicates the time at which the service was requested.
Service Request Time Stamp Fraction	O _M	This parameter contains the milliseconds fraction in relation to the Service Request Time Stamp.
Service Delivery Start Time Stamp	O _M	This field holds the time stamp reflecting either: successful session set-up, a delivery unrelated service, an unsuccessful session set-up and an unsuccessful session unrelated request.
Service Delivery Start Time Stamp Fraction	O _M	This parameter contains the milliseconds fraction in relation to the Service Delivery Start Time Stamp.
Service Delivery End Time Stamp	O _C	This field records the time at which the service delivery was terminated. It is Present only in SIP session related case. Present with Charging Data Request [Stop].
Service Delivery End Time Stamp Fraction	O _C	This parameter contains the milliseconds fraction in relation to the Service Delivery End Time Stamp.
Record Opening Time	O _C	A time stamp reflecting the time the CDF opened this record. Present only in SIP session related case.
Record Closure Time	O _M	A Time stamp reflecting the time the CDF closed the record.
Inter Operator Identifiers	O _C	Holds the identification of the home network (originating and terminating) if exchanged via SIP signalling, as recorded in the <i>P-Charging-Vector header</i> .
Originating IOI	O _C	This parameter corresponds to Orig-IOI header of the P-Charging-Vector defined in TS 24.229 [204].
Terminating IOI	O _C	This parameter corresponds to Term-IOI header of the P-Charging-Vector defined in TS 24.229 [204].
Transit IOI List	O _C	This parameter corresponds to Transit-IOI List of the P-Charging-Vector defined in TS 24.229 [204].
Local Record Sequence Number	O _M	This field includes a unique record number created by this node. The number is allocated sequentially for each partial CDR (or whole CDR) including all CDR types. The number is unique within the CDF.
Record Sequence Number	O _C	This field contains a running sequence number employed to link the partial records generated by the CDF for a particular session.
Cause For Record Closing	O _M	This field contains a reason for the close of the CDR.
Incomplete CDR Indication	O _C	This field provides additional diagnostics when the CDF detects missing Charging Data Requests.

Field	Category	Description
IMS Charging Identifier	O _M	This parameter holds the IMS charging identifier (ICID) as generated by the IMS node for the SIP session.
Related IMS Charging Identifier	O _C	This parameter holds the Related IMS charging identifier when the session is the target access leg in case of access transfer.
Related IMS Charging Identifier Generation Node	O _C	This parameter holds the identifier of the server that generated the Related IMS charging identifier.
List of Early SDP Media Components	O _C	This is a grouped field which may occur several times in one CDR. This field shall not be present if no media components are set to active before the final SIP session answer to the initial SIP Invite is received. This field can be present in either session or event CDRs.
SDP Session Description	O _C	Holds the Session portion of SDP data exchanged in the above mentioned scenario, if available.
SDP Type	O _M	This parameter indicates if the SDP media component is an SDP offer or SDP answer.
SDP Offer Timestamp	O _M	This parameter contains the time of the SIP request which conveys the SDP offer.
SDP Answer Timestamp	O _M	This parameter contains the time of the response to the SIP request which conveys the SDP answer.
SDP Media Components	O _M	This is a grouped field comprising several sub-fields associated with one media component. Since several media components may exist for a session in parallel these sub-fields may occur several times.
SDP Media Name	O _M	This field holds the name of the media as available in the SDP data.
SDP Media Description	O _M	This field holds the attributes of the media as available in the SDP data.
Access Correlation ID	O _C	This parameter holds the charging identifier from the access network, consisting of either GPRS charging ID (GCID) which is generated by the GGSN for a GPRS PDP context, Charging Id which is generated by P-GW for IP-CAN bearer or the Access Network Charging Identifier Value which is generated by another type of access network. It is present only if received from the access network when PCC architecture is implemented.
Media Initiator Flag	O _C	This field indicates if the called party has requested the session modification and it is present only if the initiator was the called party.
List of SDP Media Components	O _C	This is a grouped field which may occur several times in one CDR. The field is present only in a SIP session related case.
SDP Session Description	O _C	Holds the Session portion of the SDP data exchanged between the User Agents if available in the SIP transaction.
SDP Type	O _M	This parameter indicates if the SDP media component is an SDP offer or SDP answer.
SIP Request Timestamp	O _C	This parameter contains the time of the SIP request (usually a (RE-)INVITE). This parameter corresponds to SIP Request Timestamp in Charging Data Request [Interim].
SIP Response Timestamp	O _C	This parameter contains appropriately the time of SIP 200 OK acknowledging an SIP INVITE or of SIP ACK including an SDP answer. This parameter corresponds to SIP Response Timestamp in Charging Data Request.
SIP Request Timestamp Fraction	O _C	This parameter contains the milliseconds fraction in relation to the SIP Request Timestamp.
SIP Response Timestamp Fraction	O _C	This parameter contains the milliseconds fraction in relation to the SIP Response Timestamp.
SDP Media Components	O _M	This is a grouped field comprising several sub-fields associated with one media component. Since several media components may exist for a session in parallel these sub-fields may occur several times.
SDP Media Name	O _M	This field holds the name of the media as available in the SDP data. This parameter corresponds to SDP-Media-Name.
SDP Media Description	O _M	This field holds the attributes of the media as available in the SDP data. This parameter corresponds to SDP-Media-Description.
Local GW Inserted Indication	O _C	This field indicates whether the local IMS-AGW is inserted or not, for the media component included in SDP answer, if available.
IP realm Default Indication	O _C	This field indicates whether the User Plane IP realm associated to the media component included in SDP answer, is the Default IP realm or not, if available.
Access Correlation ID	O _C	This parameter holds the charging identifier from the access network, consisting of either GPRS charging ID (GCID) which is generated by the GGSN for a GPRS PDP context, Charging Id which is generated by P-GW for IP-CAN bearer or the Access Network Charging Identifier Value which is generated by another type of access network. It is present only if received from the access network when PCC architecture is implemented.
Media Initiator Flag	O _C	This field indicates if the called party has requested the session modification and it is present only if the initiator was the called party.
GGSN Address	O _C	This parameter holds the control plane IP address of the GGSN that handles one or more media component(s) of a IMS session.

Field	Category	Description
Service Reason Return Code	O _M	This parameter provides the returned SIP status code for the service request for the successful and failure case.
List Of Reason Header	O _C	This parameter contains the list of SIP reason headers included in BYE or CANCEL method terminating the service, Reliability of this information is not guaranteed if the SIP or CANCEL is originated outside of the trust domain which is determined by the Operator on a "per parameter basis".
List of Message Bodies	O _C	This grouped field comprising several sub-fields describing the data that may be conveyed end-to-end in the body of a SIP message. Since several message bodies may be exchanged via SIP-signalling, this grouped field may occur several times.
Content-Type	O _M	This sub-field of Message Bodies holds the MIME type of the message body, Examples are: application/zip, image/gif, audio/mpeg, etc.
Content-Disposition	O _C	This sub-field of Message Bodies holds the content disposition of the message body inside the SIP signalling, Content-disposition header field equal to "render", indicates that "the body part should be displayed or otherwise rendered to the user". Content disposition values are: session, render, inline, icon, alert, attachment, etc.
Content-Length	O _M	This sub-field of Message Bodies holds the size of the data of a message body in bytes.
Originator	O _C	This sub-field of the "List of Message Bodies" indicates the originating party of the message body.
Access Network Information	O _C	This field contains the content of one SIP P-header "P-Access-Network-Info", available in the IMS Node when charging session starts, if available.
Additional Access Network Information	O _C	This field contains the content of an additional SIP P-header "P-Access-Network-Info", available in the IMS Node as additional location when charging session starts, if available.
Cellular Network Information	O _C	This field contains the content of one SIP "Cellular-Network-Info" header, when the UE supporting one or more cellular radio access technologies but using a non-cellular IP-CAN, such as untrusted WLAN access, provides this header field to relay information to its service provider about the radio cell identity of the cellular radio access network on which the UE most recently camped.
List of Access Network Info Change	O _C	This field is a list of grouped field describing the subsequent SIP P-header "P-Access-Network-Info" changes.
Access Network Information	O _C	This field holds the content of the SIP P-header "P-Access-Network-Info", when changed from the previous one.
Additional Access Network Information	O _C	This field holds the content of additional SIP P-header "P-Access-Network-Info" when changed from the previous one, if available.
Cellular Network Information	O _C	This field contains the content of one SIP "Cellular-Network-Info" header, when the UE supporting one or more cellular radio access technologies but using a non-cellular IP-CAN, such as untrusted WLAN access, provides this header field to relay information to its service provider about the radio cell identity of the cellular radio access network on which the UE most recently camped. This field is applicable when changed from the previous one, if available.
Access Change Time	O _C	This field contains the time at which the changed user location information was acquired.
Service Context Id	O _M	Holds the context information to which the CDR belongs. The information is obtained from the Operation Token of the Charging Data Request message.
IMS Communication Service ID	O _C	This field contains the IMS communication service identifier if received in the P-Asserted-Service header in the SIP request when the P-CSCF is serving the Terminating party or the topmost occurrence of the "+g.3gpp.icsi-ref" header field parameter of the Feature-Caps header in the SIP response when the P-CSCF is serving the Originating party.
IMS Application Reference ID	O _C	This field contains the IMS application reference identifier if received in the SIP request.
User Location Info	O _C	This field contains the network provided location information for 3GPP accesses available in the IMS Node when charging session starts, if available.
MS Time Zone	O _C	This field indicates the offset between universal time and local time in steps of 15 minutes of where the MS currently resides.
NNI Information	O _C	This grouped field holds information about the NNI used for interconnection and roaming on the loopback routing path. It is present only if RAVEL "VPLMN routing" is applied.
NNI Type	O _C	This field indicates usage of the roaming NNI for loopback routing, The loopback indication was received by the P-CSCF.
From Address	O _M	Contains the information from the SIP From header.
IMS Emergency Indication	O _C	This field indicates the registration is an emergency registration or the IMS session is an IMS emergency session, and is present only for emergency cases.

Field	Category	Description
IMS Visited Network Identifier	O _C	Contains the information from the SIP P-Visited-Network-ID header sent in a REGISTER request.
SIP Route header received	O _C	Contains the information in the topmost route header in a received initial SIP INVITE or non-session related SIP MESSAGE request. This field is used for SIP requests toward the served user.
SIP Route header transmitted	O _C	Contains the information in the route header representing the destination in a transmitted initial SIP INVITE or non-session related SIP MESSAGE request. This field is used for SIP requests from the served user.
Subscriber Equipment Number	O _C	This field contains the identification of the mobile device (e.g. IMEI) that the subscriber is using.
Instance Id	O _C	This field uniquely identifies the device (fixed or mobile) of the served user.
FE Identifier List	O _C	This parameter corresponds to FE Identifier List of the P-Charging-Vector defined in TS 24.229 [204]. This element contains one or more IM CN subsystem functional entity addresses and/or AS and application identifiers where the IM CN subsystem functional entity does create charging information for the related CDR of this IM CN subsystem functional entity.
Record Extensions	O _C	A set of operator/manufacture specific extensions to the record, conditioned upon existence of an extension.

Editor's Note: The SIP parameter from which the IMS Application Reference ID (IARI) is to be extracted requires further investigation in CT1. A mechanism to identify the IARI in use is ffs.

6.1.3.5 I-CSCF CDR content

The detailed description of the field is provided in TS 32.298 [51].

Table 6.1.3.5.1: Charging data of I-CSCF CDR

Field	Category	Description
Record Type	M	Identifies the type of record. The parameter is derived from the Node functionality parameter.
Retransmission	O _C	This parameter, when present, indicates that information from retransmitted Charging Data Requests has been used in this CDR
SIP Method	O _C	Specifies the SIP-method for which the CDR is generated. Only available in session unrelated cases.
Event	O _C	This field identifies the SIP event package to which the SIP request is referred.
Expires Information	O _C	This field indicates the validity time of either the SIP message or its content, depending on the SIP method.
Role of Node	O _M	This field indicates whether the I-CSCF is serving the Originating or the Terminating party.
Node Address	O _M	This item holds the address of the node providing the information for the CDR. This may either be the IP address or the FQDN of the IMS node generating the accounting data.
Session ID	O _M	The Session identification. For a SIP session the Session-ID contains the SIP Call ID as defined in the Session Initiation Protocol RFC 3261 [404].
Session Priority	O _C	The field contains the priority of the session.
List Of Calling Party Address	O _M	The address or addresses (Public User ID or Public Service ID) of the party requesting a service or initiating a session. In the case of no P-Asserted-Identity is known, this list shall include one item with the value "unknown".
List of Associated URI	O _C	The list of non-barred public user identities (SIP URIs and/or Tel URIs) associated to the public user identity under registration.
Called Party Address	O _M	In the context of an end-to-end SIP transaction this field holds the address of the party (Public User ID) to whom the SIP transaction is posted.
Number Portability routing information	O _C	This field includes information on number portability after DNS/ENUM request from S-CSCF in the calling user's home network.
Carrier Select routing information	O _C	This field includes information on carrier select after DNS/ENUM request from S-CSCF in the calling user's home network.
Service Request Time Stamp	O _M	This field contains the time stamp, which indicates the time at which the service was requested. This parameter corresponds to SIP Request Timestamp. Present with Charging Data Request [Event].
Service Request Time Stamp Fraction	O _M	This parameter contains the milliseconds fraction in relation to the Service Request Time Stamp.
Inter Operator Identifiers	O _C	Holds the identification of the home network (originating and terminating) if exchanged via SIP signalling, as recorded in the <i>P-Charging-Vector header</i> .
Originating IOI	O _C	This parameter corresponds to Orig-IOI header of the P-Charging-Vector defined in TS 24.229 [204].
Terminating IOI	O _C	This parameter corresponds to Term-IOI header of the P-Charging-Vector defined in TS 24.229 [204].
Local Record Sequence Number	O _M	This field includes a unique record number created by this node. The number is allocated sequentially for each partial CDR (or whole CDR) including all CDR types. The number is unique within the CDF.
Cause For Record Closing	O _M	This field contains a reason for the close of the CDR.
Incomplete CDR Indication	O _C	This field provides additional diagnostics when the CDF detects missing Charging Data Requests.
S-CSCF Information	O _C	This field contains Information related to the serving CSCF, e.g. the S-CSCF capabilities upon registration event or the S-CSCF address upon the session establishment event.
IMS Charging Identifier	O _M	This parameter holds the IMS charging identifier (ICID) as generated by the IMS node for the SIP session.
Service Reason Return Code	O _M	This parameter provides the returned SIP status code for the service request for the successful and failure case,
List Of Reason Header	O _C	This parameter contains the list of SIP reason headers included in BYE or CANCEL method terminating the service, Reliability of this information is not guaranteed if the SIP or CANCEL is originated outside of the trust domain which is determined by the Operator on a "per parameter basis".
Access Network Information	O _C	This field contains the content of one SIP P-header "P-Access-Network-Info" if available.
Additional Access Network Information	O _C	This field contains the content of an additional SIP P-header "P-Access-Network-Info" if available.
Cellular Network Information	O _C	This field contains the content of one SIP "Cellular-Network-Info" header, when the UE supporting one or more cellular radio access technologies but using a non-cellular IP-CAN, such as untrusted WLAN access, provides this header field to relay information to its service provider about the radio cell identity of the cellular radio access network on which the UE most recently camped.
Service Context Id	O _M	Holds the context information to which the CDR belongs. The information is obtained from the Operation Token of the Charging Data Request message.

Field	Category	Description
User Location Info	O _C	This field contains the network provided location information for 3GPP accesses, if available .
MS Time Zone	O _C	This field indicates the offset between universal time and local time in steps of 15 minutes of where the MS currently resides.
From Address	O _M	Contains the information from the SIP From header.
IMS Emergency Indication	O _C	This field indicates the registration is an emergency registration, and is present only for emergency registrations.
SIP Route header transmitted	O _C	Contains the information in the route header representing the destination in a transmitted initial SIP INVITE or non-session related SIP MESSAGE request.
Record Extensions	O _C	A set of operator/manufacture specific extensions to the record, conditioned upon existence of an extension.
FE Identifier List	O _C	This parameter corresponds to FE Identifier List of the P-Charging-Vector defined in TS 24.229 [204]. This element contains one or more IM CN subsystem functional entity addresses and/or AS and application identifiers where the IM CN subsystem functional entity does create charging information for the related CDR of this IM CN subsystem functional entity.

6.1.3.6 MRFC CDR content

The detailed description of the field is provided in TS 32.298 [51].

Table 6.1.3.6.1: Charging data of MRFC CDR

Field	Category	Description
Record Type	M	Identifies the type of record. The parameter is derived from the Node functionality parameter.
Retransmission	O _C	This parameter, when present, indicates that information from retransmitted Charging Data Requests has been used in this CDR.
SIP Method	O _C	Specifies the SIP-method for which the CDR is generated. Only available in session unrelated cases.
Event	O _C	This field identifies the SIP event package to which the SIP request is referred.
Expires Information	O _C	This field indicates the validity time of either the SIP message or its content, depending on the SIP method.
Node Address	O _M	This item holds the address of the node providing the information for the CDR. This may either be the IP address or the FQDN of the IMS node generating the accounting data.
Session ID	O _M	The Session identification. For a SIP session the Session-ID contains the SIP Call ID as defined in the Session Initiation Protocol RFC 3261 [404].
Service ID	O _M	This field identifies the service the MRFC is hosting. For conferences the conference ID is used here.
Session Priority	O _C	The field contains the priority of the session.
List Of Calling Party Address	O _M	The address or addresses (Public User ID or Public Service ID) of the party requesting a service or initiating a session. In the case of no P-Asserted-Identify is known, this list shall include a one item with the value "unknown".
Called Party Address	O _C	For SIP transactions, except for registration, this field holds the address of the party (Public User ID or Public Service ID) to whom the SIP transaction is posted. For registration transactions, this field holds the Public User ID under registration.
Requested Party Address	O _C	For SIP transactions this field holds the address of the party (Public User ID or Public Service ID) to whom the SIP transaction was originally posted. This field is only present if different from the Called Party Address parameter.
List of Called Asserted Identity	O _C	The address or addresses of the final asserted identities. Present if the final asserted identities are available in the SIP 2xx response.
List of Subscription Id	O _M	Holds the public user identities of the served user
Service Request Time Stamp	O _M	This field contains the time stamp which indicates the time at which the service was requested. This parameter corresponds to SIP Request Timestamp. Present with Charging Data Request [Start] and Charging Data Request [Event].
Service Request Time Stamp Fraction	O _M	This parameter contains the milliseconds fraction in relation to the Service Request Time Stamp.
Service Delivery Start Time Stamp	O _M	This field holds the time stamp reflecting either: successful session set-up, a delivery unrelated service, an unsuccessful session set-up and an unsuccessful session unrelated request. This parameter corresponds to SIP Response Timestamp. Present with Charging Data Request [Start] and Charging Data Request [EVENT].
Service Delivery Start Time Stamp Fraction	O _M	This parameter contains the milliseconds fraction in relation to the Service Delivery Start Time Stamp.
Service Delivery End Time Stamp	O _C	This field records the time at which the service delivery was terminated. It is Present only in SIP session related case. This parameter corresponds to SIP Request Timestamp. Present with Charging Data Request [Stop].
Service Delivery End Time Stamp Fraction	O _C	This parameter contains the milliseconds fraction in relation to the Service Delivery End Time Stamp.
Record Opening Time	O _C	A time stamp reflecting the time the CDF opened this record. Present only in SIP session related case.
Record Closure Time	O _M	A Time stamp reflecting the time the CDF closed the record.
Application Servers Information	O _C	This is a grouped CDR field containing the fields: "Application Server Involved" and "Application Provided Called Parties".
Application Servers Involved	O _C	Holds the ASs (if any) identified by the SIP URIs.
Application Provided Called Parties	O _C	Holds a list of the Called Party Address(es), if the address(es) are determined by an AS (SIP URI, E.164...).
Inter Operator Identifiers	O _C	Holds the identification of the home network (originating and terminating) if exchanged via SIP signalling, as recorded in the <i>P-Charging-Vector header</i> .
Originating IOI	O _C	This parameter corresponds to Orig-IOI header of the P-Charging-Vector defined in TS 24.229 [204].
Terminating IOI	O _C	This parameter corresponds to Term-IOI header of the P-Charging-Vector defined in TS 24.229 [204].
Transit IOI List	O _C	This parameter corresponds to Transit-IOI List of the P-Charging-Vector defined in TS 24.229 [204].
Local Record Sequence Number	O _M	This field includes a unique record number created by this node. The number is allocated sequentially for each partial CDR (or whole CDR) including all CDR types. The number is unique within the CDF.
Record Sequence Number	O _C	This field contains a running sequence number employed to link the partial records generated by the CDF for a particular session.
Cause For Record Closing	O _M	This field contains a reason for the close of the CDR.

Field	Category	Description
Incomplete CDR Indication	O _C	This field provides additional diagnostics when the CDF detects missing Charging Data Requests.
IMS Charging Identifier	O _M	This parameter holds the IMS charging identifier (ICID) as generated by the IMS node for the SIP session.
List of Early SDP Media Components	O _C	This is a grouped field which may occur several times in one CDR. This field shall not be present if no media components are set to active before the final SIP session answer to the initial SIP Invite is received. This field can be present in either session or event CDRs.
SDP Session Description	O _C	Holds the Session portion of SDP data exchanged in the above mentioned scenario, if available.
SDP Type	O _M	This parameter indicates if the SDP media component is an SDP offer or SDP answer.
SDP Offer Timestamp	O _M	This parameter contains the time of the SIP request which conveys the SDP offer.
SDP Answer Timestamp	O _M	This parameter contains the time of the response to the SIP request which conveys the SDP answer.
SDP Media Components	O _M	This is a grouped field comprising several sub-fields associated with one media component. Since several media components may exist for a session in parallel these sub-fields may occur several times.
SDP Media Name	O _M	This field holds the name of the media as available in the SDP data.
SDP Media Description	O _M	This field holds the attributes of the media as available in the SDP data.
Access Correlation ID	O _C	This parameter holds the charging identifier from the access network, consisting of either GPRS charging ID (GCID) which is generated by the GGSN for a GPRS PDP context, Charging Id which is generated by P-GW for IP-CAN bearer or the Access Network Charging Identifier Value which is generated by another type of access network. It is present only if received from the access network when PCC architecture is implemented.
Media Initiator Flag	O _C	This field indicates if the called party has requested the session modification and it is present only if the initiator was the called party.
List of SDP Media Components	O _C	This is a grouped field which may occur several times in one CDR. The field is present only in a SIP session related case
SDP Session Description	O _C	Holds the Session portion of the SDP data exchanged between the User Agents if available in the SIP transaction.
SDP Type	O _M	This parameter indicates if the SDP media component is an SDP offer or SDP answer.
SIP Request Timestamp	O _C	This parameter contains the time of the SIP request (usually a (RE-)INVITE). This parameter corresponds to SIP Request Timestamp in the Charging Data Request [Interim].
SIP Response Timestamp	O _C	This parameter contains the time of the response to the SIP request (usually a SIP 200 OK). This parameter corresponds to SIP Response Timestamp In the Charging Data Request [Interim].
SIP Request Timestamp Fraction	O _C	This parameter contains the milliseconds fraction in relation to the SIP Request Timestamp.
SIP Response Timestamp Fraction	O _C	This parameter contains the milliseconds fraction in relation to the SIP Response Timestamp.
SDP Media Components	O _M	This is a grouped field comprising several sub-fields associated with one media component. Since several media components may exist for a session in parallel these sub-fields may occur several times.
SDP Media Name	O _M	This field holds the name of the media as available in the SDP data. This parameter corresponds to SDP-Media-Name.
SDP Media Description	O _M	This field holds the attributes of the media as available in the SDP data.
Access Correlation ID	O _C	This parameter holds the charging identifier from the access network, consisting of either GPRS charging ID (GCID) which is generated by the GGSN for a GPRS PDP context, Charging Id which is generated by P-GW for IP-CAN bearer or the Access Network Charging Identifier Value which is generated by another type of access network. It is present only if received from the access network when PCC architecture is implemented.
Media Initiator Flag	O _C	This field indicates if the called party has requested the session modification and it is present only if the initiator was the called party.
GGSN Address	O _C	This parameter holds the control plane IP address of the GGSN that handles one or more media component(s) of a IMS session.
Service Reason Return Code	O _M	This parameter provides the returned SIP status code for the service request for the successful and failure case,
List Of Reason Header	O _C	This parameter contains the list of SIP reason headers included in BYE or CANCEL method terminating the service, Reliability of this information is not guaranteed if the SIP or CANCEL is originated outside of the trust domain which is determined by the Operator on a "per parameter basis".
Access Network Information	O _C	This field contains the content of one SIP P-header "P-Access-Network-Info", available in the IMS Node when charging session starts, if available.

Field	Category	Description
Additional Access Network Information	O _C	This field contains the content of an additional SIP P-header "P-Access-Network-Info" available in the IMS Node as additional location when charging session starts, if available.
Cellular Network Information	O _C	This field contains the content of one SIP "Cellular-Network-Info" header, when the UE supporting one or more cellular radio access technologies but using a non-cellular IP-CAN, such as untrusted WLAN access, provides this header field to relay information to its service provider about the radio cell identity of the cellular radio access network on which the UE most recently camped.
List of Access Network Info Change	O _C	This field is a list of grouped field describing the subsequent SIP P-header "P-Access-Network-Info" changes.
Access Network Information	O _C	This field holds the content of the SIP P-header "P-Access-Network-Info", when changed from the previous one.
Additional Access Network Information	O _C	This field holds the content of additional SIP P-header "P-Access-Network-Info" when changed from the previous one, if available.
Cellular Network Information	O _C	This field contains the content of one SIP "Cellular-Network-Info" header, when the UE supporting one or more cellular radio access technologies but using a non-cellular IP-CAN, such as untrusted WLAN access, provides this header field to relay information to its service provider about the radio cell identity of the cellular radio access network on which the UE most recently camped. This field is applicable when changed from the previous one, if available.
Access Change Time	O _C	This field contains the time at which the changed user location information was acquired.
Service Context Id	O _M	Holds the context information to which the CDR belongs. The information is obtained from the Operation Token of the Charging Data Request message.
Online Charging Flag	O _C	This field indicates the Online Charging Request was sent based on the provided ECF address from the SIP P-header "P-Charging-Function-Addresses". NOTE: No proof that online charging action has been taken
User Location Info	O _C	This field contains the network provided location information for 3GPP accesses available in the IMS Node when charging session starts, if available.
MS Time Zone	O _C	This field indicates the offset between universal time and local time in steps of 15 minutes of where the MS currently resides.
From Address	O _M	Contains the information from the SIP From header.
Record Extensions	O _C	A set of operator/manufacture specific extensions to the record, conditioned upon existence of an extension.
FE Identifier List	O _C	This parameter corresponds to FE Identifier List of the P-Charging-Vector defined in TS 24.229 [204]. This element contains one or more IM CN subsystem functional entity addresses and/or AS and application identifiers where the IM CN subsystem functional entity does create charging information for the related CDR of this IM CN subsystem functional entity.

6.1.3.7 MGCF CDR content

The detailed description of the field is provided in TS 32.298 [51].

Table 6.1.3.7.1: Charging data of MGCF CDR

Field	Category	Description
Record Type	M	Identifies the type of record. The parameter is derived from the Node functionality parameter.
Retransmission	O _C	This parameter, when present, indicates that information from retransmitted Charging Data Requests has been used in this CDR
SIP Method	O _C	Specifies the SIP-method for which the CDR is generated. Only available in session unrelated cases.
Event	O _C	This field identifies the SIP event package to which the SIP request is referred.
Expires Information	O _C	This field indicates the validity time of either the SIP message or its content, depending on the SIP method.
Role of Node	O _M	This field indicates whether the MGCF is serving the Originating or the Terminating party.
Node Address	O _M	This item holds the address of the node providing the information for the CDR. This may either be the IP address or the FQDN of the IMS node generating the accounting data.
Session ID	O _M	The Session identification. For a SIP session the Session-ID contains the SIP Call ID as defined in the Session Initiation Protocol RFC 3261 [404].
Session Priority	O _C	The field contains the priority of the session.
List Of Calling Party Address	O _M	The address or addresses (Public User ID or Public Service ID) of the party requesting a service or initiating a session. In the case of no P-Asserted-Identify is known, this list shall include a one item with the value "unknown".
Called Party Address	O _M	In the context of an end-to-end SIP transaction this field holds the address of the party (Public User ID) to whom the SIP transaction is posted.
Number Portability routing information	O _C	This field includes information on number portability after DNS/ENUM request from S-CSCF in the calling user's home network.
Carrier Select routing information	O _C	This field includes information on carrier select after DNS/ENUM request from S-CSCF in the calling user's home network.
Service Request Time Stamp	O _M	This field contains the time stamp which indicates the time at which the service was requested. This parameter corresponds to SIP Request Timestamp. Present with Charging Data Request [Start] and Charging Data Request [Event].
Service Request Time Stamp Fraction	O _M	This parameter contains the milliseconds fraction in relation to the Service Request Time Stamp.
Service Delivery Start Time Stamp	O _M	This field holds the time stamp reflecting either: successful session set-up, a delivery unrelated service, an unsuccessful session set-up and an unsuccessful session unrelated request. This parameter corresponds to SIP Response Timestamp. Present with Charging Data Request [Start] and Charging Data Request [Event].
Service Delivery Start Time Stamp Fraction	O _M	This parameter contains the milliseconds fraction in relation to the Service Delivery Start Time Stamp.
Service Delivery End Time Stamp	O _C	This field records the time at which the service delivery was terminated. It is Present only in SIP session related case. This parameter corresponds to SIP Request Timestamp. Present with Charging Data Request [Stop].
Service Delivery End Time Stamp Fraction	O _C	This parameter contains the milliseconds fraction in relation to the Service Delivery End Time Stamp.
Record Opening Time	O _C	A time stamp reflecting the time the CDF opened this record. Present only in SIP session related case.
Record Closure Time	O _M	A Time stamp reflecting the time the CDF closed the record.
Inter Operator Identifiers	O _C	Holds the identification of the home network (originating and terminating) if exchanged via SIP signalling, as recorded in the <i>P-Charging-Vector header</i> .
Originating IOI	O _C	This parameter corresponds to Orig-IOI header of the P-Charging-Vector defined in TS 24.229 [204].
Terminating IOI	O _C	This parameter corresponds to Term-IOI header of the P-Charging-Vector defined in TS 24.229 [204].
Transit IOI List	O _C	This parameter corresponds to Transit-IOI List of the P-Charging-Vector defined in TS 24.229 [204].
Local Record Sequence Number	O _M	This field includes a unique record number created by this node. The number is allocated sequentially for each partial CDR (or whole CDR) including all CDR types. The number is unique within the CDF.
Record Sequence Number	O _C	This field contains a running sequence number employed to link the partial records generated by the CDF for a particular session.
Cause For Record Closing	O _M	This field contains a reason for the close of the CDR.
Incomplete CDR Indication	O _C	This field provides additional diagnostics when the CDF detects missing Charging Data Requests.
IMS Charging Identifier	O _M	This parameter holds the IMS charging identifier (ICID) as generated by the IMS node for the SIP session.

Field	Category	Description
List of Early SDP Media Components	O _C	This is a grouped field which may occur several times in one CDR. This field shall not be present if no media components are set to active before the final SIP session answer to the initial SIP Invite is received. This field can be present in either session or event CDRs.
SDP Session Description	O _C	Holds the Session portion of SDP data exchanged in the above mentioned scenario, if available.
SDP Type	O _M	This parameter indicates if the SDP media component is an SDP offer or SDP answer.
SDP Offer Timestamp	O _M	This parameter contains the time of the SIP Request which conveys the SDP offer.
SDP Answer Timestamp	O _M	This parameter contains the time of the response to the SIP Request which conveys the SDP answer.
SDP Media Components	O _M	This is a grouped field comprising several sub-fields associated with one media component. Since several media components may exist for a session in parallel these sub-fields may occur several times.
SDP Media Name	O _M	This field holds the name of the media as available in the SDP data.
SDP Media Description	O _M	This field holds the attributes of the media as available in the SDP data.
Media Initiator Flag	O _C	This field indicates if the called party has requested the session modification and it is present only if the initiator was the called party.
List of SDP Media Components	O _C	This is a grouped field which may occur several times in one CDR. The field is present only in a SIP session related case.
SDP Session Description	O _C	Holds the Session portion of the SDP data exchanged between the User Agents if available in the SIP transaction.
SDP Type	O _M	This parameter indicates if the SDP media component is an SDP offer or SDP answer.
SIP Request Timestamp	O _C	This parameter contains the time of the SIP Request (usually a (RE-)INVITE). This parameter corresponds to SIP Request Timestamp in Charging Data Request [Interim].
SIP Response Timestamp	O _C	This parameter contains appropriately the time of SIP 200 OK acknowledging an SIP INVITE or of SIP ACK including an SDP answer. This parameter corresponds to SIP Response Timestamp in Charging Data Request [Interim].
SIP Request Timestamp Fraction	O _C	This parameter contains the milliseconds fraction in relation to the SIP Request Timestamp.
SIP Response Timestamp Fraction	O _C	This parameter contains the milliseconds fraction in relation to the SIP Response Timestamp.
SDP Media Components	O _M	This is a grouped field comprising several sub-fields associated with one media component. Since several media components may exist for a session in parallel these sub-fields may occur several times.
SDP Media Name	O _M	This field holds the name of the media as available in the SDP data. This parameter corresponds to SDP-Media-Name.
SDP Media Description	O _M	This field holds the attributes of the media as available in the SDP data.
Media Initiator Flag	O _C	This field indicates if the called party has requested the session modification and it is present only if the initiator was the called party.
Service Reason Return Code	O _M	This parameter provides the returned SIP status code for the service request for the successful and failure case.
List Of Reason Header	O _C	This parameter contains the list of SIP reason headers included in BYE or CANCEL method terminating the service, Reliability of this information is not guaranteed if the SIP or CANCEL is originated outside of the trust domain which is determined by the Operator on a "per parameter basis".
ISUP Cause	O _C	When session is released via ISUP, this IE indicates the reason the call was released.
Trunk Group ID Incoming/Outgoing	O _M	Contains the outgoing trunk group ID for an outgoing session/call or the incoming trunk group ID for an incoming session/call.
Bearer Service	O _M	Holds the used bearer service for the PSTN leg.
Access Network Information	O _C	This field contains the content of one SIP P-header "P-Access-Network-Info" available in the IMS Node when charging session starts, if available.
Additional Access Network Information	O _C	This field contains the content of an additional SIP P-header "P-Access-Network-Info", available in the IMS Node as additional location when charging session starts, if available.
Cellular Network Information	O _C	This field contains the content of one SIP "Cellular-Network-Info" header, when the UE supporting one or more cellular radio access technologies but using a non-cellular IP-CAN, such as untrusted WLAN access, provides this header field to relay information to its service provider about the radio cell identity of the cellular radio access network on which the UE most recently camped.

Field	Category	Description
List of Access Network Info Change	O _C	This field is a list of grouped field describing the subsequent SIP P-header "P-Access-Network-Info" changes.
Access Network Information	O _C	This field holds the content of the SIP P-header "P-Access-Network-Info", when changed from the previous one.
Additional Access Network Information	O _C	This field holds the content of additional SIP P-header "P-Access-Network-Info" when changed from the previous one, if available.
Cellular Network Information	O _C	This field contains the content of one SIP "Cellular-Network-Info" header, when the UE supporting one or more cellular radio access technologies but using a non-cellular IP-CAN, such as untrusted WLAN access, provides this header field to relay information to its service provider about the radio cell identity of the cellular radio access network on which the UE most recently camped. This field is applicable when changed from the previous one, if available.
Access Change Time	O _C	This field contains the time at which the changed user location information was acquired.
Service Context Id	O _M	Holds the context information to which the CDR belongs. The information is obtained from the Operation Token of the Charging Data Request message.
Real Time Tariff Information	O _C	This field holds the tariff/add-on charge received.
From Address	O _M	Contains the information from the SIP From header.
Record Extensions	O _C	A set of operator/manufacture specific extensions to the record, conditioned upon existence of an extension.
FE Identifier List	O _C	This parameter corresponds to FE Identifier List of the P-Charging-Vector defined in TS 24.229 [204]. This element contains one or more IM CN subsystem functional entity addresses and/or AS and application identifiers where the IM CN subsystem functional entity does create charging information for the related CDR of this IM CN subsystem functional entity.

6.1.3.8 BGCF CDR content

The detailed description of the field is provided in TS 32.298 [51].

Table 6.1.3.8.1: Charging data of BGCF CDR

Field	Category	Description
Record Type	M	Identifies the type of record. The parameter is derived from the Node functionality parameter.
Retransmission	O _C	This parameter, when present, indicates that information from retransmitted Charging Data Requests has been used in this CDR.
SIP Method	O _C	Specifies the SIP-method for which the CDR is generated. Only available in session unrelated cases.
Event	O _C	This field identifies the SIP event package to which the SIP request is referred.
Expires Information	O _C	This field indicates the validity time of either the SIP message or its content, depending on the SIP method.
Role of Node	O _M	This field indicates whether the BGCF is serving the Originating or the Terminating party.
Node Address	O _M	This item holds the address of the node providing the information for the CDR. This may either be the IP address or the FQDN of the IMS node generating the accounting data.
Session ID	O _M	The Session identification. For a SIP session the Session-ID contains the SIP Call ID as defined in the Session Initiation Protocol RFC 3261 [404].
Session Priority	O _C	The field contains the priority of the session.
List Of Calling Party Address	O _M	The address or addresses (Public User ID or Public Service ID) of the party requesting a service or initiating a session. In the case of no P-Asserted-Identify is known, this list shall include a one item with the value "unknown".
Called Party Address	O _M	In the context of an end-to-end SIP transaction this field holds the address of the party (Public User ID) to whom the SIP transaction is posted.
Number Portability routing information	O _C	This field includes information on number portability after DNS/ENUM request from S-CSCF in the calling user's home network.
Carrier Select routing information	O _C	This field includes information on carrier select after DNS/ENUM request from S-CSCF in the calling user's home network.
Service Request Time Stamp	O _M	This field contains the time stamp which indicates the time at which the service was requested. This parameter corresponds to SIP Request Timestamp. Present with Charging Data Request [Start] and Charging Data Request [Event].
Service Request Time Stamp Fraction	O _M	This parameter contains the milliseconds fraction in relation to the Service Request Time Stamp.
Service Delivery Start Time Stamp	O _M	This field holds the time stamp reflecting either: successful session set-up, a delivery unrelated service, an unsuccessful session set-up and an unsuccessful session unrelated request. This parameter corresponds to SIP Response Timestamp. Present with Charging Data Request [Start] and Charging Data Request [Event].
Service Delivery Start Time Stamp Fraction	O _M	This parameter contains the milliseconds fraction in relation to the Service Delivery Start Time Stamp.
Service Delivery End Time Stamp	O _C	This field records the time at which the service delivery was terminated. It is Present only in SIP session related case. This parameter corresponds to SIP Request Timestamp. Present with Charging Data Request [Stop].
Service Delivery End Time Stamp Fraction	O _C	This parameter contains the milliseconds fraction in relation to the Service Delivery End Time Stamp.
Record Opening Time	O _C	A time stamp reflecting the time the CDF opened this record. Present only in SIP session related case.
Record Closure Time	O _M	A Time stamp reflecting the time the CDF closed the record
Inter Operator Identifiers	O _C	Holds the identification of the home network (originating and terminating) if exchanged via SIP signalling, as recorded in the <i>P-Charging-Vector header</i> .
Originating IOI	O _C	This parameter corresponds to Orig-IOI header of the P-Charging-Vector defined in TS 24.229 [204].
Terminating IOI	O _C	This parameter corresponds to Term-IOI header of the P-Charging-Vector defined in TS 24.229 [204].
Transit IOI List	O _C	This parameter corresponds to Transit-IOI List of the P-Charging-Vector defined in TS 24.229 [204].
Local Record Sequence Number	O _M	This field includes a unique record number created by this node. The number is allocated sequentially for each partial CDR (or whole CDR) including all CDR types. The number is unique within the CDF.
Record Sequence Number	O _C	This field contains a running sequence number employed to link the partial records generated by the CDF for a particular session.
Cause For Record Closing	O _M	This field contains a reason for the close of the CDR.
Incomplete CDR Indication	O _C	This field provides additional diagnostics when the CDF detects missing Charging Data Requests.
IMS Charging Identifier	O _M	This parameter holds the IMS charging identifier (ICID) as generated by the IMS node for the SIP session.
Service Reason Return Code	O _M	This parameter provides the returned SIP status code for the service request for the successful and failure case,

Field	Category	Description
List Of Reason Header	O _C	This parameter contains the list of SIP reason headers included in BYE or CANCEL method terminating the service. Reliability of this information is not guaranteed if the SIP or CANCEL is originated outside of the trust domain which is determined by the Operator on a "per parameter basis".
Access Network Information	O _C	This field contains the content of the SIP P-header "P-Access-Network-Info" if available.
Additional Access Network Information	O _C	This field contains the content of an additional SIP P-header "P-Access-Network-Info" if available.
Cellular Network Information	O _C	This field contains the content of one SIP "Cellular-Network-Info" header, when the UE supporting one or more cellular radio access technologies but using a non-cellular IP-CAN, such as untrusted WLAN access, provides this header field to relay information to its service provider about the radio cell identity of the cellular radio access network on which the UE most recently camped.
Service Context Id	O _M	Holds the context information to which the CDR belongs. The information is obtained from the Operation Token of the Charging Data Request message.
From Address	O _M	Contains the information from the SIP From header.
Record Extensions	O _C	A set of operator/manufacture specific extensions to the record, conditioned upon existence of an extension.
NNI Information	O _C	This grouped field holds information about the NNI used for interconnection and roaming on the loopback routing path. It is present only if RAVEL "VPLMN routing" is applied.
NNI Type	O _C	This field indicates usage of the roaming NNI for loopback routing, i.e. BGCF performed the loopback decision.
FE Identifier List	O _C	This parameter corresponds to FE Identifier List of the P-Charging-Vector defined in TS 24.229 [204]. This element contains one or more IM CN subsystem functional entity addresses and/or AS and application identifiers where the IM CN subsystem functional entity does create charging information for the related CDR of this IM CN subsystem functional entity.

6.1.3.9 SIP AS CDR content

The detailed description of the field is provided in TS 32.298 [51].

Table 6.1.3.9.1: Charging data of AS CDR

Field	Category	Description
Record Type	M	Identifies the type of record. The parameter is derived from the Node functionality parameter.
Retransmission	O _C	This parameter, when present, indicates that information from retransmitted Charging Data Requests has been used in this CDR
SIP Method	O _C	Specifies the SIP-method for which the CDR is generated. Only available in session unrelated cases.
Event	O _C	This field identifies the SIP event package to which the SIP request is referred.
Expires Information	O _C	This field indicates the validity time of either the SIP message or its content, depending on the SIP method.
Role of Node	O _M	This field indicates whether the AS is serving the Originating Terminating or Forwarding party.
Node Address	O _M	This item holds the address of the node providing the information for the CDR. This may either be the IP address or the FQDN of the IMS node generating the accounting data.
Session ID	O _M	The Session identification. For a SIP session the Session-ID contains the SIP Call ID as defined in the Session Initiation Protocol RFC 3261 [404]. When the AS acts as B2BUA, the incoming session is identified, except for the "OneChargingSession" option, where it contains either the incoming or outgoing dialog SIP Call Id involved during IMS session setup.
Outgoing Session ID	O _C	When the AS acts as B2BUA, the outgoing session is identified by the Outgoing Session ID which contains the SIP Call ID (as defined in the RFC 3261 [404]). This field is not used for the "OneChargingSession" option
Session Priority	O _C	The field contains the priority of the session.
List Of Calling Party Address	O _M	The address or addresses (Public User ID or Public Service ID) of the party requesting a service or initiating a session. In the case of no P-Asserted-Identify is known, this list shall include a one item with the value "unknown".
Called Party Address	O _M	For SIP transactions, except for registration, this field holds the address of the party (Public User ID or Public Service ID) to whom the SIP transaction is posted. For registration transactions, this field holds the Public User ID under registration.
Number Portability routing information	O _C	This field includes information on number portability after DNS/ENUM request from S-CSCF in the calling user's home network.
Carrier Select routing information	O _C	This field includes information on carrier select after DNS/ENUM request from S-CSCF in the calling user's home network.
Alternate Charged Party Address	O _C	The address of an alternate party that is identified by the AS at session initiation, and is charged in place of the calling party.
List of Requested Party Address	O _C	This field is a list of Requested Party Address. This field is only present if different from the Called Party Address parameter.
Private User ID	O _C	This field holds the private user identity of the served party defined in TS 23.003 [104], if available.
List of Subscription Id	O _M	Holds the public user identities of the served user
List of Called Asserted Identity	O _C	The address or addresses of the final asserted identities. Present if the final asserted identities are available in the SIP 2xx response.
List of Called Identity Changes	O _C	List of terminating identity address changes and associated timestamps.
Called Identity Change Time Stamp	O _C	Timestamp of SIP UPDATE or SIP RE-INVITE with changed terminating identity information.
Called Identity	O _C	Changed terminating identity information received in a SIP UPDATE or SIP RE-INVITE.
Service Request Time Stamp	O _M	This field contains the time stamp which indicates the time at which the service was requested. This parameter corresponds to SIP Request Timestamp. Present with Charging Data Request [Start] and Charging Data Request [Event].
Service Request Time Stamp Fraction	O _M	This parameter contains the milliseconds fraction in relation to the Service Request Time Stamp.
Service Delivery Start Time Stamp	O _M	This field holds the time stamp reflecting either: successful session set-up, a delivery unrelated service, an unsuccessful session set-up and an unsuccessful session unrelated request. This parameter corresponds to SIP Response Timestamp. Present with Charging Data Request [Start] and Charging Data Request [Event].
Service Delivery Start Time Stamp Fraction	O _M	This parameter contains the milliseconds fraction in relation to the Service Delivery Start Time Stamp.
Service Delivery End Time Stamp	O _C	This field records the time at which the service delivery was terminated. It is Present only in SIP session related case. This parameter corresponds to SIP Request Timestamp. Present with Charging Data Request [Stop].
Service Delivery End Time Stamp Fraction	O _C	This parameter contains the milliseconds fraction in relation to the Service Delivery End Time Stamp.
Record Opening Time	O _C	A time stamp reflecting the time the CDF opened this record. Present only in SIP session related case.
Record Closure Time	O _M	A Time stamp reflecting the time the CDF closed the record.

Field	Category	Description
Inter Operator Identifiers	O _C	Holds the identification of the home network (originating and terminating) if exchanged via SIP signalling, as recorded in the <i>P-Charging-Vector header</i> .
Originating IOI	O _C	This parameter corresponds to Orig-IOI header of the P-Charging-Vector defined in TS 24.229 [204].
Terminating IOI	O _C	This parameter corresponds to Term-IOI header of the P-Charging-Vector defined in TS 24.229 [204].
Transit IOI List	O _C	This parameter corresponds to Transit-IOI List of the P-Charging-Vector defined in TS 24.229 [204]. This field may occur several times in one CDR. Each occurrence represents transit IOI values received from the path inbound to or outbound from the S-CSCF.
Local Record Sequence Number	O _M	This field includes a unique record number created by this node. The number is allocated sequentially for each partial CDR (or whole CDR) including all CDR types. The number is unique within the CDF.
Record Sequence Number	O _C	This field contains a running sequence number employed to link the partial records generated by the CDF for a particular session.
Cause For Record Closing	O _M	This field contains a reason for the close of the CDR.
Incomplete CDR Indication	O _C	This field provides additional diagnostics when the CDF detects missing Charging Data Requests.
IMS Charging Identifier	O _M	This parameter holds the IMS charging identifier (ICID) as generated by the IMS node for the SIP session.
Related IMS Charging Identifier	O _C	This field contains the related IMS Charging Identifier in case of access transfer.
Related IMS Charging Identifier Generation Node	O _C	This parameter holds the identifier of the server that generated the Related IMS charging identifier.
List of Early SDP Media Components	O _C	This is a grouped field which may occur several times in one CDR. This field shall not be present if no media components are set to active before the final SIP session answer to the initial SIP Invite is received. This field can be present in either session or event CDRs.
SDP Session Description	O _C	Holds the Session portion of SDP data exchanged in the above mentioned scenario, if available.
SDP Type	O _M	This parameter indicates if the SDP media component is an SDP offer or SDP answer.
SDP Offer Timestamp	O _M	This parameter contains the time of the SIP Request which conveys the SDP offer.
SDP Answer Timestamp	O _M	This parameter contains the time of the response to the SIP Request which conveys the SDP answer.
SDP Media Components	O _M	This is a grouped field comprising several sub-fields associated with one media component. Since several media components may exist for a session in parallel these sub-fields may occur several times.
SDP Media Name	O _M	This field holds the name of the media as available in the SDP data.
SDP Media Description	O _M	This field holds the attributes of the media as available in the SDP data.
Access Correlation ID	O _C	This parameter holds the charging identifier from the access network, consisting of either GPRS charging ID (GCID) which is generated by the GGSN for a GPRS PDP context, Charging Id which is generated by P-GW for IP-CAN bearer or the Access Network Charging Identifier Value which is generated by another type of access network. It is present only if received from the access network when PCC architecture is implemented.
Media Initiator Flag	O _C	This field indicates if the called party has requested the session modification and it is present only if the initiator was the called party.
List of SDP Media Components	O _C	This is a grouped field which may occur several times in one CDR. The field is present only in a SIP session related case. When the AS acts as B2BUA and "OneChargingSession" option applies, only SDP media components received by the AS are included, i.e. those generated by the AS are not included.
SDP Session Description	O _C	Holds the Session portion of the SDP data exchanged between the User Agents if available in the SIP transaction.
SDP Type	O _M	This parameter indicates if the SDP media component is an SDP offer or SDP answer.
SIP Request Timestamp	O _C	This parameter contains the time of the SIP Request (usually a SIP (RE-)INVITE). This parameter corresponds to SIP Request Timestamp in Charging Data Request [Interim].
SIP Response Timestamp	O _C	This parameter contains appropriately the time of SIP 200 OK acknowledging an SIP INVITE or of SIP ACK including an SDP answer. This parameter corresponds to SIP Response Timestamp in Charging Data Request [Interim].
SIP Request Timestamp Fraction	O _C	This parameter contains the milliseconds fraction in relation to the SIP Request Timestamp.

Field	Category	Description
SIP Response Timestamp Fraction	O _C	This parameter contains appropriately the time of SIP 200 OK acknowledging an SIP INVITE or of SIP ACK including an SDP answer. This parameter corresponds to SIP Response Timestamp in Charging Data Request [Interim].
SDP Media Components	O _M	This is a grouped field comprising several sub-fields associated with one media component. Since several media components may exist for a session in parallel these sub-fields may occur several times.
SDP Media Name	O _M	This field holds the name of the media as available in the SDP data.
SDP Media Description	O _M	This field holds the attributes of the media as available in the SDP data.
Access Correlation ID	O _C	This parameter holds the charging identifier from the access network, consisting of either GPRS charging ID (GCID) which is generated by the GGSN for a GPRS PDP context, Charging Id which is generated by P-GW for IP-CAN bearer or the Access Network Charging Identifier Value which is generated by another type of access network. It is present only if received from the access network when PCC architecture is implemented.
Media Initiator Flag	O _C	This field indicates if the called party has requested the session modification and it is present only if the initiator was the called party.
GGSN Address	O _C	This parameter holds the control plane IP address of the GGSN that handles one or more media component(s) of a IMS session.
Service Reason Return Code	O _M	This parameter provides the returned SIP status code for the service request for the successful and failure case,
List Of Reason Header	O _C	This parameter contains the list of SIP reason headers included in BYE or CANCEL method terminating the service, Reliability of this information is not guaranteed if the SIP or CANCEL is originated outside of the trust domain which is determined by the Operator on a "per parameter basis".
Service Specific Info	O _C	This is a grouped field that contains service specific data if and as provided by an AS. It may occur several times in one CDR.
Service Specific Data	O _M	This sub-field of Service Specific Data holds the value of the Service Specific Data.
Service Specific Type	O _M	This sub-field of Service Specific Data holds the type of the Service Specific Data.
List of Message Bodies	O _C	This grouped field comprising several sub-fields describing the data that may be conveyed end-to-end in the body of a SIP message. Since several message bodies may be exchanged via SIP-signalling, this grouped field may occur several times.
Content-Type	O _M	This sub-field of Message Bodies holds the MIME type of the message body, Examples are: application/zip, image/gif, audio/mpeg, etc.
Content-Disposition	O _C	This sub-field of Message Bodies holds the content disposition of the message body inside the SIP signalling, Content-disposition header field equal to "render", indicates that "the body part should be displayed or otherwise rendered to the user". Content disposition values are : session, render, inline, icon, alert, attachment, etc.
Content-Length	O _M	This sub-field of Message Bodies holds the size of the data of a message body in bytes.
Originator	O _C	This sub-field of the "List of Message Bodies" indicates the originating party of the message body.
Access Network Information	O _C	This field contains the content of the SIP P-header "P-Access-Network-Info" available in the IMS Node when charging session starts, if available.
Additional Access Network Information	O _C	This field contains the content of an additional SIP P-header "P-Access-Network-Info", available in the IMS Node as additional location when charging session starts, if available.
Cellular Network Information	O _C	This field contains the content of one SIP "Cellular-Network-Info" header, when the UE supporting one or more cellular radio access technologies but using a non-cellular IP-CAN, such as untrusted WLAN access, provides this header field to relay information to its service provider about the radio cell identity of the cellular radio access network on which the UE most recently camped.
List of Access Network Info Change	O _C	This field is a list of grouped field describing the subsequent SIP P-header "P-Access-Network-Info" and "Cellular-Network-Info" changes.
Access Network Information	O _C	This field holds the content of the SIP P-header "P-Access-Network-Info", when changed from the previous one.
Additional Access Network Information	O _C	This field holds the content of additional SIP P-header "P-Access-Network-Info" when changed from the previous one, if available.

Field	Category	Description
Cellular Network Information	O _C	This field contains the content of one SIP "Cellular-Network-Info" header, when the UE supporting one or more cellular radio access technologies but using a non-cellular IP-CAN, such as untrusted WLAN access, provides this header field to relay information to its service provider about the radio cell identity of the cellular radio access network on which the UE most recently camped. This field is applicable when changed from the previous one, if available.
Access Change Time	O _C	This field contains the time at which the changed user location information was acquired.
VLR Number	O _C	This field holds VLRNumber of User-Data AVP in User-Data-Answer (UDA) command defined in TS 29.328 [215] if available.
MSC Address	O _C	This field holds MSCNumber of User-Data AVP in User-Data-Answer (UDA) command defined in TS 29.328 [215] if available.
List of Access Transfer Information	O _C	This field is a list of grouped field describing the subsequent session transfers. Each other occurrence comprises sub-fields describing the session transfer performed.
Access Transfer Type	O _C	This field contains indication about the access transfer performed. This field is present only when transfer occurred.
Inter-UE Transfer	O _C	This field indicates that an inter-UE access transfer has been performed. This field is present only when transfer occurred.
Access Network Information	O _C	This field holds the content of one SIP P-header "P-Access-Network-Info" from the SIP INVITE requesting the transfer, if available
Additional Access Network Information	O _C	This field contains the content of an additional SIP P-header "P-Access-Network-Info" from the SIP INVITE requesting the transfer, if available.
Cellular Network Information	O _C	This field contains the content of one SIP "Cellular-Network-Info" header, when the UE supporting one or more cellular radio access technologies but using a non-cellular IP-CAN, such as untrusted WLAN access, provides this header field to relay information to its service provider about the radio cell identity of the cellular radio access network on which the UE most recently camped.
Subscriber Equipment Number	O _C	This field contains the identification of the mobile device (e.g. IMEI) that the subscriber is using following successful inter-UE transfer.
Instance Id	O _C	This field uniquely identifies the device (fixed or mobile) of the served user following successful inter-UE transfer.
Related IMS Charging Identifier	O _C	This field contains the related IMS Charging Identifier in case of access transfer.
Related IMS Charging Identifier Generation Node	O _C	This parameter holds the identifier of the server that generated the Related IMS charging identifier in case of access transfer.
Access Transfer Time	O _C	This field contains the time stamp, which indicates the time at which the session transfer has been performed.
Service Context Id	O _M	Holds the context information to which the CDR belongs. The information is obtained from the Operation Token of the Charging Data Request message.
IMS Communication Service ID	O _C	This field contains the IMS communication service identifier if received in the P-Asserted-Service header in the SIP request.
Online Charging Flag	O _C	This field indicates the Online Charging Request was sent based on the provided ECF address from the SIP P-header "P-Charging-Function-Addresses". NOTE: No proof that online charging action has been taken
Real Time Tariff Information	O _C	This field holds the tariff/add-on charge received.
Initial IMS Charging Identifier	O _C	This parameter holds the Initial IMS charging identifier (ICID) as generated by the IMS node for the initial SIP session created for IMS service continuity. This field is not used for the "OneChargingSession" option.
User Location Info	O _C	This field indicates contains the network provided location information for 3GPP accesses available in the IMS Node when charging session starts, if available.
MS Time Zone	O _C	This field indicates the offset between universal time and local time in steps of 15 minutes of where the MS currently resides.
NNI Information	O _C	This grouped field holds information about the NNI used for interconnection and roaming on the loopback routing path. It is present only if RAVEL "VPLMN routing" is applied.
NNI Type	O _C	This field indicates usage of the roaming NNI for loopback routing, The loopback indication was received by the AS.
From Address	O _M	Contains the information from the SIP From header.
IMS Visited Network Identifier	O _C	Contains the information from the SIP P-Visited-Network-ID header received in a REGISTER request.
Subscriber Equipment Number	O _C	This field contains the identification of the mobile device (e.g. IMEI) that the subscriber is using.

Field	Category	Description
Instance Id	O _c	This field uniquely identifies the device (fixed or mobile) of the served user.
TAD Identifier	O _c	This field indicates the type of access network (CS or PS) through which the session shall be terminated.
3GPP PS Data Off Status	O _c	This field holds the 3GPP PS Data Off Status associated with the registration, as defined in TS 23.228 [201], when available.
Record Extensions	O _c	A set of operator/manufacture specific extensions to the record, conditioned upon existence of an extension.
FE Identifier List	O _c	This parameter corresponds to FE Identifier List of the P-Charging-Vector defined in TS 24.229 [204]. This element contains one or more IM CN subsystem functional entity addresses and/or AS and application identifiers where the IM CN subsystem functional entity does create charging information for the related CDR of this IM CN subsystem functional entity.

6.1.3.10 IBCF CDR content

The detailed description of the field is provided in TS 32.298 [51].

Table 6.1.3.10.1: Charging data of IBCF CDR

Field	Category	Description
Record Type	M	Identifies the type of record. The parameter is derived from the Node functionality parameter.
Retransmission	O _C	This parameter, when present, indicates that information from retransmitted Charging Data Requests has been used in this CDR.
SIP Method	O _C	Specifies the SIP-method for which the CDR is generated. Only available in session unrelated cases.
Event	O _C	This field identifies the SIP event package to which the SIP request is referred.
Expires Information	O _C	This field indicates the validity time of either the SIP message or its content, depending on the SIP method.
Role of Node	O _M	This field indicates whether the IBCF is serving the Originating or the Terminating party.
Node Address	O _M	This item holds the address of the node providing the information for the CDR. This may either be the IP address or the FQDN of the IMS node generating the accounting data.
Session ID	O _M	The Session identification. For a SIP session the Session-ID contains the SIP Call ID as defined in the Session Initiation Protocol RFC 3261 [404].
Session Priority	O _C	The field contains the priority of the session.
List Of Calling Party Address	O _M	The address or addresses (Public User ID or Public Service ID) of the party requesting a service or initiating a session. In the case of no P-Asserted-Identify is known, this list shall include a one item with the value "unknown".
Called Party Address	O _M	In the context of an end-to-end SIP transaction this field holds the address of the party (Public User ID) to whom the SIP transaction is posted.
Service Request Time Stamp	O _M	This field contains the time stamp which indicates the time at which the service was requested. This parameter corresponds to SIP Request Timestamp. Present with Charging Data Request [Start] and Charging Data Request [Event].
Service Request Time Stamp Fraction	O _M	This parameter contains the milliseconds fraction in relation to the Service Request Time Stamp.
Service Delivery Start Time Stamp	O _M	This field holds the time stamp reflecting either: successful session set-up, a delivery unrelated service, an unsuccessful session set-up and an unsuccessful session unrelated request. This parameter corresponds to SIP Response Timestamp. Present with Charging Data Request [Start] and Charging Data Request [Event].
Service Delivery Start Time Stamp Fraction	O _M	This parameter contains the milliseconds fraction in relation to the Service Delivery Start Time Stamp.
Service Delivery End Time Stamp	O _C	This field records the time at which the service delivery was terminated. It is present only in SIP session related case. This parameter corresponds to SIP Request Timestamp. Present with Charging Data Request [Stop].
Service Delivery End Time Stamp Fraction	O _C	This parameter contains the milliseconds fraction in relation to the Service Delivery End Time Stamp.
Record Opening Time	O _C	A time stamp reflecting the time the CDF opened this record. Present only in SIP session related case.
Record Closure Time	O _M	A Time stamp reflecting the time the CDF closed the record
Inter Operator Identifiers	O _C	Holds the identification of the home network (originating and terminating) if exchanged via SIP signalling, as recorded in the <i>P-Charging-Vector header</i> .
Originating IOI	O _C	This parameter corresponds to Orig-IOI header of the P-Charging-Vector defined in TS 24.229 [204].
Terminating IOI	O _C	This parameter corresponds to Term-IOI header of the P-Charging-Vector defined in TS 24.229 [204].
Transit IOI List	O _C	This parameter corresponds to Transit-IOI List of the P-Charging-Vector defined in TS 24.229 [204].
Local Record Sequence Number	O _M	This field includes a unique record number created by this node. The number is allocated sequentially for each partial CDR (or whole CDR) including all CDR types. The number is unique within the CDF.
Record Sequence Number	O _C	This field contains a running sequence number employed to link the partial records generated by the CDF for a particular session.
Cause For Record Closing	O _M	This field contains a reason for the close of the CDR.
Incomplete CDR Indication	O _C	This field provides additional diagnostics when the CDF detects missing Charging Data Requests.
IMS Charging Identifier	O _M	This parameter holds the IMS charging identifier (ICID) as generated by the IMS node for the SIP session.
List of Early SDP Media Components	O _C	This is a grouped field which may occur several times in one CDR. This field shall not be present if no media components are set to active before the final SIP session answer to the initial SIP Invite is received. This field can be present in either session or event CDRs.
SDP Session Description	O _C	Holds the Session portion of SDP data exchanged in the above mentioned scenario, if available.
SDP Type	O _M	This parameter indicates if the SDP media component is an SDP offer or SDP answer.

Field	Category	Description
SDP Offer Timestamp	O _M	This parameter contains the time of the SIP Request which conveys the SDP offer.
SDP Answer Timestamp	O _M	This parameter contains the time of the response to the SIP Request which conveys the SDP answer.
SDP Media Components	O _M	This is a grouped field comprising several sub-fields associated with one media component. Since several media components may exist for a session in parallel these sub-fields may occur several times.
SDP Media Name	O _M	This field holds the name of the media as available in the SDP data.
SDP Media Description	O _M	This field holds the attributes of the media as available in the SDP data.
Media Initiator Flag	O _C	This field indicates if the called party has requested the session modification and it is present only if the initiator was the called party.
List of SDP Media Components	O _C	This is a grouped field which may occur several times in one CDR. The field is present only in a SIP session related case.
SDP Session Description	O _C	Holds the Session portion of the SDP data exchanged between the User Agents if available in the SIP transaction.
SDP Type	O _M	This parameter indicates if the SDP media component is an SDP offer or SDP answer.
SIP Request Timestamp	O _C	This parameter contains the time of the SIP Request (usually a (RE-)INVITE). This parameter corresponds to SIP Request Timestamp in Charging Data Request [Interim].
SIP Response Timestamp	O _C	This parameter contains appropriately the time of SIP 200 OK acknowledging an SIP INVITE or of SIP ACK including an SDP answer. This parameter corresponds to SIP Response Timestamp in Charging Data Request [Interim].
SIP Request Timestamp Fraction	O _C	This parameter contains the milliseconds fraction in relation to the SIP Request Timestamp.
SIP Response Timestamp Fraction	O _C	This parameter contains the milliseconds fraction in relation to the SIP Response Timestamp.
SDP Media Components	O _M	This is a grouped field comprising several sub-fields associated with one media component. Since several media components may exist for a session in parallel these sub-fields may occur several times.
SDP Media Name	O _M	This field holds the name of the media as available in the SDP data.
SDP Media Description	O _M	This field holds the attributes of the media as available in the SDP data.
Local GW Inserted Indication	O _C	This field indicates whether the local TrGW is inserted or not, for the media component included in SDP answer, if available.
IP Realm Default Indication	O _C	This field indicates whether the User Plane IP realm associated to the media component included in SDP answer, is the Default IP realm or not, if available.
Transcoder Inserted Indication	O _C	This field indicates whether a transcoder is inserted or not, for the media component included in the SDP answer, if available.
Media Initiator Flag	O _C	This field indicates if the called party has requested the session modification and it is present only if the initiator was the called party.
Service Reason Return Code	O _M	This parameter provides the returned SIP status code for the service request for the successful and failure case,
List Of Reason Header	O _C	This parameter contains the list of SIP reason headers included in BYE or CANCEL method terminating the service, Reliability of this information is not guaranteed if the SIP or CANCEL is originated outside of the trust domain which is determined by the Operator on a "per parameter basis".
List of Message Bodies	O _C	This grouped field comprising several sub-fields describing the data that may be conveyed end-to-end in the body of a SIP message. Since several message bodies may be exchanged via SIP-signalling, this grouped field may occur several times.
Content-Type	O _M	This sub-field of Message Bodies holds the MIME type of the message body, Examples are: application/zip, image/gif, audio/mpeg, etc.
Content-Disposition	O _C	This sub-field of Message Bodies holds the content disposition of the message body inside the SIP signalling, Content-disposition header field equal to "render", indicates that "the body part should be displayed or otherwise rendered to the user". Content disposition values are : session, render, inline, icon, alert, attachment, etc.
Content-Length	O _M	This sub-field of Message Bodies holds the size of the data of a message body in bytes.
Originator	O _C	This sub-field of the "List of Message Bodies" indicates the originating party of the message body.
Access Network Information	O _C	This field contains the content of one SIP P-header "P-Access-Network-Info" available in the IMS Node when charging session starts, if available.
Additional Access Network Information	O _C	This field contains the content of an additional SIP P-header "P-Access-Network-Info", available in the IMS Node as additional location when charging session starts, if available.

Field	Category	Description
Cellular Network Information	O _C	This field contains the content of one SIP "Cellular-Network-Info" header, when the UE supporting one or more cellular radio access technologies but using a non-cellular IP-CAN, such as untrusted WLAN access, provides this header field to relay information to its service provider about the radio cell identity of the cellular radio access network on which the UE most recently camped. This field is applicable when changed from the previous one, if available.
List of Access Network Info Change	O _C	This field is a list of grouped field describing the subsequent SIP P-header "P-Access-Network-Info" and "Cellular-Network-Info" changes.
Access Network Information	O _C	This field holds the content of the SIP P-header "P-Access-Network-Info", when changed from the previous one.
Additional Access Network Information	O _C	This field holds the content of additional SIP P-header "P-Access-Network-Info" when changed from the previous one, if available.
Cellular Network Information	O _C	This field contains the content of one SIP "Cellular-Network-Info" header, when the UE supporting one or more cellular radio access technologies but using a non-cellular IP-CAN, such as untrusted WLAN access, provides this header field to relay information to its service provider about the radio cell identity of the cellular radio access network on which the UE most recently camped. This field is applicable when changed from the previous one, if available.
Access Change Time	O _C	This field contains the time at which the changed user location information was acquired.
IMS Communication Service ID	O _C	This field contains the identifier for the type of communication service the IMS is currently providing for the session if received in the P-Asserted-Service header in the SIP request when the IBCF is downstream from the S-CSCF serving the Originating party or the topmost occurrence of the "+g.3gpp.icsi-ref" header field parameter of the Feature-Caps header in the SIP response when the IBCF is upstream from the S-CSCF serving the Originating party.
Service Context Id	O _M	Holds the context information to which the CDR belongs. The information is obtained from the Operation Token of the Charging Data Request message.
Real Time Tariff Information	O _C	This field holds the tariff/add-on charge received.
User Location Info	O _C	This field indicates contains the network provided location information for 3GPP accesses available in the IMS Node when charging session starts, if available.
MS Time Zone	O _C	This field indicates the offset between universal time and local time in steps of 15 minutes of where the MS currently resides.
NNI Information	O _C	This grouped field comprising several sub-fields holds information about the NNI used for interconnection and roaming. This field may occur more than once in a CDR e.g. when routing capability in support of transit is collocated with the IBCF.
Session Direction	O _C	This field indicates whether the NNI is used for an inbound or outbound service request on the control plane in case of interconnection and roaming.
NNI Type	O _C	This field indicates whether the type of used NNI is non-roaming, roaming with loopback routing, or roaming without loopback routing.
Relationship Mode	O _C	This field indicates whether the other functional entity (contact point of the neighbouring network) is regarded as part of the same trust domain.
Neighbour Node Address	O _C	This field holds the control plane IP address of the neighbouring network contact point that handles the service request in case of interconnection and roaming.
From Address	O _M	Contains the information from the SIP From header.
SIP Route header received in an INVITE request	O _C	Contains the information in the topmost route header in a received initial SIP INVITE and non-session related SIP MESSAGE request.
Record Extensions	O _C	A set of operator/manufacture specific extensions to the record, conditioned upon existence of an extension.
FE Identifier List	O _C	This parameter corresponds to FE Identifier List of the P-Charging-Vector defined in TS 24.229 [204]. This element contains one or more IM CN subsystem functional entity addresses and/or AS and application identifiers where the IM CN subsystem functional entity does create charging information for the related CDR of this IM CN subsystem functional entity.

6.1.3.11 E-CSCF CDR content

The detailed description of the field is provided in TS 32.298 [51].

Table 6.1.3.11.1: Charging data of E-CSCF CDR

Field	Category	Description
Record Type	M	Identifies the type of record. The parameter is derived from the Node functionality parameter.
Retransmission	O _C	This parameter, when present, indicates that information from retransmitted Charging Data Requests has been used in this CDR
SIP Method	O _C	Specifies the SIP-method for which the CDR is generated. Only available in session unrelated cases.
Event	O _C	This field identifies the SIP event package to which the SIP request is referred.
Expires Information	O _C	This field indicates the validity time of either the SIP message or its content, depending on the SIP method.
Role of Node	O _M	This field indicates whether the E-CSCF is serving the Originating or the Terminating party.
Node Address	O _M	This item holds the address of the node providing the information for the CDR. This may either be the IP address or the FQDN of the IMS node generating the accounting data.
Session ID	O _M	The Session identification. For a SIP session the Session-ID contains the SIP Call ID as defined in the Session Initiation Protocol RFC 3261 [404].
Session Priority	O _C	The field contains the priority of the session.
List Of Calling Party Address	O _M	The address or addresses (Public User ID or Public Service ID) of the party requesting a service or initiating a session. In case no P-Asserted-Identity is known, this list shall include one item with the value "unknown".
Called Party Address	O _M	For SIP transactions, this field holds the address of the party (Public User ID or Public Service ID) to whom the SIP transaction is posted. It could be in the format of a SIP URI, a Tel URI or a URN
Requested Party Address	O _C	For SIP transactions this field holds the address of the party (Public User ID or Public Service ID) to whom the SIP transaction was originally posted. It could be in the format of a SIP URI, a TEL URI or a URN. This field is only present if different from the Called Party Address parameter.
List of Called Asserted Identity	O _C	The address or addresses of the final asserted identities. Present if the final asserted identities are available in the SIP 2xx RESPONSE.
List of Called Identity Changes	O _C	List of terminating identity address changes and associated timestamps.
Called Identity Change Time Stamp	O _C	Timestamp of SIP UPDATE or SIP RE-INVITE with changed terminating identity information.
Called Identity	O _C	Changed terminating identity information received in a SIP UPDATE or SIP RE-INVITE.
List of Subscription Id	O _C	Holds the public user identities of the served user
Service Request Time Stamp	O _M	This field contains the time stamp, which indicates the time at which the service was requested.
Service Request Time Stamp Fraction	O _M	This parameter contains the milliseconds fraction in relation to the Service Request Time Stamp.
Service Delivery Start Time Stamp	O _M	This field holds the time stamp reflecting either: successful session set-up, a delivery unrelated service, an unsuccessful session set-up and an unsuccessful session unrelated request.
Service Delivery Start Time Stamp Fraction	O _M	This parameter contains the milliseconds fraction in relation to the Service Delivery Start Time Stamp.
Service Delivery End Time Stamp	O _C	This field records the time at which the service delivery was terminated. It is Present only in SIP session related case.
Service Delivery End Time Stamp Fraction	O _C	This parameter contains the milliseconds fraction in relation to the Service Delivery End Time Stamp.
Record Opening Time	O _C	A time stamp reflecting the time the CDF opened this record. Present only in SIP session related case.
Record Closure Time	O _M	A Time stamp reflecting the time the CDF closed the record.
Application Servers Information	O _C	This is a grouped CDR field containing the fields: "Application Server Involved" and "Application Provided Called Parties".
Application Servers Involved	O _C	Holds the ASs (if any) identified by the SIP URIs.
Application Provided Called Parties	O _C	Holds a list of the Called Party Address(es), if the address(es) are determined by an AS (SIP URI, E.164...).
List of Inter Operator Identifiers	O _C	Holds the identification of the home network (originating and terminating) if exchanged via SIP signalling, as recorded in the P-Charging-Vector header. This grouped field may occur several times in one CDR.
Originating IOI	O _C	This parameter corresponds to Orig-IOI header of the P-Charging-Vector defined in TS 24.229 [204].
Terminating IOI	O _C	This parameter corresponds to Term-IOI header of the P-Charging-Vector defined in TS 24.229 [204].
Local Record Sequence Number	O _M	This field includes a unique record number created by E-CSCF. The number is allocated sequentially for each partial CDR (or whole CDR) including all CDR types. The number is unique within the CDF.
Record Sequence Number	O _C	This field contains a running sequence number employed to link the partial records generated by the CDF for a particular session.
Cause For Record Closing	O _M	This field contains a reason for the close of the CDR.

Field	Category	Description
Incomplete CDR Indication	O _C	This field provides additional diagnostics when the CDF detects missing Charging Data Requests.
IMS Charging Identifier	O _M	This parameter holds the IMS charging identifier (ICID) as generated by the IMS node for the SIP session.
List of Early SDP Media Components	O _C	This is a grouped field which may occur several times in one CDR. This field shall not be present if no media components are set to active before the final SIP session answer to the initial SIP Invite is received. This field can be present in either session or event CDRs.
SDP Session Description	O _C	Holds the Session portion of SDP data exchanged in the above mentioned scenario, if available.
SDP Type	O _M	This parameter indicates if the SDP media component is an SDP offer or SDP answer.
SDP Offer Timestamp	O _M	This parameter contains the time of the SIP Request which conveys the SDP offer.
SDP Answer Timestamp	O _M	This parameter contains the time of the response to the SIP Request which conveys the SDP answer.
SDP Media Components	O _M	This is a grouped field comprising several sub-fields associated with one media component. Since several media components may exist for a session in parallel these sub-fields may occur several times.
SDP Media Name	O _M	This field holds the name of the media as available in the SDP data.
SDP Media Description	O _M	This field holds the attributes of the media as available in the SDP data.
Access Correlation ID	O _C	This parameter holds the charging identifier from the access network, consisting of either GPRS charging ID (GCID) which is generated by the GGSN for a GPRS PDP context, Charging Id which is generated by P-GW for IP-CAN bearer or the Access Network Charging Identifier Value which is generated by another type of access network. It is present only if received from the access network when PCC architecture is implemented.
Media Initiator Flag	O _C	This field indicates if the called party has requested the session modification and it is present only if the initiator was the called party.
List of SDP Media Components	O _C	This is a grouped field which may occur several times in one CDR. The field is present only in a SIP session related case.
SDP Session Description	O _C	Holds the Session portion of the SDP data exchanged between the User Agents if available in the SIP transaction.
SDP Type	O _M	This parameter indicates if the SDP media component is an SDP offer or SDP answer.
SIP Request Timestamp	O _C	This parameter contains the time of the SIP Request (usually a (RE-)INVITE).
SIP Response Timestamp	O _C	This parameter contains appropriately the time of SIP 200 OK acknowledging an SIP INVITE or of SIP ACK including an SDP answer.
SIP Request Timestamp Fraction	O _C	This parameter contains the milliseconds fraction in relation to the SIP Request Timestamp.
SIP Response Timestamp Fraction	O _C	This parameter contains the milliseconds fraction in relation to the SIP Response Timestamp.
SDP Media Components	O _M	This is a grouped field comprising several sub-fields associated with one media component. Since several media components may exist for a session in parallel these sub-fields may occur several times.
SDP Media Name	O _M	This field holds the name of the media as available in the SDP data.
SDP Media Description	O _M	This field holds the attributes of the media as available in the SDP data.
Access Correlation ID	O _C	This parameter holds the charging identifier from the access network, consisting of either GPRS charging ID (GCID) which is generated by the GGSN for a GPRS PDP context, Charging Id which is generated by P-GW for IP-CAN bearer or the Access Network Charging Identifier Value which is generated by another type of access network. It is present only if received from the access network when PCC architecture is implemented.
Media Initiator Flag	O _C	This field indicates if the called party has requested the session modification and it is present only if the initiator was the called party.
GGSN Address	O _C	This parameter holds the control plane IP address of the GGSN that handles one or more media component(s) of an IMS session.
Service Reason Return Code	O _M	This parameter provides the returned SIP status code for the service request for the successful and failure case,
List Of Reason Header	O _C	This parameter contains the list of SIP reason headers included in BYE or CANCEL method terminating the service, Reliability of this information is not guaranteed if the SIP or CANCEL is originated outside of the trust domain which is determined by the Operator on a "per parameter basis".
List of Message Bodies	O _C	This grouped field comprising several sub-fields describing the data that may be conveyed end-to-end in the body of a SIP message. Since several message bodies may be exchanged via SIP-signalling, this grouped field may occur several times.

Field	Category	Description
Content-Type	O _M	This sub-field of Message Bodies holds the MIME type of the message body, Examples are: application/zip, image/gif, audio/mpeg, etc.
Content-Disposition	O _C	This sub-field of Message Bodies holds the content disposition of the message body inside the SIP signalling, Content-disposition header field equal to "render", indicates that "the body part should be displayed or otherwise rendered to the user". Content disposition values are: session, render, inline, icon, alert, attachment, etc.
Content-Length	O _M	This sub-field of Message Bodies holds the size of the data of a message body in bytes.
Originator	O _C	This sub-field of the "List of Message Bodies" indicates the originating party of the message body.
Access Network Information	O _C	This field contains the content of one SIP P-header "P-Access-Network-Info" available in the IMS Node when charging session starts, if available.
Additional Access Network Information	O _C	This field contains the content of additional SIP P-header "P-Access-Network-Info", available in the IMS Node as additional location when charging session starts, if available.
Cellular Network Information	O _C	This field contains the content of one SIP "Cellular-Network-Info" header, when the UE supporting one or more cellular radio access technologies but using a non-cellular IP-CAN, such as untrusted WLAN access, provides this header field to relay information to its service provider about the radio cell identity of the cellular radio access network on which the UE most recently camped.
List of Access Network Info Change	O _C	This field is a list of grouped field describing the subsequent SIP P-header "P-Access-Network-Info" and "Cellular-Network-Info" changes.
Access Network Information	O _C	This field holds the content of the SIP P-header "P-Access-Network-Info", when changed from the previous one.
Cellular Network Information	O _C	This field contains the content of one SIP "Cellular-Network-Info" header, when the UE supporting one or more cellular radio access technologies but using a non-cellular IP-CAN, such as untrusted WLAN access, provides this header field to relay information to its service provider about the radio cell identity of the cellular radio access network on which the UE most recently camped. This field is applicable when changed from the previous one, if available.
Additional Access Network Information	O _C	This field holds the content of additional SIP P-header "P-Access-Network-Info" when changed from the previous one, if available.
Access Change Time	O _C	This field contains the time at which the changed user location information was acquired.
Service Context Id	O _M	Holds the context information to which the CDR belongs. The information is obtained from the Operation Token of the Charging Data Request message.
IMS Communication Service ID	O _C	This field contains the IMS communication service identifier if received in the P-Asserted-Service header in the SIP request.
User Location Info	O _C	This field contains the network provided location information for 3GPP accesses available in the IMS Node when charging session starts, if available.
MS Time Zone	O _C	This field indicates the offset between universal time and local time in steps of 15 minutes of where the MS currently resides.
From Address	O _M	Contains the information from the SIP From header.
Record Extensions	O _C	A set of operator/manufacture specific extensions to the record, conditioned upon existence of an extension.
FE Identifier List	O _C	This parameter corresponds to FE Identifier List of the P-Charging-Vector defined in TS 24.229 [204]. This element contains one or more IM CN subsystem functional entity addresses and/or AS and application identifiers where the IM CN subsystem functional entity does create charging information for the related CDR of this IM CN subsystem functional entity.

6.1.3.12 TRF CDR content

The detailed description of the field is provided in TS 32.298 [51].

Table 6.1.3.12.1: Charging data of TRF CDR

Field	Category	Description
Record Type	M	Identifies the type of record. The parameter is derived from the Node functionality parameter.
Retransmission	O _C	This parameter, when present, indicates that information from retransmitted Charging Data Requests has been used in this CDR.
SIP Method	O _C	Specifies the SIP-method for which the CDR is generated. Only available in session unrelated cases.
Event	O _C	This field identifies the SIP event package to which the SIP request is referred.
Expires Information	O _C	This field indicates the validity time of either the SIP message or its content, depending on the SIP method.
Role of Node	O _M	This field indicates whether the TRF is serving the Originating or the Terminating party.
Node Address	O _M	This item holds the address of the node providing the information for the CDR. This may either be the IP address or the FQDN of the IMS node generating the accounting data.
Session ID	O _M	The Session identification. For a SIP session the Session-ID contains the SIP Call ID as defined in the Session Initiation Protocol RFC 3261 [404].
Session Priority	O _C	The field contains the priority of the session.
List Of Calling Party Address	O _M	The address or addresses (Public User ID or Public Service ID) of the party requesting a service or initiating a session.
Called Party Address	O _M	In the context of an end-to-end SIP transaction this field holds the address of the party (Public User ID) to whom the SIP transaction is posted.
List of Called Asserted Identity	O _C	The address or addresses of the final asserted identities. Present if the final asserted identities are available in the SIP 2xx response.
List of Called Identity Changes	O _C	List of terminating identity address changes and associated timestamps.
Called Identity Change Time Stamp	O _C	Timestamp of SIP UPDATE or SIP RE-INVITE with changed terminating identity information.
Called Identity	O _C	Changed terminating identity information received in a SIP UPDATE or SIP RE-INVITE.
Requested Party Address	O _C	For SIP transactions this field holds the address of the party (Public User ID or Public Service ID) to whom the SIP transaction was originally posted. This field is only present if different from the Called Party Address parameter.
List of Subscription Id	O _C	Holds the public user identities of the served user.
Number Portability routing information	O _C	This field includes information on number portability after DNS/ENUM request from the TRF.
Carrier Select routing information	O _C	This field includes information on carrier select after DNS/ENUM request from the TRF.
Service Request Time Stamp	O _M	This field contains the time stamp which indicates the time at which the service was requested. This parameter corresponds to SIP Request Timestamp. Present with Charging Data Request [Start] and Charging Data Request [Event].
Service Request Time Stamp Fraction	O _M	This parameter contains the milliseconds fraction in relation to the Service Request Time Stamp.
Service Delivery Start Time Stamp	O _M	This field holds the time stamp reflecting either: successful session set-up, a delivery unrelated service, an unsuccessful session set-up and an unsuccessful session unrelated request. This parameter corresponds to SIP Response Timestamp. Present with Charging Data Request [Start] and Charging Data Request [Event].
Service Delivery Start Time Stamp Fraction	O _M	This parameter contains the milliseconds fraction in relation to the Service Delivery Start Time Stamp.
Service Delivery End Time Stamp	O _C	This field records the time at which the service delivery was terminated. It is Present only in SIP session related case. This parameter corresponds to SIP Request Timestamp. Present with Charging Data Request [Stop].
Service Delivery End Time Stamp Fraction	O _C	This parameter contains the milliseconds fraction in relation to the Service Delivery End Time Stamp.
Record Opening Time	O _C	A time stamp reflecting the time the CDF opened this record. Present only in SIP session related case.
Record Closure Time	O _M	A Time stamp reflecting the time the CDF closed the record
Application Servers Information	O _C	This is a grouped CDR field containing the fields: "Application Server Involved" and "Application Provided Called Parties".
Application Servers Involved	O _C	Holds the ASs (if any) identified by the SIP URIs.
Application Provided Called Parties	O _C	Holds a list of the Called Party Address(es), if the address(es) are determined by an AS (SIP URI, E.164...).
Inter Operator Identifiers	O _C	Holds the identification of the home network (originating and terminating) if exchanged via SIP signalling, as recorded in the <i>P-Charging-Vector header</i> . This grouped field may occur several times in one CDR.
Originating IOI	O _C	This parameter corresponds to Orig-IOI header of the P-Charging-Vector defined in TS 24.229 [204].
Terminating IOI	O _C	This parameter corresponds to Term-IOI header of the P-Charging-Vector defined in TS 24.229 [204].

Field	Category	Description
Transit IOI List	O _C	This parameter corresponds to Transit-IOI List of the P-Charging-Vector defined in TS 24.229 [204]. This field may occur several times in one CDR. Each occurrence represents transit IOI values received from the path inbound to or outbound from the TRF.
Local Record Sequence Number	O _M	This field includes a unique record number created by this node. The number is allocated sequentially for each partial CDR (or whole CDR) including all CDR types. The number is unique within the CDF.
Record Sequence Number	O _C	This field contains a running sequence number employed to link the partial records generated by the CDF for a particular session.
Cause For Record Closing	O _M	This field contains a reason for the close of the CDR.
Incomplete CDR Indication	O _C	This field provides additional diagnostics when the CDF detects missing Charging Data Requests.
IMS Charging Identifier	O _M	This parameter holds the IMS charging identifier (ICID) as generated by the IMS node for the SIP session.
List of Early SDP Media Components	O _C	This is a grouped field which may occur several times in one CDR. This field shall not be present if no media components are set to active before the final SIP session answer to the initial SIP Invite is received. This field can be present in either session or event CDRs.
SDP Session Description	O _C	Holds the Session portion of SDP data exchanged in the above mentioned scenario, if available.
SDP Type	O _M	This parameter indicates if the SDP media component is an SDP offer or SDP answer.
SDP Offer Timestamp	O _M	This parameter contains the time of the SIP Request which conveys the SDP offer.
SDP Answer Timestamp	O _M	This parameter contains the time of the response to the SIP Request which conveys the SDP answer.
SDP Media Components	O _M	This is a grouped field comprising several sub-fields associated with one media component. Since several media components may exist for a session in parallel these sub-fields may occur several times.
SDP Media Name	O _M	This field holds the name of the media as available in the SDP data.
SDP Media Description	O _M	This field holds the attributes of the media as available in the SDP data.
Media Initiator Flag	O _C	This field indicates if the called party has requested the session modification and it is present only if the initiator was the called party.
List of SDP Media Components	O _C	This is a grouped field which may occur several times in one CDR. The field is present only in a SIP session related case.
SDP Session Description	O _C	Holds the Session portion of the SDP data exchanged between the User Agents if available in the SIP transaction.
SDP Type	O _M	This parameter indicates if the SDP media component is an SDP offer or SDP answer.
SIP Request Timestamp	O _C	This parameter contains the time of the SIP Request (usually a (RE-)INVITE). This parameter corresponds to SIP Request Timestamp in Charging Data Request [Interim].
SIP Response Timestamp	O _C	This parameter contains appropriately the time of SIP 200 OK acknowledging an SIP INVITE or of SIP ACK including an SDP answer. This parameter corresponds to SIP Response Timestamp in Charging Data Request [Interim].
SIP Request Timestamp Fraction	O _C	This parameter contains the milliseconds fraction in relation to the SIP Request Timestamp.
SIP Response Timestamp Fraction	O _C	This parameter contains the milliseconds fraction in relation to the SIP Response Timestamp.
SDP Media Components	O _M	This is a grouped field comprising several sub-fields associated with one media component. Since several media components may exist for a session in parallel these sub-fields may occur several times.
SDP Media Name	O _M	This field holds the name of the media as available in the SDP data.
SDP Media Description	O _M	This field holds the attributes of the media as available in the SDP data.
Media Initiator Flag	O _C	This field indicates if the called party has requested the session modification and it is present only if the initiator was the called party.
Service Reason Return Code	O _M	This parameter provides the returned SIP status code for the service request for the successful and failure case,
List Of Reason Header	O _C	This parameter contains the list of SIP reason headers included in BYE or CANCEL method terminating the service, Reliability of this information is not guaranteed if the SIP or CANCEL is originated outside of the trust domain which is determined by the Operator on a "per parameter basis".
List of Message Bodies	O _C	This grouped field comprising several sub-fields describing the data that may be conveyed end-to-end in the body of a SIP message. Since several message bodies may be exchanged via SIP-signalling, this grouped field may occur several times.
Content-Type	O _M	This sub-field of Message Bodies holds the MIME type of the message body, Examples are: application/zip, image/gif, audio/mpeg, etc.

Field	Category	Description
Content-Disposition	O _C	This sub-field of Message Bodies holds the content disposition of the message body inside the SIP signalling, Content-disposition header field equal to "render", indicates that "the body part should be displayed or otherwise rendered to the user". Content disposition values are : session, render, inline, icon, alert, attachment, etc.
Content-Length	O _M	This sub-field of Message Bodies holds the size of the data of a message body in bytes.
Originator	O _C	This sub-field of the "List of Message Bodies" indicates the originating party of the message body.
IMS Communication Service Id	O _C	Contains the identifier for the type of communication service the IMS is currently providing for the session.
Service Context Id	O _M	Holds the context information to which the CDR belongs. The information is obtained from the Operation Token of the Charging Data Request message.
User Location Info	O _C	This field contains the network provided location information for 3GPP accesses, if available.
MS Time Zone	O _C	This field indicates the offset between universal time and local time in steps of 15 minutes of where the MS currently resides.
NNI Information	O _C	This grouped field comprising several sub-fields holds information about the NNI used for interconnection and roaming. This field may occur more than once in a CDR e.g. when routing capability in support of transit is collocated with the TRF.
NNI Type	O _C	This field indicates whether the type of used NNI is non-roaming, roaming with loopback routing, or roaming without loopback routing.
SIP Route header received	O _C	Contains the information in the topmost route header in a received initial SIP INVITE or non-session related SIP MESSAGE request.
Record Extensions	O _C	A set of operator/manufacturer specific extensions to the record, conditioned upon existence of an extension.
FE Identifier List	O _C	This parameter corresponds to FE Identifier List of the P-Charging-Vector defined in TS 24.229 [204]. This element contains one or more IM CN subsystem functional entity addresses and/or AS and application identifiers where the IM CN subsystem functional entity does create charging information for the related CDR of this IM CN subsystem functional entity.

6.1.3.13 ATCF CDR content

The detailed description of the field is provided in TS 32.298 [51].

Table 6.1.3.13.1: Charging data of ATCF CDR

Field	Category	Description
Record Type	M	Identifies the type of record. The parameter is derived from the Node functionality parameter.
Retransmission	O _C	This parameter, when present, indicates that information from retransmitted Charging Data Requests has been used in this CDR
SIP Method	O _C	Specifies the SIP-method for which the CDR is generated. Only available in session unrelated cases.
Event	O _C	This field identifies the SIP event package to which the SIP request is referred.
Expires Information	O _C	This field indicates the validity time of either the SIP message or its content, depending on the SIP method.
Role of Node	O _M	This field indicates whether the ATCF is serving the Originating or the Terminating party.
Node Address	O _M	This item holds the address of the node providing the information for the CDR. This may either be the IP address or the FQDN of the IMS node generating the accounting data.
Session ID	O _M	The Session identification. For a SIP session the Session-ID contains the SIP Call ID as defined in the Session Initiation Protocol RFC 3261 [404]. When the ATCF acts as B2BUA, the incoming session is identified, except for the "OneChargingSession" option, where it contains either the incoming or outgoing dialog SIP Call Id involved during IMS session setup.
Outgoing Session ID	O _C	When the ATCF acts as B2BUA, the outgoing session is identified by the Outgoing Session ID which contains the SIP Call ID (as defined in the RFC 3261 [404]). This field is not used for the "OneChargingSession" option
Session Priority	O _C	The field contains the priority of the session.
List Of Calling Party Address	O _M	The address or addresses (Public User ID or Public Service ID, Correlation MSISDN) of the party requesting a service or initiating a session. In the case of no P-Asserted-Identify is known, this list shall include one item with the value "unknown".
Called Party Address	O _M	For SIP transactions, except for registration, this field holds the address of the party (Public User ID or Public Service ID) to whom the SIP transaction is posted. For registration transactions, this field holds the Public User ID under registration.
List of Requested Party Address	O _C	This field is a list of Requested Party Address. This field is only present if different from the Called Party Address parameter.
Private User ID	O _C	This field holds the private user identity of the served party defined in TS 23.003 [104], if available.
List of Subscription Id	O _M	Holds the public user identities of the served user
List of Called Asserted Identity	O _C	The address or addresses of the final asserted identities. Present if the final asserted identities are available in the SIP 2xx response.
List of Called Identity Changes	O _C	List of terminating identity address changes and associated timestamps.
Called Identity Change Time Stamp	O _C	Timestamp of SIP UPDATE or SIP RE-INVITE with changed terminating identity information.
Called Identity	O _C	Changed terminating identity information received in a SIP UPDATE or SIP RE-INVITE.
Service Request Time Stamp	O _M	This field contains the time stamp which indicates the time at which the service was requested. This parameter corresponds to SIP Request Timestamp. Present with Charging Data Request [Start] and Charging Data Request [Event].
Service Request Time Stamp Fraction	O _M	This parameter contains the milliseconds fraction in relation to the Service Request Time Stamp.
Service Delivery Start Time Stamp	O _M	This field holds the time stamp reflecting either: successful session set-up, a delivery unrelated service, an unsuccessful session set-up and an unsuccessful session unrelated request. This parameter corresponds to SIP Response Timestamp. Present with Charging Data Request [Start] and Charging Data Request [Event].
Service Delivery Start Time Stamp Fraction	O _M	This parameter contains the milliseconds fraction in relation to the Service Delivery Start Time Stamp.
Service Delivery End Time Stamp	O _C	This field records the time at which the service delivery was terminated. It is Present only in SIP session related case. This parameter corresponds to SIP Request Timestamp. Present with Charging Data Request [Stop].
Service Delivery End Time Stamp Fraction	O _C	This parameter contains the milliseconds fraction in relation to the Service Delivery End Time Stamp.
Record Opening Time	O _C	A time stamp reflecting the time the CDF opened this record. Present only in SIP session related case.
Record Closure Time	O _M	A Time stamp reflecting the time the CDF closed the record.
Inter Operator Identifiers	O _C	Holds the identification of the home network (originating and terminating) if exchanged via SIP signalling, as recorded in the <i>P-Charging-Vector header</i> .
Originating IOI	O _C	This parameter corresponds to Orig-IOI header of the P-Charging-Vector defined in TS 24.229 [204].
Terminating IOI	O _C	This parameter corresponds to Term-IOI header of the P-Charging-Vector defined in TS 24.229 [204].

Field	Category	Description
Local Record Sequence Number	O _M	This field includes a unique record number created by this node. The number is allocated sequentially for each partial CDR (or whole CDR) including all CDR types. The number is unique within the CDF.
Record Sequence Number	O _C	This field contains a running sequence number employed to link the partial records generated by the CDF for a particular session.
Cause For Record Closing	O _M	This field contains a reason for the close of the CDR.
Incomplete CDR Indication	O _C	This field provides additional diagnostics when the CDF detects missing Charging Data Requests.
IMS Charging Identifier	O _M	This parameter holds the IMS charging identifier (ICID) as generated by the IMS node for the SIP session.
Related IMS Charging Identifier	O _C	This field contains the related IMS Charging Identifier in case of access transfer.
Related IMS Charging Identifier Generation Node	O _C	This parameter holds the identifier of the server that generated the Related IMS charging identifier.
List of Early SDP Media Components	O _C	This is a grouped field which may occur several times in one CDR. This field shall not be present if no media components are set to active before the final SIP session answer to the initial SIP Invite is received. This field can be present in either session or event CDRs.
SDP Session Description	O _C	Holds the Session portion of SDP data exchanged in the above mentioned scenario, if available.
SDP Type	O _M	This parameter indicates if the SDP media component is an SDP offer or SDP answer.
SDP Offer Timestamp	O _M	This parameter contains the time of the SIP Request which conveys the SDP offer.
SDP Answer Timestamp	O _M	This parameter contains the time of the response to the SIP Request which conveys the SDP answer.
SDP Media Components	O _M	This is a grouped field comprising several sub-fields associated with one media component. Since several media components may exist for a session in parallel these sub-fields may occur several times.
SDP Media Name	O _M	This field holds the name of the media as available in the SDP data.
SDP Media Description	O _M	This field holds the attributes of the media as available in the SDP data.
Access Correlation ID	O _C	This parameter holds the charging identifier from the access network, consisting of either GPRS charging ID (GCID) which is generated by the GGSN for a GPRS PDP context, Charging Id which is generated by P-GW for IP-CAN bearer or the Access Network Charging Identifier Value which is generated by another type of access network. It is present only if received from the access network when PCC architecture is implemented.
Media Initiator Flag	O _C	This field indicates if the called party has requested the session modification and it is present only if the initiator was the called party.
List of SDP Media Components	O _C	This is a grouped field which may occur several times in one CDR. . The field is present only in a SIP session related case. When the ATCF acts as B2BUA and "OneChargingSession" option applies, only SDP media components received by the ATCF are included, i.e. those generated by the ATCF are not included.
SDP Session Description	O _C	Holds the Session portion of the SDP data exchanged between the User Agents if available in the SIP transaction.
SDP Type	O _M	This parameter indicates if the SDP media component is an SDP offer or SDP answer.
SIP Request Timestamp	O _C	This parameter contains the time of the SIP Request (usually a (RE-)INVITE). This parameter corresponds to SIP Request Timestamp in Charging Data Request [Interim].
SIP Response Timestamp	O _C	This parameter contains appropriately the time of SIP 200 OK acknowledging an SIP INVITE or of SIP ACK including an SDP answer. This parameter corresponds to SIP Response Timestamp in Charging Data Request [Interim].
SIP Request Timestamp Fraction	O _C	This parameter contains the milliseconds fraction in relation to the SIP Request Timestamp.
SIP Response Timestamp Fraction	O _C	This parameter contains appropriately the time of SIP 200 OK acknowledging an SIP INVITE or of SIP ACK including an SDP answer. This parameter corresponds to SIP Response Timestamp in Charging Data Request [Interim].
SDP Media Components	O _M	This is a grouped field comprising several sub-fields associated with one media component. Since several media components may exist for a session in parallel these sub-fields may occur several times.
SDP Media Name	O _M	This field holds the name of the media as available in the SDP data.
SDP Media Description	O _M	This field holds the attributes of the media as available in the SDP data.

Field	Category	Description
Access Correlation ID	O _C	This parameter holds the charging identifier from the access network, consisting of either GPRS charging ID (GCID) which is generated by the GGSN for a GPRS PDP context, Charging Id which is generated by P-GW for IP-CAN bearer or the Access Network Charging Identifier Value which is generated by another type of access network. It is present only if received from the access network when PCC architecture is implemented.
Media Initiator Flag	O _C	This field indicates if the called party has requested the session modification and it is present only if the initiator was the called party.
GGSN Address	O _C	This parameter holds the control plane IP address of the GGSN that handles one or more media component(s) of a IMS session.
Service Reason Return Code	O _M	This parameter provides the returned SIP status code for the service request for the successful and failure case,
List Of Reason Header	O _C	This parameter contains the list of SIP reason headers included in BYE or CANCEL method terminating the service, Reliability of this information is not guaranteed if the SIP or CANCEL is originated outside of the trust domain which is determined by the Operator on a "per parameter basis".
List of Message Bodies	O _C	This grouped field comprising several sub-fields describing the data that may be conveyed end-to-end in the body of a SIP message. Since several message bodies may be exchanged via SIP-signalling, this grouped field may occur several times.
Content-Type	O _M	This sub-field of Message Bodies holds the MIME type of the message body, Examples are: application/zip, image/gif, audio/mpeg, etc.
Content-Disposition	O _C	This sub-field of Message Bodies holds the content disposition of the message body inside the SIP signalling, Content-disposition header field equal to "render", indicates that "the body part should be displayed or otherwise rendered to the user". Content disposition values are : session, render, inline, icon, alert, attachment, etc.
Content-Length	O _M	This sub-field of Message Bodies holds the size of the data of a message body in bytes.
Originator	O _C	This sub-field of the "List of Message Bodies" indicates the originating party of the message body.
Access Network Information	O _C	This field contains the content of one SIP P-header "P-Access-Network-Info", available in the IMS Node when charging session starts, if available.
Additional Access Network Information	O _C	This field contains the content of additional SIP P-header "P-Access-Network-Info", available in the IMS Node as additional location when charging session starts, if available.
Cellular Network Information	O _C	This field contains the content of one SIP "Cellular-Network-Info" header, when the UE supporting one or more cellular radio access technologies but using a non-cellular IP-CAN, such as untrusted WLAN access, provides this header field to relay information to its service provider about the radio cell identity of the cellular radio access network on which the UE most recently camped.
List of Access Network Info Change	O _C	This field is a list of grouped field describing the subsequent SIP P-header "P-Access-Network-Info" and "Cellular-Network-Info" changes.
Access Network Information	O _C	This field holds the content of the SIP P-header "P-Access-Network-Info", when changed from the previous one.
Additional Access Network Information	O _C	This field holds the content of additional SIP P-header "P-Access-Network-Info" when changed from the previous one, if available.
Cellular Network Information	O _C	This field contains the content of one SIP "Cellular-Network-Info" header, when the UE supporting one or more cellular radio access technologies but using a non-cellular IP-CAN, such as untrusted WLAN access, provides this header field to relay information to its service provider about the radio cell identity of the cellular radio access network on which the UE most recently camped. This field is applicable when changed from the previous one, if available.
Access Change Time	O _C	This field contains the time at which the changed user location information was acquired.
List of Access Transfer Information	O _C	This field is a list of grouped field describing the subsequent session transfers. Each other occurrence comprises sub-fields describing the session transfer performed.
Access Transfer Type	O _C	This field contains indication about the access transfer performed. This field is present only when transfer occurred.
Access Network Information	O _C	This field holds the content of one SIP P-header "P-Access-Network-Info" from the SIP INVITE requesting the transfer, if available.
Additional Access Network Information	O _C	This field contains the content of an additional SIP P-header "P-Access-Network-Info" from the SIP INVITE requesting the transfer, if available.
Cellular Network Information	O _C	This field contains the content of one SIP "Cellular-Network-Info" header, when the UE supporting one or more cellular radio access technologies but using a non-cellular IP-CAN, such as untrusted WLAN access, provides this header field to relay information to its service provider about the radio cell identity of the cellular radio access network on which the UE most recently camped.

Field	Category	Description
Subscriber Equipment Number	O _C	This field contains the identification of the mobile device (e.g. IMEI) that the subscriber is using following successful inter-UE transfer.
Instance Id	O _C	This field uniquely identifies the device (fixed or mobile) of the served user following successful inter-UE transfer.
Related IMS Charging Identifier	O _C	This field contains the related IMS Charging Identifier in case of access transfer.
Related IMS Charging Identifier Generation Node	O _C	This parameter holds the identifier of the server that generated the Related IMS charging identifier in case of access transfer.
Access Transfer Time	O _C	This field contains the time stamp, which indicates the time at which the session transfer occurred.
Service Context Id	O _M	Holds the context information to which the CDR belongs. The information is obtained from the Operation Token of the Charging Data Request message.
IMS Communication Service ID	O _C	This field contains the IMS communication service identifier if received in the P-Asserted-Service header in the SIP request when the ATCF is downstream from the S-CSCF serving the Originating party or the topmost occurrence of the "+g.3gpp.icsi-ref" header field parameter of the Feature-Caps header in the SIP response when the ATCF is upstream from the S-CSCF serving the Originating party.
Initial IMS Charging Identifier	O _C	This parameter holds the Initial IMS charging identifier (ICID) as generated by the IMS node for the initial SIP session created for IMS service continuity. This field is not used for the "OneChargingSession" option.
User Location Info	O _C	This field contains the network provided location information for 3GPP accesses available in the IMS Node when charging session starts, if available.
MS Time Zone	O _C	This field indicates the offset between universal time and local time in steps of 15 minutes of where the MS currently resides.
NNI Information	O _C	This grouped field holds information about the NNI used for interconnection and roaming on the loopback routing path. It is present only if RAVEL "VPLMN routing" is applied.
NNI Type	O _C	This field indicates usage of the roaming NNI for loopback routing. The loopback indication was received by the AS.
From Address	O _M	Contains the information from the SIP From header.
SIP Route header received	O _C	Contains the information in the topmost route header in a received initial SIP INVITE or non-session related SIP MESSAGE request.
SIP Route header transmitted	O _C	Contains the information in the route header representing the destination in a transmitted initial SIP INVITE or non-session related SIP MESSAGE request.
Record Extensions	O _C	A set of operator/manufacturer specific extensions to the record, conditioned upon existence of an extension.
FE Identifier List	O _C	This parameter corresponds to FE Identifier List of the P-Charging-Vector defined in TS 24.229 [204]. This element contains one or more IM CN subsystem functional entity addresses and/or AS and application identifiers where the IM CN subsystem functional entity does create charging information for the related CDR of this IM CN subsystem functional entity.

NOTE: ATCF collocated with P-CSCF or IBCF applies combined offline charging with applicable fields described in table 6.3.2.1.

6.1.3.14 TF CDR content

The detailed description of the field is provided in TS 32.298 [51].

Table 6.1.3.14.1: Charging data of TF CDR

Field	Category	Description
Record Type	M	Identifies the type of record. The parameter is derived from the Node functionality parameter.
Retransmission	O _C	This parameter, when present, indicates that information from retransmitted Charging Data Requests has been used in this CDR
SIP Method	O _C	Specifies the SIP-method for which the CDR is generated. Only available in session unrelated cases.
Event	O _C	This field identifies the SIP event package to which the SIP request is referred.
Expires Information	O _C	This field indicates the validity time of either the SIP message or its content, depending on the SIP method.
Role of Node	O _C	This field indicates whether the Transit Functions are serving the Originating or the Terminating party.
Node Address	O _M	This item holds the address of the node providing the information for the CDR. This may either be the IP address or the FQDN of the IMS node generating the accounting data.
Session ID	O _M	The Session identification. For a SIP session the Session-ID contains the SIP Call ID as defined in the Session Initiation Protocol RFC 3261 [404].
Session Priority	O _C	The field contains the priority of the session.
List Of Calling Party Address	O _M	The address or addresses (Public User ID or Public Service ID) of the party requesting a service or initiating a session. In the case of no P-Asserted-Identify is known, this list shall include one item with the value "unknown".
Called Party Address	O _M	For SIP transactions, except for registration, this field holds the address of the party (Public User ID or Public Service ID) to whom the SIP transaction is posted. For registration transactions, this field holds the Public User ID under registration.
Requested Party Address	O _C	For SIP transactions this field holds the address of the party (Public User ID or Public Service ID) to whom the SIP transaction was originally posted. This field is only present if different from the Called Party Address parameter.
List of Called Asserted Identity	O _C	The address or addresses of the final asserted identities. Present if the final asserted identities are available in the SIP 2xx response.
List of Called Identity Changes	O _C	List of terminating identity address changes and associated timestamps.
Called Identity Change Time Stamp	O _C	Timestamp of SIP UPDATE or SIP RE-INVITE with changed terminating identity information.
Called Identity	O _C	Changed terminating identity information received in a SIP UPDATE or SIP RE-INVITE.
Service Request Time Stamp	O _M	This field contains the time stamp, which indicates the time at which the service was requested.
Service Request Time Stamp Fraction	O _M	This parameter contains the milliseconds fraction in relation to the Service Request Time Stamp.
Service Delivery Start Time Stamp	O _M	This field holds the time stamp reflecting either: successful session set-up, a delivery unrelated service, an unsuccessful session set-up and an unsuccessful session unrelated request.
Service Delivery Start Time Stamp Fraction	O _M	This parameter contains the milliseconds fraction in relation to the Service Delivery Start Time Stamp.
Service Delivery End Time Stamp	O _C	This field records the time at which the service delivery was terminated. It is Present only in SIP session related case.
Service Delivery End Time Stamp Fraction	O _C	This parameter contains the milliseconds fraction in relation to the Service Delivery End Time Stamp.
Record Opening Time	O _C	A time stamp reflecting the time the CDF opened this record. Present only in SIP session related case.
Record Closure Time	O _M	A Time stamp reflecting the time the CDF closed the record.
Application Servers Information	O _C	This a grouped CDR field containing the fields: "Application Server Involved" and "Application Provided Called Parties", to cover the case of transit network providing IMS application services.
Application Servers Involved	O _C	Holds the ASs (if any) identified by the SIP URIs.
Application Provided Called Parties	O _C	Holds a list of the Called Party Address(es), if the address(es) are determined by an AS (SIP URI, E.164...).
List of Inter Operator Identifiers	O _C	Holds the identification of the home network (originating and terminating) if exchanged via SIP signalling, as recorded in the P-Charging-Vector header. This grouped field may occur several times in one CDR.
Originating IOI	O _C	This parameter corresponds to Orig-IOI header of the P-Charging-Vector defined in TS 24.229 [204].
Terminating IOI	O _C	This parameter corresponds to Term-IOI header of the P-Charging-Vector defined in TS 24.229 [204].

Field	Category	Description
Transit IOI List	O _C	This parameter corresponds to Transit-IOI List of the P-Charging-Vector defined in TS 24.229 [204]. This field may occur several times in one CDR. Each occurrence represents transit IOI values received from the path inbound to or outbound from the TF, including the own Transit IOI.
Local Record Sequence Number	O _M	This field includes a unique record number created by the Transit Functions. The number is allocated sequentially for each partial CDR (or whole CDR) including all CDR types. The number is unique within the CDF.
Record Sequence Number	O _C	This field contains a running sequence number employed to link the partial records generated by the CDF for a particular session.
Cause For Record Closing	O _M	This field contains a reason for the close of the CDR.
Incomplete CDR Indication	O _C	This field provides additional diagnostics when the CDF detects missing Charging Data Requests.
IMS Charging Identifier	O _M	This parameter holds the IMS charging identifier (ICID) as generated by the IMS node for the SIP session.
List of Early SDP Media Components	O _C	This is a grouped field which may occur several times in one CDR. This field shall not be present if no media components are set to active before the final SIP session answer to the initial SIP Invite is received. This field can be present in either session or event CDRs.
SDP Session Description	O _C	Holds the Session portion of SDP data exchanged in the above mentioned scenario, if available.
SDP Type	O _M	This parameter indicates if the SDP media component is an SDP offer or SDP answer.
SDP Offer Timestamp	O _M	This parameter contains the time of the SIP Request which conveys the SDP offer.
SDP Answer Timestamp	O _M	This parameter contains the time of the response to the SIP Request which conveys the SDP answer.
SDP Media Components	O _M	This is a grouped field comprising several sub-fields associated with one media component. Since several media components may exist for a session in parallel these sub-fields may occur several times.
SDP Media Name	O _M	This field holds the name of the media as available in the SDP data.
SDP Media Description	O _M	This field holds the attributes of the media as available in the SDP data.
Media Initiator Flag	O _C	This field indicates if the called party has requested the session modification and it is present only if the initiator was the called party.
List of SDP Media Components	O _C	This is a grouped field which may occur several times in one CDR. The field is present only in a SIP session related case.
SDP Session Description	O _C	Holds the Session portion of the SDP data exchanged between the User Agents if available in the SIP transaction.
SDP Type	O _M	This parameter indicates if the SDP media component is an SDP offer or SDP answer.
SIP Request Timestamp	O _C	This parameter contains the time of the SIP Request (usually a SIP (RE-)INVITE).
SIP Response Timestamp	O _C	This parameter contains appropriately the time of SIP 200 OK acknowledging an SIP INVITE or of SIP ACK including an SDP answer.
SIP Request Timestamp Fraction	O _C	This parameter contains the milliseconds fraction in relation to the SIP Request Timestamp.
SIP Response Timestamp Fraction	O _C	This parameter contains the milliseconds fraction in relation to the SIP Response Timestamp.
SDP Media Components	O _M	This is a grouped field comprising several sub-fields associated with one media component. Since several media components may exist for a session in parallel these sub-fields may occur several times.
SDP Media Name	O _M	This field holds the name of the media as available in the SDP data.
SDP Media Description	O _M	This field holds the attributes of the media as available in the SDP data.
Media Initiator Flag	O _C	This field indicates if the called party has requested the session modification and it is present only if the initiator was the called party.
Service Reason Return Code	O _M	This parameter provides the returned SIP status code for the service request for the successful and failure case,
List Of Reason Header	O _C	This parameter contains the list of SIP reason headers included in SIP BYE or CANCEL method terminating the service, Reliability of this information is not guaranteed if the SIP or CANCEL is originated outside of the trust domain which is determined by the Operator on a "per parameter basis".
List of Message Bodies	O _C	This grouped field comprising several sub-fields describing the data that may be conveyed end-to-end in the body of a SIP message. Since several message bodies may be exchanged via SIP-signalling, this grouped field may occur several times.

Field	Category	Description
Content-Type	O _M	This sub-field of Message Bodies holds the MIME type of the message body, Examples are: application/zip, image/gif, audio/mpeg, etc.
Content-Disposition	O _C	This sub-field of Message Bodies holds the content disposition of the message body inside the SIP signalling, Content-disposition header field equal to "render", indicates that "the body part should be displayed or otherwise rendered to the user". Content disposition values are: session, render, inline, icon, alert, attachment, etc.
Content-Length	O _M	This sub-field of Message Bodies holds the size of the data of a message body in bytes.
Originator	O _C	This sub-field of the "List of Message Bodies" indicates the originating party of the message body.
Service Context Id	O _M	Holds the context information to which the CDR belongs. The information is obtained from the Operation Token of the Charging Data Request message.
IMS Communication Service ID	O _C	This field contains the IMS communication service identifier if received in the P-Asserted-Service header in the SIP request.
NNI Information	O _C	This grouped field holds information about the NNI used for interconnection and roaming on the loopback routing path. It is present only if "VPLMN routing" is applied in a Roaming Architecture for Voice over IMS with Local breakout.
NNI Type	O _C	This field indicates usage of the roaming NNI for loopback routing, i.e. S-CSCF performed the loopback decision.
From Address	O _M	Contains the information from the SIP From header.
SIP Route header received	O _C	Contains the information in the topmost route header in a received initial SIP INVITE or non-session related SIP MESSAGE request prior to triggering of any ASs.
SIP Route header transmitted	O _C	Contains the information in the route header representing the destination in a transmitted initial SIP INVITE or non-session related SIP MESSAGE request following triggering of all ASs.
Record Extensions	O _C	A set of operator/manufacture specific extensions to the record, conditioned upon existence of an extension.
FE Identifier List	O _C	This parameter corresponds to FE Identifier List of the P-Charging-Vector defined in TS 24.229 [204]. This element contains one or more IM CN subsystem functional entity addresses and/or AS and application identifiers where the IM CN subsystem functional entity does create charging information for the related CDR of this IM CN subsystem functional entity.

Editor's note: More investigation on parameters occurrence should be worked out.

6.2 Data description for IMS online charging

6.2.1 Ro message contents

6.2.1.0 Introduction

The IMS nodes generate Debit / Reserve Units message information that can be transferred from the CTF to the OCF. For this purpose, IMS online charging utilises the *Debit Units / Reserve Units* procedure that is specified in the 3GPP Debit / Reserve Units operation in TS 32.299 [50].

The *Debit / Reserve Units* procedure employs the *Debit / Reserve Units Request* and *Debit / Reserve Units Response* messages. Table 6.2.1.0 describes the use of these messages in IMS online charging.

Table 6.2.1.0: Online charging messages reference table

Message	Source	Destination
Debit / Reserve Units Request	MRFC, AS, IMS-GWF	OCS
Debit / Reserve Units Response	OCS	MRFC, AS, IMS-GWF

6.2.1.1 Debit / Reserve Units Request message

Table 6.2.1.1.1 illustrates the basic structure of a *Debit / Reserve Units Request* message from the CTF in MRFC and AS and the IMS-GWF as used for IMS online charging.

Table 6.2.1.1.1: Debit / Reserve Units Request message contents

Information Element	Category	Description
Session Identifier	M	Described in TS 32.299 [50]
Originator Host	M	Described in TS 32.299 [50]
Originator Domain	M	Described in TS 32.299 [50]
Destination Domain	M	Described in TS 32.299 [50]
Operation Identifier	M	Described in TS 32.299 [50]
Operation Token	M	Described in TS 32.299 [50]
Operation Type	M	Described in TS 32.299 [50]
Operation Number	M	Described in TS 32.299 [50]
Destination Host	O _C	Described in TS 32.299 [50]
User Name	O _C	The field contains the Private User Identity defined in TS 23.003 [104].
Origination State	O _C	Described in TS 32.299 [50]
Origination Timestamp	O _C	Described in TS 32.299 [50]
Subscriber Identifier	O _M	This field contains the identification of the mobile subscriber (i.e. MSISDN or SIP-URI) that uses the requested service.
Termination Cause	O _C	Described in TS 32.299 [50]
Requested Action	O _C	Described in TS 32.299 [50]
Multiple Operation	O _M	Described in TS 32.299 [50]
Multiple Unit Operation	O _C	Described in TS 32.299 [50]
Subscriber Equipment Number	O _C	Described in TS 32.299 [50]
Proxy Information	O _C	Described in TS 32.299 [50]
Route Information	O _C	Described in TS 32.299 [50]
Service Information	O _M	This field holds additional 3GPP service specific parameter: - IMS Information, - PS Information

6.2.1.2 Debit / Reserve Units Response message

Table 6.2.1.2.1 illustrates the basic structure of a Debit / Reserve Units Response message as used for IMS charging. This message is always used by the OCS as specified below, independent of the receiving IMS node and the operation type that is being replied to.

Table 6.2.1.2.1: Debit / Reserve Units Response message contents for MRFC, AS and IMS-GWF

Information Element	Category	Description
Session Identifier	M	Described in TS 32.299 [50]
Operation Result	M	Described in TS 32.299 [50]
Originator Host	M	Described in TS 32.299 [50]
Originator Domain	M	Described in TS 32.299 [50]
Operation Identifier	M	Described in TS 32.299 [50]
Operation Type	M	Described in TS 32.299 [50]
Operation Number	M	Described in TS 32.299 [50]
Operation Failover	O _C	Described in TS 32.299 [50]
Multiple Unit Operation	O _C	Described in TS 32.299 [50]
Announcement Information	O _C	Described in TS 32.281 [41]
Operation Failure Action	O _C	Described in TS 32.299 [50]. This field defines the operation if a failure has occurred at the OCS for SCUR and ECUR.
Operation Event Failure Action	O _C	Described in TS 32.299 [50]. This field defines the operation if a failure has occurred at the OCS for IEC.
Redirection Host	O _C	Described in TS 32.299 [50]
Redirection Host Usage	O _C	Described in TS 32.299 [50]
Redirection Cache Time	O _C	Described in TS 32.299 [50]
Proxy Information	O _C	Described in TS 32.299 [50]
Route Information	O _C	Described in TS 32.299 [50]
Failed parameter	O _C	Described in TS 32.299 [50]
Service Information	O _C	This field holds additional 3GPP service specific parameter: - IMS Information, - PS Information

6.3 IMS charging specific parameters

6.3.1 Definition of IMS charging information

6.3.1.0 General

The IMS Information parameter used for IMS charging is provided in the Service Information parameter.

6.3.1.1 IMS charging information assignment for Service Information

The components in the Service Information that are use for IMS charging can be found in Table 6.3.1.1.1.

Table 6.3.1.1.1: Service Information used for IMS charging

Information Element	Category	Description	Provided by IMS NE
Service Information	O _M	This is a structured field and holds the 3GPP specific parameter as defined in TS 32.299 [50]. For IMS Charging the IMS Information is used.	All
Subscriber Identifier	O _M	Described in TS 32.299 [50] and contains the Public User Identity/Identities, if offline charging applies.	Not in IBCF nor I-CSCF nor MGCF nor BGCF nor TF
IMS Information	O _M	This is a structured field and holds the IMS specific parameters. The details are defined in clause 6.3.1.2.	All
PS Information	O _C	This is a structured field and holds PS specific parameters. The complete structure is defined in TS 32.251 [11].	All
GGSN Address	O _C	This field holds the IP-address of the GGSN that generated the GPRS Charging ID, as described in [1].	Not in I-CSCF nor MGCF nor BGCF nor IBCF
User Location Info	O _C	This field contains the network provided location information for 3GPP accesses, if available.	Not in MGCF nor BGCF nor TF
MS Time Zone	O _C	This field indicates the offset between universal time and local time in steps of 15 minutes of where the MS currently resides.	Not in MGCF nor BGCF nor TF
Subscriber Equipment Number	O _C	This field contains the identification of the mobile device (i.e., IMEI) that the subscriber is using. Note: In TS 32.251 [11], this is identified as User Equipment Info within PS Information.	P-CSCF, S-CSCF, AS
3GPP PS Data Off Status	O _C	This field holds the 3GPP PS Data Off Status associated with the registration, as defined in TS 23.228 [201], when available.	AS
VCS Information	O _C	This is a structured field and holds VCS specific parameters. The complete structure is defined in TS 32.276 [36].	MGCF,AS
ISUP Cause	O _C	This indicates the reason the call was released.	MGCF
VLR Number	O _C	This identifies the international E.164 address of the VLR serving the user.	AS
MSC Address	O _C	This identifies the international E.164 address of the MSC that generated the network call reference number.	AS

6.3.1.2 Definition of the IMS Information

IMS specific charging information is provided within the IMS Information. The fields of the IMS Information which are differently covered in several IMS network nodes are indicated by the node specific type.

The detailed structure of the IMS Information can be found in table 6.3.1.2.1.

Table 6.3.1.2.1: Structure of the IMS Information

Information Element	Category	Description	Provided by IMS NE
Event Type	O _C	This field holds the SIP Method, the content of the SIP "Event" header and the content of the SIP "expires" header when present in the SIP request.	All
Node Functionality	M	This field contains the function of the node.	All
Role of Node	O _M	This field specifies whether the IMS node is serving the Originating or the Terminating party.	Not in MRFC
User Session ID	O _M	This field holds the session identifier. For a SIP session the <i>Session-ID</i> contains the SIP Call ID. When the AS acts as B2BUA, the incoming session is identified.	All
Outgoing Session ID	O _C	When the AS acts as B2BUA, the outgoing side session is identified by the <i>Outgoing Session ID</i> which contains the SIP Call ID.	AS
Session Priority	O _C	This field contains the priority of the session.	All
Calling Party Address	O _M	This field holds the address (SIP URI or Tel URI) URI of the party (Public User Identity or Public Service Identity) initiating a session or requesting a service.	All
Called Party Address	O _M	For SIP transactions, except for registration, this field holds the address of the party (Public User ID or Public Service ID) to whom the SIP transaction is posted. For registration transactions, this field holds the Public User ID under registration.	All
Number Portability routing information	O _C	This field includes information on number portability after DNS/ENUM request from IMS node in the calling user's home network.	S-CSCF, I-CSCF, AS, MGCF, BGCF, TF, TRF
Carrier Select routing information	O _C	This field includes information on carrier select after DNS/ENUM request from IMS node in the calling user's home network.	S-CSCF, I-CSCF, AS, MGCF, BGCF, TF, TRF
Alternate Charged Party Address	O _C	The address of an alternate party that is identified by the AS at session initiation, and is charged in place of the calling party.	AS
Requested Party Address	O _C	For SIP transactions this field initially holds the address of the party (Public User ID or Public Service ID) to whom the SIP transaction was originally posted. This field is only present if different from the Called Party Address parameter.	S-CSCF, P-CSCF, E-CSCF, AS, MRFC, TF, TRF, ATCF
Called Asserted Identity	O _C	The address of the final asserted identity. Present if the final asserted identity is available in the SIP 2xx response.	S-CSCF, E-CSCF, AS, MRFC, TF, TRF, ATCF
Called Identity Change	O _C	Terminating identity address change and associated time stamp.	S-CSCF, P-CSCF, E-CSCF, AS, TF, TRF, ATCF
Called Identity Change Time Stamp	O _C	Time stamp of SIP UPDATE or SIP RE-INVITE with changed terminating identity information.	S-CSCF, P-CSCF, E-CSCF, AS, TF, TRF, ATCF
Called Identity	O _C	Changed terminating identity information received in a SIP UPDATE or SIP RE-INVITE.	S-CSCF, P-CSCF, E-CSCF, AS, TF, TRF, ATCF
Associated URI	O _C	This field holds a non-barred public user identity (SIP URI or Tel URI) associated to the public user identity under registration and is present for registration transactions.	S-CSCF, P-CSCF, I-CSCF, IBCF
Time Stamps	O _C	This field holds the time of the SIP Request and the time of the response to the SIP Request.	All

Information Element	Category	Description	Provided by IMS NE
Application Server Information	O _C	This field holds the SIP URI(s) of the AS(s) addressed during the session and the called party number (SIP URI, E.164), if an AS determines it.	S-CSCF, E-CSCF, MRFC, TF, TRF
Inter Operator Identifier	O _C	This field holds the identification of the network neighbours (originating and terminating) as exchanged via SIP signalling if available. This field may occur several times.	All
IMS Charging Identifier	O _M	This field holds the IMS Charging Identifier (ICID) as generated by a IMS node for a SIP session.	All
Related IMS Charging Identifier	O _C	This field holds the Related IMS charging identifier when the session is the target access leg in case of access transfer.	P-CSCF, AS, ATCF
Related IMS Charging Identifier Generation Node	O _C	This field holds the identifier of the server that generated the Related IMS charging identifier.	P-CSCF, AS, ATCF
Transit IOI List	O _C	This field holds the identification of the involved transit networks as exchanged via SIP signalling if available. This field may occur several times. When received from the AS, each occurrence of this field represents transit networks inbound to or outbound from the S-CSCF.	Not in E-CSCF nor I-CSCF nor ATCF
Early Media Description	O _C	This field holds session and media parameters related to media components set to active during the SIP session establishment and before a final successful or unsuccessful SIP answer to the initial SIP INVITE request is received. Once a media component is set to active, subsequent status changes shall be registered. Since several SDP negotiations may occur during the SIP session establishment, this field may occur several times.	Not in I-CSCF nor BGCF
SDP Session Description	O _C	This field holds the content of an "attribute-line" (i=, c=, b=, k=, a=, etc.) related to a session.	Not in I-CSCF nor BGCF
SDP Media Component	O _C	This is a grouped field comprising several sub-fields associated with one media component. Since several media components may exist for a session in parallel these sub-fields may occur several times.	Not in I-CSCF nor BGCF
Served Party IP Address	O _C	This field holds the IP address of either the calling or called party, depending on whether the P-CSCF is in touch with the calling or the called party.	P-CSCF
Server Capabilities	O _C	This field contains the server capabilities as described in 3GPP TS 29.229 [205].	I-CSCF
Trunk Group ID	O _C	This field identifies the incoming and outgoing PSTN legs.	MGCF
Bearer Service	O _C	This field holds the used bearer service for the PSTN leg.	MGCF
Service Id	O _C	This field identifies the service the MRFC is hosting. For conferences the conference ID is used as the value of this parameter.	MRFC
Service Specific Info	O _C	This field contains service specific data if and as provided by an AS.	AS
Message Bodies	O _C	This field holds information about the Message body, Content-Type, Content-Length, Content-Disposition and Originator if available.	Not in I-CSCF nor MRFC nor BGCF
Access Network Information	O _C	This field contains the content of one P-header P-Access-Network-Info, if available.	Not in TF nor TRF
Additional Access Network Information	O _C	This field contains the content of an additional SIP P-header "P-Access-Network-Info", if available.	Not in TF nor TRF
Cellular Network Information	O _C	This field contains the content of one SIP "Cellular-Network-Info" header, when the UE supporting one or more cellular radio access technologies but using a non-cellular IP-CAN, such as untrusted WLAN access, provides this header field to relay information to its service provider about the radio cell identity of the cellular radio access network on which the UE most recently camped.	Not in TF nor TRF
Access Transfer Information	O _C	This field contains information related to the session transfer.	AS, ATCF
Access Network Info Change	O _C	This field is a grouped field describing the subsequent SIP P-header "P-Access-Network-Info" changes and associated time stamp.	S-CSCF, P-CSCF, E-CSCF, IBCF, MRFC, MGCF, AS
IMS Communication Service ID	O _C	This field contains the IMS communication service identifier if received in the P-Asserted-Service header in the SIP request for all applicable IMS nodes downstream from the S-CSCF serving the Originating party. This field contains the IMS communication service identifier if received in the "+g.3gpp.icsi-ref" header field parameter of the Feature-Caps header in the SIP response for all applicable IMS nodes upstream from the S-CSCF serving the Originating party.	S-CSCF, P-CSCF, E-CSCF, IBCF, ATCF, TRF, AS
IMS Application Reference ID	O _C	This field contains the IMS application reference identifier if received in the SIP Request.	P-CSCF
Cause Code	O _C	This field contains the cause value.	All

Information Element	Category	Description	Provided by IMS NE
Reason Header	O _C	This field contains SIP reason header included in BYE or CANCEL method, Reliability of this information is not guaranteed if the SIP or CANCEL is originated outside of the trust domain which is determined by the Operator on a "per parameter basis". Since several Reason Header may exist for a SIP message, these sub-fields may occur several times	All
Real Time Tariff Information	O _C	This field holds the tariff/add-on charge received.	S-CSCF, IBCF, MGCF, AS
Online Charging Flag	O _C	This field indicates the Online Charging Request was sent based on the provided ECF address from the SIP P-header "P-Charging-Function-Addresses". NOTE: No proof that online charging action has been taken	S-CSCF, AS, MRFC
Account Expiration	O _C	This field indicates the subscriber account expiration date and time of day.	OCS
Initial IMS Charging Identifier	O _C	This field holds the Initial IMS charging identifier (ICID) as generated by the IMS node for the initial SIP session created for IMS service continuity.	AS, ATCF
NNI Information	O _C	This field holds information about the NNI used for interconnection and roaming.	P-CSCF, S-CSCF, BGCF, AS, IBCF, ATCF, TF, TRF
From Address	O _M	Contains the information from the SIP From header.	Not in TRF
IMS Emergency Indication	O _C	This field indicates the registration is an emergency registration or the IMS session is an IMS emergency session	P-CSCF, S-CSCF, I-CSCF
IMS Visited Network Identifier	O _C	Contains the information from the SIP P-Visited-Network-ID header.	P-CSCF, S-CSCF, AS
SIP Route header received	O _C	Contains the information in the topmost route header in a received initial SIP INVITE or non-session related SIP MESSAGE request.	P-CSCF, S-CSCF, IBCF, TRF, ATCF, TF
SIP Route header transmitted	O _C	Contains the information in the route header representing the destination in a transmitted initial SIP INVITE or non-session related SIP MESSAGE request.	P-CSCF, S-CSCF, I-CSCF, ATCF, TF
Instance Id	O _C	This field uniquely identifies the device (fixed or mobile) of the served user.	P-CSCF, S-CSCF, AS
TAD Identifier	O _C	This field indicates the type of access network (CS or PS) through which the session shall be terminated.	AS
FE Identifier List	O _C	This element contains one or more IM CN subsystem functional entity addresses and/or AS and application identifiers where the IM CN subsystem functional entity does create charging information for the related CDR of this IM CN subsystem functional entity.	All

6.3.2 Detailed message format for offline charging

The following clause specifies per Operation Type the charging data that are sent by each of the IMS Network Elements for:

- IMS session and IMS event (S/I/S/E)
S-CSCF, E-CSCF, P-CSCF, MGFC, AS, IBCF, TRF, ATCF, TF
- IMS session only (S/I/S)
MRFC
- IMS event only (E)
I-CSCF, BGCF

The Operation Types are listed in the following order: S (Start)/I (Interim)/S (Stop)/E (Event). Therefore, when all Operation Types are possible it is marked as SISE. If only some Operation Types are allowed for a node, only the appropriate letters are used (i.e. SIS or E) as indicated in the table heading. The omission of an Operation Type for a particular field is marked with "-" (i.e. SI-E). Also, when an entire field is not allowed in a node the entire cell is marked as "-".

Table 6.3.2.1 illustrates the basic structure of the supported fields in the Charging Data Request message for IMS offline charging.

Table 6.3.2.1: Supported fields in *Charging Data Request* message

Information Element	Node Type	S-CSCF	E-CSCF	P-CSCF	I-CSCF	MRFC	MGCF	BGCF	AS	IBCF	TF	TRF	ATCF
	Supported Operation Types	S/I/S/E	S/I/S/E	S/I/S/E	E	S/I/S	S/I/S/E	E	S/I/S/E	S/I/S/E	S/I/S/E	S/I/S/E	S/I/S/E
Session Identifier		SISE	SISE	SISE	E	SIS	SISE	E	SISE	SISE	SISE	SISE	SISE
Originator Node		SISE	SISE	SISE	E	SIS	SISE	E	SISE	SISE	SISE	SISE	SISE
Originator Domain		SISE	SISE	SISE	E	SIS	SISE	E	SISE	SISE	SISE	SISE	SISE
Destination Domain		SISE	SISE	SISE	E	SIS	SISE	E	SISE	SISE	SISE	SISE	SISE
Operation Type		SISE	SISE	SISE	E	SIS	SISE	E	SISE	SISE	SISE	SISE	SISE
Operation Number		SISE	SISE	SISE	E	SIS	SISE	E	SISE	SISE	SISE	SISE	SISE
Operation Identifier		SISE	SISE	SISE	E	SIS	SISE	E	SISE	SISE	SISE	SISE	SISE
User Name (see note1)		SISE	-	SISE	-	-	-	-	SISE	-	-	-	SISE
Destination Host		SISE	SISE	SISE	E	SIS	SISE	E	SISE	SISE	SISE	SISE	SISE
Operation Interval		SIS-	SIS-	SIS-	-	SIS	SIS-	-	SIS-	SIS-	SIS-	SIS-	SIS-
Origination State		SISE	SISE	SISE	E	SIS	SISE	E	SISE	SISE	SISE	SISE	SISE
Origination Timestamp		SISE	SISE	SISE	E	SIS	SISE	E	SISE	SISE	SISE	SISE	SISE
Proxy Information		SISE	SISE	SISE	E	SIS	SISE	E	SISE	SISE	SISE	SISE	SISE
Route Information		SISE	SISE	SISE	E	SIS	SISE	E	SISE	SISE	SISE	SISE	SISE
Operation Token		SISE	SISE	SISE	E	SIS	SISE	E	SISE	SISE	SISE	SISE	SISE
Subscriber Identifier		SISE	SISE	SISE	-	SIS	-	-	SISE	-	-	SISE	SISE
Service Information with PS, IMS and VCS Information													
Event Type		SISE	SISE	SISE	E	SIS	SISE	E	SISE	SISE	SISE	SISE	SISE
Role of Node		SISE	SISE	SISE	E	---	SISE	E	SISE	SISE	SISE	SISE	SISE
Node Functionality		SISE	SISE	SISE	E	SIS	SISE	E	SISE	SISE	SISE	SISE	SISE
User Session Id		SISE	SISE	SISE	E	SIS	SISE	E	SISE	SISE	SISE	SISE	SISE
Outgoing Session ID		-	-	-	-	-	-	-	SISE	-	-	-	-
Session Priority		S--E	S--E	S--E	E	S--	S--E	E	S--E	S--E	S--E	S--E	S--E
Calling Party Address		SISE	SISE	SISE	E	SIS	SISE	E	SISE	SISE	SISE	SISE	SISE
Called Party Address		SISE	SISE	SISE	E	SIS	SISE	E	SISE	SISE	SISE	SISE	SISE
Number Portability routing information		S--E	-	-	E	-	S--E	E	S--E	-	S--E	S--E	-
Carrier Select routing information		S--E	-	-	E	-	S--E	E	S--E	-	S--E	S--E	-
Alternate Charged Party Address		-	-	-	-	-	-	-	S---	-	-	-	-
Requested Party Address		S--E	S--E	-	-	S--	-	-	SISE	-	S--E	S--E	SISE
Called Asserted Identity		S--E	S--E	S--E	-	S--	-	-	S--E	-	S--E	S--E	S--E
Called Identity Change		-I--	-I--	-I--	-	-	-	-	-I--	-	-I--	-I--	-I--
Called Identity Change Time Stamp		-I--	-I--	-I--	-	-	-	-	-I--	-	-I--	-I--	-I--
Called Identity		-I--	-I--	-I--	-	-	-	-	-I--	-	-I--	-I--	-I--
Associated URI (see note 5)		---E	-	---E	E	-	-	-	-	---E	-	-	-
Time stamps (see note 3)		SISE	SISE	SISE	E	SIS	SISE	E	SISE	SISE	SISE	SISE	SISE
Application server Information (see note 1)		SISE	SISE	-	-	SIS	-	-	-	-	SISE	SISE	-
Inter Operator Identifiers (see note 1)		SISE	SISE	SISE	E	SIS	SISE	E	SISE	SISE	SISE	SISE	SISE
Transit IOI List (see note 1)		SISE	-	SISE	-	SIS	SISE	E	SISE	SISE	SISE	SISE	-
IMS Charging Identifier		SISE	SISE	SISE	E	SIS	SISE	E	SISE	SISE	SISE	SISE	SISE
Related IMS Charging Identifier		-	-	SISE	-	-	-	-	SISE	-	-	-	SISE
Related IMS Charging Identifier Generation Node		-	-	SISE	-	-	-	-	SISE	-	-	-	SISE
Early Media Description (see note 4)		S--E	S--E	S--E	-	S--	S--E	-	S--E	S--E	S--E	S--E	S--E
SDP Session Description		SI-E	SI-E	SI-E	-	SI-E	SI-E	-	SI-E	SI-E	SI-E	SI-E	SI-E
SDP Media Component (see note 4)		SI-E	SI-E	SI-E	-	SI-E	SI-E	-	SI-E	SI-E	SI-E	SI-E	SI-E
GGSN Address		SI--	SI--	SI--	-	SI--	SI--	-	SI--	-	-	-	SI--
User Location Info		SISE	SISE	SISE	E	SIS	-	-	SISE	SISE	-	SISE	SISE
MS Time Zone		SISE	SISE	SISE	E	SIS	-	-	SISE	SISE	-	SISE	SISE

Served Party (see note 1)	-	-	SISE	-	-	-	-	-	-	-	-	-
Server Capabilities (see note 1)	-	-	-	E	-	-	-	-	-	-	-	-
Trunk Group ID (see note 1)	-	-	-	-	-	SISE	-	-	-	-	-	-
Bearer Service (see note 1)	-	-	-	-	-	SISE	-	-	-	-	-	-
Service Id (see note 1)	-	-	-	-	SIS	-	-	-	-	-	-	-
Service Specific Info (see note 1)	-	-	-	-	-	-	-	SISE	-	-	-	-
Message Bodies (see note 2)	SISE	SISE	SISE	-	-	SISE	-	SISE	SISE	SISE	SISE	SISE
Cause Code	--SE	--SE	--SE	E	--S	--SE	E	--SE	--SE	--SE	--SE	--SE
Reason Header	--SE	--SE	--SE	E	--S	--SE	E	--SE	--SE	--SE	--SE	--SE
ISUP Cause	-	-	-	-	-	--SE	-	-	-	-	-	-
Access Network Information	SISE	SISE	SISE	E	SIS	SISE	E	SISE	SISE	-	-	SISE
Additional Access Network Information	SISE	SISE	SISE	E	SIS	SISE	E	SISE	SISE	-	-	SISE
Cellular Network Information	SISE	SISE	SISE	E	SIS	SISE	E	SISE	SISE	-	-	SISE
VLR Number	-	-	-	-	-	-	-	S--E	-	-	-	-
MSC Address	-	-	-	-	-	-	-	S--E	-	-	-	-
IMS Communication Service ID	S--E	S--E	S--E	-	-	-	-	S--E	S--E	S--E	S--E	S--E
IMS Application Reference ID	-	-	S--E	-	-	-	-	-	-	-	-	-
Real Time Tariff Information	SI-E	-	-	-	-	SI-E	-	SI-E	SI-E	-	-	-
Initial IMS Charging Identifier	-	-	-	-	-	-	-	SISE	-	-	-	SISE
NNI Information	S--E	-	S--E	-	-	-	E	S--E	S--E	S--E	S--E	--S-
From Address	SISE	SISE	SISE	E	SIS	SISE	E	SISE	SISE	SISE	-	SISE
Access Network Info Change	-I--	-I--	-I--	-	-I--	-I--	-	-I--	-I--	-	-	-
Access Transfer Information	-	-	-	-	-	-	-	SI--	-	-	-	SI--
IMS Emergency Indication	SISE	-	SISE	E	-	-	-	-	-	-	-	-
IMS Visited Network Identifier	SISE	-	SISE	-	-	-	-	SISE	-	-	-	-
Route Header Received	S--E	-	S--E	E	-	-	-	-	S--E	S--E	S--E	S--E
Route Header Transmitted	S--E	-	S--E	E	-	-	-	-	-	S--E	-	S--E
Subscriber Equipment Number	SISE	-	SISE	-	-	-	-	SISE	-	-	-	-
Instance Id	SISE	-	SISE	-	-	-	-	SISE	-	-	-	-
TAD Identifier	-	-	-	-	-	-	-	S---	-	-	-	-
3GPP PS Data Off Status	-	-	-	-	-	-	-	E	-	-	-	-
FE Identifier	SISE	SISE	SISE	E	SIS	SISE	E	SISE	SISE	SISE	SISE	SISE

NOTE 1: Only present if available in the CTF of the IMS node.
 NOTE 2: Present only if Messages Bodies is included in the SIP message that triggered the Charging Data Request.
 NOTE 3: Only present if Charging Data Request is triggered on a SIP message (e.g. SIP INVITE, SIP UPDATE).
 NOTE 4: To be determined for presence in IBCF.
 NOTE 5: Only present if Charging Data Request is triggered on SIP REGISTER 200 OK.

Table 6.3.2.2 illustrates the basic structure of the supported fields in the Charging Data Response message for IMS offline charging.

Table 6.3.2.2: Supported fields in *Charging Data Response* message

Information Element	Node Type	S-CSCF	E-CSCF	P-CSCF	I-CSCF	MRFC	MGCF	BGCF	AS	IBCF	TRF	ATCF
	Supported Operation Types	S/I/S/E	S/I/S/E	S/I/S/E	E	S/I/S	S/I/S/E	E	S/I/S/E	S/I/S/E	S/I/S/E	S/I/S/E
Session Identifier		SISE	SISE	SISE	E	SIS	SISE	E	SISE	SISE	SISE	SISE
Originator Node		SISE	SISE	SISE	E	SIS	SISE	E	SISE	SISE	SISE	SISE
Originator Domain		SISE	SISE	SISE	E	SIS	SISE	E	SISE	SISE	SISE	SISE
Destination Domain		SISE	SISE	SISE	E	SIS	SISE	E	SISE	SISE	SISE	SISE
Operation Type		SISE	SISE	SISE	E	SIS	SISE	E	SISE	SISE	SISE	SISE
Operation Number		SISE	SISE	SISE	E	SIS	SISE	E	SISE	SISE	SISE	SISE
Operation Identifier		SISE	SISE	SISE	E	SIS	SISE	E	SISE	SISE	SISE	SISE
User Name		SISE	SISE	SISE	E	SIS	SISE	E	SISE	SISE	SISE	SISE
Operation Interval		SI--	SI--	SI--	-	SI-	SI--	-	SI--	SI--	SI--	SI--
Origination State		SISE	SISE	SISE	E	SIS	SISE	E	SISE	SISE	SISE	SISE
Origination Timestamp		SISE	SISE	SISE	E	SIS	SISE	E	SISE	SISE	SISE	SISE
Proxy Information		SISE	SISE	SISE	E	SIS	SISE	E	SISE	SISE	SISE	SISE
Route Information		SISE	SISE	SISE	E	SIS	SISE	E	SISE	SISE	SISE	SISE

6.3.3 Detailed message format for online charging

The following table specifies per Operation Type the charging data that are sent by each of the IMS Network Elements for:

- IMS session and IMS event (I/U/T/E)

IMS-GWF, AS

- IMS session only (I/U/T)

MRFC

The Operation Types are listed in the following order: I (Initial)/U (Update)/T (Terminate)/E (Event). Therefore, when all Operation Types are possible it is marked as IUTE. If only some Operation types are allowed for a node, only the appropriate letters are used (i.e. IUT or E) as indicated in the table heading. The omission of an Operation Type for a particular field is marked with "-" (i.e. IU-E). Also, when an entire field is not allowed in a node the entire cell is marked as "-".

Note that not for all structured fields the individual field members are listed in the table. Detailed descriptions of the fields are provided in TS 32.299 [50].

Table 6.3.3.1 illustrates the basic structure of the supported fields in the Debit / Reserve Units Request for IMS online charging.

Table 6.3.3.1: Supported fields in *Debit / Reserve Units Request* message

Information Element	Node Type	IMS-GWF	MRFC	AS
	Supported Operation Types	I/U/T/E	I/U/T	I/U/T/E
Session Identifier		IUTE	IUT	IUTE
Originator Host		IUTE	IUT	IUTE
Originator Domain		IUTE	IUT	IUTE
Destination Domain		IUTE	IUT	IUTE
Operation Identifier		IUTE	IUT	IUTE
Operation Token		IUTE	IUT	IUTE
Operation Type		IUTE	IUT	IUTE
Operation Number		IUTE	IUT	IUTE
Destination Host		IUTE	IUT	IUTE
User Name		IUTE	-	IUTE
Origination State		IUTE	IUT	IUTE
Origination Timestamp		IUTE	IUT	IUTE
Subscriber Identifier		IUTE	IUT	IUTE
Termination Cause		-T-	-T	-T-
Requested Action		---E	-	---E
Multiple Operation		IUTE	IUT	IUTE
Multiple Unit Operation		IUTE	IUT	IUTE
Service Units Requested		IU-E	IU-	IU-E
Service Units Used		-UT-	-UT	-UT-
Subscriber Equipment Number		IUTE	IUT	IUTE
Proxy Information		IUTE	IUT	IUTE
Route Information		IUTE	IUT	IUTE
Extended Information		IUTE	IUT	IUTE
Service Information with PS and IMS Information				
Event Type		IUTE	IUT	IUTE
Role Of Node		IUTE	-	IUTE
Node Functionality		IUTE	IUT	IUTE
User Session Id		IUTE	IUT	IUTE
Outgoing Session ID		-	-	IUTE
Session Priority		I--E	I--	I--E
Calling Party Address		IUTE	IUT	IUTE
Called Party Address		IUTE	IUT	IUTE
Number Portability routing information		I--E	-	I--E
Carrier Select routing information		I--E	-	I--E
Requested Party Address		I--E	I--	I--E
Called Asserted Identity		-U-E	-U-	-U-E
Called Identity Change		-U--	-	-U--
Called Identity Change Time Stamp		-U--	-	-U--
Called Identity		-U--	-	-U--
Associated URI		---E	-	-
Application Server Information		IUTE	IUT	-
Inter Operator Identifier		IUTE	IUT	IUTE
Transit IOI List		IUTE	IUT	IUTE
IMS Charging Identifier		IUTE	IUT	IUTE
Related IMS Charging Identifier		-	-	IUTE
Related IMS Charging Identifier Generation Node		-	-	IUTE
SDP Session Description		IU--	IU-	IU--
SDP Media Component		IU--	IU-	IU--
GGSN Address		IU--	IU-	IU--
User Location Info		IUTE	IUT	IUTE
MS Time Zone		IUTE	IUT	IUTE
Served Party		-	-	-
Server Capabilities		-	-	-
Trunk Group ID		-	-	-
Bearer Service		-	-	-
Service Id		-	IUT	-
Service Specific Info		-	-	-
Messages Bodies		IUTE	-	IUTE
Cause Code		--TE	--T	--TE
Reason Header		--TE	--T	--TE
Access Network Information		IUTE	IUT	IUTE
Additional Access Network Information		IUTE	IUT	IUTE

Cellular Network Information	IUTE	IUT	IUTE
IMS Communication Service ID	I--E	-	I--E
Tariff Information	-U--	-	-U--
Initial IMS Charging Identifier	-	-	IUTE
From Address	IUTE	IUT	IUTE
Access Transfer Information	-	-	-U--
IMS Emergency Indication	-	-	-
IMS Visited Network Identification	IUTE	-	IUTE
Route Header Received	-	-	-
Route Header Transmitted	-	-	-
Instance Id	IUTE	-	IUTE
3GPP PS Data Off Status	-	-	E

Table 6.3.3.2 illustrates the basic structure of the supported fields in the Debit / Reserve Units Response for IMS online charging.

Table 6.3.3.2: Supported fields in *Debit / Reserve Units Response* message

Information Element	Node Type	IMS-GWF	MRFC	AS
	Supported Operation Types	I/U/T/E	I/U/T	I/U/T/E
Session Identifier		IUTE	IUT	IUTE
Operation Result		IUTE	IUT	IUTE
Originator Host		IUTE	IUT	IUTE
Originator Domain		IUTE	IUT	IUTE
Operation Identifier		IUTE	IUT	IUTE
Operation Type		IUTE	IUT	IUTE
Operation Number		IUTE	IUT	IUTE
Operation Failover		IUTE	IUT	IUTE
Multiple Unit Operation		IUTE	IUT	IUTE
Announcement Information		IU--	-	IU--
Operation Failure Action		-	-	-
Redirection Host		-	-	-
Redirection Host Usage		-	-	-
Redirection Cache Time		-	-	-
Proxy Information		-	-	-
Route Information		-	-	-
Failed parameter		-	-	-
Extended Information		IUTE	IUT	IUTE
Service Information with IMS Information				
Account Expiration		-	-	IUTE

6.3.4 Formal IMS charging parameter description

6.3.4.1 IMS charging information for CDRs

The detailed definitions, abstract syntax and encoding of the IMS CDR parameters are specified in TS 32.298 [51].

6.3.4.2 IMS charging information for charging events

The detailed charging event parameter definitions are specified in TS 32.299 [50].

Annex A (informative): Bibliography

This Annex is a placeholder for documents which are not explicitly cited in this specification.

Annex B (informative): Message flows for service termination by OCS

B.0 General

This annex describes several scenarios related to IMS service termination in IMS-GWF.

SIP messages and Diameter transactions associated with these charging scenarios are shown primarily to illustrate the service termination procedures. They are not intended to be exhaustive and depend on the Diameter CCR triggers configured by the operator. The triggers for sending Debit / Reserve Units Requests from the IMS-GWF to the OCS are defined according to table 5.3.1.1.

B.1 Scenario 1 - session related (SCUR): service termination on reception of an initial SIP INVITE request

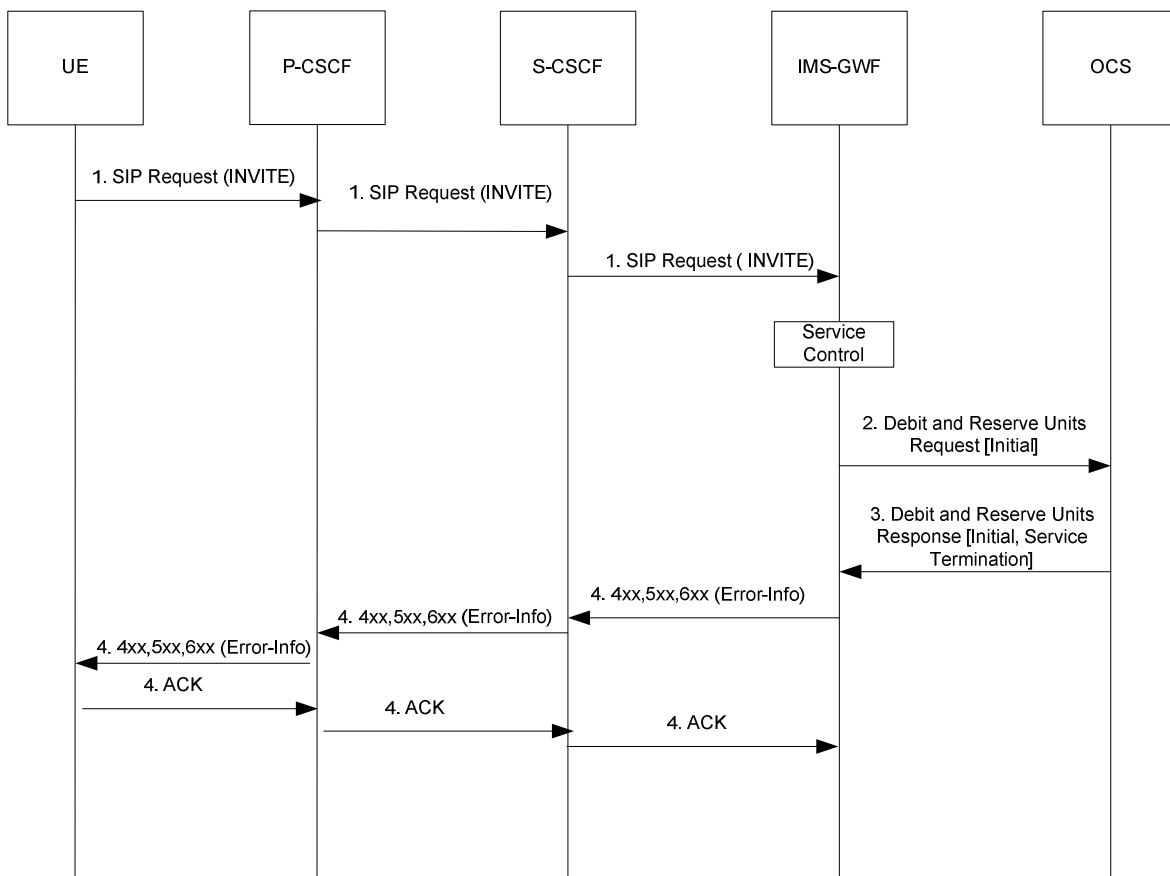

Figure B.1.1: Service termination triggered by an initial SIP request

B.2 Scenario 2 - session related (SCUR): service termination triggered after an early SIP dialog is established

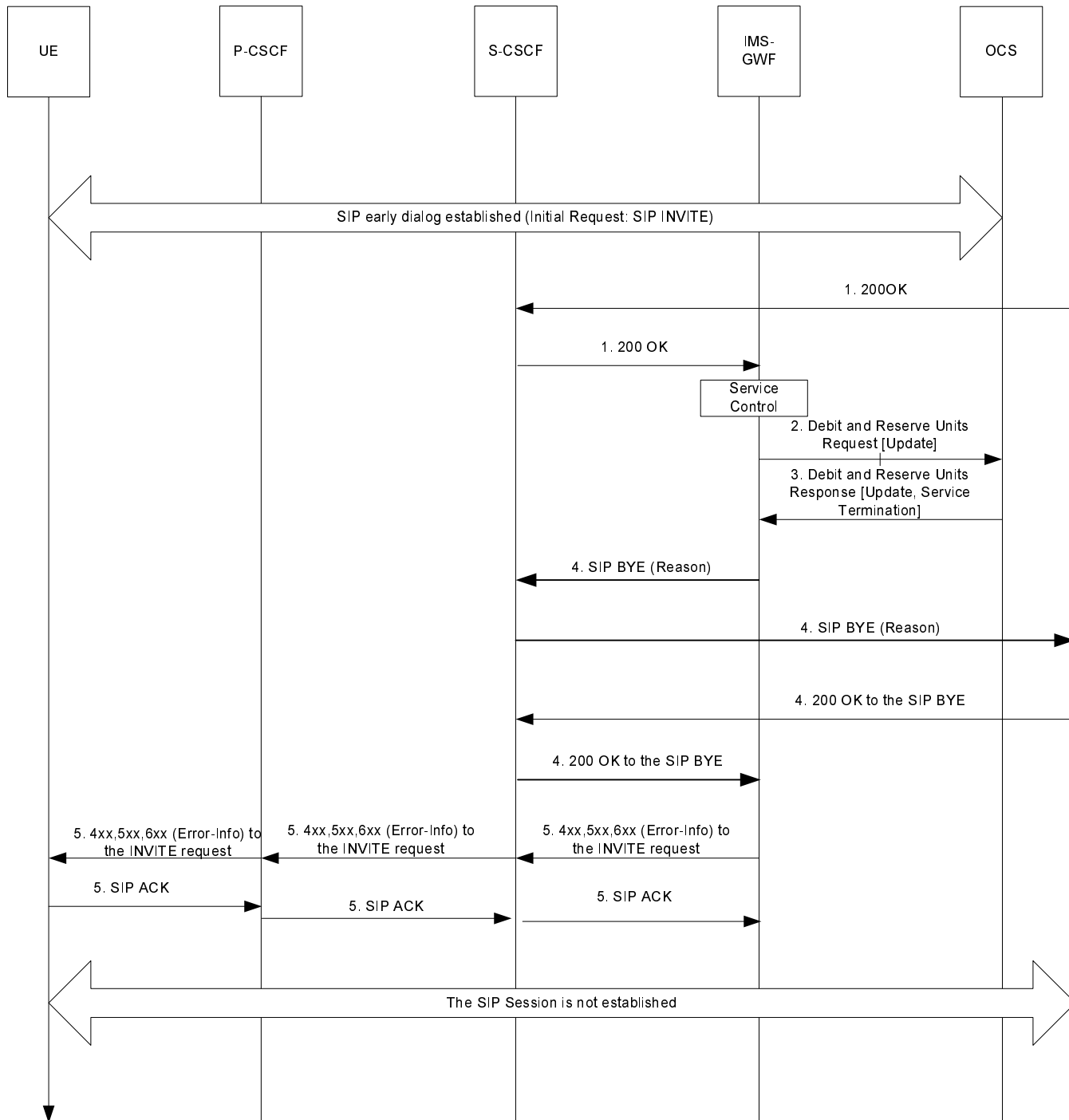

Figure B.2.1: Service termination triggered by the SIP 200OK response to the initial SIP INVITE

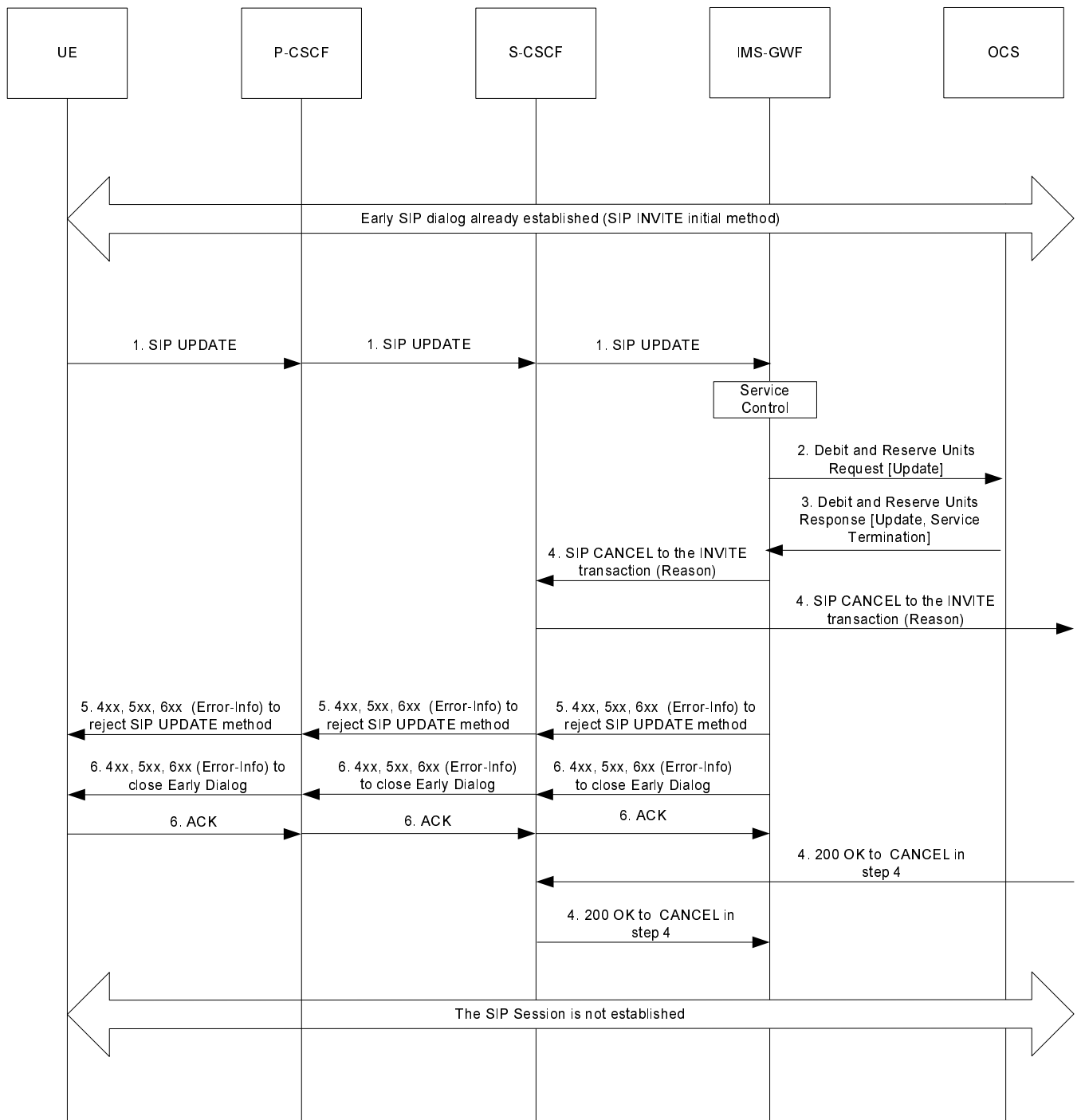

Figure B.2.2: Service termination triggered by an SIP UPDATE request within an early SIP dialog

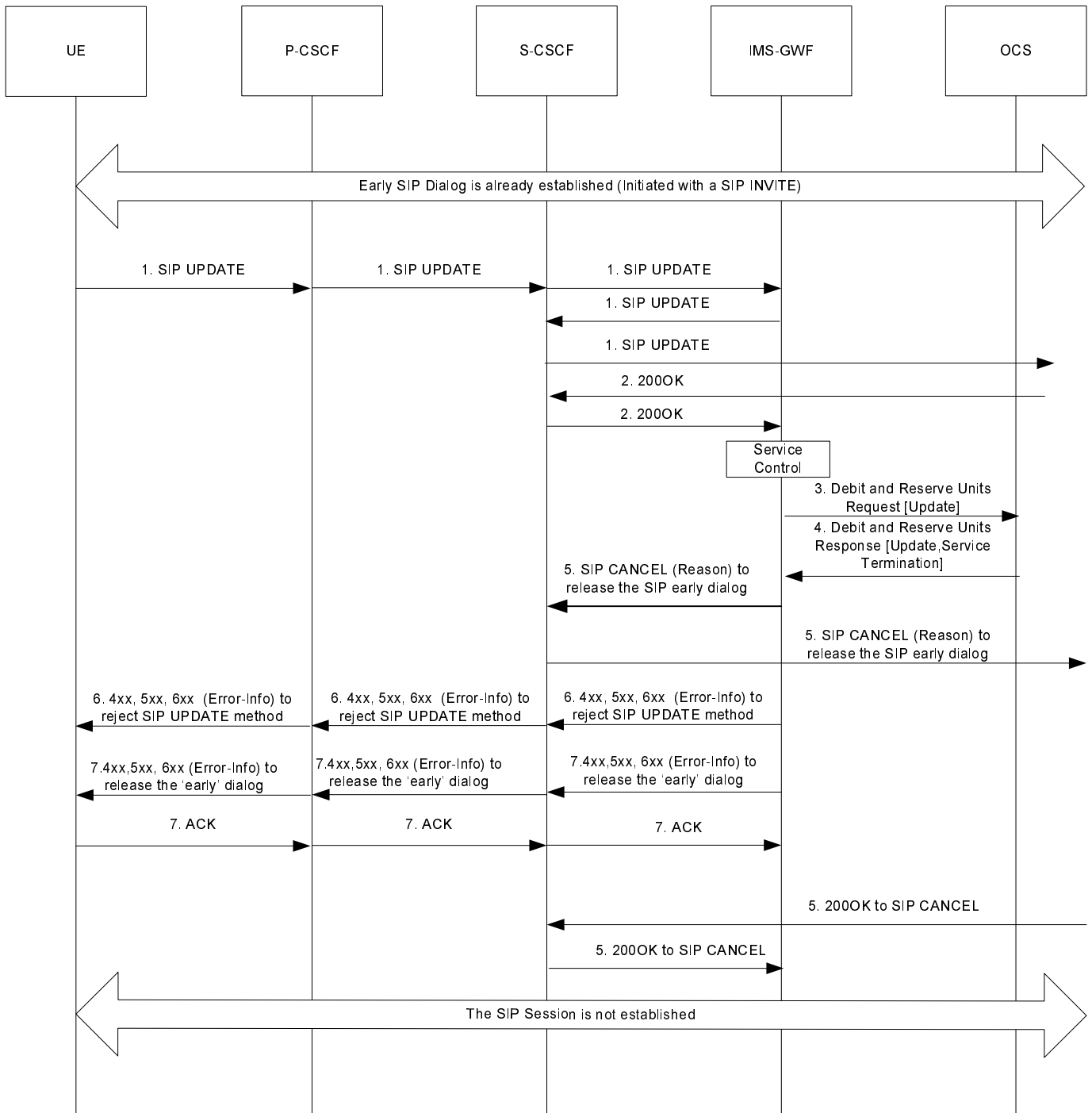

Figure B.2.3: Service termination triggered by the SIP 200OK to an SIP UPDATE request within an early SIP dialog

B.3 Scenario 3 - session related (SCUR): service termination triggered after a confirmed SIP dialog is established

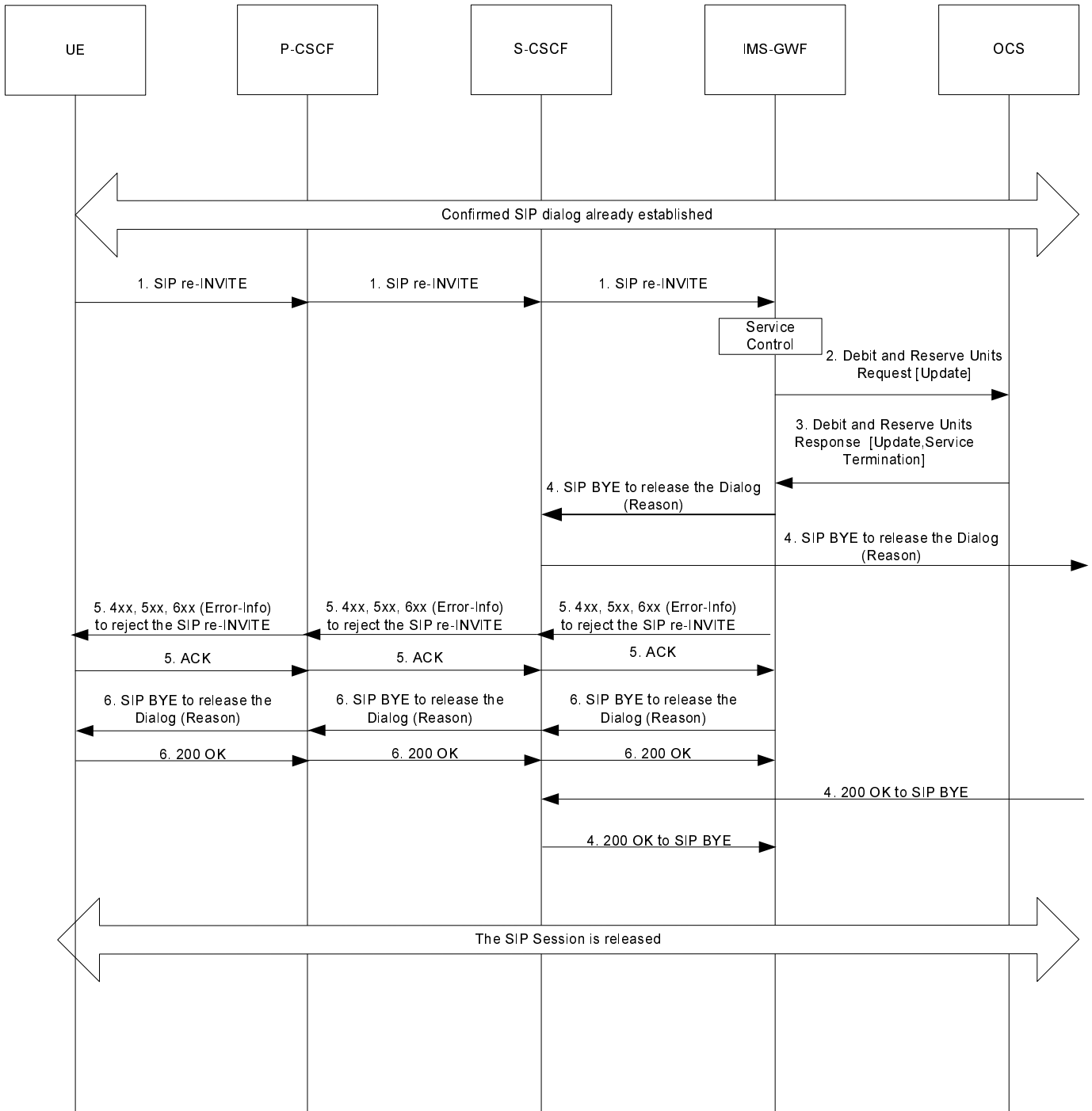

Figure B.3.1: Service termination triggered by a SIP RE-INVITE request within a confirmed SIP dialog

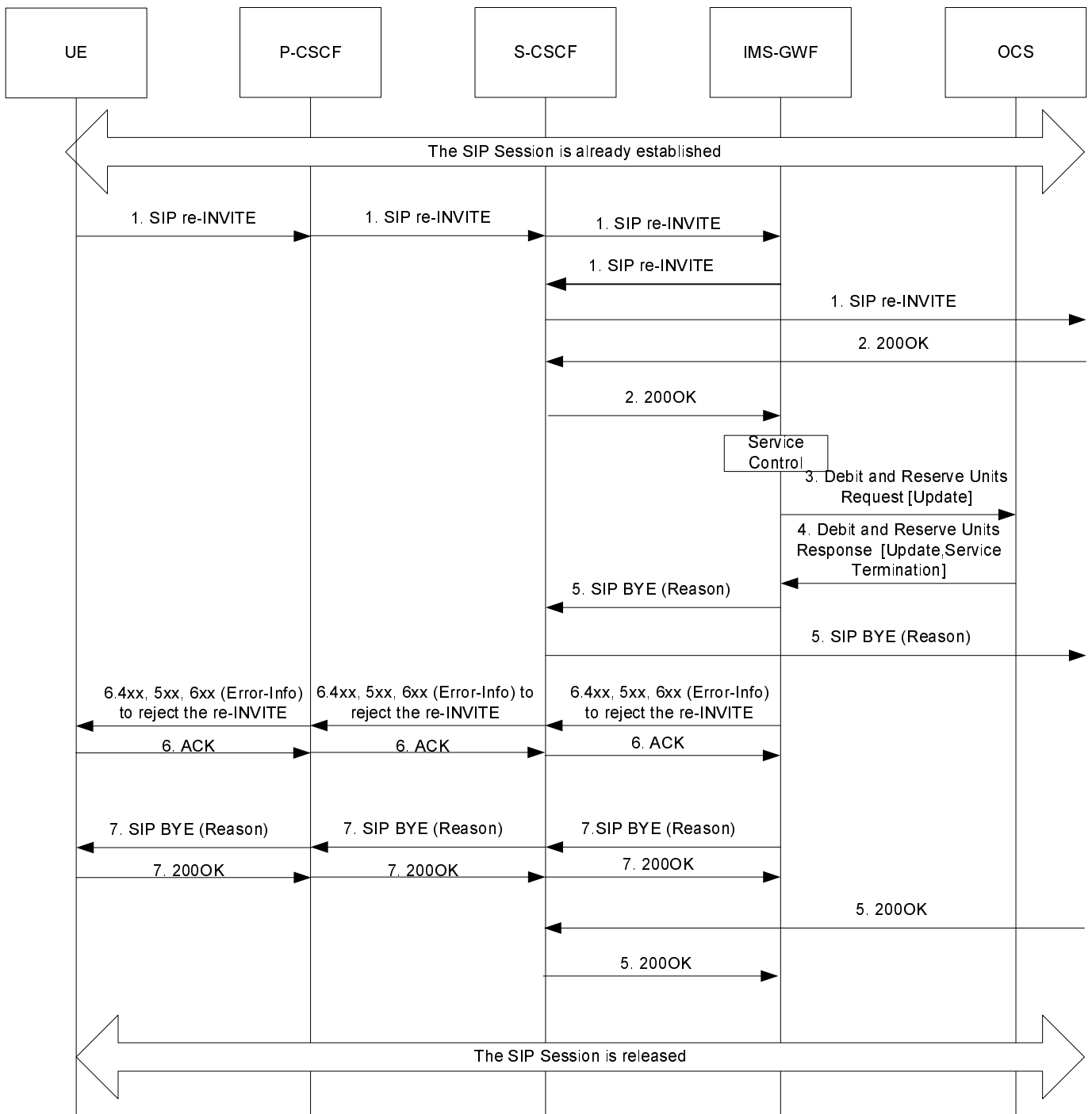

Figure B.3.2: Service termination triggered by the SIP 200 OK response to a SIP RE-INVITE request within a confirmed SIP dialog

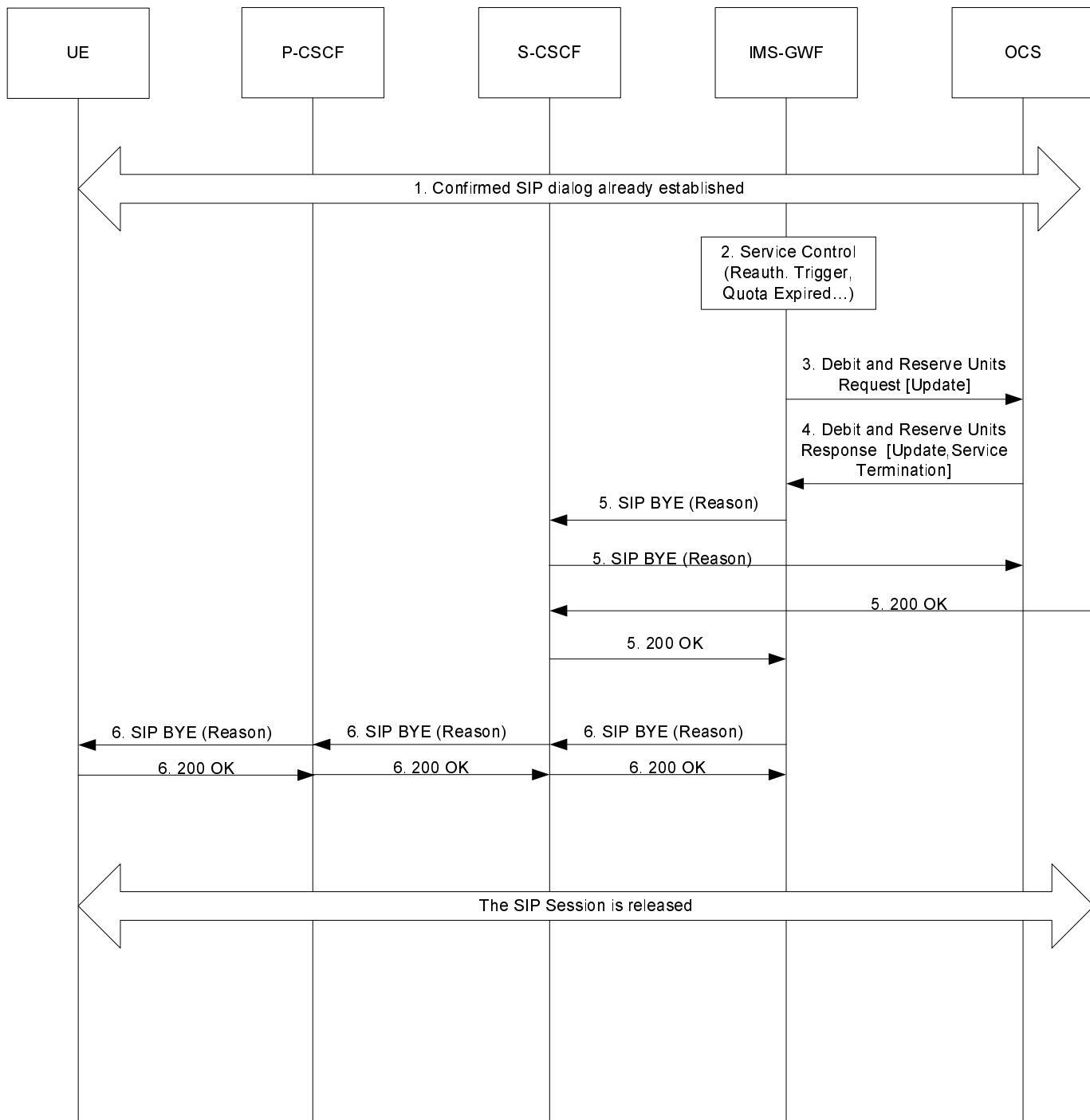

Figure B.3.3: Service termination triggered by the charging application procedures as defined in TS 32.299 [50] within a confirmed SIP dialog

B.4 Scenario 4 - session unrelated (ECUR): service termination on reception of an initial non-INVITE SIP request

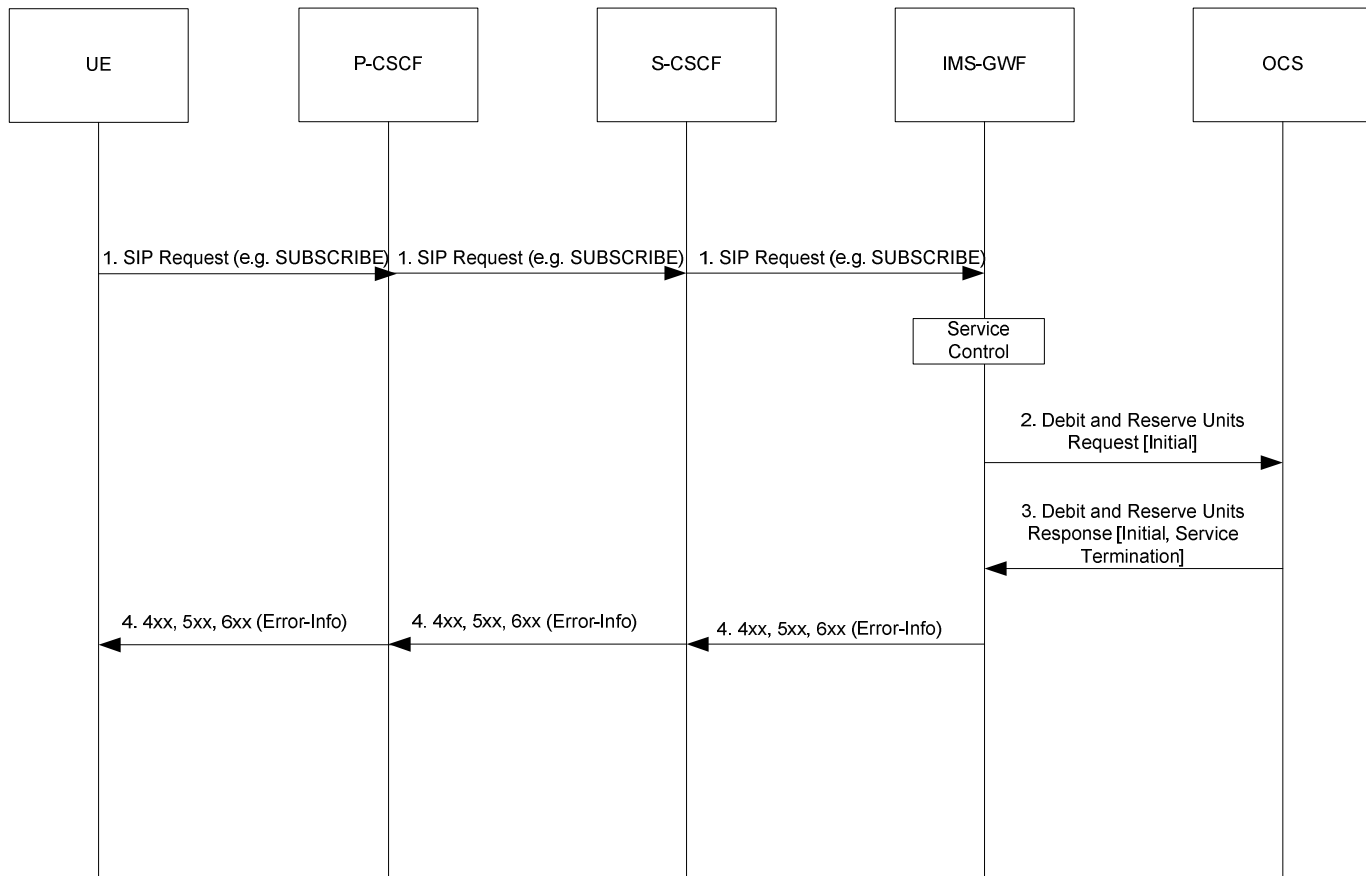

Figure B.4.1: Service termination triggered by the reception of a non-INVITE SIP request

B.5 Scenario 5 - session unrelated (IEC): service termination on reception of an initial non-INVITE SIP request

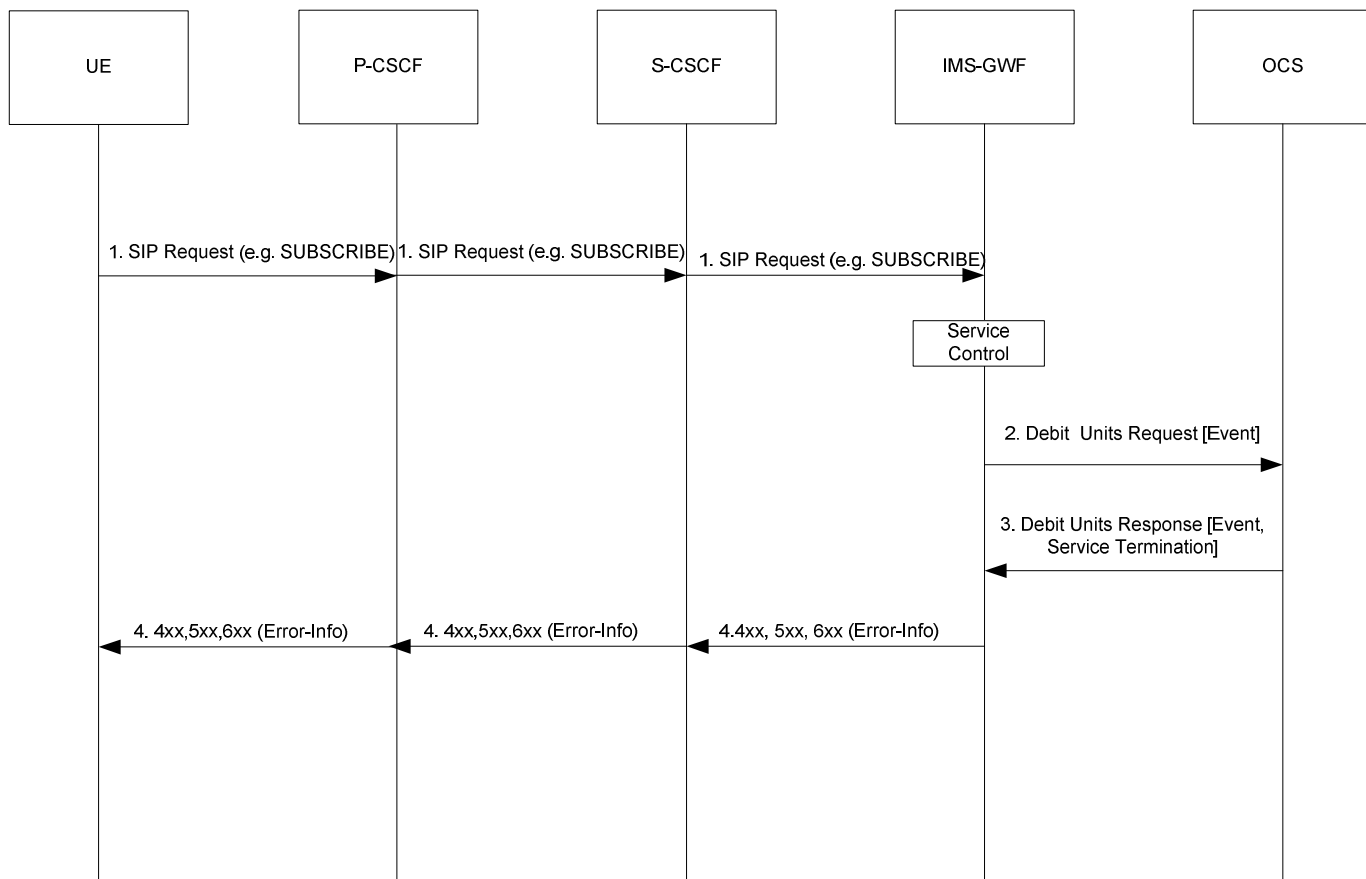

Figure B.5.1: Service termination triggered by the reception of a non-INVITE SIP request

Annex C (informative): Change history

Change history							
Date	TSG #	TSG Doc.	CR	Rev	Subject/Comment	Old	New
Jun 2007	SP-36	SP-070292	0051	--	Clarification of unsuccessful re-INVITE and UPDATE	7.3.0	8.0.0
Sep 2007	SP-37	SP-070674	0053	--	Add IMS Communication Service Identification (ICSI) in Charging information	8.0.0	8.1.0
Dec 2007	SP-38	SP-070745	0054	--	Correct Private User ID - Align with 32.299 Diameter charging applications	8.1.0	8.2.0
Mar 2008	SP-39	SP-080059	0055	1	Add IBCF into stage 2 flows and data descriptions for IMS Charging - Align with 23.002, 23.228	8.2.0	8.3.0
Mar 2008	SP-39	SP-080074	0056	--	Add on Number Portability and Carrier Select routing information	8.2.0	8.3.0
Jun 2008	SP-40	SP-080271	0058	--	Correction on supported fields in the Charging Operations	8.3.0	8.4.0
Sep 2008	SP-41	SP-081214	0059	--	Correction on Number Portability and Carrier Select Routing Information	8.4.0	8.5.0
Sep 2008	SP-41	SP-081287	0060	--	Charging management for IMS service continuity	8.4.0	8.5.0
Dec 2008	SP-42	SP-080706	0063	-	Charging management for IMS service continuity	8.5.0	8.6.0
Dec 2008	SP-42	SP-080841	0062	-	Correction on Multiple Unit Operation category	8.5.0	8.6.0
Dec 2008	SP-42	SP-080706	0064	-	Clarification of the online charging in TS 32.260	8.5.0	8.6.0
Dec 2008	SP-42	SP-080707	0065	-	Reference to MMTEL services	8.5.0	8.6.0
Dec 2008	SP-42	SP-080706	0066	-	Addition of the AS in the message flows for online charging scenarios	8.5.0	8.6.0
Dec 2008	SP-42	SP-080706	0067	-	Addition of SDP offer and answer and clarification on media initiator	8.5.0	8.6.0
Jun 2009	SP-44	SP-090432	0068	-	Correction of SIP request/response timestamps category	8.6.0	8.7.0
Sep 2009	SP-45	SP-090536	0073	-	Correction of number portability and carrier select information	9.0.0	9.1.0
Sep 2009	SP-45	SP-090538	0074	-	Add field in CDR contents for RTTI support in IMS offline charging	9.0.0	9.1.0
Sep 2009	SP-45	SP-090538	0075	-	Add ACR triggers for the support of RTTI	9.0.0	9.1.0
Dec 2009	SP-46	SP-090722	0076	-	Support of RTTI in IMS online charging	9.1.0	9.2.0
Dec 2009	SP-46	SP-090720	0078	-	Correction on priority session treatment – alignment with TS 22.153	9.1.0	9.2.0
Dec 2009	SP-46	SP-090721	0079	-	Modification on SDP handling in IMS charging	9.1.0	9.2.0
Dec 2009	SP-46	SP-090721	0080	-	Account expiration information from OCS to IMS Application Servers	9.1.0	9.2.0
Dec 2009	SP-46	SP-090722	0081	-	Addition of ACR triggering SIP method and correction	9.1.0	9.2.0
Mar 2010	SP-47	SP-100039	0083	-	Correction on MRFC Charging Data Record - Alignment with TS 32.298	9.2.0	9.3.0
Mar 2010	SP-47	SP-100040	0086	-	Correction of Role of Node charging parameter description	9.2.0	9.3.0
Mar 2010	SP-47	SP-100040	0088	-	Correction of THIG functionality entity alignment with TS 24.229	9.2.0	9.3.0
Mar 2010	SP-47	SP-100040	0090	-	Data integrity of charging information forwarded to charging domain	9.2.0	9.3.0
Mar 2010	SP-47	SP-100041	0091	-	Correction on Session Id for AS acting as B2BUA	9.2.0	9.3.0
Mar 2010	SP-47	SP-100041	0092	-	Correction on SDP handling in IMS Charging	9.2.0	9.3.0
Mar 2010	SP-47	SP-100044	0093	-	Add message flow for support of RTTI in SIP INFO	9.2.0	9.3.0
Jun 2010	SP-48	SP-100265	0095	-	Correction of trigger conditions	9.3.0	9.4.0
Jun 2010	SP-48	SP-100265	0097	-	Alignment for "Inter Operator Identification" description setting for IMS Centralised service with TS 24.292	9.3.0	9.4.0
Jun 2010	SP-48	SP-100266	0099	-	Charging information for Emergency IMS Sessions	9.3.0	10.0.0
Oct 2010	SP-49	SP-100497	0101	-	Correction on Accounting Request message triggering enablement	10.0.0	10.1.0
Oct 2010	SP-49	SP-100497	0103	-	Clarification on Associated-URI during Registration	10.0.0	10.1.0
Oct 2010	SP-49	SP-100497	0105	-	Alignments on Charging Principles	10.0.0	10.1.0
Oct 2010	SP-49	SP-100498	0106	-	Change of title format	10.0.0	10.1.0
Oct 2010	SP-49	SP-100498	0107	-	Correction on Triggering of unsuccessful SIP session	10.0.0	10.1.0
Dec 2010	SP-50	SP-100757	0114	--	Correction of Operation Interval in the Charging Data Request and Response messages - Align with IETF RFC 3588	10.1.0	10.2.0
Dec 2010	SP-50	SP-100758	0110	2	Add missing timestamp granularity	10.1.0	10.2.0
Dec 2010	SP-50	SP-100759	0108	1	Replace the Authorized-QoS AVP name with Authorised-QoS AVP	10.1.0	10.2.0
Dec 2010	SP-50	SP-100759	0111	2	Replace the non-existing "MRFC" by "MRFC" (Media Resource Function Controller) in Figure 4.3: IMS online charging Architecture	10.1.0	10.2.0
Mar 2011	SP-51	SP-110108	0119	1	Correction on availability of Called Asserted Identity	10.2.0	10.3.0
Mar 2011	SP-51	SP-110109	0115	2	Correction on ICSI availability - Align with SA2 TS 23.228	10.2.0	10.3.0
Mar 2011	SP-51	SP-110109	0116	1	Addition of IARI in IMS Offline charging information, alignment with TS 22.115 and TS 23.228	10.2.0	10.3.0
May 2011	SP-52	SP-110281	0122	1	Correction on Access-Correlation-ID field	10.3.0	10.4.0
May 2011	SP-52	SP-110404	0123	1	Correction on supported fields in IBCF - Alignment with TS 32.298	10.3.0	10.4.0
May 2011	SP-52	SP-110294	0124	1	Introduction of OMR procedures in IMS Charging	10.3.0	10.4.0
May 2011	SP-52	SP-110294	0125	1	Introduction of transcoding related OMR procedures in IMS Charging	10.3.0	10.4.0
May 2011	SP-52	SP-110294	0126	1	CDRs enhancement for OMR Charging introduction	10.3.0	10.4.0
May 2011	SP-52	SP-110280	0128	1	Correction in SCC AS CDR for IMS service continuity	10.3.0	10.4.0
May 2011	SP-52	SP-110281	0131	1	Correction on IMS Application Reference Identifier (IARI) in IMS Charging	10.3.0	10.4.0
May 2011	SP-52	SP-110283	0120	1	Add Transit Inter Operator Identifier for IMS Interconnection Charging	10.4.0	11.0.0
Sep 2011	SP-53	SP-110529	0134	-	Correction for emergency IMS session service continuity	11.0.0	11.1.0
Dec 2011	SP-54	SP-110711	0137	2	Addition of Served User in IMS charging information	11.1.0	11.2.0
Dec 2011	SP-54	SP-110712	0136	2	Add Transit IOI to IMS Offline Charging	11.1.0	11.2.0
Dec 2011	SP-54	SP-110712	0140	2	Correction of Transit IOI description	11.1.0	11.2.0
Dec 2011	--	--	--	--	Editorial correction of figures 5.2.2.1.13.5-1, 5.2.2.1.13.6-1	11.2.0	11.2.1
March 2012	SP-55	SP-120048	0144	2	Correction of Diameter AVP usage on Ro charging interfaces	11.2.1	11.3.0
March 2012	SP-55	SP-120049	0142	--	Add Status in Application Server Information in IMS Charging	11.2.1	11.3.0
March 2012	SP-55	SP-120049	0143	1	Correct description of Charging trigger condition in IMS Charging	11.2.1	11.3.0
June-2012	SP-56	SP-120366	0146	1	Flow description for single charging session from AS acting as B2BUA	11.3.0	11.4.0

June-2012	SP-56	SP-120366	0147	1	Flow description for single charging session from SCC AS – originating and terminating	11.3.0	11.4.0
June-2012	SP-56	SP-120374	0148	2	R11 CR 32260 Enhancing IMS charging for RAVEL	11.3.0	11.4.0
June-2012	SP-56	SP-120397	0149	3	R11 CR 32260 Add charging parameters for NetLoc	11.3.0	11.4.0
June-2012	SP-56	SP-120359	0153	1	Rel-11 CR 32.260 Correction of List of Message Bodies	11.3.0	11.4.0
June-2012	SP-56	SP-120366	0155	-	Flow description for SCC AS session transfert PS to CS and CS to PS– single charging session	11.3.0	11.4.0
June-2012	SP-56	SP-120366	0156	-	Flow description for SCC AS session establishment – CS+PS - single charging session	11.3.0	11.4.0
June-2012	SP-56	SP-120366	0157	1	Flow description for SCC AS session CS+PS transfer -- single charging session	11.3.0	11.4.0
Sep-2012	SP-57	SP-120576	0158	-	Correction on session establishment flow for RAVEL	11.4.0	11.5.0
Sep-2012	SP-57	SP-120576	0159	-	Introduction of Loopback indicator in BGCF CDR for RAVEL	11.4.0	11.5.0
Sep-2012	SP-57	SP-120561	0163	-	Remove Authorised-Qos from P-CSCF CDR	11.4.0	11.5.0
Sep-2012	SP-57	SP-120566	0164	1	Clarify fields under Service information used for IMS Charging	11.4.0	11.5.0
Sep-2012	SP-57	SP-120576	0165	1	Add TRF CDR to Offline Charging	11.4.0	11.5.0
Sep-2012	SP-57	SP-120569	0167	1	Enhancement on flows for "OneChargingSession" option description	11.4.0	11.5.0
Sep-2012	SP-57	SP-120569	0168	1	Introduction EATF flow for "OneChargingSession" option description	11.4.0	11.5.0
Sep-2012	SP-57	SP-120569	0169	1	Update SIP AS CDR description for "OneChargingSession" option	11.4.0	11.5.0
Sep-2012	SP-57	SP-120566	0170	2	Correct flow for SCC AS session transfer PS to CS	11.4.0	11.5.0
Sep-2012	SP-57	SP-120569	0172	1	Flows for SRVCC Originating and Terminating sessions through ATCF	11.4.0	11.5.0
Sep-2012	SP-57	SP-120566	0174	2	Correction of calling party handling	11.4.0	11.5.0
Sep-2012	SP-57	SP-120562	0177	-	Correction of Called-Party-Address AVP	11.4.0	11.5.0
Dic-2012	SP-58	SP-120789	0179	1	Rel-11 CR 32.260 ICID Generation Alignment	11.5.0	11.6.0
Dic-2012	SP-58	SP-120793	0180	1	R11 CR 32260 Flows for SRVCC session transfers through ATCF	11.5.0	11.6.0
Dic-2012	SP-58	SP-120793	0181	3	R11 CR 32260 Offline Charging description for ATCF	11.5.0	11.6.0
Dic-2012	SP-58	SP-120785	0186	2	R11 CR 32260 Emergency Indicator introduction in P-CSCF CDR	11.5.0	11.6.0
Dic-2012	SP-58	SP-120784	0192	1	Rel-11 CR 32.260 Correction on the charging at MRFC	11.5.0	11.6.0
Dic-2012	SP-58	SP-120789	0193	2	Correction on charging for IMS transit functions	11.5.0	11.6.0
Mar 2013	SP-59	SP-130062	0183	3	Multiple sets of inter operator identifiers in IMS CDRs for IMS Roaming	11.6.0	11.7.0
		SP-130054	0199	1	Related ICID Corrections for SRVCC Charging Correlation		
		SP-130051	0202	1	Emergency Indicator introduction in S-CSCF and I-CSCF CDR		
		SP-130054	0203	1	IMS User Charging when Roaming		
		SP-130063	0204	1	Correction for Access Network Information in TRF CDR		
		SP-130054	0205	1	Correction of GTP' usage with respect to CCF functionality		
		SP-130279	0206	1	Remove RTTI from TRF and TF CDRs	11.7.0	11.8.0
Jun-2013	SP-60	SP-130277	0207	2	Corrections for Network Provided Location Information	11.8.0	12.0.0
		SP-130271	0210	1	Introduction of reason header in IMS offline Charging	11.8.0	12.0.0
Jun 2013					Editorial changes (Missing clauses in the content added, wrong style used in CDR Category field, colored text in CDR field description removed, empty lines removed, and tables format adjusted)	11.8.0	12.0.0
Sep-2013	SP-61	SP-130443	0214	-	Requested Party Address clarification	12.0.0	12.1.0
		SP-130438	0221	-	Remove RTTI from ACR [Stop] and CCR [Terminate]		
		SP-130435	0224	1	Additional Access Network Information Field		
Dec-2013	SP-62	SP-130619	0226	1	Addition of Instance Id for IMS Charging	12.1.0	12.2.0
		SP-130678	0234	1	Correction for SRVCC Originating and Terminating Flows through ATCF		
		SP-130676	0239	-	Correction for use of Destination-Host AVP in ACR		
		SP-130627	0241	1	Correction for Route Header for IMS Interconnection Charging		
Mar-2014	SP-63	SP-140035	0243	1	Correction for SIP Route header transmitted in S-CSCF CDR	12.2.0	12.3.0
Jun-2014	SP-64	SP-140346	0246	3	Correction for SRVCC PS to CS transfer Flows through ATCF	12.3.0	12.4.0
			0248	3	Correction for SRVCC CS to PS transfer Flows through ATCF		
			0252	1	correction of ATCF CDR		
			0254	1	Correction for TADS indication in SIP AS CDR		
		SP-140343	0256	1	Clarification on Transit IOI from AS in online and offline charging		
		SP-140346	0265	1	Clarification of OneChargingSession applicable for ATCF		
2014-07	-	-	-	-	Rapporteur/MCC: General editorial changes and clean-up.	12.4.0	12.4.1
2014-09	SP-65	SP-140564	0271	1	Corrections for alignment between charging specifications	12.4.1	12.5.0
		SP-140561	0276	-	Removal of duplicate Requested Action in IMS online charging		
		SP-140568	0278	1	Correction on inconsistent defined parameter for NetLoc		
		SP-140564	0279	-	Correction of Subscriber Equipment Number and Instance Id for privacy concerns		
		SP-140561	0284	1	SDP general handling clarification		
2014-12	SP-66	SP-140803	0291	1	Correction for use of Feature-Caps for IMS Communication Service Id	12.5.0	12.6.0
		SP-140804	0292	-	Additional corrections for removal of I-WLAN solution		
		SP-140805	0293	1	Corrections on definition for parameter category		
		SP-140803	0295	1	Consistency correction of SDP information occurrence in BGCF CDR		
			0297	1	Correction on general SDP handling		
		SP-140806	0298	1	Correction on use of Operation Interval	12.6.0	13.0.0
2015-03	SP-67	SP-150064	0303	1	Correction for unavailable fields in E-CSCF CDR	13.0.0	13.1.0
		SP-150062	0304	1	Introduction of reason header in IMS online charging		
2015-06	SP-68	SP-150329	0307	1	Introduction of enhancements for IMS Service Continuity	13.1.0	13.2.0
		SP-150325	0309	1	correction on From Address parameter		
		SP-150329	0311	1	Clarification on Related ICID		
		SP-150326	0312	-	Correction on parameter provision		
		SP-150329	0313	-	Addition of Inter-UE transfer call flows for IMS Service Continuity		

		SP-150324	0316	1	Clarification on IMS Transit Functions		
		SP-150330	0317	1	OCS-provided announcements introduction		
2015-09	SP-69	SP-150428	0318	1	Correction on enhancements for IMS Service Continuity	13.2.0	13.3.0
		SP-150429	0319	2	Message sequence diagrams for OCS-provided announcements		
		SP-150424	0321	1	Missing message sequence chart for session transfer		
		SP-150422	0324	1	Update of Reference RFC7315		
		SP-150425	0327	1	Inclusion of loopback indication		
		SP-150429	0328	1	Clarification of description for IMS support of OCS-provided announcements		
		SP-150425	0329	1	Introduce ISUP release cause to MGCF CDR		
		SP-150417	0331	1	Update of SIP methods triggering offline charging session termination		
		SP-150422	0333	1	Correction of enhanced MSC server reference		
		SP-150429	0334	1	Indication to the UE of the reason for IMS service release		
		2015-12	SP-70	SP-150816	0335		
0337	2				Removal of Announcement description		
SP-150698	0343			-	Clarification on NNI Information for loopback indication		
	0344			-	Clarification on trigger conditions for IMS CDR closure		
SP-150701	0347			1	Introduction of ULI TZ Changes in IMS offline and online charging		
	0348			1	Update of SIP methods triggering online charging session termination		
SP-150694	0349			-	Correction of 2xx triggers for online and offline charging		
SP-150698	0355			1	Charging support for Terminating Identification Presentation feature changes in terminating identity		
	0358			1	Correction on CS Location Information in SIP AS CDR		
	0359			2	Cell information received with untrusted WLAN access information		
2016-03	SP-71	SP-160034	0360	-	Correction for UE identification associated with inter-UE transfer	13.4.0	13.5.0
2016-03	SP-71	SP-160038	0361	1	Correction of 2xx trigger for BYE request to align offline and online charging	13.4.0	13.5.0

Change history							
Date	Meeting	TDoc	CR	Rev	Cat	Subject/Comment	New version
2016-06	SA#72	SP-160416	0362	-	F	Correction of cell information received with untrusted WLAN access information – alignment with TS 24.229	13.6.0
2016-06	SA#72	SP-160416	0363	-	F	Correcting missing usage of VCS Information for AS	13.6.0
2016-12	SA#74	SP-160845	0369	-	A	Correction on Requested Party Address for Emergency IMS session	13.7.0
2016-12	SA#74	SP-160850	0370	1	B	Add charging support for roaming architecture for voice over IMS with home routed traffic	14.0.0
2016-12	SA#74	SP-160850	0371	1	B	Clarification on location of P-CSCF and CDF in message flows	14.0.0
2016-12	SA#74	SP-160847	0372	1	F	Correction on Access Network Info change with the time in offline	14.0.0
2016-12	SA#74	SP-160847	0373	1	F	Correction on Role-Of-node for AS serving the forwarding	14.0.0
2016-12	SA#74	SP-160847	0374	1	F	Correction of Number portability Routing information	14.0.0
2017-03	SA#75	SP-170138	0375	1	C	Remove reference to RFC 3588	14.1.0
2017-06	SA#76	SP-170501	0376	1	B	Introduction of 3GPP Data Off status indication in AS charging	14.2.0
2017-06	SA#76	SP-170498	0378	1	B	Implement IMS visited network identifier for S8HR	14.2.0
2017-06	SA#76	SP-170514	0379	1	F	Correction of TRF description	14.2.0
2017-06	SA#76	SP-170506	0381	1	B	Addition of FE Identifier List to IMS Charging	14.2.0
2017-06	SA#76	SP-170507	0385	1	A	Correction on handling of Private and Public user ID for IMS charging	14.2.0
2017-09	SA#77	SP-170654	0388	-	A	Correction in the Trigger for Charging from I-CSCF	14.3.0

History

Document history		
V14.1.0	April 2017	Publication
V14.2.0	July 2017	Publication
V14.3.0	October 2017	Publication