



**Digital cellular telecommunications system (Phase 2+) (GSM);
Universal Mobile Telecommunications System (UMTS);
LTE;
Telecommunication management;
Charging management;
Short Message Service (SMS) charging
(3GPP TS 32.274 version 16.0.0 Release 16)**



Reference

RTS/TSGS-0532274vg00

Keywords

GSM,LTE,UMTS

ETSI

650 Route des Lucioles
F-06921 Sophia Antipolis Cedex - FRANCE

Tel.: +33 4 92 94 42 00 Fax: +33 4 93 65 47 16

Siret N° 348 623 562 00017 - NAF 742 C
Association à but non lucratif enregistrée à la
Sous-Préfecture de Grasse (06) N° 7803/88

Important notice

The present document can be downloaded from:

<http://www.etsi.org/standards-search>

The present document may be made available in electronic versions and/or in print. The content of any electronic and/or print versions of the present document shall not be modified without the prior written authorization of ETSI. In case of any existing or perceived difference in contents between such versions and/or in print, the prevailing version of an ETSI deliverable is the one made publicly available in PDF format at www.etsi.org/deliver.

Users of the present document should be aware that the document may be subject to revision or change of status.

Information on the current status of this and other ETSI documents is available at

<https://portal.etsi.org/TB/ETSIDeliverableStatus.aspx>

If you find errors in the present document, please send your comment to one of the following services:

<https://portal.etsi.org/People/CommiteeSupportStaff.aspx>

Copyright Notification

No part may be reproduced or utilized in any form or by any means, electronic or mechanical, including photocopying and microfilm except as authorized by written permission of ETSI.

The content of the PDF version shall not be modified without the written authorization of ETSI.

The copyright and the foregoing restriction extend to reproduction in all media.

© ETSI 2020.

All rights reserved.

DECT™, **PLUGTESTS™**, **UMTS™** and the ETSI logo are trademarks of ETSI registered for the benefit of its Members.

3GPP™ and **LTE™** are trademarks of ETSI registered for the benefit of its Members and of the 3GPP Organizational Partners.

oneM2M™ logo is a trademark of ETSI registered for the benefit of its Members and of the oneM2M Partners.

GSM® and the GSM logo are trademarks registered and owned by the GSM Association.

Intellectual Property Rights

Essential patents

IPRs essential or potentially essential to normative deliverables may have been declared to ETSI. The information pertaining to these essential IPRs, if any, is publicly available for **ETSI members and non-members**, and can be found in ETSI SR 000 314: "*Intellectual Property Rights (IPRs); Essential, or potentially Essential, IPRs notified to ETSI in respect of ETSI standards*", which is available from the ETSI Secretariat. Latest updates are available on the ETSI Web server (<https://ipr.etsi.org/>).

Pursuant to the ETSI IPR Policy, no investigation, including IPR searches, has been carried out by ETSI. No guarantee can be given as to the existence of other IPRs not referenced in ETSI SR 000 314 (or the updates on the ETSI Web server) which are, or may be, or may become, essential to the present document.

Trademarks

The present document may include trademarks and/or tradenames which are asserted and/or registered by their owners. ETSI claims no ownership of these except for any which are indicated as being the property of ETSI, and conveys no right to use or reproduce any trademark and/or tradename. Mention of those trademarks in the present document does not constitute an endorsement by ETSI of products, services or organizations associated with those trademarks.

Legal Notice

This Technical Specification (TS) has been produced by ETSI 3rd Generation Partnership Project (3GPP).

The present document may refer to technical specifications or reports using their 3GPP identities. These shall be interpreted as being references to the corresponding ETSI deliverables.

The cross reference between 3GPP and ETSI identities can be found under <http://webapp.etsi.org/key/queryform.asp>.

Modal verbs terminology

In the present document "**shall**", "**shall not**", "**should**", "**should not**", "**may**", "**need not**", "**will**", "**will not**", "**can**" and "**cannot**" are to be interpreted as described in clause 3.2 of the [ETSI Drafting Rules](#) (Verbal forms for the expression of provisions).

"**must**" and "**must not**" are **NOT** allowed in ETSI deliverables except when used in direct citation.

Contents

Intellectual Property Rights	2
Legal Notice	2
Modal verbs terminology.....	2
Foreword.....	6
1 Scope	7
2 References	8
3 Definitions and abbreviations.....	9
3.1 Definitions	9
3.2 Symbols.....	9
3.3 Abbreviations	9
4 Architecture considerations	10
4.1 High level SMS architecture	10
4.2 SMS offline charging architecture.....	10
4.3 SMS online charging architecture	10
4.4 SMS converged charging architecture.....	11
5 SMS charging principles and scenarios.....	12
5.1 SMS charging principles	12
5.1.1 General principles	12
5.1.2 Segmentation and concatenation.....	12
5.1.3 Triggers for generation of charging information	12
5.1.4 SMS via T4.....	13
5.2 SMS offline charging scenarios.....	14
5.2.1 Basic principles.....	14
5.2.2 Rf message flows	15
5.2.2.0 Introduction	15
5.2.2.1 SMS Submission	15
5.2.2.2 SMS Delivery.....	17
5.2.2.3 Delivery Report.....	18
5.2.2.4 Device Triggering using T4	19
5.2.2.4.1 SMS submission to SMS-SC for Device Triggering	19
5.2.2.4.2 SMS Delivery from SMS-SC for Device Triggering	19
5.2.2.4.3 SMS Device Triggering Delivery Report	21
5.2.2.4.4 SMS submission to SMS-SC for Device Triggering - Replace procedure	21
5.2.2.4.5 SMS submission to SMS-SC for Device Triggering - Recall procedure.....	21
5.2.2.5 Offline charging error cases - Diameter procedures.....	22
5.2.2.6 MSISDN-less SMS MO via T4.....	22
5.2.2.6.1 Introduction	22
5.2.2.6.2 MSISDN-less SMS MO via T4 - successful case.....	22
5.2.2.6.3 MSISDN-less SMS MO via T4 - error cases.....	23
5.2.2.6.3.1 MSISDN-less SMS MO via T4 - failure at submission to SMS-SC.....	23
5.2.2.6.3.2 MSISDN-less SMS MO via T4 - failure at the MTC-IWF	24
5.2.3 CDR generation	26
5.2.3.0 Triggers for SMS CDR generation.....	26
5.2.3.1 Triggers for SMS CDR charging information collection	26
5.2.3.2 Triggers for SMS CDR charging information addition.....	26
5.2.3.3 Triggers for SMS CDR closure	26
5.2.4 Ga record transfer flows	26
5.2.5 B _{sm} CDR file transfer	26
5.3 SMS online charging scenarios	27
5.3.1 Basic principles.....	27
5.3.2 R _o message flows	28
5.3.2.1 Simple submission	28
5.3.2.2 Enhanced submission	29

5.3.2.3	Delivery report	29
5.3.2.4	Origination retry	30
5.3.2.5	Termination charge	32
5.3.2.6	Termination charge retry	34
5.3.2.7	Unsuccessful transaction	36
5.3.2.8	IMS/SMS Interworking Messages Charging	38
5.3.2.9	Simple Submission with SM service request	41
5.3.2.10	Void	42
5.3.2.11	Device Triggering using T4	42
5.3.2.11.1	SMS submission to SMS-SC for Device Triggering	42
5.3.2.11.2	SMS Delivery from SMS-SC for Device Triggering	42
5.3.2.11.3	Unsuccessful SMS Delivery from SMS-SC for Device Triggering	45
5.3.2.11.4	SMS submission to SMS-SC for Device Triggering - Replace procedure	47
5.3.2.11.5	SMS submission to SMS-SC for Device Triggering - Recall procedure	47
5.3.2.12	MSISDN-less SMS MO via T4	48
5.3.2.12.1	Introduction	48
5.3.2.12.2	MSISDN-less SMS MO via T4 - successful case	49
5.3.2.12.3	MSISDN-less SMS MO via T4 - error cases	50
5.3.2.12.3.1	MSISDN-less SMS MO via T4 - failure at submission to SMS-SC	50
5.3.2.12.3.2	MSISDN-less SMS MO via T4 - failure at the MTC-IWF	50
5.3.3	Credit-Control related	52
5.3.3.1	Triggers for stopping for an SMS Credit-Control session	52
5.3.3.2	Triggers for providing interim information for a SMS Credit-Control session	52
5.4	SMS converged online and offline charging scenarios	52
5.4.1	Basic principles	52
5.4.1.1	General	52
5.4.1.2	Applicable Triggers in the SMSF	52
5.4.1.2.1	General	52
5.4.1.3	CHF selection	53
5.4.2	Message flows	54
5.4.2.1	Introduction	54
5.4.2.2	SMS Submission - IEC	54
5.4.2.3	SMS Delivery - IEC	55
5.4.2.4	SMS Submission - ECUR	56
5.4.2.5	SMS Submission - PEC	58
5.4.2.6	SMS Delivery - PEC	59
5.4.3	CDR generation	59
5.4.3.1	Introduction	59
5.4.3.2	Triggers for CHF CDR	60
5.4.3.2.1	General	60
5.4.3.2.2	Triggers for CHF CDR generation	60
5.4.3.2.3	Triggers for CHF CDR opening	60
5.4.3.2.4	Triggers for CHF CDR closure	60
5.4.4	Ga record transfer flows	60
5.4.5	B _{sm} CDR file transfer	60
6	Definition of charging information	61
6.1	Data description for SMS offline charging	61
6.1.1	R _f message contents	61
6.1.1.1	Summary of offline charging message formats	61
6.1.1.2	Structure for the offline charging message formats	61
6.1.1.2.1	Charging Data Request message	61
6.1.1.2.2	Charging Data Response message	62
6.1.2	G _a message contents	62
6.1.3	CDR description on the B _{sm} interface	62
6.1.3.1	CDR field types	62
6.1.3.2	CDR triggers	62
6.1.3.3	SC-SMO CDR content	63
6.1.3.4	SC-SMT CDR content	66
6.1.3.5	SC-DVT-T4 CDR content	69
6.1.3.6	SC-SMO-T4 CDR content	70
6.1.3.7	ISM-SMO CDR content	71

6.1.3.8	ISM-SMT CDR content	72
6.2	Data description for SMS online charging	73
6.2.1	R _o message contents.....	73
6.2.1.0	Introduction.....	73
6.2.1.1	Summary of message formats	74
6.2.1.2	Structure for the Credit-Control message formats.....	74
6.2.1.2.1	Debit/Reserve Units Request message	74
6.2.1.2.2	Debit / Reserve Units Response message	75
6.2a	Data description for SMS converged charging.....	75
6.2a.1	Message contents	75
6.2a.1.1	General	75
6.2a.1.2	Structure for the converged charging message formats.....	76
6.2a.1.2.1	Charging Data Request message	76
6.2a.1.2.2	Charging Data Response message	76
6.2a.2	G _a message contents	77
6.2a.3	CDR description on the B _{sm} interface	77
6.2a.3.1	General	77
6.2a.3.2	SMS charging CHF CDR data	77
6.3	SMS charging specific parameters	78
6.3.1	Definition of the SMS charging information	78
6.3.1.1	SMS charging information assignment for Service Information.....	78
6.3.1.2	Definition of the SMS Information	80
6.3.1A	Detailed message format for offline charging.....	82
6.3.2	Formal parameter description	84
6.3.2.1	SMS charging information for CDRs.....	84
6.3.2.2	SMS charging information for charging events	84
6.3.3	Detailed message format for online charging	84
6.4	Bindings for SMS charging	87
6.5	Definition of the SMS converged charging information	89
6.5.1	General.....	89
6.5.2	Definition of SMS charging information	90
6.5.3	Detailed message format for converged charging.....	90
6.5.4	Formal SMS converged charging parameter description.....	93
6.5.4.1	SMS charging CHF CDR parameters	93
6.5.4.2	SMS charging resources attributes.....	93
6.6	Bindings for SMS converged charging	93
Annex A (informative):	Bibliography.....	94
Annex B (informative):	Change history	95
History		97

Foreword

This Technical Specification has been produced by the 3rd Generation Partnership Project (3GPP).

The contents of the present document are subject to continuing work within the TSG and may change following formal TSG approval. Should the TSG modify the contents of the present document, it will be re-released by the TSG with an identifying change of release date and an increase in version number as follows:

Version x.y.z

where:

- x the first digit:
 - 1 presented to TSG for information;
 - 2 presented to TSG for approval;
 - 3 or greater indicates TSG approved document under change control.
- y the second digit is incremented for all changes of substance, i.e. technical enhancements, corrections, updates, etc.
- z the third digit is incremented when editorial only changes have been incorporated in the document.

1 Scope

The present document is part of a series of Technical Specifications (TSs) that specify charging functionality and charging management in 3GPP networks. The 3GPP core network charging architecture and principles are specified in TS 32.240 [2], which provides an umbrella for other charging management TSs that specify:

- the content of the CDRs per domain / subsystem / service (offline charging);
- the content of real-time charging messages per domain / subsystem / service (online charging);
- the functionality of online and offline charging for those domains / subsystems / services;
- the interfaces that are used in the charging framework to transfer the charging information (i.e. CDRs or charging events).

The complete document structure for these TSs is defined in TS 32.240 [2].

The present document specifies the Offline and Online Charging description for the Short Message Service (SMS), based on the functional description in TS 23.040 [7], TS 23.204 [8] for SMS over IP, and TS 23.682 [17] for SMS procedures using T4. The present document does not replace existing offline SMS charging functionality defined for Circuit Switched in TS 32.250 [9] and for Packet Switched in TS 32.251 [10], and therefore is in addition to those specifications. This charging description includes the offline and online charging architecture and scenarios specific to SMS, as well as the mapping of the common 3GPP charging architecture specified in TS 32.240 [2] onto SMS. It further specifies the structure and content of the CDRs for offline charging, and the charging events for online charging. The present document is related to other 3GPP charging TSs as follows:

- The common 3GPP charging architecture is specified in TS 32.240 [2];
- The parameters, abstract syntax and encoding rules for the CDRs are specified in TS 32.298 [3];
- A transaction based mechanism for the transfer of CDRs within the network is specified in TS 32.295 [6];
- The file based mechanism used to transfer the CDRs from the network to the operator's billing domain (e.g. the billing system or a mediation device) is specified in TS 32.297 [5];
- The 3GPP Diameter application that is used for SMS offline and online charging is specified in TS 32.299 [4].
- The services, operations and procedures of charging, using Service Based Interface are specified in TS 32.290 [19].
- The charging service of 5G system is specified in TS 32.291 [20].

Furthermore, requirements that govern the charging work are specified in TS 22.115 [102].

2 References

The following documents contain provisions which, through reference in this text, constitute provisions of the present document.

- References are either specific (identified by date of publication, edition number, version number, etc.) or non-specific.
- For a specific reference, subsequent revisions do not apply.
- For a non-specific reference, the latest version applies. In the case of a reference to a 3GPP document (including a GSM document), a non-specific reference implicitly refers to the latest version of that document *in the same Release as the present document*.

- [1] 3GPP TR 21.905: "Vocabulary for 3GPP Specifications".
- [2] 3GPP TS 32.240: "Telecommunication management; Charging management; Charging architecture and principles".
- [3] 3GPP TS 32.298: "Telecommunication management; Charging management; Charging Data Record (CDR) parameter description".
- [4] 3GPP TS 32.299: "Telecommunication management; Charging management; Diameter charging application".
- [5] 3GPP TS 32.297: "Telecommunication management; Charging management; Charging Data Record (CDR) file format and transfer".
- [6] 3GPP TS 32.295: "Telecommunication management; Charging management; Charging Data Record (CDR) transfer".
- [7] 3GPP TS 23.040: "Technical realization of Short Message Service (SMS)".
- [8] 3GPP TS 23.204: "Support of Short Message Service (SMS) over generic 3GPP Internet Protocol (IP) access; Stage 2".
- [9] 3GPP TS 32.250: "Telecommunication management; Charging management; Circuit Switched (CS) domain charging".
- [10] 3GPP TS 32.251: "Telecommunication management; Charging management; Packet Switched (PS) domain charging".
- [11] 3GPP TS 32.296: "Telecommunication management; Charging management; Online Charging System (OCS) applications and interfaces".
- [12] IETF RFC 4006: "Diameter Credit-Control Application".
- [13] 3GPP TS 32.270: "Telecommunication management; Charging management; Multimedia Messaging Service (MMS) charging".
- [14] 3GPP TS 23.038: "Alphabets and language-specific information".
- [15] 3GPP TS 32.260: "Telecommunication management; Charging management; IP Multimedia Services (IMS) charging".
- [16] 3GPP TS 22.142: "Value Added Services (VAS) for Short Message Service (SMS) requirements".
- [17] 3GPP TS 23.682: "Architecture enhancements to facilitate communications with packet data networks and applications".
- [18] 3GPP TS 29.337: "Diameter-based T4 interface for communications with packet data networks and applications".
- [19] 3GPP TS 32.290: "Telecommunication management; Charging management; 5G system; Services, operations and procedures of charging using Service Based Interface (SBI)".

[20]	3GPP TS 32.291: "Telecommunication management; Charging management 5G system; Charging service, stage 3".
[21]-[99]	Void.
[100]-[199]	Void.
[200]	3GPP TS 29.338: "Diameter based protocols to support Short Message Service (SMS) capable Mobile Management Entities (MMEs)".
[201]	3GPP TS 23.501: "System Architecture for the 5G System".
[202]	3GPP TS 23.502: "Procedures for the 5G System".
[203]	3GPP TS 29.061: "Interworking between the Public Land Mobile Network (PLMN) supporting packet based services and Packet Data Networks (PDN)".

3 Definitions and abbreviations

3.1 Definitions

For the purposes of the present document, the terms and definitions given in TR 21.905 [1], TS 32.240 [2] and the following apply. A term defined in the present document takes precedence over the definition of the same term, if any, in TR 21.905 [1] or TS 32.240 [2].

SMS node: An SMS node, in the present document, refers to either an SMS router, IP-SM-GW, SMS-SC, SMSF or a combination of these nodes.

3.2 Symbols

For the purposes of the present document, the following symbols apply:

Bsm	Reference point for the CDR file transfer from SMS CGF to the BD,
Ga	Reference point for CDR transfer between a CDF and the CGF.
Rf	Offline charging reference point between a 3G network element and the CDF.
Ro	Online charging reference point between a 3G network element and the OCS.T4 Reference point used between MTC-IWF and the SMS-SC in the HPLMN.

3.3 Abbreviations

For the purposes of the present document, the abbreviations given in TR 21.905 [1], TS 32.240 [2] and the following apply:

5GS	5G System
NCGI	NR Cell Global Identity

4 Architecture considerations

4.1 High level SMS architecture

The high level SMS architecture is as defined in TS 23.040 [7]. Only the SMS Router, SMS-SC, IP-SM-GW and the SMSF are within the scope of the present document. The details for the other nodes in the SMS architecture are defined in TS 32.250 [9] and TS 32.251 [10].

4.2 SMS offline charging architecture

The architecture for SMS offline charging is described in figure 4.2.1

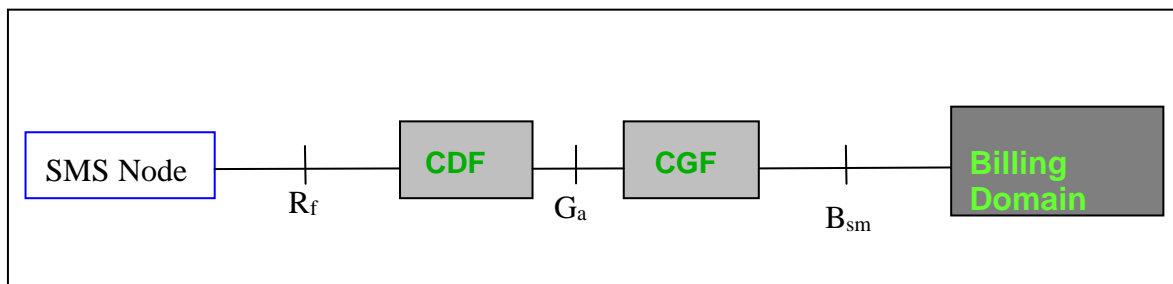

Figure 4.2.1: SMS offline charging architecture

The SMS Nodes for which this architecture applies are the SMS-SC and IP-SM-GW.

Details on the interfaces and functions can be found in TS 32.240 [2] for the general architecture components. The Rf interface is described in clause 6.1.1, Ga in clause 6.1.2, and Bsm in clause 6.1.3 of this document.

4.3 SMS online charging architecture

For online charging, the relevant SMS nodes utilise the Ro interface and application towards the OCS as specified in TS 32.299 [4]. The Ro reference point covers all online charging functionality required for SMS.

The SMS online charging architecture is depicted in figure 4.3.1

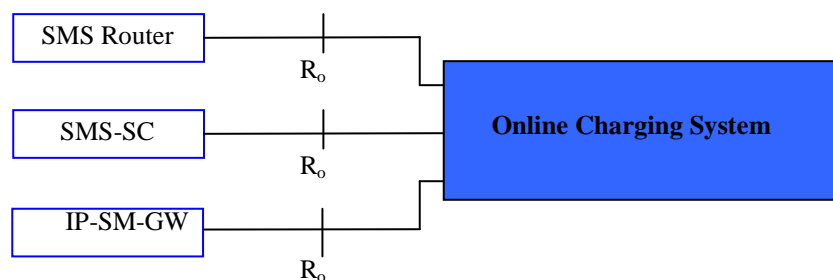

Figure 4.3.1: SMS online charging architecture

Details on the interfaces and functions can be found in TS 32.240 [2] for the general architecture components, TS 32.296 [11] for the OCS, and TS 32.299 [4] for the Ro application.

4.4 SMS converged charging architecture

The architectural options for SMS converged charging are depicted in figure 4.4.1

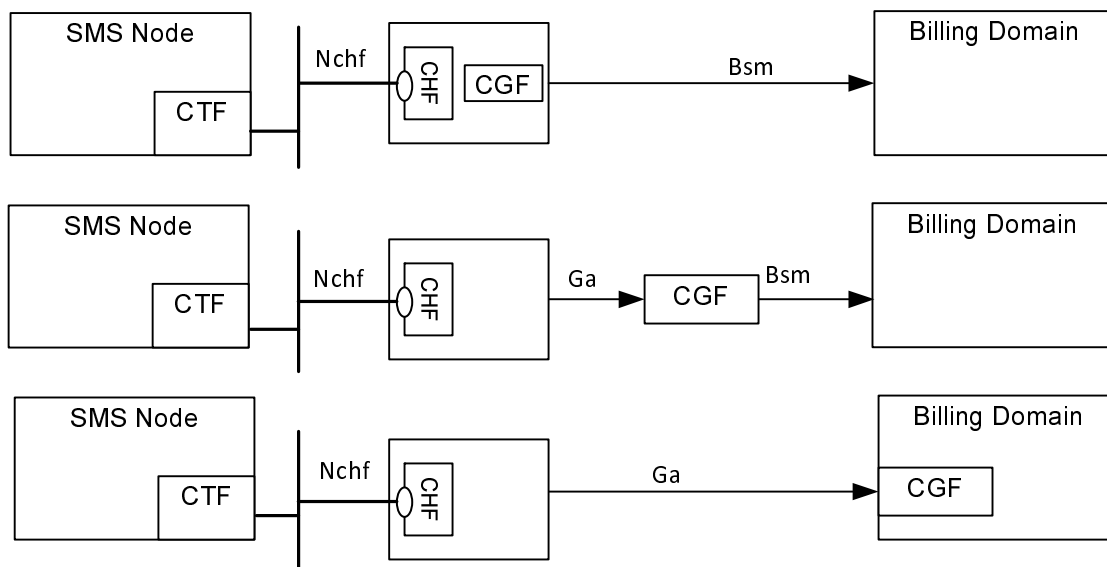

Figure 4.4.1: SMS converged charging architecture

The SMS Node for which this architecture applies is the SMSF.

The general architecture components can be found in TS 32.240 [2].

Ga is described in clause 5.2.4 and Bsm in clause 5.2.5 of this document, and Nchf is described in TS 32.290 [19].

5 SMS charging principles and scenarios

5.1 SMS charging principles

5.1.1 General principles

The Short Message Service (SMS) comprises 5 main operational scenarios:

- **Person to Person:** The message is sent by a UE as originator and received by a UE as destination.
- **Person to Application:** The message is sent by a UE as originator and received by a third party application as destination.
- **Application to Person:** The message is sent by a third party application as originator and received by a UE as destination.
- **Application to Application:** The message is sent by a third party application as originator and received by another third party application as destination.
- **Device Triggering:** the message is sent on behalf of an application as originator and received by a device as destination.
- **MSISDN-less UE to Application via T4:** the message is sent by a MSISDN-less UE as originator and received by a third party application as destination (e.g. SCS/AS) in MSISDN-less MO-SMS via T4 scenario.

In addition SMS nodes may apply services such as Value Added Services (VAS) specified in TS 22.142 [16], services defined in industry standard protocols for SM submission from applications in a fixed network (protocols such as SMPP, UCP/EMI, OIS, CIMD, etc.) or vendor specific services as endorsed by TS 23.040 [7]. As such, the SMS node collects charging information such as:

- the destination and source addresses applied for an SM;
- an indication of origination or termination handling;
- identification of the node(s) and connection(s) involved in the SM transaction;
- SM validity period;
- in scenarios involving an application / VASP, the charging information describes the identification of the application / VASP;
- requested SM service type.

5.1.2 Segmentation and concatenation

Information about concatenated messages should be sent to the charging systems in order to apply the appropriate charging models. The charging system may be required to be stateful to process information about segmented messages.

5.1.3 Triggers for generation of charging information

The following service level events shall, based on operator configuration, trigger the generation of charging information:

- Simple submission, except for device triggering – based on reception at the SMS node.
- Enhanced submission – based on completion of the transaction handling at the SMS node.
- Origination retry – based on the enhanced submission where the initial handling fails and a redelivery attempt is initiated.
- Delivery, except for device triggering – based on delivery from the SMS node.

- Delivery report – reports based on the delivery to Person.
- Termination – Application to Person scenario only.
- Termination retry – Application to Person scenario only – reattempt delivery of an SM to a terminating entity;
- SM Service request.
- SMS via T4 related events specified in clause 5.1.4.

Depending on the charging model applied, a "refund" may be necessary for unsuccessful delivery in online charging.

See clause 5.2 and 5.3 for detailed procedures associated with the triggers above for offline charging and online charging respectively.

5.1.4 SMS via T4

For the following TS 23.682 [17] procedures using T4 interface and relying on SMS capability, online and offline charging functionalities are based on SMS-SC reporting chargeable events associated with the corresponding functionalities:

- Device Triggering Function;
- MSISDN-less MO-SMS via T4.

For Device Triggering functionality, following chargeable events are considered:

- Device Trigger submitted to the SMS-SC from MTC-IWF, for request, replace and recall;
- SMS Delivery from the SMS-SC for Device Triggering towards the UE - based on delivery from the SMS node;
- SMS Delivery from the SMS-SC for Device Triggering towards the UE - based on completion of the transaction handling at the SMS node;

The protocol description for Device Triggering functionality is detailed in TS 29.337 [18].

For MSISDN-less MO-SMS via T4 functionality, allowing MSISDN-less UE to send small data to an SCS/AS (i.e. destination SME) using SMS-MO, the completion of the transaction at the SMS-SC is considered, since SMS-SC store and forward capability for MO-SMS is not used. Instead, the SMS-MO received by the SMS-SC through MO submission TS 23.040 [12]) procedures, is directly forwarded to the MTC-IWF through appropriate protocol for further transfer to the recipient SCS/AS. Also, the SMS-MO delivery answer status from MTC-IWF received by the SMS-SC is directly conveyed back to the UE.

For MSISDN-less MO-SMS via T4 functionality, the chargeable event considered is:

- MO-SMS via T4 submission - based on Delivery response from the MTC-IWF.

The protocol description for MSISDN-less MO-SMS via T4 functionality is detailed in TS 29.338 [200].

5.2 SMS offline charging scenarios

5.2.1 Basic principles

SMS offline charging functionality is based on SMS Nodes reporting chargeable events associated with SM transactions.

The SMS offline charging applies to the SMS-SC and IP-SM-GW.

SMS offline charging uses the Diameter Offline Charging as specified in TS 32.299 [4].

Event based charging applies, with reporting achieved by sending *Charging Data Request* [Event] to the CDF.

SMS transactions are collected independently by the SMS Node , or on completion handling at SMS Node (enhanced submission) .

5.2.2 Rf message flows

5.2.2.0 Introduction

The different scenarios below focus on the different message exchanges from/to the SMS Node and the corresponding message flows between the SMS Node and the CDF.

The sequence of messages exchanged between the SMS Node and the other nodes are described with generic names (i.e SMS submit, SMS deliver), to reflect SMS reception or sending by/from the SMS Node, independently from the protocol conveying the SMS.

Each message flow is applicable to different Network scenario, which are referred-to by relevant TSs.

The SMS Nodes for which these message flows apply are the SMS-SC and IP-SM-GW.

5.2.2.1 SMS Submission

Figure 5.2.2.1.1 describes the scenario where UE or a third party application originates SMS-MO destined to a recipient UE:

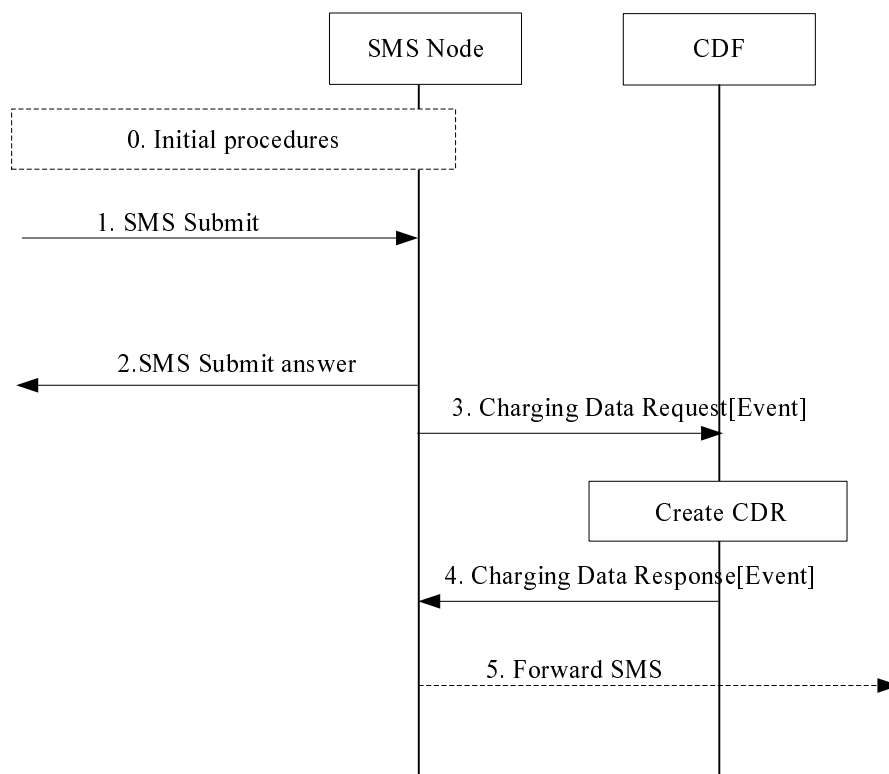

Figure 5.2.2.1.1: Offline charging - SMS submission to SMS Node

- 0) Initial procedures: see applicable Network scenario.
- 1) The SMS Node receives a "SMS Submit" incoming message originated by a UE or a third party application.
- 2) The SMS Node returns "SMS Submit Answer" with appropriate result associated to the reception of the SM: successfully received by SMS-SC or failed due to error at SMS Node.
- 3) The SMS Node triggers a *Charging Data Charging Data Request* with *Operation Type* indicating *EVENT_RECORD* to record successful or unsuccessful reception of the SM, with originator identified as UE or as a third party application, depending on the scenario.

NOTE: In the scenario where a third party application is originator, sending application identification to the CDF allows to apply accurate charging model of Termination scenario, i.e. recipient UE to be charged for the delivered SM, instead of originator or both parties.

- 4) The CDF creates a SMO CDR and acknowledges the reception of the data.
- 5) Forward SMS per applicable Network scenario.

The table 5.2.2.1.1 describes the correspondence between the message in this scenario, and the message in the different Network scenario for which it is applicable.

Table 5.2.2.1.1: Messages mapping

Message	Message in Network scenario	Reference
1. SMS submit	10a. Message Transfer	TS 23.040[7] Figure 18a): Successful short message transfer attempt
	3. Message	TS 23.204[8] Figure 6.3: Successful encapsulated Short Message origination procedure
	3. Delivery report	TS 23.204[8] Figure 6.5: Delivery report procedure
2. SMS submit answer	10b. Delivery report	TS 23.040[7] Figure 18a): Successful short message transfer attempt
	4. Accepted	TS 23.204[8] Figure 6.3: Successful encapsulated Short Message origination procedure
	4. Accepted	TS 23.204[8] Figure 6.5: Delivery report procedure
5. Forward SMS	Not applicable	TS 23.040[7] Figure 18a): Successful short message transfer attempt
	6. Forward short message	TS 23.204[8] Figure 6.3: Successful encapsulated Short Message origination procedure
	6. Delivery report	TS 23.204[8] Figure 6.5: Delivery report procedure

5.2.2.2 SMS Delivery

Figure 5.2.2.2.1 describes the scenario where SMS Node originates SM transfer towards the receiving party.

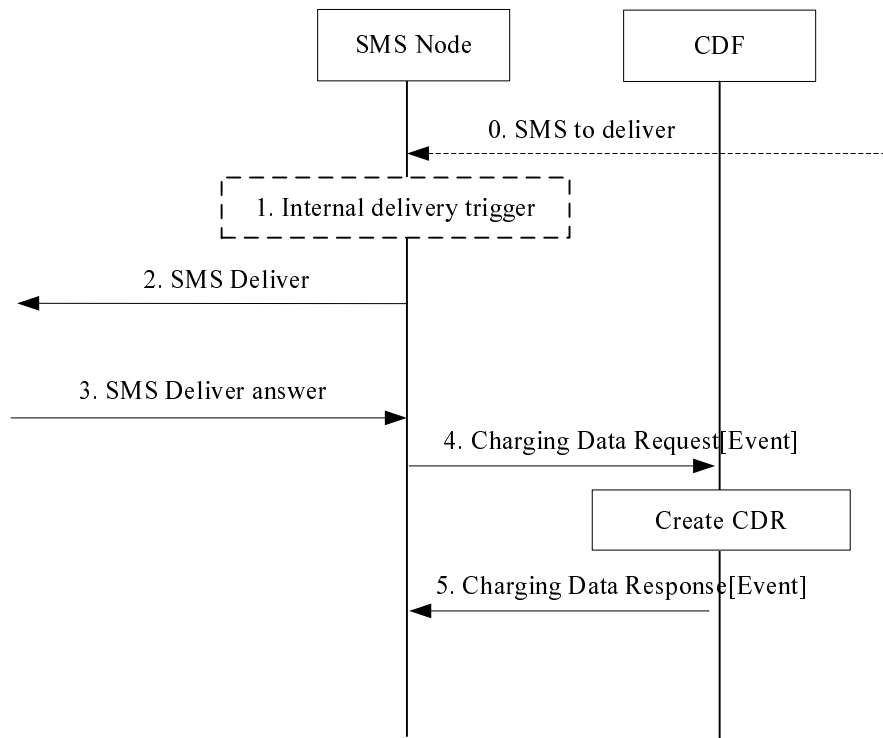

Figure 5.2.2.2.1: Offline charging SMS Transfer from SMS Node

- 0) "SMS to deliver" optionally received by SMS Node in order to deliver a MT SMS towards the UE: see applicable Network scenario.
- 1) The SMS Node decides to forward "SMS Deliver" message towards the receiving party, as a first attempt (based on step 0) or due to internal trigger for a retry delivery of a previously failed and stored SM.
- 2) The SMS Node forwards the "SMS Deliver" message towards the receiving party.
- 3) The SMS Node receives "SMS Deliver Answer" message as the delivery success or failure of the SM transfer attempt.
- 4) The SMS Node triggers a Charging Data Request[Event] to record successful or unsuccessful result of SM delivery.
- 5) The CDF creates a SMT CDR and acknowledges the reception of the data.

The table 5.2.2.2.1 describes the correspondence between the message in this scenario, and the message in the different Network scenario for which it is applicable.

Table 5.2.2.2.1: Messages mapping

Message	Message in Network scenario	Reference
1. SMS to deliver	Not applicable	TS 23.040[7] Figure 15a): Successful short message transfer attempt via the MSC or the SGSN
	4. Forward short message	TS 23.204 [8] Figure 6.4: Successful encapsulated Short Message termination procedure
	9. Submit report	TS 23.204[8] Figure 6.3: Successful encapsulated Short Message origination procedure
3. SMS deliver	1a. Message transfer	TS 23.040[7] Figure 15a): Successful short message transfer attempt via the MSC or the SGSN
	6. Message	TS 23.204[8] Figure 6.4: Successful encapsulated Short Message termination procedure
	10. Submit report	TS 23.204[8] Figure 6.3: Successful encapsulated Short Message origination procedure
4. SMS deliver answer	Not shown	TS 23.040[7] Figure 15a): Successful short message transfer attempt via the MSC or the SGSN
	9. OK	TS 23.204 [8] Figure 6.4: Successful encapsulated Short Message termination procedure
	13. OK	TS 23.204[8] Figure 6.3: Successful encapsulated Short Message origination procedure

5.2.2.3 Delivery Report

Delivery Report or Status Report (SC informing the originating UE of the delivery outcome of a previously submitted short message) issued by the SMS Node uses the same procedures as the "SMS Delivery from the SMS Node" described within clause 5.2.2.2, as it is contained within a new SM.

5.2.2.4 Device Triggering using T4

5.2.2.4.1 SMS submission to SMS-SC for Device Triggering

Figure 5.2.2.4.1.1 describes the scenario where the MTC-IWF submits a request to SMS-SC for SM transfer towards the UE for Device Triggering purpose.

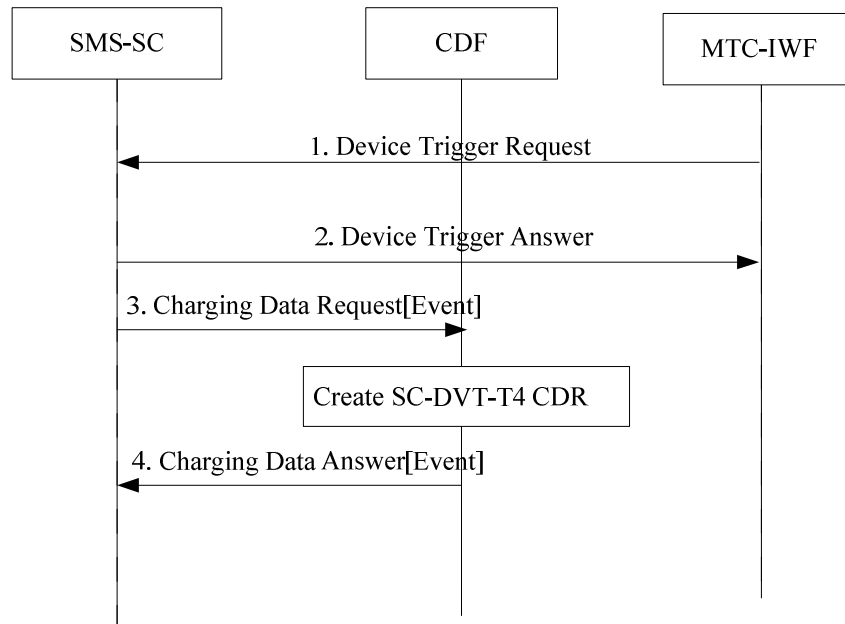

Figure 5.2.2.4.1.1: Offline charging - SMS submission to SMS-SC for Device Triggering

- 1) The SMS-SC receives an incoming "Device Trigger Request" from an MTC-IWF over T₄, destined to a UE recipient.
- 2) The SMS-SC returns "Device Trigger Answer" with appropriate result associated to the reception of the trigger request: successfully received by SMS-SC or failed due to error at SMS-SC.
- 3) The SMS-SC triggers a *Charging Data Request* with *Operation Type* indicating EVENT_RECORD to record successful or unsuccessful reception of the SM from the MTC-IWF, with originator identified as SCS Identity.
- 4) The CDF creates a SC- DVT-T4 CDR and acknowledges the reception of the data.

5.2.2.4.2 SMS Delivery from SMS-SC for Device Triggering

Figure 5.2.2.4.2.1 describes the scenario where SMS-SC originates the SMS Device Triggering transfer towards the UE.

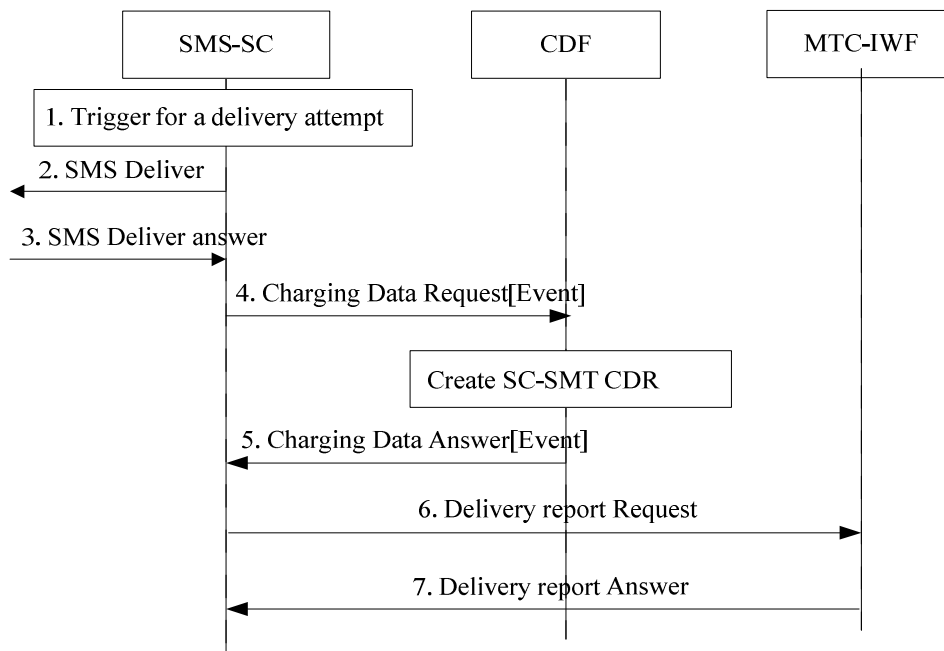

Figure 5.2.2.4.2.1: Offline charging - SMS delivery for Device Triggering

- 1) The SMS-SC decides to forward "SMS Deliver" message towards the receiving party, as a first attempt upon device trigger request received from MTC-IWF, or due to internal trigger for a retry delivery of a previously failed and stored SM for Device Triggering, or internal trigger for a first attempt of a previously stored SM.
- 2) The SMS-SC forwards the "SMS Deliver" message towards the receiving party.
- 3) The SMS-SC receives "SMS Deliver Answer" message as the delivery success or failure of the SM transfer attempt.
- 4) The SMS-SC triggers a Charging Data Request[Event] to record successful or unsuccessful result of SM delivery, including a value for "Device Triggering indication".
- 5) The CDF creates a SC-SMT CDR and acknowledges the reception of the data.
- 6) The SMS-SC sends "Delivery Report Request" to MTC-IWF with appropriate result associated to the successful delivery of the device trigger to the UE.
- 7) The MTC-IWF acknowledges by sending "Delivery Report Answer".

5.2.2.4.3 SMS Device Triggering Delivery Report

The SMS Device Triggering Delivery Report corresponds to the SMS-SC reporting the Delivery Report of Device Trigger to the MTC-IWF in the scenario described in clause 5.2.2.4.2. The Delivery Report itself is not a trigger for a charging event.

5.2.2.4.4 SMS submission to SMS-SC for Device Triggering - Replace procedure

Figure 5.2.2.4.4.1 describes the scenario where the MTC-IWF submits a request to SMS-SC for a replace procedure of Device Triggering:

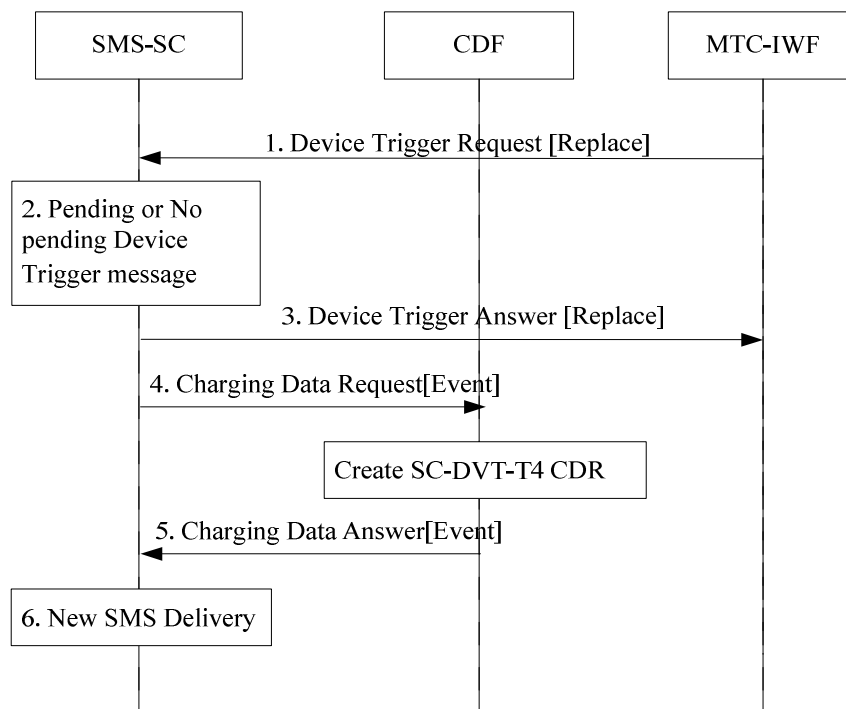

Figure 5.2.2.4.4.1: Offline charging - SMS submission to SMS-SC for replace Device Triggering

- 1) The SMS-SC receives an incoming "Device Trigger Request" indicating "Replace" from an MTC-IWF over T₄.
- 2) If the SMS-SC determines the trigger message identified by the External Identifier or MSISDN, SCS Identifier, and old trigger reference number in the received Device Trigger Replace message, is pending at SMS-SC, the new trigger message replaces the previous one. If no trigger message is pending this corresponds to a failed replace procedure.
- 3) The SMS-SC returns "Device Trigger Answer" with appropriate result of the successful or unsuccessful replace procedure.
- 4) The SMS-SC triggers a Charging Data Request[Event] to record successful or unsuccessful result of the replace procedure.
- 5) The CDF creates a SC-DVT-T4 CDR and acknowledges the reception of the data.
- 6) In case of successful replace, the new SM to be delivered uses the same procedure as per clause 5.2.2.4.2.1.

5.2.2.4.5 SMS submission to SMS-SC for Device Triggering - Recall procedure

Figure 5.2.2.4.5.1 describes the scenario where the MTC-IWF submits a request to SMS-SC for a recall procedure for Device Triggering:

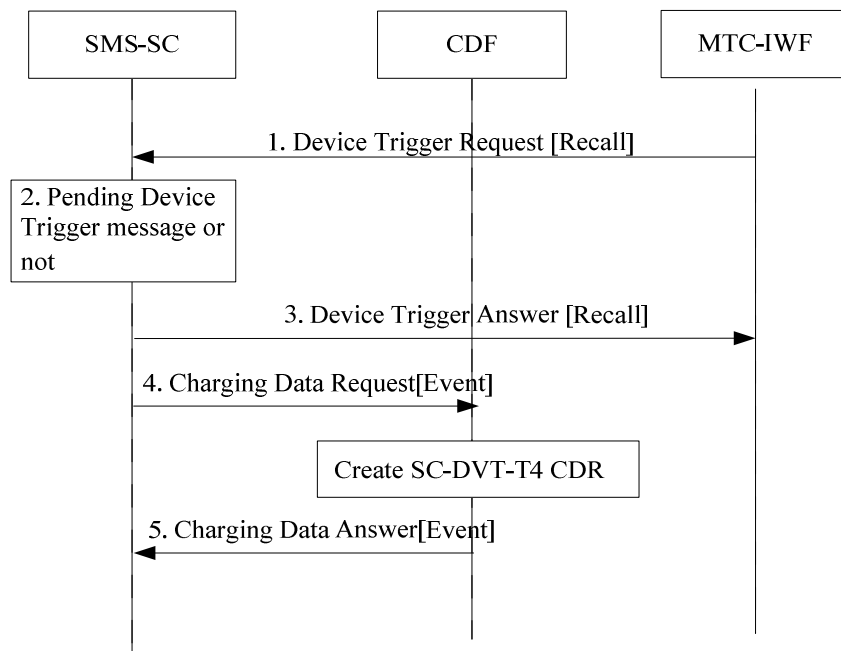

Figure 5.2.2.4.5.1: Offline charging - SMS submission to SMS-SC for recall Device Triggering

- 1) The SMS-SC receives an incoming "Device Trigger Request" indicating "Recall" from an MTC-IWF over T₄.
- 2) The SMS-SC determines the trigger message identified by the External Identifier or MSISDN, SCS Identifier, and old trigger reference number in the received Device Trigger Recall message, is pending at SMS-SC. The stored trigger message is deleted.
- 3) The SMS-SC returns "Device Trigger Answer" with appropriate result of the recall procedure.
- 4) The SMS-SC triggers a Charging Data Request[Event] to record successful or unsuccessful result of the recall procedure.
- 5) The CDF creates a SC-DVT-T4 CDR and acknowledges the reception of the data.

5.2.2.5 Offline charging error cases - Diameter procedures

The Offline Charging error cases in Diameter (Accounting) Related Procedures associated to *Charging Data Request /Response*, from SMS node as network element are specified in TS 32.299 [4] clause 6.1.3.

5.2.2.6 MSISDN-less SMS MO via T4

5.2.2.6.1 Introduction

The message flows associated to the MSISDN-less SMS MO via T₄, illustrate the triggers occurring in the SMS-SC Node. As specified in TS 23.682 [17], the SMS delivery procedures to SMS-SC and SMS delivery report from SMS-SC are per TS 23.040 [12], therefore involving SMS-GMSC/SMS-IW MSC depending on the scenario. However, per this TS 23.040 [12], the interface between the SMS-GMSC/SMS-IW MSC and the SMS-SC is out of scope of 3GPP, therefore SMS-GMSC/SMS-IW MSC are assumed as internal to SMS-SC for the charging flows with triggers description.

5.2.2.6.2 MSISDN-less SMS MO via T4 - successful case

Figure 5.2.2.6.2.1 describes the scenario where MSISDN-less UE originates SMS-MO destined to a recipient SCS/AS using MSISDN-less SMS MO via T₄ procedure:

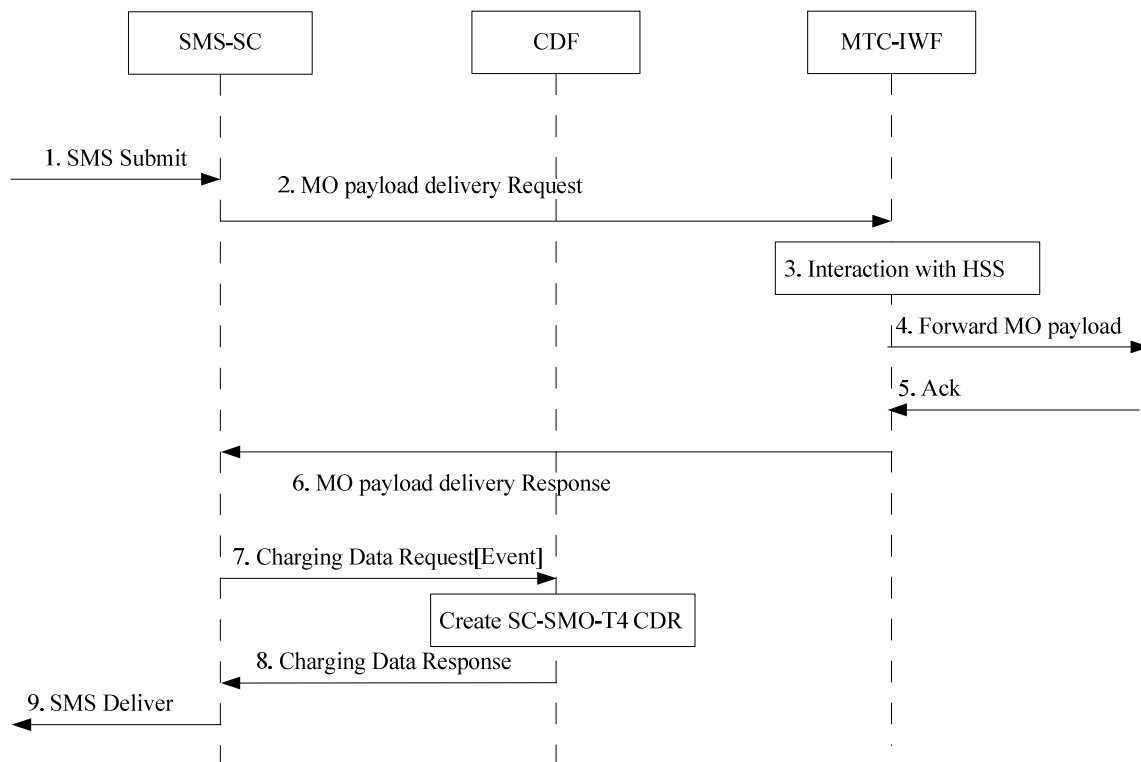

Figure 5.2.2.6.2.1: Offline charging MSISDN-less SMS MO via T4 – successful case

- 1) The SMS-SC receives a "SMS Submit" incoming message originated by a MSISDN-less UE to deliver small data to SCS/AS.
- 2) The SMS-SC sends the "MO payload delivery Request" message to the MTC-IWF address (as pre-configured in the SMS-SC for this SCS/AS), with the SMS payload and the destination SME address (long/short code of the SCS/AS).
- 3) The MTC-IWF retrieves the external ID from the HSS (based on the IMSI of the UE and application port ID).
- 4-5) The MTC-IWF forwards the SMS to the SCS/AS (received destination SME), and receives the successful or failure answer.
- 6) The MTC-IWF returns a success or failure delivery indication to SMS-SC, along with the external identifier associated to this transaction.
- 7) The SMS-SC triggers a *Charging Data Request* with *Operation Type* indicating *EVENT_RECORD* to record successful or unsuccessful delivery of the SM.
- 8) The CDF creates a SC-SMO-T4 CDR and acknowledges the reception of the data.
- 9) The SMS-SC indicates success/failure back to UE.

5.2.2.6.3 MSISDN-less SMS MO via T4 - error cases

5.2.2.6.3.1 MSISDN-less SMS MO via T4 - failure at submission to SMS-SC

Figure 5.2.2.6.3.1.1 describes the scenario where MSISDN-less UE originates SMS-MO destined to a recipient SCS/AS using MSISDN-less SMS MO via T4 procedure, and failure at submission to SMS-SC:

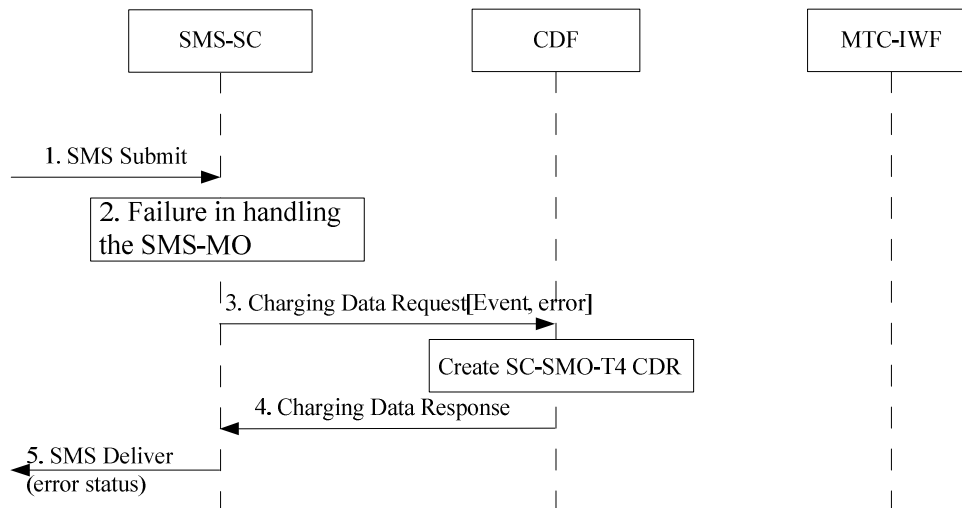

Figure 5.2.2.6.3.1.1: Offline charging MSISDN-less SMS MO via T4 – failure at submission

- 1) The SMS-SC receives a "SMS Submit" incoming message originated by a MSISDN-less UE to deliver small data to SCS/AS.
- 2) Failure in handling the submitted SMS-MO in the SMS-SC.
- 3) The SMS-SC triggers a *Charging Data Charging Data Request* with *Operation Type* indicating *EVENT_RECORD* to record the unsuccessful delivery of the SM.
- 4) The CDF creates a SC-SMO-T4 CDR and acknowledges the reception of the data.
- 5) The SMS-SC indicates the failure back to UE.

5.2.2.6.3.2 MSISDN-less SMS MO via T4 - failure at the MTC-IWF

Figure 5.2.2.6.3.2.1 describes the scenario where MSISDN-less UE originates SMS-MO destined to a recipient SCS/AS using MSISDN-less SMS MO via T4 procedure, and failure at the MTC-IWF:

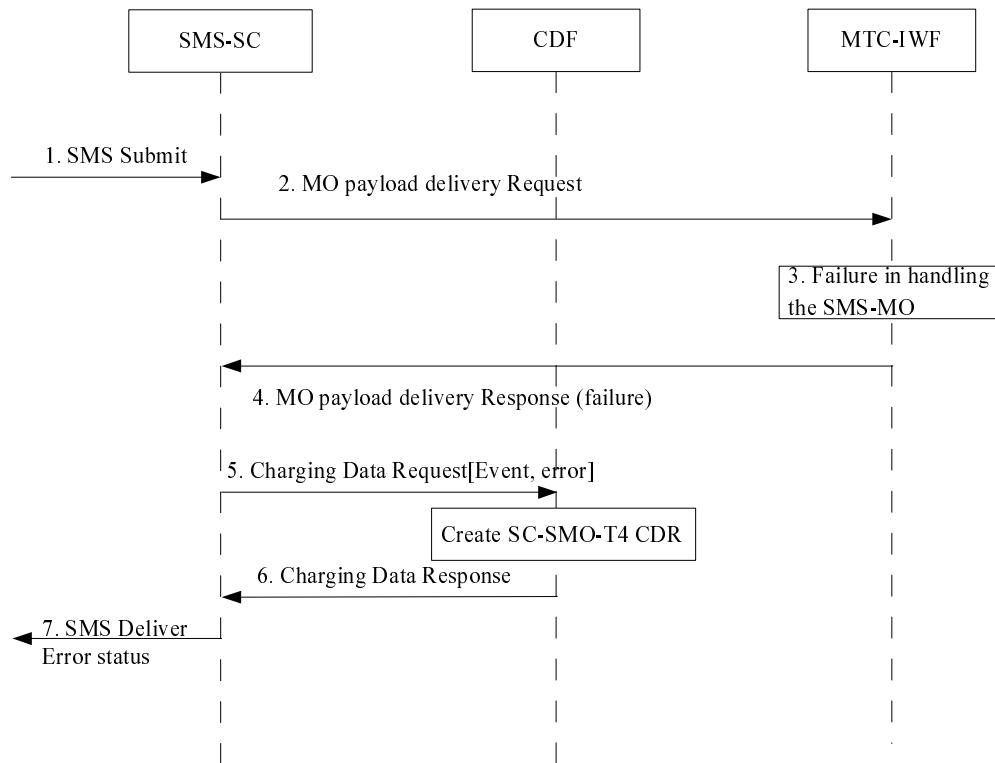

Figure 5.2.2.6.3.2.1; Offline charging MSISDN-less SMS MO via T4 - failure at the MTC-IWF

- 1) The SMS-SC receives a "SMS Submit" incoming message originated by a MSISDN-less UE to deliver small data to SCS/AS.
- 2) The SMS-SC sends the "MO payload delivery Request" message to the MTC-IWF address (as pre-configured in the SMS-SC for this SCS/AS), with the SMS payload and the destination SME address (long/short code of the SCS/AS).
- 3) Failure in handling the submitted SMS-MO in the MTC-IWF.
- 4) The MTC-IWF returns the failure delivery indication to SMS-SC.
- 5) The SMS-SC triggers a *Charging Data Charging Data Request* with *Operation Type* indicating *EVENT_RECORD* to record the unsuccessful delivery of the SM.
- 6) The CDF creates a SC-SMO-T4 CDR and acknowledges the reception of the data.
- 7) The SMS-SC indicates the failure back to UE.

5.2.3 CDR generation

5.2.3.0 Triggers for SMS CDR generation

SMS related CDRs (i.e. SC-SMO, SC-SMT, ISM-SMO, ISM-SMT, SC-SMO-T4 and SC-DVT-T4 CDRs) are used to collect charging information related to individual Charging Data Request [Event]. A single CDR is generated by the CDF for each event, and subsequently transferred to the Charging Gateway Function (CGF).

5.2.3.1 Triggers for SMS CDR charging information collection

The triggers for CDR creation are described in clause 5.2.3.0.

5.2.3.2 Triggers for SMS CDR charging information addition

The triggers for CDR creation are described in clause 5.2.3.0.

5.2.3.3 Triggers for SMS CDR closure

The triggers for CDR creation are described in clause 5.2.3.0.

5.2.4 Ga record transfer flows

Details of the Ga protocol application are specified in TS 32.295 [6].

5.2.5 B_{sm} CDR file transfer

Details of the Bsm protocol application are specified in TS 32.297 [5].

5.3 SMS online charging scenarios

5.3.1 Basic principles

SMS online charging uses the Credit-Control application as specified in TS 32.299 [4].

SMS charging may use the Immediate Event Charging (IEC) principle or the Event Charging with Unit Reservation (ECUR) principle as specified in TS 32.299 [4]. The chargeable events for subscriber charging are associated with SM transactions.

An implementation may use either IEC or ECUR for charging events based on operator configuration.

The units used for quota shall be service specific and based on an SM.

The selection of the OCS is implementation specific as there is no guaranteed means of providing the OCS address to the CTF.

In addition, SMS charging may use the Refund Account principle when the operation has not been successfully completed after an IIEC.

NOTE: For SMSIP, the IP-SM-GW may receive information relevant for online charging through signalling in IMS.

5.3.2 R_o message flows

5.3.2.1 Simple submission

This clause contains message flows for the different operation models IEC (figure 5.3.2.1.1) and ECUR (figure 5.3.2.1.2).

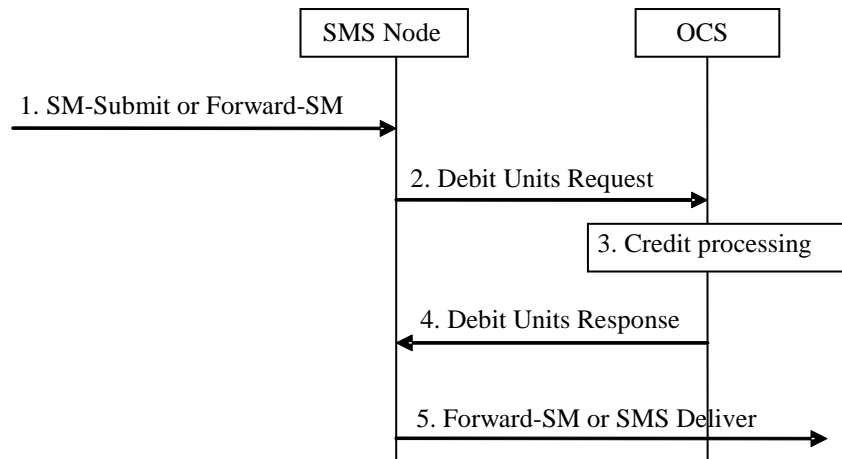

Figure 5.3.2.1.1: Online charging in simple submission for IEC

- 1) Depending on which SMS mechanism (i.e. SMS or SMSIP) is in operation, the SMS node receives an incoming SM-Submit or a MAP-Forward-SM.
- 2) The SMS node triggers a Debit Units Request message to the OCS.
- 3) The OCS performs the appropriate credit processing based on the received request.
- 4) The OCS responds with a Debit Units Response message to the SMS node.
- 5) If authorized, the SMS node continues the SM processing as appropriate for the origination procedures.

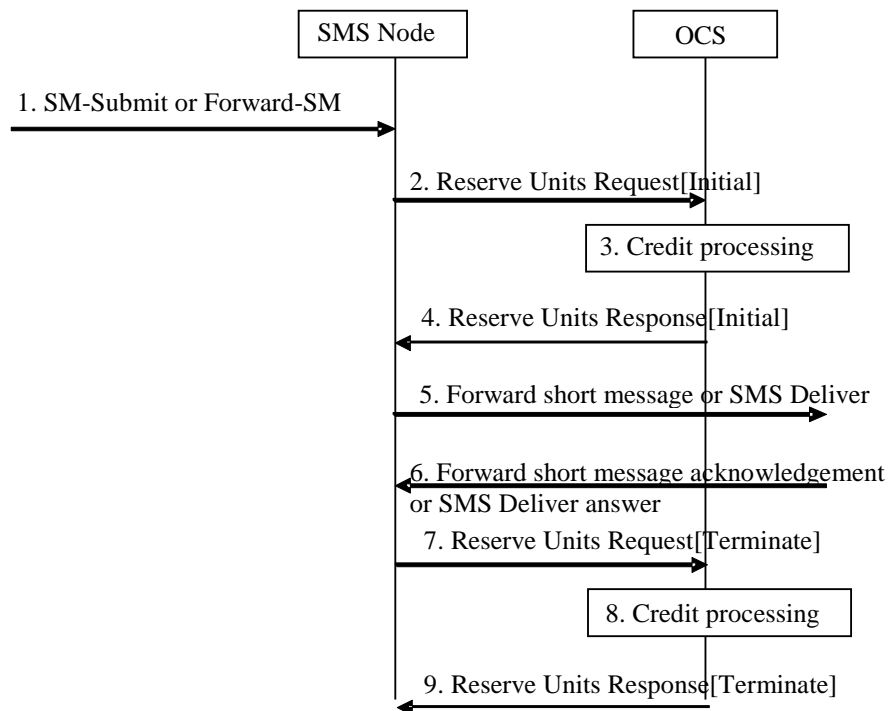

Figure 5.3.2.1.2: Online charging in simple submission for ECUR

- 1) Depending on which SMS mechanism (i.e. SMS or SMSIP) is in operation, the SMS node receives an incoming SM-Submit or a MAP-Forward-SM.
- 2) The SMS node triggers a Reserve Units Request [Initial] message to the OCS.
- 3) The OCS performs the appropriate credit processing based on the received request.
- 4) The OCS responds with a Reserve Units Response message to the SMS node.
- 5) If authorized, the SMS node continues the SM processing as appropriate for the origination procedures.
- 6) The SM transaction is successfully acknowledged.
- 7) The SMS node triggers a Reserve Units Request [Terminate] message to the OCS reporting the successful event transaction.
- 8) The OCS performs the appropriate credit processing based on the received request.
- 9) The OCS responds with a Reserve Units Response message to the SMS node.

5.3.2.2 Enhanced submission

The enhanced submission procedures are similar to the simple submission procedures using ECUR. However, the trigger for Reserve Units Request (Terminate) may be based on unsuccessful handling, e.g. negative acknowledgement and with or without successful storage of the message for future redelivery attempts. See failure scenarios defined in clause 5.3.2.7.

5.3.2.3 Delivery report

The origination of delivery reports use the same procedures as the simple submission procedures as described within clause 5.3.2.1. The delivery report itself is contained within a new SM.

5.3.2.4 Origination retry

This clause contains message flows for the different operation models IEC (figure 5.3.2.4.1) and ECUR (figure 5.3.2.4.2) for redelivery attempts in the origination direction.

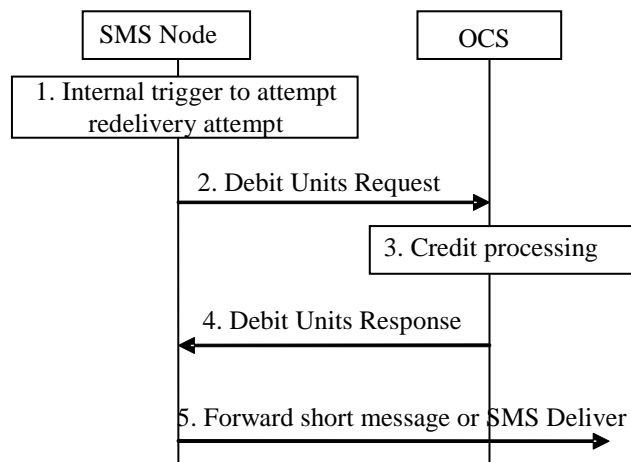

Figure 5.3.2.4.1: Online charging in origination redelivery attempt for IEC

- 1) An SMS node internal trigger occurs to attempt a redelivery of a previously failed and stored SM.
- 2) The SMS node triggers a Debit Units Request message to the OCS.
- 3) The OCS performs the appropriate credit processing based on the received request.
- 4) The OCS responds with a Debit Units Response message to the SMS node.
- 5) If authorized, the SMS node continues the SM processing as appropriate for the origination procedures.

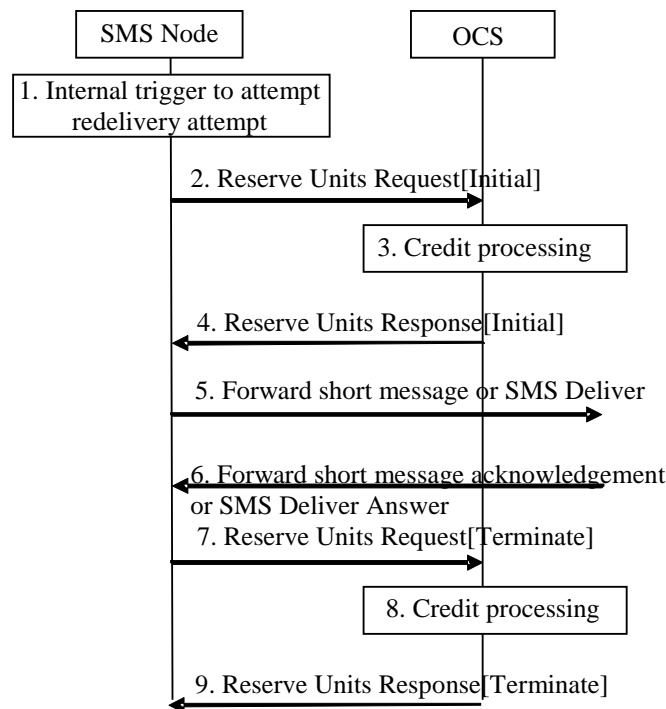

Figure 5.3.2.4.2: Online charging in origination redelivery attempt for ECUR

- 1) An SMS node internal trigger occurs to attempt a redelivery of a previously failed and stored SM.
- 2) The SMS node triggers a Reserve Units Request[Initial] message to the OCS.
- 3) The OCS performs the appropriate credit processing based on the received request.
- 4) The OCS responds with a Reserve Units Response message to the SMS node.
- 5) If authorized, the SMS node continues the SM processing as appropriate for the origination or termination procedures.
- 6) The SM transaction is successfully acknowledged.
- 7) The SMS node triggers a Reserve Units Request[Terminate] message to the OCS reporting the successful event transaction.
- 8) The OCS performs the appropriate credit processing based on the received request.
- 9) The OCS responds with a Reserve Units Response message to the SMS node.

5.3.2.5 Termination charge

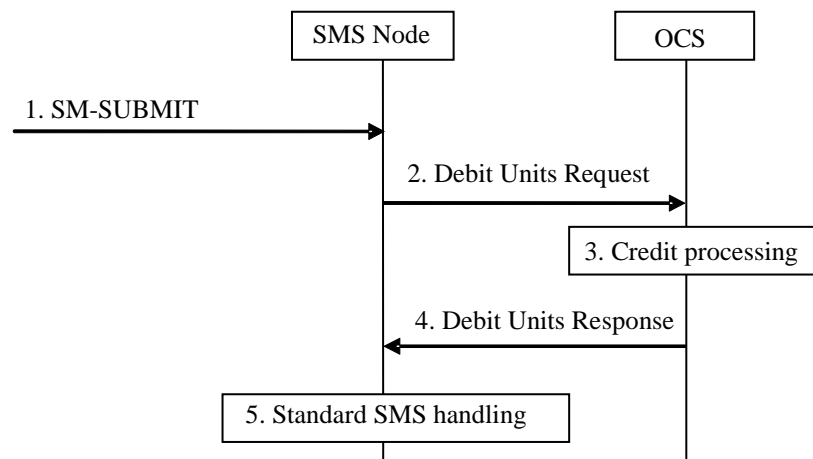

Figure 5.3.2.5.1: Online charging in termination for IEC

1) The SMS node receives an incoming SM-SUBMIT from an application destined for a mobile recipient.

NOTE: This scenario differs from simple submission charging as described in clause 5.3.2.1 in that typically the mobile recipient (instead of originator or both parties) will be charged for such a short message.

2) The SMS node triggers a Debit Units Request message to the OCS.

3) The OCS performs the appropriate credit processing based on the received request.

4) The OCS responds with a Debit Units Response message to the SMS node.

5) If authorized, the SMS node continues the SM processing as appropriate for the termination procedures.

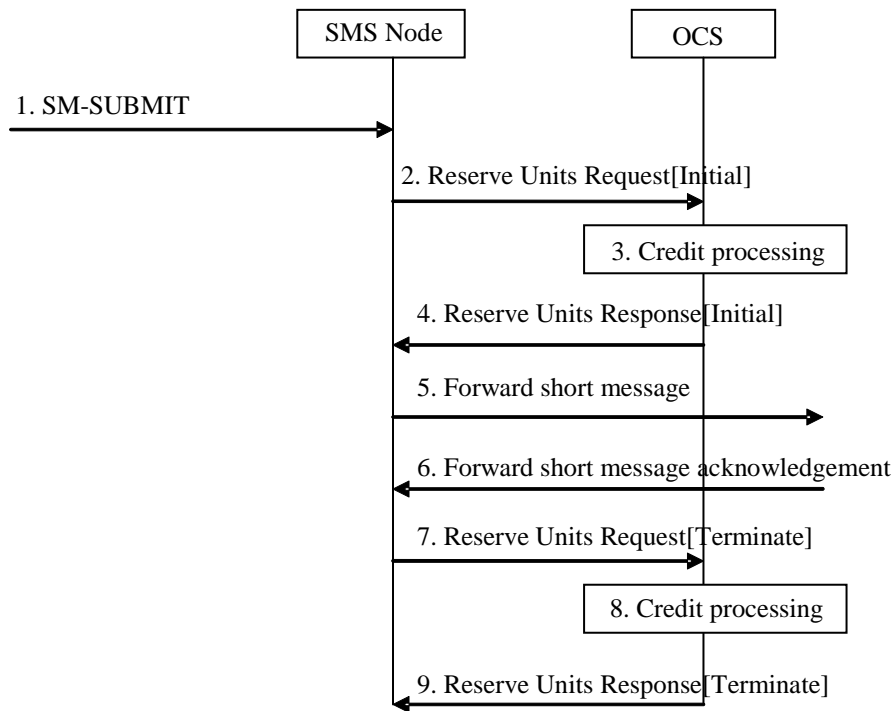

Figure 5.3.2.5.2: Online charging in termination for ECUR

1) The SMS node receives an incoming SM-SUBMIT from an application destined for a mobile recipient.

NOTE: This scenario differs from simple submission charging as described in clause 5.3.2.1 in that typically the mobile recipient (instead of originator or both parties) will be charged for such a short message.

2) The SMS node triggers a Reserve Units Request [Initial] message to the OCS.

3) The OCS performs the appropriate credit processing based on the received request.

4) The OCS responds with a Reserve Units Response message to the SMS node.

5) If authorized, the SMS node continues the SM processing as appropriate for the termination procedures.

6) The SM transaction is successfully acknowledged.

7) The SMS node triggers a Reserve Units Request [Terminate] message to the OCS reporting the successful event transaction.

8) The OCS performs the appropriate credit processing based on the received request.

9) The OCS responds with a Reserve Units Response message to the SMS node.

5.3.2.6 Termination charge retry

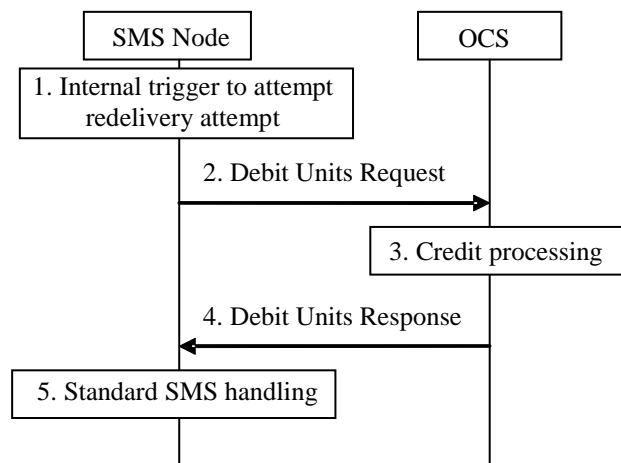

Figure 5.3.2.6.1: Online charging in termination redelivery attempt for IEC

- 1) An SMS node internal trigger occurs to attempt a redelivery of a previously failed and stored SM.
- 2) The SMS node triggers a Debit Units Request message to the OCS.
- 3) The OCS performs the appropriate credit processing based on the received request.
- 4) The OCS responds with a Debit Units Response message to the SMS node.
- 5) If authorized, the SMS node continues the SM processing as appropriate for the termination procedures.

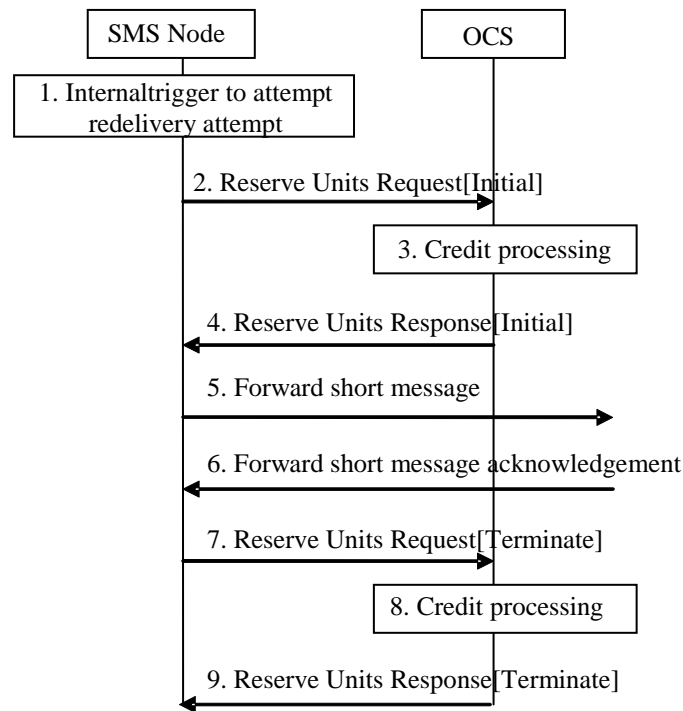

Figure 5.3.2.6.2: Online charging in termination redelivery attempt for ECUR

- 1) An SMS node internal trigger occurs to attempt a redelivery of a previously failed and stored SM.
- 2) The SMS node triggers a Reserve Units Request[Initial] message to the OCS.
- 3) The OCS performs the appropriate credit processing based on the received request.
- 4) The OCS responds with a Reserve Units Response message to the SMS node.
- 5) If authorized, the SMS node continues the SM processing as appropriate for the termination procedures.
- 6) The SM transaction is successfully acknowledged.
- 7) The SMS node triggers a Reserve Units Request[Terminate] message to the OCS reporting the successful event transaction.
- 8) The OCS performs the appropriate credit processing based on the received request.
- 9) The OCS responds with a Reserve Units Response message to the SMS node.

5.3.2.7 Unsuccessful transaction

Unsuccessful transaction after IEC

Figure 5.3.2.7.1 only applies where a refund action is required for unsuccessful delivery.

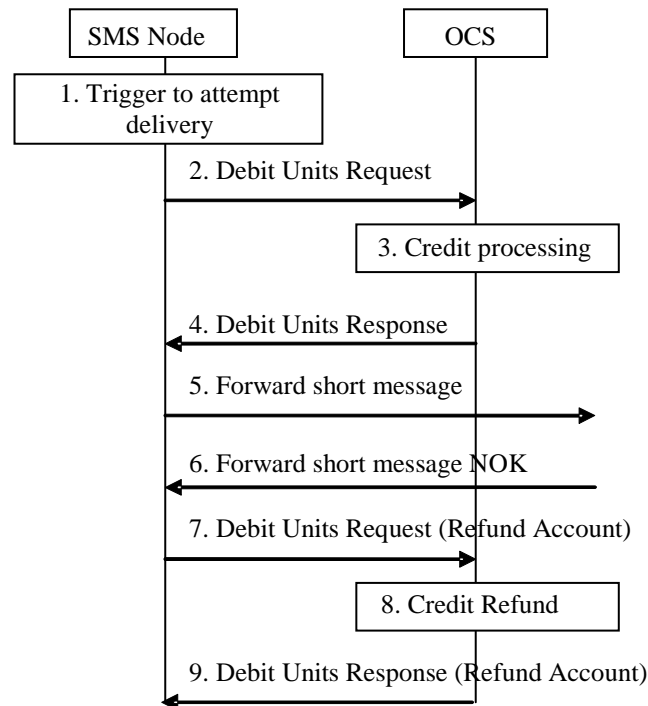
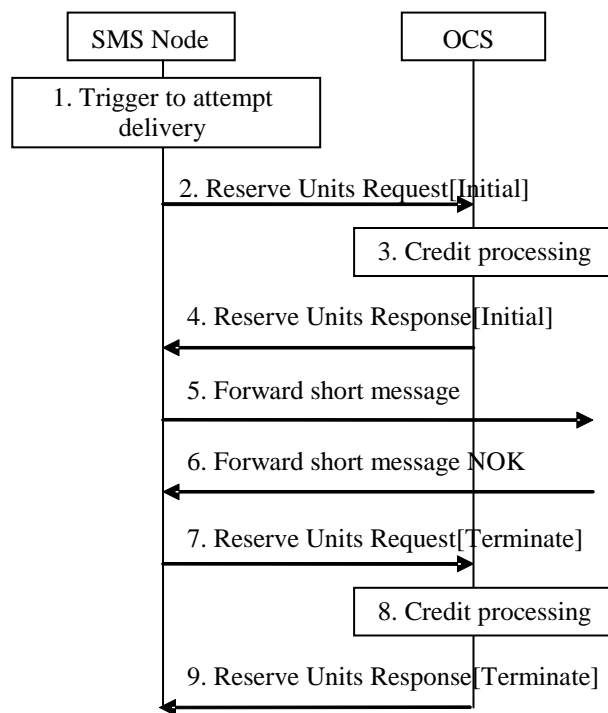

Figure 5.3.2.7.1: Unsuccessful transaction after IEC

- 1) The SMS node receives a trigger to attempt delivery of an SM. This may be for origination, termination or redelivery attempt.
- 2) The SMS node triggers a Debit Units Request message to the OCS.
- 3) The OCS performs the appropriate credit processing based on the received request.
- 4) The OCS responds with a Debit Units Response message to the SMS node.
- 5) If authorized, the SMS node continues the SM processing as appropriate for origination or termination procedures.
- 6) The SM transaction is acknowledged as an unsuccessful transaction (either via explicit signalling or an internal trigger).
- 7) The SMS node triggers a Debit Units Request (Refund Account) message to the OCS.
- 8) The OCS performs the appropriate refund processing based on the received request.
- 9) The OCS responds with a Debit Units Response (Refund Account) message to the SMS node.

Unsuccessful transaction in ECUR**Figure 5.3.2.7.2: Unsuccessful transaction for ECUR**

- 1) The SMS node receives a trigger occurs to attempt delivery of an SM. This may be for origination, termination or redelivery attempt.
- 2) The SMS node triggers a Reserve Units Request[Initial] message to the OCS.
- 3) The OCS performs the appropriate credit processing based on the received request.
- 4) The OCS responds with a Reserve Units Response message to the SMS node.
- 5) If authorized, the SMS node continues the SM processing as appropriate for the origination or termination procedures.
- 6) The SM transaction is acknowledged as an unsuccessful transaction (either via explicit signalling or an internal trigger).
- 7) The SMS node triggers a Reserve Units Request[Terminate] message to the OCS reporting the used unit for the service to zero. This characterizes the unsuccessful event transaction.
- 8) The OCS performs the appropriate credit processing based on the received request.
- 9) The OCS responds with a Reserve Units Response message to the SMS node.

5.3.2.8 IMS/SMS Interworking Messages Charging

This clause contains message flows for the different operation models IEC (figure 5.3.2.8.1) and ECUR (figure 5.3.2.8.2) for IMS/SMS Interworking messages in the origination direction.

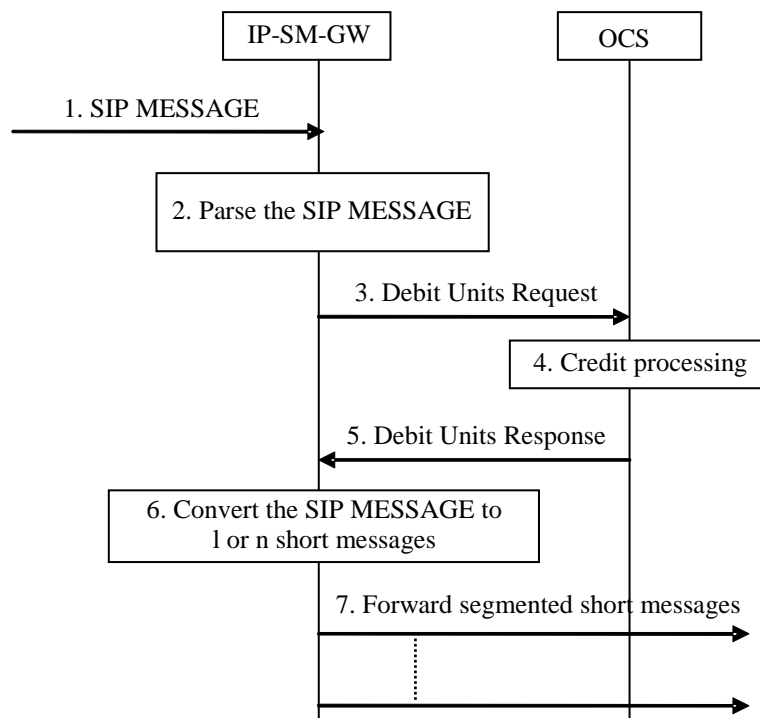

Figure 5.3.2.8.1: Online charging in origination IMS/SMS Interworking Messages for IEC

- 1) The IP-SM-GW receives an incoming SIP MESSAGE.
- 2) The IP-SM-GW parses the SIP MESSAGE.
- 3) The IP-SM-GW triggers a Debit Units Request message to the OCS.
- 4) The OCS performs the appropriate credit processing based on the received Debit Units Request.
- 5) The OCS responds with a Debit Units Response message to the IP-SM-GW.
- 6) IP-SM-GW converts the SIP MESSAGE to 1 or n ($n \geq 1$) short messages.
- 7) If authorized, the IP-SM-GW forwards the segmented short messages.

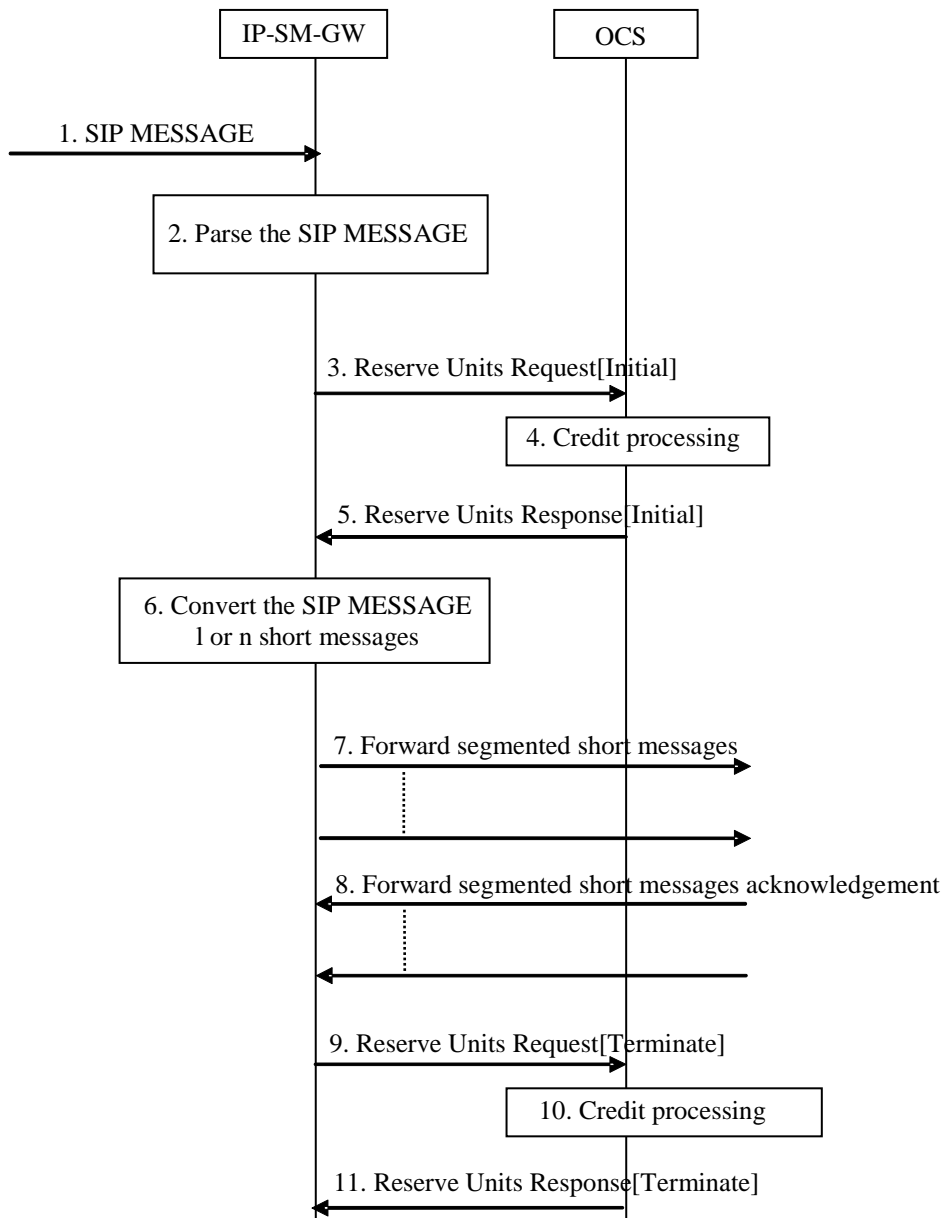

Figure 5.3.2.8.2: Online charging in origination IMS/SMS Interworking Messages for ECUR

- 1) The IP-SM-GW receives an incoming SIP MESSAGE.
- 2) The IP-SM-GW parses the SIP MESSAGE.
- 3) The IP-SM-GW triggers a Reserve Units Request[Initial] message to the OCS.
- 4) The OCS performs the appropriate credit processing based on the received Reserve Units Request.
- 5) The OCS responds with a Reserve Units Response message to the IP-SM-GW.
- 6) IP-SM-GW converts the SIP MESSAGE to 1 or n ($n \geq 1$) short messages.
- 7) If authorized, the IP-SM-GW forwards segmented short messages.
- 8) All the short messages transactions are successfully acknowledged.
- 9) The IP-SM-GW triggers a Reserve Units Request[Terminate] message to the OCS reporting the successful event transaction.
- 10) The OCS performs the appropriate credit processing based on the received request.

11) The OCS responds with a Reserve Units Response message to the IP-SM-GW.

5.3.2.9 Simple Submission with SM service request

This clause contains message flows for operation models IEC (figure 5.3.2.9-1) where application of a SM service is subject to charging independent from the SM submission.

Editors Note: Simple SM submission with SM service request for operation model ECUR is FFS.

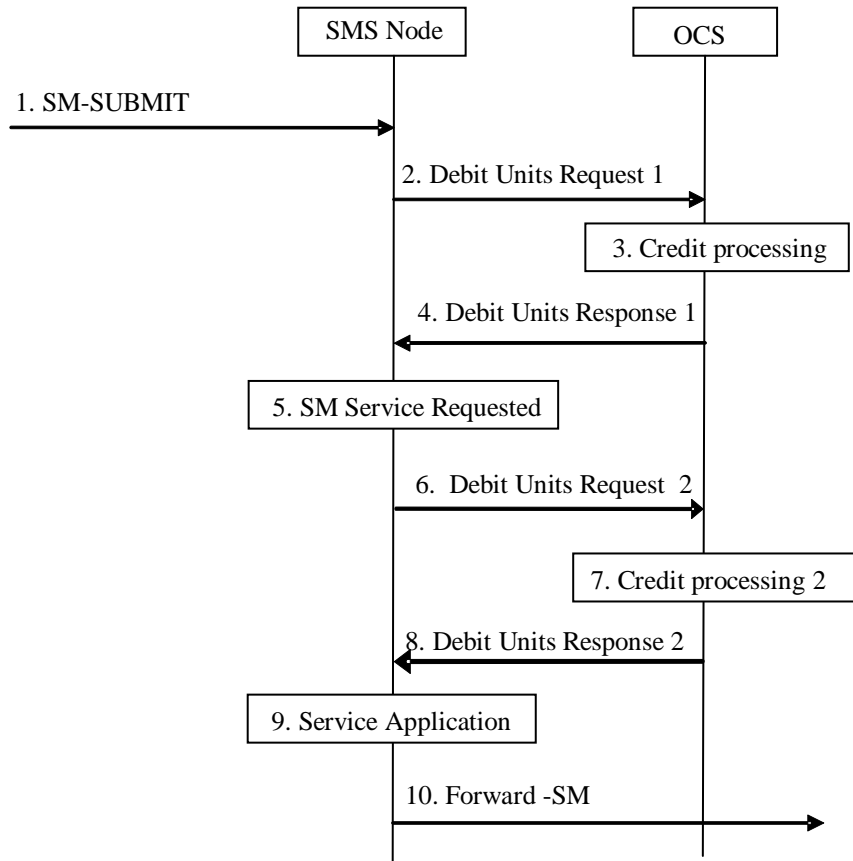

Figure 5.3.2.9.1: Online charging in simple submission with SM service request for IEC

- 1) Depending on which SMS mechanism (i.e. SMS or SMSIP) is in operation, the SMS node receives an incoming SM-Submit or a MAP-Forward-SM which includes a SM service request (such as forwarding or SM copy).
- 2) The SMS node triggers a Debit Units Request message to the OCS for the SM submission.
- 3) The OCS performs the appropriate credit processing based on the received request.
- 4) The OCS responds with a Debit Units Response message for the SM submission to the SMS node.
- 5) If normal SM processing is authorized in step 4, the SMS Node analyzes the SM and detects that a SM service shall be applied that is subject to charging.
- 6) If a SM service subject to charging is detected in step 5, the SMS node triggers an additional Debit Units Request message to the OCS for the requested SM service.
- 7) The OCS performs the appropriate credit processing based on the received request.
- 8) The OCS responds with a Debit Units Response message for the requested SM service to the SMS node.
- 9) If authorized in step 7, the SMS node applies the requested SM service.

NOTE 1: Depending on the nature of the requested SM service, "service application" may involve creating additional messages (for example in case of a SM copy service). This is deemed part of step 9 and not otherwise shown in this diagram.

- 10) If authorized in step 4, the SMS node continues the SM processing as appropriate for the origination procedures.

NOTE 2: Authorization of SM processing is independent of the authorization for application of a SM service. I.e. if authorization for SM processing is granted in step 4 but authorization for SM service is refused in step 8 SM processing appropriate for the originating service continues without applying the requested SM service.

5.3.2.10 Void

5.3.2.11 Device Triggering using T4

5.3.2.11.1 SMS submission to SMS-SC for Device Triggering

This clause contains the message flows for the scenario where the MTC-IWF submits a request to SMS-SC for SM transfer towards the UE for Device Triggering purpose, in IEC operation model (figure 5.3.2.11.1.1):

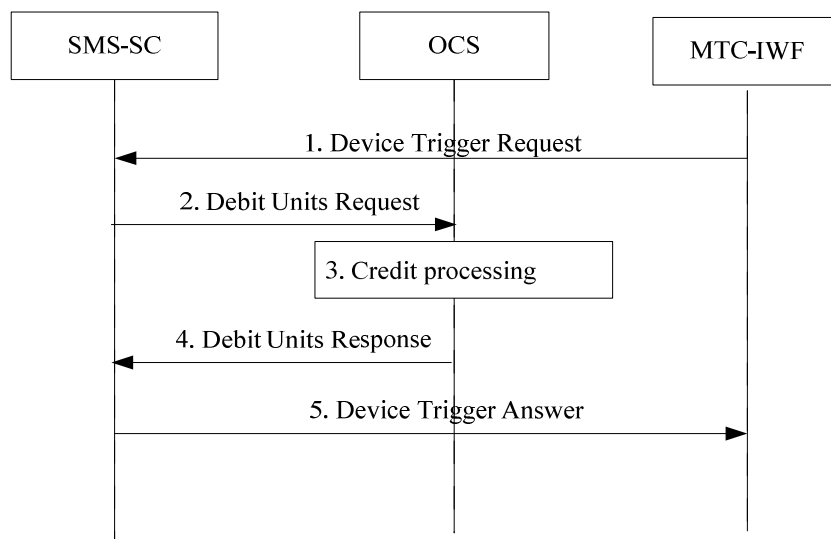

Figure 5.3.2.11.1.1: Online charging - SMS submission to SMS-SC for Device Triggering - IEC

- 1) The SMS-SC receives an incoming "Device Trigger Request" from an MTC-IWF over T4, destined to a UE recipient.
- 2) The SMS-SC triggers a Debit Units Request message to the OCS.
- 3) The OCS performs the appropriate credit processing based on the received request.
- 4) The OCS responds with a Debit Units Response message to the SMS-SC.
- 5) The SMS-SC returns "Device Trigger Answer" with appropriate result associated to the reception of the trigger request: successfully received by SMS-SC or failed due to error at SMS-SC.

5.3.2.11.2 SMS Delivery from SMS-SC for Device Triggering

This clause contains message flows for the different operation models IEC (figure 5.3.2.11.2.1) and ECUR (figure 5.3.2.11.2.2) for delivery attempts from SMS-SC for SM transfer towards the UE for Device Triggering.

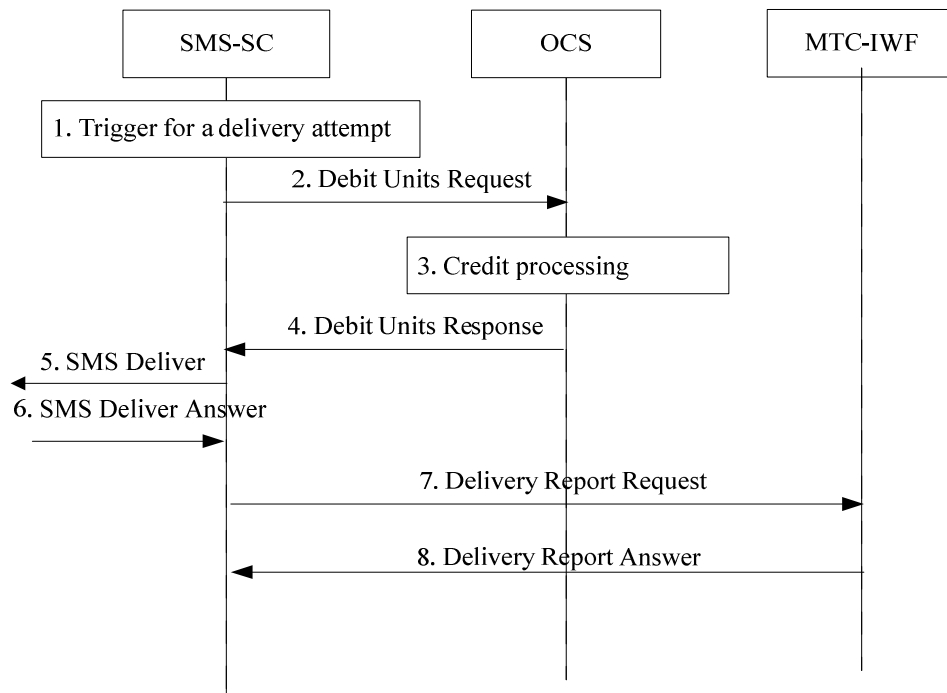

Figure 5.3.2.11.2.1: Online charging SMS Delivery retry from SMS-SC for Device Triggering – IEC

- 1) The SMS-SC decides to forward "SMS Deliver" message towards the receiving party, based on same trigger as step 1 of Figure 5.2.2.4.2.1.
- 2) The SMS-SC triggers a Debit Units Request message to the OCS.
- 3) The OCS performs the appropriate credit processing based on the internal trigger.
- 4) The OCS responds with a Debit Units Response message to the SMS-SC.
- 5) If authorized, the SMS-SC continues the SM processing for delivering the short message to the UE.
- 6) The SMS-SC receives "SMS Deliver Answer" message as the delivery success of the SM transfer.
- 7) The SMS-SC sends "Delivery Report Request" to MTC-IWF with appropriate result associated to the successful delivery of the device trigger to the UE.
- 8) The MTC-IWF acknowledges by sending "Delivery Report Answer".

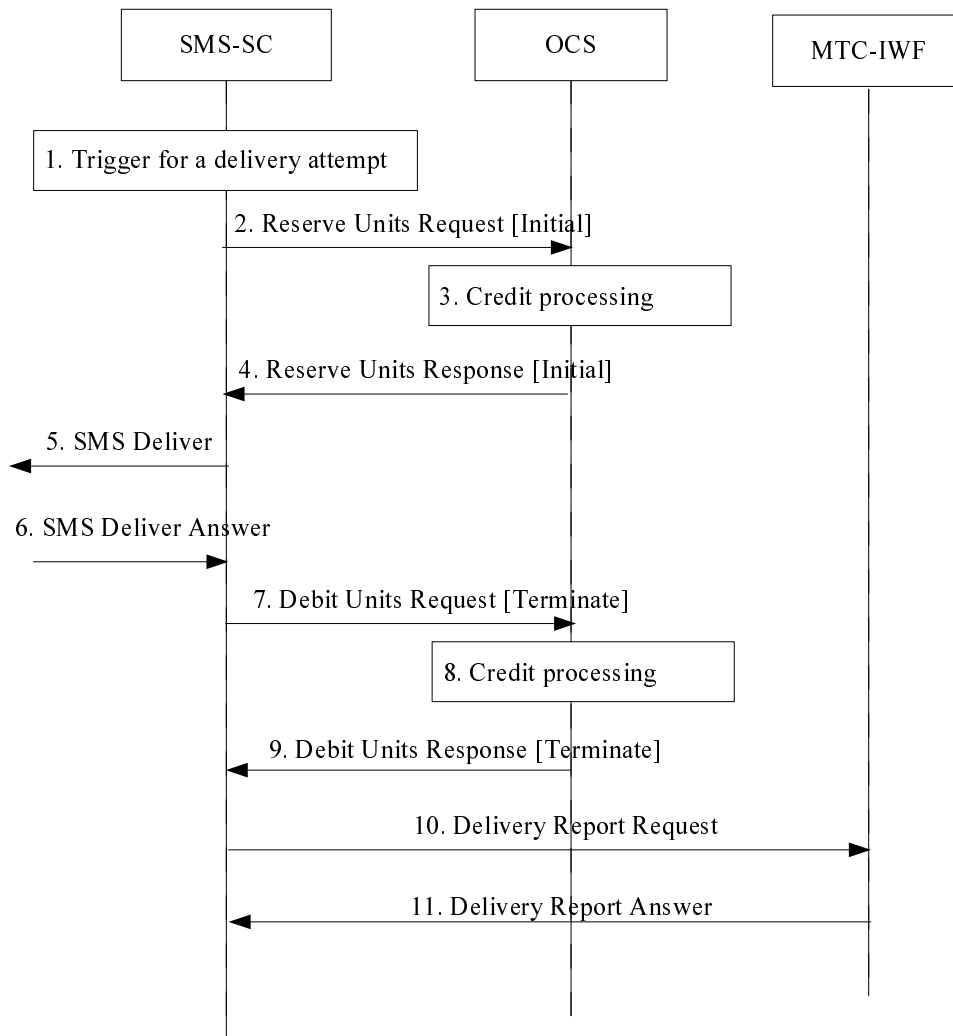

Figure 5.3.2.11.2.2: Online charging SMS Delivery retry from SMS-SC for Device Triggering - ECUR

- 1) The SMS-SC decides to forward "SMS Deliver" message towards the receiving party, based on same trigger as step 1 of Figure 5.2.2.4.2.1.
- 2) The SMS-SC triggers a Reserve Units Request [Initial] message to the OCS.
- 3) The OCS performs the appropriate credit processing based on the received request.
- 4) The OCS responds with a Reserve Units Response message to the SMS-SC.
- 5) If authorized, the SMS-SC continues the SM processing for delivering the short message to the UE.
- 6) The SMS-SC receives "SMS Deliver Answer" message as the delivery success of the SM transfer.
- 7) The SMS-SC triggers a Debit Units Request[Terminate] message to the OCS reporting the successful transaction.
- 8) The OCS performs the appropriate credit processing based on the received request.
- 9) The OCS responds with a Debit Units Response message to the SMS-SC.
- 10) The SMS-SC sends "Delivery Report Request" to MTC-IWF with appropriate result associated to the successful delivery of the device trigger to the UE.

11) The MTC-IWF acknowledges by sending "Delivery Report Answer".

5.3.2.11.3 Unsuccessful SMS Delivery from SMS-SC for Device Triggering

This clause contains message flows for the different operation models IEC (figure 5.3.2.11.3.1) and ECUR (figure 5.3.2.11.3.2) for unsuccessful delivery from SMS-SC of a SM towards the UE for Device Triggering.

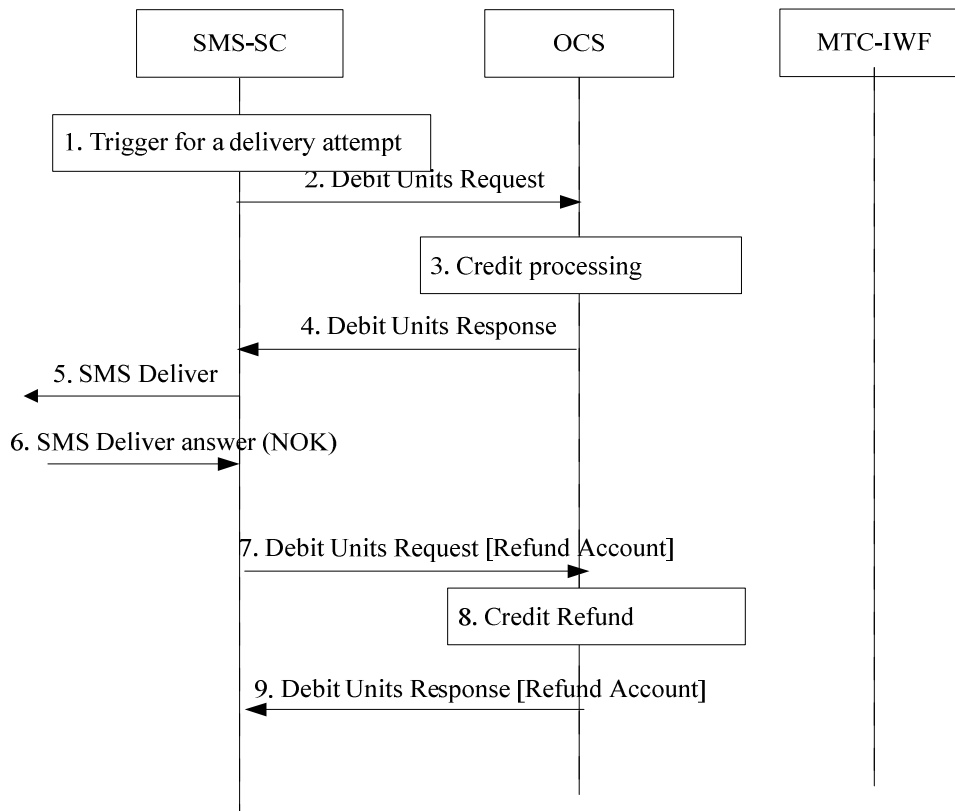

Figure 5.3.2.11.3.1: Online charging unsuccessful SMS Delivery from SMS-SC for Device Triggering after IEC

- 1) The SMS-SC decides to forward "SMS Deliver" message towards the receiving party, based on same trigger as step 1 of Figure 5.2.2.4.2.1.
- 2) The SMS-SC triggers a Debit Units Request message to the OCS.
- 3) The OCS performs the appropriate credit processing based on the internal trigger.
- 4) The OCS responds with a Debit Units Response message to the SMS-SC.
- 5) If authorized, the SMS-SC continues the SM processing for delivering the short message to the UE.
- 6) The SMS-SC receives "SMS Deliver Answer" message as the delivery failure of the SM transfer attempt, or an internal trigger indicating failure.
- 7) The SMS-SC triggers a Debit Units Request (Refund Account) message to the OCS.
- 8) The OCS performs the appropriate refund processing based on the received request.
- 9) The OCS responds with a Debit Units Response (Refund Account) message to the SMS-SC.

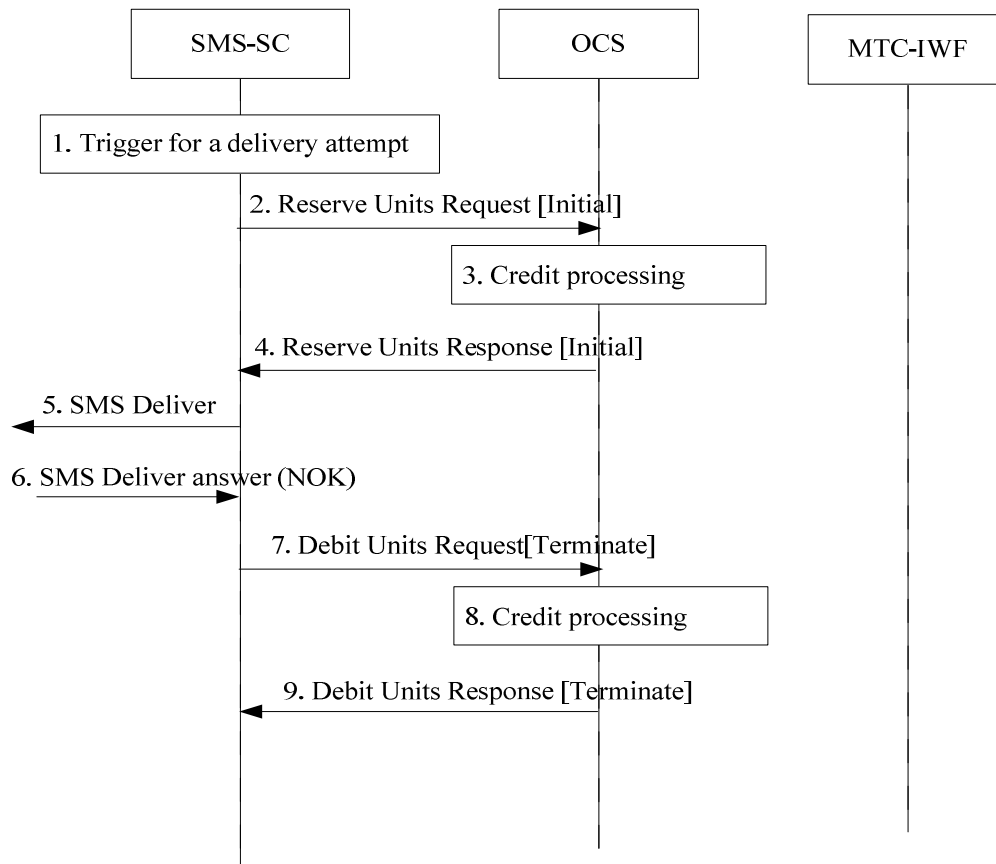

Figure 5.3.2.11.3.2: Online charging Unsuccessful SMS Delivery from SMS-SC for Device Triggering after ECUR

- 1) The SMS-SC decides to forward "SMS Deliver" message towards the receiving party, based on same trigger as step 1 of Figure 5.2.2.4.2.1.
- 2) The SMS-SC triggers a Reserve Units Request [Initial] message to the OCS.
- 3) The OCS performs the appropriate credit processing based on the received request.
- 4) The OCS responds with a Reserve Units Response message to the SMS-SC.
- 5) If authorized, the SMS-SC continues the SM processing for delivering the short message to the UE.
- 6) The SMS-SC receives "SMS Deliver Answer" message as the delivery failure of the SM transfer attempt, or an internal trigger indicating failure.
- 7) The SMS-SC triggers a Debit Units Request [Terminate] message to the OCS reporting the used unit for the service to zero, as a failed transaction.
- 8) The OCS performs the appropriate credit processing based on the received request.
- 9) The OCS responds with a Debit Units Response message to the SMS-SC.

5.3.2.11.4 SMS submission to SMS-SC for Device Triggering - Replace procedure

Figure 5.3.2.11.4.1 describes the scenario where the MTC-IWF submits a request to SMS-SC for a replace procedure of Device Triggering, in IEC operation model:

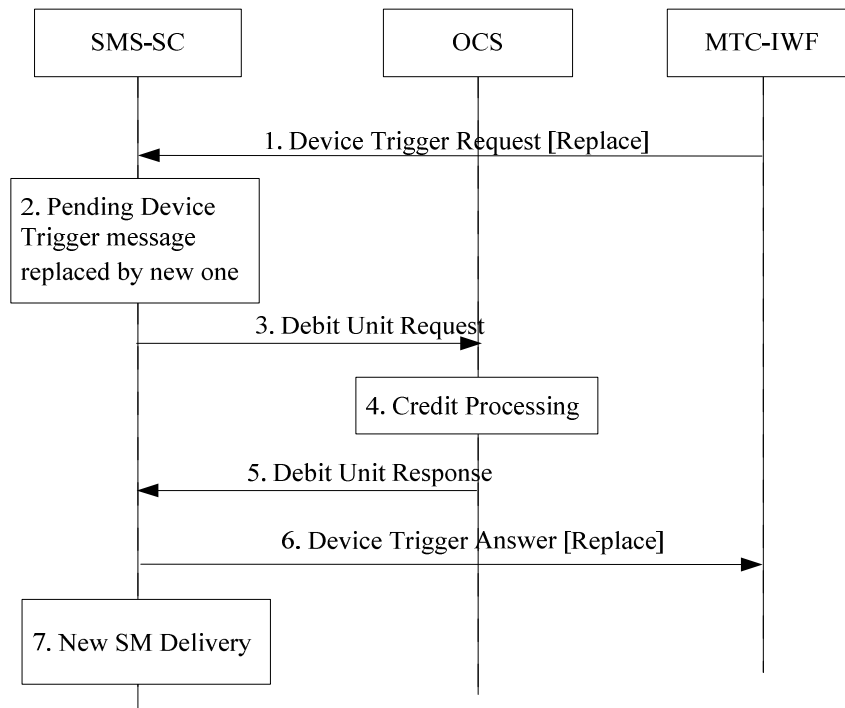

Figure 5.3.2.11.4.1: Online charging - SMS submission to SMS-SC for replace Device Triggering

- 1) The SMS-SC receives an incoming "Device Trigger Request" indicating "Replace" from an MTC-IWF over T₄.
- 2) The SMS-SC determines the trigger message identified by the External Identifier or MSISDN, SCS Identifier, and old trigger reference number in the received Device Trigger Replace message, is pending at SMS-SC: the new trigger message replaces the previous one.
- 3) The SMS-SC triggers a Debit Units Request message to the OCS.
- 4) The OCS performs the appropriate credit processing based on the received replace request.
- 5) The OCS responds with a Debit Units Response message to the SMS-SC.
- 6) The SMS-SC returns "Device Trigger Answer" with appropriate result of the successful or unsuccessful replace procedure.
- 7) In case of successful replace, the new SM to be delivered uses the same procedure as per clause 5.3.2.x.2.

5.3.2.11.5 SMS submission to SMS-SC for Device Triggering - Recall procedure

Figure 5.3.2.11.5.1 describes the scenario where the MTC-IWF submits a request to SMS-SC for a recall procedure for Device Triggering:

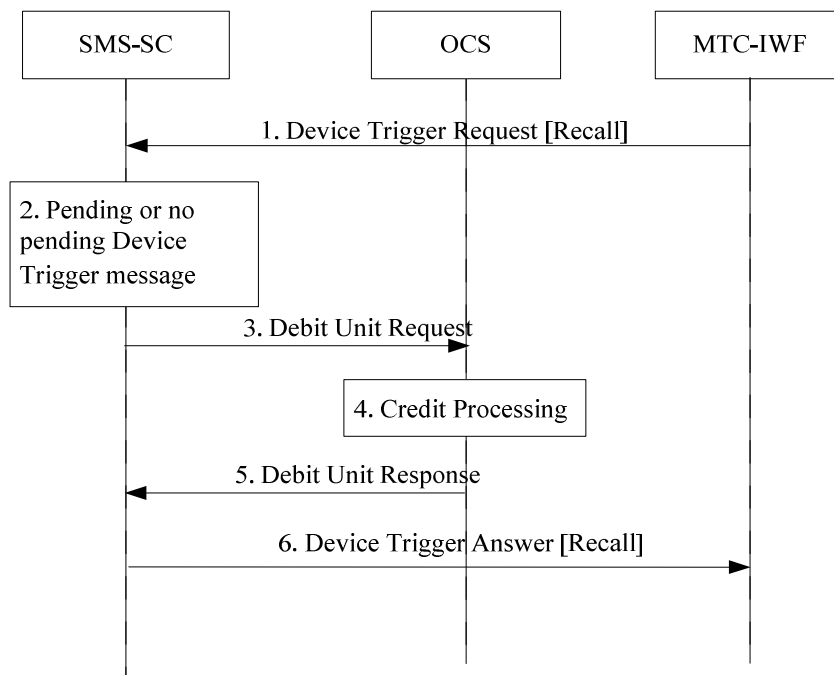

Figure 5.3.2.11.5.1: Online charging - SMS submission to SMS-SC for recall Device Triggering

- 1) The SMS-SC receives an incoming "Device Trigger Request" indicating "Recall" from an MTC-IWF over T₄.
- 2) The SMS-SC determines the trigger message identified by the External Identifier or MSISDN, SCS Identifier, and old trigger reference number in the received Device Trigger Recall message, is pending at SMS-SC: the old trigger message is deleted.
- 3) The SMS-SC triggers a Debit Units Request message to the OCS.
- 4) The OCS performs the appropriate credit processing based on the received recall request.
- 5) The OCS responds with a Debit Units Response message to the SMS-SC.
- 6) The SMS-SC returns "Device Trigger Answer" with appropriate result of the recall procedure. In case in step 2 there was no pending Device trigger message, a failure is reported.

5.3.2.12 MSISDN-less SMS MO via T4

5.3.2.12.1 Introduction

The message flows associated to the MSISDN-less SMS MO via T₄, describe the triggers occurring in the SMS-SC Node. As specified in TS 23.682 [17], the SMS delivery procedures to SMS-SC and SMS delivery report from SMS-SC are per TS 23.040 [12], therefore involving SMS-GMSC/SMS-IW MSC depending on the scenario. However, per this TS 23.040 [12], the interface between the SMS-GMSC/SMS-IW MSC and the SMS-SC is out of scope of 3GPP, therefore SMS-GMSC/SMS-IW MSC are assumed as internal to SMS-SC for the charging flows with triggers description.

The network does not perform any storing and forwarding functionality for MO-SMS.

Only ECUR operation model is applicable to MSISDN-less SMS MO via T₄.

NOTE: As specified in TS 23.682 [17], the external identifier associated to the transaction is not available before the when the MO payload delivery response is received by the SMS-SC, therefore the IEC operation model is considered as not relevant for successful scenario.

5.3.2.12.2 MSISDN-less SMS MO via T4 - successful case

Figure 5.3.2.12.2.1 describes the scenario where MSISDN-less UE originates SMS-MO destined to a recipient SCS/AS using MSISDN-less SMS MO via T4 procedure, in ECUR operation model:

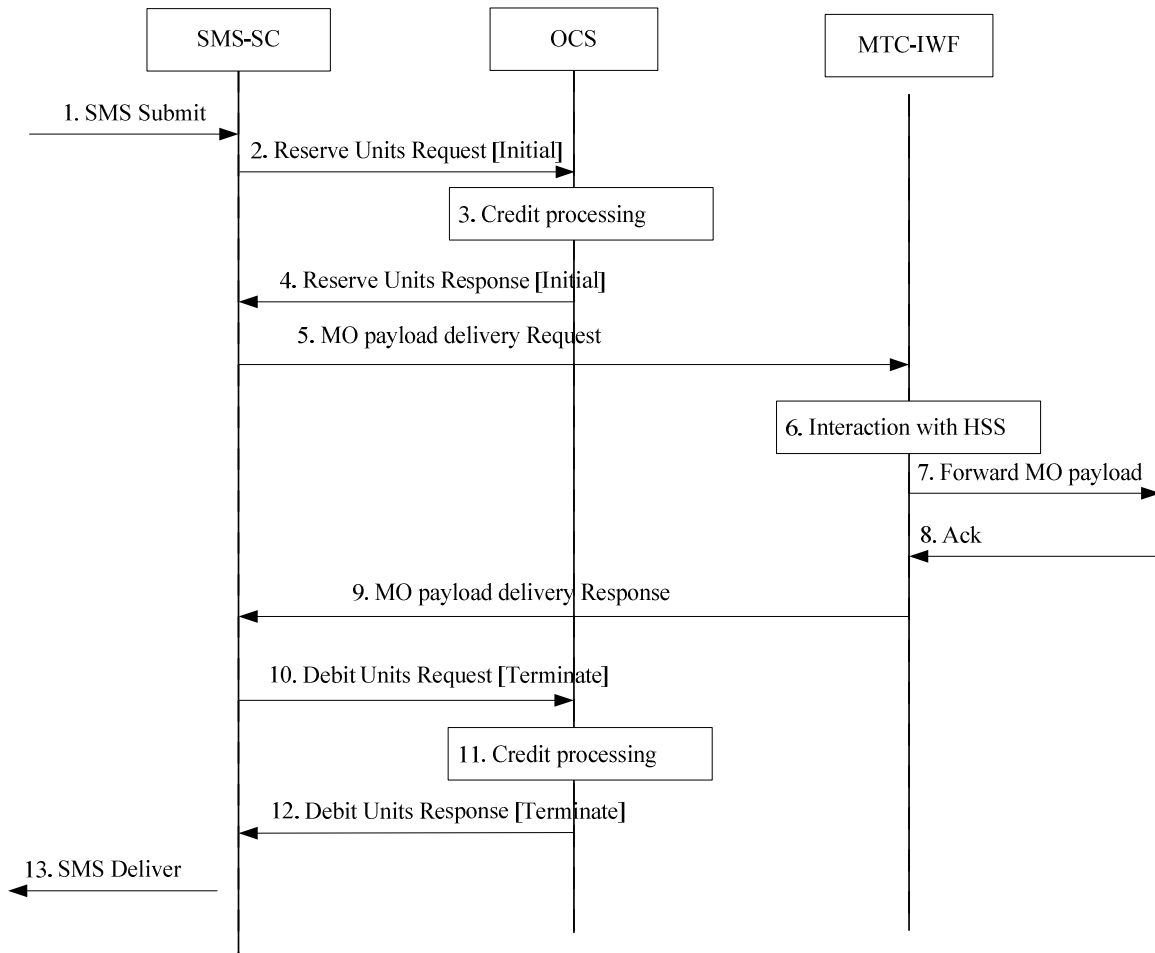

Figure 5.3.2.12.2.1: Online charging MSISDN-less SMS MO via T4 – successful case

- 1) The SMS-SC receives a "SMS Submit" incoming message originated by a MSISDN-less UE to deliver small data to SCS/AS.
- 2) The SMS-SC triggers a Reserve Units Request[Initial] message to the OCS.
- 3) The OCS performs the appropriate credit processing based on the received request.
- 4) The OCS responds with a Reserve Units Response message to the SMS-SC.
- 5) If authorized, the SMS-SC sends the "MO payload delivery Request" message to the MTC-IWF address (as pre-configured in the SMS-SC for this SCS/AS), with the SMS payload and the destination SME address (long/short code of the SCS/AS).
- 6) The MTC-IWF retrieves the external ID from the HSS (based on the IMSI of the UE and application port ID).
- 7_8) The MTC-IWF forwards the SMS to the SCS/AS (received destination SME), and receives the successful answer.
- 9) The MTC-IWF returns the success indication to SMS-SC, along with the external identifier associated to this transaction.
- 10) The SMS-SC triggers a Debit Units Request[Terminate] message to the OCS.

- 11) The OCS performs the appropriate credit processing based on the received request.
- 12) The OCS responds with a Debit Units Response message to the SMS-SC.
- 13) The SMS-SC indicates success back to UE.

5.3.2.12.3 MSISDN-less SMS MO via T4 - error cases

5.3.2.12.3.1 MSISDN-less SMS MO via T4 - failure at submission to SMS-SC

Figure 5.3.2.12.3.1.1 describes the scenario where MSISDN-less UE originates SMS-MO destined to a recipient SCS/AS using MSISDN-less SMS MO via T4 procedure, and failure at submission to SMS-SC:

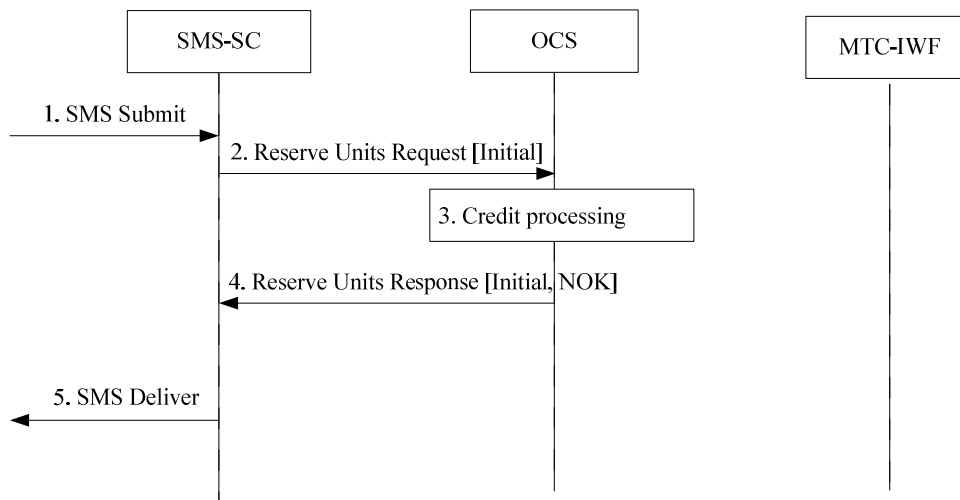

Figure 5.3.2.12.3.1.1: Online charging MSISDN-less SMS MO via T4 – failure at submission

- 1) The SMS-SC receives a "SMS Submit" incoming message originated by a MSISDN-less UE to deliver small data to SCS/AS.
- 2) The SMS-SC triggers a Reserve Units Request[Initial] message to the OCS.
- 3) The OCS performs the appropriate credit processing based on the received request and identified the transaction is not authorized.
- 4) The OCS responds with a Reserve Units Response [Initial, NOK] message to the SMS-SC.
- 5) The SMS-SC indicates failure back to UE, and will not initiate any message towards the MTC-IWF due to this failed attempt.

5.3.2.12.3.2 MSISDN-less SMS MO via T4 - failure at the MTC-IWF

Figure 5.3.2.12.3.2.1 describes the scenario where MSISDN-less UE originates SMS-MO destined to a recipient SCS/AS using MSISDN-less SMS MO via T4 procedure, and failure at the MTC-IWF:

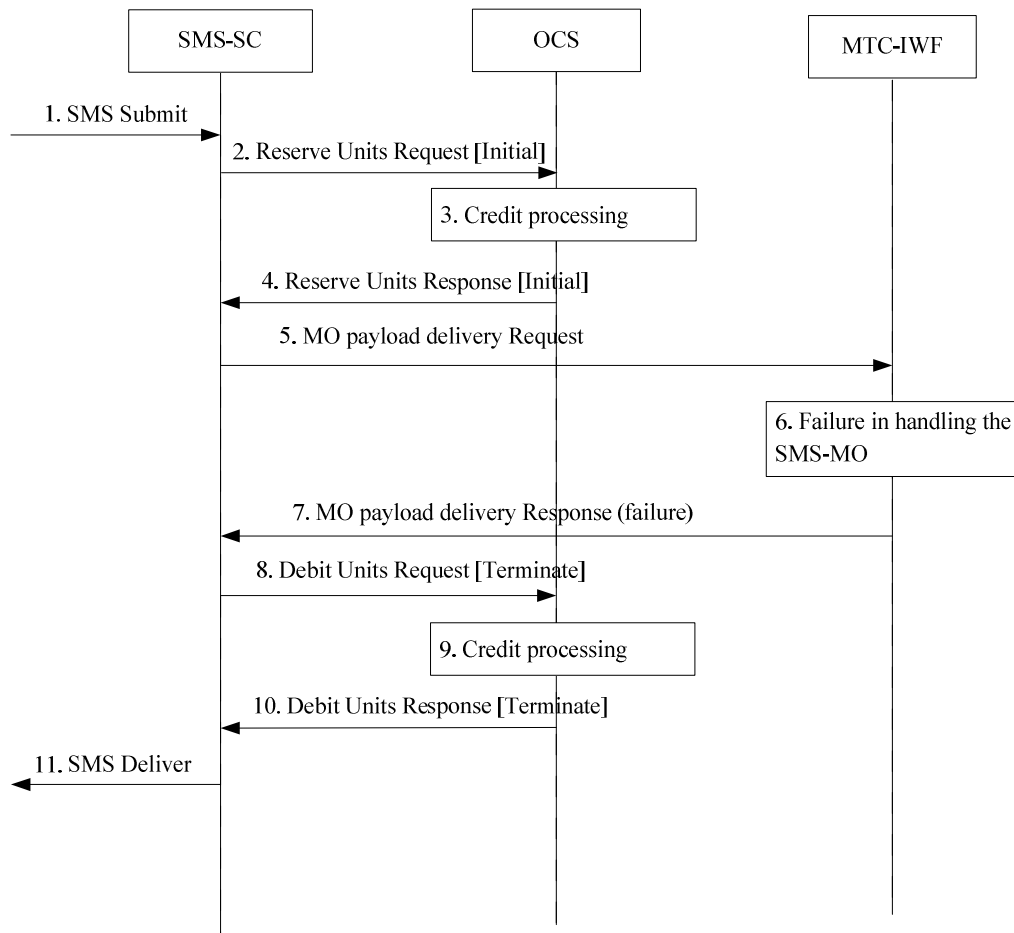

Figure 5.3.2.12.3.2.1; Online charging MSISDN-less SMS MO via T4 - failure at the MTC-IWF

- 1) The SMS-SC receives a "SMS Submit" incoming message originated by a MSISDN-less UE to deliver small data to SCS/AS.
- 2) The SMS-SC triggers a Reserve Units Request[Initial] message to the OCS.
- 3) The OCS performs the appropriate credit processing based on the received request.
- 4) The OCS responds with a Reserve Units Response [Initial] message to the SMS-SC.
- 5) If authorized, the SMS-SC sends the "MO payload delivery Request" message to the MTC-IWF address (as pre-configured in the SMS-SC for this SCS/AS), with the SMS payload and the destination SME address (long/short code of the SCS/AS).
- 6) Failure in handling the submitted SMS-MO in the MTC-IWF, including failure submission to the SCS/AS step 7 and 8 in Figure 5.3.2.y.2.1.
- 7) The MTC-IWF returns the failure delivery indication to SMS-SC.
- 8) The SMS-SC triggers a Debit Units Request[Terminate] message to the OCS, reporting the used unit for the service to zero.
- 9) The OCS performs the appropriate credit processing based on the received request.
- 10) The OCS responds with a Debit Units Response message to the SMS-SC.
- 11) The SMS-SC indicates failure back to UE.

5.3.3 Credit-Control related

5.3.3.1 Triggers for stopping for an SMS Credit-Control session

Used in ECUR only, a Debit / Reserve Units Request message to terminate the Credit-Control session is sent to OCS when:

- Validity time for granted quota expires;
- Granted quota runs out (i.e. a successful event has occurred);
- Abort-Session-Request is received from the OCS.

The expiration of the validity time for quota does not require the SMS procedures to be terminated. The CTF shall be configurable as to whether on expiration of validity time, the service should be aborted or not; i.e. whether the stored message should be deleted and no further (re-)delivery attempt should be made.

5.3.3.2 Triggers for providing interim information for a SMS Credit-Control session

The provision of interim information for Credit-Control is not used in this release of the specification, due to the use of IEC and ECUR.

5.4 SMS converged online and offline charging scenarios

5.4.1 Basic principles

5.4.1.1 General

Converged charging may be performed by the SMSF interacting with CHF using Nchf specified in TS 32.290 [19] and TS 32.291 [20]. In order to provide the data required for the management activities outlined in TS 32.240 [2] (Credit-Control, accounting, billing, statistics etc.), the SMSF shall be able to perform converged charging for each of the SMS transactions.

The SMSF shall be able to perform convergent charging by interacting with CHF, for charging data related to SMS over NAS. The Charging Data Request and Charging Data Response are exchanged between the SMSF and the CHF, based on PEC, IEC or ECUR scenarios specified in TS 32.290 [19]. The Charging Data Request is issued by the SMSF towards the CHF when certain conditions (chargeable events) are met.

Converged charging uses centralized or decentralized unit determination and centralized rating scenarios for convergent charging IEC and ECUR specified in TS 32.290 [19].

The contents and purpose of each charging event that triggers interaction with CHF, as well as the chargeable events that trigger them, are described in the following sub-clauses.

A detailed formal description of the converged charging parameters defined in the present document is to be found in TS 32.291 [20].

A detailed formal description of the CDR parameters defined in the present document is to be found in TS 32.298 [3].

The chargeable events or messages exchanged between the SMSF and the other nodes are described with generic names (i.e SMS submit, SMS deliver), to reflect SMS reception or sending by/from the SMSF, independently from the protocol conveying the SMS.

5.4.1.2 Applicable Triggers in the SMSF

5.4.1.2.1 General

When a charging event is issued towards the CHF, it includes details such as Subscriber identifier (e.g. SUPI).

Each trigger condition (i.e. chargeable event) defined for the SMS over NAS converged charging functionality, is specified with the associated behaviour when they are met.

When a MO or MT SMS is sent through the SMSF, and the converged charging is activated, the SMSF invokes a Charging Data Request [Initial] towards the CHF to get authorization to start in ECUR mode. In IEC mode, the Charging Data Request [Event] is sent towards the CHF.

Table 5.4.1.2.1 summarizes the set of default trigger conditions and their category which shall be supported by the SMSF. For "immediate report" category, the table also provides the corresponding Charging Data Request [Initial, Event, Termination] message sent from SMSF towards the CHF.

Table 5.4.1.2.1: Default Trigger conditions in SMSF

Trigger Conditions	Trigger level	Default category	CHF allowed to change category	CHF allowed to enable and disable	Message when "immediate reporting" category
SMS Submit	-	Immediate	Not Applicable	Not Applicable	IEC: Charging Data Request [Event] ECUR: Charging Data Request [Initial]
SMS to deliver	-	Immediate	Not Applicable	Not Applicable	IEC: Charging Data Request [Event] ECUR: Charging Data Request [Termination]
SMS Submit Answer	-	Immediate	Not Applicable	Not Applicable	PEC: Charging Data Request [Event]
SMS Deliver Answer	-	Immediate	Not Applicable	Not Applicable	PEC: Charging Data Request [Event]

For converged charging, the following details of chargeable events and corresponding actions in the SMSF are defined in Table 5.4.1.2.2:

Table 5.4.1.2.2: Chargeable events and their related actions in SMSF

Chargeable event	Conditions	SMSF action
SMS Submit		IEC: Charging Data Request [Event] ECUR: Charging Data Request [Initial] with a possible request quota for later use
SMS to deliver		IEC: Charging Data Request [Event] ECUR: Charging Data Request [Termination], indicating that charging session is terminated
SMS Submit Answer		PEC: Charging Data Request [Event]
SMS Deliver Answer		PEC: Charging Data Request [Event]

The CDR generation mechanism processed by the CHF upon receiving Charging Data Request [Event, Initial, Termination] issued by the SMSF for these chargeable events, is specified in clause 5.4.3.

5.4.1.3 CHF selection

The CHF to be used by the SMSF can be:

- Discovered via NRF upon SMS activation from AMF to SMSF.
- SMSF locally provisioned in charging characteristics.

The option depends on Operator's policies.

When CHF selection by SMSF is performed via NRF based discovery:

- For UE determined by SMSF as served by the same PLMN as the SMSF (i.e. non-roaming scenario), the CHF of the PLMN can be discovered based on the UE identifier.

- For UE determined by SMSF in V-PLMN as an in-bound roamer (i.e. roaming scenario), the CHF of the V-PLMN can be discovered based on the PLMN Id of the UE H-PLMN.

5.4.2 Message flows

5.4.2.1 Introduction

The different scenarios below focus on the different messages from/to the SMS Node and corresponding interaction with the CHF, based on scenarios specified in TS 23.502 [202] clause 4.13.3.

5.4.2.2 SMS Submission - IEC

Figure 5.4.2.2.1 describes the scenario where a SMS is submitted to the SMSF for IEC mode

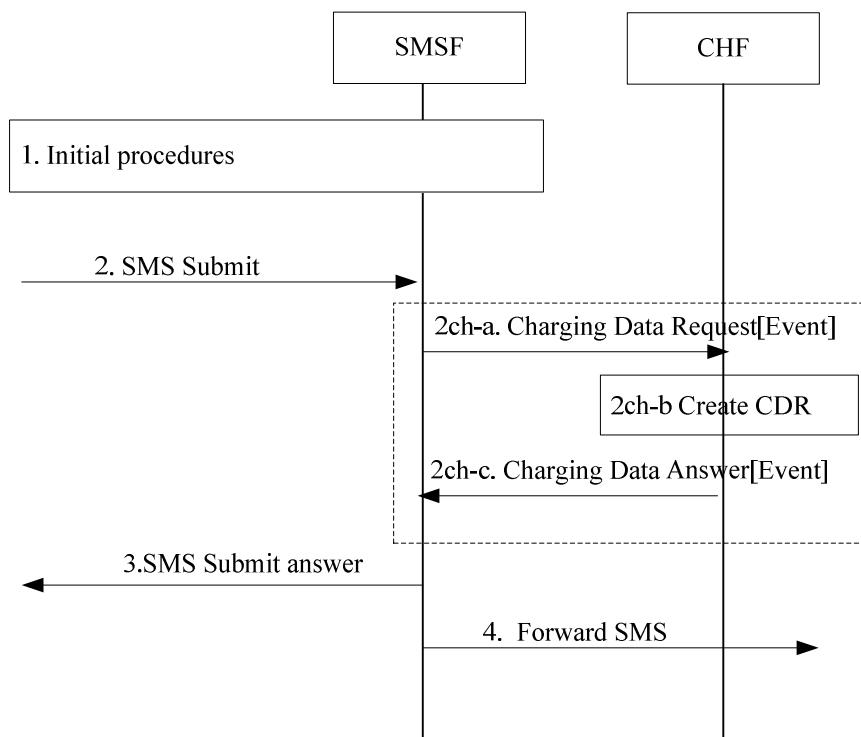

Figure 5.4.2.2.1: SMS submission to SMSF for IEC

1. Initial procedures: see applicable flows.
2. The SMSF receives a "SMS Submit" incoming message originated by a UE.
- 2ch-a. The SMSF sends Charging Data Request[Event] to CHF for the received MO SMS.
- 2ch-b. The CHF creates a CDR for this MO SMS.
- 2ch-c. The CHF acknowledges by sending Charging Data Response[Event] to the SMSF.
3. The SMSF returns "SMS Submit Answer" with appropriate result successful or unsuccessful reception of the SM by the SMSF.
4. Forward SMS per applicable flows.

The table 5.4.2.2.1 describes the correspondence between the message in this scenario, and the message in the different Network scenario for which it is applicable.

Table 5.4.2.2.1: Messages mapping

Message	Message in Network scenario	Reference
2. SMS submit	2b. Nsmsf_SMSservice_UplinkSMS (SMS body)	TS 23.502[202] Figure 4.13.3.3-1: MO SMS over NAS
	6b. Nsmsf_SMSservice_UplinkSMS (Delivery report)	TS 23.502[202] Figure 4.13.3.6-1: MT SMS over NAS in CM_IDLE state via 3GPP access
3. SMS submit answer	2c. Namf_Communication_N1N2MessageTransfer (CP Ack)	TS 23.502[202] Figure 4.13.3.3-1: MO SMS over NAS
	6c. Namf_Communication_N1N2MessageTransfer (CP Ack)	TS 23.502[202] Figure 4.13.3.6-1: MT SMS over NAS in CM_IDLE state via 3GPP access
4. Forward SMS	3. Forward MO	TS 23.502[202] Figure 4.13.3.3-1: MO SMS over NAS
	7. Delivery report	TS 23.502[202] Figure 4.13.3.6-1: MT SMS over NAS in CM_IDLE state via 3GPP access

5.4.2.3 SMS Delivery - IEC

Figure 5.4.2.3.1 describes the scenario where a SMS is delivered from the SMSF for IEC mode

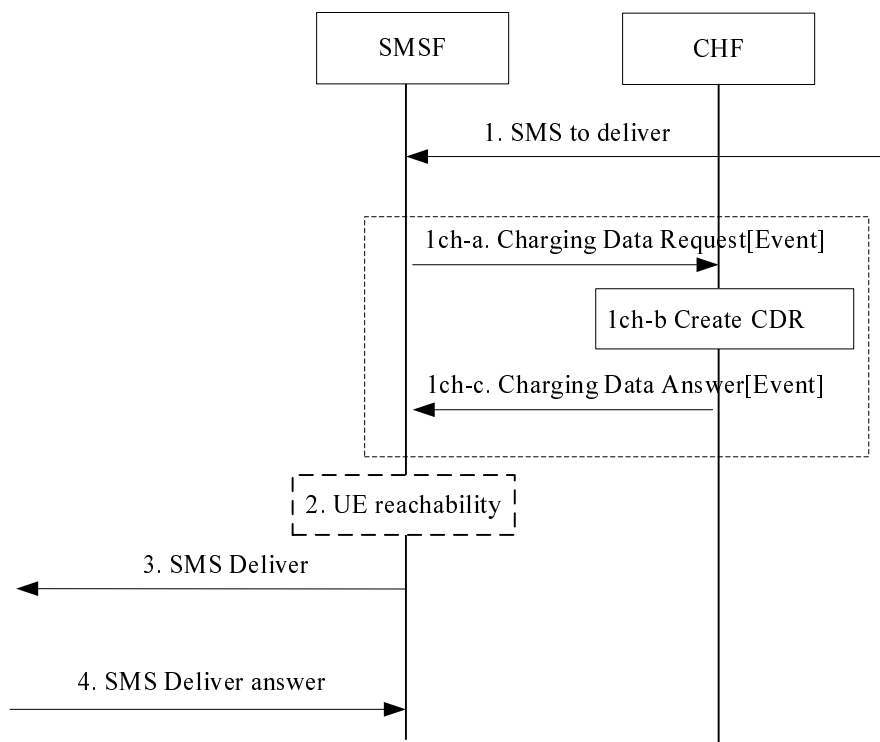

Figure 5.4.2.3.1 SMS delivery from SMSF for IEC

- 1. "SMS to deliver" received by SMSF in order to deliver a MT SMS over NAS towards the UE: see applicable flows.
- 1ch-a. The SMSF sends Charging Data Request[Event] to CHF for the MT SMS delivery.
- 1ch-b. The CHF creates a CDR for this MT SMS.
- 1ch-c. The CHF acknowledges by sending Charging Data Response[Event] to the SMSF.
- 2. UE reachability criteria met.

3. The SMSF forwards the "SMS Deliver" message towards the UE.
4. The SMSF receives "SMS Deliver Answer" message as the delivery success or failure of the SM transfer attempt.

The table 5.4.2.3.1 describes the correspondence between the message in this scenario, and the message in the different Network scenario for which it is applicable.

Table 5.4.2.3.1: Messages mapping

Message	Message in Network scenario	Reference
1. SMS to deliver	3. Forward MT SM	TS 23.502[202] Figure 4.13.3.6-1: MT SMS over NAS in CM_IDLE state via 3GPP access
	5. Submit report	TS 23.502[202] Figure 4.13.3.3-1: MO SMS over NAS
3. SMS deliver	5. Namf_Communication_N1N2MessageTransfer (SMS body)	TS 23.502[202] Figure 4.13.3.6-1: MT SMS over NAS in CM_IDLE state via 3GPP access
	6a. Namf_Communication_N1N2MessageTransfer (Submit Report)	TS 23.502[202] Figure 4.13.3.3-1: MO SMS over NAS
4. SMS deliver answer	5d. Nsmsf_SMSservice_UplinkSMS (CP Ack)	TS 23.502[202] Figure 4.13.3.6-1: MT SMS over NAS in CM_IDLE state via 3GPP access
	6d. Nsmsf_SMSservice_UplinkSMS (CP Ack)	TS 23.502[202] Figure 4.13.3.3-1: MO SMS over NAS

5.4.2.4 SMS Submission - ECUR

Figure 5.4.2.4.1 describes the scenario where a SMS is submitted to the SMSF for ECUR mode.

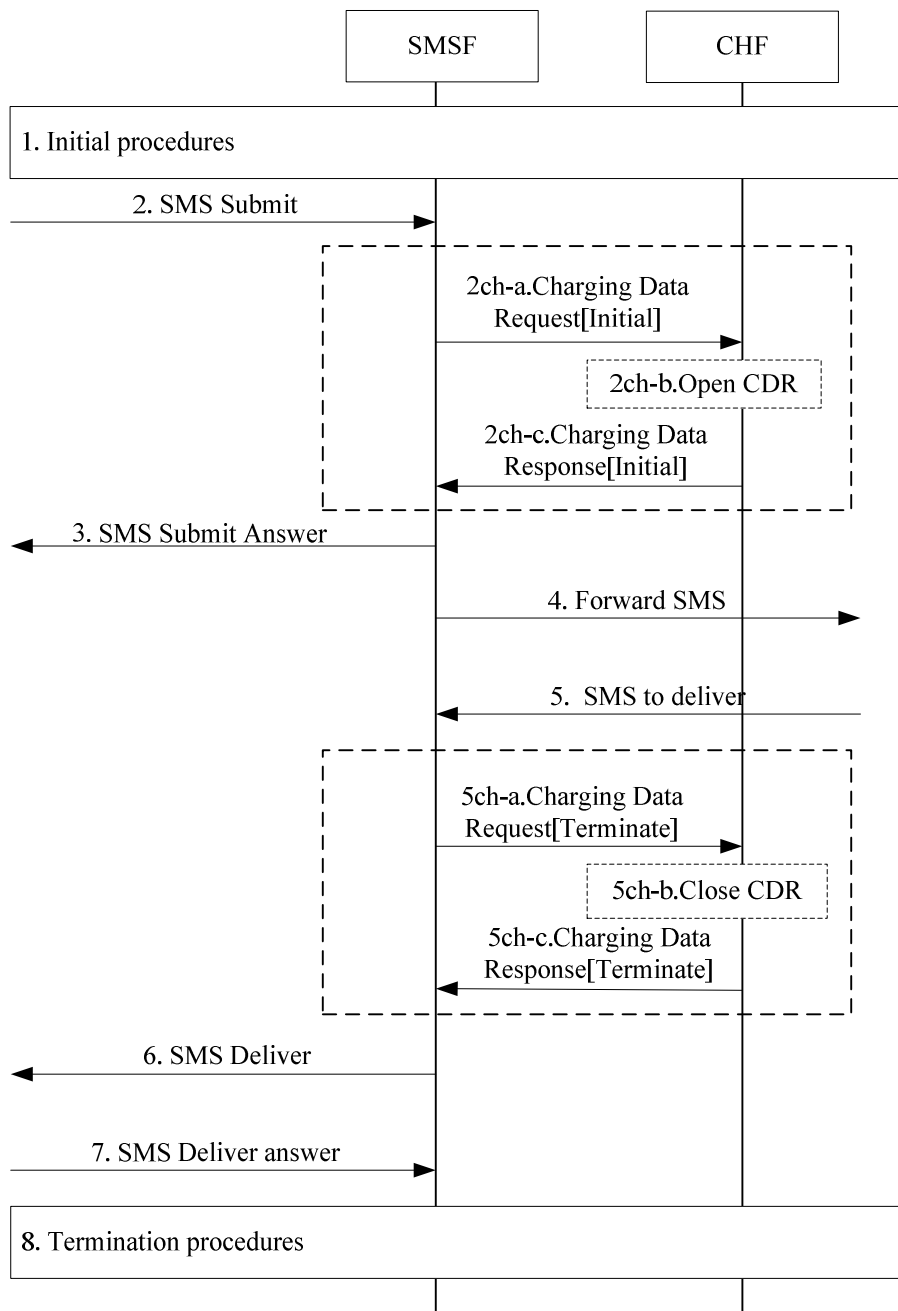

Figure 5.4.2.4.1: Converged charging SMS Submission using ECUR

1. Initial procedures: see applicable flows.
2. The SMSF receives a "SMS Submit" incoming message originated by a UE.
- 2ch-a. The SMSF sends Charging Data Request [Initial] to CHF for authorization for the UE to submit the SMS message.
- 2ch-b. The CHF opens CDR for this SMS submission.
- 2ch-c. The CHF acknowledges by sending Charging Data Response [Initial] to the SMSF
3. The SMSF returns "SMS Submit Answer" with appropriate result successful or unsuccessful reception of the SM by the SMSF.
4. Forward SMS per applicable flows.

5. "SMS to deliver" received by SMSF: see applicable flows.
- 5ch-a. The SMSF sends Charging Data Request [Termination] to the CHF for terminating the charging associated with SMS submission.
- 5ch-b. The CHF closes the CDR for this SMS submission.
- 5ch-c. The CHF acknowledges by sending Charging Data Response [Termination] to the SMSF.
6. The SMSF forwards the "SMS Deliver" message towards the UE.
7. The SMSF receives "SMS Deliver Answer" message as the delivery success or failure of the SM transfer attempt.
8. Termination procedures: see applicable flows

The correspondence between "SMS Submit/SMS Submit Answer" and " SMS to deliver/SMS Deliver/ SMS Deliver Answer" messages in this scenario, and the messages in the different Network scenario for which they are applicable, is described in table 5.4.2.2.1 and table 5.4.2.3.1 respectively.

5.4.2.5 SMS Submission - PEC

Figure 5.4.2.5.1 describes the scenario where a SMS is submitted to the SMSF for PEC mode

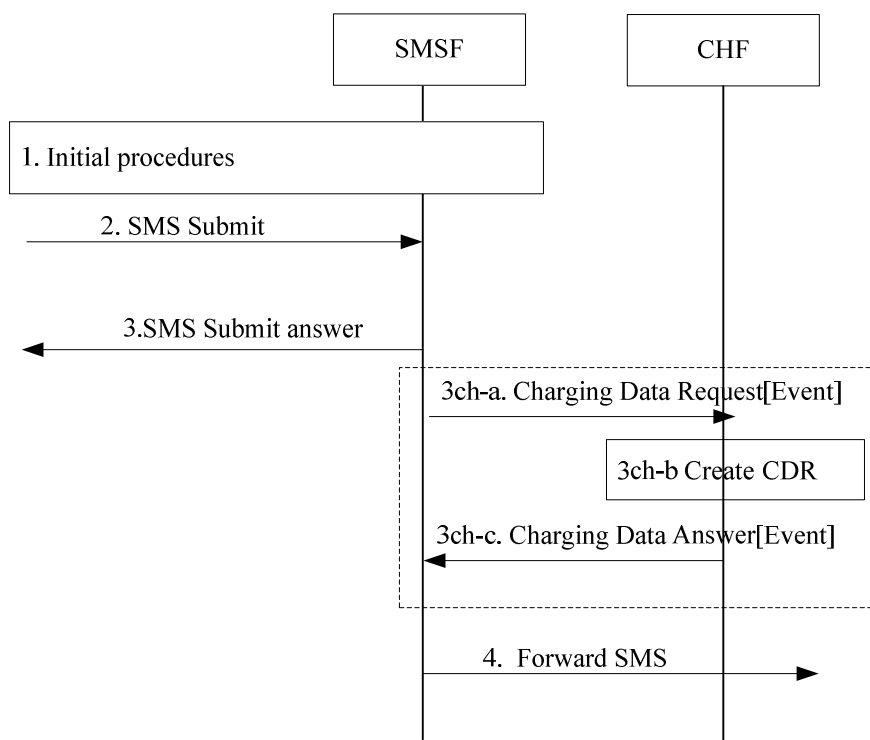

Figure 5.4.2.5.1: SMS submission to SMSF - PEC

1. Initial procedures: see applicable flows in table 5.4.2.2.1.
2. The SMSF receives a "SMS Submit" incoming message originated by a UE.
3. The SMSF returns "SMS Submit Answer" with appropriate result successful or unsuccessful reception of the SM by the SMSF.
- 3ch-a. The SMSF sends Charging Data Request [Event] to CHF for the received MO SMS.
- 3ch-b. The CHF creates a CDR for this MO SMS.
- 3ch-c. The CHF acknowledges by sending Charging Data Response [Event] to the SMSF.

4. Forward SMS per applicable flows table 5.4.2.2.1.

5.4.2.6 SMS Delivery - PEC

Figure 5.4.2.6.1 describes the scenario where a SMS is delivered from the SMSF for PEC mode

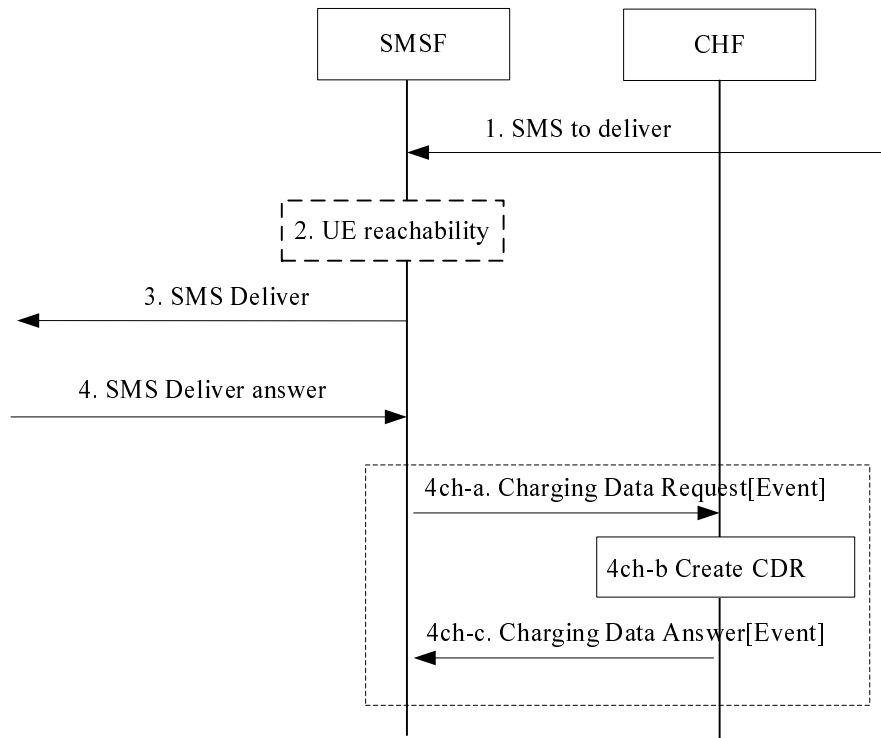

Figure 5.4.2.6.1 SMS delivery from SMSF - PEC

1. "SMS to deliver" received by SMSF in order to deliver a MT SMS over NAS towards the UE: see applicable flows in table 5.4.2.3.1.
2. UE reachability criteria met.
3. The SMSF forwards the "SMS Deliver" message towards the UE.
4. The SMSF receives "SMS Deliver Answer" message as the delivery success or failure of the SM transfer attempt.
- 4ch-a. The SMSF sends Charging Data Request [Event] to CHF for the MT SMS delivery.
- 4ch-b. The CHF creates a CDR for this MT SMS.
- 4ch-c. The CHF acknowledges by sending Charging Data Response [Event] to the SMSF.

5.4.3 CDR generation

5.4.3.1 Introduction

The CHF CDRs for SMS charging are generated by the CHF to collect charging information that they subsequently transfer to the Charging Gateway Function (CGF).

The following clauses describe in details the conditions for generating, opening and closing the CHF CDR, which shall be supported by the CHF.

5.4.3.2 Triggers for CHF CDR

5.4.3.2.1 General

A SMS charging CHF CDR is used to collect charging information related to SMS chargeable events for PEC, IEC and ECUR.

5.4.3.2.2 Triggers for CHF CDR generation

A CHF CDR is generated by the CHF for each received Charging Data Request[Event].

5.4.3.2.3 Triggers for CHF CDR opening

A CHF CDR shall be opened when the CHF receives Charging Data Request[Initial].

5.4.3.2.4 Triggers for CHF CDR closure

The CHF CDR shall be closed when the CHF receives Charging Data Request[Termination].

5.4.4 Ga record transfer flows

Details of the Ga protocol application are specified in TS 32.295 [6].

5.4.5 B_{sm} CDR file transfer

Details of the Bsm protocol application are specified in TS 32.297 [5].

6 Definition of charging information

6.1 Data description for SMS offline charging

6.1.1 R_f message contents

6.1.1.1 Summary of offline charging message formats

The SMS Node generates accounting information that can be transferred from the CTF to the CDF. For this purpose, SMS offline charging utilizes the *Charging Data Transfer Operation* that is specified in the 3GPP accounting application described in TS 32.299 [4].

The *Charging Data Transfer* operation employs the *Charging Data Request* and *Charging Data Response* messages. Table 6.1.1.1.1 describes the use of these messages for offline charging.

Table 6.1.1.1.1: Offline charging messages reference table

Command-Name	Source	Destination
<i>Charging Data Request</i>	CTF	CDF
<i>Charging Data Response</i>	CDF	CTF

This clause describes the different fields used in the Charging Data messages and the category in the tables are used according to the charging data configuration defined in clause 5.4 of TS 32.240 [2].

6.1.1.2 Structure for the offline charging message formats

6.1.1.2.1 Charging Data Request message

Table 6.1.1.2.1.1 illustrates the basic structure of a *Charging Data Request* message as used for SMS offline charging.

Table 6.1.1.2.1.1: Charging Data Request message contents

Information Element	Category	Description
Session Identifier	M	Described in TS 32.299 [4]
Originator Host	M	Described in TS 32.299 [4]
Originator Domain	M	Described in TS 32.299 [4]
Destination Domain	M	Described in TS 32.299 [4]
Operation Type	M	This field contains event type transfer (immediate event based charging).
Operation Number	M	Described in TS 32.299 [4]
Operation Identifier	O _M	Described in TS 32.299 [4]
User Name	O _C	This field contains the identification of the source node.
Origination Timestamp	O _C	Described in TS 32.299 [4]
Proxy Information	O _C	Described in TS 32.299 [4]
Route Information	O _C	Described in TS 32.299 [4]
Operation Token	O _M	This field contains the service context, i.e. SMS charging.
Service Information	O _M	This field holds the 3GPP specific SMS parameter. Described in clause 6.3.

6.1.1.2.2 Charging Data Response message

Table 6.1.1.2.2.1 illustrates the basic structure of a *Charging Data Response* message as used for SMS offline charging.

Table 6.1.1.2.2.1: Charging Data Response Message Contents

Information Element	Category	Description
Session Identifier	M	Described in TS 32.299 [4]
Operation Result	M	Described in TS 32.299 [4]
Originator Host	M	Described in TS 32.299 [4]
Originator Domain	M	Described in TS 32.299 [4]
Operation Type	M	This field contains event type transfer (immediate event based charging).
Operation Number	M	Described in TS 32.299 [4]
Operation Identifier	O _M	Described in TS 32.299 [4]
User Name	O _C	This field contains the identification of the source node.
Destination Host	O _C	Described in TS 32.299 [4]
Error Reporting Host	O _C	Described in TS 32.299 [4]
Origination Timestamp	O _C	Described in TS 32.299 [4]
Proxy Information	O _C	Described in TS 32.299 [4]

6.1.2 G_a message contents

Refer to clause 5.2.4 for further information.

6.1.3 CDR description on the B_{sm} interface

6.1.3.1 CDR field types

The following Standard CDR content and format are considered:

- generated from SMS-SC:
 - SC-SMO CDR;
 - SC-SMT CDR;
 - SC-SMO-T4 CDR;
 - SC-DVT-T4 CDR.
- generated from IP-SM-GW:
 - ISM-SMO CDR;
 - ISM-SMT CDR.

The content of each CDR type is defined in the tables in clauses 6.1.3.3 to 6.1.3.8.

For each CDR type the field definition includes the field name, category and description. The category in the tables are used according to the charging data configuration defined in clause 5.4 of TS 32.240 [2].

The detailed specification of the CDR parameters and their encoding is contained in TS 32.298 [3], while TS 32.297 [5] specifies the details of the CDR file transfer to the Billing Domain (BD). Additional CDR formats and contents may be available at the interface to the billing system to meet the requirements of the Billing System (BS), these are outside of the scope of 3GPP standardization.

6.1.3.2 CDR triggers

The generation of the SMS related CDRs is based on reception of Charging Data Request[Event] messages transferred from the SMS node to the CDF. One CDR is created in the CDF for each Charging Data Request[Event] message received.

6.1.3.3 SC-SMO CDR content

The content of SC-SMO CDR is defined in the table 6.1.3.3.1.

Table 6.1.3.3.1: SC-SMO record

Field	Category	Description
Record Type	M	SMS-SC SMS originated.
SMS Node Address	M	This field holds the address (e.g. E.164) of the SMS-service centre sending the Charging Data Request used for producing the record. (SMSC Address)
Originator Info	O _M	This field is a grouped field and holds information on originator of the SM.
Originator IMSI	O _M	This field holds the IMSI of the subscriber sending the short message, in case of Mobile Originating message, if available.
Originator MSISDN	O _C	This field holds the primary MSISDN of the subscriber sending the message, if available.
Originator Other Address	O _M	This field holds the address of the originator of the SM, when different from IMSI and MSISDN, if available: e.g. email, short code. Multiple addresses may be carried.
Originator SCCP Address	O _C	This field holds the SCCP calling address used to receive the SM at the SMS node, when applicable.
Originator Received Address	O _C	This field holds the original, unmodified address of the originator of the SM, as received by the SMS node, in case address manipulation (such as number plan corrections) have been applied in the SMS node.
SM Originator Interface	O _M	This field contains information describing the interface on which the SM was received by the SMS node. In case the charging event is for application to person messaging or for application to application messaging (see clause 5.1.1) this field holds the identification of the application sending the SM.
SM Originator Protocol Id	O _C	This field holds the TP-PROTOCOL-ID (TP-PID) as defined in TS 23.040 [7] describing the protocol used for the SM by originator.
Recipient Info	O _M	This field is a grouped field and holds recipient information for the SM. Multiple occurrences of this field are allowed in case: - multiple recipients are associated with the charged event and - all other charging information is identical for all recipients.
Recipient IMSI	O _C	This field holds the IMSI of the recipient of the SM, as received by the SMS Node, if available.
Recipient MSISDN	O _C	This field holds the MSISDN of the recipient of the SM, as received by the SMS Node, if available.
Recipient Other Address	O _C	This field holds the address of the recipient of the SM, as received by the SMS Node, when different from IMSI and MSISDN, if available: e.g. email, short code, external identifier. Multiple addresses may be carried.
Recipient Received Address	O _C	This field holds the original, unmodified address of the recipient of the SM, as received by the SMS node, in case address manipulation (such as number plan corrections) have been applied in the SMS node.
SM Destination Interface	O _M	This is a structured field containing information describing the interface on which the SM is to be delivered (i.e. the next hop). In case the charging event is for person to application messaging or for application to application messaging (see clause 5.1.1) this field holds the identification of the application.
Served IMEI	O _C	The field holds IMEI or IMEISV of the UE, if available
Event Time stamp	M	This field holds the timestamp of when the submitted SM arrived at the SMS-SC.
Message Reference	M	This field holds the identity used to identify an SM in the SMS node associated with entity that submitted it, and corresponds to the TP-Message-Reference (TP-MR) as defined in TS 23.040 [7].
SM Total Number	O _C	This field holds the total number of short messages when this SM is part of concatenated short message. This field is present only in case of concatenated short message.
SM sequence Number	O _C	This field holds the sequence number of this SM within the concatenated short message when applicable. This field is present only in case of concatenated short message.
Message size	O _C	This field holds the length of the user data part of the SM, and corresponds to the TP-User-Data-Length (TP-UDL) as defined in TS 23.040 [7].
Message Class	O _M	Used as defined in TS 32.270 [13]. It is implementation dependent the value selected for a specific transaction.

Field	Category	Description
SM Delivery Report Requested	O _c	This field holds indication whether a delivery report is requested by the SM originator, and corresponds to the TP-Status-Report-Request (TP-SRR) as defined in TS 23.040 [7].
SM Data Coding Scheme	O _M	This field holds the data coding scheme used within the SM. The information to populate this field is obtained from TP-DCS header.
SM Message Type	O _M	This field identifies the message that triggered the generation of charging information.
SM Reply Path Requested	O _c	This field holds an indication of whether a reply SM to an original SM shall follow the same path as identified by the TP-Reply-Path (TP-RP) flag.
SM User Data Header	O _c	This field carries the user data header extracted from the user data of the SM. The user data header (TP-UDH) is specified in TS 23.040 [7].
User Location Info	O _c	This field holds the information about the location of the subscriber as defined in TS 29.061 [203] "3GPP-User-Location-Info" during the SMS transaction, in case of Mobile Originating message, if available. "NCGI", "5GS TAI", "5GS TAI and NCGI", "NG-RAN Node ID" and "5GS TAI and NG-RAN Node ID" values are applicable.
RAT Type	O _c	This field holds the Radio Access Technology (RAT) type used for the SMS transaction, in case of Mobile Originating message, if available.
UE Time Zone	O _c	This field indicates the offset between universal time and local time in steps of 15 minutes of where the UE currently resides, in case of Mobile Originating message, if available.
SMS Result	C	The field holds the result of the attempted SM submission, if unsuccessful.
Record extensions	O _c	A set of network/ manufacturer specific extensions to the record, when available.

6.1.3.4 SC-SMT CDR content

The content of SC-SMT CDR is defined in table 6.1.3.4.1.

Table 6.1.3.4.1: SC-SMT record

Field	Category	Description
Record Type	M	SMS-SC SMS Terminated.
SMS Node Address	M	This field holds the address (e.g. E.164) of the SMS-service centre sending the Charging Data Request used for producing the record. (SMSC Address).
Recipient Info	O _M	This field is a grouped field and holds information on the recipient for the SM.
Recipient IMSI	O _M	The IMSI of the subscriber the short message was delivered to, in case of Mobile Terminating message, if available.
Recipient MSISDN	O _c	The primary MSISDN of the subscriber the short message was delivered to, if available.
Recipient Other Address	O _c	This field holds the address of the recipient of the SM, when different from IMSI and MSISDN, if available: e.g. email, short code. Multiple addresses may be carried. This field holds the external identifier of the recipient of the SM, when the SM is to be delivered for Device Trigger, if available.
Recipient SCCP Address	O _c	This field holds the SCCP called address used by the SMS node to onward deliver the SM.
Recipient Received Address	O _c	This field holds the original, unmodified address of the recipient of the SM, as received by the SMS node, in case address manipulation (such as number plan corrections) have been applied in the SMS node.
SM Destination Interface	O _M	This is a structured field containing information describing the interface on which the SM was requested to be delivered (i.e. the next hop). In case the charging event is for person to application messaging or for application to application messaging (see clause 5.1.1) this field holds the identification of the application. In case the SM is for Device Trigger, this field is not present .
SM Recipient Protocol Id	O _c	This field holds the TP-PROTOCOL-ID (TP-PID) as defined in TS 23.040 [7]. In case the SM is for Device Trigger, this field holds the "Device Triggering Short Message code".
Originator Info	O _M	This field is a grouped field and holds information on the originator of the SM, if available.
Originator IMSI	O _M	This field holds the IMSI of the subscriber originator of the SM, if available.
Originator MSISDN	O _c	This field holds the MSISDN of the subscriber originator of the SM, if available.
Originator Other Address	O _M	This field holds the address of the originator of the SM, when different from IMSI and MSISDN, if available: e.g. short-code. Multiple addresses may be carried. In case the SM is for Device Trigger, this field holds the SME address of the Service Capability Server that is requesting a device trigger to the UE as specified in TS 29.337 [18].
Originator Received Address	O _c	This field holds the original, unmodified address of the originator of the SM, as received by the SMS node, in case address manipulation (such as number plan corrections) have been applied in the SMS node.
SM Originator Interface	O _c	This field contains information describing the interface on which the SM was received by the SMS node. In case the charging event is for application to person messaging or for application to application messaging (see clause 5.1.1) this field holds the identification of the application sending the SM. In case the SM is for Device Trigger, this field is not present .
Served IMEI	O _C	The field holds IMEI or IMEISV of the UE, if available.
Submission Time	O _c	This field holds the timestamp of when the submitted SM arrived at the originating SMS Node. The information to populate this field is obtained from the TP-Service-Center-Time-Stamp (TP-SCTS) as defined in TS 23.040 [7].
Event Time stamp	M	This field holds the timestamp of result (successful or unsuccessful) of SM delivery: last result in case of multiple retries.
SM Priority	O _c	This field holds any priority information associated with an SM, as defined in TS 23.040 [7].
Message Reference	O _M	This field holds the identity used to identify an SM in the SMS node associated with entity that submitted it, and corresponds to the TP-Message-Reference (TP-MR) as defined in TS 23.040 [7]. This information is only applicable to delivery report charging procedures.
SM Total Number	O _c	This field holds the total number of short messages when this SM is part of concatenated short message. This field is present only in case of concatenated short message.
SM Sequence Number	O _c	This field holds the sequence number of this SM within the concatenated short message when applicable. This field is present only in case of concatenated short message.

Field	Category	Description
Message size	O _c	This field holds the length of the user data part of the SM, and corresponds to the TP-User-Data-Length (TP-UDL) as defined in TS 23.040 [7].
Message Class	O _M	Used as defined in TS 32.270 [13]. It is implementation dependent the value selected for a specific transaction.
SM Delivery Report Requested	O _c	This field holds indication whether a delivery report was requested by the SM originator, and corresponds to the TP-Status-Report-Indication (TP-SRI) as defined in TS 23.040 [7].
SM Data Coding Scheme	O _M	This field holds the data coding scheme used within the SM. The information to populate this field is obtained from TP-DCS header.
SM Message Type	O _M	This field identifies the message that triggered the generation of charging information.
SM Reply Path Requested	O _c	This field holds an indication of whether a reply SM to an original SM was requested to follow the same path as identified by the TP-Reply-Path (TP-RP) flag.
SM User Data Header	O _c	This field carries the user data header extracted from the user data of the SM. The user data header (TP-UDH) is specified in TS 23.040 [7].
SM Status	O _c	This field holds the information from the TP-Status field in a Status-Report TPDU. This information is only applicable to delivery report charging procedures.
SM Discharge Time	O _c	This field holds the time associated with the event being reported in the SM Status field. This information is only applicable to delivery report charging procedures.
User Location Info	O _c	This field holds the information about the location of the subscriber as defined in TS 29.061 [203] "3GPP-User-Location-Info", during the SMS transaction, in case of Mobile Terminating message, if available. "NCGI", "5GS TAI", "5GS TAI and NCGI", "NG-RAN Node ID" and "5GS TAI and NG-RAN Node ID" values are applicable.
RAT Type	O _c	This field holds the Radio Access Technology (RAT) type as defined in TS 29.061 [203] "3GPP-RAT-type", used for the SMS transaction, in case of Mobile Terminating message, if available. "NG-RAN" value is applicable.
UE Time Zone	O _c	This field indicates the offset between universal time and local time in steps of 15 minutes of where the UE currently resides, in case of Mobile Terminating message, if available.
SMS Result	C	The field holds the result of the attempted SM delivery, if unsuccessful.
SM Device Trigger information	O _c	This field holds the set of information related to SMS submission to SMS-SC for Device Trigger.
SM DT Reference Number	O _c	This field holds the Reference Number related to the device trigger request, if available.
SMS Application Port ID	O _c	This field holds the Application Port ID of the triggering application for the device trigger request, if available.
Record extensions	O _c	A set of network/ manufacturer specific extensions to the record, when available.

6.1.3.5 SC-DVT-T4 CDR content

The content of SC-DVT-T4 CDR is defined in the table 6.1.3.5.1.

Table 6.1.3.5.1: SC-DVT-T4 record

Field	Category	Description
Record Type	M	Device Trigger over T4.
SMS Node Address	M	This field holds the address (e.g. E.164) of the SMS-service centre sending the Charging Data Request used for producing the record. (SMSC Address)
Event Time stamp	M	This field holds the timestamp of when the Device Trigger request arrived at the SMS-SC.
Originator Info	O _M	This field is a grouped field and holds information on originator of the Device Trigger.
Originator Other Address	O _M	This field holds the SME address of the Service Capability Server that is requesting a device trigger to the UE as specified in TS 29.337 [18].
Recipient Info	O _M	This field is a grouped field and holds recipient information for the SM to be delivered.
Recipient IMSI	O _M	This field holds the IMSI of the recipient of the SM to be delivered for Device Trigger, as received in the User Identifier from MTC-IWF, specified in TS 29.337 [18].
Recipient MSISDN	O _c	This field holds the MSISDN of the recipient of the SM to be delivered for Device Trigger, as received in the User Identifier from MTC-IWF, specified in TS 29.337 [18], if available.
Recipient Other Address	O _c	This field holds the the external identifier of the recipient of the SM to be delivered for Device Trigger, as received in the User Identifier from MTC-IWF, specified in TS 29.337 [18], if available.
SM Device Trigger Indicator	O _c	This field holds indication on the device trigger submission to SMS-SC: trigger, replace or recall.
SM Device Trigger information	O _c	This field holds the set of information related to Device Trigger submission to SMS-SC.
MTC IWF Address	O _c	This field holds the MTC IWF address from which device trigger is received.
SM DT Reference Number	O _c	This field holds the Reference Number related to the device trigger request, if available.
SM Old DT Reference Number	O _c	This field holds the Reference Number related to the device trigger intended to be replaced or recalled in the request. This information element shall be present if SM Device Trigger Indicator is recall or replace.
SM Serving Node	O _c	This field holds the serving node identity, i.e. SGSN/MME/MSC identity serving the UE, as received from MTC-IWF, if available.
SM DT Validity Period	O _c	This field holds the validity period of the device trigger request, if available.
SM DT Priority Indication	O _c	This field holds the priority of the device trigger request, if available.
SMS Application Port ID	O _c	This field holds the Application Port ID of the triggering application for the device trigger request, if available.
Result	M	This field holds the result of Device Trigger request to SMS-SC
Record extensions	O _c	A set of network/ manufacturer specific extensions to the record, when available.

6.1.3.6 SC-SMO-T4 CDR content

The content of SC-SMO-T4 CDR is defined in the table 6.1.3.6.1.

Table 6.1.3.6.1: SC-SMO-T4 record

Field	Category	Description
Record Type	M	SMS originated via T4.
SMS Node Address	M	This field holds the address (e.g. E.164) of the SMS-service centre sending the Charging Data Request used for producing the record. (SMSC Address)
Originator Info	O _M	This field is a grouped field and holds information on originator of the SM.
Originator IMSI	O _M	This field holds the IMSI of the subscriber sending the short message, if available.
Originator SCCP Address	O _c	This field holds the SCCP calling address used to receive the SM at the SMS node, when applicable.
SM Originator Protocol Id	O _c	This field holds the TP-PROTOCOL-ID (TP-PID) as defined in TS 23.040 [7] describing the protocol used for the SM by originator.
Recipient Info	O _M	This field is a grouped field and holds recipient information for the SM.
Recipient Other Address	O _c	This field holds the SME address of the SCS/AS, recipient of the SM, as received by the SMS-SC.
Served IMEI	O _c	The field holds IMEI or IMEISV of the UE, if available
Event Time stamp	M	This field holds the timestamp of when the submitted SM arrived at the SMS-SC.
Message Reference	M	This field holds the identity used to identify an SM in the SMS node associated with entity that submitted it, and corresponds to the TP-Message-Reference (TP-MR) as defined in TS 23.040 [7].
Message size	O _c	This field holds the length of the user data part of the SM, and corresponds to the TP-User-Data-Length (TP-UDL) as defined in TS 23.040 [7].
Message Class	O _M	Used as defined in TS 32.270 [13]. It is implementation dependent the value selected for a specific transaction.
SM Delivery Report Requested	O _c	This field holds indication whether a delivery report is requested by the SM originator, and corresponds to the TP-Status-Report-Request (TP-SRR) as defined in TS 23.040 [7].
SM Data Coding Scheme	O _M	This field holds the data coding scheme used within the SM. The information to populate this field is obtained from TP-DCS header.
SM Message Type	O _M	This field identifies the message that triggered the generation of charging information, indicating "MO-SMS via T4 submission"
SM Reply Path Requested	O _c	This field holds an indication of whether a reply SM to an original SM shall follow the same path as identified by the TP-Reply-Path (TP-RP) flag.
SM User Data Header	O _c	This field carries the user data header extracted from the user data of the SM. The user data header (TP-UDH) is specified in TS 23.040 [7]
User Location Info	O _c	This field holds the information about the location of the subscriber during the SMS transaction, if available.
RAT Type	O _c	This field holds the Radio Access Technology (RAT) type used for the SMS transaction, if available.
UE Time Zone	O _c	This field indicates the offset between universal time and local time in steps of 15 minutes of where the UE currently resides, if available.
SMS Result	C	The field holds the result of the attempted SM submission, if unsuccessful.
MTC IWF Address	O _c	This field holds the MTC IWF address used by the SMS-SC for the Mobile Originating message transfer to the SCS/AS.
SMS Application Port ID	O _c	This field holds the Application Port ID of the Mobile Originating message handled by the SMS-SC.
External Identifier	O _M	This field holds the External Identifier associated to the sender of the Mobile Originated short message, if available.
Record extensions	O _c	A set of network/ manufacturer specific extensions to the record, when available.

6.1.3.7 ISM-SMO CDR content

The content of ISM-SMO CDR is defined in the table 6.1.3.7.1.

Table 6.1.3.7.1: ISM-SMO record

Field	Category	Description
Record Type	M	IP-SM-GW SMS originated.
SMS Node Address	M	This field holds the address of the IP-SM-GW sending the Charging Data Request used for producing the record.
Originator Info	O _M	This field and sub-fields are described in table 6.1.3.3.1
Recipient Info	O _M	This field and sub-fields are described in table 6.1.3.3.1
Subscriber Equipment Number	O _c	This field holds the subscriber equipment information.
Event Time stamp	M	Described in table 6.1.3.3.1
Message Reference	M	Described in table 6.1.3.3.1
SM Total Number	O _c	Described in table 6.1.3.3.1
SM sequence Number	O _c	Described in table 6.1.3.3.1
Message size	O _c	Described in table 6.1.3.3.1
Message Class	O _M	Described in table 6.1.3.3.1
SM Delivery Report Requested	O _c	Described in table 6.1.3.3.1
SM Data Coding Scheme	O _M	Described in table 6.1.3.3.1
SM Message Type	O _M	Described in table 6.1.3.3.1
SM Reply Path Requested	O _c	Described in table 6.1.3.3.1
SM User Data Header	O _c	Described in table 6.1.3.3.1
SMS Result	C	Described in table 6.1.3.3.1
User Location Info	O _c	Described in table 6.1.3.3.1
RAT Type	O _c	Described in table 6.1.3.3.1
UE Time Zone	O _c	Described in table 6.1.3.3.1
PDP Address	O _c	This field holds the IP address used by the subscriber for the SMS transaction.
User Session Id	O _c	This field holds the session identifier. For a SIP session the Session-ID contains the SIP Call ID.
Number Portability routing information	O _c	This field includes information on number portability after DNS/ENUM request from S-CSCF in the sms originator user's home network.
Carrier Select routing information	O _c	This field includes information on carrier select after DNS/ENUM request from S-CSCF in the sms originator user's home network.
Record extensions	O _c	A set of network/ manufacturer specific extensions to the record, when available.

6.1.3.8 ISM-SMT CDR content

The content of ISM-SMT CDR is defined in table 6.1.3.8.1.

Table 6.1.3.8.1: ISM-SMT record

Field	Category	Description
Record Type	M	IP-SM-GW SMS Terminated.
SMS Node Address	M	This field holds the address of the IP-SM-GW sending the Charging Data Request used for producing the record.
Recipient Info	O _M	This field and sub-fields are described in table 6.1.3.4.1, except for Device trigger which is not applicable.
Originator Info	O _M	This field and sub-fields are described in table 6.1.3.4.1, except for Device trigger which is not applicable.
Subscriber Equipment Number	O _c	This field holds the subscriber equipment information.
Submission Time	O _c	Described in table 6.1.3.4.1
Event Time stamp	M	Described in table 6.1.3.4.1
SM Priority	O _c	Described in table 6.1.3.4.1
Message Reference	O _M	Described in table 6.1.3.4.1
SM Total Number	O _c	Described in table 6.1.3.4.1
SM Sequence Number	O _c	Described in table 6.1.3.4.1
Message size	O _c	Described in table 6.1.3.4.1
Message Class	O _M	Described in table 6.1.3.4.1
SM Delivery Report Requested	O _c	Described in table 6.1.3.4.1
SM Data Coding Scheme	O _M	Described in table 6.1.3.4.1
SM Message Type	O _M	Described in table 6.1.3.4.1
SM Reply Path Requested	O _c	Described in table 6.1.3.4.1
SM User Data Header	O _c	Described in table 6.1.3.4.1
SM Status	O _c	Described in table 6.1.3.4.1
SM Discharge Time	O _c	Described in table 6.1.3.4.1
SMS Result	C	Described in table 6.1.3.4.1
User Location Info	O _c	Described in table 6.1.3.4.1
RAT Type	O _c	Described in table 6.1.3.4.1
UE Time Zone	O _c	Described in table 6.1.3.4.1
PDP Address	O _c	This field holds the IP address used by the subscriber for the SMS transaction.
User Session Id	O _c	This field holds the session identifier. For a SIP session the Session-ID contains the SIP Call ID.
Number Portability routing information	O _c	This field includes information on number portability after DNS/ENUM request from S-CSCF in the sms recipient user's home network.
Carrier Select routing information	O _c	This field includes information on carrier select after DNS/ENUM request from S-CSCF in the sms recipient user's home network.
Record extensions	O _c	A set of network/ manufacturer specific extensions to the record, when available.

6.2 Data description for SMS online charging

6.2.1 R_o message contents

6.2.1.0 Introduction

The SMS node generates Debit / Reserve Units information that can be transferred from the CTF to the OCF. For this purpose, SMS online charging utilizes the *Debit Units and Reserve Units* procedure that is specified in the 3GPP Debit / Reserve Units operation in TS 32.299 [4].

The SMS node generates refund information that can be transferred from the CTF to the OCF. For this purpose, it uses REFUND procedure defined in IETF RFC 4006 [12] with extended AVPs.

The *Debit / Reserve Units* procedure employs the *Debit / Reserve Units Request* and *Debit / Reserve Units Response* messages.

The Refund Account procedure employs the Debit Units Request (Refund Account) request and response messages.

Table 6.2.1.0.1 describes the use of these messages for SMS online charging.

Table 6.2.1.0.1: SMS online charging messages contents

Command-Name	Source	Destination
Debit / Reserve Units Request	CTF	OCS
Debit / Reserve Units Response	OCS	CTF

This clause describes the different fields used in the *Debit / Reserve Units Request* and *Debit / Reserve Units Response* messages and the category in the tables are used according to the charging data configuration defined in clause 5.4 of TS 32.240 [2].

Detailed descriptions of the fields are provided in TS 32.299 [4].

6.2.1.1 Summary of message formats

6.2.1.2 Structure for the Credit-Control message formats

6.2.1.2.1 Debit/Reserve Units Request message

Table 6.2.1.2.1.1 illustrates the basic structure of a *Debit / Reserve Units Request* message from SMS node as used for SMS online charging.

Table 6.2.1.2.1.1: *Debit / Reserve Units Request* message contents for SMS

Information Element	Category	Description
Session Identifier	M	This field identifies the operation session.
Originator Host	M	This field contains the identification of the source point of the operation.
Originator Domain	M	This field contains the realm of the operation originator.
Destination Domain	M	This field contains the realm of the operation destination.
Operation Identifier	M	This field is a unique operation identifier.
Operation Token	M	This field contains the service context, i.e. SMS charging.
Operation Type	M	This field defines the transfer type: event for immediate event based charging and initial, terminate for ECUR based charging.
Operation Number	M	This field contains the sequence number of the transferred messages.
Destination Host	O _C	This field contains the identification of the destination point of the operation.
User Name	O _C	This field contains the identification of the source node.
Origination State	O _C	Used for ECUR only.
Origination Timestamp	O _C	This field contains the time when the operation is requested.
Subscriber Identifier	O _M	This field contains the identification of the subscriber (i.e. MSISDN) that uses the requested service.
Termination Cause	O _C	This field contains information about the cause for termination of a Credit-Control session. Used for terminating Credit-Control sessions in ECUR only.
Requested-Action	O _C	This field contains the requested action, used for IEC only.
Multiple Operation	O _M	This field indicate the occurrence of multiple operations.
Multiple Unit Operation	O _C	This field contains the parameter for the quota management.
Subscriber Equipment Number	O _C	This field contains the identification of the user equipment used to access service. Included if information is made available to the node.
Proxy Information	O _C	This field contains the parameter of the proxy.
Route Information	O _C	This field contains the parameter of the route.
Service Information	O _M	This field holds the SMS specific parameter and is described in clause 6.3.

6.2.1.2.2 Debit / Reserve Units Response message

Table 6.2.1.2.2.1 illustrates the basic structure of a Debit / Reserve Units Response message as used for SMS charging. This message is always used by the OCS as specified below, independent of the receiving SMS node and the operation type that is being replied to.

Table 6.2.1.2.2.1: Debit / Reserve Units Response message contents for SMS

Information Element	Category	Description
Session Identifier	M	This field identifies the operation session.
Operation Result	M	This field identifies the result of the operation.
Originator Host	M	This field contains the identification of the source point of the operation.
Originator Domain	M	This field contains the realm of the operation originator.
Operation Identifier	M	This field is a unique operation identifier.
Operation Type	M	This field defines the transfer type: event for event based charging and start, interim, stop for session based charging.
Operation Number	M	This field contains the sequence number of the transferred messages.
Operation Failover	-	Not used for SMS in 3GPP.
Multiple Unit Operation	O _c	This field contains the parameter for the quota management. Used in IEC for refund purpose and in ECUR.
Operation Failure Action	O _c	This field defines the resulting operation at the SMS node if a failure has occurred at the OCS for ECUR.
Operation Event Failure Action	O _c	This field defines the resulting operation at the SMS node if a failure has occurred at the OCS for IEC.
Redirection Host	O _c	
Redirection Host Usage	O _c	
Redirection Cache Time	O _c	
Proxy Information	O _c	This field contains the parameter of the proxy.
Route Information	O _c	This field contains the parameter of the route.
Failed parameter	O _c	This field contains missing and/or unsupported parameter that caused the failure.
Service Information	O _c	This field contains SMS specific information.

Editor's Note: The mechanism to carry refund information is For Future Study.

6.2a Data description for SMS converged charging

6.2a.1 Message contents

6.2a.1.1 General

The Charging Data Request and Charging Data Response are specified in TS 32.290 [57] and include charging information. The Charging Data Request can be of type [Event, Initial, Termination].

Table 6.2a.1.1.1 describes the use of these messages for converged charging.

Table 6.2a.1.1.1: Converged charging messages reference table

Message	Source	Destination
Charging Data Request	SMSF	CHF
Charging Data Response	CHF	SMSF

The following clauses describe the different fields used in the Charging Data messages and the category in the tables is used according to the charging data configuration defined in clause 5.4 of TS 32.240 [2].

6.2a.1.2 Structure for the converged charging message formats

6.2a.1.2.1 Charging Data Request message

Table 6.2a.1.2.1.1 illustrates the basic structure of a Charging Data Request message as used for SMS converged charging.

Table 6.2a.1.2.1.1: Charging Data Request message contents

Information Element	Category	Description
Session Identifier	O _C	Described in TS 32.290 [57]
Subscriber Identifier	O _M	Described in TS 32.290 [57]
NF Consumer Identification	M	Described in TS 32.290 [57]
NF Functionality	M	Described in TS 32.290 [57]
NF Name	O _C	Described in TS 32.290 [57]
NF Address	O _C	Described in TS 32.290 [57]
NF PLMN ID	O _C	Described in TS 32.290 [57]
Invocation Timestamp	M	Described in TS 32.290 [57]
Invocation Sequence Number	M	Described in TS 32.290 [57]
One-time Event	O _C	Described in TS 32.290 [57]
One-time Event Type	O _C	Described in TS 32.290 [57]
Service Specification Information	O _C	Described in TS 32.290 [57]
Notify URI	O _C	This field is not applicable.
Triggers	O _C	This field is described in TS 32.290 [57] and holds the SMS specific triggers described in clause 5.x
Multiple Unit Usage	O _C	This field is present when the number of units is beyond one (i.e. more than one SMS)
Rating Group	M	Described in TS 32.290 [57]
Requested Unit	O _C	Described in TS 32.290 [57]
Used Unit Container	O _C	This field holds SMS charging information when more than one SMS. It may have multiple occurrences.
SMS Charging Information	O _M	This field holds the SMS specific information described in clause 6.5.2

6.2a.1.2.2 Charging Data Response message

Table 6.2a.1.2.2.1 illustrates the basic structure of a Charging Data Response message as used for SMS converged charging.

Table 6.2a.1.2.2.1: Charging Data Response Message Contents

Information Element	Category	Description
Session Identifier	O _C	Described in TS 32.290 [57]
Invocation Timestamp	M	Described in TS 32.290 [57]
Invocation Result	O _C	Described in TS 32.290 [57]
Result code	O _C	Described in TS 32.290 [57]
Failed parameter	O _C	Described in TS 32.290 [57]
Failure Handling	O _C	Described in TS 32.290 [57]
Invocation Sequence Number	M	Described in TS 32.290 [57]
Session Failover	O _C	Described in TS 32.290 [57]
Triggers	O _C	This field is not applicable.
Multiple Unit information	O _C	This field is applicable for ECUR.
Result Code	O _C	Described in TS 32.290 [57]
Rating Group	O _M	Described in TS 32.290 [57]
Granted Unit	O _C	Described in TS 32.290 [57]
Validity Time	O _C	Described in TS 32.290 [57]

6.2a.2 G_a message contents

Refer to clause 5.4.4.

6.2a.3 CDR description on the B_{sm} interface

6.2a.3.1 General

This clause describes the CDR content and format generated for SMS converged charging.

The following tables provide a brief description of each CDR parameter. The category in the tables is used according to the charging data configuration defined in clause 5.4 of TS 32.240 [2]. Full definitions of the CDR parameters, sorted by the name in alphabetical order, are provided in TS 32.298 [3].

6.2a.3.2 SMS charging CHF CDR data

If enabled, CHF CDRs for SMS charging shall be produced for SMS chargeable events.

The fields of SMS charging CHF CDR are specified in table 6.2x.3.2.1.

Table 6.2a.3.2.1: SMS charging CHF record data

Field	Category	Description
Record Type	M	Described in TS 32.298 [3]
Recording Network Function ID	O _M	Described in TS 32.298 [3]
Subscriber Identifier	M	This field holds the 5G Subscription Permanent Identifier (SUPI) of the served party.
NF Consumer Information	M	This field holds the information of the SMSF that used the charging service.
NF Functionality	M	This field contains the function of the node (i.e. SMSF)
NF Name	O _C	This field holds the name of the SMSF used.
NF Address	O _C	This fields holds the IP Address of the SMSF used.
NF PLMN ID	O _C	This field holds the PLMN identifier (MCC MNC) of the SMSF.
Triggers	O _C	This field is described in TS 32.298 [3] and holds the SMS specific triggers described in clause 5.x
List of Multiple Unit Usage	O _M	This field is present when the number of units is beyond one (i.e. more than one SMS)
Record Opening Time	O _C	Described in TS 32.298 [3]
Duration	M	Described in TS 32.298 [3]
Record Sequence Number	C	Described in TS 32.298 [3]
Cause for Record Closing	M	Described in TS 32.298 [3]
Local Record Sequence Number	O _M	Described in TS 32.298 [3]
Record Extensions	O _C	Described in TS 32.298 [3]
SMS Charging Information	O _M	This field holds the SMS specific information defined in clause 6.x

6.3 SMS charging specific parameters

6.3.1 Definition of the SMS charging information

6.3.1.1 SMS charging information assignment for Service Information

The components in the Service-Information that are use for SMS charging can be found in table 6.3.1.1.1

Table 6.3.1.1.1: Service-Information used for SMS Charging

Information Element	Category	Description
Service Information	O _M	This is a structured field and holds the 3GPP specific parameter as defined in TS 32.299 [4]. For SMS Charging the SMS-Information and selected parameters of MMS Information, PS-Information and IMS information are used.
SMS Information	O _M	This is a structured field and holds the SMS specific parameters. The details are defined in table 6.3.1.2.
MMS Information	O _M	This is a structure field and the following parameters are specific to SMS. The complete structure is defined in TS 32.270 [13]
Originator Address	O _M	This field holds the address of the originator of the SM. This is typically an E.164 number or a short-code. Multiple addresses may be carried if additional information is available, e.g. IMSI and E.164 number. This field holds the SME address of the SCS requesting a device trigger to the UE as specified in TS 29.337 [18], in case of SM for Device Trigger.
Submission Time	O _C	This field holds the timestamp of when the submitted SM arrived at the originating SMS Node. The information to populate this field is obtained from the TP-Service-Center-Time-Stamp (TP-SCTS) as defined in TS 23.040 [7]. If a refund or retransmission is required, the timestamp carries the timestamp associated with the original submitted SM.
Priority	O _C	This field holds any priority information associated with an SM. Applicable to terminating procedures only. Priority handling is defined in TS 23.040 [7]. The value "low" is not applicable.
Message Id	O _M	This field carries the identity used to identify an SM in the SMS node associated with entity that submitted it. The information to populate this field is obtained from the TP-Message-Reference (TP-MR) as defined in TS 23.040 [7].
Message Size	O _M	This field carries the length of the user data part of the SM. The information to populate this field is obtained from the TP-User-Data-Length (TP-UDL) as defined in TS 23.040 [7]
Message Class	O _M	Used as defined in TS 32.270 [13]. It is implementation dependent the value selected for a specific transaction.
Delivery Report Requested	O _C	This field indicates whether a delivery report is requested by the SM originator. The information to populate this field is obtained from the TP-Status-Report-Request (TP-SRR) as defined in TS 23.040 [7]
PS Information	O _C	This is a structured field and the following parameters are specific to SMS. The complete structure is defined in TS 32.251 [10].
PDP Address	O _C	This field holds the IP address used by the subscriber for the SMS transaction. Included if the SMS node is the IP-SM-GW.
3GPP User Location Info	O _C	This field holds the information about the location of the subscriber as defined in TS 29.061 [203] "3GPP-User-Location-Info", during the SMS transaction. "NCGI", "5GS TAI", "5GS TAI and NCGI", "NG-RAN Node ID" and "5GS TAI and NG-RAN Node ID" values are applicable.
3GPP RAT Type	O _C	This field holds information about the radio access technology as defined in TS 29.061 [203] "3GPP-RAT-type", used for the SMS transaction. "NG-RAN" value is applicable.
MS Time Zone	O _C	This field indicates the offset between universal time and local time in steps of 15 minutes of where the MS currently resides.
User Equipment Info	O _C	This field holds the identification of the terminal (IMEI or IMEISV...)
IMS Information	O _C	This is a structured field and the following parameters are specific to SMS. The complete structure is defined in TS 32.260 [15].
User Session Id	O _C	This field holds the session identifier. For a SIP session the Session-ID contains the SIP Call ID.
Number Portability routing information	O _C	This field includes information on number portability after DNS/ENUM request from S-CSCF in the calling user's home network.
Carrier Select routing information	O _C	This field includes information on carrier select after DNS/ENUM request from S-CSCF in the calling user's home network.

6.3.1.2 Definition of the SMS Information

The components in the SMS Information that are used for SMS charging can be found in table 6.3.1.2.1

Table 6.3.1.2.1: SMS Information used for SMS Charging

Information Element	Category	Description
SMS Node	O _M	Identifies the SMS Node as IP-SM-GW or SMS Router or a combined IP-SM-GW / SMS Router or as SMS-SC.
SM Client Address	O _M	This field holds the address of the SMS node to which the charging system is connected to. This may be the same as the SMSC Address field.
Originator SCCP Address	O _C	This field holds the SCCP calling address used to receive the SM at the SMS node. Only present if SMSIP is not used for the inward connection.
Originator Received Address	O _C	This field holds the original, unmodified address of the originator of the SM, as received by the SMS node, in case address manipulation (such as number plan corrections) have been applied in the SMS node. This is typically an E.164 number or a short-code. Multiple addresses may be carried if additional information is available, e.g. IMSI and E.164 number.
Recipient Info	O _C	This field holds recipient information for the SM. Each occurrence of this field denotes a different recipient. Multiple occurrences of this field are allowed in case: - multiple recipients are associated with the charged event and - all other charging information is identical for all recipients. In case the SM contains a Delivery Report, as described in clause 5.3.2.3, this field identifies the recipient of this Delivery Report. This recipient information shall correspond to the originator information of the message that triggered this Delivery Report. (Note 2)
Recipient Address	O _C	This field holds the address of the recipient of the SM. This is typically an E.164 number or a short-code. Multiple addresses may be carried if additional information is available, e.g. short-code, IMSI, E.164 number, long/short code of the SCS/AS, or external identifier for Device Trigger.
Recipient Received Address	O _C	This field holds the original, unmodified address of the recipient of the SM, as received by the SMS node, in case address manipulation (such as number plan corrections) have been applied in the SMS node. This is typically an E.164 number or a short-code. Multiple addresses may be carried if additional information is available, e.g. short-code, IMSI, or E.164 number.
Recipient SCCP Address	O _C	This field holds the SCCP called address used by the SMS node to onward deliver the SM. Only present if SMSIP is not used for the outward connection.
SM Destination Interface	O _M	This is a structured field containing information describing the interface on which the SM is to be delivered (i.e. the next hop). In case the charging event is for person to application messaging or for application to application messaging (see clause 5.1.1) this field holds the identification of the application. (See also Note 3)
SM Protocol Id	O _C	This field holds the TP-PROTOCOL-ID (TP-PID) as defined in TS 23.040 [7]. This field relates to the recipient when charging MT SMS messages as specified in TS 32.240 [2].
SMSC Address	O _M	This field holds the address of the SMSC to which the originating or terminating SM is directed to.
SM Data Coding Scheme	O _M	This field holds the data coding scheme used within the SM. The information to populate this field is obtained from TP-DCS header.
SM Message Type	O _M	This field identifies the message that triggered the generation of charging information.
SM Originator Interface	O _M	This is a structured field containing information describing the interface on which the SM was received by the SMS node (i.e. the previous hop) In case the charging event is for application to person messaging or for application to application messaging (see clause 5.1.1) this field holds the identification of the application. (See also Note 3)
SM Protocol Id	O _C	This field holds the TP-PROTOCOL-ID (TP-PID) as defined in TS 23.040 [7]. This field relates to the originator when charging MO SMS messages as specified in TS 32.240 [2].
SM Reply Path Requested	O _C	This field carries an indication of whether a reply SM to an original SM shall follow the same path as identified by the TP-Reply-Path (TP-RP) flag.
SM User Data Header	O _C	This field carries the user data header extracted from the user data of the SM. The user data header (TP-UDH) is specified in TS 23.040 [7]
SM Status	O _C	This field holds the information from the TP-Status field in a Status-Report TPDU. This information is only applicable to delivery report charging procedures or where ECUR is employed.
SM Discharge Time	O _C	This field holds the time associated with the event being reported in the SM Status field. This information is only applicable to delivery report charging procedures.

Number of Messages Sent	O _C	Indicates the number of SMSs sent by the IMS application or the total number of short messages when this SM is part of concatenated short message, if applicable.
SM Service Type	O _C	This field indicates the type of SM service that caused the charging interaction. It is only applicable for SM supplementary service procedures.
SM Sequence Number	O _C	This field holds the sequence number of this SM within the concatenated short message when applicable. This field is present only in case of concatenated short message. This field is only for offline charging.
SMS result	C	The field holds the result of the attempted SM transaction, if unsuccessful. This field is only for offline charging.
SM Device Trigger Indicator	O _C	This field holds indication on the device trigger submission to SMS-SC: request, replace or recall.
SM Device Trigger information	O _C	This field holds the set of information related to SMS transaction for Device Trigger.
MTC IWF Address	O _C	This field holds the MTC IWF address which originated the device trigger.
SM DT Reference Number	O _C	This field holds the Reference Number related to the device trigger request, if available.
SM Serving Node	O _C	This field holds the serving node identity, i.e. SGSN/MME/MSC identity serving the UE, as received from MTC-IWF, if available.
SM DT Validity Period	O _C	This field holds the validity period of the device trigger request, if available.
SM DT Priority Indication	O _C	This field holds the priority of the device trigger request, if available.
SMS Application Port ID	O _C	This field holds the Application Port ID of the triggering application for the device trigger request, if available.
MTC IWF Address	O _C	This field holds the MTC IWF address used by the SMS-SC for the Mobile Originating message transfer to the SCS/AS.
SMS Application Port ID	O _C	This field holds the Application Port ID of the Mobile Originating message handled by the SMS-SC.
External Identifier	O _M	This field holds the External Identifier associated to the sender of the Mobile Originated short message, if available.

NOTE 1: The case of multi-destinations of SMS refers to SMS and Internet Electronic Mail interworking as specified in clause 3.8 of TS 23.040 [7].

NOTE 2: Implementations vary as to the originator address that is presented to an end user for a Delivery Report. Typically the originator address either identifies the SMS node that generated the Delivery Report or the originator address of a Delivery Report identifies the recipient of the original message that triggered this Report. It is expected that the charging event contains the information presented to the end user.

NOTE 3: There is a distinction between short numbers (as conveyed in originator and/or recipient address fields) and the identification of SM applications (as carried in SM Originator Interface and/or SM Destination Interface). Short numbers are used by end users to address a service of an applications. Multiple short numbers may map to one application capable of multiple services. The identification of an application is how an application is know to the operator.

6.3.1A Detailed message format for offline charging

This clause specifies the charging data that are sent by the SMS Node in the Charging Data Request, with [Event] Operation Type.

When a particular field is not supported, this field is marked with "-".

Table 6.3.1A.1 illustrates the basic structure of the supported fields in Service Information of the *Charging Data Request* message for SMS offline charging.

Table 6.3.1A.1: Supported fields in *Charging Data Request* message

Information Element	Node Type	SMS-C				IP-SM-GW	
	CDR Type	SC-SMO	SC-SMT	SC-DVT-T4	SC-SMO-T4	ISM-SMO	ISM-SMT
	Supported Operation Types	E	E	E	E	E	E
Session Identifier		E	E	E	E	E	E
Originator Host		E	E	E	E	E	E
Originator Realm		E	E	E	E	E	E
Destination Domain		E	E	E	E	E	E
Operation Type		E	E	E	E	E	E
Operation Number		E	E	E	E	E	E
Operation Identifier		E	E	E	E	E	E
User Name		E	E	E	E	E	E
Destination Host		E	E	E	E	E	E
Operation Interval		-	-	-	-	-	-
Origination State		E	E	E	E	E	E
Origination Timestamp		E	E	E	E	E	E
Proxy Information		E	E	E	E	E	E
Route Information		E	E	E	E	E	E
Operation Token		E	E	E	E	E	E
Service Information with MMS, PS, IMS and SMS Information							
SMS Node		-	-	-	E	-	-
SM Client Address		E	E	E	E	E	E
Originator SCCP Address		E	E	-	E	E	E
Originator Received Address		E	E	-	E	E	E
Recipient Info		E	E	E	E	E	E
SMSC Address		-	-	-	-	-	-
SM Data Coding Scheme		E	E	-	E	E	E
SM Message Type		E	E	E	E	E	E
SM Originator Interface		-	E	-	-	-	E
SM Protocol Id		E	-	-	E	E	-
SM Reply Path Requested		E	E	-	E	E	E
SM User Data Header		E	E	-	E	E	E
SM Status		-	E	-	E	-	E
SM Discharge Time		-	E	-	-	-	E
Number of Messages Sent		E	E	-	-	E	E
SM Service Type		-	-	-	-	-	-
SMS result		E	E	E	E	E	E
SM Sequence Number		E	E	-	-	E	E
SM Device Trigger Indicator		-	-	E	E	-	-
SM Device Trigger information		-	E	E	E	-	E
Originator Address		E	E	E	E	E	E
Submission Time		E	E	E	E	E	E
Priority		-	E	-	-	-	E
Message Id		E	E	-	E	E	E
Message Size		E	E	-	E	E	E
Message Class		E	E	-	E	E	E
Delivery Report Requested		E	E	-	E	E	E
PDP Address		-	-	-	-	E	E
3GPP User Location Info		E	E	-	E	E	E
3GPP RAT Type		E	E	-	E	E	E
MS Time Zone		E	E	-	E	E	E
User Equipment Info		E	E	-	E	E	E
User Session Id		-	-	-	-	E	E
Number Portability routing information		-	-	-	-	E	E
Carrier Select routing information		-	-	-	-	E	E
MTC IWF Address		-	-	-	E	-	-
SMS Application Port ID		-	-	-	E	-	-
External Identifier		-	-	-	E	-	-

6.3.2 Formal parameter description

6.3.2.1 SMS charging information for CDRs

The detailed definitions, abstract syntax and encoding of the SMS CDR parameters are specified in TS 32.298 [3].

6.3.2.2 SMS charging information for charging events

The detailed charging event parameter definitions are specified in TS 32.299 [50].

6.3.3 Detailed message format for online charging

The Operation types are listed in the following order: I [initial]/ T [terminate]/E [event]. Therefore, when all Operation types are possible it is marked as ITE. If only some Operation types are allowed for a node, only the appropriate letters are used (i.e. IT or E) as indicated in the table heading. The omission of an Operation type for a particular field is marked with "-" (i.e. I-E). Also, when an entire field is not allowed in a node the entire cell is marked as "-".

Table 6.3.3.1 illustrates the basic structure of the supported fields in the Debit / Reserve Units Request for SMS, T4 Device Triggering, and for MO-SMS via T4 submission, online charging.

Table 6.3.3.1: Supported fields in *Debit / Reserve Units Request* message

Information Element	Service Type	SMS	T4 Device Triggering	MO-SMS T4
	Supported Operation Types	I/T/E	E	I/T
Session Identifier		ITE	E	IT
Originator Host		ITE	E	IT
Originator Domain		ITE	E	IT
Destination Domain		ITE	E	IT
Operation Identifier		ITE	E	IT
Operation Token		ITE	E	IT
Operation Type		ITE	E	IT
Operation Number		ITE	E	IT
Destination Host		ITE	E	IT
User Name		ITE	E	IT
Origination State		ITE	-	IT
Origination Timestamp		ITE	E	IT
Subscriber Identifier		ITE	E	IT
Termination Cause		-T-	-	-T
Requested Action		--E	E	-
Multiple Operation		ITE	E	IT
Multiple Unit Operation		ITE	E	IT
Subscriber Equipment Number		ITE	-	IT
Proxy Information		ITE	E	IT
Route Information		ITE	E	IT
Service Information		ITE	E	IT
Service Information with MMS, PS, IMS and SMS Information				
SMS Node		ITE	-	IT
SM Client Address		ITE	E	IT
Originator Info		ITE	E	IT
Recipient Info		ITE	E	IT
SMSC Address		ITE	-	-
SM Data Coding Scheme		ITE	-	IT
SM Message Type		ITE	E	IT
SM Originator Interface		ITE	-	-
SM Protocol Id		ITE	-	IT
SM Reply Path Requested		ITE	-	IT
SM User Data Header		ITE	-	IT
SM Status		ITE	-	IT
SM Discharge Time		ITE	-	-
Number of Messages Sent		ITE	-	-
SM Service Type		ITE	-	-
SMS result		-	E	IT
SM Sequence Number		-	-	-
SM Device Trigger Indicator		ITE	E	-
SM Device Trigger information		ITE	E	-
Originator Address		ITE	-	IT
Submission Time		ITE	E	IT
Priority		ITE	-	IT
Message Id		ITE	-	IT
Message Size		ITE	-	IT
Message Class		ITE	-	IT
Delivery Report Requested		ITE	-	IT
PDP Address		ITE	-	-
3GPP User Location Info		ITE	-	IT
3GPP RAT Type		ITE	-	IT
MS Time Zone		ITE	-	IT
User Equipment Info		-	-	-
User Session Id		ITE	-	-
Number Portability routing information		ITE	-	-
Carrier Select routing information		ITE	-	-
MTC IWF Address		-	-	IT
SMS Application Port ID		-	-	IT
External Identifier		-	-	-T

6.4 Bindings for SMS charging

This clause describes the mapping between the Service Information fields, AVPs and CDR parameters for SMS charging.

Table 6.4.1 describes the mapping of the Information Element, AVP and CDR parameter of SC-SMO and SC-SMT CDRs in SMS charging.

Table 6.4.1: Bindings of CDR parameter, Information Element and AVP

CDR parameter	Information Element	AVP
	Service Information	Service-Information
	SMS Information	SMS-Information
-	SMS Node	SMS-Node
SMS Node Address	SM Client Address	Client-Address
Originator SCCP Address	Originator SCCP Address	Originator-SCCP-Address
Originator Received Address	Originator Received Address	Originator-Received-Address
Recipient Info	Recipient Info	Recipient-Info
Recipient IMSI	Recipient Address	Recipient-Address
Recipient MSISDN	Recipient Address	Recipient-Address
Recipient Other Address	Recipient Address	Recipient-Address
Recipient Received Address	Recipient Received Address	Recipient-Received-Address
Recipient SCCP Address	Recipient SCCP Address	Recipient-SCCP-Address
SM Destination Interface	SM Destination Interface	Destination-Interface
SM Recipient Protocol Id	SM Protocol Id	SM-Protocol-Id
-	SMSC Address	SMSC-Address
SM Data Coding Scheme	SM Data Coding Scheme	Data-Coding-Scheme
SM Message Type	SM Message Type	SM-Message-Type
SM Originator Interface	SM Originator Interface	Originator-Interface
SM Originator Protocol Id	SM Protocol Id	SM-Protocol-Id
SM Reply Path Requested	SM Reply Path Requested	Reply-Path-Requested
SM User Data Header	SM User Data Header	SM-User-Data-Header
SM Status	SM Status	SM-Status
SM Discharge Time	SM Discharge Time	SM-Discharge-Time
SM Total Number	Number of Messages Sent	Number-of-Messages-Sent
-	SM Service Type	SM-Service-Type
SMS result	SMS result	SMS-result
SM Sequence Number	SM Sequence Number	SM-Sequence-Number
SM Device Trigger Indicator	SM Device Trigger Indicator	SM-Device-Trigger-Indicator
SM Device Trigger information	SM Device Trigger information	SM-Device-Trigger-information
MTC IWF Address	MTC IWF Address	MTC-IWF-Address
SM DT Reference Number	SM DT Reference Number	Reference-Number
SM Serving Node	SM Serving Node	Serving-Node
SM DT Validity Period	SM DT Validity Period	Validity-Time
SM DT Priority Indication	SM DT Priority Indication	Priority-Indication
SMS Application Port ID	SMS Application Port ID	Application-Port-Identifier
MTC IWF Address	MTC IWF Address	MTC-IWF-Address
SMS Application Port ID	SMS Application Port ID	Application-Port-Identifier
External Identifier	External Identifier	External-Identifier
-	MMS Information	MMS-Information
Originator IMSI	Originator Address	Originator-Address
Originator MSISDN	Originator Address	Originator-Address
Originator Other Address	Originator Address	Originator-Address
Event Time stamp	Submission Time	Submission-Time
Submission Time	Submission Time	Submission-Time
SM Priority	Priority	Priority
Message Reference	Message Id	Message-ID
Message size	Message Size	Message-Size
Message Class	Message Class	Message-Class
SM Delivery Report Requested	Delivery Report Requested	Delivery-Report-Requested
-	PS Information	PS-Information
PDP Address	PDP Address	PDP-Address
User Location Info	3GPP User Location Info	3GPP-User-Location-Info
RAT Type	3GPP RAT Type	3GPP-RAT-Type
UE Time Zone	MS Time Zone	3GPP-MS-Time-Zone
Served IMEI	User Equipment Info	User-Equipment-Info
Subscriber Equipment Number	User Equipment Info	User-Equipment-Info
-	IMS Information	IMS-Information
User Session Id	User Session Id	User-Session-Id
Number Portability routing information	Number Portability routing information	Number-Portability-routing-information
Carrier Select routing information	Carrier Select routing information	Carrier-Select-routing-information

6.5 Definition of the SMS converged charging information

6.5.1 General

The Charging Information parameter used for SMS converged charging is provided in the following sub-clauses.

6.5.2 Definition of SMS charging information

SMS specific charging information used for SMS converged charging is provided within the SMS charging Information.

Table 6.5.2.1: Structure of SMS Charging information

Information Element	Category	Description
Originator Info	O _M	This field is a grouped field and holds information on originator of the SMS
Originator SUPI	O _M	This field holds the SUPI of the originator of the SMS, if available. This field is present if different from subscriber identifier field.
Originator GPSI	O _C	This field holds the GPSI of the originator of the SMS, if available.
Originator Other Address	O _M	This field holds the address of the originator of the SMS, when different from SUPI and GPSI, if available: e.g. email, short code. This field may have multiple occurrences.
Originator Received Address	O _C	Described in table 6.3.1.2.1
Originator SCCP Address	O _C	Described in table 6.3.1.2.1
SM Originator Interface	O _M	Described in table 6.3.1.2.1
SM Originator Protocol Id	O _C	Described in table 6.3.1.2.1: SM Protocol Id information element
Recipient Info	O _C	Described in table 6.3.1.2.1
Recipient SUPI	O _M	This field holds the SUPI of the recipient of the SMS, if available. This field is present if different from subscriber identifier field.
Recipient GPSI	O _C	This field holds the GPSI of the recipient of the SMS, if available.
Recipient Other Address	O _C	This field holds the address of the recipient of the SMS, when different from SUPI and GPSI, if available: e.g. email, short code. This field may have multiple occurrences
Recipient Received Address	O _C	Described in table 6.3.1.2.1
Recipient SCCP Address	O _C	Described in table 6.3.1.2.1
SM Destination Interface	O _M	Described in table 6.3.1.2.1
SM Recipient Protocol Id	O _C	Described in table 6.3.1.2.1: SM Protocol Id information element.
User Equipment Info	O _C	This field holds the identification of the terminal (i.e. PEI, MAC Address) used by the UE the SMS transaction, if available.
Roamer In Out	O _C	This field holds an indication of the UE is an in-bound roamer. This field is present only if UE is identified as a roamer.
User Location Info	O _C	Described in table 6.3.1.2.1
UE Time Zone	O _C	Described in table 6.3.1.2.1
RAT Type	O _C	Described in table 6.3.1.2.1
SMSC Address	O _M	Described in table 6.3.1.2.1
SM Data Coding Scheme	O _M	Described in table 6.3.1.2.1
SM Message Type	O _M	Described in table 6.3.1.2.1
SM Reply Path Requested	O _C	Described in table 6.3.1.2.1
SM User Data Header	O _C	Described in table 6.3.1.2.1
SM Status	O _C	Described in table 6.3.1.2.1
SM Discharge Time	O _C	Described in table 6.3.1.2.1
Number of Messages Sent	O _C	Described in table 6.3.1.2.1
SM Service Type	O _C	Described in table 6.3.1.2.1
SM Sequence Number	O _C	Described in table 6.3.1.2.1
SMS result	C	Described in table 6.3.1.2.1
Submission Time	O _C	Described in table 6.3.1.2.1
SM Priority	O _C	Described in table 6.3.1.2.1
Message Reference	O _M	Described in table 6.3.1.2.1
Message Size	O _M	Described in table 6.3.1.2.1
Message Class	O _M	Described in table 6.3.1.2.1
Delivery Report Requested	O _C	Described in table 6.3.1.2.1

6.5.3 Detailed message format for converged charging

The following clause specifies per Operation Type the charging data that are sent by SMS Node for 5G SMS converged charging.

The Operation Types are listed in the following order: I (Initial)/T (Termination)/E (Event). Therefore, when all Operation Types are possible it is marked as ITE. If only some Operation Types are allowed for a node, only the

appropriate letters are used (i.e. IT or E) as indicated in the table heading. The omission of an Operation Type for a particular field is marked with "-" (i.e. I-E). Also, when an entire field is not allowed in a node the entire cell is marked as "-".

Table 6.5.3.1 defines the basic structure of the supported fields in the *Charging Data Request* message for SMS converged charging.

Table 6.5.3.1: Supported fields in *Charging Data Request* message

Information Element	Node Type	SMSF
	Supported Operation Types	ITE
Session Identifier		ITE
Subscriber Identifier		ITE
NF Consumer Identification		ITE
Invocation Timestamp		ITE
Invocation Sequence Number		ITE
One-time Event		--E
One-time Event Type		--E
Service Specification Information		ITE
Notify URI		-
Triggers		ITE
Multiple Unit Usage		ITE
Rating Group		IT-
Requested Unit		I--
Used Unit Container		IT-
SMS Charging Information		
Originator Info		ITE
Recipient Info		ITE
User Equipment Info		ITE
Roamer In Out		ITE
User Location Info		ITE
UE Time Zone		ITE
RAT Type		ITE
SMSC Address		ITE
SM Data Coding Scheme		ITE
SM Message Type		ITE
SM Reply Path Requested		ITE
SM User Data Header		ITE
SM Status		ITE
SM Discharge Time		ITE
Number of Messages Sent		ITE
SM Service Type		ITE
SM Sequence Number		ITE
SMS result		ITE
Submission Time		ITE
SMPriority		ITE
Message Reference		ITE
Message Size		ITE
Message Class		ITE
Delivery Report Requested		ITE

Table 6.5.3.2 defines the basic structure of the supported fields in the *Charging Data Response* message for SMS converged charging.

Table 6.5.3.2: Supported fields in *Charging Data Response* message

Information Element	Node Type	SMSF
	Supported Operation Types	ITE
Session Identifier		ITE
Invocation Timestamp		ITE
Invocation Result		ITE
Invocation Sequence Number		ITE
Session Failover		I--
Triggers		-
Multiple Unit information		I-E
Result Code		I--
Rating Group		I--
Granted Unit		I--
Validity Time		I--

6.5.4 Formal SMS converged charging parameter description

6.5.4.1 SMS charging CHF CDR parameters

The detailed definitions, abstract syntax and encoding of the SMS charging CHF CDR parameters are specified in TS 32.298 [51].

6.5.4.2 SMS charging resources attributes

The detailed definitions of resources attributes used for SMS charging are specified in TS 32.291 [58].

6.6 Bindings for SMS converged charging

This mapping between the Information Elements, resource attributes and CHF CDR parameters for SMS converged charging is described in clause 7 of TS 32.291 [58].

Annex A (informative): Bibliography

This Annex is a placeholder for documents which are not explicitly cited in this specification.

Annex B (informative): Change history

Change history								
Date	TSG #	TSG Doc.	CR	Rev	Subject/Comment	Category	Old	New
Sep 2007	SP-37	SP-070620	--	--	Submitted to TSG SA#37 for Information	--	1.0.0	
Dec 2007	SP-38	SP-070748	--	--	Submitted to TSG SA#38 for Approval	--	2.0.0	8.0.0
Dec 2007	--	--	--	--	editHelp: the figures are now visible in normal view	--	8.0.0	8.0.1
Mar 2008	SP-39	SP-080074	0001	--	Correction on Service Information for SMS Charging	F	8.0.1	8.1.0
Jun 2008	SP-40	SP-080330	0002	--	Support of Number Portability and Carrier Selection in SMS Online Charging	B	8.1.0	8.2.0
Sep 2008	SP-41	SP-081216	0003	--	Multiple SMS destination – Alignment with TS 23.040	C	8.2.0	8.3.0
Sep 2008	SP-41	SP-081224	0004	--	Introduce Online Charging from SMS-SC into 3GPP TS 32.274	B	8.2.0	8.3.0
Dec 2008	SP-42	SP-080706	0005	--	Correction on Multiple Unit Operation category	F	8.3.0	8.4.0
Dec 2008	SP-42	SP-080706	0006	--	Add SMS-SC as SMS node type	B	8.3.0	8.4.0
Dec 2008	SP-42	SP-080706	0007	--	Additional Address Info for SMS charging	B	8.3.0	8.4.0
Dec 2008	SP-42	SP-080706	0008	--	Add charging of SMS services to 32.274	B	8.3.0	8.4.0
Mar 2009	SP-43	SP-090045	0009	--	SMS IE structure alignment	F	8.4.0	8.5.0
Jun 2009	SP-44	SP-090293	0010	--	Clarification of "Termination charge" and application addressing	F	8.5.0	8.6.0
Sep 2009	SP-45	SP-090536	0011	--	IE usage for Delivery Reports and Application Identifiers	F	8.6.0	8.7.0
Dec 2009	-	-	-	-	Update to Rel-9 version (MCC)	-	8.7.0	9.0.0
Mar 2011	-	-	-	-	Update to Rel-10 version (MCC)	-	9.0.0	10.0.0
Sep-2012	SP-57	SP-120575	0014	-	Addition of MS Timezone for NetLoc	B	10.0.0	11.0.0
Mar 2013	SP-59	SP-130055	0017	1	Introduction of SMS-SC Offline Charging Architecture	B	11.0.0	12.0.0
Mar 2013					Editorial changes on CDR tables (MCC)		12.0.0	12.0.1
Jun-2013	SP-60	SP-130274	0018	1	Introduction SMS Offline charging principles and flows	B	12.0.1	12.1.0
Dec-2013	SP-62	SP-130628	0020	1	Introduce Charging Data Request/Response in flow description	B	12.1.0	12.2.0
			0021	-	Introduction of offline charging Diameter error cases	B		
			0022	1	Introduction of Rf message content	B		
Mar-2014	SP-63	SP-140045	0024	1	Introduction of information for SMS offline Charging	B	12.2.0	12.3.0
			0027	-	SCS Identity identified as Originator for Device Triggering	B		
			0028	1	Introduction of new SC-SMO and SC-SMT CDRs description	B		
2014-07	-	-	-	-	Rapporteur/MCC: General editorial changes and clean-up.	-	12.3.0	12.3.1
2014-09	SP-65	SP-140564	0029	1	Corrections for alignment between charging specifications	F	12.3.1	12.4.0
2014-12	SP-66	SP-140805	0030	-	Corrections on definition for parameter category	F	12.4.0	12.5.0
2015-06	SP-68	SP-150327	0031	-	Correction on category for MSISDN from Om to Oc for SMS CDRs	F	12.5.0	12.6.0
2016-01					Update to Rel-13 (MCC)		12.6.0	13.0.0

Change history							
Date	Meeting	TDoc	CR	Rev	Cat	Subject/Comment	New version
2016-09	SA#73	SP-160622	0032	1	F	Correction on use of Multiple Operation and Multiple Unit Operation for IEC	13.1.0
2016-12	SA#74	SP-160847	0033	1	F	Correction SMS Delivery handling	14.0.0
2017-03	SA#75	SP-170138	0034	1	D	Remove reference to RFC 3588	14.1.0
2017-03	SA#75	SP-170135	0035	1	B	Introduce charging principle for MSISDN-less MO-SMS via T4	14.1.0
2017-03	SA#75	SP-170135	0036	-	B	Introduce Message flows offline charging for MSISDN-less MO-SMS via T4	14.1.0
2017-03	SA#75	SP-170135	0037	1	B	Remove Editor's Note in clause 5.2.3, 5.2.4, 5.2.5, and 6.1.2	14.1.0
2017-06	SA#76	SP-170500	0038	1	B	Improve Message flows offline charging for SMS delivery	14.2.0
2017-06	SA#76	SP-170500	0039	1	B	Introduce additional Message flows offline charging for Device Triggering	14.2.0
2017-06	SA#76	SP-170500	0040	1	B	Introduce Message flows online charging for Device Triggering	14.2.0
2017-06	SA#76	SP-170500	0041	1	B	Introduce Message flows online charging for MSISDN-less MO-SMS via T4	14.2.0
2017-06	SA#76	SP-170500	0046	1	B	Introduce new CDR for Device Triggering	14.2.0
2017-06	SA#76	SP-170500	0047	-	B	Clarify the chargeable events for SMS via T4	14.2.0
2017-06	SA#76	SP-170500	0048	-	B	Remove T4 Device Trigger dedicated fields from SC-SMO and SC-SMT CDRs	14.2.0
2017-06	SA#76	SP-170500	0049	1	B	Introduce Device Trigger and SMS MO via T4 in SMS information	14.2.0
2017-06	SA#76	SP-170500	0050	-	B	Introduce new CDR for SMS MO via T4	14.2.0
2018-06	-	-	-	-	-	Update to Rel-15 version (MCC)	15.0.0
2018-12	SA#82	SP-181052	0053	1	B	Addition of Converged Charging	15.1.0
2018-12	SA#82	SP-181052	0054	1	B	Introduction of SMSF as a new Node for SMS charging	15.1.0
2018-12	SA#82	SP-181052	0056	1	B	Introduction of CHF CDR generation for SMSF	15.1.0
2018-12	SA#82	SP-181052	0057	2	B	Introduction of Message content charging SMSF	15.1.0
2018-12	SA#82	SP-181052	0058	2	B	Introduction of CHF CDR description for SMSF	15.1.0
2018-12	SA#82	SP-181052	0059	3	B	Introduction of SMS information converged charging	15.1.0
2018-12	SA#82	SP-181052	0060	-	B	Introduction of 5GS for SMS charging via Ro Rf	15.1.0
2018-12	SA#82	SP-181052	0061	1	B	Introduction of offline charging for IP-SM-GW architecture and flows	15.1.0
2018-12	SA#82	SP-181052	0062	1	B	Introduction of offline charging for IP-SM-GW CDRs	15.1.0
2018-12	SA#82	SP-181052	0063	1	B	Introduction of Detailed message format	15.1.0
2018-12	SA#82	SP-181052	0064	-	B	Introduction of clauses on formal description and binding	15.1.0
2018-12	SA#82	SP-181052	0680	1	B	Addition of SMS Charging to CHF CDR	15.1.0
2019-03	SA#83	SP-190117	0065	-	F	Correction of NF Consumer Information	15.2.0
2019-03	SA#83	SP-190117	0066	-	F	Correction of category Invocation result	15.2.0
2019-12	SA#86	SP-191163	0067	1	F	Addition of Post Event Charging flows	15.3.0
2019-12	SA#86	SP-191163	0068	-	F	Correction of message content for Post Event Charging	15.3.0
2019-12	SA#86	SP-191160	0069	-	F	Correction of Service Specification Information	15.3.0
2019-12	SA#86	SP-191163	0070	1	F	Clarify CHF selection via NRF and roaming	15.3.0
2019-12	SA#86	SP-191163	0071	1	F	Correction of Multiple Unit Information	15.3.0
2020-07	-	-	-	-	-	Update to Rel-16 version (MCC)	16.0.0

History

Document history		
V16.0.0	August 2020	Publication