



**5G;
Telecommunication management;
Charging management;
5G system;
Services, operations and procedures of charging using
Service Based Interface (SBI)
(3GPP TS 32.290 version 17.4.0 Release 17)**



Reference

RTS/TSGS-0532290vh40

Keywords

5G

ETSI

650 Route des Lucioles
F-06921 Sophia Antipolis Cedex - FRANCE

Tel.: +33 4 92 94 42 00 Fax: +33 4 93 65 47 16

Siret N° 348 623 562 00017 - APE 7112B
Association à but non lucratif enregistrée à la
Sous-Préfecture de Grasse (06) N° w061004871

Important notice

The present document can be downloaded from:
<http://www.etsi.org/standards-search>

The present document may be made available in electronic versions and/or in print. The content of any electronic and/or print versions of the present document shall not be modified without the prior written authorization of ETSI. In case of any existing or perceived difference in contents between such versions and/or in print, the prevailing version of an ETSI deliverable is the one made publicly available in PDF format at www.etsi.org/deliver.

Users of the present document should be aware that the document may be subject to revision or change of status. Information on the current status of this and other ETSI documents is available at <https://portal.etsi.org/TB/ETSIDeliverableStatus.aspx>

If you find errors in the present document, please send your comment to one of the following services:
<https://portal.etsi.org/People/CommitteeSupportStaff.aspx>

If you find a security vulnerability in the present document, please report it through our Coordinated Vulnerability Disclosure Program:
<https://www.etsi.org/standards/coordinated-vulnerability-disclosure>

Notice of disclaimer & limitation of liability

The information provided in the present deliverable is directed solely to professionals who have the appropriate degree of experience to understand and interpret its content in accordance with generally accepted engineering or other professional standard and applicable regulations.

No recommendation as to products and services or vendors is made or should be implied.

No representation or warranty is made that this deliverable is technically accurate or sufficient or conforms to any law and/or governmental rule and/or regulation and further, no representation or warranty is made of merchantability or fitness for any particular purpose or against infringement of intellectual property rights.

In no event shall ETSI be held liable for loss of profits or any other incidental or consequential damages.

Any software contained in this deliverable is provided "AS IS" with no warranties, express or implied, including but not limited to, the warranties of merchantability, fitness for a particular purpose and non-infringement of intellectual property rights and ETSI shall not be held liable in any event for any damages whatsoever (including, without limitation, damages for loss of profits, business interruption, loss of information, or any other pecuniary loss) arising out of or related to the use of or inability to use the software.

Copyright Notification

No part may be reproduced or utilized in any form or by any means, electronic or mechanical, including photocopying and microfilm except as authorized by written permission of ETSI.

The content of the PDF version shall not be modified without the written authorization of ETSI.
The copyright and the foregoing restriction extend to reproduction in all media.

© ETSI 2022.
All rights reserved.

Intellectual Property Rights

Essential patents

IPRs essential or potentially essential to normative deliverables may have been declared to ETSI. The declarations pertaining to these essential IPRs, if any, are publicly available for **ETSI members and non-members**, and can be found in ETSI SR 000 314: "*Intellectual Property Rights (IPRs); Essential, or potentially Essential, IPRs notified to ETSI in respect of ETSI standards*", which is available from the ETSI Secretariat. Latest updates are available on the ETSI Web server (<https://ipr.etsi.org/>).

Pursuant to the ETSI Directives including the ETSI IPR Policy, no investigation regarding the essentiality of IPRs, including IPR searches, has been carried out by ETSI. No guarantee can be given as to the existence of other IPRs not referenced in ETSI SR 000 314 (or the updates on the ETSI Web server) which are, or may be, or may become, essential to the present document.

Trademarks

The present document may include trademarks and/or tradenames which are asserted and/or registered by their owners. ETSI claims no ownership of these except for any which are indicated as being the property of ETSI, and conveys no right to use or reproduce any trademark and/or tradename. Mention of those trademarks in the present document does not constitute an endorsement by ETSI of products, services or organizations associated with those trademarks.

DECT™, **PLUGTESTS™**, **UMTS™** and the ETSI logo are trademarks of ETSI registered for the benefit of its Members. **3GPP™** and **LTE™** are trademarks of ETSI registered for the benefit of its Members and of the 3GPP Organizational Partners. **oneM2M™** logo is a trademark of ETSI registered for the benefit of its Members and of the oneM2M Partners. **GSM®** and the GSM logo are trademarks registered and owned by the GSM Association.

Legal Notice

This Technical Specification (TS) has been produced by ETSI 3rd Generation Partnership Project (3GPP).

The present document may refer to technical specifications or reports using their 3GPP identities. These shall be interpreted as being references to the corresponding ETSI deliverables.

The cross reference between 3GPP and ETSI identities can be found under <http://webapp.etsi.org/key/queryform.asp>.

Modal verbs terminology

In the present document "**shall**", "**shall not**", "**should**", "**should not**", "**may**", "**need not**", "**will**", "**will not**", "**can**" and "**cannot**" are to be interpreted as described in clause 3.2 of the [ETSI Drafting Rules](#) (Verbal forms for the expression of provisions).

"**must**" and "**must not**" are **NOT** allowed in ETSI deliverables except when used in direct citation.

Contents

Intellectual Property Rights	2
Legal Notice	2
Modal verbs terminology.....	2
Foreword.....	5
1 Scope	6
2 References	6
3 Definitions, symbols and abbreviations	7
3.1 Definitions	7
3.2 Symbols.....	7
3.3 Abbreviations	7
4 Architecture reference model	8
4.1 General	8
4.2 Reference architecture	8
5 Charging function requirement	8
5.1 Offline charging scenario	8
5.1.1 Basic principles.....	8
5.1.2 Charging scenarios.....	8
5.1.2.1 Introduction.....	8
5.1.2.2 Scenarios	9
5.1.2.2.1 Event based charging.....	9
5.1.2.2.2 Session based charging.....	10
5.2 Online charging scenario.....	11
5.2.1 Basic principles.....	11
5.2.2 Charging scenarios.....	11
5.2.2.1 Introduction.....	11
5.2.2.2 Scenarios	12
5.2.3 Void	12
5.3 Converged Charging scenario	12
5.3.1 Basic principles.....	12
5.3.2 Charging scenarios.....	12
5.3.2.1 Introduction.....	12
5.3.2.2 Event based charging	12
5.3.2.3 Session based charging	13
5.3.2.5 Switch between quota managed and not quota managed	23
5.4 Other functionalities	24
5.4.1 Re-authorization	24
5.4.2 Threshold based re-authorization triggers.....	25
5.4.3 Termination action.....	25
5.4.4 Service termination	25
5.4.5 Trigger Mechanism.....	25
5.4.6 CHF-controlled quota management.....	26
5.4.7 Charging identifier.....	26
5.5 Error handling	27
5.5.1 Failure handling	27
5.5.1.1 CTF detected failure.....	27
5.5.1.2 CHF detected failure	27
5.5.2 Retry handling	27
5.5.3 Response code handling.....	28
6 Service definition	28
6.1 NF service framework.....	28
6.2 Nchf_ConvergedCharging service	29
6.2.1 General.....	29

6.2.2	Nchf_ConvergedCharging_Create service operation.....	30
6.2.3	Nchf_ConvergedCharging_Update service operation	30
6.2.4	Nchf_ConvergedCharging_Release service operation.....	30
6.2.5	Nchf_ConvergedCharging_Notify service operation	31
6.3	Nchf_SpendingLimitControl service.....	31
6.3.1	Overview	31
6.4	Void.....	31
6.5	Nchf_OfflineOnlyCharging service	31
6.5.1	General.....	31
6.5.2	Nchf_OfflineOnlyCharging_Create service operation.....	31
6.5.3	Nchf_OfflineOnlyCharging_Update service operation	32
6.5.4	Nchf_OfflineOnlyCharging_Release service operation.....	32
7	Message contents.....	32
Annex A (informative): Change history		39
History		42

Foreword

This Technical Specification has been produced by the 3rd Generation Partnership Project (3GPP).

The contents of the present document are subject to continuing work within the TSG and may change following formal TSG approval. Should the TSG modify the contents of the present document, it will be re-released by the TSG with an identifying change of release date and an increase in version number as follows:

Version x.y.z

where:

- x the first digit:
 - 1 presented to TSG for information;
 - 2 presented to TSG for approval;
 - 3 or greater indicates TSG approved document under change control.
- y the second digit is incremented for all changes of substance, i.e. technical enhancements, corrections, updates, etc.
- z the third digit is incremented when editorial only changes have been incorporated in the document.

1 Scope

The present document specifies service, operations and procedures of 5G charging for service based interface. This charging description includes the charging architecture and scenarios as well as the mapping of the common charging architecture specified in TS 32.240 [1]. The present document is related to other 3GPP charging TSs as follows:

- The common 3GPP charging architecture is specified in TS 32.240 [1].
- The protocol that are used for service based interface is specified in TS 32.291 [58].

The description is following the same methodology as used in TS 23.501 [201] and TS 23.502 [202] for the 5G system.

2 References

The following documents contain provisions which, through reference in this text, constitute provisions of the present document.

- References are either specific (identified by date of publication, edition number, version number, etc.) or non-specific.
- For a specific reference, subsequent revisions do not apply.
- For a non-specific reference, the latest version applies. In the case of a reference to a 3GPP document (including a GSM document), a non-specific reference implicitly refers to the latest version of that document *in the same Release as the present document*.

- [1] 3GPP TS 32.240: "Telecommunication management; Charging management; Charging architecture and principles".
- [2] - [29] Void.
- [30] 3GPP TS 32.255: "Telecommunication management; Charging management; 5G Data connectivity domain charging; stage 2".
- [31] 3GPP TS 32.260: "Telecommunication management; Charging management; IP Multimedia Subsystem (IMS) charging".
- [32] 3GPP TS 32.254: "Telecommunication management; Charging management; Exposure function Northbound Application Program Interfaces (APIs) charging".
- [33] 3GPP TS 32.256: "Telecommunication management; Charging management; 5G connection and mobility domain charging; Stage 2".
- [34] 3GPP TS 32.274: "Telecommunication management; Charging management; Short Message Service (SMS) charging".
- [35] 3GPP TS 28.201: "Telecommunication management; Charging management; Network slice performance and analytics charging in the 5G System (5GS); Stage 2".
- [36] 3GPP TS 28.202: "Telecommunication management; Charging management; Network slice management charging in the 5G System (5GS); Stage 2".
- [37] - [49] Void.
- [50] 3GPP TS 32.299: "Telecommunication management; Charging management; Diameter charging application".
- [51] - [54] Void.
- [55] - [57] Void.
- [58] 3GPP TS 32.291: "Telecommunication management; Charging management; 5G system; Charging service, stage 3".

[59] - [99]	Void.
[100]	3GPP TR 21.905: "Vocabulary for 3GPP Specifications".
[101] - [200]	Void.
[201]	3GPP TS 23.501: "System Architecture for the 5G System; Stage 2".
[202]	3GPP TS 23.502: "Procedures for the 5G System; Stage 2".
[203] - [206]	Void.
[207] - [299]	Void.
[300]	3GPP TS 29.510: " 5G System; Network function repository services; Stage 3".
[301] - [370]	Void.
[371] - [399]	Void.
[400] - [499]	Void.
[500] - [599]	Void.

3 Definitions, symbols and abbreviations

3.1 Definitions

For the purposes of the present document, the terms and definitions given in 3GPP TR 21.905 [100], TS 32.240 [1] and the following apply. A term defined in the present document takes precedence over the definition of the same term, if any, in either 3GPP TR 21.905 [100] or TS 32.240 [1].

5G Access Network: An access network comprising a NG-RAN and/or non-3GPP AN connecting to a 5G Core Network.

5G Core Network: The core network specified in the present document. It connects to a 5G Access Network.

NF service: a functionality exposed by a NF through a service based interface and consumed by other authorized NFs.

NF service operation: An elementary unit a NF service is composed of.

service based interface: It represents how a set of services is provided/exposed by a given NF.

charging session: The association between the CHF (NF Service Producer) that provides the charging service and NF service consumer.

3.2 Symbols

For the purposes of the present document, the following symbols apply:

Nchf	Service-based interface exhibited by Charging Function.
------	---

3.3 Abbreviations

For the purposes of the present document, the abbreviations given in 3GPP TR 21.905 [100] and the following apply. An abbreviation defined in the present document takes precedence over the definition of the same abbreviation, if any, in 3GPP TR 21.905 [100].

5GC	5G Core Network
5GS	5G System
AMF	Access and Mobility Management Function
CCS	Converged Charging System

CEF	Charging Enablement Function
CHF	Charging Function
IEC	Immediate Event Charging
MnS	Management Service
NF	Network Function
PCF	Policy Control Function
SBI	Service based Interface
SMSF	Short Message Service Function
SMF	Session Management Function

4 Architecture reference model

4.1 General

The present document describes the service based architecture for 5G Charging.

4.2 Reference architecture

The NFs with CTF interact with CHF using Nchf interface for converged charging or offline only charging. The NF PCF interacts with CHF using Nchf interface for Spending Limit Control. The Nchf is a service based interface for NF and CHF.

Figure 4.2.1 depicts the reference architecture for the Nchf Interface.

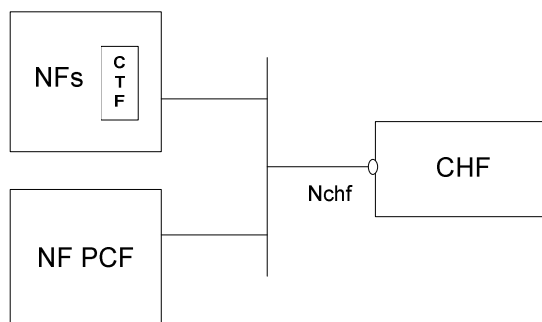

Figure 4.2.1: Reference Architecture for the Nchf Interface; SBI representation

5 Charging function requirement

5.1 Offline charging scenario

5.1.1 Basic principles

Basic principles for offline charging are defined in TS 32.240 [1].

5.1.2 Charging scenarios

5.1.2.1 Introduction

Two basic scenarios are used:

- Event based charging;
- Session based charging.

Both scenarios may generate CDR files, which may then be transferred to the network operator's BD for the purpose of subscriber billing and/or inter-operator accounting.

5.1.2.2 Scenarios

5.1.2.2.1 Event based charging

Figure 5.1.2.2.1.1 shows a scenario for Post Event Charging, (PEC) where the NF (CTF) interacts with the CHF after the service delivery.

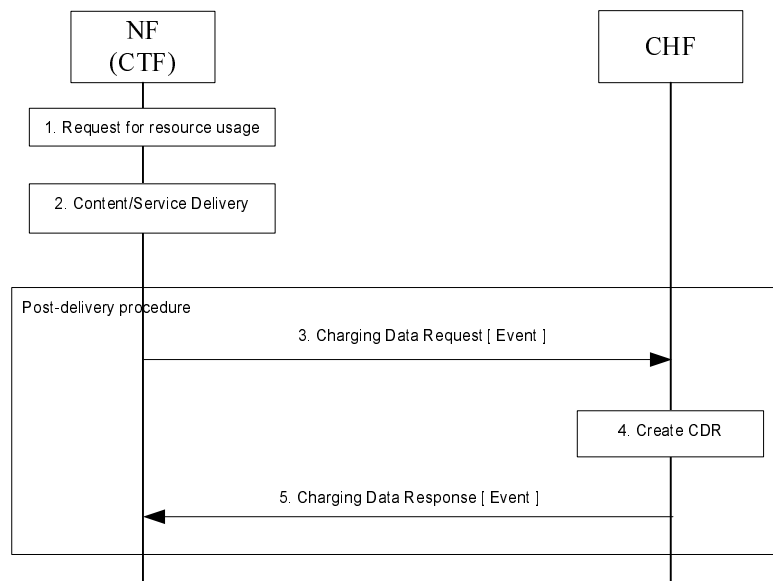

Figure 5.1.2.2.1.1: Post Event Charging

- 1) **Request for resource usage:** A request for session establishment is received in the NF (CTF).
- 2) **Content/Service Delivery:** the NF (CTF) delivers the content/service.
- 3) **Charging Data Request [Event]:** The NF (CTF) the CTF generates charging data related to the delivered service and sends the request for the CHF to store related charging data for CDR generation purpose.
- 4) **Create CDR:** the CHF stores received information and creates a CDR related to the service.
- 5) **Charging Data Response [Event]:** The CHF informs the NF (CTF) on the result of the request.

5.1.2.2.2 Session based charging

Figure 5.1.2.2.1 shows a scenario for Offline session based charging where the NF (CTF) interacts with the CHF.

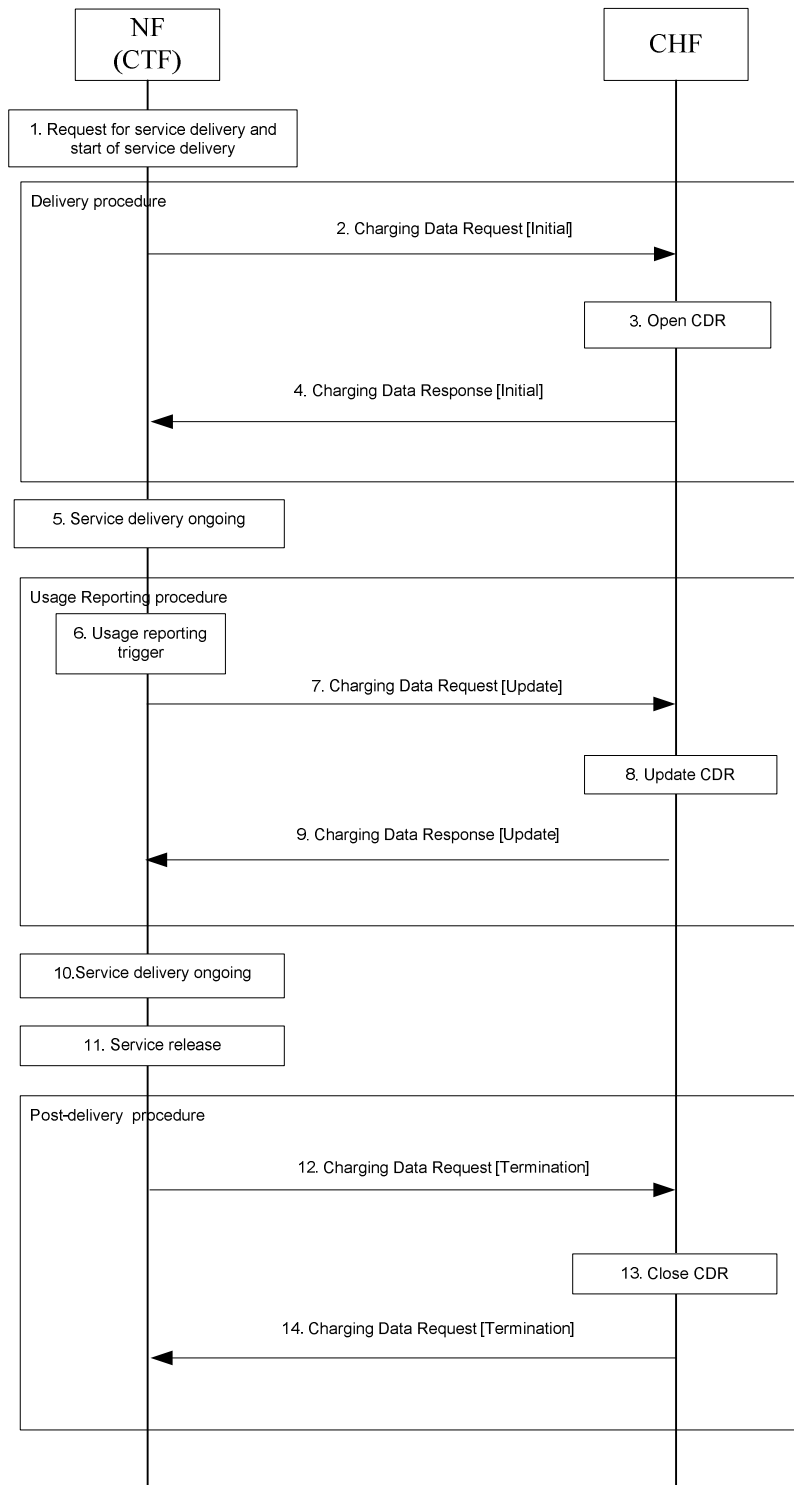

Figure 5.1.2.2.1: Offline charging

- 1) **Request for service delivery and start of service delivery:** A request for session establishment is received in the NF (CTF).
- 2) **Charging Data Request [Initial]:** The NF (CTF) sends the request to inform the CHF about the service to be started.

- 3) **Open CDR:** the CHF opens a CDR related to the service.
- 4) **Charging Data Response [Initial]:** The CHF informs the NF (CTF) on the result of the request and optionally provides the usage reporting triggers applicable to the service.
- 5) **Content/Service Delivery:** the NF (CTF) delivers the content/service.
- 6) **Usage Reporting Trigger:** the NF (CTF) generates charging data related to service delivered, based on a trigger for usage reporting is met.
- 7) **Charging Data Request [Update]:** the NF (CTF) sends the request for reporting the related charging data to the CHF.
- 8) **Update CDR:** the CHF updates the CDR with charging data related to the service.
- 9) **Charging Data Response [Update]:** The CHF informs the NF (CTF) on the result of the request.
- 10) **Content/Service Delivery:** the NF (CTF) delivers the content/service.
- 11) **Service release:** the service is released.
- 12) **Charging Data Request [Termination]:** the NF (CTF) sends the request to the CHF, for charging data related to the service termination.
- 13) **Close CDR:** the CHF closes the CDR with charging data related to the service termination.
- 14) **Charging Data Response [Termination]:** The CHF informs the NF (CTF) on the result of the request.

5.2 Online charging scenario

5.2.1 Basic principles

Basic principles for online charging are defined in TS 32.240 [1].

5.2.2 Charging scenarios

5.2.2.1 Introduction

The following basic scenarios are used:

- 1 Immediate Event Charging
 - a) Decentralized Unit Determination and Centralized Rating
 - b) Centralized Unit Determination and Centralized Rating
 - c) Decentralized Unit Determination and Decentralized Rating
- 2 Event charging with Unit Reservation
 - a) Decentralized Unit Determination and Centralized Rating
 - b) Centralized Unit Determination and Centralized Rating
 - c) Decentralized Unit Determination and Decentralized Rating
- 3 Session charging with Unit Reservation
 - a) Decentralized Unit Determination and Centralized Rating
 - b) Centralized Unit Determination and Centralized Rating

c) Decentralized Unit Determination and Decentralized Rating

The combination of Centralized Unit Determination with Decentralized Rating is not possible.

5.2.2.2 Scenarios

The scenarios described in TS 32.299 [50], clauses 5.2.2.1, 5.2.2.2 and 5.2.2.3, apply with the CHF acting as an OCF.

5.2.3 Void

5.3 Converged Charging scenario

5.3.1 Basic principles

When offline charging and online charging are applicable to a service delivery, the charging information of both offline charging (without quota management) and online charging (with quota management) can be provided in a single command. The triggering for reporting the charging information can be any triggers of the offline charging or online charging (deferred or immediate triggers).

The invocation of the Charging Data Request for start of service, in case there is no valid quota for the rating group, can be done in either blocking mode or non-blocking mode:

- blocking mode: the service delivery shall not start before its authorization from CHF;
- non-blocking mode: the service delivery may start before its authorization from CHF.

For invoking the ConvergedCharging service with quota management, the ConvergedCharging service will operate in decentralized unit determination with the provided amounts of the Quota Requested information element otherwise if no amount is included in the Quota Requested information element, the ConvergedCharging service will operate in centralized unit determination and rating.

5.3.2 Charging scenarios

5.3.2.1 Introduction

Converged charging for both events and sessions between CTF and the CHF is performed as defined in TS 32.240 [1].

Two basic scenarios are used:

- Converged Event based charging;
- Converged Session based charging.

5.3.2.2 Event based charging

For Converged Event based Charging, the following cases are supported:

- Immediate Event Charging (IEC);
- Post Event Charging (PEC).

The scenario for Event based charging supported by IEC is shown in figure 5.3.2.2.1 with: Decentralized and Centralized Unit Determination, Centralized Rating configuration and user's account balance deduction before service

delivery, where the NF (CTF) may invoke converged charging service towards the CHF, prior to service delivery if needed.

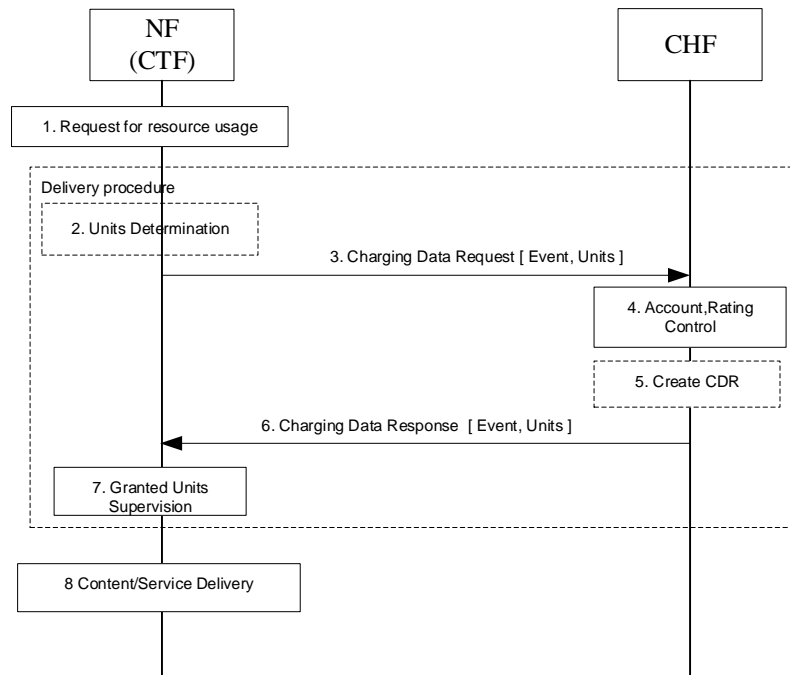

Figure 5.3.2.2.1: IEC- Event based charging with Decentralized and Centralized Unit Determination, Centralized Rating

- 1) **Request for resource usage:** A request for session establishment is received in the NF (CTF). The service is configured to be authorized by the CHF to start.
- 2) **Units Determination:** the NF (CTF) determines the number of units depending on the service requested by the UE in "Decentralized Units determination" scenario.
- 3) **Charging Data Request [Event, Units]:** The NF (CTF) sends the request to the CHF for the service to be granted authorization, and to allow the number of units, if determined in item 2, to be rated and accounted.
- 4) **Account, Rating Control:** The CHF calculates the number of monetary units that represents the price and makes deduction of the calculated amount from user's account balance based on the number of units requested or on internal unit determination, if the user's credit balance is sufficient.
- 5) **Create CDR:** based on policies, the CHF creates a CDR related to the service.
- 6) **Charging Data Response [Event, Units]:** The CHF grants authorization to NF (CTF) for the service to start, with a number of granted units.
- 7) **Granted Units Supervision:** The service starts and the NF (CTF) monitors the consumption of the granted units.
- 8) **Content/Service Delivery:** the NF (CTF) delivers the content/service based on the number of units.

The scenario for Event based charging supported by PEC is described in figure 5.1.2.2.1.1.

5.3.2.3 Session based charging

For Converged Session based Charging, the following cases are supported:

- SCUR
- ECUR

Figure 5.3.2.3.1 shows a blocking mode scenario for Session based charging (SCUR) with: Unit Reservation, Decentralized and Centralized Unit Determination, Centralized Rating configuration, user's account deduction, where the NF (CTF) invokes a converged charging service towards the CHF.

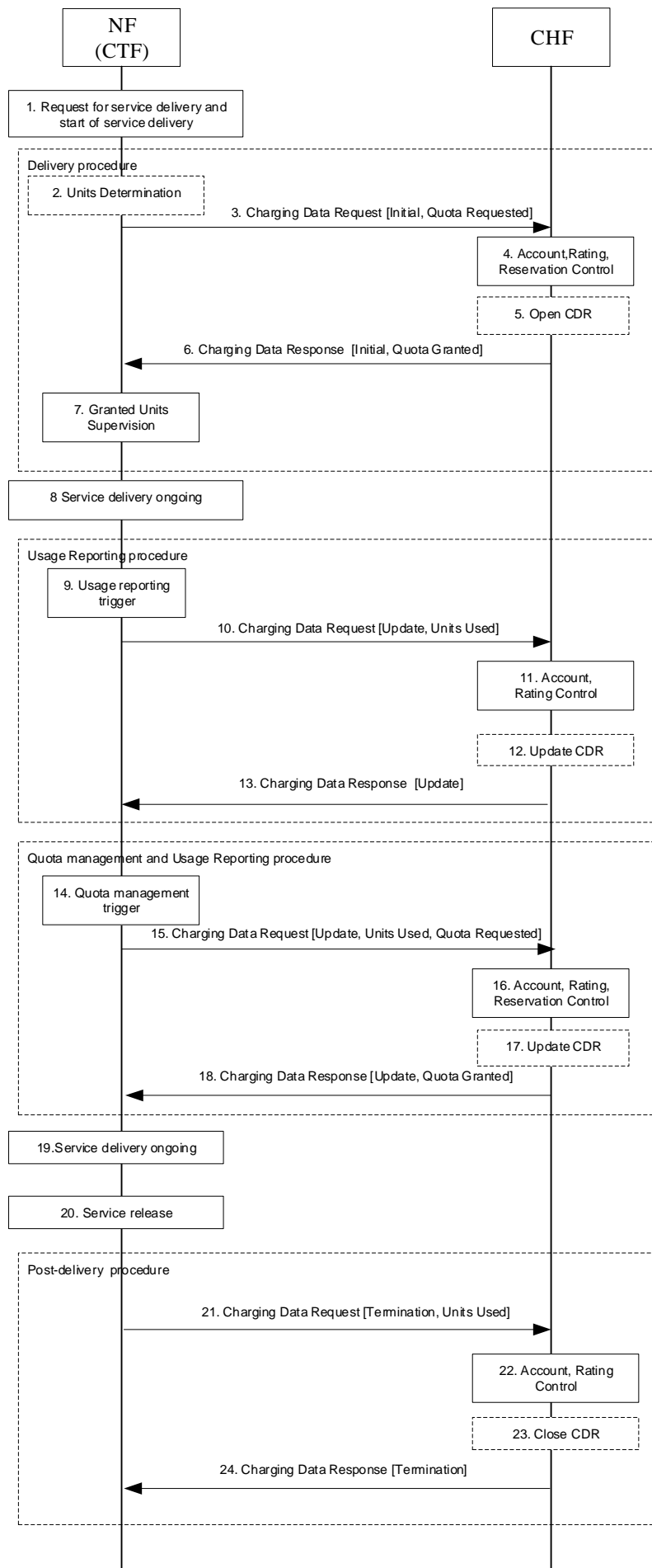

Figure 5.3.2.3.1: SCUR - Session based charging with Decentralized and Centralized Unit Determination, Centralized Rating

- 1) **Request for service delivery:** A request for session establishment is received in the NF (CTF). The service is configured to be authorized by the CHF to start.
- 2) **Units Determination:** the NF (CTF) determines the number of units depending on the service requested by the UE in "Decentralized Units determination" scenario.
- 3) **Charging Data Request [Initial, Quota Requested]:** The NF (CTF) sends the request to the CHF for the service to be granted authorization to start, and to reserve the number of units if determined in item 2.
- 4) **Account, Rating, Reservation Control:** the CHF rates the requests either based on the number of units requested or on internal unit determination, checks if corresponding funds can be reserved on the user's account balance. If the account has sufficient funds, the CHF performs the corresponding reservations.
- 5) **Open CDR:** based on policies, the CHF opens a CDR related to the service.
- 6) **Charging Data Response [Initial, Quota Granted]:** The CHF grants authorization to NF (CTF) for the service to start, with the reserved number of units.
- 7) **Granted Units Supervision:** the NF (CTF) monitors the consumption of the granted units.
- 8) **Start of service delivery:** the NF (CTF) starts to deliver the content/service based on the reserved number of units.
- 9) **Usage Reporting Trigger:** the NF (CTF) generates charging data related to the service delivered that is not under quota management, based on a trigger for usage reporting is met.
- 10) **Charging Data Request [Update, Unit Used]:** the NF (CTF) sends the request for reporting the related charging data, including the used units, to the CHF.
- 11) **Account, Rating Control:** The CHF performs the reported usage process involving rating entity and user's account balance.
- 12) **Update CDR:** based on policies, the CHF updates the CDR with charging data related to the service.
- 13) **Charging Data Response [Update]:** The CHF informs the NF (CTF) on the result of the request.
- 14) **Quota management Trigger:** A Trigger associated to Quota management is met. Units determination is performed when applicable.
- 15) **Charging Data Request [Update, Unit Used, Quota Requested]:** the NF (CTF) sends the request to the CHF, for more units to be granted for the service to continue, and reporting the used units.
- 16) **Account, Rating, Reservation Control:** The CHF performs the process related to the reported usage and the requested reservation, involving rating entity and user's account balance.
- 17) **Update CDR:** based on policies, the CHF updates the CDR with charging data related to the service.
- 18) **Charging Data Response [Update, Quota Granted]:** The CHF grants quota to NF (CTF) for the service to continue, with the reserved number of units.
- 19) **Content/Service Delivery:** the NF (CTF) delivers the content/service based on the granted quota.
- 20) **Session released:** the session is released.
- 21) **Charging Data Request [Termination, Unit Used]:** the NF (CTF) sends the request to the CHF, for charging data related to the service termination with the final consumed units.
- 22) **Account, Rating Control:** The CHF performs the service termination process involving rating entity and user's account balance.
- 23) **Close CDR:** based on policies, the CHF closes the CDR with charging data related to the service termination and the last reported units.
- 24) **Charging Data Response [Termination]:** The CHF informs the NF (CTF) on the result of the request.

Figure 5.3.2.3.2 shows a Non-blocking mode scenario for Session based charging (SCUR) with: Unit Reservation, Decentralized and Centralized Unit Determination, Centralized Rating configuration , user's account deduction , where the NF (CTF) invokes a converged charging service towards the CHF.

NF (CTF) may use blocking mode instead when risk of quota overdraft is more important than latency.

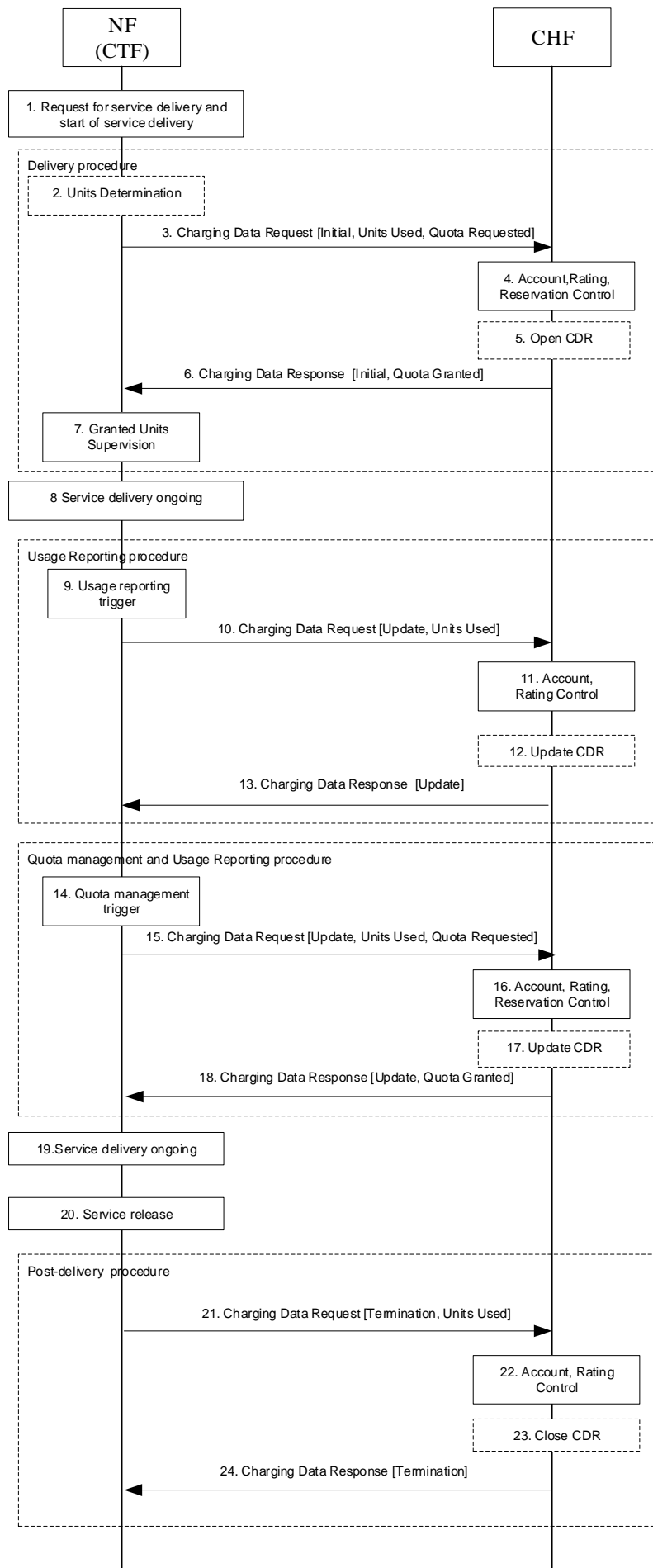

Figure 5.3.2.3.2: SCUR - Session based charging with Decentralized and Centralized Unit Determination, Centralized Rating, immediate start of service delivery (Non-blocking mode)

- 1) **Request for service delivery and start of service delivery:** A request for session establishment is received in the NF (CTF). The NF (CTF) is configured to allow the service to be delivered.
- 2) **Units Determination:** the NF (CTF) determines the number of units depending on the service requested, in "Decentralized Units determination" scenario.
- 3) **Charging Data Request [Initial, Unit Used, Quota Requested]:** the NF (CTF) sends the request to the CHF to reserve the number of units if determined in step 2, it may also report the used units.
- 4) **Account, Rating, Reservation Control:** the CHF rates the requests either based on the number of units requested or on internal unit determination, checks if corresponding funds can be reserved on the user's account balance. If the account has sufficient funds, the CHF performs the corresponding reservation.
- 5) **Open CDR:** based on policies, the CHF opens a CDR related to the service.
- 6) **Charging Data Response [Initial, Quota Granted]:** the CHF grants the reserved number of units to NF (CTF).
- 7) **Granted Units Supervision:** The NF (CTF) monitors the consumption of the granted units.
- 8) **Service delivery ongoing:** the NF (CTF) continues to deliver the service.
- 9) **Usage reporting trigger:** the NF (CTF) generates charging data related to a service delivered that is not under quota management, based on that a trigger for service usage reporting is met.
- 10) **Charging Data Request [Update, Unit Used]:** the NF (CTF) reports the charging data related to service delivered, including the used units, to the CHF.
- 11) **Account, Rating Control:** the CHF uses the reported charging data to rate the usage and deduct the funds corresponding to the usage on the account balance.
- 12) **Update CDR:** based on policies, the CHF updates the CDR with charging data related to the service.
- 13) **Charging Data Response [Update]:** The CHF informs the NF (CTF) on the result of the request.
- 14) **Quota management Trigger:** A Trigger associated to Quota management is met. Units determination is performed when applicable.
- 15) **Charging Data Request [Update, Unit Used, Quota Requested]:** the NF (CTF) sends the request to the CHF, for more units to be granted for the service to continue, and reporting the used units.
- 16) **Account, Rating, Reservation Control:** same as step 4, with the option to also deduct the funds corresponding to the usage on the account balance.
- 17) **Update CDR:** based on policies, the CHF updates the CDR with charging data related to the service.
- 18) **Charging Data Response [Update, Quota Granted]:** The CHF grants quota to NF (CTF) for the service, with the reserved number of units.
- 19) **Service delivery ongoing:** the NF (CTF) continues to deliver the service.
- 20) **Service release:** the NF (CTF) is requested to end the service delivery and does this.
- 21) **Charging Data Request [Termination, Unit Used]:** the NF (CTF) sends the request to the CHF, for charging data related to the service termination with the final consumed units.
- 22) **Account, Rating Control:** the CHF performs the service termination process which involve using the reported charging data to rate the usage and deduct the funds corresponding to the usage on the account balance.
- 23) **Close CDR:** based on policies, the CHF closes the CDR with charging data related to the service termination and the last reported units.
- 24) **Charging Data Response [Termination]:** The CHF informs the NF (CTF) on the result of the request.

Figure 5.3.2.3.3 shows a scenario for Session based charging (ECUR) in Decentralized and Centralized Unit Determination, Centralized Rating configuration, where the NF (CTF) invokes a converged charging service towards the CHF, prior to service delivery if needed.

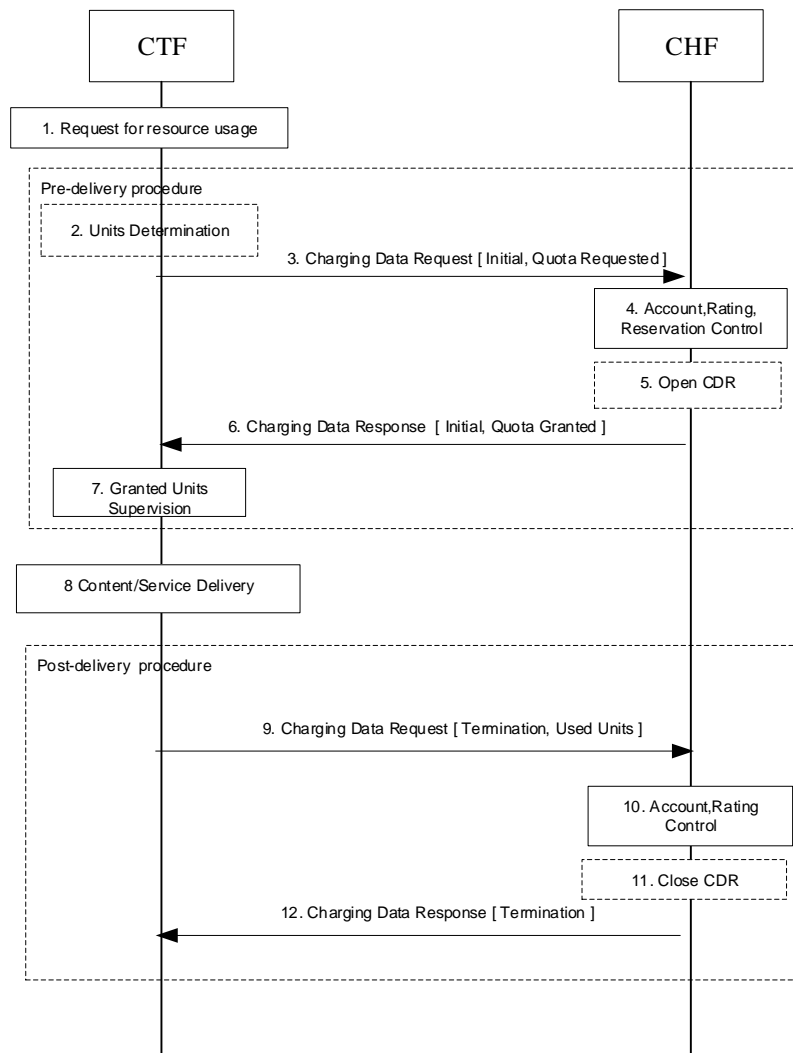

Figure 5.3.2.3.3: ECUR - Session based charging with - Decentralized and Centralized Unit Determination, Centralized Rating.

- 1) **Request for resource usage:** A request for session establishment is received in the NF (CTF). The service is configured to be authorized by the CHF to start.
- 2) **Units Determination:** the NF (CTF) determines the number of units depending on the service requested by the UE in "Decentralized Units determination" scenario.
- 3) **Charging Data Request [Initial, Quota Requested]:** The NF (CTF) sends the request to the CHF for the service to be granted authorization to start, and to reserve the number of units if determined in item 2.
- 4) **Account, Rating, Reservation Control:** the CHF rates the requests either based on the number of units requested or on internal unit determination, checks if corresponding funds can be reserved on the user's account balance. If the account has sufficient funds, the CHF performs the corresponding reservation.
- 5) **Open CDR:** based on policies, the CHF opens a CDR related to the service.
- 6) **Charging Data Response [Initial, Quota Granted]:** The CHF grants authorization to NF (CTF) for the service to start, with the reserved number of units.

- 7) **Granted Units Supervision:** The service starts and the NF (CTF) monitors the consumption of the granted units.
- 8) **Content/Service Delivery:** the NF (CTF) delivers the content/service based on the reserved number of units.
- 9) **Charging Data Request [Termination, Unit Used]:** the NF (CTF) sends the request to the CHF, for charging data related to the delivered service with the consumed units.
- 10) **Account, Rating Control:** The CHF performs the process for the delivered service involving rating entity and user's account balance.
- 11) **Close CDR:** based on policies, the CHF closes the CDR with charging data related to the delivered service.
- 12) **Charging Data Response [Termination]:** The CHF informs the NF (CTF) on the result of the request.

5.3.2.4 Charging notification

The CHF can in Converged Session based Charging provide notifications to the NF (CTF), the NF (CTF) implicitly subscribes to these when it sends a Charging Data Request [Initial], i.e. there is no separate subscription request from the NF for notification.

Figure 5.3.2.4-1 shows a scenario for Session based charging with a notification from the CHF triggering a Charging Data Request [Update].

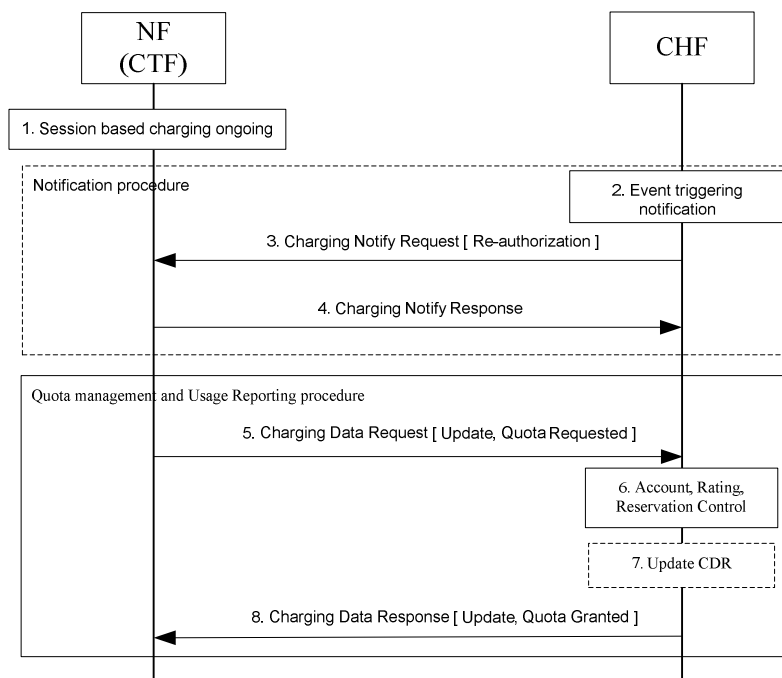

Figure 5.3.2.x.1: Session based charging – Notification with Re-authorization

- 1) **Session based charging ongoing:** there is a session based charging ongoing and there have at least been a Charging Data Request [Initial] sent from the NF (CTF) to the CHF, and the CHF have opened a CDR.
- 2) **Event triggering notification:** an event is detected in the CHF that requires a notification to be sent to the NF (CTF). In this scenario a request for triggering a Charging Data Request [Update, Quota Request] is sent, but also requests for Charging Data Request [Update] (without request for quota) is possible.
- 3) **Charging Notify Request [Re-authorization]:** the CHF sends the request to the NF (CTF), for a triggering of a Charging Data Request [Update, Quota Request] i.e. Re-authorization.
- 4) **Charging Notify Response:** the NF (CTF) acknowledges the request by sending a response.

- 5) **Charging Data Request [Update, Quota Requested]:** the NF (CTF) sends the request to the CHF, to be granted with more unit for the service to continue, and also for reporting the used units.
- 6) **Account, Rating, Reservation Control:** the CHF performs the process related to the reported usage and the requested reservation, involving rating entity and user's account balance.
- 7) **Update CDR:** based on policies, the CHF updates the CDR with charging data related to the service.
- 8) **Charging Data Response [Update, Quota Granted]:** the CHF grants quota to NF (CTF) for the service to continue, with the reserved number of units.

Figure 5.3.2.4.2 shows a scenario for Session based charging with a notification from the CHF triggering a Charging Data Request [Termination].

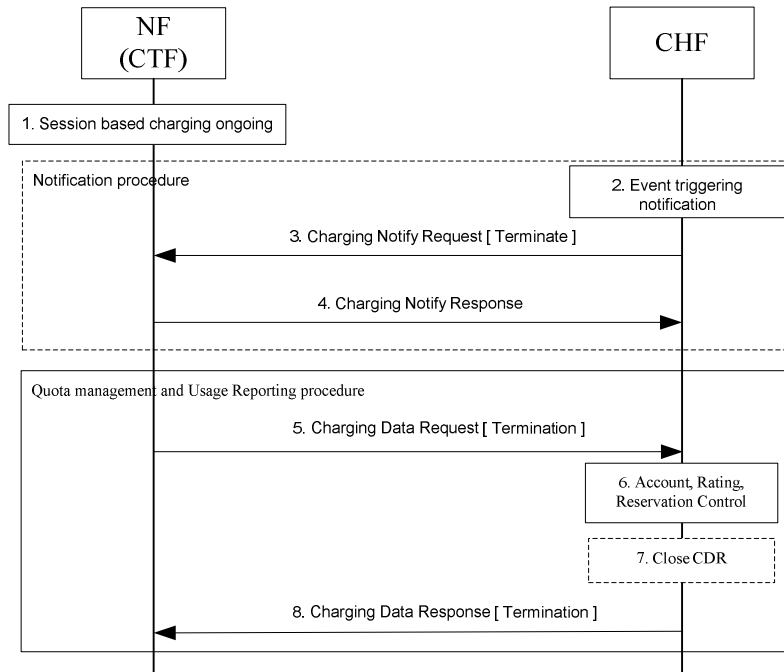

Figure 5.3.2.4.2: Session based charging – Notification with termination

- 1) **Session based charging ongoing:** there is a session based charging ongoing and there have at least been a Charging Data Request [Initial] sent from the NF (CTF) to the CHF, and the CHF have opened a CDR.
- 2) **Event triggering notification:** an event is detected in the CHF that requires a notification to be sent to the NF (CTF). In this scenario a request for triggering a Charging Data Request [Termination] is sent.
- 3) **Charging Notify Request [Terminate]:** the CHF sends the request to the NF (CTF), for a triggering of a Charging Data Request [Termination] i.e. the termination of the charging session.
- 4) **Charging Notify Response:** the NF (CTF) acknowledges the request by sending a response.
- 5) **Charging Data Request [Termination]:** the NF (CTF) sends the request to the CHF, for charging data related to the service termination with the final consumed units.
- 6) **Account, Rating Control:** the CHF performs the process related to the reported usage, involving rating entity and user's account balance.
- 7) **Close CDR:** based on policies, the CHF closes the CDR with charging data related to the service.
- 8) **Charging Data Response [Termination]:** The CHF informs the NF (CTF) on the result of the request.

5.3.2.5 Switch between quota managed and not quota managed

When converged charging is used for a service delivery it is possible to in online charging to switch from quota management to quota management suspended, and in some cases back again.

Figure 5.3.2.5.1 shows a scenario for Session based charging (SCUR) with a suspension of quota management and resume of quota management.

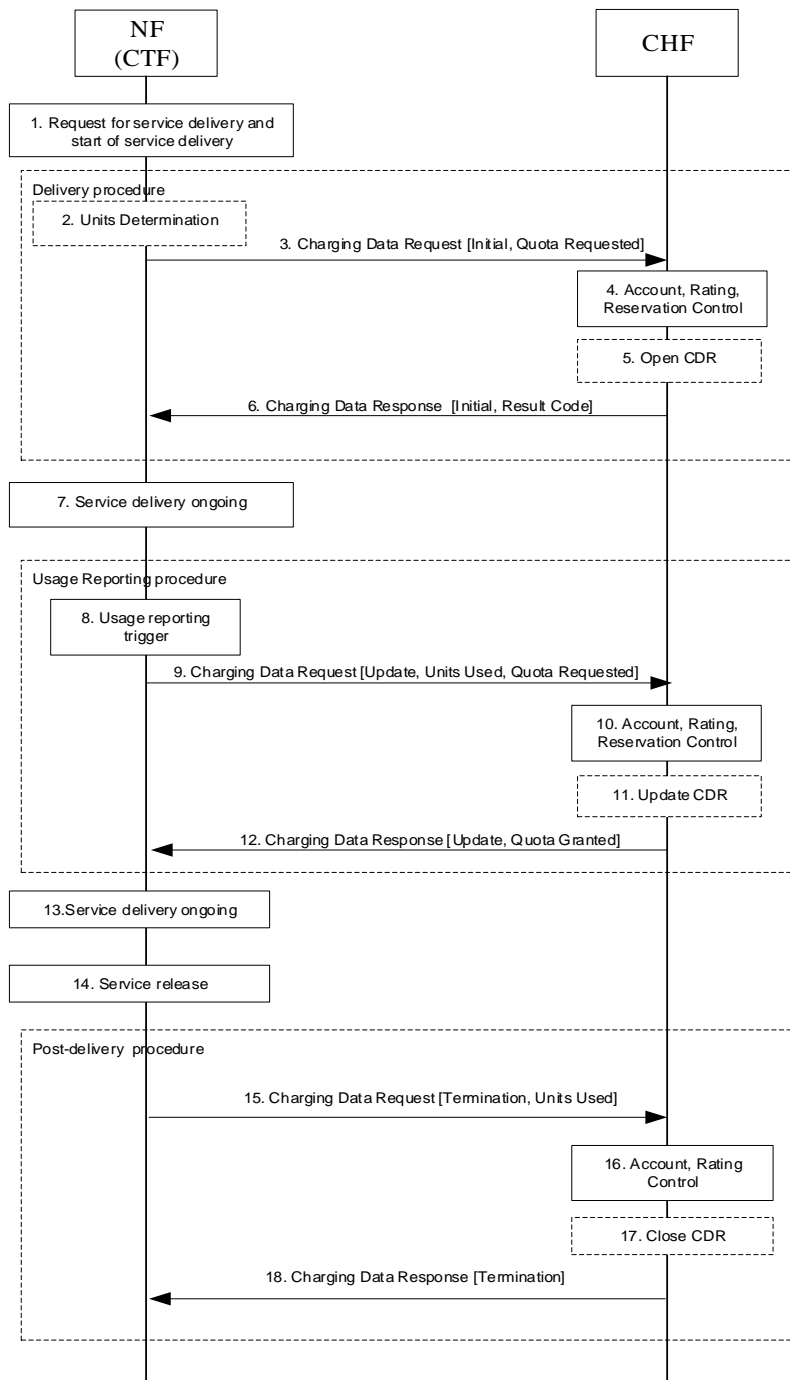

Figure 5.3.2.5.1: SCUR - Session based charging with suspend and resume of quota management.

- 1) **Request for resource usage:** A request for session establishment is received in the NF (CTF). The service is configured to be authorized by the CHF to start.

- 2) **Units Determination:** the NF (CTF) determines the number of units depending on the service requested by the UE in "Decentralized Units determination" scenario.
- 3) **Charging Data Request [Initial, Quota Requested]:** The NF (CTF) sends the request to the CHF for the service to be granted authorization to start, and to reserve the number of units if determined in item 2.
- 4) **Account, Rating, Reservation Control:** the CHF rates the requests and checks need for quota management. If not needed for the service at the moment a switch from online to offline type of charging is to be performed.
- 5) **Open CDR:** based on policies, the CHF opens a CDR related to the service.
- 6) **Charging Data Response [Initial, Result Code]:** The CHF grants authorization to NF (CTF) for the service to start, with a result code indicating that quota management is suspended.
- 7) **Content/Service Delivery:** the NF (CTF) delivers the content/service without quota management.
- 8) **Usage Reporting Trigger:** the NF (CTF) generates charging data related to the service delivered that is not under quota management, based on a trigger for usage reporting is met.
- 9) **Charging Data Request [Update, Unit Used, Quota Requested]:** the NF (CTF) sends the request to the CHF, for units to be granted making it possible to resume the quota management. It also reports the used units with an indication that these were used with quota management suspended.
- 10) **Account, Rating, Reservation Control:** The CHF performs the process related to the reported usage and checks if quota management should continue to be suspended or should be resumed. If needed for the service, CHF checks if corresponding funds can be reserved on the user's account balance.
- 11) **Update CDR:** based on policies, the CHF updates the CDR with charging data related to the service.
- 12) **Charging Data Response [Update, Quota Granted]:** The CHF grants quota to NF (CTF) for the service to continue and with this indicating that quota management is to be resumed, with the reserved number of units.
- 13) **Content/Service Delivery:** the NF (CTF) delivers the content/service based on the granted quota.
- 14) **Session released:** the session is released.
- 15) **Charging Data Request [Termination]:** the NF (CTF) sends the request to the CHF, for charging data related to the service termination with the final consumed units.
- 16) **Account, Rating Control:** The CHF performs the service termination process involving rating entity and user's account balance.
- 17) **Close CDR:** based on policies, the CHF closes the CDR with charging data related to the service termination and the last reported units.
- 18) **Charging Data Response [Termination]:** The CHF informs the NF (CTF) on the result of the request.

5.4 Other functionalities

5.4.1 Re-authorization

The CHF (NF Service Producer) may trigger a re-authorization request and the NF Service Consumer shall report quota usage. The reason for the quota being reported shall be notified to the CHF (NF Service Producer). This is described under charging notification procedure in clause 5.3.2.4.

The NF Service Consumer may receive a Charging Notify Request while waiting for a Charging Data Response from the CHF. In this case the NF Service Consumer shall not send a new Charging Data Request.

The NF Service Consumer may receive a Charging Notify Request while not waiting for any Charging Data Response from the CHF. In this case the NF Service Consumer shall send a new Charging Data Request.

5.4.2 Threshold based re-authorization triggers

The CHF (NF Service Producer) may optionally include an indication to the NF Service Consumer of the remaining quota threshold that shall trigger a quota re-authorization.

If received quota threshold based re-authorization triggers (i.e. `timeQuotaThreshold`, `volumeQuotaThreshold`, `unitQuotaThreshold`), the NF Service Consumer shall seek re-authorization for the quota when the quota contents fall below the supplied threshold. The NF Service Consumer allows the service to continue whilst the re-authorization is progress, until the remaining part had been used up.

5.4.3 Termination action

The CHF (NF Service Producer) may use the Final Unit Indication to indicate specify to the NF Service Consumer the behaviour on consumption of the final granted units, or zero units granted in the first place; this is known as termination action.

The NF Service Consumer should perform the action indicated in the Final Unit Indication, which may be to terminate, redirect or to restrict access, when any final granted units have been used. If the granted units contain no units it means that the action should be performed immediately.

If the action is terminate, then the NF Consumer may terminate all the services belonging to the rating group.

If the action is redirect, then the NF Consumer may redirect all access to the services belonging to the rating group to the destination indicated, if filter rules are provided it may also restrict the access towards the new destination.

If the action is restrict access, then the NF Consumer may restrict access to the services belonging to the rating group based on filter rules.

5.4.4 Service termination

The CHF (NF Service Producer) may determine that a service requires termination. The NF Service Producer may perform this termination synchronously if it has a request pending processing by returning response.

If the CHF (NF Service Producer) does not have a pending request (asynchronous), the NF Service Producer may trigger an abort notification to terminate the charging session. On reception of an abort notification, the NF consumer shall terminate the associated charging session by sending a `Nchf_ConvergedCharging_Release`. If the associated charging session is not currently active or NF consumer does not terminate the charging session for any other reason, the corresponding error response is returned.

The CTF (NF Service Consumer) may determine service termination. For session based charging the termination request shall include the used units if any. For event based charging there may be no used unit reported.

5.4.5 Trigger Mechanism

There are a number of mid-session service events, defined as triggers, which could affect the rating of the current service usage, e.g. QoS changes or end user location updates. The details for this these triggers are defined in the service specific document (middle tier TS). The relationship between service session and charging session is 1:1.

There are two levels of triggers: service session and rating group. The service session level triggers are applicable for all rating groups within a charging session, whereas a rating group level trigger is only applicable to that rating group. Any limit or threshold set on the service session level is the total limit for the service session including all the rating groups. The behaviour at trigger detection is specified by the middle tier TS.

Triggers enabled or disabled by default by the NF consumer, may be enabled or disabled by CHF in response to the NF consumer.

The CHF may enable one or more triggers at the NF consumer, by including them in the Triggers element. Each Triggers element can only contain one trigger of each type. The omitted triggers in the Triggers element shall be interpreted by the NF consumer as disabled. The enabled and disabled triggers setting at the NF consumer shall remain in effect until another Triggers element is received from the CHF for the service session or rating group. When the NF consumer receives a Triggers element it shall enable all triggers present in the Triggers element and disable all other

triggers at the same level. The presence of the Triggers element without any trigger type in a response message allows CHF to disable all the triggers at the NF Consumer for service session or rating group.

NOTE: This removes the need for the CHF to send trigger information in every response message when they have not changed.

Two categories of chargeable events are identified:

- immediate report: chargeable events for which, when occurring, the current counts are closed and sent together with the charging data generated by the NF consumer towards the CHF in a Charging Data Request message. Counts indicating zero usage may be reported. New counts are started by the NF consumer.
- deferred report: chargeable events for which, when occurring, the current counts are closed and stored together with the charging data generated by the NF consumer. Counts indicating zero usage may be included. The stored counts will be sent to the CHF in next a Charging Data Request message. New counts are started by the NF consumer.

CHF may change the category of one or more triggers by using the Triggers element containing category information in the response message.

For the rating group: the rating group level triggers and category take precedence over the service session level triggers and category.

If there is a request for quota management outstanding for a rating group i.e., the request has not been responded to, any new request for quota management for the same rating group should be postponed until after the response has been received.

5.4.6 CHF-controlled quota management

CHF can instruct NF consumer (CTF) to suspend quota management for a given Rating Group and then subsequently the CHF can instruct the NF consumer (CTF) to resume quota management for the given Rating Group with suspended quota management within the charging session.

Upon receiving Charging Data Request [Initial/Update] with usage reporting for a set of rating groups, the CHF may suspend quota management for particular rating groups, by including in Charging Data Response messages for these particular rating groups:

- explicit setting of without quota management or
- granted quotas with appropriate content to ensure the service to continue without further quota management related updates.

CHF may instruct NF consumer (CTF) to resume quota management for a given rating group for which quota management was previously suspended:

- by using Re-authorization procedure or
- by granting quotas in the response to any Charging Data Request [Update] generated in situation quota management triggers are not used, by other existing active triggers of the NF consumer (CTF).

5.4.7 Charging identifier

The charging identifier is assigned by the NF consumer, making it possible to correlate the charging information from different events or sessions. The assignment is NF consumer dependent. The charging identifier may also be used for duplicate detection see clause 5.5.2.

5.5 Error handling

5.5.1 Failure handling

5.5.1.1 CTF detected failure

The failure handling determines what to do if the sending of charging data request to the CHF without response in a period of time (request times out).

In the case of the NF consumer (CTF) request times out, CHF uses application level failure handling (Terminate, Continue, Retry_and_terminate). Failure handling may be received from the CHF or may be locally configured. The value received from the CHF in the charging data response will always override any already existing value. Failover handling indication informs NF Consumer whether alternative CHF is supported.

In case there is an application level error response from the CHF, NF consumer (CTF) action will depend on the type of Application Error.

For protocol level errors, refer to applicable protocol failure handling mechanisms as described in 32.291 [58].

5.5.1.2 CHF detected failure

The CHF closes a CDR and all the reserved resources are freed for the charging session when it detects that expected charging data request for a particular session have not been received for a period of time. The charging session may be kept or released based on local configuration.

A Charging Data Request [Initial] received by a CHF, which can be associated to an existing charging session (i.e. resource in CHF), shall be handled as a valid request and be answered with Charging Data Response [Initial] with the charging session id (i.e. resource id).

A Charging Data Request [Update] received by a CHF, which cannot be associated to any existing charging session (i.e. resource in CHF), shall be handled as a valid request with the associated resource creation and quota usage handling.

A Charging Data Request [Termination] received by a CHF, which cannot be associated to any existing charging session (i.e. resource in CHF), shall be handled as a valid request with associated new resource creation, and optional corresponding CDR creation.

The Invocation Sequence Number in Charging Data Request [Initial] with value different from 0 or 1 is faulty and shall be rejected by CHF.

5.5.2 Retry handling

In case a NF consumer (CTF) does not receive a Charging Data Response, it may retransmit the Charging Data Request message. The number of retries and delay between retries shall be locally configured in the NF consumer (CTF).

If the retried charging data request [Initial] is received by the same CHF, the uniqueness checking may be based on the Charging Identifier included in the charging data request. CHF shall respond to the retried charging data request [Initial] with the original charging session identifier.

If the retried request is charging data request [Update] or charging data request [Termination], the uniqueness checking may be based on the inspection of the Charging Session Identifier and Invocation Sequence Number pair.

If retried message shall have the same Invocation Sequence Number as the original of the retried message i.e. the Invocation Sequence Number shall not be incremented when the message is retried. The NF consumer (CTF) may send the retried message to an alternative CHF if the Session Failover indication is received from the CHF.

In the case of a notification request time out the CHF may retry the message. The number of retries and delay between retries shall be locally configured in the CHF.

5.5.3 Response code handling

The Charging Data Response includes a response code (i.e. Invocation Result Code in Invocation Result) which may indicate an error. The response codes supported by Nchf_ConvergedCharging service operations are specified 3GPP TS 32.291 [58].

A NF Consumer (CTF) receiving a Charging Data Response [Initial] with a response code indicating the Charging Data Request [Initial] was unsuccessfully processed, shall perform the error handling applicable to the response code and may send a Charging Data Request [Termination] to the CHF.

A NF Consumer (CTF) receiving a Charging Data Response [Termination] with a response code indicating the Charging Data Request [Termination] was unsuccessfully processed, shall perform the error handling applicable to the response code.

A NF Consumer (CTF) receiving a Charging Data Response [Update] with a response code indicating the Charging Data Request [Update] was unsuccessfully processed, shall perform the error handling applicable to the response code and may send a Charging Data Request [Termination] to the CHF.

The Charging Data Response may also include multiple "Multiple Unit Information" Information Elements, each one indicated with a Result code (i.e. applicable at Rating group level). The Result code values supported by Nchf_ConvergedCharging service operations are specified 3GPP TS 32.291 [58]. Any Invocation Result Code value different than success takes precedence over the set of "Multiple Unit Information" Result Codes.

6 Service definition

6.1 NF service framework

5G Charging Function supports to interact with NRF, as specified in clause 7.1 of TS 23.501 [201] and clauses 4.17 and 5.2.7 of TS 23.502 [202] to enable following functionalities:

- CHF instance(s) registration, CHF service(s) instance(s) registration in a CHF instance.
- CHF instance(s) update, CHF service(s) instance(s) update in a CHF instance.
- CHF instance(s) deregistration.
- CHF instance(s) and CHF service(s) instance(s) discovery by CHF service consumer.

The services specified in clause 7.2.6 TS 23.501 [201] may be used and the interaction is described in TS 29.510 [300]:

- Nnrf_NFManagement.
- Nnrf_NFDiscovery.
- Nnrf_AccessToken.

The Nnrf_NFManagement_NFRegister service invoked by CHF for CHF instance(s) and CHF service(s) instance(s) registration described in the TS 29.510 [300] may include in particular:

- Range(s) of SUPIs.
- Range(s) of GPSIs.
- Range(s) of PLMNs.
- CHF Group ID.
- CHF set ID.
- CHF service set ID.

These parameters may also be used by CHF service consumer(s) invoking the Nnrf_NFDiscovery service for the CHF instance(s) and CHF service(s) instance(s) discovery.

A CHF instance is either a part of:

- a primary CHF instance and secondary CHF instance pair, or
- a CHF set.

6.2 Nchf_ConvergedCharging service

6.2.1 General

Service description: The ConvergedCharging service provides charging for session and event based NF services. This ConvergedCharging service offers charging:

- With quota management (online; this includes support for both blocking mode and non-blocking mode)
- Without quota management (offline)
- Charging information record generation

The following table shows the CHF Services and CHF Service Operations.

Table 6.2.1-1: NF services provided by the CHF

Service Name	Service Operations	Operation Semantics	Example Consumer(s)
Nchf_ConvergedCharging	Create	Request/Response	SMF, SMSF, AMF, SMF+PGW-C, NEF, IMS-Node, CEF, MnS Producer
	Update	Request/Response	SMF, SMF+PGW-C, IMS-Node
	Release	Request/Response	SMF, SMSF, AMF, NEF, SMF+PGW-C, IMS-Node
	Notify	Notify	SMF, SMF+PGW-C, IMS-Node

The applicability of ConvergedCharging service to:

- SMF and SMF+PGW-C as consumer is specified in TS 32.255 [30] for 5G data connectivity domain charging;
- IMS-Node as consumer is specified in TS 32.260 [31] for IMS charging;
- NEF as consumer is specified in TS 32.254 [32] for exposure function Northbound Application Program Interfaces charging;
- AMF as consumer is specified in the TS 32.256[33] for 5G connection and mobility domain charging;
- SMSF as consumer is specified in TS 32.274[34] for short message service charging;
- CEF as consumer is specified in the TS 28.201[35] and TS 28.202[36] for Network slice charging;
- MnS Producer as consumer is specified in the TS 28.201[35] and TS 28.202[36] for Network slice charging.

The input and output parameters described in the clauses below are common to all NF Consumers. The usage of these common parameters and additional NF Consumer specific parameters are specified in dedicated charging specifications.

6.2.2 Nchf_ConvergedCharging_Create service operation

Service operation name: Nchf_ConvergedCharging_Create

Description: Provides charging capabilities before service delivery, offers charging with and without quota management, as well as charging information record generation. It is used for both session and event based charging. Provides means for the NF Consumer to create the resource of the charging session. If it is used for session based charging the operation also makes an implicit subscribe to notification of events in CHF that requires re-authorization or abort.

The service operation may be used to request quota authorisation for service delivery and may open a CDR in the CHF, based on the information provided by the NF Consumer.

Known NF Consumers: SMF, SMSF, AMF, IMS-Node, SMF+PGW-C, NEF, CEF, MnS Producer.

Inputs, Required: Subscriber identifier, either service identification or rating group.

Inputs, Optional: Requested service units, one-time event, destination address, provider, location information, time and date.

Outputs, Required: Result indication.

Outputs, Optional: Granted service units, validity time, triggers.

6.2.3 Nchf_ConvergedCharging_Update service operation

Service operation name: Nchf_ConvergedCharging_Update

Description: Provides charging capabilities during service delivery, offers usage reporting and quota management, as well as charging information record generation.

The service operation is used to report usage and may request further quota authorisation, if the trigger conditions occurs, this operation may cause update of the CDR or production of an interim CDR in the CHF.

Known NF Consumers: SMF, IMS-Node, SMF+PGW-C.

Inputs, Required: Subscriber identifier (Optional for emergency session), session identifier, reporting reason.

Inputs, Optional: Requested service units, used service units.

Outputs, Required: Result indication.

Outputs, Optional: Granted service units, validity time, triggers.

6.2.4 Nchf_ConvergedCharging_Release service operation

Service operation name: Nchf_ConvergedCharging_Release

Description: Provides charging capabilities after service delivery, offers usage reporting and charging information record generation. Provides means for the NF Consumer to release the resource of charging session information.

The charging delete request is used to report usage and close the CDR in the CHF if it has been opened.

Known NF Consumers: SMF, AMF, SMF+PGW-C, SMSF, NEF.

Inputs, Required: Subscriber identifier, session identifier, release reason.

Inputs, Optional: Used service units.

Outputs, Required: Result indication.

Outputs, Optional: None.

6.2.5 Nchf_ConvergedCharging_Notify service operation

Service operation name: Nchf_ConvergedCharging_Notify

Description: Provides notification to NF consumers of the subscribed events.

CHF provides the re-authorization type notification that would lead NF consumers to send an Nchf_ConvergedCharging_Update reporting the current usage.

CHF provides the abort type notification that would lead NF consumers to send an Nchf_ConvergedCharging_Release to terminate the charging session.

Known NF Consumers: SMF, IMS-Node, SMF+PGW-C.

Inputs, Required: Subscriber identifier, notification type (re-authorization or abort).

Inputs, Optional: rating group, service id.

Outputs, Required: Result indication.

Outputs, Optional: None

6.3 Nchf_SpendingLimitControl service

6.3.1 Overview

The "Nchf_SpendingLimitControl" service is defined in 23.502 [202] clause 5.2.17.2.

6.4 Void

6.5 Nchf_OfflineOnlyCharging service

6.5.1 General

Service description: The OfflineOnlyCharging service provides charging for session based NF services. This OfflineCharging service offers charging information record generation.

The following table shows the CHF Services and CHF Service Operations.

Table 6.5.1-1: NF services provided by the CHF

Service Name	Service Operations	Operation Semantics	Example Consumer(s)
Nchf_OfflineOnlyCharging	Create	Request/Response	SMF, IMS-Node
	Update	Request/Response	SMF, IMS-Node
	Release	Request/Response	SMF, IMS-Node

The applicability of OfflineOnlyCharging service to SMF as NF consumer is specified in TS 32.255 [30] for 5G data connectivity domain charging. The applicability of OfflineOnlyCharging service to IMS-Node as NF consumer is specified in TS 32.260 [31] for IMS charging.

The input and output parameters described in the clauses below are common to all NF Consumers. The usage of these common parameters and additional NF Consumer specific parameters are specified in dedicated charging specifications.

6.5.2 Nchf_OfflineOnlyCharging_Create service operation

Service operation name: Nchf_OfflineOnlyCharging_Create

Description: Provides charging capabilities before service delivery, offers charging information record generation. Provides means for the NF Consumer to create the resource of the charging session.

The service operation shall open a CDR in the CHF, based on the information provided by the NF Consumer.

Known NF Consumers: SMF, IMS-Node.

Inputs, Required: Subscriber identifier, either service identification or rating group.

Inputs, Optional: destination address, provider, location information, time and date.

Outputs, Required: Result indication.

Outputs, Optional: triggers.

6.5.3 Nchf_OfflineOnlyCharging_Update service operation

Service operation name: Nchf_OfflineOnlyCharging_Update

Description: Provides charging capabilities during service delivery, charging information record generation.

If the trigger conditions occurs, this operation may cause update of the CDR or production of an interim CDR in the CHF.

Known NF Consumers: SMF.

Inputs, Required: Subscriber identifier (exception for emergency session), session identifier, reporting reason.

Inputs, Optional: None.

Outputs, Required: Result indication.

Outputs, Optional: triggers.

6.5.4 Nchf_OfflineOnlyCharging_Release service operation

Service operation name: Nchf_OfflineOnlyCharging_Release

Description: Provides charging capabilities after service delivery, charging information record generation. Provides means for the NF Consumer to release the resource of charging session information.

The charging delete request is used to close the CDR in the CHF if it has been opened.

Known NF Consumers: SMF, IMS-Node.

Inputs, Required: Subscriber identifier, session identifier, release reason.

Inputs, Optional: None.

Outputs, Required: Result indication.

Outputs, Optional: None.

7 Message contents

Converged charging or offline only charging is performed by NF (CTF) consuming service operations exposed by CHF, achieved using Charging Data Request and Charging Data Response.

The information structure used for these services operations is composed of two parts:

- Common structures specified in the present document.
- NF (CTF) consumer specific structures specified in the middle tier TSs.

Table 7.1 describes the data structure which is common to operations in request semantics.

Table 7.1: Common Data structure of Charging Data Request

Information Element	Converged Charging Category	Offline Only Charging Category	Description
Session Identifier	O _C	O _C	This field identifies the charging session.
Subscriber Identifier	O _M	O _M	This field contains the identification of the individual subscriber that uses the requested service.
NF Consumer Identification	M	M	This is a grouped field which contains a set of information identifying the NF consumer of the charging service.
NF Functionality	M	M	This field contains the function of the node.
NF Name	O _C	O _C	This field holds the name (i.e. UUID) of the NF consumer. At least one of the NF Address or NF Name shall be present.
NF Address	O _C	O _C	This field holds the address (i.e. IP address and/or FQDN) of NF consumer. At least one of the NF Address or NF Name shall be present.
NF PLMN ID	O _C	O _C	This field holds the PLMN ID of the network the NF consumer belongs to.
Charging Identifier	O _M	-	This field contains the charging identifier allowing correlation of charging information. Only applicable if not provided in the NF (CTF) consumer specific structure.
Invocation Timestamp	M	M	This field holds the timestamp of the charging service invocation by the NF consumer
Invocation Sequence Number	M	M	This field contains the sequence number of the charging service invocation by the NF consumer in a charging session.
Retransmission Indicator	O _C	O _C	This field indicates if included, this is a retransmitted request message.
One-time Event	O _C	-	This field indicates, if included, that this is event based charging and whether this is a one-time event in that there will be no update or termination.
One-time Event Type	O _C	-	This field indicates the type of the one time event, i.e. Immediate or Post event charging.
Notify URI	O _C	-	This field contains URI to which notifications are sent by the CHF. The latest received value shall always be used at notifications.
Supported Features	O _C	-	This field indicates the features supported by the NF consumer.
Service Specification Information	O _C	-	This field identifies the technical specification for the service (e.g. TS 32.255) and release version (e.g. Release 16) that applies to the request. It is for information.
Triggers	O _C	O _C	This field identifies the event(s) triggering the request and is common to all Multiple Unit Usage occurrences.
Multiple Unit Usage	O _C	O _C	This field contains the parameters for the quota management request and/or usage reporting. It may have multiple occurrences.
Rating Group	M	M	This field holds the identifier of a rating group.
Requested Unit	O _C	-	This field indicates, if included, that quota management is required. It may additionally contain the amount of requested service units for a particular category.
Time	O _C	-	This field holds the amount of requested time.
Total Volume	O _C	-	This field holds the amount of requested volume in both uplink and downlink directions.
Uplink Volume	O _C	-	This field holds the amount of requested volume in uplink direction.
Downlink Volume	O _C	-	This field holds the amount of requested volume in downlink direction.
Service Specific Units	O _C	-	This field holds the amount of requested service specific units.
Used Unit Container	O _C	O _C	This field contains the amount of used non-monetary service units measured up to the triggers and trigger timestamp. It may have multiple occurrences.
Service Identifier	O _C	O _C	This field holds the Service Identifier.

Information Element	Converged Charging Category	Offline Only Charging Category	Description
Quota management Indicator	O _C	-	This field holds an indicator on whether the reported used units are with quota management control, without quota management control or with quota management control temporary suspended. If the field is not present, it indicates the used unit is without quota management applied.
Triggers	O _C	O _C	This field holds reason for charging information reporting or closing for the used unit container.
Trigger Timestamp	O _C	O _C	This field holds the timestamp of the trigger.
Time	O _C	O _C	This field holds the amount of used time.
Total Volume	O _C	O _C	This field holds the amount of used volume in both uplink and downlink directions.
Uplink Volume	O _C	O _C	This field holds the amount of used volume in uplink direction.
Downlink Volume	O _C	O _C	This field holds the amount of used volume in downlink direction.
Service Specific Unit	O _C	O _C	This field holds the amount of used service specific units.
Event Time Stamps	O _C	O _C	This field holds the timestamps of the event reported in the Service Specific Units, if the reported units are event based.
Local Sequence Number	O _M	O _M	This field holds the container sequence number.

Table 7.2 describes the data structure which is common to operations in response semantics.

Table 7.2: Common Data structure of Charging Data Response

Information Element	Converged Charging Category	Offline Only Charging Category	Description
Session Identifier	O _c	O _c	This field identifies the charging session.
Invocation Timestamp	M	M	This field holds the timestamp of the charging service response from the CHF.
Invocation Result	O _c	O _c	This field holds the failure handling and in case of unsuccessful result of the charging service invocation by the NF consumer the result code.
Invocation Result	O _c	O _c	This field contains the result code in case of failure.
Failed parameter	O _c	O _c	This field holds missing and/or unsupported parameter that caused the failure.
Failure Handling	O _c	O _c	This field holds the failure handling to be performed by the NF consumer when failure.
Invocation Sequence Number	M	M	This field holds the sequence number of the charging service invocation by the NF consumer.
Session Failover	O _c	O _c	This field indicates whether alternative CHF is supported for ongoing charging service failover handling by NF consumer.
Supported Features	O _c	-	This field indicates from the supported features indicated by the NF consumer, those supported by the CHF.
Triggers	O _c	O _c	This field holds the triggers supplied from the CHF for the charging session that are independent of rating group for quota management and without quota management.
Multiple Unit Information	O _c	-	This field holds the parameters for the quota management and/or usage reporting information. It may have multiple occurrences.
Result Code	O _c	-	This field contains the result of the Rating Group quota allocation.
Rating Group	O _M	-	The identifier of a rating group.
Granted Unit	O _c	-	This field holds the granted quota.
Tariff Time Change	O _c	-	This field contains the switch time when the tariff will be changed.
Time	O _c	-	This field holds the amount of granted time.
Total Volume	O _c	-	This field holds the amount of granted volume in both uplink and downlink directions.
Uplink Volume	O _c	-	This field holds the amount of granted volume in uplink direction.
Downlink Volume	O _c	-	This field holds the amount of granted volume in downlink direction.
Service Specific Units	O _c	-	This field holds the amount of granted requested service specific units.
Validity Time	O _c	-	This field defines the time in order to limit the validity of the granted quota for a given category instance.
Final Unit Indication	O _c	-	This field indicates the granted final units for the service.
Time Quota Threshold	O _c	-	This field indicates the threshold in seconds when the granted quota is time
Volume Quota Threshold	O _c	-	This field indicates the threshold in octets when the granted quota is volume
Unit Quota Threshold	O _c	-	This field indicates the threshold in service specific units, that are defined in the service specific documents, when the granted quota is service specific
Quota Holding Time	O _c	-	This field holds the quota holding time in seconds.
Triggers	O _c	O _c	This field holds triggers for usage reporting associated to the rating group, which is supplied from the CHF.

The CTF NF consumer specific structures which are specified in the middle tier TSs, are defined as extensions of:

- common part structure of Charging Data Request and Charging Data Response.
- structure of Multiple Unit Usage.
- structure of Multiple Unit Information.

Table 7.3 describes the data structure which is common to Charging Notify Request.

Table 7.3: Common Data structure of Charging Notify Request

Information Element	Converged Charging Category	Description
Notify URI	M	This field holds the URI previously supplied by the CHF for notifications associated to the charging session.
Notification type	M	This field holds the type of notification indicating re-authorization or termination.
Reauthorization Details	Oc	This field holds the details of re-authorization. It's only present when type of notification is re-authorization. If not present and type of notification is re-authorization, the re-authorization notification applies to all units.
Service Identifier	Oc	This field holds the Service Identifier to which re-authorization notification applies. If present, the rating group shall also be present. If not present the re-authorization notification applies to all service identifiers.
Rating Group	Oc	This field holds the rating group to which re-authorization notification applies. If not present the re-authorization notification applies to all rating groups.
Quota management Indicator	Oc	This field holds an indicator on whether the re-authorization notification is for quota management control or not. If not present the re-authorization notification applies to both units with and without quota management.

Table 7.4 describes the data structure which is common to Charging Notify Response.

Table 7.4: Common Data structure of Charging Notify Response

Information Element	Category	Description
Invocation Result	Oc	This field holds the result code in case of unsuccessful result of the charging notify request.
Invocation Result Code	Oc	This field contains the result code in case of failure.
Failed parameter	Oc	This field holds missing and/or unsupported parameter that caused the failure.

Annex A (informative): Change history

Change history							
Date	Meeting	TDoc	CR	Rev	Cat	Subject/Comment	New version
2018-06	SA#80					Upgrade to change control version	15.0.0
2018-09	SA#81	SP-180832	0002	-	B	Charging Session Definition	15.1.0
2018-09	SA#81	SP-180832	0003	-	F	Correction on CTF in 5G Charging	15.1.0
2018-09	SA#81	SP-180832	0004	1	B	Introduce Use of NRF Framework	15.1.0
2018-09	SA#81	SP-180832	0005	-	B	Update combined scenarios	15.1.0
2018-09	SA#81	SP-180832	0008	1	B	Correction on Message content	15.1.0
2018-09	SA#81	SP-180832	0009	1	B	Correction on Nchf_ConvergedCharging_Notify Service Operation	15.1.0
2018-09	SA#81	SP-180832	0010	1	B	Correction on the requirement for Converged Charging	15.1.0
2018-09	SA#81	SP-180832	0011	1	B	Update of service operation	15.1.0
2018-09	SA#81	SP-180832	0013	1	B	Update of scenarios	15.1.0
2018-09	SA#81	SP-180832	0017	-	B	Converged Charging service definition update	15.1.0
2018-12	SA#82	SP-181059	0019	1	F	Clarification of requested units handling	15.2.0
2018-12	SA#82	SP-181059	0020	1	F	Allow updating of Notify URI	15.2.0
2018-12	SA#82	SP-181059	0021	1	F	Correction of Invocation result at http ok	15.2.0
2018-12	SA#82	SP-181052	0022	1	B	Addition of event charging	15.2.0
2018-12	SA#82	SP-181059	0023	1	F	Add description for Charging Notification	15.2.0
2019-03	SA#83	SP-190116	0024	1	F	Correction of NF Consumer Information	15.3.0
2019-03	SA#83	SP-190117	0027	-	F	Correction of SMSF as NF Consumer	15.3.0
2019-03	SA#83	SP-190116	0030	-	F	Correction of create operation for subscriber identifier	15.3.0
2019-03	SA#83	SP-190116	0031	1	F	Correction of Multiple Unit Information in ChargingDataResponse	15.3.0
2019-03	SA#83	SP-190116	0034	1	F	Addition of error handling	15.3.0
2019-03	SA#83	SP-190127	0025	1	B	Add offline only charging	16.0.0
2019-03	SA#83	SP-190127	0026	1	B	Add offline only charging service definition	16.0.0
2019-03	SA#83	SP-190127	0035	1	B	Add offline only charging service scenario	16.0.0
2019-06	SA#84	SP-190384	0037	1	A	Clarify the trigger mechanism	16.1.0
2019-06	SA#84	SP-190387	0039	1	C	Addition of message retry	16.1.0
2019-06	SA#84	SP-190384	0042	1	A	Correction on error handling	16.1.0
2019-06	SA#84	SP-190382	0043	1	B	Correct offline only charging service API name	16.1.0
2019-06	SA#84	SP-190384	0051	-	A	Correction of service operation name for Release	16.1.0
2019-09	SA#85	SP-190758	0052	1	B	Add offline only charging service message content	16.2.0
2019-09	SA#85	SP-190761	0053	1	A	Introduce event offline scenario	16.2.0
2019-09	SA#85	SP-190763	0055	1	B	Introduce AMF as a new NF consumer	16.2.0
2019-09	SA#85	SP-190761	0057	1	A	Correction of Multiple Quota reference	16.2.0
2019-09	SA#85	SP-190761	0068	1	A	Add the NF services	16.2.0
2019-09	SA#85	SP-190761	0070	1	A	Add the Service Specification Information	16.2.0
2019-09	SA#85	SP-190761	0071	1	A	Correction on Trigger Mechanism	16.2.0
2019-09	SA#85	SP-190761	0072	1	A	Clarification of Retry handling	16.2.0
2019-09	SA#85	SP-190761	0074	1	A	Correction of failure handling	16.2.0
2019-09	SA#85	SP-190761	0076	1	A	Event based charging mechanism	16.2.0
2019-09	SA#85	SP-190761	0077	1	A	Correction on response code handling	16.2.0
2019-09	SA#85					Correction in CR0053 (MCC)	16.2.1
2019-12	SA#86	SP-191160	0084	1	A	Add clarifications to failure handling	16.3.0
2019-12	SA#86	SP-191159	0086	1	F	Explanation of when Units Usage must be reported	16.3.0
2019-12	SA#86	SP-191159	0087	1	F	Clarification of Units Usage reporting	16.3.0
2019-12	SA#86	SP-191160	0088	-	D	Wrong name on CR	16.3.0
2019-12	SA#86	SP-191159	0091	1	F	Correction of Converged Charging principles	16.3.0
2019-12	SA#86	SP-191160	0093	-	A	Correction of ChargingNotifyResponse description	16.3.0
2019-12	SA#86	SP-191159	0094	-	F	Clarify Retransmission IE	16.3.0
2019-12	SA#86	SP-191160	0098	1	A	Correction of notify response	16.3.0
2019-12	SA#86	SP-191159	0101	1	F	Add the group id for CHF registration	16.3.0
2019-12	SA#86	SP-191160	0103	1	A	Correction to NF consumer identification	16.3.0
2020-07	SA#88-e	SP-200484	0114	1	F	Correction on Service Termination	16.4.0
2020-07	SA#88-e	SP-200485	0117	1	F	Correction of two SCUR Scenarios figure title and message description	16.4.0
2020-07	SA#88-e	SP-200509	0118	1	F	Correction of NF Consumers AMF for Nchf_ConvergedCharging_Release	16.4.0
2020-07	SA#88-e	SP-200508	0119	1	B	Add CHF-Controlled Quota Management functionality	16.4.0
2020-07	SA#88-e	SP-200508	0123	1	B	Flows for switch to offline	16.4.0
2020-09	SA#89e	SP-200741	0128	1	F	Add the attributes for CHFQM	16.5.0
2020-09	SA#89e	SP-200813	0130	1	F	Correction on Converged Charging and Requested Unit handling	16.5.0
2020-12	SA#90e	SP-201051	0132	1	F	Failure handling for InvocationSequenceNumber	16.6.0
2020-12	SA#90e	SP-201051	0134	-	F	Correction on missing PGW-C+SMF and NEF as NF consumers	16.6.0
2020-12	SA#90e	SP-201051	0135	1	F	Correcting trigger of usage reporting	16.6.0
2020-12	SA#90e	SP-201049	0137	1	A	Correcting handling of charging identifier	16.6.0
2020-12	SA#90e	SP-201069	0138	-	F	Correction on quota managed scenario	16.6.0
2020-12	SA#90e	SP-201088	0140	1	F	Add the NB Mode disable	16.6.0
2020-12	SA#90e	SP-201088	0142	1	F	Correction on the Quota Management Mode	16.6.0
2020-12	SA#90e	SP-201068	0143	1	B	Adding IMS nodes as NF consumers	17.0.0

2020-12	SA#90e	SP-201070	0144	1	B	Add PGW as consumer of ConvergedCharging service	17.0.0
2021-03	SA#91e	SP-210149	0146	-	A	Correction on covered session based charging	17.1.0
2021-03	SA#91e	SP-210165	0147	1	B	Add the TS reference for PGW	17.1.0
2021-03	SA#91e	SP-210158	0149	1	A	Correction on missing NS charging NF Consumers	17.1.0
2021-03	SA#91e	SP-210146	0151	-	A	Correction on Supported Features attribute	17.1.0
2021-03	SA#91e	SP-210146	0153	1	A	Trigger Clarification	17.1.0
2021-03	SA#91e	SP-210149	0158	1	F	Correcting final unit handling	17.1.0
2021-06	SA#92e	SP-210466	0159	1	F	Delete PGW as consumer of ConvergedCharging service	17.2.0
2021-06	SA#92e	SP-210399	0160	1	B	Add IMS Information in Offline Only Charging	17.2.0
2021-06	SA#92e	SP-210418	0162	1	A	Correction on support of CHF set and CHF service set	17.2.0
2021-09	SA#93e	SP-210888	0165	1	B	Update service description regarding GERAN and UTRAN access	17.3.0
2021-09	SA#93e	SP-210886	0167	-	A	Correcting of trigger type usage	17.3.0
2021-09	SA#93e	SP-210886	0169	-	A	Quota threshold clarification	17.3.0
2021-12	SA#94e	SP-211463	0170	1	F	Correcting charging identifier handling	17.4.0
2021-12	SA#94e	SP-211485	0172	1	A	Addition of the Threshold based re-authorization triggers	17.4.0
2021-12	SA#94e	SP-211485	0174	1	A	Clarification on the SMF immediate Report	17.4.0
2021-12	SA#94e	SP-211485	0176	-	A	Clarify the NF consumers	17.4.0

History

Document history		
V17.4.0	May 2022	Publication