

ETSI TS 132 405 V17.0.0 (2022-04)



**Digital cellular telecommunications system (Phase 2+) (GSM);
Universal Mobile Telecommunications System (UMTS);
Telecommunication management;
Performance Management (PM);
Performance measurements;
Universal Terrestrial Radio Access Network (UTRAN)
(3GPP TS 32.405 version 17.0.0 Release 17)**



Reference

RTS/TSGS-0532405vh00

Keywords

GSM,UMTS

ETSI

650 Route des Lucioles
F-06921 Sophia Antipolis Cedex - FRANCE

Tel.: +33 4 92 94 42 00 Fax: +33 4 93 65 47 16

Siret N° 348 623 562 00017 - APE 7112B
Association à but non lucratif enregistrée à la
Sous-Préfecture de Grasse (06) N° w061004871

Important notice

The present document can be downloaded from:

<http://www.etsi.org/standards-search>

The present document may be made available in electronic versions and/or in print. The content of any electronic and/or print versions of the present document shall not be modified without the prior written authorization of ETSI. In case of any existing or perceived difference in contents between such versions and/or in print, the prevailing version of an ETSI deliverable is the one made publicly available in PDF format at www.etsi.org/deliver.

Users of the present document should be aware that the document may be subject to revision or change of status.

Information on the current status of this and other ETSI documents is available at

<https://portal.etsi.org/TB/ETSIDeliverableStatus.aspx>

If you find errors in the present document, please send your comment to one of the following services:

<https://portal.etsi.org/People/CommitteeSupportStaff.aspx>

If you find a security vulnerability in the present document, please report it through our
Coordinated Vulnerability Disclosure Program:

<https://www.etsi.org/standards/coordinated-vulnerability-disclosure>

Notice of disclaimer & limitation of liability

The information provided in the present deliverable is directed solely to professionals who have the appropriate degree of experience to understand and interpret its content in accordance with generally accepted engineering or other professional standard and applicable regulations.

No recommendation as to products and services or vendors is made or should be implied.

No representation or warranty is made that this deliverable is technically accurate or sufficient or conforms to any law and/or governmental rule and/or regulation and further, no representation or warranty is made of merchantability or fitness for any particular purpose or against infringement of intellectual property rights.

In no event shall ETSI be held liable for loss of profits or any other incidental or consequential damages.

Any software contained in this deliverable is provided "AS IS" with no warranties, express or implied, including but not limited to, the warranties of merchantability, fitness for a particular purpose and non-infringement of intellectual property rights and ETSI shall not be held liable in any event for any damages whatsoever (including, without limitation, damages for loss of profits, business interruption, loss of information, or any other pecuniary loss) arising out of or related to the use of or inability to use the software.

Copyright Notification

No part may be reproduced or utilized in any form or by any means, electronic or mechanical, including photocopying and microfilm except as authorized by written permission of ETSI.

The content of the PDF version shall not be modified without the written authorization of ETSI.

The copyright and the foregoing restriction extend to reproduction in all media.

© ETSI 2022.
All rights reserved.

Intellectual Property Rights

Essential patents

IPRs essential or potentially essential to normative deliverables may have been declared to ETSI. The declarations pertaining to these essential IPRs, if any, are publicly available for **ETSI members and non-members**, and can be found in ETSI SR 000 314: "*Intellectual Property Rights (IPRs); Essential, or potentially Essential, IPRs notified to ETSI in respect of ETSI standards*", which is available from the ETSI Secretariat. Latest updates are available on the ETSI Web server (<https://ipr.etsi.org/>).

Pursuant to the ETSI Directives including the ETSI IPR Policy, no investigation regarding the essentiality of IPRs, including IPR searches, has been carried out by ETSI. No guarantee can be given as to the existence of other IPRs not referenced in ETSI SR 000 314 (or the updates on the ETSI Web server) which are, or may be, or may become, essential to the present document.

Trademarks

The present document may include trademarks and/or tradenames which are asserted and/or registered by their owners. ETSI claims no ownership of these except for any which are indicated as being the property of ETSI, and conveys no right to use or reproduce any trademark and/or tradename. Mention of those trademarks in the present document does not constitute an endorsement by ETSI of products, services or organizations associated with those trademarks.

DECT™, **PLUGTESTS™**, **UMTS™** and the ETSI logo are trademarks of ETSI registered for the benefit of its Members. **3GPP™** and **LTE™** are trademarks of ETSI registered for the benefit of its Members and of the 3GPP Organizational Partners. **oneM2M™** logo is a trademark of ETSI registered for the benefit of its Members and of the oneM2M Partners. **GSM®** and the GSM logo are trademarks registered and owned by the GSM Association.

Legal Notice

This Technical Specification (TS) has been produced by ETSI 3rd Generation Partnership Project (3GPP).

The present document may refer to technical specifications or reports using their 3GPP identities. These shall be interpreted as being references to the corresponding ETSI deliverables.

The cross reference between 3GPP and ETSI identities can be found under <http://webapp.etsi.org/key/queryform.asp>.

Modal verbs terminology

In the present document "**shall**", "**shall not**", "**should**", "**should not**", "**may**", "**need not**", "**will**", "**will not**", "**can**" and "**cannot**" are to be interpreted as described in clause 3.2 of the [ETSI Drafting Rules](#) (Verbal forms for the expression of provisions).

"**must**" and "**must not**" are **NOT** allowed in ETSI deliverables except when used in direct citation.

Contents

Intellectual Property Rights	2
Legal Notice	2
Modal verbs terminology.....	2
Foreword.....	12
1 Scope	14
2 References	14
3 Measurement family and abbreviations.....	15
3.1 Measurement family.....	15
3.2 Abbreviations	16
4 Measurements related to the RNC.....	18
4.1 RAB management	18
4.1.1 Overview	18
4.1.1.1 Measurements are based on the success and failure of procedures	18
4.1.1.2 Combination of Traffic Class and Core Network domains	18
4.1.1.3 Considered Radio Access Bearer management procedures	18
4.1.1.4 Measurements relate to RAB establishment, modification and release	19
4.1.2 RAB establishment for CS domain.....	20
4.1.2.0 Introduction.....	20
4.1.2.1 Attempted RAB establishments for CS domain.....	20
4.1.2.2 Successful RAB establishments without queuing for CS domain.....	20
4.1.2.3 Failed RAB establishments without queuing for CS domain.....	21
4.1.2.4 Successful RAB establishments with queuing for CS domain.....	22
4.1.2.5 Failed RAB establishments with queuing for CS domain.....	22
4.1.3 RAB establishment for PS domain	23
4.1.3.0 Introduction.....	23
4.1.3.1 Attempted RAB establishments for PS domain	23
4.1.3.2 Successful RAB establishments without queuing for PS domain	24
4.1.3.3 Failed RAB establishments without queuing for PS domain	25
4.1.3.4 Successful RAB establishments with queuing for PS domain	25
4.1.3.5 Failed RAB establishments with queuing for PS domain	26
4.1.4 RAB modification for CS domain	27
4.1.4.0 Introduction.....	27
4.1.4.1 Attempted RAB modifications for CS domain	27
4.1.4.2 Successful RAB modifications without queuing for CS domain	27
4.1.4.3 Failed RAB modifications without queuing for CS domain	28
4.1.4.4 Successful RAB modifications with queuing for CS domain	28
4.1.4.5 Failed RAB modifications with queuing for CS domain	28
4.1.5 RAB modification for PS domain.....	30
4.1.5.0 Introduction.....	30
4.1.5.1 Attempted RAB modifications for PS domain.....	30
4.1.5.2 Successful RAB modifications without queuing for PS domain.....	30
4.1.5.3 Failed RAB modifications without queuing for PS domain.....	31
4.1.5.4 Successful RAB modifications with queuing for PS domain.....	31
4.1.5.5 Failed RAB modifications with queuing for PS domain.....	31
4.1.6 RAB release request by CN for CS domain.....	33
4.1.6.0 Introduction.....	33
4.1.6.1 Attempted RAB releases for CS domain.....	33
4.1.6.2 Successful RAB releases for CS domain	33
4.1.6.3 Failed RAB releases for CS domain.....	34
4.1.6.4 Void.....	34
4.1.6.5 Void.....	34
4.1.7 RAB release request by CN for PS domain	35
4.1.7.0 Introduction.....	35
4.1.7.1 Attempted RAB releases for PS domain	35

4.1.7.2	Successful RAB releases for PS domain	35
4.1.7.3	Failed RAB releases for PS domain	36
4.1.7.4	Void.....	36
4.1.7.5	Void.....	36
4.1.8	RAB setup time.....	37
4.1.8.1	RAB CS connection set-up time (Mean).....	37
4.1.8.2	RAB CS connection set-up time (Maximum)	37
4.1.8.3	RAB PS connection set-up time (Mean)	37
4.1.8.4	RAB PS connection set-up time (Maximum).....	38
4.1.9	RAB release request by UTRAN	39
4.1.9.1	RAB release requests for CS domain	39
4.1.9.2	RAB release requests for PS domain	39
4.1.9.3	The number of RAB related to the Iu release request for CS domain	39
4.1.9.4	The number of RAB related to the Iu release request for PS domain	40
4.2	Void.....	40
4.3	Signalling connection establishment	41
4.3.1	Attempted signalling connection establishments for CS domain.....	41
4.3.2	Attempted signalling connection establishments for PS domain	41
4.4	RRC connection establishment.....	42
4.4.1	RRC connection establishments	42
4.4.1.0	Introduction	42
4.4.1.1	Attempted RRC connection establishments	42
4.4.1.2	Failed RRC connection establishments.....	42
4.4.1.3	Successful RRC connection establishments.....	43
4.4.2	RRC connection establishment setup time.....	44
4.4.2.1	RRC connection set-up time (Mean).....	44
4.4.2.2	RRC connection set-up time (Max)	44
4.4.3	RRC connection usage.....	46
4.4.3.1	General	46
4.4.3.2	RRC connection usage (Mean)	46
4.4.3.3	RRC connection usage (Maximum).....	46
4.4.3.4	RRC connection usage per UE multi-mode/multi-RAT capability.....	46
4.5	RRC connection re-establishment	48
4.5.0	Introduction.....	48
4.5.1	Attempted RRC re-establishments.....	48
4.5.2	Failed RRC re-establishments.....	48
4.5.3	Successful RRC re-establishments	49
4.6	RRC connection release	50
4.6.1	Attempted RRC connection releases on DCCH.....	50
4.6.2	Attempted RRC connection releases on CCCH.....	50
4.7	RLC connection.....	51
4.7.1	Number of RLC blocks sent (per Mode)	51
4.7.2	Number of RLC blocks Received (per Mode).....	51
4.7.3	Discarded RLC blocks by RNC.....	51
4.7.4	Number of Retransmitted RLC blocks in Acknowledge Mode	52
4.8	Soft handover	53
4.8.1	Radio link additions to active link set (UE side).....	53
4.8.1.0	Introduction.....	53
4.8.1.1	Attempted radio link additions to active link set (UE side)	53
4.8.1.2	Successful radio link additions to active link set (UE side)	53
4.8.1.3	Failed radio link additions to active link set (UE side)	53
4.8.2	Radio link deletions from active link set (UE side)	55
4.8.2.1	Attempted radio link deletions from active link set (UE side).....	55
4.8.2.2	Successful radio link deletions from active link set (UE side).....	55
4.8.3	Measurements related to the soft handover radio link	56
4.8.3.0	Introduction.....	56
4.8.3.1	Mean number of the radio link established by the best UTRAN cell.....	56
4.8.3.2	Mean number of the radio link established by other UTRAN cell.....	56
4.9	Radio link management procedures	57
4.9.1	Overview	57
4.9.1.1	Considered radio link management procedures	57
4.9.1.2	Relation between Iub measurements and Iur measurements.....	60

4.9.2	Radio link setups on Iub	61
4.9.2.0	Introduction	61
4.9.2.1	Attempted radio link setups on Iub	61
4.9.2.2	Successful radio link setups on Iub	61
4.9.2.3	Failed radio link setups on Iub	62
4.9.3	Radio link setups on Iur	63
4.9.3.0	Introduction	63
4.9.3.1	Attempted radio link setups on Iur	63
4.9.3.2	Successful radio link setups on Iur	63
4.9.3.3	Failed radio link setups on Iur	63
4.9.4	Radio link additions on Iub	65
4.9.4.0	Introduction	65
4.9.4.1	Attempted radio link additions on Iub	65
4.9.4.2	Successful radio link additions on Iub	65
4.9.4.3	Failed radio link additions on Iub	66
4.9.5	Radio link additions on Iur	67
4.9.5.0	Introduction	67
4.9.5.1	Attempted radio link additions on Iur	67
4.9.5.2	Successful radio link additions on Iur	67
4.9.5.3	Failed radio link additions on Iur	67
4.9.6	Radio link deletions on Iub	69
4.9.6.1	Attempted radio link deletions on Iub	69
4.9.6.2	Successful radio link deletions on Iub	69
4.9.7	Radio link deletions on Iur	70
4.9.7.1	Attempted radio link deletions on Iur	70
4.9.7.2	Successful radio link deletions on Iur	70
4.10	Hard handover	71
4.10.1	Void	71
4.10.2	Outgoing intra-NodeB hard handovers	71
4.10.2.0	Introduction	71
4.10.2.1	Attempted outgoing intra-NodeB hard handovers	71
4.10.2.2	Successful outgoing intra-NodeB hard handovers	71
4.10.2.3	Failed outgoing intra-NodeB hard handovers	71
4.10.3	Outgoing inter-NodeB, intra-RNC hard handovers	73
4.10.3.0	Introduction	73
4.10.3.1	Attempted outgoing inter-NodeB, intra-RNC hard handovers	73
4.10.3.2	Successful outgoing inter-NodeB, intra-RNC hard handovers	73
4.10.3.3	Failed outgoing inter-NodeB, intra-RNC hard handovers	73
4.10.4	Outgoing inter-RNC hard handovers via Iur	75
4.10.4.0	Introduction	75
4.10.4.1	Attempted outgoing inter-RNC hard handovers via Iur	75
4.10.4.2	Successful outgoing inter-RNC hard handovers via Iur	75
4.10.4.3	Failed outgoing inter-RNC hard handovers via Iur	75
4.10.5	Relocation preparation for outgoing inter-RNC hard handovers switching in the CN	77
4.10.5.0	Introduction	77
4.10.5.1	Attempted relocation preparation for outgoing inter-RNC hard handovers switching in the CN	77
4.10.5.2	Successful relocation preparation for outgoing inter-RNC hard handovers switching in the CN	77
4.10.5.3	Failed relocation preparation for outgoing inter-RNC hard handovers switching in the CN	77
4.10.6	Outgoing inter-RNC hard handovers switching in the CN	79
4.10.6.0	Introduction	79
4.10.6.1	Attempted outgoing inter-RNC hard handovers switching in the CN	79
4.10.6.2	Successful outgoing inter-RNC hard handovers switching in the CN	79
4.10.6.3	Failed outgoing inter-RNC hard handovers switching in the CN	79
4.10.7	Outgoing hard handovers per neighbour cell relation	81
4.10.7.0	Introduction	81
4.10.7.1	Attempted outgoing hard handovers per neighbour cell relation	81
4.10.7.2	Successful outgoing hard handovers per neighbour cell relation	81
4.10.7.3	Failed outgoing hard handovers per neighbour cell relation	81
4.11	Relocation	83
4.11.1	Relocations for CS domain	83
4.11.1.1	Relocation preparations with UE involved for CS domain	83
4.11.1.0	Introduction	83

4.11.1.1.1	Attempted relocation preparations with UE involved for CS domain	83
4.11.1.1.2	Successful relocation preparations with UE involved for CS domain	83
4.11.1.1.3	Failed relocation preparations with UE involved for CS domain	83
4.11.1.2	Relocation preparations with UE not involved for CS domain	84
4.11.1.2.0	Introduction	84
4.11.1.2.1	Attempted relocation preparations with UE not involved for CS domain	84
4.11.1.2.2	Successful relocation preparations with UE not involved for CS domain	84
4.11.1.2.3	Failed relocation preparations with UE not involved for CS domain	85
4.11.1.3	Relocation resource allocations with UE involved for CS domain	85
4.11.1.3.0	Introduction	85
4.11.1.3.1	Attempted relocations resource allocations with UE involved for CS domain	85
4.11.1.3.2	Successful relocation resource allocations with UE involved for CS domain	86
4.11.1.3.3	Failed relocation resource allocations with UE involved for CS domain	86
4.11.1.4	Relocation resource allocations with UE not involved for CS domain	86
4.11.1.4.0	Introduction	86
4.11.1.4.1	Attempted relocations resource allocations with UE not involved for CS domain	86
4.11.1.4.2	Successful relocation resource allocations with UE not involved for CS domain	87
4.11.1.4.3	Failed relocation resource allocations with UE not involved for CS domain	87
4.11.1.5	Relocations for CS domain	88
4.11.1.5.1	Successful relocations for CS domain	88
4.11.2	Relocations for PS domain	89
4.11.2.1	Relocation preparations with UE involved for PS domain	89
4.11.2.1.0	Introduction	89
4.11.2.1.1	Attempted relocation preparations with UE involved for PS domain	89
4.11.2.1.2	Successful relocation preparations with UE involved for PS domain	89
4.11.2.1.3	Failed relocation preparations with UE involved for PS domain	89
4.11.2.2	Relocation preparations with UE not involved for PS domain	90
4.11.2.2.0	Introduction	90
4.11.2.2.1	Attempted relocation preparations with UE not involved for PS domain	90
4.11.2.2.2	Successful relocation preparations with UE not involved for PS domain	90
4.11.2.2.3	Failed relocation preparations with UE not involved for PS domain	91
4.11.2.3	Relocation resource allocations with UE involved for PS domain	91
4.11.2.3.0	Introduction	91
4.11.2.3.1	Attempted relocations resource allocations with UE involved for PS domain	91
4.11.2.3.2	Successful relocation resource allocations with UE involved for PS domain	92
4.11.2.3.3	Failed relocation resource allocations with UE involved for PS domain	92
4.11.2.4	Relocation resource allocations with UE not involved for PS domain	92
4.11.2.4.0	Introduction	92
4.11.2.4.1	Attempted relocations resource allocations with UE not involved for PS domain	92
4.11.2.4.2	Successful relocation resource allocations with UE not involved for PS domain	93
4.11.2.4.3	Failed relocation resource allocations with UE not involved for PS domain	93
4.11.2.5	Relocations for PS domain	94
4.11.2.5.1	Successful relocations for PS domain	94
4.12	Circuit switched inter-RAT handover	94
4.12.1	Relocation preparation for outgoing circuit switched inter-RAT handovers	94
4.12.1.0	Introduction	94
4.12.1.1	Attempted relocation preparation for outgoing circuit switched inter-RAT handovers	94
4.12.1.2	Successful relocation preparation for outgoing circuit switched inter-RAT handovers	94
4.12.1.3	Failed relocation preparation for outgoing circuit switched inter-RAT handovers	95
4.12.2	Outgoing circuit switched inter-RAT handovers	96
4.12.2.0	Introduction	96
4.12.2.1	Attempted outgoing circuit switched inter-RAT handovers	96
4.12.2.2	Successful outgoing circuit switched inter-RAT handovers	96
4.12.2.3	Failed outgoing circuit switched inter-RAT handovers	96
4.12.3	Incoming circuit switched inter-RAT handovers	97
4.12.3.0	Introduction	97
4.12.3.1	Attempted incoming circuit switched inter-RAT handovers	97
4.12.3.2	Successful incoming circuit switched inter-RAT handovers	97
4.12.3.3	Failed incoming circuit switched inter-RAT handovers	97
4.13	Packet switched inter-RAT handover	99
4.13.1	Outgoing packet switched inter-RAT handovers, UTRAN controlled	99
4.13.1.0	Introduction	99

4.13.1.1	Attempted outgoing packet switched inter-RAT handovers, UTRAN controlled.....	99
4.13.1.2	Successful outgoing packet switched inter-RAT handovers, UTRAN controlled	99
4.13.1.3	Failed outgoing packet switched inter-RAT handovers UTRAN controlled	99
4.13.2	Outgoing packet switched inter-RAT handovers, UE controlled.....	100
4.13.2.1	Successful outgoing packet switched inter-RAT handovers, UE controlled.....	100
4.14	Iu connection release	101
4.14.1	Overview	101
4.14.1.1	Considered Iu connection release procedures	101
4.14.2	Iu connection release request by UTRAN	102
4.14.2.1	Attempted Iu connection release request by UTRAN for CS domain.....	102
4.14.2.2	Attempted Iu connection release request by UTRAN for PS domain.....	102
4.14.3	Iu connection release by CN	103
4.14.3.1	Attempted Iu connection release by CN for CS domain	103
4.14.3.2	Attempted Iu connection release by CN for PS domain.....	103
4.14.3.3	Successful Iu connection release by CN for CS domain.....	103
4.14.3.4	Successful Iu connection release by CN for PS domain	104
4.15	Intra-cell DCA.....	105
4.15.0	Introduction.....	105
4.15.1	Attempted intra-cell DCA.....	105
4.15.2	Successful intra-cell DCA	105
4.15.3	Failed intra-cell DCA.....	106
4.16	TDD Code Resources.....	107
4.16.1	UTRAN Cell Max Downlink Code Resources Used.....	107
4.16.2	UTRAN Cell Max Uplink Code Resources Used.....	107
4.16.3	Mean Downlink Code Resources Used of an UTRAN Cell	108
4.16.4	Mean Uplink Code Resources Used of an UTRAN Cell.....	108
4.17	Measurements related to TDD UTRAN cell Radio Frequency Carrier.....	109
4.17.1	Mean Transmitted Carrier Power of an UTRAN Cell	109
4.17.2	Maximum Transmitted Carrier Power of an UTRAN Cell.....	109
4.17.3	Mean Received Total Wideband Power of an UTRAN Cell	109
4.17.4	The Maximum Received Total Wideband Power of an UTRAN Cell.....	110
4.17.5	Mean DPCH Transmitted Code Power of an UTRAN Cell.....	110
4.17.6	Maximum DPCH Transmitted Code Power of an UTRAN Cell.....	111
4.17.7	Mean DPCH Received Signal Code Power of an UTRAN Cell.....	111
4.17.8	Maximum DPCH Received Signal Code Power of an UTRAN Cell	111
4.17.9	Mean Interference Signal Code Power of an UTRAN Cell	112
4.17.10	Maximum Interference Signal Code Power of an UTRAN Cell.....	113
4.17.11	Mean transmitted carrier power of all codes not used for HS-PDSCH , HS-SCCH, E-AGCH or E-HICH transmission	113
4.17.12	Maximum transmitted carrier power of all codes not used for HS-PDSCH , HS-SCCH, E-AGCH or E-HICH transmission.....	113
4.18	Measurements related to the UTRAN cell FDD carrier (RF Performance metrics).....	115
4.18.0	Introduction.....	115
4.18.1	Mean Transmitted Carrier Power of an UTRAN Cell	115
4.18.2	Maximum Transmitted Carrier Power of an UTRAN Cell.....	115
4.18.3	Mean Received Total Wideband Power of an UTRAN Cell	116
4.18.4	Maximum Received Total Wideband Power of an UTRAN Cell.....	116
4.18.5	Mean Radio Link Transmitted Code Power of an UTRAN Cell	116
4.18.6	Maximum Radio Link Transmitted Code Power of an UTRAN Cell.....	117
4.18.7	Mean transmitted carrier power of all codes not used for HS-PDSCH, HS-SCCH, E-AGCH, E-RGCH or E-HICH transmission of an UTRAN Cell.....	117
4.18.8	Maximum transmitted carrier power of all codes not used for HS-PDSCH, HS-SCCH, E-AGCH, E-RGCH or E-HICH transmission of an UTRAN Cell.....	118
4.19	FDD Code Resources	119
4.19.1	Code Resources Used of an FDD mode UTRAN Cell	119
4.20	Paging.....	120
4.20.1	Overview	120
4.20.1.0	Introduction.....	120
4.20.1.1	Considered Paging procedures	120
4.20.2	Paging request from CN	121
4.20.3	Paging Type 1	121
4.20.3.1	Attempted Paging Type 1.....	121

4.20.4	Paging Type 2	122
4.20.4.1	Attempted Paging Type 2.....	122
4.21	ATM layer measurement.....	123
4.21.1	Cell collection.....	123
4.21.1.1	Ingress cells (whole stream).....	123
4.21.1.2	Egress cells (whole stream).....	123
4.22	HSDPA setup	124
4.22.1	Mac-d setup for HSDPA.....	124
4.22.1.0	Introduction.....	124
4.22.1.1	Attempted Mac-d setups for HSDPA.....	124
4.22.1.2	Successful Mac-d setups for HSDPA.....	124
4.22.1.3	Failed Mac-d setups for HSDPA.....	125
4.22.2	RB setup for HSDPA.....	126
4.22.2.0	Introduction.....	126
4.22.2.1	Attempted RB setups for HSDPA.....	126
4.22.2.2	Successful RB setups for HSDPA.....	126
4.22.2.3	Failed RB setups for HSDPA.....	126
4.23	Call duration in UTRAN cell	128
4.23.1	Call duration in UTRAN cell for CS domain	128
4.24	Measurements related to channel switches between FACH/DCH and HS-DSCH.....	129
4.24.1	Measurements related to channel switches from FACH/DCH to HS-DSCH intra UTRAN cell.....	129
4.24.1.1	Attempted channel switches from FACH to HS-DSCH	129
4.24.1.2	Successful channel switches from FACH to HS-DSCH	129
4.24.1.3	Attempted channel switches from DCH to HS-DSCH.....	129
4.24.1.4	Successful channel switches from DCH to HS-DSCH	130
4.24.2	Measurements related to channel switches from HS-DSCH to FACH/DCH intra UTRAN cell.....	131
4.24.2.1	Attempted channel switches from HS-DSCH to FACH	131
4.24.2.2	Successful channel switches from HS-DSCH to FACH.....	131
4.24.2.3	Attempted channel switches from HS-DSCH to DCH.....	131
4.24.2.4	Successful channel switches from HS-DSCH to DCH	132
4.25	HSDPA mobility related measurements.....	133
4.25.1	Serving HS-DSCH cell change.....	133
4.25.1.1	Attempted serving HS-DSCH cell changes.....	133
4.25.1.2	Successful serving HS-DSCH cell changes	133
4.26	Measurements related to MAC-hs.....	134
4.26.1	Measurements related to MAC-hs feedback decoding	134
4.26.1.1	Number of acknowledged transmitted MAC-hs PDUs	134
4.26.1.2	Number of transmitted MAC-hs PDUs.....	134
4.27	Mean number of HSDPA users in a serving HS-DSCH cell.....	135
4.28	Number of octets of acknowledged MAC-hs PDUs.....	135
4.29	Number of TTIs with user data packets in buffer.....	135
4.30	HSDPA Release measurements.....	136
4.30.1	Overview of HSDPA Release	136
4.30.1.1	General	136
4.30.1.2	Considered RRC procedures	136
4.30.1.3	Considered RANAP protocol procedures	139
4.30.2	Normal HSDPA Release.....	140
4.30.2.1	RNC Initiated Release due to user inactivity	140
4.30.2.2	Switch to DCH/FACH	140
4.30.2.3	HS-DSCH serving cell change.....	140
4.30.2.4	CN Initiated release.....	140
4.30.3	Abnormal RB releases for HS-DSCH.....	141
4.31	RRC Connection mobility	142
4.31.1	Cell update	142
4.31.1.1	Attempted cell update	142
4.32	Measurements related to received uplink transport block	143
4.32.1	Measurements related to received uplink transport block for CS domain	143
4.32.1.1	Number of received uplink transport blocks of DCH for CS domain	143
4.32.1.2	Number of received uplink faulty transport blocks of DCH for CS domain.....	143
4.32.2	Measurements related to received uplink transport block for PS domain.....	145
4.32.2.1	Number of received uplink transport blocks of DCH for PS domain.....	145
4.32.2.2	Number of received uplink faulty transport blocks of DCH for PS domain	145

4.33	Measurements related to equipment resources	147
4.33.1	RNC Processor usage.....	147
4.33.1.1	Mean processor usage	147
4.33.1.2	Peak processor usage.....	147
4.34	HSUPA related measurements	148
4.34.1	HSUPA setup.....	151
4.34.1.1	Mac-d setup for HSUPA	151
4.34.1.1.0	Introduction	151
4.34.1.1.1	Attempted Mac-d setups for HSUPA	151
4.34.1.1.2	Successful Mac-d setups for HSUPA	151
4.34.1.1.3	Failed Mac-d setups for HSUPA	152
4.34.1.2	RB setup for HSUPA	154
4.34.1.2.0	Introduction	154
4.34.1.2.1	Attempted RB setups for HSUPA	154
4.34.1.2.2	Successful RB setups for HSUPA	154
4.34.1.2.3	Failed RB setups for HSUPA	155
4.34.2	Active set related to HSUPA	156
4.34.2.1	Radio link additions to the E-DCH active set (UE side)	156
4.34.2.1.0	Introduction	156
4.34.2.1.1	Attempted radio link additions to the E-DCH active set (UE side).....	156
4.34.2.1.2	Successful radio link additions to the E-DCH active set (UE side).....	156
4.34.2.1.3	Failed radio link additions to the E-DCH active set (UE side).....	157
4.34.2.2	Radio link deletions to the E-DCH active set (UE side)	157
4.34.2.2.1	Attempted radio link deletions to the E-DCH active set (UE side)	157
4.34.2.2.2	Successful radio link deletions to the E-DCH active set (UE side).....	158
4.34.3	Serving E-DCH cell change.....	159
4.34.3.1	Outgoing serving E-DCH cell change.....	159
4.34.3.1.1	Attempted outgoing serving E-DCH cell change	159
4.34.3.1.2	Successful outgoing serving E-DCH cell change	159
4.34.3.2	Outgoing serving E-DCH cell change per neighbour cell relation.....	159
4.34.3.2.1	Attempted outgoing serving E-DCH cell change per neighbour cell relation	159
4.34.3.2.2	Successful outgoing serving E-DCH cell change per neighbour cell relation	160
4.34.4	Mean number of HSUPA users of a serving E-DCH cell	161
4.34.5	Measurements related to channel switches between RACH/DCH and E-DCH.....	162
4.34.5.1	Measurements related to channel switches from RACH/DCH to E-DCH	162
4.34.5.1.1	Attempted channel switches from RACH to E-DCH	162
4.34.5.1.2	Successful channel switches from RACH to E-DCH	162
4.34.5.1.3	Attempted channel switches from DCH to E-DCH.....	163
4.34.5.1.4	Successful channel switches from DCH to E-DCH.....	163
4.34.5.2	Measurements related to channel switches from E-DCH to RACH/DCH	163
4.34.5.2.1	Attempted channel switches from E-DCH to RACH	163
4.34.5.2.2	Successful channel switches from E-DCH to RACH.....	164
4.34.5.2.3	Attempted channel switches from E-DCH to DCH.....	164
4.34.5.2.4	Successful channel switches from E-DCH to DCH.....	165
4.34.6	Measurements related to MAC-e feedback decoding	166
4.34.6.1	Number of received MAC-e PDUs	166
4.34.6.2	Number of received acknowledged MAC-e PDUs	166
4.34.7	Number of octets of acknowledged MAC-e PDUs.....	167
4.34.8	HSUPA Release measurements	168
4.34.8.1	Normal HSUPA Release	168
4.34.8.1.1	RNC initiated release due to user inactivity	168
4.34.8.1.2	RNC initiated release due to switch to DCH/RACH.....	168
4.34.8.1.3	RNC initiated release due to serving E-DCH cell change	168
4.34.8.1.4	CN initiated release	168
4.34.8.2	Abnormal RB releases for E-DCH.....	169
4.35	Radio resource utilization related measurements	169
4.35.1	UTRAN Cell Unavailable Time.....	169
4.36	MBMS related measurements	169
4.36.1	Number of octets of MBMS data on MAC layer.....	169
4.36.2	Session related measurements.....	170
4.36.2.1	Attempted MBMS session start.....	170
4.36.2.2	Successful MBMS session start	170

4.36.2.3	Attempted MBMS session stop.....	171
4.36.2.4	Successful MBMS session stop.....	171
4.37	Dual-Cell HSDPA related measurements.....	171
4.37.1	Dual-Cell HSDPA Scheduling duration in UTRAN cell.....	171
4.37.2	Individual cell HSDPA Scheduling duration in UTRAN cell.....	172
4.37.3	Attempted Dual-Cell HSDPA establishments	172
4.37.4	Successful Dual-Cell HSDPA establishments	172
4.37.5	Failed Dual-Cell HSDPA establishments	173
4.38	Measurement report related measurements	174
4.38.1	P-CCPCH RSCP.....	174
4.38.2	UTRAN RSCP	174
4.38.3	UE timing advance.....	175
4.38.4	UTRAN AOA value	175
4.38.5	UE timeslot ISCP.....	176
4.38.6	UTRAN timeslot ISCP	176
4.38.7	UE transmitted power	177
4.38.8	UpPTS interference.....	177
4.38.9	UTRAN SIR	178
4.38.10	UE SIR.....	178
4.38.11	SIR Target.....	179
4.38.12	Uplink Bit Error Rate for AMR 12.2K	179
4.38.13	Uplink Bit Error Rate for CS 64K	180
4.38.14	Uplink Bit Error Rate for PS.....	181
4.38.15	Downlink BLER for AMR 12.2K.....	182
4.38.16	Downlink BLER for CS 64K.....	183
4.38.17	Downlink BLER for PS	184
4.39	HSPA evolution scheduling related measurements.....	186
4.39.1	Number of 64QAM scheduled TTIs in UTRAN cell.....	186
4.39.2	Number of MIMO scheduled TTIs in UTRAN cell.....	186
4.39.3	Number of total modulation mode scheduled TTIs in UTRAN cell.....	186
4.40	Iur-g related measurements.....	186
4.40.1	Attempted relocation resource reservation for inter-RAT handovers with Iur-g interface	187
4.40.2	Successful relocation resource reservation for inter-RAT handovers with Iur-g interface	188
4.40.3	Attempted outgoing preparation inter-RAT handovers with Iur-g interface (UMTS->GSM).....	188
4.40.4	Successful outgoing preparation inter-RAT handovers with Iur-g interface (UMTS->GSM)	188
4.40.5	Attempted outgoing inter-RAT handovers with Iur-g interface (UMTS->GSM).....	189
4.40.6	Successful outgoing inter-RAT handovers with Iur-g interface (UMTS->GSM).....	189
5	Measurements related to the NodeB and RNC.....	189
5.1	Power, Energy and Environmental (PEE) measurements	189
5.1.1	Power	190
5.1.1.1	Average Power	190
5.1.1.2	Minimum Power	190
5.1.1.3	Maximum Power.....	190
5.1.2	Energy.....	190
5.1.3	Temperature.....	191
5.1.3.1	Average Temperature.....	191
5.1.3.2	Minimum Temperature	191
5.1.3.3	Maximum Temperature.....	191
5.1.4	Voltage.....	192
5.1.5	Current	192
5.1.6	Humidity.....	192
Annex A (informative):	Use cases for measurement report related measurements.....	193
A.1	Use case of P-CCPCH RSCP	193
A.2	Use case of UTRAN RSCP	193
A.3	Use case of UE timing advance.....	193
A.4	Use case of UTRAN AOA value	194
A.5	Use case of UE timeslot ISCP.....	194

A.6	Use case of UTRAN timeslot ISCP	194
A.7	Use case of UE transmitted power	194
A.8	Use case of UpPTS interference.....	194
A.9	Use case of SIR	195
A.10	Use case of Bit Error Rate and BLER.....	195
A.11	Monitoring of Energy Saving.....	195
Annex B (informative): Use cases for performance measurements defintion.....		196
B.0	Introduction	196
B.1	HSPA evolution related performance.....	196
B.2	RAB establishment related performance.....	196
B.3	Iurg related measurements.....	196
B.4	RRC connection usage per UE multi-mode/multi-RAT capability related measurement.....	196
B.5	Monitoring of Power, Energy and Environmental (PEE) parameters	197
Annex C (informative): Change history		198
History		201

Foreword

This Technical Specification has been produced by the 3rd Generation Partnership Project (3GPP).

The contents of the present document are subject to continuing work within the TSG and may change following formal TSG approval. Should the TSG modify the contents of the present document, it will be re-released by the TSG with an identifying change of release date and an increase in version number as follows:

Version x.y.z

where:

- x the first digit:
 - 1 presented to TSG for information;
 - 2 presented to TSG for approval;
 - 3 or greater indicates TSG approved document under change control.
- y the second digit is incremented for all changes of substance, i.e. technical enhancements, corrections, updates, etc.
- z the third digit is incremented when editorial only changes have been incorporated in the document.

Introduction

The present document is part of a TS-family covering the 3rd Generation Partnership Project; Technical Specification Group Services and System Aspects; Telecommunication management; as identified below:

32.401 Performance Management (PM); Concept and requirements

52.402 Performance Management (PM); Performance measurements – GSM

32.404 Performance Management (PM); Performance measurements - Definitions and template

32.405 Performance Management (PM); Performance measurements Universal Terrestrial Radio Access Network (UTRAN)

32.406 Performance Management (PM); Performance measurements Core Network (CN) Packet Switched (PS) domain

32.407 Performance Management (PM); Performance measurements Core Network (CN) Circuit Switched (CS) domain

32.408 Performance Management (PM); Performance measurements Teleservice

32.409 Performance Management (PM); Performance measurements IP Multimedia Subsystem (IMS)

The present document is part of a set of specifications, which describe the requirements and information model necessary for the standardised Operation, Administration and Maintenance (OA&M) of a multi-vendor UTRAN-system.

During the lifetime of an UTRAN network, its logical and physical configuration will undergo changes of varying degrees and frequencies in order to optimise the utilisation of the network resources. These changes will be executed through network configuration management activities and/or network engineering, see TS 32.600 [3].

Many of the activities involved in the daily operation and future network planning of a UTRAN network require data on which to base decisions. This data refers to the load carried by the network and the grade of service offered. In order to produce this data performance measurements are executed in the NEs, which comprise the network. The data can then be transferred to an external system, e.g. an Operations System (OS) in TMN terminology, for further evaluation. The purpose of the present document is to describe the mechanisms involved in the collection of the data and the definition of the data itself.

Annex B of TS 32.404 helps in the definition of new performance measurements that can be submitted to 3GPP for potential adoption and inclusion in the present document. Annex B of TS 32.404 discusses a top-down performance measurement definition methodology that focuses on how the end-user of performance measurements can use the measurements.

1 Scope

The present document describes the measurements for Universal Terrestrial Radio Access Network (UTRAN). TS 32.401 [1] describes Performance Management concepts and requirements.

The present document is valid for all measurement types provided by an implementation of a UTRAN. Only measurement types that are specific to UTRAN are defined within the present documents.

Vendor specific measurement types used in UTRAN are not covered. Instead, these could be applied according to manufacturer's documentation.

Measurements related to "external" technologies (such as ATM or IP) as described by "external" standards bodies (e.g. ITU-T or IETF) shall only be referenced within this specification, wherever there is a need identified for the existence of such a reference.

The definition of the standard measurements is intended to result in comparability of measurement data produced in a multi-vendor network, for those measurement types that can be standardised across all vendors' implementations.

The structure of the present document is as follows:

- Header 1: Network Element (e.g. RNC related measurements);
- Header 2: Measurement function (e.g. soft handover measurements);
- Header 3: Measurements.

2 References

- The following documents contain provisions which, through reference in this text, constitute provisions of the present document.

- References are either specific (identified by date of publication and/or edition number or version number) or non-specific.
- For a specific reference, subsequent revisions do not apply.
- For a non-specific reference, the latest version applies. In the case of a reference to a 3GPP document (including a GSM document), a non-specific reference implicitly refers to the latest version of that document *in the same Release as the present document*.

- [1] 3GPP TS 32.401: "Telecommunication management; Performance Management (PM); Concept and requirements".
- [2] 3GPP TS 23.107: "Quality of Service (QoS) concept and architecture".
- [3] 3GPP TS 32.600: "Telecommunication management; Configuration Management (CM); Concept and high-level requirements".
- [4] 3GPP TS 25.331: "Radio Resource Control (RRC) protocol specification".
- [5] 3GPP TS 25.413: "UTRAN Iu Interface RANAP signalling".
- [6] 3GPP TS 25.423: "UTRAN Iur Interface RNSAP signalling".
- [7] 3GPP TS 25.433: "UTRAN Iub Interface NBAP signalling".
- [8] 3GPP TS 25.133: "Requirements for support of radio resource management (FDD)".
- [9] 3GPP TS 25.123: "Requirements for support of radio resource management (TDD)".
- [10] 3GPP TS 25.322: "Radio Link Control (RLC) protocol specification".
- [11] af-nm-0185.000, "M4 Interface ATM Network View CORBA MIB".
- [12] 3GPP TS 32.432: "Telecommunication management; Performance measurement: File format definition".

- [13] 3GPP TS 25.993: "Typical examples of Radio Access Bearers (RABs) and Radio Bearers (RBs) supported by Universal Terrestrial Radio Access (UTRA)".
- [14] 3GPP TS 25.215: "Physical layer – Measurements (FDD)".
- [15] 3GPP TS 32.432: "Telecommunication management; Performance measurement: File format definition".
- [16] 3GPP TS 25.225: "Physical layer – Measurements (TDD)".
- [17] 3GPP TS 25.427: "UTRAN Iub/Iur interface user plane protocol for DCH data streams".
- [18] 3GPP TS 32.410: "Key Performance Indicators (KPI) for UMTS and GSM".
- [19] 3GPP TS 25.308: "High Speed Downlink Packet Access (HSDPA): Overall Description; Stage 2".
- [20] 3GPP TS 43.130: "Technical Specification Group GSM/EDGE Radio Access Network; Iur-g interface; Stage 2".
- [21] ES 203 228 V1.0.0: "Environmental Engineering (EE); Assessment of mobile network energy efficiency".
- [22] ETSI ES 202 336-12 V1.1.1: "Environmental Engineering (EE); Monitoring and control interface for infrastructure equipment (power, cooling and building environment systems used in telecommunication networks); Part 12: ICT equipment power, energy and environmental parameters monitoring information model".

3 Measurement family and abbreviations

3.1 Measurement family

The measurement names defined in the present document are all beginning with a prefix containing the measurement family name (e.g. RAB.AttEstabCS.Conv). This family name identifies all measurements which relate to a given functionality and it may be used for measurement administration (see TS 32.401 [1]).

The list of families currently used in the present document is as follows:

- ATML (measurements related to ATM Layer).
- CARR (measurements related to UTRAN cell Radio Frequency carrier).
- CR (measurements related to Code Resources).
- DCA (measurements related to Dynamic Channel Allocation).
- EQPT (measurements related to Equipment).
- FP (measurements related to Frame Protocol).
- HHO (measurements related to Hard Handover).
- HSDPA (measurements related to High Speed Downlink Packet Access).
- HSUPA (measurements related to High Speed Uplink Packet Access).
- HSPA-E (measurements related to High Speed Packet Access Evolution).
- IRATHO (measurements related to inter-Radio Access Technology Handover).
- IU (measurements related to Iu connection).
- MBMS (measurements related to Multimedia Broadcast Multicast Service).

- MR (measurements related to Measurement Report).
- PEE (measurements related to Power, Energy and Environmental parameters).
- RAB (measurements related to Radio Access Bearer management).
- RELOC (measurements related to SRNS Relocation).
- RLC (measurements related to Radio Link Control).
- RLM (measurements related to Radio Link Management).
- RRC (measurements related to Radio Resource Control).
- RRU (measurements related to Radio Resource Usage).
- SHO (measurements related to Soft Handover).
- SIG (measurements related to Signalling).
- TCR (measurements related to TDD Code Resources).

3.2 Abbreviations

For the purposes of the present document, the following abbreviations apply:

AOA	Angle Of Arrival
ASN.1	Abstract Syntax Notation 1
BER	Basic Encoding Rules
BLER	Block Error Rate
CN	Core Network
DTD	Document Type Definition
EE	Energy Efficiency
EGQM	Enhanced Goal, Question, Metric
EM	(Network) Element Manager
GQM	Goal, Question, Metric
HSDPA	High Speed Downlink Packet Access
HSUPA	High Speed Uplink Packet Access
Itf	Interface
ISCP	Interference Signal Code Power
MSC	Mobile services Switching Centre
NE	Network Element
NM	Network Manager
OA&M	Operation, Administration and Maintenance
OS	Operations System (EM, NM)
OSI	Open Systems Interconnection
P-CCPCH	Primary Common Control Physical Channel
PEE	Power, Energy and Environmental
PM	Performance Management
QoS	Quality of Service
RNC	Radio Network Controller
RSCP	Received Signal Code Power
SIR	Signal to Interference Ratio
UMTS	Universal Mobile Telecommunications System
UTRAN	Universal Terrestrial Radio Access Network

You can find below a list of abbreviations used within the measurement types for field E of the measurement template.

Ackd	Acknowledged
Assn	Assign(ment,ed)
Att	Attempt(s,ed)
Bgrd	Background
Call	Call
Chg	Change

Conn	Connection
Combi	Combined
CS	Circuit switched
Ctrl	Controlled
Conv	Conversational
Del	Deletion
Drop	Drop(ped)
Estab	Establish (ed,ment)
Fail	Fail(ed, ure)
FDD	Frequency Division Duplex
FP	Frame Protocol
HHO	Hard Handover
HO	Handover
Inc	Incoming
Intact	Interactive
Inter	Inter
Intra	Intra
Invol	Involve(d)
ISCP	Interference Signal Code Power
Max	Maximum
Nat	National
Netw	Network
NodeB	NodeB
Oct	Octet(s)
Oth	Other
Out	Outgoing
Pkt	Packet(s)
Prep	Preparation
Proc	Procedure
PS	Packet switched
RAB	Radio Access Bearer
RAT	Radio Access Technology
RB	Radio Bearer
ReEstab	Re-establish (ed,ment)
Rel	Released
Reloc	Relocation
Req	Request(s,ed)
Res	Resource
RL	Radio Link
RNC	RNC
RRC	Radio Resource Control
RTWP	Received Total Wideband Power
Setup	Setup
SGSN	SGSN
SHO	Soft Handover
Sig	Signalling
Strm	Streaming
Sub	Subscriber
Succ	Success(es,ful)
TCP	Transmitted Carrier Power
UE	User Equipment
UTRAN	UTRAN

4 Measurements related to the RNC

4.1 RAB management

4.1.1 Overview

4.1.1.1 Measurements are based on the success and failure of procedures

The proposed measurements are not merely based on the counting of a given type of message since a same message may be repeated by an implementation dependent process. The aim here is to provide implementation independent specification.

Proposed measurements are based on the success/failure of procedures identified in the reference documents. The end of a procedure implies a stable state of the communication between the two involved parties. This stable state is normally the object of a common understanding from the two parties. As a consequence, proposed measurements are attached either to the successful or the unsuccessful issue of a procedure.

4.1.1.2 Combination of Traffic Class and Core Network domains

A Radio Access Bearer (RAB) is characterized by several QOS parameters among them is the Traffic Class. Currently there are not any 3GPP specifications including TS 23.107 [2] in which may be found restrictions related to the possible combinations between Traffic Class and Core Network domain.

Consequently, as a conservative position, this specification should leave open every possible combination between Traffic Class and Core Network domain as specification TS 23.107 [2] does.

4.1.1.3 Considered Radio Access Bearer management procedures

Performance Measurement definitions in this subclause are based on TS 25.413 [5].

The following paragraphs are of interest for this purpose:

- RAB Assignment;
- RAB Release Request;
- RAB ASSIGNMENT REQUEST;
- RAB ASSIGNMENT RESPONSE;
- RAB RELEASE REQUEST.

These paragraphs show in particular the following diagrams.

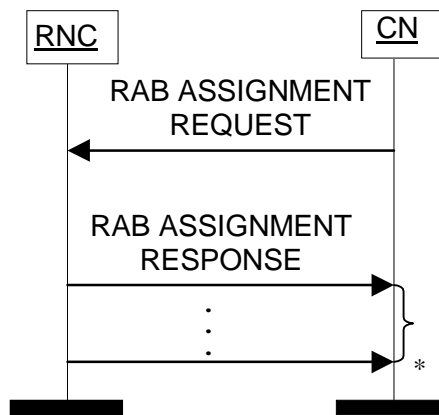

* it can be several responses

Figure: RAB Assignment procedure. Successful operation

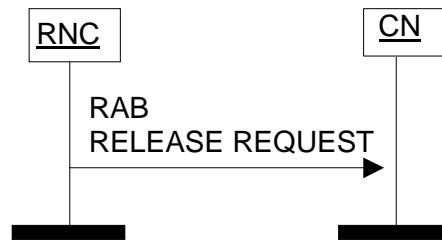

Figure: RAB Release Request procedure

4.1.1.4 Measurements relate to RAB establishment, modification and release

RAB management procedure includes RAB Assignment procedure and RAB Release Request procedure. The purpose of RAB Assignment procedure is to establish new RABs and/or to enable modifications and/or releases of already established RABs for a given UE. If RABs are failed to be established or modified, the involved services may fail. RAB release request can be initiated by CN or RNC when the services terminate normally or abnormally.

During daily maintenance of network, measurements regarding RAB establishment, modification and release are useful for operators to evaluate RAB management procedures, to analyze failure reasons of RAB establishment and RAB modification, and to analyze the causes of RAB release, especially in case RAB release abnormally.

4.1.2 RAB establishment for CS domain

4.1.2.0 Introduction

The five measurement types defined in the clause 4.1.2 for CS domain are subject to the "4 out of 5 approach".

4.1.2.1 Attempted RAB establishments for CS domain

- a) This measurement provides the number of requested RAB in establishment attempts for CS domain. The measurement is split into subcounters per traffic class.
- b) CC
- c) On receipt by the RNC of a RANAP RAB ASSIGNMENT REQUEST message for CS domain, each requested RAB in establishment attempts is added to the relevant measurement according to the traffic class requested. See TS 25.413 [5] and TS 23.107 [2]. For conversational service, the relevant measurement according to the data rates requested, see TS 25.993 [13] as follows:

uplink<U>:

- 1: AMR rate (12.2 10.2 7.95 7.4 6.7 5.9 5.15 4.75) kbps
- 2: 12.2 kbps
- 3: 28.8 kbps
- 4: 32 kbps
- 5: 64 kbps
- 6: AMR -WB-rate (12.65, 8.8, 6.65) kbps

downlink<D>:

- 1: AMR rate (12.2 10.2 7.95 7.4 6.7 5.9 5.15 4.75) kbps
- 2: 12.2 kbps
- 3: 28.8 kbps
- 4: 32 kbps
- 5: 64 kbps
- 6: AMR -WB-rate (12.65, 8.8, 6.65) kbps

As indicated above, <U> and <D> are integer values that map to the conversational service specified uplink and downlink data rates respectively.

NOTE : The addition is performed with the condition that the RAB has not been setup or modified successfully in a previous RANAP RAB ASSIGNMENT RESPONSE or RELOCATION REQUEST ACKNOWLEDGE.

- d) Each measurement is an integer value.
- e) RAB.AttEstabCS.Conv.<U><D>
RAB.AttEstabCS.Strm
RAB.AttEstabCS.Intact
RAB.AttEstabCS.Bgrd
- f) RncFunction
- g) Valid for circuit switched traffic
- h) UMTS
- i) One usage of this measurement is to support the coverage ratio (CR) calculation for EE coverage area determination in [21].

4.1.2.2 Successful RAB establishments without queuing for CS domain

- a) This measurement provides the number of successfully established RABs for CS domain in which a queuing process has not been involved. The measurement is split into subcounters per traffic class.
- b) CC
- c) On transmission by the RNC of a RANAP RAB ASSIGNMENT RESPONSE message for CS domain, each successfully established RAB is added to the relevant measurement according to the traffic class requested in the

RAB ASSIGNMENT REQUEST message. See TS 25.413 [5] and TS 23.107 [2]. For conversational service, the relevant measurement according to the data rates requested, see TS 25.993 [13] as follows:

uplink<U>:

- 1: AMR rate (12.2 10.2 7.95 7.4 6.7 5.9 5.15 4.75) kbps
- 2: 12.2 kbps
- 3: 28.8 kbps
- 4: 32 kbps
- 5: 64 kbps
- 6: AMR -WB-rate (12.65, 8.8, 6.65) kbps

downlink<D>:

- 1: AMR rate (12.2 10.2 7.95 7.4 6.7 5.9 5.15 4.75) kbps
- 2: 12.2 kbps
- 3: 28.8 kbps
- 4: 32 kbps
- 5: 64 kbps
- 6: AMR -WB-rate (12.65, 8.8, 6.65) kbps

As indicated above, <U> and <D> are integer values that map to the conversational service specified uplink and downlink data rates respectively.

NOTE: The addition is performed with the condition that the RAB has not been mentioned as queued in a previous RANAP RAB ASSIGNMENT RESPONSE and the RAB has not been setup or modified successfully in a previous RANAP RAB ASSIGNMENT RESPONSE or RELOCATION REQUEST ACKNOWLEDGE.

- d) Each measurement is an integer value.
- e) RAB.SuccEstabCSNoQueuing.Conv.<U><D>
RAB.SuccEstabCSNoQueuing.Strm
RAB.SuccEstabCSNoQueuing.Intact
RAB.SuccEstabCSNoQueuing.Bgrd.
- f) RncFunction.
- g) Valid for circuit switched traffic.
- h) UMTS.
- i) One usage of this measurement is to support the coverage ratio (CR) calculation for EE coverage area determination in [21].

4.1.2.3 Failed RAB establishments without queuing for CS domain

- a) This measurement provides the number of RABs failed to establish for CS domain in which a queuing process has not been involved. The measurement is split into subcounters per failure cause.
- b) CC
- c) On transmission by the RNC of a RANAP RAB ASSIGNMENT RESPONSE message for CS domain, each RAB failed to establish is added to the relevant measurement according to the failure cause. Possible causes are included in TS 25.413 [5]. The sum of all supported per cause measurements shall equal the total number of RAB Establishment Failures. In case only a subset of per cause measurements is supported, a sum subcounter will be provided first.

NOTE: The addition is performed with the condition that the RAB has not been mentioned as queued in a previous RANAP RAB ASSIGNMENT RESPONSE and the RAB has not been setup or modified successfully in a previous RANAP RAB ASSIGNMENT RESPONSE or RELOCATION REQUEST ACKNOWLEDGE.

- d) Each measurement is an integer value. The number of measurements is equal to the number of causes supported plus a possible sum value identified by the *.sum* suffix.
- e) The measurement name has the form RAB.FailEstabCSNoQueuing.*Cause* where *Cause* identifies the failure cause.

- f) RncFunction.
- g) Valid for circuit switched traffic.
- h) UMTS.
- i) One usage of this measurement is to support the coverage ratio (CR) calculation for EE coverage area determination in [21].

4.1.2.4 Successful RAB establishments with queuing for CS domain

- a) This measurement provides the number of successfully established RABs for CS domain in which a queuing process has been involved. The measurement is split into subcounters per traffic class.
- b) CC
- c) On transmission by the RNC of a RANAP RAB ASSIGNMENT RESPONSE message for CS domain, each successfully established RAB is added to the relevant measurement according to the traffic class. See TS 25.413 [5] and TS 23.107 [2]. For conversational service, the relevant measurement according to the data rates requested, see TS 25.993 [13] as follows:

uplink<U>:

- 1: AMR rate (12.2 10.2 7.95 7.4 6.7 5.9 5.15 4.75) kbps
- 2: 12.2 kbps
- 3: 28.8 kbps
- 4: 32 kbps
- 5: 64 kbps
- 6: AMR -WB-rate (12.65, 8.8, 6.65) kbps

downlink<D>:

- 1: AMR rate (12.2 10.2 7.95 7.4 6.7 5.9 5.15 4.75) kbps
- 2: 12.2 kbps
- 3: 28.8 kbps
- 4: 32 kbps
- 5: 64 kbps
- 6: AMR -WB-rate (12.65, 8.8, 6.65) kbps

As indicated above, <U> and <D> are integer values that map to the conversational service specified uplink and downlink data rates respectively.

NOTE: The addition is performed with the condition that the RAB has been mentioned as queued in a previous RANAP RAB ASSIGNMENT RESPONSE and the RAB has not been setup or modified successfully in a previous RANAP RAB ASSIGNMENT RESPONSE or RELOCATION REQUEST ACKNOWLEDGE.

- d) Each measurement is an integer value.
- e) RAB.SuccEstabCSQueuing.Conv.<U><D>
RAB.SuccEstabCSQueuing.Strm
RAB.SuccEstabCSQueuing.Intact
RAB.SuccEstabCSQueuing.Bgrd
- f) RncFunction.
- g) Valid for circuit switched traffic.
- h) UMTS.
- i) One usage of this measurement is to support the coverage ratio (CR) calculation for EE coverage area determination in [21].

4.1.2.5 Failed RAB establishments with queuing for CS domain

- a) This measurement provides the number of RABs failed to establish for CS domain in which a queuing process has been involved. The measurement is split into subcounters per failure cause.
- b) CC

- c) On transmission by the RNC of a RANAP RAB ASSIGNMENT RESPONSE message for CS domain, each RAB failed to establish is added to the relevant measurement according to the cause. Possible causes are included in TS 25.413 [5]. The sum of all supported per cause measurements shall equal the total number of RAB Establishment Failures. In case only a subset of per cause measurements is supported, a sum subcounter will be provided first.

NOTE: The addition is performed with the condition that the RAB has been mentioned as queued in a previous RANAP RAB ASSIGNMENT RESPONSE and the RAB has not been setup or modified successfully in a previous RANAP RAB ASSIGNMENT RESPONSE or RELOCATION REQUEST ACKNOWLEDGE.

- d) Each measurement is an integer value. The number of measurements is equal to the number of causes plus a possible sum value identified by the *.sum* suffix.
- e) The measurement name has the form RAB.FailEstabCSQueuing.*Cause* where *Cause* identifies the failure cause.
- f) RncFunction.
- g) Valid for circuit switched traffic.
- h) UMTS.
- i) One usage of this measurement is to support the coverage ratio (CR) calculation for EE coverage area determination in [21].

4.1.3 RAB establishment for PS domain

4.1.3.0 Introduction

The five measurement types defined in the clause 4.1.3 for PS domain are subject to the "4 out of 5 approach".

4.1.3.1 Attempted RAB establishments for PS domain

- a) This measurement provides the number of requested RABs in establishment attempts for PS domain. The measurement is split into subcounters per traffic class.
- b) CC
- c) On receipt by the RNC of a RANAP RAB ASSIGNMENT REQUEST message for PS domain, each requested RAB in establishment attempts is added to the relevant measurement according to the traffic class requested. See TS 25.413 [5] and TS 23.107 [2]. For streaming service, the relevant measurement according to the data rates requested, see TS 25.993 [13] as follows:

uplink<U>:

- 1: 14.4 kbps
- 2: 28.8 kbps
- 3: 57.6 kbps
- 4: 64 kbps
- 5: 128 kbps
- 6: 384kbps

downlink<D>:

- 1: 14.4 kbps
- 2: 28.8 kbps
- 3: 57.6 kbps
- 4: 64 kbps
- 5: 128 kbps
- 6: 384 kbps

As indicated above, <U> and <D> are integer values that map to the streaming service specified uplink and downlink data rates respectively.

NOTE: The addition is performed with the condition that the RAB has not been setup or modified successfully in a previous RANAP RAB ASSIGNMENT RESPONSE or RELOCATION REQUEST ACKNOWLEDGE.

- d) Four integer values.
- e) RAB.AttEstabPS.Conv
RAB.AttEstabPS.Strm.<U><D>
RAB.AttEstabPS.Intact
RAB.AttEstabPS.Bgrd
- f) RncFunction.
- g) Valid for packet switched traffic.
- h) UMTS.
- i) One usage of this measurement is to support the coverage ratio (CR) calculation for EE coverage area determination in [21].

4.1.3.2 Successful RAB establishments without queuing for PS domain

- a) This measurement provides the number of successfully established RABs for PS domain in which a queuing process has not been involved. The measurement is split into subcounters per traffic class.
- b) CC
- c) On transmission by the RNC of a RANAP RAB ASSIGNMENT RESPONSE message for PS domain, each successfully established RAB is added to the relevant measurement according to the traffic class. See TS 25.413 [5] and TS 23.107 [2]. For streaming service, the relevant measurement according to the data rates requested, see TS 25.993 [13] as follows:

uplink<U>:

- 1: 14.4 kbps
- 2: 28.8 kbps
- 3: 57.6 kbps
- 4: 64 kbps
- 5: 128 kbps
- 6: 384kbps

downlink<D>:

- 1: 14.4 kbps
- 2: 28.8 kbps
- 3: 57.6 kbps
- 4: 64 kbps
- 5: 128 kbps
- 6: 384 kbps

As indicated above, <U> and <D> are integer values that map to the streaming service specified uplink and downlink data rates respectively.

NOTE: The addition is performed with the condition that the RAB has not been mentioned as queued in a previous RANAP RAB ASSIGNMENT RESPONSE and the RAB has not been setup or modified successfully in a previous RANAP RAB ASSIGNMENT RESPONSE or RELOCATION REQUEST ACKNOWLEDGE.

- d) Four integer values.
- e) RAB.SuccEstabPSNoQueuing.Conv
RAB.SuccEstabPSNoQueuing.Strm.<U><D>
RAB.SuccEstabPSNoQueuing.Intact
RAB.SuccEstabPSNoQueuing.Bgrd
- f) RncFunction.
- g) Valid for packet switched traffic.
- h) UMTS.
- i) One usage of this measurement is to support the coverage ratio (CR) calculation for EE coverage area determination in [21].

4.1.3.3 Failed RAB establishments without queuing for PS domain

- a) This measurement provides the number of RABs failed to establish for PS in which a queuing process has not been involved. The measurement is split into subcounters per failure cause.
- b) CC
- c) On transmission by the RNC of a RANAP RAB ASSIGNMENT RESPONSE message for PS domain, each RAB failed to establish is added to the relevant measurement according to the failure cause. Possible causes are included in TS 25.413 [5]. The sum of all supported per cause measurements shall equal the total number of RAB Establishment Failures. In case only a subset of per cause measurements is supported, a sum subcounter will be provided first.

NOTE: The addition is performed with the condition that the RAB has not been mentioned as queued in a previous RANAP RAB ASSIGNMENT RESPONSE and the RAB has not been setup or modified successfully in a previous RANAP RAB ASSIGNMENT RESPONSE or RELOCATION REQUEST ACKNOWLEDGE.

- d) Each measurement is an integer value. The number of measurements is equal to the number of causes plus a possible sum value identified by the *.sum* suffix.
- e) The measurement name has the form RAB.FailEstabPSNoQueuing.*Cause* where *Cause* identifies the failure cause.
- f) RncFunction.
- g) Valid for packet switched traffic.
- h) UMTS.
- i) One usage of this measurement is to support the coverage ratio (CR) calculation for EE coverage area determination in [21].

4.1.3.4 Successful RAB establishments with queuing for PS domain

- a) This measurement provides the number of successfully established RABs for PS domain in which a queuing process has been involved. The measurement is split into subcounters per traffic class.
- b) CC
- c) On transmission by the RNC of a RANAP RAB ASSIGNMENT RESPONSE message for PS domain, each successfully established RAB is added to the relevant measurement according to the traffic class. See TS 25.413 [5] and TS 23.107 [2]. For streaming service, the relevant measurement according to the data rates requested, see TS 25.993 [13] as follows:

uplink<U>:

- 1: 14.4 kbps
- 2: 28.8 kbps
- 3: 57.6 kbps
- 4: 64 kbps
- 5: 128 kbps
- 6: 384kbps

downlink<D>:

- 1: 14.4 kbps
- 2: 28.8 kbps
- 3: 57.6 kbps
- 4: 64 kbps
- 5: 128 kbps
- 6: 384 kbps

As indicated above, <U> and <D> are integer values that map to the streaming service specified uplink and downlink data rates respectively.

NOTE: The addition is performed with the condition that the RAB has been mentioned as queued in a previous RANAP RAB ASSIGNMENT RESPONSE and the RAB has not been setup or modified successfully in a previous RANAP RAB ASSIGNMENT RESPONSE or RELOCATION REQUEST ACKNOWLEDGE.

- d) Four integer values.
- e) RAB.SuccEstabPSQueuing.Conv
RAB.SuccEstabPSQueuing.Strm.<U><D>
RAB.SuccEstabPSQueuing.Intact
RAB.SuccEstabPSQueuing.Bgrd
- f) RncFunction.
- g) Valid for packet switched traffic.
- h) UMTS.
- i) One usage of this measurement is to support the coverage ratio (CR) calculation for EE coverage area determination in [21].

4.1.3.5 Failed RAB establishments with queuing for PS domain

- a) This measurement provides the number of RABs failed to establish for PS domain in which a queuing process has been involved. The measurement is split into subcounters per failure cause.
- b) CC
- c) On transmission by the RNC of a RANAP RAB ASSIGNMENT RESPONSE message for PS domain, each RAB failed to establish is added to the relevant measurement according to the cause. Possible causes are included in TS 25.413 [5]. The sum of all supported per cause measurements shall equal the total number of RAB Establishment Failures. In case only a subset of per cause measurements is supported, a sum subcounter will be provided first.

NOTE: The addition is performed with the condition that the RAB has been mentioned as queued in a previous RANAP RAB ASSIGNMENT RESPONSE and the RAB has not been setup or modified successfully in a previous RANAP RAB ASSIGNMENT RESPONSE or RELOCATION REQUEST ACKNOWLEDGE.

- d) Each measurement is an integer value. The number of measurements is equal to the number of causes plus a possible sum value identified by the *.sum* suffix.
- e) The measurement name has the form RAB.FailEstabPSQueuing.*Cause* where *Cause* identifies the failure cause.
- f) RncFunction.
- g) Valid for packet switched traffic.
- h) UMTS.
- i) One usage of this measurement is to support the coverage ratio (CR) calculation for EE coverage area determination in [21].

4.1.4 RAB modification for CS domain

4.1.4.0 Introduction

The five measurement types defined in the clause 4.1.4 for CS domain are subject to the "4 out of 5 approach".

4.1.4.1 Attempted RAB modifications for CS domain

- a) This measurement provides the number of requested RABs in modification attempts for CS domain. The measurement is split into subcounters per traffic class.
- b) CC
- c) On receipt by the RNC of a RANAP RAB ASSIGNMENT REQUEST message for CS domain, each requested RAB in modification attempts is added to the relevant measurement according to the traffic class requested. See TS 25.413 and TS 23.107.

NOTE: The addition is performed with the condition that the RAB has been setup or modified successfully in a previous RANAP RAB ASSIGNMENT RESPONSE or RELOCATION REQUEST ACKNOWLEDGE.

- d) Four integer values.
- e) RAB.AttModCS.Conv
RAB.AttModCS.Strm
RAB.AttModCS.Intact
RAB.AttModCS.Bgrd
- f) RncFunction
- g) Valid for circuit switched traffic
- h) UMTS

4.1.4.2 Successful RAB modifications without queuing for CS domain

- a) This measurement provides the number of successfully modified RABs for CS domain in which a queuing process has not been involved. The measurement is split into subcounters per traffic class.
- b) CC
- c) On transmission by the RNC of a RANAP RAB ASSIGNMENT RESPONSE message for CS domain, each successfully modified RAB is added to the relevant measurement according to the traffic class requested in the RAB ASSIGNMENT REQUEST message. See TS 25.413 [5] and TS 23.107 [2].

NOTE: The addition is performed with the condition that the RAB has not been mentioned as queued in a previous RANAP RAB ASSIGNMENT RESPONSE and the RAB has been setup or modified successfully in a previous RANAP RAB ASSIGNMENT RESPONSE or RELOCATION REQUEST ACKNOWLEDGE.

- d) Four integer values.
- e) RAB.SuccModCSNoQueuing.Conv
RAB.SuccModCSNoQueuing.Strm
RAB.SuccModCSNoQueuing.Intact
RAB.SuccModCSNoQueuing.Bgrd
- f) RncFunction
- g) Valid for circuit switched traffic
- h) UMTS

4.1.4.3 Failed RAB modifications without queuing for CS domain

- a) This measurement provides the number of RABs failed to modify for CS domain in which a queuing process has not been involved. The measurement is split into subcounters per failure cause.
- b) CC
- c) On transmission by the RNC of a RANAP RAB ASSIGNMENT RESPONSE message for CS domain, each RAB failed to modify is added to the relevant measurement according to the failure cause. Possible causes are included in TS 25.413 [5]. The sum of all supported per cause measurements shall equal the total number of RAB Modification Failures. In case only a subset of per cause measurements is supported, a sum measurement subtype will be provided first.

NOTE: The addition is performed with the condition that the RAB has not been mentioned as queued in a previous RANAP RAB ASSIGNMENT RESPONSE and the RAB has been setup or modified successfully in a previous RANAP RAB ASSIGNMENT RESPONSE or RELOCATION REQUEST ACKNOWLEDGE.

- d) Each measurement is an integer value. The number of measurements is equal to the number of causes supported plus a possible sum value identified by the *.sum* suffix.
- e) The measurement name has the form RAB.FailModCSNoQueuing.*Cause* where *Cause* identifies the failure cause.
- f) RncFunction
- g) Valid for circuit switched traffic
- h) UMTS

4.1.4.4 Successful RAB modifications with queuing for CS domain

- a) This measurement provides the number of successfully modified RABs for CS domain in which a queuing process has been involved. The measurement is split into subcounters per traffic class.
- b) CC
- c) On transmission by the RNC of a RANAP RAB ASSIGNMENT RESPONSE message for CS domain, each successfully modified RAB is added to the relevant measurement according to the traffic class. See TS 25.413 [5] and TS 23.107 [2].

NOTE: The addition is performed with the condition that the RAB has been mentioned as queued in a previous RANAP RAB ASSIGNMENT RESPONSE and the RAB has been setup or modified successfully in a previous RANAP RAB ASSIGNMENT RESPONSE or RELOCATION REQUEST ACKNOWLEDGE.

- d) Four integer values.
- e) RAB.SuccModCSQueuing.Conv
RAB.SuccModCSQueuing.Strm
RAB.SuccModCSQueuing.Intact
RAB.SuccModCSQueuing.Bgrd
- f) RncFunction
- g) Valid for circuit switched traffic
- h) UMTS

4.1.4.5 Failed RAB modifications with queuing for CS domain

- a) This measurement provides the number of RABs failed to modify for CS domain in which a queuing process has been involved. The measurement is split into subcounters per failure cause.
- b) CC

- c) On transmission by the RNC of a RANAP RAB ASSIGNMENT RESPONSE message for CS domain, each RAB failed to modify is added to the relevant measurement according to the cause. Possible causes are included in TS 25.413 [5]. The sum of all supported per cause measurements shall equal the total number of RAB Modification Failures. In case only a subset of per cause measurements is supported, a sum measurement subtype will be provided first.

NOTE: The addition is performed with the condition that the RAB has been mentioned as queued in a previous RANAP RAB ASSIGNMENT RESPONSE and the RAB has been setup or modified successfully in a previous RANAP RAB ASSIGNMENT RESPONSE or RELOCATION REQUEST ACKNOWLEDGE.

- d) Each measurement is an integer value. The number of measurements is equal to the number of causes plus a possible sum value identified by the *.sum* suffix.
- e) The measurement name has the form RAB.FailModCSQueuing.*Cause* where *Cause* identifies the failure cause.
- f) RncFunction
- g) Valid for circuit switched traffic
- h) UMTS

4.1.5 RAB modification for PS domain

4.1.5.0 Introduction

The five measurement types defined in the clause 4.1.5 for PS domain are subject to the "4 out of 5 approach".

4.1.5.1 Attempted RAB modifications for PS domain

- a) This measurement provides the number of requested RABs in modification attempts for PS domain. The measurement is split into subcounters per traffic class.
- b) CC
- c) On receipt by the RNC of a RANAP RAB ASSIGNMENT REQUEST message for PS domain, each requested RAB in modification attempts is added to the relevant measurement according to the traffic class requested. See TS 25.413 [5] and TS 23.107 [2].

NOTE: The addition is performed with the condition that the RAB has been setup or modified successfully in a previous RANAP RAB ASSIGNMENT RESPONSE or RELOCATION REQUEST ACKNOWLEDGE.

- d) Four integer values.
- e) RAB.AttModPS.Conv
RAB.AttModPS.Strm
RAB.AttModPS.Intact
RAB.AttModPS.Bgrd.
- f) RncFunction
- g) Valid for packet switched traffic.
- h) UMTS

4.1.5.2 Successful RAB modifications without queuing for PS domain

- a) This measurement provides the number of successfully modified RABs for PS domain in which a queuing process has not been involved. The measurement is split into subcounters per traffic class.
- b) CC
- c) On transmission by the RNC of a RANAP RAB ASSIGNMENT RESPONSE message for PS domain, each successfully modified RAB is added to the relevant measurement according to the traffic class. See TS 25.413 [5] and TS 23.107 [2].

NOTE: The addition is performed with the condition that the RAB has not been mentioned as queued in a previous RANAP RAB ASSIGNMENT RESPONSE and the RAB has been setup or modified successfully in a previous RANAP RAB ASSIGNMENT RESPONSE or RELOCATION REQUEST ACKNOWLEDGE.

- d) Four integer values.
- e) RAB.SuccModPSNoQueuing.Conv
RAB.SuccModPSNoQueuing.Strm
RAB.SuccModPSNoQueuing.Intact
RAB.SuccModPSNoQueuing.Bgrd.
- f) RncFunction
- g) Valid for packet switched traffic.
- h) UMTS

4.1.5.3 Failed RAB modifications without queuing for PS domain

- a) This measurement provides the number of RABs failed to modify for PS in which a queuing process has not been involved. The measurement is split into subcounters per failure cause.
- b) CC
- c) On transmission by the RNC of a RANAP RAB ASSIGNMENT RESPONSE message for PS domain, each RAB failed to modify is added to the relevant measurement according to the failure cause. Possible causes are included in TS 25.413 [5]. The sum of all supported per cause measurements shall equal the total number of RAB Modification Failures. In case only a subset of per cause measurements is supported, a sum measurement subtype will be provided first.

NOTE: The addition is performed with the condition that the RAB has not been mentioned as queued in a previous RANAP RAB ASSIGNMENT RESPONSE and the RAB has been setup or modified successfully in a previous RANAP RAB ASSIGNMENT RESPONSE or RELOCATION REQUEST ACKNOWLEDGE.

- d) Each measurement is an integer value. The number of measurements is equal to the number of causes plus a possible sum value identified by the *.sum* suffix.
- e) The measurement name has the form RAB.FailModPSNoQueuing.*Cause* where *Cause* identifies the failure cause.
- f) RncFunction
- g) Valid for packet switched traffic.
- h) UMTS

4.1.5.4 Successful RAB modifications with queuing for PS domain

- a) This measurement provides the number of successfully modified RABs for PS domain in which a queuing process has been involved. The measurement is split into subcounters per traffic class.
- b) CC
- c) On transmission by the RNC of a RANAP RAB ASSIGNMENT RESPONSE message for PS domain, each successfully modified RAB is added to the relevant measurement according to the traffic class. See TS 25.413 [5] and TS 23.107 [2].

NOTE: The addition is performed with the condition that the RAB has been mentioned as queued in a previous RANAP RAB ASSIGNMENT RESPONSE and the RAB has been setup or modified successfully in a previous RANAP RAB ASSIGNMENT RESPONSE or RELOCATION REQUEST ACKNOWLEDGE.

- d) Four integer values.
- e) RAB.SuccModPSQueuing.Conv
RAB.SuccModPSQueuing.Strm
RAB.SuccModPSQueuing.Intact
RAB.SuccModPSQueuing.Bgrd.
- f) RncFunction
- g) Valid for packet switched traffic.
- h) UMTS

4.1.5.5 Failed RAB modifications with queuing for PS domain

- a) This measurement provides the number of RABs failed to modify for PS domain in which a queuing process has been involved. The measurement is split into subcounters per failure cause.
- b) CC

- c) On transmission by the RNC of a RANAP RAB ASSIGNMENT RESPONSE message for PS domain, each RAB failed to modify is added to the relevant measurement according to the cause. Possible causes are included in TS 25.413 [5]. The sum of all supported per cause measurements shall equal the total number of RAB Modification Failures. In case only a subset of per cause measurements is supported, a sum measurement subtype will be provided first.

NOTE: The addition is performed with the condition that the RAB has been mentioned as queued in a previous RANAP RAB ASSIGNMENT RESPONSE and the RAB has been setup or modified successfully in a previous RANAP RAB ASSIGNMENT RESPONSE or RELOCATION REQUEST ACKNOWLEDGE.

- d) Each measurement is an integer value. The number of measurements is equal to the number of causes plus a possible sum value identified by the *.sum* suffix.
- e) The measurement name has the form RAB.FailModPSQueuing.*Cause* where *Cause* identifies the failure cause.
- f) RncFunction
- g) Valid for packet switched traffic.
- h) UMTS

4.1.6 RAB release request by CN for CS domain

4.1.6.0 Introduction

The three measurement types defined in the clause 4.1.6 for CS domain are subject to the "2 out of 3 approach".

4.1.6.1 Attempted RAB releases for CS domain

- a) This measurement provides the number of requested RABs in release attempts for CS domain. The measurement is split into subcounters per release cause.
- b) CC
- c) On receipt by the RNC of a RANAP RAB ASSIGNMENT REQUEST message for CS domain, each requested RAB in release attempts is added to the relevant measurement according to the release cause requested. Possible causes are included in TS 25.413 [5]. The sum of all supported per cause measurements shall equal the total number of RAB Release Attempts. In case only a subset of per cause measurements is supported, a sum measurement subtype will be provided first. See TS 25.413 [5] and TS 23.107 [2].
- d) Each measurement is an integer value. The number of measurements is equal to the number of causes plus a possible sum value identified by the *.sum* suffix.
- e) The measurement name has the form RAB.AttRelCS.Cause where *Cause* identifies the release cause.
- f) RncFunction.
- g) Valid for circuit switched traffic.
- h) UMTS.
- i) One usage of this measurement is to support the coverage ratio (CR) calculation for EE coverage area determination in [21].

4.1.6.2 Successful RAB releases for CS domain

- a) This measurement provides the number of successfully released RABs for CS domain. The measurement is split into subcounters per release cause.
- b) CC
- c) On transmission by the RNC of a RANAP RAB ASSIGNMENT RESPONSE message for CS domain, each successfully released RAB is added to the relevant measurement according to the release cause requested in the RAB ASSIGNMENT REQUEST message. Possible causes are included in TS 25.413 [5]. The sum of all supported per cause measurements shall equal the total number of RAB Release Successes. In case only a subset of per cause measurements is supported, a sum measurement subtype will be provided first. See TS 25.413 [5] and TS 23.107 [2].
- d) Each measurement is an integer value. The number of measurements is equal to the number of causes plus a possible sum value identified by the *.sum* suffix.
- e) The measurement name has the form RAB.SuccRelCS.Cause where *Cause* identifies the release cause.
- f) RncFunction.
- g) Valid for circuit switched traffic.
- h) UMTS.
- i) One usage of this measurement is to support the coverage ratio (CR) calculation for EE coverage area determination in [21].

4.1.6.3 Failed RAB releases for CS domain

- a) This measurement provides the number of RABs failed to release for CS domain. The measurement is split into subcounters per failure cause.
- b) CC
- c) On transmission by the RNC of a RANAP RAB ASSIGNMENT RESPONSE message for CS domain, each RAB failed to release is added to the relevant measurement according to the failure cause. Possible causes are included in TS 25.413 [5]. The sum of all supported per cause measurements shall equal the total number of RAB Release Failures. In case only a subset of per cause measurements is supported, a sum measurement subtype will be provided first.
- d) Each measurement is an integer value. The number of measurements is equal to the number of causes supported plus a possible sum value identified by the *.sum* suffix.
- e) The measurement name has the form RAB.FailRelCS.*Cause* where *Cause* identifies the failure cause.
- f) RncFunction.
- g) Valid for circuit switched traffic.
- h) UMTS.
- i) One usage of this measurement is to support the coverage ratio (CR) calculation for EE coverage area determination in [21].

4.1.6.4 Void

4.1.6.5 Void

4.1.7 RAB release request by CN for PS domain

4.1.7.0 Introduction

The three measurement types defined in the clause 4.1.7 for PS domain are subject to the "2 out of 3 approach".

4.1.7.1 Attempted RAB releases for PS domain

- a) This measurement provides the number of requested RABs in release attempts for PS domain. The measurement is split into subcounters per release cause.
- b) CC
- c) On receipt by the RNC of a RANAP RAB ASSIGNMENT REQUEST message for PS domain, each requested RAB in release attempts is added to the relevant measurement according to the release cause. Possible causes are included in TS 25.413 [5]. The sum of all supported per cause measurements shall equal the total number of RAB Release Attempts. In case only a subset of per cause measurements is supported, a sum measurement subtype will be provided first. See TS 25.413 [5] and TS 23.107 [2].
- d) Each measurement is an integer value. The number of measurements is equal to the number of causes plus a possible sum value identified by the *.sum* suffix.
- e) The measurement name has the form RAB.AttRelPS.Cause where *Cause* identifies the release cause.
- f) RncFunction.
- g) Valid for packet switched traffic.
- h) UMTS.
- i) One usage of this measurement is to support the coverage ratio (CR) calculation for EE coverage area determination in [21].

4.1.7.2 Successful RAB releases for PS domain

- a) This measurement provides the number of successfully released RABs for PS domain. The measurement is split into subcounters per release cause.
- b) CC
- c) On transmission by the RNC of a RANAP RAB ASSIGNMENT RESPONSE message for PS domain, each successfully released RAB is added to the relevant measurement according to the release cause. Possible causes are included in TS 25.413 [5]. The sum of all supported per cause measurements shall equal the total number of RAB Release Successes. In case only a subset of per cause measurements is supported, a sum measurement subtype will be provided first. See TS 25.413 [5] and TS 23.107 [2].
- d) Each measurement is an integer value. The number of measurements is equal to the number of causes plus a possible sum value identified by the *.sum* suffix.
- e) e) The measurement name has the form RAB.SuccRelPS.Cause where *Cause* identifies the release cause.
- f) RncFunction.
- g) Valid for packet switched traffic.
- h) UMTS.
- i) One usage of this measurement is to support the coverage ratio (CR) calculation for EE coverage area determination in [21].

4.1.7.3 Failed RAB releases for PS domain

- a) This measurement provides the number of RABs failed to release for PS. The measurement is split into subcounters per failure cause.
- b) CC
- c) On transmission by the RNC of a RANAP RAB ASSIGNMENT RESPONSE message for PS domain, each RAB failed to release is added to the relevant measurement according to the failure cause. Possible causes are included in TS 25.413 [5]. The sum of all supported per cause measurements shall equal the total number of RAB Release Failures. In case only a subset of per cause measurements is supported, a sum measurement subtype will be provided first.
- d) Each measurement is an integer value. The number of measurements is equal to the number of causes plus a possible sum value identified by the *.sum* suffix.
- e) The measurement name has the form RAB.FailRelPS.*Cause* where *Cause* identifies the failure cause.
- f) RncFunction.
- g) Valid for packet switched traffic.
- h) UMTS.
- i) One usage of this measurement is to support the coverage ratio (CR) calculation for EE coverage area determination in [21].

4.1.7.4 Void

4.1.7.5 Void

4.1.8 RAB setup time

4.1.8.1 RAB CS connection set-up time (Mean)

- a) This measurement provides the mean time during each granularity period for a RNC to establish a RAB CS connection.
- b) DER (n=1).
- c) This measurement is obtained by accumulating the time intervals for each successful RAB establishment between the receipt by the RNC of a RANAP "RAB ASSIGNMENT REQUEST" message to establish a RAB for CS domain, and the first corresponding (based on RAB ID) transmission by the RNC of a RANAP "RAB ASSIGNMENT RESPONSE" message for successfully established RABs over a granularity period using DER, see TS 25.413 [5]. This end value of the time will then be divided by the number of successfully established RABs observed in the granularity period to give the arithmetic mean, the accumulator shall be reinitialised at the beginning of each granularity period.
- d) Each measurement is an integer value.(in milliseconds).
- e) RAB.SuccEstabCSSetupTimeMean
- f) RncFunction
- g) Valid for circuit switched traffic
- h) UMTS

4.1.8.2 RAB CS connection set-up time (Maximum)

- a) This measurement provides the maximum time during each granularity period for a RNC to establish a RAB CS connection.
- b) GAUGE.
- c) This measurement is obtained by monitoring the time intervals for each successful RAB establishment between the receipt by the RNC of a RANAP "RAB ASSIGNMENT REQUEST" message to establish a RAB for CS domain, and the first corresponding (based on RAB ID) transmission by the RNC of a RANAP "RAB ASSIGNMENT RESPONSE" message for successfully established RABs see TS 25.413 [5]. The high tide mark of this time will be stored in a gauge, the gauge shall be reinitialised at the beginning of each granularity period.
- d) Each measurement is an integer value.(in milliseconds).
- e) RAB.SuccEstabCSSetupTimeMax
- f) RncFunction
- g) Valid for circuit switched traffic
- h) UMTS

4.1.8.3 RAB PS connection set-up time (Mean)

- a) This measurement provides the mean time during each granularity period for a RNC to establish a RAB PS connection.
- b) DER (n=1).
- c) This measurement is obtained by accumulating the time intervals for each successful RAB establishment between the receipt by the RNC of a RANAP "RAB ASSIGNMENT REQUEST" message to establish a RAB for PS domain, and the first corresponding (based on RAB ID) transmission by the RNC of a RANAP "RAB ASSIGNMENT RESPONSE" message for successfully established RABs over a granularity period using DER, see TS 25.413 [5]. This end value of the time will then be divided by the number of successfully established RABs observed in the granularity period to give the arithmetic mean, the accumulator shall be reinitialised at the beginning of each granularity period.

- d) Each measurement is an integer value.(in milliseconds).
- e) RAB.SuccEstabPSSetupTimeMean
- f) RncFunction
- g) Valid for packet switched traffic.
- h) UMTS

4.1.8.4 RAB PS connection set-up time (Maximum)

- a) This measurement provides the maximum time during each granularity period for a RNC to establish a RAB PS connection.
- b) GAUGE.
- c) This measurement is obtained by monitoring the time intervals for each successful RAB establishment between the receipt by the RNC of a RANAP "RAB ASSIGNMENT REQUEST" message to establish a RAB for PS domain, and the first corresponding (based on RAB ID) transmission by the RNC of a RANAP "RAB ASSIGNMENT RESPONSE" message for successfully established RABs see TS 25.413 [5]. The high tide mark of this time will be stored in a gauge, the gauge shall be reinitialised at the beginning of each granularity period.
- d) Each measurement is an integer value.(in milliseconds).
- e) RAB.SuccEstabPSSetupTimeMax
- f) RncFunction
- g) Valid for packet switched traffic.
- h) UMTS

4.1.9 RAB release request by UTRAN

4.1.9.1 RAB release requests for CS domain

- a) This measurement provides the number of RABs requested to release by UTRAN for CS domain split into subcounters per cause.
- b) CC
- c) On transmission by the RNC of a RANAP RAB RELEASE REQUEST message for CS domain, each RAB requested to be released is added to the relevant per cause measurement. Possible causes are included in TS 25.413 [5]. The sum of all supported per cause measurements shall equal the total number of RAB Release Requests for the CS domain. In case only a subset of per cause measurements is supported, a sum subcounter will be provided first.
- d) Each measurement is an integer value. The number of measurements is equal to the number of causes plus a possible sum value identified by the *.sum* suffix.
- e) The measurement name has the form RAB.RelReqCS.Cause where *Cause* identifies the release cause.
- f) RncFunction
- g) Valid for circuit switched traffic
- h) UMTS

4.1.9.2 RAB release requests for PS domain

- a) This measurement provides the number of RABs requested to release by UTRAN for PS domain split into subcounters per cause.
- b) CC
- c) On transmission by the RNC of a RANAP RAB RELEASE REQUEST message for PS domain, each RAB requested to be released is added to the relevant per cause measurement. Possible causes are included in TS 25.413 [5]. The sum of all supported per cause measurements shall equal the total number of RAB Release Requests for the PS domain. In case only a subset of per cause measurements is supported, a sum subcounter will be provided first.
- d) Each measurement is an integer value. The number of measurements is equal to the number of causes plus a possible sum value identified by the *.sum* suffix.
- e) The measurement name has the form RAB.RelReqPS.Cause where *Cause* identifies the release cause.
- f) RncFunction
- g) Valid for packet switched traffic.
- h) UMTS

4.1.9.3 The number of RAB related to the Iu release request for CS domain

- a) This measurement provides the number of RAB related to the Iu release request for CS domain. The measurement is split into subcounters per traffic class.
- b) CC
- c) On transmission by the RNC of a RANAP IU RELEASE REQUEST message for CS domain, each RAB related to the RANAP IU RELEASE REQUEST message is added to the relevant measurement according to the traffic class requested when the RANAP message IU RELEASE REQUEST is sent to the CS CN.
- d) Each measurement is an integer value

- e) RAB.NbrIuRelReqCS.Conv
RAB.NbrIuRelReqCS.Strm
RAB.NbrIuRelReqCS.Intact
RAB.NbrIuRelReqCS.Bgrd
- f) UtranCellFDD
UtranCellTDDLcr
UtranCellTDDHcr
- g) Valid for circuit switched traffic
- h) UMTS

4.1.9.4 The number of RAB related to the Iu release request for PS domain

- a) This measurement provides the number of RAB related to the Iu release request for PS domain. The measurement is split into subcounters per traffic class.
- b) CC
- c) On transmission by the RNC of a RANAP IU RELEASE REQUEST message for PS domain, each RAB related to the RANAP IU RELEASE REQUEST message is added to the relevant measurement according to the traffic class requested when the RANAP message IU RELEASE REQUEST is sent to the PS CN.
- d) Each measurement is an integer value.
- e) RAB.NbrIuRelReqPS.Conv
RAB.NbrIuRelReqPS.Strm
RAB.NbrIuRelReqPS.Intact
RAB.NbrIuRelReqPS.Bgrd
- f) UtranCellFDD
UtranCellTDDLcr
UtranCellTDDHcr
- g) Valid for packet switched traffic.
- h) UMTS

4.2 Void

4.3 Signalling connection establishment

4.3.1 Attempted signalling connection establishments for CS domain

- a) This measurement provides the number of attempts by RNC to establish an Iu control plane connection between the RNC and a CS CN.

NOTE: There is no confirmation in response to this message to indicate that the CN-RNC connection was successfully setup.

- b) CC
- c) Transmission of a RANAP Initial UE message by the RNC to the CN. This is sent by the RNC on receipt of an RRC Initial Direct Transfer message from the UE.
- d) A single integer value
- e) SIG.AttConnEstabCS.
- f) RncFunction
- g) Valid for circuit switching.
- h) UMTS

4.3.2 Attempted signalling connection establishments for PS domain

- a) This measurement provides the number of requests by RNC to establish an Iu control plane connection between the RNC and a PS CN.

NOTE: There is no confirmation in response to this message to indicate that the CN-RNC connection was successfully setup.

- b) CC
- c) Transmission of a RANAP Initial UE message by the RNC to the CN. This is sent by the RNC on receipt of an RRC Initial Direct Transfer message from the UE.
- d) A single integer value
- e) SIG.AttConnEstabPS.
- f) RncFunction
- g) Valid for packet switching.
- h) UMTS

4.4 RRC connection establishment

4.4.1 RRC connection establishments

4.4.1.0 Introduction

The three measurement types defined in the clause 4.4.1.n are subject to the "2 out of 3 approach".

4.4.1.1 Attempted RRC connection establishments

- a) This measurement provides the number of RRC connection establishment attempts for each establishment cause.
- b) CC
- c) Receipt of an RRC Connection Request message by the RNC from the UE. Each RRC Connection Request message received is added to the relevant per cause measurement. The possible causes are included in TS 25.331 [4]. The sum of all supported per cause measurements shall equal the total number of RRC Connection Establishment attempts. In case only a subset of per cause measurements is supported, a sum subcounter will be provided first.
- d) Each measurement is an integer value. The number of measurements is equal to the number of causes plus a possible sum value identified by the *.sum* suffix.
- e) The measurement name has the form *RRC.AttConnEstab.Cause* where *Cause* identifies the Establishment Cause.
- f) UtranCellFDD
UtranCellTDDLcr
UtranCellTDDHcr
- g) Valid for circuit switched and packet switched traffic
- h) UMTS

4.4.1.2 Failed RRC connection establishments

- a) This measurement provides the number of RRC establishment failures for each rejection cause.
- b) CC
- c) Transmission of an RRC Connection Reject message by the RNC to the UE or an expected RRC CONNECTION SETUP COMPLETE message not received by the RNC. Each RRC Connection Reject message received is added to the relevant per cause measurement. The possible causes are included in TS 25.331 [4]. Each expected RRC CONNECTION SETUP COMPLETE not received by the RNC is added to the measurement cause 'No Reply' (not specified in TS 25.331 [4]). Each RRC connection which is not established because the cell is going to Energy Saving mode is added to the measurement cause 'EnergySaving' (not specified in TS 25.331 [4])
The sum of all supported per cause measurements shall equal the total number of RRC Connection Establishment Failures. In case only a subset of per cause measurements is supported, a sum subcounter will be provided first.
- d) Each measurement is an integer value. The number of measurements is equal to the number of causes plus a possible sum value identified by the *.sum* suffix.
- e) The measurement name has the form *RRC.FailConnEstab.Cause* where *Cause* identifies the Rejection Cause.
The cause 'No Reply' is identified by the *.NoReply* suffix.
The cause 'Energy Saving' is identified by the *.EnergySaving* suffix.
- f) UtranCellFDD
UtranCellTDDLcr
UtranCellTDDHcr

- g) Valid for circuit switched and packet switched traffic.
- h) UMTS.
- i) One usage of this measurement is to support the coverage ratio (CR) calculation for EE coverage area determination in [21].

4.4.1.3 Successful RRC connection establishments

- a) This measurement provides the number of successful RRC establishments for each establishment cause.
- b) CC
- c) Receipt by the RNC of a RRC CONNECTION SETUP COMPLETE message following a RRC establishment attempt. Each RRC Connection Setup Complete message received is added to the relevant per cause measurement. The possible causes are included in TS 25.331 [4]. The sum of all supported per cause measurements shall equal the total number of RRC Connection Establishments. In case only a subset of per cause measurements is supported, a sum subcounter will be provided first.
- d) Each measurement is an integer value. The number of measurements is equal to the number of causes plus a possible sum value identified by the *.sum* suffix.
- e) The measurement name has the form RRC.SuccConnEstab.*Cause* where *Cause* identifies the Establishment Cause.
- f) UtranCellFDD
UtranCellTDDLcr
UtranCellTDDHer
- g) Valid for circuit switched and packet switched traffic.
- h) UMTS.
- i) One usage of this measurement is to support the coverage ratio (CR) calculation for EE coverage area determination in [21].

4.4.2 RRC connection establishment setup time

4.4.2.1 RRC connection set-up time (Mean)

- a) This measurement provides the mean time per establishment cause it takes for the RNC to establish a RRC connection during each granularity period. The measurement is split into subcounters per establishment cause.
- b) DER (n=1)
- c) This measurement is obtained by accumulating the time intervals for every successful RRC connection establishment per establishment cause between the receipt by the RNC from the UE of a "RRC CONNECTION REQUEST" and the corresponding "RRC CONNECTION SETUP COMPLETE" message over a granularity period using DER. The end value of this time will then be divided by the number of successful RRC connections observed in the granularity period to give the arithmetic mean, the accumulator shall be reinitialised at the beginning of each granularity period. The measurement is split into subcounters per establishment cause, see TS 25.331 [4].

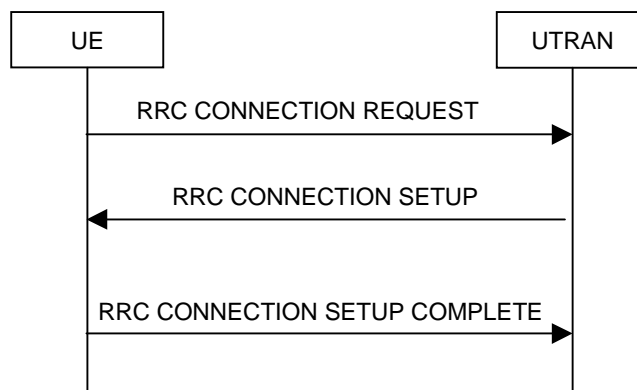

Figure

- d) Each measurement is an integer value.(in milliseconds)
- e) RRC.AttConnEstabTimeMean.Cause
where *Cause* identifies the Establishment Cause.
- f) UtranCellFDD
UtranCellTDDLcr
UtranCellTDDHcr
- g) Valid for circuit switched and packet switched traffic
- h) UMTS

4.4.2.2 RRC connection set-up time (Max)

- a) This measurement provides the maximum time per establishment cause it takes for the RNC in order to establish a RRC connection during each granularity period. The measurement is split into subcounters per establishment cause.
- b) GAUGE
- c) This measurement is obtained by monitoring the time intervals for each successful RRC connection establishment per establishment cause between the receipt by the RNC from the UE of a "RRC CONNECTION REQUEST" and the corresponding "RRC CONNECTION SETUP COMPLETE" message, see TS 25.331 [4]. The high tide mark of this time will be stored in a gauge, the gauge shall be reinitialised at the beginning of each granularity period. The measurement is split into subcounters per establishment cause.

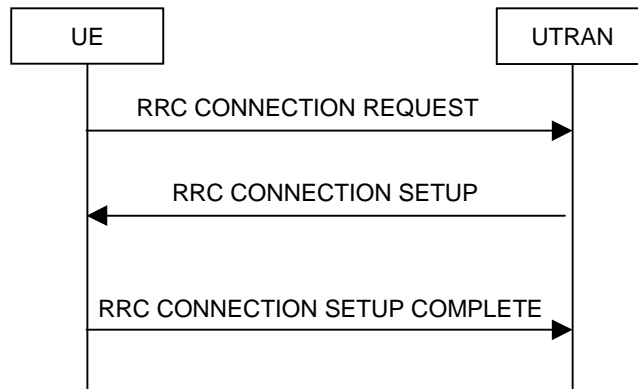
**Figure**

- d) Each measurement is an integer value.(in milliseconds)
- e) `RRC.AttConnEstabTimeMax.Cause`
where *Cause* identifies the Establishment Cause.
- f) UtranCellFDD
UtranCellTDDLcr
UtranCellTDDHcr
- g) Valid for circuit switched and packet switched traffic
- h) UMTS

4.4.3 RRC connection usage

4.4.3.1 General

The amount of RRC connections can be used to indicate user loading levels.

4.4.3.2 RRC connection usage (Mean)

- 1) This measurement provides the average number of simultaneous RRC connections.
- 2) SI
- 3) This measurement is obtained by sampling at a pre-defined interval, the amount of successful RRC connections for each UtranCell and then taking the arithmetic mean.
- 4) A single integer value
- 5) RRC.MeanConn
- 6) UtranCellFDD
UtranCellTDDLcr
UtranCellTDDHcr
- 7) Valid for circuit switched and packet switched traffic
- 8) UMTS

4.4.3.3 RRC connection usage (Maximum)

- a) This measurement provides the maximum number of simultaneous RRC connections.
- b) SI
- c) This measurement is obtained by sampling at a pre-defined interval, the amount of successful RRC connections for each UtranCell and then taking the maximum.
- d) A single integer value
- e) RRC.MaxConn.
- f) UtranCellFDD
UtranCellTDDLcr
UtranCellTDDHcr
- g) Valid for circuit switched and packet switched traffic
- h) UMTS

4.4.3.4 RRC connection usage per UE multi-mode/multi-RAT capability

- a) This measurement provides RRC connection usage in utran cell per UE multi-mode/multi-RAT capability. The measurement is split into subcounters per UE multi-mode/multi-RAT capability. (See TS 25.331 [4] Clause 10.3.3.41).
- b) DER (n=1)
- c) This measurement is obtained by accumulating the time intervals for every successful RRC connection between the receipt of a RRC CONNECTION SETUP COMPLETE and transmission of the corresponding RRC CONNECTION RELEASE message by the RNC. The possible UE multi-mode/multi-RAT capabilities are included in TS 25.331 [4] Clause 10.3.3.41. One or more subcounters are stepped based on received UE multi-mode/multi-RAT capabilities.
- d) Each measurement is an integer value. (in seconds)

- e) RRC.ConnUsage.fdd
 - RRC.ConnUsage.tdd
 - RRC.ConnUsage.fdd-tdd
 - RRC.ConnUsage.supportOfGSM
 - RRC.ConnUsage.supportOfMulticarrier
 - RRC.ConnUsage.supportOfEUTRAFDD
 - RRC.ConnUsage.supportOfEUTRATDD
- f) UtranCellFDD
 - UtranCellTDDLcr
 - UtranCellTDDHcr
- g) Valid for circuit switched and packet switched traffic
- h) UMTS

4.5 RRC connection re-establishment

4.5.0 Introduction

The three measurement types defined in the subclause 4.5.n are subject to the "2 out of 3 approach".

4.5.1 Attempted RRC re-establishments

- a) This measurement provides the number of RRC re-establishments attempts.
- b) CC
- c) Receipt by the RNC of a CELL UPDATE message using the Cell Update cause "Radio link failure". See TS 25.331 [4].
- d) A single integer value
- e) RRC.AttConnReEstab.
- f) UtranCellFDD
UtranCellTDDLcr
UtranCellTDDHcr
- g) Valid for circuit switched and packet switched traffic
- h) UMTS

4.5.2 Failed RRC re-establishments

- a) This measurement provides the number of RRC re-establishment failures.
- b) CC
- c) Transmission of an RRC Connection Release message by RNC to the UE or an expected UTRAN Mobility Information Confirm message not received by RNC from the UE. See TS 25.331 [4].
Each RRC Connection Release message received is added to the relevant per cause measurement. The possible causes are included in TS 25.331 [4].
Each expected UTRAN Mobility Information Confirm message not received by the RNC is added to the measurement cause 'No Reply' (not specified in TS 25.331 [4]).
The sum of all supported per cause measurements shall equal the total number of RRC re-establishment failures. In case only a subset of per cause measurements is supported, a sum subcounter will be provided first.
- d) Each measurement is an integer value. The number of measurements is equal to the number of causes plus a possible sum value identified by the *.sum* suffix.
- e) The measurement name has the form RRC.FailConnReEstab.*Cause* where *Cause* identifies the Failure Cause.
The cause 'No Reply' is identified by the *.NoReply* suffix.
- f) UtranCellFDD
UtranCellTDDLcr
UtranCellTDDHcr
- g) Valid for circuit switched and packet switched traffic
- h) UMTS

4.5.3 Successful RRC re-establishments

- a) This measurement provides the number of successful RRC re-establishments.
- b) CC
- c) Receipt by the RNC of a UTRAN MOBILITY INFORMATION CONFIRM in a CELL UPDATE procedure using the value cause "Radio link failure". See TS 25.331 [4].
- d) A single integer value
- e) RRC.SuccConnReEstab.
- f) UtranCellFDD
UtranCellTDDLcr
UtranCellTDDHcr
- g) Valid for circuit switched and packet switched traffic
- h) UMTS

4.6 RRC connection release

4.6.1 Attempted RRC connection releases on DCCH

- a) This measurement provides the number of RRC connection release attempts per release cause sent from UTRAN to the UE on the DCCH.
- b) CC
- c) Transmission of an RRC CONNECTION RELEASE message by the RNC to the UE on DCCH. Each RRC Connection Release message sent on DCCH is added to the relevant per cause measurement. The possible causes are included in TS 25.331 [4]. The sum of all supported per cause measurements shall equal the total number of RRC Connection Release attempts on DCCH. In case only a subset of per cause measurements is supported, a sum subcounter will be provided first.
- d) Each measurement is an integer value. The number of measurements is equal to the number of causes plus a possible sum value identified by the *.sum* suffix.
- e) The measurement name has the form RRC.AttConnRelDCCH.*Cause* where *Cause* identifies the Release Cause.
- f) UtranCellFDD
UtranCellTDDLcr
UtranCellTDDHcr
- g) Valid for circuit switched and packet switched traffic
- h) UMTS

4.6.2 Attempted RRC connection releases on CCCH

- a) This measurement provides the number of RRC connection release attempts per release cause sent from UTRAN to the UE on the CCCH.
- b) CC
- c) Transmission by the RNC of an RRC CONNECTION RELEASE message to the UE on CCCH. Each RRC Connection Release message sent on CCCH is added to the relevant per cause measurement. The possible causes are included in TS 25.331 [4]. The sum of all supported per cause measurements shall equal the total number of RRC Connection Release attempts on CCCH. In case only a subset of per cause measurements is supported, a sum subcounter will be provided first.
- d) Each measurement is an integer value. The number of measurements is equal to the number of causes plus a possible sum value identified by the *.sum* suffix.
- e) The measurement name has the form RRC.AttConnRelCCCH.*Cause* where *Cause* identifies the Release Cause.
- f) UtranCellFDD
UtranCellTDDLcr
UtranCellTDDHcr
- g) Valid for circuit switched and packet switched traffic
- h) UMTS

4.7 RLC connection

4.7.1 Number of RLC blocks sent (per Mode)

- a) This measurement provides the number of RLC blocks sent by the RNC including retransmitted blocks.
- b) CC
- c) Transmission of RLC block, see TS 25.322 [10].
- d) RLC.NbrBlocksSent.TM
RLC.NbrBlocksSent.UM
RLC.NbrBlocksSent.AM
- e) A single integer value
- f) RncFunction, per Mode (Transparent, Unacknowledged and Acknowledged).
- g) Valid for packet switching and circuit switching.
- h) UMTS

4.7.2 Number of RLC blocks Received (per Mode)

- a) This measurement provides the number of received RLC blocks by the RNC.
- b) CC
- c) Receipt of a RLC blocks from a peer entity and before any error checking, see TS 25.322 [10].
- d) RLC.NbrBlocksReceived.TM
RLC.NbrBlocksReceived.UM
RLC.NbrBlocksReceived.AM
- e) A single integer value
- f) RncFunction per Mode (Transparent, Unacknowledged and Acknowledged).
- g) Valid for packet switching and circuit switching.
- h) UMTS

4.7.3 Discarded RLC blocks by RNC

- a) This measurement provides the number of discarded RLC blocks in case of error detection in the RNC (uplink transmission, RNC).
- b) CC
- c) Discard of a received block in the RNC, see TS 25.322 [10].
- d) RLC.DiscardedBlocksByRNC.
- e) A single integer value
- f) RncFunction
- g) Valid for packet switching.
- h) UMTS

4.7.4 Number of Retransmitted RLC blocks in Acknowledge Mode

- a) This measurement provides the number of retransmitted RLC blocks in RLC acknowledge mode, detected in the UE and signalled to the RNC (downlink transmission, UE).
- b) CC
- c) Receipt of a NACK or SACK block from the peer entity (UE) , see TS 25.322 [10].
- d) RLC.RetransmittedBlocksToUE.
- e) A single integer value
- f) RncFunction
- g) Valid for packet switching.
- h) UMTS

4.8 Soft handover

4.8.1 Radio link additions to active link set (UE side)

4.8.1.0 Introduction

The three measurement types defined in the subclause 4.8.1.n for the radio link additions to active link set (UE side) are subject to the "2 out of 3 approach".

4.8.1.1 Attempted radio link additions to active link set (UE side)

- a) This measurement provides the number of attempted radio link additions during active link set update procedure (UE side) for each cell. This measurement shall be increased for each attempted radio link addition (UE side). This measurement is only valid for FDD mode.
- b) CC
- c) Transmission of an ACTIVE SET UPDATE message (RRC) by the serving RNC to the UE. Within an ACTIVE SET UPDATE message more than one radio link can be added. Each existing radio link addition information element shall be considered separately (see TS 25.331 [4]).
- d) A single integer value
- e) SHO.AttRLAddUESide.
- f) UtranCellFDD
- g) Valid for circuit switched and packet switched traffic
- h) UMTS

4.8.1.2 Successful radio link additions to active link set (UE side)

- a) This measurement provides the number of successful radio link additions during active link set update procedure (UE side) for each cell. This measurement shall be increased for each successful radio link addition (UE side). This measurement is only valid for FDD mode.
- b) CC
- c) Receipt of an ACTIVE SET UPDATE COMPLETE message (RRC), sent by the UE to the SERVING RNC, in response to an ACTIVE SET UPDATE message with one or more existing radio link addition information element. One ACTIVE SET UPDATE COMPLETE message can be related to more than one added radio link. Each successful added radio link shall be considered separately (see TS 25.331 [4]).
- d) A single integer value
- e) SHO.SuccRLAddUESide.
- f) UtranCellFDD
- g) Valid for circuit switched and packet switched traffic
- h) UMTS

4.8.1.3 Failed radio link additions to active link set (UE side)

- a) This measurement provides the number of failed radio link additions during active link set Update procedure (UE side) for each cell per cause. For each failure cause a separate subcounter is defined. Every failed radio link addition (UE side) shall be considered separately. This measurement is only valid for FDD mode.
- b) CC

- c) Receipt of an ACTIVE SET UPDATE FAILURE message (RRC) sent by UE to the UTRAN in response to an ACTIVE SET UPDATE message with non-empty radio link addition information element or an expected ACTIVE SET UPDATE COMPLETE message not received by the RNC. Each message can be related to more than one radio link.
- Each failed attempt to add a radio link shall be considered separately and added to the relevant per cause measurement. Failure causes are defined within TS 25.331 [4].
 - Each expected ACTIVE SET UPDATE COMPLETE message not received by the RNC is added to the measurement cause 'No Reply' (not specified in TS 25.331 [4]).
 - The sum of all supported per cause measurements shall equal the total number of failures. In case only a subset of per cause measurements is supported, a sum subcounter will be provided first.
- d) Each measurement is an integer value. The number of measurements is equal to the number of causes supported plus a possible sum value identified by the *.sum* suffix.
- e) The measurement name has the form SHO.FailRLAddUESide.*Cause* where *Cause* identifies the failure cause.
The cause 'No Reply' is identified by the *.NoReply* suffix.
- f) UtranCellFDD
- g) Valid for circuit switched and packet switched traffic
- h) UMTS

4.8.2 Radio link deletions from active link set (UE side)

4.8.2.1 Attempted radio link deletions from active link set (UE side)

- a) This measurement provides the number of attempted radio link deletions during active link set update procedure (UE side) for each cell. This measurement shall be increased for each attempted radio link deletion (UE side). This measurement is only valid for FDD mode.
- b) CC
- c) Transmission of an ACTIVE SET UPDATE message (RRC) by the SERVING RNC to the UE. Within an ACTIVE SET UPDATE message more than one radio link can be removed. Each existing radio link removal information element shall be considered separately (see TS 25.331 [4]).
- d) A single integer value
- e) SHO.AttRLDelUESide.
- f) UtranCellFDD
- g) Valid for circuit switched and packet switched traffic
- h) UMTS

4.8.2.2 Successful radio link deletions from active link set (UE side)

- a) This measurement provides the number of successful radio link deletions during active link set update procedure (UE side) for each cell. This measurement shall be increased for each successful radio link deletion (UE side). This measurement is only valid for FDD mode.
- b) CC
- c) Receipt of an ACTIVE SET UPDATE COMPLETE message (RRC) sent by UE to the Serving RNC in response to an ACTIVE SET UPDATE message with one or more existing radio link removal information element. One ACTIVE SET UPDATE COMPLETE message can be related to more than one deleted radio link. Each successful deleted radio link shall be considered separately (see TS 25.331 [4]).
- d) A single integer value
- e) SHO.SuccRLDelUESide.
- f) UtranCellFDD
- g) Valid for circuit switched and packet switched traffic
- h) UMTS

4.8.3 Measurements related to the soft handover radio link

4.8.3.0 Introduction

The following measurements are provided at the best UTRAN cell of the active set (UE side).

The "best" FDD cell has the largest value when the measurement quantity is "Ec/No" or "RSCP". On the other hand, the "best" cell has the smallest value when the measurement quantity is "Pathloss". See TS 25.331 [4].

The other UTRAN cell is other than the best UTRAN cell of active set (UE side).

4.8.3.1 Mean number of the radio link established by the best UTRAN cell

- a) This measurement provides the mean number of the radio link established by the measured UTRAN cell that is the best UTRAN cell of active set (UE side).
- b) SI.
- c) This measurement is obtained by RNC sampling at a pre-defined interval the number of the radio link established by the best UTRAN cell of active set (UE side), and then taking the arithmetic mean.
- d) A single integer value
- e) SHO.MeanNbrRLEstab.
- f) UtranCellFDD
- g) Valid for circuit switched and packet switched traffic
- h) UMTS

4.8.3.2 Mean number of the radio link established by other UTRAN cell

- a) This measurement provides the mean number of the radio link established by other UTRAN cell that is other than the best UTRAN cell of active set (UE side), also the best UTRAN cell of active set (UE side) is measured UTRAN cell.
- b) SI.
- c) This measurement is obtained by RNC sampling at a pre-defined interval the number of the radio link established by the other UTRAN cell that is other than the best UTRAN cell of active set (UE side), and then taking the arithmetic mean.
- d) A single integer value
- e) SHO.MeanNbrRLEstabByOthCell.
- f) UtranCellFDD
- g) Valid for circuit switched and packet switched traffic
- h) UMTS

4.9 Radio link management procedures

4.9.1 Overview

4.9.1.1 Considered radio link management procedures

Performance Measurement definitions in subclause 4.9 are based on the TS 25.423 [6] and TS 25.433 [7].

The following paragraphs are of interest for this purpose:

- Radio Link Setup (NBAP);
- Radio Link Addition (NBAP);
- Radio Link Deletion (NBAP);
- Radio Link Setup (RNSAP);
- Radio Link Addition (RNSAP);
- Radio Link Deletion (RNSAP);
- RADIO LINK SETUP REQUEST (NBAP);
- RADIO LINK SETUP RESPONSE (NBAP);
- RADIO LINK SETUP FAILURE (NBAP);
- RADIO LINK ADDITION REQUEST (NBAP);
- RADIO LINK ADDITION RESPONSE (NBAP);
- RADIO LINK ADDITION FAILURE (NBAP);
- RADIO LINK DELETION REQUEST (NBAP);
- RADIO LINK DELETION RESPONSE (NBAP);
- RADIO LINK SETUP REQUEST (RNSAP);
- RADIO LINK SETUP RESPONSE (RNSAP);
- RADIO LINK SETUP FAILURE (RNSAP);
- RADIO LINK ADDITION REQUEST (RNSAP);
- RADIO LINK ADDITION RESPONSE (RNSAP);
- RADIO LINK ADDITION FAILURE (RNSAP);
- RADIO LINK DELETION REQUEST (RNSAP);
- RADIO LINK DELETION RESPONSE (RNSAP).

These paragraphs show in particular the following diagrams:

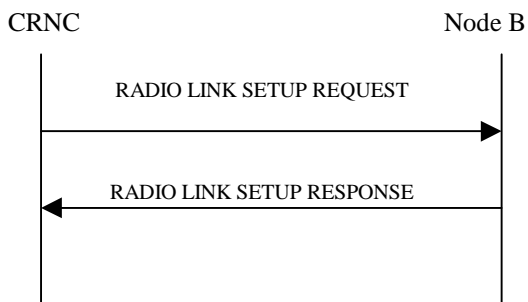

Figure: Radio Link Setup procedure on Iub, Successful Operation

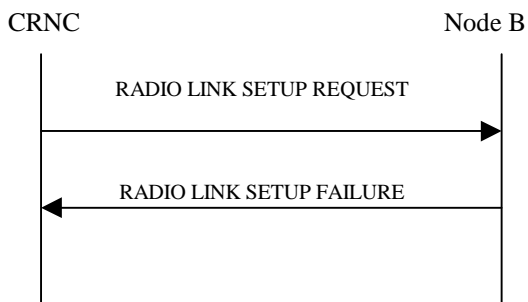

Figure: Radio Link Setup procedure on Iub, Unsuccessful Operation

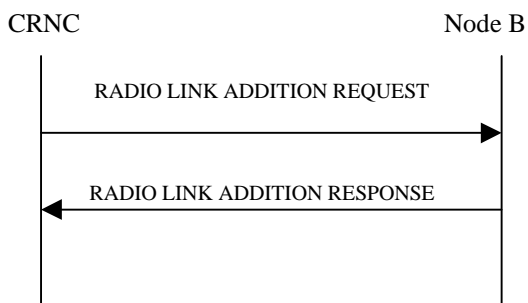

Figure: Radio Link Addition procedure on Iub, Successful Operation

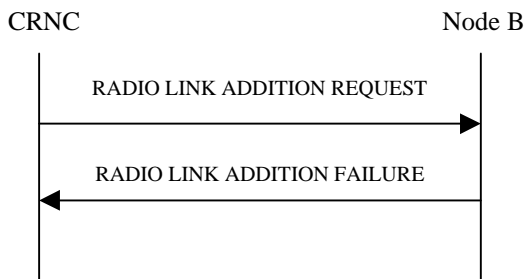

Figure: Radio Link Addition procedure on Iub, Unsuccessful Operation

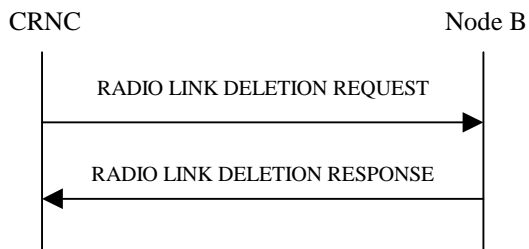

Figure: Radio Link Deletion procedure on Iub, Successful Operation

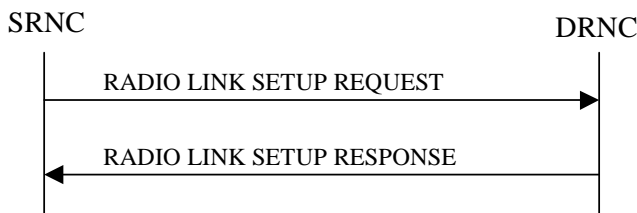

Figure: Radio Link Setup procedure on Iur, Successful Operation

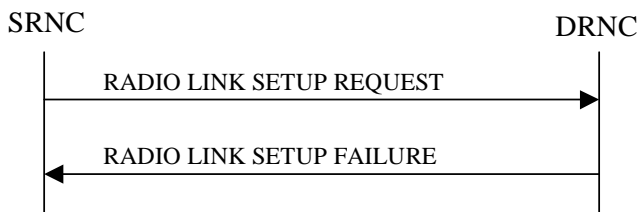

Figure: Radio Link Setup procedure on Iur, Unsuccessful Operation

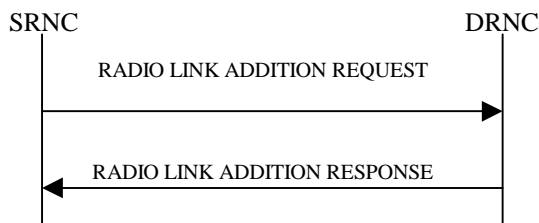

Figure: Radio Link Addition procedure on Iur, Successful Operation

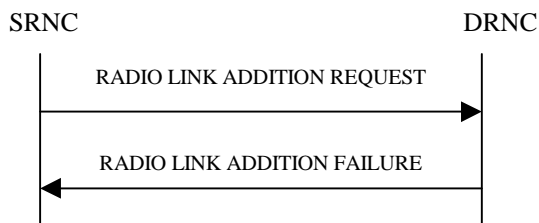

Figure: Radio Link Addition procedure on Iur, Unsuccessful Operation

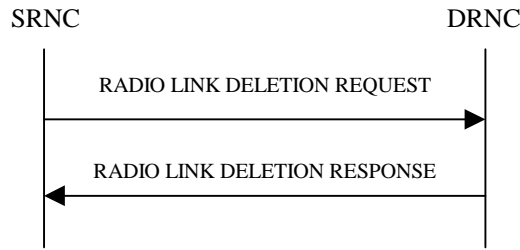

Figure: Radio Link Deletion procedure on Iur, Successful Operation

4.9.1.2 Relation between Iub measurements and Iur measurements

The following figure shows the relation between Iub interface and Iur interface. There are two cases for SRNC (CRNC1) to request radio link management activities in this figure.

In case (1), SRNC (CRNC1) sets up/adds/deletes radio links in NodeB1 and NodeB1 is directly controlled by SRNC (CRNC1).

In case (2/2bis), NodeB2 is directly controlled by DRNC (CRNC2). If SRNC (CRNC1) wants to set up/add/delete radio links in NodeB2, SRNC (CRNC1) will send request to DRNC (CRNC2), and DRNC (CRNC2) set up/add/delete radio links in NodeB2. In such case, if DRNC (CRNC2) fails to set up/add radio links in NodeB2 and receives failure message from NodeB2, DRNC (CRNC2) will send failure message back to SRNC (CRNC1). Furthermore if DRNC (CRNC2) has problem inside and fails to send request to NodeB2, it will send failure message back to the SRNC (CRNC1) directly.

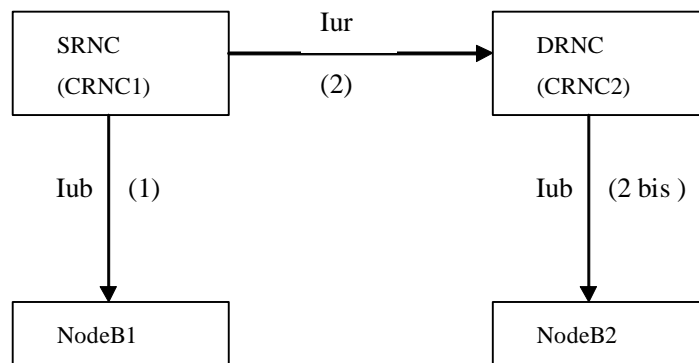

Figure: Relation between Iub interface and Iur interface

Subclause 4.9 has separated measurements for both Iur interface and Iub interface. From the above figure and description, we can see that the Iub interface measurements and Iur interface measurements overlap in some degree. Based on maintenance requirements, these two kinds measurements are needed and they are useful for operators to evaluate both the Iub interface and Iur interface, and to analyze all the failure cases they concern.

4.9.2 Radio link setups on Iub

4.9.2.0 Introduction

The three measurement types defined in the subclauses 4.9.2.n for radio link setups on Iub are subject to the "2 out of 3 approach".

4.9.2.1 Attempted radio link setups on Iub

- a) This measurement provides the number of attempted radio link setups on Iub for each cell. This measurement shall be increased for each attempted radio link setup on Iub. This measurement is valid for FDD and TDD mode.
- b) CC
- c) Transmission of a RADIO LINK SETUP REQUEST message (NBAP) by the controlling RNC to the NodeB. Within a RADIO LINK SETUP REQUEST message more than one radio link can be set up. Each existing radio link information element shall be considered separately (see TS 25.433 [7]).
- d) A single integer value
- e) RLM.AttRLSetupIub.
- f) UtranCellFDD
UtranCellTDDLcr
UtranCellTDDHcr
- g) Valid for circuit switched and packet switched traffic
- h) UMTS

4.9.2.2 Successful radio link setups on Iub

- a) This measurement provides the number of successful radio link setups on Iub for each cell. This measurement shall be increased for each successful radio link setup on Iub. This measurement is valid for FDD and TDD mode.
- b) CC
- c) This measurement is based on two different events:
 - Receipt of a RADIO LINK SETUP RESPONSE message (NBAP) sent by NodeB to the controlling RNC in response to a RADIO LINK SETUP REQUEST message with one or more existing radio link information elements. One RADIO LINK SETUP RESPONSE message can be related to more than one radio link. Each radio link that is set up successfully shall be considered separately (see TS 25.433 [7]).
 - Receipt of a RADIO LINK SETUP FAILURE message (NBAP) sent by NodeB to the controlling RNC in response to a RADIO LINK SETUP REQUEST message with at least one Successful RL Information Response information element. One RADIO LINK SETUP FAILURE message can be related to more than one radio link. Each radio link that is set up successfully shall be considered separately (see TS 25.433 [7]).
- d) A single integer value
- e) RLM.SuccRLSetupIub.
- f) UtranCellFDD
UtranCellTDDLcr
UtranCellTDDHcr
- g) Valid for circuit switched and packet switched traffic
- h) UMTS

4.9.2.3 Failed radio link setups on Iub

- a) This measurement provides the number of failed radio link setups on Iub for each cell. This measurement shall be increased for each failed radio link setup on Iub. For each failure cause a separate measurement is defined. Every failed radio link setup on Iub shall be considered separately. This measurement is valid for FDD and TDD mode.
- b) CC
- c) Receipt of a RADIO LINK SETUP FAILURE message (NBAP) sent by NodeB to the controlling RNC in response to a RADIO LINK SETUP REQUEST message with one or more existing radio link information elements. One RADIO LINK SETUP FAILURE message can be related to more than one radio link. Each failed attempt to set up a radio link shall be considered separately. Failure causes are defined within TS 25.433 [7].

Each expected RADIO LINK SETUP RESPONSE or RADIO LINK SETUP FAILURE not received by the controlling RNC is added to the measurement cause 'No Reply' (not specified in TS 25.433 [7]).

The sum of all supported per cause measurements shall equal the total number of failures. In case only a subset of per cause measurements is supported, a sum measurement subtype will be provided first.

- d) Each measurement is an integer value. The number of measurements is equal to the number of causes supported plus a possible sum value identified by the *.sum* suffix.
- e) The measurement name has the form RLM.FailRLSetupIub.*Cause* where *Cause* identifies the failure cause.
- f) UtranCellFDD
UtranCellTDDLcr
UtranCellTDDHcr
- g) Valid for circuit switched and packet switched traffic
- h) UMTS

4.9.3 Radio link setups on Iur

4.9.3.0 Introduction

The three measurement types defined in the subclauses 4.9.3.n for radio link setups on Iur are subject to the "2 out of 3 approach".

4.9.3.1 Attempted radio link setups on Iur

- a) This measurement provides the number of attempted radio link setups on Iur for each cell. This measurement shall be increased for each attempted radio link setup on Iur. This measurement is valid only for FDD mode.
- b) CC
- c) Receipt of a RADIO LINK SETUP REQUEST message (RNSAP) sent by the serving RNC to the drift RNC. Within a RADIO LINK SETUP REQUEST message more than one radio link can be set up. Each existing radio link information element shall be considered separately (see TS 25.423 [6]).
- d) A single integer value
- e) RLM.AttRLSetupIur.
- f) UtranCellFDD
- g) Valid for circuit switched and packet switched traffic
- h) UMTS

4.9.3.2 Successful radio link setups on Iur

- a) This measurement provides the number of successful radio link setups on Iur for each cell. This measurement shall be increased for each successful radio link setup on Iur. This measurement is valid only for FDD mode.
- b) CC
- c) This measurement is based on two different events:
 - Transmission of a RADIO LINK SETUP RESPONSE message (RNSAP) by the drift RNC to the serving RNC in response to a RADIO LINK SETUP REQUEST message with one or more existing radio link information elements. One RADIO LINK SETUP RESPONSE message can be related to more than one radio link. Each radio link that is set up successfully shall be considered separately (see TS 25.423 [6]).
 - Transmission of a RADIO LINK SETUP FAILURE message (RNSAP) by the drift RNC to the serving RNC in response to a RADIO LINK SETUP REQUEST message with at least one Successful RL Information Response information element. One RADIO LINK SETUP FAILURE message can be related to more than one radio link. Each radio link that is set up successfully shall be considered separately (see TS 25.423 [6]).
- d) A single integer value
- e) RLM.SuccRLSetupIur.
- f) UtranCellFDD
- g) Valid for circuit switched and packet switched traffic
- h) UMTS

4.9.3.3 Failed radio link setups on Iur

- a) This measurement provides the number of failed radio link setups on Iur for each cell. This measurement shall be increased for each failed radio link setup on Iur. For each failure cause a separate measurement is defined. Every failed radio link setup on Iur shall be considered separately. This measurement is valid only for FDD mode.
- b) CC

- c) Transmission of a RADIO LINK SETUP FAILURE message (RNSAP) by the drift RNC to the serving RNC in response to a RADIO LINK SETUP REQUEST message with one or more existing radio link information elements. One RADIO LINK SETUP FAILURE message can be related to more than one radio link. Each failed attempt to set up a radio link shall be considered separately. Failure causes are defined within TS 25.423 [6].

The sum of all supported per cause measurements shall equal the total number of failures. In case only a subset of per cause measurements is supported, a sum measurement subtype will be provided first.

- d) Each measurement is an integer value. The number of measurements is equal to the number of causes supported plus a possible sum value identified by the *.sum* suffix.
- e) The measurement name has the form RLM.FailRLSetupIur.*Cause* where *Cause* identifies the failure cause.
- f) UtranCellFDD
- g) Valid for circuit switched and packet switched traffic
- h) UMTS

4.9.4 Radio link additions on Iub

4.9.4.0 Introduction

The three measurement types defined in the subclauses 4.9.4.n for radio link additions on Iub are subject to the "2 out of 3 approach".

4.9.4.1 Attempted radio link additions on Iub

- a) This measurement provides the number of attempted radio link additions on Iub for each cell. This measurement shall be increased for each attempted radio link addition on Iub. This measurement is valid for FDD and TDD mode.
- b) CC
- c) Transmission of a RADIO LINK ADDITION REQUEST message (NBAP) by the controlling RNC to the NodeB. Within a RADIO LINK ADDITION REQUEST message more than one radio link can be added. Each existing radio link information element shall be considered separately (see TS 25.433 [7]).
- d) A single integer value
- e) RLM.AttRLAddIub.
- f) UtranCellFDD
UtranCellTDDLcr
UtranCellTDDHcr
- g) Valid for circuit switched and packet switched traffic
- h) UMTS

4.9.4.2 Successful radio link additions on Iub

- a) This measurement provides the number of successful radio link additions on Iub for each cell. This measurement shall be increased for each successful radio link addition on Iub. This measurement is valid for FDD and TDD mode.
- b) CC
- c) This measurement is based on two different events:
 - Receipt of a RADIO LINK ADDITION RESPONSE message (NBAP) sent by NodeB to the controlling RNC in response to a RADIO LINK ADDITION REQUEST message with one or more existing radio link information elements. One RADIO LINK ADDITION RESPONSE message can be related to more than one added radio link. Each successful added radio link shall be considered separately (see TS 25.433 [7]).
 - Receipt of a RADIO LINK ADDITION FAILURE message (NBAP) sent by NodeB to the controlling RNC in response to a RADIO LINK ADDITION REQUEST message with at least one Successful RL Information Response information element. One RADIO LINK ADDITION FAILURE message can be related to more than one radio link. Each successful added radio link shall be considered separately (see TS 25.433 [7]).
- d) A single integer value
- e) RLM.SuccRLAddIub.
- f) UtranCellFDD
UtranCellTDDLcr
UtranCellTDDHcr
- g) Valid for circuit switched and packet switched traffic
- h) UMTS

4.9.4.3 Failed radio link additions on Iub

- a) This measurement provides the number of failed radio link additions on Iub for each cell. This measurement shall be increased for each failed radio link addition on Iub. For each failure cause a separate measurement is defined. Every failed radio link addition on Iub shall be considered separately. This measurement is valid for FDD and TDD mode.
- b) CC
- c) Receipt of a RADIO LINK ADDITION FAILURE message (NBAP) sent by NodeB to the controlling RNC in response to a RADIO LINK ADDITION REQUEST message with one or more existing radio link information elements. One RADIO LINK ADDITION FAILURE message can be related to more than one radio link. Each failed attempt to add a radio link shall be considered separately. Failure causes are defined within TS 25.433 [7].

Each expected RADIO LINK ADDITION RESPONSE or RADIO LINK ADDITION FAILURE not received by the controlling RNC is added to the measurement cause 'No Reply' (not specified in TS 25.433 [7]).

The sum of all supported per cause measurements shall equal the total number of failures. In case only a subset of per cause measurements is supported, a sum measurement subtype will be provided first.

- d) Each measurement is an integer value. The number of measurements is equal to the number of causes supported plus a possible sum value identified by the *.sum* suffix.
- e) The measurement name has the form RLM.FailRLAddIub.*Cause* where *Cause* identifies the failure cause.
- f) UtranCellFDD
UtranCellTDDLcr
UtranCellTDDHcr
- g) Valid for circuit switched and packet switched traffic
- h) UMTS

4.9.5 Radio link additions on Iur

4.9.5.0 Introduction

The three measurement types defined in the subclauses 4.9.5.n for radio link additions on Iur are subject to the "2 out of 3 approach".

4.9.5.1 Attempted radio link additions on Iur

- a) This measurement provides the number of attempted radio link additions on Iur for each cell. This measurement shall be increased for each attempted radio link addition on Iur. This measurement is valid only for FDD mode.
- b) CC
- c) Receipt of a RADIO LINK ADDITION REQUEST message (RNSAP) sent by the serving RNC to the drift RNC. Within a RADIO LINK ADDITION REQUEST message more than one radio link can be added. Each existing radio link information element shall be considered separately (see TS 25.423 [6]).
- d) A single integer value
- e) RLM.AttRLAddIur.
- f) UtranCellFDD
- g) Valid for circuit switched and packet switched traffic
- h) UMTS

4.9.5.2 Successful radio link additions on Iur

- a) This measurement provides the number of successful radio link additions on Iur for each cell. This measurement shall be increased for each successful radio link addition on Iur. This measurement is valid only for FDD mode.
- b) CC
- c) This measurement is based on two different events:
 - Transmission of a RADIO LINK ADDITION RESPONSE message (RNSAP) by the drift RNC to the serving RNC in response to a RADIO LINK ADDITION REQUEST message with one or more existing radio link information elements. One RADIO LINK ADDITION RESPONSE message can be related to more than one added radio link. Each successful added radio link shall be considered separately (see TS 25.423 [6]).
 - Transmission of a RADIO LINK ADDITION FAILURE message (RNSAP) by the drift RNC to the serving RNC in response to a RADIO LINK ADDITION REQUEST message with at least one Successful RL Information Response information element. One RADIO LINK ADDITION FAILURE message can be related to more than one radio link. Each successful added radio link shall be considered separately (see TS 25.423 [6]).
- d) A single integer value
- e) RLM.SuccRLAddIur.
- f) UtranCellFDD
- g) Valid for circuit switched and packet switched traffic
- h) UMTS

4.9.5.3 Failed radio link additions on Iur

- a) This measurement provides the number of failed radio link additions on Iur for each cell. This measurement shall be increased for each failed radio link addition on Iur. For each failure cause a separate measurement is defined. Every failed radio link addition shall be considered separately. This measurement is valid only for FDD mode.

- b) CC
- c) Transmission of a RADIO LINK ADDITION FAILURE message (RNSAP) by the drift RNC to the serving RNC in response to a RADIO LINK ADDITION REQUEST message with one or more existing radio link information elements. One RADIO LINK ADDITION FAILURE message can be related to more than one radio link. Each failed attempt to add a radio link shall be considered separately. Failure causes are defined within TS 25.423 [6].

The sum of all supported per cause measurements shall equal the total number of Failures. In case only a subset of per cause measurements is supported, a sum measurement subtype will be provided first.

- d) Each measurement is an integer value. The number of measurements is equal to the number of causes supported plus a possible sum value identified by the *.sum* suffix.
- e) The measurement name has the form RLM.FailRLAddIur.*Cause* where *Cause* identifies the failure cause.
- f) UtranCellFDD
- g) Valid for circuit switched and packet switched traffic
- h) UMTS

4.9.6 Radio link deletions on Iub

4.9.6.1 Attempted radio link deletions on Iub

- a) This measurement provides the number of attempted radio link deletions on Iub for each cell. This measurement shall be increased for each attempted radio link deletion on Iub. This measurement is valid for FDD and TDD mode.
- b) CC
- c) Transmission of a RADIO LINK DELETION REQUEST message (NBAP) by the controlling RNC to the NodeB. Within a RADIO LINK DELETION REQUEST message more than one radio link can be removed. Each existing radio link information element shall be considered separately (see TS 25.433 [7]).
- d) A single integer value
- e) RLM.AttRLDeIub.
- f) UtranCellFDD
UtranCellTDDLcr
UtranCellTDDHcr
- g) Valid for circuit switched and packet switched traffic
- h) UMTS

4.9.6.2 Successful radio link deletions on Iub

- a) This measurement provides the number of successful radio link deletions on Iub for each cell. This measurement shall be increased for each successful radio link deletion on Iub. This measurement is valid for FDD and TDD mode.
- b) CC
- c) Receipt of a RADIO LINK DELETION RESPONSE message (NBAP) sent by NodeB to the controlling RNC in response to a RADIO LINK DELETION REQUEST message with one or more existing radio link removal information element. One RADIO LINK DELETION RESPONSE message can be related to more than one deleted radio link. Each successful deleted radio link shall be considered separately (see TS 25.433 [7]).
- d) A single integer value
- e) RLM.SuccRLDeIub.
- f) UtranCellFDD
UtranCellTDDLcr
UtranCellTDDHcr
- g) Valid for circuit switched and packet switched traffic
- h) UMTS

4.9.7 Radio link deletions on Iur

4.9.7.1 Attempted radio link deletions on Iur

- a) This measurement provides the number of attempted radio link deletions on Iur for each cell. This measurement shall be increased for each attempted radio link deletion on Iur. This measurement is valid only for FDD mode.
- b) CC
- c) Receipt of a RADIO LINK DELETION REQUEST message (RNSAP) sent by the serving RNC to the drift RNC. Within a RADIO LINK DELETION REQUEST message more than one radio link can be removed. Each existing radio link information element shall be considered separately (see TS 25.423 [6]).
- d) A single integer value
- e) RLM.AttRLDeIur.
- f) UtranCellFDD
- g) Valid for circuit switched and packet switched traffic
- h) UMTS

4.9.7.2 Successful radio link deletions on Iur

- a) This measurement provides the number of successful radio link deletions on Iur for each cell. This measurement shall be increased for each successful radio link deletion on Iur. This measurement is valid only for FDD mode.
- b) CC
- c) Transmission of a RADIO LINK DELETION RESPONSE message (RNSAP) by the drift RNC to the serving RNC in response to a RADIO LINK DELETION REQUEST message with one or more existing radio link removal information element. One RADIO LINK DELETION RESPONSE message can be related to more than one deleted radio link. Each successful deleted radio link shall be considered separately (see TS 25.423 [6]).
- d) A single integer value
- e) RLM.SuccRLDeIur.
- f) UtranCellFDD
- g) Valid for circuit switched and packet switched traffic
- h) UMTS

4.10 Hard handover

4.10.1 Void

4.10.2 Outgoing intra-NodeB hard handovers

4.10.2.0 Introduction

The three measurement types defined in the subclause 4.10.2 for outgoing intra-NodeB hard handovers are subject to the "2 out of 3 approach".

4.10.2.1 Attempted outgoing intra-NodeB hard handovers

- a) This measurement provides the number of attempted outgoing intra-NodeB hard handovers.
- b) CC.
- c) Transmission of a RRC message PHYSICAL CHANNEL RECONFIGURATION, RADIO BEARER SETUP, RADIO BEARER RECONFIGURATION, RADIO BEARER RELEASE, or TRANSPORT CHANNEL RECONFIGURATION from the source RNC to the UE, indicating the attempt of an outgoing intra-NodeB hard handover (see TS 25.331 [4]).
- d) A single integer value.
- e) HHO.AttOutIntraNodeB.
- f) UtranCellFDD
UtranCellTDDLcr
UtranCellTDDHcr
- g) Valid for circuit switched and packet switched traffic.
- h) UMTS.

4.10.2.2 Successful outgoing intra-NodeB hard handovers

- a) This measurement provides the number of successful outgoing intra-NodeB hard handovers.
- b) CC.
- c) Receipt of a RRC message PHYSICAL CHANNEL RECONFIGURATION COMPLETE, RADIO BEARER SETUP COMPLETE, RADIO BEARER RECONFIGURATION COMPLETE, RADIO BEARER RELEASE COMPLETE, or TRANSPORT CHANNEL RECONFIGURATION COMPLETE sent from the UE to the source RNC, indicating a successful outgoing intra-NodeB hard handover (see TS 25.331 [4]).
- d) A single integer value.
- e) HHO.SuccOutIntraNodeB.
- f) UtranCellFDD
UtranCellTDDLcr
UtranCellTDDHcr
- g) Valid for circuit switched and packet switched traffic.
- h) UMTS.

4.10.2.3 Failed outgoing intra-NodeB hard handovers

- a) This measurement provides the number of failed outgoing intra-NodeB hard handovers per cause.
- b) CC.

- c) Receipt of a RRC message PHYSICAL CHANNEL RECONFIGURATION FAILURE, RADIO BEARER SETUP FAILURE, RADIO BEARER RECONFIGURATION FAILURE, RADIO BEARER RELEASE FAILURE, or TRANSPORT CHANNEL RECONFIGURATION FAILURE sent from the UE to the source RNC, indicating a failed outgoing intra-NodeB hard handover. Failure causes are defined within TS 25.331 [4].

Each expected RRC message PHYSICAL CHANNEL RECONFIGURATION COMPLETE, RADIO BEARER SETUP COMPLETE, RADIO BEARER RECONFIGURATION COMPLETE, RADIO BEARER RELEASE COMPLETE, TRANSPORT CHANNEL RECONFIGURATION COMPLETE, PHYSICAL CHANNEL RECONFIGURATION FAILURE, RADIO BEARER SETUP FAILURE, RADIO BEARER RECONFIGURATION FAILURE, RADIO BEARER RELEASE FAILURE, or TRANSPORT CHANNEL RECONFIGURATION FAILURE not received by the source RNC is added to the measurement cause 'No Reply' (not specified in TS 25.331 [4]).

The sum of all supported per cause measurements shall equal the total number of failed events. In case only a subset of per cause measurements is supported, a sum subcounter will be provided first.

- d) Each measurement is an integer value. The number of measurements is equal to the number of causes supported plus a possible sum value identified by the *.sum* suffix.
- e) The measurement name has the form HHO.FailOutIntraNodeB.*Cause* where *Cause* identifies the failure cause.
The cause 'No Reply' is identified by the *.NoReply* suffix.
- f) UtranCellFDD
UtranCellTDDLcr
UtranCellTDDHcr
- g) Valid for circuit switched and packet switched traffic.
- h) UMTS.

4.10.3 Outgoing inter-NodeB, intra-RNC hard handovers

4.10.3.0 Introduction

The three measurement types defined in the subclause 4.10.3 for outgoing inter-NodeB, intra-RNC hard handovers are subject to the "2 out of 3 approach".

4.10.3.1 Attempted outgoing inter-NodeB, intra-RNC hard handovers

- a) This measurement provides the number of attempted outgoing inter-NodeB, intra-RNC hard handovers.
- b) CC.
- c) Transmission of a RRC message PHYSICAL CHANNEL RECONFIGURATION, RADIO BEARER SETUP, RADIO BEARER RECONFIGURATION, RADIO BEARER RELEASE, or TRANSPORT CHANNEL RECONFIGURATION from the source RNC to the UE, indicating the attempt of an outgoing inter-NodeB, intra-RNC hard handover (see TS 25.331 [4]).
- d) A single integer value.
- e) HHO.AttOutInterNodeBIntraRNC.
- f) UtranCellFDD
UtranCellTDDLcr
UtranCellTDDHcr
- g) Valid for circuit switched and packet switched traffic.
- h) UMTS.

4.10.3.2 Successful outgoing inter-NodeB, intra-RNC hard handovers

- a) This measurement provides the number of successful outgoing inter-NodeB, intra-RNC hard handovers.
- b) CC.
- c) Receipt of a RRC message PHYSICAL CHANNEL RECONFIGURATION COMPLETE, RADIO BEARER SETUP COMPLETE, RADIO BEARER RECONFIGURATION COMPLETE, RADIO BEARER RELEASE COMPLETE, or TRANSPORT CHANNEL RECONFIGURATION COMPLETE sent from the UE to the source RNC, indicating a successful outgoing inter-NodeB, intra-RNC hard handover (see TS 25.331 [4]).
- d) A single integer value.
- e) HHO.SuccOutInterNodeBIntraRNC.
- f) UtranCellFDD
UtranCellTDDLcr
UtranCellTDDHcr
- g) Valid for circuit switched and packet switched traffic.
- h) UMTS.

4.10.3.3 Failed outgoing inter-NodeB, intra-RNC hard handovers

- a) This measurement provides the number of failed outgoing inter-NodeB, intra-RNC hard handovers per cause.
- b) CC.
- c) Receipt of a RRC message PHYSICAL CHANNEL RECONFIGURATION FAILURE, RADIO BEARER SETUP FAILURE, RADIO BEARER RECONFIGURATION FAILURE, RADIO BEARER RELEASE FAILURE, or TRANSPORT CHANNEL RECONFIGURATION FAILURE sent from the UE to the source RNC, indicating a failed outgoing inter-NodeB, intra-RNC hard handover. Failure causes are defined within TS 25.331 [4].

Each expected RRC message PHYSICAL CHANNEL RECONFIGURATION COMPLETE, RADIO BEARER SETUP COMPLETE, RADIO BEARER RECONFIGURATION COMPLETE, RADIO BEARER RELEASE COMPLETE, TRANSPORT CHANNEL RECONFIGURATION COMPLETE, PHYSICAL CHANNEL RECONFIGURATION FAILURE, RADIO BEARER SETUP FAILURE, RADIO BEARER RECONFIGURATION FAILURE, RADIO BEARER RELEASE FAILURE, or TRANSPORT CHANNEL RECONFIGURATION FAILURE not received by the source RNC is added to the measurement cause 'No Reply' (not specified in TS 25.331 [4]).

The sum of all supported per cause measurements shall equal the total number of failed events. In case only a subset of per cause measurements is supported, a sum subcounter will be provided first.

- d) Each measurement is an integer value. The number of measurements is equal to the number of causes supported plus a possible sum value identified by the *.sum* suffix.
- e) The measurement name has the form HHO.FailOutInterNodeBIntraRNC.*Cause* where *Cause* identifies the failure cause.
The cause 'No Reply' is identified by the *.NoReply* suffix.
- f) UtranCellFDD
UtranCellTDDLcr
UtranCellTDDHcr
- g) Valid for circuit switched and packet switched traffic.
- h) UMTS.

4.10.4 Outgoing inter-RNC hard handovers via Iur

4.10.4.0 Introduction

The three measurement types defined in the subclause 4.10.4 for outgoing inter-RNC hard handovers are subject to the "2 out of 3 approach".

4.10.4.1 Attempted outgoing inter-RNC hard handovers via Iur

- a) This measurement provides the number of attempted outgoing inter-RNC hard handovers via Iur. This measurement is only valid for FDD mode.
- b) CC.
- c) Transmission of a RRC message PHYSICAL CHANNEL RECONFIGURATION, RADIO BEARER SETUP, RADIO BEARER RECONFIGURATION, RADIO BEARER RELEASE, or TRANSPORT CHANNEL RECONFIGURATION from the source RNC to the UE, indicating the attempt of an outgoing inter-RNC hard handover via Iur (see TS 25.331 [4]).
- d) A single integer value.
- e) HHO.AttOutInterRNCIur.
- f) UtranCellFDD
- g) Valid for circuit switched and packet switched traffic.
- h) UMTS.

4.10.4.2 Successful outgoing inter-RNC hard handovers via Iur

- a) This measurement provides the number of successful outgoing inter-RNC hard handovers via Iur. This measurement is only valid for FDD mode.
- b) CC.
- c) Receipt of a RRC message PHYSICAL CHANNEL RECONFIGURATION COMPLETE, RADIO BEARER SETUP COMPLETE, RADIO BEARER RECONFIGURATION COMPLETE, RADIO BEARER RELEASE COMPLETE, or TRANSPORT CHANNEL RECONFIGURATION COMPLETE sent from the UE to the source RNC, indicating a successful outgoing inter-RNC hard handover via Iur (see TS 25.331 [4]).
- d) A single integer value.
- e) HHO.SuccOutInterRNCIur.
- f) UtranCellFDD
- g) Valid for circuit switched and packet switched traffic.
- h) UMTS.

4.10.4.3 Failed outgoing inter-RNC hard handovers via Iur

- a) This measurement provides the number of failed outgoing inter-RNC hard handovers via Iur per cause. This measurement is only valid for FDD mode.

- b) CC.
- c) Receipt of a RRC message PHYSICAL CHANNEL RECONFIGURATION FAILURE, RADIO BEARER SETUP FAILURE, RADIO BEARER RECONFIGURATION FAILURE, RADIO BEARER RELEASE FAILURE, or TRANSPORT CHANNEL RECONFIGURATION FAILURE sent from the UE to the source RNC, indicating a failed outgoing inter-RNC hard handover via Iur. Failure causes are defined within TS 25.331 [4].

Each expected RRC message PHYSICAL CHANNEL RECONFIGURATION COMPLETE, RADIO BEARER SETUP COMPLETE, RADIO BEARER RECONFIGURATION COMPLETE, RADIO BEARER RELEASE COMPLETE, TRANSPORT CHANNEL RECONFIGURATION COMPLETE, PHYSICAL CHANNEL RECONFIGURATION FAILURE, RADIO BEARER SETUP FAILURE, RADIO BEARER RECONFIGURATION FAILURE, RADIO BEARER RELEASE FAILURE, or TRANSPORT CHANNEL RECONFIGURATION FAILURE not received by the source RNC is added to the measurement cause 'No Reply' (not specified in TS 25.331 [4]).

The sum of all supported per cause measurements shall equal the total number of failed events. In case only a subset of per cause measurements is supported, a sum subcounter will be provided first.

- d) Each measurement is an integer value. The number of measurements is equal to the number of causes supported plus a possible sum value identified by the *.sum* suffix.
- e) The measurement name has the form HHO.FailOutInterRNCIur.*Cause* where *Cause* identifies the failure cause.
The cause 'No Reply' is identified by the *NoReply* suffix.
- f) UtranCellFDD
- g) Valid for circuit switched and packet switched traffic.

4.10.5 Relocation preparation for outgoing inter-RNC hard handovers switching in the CN

4.10.5.0 Introduction

The three measurement types defined in the subclause 4.10.5 for relocation preparation for outgoing inter-RNC hard handovers switching in the CN are subject to the "2 out of 3 approach".

4.10.5.1 Attempted relocation preparation for outgoing inter-RNC hard handovers switching in the CN

- a) This measurement provides the number of attempted relocation preparation for outgoing inter-RNC hard handovers switching in the CN.
- b) CC.
- c) Transmission of a RANAP message RELOCATION REQUIRED from the source RNC to the CN (Source side), indicating an attempted relocation preparation of a outgoing inter-RNC hard handover switching in the CN (see TS 25.413 [5]).
- d) A single integer value.
- e) HHO.AttRelocPrepOutInterRNCCN.
- f) UtranCellFDD
UtranCellTDDLcr
UtranCellTDDHcr
- g) Valid for circuit switched and packet switched traffic.
- h) UMTS.

4.10.5.2 Successful relocation preparation for outgoing inter-RNC hard handovers switching in the CN

- a) This measurement provides the number of successful relocation for outgoing inter-RNC hard handovers switching in the CN.
- b) CC.
- c) Receipt of a RANAP message RELOCATION COMMAND sent from the CN (Source side) to the source RNC, indicating a successful relocation preparation of a outgoing inter-RNC hard handover switching in the CN (see TS 25.413 [5]).
- d) A single integer value.
- e) HHO.SuccAttRelocPrepOutInterRNCCN.
- f) UtranCellFDD
UtranCellTDDLcr
UtranCellTDDHcr
- g) Valid for circuit switched and packet switched traffic.
- h) UMTS.

4.10.5.3 Failed relocation preparation for outgoing inter-RNC hard handovers switching in the CN

- a) This measurement provides number of failed relocation for outgoing inter-RNC hard handovers switching in the CN per cause.

- b) CC.
- c) Receipt of a RANAP message RELOCATION PREPARATION FAILURE sent from the CN (Source side) to the source RNC, indicating a failed relocation preparation for outgoing inter-RNC hard handover switching in the CN. Failure causes are defined within TS 25.413 [5]. The sum of all supported per cause measurements shall equal the total number of failed events. In case only a subset of per cause measurements is supported, a sum subcounter will be provided first.
- d) Each measurement is an integer value. The number of measurements is equal to the number of causes supported plus a possible sum value identified by the *.sum* suffix.
- e) The measurement name has the form HHO.FailRelocPrepOutInterRNCCN.*Cause* where *Cause* identifies the name of the failure cause.
- f) UtranCellFDD
UtranCellTDDLcr
UtranCellTDDHcr
- g) Valid for circuit switched and packet switched traffic.
- h) UMTS.

4.10.6 Outgoing inter-RNC hard handovers switching in the CN

4.10.6.0 Introduction

The three measurement types defined in the subclause 4.10.6 for outgoing inter-RNC hard handovers switching in the CN are subject to the "2 out of 3 approach".

4.10.6.1 Attempted outgoing inter-RNC hard handovers switching in the CN

- a) This measurement provides the number of attempted outgoing inter-RNC hard handovers switching in the CN related to UEs.
- b) CC.
- c) Transmission of a RRC message PHYSICAL CHANNEL RECONFIGURATION, RADIO BEARER SETUP, RADIO BEARER RECONFIGURATION, RADIO BEARER RELEASE, or TRANSPORT CHANNEL RECONFIGURATION from the source RNC to the UE, indicating the attempt of an inter-RNC hard handover switching in the CN (see TS 25.331 [4]).
- d) A single integer value.
- e) HHO.AttOutInterRNCCN.
- f) UtranCellFDD
UtranCellTDDLcr
UtranCellTDDHcr
- g) Valid for circuit switched and packet switched traffic.
- h) UMTS.

4.10.6.2 Successful outgoing inter-RNC hard handovers switching in the CN

- a) This measurement provides the number of successful outgoing inter-RNC hard handovers switching in the CN related to UEs.
- b) CC.
- c) Receipt of a RANAP message Iu RELEASE COMMAND sent from the CN (Source side) to the source RNC, indicating a successful inter-RNC hard handover switching in the CN (see TS 25.413 [5]).
- d) A single integer value.
- e) HHO.SuccOutInterRNCCN.
- f) UtranCellFDD
UtranCellTDDLcr
UtranCellTDDHcr
- g) Valid for circuit switched and packet switched traffic.
- h) UMTS.

4.10.6.3 Failed outgoing inter-RNC hard handovers switching in the CN

- a) This measurement provides the number of failed outgoing inter-RNC hard handovers switching in the CN related to UEs.
- b) CC.
- c) Receipt of a RRC message PHYSICAL CHANNEL RECONFIGURATION FAILURE, RADIO BEARER SETUP FAILURE, RADIO BEARER RECONFIGURATION FAILURE, RADIO BEARER RELEASE FAILURE, or TRANSPORT CHANNEL RECONFIGURATION FAILURE sent from the UE to the source RNC, indicating a failed inter-RNC hard handover switching in the CN. Failure causes are defined within

TS 25.331 [4].

Each expected RRC message PHYSICAL CHANNEL RECONFIGURATION COMPLETE, RADIO BEARER SETUP COMPLETE, RADIO BEARER RECONFIGURATION COMPLETE, RADIO BEARER RELEASE COMPLETE, TRANSPORT CHANNEL RECONFIGURATION COMPLETE, PHYSICAL CHANNEL RECONFIGURATION FAILURE, RADIO BEARER SETUP FAILURE, RADIO BEARER RECONFIGURATION FAILURE, RADIO BEARER RELEASE FAILURE, or TRANSPORT CHANNEL RECONFIGURATION FAILURE not received by the source RNC is added to the measurement cause 'No Reply' (not specified in TS 25.331 [4]).

The sum of all supported per cause measurements shall equal the total number of failed events. In case only a subset of per cause measurements is supported, a sum subcounter will be provided first.

- d) Each measurement is an integer value. The number of measurements is equal to the number of causes supported plus a possible sum value identified by the *.sum* suffix.
- e) The measurement name has the form HHO.FailOutInterRNCCN.*Cause* where *Cause* identifies the failure cause.
The cause 'No Reply' is identified by the *.NoReply* suffix.
- f) UtranCellFDD
UtranCellTDDLcr
UtranCellTDDHcr
- g) Valid for circuit switched and packet switched traffic.
- h) UMTS.

4.10.7 Outgoing hard handovers per neighbour cell relation

4.10.7.0 Introduction

The three measurement types defined in the subclause 4.10.7 for outgoing hard handovers per neighbour cell relation are subject to the "2 out of 3 approach".

4.10.7.1 Attempted outgoing hard handovers per neighbour cell relation

- a) This measurement provides the number of attempted outgoing hard handovers per neighbour cell relation.
- b) CC.
- c) Transmission of a RRC message PHYSICAL CHANNEL RECONFIGURATION, RADIO BEARER SETUP, RADIO BEARER RECONFIGURATION, RADIO BEARER RELEASE, or TRANSPORT CHANNEL RECONFIGURATION from the source RNC to the UE, indicating the attempt of an outgoing hard handover (see TS 25.331 [4]).
- d) A single integer value.
- e) HHO.AttOut.
- f) UtranRelation.
- g) Valid for circuit switched and packet switched traffic.
- h) UMTS.
- i) This measurement is mainly dedicated to Network Operator Maintenance and Vendor Performance Modelling Communities.

4.10.7.2 Successful outgoing hard handovers per neighbour cell relation

- a) This measurement provides the number of successful outgoing hard handovers per neighbour cell relation.
- b) CC.
- c) Receipt of a RRC message PHYSICAL CHANNEL RECONFIGURATION COMPLETE, RADIO BEARER SETUP COMPLETE, RADIO BEARER RECONFIGURATION COMPLETE, RADIO BEARER RELEASE COMPLETE, or TRANSPORT CHANNEL RECONFIGURATION COMPLETE sent from the UE to the source RNC, indicating a successful outgoing hard handover (see TS 25.331 [4]).
- d) A single integer value.
- e) HHO.SuccOut.
- f) UtranRelation.
- g) Valid for circuit switched and packet switched traffic.
- h) UMTS.
- i) This measurement is mainly dedicated to Network Operator Maintenance and Vendor Performance Modelling Communities.

4.10.7.3 Failed outgoing hard handovers per neighbour cell relation

- a) This measurement provides the number of failed outgoing hard handovers per neighbour cell relation per cause.
- b) CC.
- c) Receipt of a RRC message PHYSICAL CHANNEL RECONFIGURATION FAILURE, RADIO BEARER SETUP FAILURE, RADIO BEARER RECONFIGURATION FAILURE, RADIO BEARER RELEASE FAILURE, or TRANSPORT CHANNEL RECONFIGURATION FAILURE sent from the UE to the source

RNC, indicating a failed outgoing hard handover. Failure causes are defined within TS 25.331 [4].

Each expected RRC message PHYSICAL CHANNEL RECONFIGURATION COMPLETE, RADIO BEARER SETUP COMPLETE, RADIO BEARER RECONFIGURATION COMPLETE, RADIO BEARER RELEASE COMPLETE, TRANSPORT CHANNEL RECONFIGURATION COMPLETE, PHYSICAL CHANNEL RECONFIGURATION FAILURE, RADIO BEARER SETUP FAILURE, RADIO BEARER RECONFIGURATION FAILURE, RADIO BEARER RELEASE FAILURE, or TRANSPORT CHANNEL RECONFIGURATION FAILURE not received by the source RNC is added to the measurement cause 'No Reply' (not specified in TS 25.331 [4]).

The sum of all supported per cause measurements shall equal the total number of failed events. In case only a subset of per cause measurements is supported, a sum subcounter will be provided first.

- d) Each measurement is an integer value. The number of measurements is equal to the number of causes supported plus a possible sum value identified by the *.sum* suffix.
- e) The measurement name has the form HHO.FailOut.*Cause* where *Cause* identifies the failure cause. The cause 'No Reply' is identified by the *.NoReply* suffix.
- f) UtranRelation.
- g) Valid for circuit switched and packet switched traffic.
- h) UMTS.
- i) This measurement is mainly dedicated to Network Operator Maintenance and Vendor Performance Modelling Communities.

4.11 Relocation

4.11.1 Relocations for CS domain

4.11.1.1 Relocation preparations with UE involved for CS domain

4.11.1.1.0 Introduction

The three measurement types defined in the subclause 4.11.1.1.n for relocation preparations with UE involved for CS domain are subject to the "2 out of 3 approach".

4.11.1.1.1 Attempted relocation preparations with UE involved for CS domain

- a) This measurement provides the number of attempted relocation preparations with UE involved for CS domain.
- b) CC
- c) Transmission of a RANAP message RELOCATION REQUIRED from the source RNC to the CS CN (Source side) with Relocation Type set to "UE involved in relocation of SRNS", indicating an attempted relocation preparation with UE involved for CS domain (see TS 25.413 [5]).
- d) A single integer value
- e) RELOC.AttPrepUEInvolCS.
- f) RncFunction
- g) Valid for circuit switched traffic
- h) UMTS

4.11.1.1.2 Successful relocation preparations with UE involved for CS domain

- a) This measurement provides the number of successful relocation preparations with UE involved for CS domain.
- b) CC
- c) Receipt of a RANAP message RELOCATION COMMAND sent from the CS CN (Source side) to the source RNC, in response to a RELOCATION REQUIRED message with Relocation Type set to "UE involved in relocation of SRNS", indicating a successful relocation preparation with UE involved for CS domain (see TS 25.413 [5]).
- d) A single integer value
- e) RELOC.SuccPrepUEInvolCS.
- f) RncFunction
- g) Valid for circuit switched traffic
- h) UMTS

4.11.1.1.3 Failed relocation preparations with UE involved for CS domain

- a) This measurement provides the number of failed relocation preparations with UE involved for CS domain per cause.
- b) CC

- c) Receipt of a RANAP message RELOCATION PREPARATION FAILURE sent from the CS CN (Source side) to the source RNC, in response to a RELOCATION REQUIRED message with Relocation Type set to "UE involved in relocation of SRNS", indicating a failed relocation preparation with UE involved for CS domain. Failure causes are defined within TS 25.413 [5].

Each expected RANAP message RELOCATION COMMAND or RELOCATION PREPARATION FAILURE not received by the source RNC is added to the measurement cause 'No Reply' (not specified in TS 25.413 [5]).

The sum of all supported per cause measurements shall equal the total number of failed events. In case only a subset of per cause measurements is supported, a sum subcounter will be provided first.

- d) Each measurement is an integer value. The number of measurements is equal to the number of causes supported plus a possible sum value identified by the *.sum* suffix.
- e) The measurement name has the form RELOC.FailPrepUEInvolCS.*Cause* where *Cause* identifies the failure cause.
- f) RncFunction
- g) Valid for circuit switched traffic
- h) UMTS

4.11.1.2 Relocation preparations with UE not involved for CS domain

4.11.1.2.0 Introduction

The three measurement types defined in the subclause 4.11.1.2.n for relocation preparations with UE not involved for CS domain are subject to the "2 out of 3 approach".

4.11.1.2.1 Attempted relocation preparations with UE not involved for CS domain

- a) This measurement provides the number of attempted relocation preparations with UE not involved for CS domain.
- b) CC
- c) Transmission of a RANAP message RELOCATION REQUIRED from the source RNC to the CS CN (Source side) with Relocation Type set to "UE not involved in relocation of SRNS", indicating an attempted relocation preparation with UE not involved for CS domain (see TS 25.413 [5]).
- d) A single integer value
- e) RELOC.AttPrepUENotInvolCS.
- f) RncFunction
- g) Valid for circuit switched traffic
- h) UMTS

4.11.1.2.2 Successful relocation preparations with UE not involved for CS domain

- a) This measurement provides the number of successful relocation preparations with UE not involved for CS domain.
- b) CC
- c) Receipt of a RANAP message RELOCATION COMMAND sent from the CS CN (Source side) to the source RNC, in response to a RELOCATION REQUIRED message with Relocation Type set to "UE not involved in relocation of SRNS", indicating a successful relocation preparation with UE not involved for CS domain (see TS 25.413 [5]).
- d) A single integer value

- e) RELOC.SuccPrepUENotInvolCS.
- f) RncFunction
- g) Valid for circuit switched traffic
- h) UMTS

4.11.1.2.3 Failed relocation preparations with UE not involved for CS domain

- a) This measurement provides the number of failed relocation preparations with UE not involved for CS domain per cause.
- b) CC
- c) Receipt of a RANAP message RELOCATION PREPARATION FAILURE sent from the CS CN (Source side) to the source RNC, in response to a RELOCATION REQUIRED message with Relocation Type set to "UE not involved in relocation of SRNS", indicating a failed relocation preparation with UE not involved for CS domain. Failure causes are defined within TS 25.413 [5].

Each expected RANAP message RELOCATION COMMAND or RELOCATION PREPARATION FAILURE not received by the source RNC is added to the measurement cause 'No Reply' (not specified in TS 25.413 [5]).

The sum of all supported per cause measurements shall equal the total number of failed events. In case only a subset of per cause measurements is supported, a sum subcounter will be provided first.

- d) Each measurement is an integer value. The number of measurements is equal to the number of causes supported plus a possible sum value identified by the *.sum* suffix.
- e) The measurement name has the form RELOC.FailPrepUENotInvolCS.*Cause* where *Cause* identifies the failure cause.
- f) RncFunction
- g) Valid for circuit switched traffic
- h) UMTS

4.11.1.3 Relocation resource allocations with UE involved for CS domain

4.11.1.3.0 Introduction

The three measurement types defined in the subclause 4.11.1.3.n for relocation resource allocations with UE involved for CS domain are subject to the "2 out of 3 approach".

4.11.1.3.1 Attempted relocations resource allocations with UE involved for CS domain

- a) This measurement provides the number of attempted relocation resource allocations with UE involved for CS domain.
- b) CC
- c) Receipt of a RANAP message RELOCATION REQUEST sent from the CS CN (Target side) to the target RNC with Relocation Type set to "UE involved in relocation of SRNS", indicating an attempted relocation resource allocation with UE involved for CS domain (see TS 25.413 [5]).
- d) A single integer value
- e) RELOC.AttResAllocUEInvolCS.
- f) RncFunction
- g) Valid for circuit switched traffic

h) UMTS

4.11.1.3.2 Successful relocation resource allocations with UE involved for CS domain

- a) This measurement provides the number of successful relocation resource allocations with UE involved for CS domain.
- b) CC
- c) Transmission of a RANAP message RELOCATION REQUEST ACKNOWLEDGE from the target RNC to the CS CN (Target side), in response to a RELOCATION REQUEST message with Relocation Type set to "UE involved in relocation of SRNS", indicating a successful relocation resource allocation with UE involved for CS domain (see TS 25.413 [5]).
- d) A single integer value
- e) RELOC.SuccResAllocUEInvolCS.
- f) RncFunction
- g) Valid for circuit switched traffic
- h) UMTS

4.11.1.3.3 Failed relocation resource allocations with UE involved for CS domain

- a) This measurement provides the number of failed relocation resource allocations with UE involved for CS domain per cause.
- b) CC
- c) Transmission of a RANAP message RELOCATION FAILURE from the target RNC to the CS CN (Target side), in response to a RELOCATION REQUEST message with Relocation Type set to "UE involved in relocation of SRNS", indicating a failed relocation resource allocation with UE involved for CS domain. Failure causes are defined within TS 25.413 [5].

The sum of all supported per cause measurements shall equal the total number of failed events. In case only a subset of per cause measurements is supported, a sum subcounter will be provided first.

- d) Each measurement is an integer value. The number of measurements is equal to the number of causes supported plus a possible sum value identified by the *.sum* suffix.
- e) The measurement name has the form RELOC.FailResAllocUEInvolCS.*Cause* where *Cause* identifies the failure cause.
- f) RncFunction
- g) Valid for circuit switched traffic
- h) UMTS

4.11.1.4 Relocation resource allocations with UE not involved for CS domain

4.11.1.4.0 Introduction

The three measurement types defined in the subclause 4.11.1.4.n for relocation resource allocations with UE not involved for CS domain are subject to the "2 out of 3 approach".

4.11.1.4.1 Attempted relocations resource allocations with UE not involved for CS domain

- a) This measurement provides the number of attempted relocation resource allocations with UE not involved for CS domain.
- b) CC

- c) Receipt of a RANAP message RELOCATION REQUEST sent from the CS CN (Target side) to the target RNC with Relocation Type set to "UE not involved in relocation of SRNS", indicating an attempted relocation resource allocation with UE not involved for CS domain (see TS 25.413 [5]).
- d) A single integer value
- e) RELOC.AttResAllocUENotInvolCS
- f) RncFunction
- g) Valid for circuit switched traffic
- h) UMTS

4.11.1.4.2 Successful relocation resource allocations with UE not involved for CS domain

- a) This measurement provides the number of successful relocation resource allocations with UE not involved for CS domain.
- b) CC
- c) Transmission of a RANAP message RELOCATION REQUEST ACKNOWLEDGE from the target RNC to the CS CN (Target side), in response to a RELOCATION REQUEST message with Relocation Type set to "UE not involved in relocation of SRNS", indicating a successful relocation resource allocation with UE not involved for CS domain (see TS 25.413 [5]).
- d) A single integer value
- e) RELOC.SuccResAllocUENotInvolCS
- f) RncFunction
- g) Valid for circuit switched traffic
- h) UMTS

4.11.1.4.3 Failed relocation resource allocations with UE not involved for CS domain

- a) This measurement provides the number of failed relocation resource allocations with UE not involved for CS domain per cause.
- b) CC
- c) Transmission of a RANAP message RELOCATION FAILURE from the target RNC to the CS CN (Target side), in response to a RELOCATION REQUEST message with Relocation Type set to "UE not involved in relocation of SRNS", indicating a failed relocation resource allocation with UE not involved for CS domain. Failure causes are defined within TS 25.413 [5].

The sum of all supported per cause measurements shall equal the total number of failed events. In case only a subset of per cause measurements is supported, a sum subcounter will be provided first.

- d) Each measurement is an integer value. The number of measurements is equal to the number of causes supported plus a possible sum value identified by the *.sum* suffix.
- e) The measurement name has the form RELOC.FailResAllocUENotInvolCS.*Cause* where *Cause* identifies the failure cause.
- f) RncFunction
- g) Valid for circuit switched traffic
- h) UMTS

4.11.1.5 Relocations for CS domain

4.11.1.5.1 Successful relocations for CS domain

- a) This measurement provides the number of successful relocations for CS domain ('UE involved' and 'UE not involved' Relocations).
- b) CC
- c) Receipt of a RANAP message Iu RELEASE COMMAND sent from the CS CN (Source side) to the source RNC in response to a RELOCATION REQUIRED message, indicating a successful relocation for CS domain (see TS 25.413 [5]).
- d) A single integer value
- e) RELOC.SuccCS.
- f) RncFunction
- g) Valid for circuit switched traffic
- h) UMTS

4.11.2 Relocations for PS domain

4.11.2.1 Relocation preparations with UE involved for PS domain

4.11.2.1.0 Introduction

The three measurement types defined in the subclause 4.11.2.1.n for relocation preparations with UE involved for PS domain are subject to the "2 out of 3 approach".

4.11.2.1.1 Attempted relocation preparations with UE involved for PS domain

- a) This measurement provides the number of attempted relocation preparations with UE involved for PS domain.
- b) CC
- c) Transmission of a RANAP message RELOCATION REQUIRED from the source RNC to the PS CN (Source side) with Relocation Type set to "UE involved in relocation of SRNS", indicating an attempted relocation preparation with UE involved for PS domain (see TS 25.413 [5]).
- d) A single integer value
- e) RELOC.AttPrepUEInvolPS.
- f) RncFunction
- g) Valid for packet switched traffic.
- h) UMTS

4.11.2.1.2 Successful relocation preparations with UE involved for PS domain

- a) This measurement provides the number of successful relocation preparations with UE involved for PS domain.
- b) CC
- c) Receipt of a RANAP message RELOCATION COMMAND sent from the PS CN (Source side) to the source RNC, in response to a RELOCATION REQUIRED message with Relocation Type set to "UE involved in relocation of SRNS", indicating a successful relocation preparation with UE involved for PS domain (see TS 25.413 [5]).
- d) A single integer value
- e) RELOC.SuccPrepUEInvolPS.
- f) RncFunction
- g) Valid for packet switched traffic.
- h) UMTS

4.11.2.1.3 Failed relocation preparations with UE involved for PS domain

- a) This measurement provides the number of failed relocation preparations with UE involved for PS domain per cause.
- b) CC
- c) Receipt of a RANAP message RELOCATION PREPARATION FAILURE sent from the PS CN (Source side) to the source RNC, in response to a RELOCATION REQUIRED message with Relocation Type set to "UE involved in relocation of SRNS", indicating a failed relocation preparation with UE involved for PS domain. Failure causes are defined within TS 25.413 [5].

Each expected RANAP message RELOCATION COMMAND or RELOCATION PREPARATION FAILURE

not received by the source RNC is added to the measurement cause 'No Reply' (not specified in TS 25.413 [5]).

The sum of all supported per cause measurements shall equal the total number of failed events. In case only a subset of per cause measurements is supported, a sum subcounter will be provided first.

- d) Each measurement is an integer value. The number of measurements is equal to the number of causes supported plus a possible sum value identified by the *.sum* suffix.
- e) The measurement name has the form RELOC.FailPrepUEInvolPS.*Cause* where *Cause* identifies the failure cause.
- f) RncFunction
- g) Valid for packet switched traffic.
- h) UMTS

4.11.2.2 Relocation preparations with UE not involved for PS domain

4.11.2.2.0 Introduction

The three measurement types defined in the subclause 4.11.2.2.n for relocation preparations with UE not involved for PS domain are subject to the "2 out of 3 approach".

4.11.2.2.1 Attempted relocation preparations with UE not involved for PS domain

- a) This measurement provides the number of attempted relocation preparations with UE not involved for PS domain.
- b) CC
- c) Transmission of a RANAP message RELOCATION REQUIRED from the source RNC to the PS CN (Source side) with Relocation Type set to "UE not involved in relocation of SRNS", indicating an attempted relocation preparation with UE not involved for PS domain (see TS 25.413 [5]).
- d) A single integer value
- e) RELOC.AttPrepUENotInvolPS.
- f) RncFunction
- g) Valid for packet switched traffic.
- h) UMTS

4.11.2.2.2 Successful relocation preparations with UE not involved for PS domain

- a) This measurement provides the number of successful relocation preparations with UE not involved for PS domain.
- b) CC
- c) Receipt of a RANAP message RELOCATION COMMAND sent from the PS CN (Source side) to the source RNC, in response to a RELOCATION REQUIRED message with Relocation Type set to "UE not involved in relocation of SRNS", indicating a successful relocation preparation with UE not involved for PS domain (see TS 25.413 [5]).
- d) A single integer value
- e) RELOC.SuccPrepUENotInvolPS.
- f) RncFunction
- g) Valid for packet switched traffic.

h) UMTS

4.11.2.2.3 Failed relocation preparations with UE not involved for PS domain

- a) This measurement provides the number of failed relocation preparations with UE not involved for PS domain per cause.
- b) CC
- c) Receipt of a RANAP message RELOCATION PREPARATION FAILURE sent from the PS CN (Source side) to the source RNC, in response to a RELOCATION REQUIRED message with Relocation Type set to "UE not involved in relocation of SRNS", indicating a failed relocation preparation with UE not involved for PS domain. Failure causes are defined within TS 25.413 [5].

Each expected RANAP message RELOCATION COMMAND or RELOCATION PREPARATION FAILURE not received by the source RNC is added to the measurement cause 'No Reply' (not specified in TS 25.413 [5]).

The sum of all supported per cause measurements shall equal the total number of failed events. In case only a subset of per cause measurements is supported, a sum subcounter will be provided first.

- d) Each measurement is an integer value. The number of measurements is equal to the number of causes supported plus a possible sum value identified by the *.sum* suffix.
- e) The measurement name has the form RELOC.FailPrepUENotInvolPS.*Cause* where *Cause* identifies the failure cause.
- f) RncFunction
- g) Valid for packet switched traffic.
- h) UMTS

4.11.2.3 Relocation resource allocations with UE involved for PS domain

4.11.2.3.0 Introduction

The three measurement types defined in the subclause 4.11.2.3.n for relocation resource allocations with UE involved for PS domain are subject to the "2 out of 3 approach".

4.11.2.3.1 Attempted relocations resource allocations with UE involved for PS domain

- a) This measurement provides the number of attempted relocation resource allocations with UE involved for PS domain.
- b) CC
- c) Receipt of a RANAP message RELOCATION REQUEST sent from the PS CN (Target side) to the target RNC with Relocation Type set to "UE involved in relocation of SRNS", indicating an attempted relocation resource allocation with UE involved for PS domain (see TS 25.413 [5]).
- d) A single integer value
- e) RELOC.AttResAllocUEInvolPS.
- f) RncFunction
- g) Valid for packet switched traffic.
- h) UMTS

4.11.2.3.2 Successful relocation resource allocations with UE involved for PS domain

- a) This measurement provides the number of successful relocation resource allocations with UE involved for PS domain.
- b) CC
- c) Transmission of a RANAP message RELOCATION REQUEST ACKNOWLEDGE from the target RNC to the PS CN (Target side), in response to a RELOCATION REQUEST message with Relocation Type set to "UE involved in relocation of SRNS", indicating a successful relocation resource allocation with UE involved for PS domain (see TS 25.413 [5]).
- d) A single integer value
- e) RELOC.SuccResAllocUEInvolPS.
- f) RncFunction
- g) Valid for packet switched traffic.
- h) UMTS

4.11.2.3.3 Failed relocation resource allocations with UE involved for PS domain

- a) This measurement provides the number of failed relocation resource allocations with UE involved for PS domain per cause.
- b) CC
- c) Transmission of a RANAP message RELOCATION FAILURE from the target RNC to the PS CN (Target side), in response to a RELOCATION REQUEST message with Relocation Type set to "UE involved in relocation of SRNS", indicating a failed relocation resource allocation with UE involved for PS domain. Failure causes are defined within TS 25.413 [5].

The sum of all supported per cause measurements shall equal the total number of failed events. In case only a subset of per cause measurements is supported, a sum subcounter will be provided first.

- d) Each measurement is an integer value. The number of measurements is equal to the number of causes supported plus a possible sum value identified by the *.sum* suffix.
- e) The measurement name has the form RELOC.FailResAllocUEInvolPS.*Cause* where *Cause* identifies the failure cause.
- f) RncFunction
- g) Valid for packet switched traffic.
- h) UMTS

4.11.2.4 Relocation resource allocations with UE not involved for PS domain

4.11.2.4.0 Introduction

The three measurement types defined in the subclause 4.11.2.4.n for relocation resource allocations with UE not involved for PS domain are subject to the "2 out of 3 approach".

4.11.2.4.1 Attempted relocations resource allocations with UE not involved for PS domain

- a) This measurement provides the number of attempted relocation resource allocations with UE not involved for PS domain.
- b) CC

- c) Receipt of a RANAP message RELOCATION REQUEST sent from the PS CN (Target side) to the target RNC with Relocation Type set to "UE not involved in relocation of SRNS", indicating an attempted relocation resource allocation with UE not involved for PS domain (see TS 25.413 [5]).
- d) A single integer value
- e) RELOC.AttResAllocUENotInvolPS.
- f) RncFunction
- g) Valid for packet switched traffic.
- h) UMTS

4.11.2.4.2 Successful relocation resource allocations with UE not involved for PS domain

- a) This measurement provides the number of successful relocation resource allocations with UE not involved for PS domain.
- b) CC
- c) Transmission of a RANAP message RELOCATION REQUEST ACKNOWLEDGE from the target RNC to the PS CN (Target side), in response to a RELOCATION REQUEST message with Relocation Type set to "UE not involved in relocation of SRNS", indicating a successful relocation resource allocation with UE not involved for PS domain (see TS 25.413 [5]).
- d) A single integer value
- e) RELOC.SuccResAllocUENotInvolPS.
- f) RncFunction
- g) Valid for packet switched traffic.
- h) UMTS

4.11.2.4.3 Failed relocation resource allocations with UE not involved for PS domain

- a) This measurement provides the number of failed relocation resource allocations with UE not involved for PS domain per cause.
- b) CC
- c) Transmission of a RANAP message RELOCATION FAILURE from the target RNC to the PS CN (Target side), in response to a RELOCATION REQUEST message with Relocation Type set to "UE not involved in relocation of SRNS", indicating a failed relocation resource allocation with UE not involved for PS domain. Failure causes are defined within TS 25.413 [5].

The sum of all supported per cause measurements shall equal the total number of failed events. In case only a subset of per cause measurements is supported, a sum subcounter will be provided first.

- d) Each measurement is an integer value. The number of measurements is equal to the number of causes supported plus a possible sum value identified by the *.sum* suffix.
- e) The measurement name has the form RELOC.FailResAllocUENotInvolPS.*Cause* where *Cause* identifies the failure cause.
- f) RncFunction
- g) Valid for packet switched traffic.
- h) UMTS

4.11.2.5 Relocations for PS domain

4.11.2.5.1 Successful relocations for PS domain

- a) This measurement provides the number of successful relocations for PS domain ('UE involved' and 'UE not involved' Relocations).
- b) CC
- c) Receipt of a RANAP message Iu RELEASE COMMAND sent from the PS CN (Source side) to the source RNC in response to a RELOCATION REQUIRED message, indicating a successful relocation for PS domain (see TS 25.413 [5]).
- d) A single integer value
- e) RELOC.SuccPS.
- f) RncFunction
- g) Valid for packet switched traffic.
- h) UMTS

4.12 Circuit switched inter-RAT handover

4.12.1 Relocation preparation for outgoing circuit switched inter-RAT handovers

4.12.1.0 Introduction

The three measurement types defined in the subclause 4.12.1.n for relocation preparation for outgoing circuit switched inter-RAT handovers are subject to the "2 out of 3 approach".

4.12.1.1 Attempted relocation preparation for outgoing circuit switched inter-RAT handovers

- a) This measurement provides the number of attempted relocation preparations for outgoing circuit switched inter-RAT handovers per neighbour cell.
- b) CC
- c) Transmission of a RANAP message RELOCATION REQUIRED from the serving RNC to the CN, indicating an attempted relocation preparation of an outgoing inter-RAT handover (see TS 25.413 [5]).
- d) A single integer value
- e) IRATHO.AttRelocPrepOutCS.
- f) GsmRelation.
- g) Valid for circuit switched traffic
- h) UMTS

4.12.1.2 Successful relocation preparation for outgoing circuit switched inter-RAT handovers

- a) This measurement provides the number of successful relocation preparations for outgoing circuit switched inter-RAT handovers per neighbour cell.
- b) CC

- c) Receipt of a RANAP message RELOCATION COMMAND sent from the CN to the serving RNC, indicating a successful relocation preparation of an inter-RAT handover (see TS 25.413 [5]).
- d) A single integer value
- e) IRATHO.SuccRelocPrepOutCS.
- f) GsmRelation.
- g) Valid for circuit switched traffic
- h) UMTS

4.12.1.3 Failed relocation preparation for outgoing circuit switched inter-RAT handovers

- a) This measurement provides number of failed relocation preparations for outgoing circuit switched inter-RAT handovers per neighbour cell per cause.
- b) CC
- c) Receipt of a RANAP message RELOCATION PREPARATION FAILURE sent from the CN to the serving RNC, indicating a failed relocation preparation for outgoing inter-RAT handovers. Failure causes are defined within TS 25.413 [5].
The sum of all supported per cause measurements shall equal the total number of failed events. In case only a subset of per cause measurements is supported, a sum subcounter will be provided first.
- d) Each measurement is an integer value. The number of measurements is equal to the number of causes supported plus a possible sum value identified by the *.sum* suffix.
- e) The measurement name has the form IRATHO.FailRelocPrepOutCS.*Cause* where *Cause* identifies the failure cause.
- f) GsmRelation.
- g) Valid for circuit switched traffic
- h) UMTS

4.12.2 Outgoing circuit switched inter-RAT handovers

4.12.2.0 Introduction

The three measurement types defined in the subclause 4.12.2.n for outgoing circuit switched inter-RAT handovers are subject to the "2 out of 3 approach".

4.12.2.1 Attempted outgoing circuit switched inter-RAT handovers

- a) This measurement provides the number of attempted outgoing circuit switched inter-RAT handovers per neighbour cell from UEs point of view.
- b) CC
- c) Transmission of a RRC-message HANOVER FROM UTRAN COMMAND from serving RNC to the UE, indicating an attempted outgoing inter-RAT handover (see TS 25.331 [4]).
- d) A single integer value
- e) IRATHO.AttOutCS.
- f) GsmRelation.
- g) Valid for circuit switched traffic
- h) UMTS

4.12.2.2 Successful outgoing circuit switched inter-RAT handovers

- a) This measurement provides the number of successful outgoing circuit switched inter-RAT handovers per neighbour cell from UEs point of view.
- b) CC
- c) Receipt of a RANAP message IU RELEASE COMMAND sent from the CN to the serving RNC, indicating a successful inter-RAT handover (see TS 25.413 [5]).
- d) A single integer value
- e) IRATHO.SuccOutCS.
- f) GsmRelation.
- g) Valid for circuit switched traffic
- h) UMTS

4.12.2.3 Failed outgoing circuit switched inter-RAT handovers

- a) This measurement provides the number of failed outgoing circuit switched inter-RAT handovers per neighbour cell per cause from UEs point of view, where the UE returned to the original physical channel configuration.
- b) CC
- c) Receipt of a RRC message HANOVER FROM UTRAN FAILURE sent from the UE to the serving RNC, indicating a failed inter-RAT handover. Failure causes are defined within TS 25.331 [4].
The sum of all supported per cause measurements shall equal the total number of failed events. In case only a subset of per cause measurements is supported, a sum subcounter will be provided first.
- d) Each measurement is an integer value. The number of measurements is equal to the number of causes supported plus a possible sum value identified by the *.sum* suffix.
- e) The measurement name has the form IRATHO.FailOutCS.*Cause* where *Cause* identifies the failure cause.
- f) GsmRelation.
- g) Valid for circuit switched traffic
- h) UMTS

4.12.3 Incoming circuit switched inter-RAT handovers

4.12.3.0 Introduction

The three measurement types defined in the subclause 4.12.3.n for incoming circuit switched inter-RAT handovers are subject to the "2 out of 3 approach".

4.12.3.1 Attempted incoming circuit switched inter-RAT handovers

- a) This measurement provides the number of attempted incoming circuit switched inter-RAT handovers for each cell.
- b) CC
- c) Receipt of a RANAP RELOCATION REQUEST message sent from the CN to the target RNC, indicating the attempt of an inter-RAT handover (see TS 25.413 [5]).
- d) A single integer value
- e) IRATHO.AttIncCS.
- f) UtranCellFDD
UtranCellTDDLcr
UtranCellTDDHcrValid for circuit switched traffic
- g) UMTS

4.12.3.2 Successful incoming circuit switched inter-RAT handovers

- a) This measurement provides the number of successful incoming circuit switched inter-RAT handovers for each cell.
- b) CC
- c) Receipt of a RRC HANDOVER TO UTRAN COMPLETE message sent from the UE to the target RNC, indicating a successful inter-RAT handover (see TS 25.331 [4]).
- d) A single integer value
- e) IRATHO.SuccIncCS.
- f) UtranCellFDD
UtranCellTDDLcr
UtranCellTDDHcrValid for circuit switched traffic
- g) UMTS

4.12.3.3 Failed incoming circuit switched inter-RAT handovers

- a) This measurement provides the number of failed incoming circuit switched inter-RAT handovers per cell per cause.
- b) CC
- c) Transmission of a RANAP message RELOCATION FAILURE from the target RNC to the CN, indicating a failed inter-RAT handovers. Failure causes are defined within TS 25.413 [5].
The sum of all supported per cause measurements shall equal the total number of failed events. In case only a subset of per cause measurements is supported, a sum subcounter will be provided first.
- d) Each measurement is an integer value. The number of measurements is equal to the number of causes supported plus a possible sum value identified by the *.sum* suffix.
- e) The measurement name has the form IRATHO.FailIncCS.*Cause* where *Cause* identifies the failure cause.
- f) UtranCellFDD
UtranCellTDDLcr
UtranCellTDDHcrValid for circuit switched traffic

g) UMTS

4.13 Packet switched inter-RAT handover

4.13.1 Outgoing packet switched inter-RAT handovers, UTRAN controlled

4.13.1.0 Introduction

The three measurement types defined in the subclause 4.13.1.n for outgoing packet switched inter-RAT handovers, UTRAN controlled are subject to the "2 out of 3 approach".

4.13.1.1 Attempted outgoing packet switched inter-RAT handovers, UTRAN controlled

- a) This measurement provides the number of attempted outgoing, UTRAN controlled, Packet Switched interRAT handovers per cell.
- b) CC
- c) Transmission of a RRC-message, CELL CHANGE ORDER FROM UTRAN, from source RNC to the UE, indicating an attempted outgoing Packet Switched inter-RAT handover (see TS 25.331 [4]).
- d) A single integer value
- e) IRATHO.AttOutPSUTRAN.
- f) UtranCellFDD
UtranCellTDDLcr
UtranCellTDDHcr
- g) Valid for packet switched traffic.
- h) UMTS

4.13.1.2 Successful outgoing packet switched inter-RAT handovers, UTRAN controlled

- a) This measurement provides the number of successful outgoing, UTRAN controlled, Packet Switched interRAT handovers per cell.
- b) CC
- c) Receipt of a RANAP message, IU RELEASE COMMAND, sent from the PS CN to the source RNC, indicating a successful outgoing Packet Switched inter-RAT handover (see TS 25.413 [5]).
- d) A single integer value
- e) IRATHO.SuccOutPSUTRAN.
- f) UtranCellFDD
UtranCellTDDLcr
UtranCellTDDHcr
- g) Valid for packet switched traffic.
- h) UMTS

4.13.1.3 Failed outgoing packet switched inter-RAT handovers UTRAN controlled

- a) This measurement provides the number of failed outgoing, UTRAN controlled, Packet Switched interRAT handovers per cause, where the UE resumes the connection to UTRAN using the same resources used before receiving the cell change order. This is measured per cell.
- b) CC

- c) Receipt of an RRC message, CELL CHANGE ORDER FROM UTRAN FAILURE, sent from the UE to the source RNC, indicating a failed inter-RAT handover. Failure causes are defined within TS 25.331 [4].
The sum of all supported per cause measurements shall equal the total number of failed events. In case only a subset of per cause measurements is supported, a sum subcounter will be provided first.
- d) Each measurement is an integer value. The number of measurements is equal to the number of causes supported plus a possible sum value identified by the *.sum* suffix.
- e) The measurement name has the form IRATHO.FailOutPSUTRAN.*Cause*
where *Cause* identifies the failure cause.
- f) UtranCellFDD
UtranCellTDDLcr
UtranCellTDDHcr
- g) Valid for packet switched traffic.
- h) UMTS

4.13.2 Outgoing packet switched inter-RAT handovers, UE controlled

4.13.2.1 Successful outgoing packet switched inter-RAT handovers, UE controlled

- a) This measurement provides the number of successful outgoing, UE controlled, Packet Switched inter-RAT handovers per cell.
- b) CC
- c) Receipt of an RANAP message, SRNS CONTEXT REQUEST, sent from the PS CN to the serving RNC, indicating a successful outgoing UE controlled Packet Switched inter-RAT handover (see TS 25.413 [5]).
- d) A single integer value
- e) IRATHO.SuccOutPSUE.
- f) UtranCellFDD
UtranCellTDDLcr
UtranCellTDDHcr
- g) Valid for packet switched traffic.
- h) UMTS

4.14 Iu connection release

4.14.1 Overview

4.14.1.1 Considered Iu connection release procedures

Performance Measurement definitions in this subclause are based on TS 25.413 [5].

The following paragraphs are of interest for this purpose:

- Iu Release Request;
- Iu Release;
- IU RELEASE REQUEST;
- IU RELEASE COMMAND;
- IU RELEASE COMPLETE.

These paragraphs show in particular the following diagrams:



Figure: Iu Release Request procedure. Successful operation

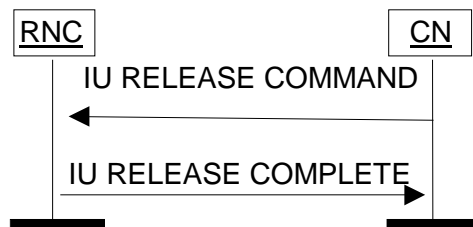

Figure: Iu Release procedure. Successful operation

4.14.2 Iu connection release request by UTRAN

4.14.2.1 Attempted Iu connection release request by UTRAN for CS domain

- a) This measurement provides the number of attempted requests by UTRAN to release an Iu connection between the RNC and a CS CN. The measurement is split into subcounters per release cause.
- b) CC
- c) Transmission of a RANAP message IU RELEASE REQUEST by the RNC to the CS CN. Each RANAP message IU RELEASE REQUEST sent to the CS CN is added to the relevant per cause measurement. The possible causes are included in TS 25.413 [5]. The sum of all supported per cause measurements shall equal the total number of IU RELEASE REQUEST attempts. In case only a subset of per cause measurements is supported, a sum measurement subtype will be provided first.
- d) Each measurement is an integer value. The number of measurements is equal to the number of causes plus a possible sum value identified by the *.sum* suffix.
- e) The measurement name has the form *IU.AttConnRelReqUTRANCS.Cause* where *Cause* identifies the release cause.
- f) RncFunction
- g) Valid for circuit switched traffic
- h) UMTS

4.14.2.2 Attempted Iu connection release request by UTRAN for PS domain

- a) This measurement provides the number of attempted requests by UTRAN to release an Iu connection between the RNC and a PS CN. The measurement is split into subcounters per release cause.
- b) CC
- c) Transmission of a RANAP message IU RELEASE REQUEST by the RNC to the PS CN. Each RANAP message IU RELEASE REQUEST sent to the PS CN is added to the relevant per cause measurement. The possible release causes are included in TS 25.413 [5]. The sum of all supported per cause measurements shall equal the total number of IU RELEASE REQUEST attempts. In case only a subset of per cause measurements is supported, a sum measurement subtype will be provided first.
- d) Each measurement is an integer value. The number of measurements is equal to the number of causes plus a possible sum value identified by the *.sum* suffix.
- e) The measurement name has the form *IU.AttConnRelReqUTRANPS.Cause* where *Cause* identifies the release cause.
- f) RncFunction
- g) Valid for packet switched traffic.
- h) UMTS

4.14.3 Iu connection release by CN

4.14.3.1 Attempted Iu connection release by CN for CS domain

- a) This measurement provides the number of attempted release by a CS CN to an Iu connection between the RNC and a CS CN. The measurement is split into subcounters per release cause.
- b) CC
- c) Receipt of a RANAP message IU RELEASE COMMAND sent by the CS CN to the RNC. Each RANAP message IU RELEASE COMMAND received from the CS CN is added to the relevant per cause measurement. The possible causes are included in TS 25.413 [5]. The sum of all supported per cause measurements shall equal the total number of IU RELEASE COMMAND attempts. In case only a subset of per cause measurements is supported, a sum measurement subtype will be provided first.
- d) Each measurement is an integer value. The number of measurements is equal to the number of causes plus a possible sum value identified by the *.sum* suffix.
- e) The measurement name has the form *IU.AttConnRelCNCS.Cause* where *Cause* identifies the release cause.
- f) RncFunction
- g) Valid for circuit switching.
- h) UMTS

4.14.3.2 Attempted Iu connection release by CN for PS domain

- a) This measurement provides the number of attempted release by a PS CN to an Iu connection between the RNC and a PS CN. The measurement is split into subcounters per release cause.
- b) CC
- c) Receipt of a RANAP message IU RELEASE COMMAND sent by the PS CN to the RNC. Each RANAP message IU RELEASE COMMAND received from the PS CN is added to the relevant per cause measurement. The possible causes are included in TS 25.413 [5]. The sum of all supported per cause measurements shall equal the total number of IU RELEASE COMMAND attempts. In case only a subset of per cause measurements is supported, a sum measurement subtype will be provided first.
- d) Each measurement is an integer value. The number of measurements is equal to the number of causes plus a possible sum value identified by the *.sum* suffix.
- e) The measurement name has the form *IU.AttConnRelCNPS.Cause* where *Cause* identifies the release cause.
- f) RncFunction
- g) Valid for packet switching.
- h) UMTS

4.14.3.3 Successful Iu connection release by CN for CS domain

- a) This measurement provides the number of successful release by a CS CN to an Iu connection between the RNC and a CS CN. The measurement is split into subcounters per release cause.
- b) CC
- c) Transmission of a RANAP message IU RELEASE COMPLETE by the RNC to the CS CN. Each RANAP message IU RELEASE COMPLETE sent to the CS CN is added to the relevant per cause measurement. The possible causes are included in TS 25.413 [5]. The sum of all supported per cause measurements shall equal the total number of IU RELEASE COMPLETE. In case only a subset of per cause measurements is supported, a sum measurement subtype will be provided first.

- d) Each measurement is an integer value. The number of measurements is equal to the number of causes plus a possible sum value identified by the *.sum* suffix.
- e) The measurement name has the form *IU.SuccConnRelCNCS.Cause* where *Cause* identifies the release cause.
- f) RncFunction
- g) Valid for circuit switching.
- h) UMTS

4.14.3.4 Successful Iu connection release by CN for PS domain

- a) This measurement provides the number of successful release by a PS CN to an Iu connection between the RNC and a PS CN. The measurement is split into subcounters per release cause.
- b) CC
- c) Transmission of a RANAP message IU RELEASE COMPLETE by the RNC to the PS CN. Each RANAP message IU RELEASE COMPLETE sent to the PS CN is added to the relevant per cause measurement. The possible causes are included in TS 25.413 [5]. The sum of all supported per cause measurements shall equal the total number of IU RELEASE COMPLETE. In case only a subset of per cause measurements is supported, a sum measurement subtype will be provided first.
- d) Each measurement is an integer value. The number of measurements is equal to the number of causes plus a possible sum value identified by the *.sum* suffix.
- e) The measurement name has the form *IU.SuccConnRelCNPS.Cause* where *Cause* identifies the release cause.
- f) RncFunction
- g) Valid for packet switching.
- h) UMTS

4.15 Intra-cell DCA

4.15.0 Introduction

The three measurement types defined in subclause 4.15...n for Intra-cell DCA are subject to the "2 out of 3 approach".

4.15.1 Attempted intra-cell DCA

- a) This measurement provides the number of attempted intra-cell DCA per cell. This measurement is only valid for TDD mode.
- b) CC
- c) Transmission of a RRC message PHYSICAL CHANNEL RECONFIGURATION, RADIO BEARER SETUP, RADIO BEARER RECONFIGURATION, RADIO BEARER RELEASE, or TRANSPORT CHANNEL RECONFIGURATION from the source RNC to the UE, indicating the attempt of an intra-cell DCA (see TS 25.331 [4]).
- d) A single integer value
- e) DCA.AttIntraCell.
- f) UtranCellTDDLcr
UtranCellTDDHcr
- g) Valid for circuit switched and packet switched traffic
- h) UMTS

4.15.2 Successful intra-cell DCA

- a) This measurement provides the number of successful intra-cell DCA per cell. This measurement is only valid for TDD mode.
- b) CC
- c) Receipt of a RRC message PHYSICAL CHANNEL RECONFIGURATION COMPLETE, RADIO BEARER SETUP COMPLETE, RADIO BEARER RECONFIGURATION COMPLETE, RADIO BEARER RELEASE COMPLETE, or TRANSPORT CHANNEL RECONFIGURATION COMPLETE sent from the UE to the source RNC, indicating a successful intra-cell DCA (see TS 25.331 [4]).
- d) A single integer value
- e) DCA.SuccIntraCell.
- f) UtranCellTDDLcr
UtranCellTDDHcr
- g) Valid for circuit switched and packet switched traffic
- h) UMTS

4.15.3 Failed intra-cell DCA

- a) This measurement provides the number of failed intra-cell DCA per cell per cause. This measurement is only valid for TDD mode.
- b) CC
- c) Receipt of a RRC message PHYSICAL CHANNEL RECONFIGURATION FAILURE, RADIO BEARER SETUP FAILURE, RADIO BEARER RECONFIGURATION FAILURE, RADIO BEARER RELEASE FAILURE, or TRANSPORT CHANNEL RECONFIGURATION FAILURE sent from the UE to the source RNC, indicating a failed intra-cell DCA. Failure causes are defined within TS 25.331 [4].

Each expected RRC message PHYSICAL CHANNEL RECONFIGURATION COMPLETE, RADIO BEARER SETUP COMPLETE, RADIO BEARER RECONFIGURATION COMPLETE, RADIO BEARER RELEASE COMPLETE, TRANSPORT CHANNEL RECONFIGURATION COMPLETE, PHYSICAL CHANNEL RECONFIGURATION FAILURE, RADIO BEARER SETUP FAILURE, RADIO BEARER RECONFIGURATION FAILURE, RADIO BEARER RELEASE FAILURE, or TRANSPORT CHANNEL RECONFIGURATION FAILURE not received by the source RNC is added to the measurement cause 'No Reply' (not specified in TS 25.331 [4]).

The sum of all supported per cause measurements shall equal the total number of failed events. In case only a subset of per cause measurements is supported, a sum subcounter will be provided first.

- d) Each measurement is an integer value. The number of measurements is equal to the number of causes supported plus a possible sum value identified by the *.sum* suffix.
- e) The measurement name has the form DCA.FailIntraCell.*Cause* where *Cause* identifies the failure cause.
The cause 'No Reply' is identified by the *.NoReply* suffix.
- f) UtranCellTDDLcr
UtranCellTDDHcr
- g) Valid for circuit switched and packet switched traffic
- h) UMTS

4.16 TDD Code Resources

4.16.1 UTRAN Cell Max Downlink Code Resources Used

- a) This measurement provides the number of OVFS codes used in the downlink of the UTRAN cell. This measurement is split into subcounters according to the Orthogonal Variable Spreading Factor (OVFS) length. This measurement is only valid for TDD mode.
- b) SI.
- c) This measurement is obtained by sampling at a pre-defined interval, the number of OVFS codes used per Spread Factor (SF), and then taking the arithmetic maximum. The SFs used are: SF= 1, SF= 16.
- d) Two integer values.
- e) TCR.DLCodeResUsed.SF1
TCR.DLCodeResUsed.SF16
- f) UtranCellTDDLcr
UtranCellTDDHcr
- g) UtranCell
- h) Valid for circuit switched and packet switched traffic
- i) UMTS

4.16.2 UTRAN Cell Max Uplink Code Resources Used

- a) This measurement provides the number of OVFS codes used in the uplink of the UTRAN cell. This measurement is split into subcounters according to the Orthogonal Variable Spreading Factor (OVFS) length. This measurement is only valid for TDD mode.
- b) SI.
- c) This measurement is obtained by sampling at a pre-defined interval, the number of OVFS codes used per Spread Factor (SF), and then taking the arithmetic maximum. The SFs used are: SF= 1, SF= 2, SF= 4, SF= 8, SF= 16.
- d) Five integer values.
- e) TCR.ULCodeResUsed.SF1
TCR.ULCodeResUsed.SF2
TCR.ULCodeResUsed.SF4
TCR.ULCodeResUsed.SF8
TCR.ULCodeResUsed.SF16.
- f) UtranCellTDDLcr
UtranCellTDDHcr
- g) Valid for circuit switched and packet switched traffic
- h) UMTS

4.16.3 Mean Downlink Code Resources Used of an UTRAN Cell

- a) This measurement provides the mean number of OVSF codes used in the downlink of the UTRAN cell. This measurement is split into subcounters according to the Orthogonal Variable Spreading Factor (OVSF) length. This measurement is only valid for TDD mode.
- b) SI.
- c) This measurement is obtained by sampling at a pre-defined interval, the number of OVSF codes used per spread factor (SF), and then taking the arithmetic mean. The SFs used are: SF= 1, SF= 16.
- d) Two integer values.
- e) TCR.DLMeanCodeResUsed.SF1,
TCR.DLMeanCodeResUsed.SF16.
- f) UtranCellTDDLcr
UtranCellTDDHcr
- g) Valid for circuit switched and packet switched traffic
- h) UMTS

4.16.4 Mean Uplink Code Resources Used of an UTRAN Cell

- a) This measurement provides the mean number of OVSF codes used in the uplink of the UTRAN cell. This measurement is split into subcounters according to the Orthogonal Variable Spreading Factor (OVSF) length. This measurement is only valid for TDD mode.
- b) SI.
- c) This measurement is obtained by sampling at a pre-defined interval, the number of OVSF codes used per Spread Factor (SF), and then taking the arithmetic mean. The SFs used are: SF= 1, SF= 2, SF= 4, SF= 8, SF= 16.
- d) Five integer values.
- e) TCR.ULMeanCodeResUsed.SF1,
TCR.ULMeanCodeResUsed.SF2,
TCR.ULMeanCodeResUsed.SF4,
TCR.ULMeanCodeResUsed.SF8,
TCR.ULMeanCodeResUsed.SF16.
- f) UtranCellTDDLcr
UtranCellTDDHcr
- g) Valid for circuit switched and packet switched traffic
- h) UMTS

4.17 Measurements related to TDD UTRAN cell Radio Frequency Carrier

4.17.1 Mean Transmitted Carrier Power of an UTRAN Cell

- a) This measurement provides the mean transmitted carrier power of an UTRAN cell. This measurement is only valid for TDD mode.
- b) SI.
- c) This measurement is obtained by sampling at a pre-defined interval, the transmitted carrier power of the same Node B reported, and then taking the arithmetic mean. For an Utran Cell in TDD mode, the minimum granularity for this measurement is a Time Slot (TS).
- d) In case a TS is configured to work for downlink, the measurement value for Transmitted Carrier Power on the basis of this TS is an integer, with a range from 0 to 100 that maps the value of the measured transmitted carrier power percentage as defined in table 9.46 of TS 25.123 [9]. When a TS is configured to work for uplink, the measurement for Transmitted Carrier Power on the basis of this TS is not valid and should have a NULL value specified in 3GPP TS 32.432 [12]. TS0 to TS6 are valid for both UtranCellTDDLcr and UtranCellTDDHcr, and TS7 to TS14 are valid only for UtranCellTDDHcr.
- e) CARR.MeanTSTCP.TSx, where x presents 0, 1, 2 ... 14.
- f) UtranCellTDDLcr
UtranCellTDDHcr
- g) Valid for circuit switched and packet switched traffic
- h) UMTS

4.17.2 Maximum Transmitted Carrier Power of an UTRAN Cell

- a) This measurement provides the maximum transmitted carrier power of an UTRAN cell. This measurement is only valid for TDD mode.
- b) SI.
- c) This measurement is obtained by sampling at a pre-defined interval, the transmitted carrier power of the same Node B reported, and then taking the maximum. For an Utran Cell in TDD mode, the minimum granularity for this measurement is a Time slot (TS).
- d) In case a TS is configured to work for downlink, the measurement value for Transmitted Carrier Power on the basis of this TS is an integer, with a range from 0 to 100, that maps the value of the measured transmitted carrier power percentage as defined in table 9.46 of TS 25.123 [9]. When a TS is configured to work for uplink, the measurement for Transmitted Carrier Power on the basis of this TS is not valid and should have a NULL value specified in 3GPP TS 32.432 [12]. TS0 to TS6 are valid for both UtranCellTDDLcr and UtranCellTDDHcr, and TS7 to TS14 are valid only for UtranCellTDDHcr.
- e) CARR.MaxTSTCP.TSx, where x presents 0, 1, 2 ... 14.
- f) UtranCellTDDLcr
UtranCellTDDHcr
- g) Valid for circuit switched and packet switched traffic
- h) UMTS

4.17.3 Mean Received Total Wideband Power of an UTRAN Cell

- a) This measurement provides the mean received total wide band power of an UTRAN cell. This measurement is only valid for TDD mode.

- b) SI.
- c) This measurement is obtained by sampling at a pre-defined interval, the received total wide band power of the same Node B reported, and then taking the arithmetic mean. For an Utran Cell in TDD mode, the minimum granularity for this measurement is a Time slot (TS).
- d) In case a TS is configured to work for downlink, the measurement value for Transmitted Carrier Power on the basis of this TS is an integer, with a range from 0 to 621 that maps the value of the received total wide band power percentage as defined in table 9.36 of TS 25.123 [9]. When a TS is configured to work for uplink, the measurement for Transmitted Carrier Power on the basis of this TS is not valid and should have a NULL value specified in 3GPP TS 32.432 [12]. TS0 to TS6 are valid for both UtranCellTDDLcr and UtranCellTDDHcr, and TS7 to TS14 are valid only for UtranCellTDDHcr.
- e) CARR.MeanTSRTWP.TSx, where x presents 0, 1, 2 ... 14.
- f) UtranCellTDDLcr
UtranCellTDDHcr
- g) Valid for circuit switched and packet switched traffic
- h) UMTS

4.17.4 The Maximum Received Total Wideband Power of an UTRAN Cell

- a) This measurement provides the maximum received total wide band power of an UTRAN cell. This measurement is only valid for TDD mode.
- b) SI.
- c) This measurement is obtained by sampling at a pre-defined interval, the received total wide band power of the same Node B reported, and then taking the maximum. For an Utran Cell in TDD mode, the minimum granularity for this measurement is a Time Slot (TS).
- d) In case a TS is configured to work for downlink, the measurement value for Transmitted Carrier Power on the basis of this TS is an integer, with a range from 0 to 621, that maps the value of the received total wide band power percentage as defined in table 9.36 of TS 25.123 [9]. When a TS is configured to work for uplink, the measurement for Transmitted Carrier Power on the basis of this TS is not valid and should have a NULL value specified in 3GPP TS 32.432 [12]. TS0 to TS6 are valid for both UtranCellTDDLcr and UtranCellTDDHcr, and TS7 to TS14 are valid only for UtranCellTDDHcr.
- e) CARR.MaxTSRTWP.TSx, where x presents 0, 1, 2 ... 14.
- f) UtranCellTDDLcr
UtranCellTDDHcr
- g) Valid for circuit switched and packet switched traffic
- h) UMTS

4.17.5 Mean DPCH Transmitted Code Power of an UTRAN Cell

- a) This measurement provides the mean of the DPCH Transmitted Code Power. This measurement is valid only for TDD mode.
- b) SI
- c) This measurement is obtained by sampling at a pre-defined interval, the DPCH Transmitted Code Power of a given UtranCell, and then taking the arithmetic mean.
- d) A single integer value from 10 to 122, that maps the value of the measured Transmitted Code Power as defined in table 9.49 of TS 25.123 [9].
- e) CARR. MeanDPCHTx

- f) UtranCellTDDLcr
UtranCellTDDHcr
- g) Valid for circuit switched and packet switched traffic
- h) UMTS

4.17.6 Maximum DPCH Transmitted Code Power of an UTRAN Cell

- a) This measurement provides the maximum of the DPCH Transmitted Code Power. This measurement is valid only for TDD mode.
- b) SI
- c) This measurement is obtained by sampling at a pre-defined interval, the DPCH Transmitted Code Power of a given UtranCell, and then taking the arithmetic maximum value.
- d) A single integer value from 10 to 122, that maps the value of the measured Transmitted Code Power as defined in table 9.49 of TS 25.123 [9].
- e) CARR. MaxDPCHTx
- f) UtranCellTDDLcr
UtranCellTDDHcr
- g) Valid for circuit switched and packet switched traffic
- h) UMTS

4.17.7 Mean DPCH Received Signal Code Power of an UTRAN Cell

- a) This measurement provides the mean of the DPCH Received Signal Code Power. This measurement is valid only for TDD mode.
- b) SI
- c) This measurement is obtained by sampling at a pre-defined interval, the DPCH Received Signal Code Power of a given UtranCell, and then taking the arithmetic mean.
- d) A single integer value from 10 to 122, that maps the value of the measured Received Signal Code Power as defined in table 9.49 of TS 25.123 [9].
- e) CARR. MeanDPCHRx
- f) UtranCellTDDLcr
UtranCellTDDHcr
- g) Valid for circuit switched and packet switched traffic
- h) UMTS

4.17.8 Maximum DPCH Received Signal Code Power of an UTRAN Cell

- a) This measurement provides the maximum of the DPCH Received Signal Code Power. This measurement is valid only for TDD mode.
- b) SI
- c) This measurement is obtained by sampling at a pre-defined interval, the DPCH Received Signal Code Power of a given UtranCell, and then taking the arithmetic maximum value.
- d) A single integer value from 10 to 122, that maps the value of the measured Received Signal Code Power as defined in table 9.49 of TS 25.123 [9].
- e) CARR. MaxDPCHRx

- f) UtranCellTDDLcr
UtranCellTDDHcr
- g) Valid for circuit switched and packet switched traffic
- h) UMTS

4.17.9 Mean Interference Signal Code Power of an UTRAN Cell

- a) This measurement provides the mean interference signal code power of an UTRAN cell in uplink. This measurement is only valid for TDD mode.
- b) SI
- c) This measurement is obtained by sampling at a pre-defined interval, the interference signal code power of the same Node B reported, and then taking the arithmetic mean. For an Utran Cell in TDD mode, the minimum granularity for this measurement is a Time Slot (TS).
- d) In case a TS is configured to work for uplink, the measurement value for interference signal code power on the basis of this TS is an integer value, with a range from 0 to 127 that maps the value of the interference signal code power as defined in table 9.34 of TS 25.123 [9]. When a TS is configured to work for downlink, the measurement for interference signal code power on the basis of this TS is not valid and should have a NULL value specified in 3GPP TS 32.432 [12]. TS0 to TS6 are valid for both UtranCellTDDLcr and UtranCellTDDHcr, and TS7 to TS14 are valid only for UtranCellTDDHcr.
- e) CARR.MeanTSISCP.TS_x, where x presents 0, 1, 2 ... 14.
- f) UtranCellTDDLcr
UtranCellTDDHcr
- g) Valid for circuit switched and packet switched traffic
- h) UMTS

4.17.10 Maximum Interference Signal Code Power of an UTRAN Cell

- a) This measurement provides the maximum interference signal code power of an UTRAN cell in uplink. This measurement is only valid for TDD mode.
- b) SI
- c) This measurement is obtained by sampling at a pre-defined interval, the interference signal code power of the same Node B reported, and then taking the maximum. For an Utran Cell in TDD mode, the minimum granularity for this measurement is a Time Slot (TS).
- d) In case a TS is configured to work for uplink, the measurement value for interference signal code power on the basis of this TS is an integer value, with a range from 0 to 127 that maps the value of the interference signal code power as defined in table 9.34 of TS 25.123 [9]. When a TS is configured to work for downlink, the measurement for interference signal code power on the basis of this TS is not valid and should have a NULL value specified in 3GPP TS 32.432 [12]. TS0 to TS6 are valid for both UtranCellTDDLcr and UtranCellTDDHcr, and TS7 to TS14 are valid only for UtranCellTDDHcr.
- e) CARR.MaxTSISCP.TSx, where x presents 0, 1, 2 ... 14.
- f) UtranCellTDDLcr
UtranCellTDDHcr
- g) Valid for circuit switched and packet switched traffic
- h) UMTS

4.17.11 Mean transmitted carrier power of all codes not used for HS-PDSCH , HS-SCCH, E-AGCH or E-HICH transmission

- a) This measurement provides the mean transmitted non-HS carrier power of an UTRAN cell. This measurement is valid only for TDD mode.
- b) SI
- c) This measurement is obtained by sampling at a pre-defined interval, the transmitted carrier power (extracted from NBAP common measurement report (see TS 25.225 [16], TS 25.433 [7])) of all codes not used for HS-PDSCH , HS-SCCH, E-AGCH or E-HICH transmission of a given UtranCell, and then taking the arithmetic mean of the measurement values obtained during the granularity period. For an UTRAN cell in TDD mode, the minimum granularity of this measurement is a Time Slot (TS).
- d) In case a TS is configured to work for downlink, the measurement value for transmitted carrier power on the basis of this TS is an integer value, with a range from 0 to 100 that maps the value of the transmitted carrier power as defined in table 9.51 of TS 25.123 [9]. When a TS is configured to work for uplink, the measurement for transmitted carrier power on the basis of this TS is not valid and should have a NULL value specified in 3GPP TS 32.432 [15]. TS0 to TS6 are valid for both UtranCellTDDLcr and UtranCellTDDHcr, and TS7 to TS14 are valid only for UtranCellTDDHcr.
- e) CARR.MeanTDDNonHSTCP.TSx, where x presents 0, 1, 2 ... 14.
- f) UtranCellTDDLcr
UtranCellTDDHcr
- g) Valid only for packet switched traffic
- h) UMTS

4.17.12 Maximum transmitted carrier power of all codes not used for HS-PDSCH , HS-SCCH, E-AGCH or E-HICH transmission

- a) This measurement provides the maximum transmitted non-HS carrier power of an UTRAN cell. This measurement is valid only for TDD mode.

- b) SI
- c) This measurement is obtained by sampling at a pre-defined interval, the transmitted carrier power (extracted from NBAP common measurement report (see TS 25.225 [16], TS 25.433 [7])) of all codes not used for HS-PDSCH , HS-SCCH, E-AGCH or E-HICH transmission of a given UtranCell, and then taking the arithmetic maximum of the measurement values obtained during the granularity period. For an UTRAN cell in TDD mode, the minimum granularity of this measurement is a Time Slot (TS).
- d) In case a TS is configured to work for downlink, the measurement value for transmitted carrier power on the basis of this TS is an integer value, with a range from 0 to 100 that maps the value of the transmitted carrier power as defined in table 9.51 of TS 25.123 [9]. When a TS is configured to work for uplink, the measurement for transmitted carrier power on the basis of this TS is not valid and should have a NULL value specified in 3GPP TS 32.432 [15]. TS0 to TS6 are valid for both UtranCellTDDLcr and UtranCellTDDHcr, and TS7 to TS14 are valid only for UtranCellTDDHcr.
- e) CARR.MaxTDDNonHSTCP.TSx, where x presents 0, 1, 2 ... 14.
- f) UtranCellTDDLcr
UtranCellTDDHcr
- g) Valid only for packet switched traffic
- h) UMTS

4.18 Measurements related to the UTRAN cell FDD carrier (RF Performance metrics)

4.18.0 Introduction

RF metrics can be used to indicate loading levels and abnormal conditions.

4.18.1 Mean Transmitted Carrier Power of an UTRAN Cell

- a) This measurement provides the average of the transmitted carrier power. This measurement is valid only for FDD mode.
- b) SI.
- c) This measurement is obtained by sampling at a pre-defined interval, the transmitted carrier power (see TS 25.133 [8]) for the RF carrier of a given UtranCell, and then taking the arithmetic mean.
- d) A single integer value from 0 to 100, that maps the value of the measured transmitted carrier power percentage as defined in table 9.43 [8].
- e) CARR.FDDMeanTCP.
- f) UtranCellFDD
- g) Valid for circuit switched and packet switched traffic
- h) UMTS
- i) Network Operator's Traffic Engineering Community, Equipment Vendor's Performance Modelling Community.

4.18.2 Maximum Transmitted Carrier Power of an UTRAN Cell

- a) This measurement provides the maximum of the transmitted carrier power. This measurement is valid only for FDD mode.
- b) SI.
- c) This measurement is obtained by sampling at a pre-defined interval, the transmitted carrier power (see TS 25.133 [8]) for the RF carrier of a given UtranCell, and then taking the maximum value.
- d) A single integer value from 0 to 100, that maps the value of the measured transmitted carrier power percentage as defined in table 9.43 [8].
- e) CARR.FDDMaxTCP.
- f) UtranCellFDD
- g) Valid for circuit switched and packet switched traffic
- h) UMTS
- i) Network Operator's Traffic Engineering Community, Equipment Vendor's Performance Modelling Community.

4.18.3 Mean Received Total Wideband Power of an UTRAN Cell

- a) This measurement provides the average of the received total wideband power. This measurement is valid only for FDD mode.
- b) SI.
- c) This measurement is obtained by sampling at a pre-defined interval, the received total wideband power (see TS 25.133 [8]) for the RF carrier of a given UtranCell, and then taking the arithmetic mean.
- d) A single integer value from 0 to 621 that maps the value of the measured received total wideband power as defined in table 9.37[8].
- e) CARR.FDDMeanRTWP.
- f) UtranCellFDD
- g) Valid for circuit switched and packet switched traffic
- h) UMTS
- i) Network Operator's Traffic Engineering Community, Equipment Vendor's Performance Modelling Community.

4.18.4 Maximum Received Total Wideband Power of an UTRAN Cell

- a) This measurement provides the maximum of the received total wideband power. This measurement is valid only for FDD mode.
- b) SI.
- c) This measurement is obtained by sampling at a pre-defined interval, the received wideband power (see TS 25.133 [8]) for the RF carrier of a given UtranCell, and then taking the maximum value.
- d) A single integer value from 0 to 621 that maps the value of the measured received total wideband power as defined in table 9.37[8].
- e) CARR.FDDMaxRTWP.
- f) UtranCellFDD
- g) Valid for circuit switched and packet switched traffic
- h) UMTS
- i) Network Operator's Traffic Engineering Community, Equipment Vendor's Performance Modelling Community.

4.18.5 Mean Radio Link Transmitted Code Power of an UTRAN Cell

- a) This measurement provides the average of the Radio Link Transmitted Code Power. This measurement is valid for only FDD mode.
- b) SI
- c) This measurement is obtained by sampling at a pre-defined interval, the Radio Link Transmitted Code Power of a given UtranCell, and then taking the arithmetic mean.
- d) A single integer value from 10 to 122, that maps the value of the measured Transmitted Code Power as defined in table 9.46 of TS 25.133 [8].
- e) CARR. MeanRadioLink
- f) UtranCellFDD
- g) Valid for circuit switched and packet switched traffic

h) UMTS

4.18.6 Maximum Radio Link Transmitted Code Power of an UTRAN Cell

- a) This measurement provides the maximum of the Radio Link Transmitted Code Power. This measurement is valid only for FDD mode.
- b) SI
- c) This measurement is obtained by sampling at a pre-defined interval, the Radio Link Transmitted Code Power of a given UtranCell, and then taking the arithmetic maximum value.
- d) A single integer value from 10 to 122, that maps the value of the measured Transmitted Code Power as defined in table 9.46 of TS 25.133 [8].
- e) CARR.MaxRadioLink
- f) UtranCellFDD
- g) Valid for circuit switched and packet switched traffic
- h) UMTS

4.18.7 Mean transmitted carrier power of all codes not used for HS-PDSCH, HS-SCCH, E-AGCH, E-RGCH or E-HICH transmission of an UTRAN Cell

- a) This measurement provides the mean transmitted non-HS carrier power of a serving HS-DSCH cell. This measurement is valid only for FDD mode.
- b) SI.
- c) This measurement is obtained by sampling at a pre-defined interval, the transmitted carrier power (extracted from NBAP common measurement report (see TS 25.215 [14], TS 25.433 [7])) of all codes not used for HS-PDSCH, HS-SCCH, E-AGCH, E-RGCH or E-HICH transmission of a given UtranCell, and then taking the arithmetic mean of the measurement values obtained during the granularity period.
- d) A single integer value from 0 to 100, that maps the value of the measured transmitted carrier power to a percentage as defined in table 9.64 (see TS 25.133 [8]).
- e) CARR.MeanFDDNonHSTCP.
- f) UtranCellFDD
- g) Valid for circuit switched and packet switched traffic
- h) UMTS

4.18.8 Maximum transmitted carrier power of all codes not used for HS-PDSCH, HS-SCCH, E-AGCH, E-RGCH or E-HICH transmission of an UTRAN Cell

- a) This measurement provides the maximum transmitted non-HS carrier power of a serving HS-DSCH cell. This measurement is valid only for FDD mode.
- b) SI.
- c) This measurement is obtained by sampling at a pre-defined interval, the transmitted carrier power (extracted from NBAP common measurement report (see TS 25.215 [14], TS 25.433 [7])) of all codes not used for HS-PDSCH, HS-SCCH, E-AGCH, E-RGCH or E-HICH transmission of a given UtranCell, and then taking the maximum of the measurement values obtained during the granularity period.
- d) A single integer value from 0 to 100, that maps the value of the measured transmitted carrier power to a percentage as defined in table 9.64 (see TS 25.133 [8]).
- e) CARR.MaxFDDNonHSTCP.
- f) UtranCellFDD
- g) Valid for circuit switched and packet switched traffic
- h) UMTS

4.19 FDD Code Resources

4.19.1 Code Resources Used of an FDD mode UTRAN Cell

- a) This measurement provides the number of OVSF codes used of an UTRAN cell. This measurement is split into subcounters according to the Orthogonal Variable Spreading Factor (OVSF) length. This measurement is only valid for FDD mode.
- b) SI.
- c) This measurement is obtained by sampling at a pre-defined interval, the number of OVSF codes used per spread factor (SF), and then taking the arithmetic mean. The SF used as following:
SF=4, SF= 8, SF= 16, SF= 32, SF= 64, SF= 128, SF= 256, SF=512.
- d) Eight integer values.
- e) CR.CodesUsed.SF4
CR.CodesUsed.SF8
CR.CodesUsed.SF16
CR.CodesUsed.SF32
CR.CodesUsed.SF64
CR.CodesUsed.SF128
CR.CodesUsed.SF256
CR.CodesUsed.SF512
- f) UtranCellFDD
- g) Valid for circuit switched and packet switched traffic
- h) UMTS

4.20 Paging

4.20.1 Overview

4.20.1.0 Introduction

Paging procedures include RANAP Paging procedure, RRC Paging and RRC UE Dedicated Paging procedure.

4.20.1.1 Considered Paging procedures

Performance Measurement definitions in this subclause are based on TS 25.331 [4] and TS 25.413 [5].

The following procedures are of interest for this purpose:

RRC: UE DEDICATED PAGING

RRC: PAGING

RANAP: PAGING

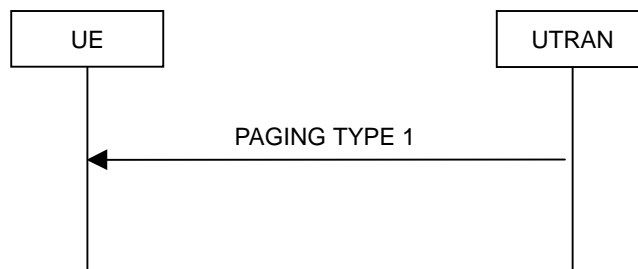

Figure: RRC Paging procedure

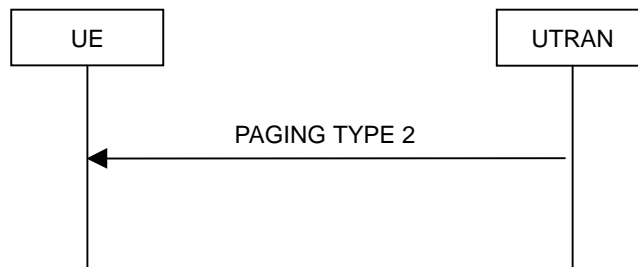

Figure: RRC UE Dedicated Paging procedure



Figure: RANAP Paging procedure (Successful operation)

4.20.2 Paging request from CN

- a) This measurement provides the number of paging requests received from CN. The measurement is split into subcounters per paging cause.
- b) CC
- c) On receipt by the RNC of a RANAP PAGING message from CN. Each RANAP message PAGING receipt by the RNC is added to the relevant per cause measurement. The possible causes are included in TS 25.413 [5]. The sum of all supported per cause measurements shall equal the total number of PAGING requests. In case only a subset of per cause measurements is supported, a sum measurement subtype will be provided first.
- d) Each measurement is an integer value.
- e) The measurement name has the form *Pag.AttCn.Cause* where *Cause* identifies the paging cause.
- f) RncFunction
- g) Valid for circuit switched and packet switched traffic
- h) UMTS

4.20.3 Paging Type 1

4.20.3.1 Attempted Paging Type 1

- a) This measurement provides the number of attempted Paging Type 1 procedures. The measurement is split into subcounters per paging cause.
- b) CC
- c) On transmission by the RNC of a RRC PAGING TYPE 1 message to the UE. Each RRC PAGING TYPE 1 message sent by the RNC is added to the relevant per cause measurement. The possible causes are included in TS 25.331 [4]. The sum of all supported per cause measurements shall equal the total number of Paging Type 1 attempts. In case only a subset of per cause measurements is supported, a sum measurement subtype will be provided first.
- d) Each measurement is an integer value.
- e) The measurement name has the form *Pag.AttPagType1.Cause* where *Cause* identifies the paging cause.
- f) UtranCellFDD
UtranCellTDDLcr
UtranCellTDDHer
- g) Valid for circuit switched and packet switched traffic
- h) UMTS

4.20.4 Paging Type 2

4.20.4.1 Attempted Paging Type 2

- a) This measurement provides the number of attempted Paging Type 2 procedures. The measurement is split into subcounters per paging cause.
- b) CC
- c) On transmission by the RNC of a RRC PAGING TYPE 2 message to the UE. Each RRC PAGING TYPE 2 message sent by the RNC is added to the relevant per cause measurement. The possible causes are included in TS 25.331 [4]. The sum of all supported per cause measurements shall equal the total number of Paging Type 2 attempts. In case only a subset of per cause measurements is supported, a sum measurement subtype will be provided first.
- d) Each measurement is an integer value.
- e) The measurement name has the form *Pag.AttPagType2.Cause* where *Cause* identifies the paging cause.
- f) UtranCellFDD
UtranCellTDDLcr
UtranCellTDDHer
- g) Valid for circuit switched and packet switched traffic
- h) UMTS

4.21 ATM layer measurement

4.21.1 Cell collection

4.21.1.1 Ingress cells (whole stream)

- a) This measurement provides the total number of ingress cells on ATM node.
- b) CC
- c) See clause 5.6.7 in [11].
- d) A single integer value, see [11].
- e) ATM.ATML.IngressCells.
- f) IubLink.
- g) Valid for circuit switched and packet switched traffic
- h) UMTS

4.21.1.2 Egress cells (whole stream)

- a) This measurement provides the total number of egress cells on ATM node.
- b) CC
- c) See NumberCellsTrnsd in [11].
- d) A single integer value, see [11].
- e) ATM.ATML.EgressCells.
- f) IubLink.
- g) Valid for circuit switched and packet switched traffic
- h) UMTS

4.22 HSDPA setup

4.22.1 Mac-d setup for HSDPA

4.22.1.0 Introduction

The three measurement types defined in this subclause are subject to the "2 out of 3 approach".

4.22.1.1 Attempted Mac-d setups for HSDPA

- a) This measurement provides the number of attempted Mac-d setups for HSDPA.
- b) CC
- c) On transmission by the RNC of a NBAP message RADIO LINK SETUP REQUEST with the "HS-DSCH Information" IE; Or on transmission by the RNC of a NBAP message RADIO LINK RECONFIGURATION PREPARE with the "HS-DSCH MAC-d Flows To Add" or "HS-DSCH Information" IE; Or on transmission by the RNC of a NBAP message RADIO LINK RECONFIGURATION REQUEST with the "HS-DSCH MAC-d Flows To Add" or "HS-DSCH Information" IE. See TS 25.433 [7].
- d) A single integer value
- e) HSDPA.AttMacdSetup
- f) UtranCellFDD
UtranCellTDDLcr
UtranCellTDDHcr
- g) Valid for packet switched traffic
- h) UMTS

4.22.1.2 Successful Mac-d setups for HSDPA

- a) This measurement provides the number of successful Mac-d setups for HSDPA.
- b) CC
- c) On receipt by the RNC of a NBAP message RADIO LINK SETUP RESPONSE, corresponding to transmission of the NBAP message RADIO LINK SETUP REQUEST with the "HS-DSCH Information" IE; Or on receipt by the RNC of a NBAP message RADIO LINK RECONFIGURATION READY, corresponding to the transmission of the NBAP message RADIO LINK RECONFIGURATION PREPARE with the "HS-DSCH MAC-d Flows To Add" or "HS-DSCH Information" IE; Or on receipt by the RNC of NBAP message RADIO LINK RECONFIGURATION RESPONSE, corresponding to the transmission of the NBAP message RADIO LINK RECONFIGURATION REQUEST with the "HS-DSCH MAC-d Flows To Add" or "HS-DSCH Information" IE. See TS 25.433 [7].
- d) A single integer value
- e) HSDPA.SuccMacdSetup
- f) UtranCellFDD
UtranCellTDDLcr
UtranCellTDDHcr
- g) Valid for packet switched traffic
- h) UMTS

4.22.1.3 Failed Mac-d setups for HSDPA

- a) This measurement provides the number of failed Mac-d setups for HSDPA. The measurement is split into subcounters per cause.
- b) CC
- c) On receipt by the RNC of a NBAP message RADIO LINK SETUP FAILURE, corresponding to transmission of the NBAP message RADIO LINK SETUP REQUEST with the “HS-DSCH Information” IE; Or on receipt by the RNC of a NBAP message RADIO LINK RECONFIGURATION FAILURE, corresponding to the transmission of the NBAP message RADIO LINK RECONFIGURATION PREPARE with the “HS-DSCH MAC-d Flows To Add” or “HS-DSCH Information” IE; Or on receipt by the RNC of NBAP message RADIO LINK RECONFIGURATION FAILURE, corresponding to the transmission of the NBAP message RADIO LINK RECONFIGURATION REQUEST with the “HS-DSCH MAC-d Flows To Add” or “HS-DSCH Information” IE. Each failed Mac-d setup for HSDPA is added to the relevant measurement according to the failure cause. Possible failure causes are included in TS 25.433 [7].

Each expected NBAP message RADIO LINK SETUP FAILURE, corresponding to transmission of the NBAP message RADIO LINK SETUP REQUEST with the “HS-DSCH Information” IE; Or NBAP message RADIO LINK RECONFIGURATION FAILURE, corresponding to the transmission of the NBAP message RADIO LINK RECONFIGURATION PREPARE with the “HS-DSCH MAC-d Flows To Add” or “HS-DSCH Information” IE; Or NBAP message RADIO LINK RECONFIGURATION FAILURE, corresponding to the transmission of the NBAP message RADIO LINK RECONFIGURATION REQUEST with the “HS-DSCH MAC-d Flows To Add” or “HS-DSCH Information” IE not received by the RNC is added to the measurement cause 'No Reply' (not specified in TS 25.433 [7]).

The sum of all supported per cause measurements shall equal the total number of failed Mac-d setups for HSDPA. In case only a subset of per cause measurements is supported, a sum subcounter will be provided first.

- d) Each measurement is an integer value. The number of measurements is equal to the number of causes plus a possible sum value identified by the *.sum* suffix.
- e) The measurement name has the form HSDPA.FailMacdSetup.*Cause* where *Cause* identifies the failure cause. The cause 'No Reply' is identified by the *.NoReply* suffix.
- f) UtranCellFDD
UtranCellTDDLcr
UtranCellTDDHcr
- g) Valid for packet switched traffic
- h) UMTS

4.22.2 RB setup for HSDPA

4.22.2.0 Introduction

The three measurement types defined in this subclause are subject to the "2 out of 3 approach".

4.22.2.1 Attempted RB setups for HSDPA

- a) This measurement provides the number of attempted radio bearer setups for HSDPA.
- b) CC
- c) On transmission by the RNC of a RRC message RADIO BEARER SETUP with the "Downlink transport channel type" set to "HS-DSCH" or "DCH + HS-DSCH" in the "RB mapping info" IE of the "RB information to setup"; Or on transmission by the RNC of a RRC message RADIO BEARER RECONFIGURATION with "Downlink transport channel type" set to "HS-DSCH" or "DCH + HS-DSCH" in the "RB mapping info" IE of the "RB information to reconfigure" if the previous "Downlink transport channel type" of this RB is not the "HS-DSCH" or "DCH + HS-DSCH". See TS 25.331 [4].
- d) A single integer value
- e) HSDPA.AttRBSetup
- f) UtranCellFDD
UtranCellTDDLcr
UtranCellTDDHcr
- g) Valid for packet switched traffic
- h) UMTS

4.22.2.2 Successful RB setups for HSDPA

- a) This measurement provides the number of successful radio bearer setups for HSDPA.
- b) CC
- c) On receipt by the RNC of a RRC message RADIO BEARER SETUP COMPLETE, corresponding to the transmission of the RRC message RADIO BEARER SETUP with the "Downlink transport channel type" set to "HS-DSCH" or "DCH + HS-DSCH" in the "RB mapping info" IE of the "RB information to setup"; Or on receipt by the RNC of a RRC message RADIO BEARER RECONFIGURATION COMPLETE, corresponding to the transmission of the RRC message RADIO BEARER RECONFIGURATION with "Downlink transport channel type" set to "HS-DSCH" or "DCH + HS-DSCH" in the "RB mapping info" IE of the "RB information to reconfigure" if the previous "Downlink transport channel type" of this RB is not the "HS-DSCH" or "DCH + HS-DSCH". See TS 25.331 [4].
- d) A single integer value
- e) HSDPA.SuccRBSetup
- f) UtranCellFDD
UtranCellTDDLcr
UtranCellTDDHcr
- g) Valid for packet switched traffic
- h) UMTS

4.22.2.3 Failed RB setups for HSDPA

- a) This measurement provides the number of failed radio bearer setups for HSDPA. The measurement is split into subcounters per cause.

- b) CC
- c) On receipt by the RNC of a RRC message RADIO BEARER SETUP FAILURE, corresponding to the transmission of the RRC message RADIO BEARER SETUP with the “Downlink transport channel type” set to “HS-DSCH” or “DCH + HS-DSCH” in the “RB mapping info” IE of the “RB information to setup”; Or on receipt by the RNC of a RRC message RADIO BEARER RECONFIGURATION FAILURE, corresponding to the transmission of the RRC message RADIO BEARER RECONFIGURATION with “Downlink transport channel type” set to “HS-DSCH” or “DCH + HS-DSCH” in the “RB mapping info” IE of the “RB information to reconfigure” if the previous “Downlink transport channel type” of this RB is not the “HS-DSCH” or “DCH + HS-DSCH”. Each failed RB setup for HSDPA is added to the relevant measurement according to the failure cause. Possible failure causes are included in TS 25.331 [4].

Each expected RRC message RADIO BEARER SETUP FAILURE, corresponding to the transmission of the RRC message RADIO BEARER SETUP with the “Downlink transport channel type” set to “HS-DSCH” or “DCH + HS-DSCH” in the “RB mapping info” IE of the “RB information to setup”; Or RRC message RADIO BEARER RECONFIGURATION FAILURE, corresponding to the transmission of the RRC message RADIO BEARER RECONFIGURATION with “Downlink transport channel type” set to “HS-DSCH” or “DCH + HS-DSCH” in the “RB mapping info” IE of the “RB information to reconfigure” if the previous “Downlink transport channel type” of this RB is not the “HS-DSCH” or “DCH + HS-DSCH” not received by the RNC is added to the measurement cause 'No Reply' (not specified in TS 25.331 [4]).

The sum of all supported per cause measurements shall equal the total number of failed RB setups for HSDPA. In case only a subset of per cause measurements is supported, a sum subcounter will be provided first.

- d) Each measurement is an integer value. The number of measurements is equal to the number of causes plus a possible sum value identified by the .sum suffix.
- e) The measurement name has the form HSDPA.FailRBSetup.Cause where *Cause* identifies the failure cause. The cause 'No Reply' is identified by the *NoReply* suffix.
- f) UtranCellFDD
UtranCellTDDLcr
UtranCellTDDHcr
- g) Valid for packet switched traffic
- h) UMTS

4.23 Call duration in UTRAN cell

4.23.1 Call duration in UTRAN cell for CS domain

- a) This measurement provides the call duration in utran cell for CS domain. The measurement is split into subcounters per traffic class (See the 3GPP TS23.107 [2]).
- b) DER (n=1)
- c) This measurement is obtained by accumulating the time intervals for each traffic class between the call start RRC RADIO BEARER SETUP COMPLETE and the call completed RRC RADIO BEARER RELEASE over a granularity period using DER. For conversational service, the relevant measurement for each specified data rate is required, the detailed data rates are listed below (see TS 25.993 [12]). The accumulator shall be reinitialised at the beginning of each granularity period. The call duration for each traffic class (for each specified data rate of conversational service) for CS domain is added to the relevant measurement. See TS 25.413 [5] and TS 23.107 [2].

uplink <U>:

- 1: AMR rate (12.2 10.2 7.95 7.4 6.7 5.9 5.15 4.75) kbps
- 2: 12.2 kbps
- 3: 28.8 kbps
- 4: 32 kbps
- 5: 64 kbps

downlink <D>:

- 1: AMR rate (12.2 10.2 7.95 7.4 6.7 5.9 5.15 4.75) kbps
- 2: 12.2 kbps
- 3: 28.8 kbps
- 4: 32 kbps
- 5: 64 kbps

As indicated above, <U> and <D> are integer values that map to the conversational service specified uplink and downlink data rates, respectively.

- d) Each measurement is an integer value. (in seconds)
- e) The measurement name has the form
RRC.CallDurationCS.Conv.<U><D>
RRC.CallDurationCS.Strm
RRC.CallDurationCS.Intact
RRC.CallDurationCS.Bgrd.
- f) UtranCellFDD
UtranCellTDDLcr
UtranCellTDDHcr
- g) Valid for circuit switched
- h) UMTS

4.24 Measurements related to channel switches between FACH/DCH and HS-DSCH

4.24.1 Measurements related to channel switches from FACH/DCH to HS-DSCH intra UTRAN cell

4.24.1.1 Attempted channel switches from FACH to HS-DSCH

- a) This measurement provides the number of attempted channel switches from FACH to HS-DSCH in the serving HS-DSCH cell.
- b) CC
- c) On transmission by the RNC of a RRC message RADIO BEARER RECONFIGURATION to UE, with the condition that channel switches from FACH to HS-DSCH (see TS 25.331 [4]).

NOTE: This measurement is dedicated to channel switches from FACH to HS-DSCH.

- d) A single integer value
- e) HSDPA.AttFachToHs
- f) UtranCellFDD
UtranCellTDDLcr
UtranCellTDDHcr
- g) Valid for packet switched traffic
- h) UMTS

4.24.1.2 Successful channel switches from FACH to HS-DSCH

- a) This measurement provides the number of successful channel switches from FACH to HS-DSCH in the serving HS-DSCH cell.
- b) CC
- c) On receipt by the RNC of a RRC message RADIO BEARER RECONFIGURATION COMPLETE from UE, with the condition that channel switches from FACH to HS-DSCH (see TS 25.331 [4]).

NOTE: This measurement is dedicated to channel switches from FACH to HS-DSCH.

- d) A single integer value
- e) HSDPA.SuccFachToHs
- f) UtranCellFDD
UtranCellTDDLcr
UtranCellTDDHcr
- g) Valid for packet switched traffic
- h) UMTS

4.24.1.3 Attempted channel switches from DCH to HS-DSCH

- a) This measurement provides the number of attempted channel switches from DCH to HS-DSCH in the serving HS-DSCH cell.
- b) CC

- c) On transmission by the RNC of a RRC message RADIO BEARER RECONFIGURATION to UE, with the condition that channel switches from DCH to HS-DSCH (see TS 25.331 [4]).
- d) A single integer value
- e) HSDPA.AttDchToHs
- f) UtranCellFDD
UtranCellTDDLcr
UtranCellTDDHcr
- g) Valid for packet switched traffic
- h) UMTS

4.24.1.4 Successful channel switches from DCH to HS-DSCH

- a) This measurement provides the number of successful channel switches from DCH to HS-DSCH in the serving HS-DSCH cell.
- b) CC
- c) On receipt by the RNC of a RRC message RADIO BEARER RECONFIGURATION COMPLETE from UE, with the condition that channel switches from DCH to HS-DSCH (see TS 25.331 [4]).
- d) A single integer value
- e) HSDPA.SuccDchToHs
- f) UtranCellFDD
UtranCellTDDLcr
UtranCellTDDHcr
- g) Valid for packet switched traffic
- h) UMTS

4.24.2 Measurements related to channel switches from HS-DSCH to FACH/DCH intra UTRAN cell

4.24.2.1 Attempted channel switches from HS-DSCH to FACH

- a) This measurement provides the number of attempted channel switches from HS-DSCH to FACH in the serving HS-DSCH cell.
- b) CC
- c) On transmission by the RNC of a RRC message RADIO BEARER RECONFIGURATION to UE, with the condition that channel switches from HS-DSCH to FACH (see TS 25.331 [4]).

Note: this measurement is dedicated to channel switches from HS-DSCH to FACH.

- d) A single integer value
- e) HSDPA.AttHsToFach
- f) UtranCellFDD
UtranCellTDDLcr
UtranCellTDDHcr
- g) Valid for packet switched traffic
- h) UMTS

4.24.2.2 Successful channel switches from HS-DSCH to FACH

- a) This measurement provides the number of successful channel switches from HS-DSCH to FACH in the serving HS-DSCH cell.
- b) CC
- c) On receipt by the RNC of a RRC message RADIO BEARER RECONFIGURATION COMPLETE from UE, with the condition that channel switches from HS-DSCH to FACH (see TS 25.331 [4]).

Note: this measurement is dedicated to channel switches from HS-DSCH to FACH.

- d) A single integer value
- e) HSDPA.SuccHsToFach
- f) UtranCellFDD
UtranCellTDDLcr
UtranCellTDDHcr
- g) Valid for packet switched traffic
- h) UMTS

4.24.2.3 Attempted channel switches from HS-DSCH to DCH

- a) This measurement provides the number of attempted channel switches from HS-DSCH to DCH in the serving HS-DSCH cell.
- b) CC
- c) On transmission by the RNC of a RRC message RADIO BEARER RECONFIGURATION to UE, with the condition that channel switches from HS-DSCH to DCH (see TS 25.331 [4]).
- d) A single integer value
- e) HSDPA.AttHsToDch

- f) UtranCellFDD
UtranCellTDDLcr
UtranCellTDDHcr
- g) Valid for packet switched traffic
- h) UMTS

4.24.2.4 Successful channel switches from HS-DSCH to DCH

- a) This measurement provides the number of successful channel switches from HS-DSCH to DCH in the serving HS-DSCH cell.
- b) CC
- c) On receipt by the RNC of a RRC message RADIO BEARER RECONFIGURATION COMPLETE from UE, with the condition that channel switches from HS-DSCH to DCH (see TS 25.331 [4]).
- d) A single integer value
- e) HSDPA.SuccHsToDch
- f) UtranCellFDD
UtranCellTDDLcr
UtranCellTDDHcr
- g) Valid for packet switched traffic
- h) UMTS

4.25 HSDPA mobility related measurements

4.25.1 Serving HS-DSCH cell change

4.25.1.1 Attempted serving HS-DSCH cell changes

- a) This measurement provides the number of attempted serving HS-DSCH cell changes.
- b) CC
- c) On transmission by the RNC of a RRC message PHYSICAL CHANNEL RECONFIGURATION, RADIO BEARER SETUP, RADIO BEARER RECONFIGURATION, RADIO BEARER RELEASE, or TRANSPORT CHANNEL RECONFIGURATION from the source RNC to the UE, also the target cell is different with source cell, indicating the attempt of serving HS-DSCH cell change (see TS 25.331 [4]).
- d) A single integer value
- e) HSDPA.AttCellChange
- f) UtranCellFDD
UtranCellTDDLcr
UtranCellTDDHcr
- g) Valid for packet switched traffic
- h) UMTS

4.25.1.2 Successful serving HS-DSCH cell changes

- a) This measurement provides the number of successfully performed serving HS-DSCH cell changes.
- b) CC
- c) On receipt by the RNC of a RRC message PHYSICAL CHANNEL RECONFIGURATION COMPLETE, RADIO BEARER SETUP COMPLETE, RADIO BEARER RECONFIGURATION COMPLETE, RADIO BEARER RELEASE COMPLETE, or TRANSPORT CHANNEL RECONFIGURATION COMPLETE sent from the UE to the source RNC, also the target cell is different with source cell indicating a successful serving HS-DSCH cell change (see TS 25.331 [4]).
- d) A single integer value
- e) HSDPA.SuccCellChange
- f) UtranCellFDD
UtranCellTDDLcr
UtranCellTDDHcr
- g) Valid for packet switched traffic
- h) UMTS

4.26 Measurements related to MAC-hs

4.26.1 Measurements related to MAC-hs feedback decoding

4.26.1.1 Number of acknowledged transmitted MAC-hs PDUs

- a) This measurement provides the number of acknowledged transmitted MAC-hs PDUs during the period of measurement, detected in MAC-hs layer in the serving HS-DSCH cell.
- b) CC.
- c) On receipt by the NodeB of a PDU acknowledged by ACK message of MAC-hs from UE.
- d) A single integer value.
- e) HSDPA.NbrAckdMachsPdu
- f) UtranCellFDD
UtranCellTDDLcr
UtranCellTDDHcr
- g) Valid for packet switched traffic.
- h) UMTS.

4.26.1.2 Number of transmitted MAC-hs PDUs

- a) This measurement provides the number of transmitted MAC-hs PDUs including acknowledged and unacknowledged PDUs during the period of measurement, detected in MAC-hs layer in the serving HS-DSCH cell.
- b) CC.
- c) On transmission by the NodeB of a PDU of MAC-hs to UE.
- d) A single integer value.
- e) HSDPA.NbrMachsPdu
- f) UtranCellFDD
UtranCellTDDLcr
UtranCellTDDHcr
- g) Valid for packet switched traffic.
- h) UMTS.

4.27 Mean number of HSDPA users in a serving HS-DSCH cell

- a) This measurement provides the mean number of simultaneous HSDPA users in a serving HS-DSCH cell.
- b) SI.
- c) This measurement is obtained by sampling at a pre-defined interval the number of simultaneous users in a serving HS-DSCH cell and then taking the arithmetic mean.
- d) A single integer value.
- e) HSDPA.MeanNbrUser
- f) UtranCellFDD
UtranCellTDDLcr
UtranCellTDDHcr
- g) Valid for packet switched traffic.
- h) UMTS.

4.28 Number of octets of acknowledged MAC-hs PDUs

- a) This measurement provides the number of octets of downlink acknowledged MAC-hs PDUs in the serving HS-DSCH cell.
- b) CC.
- c) On transmission by the NodeB of an acknowledged PDU on the MAC-hs layer. The number of octets of MAC-hs layer in one serving HS-DSCH cell is calculated by sum of size of each MAC-hs PDU header including MAC-hs PDU header.
- d) A single integer value.
- e) HSDPA.NbrAckdMacHsOcts
- f) UtranCellFDD
UtranCellTDDLcr
UtranCellTDDHcr
- g) Valid for packet switched traffic.
- h) UMTS.

4.29 Number of TTIs with user data packets in buffer

- a) This measurement provides the number of TTIs with user data packets in MAC-hs buffer.
- b) CC.
- c) On receipt by the NodeB of a HSDPA frame with user data packets in MAC-hs buffer.
- d) A single integer value.
- e) HSDPA.NbrTTINonEmptyBuffer
- f) UtranCellFDD
UtranCellTDDLcr
UtranCellTDDHcr
- g) Valid for packet switched traffic.

h) UMTS.

4.30 HSDPA Release measurements

4.30.1 Overview of HSDPA Release

4.30.1.1 General

The HSDPA release is executed via releasing the HS-DSCH. It can happen with RRC Connection Release procedure and various Radio Bearer Control procedures. The RANAP procedures RAB Assignment Request or Iu Release Command can also be involved.

There is always a RRC procedure used but not necessarily a RANAP procedure.

As there are HSDPA release cases that doesn't involve CN (RANAP) the triggering of required measurements is always based primarily on RRC triggering.

In cases that the CN has initiated the release of a RAB and/or Iu connection that currently has a Radio Bearer including HS-DSCH the RANAP interface is included in the triggering part of the related requirement.

4.30.1.2 Considered RRC procedures

RRC Protocol procedures related HSDPA (HS-DSCH Release)

RRC connection release (TS 25.331: RRC Connection Management procedures chapter 8.1.4):

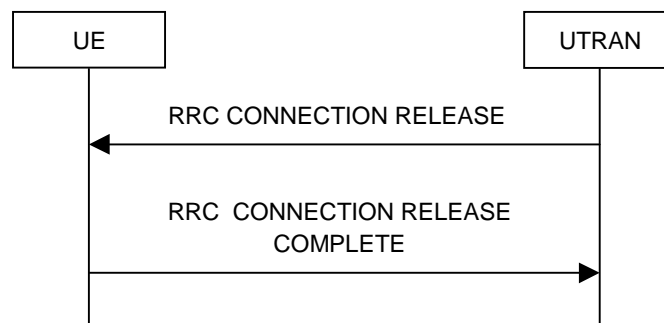

Figure: RRC Connection Release procedure on the DCCH

Radio Bearer control /Reconfiguration procedures (TS25.331 Radio Bearer Control Procedures)

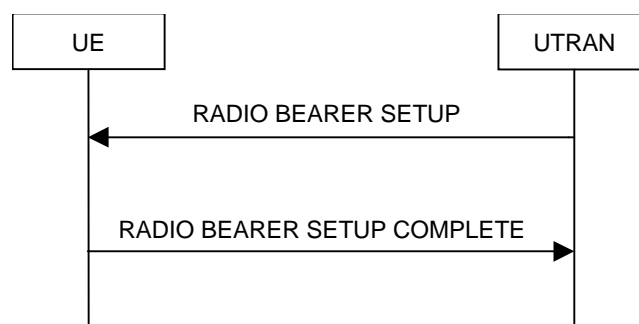

Figure: Radio Bearer Establishment, normal case

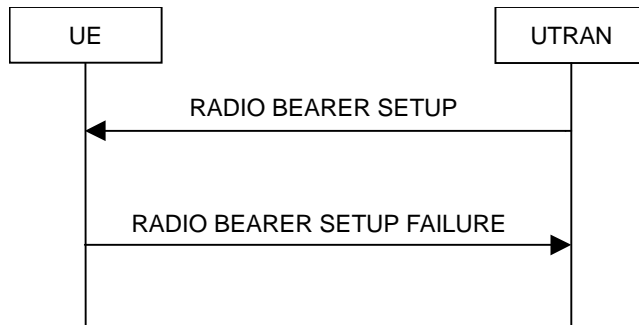

Figure: Radio Bearer Establishment, failure case

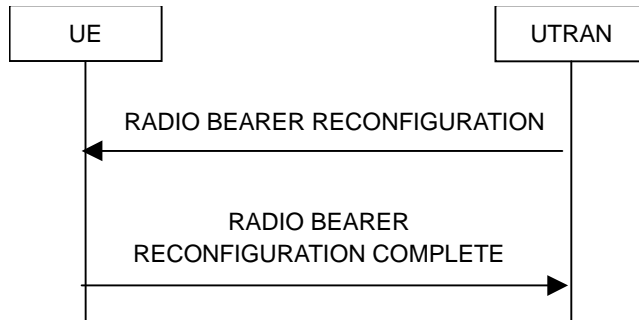

Figure: Radio bearer reconfiguration, normal flow

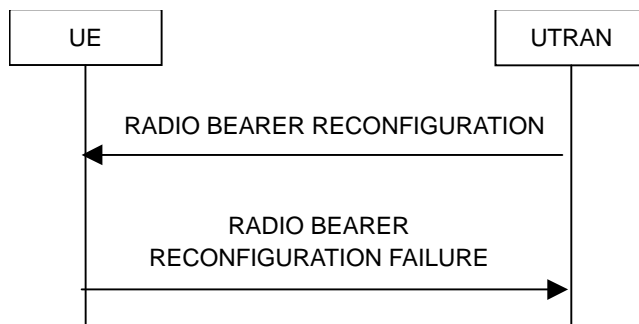

Figure: Radio bearer reconfiguration, failure case

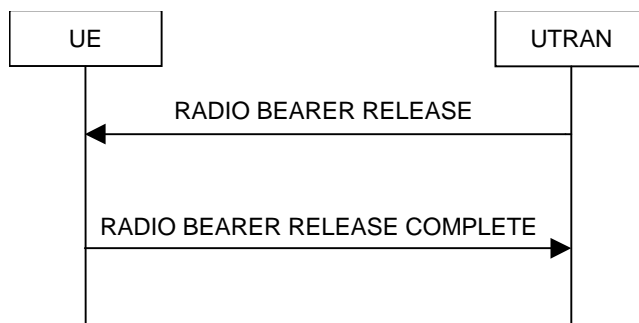

Figure: Radio Bearer Release, normal case

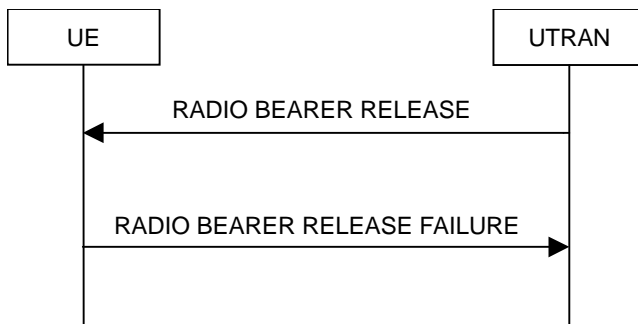

Figure: Radio Bearer Release, failure case

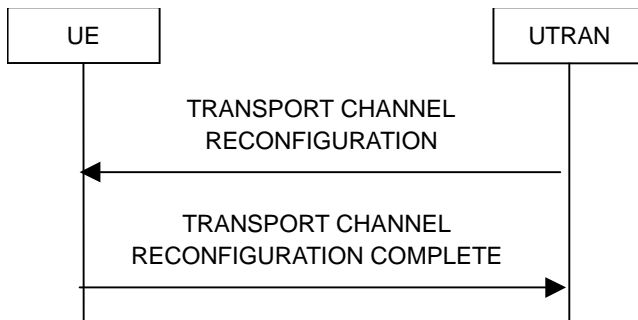

Figure: Transport channel reconfiguration, normal flow

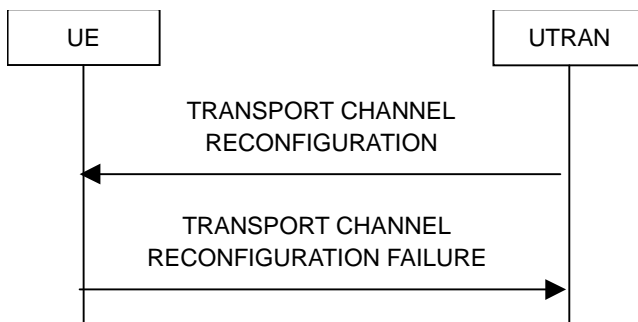

Figure: Transport channel reconfiguration, failure case

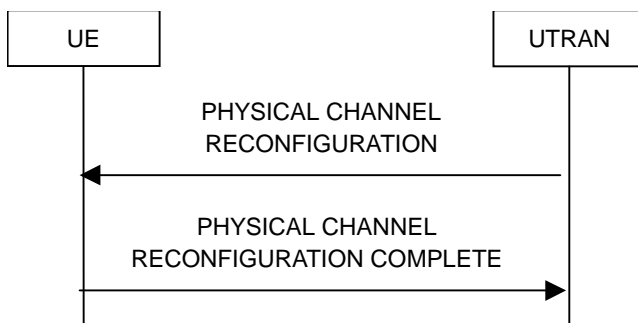

Figure: Physical channel reconfiguration, normal flow

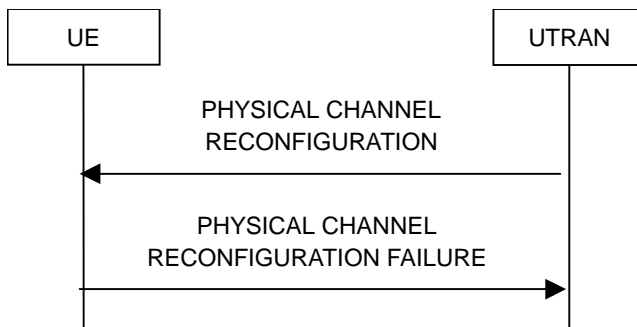
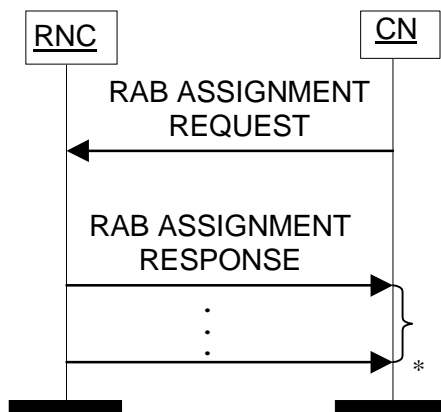

Figure : Physical channel reconfiguration, failure case

4.30.1.3 Considered RANAP protocol procedures

RAB Assignment (TS 25.413 Chapter 8.2)



* it can be several responses

Figure: RAB Assignment procedure. Successful operation.

Iu Release (TS 25.413 Chapter 8.5)

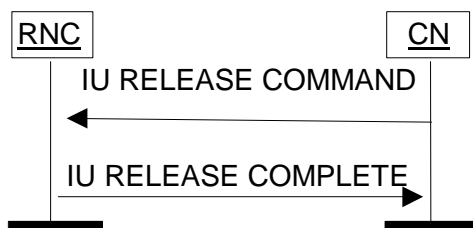

Figure: Iu Release procedure. Successful operation.

4.30.2 Normal HSDPA Release

4.30.2.1 RNC Initiated Release due to user inactivity

- a) This measurement provides the number of times when the UE is removed from HS-DSCH transport channel due to user inactivity
- b) CC.
- c) On transmission of the RRC: RADIO BEARER RECONFIGURATION or RRC: RADIO BEARER RELEASE or RRC CONNECTION RELEASE message by the RNC when there is no more data left in the buffer to send (equals to the RANAP cause 16 user inactivity).
- d) A single integer value.
- e) The measurement name has the form HSDPA.SuccHSDSCHreleaseUserInact
- f) UtranCellFDD
UtranCellTDDLcr
UtranCellTDDHcr.
- g) Valid for packet switched traffic.
- h) UMTS.

4.30.2.2 Switch to DCH/FACH

The measurement definition is in section 4.24

4.30.2.3 HS-DSCH serving cell change

The measurement definition is in section 4.25

4.30.2.4 CN Initiated release

- a) This measurement provides the number of times when the UE is removed from HS-DSCH transport channel due to a release initiated by the Core Network.
- b) CC.
- c) On reception of RANAP RAB ASSIGNMENT REQUEST or RANAP IU RELEASE COMMAND that results an HS-DSCH release. The release of HS-DSCH is executed by the transmission of the RRC RADIO BEARER RECONFIGURATION or RRC RADIO BEARER RELEASE or RRC CONNECTION RELEASE message.
- d) A single integer value.
- e) The measurement name has the form HSDPA.SuccCnInitHSDSCHrelease
- f) UtranCellFDD
UtranCellTDDLcr
UtranCellTDDHcr.
- g) Valid for packet switched traffic.
- h) UMTS.

4.30.3 Abnormal RB releases for HS-DSCH

- a) This measurement provides the number of times when the UE is removed from HS-DSCH transport channel, and trigger reason is a failure. The reason can be e.g. RL failure.
- b) CC.
- c) On receipt by the RRC: RADIO BEARER RECONFIGURATION COMPLETE, or RRC: RADIO BEARER RELEASE COMPLETE message sent by the UE. Or when the UE does not respond to RRC: RADIO BEARER RECONFIGURATION or RRC: RADIO BEARER RELEASE message. All other release scenarios are considered as abnormal releases, which are not counted in normal releases, i.e. the release is not because of user inactivity or switch to DCH or HS-DSCH serving cell changes or CN initiated release.
- d) A single integer value.
- e) The measurement name has the form HSDPA.failHSDSCHrelease
- f) UtranCellFDD
UtranCellTDDLcr
UtranCellTDDHcr.
- g) Valid for packet switched traffic.
- h) UMTS.

4.31 RRC Connection mobility

4.31.1 Cell update

4.31.1.1 Attempted cell update

- a) This measurement provides the number of cell update attempts per update cause sent from the UE to UTRAN.
- b) CC
- c) Receipt of a CELL UPDATE message sent from UE to the RNC. Each cell update message sent is added to the relevant per cause measurement. The possible causes are included in TS 25.331 [4]. The sum of all supported per cause measurements shall equal the total number of cell update attempts. In case only a subset of per cause measurements is supported, a sum subcounter will be provided first.
- d) Each measurement is an integer value. The number of measurements is equal to the number of causes plus a possible sum value identified by the *.sum* suffix.
- e) The measurement name has the form RRC.AttCellUpdate.*Cause* where *Cause* identifies the Cell Update Cause.
- f) UtranCellFDD
UtranCellTDDLcr
UtranCellTDDHcr
- g) Valid for circuit switched and packet switched traffic
- h) UMTS

4.32 Measurements related to received uplink transport block

4.32.1 Measurements related to received uplink transport block for CS domain

4.32.1.1 Number of received uplink transport blocks of DCH for CS domain

a) This measurement provides the number of received uplink transport blocks of DCH during the period of measurement for the CS domain. In case of soft handover, this measurement is valid after combination, based on best UTRAN cell for FDD mode only.

b) CC.

c) On receipt by the RNC of an uplink transport block of DCH from UE for CS domain. For conversational service, the relevant measurement for each specified data rate is required. The detailed data rates are listed below (see TS 25.993 [12]).

uplink <U>:

1: AMR rate (12.2 10.2 7.95 7.4 6.7 5.9 5.15 4.75) kbps

2: 12.2 kbps

3: 28.8 kbps

4: 32 kbps

5: 64 kbps

As indicated above <U> maps to the conversational service specified uplink data rates.

d) A single integer value.

e) FP.NbrBlocksReceivedCS.Conv.<U>

FP.NbrBlocksReceivedCS.Strm

FP.NbrBlocksReceivedCS.Intact

FP.NbrBlocksReceivedCS.Bgrd

f) UtranCellFDD

UtranCellTDDLcr

UtranCellTDDHcr

g) Valid for circuit switched traffic.

h) UMTS.

4.32.1.2 Number of received uplink faulty transport blocks of DCH for CS domain

a) This measurement provides the number of received uplink faulty transport blocks of DCH during the period of measurement for CS domain. In case of soft handover, this measurement is valid after combination, based on best UTRAN cell for FDD mode only.

b) CC.

c) On receipt by the RNC of an uplink faulty transport block using CRC indicator (see TS 25.427[17]) of DCH from UE for CS domain. For conversational service, the relevant measurement for each specified data rate is required. The detailed data rates are listed below (see TS 25.993 [12]).

uplink <U>:

1: AMR rate (12.2 10.2 7.95 7.4 6.7 5.9 5.15 4.75) kbps

2: 12.2 kbps

3: 28.8 kbps

4: 32 kbps

5: 64 kbps

As indicated above <U> maps to the conversational service specified uplink data rates.

d) A single integer value.

e) FP.NbrErrBlocksReceivedCS.Conv.<U>

FP.NbrErrBlocksReceivedCS.Strm

FP.NbrErrBlocksReceivedCS.Intact
FP.NbrErrBlocksReceivedCS.Bgrd

- f) UtranCellFDD
UtranCellTDDLcr
UtranCellTDDHcr
- g) Valid for circuit switched traffic.
- h) UMTS.

4.32.2 Measurements related to received uplink transport block for PS domain

4.32.2.1 Number of received uplink transport blocks of DCH for PS domain

a) This measurement provides the number of received uplink transport blocks of DCH during the period of measurement for PS domain. In case of soft handover, this measurement is valid after combination, based on best UTRAN cell for FDD mode only.

b) CC.

c) On receipt by the RNC of an uplink transport block of DCH from UE for PS domain. For conversational service, the relevant measurement for each specified data rate is required. The detailed data rates are listed below (see TS 25.993 [12]).

uplink <U>:

1: AMR rate (12.2 10.2 7.95 7.4 6.7 5.9 5.15 4.75) kbps

2: 12.2 kbps

3: 28.8 kbps

4: 32 kbps

5: 64 kbps

As indicated above <U> maps to the conversational service specified uplink data rates.

d) A single integer value.

e) FP.NbrBlocksReceivedPS.Conv.<U>

FP.NbrBlocksReceivedPS.Strm

FP.NbrBlocksReceivedPS.Intact

FP.NbrBlocksReceivedPS.Bgrd

f) UtranCellFDD

UtranCellTDDLcr

UtranCellTDDHcr

g) Valid for packet switched traffic.

h) UMTS.

4.32.2.2 Number of received uplink faulty transport blocks of DCH for PS domain

a) This measurement provides the number of received uplink faulty transport blocks of DCH during the period of measurement for PS domain. In case of soft handover, this measurement is valid after combination, based on best UTRAN cell for FDD mode only.

b) CC.

c) On receipt by the RNC of an uplink faulty transport block using CRC indicator (see TS 25.427[17]) of DCH from UE for PS domain. For conversational service, the relevant measurement for each specified data rate is required. The detailed data rates are listed below (see TS 25.993 [12]).

uplink <U>:

1: AMR rate (12.2 10.2 7.95 7.4 6.7 5.9 5.15 4.75) kbps

2: 12.2 kbps

3: 28.8 kbps

4: 32 kbps

5: 64 kbps

As indicated above <U> maps to the conversational service specified uplink data rates.

d) A single integer value.

e) FP.NbrErrBlocksReceivedPS.Conv.<U>

FP.NbrErrBlocksReceivedPS.Strm

FP.NbrErrBlocksReceivedPS.Intact

FP.NbrErrBlocksReceivedPS.Bgrd

- f) UtranCellFDD
UtranCellTDDLcr
UtranCellTDDHcr
- g) Valid for packet switched traffic.
- h) UMTS.

4.33 Measurements related to equipment resources

4.33.1 RNC Processor usage

4.33.1.1 Mean processor usage

- a) This measurement provides the mean usage of each key processor during the granularity period. Each equipment may have more than one key processors, the measurement is split into subcounters per key processor.
- b) SI.
- c) This measurement is obtained by sampling at a pre-defined interval the usage of the processor and then taking the arithmetic mean for each key processor.
- d) Each measurement is an integer value (Unit: %).
- e) The measurement name has the form EQPT.MeanProcessorUsage.*ProcessorID* where *ProcessorID* identifies the key processor of this equipment, the format of *ProcessorID* is vendor specific.
- f) ManagedElement.
- g) Valid for circuit switched and packet switched traffic.
- h) UMTS.

4.33.1.2 Peak processor usage

- a) This measurement provides the peak usage of each key processor during the granularity period. Each equipment may have more than one key processors, the measurement is split into subcounters per key processor.
- b) SI.
- c) This measurement is obtained by sampling at a pre-defined interval the usage of the processor and then taking the maximum for each key processor.
- d) Each measurement is an integer value (Unit: %).
- e) The measurement name has the form EQPT.PeakProcessorUsage.*ProcessorID* where *ProcessorID* identifies the key processor of this equipment, the format of *ProcessorID* is vendor specific.
- f) ManagedElement.
- g) Valid for circuit switched and packet switched traffic.
- h) UMTS.

4.34 HSUPA related measurements

Performance Measurement definitions in this subclause are based on TS 25.331 [4] and TS 25.433 [7].

The following procedures are of interest for this purpose:

NBAP: RADIO LINK SETUP REQUEST
NBAP: RADIO LINK RECONFIGURATION PREPARE
NBAP: RADIO LINK RECONFIGURATION REQUEST
NBAP: RADIO LINK ADDITION REQUEST
NBAP: RADIO LINK SETUP RESPONSE
NBAP: RADIO LINK RECONFIGURATION READY
NBAP: RADIO LINK RECONFIGURATION RESPONSE
NBAP: RADIO LINK ADDITION RESPONSE
NBAP: RADIO LINK SETUP FAILURE
NBAP: RADIO LINK RECONFIGURATION FAILURE
NBAP: RADIO LINK RECONFIGURATION FAILURE
NBAP: RADIO LINK ADDITION FAILURE
RRC: RADIO BEARER SETUP
RRC: RADIO BEARER RECONFIGURATION
RRC: RADIO BEARER SETUP COMPLETE
RRC: RADIO BEARER RECONFIGURATION COMPLETE
RRC: RADIO BEARER SETUP FAILURE
RRC: RADIO BEARER RECONFIGURATION FAILURE

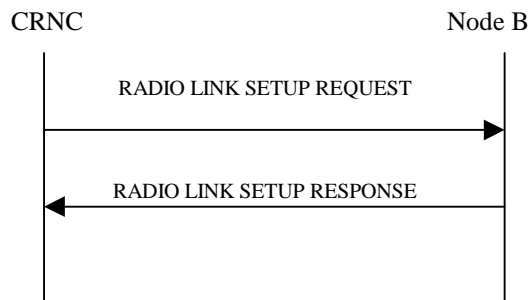

Figure : Radio Link Setup procedure, Successful Operation

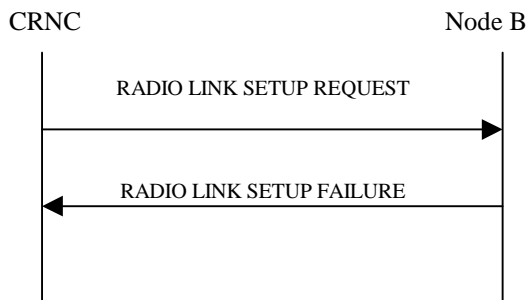

Figure: Radio Link Setup procedure, Unsuccessful Operation

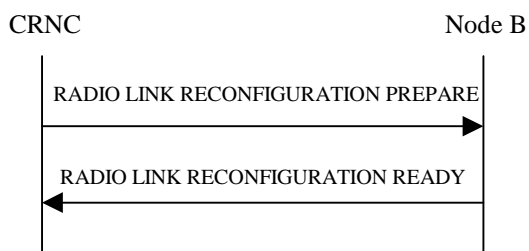

Figure: Radio Link Reconfiguration Preparation procedure, Successful Operation

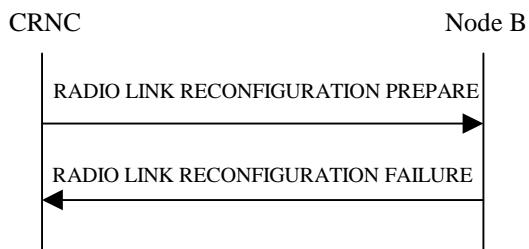

Figure: Radio Link Reconfiguration Preparation procedure, Unsuccessful Operation

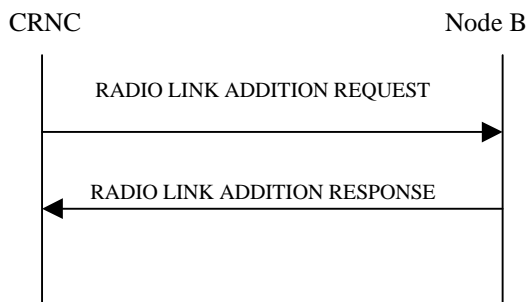

Figure: Radio Link Addition procedure, Successful Operation

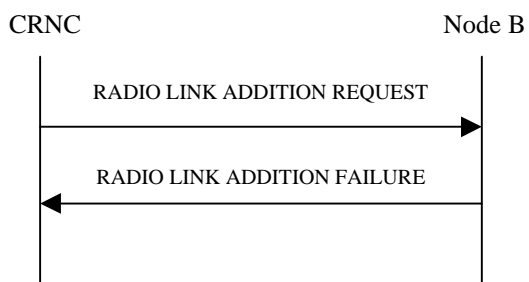

Figure: Radio Link Addition procedure: Unsuccessful Operation

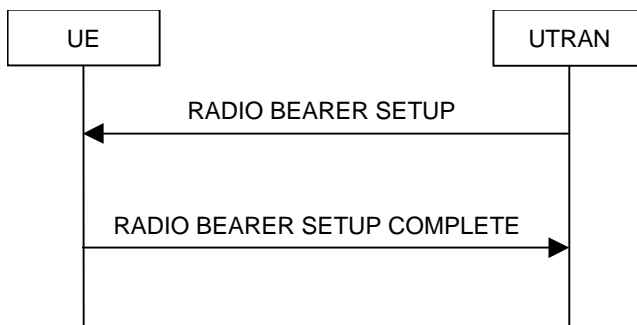

Figure: Radio Bearer Establishment, normal case

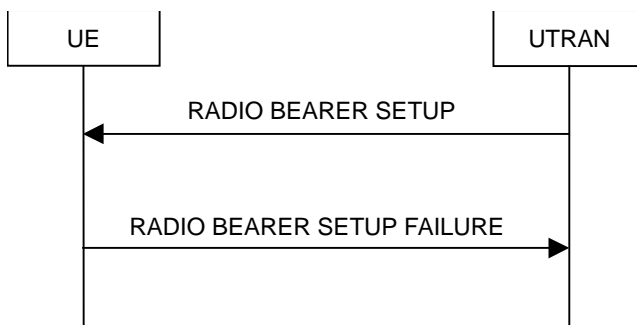

Figure: Radio Bearer Establishment, failure case

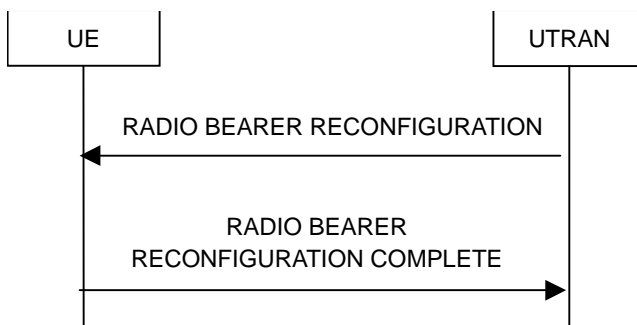

Figure: Radio bearer reconfiguration, normal flow

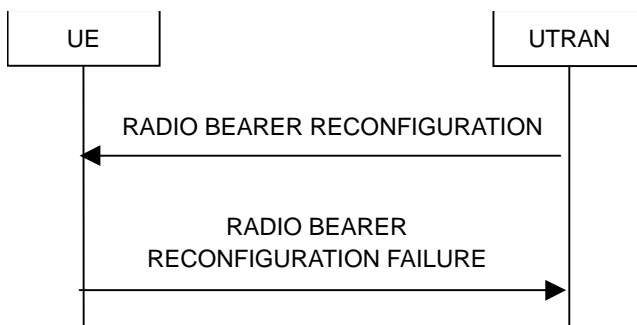

Figure: Radio bearer reconfiguration, failure case

4.34.1 HSUPA setup

4.34.1.1 Mac-d setup for HSUPA

4.34.1.1.0 Introduction

The three measurement types defined in this subclause are subject to the "2 out of 3 approach".

4.34.1.1.1 Attempted Mac-d setups for HSUPA

- a) This measurement provides the number of attempted Mac-d setups for HSUPA.
- b) CC
- c)

For FDD:

On transmission by the RNC of a NBAP message RADIO LINK SETUP REQUEST with the "E-DCH FDD Information" IE; Or on transmission by the RNC of a NBAP message RADIO LINK RECONFIGURATION PREPARE with the "E-DCH MAC-d Flows To Add" or "E-DCH FDD Information" IE; Or on transmission by the RNC of a NBAP message RADIO LINK RECONFIGURATION REQUEST with the "E-DCH MAC-d Flows To Add" or "E-DCH FDD Information" IE; Or on transmission by the RNC of a NBAP message RADIO LINK ADDITION REQUEST with the "E-DCH FDD Information" IE. See TS 25.433 [7].

For TDD:

On transmission by the RNC of a NBAP message RADIO LINK SETUP REQUEST with the "E-DCH MAC-d Flows Information TDD" IE; Or on transmission by the RNC of a NBAP message RADIO LINK RECONFIGURATION PREPARE with the "E-DCH MAC-d Flows To Add" IE; Or on transmission by the RNC of a NBAP message RADIO LINK RECONFIGURATION REQUEST with the "E-DCH MAC-d Flows To Add" IE; Or on transmission by the RNC of a NBAP message RADIO LINK ADDITION REQUEST with the "E-DCH MAC-d Flows Information TDD" IE. See TS 25.433 [7].

- d) A single integer value
- e) HSUPA.AttMacdSetup
- f) UtranCellFDD
UtranCellTDDLcr
UtranCellTDDHcr
- g) Valid for packet switched traffic
- h) UMTS

4.34.1.1.2 Successful Mac-d setups for HSUPA

- a) This measurement provides the number of successful Mac-d setups for HSUPA.
- b) CC
- c)

For FDD:

On receipt by the RNC of a NBAP message RADIO LINK SETUP RESPONSE, corresponding to transmission of the NBAP message RADIO LINK SETUP REQUEST with the "E-DCH FDD Information" IE; Or on receipt by the RNC of a NBAP message RADIO LINK RECONFIGURATION READY, corresponding to the transmission of the NBAP message RADIO LINK RECONFIGURATION PREPARE with the "E-DCH MAC-d Flows To Add" or "E-DCH FDD Information" IE; Or on receipt by the RNC of NBAP message RADIO LINK RECONFIGURATION RESPONSE, corresponding to the transmission of the NBAP message RADIO LINK RECONFIGURATION

REQUEST with the “E-DCH MAC-d Flows To Add” or “E-DCH FDD Information” IE; Or on receipt by the RNC of NBAP message RADIO LINK ADDITION RESPONSE, corresponding to the transmission of the NBAP message RADIO LINK ADDITION REQUEST with the “E-DCH FDD Information” IE. See TS 25.433 [7].

For TDD:

On receipt by the RNC of a NBAP message RADIO LINK SETUP RESPONSE, corresponding to transmission of the NBAP message RADIO LINK SETUP REQUEST with the “E-DCH MAC-d Flows Information TDD” IE; Or on receipt by the RNC of a NBAP message RADIO LINK RECONFIGURATION READY, corresponding to the transmission of the NBAP message RADIO LINK RECONFIGURATION PREPARE with the “E-DCH MAC-d Flows To Add” IE; Or on receipt by the RNC of NBAP message RADIO LINK RECONFIGURATION RESPONSE, corresponding to the transmission of the NBAP message RADIO LINK RECONFIGURATION REQUEST with the “E-DCH MAC-d Flows To Add” IE; Or on receipt by the RNC of NBAP message RADIO LINK ADDITION RESPONSE, corresponding to the transmission of the NBAP message RADIO LINK ADDITION REQUEST with the “E-DCH MAC-d Flows Information TDD” IE. See TS 25.433 [7].

- d) A single integer value
- e) HSUPA.SuccMacdSetup
- f) UtranCellFDD
UtranCellTDDLcr
UtranCellTDDHcr
- g) Valid for packet switched traffic
- h) UMTS

4.34.1.1.3 Failed Mac-d setups for HSUPA

- a) This measurement provides the number of failed Mac-d setups for HSUPA. The measurement is split into subcounters per cause.
- b) CC
- c)

For FDD:

On receipt by the RNC of a NBAP message RADIO LINK SETUP FAILURE, corresponding to transmission of the NBAP message RADIO LINK SETUP REQUEST with the “E-DCH FDD Information” IE; Or on receipt by the RNC of a NBAP message RADIO LINK RECONFIGURATION FAILURE, corresponding to the transmission of the NBAP message RADIO LINK RECONFIGURATION PREPARE with the “E-DCH MAC-d Flows To Add” or “E-DCH FDD Information” IE; Or on receipt by the RNC of NBAP message RADIO LINK RECONFIGURATION FAILURE, corresponding to the transmission of the NBAP message RADIO LINK RECONFIGURATION REQUEST with the “E-DCH MAC-d Flows To Add” or “E-DCH FDD Information” IE; Or on receipt by the RNC of NBAP message RADIO LINK ADDITION FAILURE, corresponding to the transmission of the NBAP message RADIO LINK ADDITION REQUEST with the “E-DCH FDD Information” IE.

Each expected NBAP message RADIO LINK SETUP RESPONSE, corresponding to transmission of the NBAP message RADIO LINK SETUP REQUEST with the “E-DCH FDD Information” IE; Or RADIO LINK RECONFIGURATION READY, corresponding to the transmission of the NBAP message RADIO LINK RECONFIGURATION PREPARE with the “E-DCH MAC-d Flows To Add” or “E-DCH FDD Information” IE; Or RADIO LINK RECONFIGURATION RESPONSE, corresponding to the transmission of the NBAP message RADIO LINK RECONFIGURATION REQUEST with the “E-DCH MAC-d Flows To Add” or “E-DCH FDD Information” IE; Or RADIO LINK ADDITION RESPONSE, corresponding to the transmission of the NBAP message RADIO LINK ADDITION REQUEST with the “E-DCH FDD Information” IE not received by the RNC is added to the measurement cause 'No Reply' (not specified in TS 25.331 [4]).

For TDD:

On receipt by the RNC of a NBAP message RADIO LINK SETUP FAILURE, corresponding to transmission of the NBAP message RADIO LINK SETUP REQUEST with the “E-DCH MAC-d Flows Information TDD” IE; Or on receipt by the RNC of a NBAP message RADIO LINK RECONFIGURATION FAILURE, corresponding to the

transmission of the NBAP message RADIO LINK RECONFIGURATION PREPARE with the “E-DCH MAC-d Flows To Add” IE; Or on receipt by the RNC of NBAP message RADIO LINK RECONFIGURATION FAILURE, corresponding to the transmission of the NBAP message RADIO LINK RECONFIGURATION REQUEST with the “E-DCH MAC-d Flows To Add” IE; Or on receipt by the RNC of NBAP message RADIO LINK ADDITION FAILURE, corresponding to the transmission of the NBAP message RADIO LINK ADDITION REQUEST with the “E-DCH MAC-d Flows Information TDD” IE.

Each expected NBAP message RADIO LINK SETUP RESPONSE, corresponding to transmission of the NBAP message RADIO LINK SETUP REQUEST with the “E-DCH MAC-d Flows Information TDD” IE; Or RADIO LINK RECONFIGURATION READY, corresponding to the transmission of the NBAP message RADIO LINK RECONFIGURATION PREPARE with the “E-DCH MAC-d Flows To Add” IE; Or RADIO LINK RECONFIGURATION RESPONSE, corresponding to the transmission of the NBAP message RADIO LINK RECONFIGURATION REQUEST with the “E-DCH MAC-d Flows To Add” IE; Or RADIO LINK ADDITION RESPONSE, corresponding to the transmission of the NBAP message RADIO LINK ADDITION REQUEST with the “E-DCH MAC-d Flows Information TDD” IE not received by the RNC is added to the measurement cause 'No Reply' (not specified in TS 25.331 [4]).

Each failed Mac-d setup for HSUPA is added to the relevant measurement according to the failure cause. Possible failure causes are included in TS 25.433 [7]. The sum of all supported per cause measurements shall equal the total number of failed Mac-d setups for HSUPA. In case only a subset of per cause measurements is supported, a sum subcounter will be provided first.

- d) Each measurement is an integer value. The number of measurements is equal to the number of causes plus a possible sum value identified by the *.sum* suffix.
- e) HSUPA.FailMacdSetup.*Cause*
where *Cause* identifies the failure cause.
The cause 'No Reply' is identified by the *.NoReply* suffix.
- f) UtranCellFDD
UtranCellTDDLcr
UtranCellTDDHcr
- g) Valid for packet switched traffic
- h) UMTS

4.34.1.2 RB setup for HSUPA

4.34.1.2.0 Introduction

The three measurement types defined in this subclause are subject to the "2 out of 3 approach".

4.34.1.2.1 Attempted RB setups for HSUPA

- a) This measurement provides the number of attempted radio bearer setups for HSUPA.
- b) CC
- c) On transmission by the RNC of a RRC message RADIO BEARER SETUP with the "Uplink transport channel type" set to "E-DCH" in the "RB mapping info" IE of the "RB information to setup"; Or on transmission by the RNC of a RRC message RADIO BEARER RECONFIGURATION with "Uplink transport channel type" set to "E-DCH" in the "RB mapping info" IE of the "RB information to reconfigure" if the previous "Uplink transport channel type" of this RB is not the "E-DCH". See TS 25.331 [4].
- d) A single integer value
- e) HSUPA.AttRBSetup
- f) UtranCellFDD
UtranCellTDDLcr
UtranCellTDDHcr
- g) Valid for packet switched traffic
- h) UMTS

4.34.1.2.2 Successful RB setups for HSUPA

- a) This measurement provides the number of successful radio bearer setups for HSUPA.
- b) CC
- c) On receipt by the RNC of a RRC message RADIO BEARER SETUP COMPLETE, corresponding to the transmission of the RRC message RADIO BEARER SETUP with the "Uplink transport channel type" set to "E-DCH" in the "RB mapping info" IE of the "RB information to setup"; Or on receipt by the RNC of a RRC message RADIO BEARER RECONFIGURATION COMPLETE, corresponding to the transmission of the RRC message RADIO BEARER RECONFIGURATION with "Uplink transport channel type" set to "E-DCH" in the "RB mapping info" IE of the "RB information to reconfigure" if the previous "Uplink transport channel type" of this RB is not the "E-DCH". See TS 25.331 [4].
- d) A single integer value
- e) HSUPA.SuccRBSetup
- f) UtranCellFDD
UtranCellTDDLcr
UtranCellTDDHcr
- g) Valid for packet switched traffic
- h) UMTS

4.34.1.2.3 Failed RB setups for HSUPA

- a) This measurement provides the number of failed radio bearer setups for HSUPA. The measurement is split into subcounters per cause.
- b) CC
- c) On receipt by the RNC of a RRC message RADIO BEARER SETUP FAILURE, corresponding to the transmission of the RRC message RADIO BEARER SETUP with the “Uplink transport channel type” set to “E-DCH” in the “RB mapping info” IE of the “RB information to setup”; Or on receipt by the RNC of a RRC message RADIO BEARER RECONFIGURATION FAILURE, corresponding to the transmission of the RRC message RADIO BEARER RECONFIGURATION with “Uplink transport channel type” set to “E-DCH” or in the “RB mapping info” IE of the “RB information to reconfigure” if the previous “Uplink transport channel type” of this RB is not the “E-DCH”.

Each expected RRC message RADIO BEARER SETUP COMPLETE, corresponding to the transmission of the RRC message RADIO BEARER SETUP with the “Uplink transport channel type” set to “E-DCH” in the “RB mapping info” IE of the “RB information to setup”; Or RADIO BEARER RECONFIGURATION COMPLETE, corresponding to the transmission of the RRC message RADIO BEARER RECONFIGURATION with “Uplink transport channel type” set to “E-DCH” in the “RB mapping info” IE of the “RB information to reconfigure” if the previous “Uplink transport channel type” of this RB is not the “E-DCH” not received by the RNC is added to the measurement cause 'No Reply' (not specified in TS 25.331 [4]).

Each failed RB setup for HSUPA is added to the relevant measurement according to the failure cause. Possible failure causes are included in TS 25.331 [4]. The sum of all supported per cause measurements shall equal the total number of failed RB setups for HSUPA. In case only a subset of per cause measurements is supported, a sum subcounter will be provided first.

- d) Each measurement is an integer value. The number of measurements is equal to the number of causes plus a possible sum value identified by the .sum suffix.
- e) HSUPA.FailRBSetup.Cause
where *Cause* identifies the failure cause.
The cause 'No Reply' is identified by the .NoReply suffix.
- f) UtranCellFDD
UtranCellTDDLcr
UtranCellTDDHcr
- g) Valid for packet switched traffic
- h) UMTS

4.34.2 Active set related to HSUPA

4.34.2.1 Radio link additions to the E-DCH active set (UE side)

4.34.2.1.0 Introduction

The three measurement types defined for the radio link additions to the E-DCH active set (UE side) are subject to the "2 out of 3 approach".

4.34.2.1.1 Attempted radio link additions to the E-DCH active set (UE side)

- a) This measurement provides the number of attempted radio link additions to the E-DCH active set (UE side). This measurement shall be increased for each attempted radio link addition (UE side). This measurement is only valid for FDD mode.
- b) CC
- c) On transmission by the serving RNC of a RRC message ACTIVE SET UPDATE from the RNC to the UE, IE "E-DCH reconfiguration information": IE "Primary CPICH info" used for the reference ID along with the IE "E-HICH information" to indicate which radio link to add to the E-DCH active set. Within an ACTIVE SET UPDATE message more than one radio link can be added. Each existing radio link addition information element shall be considered separately (see TS 25.331 [4]).
- d) A single integer value
- e) HSUPA.AttEdchAddUESide
- f) UtranCellFDD
- g) Valid for packet switched traffic
- h) UMTS

4.34.2.1.2 Successful radio link additions to the E-DCH active set (UE side)

- a) This measurement provides the number of successful radio link additions to the E-DCH active set (UE side). This measurement shall be increased for each successful radio link addition (UE side). This measurement is only valid for FDD mode.
- b) CC
- c) On receipt by the serving RNC of a RRC message ACTIVE SET UPDATE COMPLETE from the UE to the RNC, in response to an ACTIVE SET UPDATE message with one or more existing IE "E-DCH reconfiguration information": IE "Primary CPICH info" used for the reference ID along with the IE "E-HICH information" to indicate which radio link to add to the E-DCH active set. One ACTIVE SET UPDATE COMPLETE message can be related to more than one added radio link. Each successful added radio link shall be considered separately (see TS 25.331 [4]).
- d) A single integer value
- e) HSUPA.SuccEdchAddUESide
- f) UtranCellFDD
- g) Valid for packet switched traffic
- h) UMTS

4.34.2.1.3 Failed radio link additions to the E-DCH active set (UE side)

- a) This measurement provides the number of failed radio link additions to the E-DCH active set (UE side) during E-DCH active set update procedure (UE side) for each cell per cause. For each failure cause a separate subcounter is defined. Every failed radio link addition (UE side) shall be considered separately. This measurement is only valid for FDD mode.
- b) CC
- c) Receipt of an ACTIVE SET UPDATE FAILURE message (RRC) sent by UE to the RNC in response to an ACTIVE SET UPDATE message with one or more existing IE "E-DCH reconfiguration information": IE "Primary CPICH info" used for the reference ID along with the IE "E-HICH information" to indicate which radio link to add to the E-DCH active set or an expected ACTIVE SET UPDATE COMPLETE message not received by the RNC. Each message can be related to more than one radio link.
 - Each failed attempt to add a radio link to the E-DCH active set shall be considered separately and added to the relevant per cause measurement. Failure causes are defined within TS 25.331 [4].
 - Each expected ACTIVE SET UPDATE COMPLETE message not received by the RNC is added to the measurement cause 'No Reply' (not specified in TS 25.331 [4]).
 - The sum of all supported per cause measurements shall equal the total number of failures. In case only a subset of per cause measurements is supported, a sum subcounter will be provided first.
- d) Each measurement is an integer value. The number of measurements is equal to the number of causes supported plus a possible sum value identified by the *.sum* suffix.
- e) HSUPA.FailEdchAddUESide.Cause
- f) UtranCellFDD
- g) Valid for packet switched traffic
- h) UMTS

4.34.2.2 Radio link deletions to the E-DCH active set (UE side)

4.34.2.2.1 Attempted radio link deletions to the E-DCH active set (UE side)

- a) This measurement provides the number of attempted radio link deletions to the E-DCH active set (UE side). This measurement shall be increased for each attempted radio link deletion (UE side). This measurement is only valid for FDD mode.
- b) CC
- c) On transmission by the serving RNC of a RRC message ACTIVE SET UPDATE from the RNC to the UE, IE "E-DCH reconfiguration information": IE "Primary CPICH info" used for the reference ID along with the IE "E-HICH release indicator" to indicate which radio link to remove from the E-DCH active set. Within an ACTIVE SET UPDATE message more than one radio link can be deleted. Each existing radio link deletion information element shall be considered separately (see TS 25.331 [4]).
- d) A single integer value
- e) HSUPA.AttEdchDelUESide
- f) UtranCellFDD
- g) Valid for packet switched traffic
- h) UMTS

4.34.2.2.2 Successful radio link deletions to the E-DCH active set (UE side)

- a) This measurement provides the number of successful radio link deletions to the E-DCH active set (UE side). This measurement shall be increased for each successful radio link deletion (UE side). This measurement is only valid for FDD mode.
- b) CC
- c) On receipt by the serving RNC of a RRC message ACTIVE SET UPDATE COMPLETE from the UE to the RNC, in response to an ACTIVE SET UPDATE message with one or more existing IE "E-DCH reconfiguration information": IE "Primary CPICH info" used for the reference ID along with the IE "E-HICH release indicator" to indicate which radio link to remove from the E-DCH active set. One ACTIVE SET UPDATE COMPLETE message can be related to more than one deleted radio link. Each successful deleted radio link shall be considered separately (see TS 25.331 [4]).
- d) A single integer value
- e) HSUPA.SuccEdchDelUESide
- f) UtranCellFDD
- g) Valid for packet switched traffic
- h) UMTS

4.34.3 Serving E-DCH cell change

4.34.3.1 Outgoing serving E-DCH cell change

4.34.3.1.1 Attempted outgoing serving E-DCH cell change

- a) This measurement provides the number of attempted outgoing serving E-DCH cell change.
- b) CC
- c) On transmission by the RNC of a RRC message RADIO BEARER SETUP, RADIO BEARER RECONFIGURATION, RADIO BEARER RELEASE, TRANSPORT CHANNEL RECONFIGURATION, or PHYSICAL CHANNEL RECONFIGURATION from the source RNC to the UE, indicating the attempt of outgoing serving E-DCH cell change (see TS 25.331 [4]).
- d) A single integer value
- e) HSUPA.AttOutCellChange
- f) UtranCellFDD
UtranCellTDDLcr
UtranCellTDDHcr
- g) Valid for packet switched traffic
- h) UMTS

4.34.3.1.2 Successful outgoing serving E-DCH cell change

- a) This measurement provides the number of successful outgoing serving E-DCH cell change.
- b) CC
- c) On receipt by the RNC of a RRC message RADIO BEARER SETUP COMPLETE, RADIO BEARER RECONFIGURATION COMPLETE, RADIO BEARER RELEASE COMPLETE, TRANSPORT CHANNEL RECONFIGURATION COMPLETE, or PHYSICAL CHANNEL RECONFIGURATION COMPLETE sent from the UE to the source RNC, indicating a successful outgoing serving E-DCH cell change (see TS 25.331 [4]).
- d) A single integer value
- e) HSUPA.SuccOutCellChange
- f) UtranCellFDD
UtranCellTDDLcr
UtranCellTDDHcr
- g) Valid for packet switched traffic
- h) UMTS

4.34.3.2 Outgoing serving E-DCH cell change per neighbour cell relation

4.34.3.2.1 Attempted outgoing serving E-DCH cell change per neighbour cell relation

- a) This measurement provides the number of attempted outgoing serving E-DCH cell change per neighbour cell relation.
- b) CC
- c) On transmission by the RNC of a RRC message RADIO BEARER SETUP, RADIO BEARER RECONFIGURATION, RADIO BEARER RELEASE, TRANSPORT CHANNEL RECONFIGURATION, or

PHYSICAL CHANNEL RECONFIGURATION from the source RNC to the UE, indicating the attempt of outgoing serving E-DCH cell change (see TS 25.331 [4]).

- d) A single integer value
- e) HSUPA.AttOut
- f) UtranRelation
- g) Valid for packet switched traffic
- h) UMTS

4.34.3.2.2 Successful outgoing serving E-DCH cell change per neighbour cell relation

- a) This measurement provides the number of successful outgoing serving E-DCH cell change per neighbour cell relation.
- b) CC
- c) On receipt by the RNC of a RRC message RADIO BEARER SETUP COMPLETE, RADIO BEARER RECONFIGURATION COMPLETE, RADIO BEARER RELEASE COMPLETE, TRANSPORT CHANNEL RECONFIGURATION COMPLETE, or PHYSICAL CHANNEL RECONFIGURATION COMPLETE sent from the UE to the source RNC, indicating a successful outgoing serving E-DCH cell change (see TS 25.331 [4]).
- d) A single integer value
- e) HSUPA.SuccOut
- f) UtranRelation
- g) Valid for packet switched traffic
- h) UMTS

4.34.4 Mean number of HSUPA users of a serving E-DCH cell

- a) This measurement provides the mean number of simultaneous HSUPA users in a serving E-DCH cell.
- b) SI.
- c) This measurement is obtained by sampling at a pre-defined interval the number of simultaneous users in a serving E-DCH cell and then taking the arithmetic mean.
- d) A single real value.
- e) HSUPA.MeanNbrUser
- f) UtranCellFDD
UtranCellTDDLcr
UtranCellTDDHcr
- g) Valid for packet switched traffic.
- h) UMTS.

4.34.5 Measurements related to channel switches between RACH/DCH and E-DCH

4.34.5.1 Measurements related to channel switches from RACH/DCH to E-DCH

4.34.5.1.1 Attempted channel switches from RACH to E-DCH

- a) This measurement provides the number of attempted channel switches from RACH to E-DCH in the serving E-DCH cell.
- b) CC
- c) On transmission by the RNC of a RRC message RADIO BEARER RECONFIGURATION, RADIO BEARER SETUP, RADIO BEARER RELEASE, CELL UPDATE CONFIRM, or TRANSPORT CHANNEL RECONFIGURATION to UE, with the condition that channel switches only from RACH to E-DCH (see TS 25.331 [4]).
- d) A single integer value
- e) HSUPA.AttRachToEdch
- f) UtranCellFDD
UtranCellTDDLcr
UtranCellTDDHcr
- g) Valid for packet switched traffic
- h) UMTS

4.34.5.1.2 Successful channel switches from RACH to E-DCH

- a) This measurement provides the number of successful channel switches from RACH to E-DCH in the serving E-DCH cell.
- b) CC
- c) On receipt by the RNC of a RRC message RADIO BEARER RECONFIGURATION COMPLETE, RADIO BEARER SETUP COMPLETE, RADIO BEARER RELEASE COMPLETE, or TRANSPORT CHANNEL RECONFIGURATION COMPLETE from UE, with the condition that channel switches only from RACH to E-DCH (see TS 25.331 [4]).
- d) A single integer value
- e) HSUPA.SuccRachToEdch
- f) UtranCellFDD
UtranCellTDDLcr
UtranCellTDDHcr
- g) Valid for packet switched traffic
- h) UMTS

4.34.5.1.3 Attempted channel switches from DCH to E-DCH

- a) This measurement provides the number of attempted channel switches from DCH to E-DCH in the serving E-DCH cell.
- b) CC
- c) On transmission by the RNC of a RRC message RADIO BEARER RECONFIGURATION, RADIO BEARER SETUP, RADIO BEARER RELEASE, CELL UPDATE CONFIRM, or TRANSPORT CHANNEL RECONFIGURATION to UE, with the condition that channel switches from DCH to E-DCH (see TS 25.331 [4]).
- d) A single integer value
- e) HSUPA.AttDchToEdch
- f) UtranCellFDD
UtranCellTDDLcr
UtranCellTDDHcr
- g) Valid for packet switched traffic
- h) UMTS

4.34.5.1.4 Successful channel switches from DCH to E-DCH

- a) This measurement provides the number of successful channel switches from DCH to E-DCH in the serving E-DCH cell.
- b) CC
- c) On receipt by the RNC of a RRC message RADIO BEARER RECONFIGURATION COMPLETE, RADIO BEARER SETUP COMPLETE, RADIO BEARER RELEASE COMPLETE, or TRANSPORT CHANNEL RECONFIGURATION COMPLETE from UE, with the condition that channel switches from DCH to E-DCH (see TS 25.331 [4]).
- d) A single integer value
- e) HSUPA.SuccDchToEdch
- f) UtranCellFDD
UtranCellTDDLcr
UtranCellTDDHcr
- g) Valid for packet switched traffic
- h) UMTS

4.34.5.2 Measurements related to channel switches from E-DCH to RACH/DCH

4.34.5.2.1 Attempted channel switches from E-DCH to RACH

- a) This measurement provides the number of attempted channel switches from E-DCH to RACH in the serving E-DCH cell.
- b) CC
- c) On transmission by the RNC of a RRC message RADIO BEARER RECONFIGURATION, RADIO BEARER SETUP, RADIO BEARER RELEASE, CELL UPDATE CONFIRM, or TRANSPORT CHANNEL

RECONFIGURATION to UE, with the condition that channel switches only from E-DCH to RACH (see TS 25.331 [4]).

- d) A single integer value
- e) HSUPA.AttEdchToRach
- f) UtranCellFDD
UtranCellTDDLcr
UtranCellTDDHcr
- g) Valid for packet switched traffic
- h) UMTS

4.34.5.2.2 Successful channel switches from E-DCH to RACH

- a) This measurement provides the number of successful channel switches from E-DCH to RACH in the serving E-DCH cell.
- b) CC
- c) On receipt by the RNC of a RRC message RADIO BEARER RECONFIGURATION COMPLETE, RADIO BEARER SETUP COMPLETE, RADIO BEARER RELEASE COMPLETE, or TRANSPORT CHANNEL RECONFIGURATION COMPLETE from UE, with the condition that channel switches only from E-DCH to RACH (see TS 25.331 [4]).
- d) A single integer value
- e) HSUPA.SuccEdchToRach
- f) UtranCellFDD
UtranCellTDDLcr
UtranCellTDDHcr
- g) Valid for packet switched traffic
- h) UMTS

4.34.5.2.3 Attempted channel switches from E-DCH to DCH

- a) This measurement provides the number of attempted channel switches from E-DCH to DCH in the serving E-DCH cell.
- b) CC
- c) On transmission by the RNC of a RRC message RADIO BEARER RECONFIGURATION, RADIO BEARER SETUP, RADIO BEARER RELEASE, CELL UPDATE CONFIRM, or TRANSPORT CHANNEL RECONFIGURATION to UE, with the condition that channel switches from E-DCH to DCH (see TS 25.331 [4]).
- d) A single integer value
- e) HSUPA.AttEdchToDch
- f) UtranCellFDD
UtranCellTDDLcr
UtranCellTDDHcr
- g) Valid for packet switched traffic
- h) UMTS

4.34.5.2.4 Successful channel switches from E-DCH to DCH

- a) This measurement provides the number of successful channel switches from E-DCH to DCH in the serving E-DCH cell.
- b) CC
- c) On receipt by the RNC of a RRC message RADIO BEARER RECONFIGURATION COMPLETE, RADIO BEARER SETUP COMPLETE, RADIO BEARER RELEASE COMPLETE, or TRANSPORT CHANNEL RECONFIGURATION COMPLETE from UE, with the condition that channel switches from E-DCH to DCH (see TS 25.331 [4]).
- d) A single integer value
- e) HSUPA.SuccEdchToDch
- f) UtranCellFDD
UtranCellTDDLcr
UtranCellTDDHcr
- g) Valid for packet switched traffic
- h) UMTS

4.34.6 Measurements related to MAC-e feedback decoding

4.34.6.1 Number of received MAC-e PDUs

- a) This measurement provides the number of received MAC-e PDUs including acknowledged and unacknowledged PDUs during the period of measurement, detected in MAC-e layer in the serving E-DCH cell.
- b) CC.
- c) On receipt by the NodeB of a PDU of MAC-e from UE.
- d) A single integer value.
- e) HSUPA.NbrMacePdu
- f) UtranCellFDD
UtranCellTDDLcr
UtranCellTDDHcr
- g) Valid for packet switched traffic.
- h) UMTS.

4.34.6.2 Number of received acknowledged MAC-e PDUs

- a) This measurement provides the number of successfully received MAC-e PDUs that has been acknowledged to the UE during the period of measurement, detected in MAC-e layer in the serving E-DCH cell.
- b) CC.
- c) On transmission by the NodeB of a ACK on E-HICH from NodeB to UE indicating a correct reception a MAC-e PDU.
- d) A single integer value.
- e) HSUPA.NbrAckdMacePdu
- f) UtranCellFDD
UtranCellTDDLcr
UtranCellTDDHcr
- g) Valid for packet switched traffic.
- h) UMTS.

4.34.7 Number of octets of acknowledged MAC-e PDUs

- a) This measurement provides the number of octets of uplink acknowledged MAC-e PDUs in the E-DCH cell.
- b) CC.
- c) On receipt by the NodeB of an acknowledged PDU on the MAC-e layer. The number of octets of MAC-e layer in one E-DCH cell is calculated by sum of size of each MAC-e PDU header including MAC-e PDU header.
- d) A single integer value.
- e) HSUPA.NbrAckdMaceOcts
- f) UtranCellFDD
UtranCellTDDLcr
UtranCellTDDHcr
- g) Valid for packet switched traffic.
- h) UMTS.

4.34.8 HSUPA Release measurements

4.34.8.1 Normal HSUPA Release

4.34.8.1.1 RNC initiated release due to user inactivity

- a) This measurement provides the number of times when the UE is removed from E-DCH transport channel due to user inactivity in the serving E-DCH cell.
- b) CC.
- c) On transmission by the RNC of the RRC: RADIO BEARER RECONFIGURATION or RRC: RADIO BEARER RELEASE or RRC CONNECTION RELEASE message that indicates an E-DCH release when RNC detected UE has no data to send in a predefined interval (equals to the RANAP cause 16 user inactivity).
- d) A single integer value.
- e) HSUPA.SuccEdchReleaseUserInact
- f) UtranCellFDD
UtranCellTDDLcr
UtranCellTDDHcr
- g) Valid for packet switched traffic.
- h) UMTS.

4.34.8.1.2 RNC initiated release due to switch to DCH/RACH

The measurement definition is in section 4.34.5.2.

4.34.8.1.3 RNC initiated release due to serving E-DCH cell change

The measurement definition is in section 4.34.3.

4.34.8.1.4 CN initiated release

- a) This measurement provides the number of times when the UE is removed from E-DCH transport channel due to a release initiated by the Core Network in the serving E-DCH cell.
- b) CC.
- c) On reception by the RNC of RANAP RAB ASSIGNMENT REQUEST or RANAP IU RELEASE COMMAND that results an E-DCH release. The release of E-DCH is executed by the transmission of the RRC RADIO BEARER RECONFIGURATION or RRC RADIO BEARER RELEASE or RRC CONNECTION RELEASE message.
- d) A single integer value.
- e) HSUPA.SuccCnInitEdchRelease
- f) UtranCellFDD
UtranCellTDDLcr
UtranCellTDDHcr
- g) Valid for packet switched traffic.
- h) UMTS.

4.34.8.2 Abnormal RB releases for E-DCH

- a) This measurement provides the number of times when the UE is removed from E-DCH transport channel, and trigger reason is not a normal release, e.g. user inactivity, switch to DCH/RACH, serving E-DCH cell changes or CN initiated release.
- b) CC.
- c) On receipt by the RNC of the RRC: RADIO BEARER RECONFIGURATION COMPLETE corresponding to the transmission of the RRC message RADIO BEARER RECONFIGURATION, or RRC: RADIO BEARER RELEASE COMPLETE corresponding to the transmission of the RRC message RADIO BEARER RELEASE. Or when the UE does not respond to RRC: RADIO BEARER RECONFIGURATION or RRC: RADIO BEARER RELEASE message, and the E-DCH release does not categorize as a normal release, e.g. user inactivity, switch to DCH/RACH, serving E-DCH cell changes or CN initiated release.
- d) A single integer value.
- e) HSUPA.AbnormalEdchRelease
- f) UtranCellFDD
UtranCellTDDLcr
UtranCellTDDHcr
- g) Valid for packet switched traffic.
- h) UMTS.

4.35 Radio resource utilization related measurements

4.35.1 UTRAN Cell Unavailable Time

- a) This measurement provides the length of time the cell has been unavailable for each cause.
- b) DER (n=1)
- c) This measurement is obtained by accumulating the time periods when the cell is unavailable per cause. The possible cause could be “manual intervention”, “fault”, “transport problem” or “energy saving”. The sum of all supported per cause measurements shall equal the total time periods of cell unavailability. In case only a subset of per cause measurements is supported, a sum subcounter will be provided first.
- d) Each measurement is an integer value (in seconds). The number of measurements is equal to the number of supported causes plus a possible sum value identified by the *.sum* suffix.
- e) RRU.UTRANCellUnavailableTime.ManualIntervention
RRU.UTRANCellUnavailableTime.TransportProblem
RRU.UTRANCellUnavailableTime.EnergySaving
RRU.UTRANCellUnavailableTime.Fault
- f) UtranGenericCell
- g) Valid for packet switched traffic and circuit switched traffic
- h) UMTS
- i) This measurement is to support KPI “UTRAN Cell Availability” defined in [18].

4.36 MBMS related measurements

4.36.1 Number of octets of MBMS data on MAC layer

- a) This measurement provides the number of octets of MBMS data on MAC-m layer.

- b) CC
- c) On transmission by the RNC of a PDU on the MAC layer for MBMS. The number of octets of MAC layer for MBMS is calculated by sum of PDU size including PDU header.
- d) A single integer value.
- e) MBMS.NbrOctMac
- f) UtranCellFDD
UtranCellTDDLcr
UtranCellTDDHcr
- g) Valid for packet switched traffic
- h) UMTS

4.36.2 Session related measurements

4.36.2.1 Attempted MBMS session start

- a) This measurement provides the number of attempted MBMS session start.
- b) CC
- c) On receipt by the RNC of a MBMS SESSION START message from CN (see TS 25.413 [5]), each MBMS SESSION START message is added to the measurement when MBMS resources attempt to be established in relevant cell.
- d) A single integer value.
- e) MBMS.AttSessionStart
- f) UtranCellFDD
UtranCellTDDLcr
UtranCellTDDHcr
- g) Valid for packet switched traffic.
- h) UMTS

4.36.2.2 Successful MBMS session start

- a) This measurement provides the number of successful MBMS session start.
- b) CC
- c) Transmission by the RNC of a MBMS SESSION START RESPONSE message to CN (see TS 25.413 [5]), each MBMS SESSION START RESPONSE message is added to the measurement when MBMS resources have been established in relevant cell.
- d) A single integer value.
- e) MBMS.SuccSessionStart
- f) UtranCellFDD
UtranCellTDDLcr
UtranCellTDDHcr
- g) Valid for packet switched traffic.
- h) UMTS

4.36.2.3 Attempted MBMS session stop

- a) This measurement provides the number of attempted MBMS session stop.
- b) CC
- c) On receipt by the RNC of a MBMS SESSION STOP message from CN (see TS 25.413 [5]), each MBMS SESSION STOP message is added to the measurement when MBMS resources attempt to be released in relevant cell.
- d) A single integer value.
- e) MBMS.AttSessionStop
- f) UtranCellFDD
UtranCellTDDLcr
UtranCellTDDHcr
- g) Valid for packet switched traffic.
- h) UMTS

4.36.2.4 Successful MBMS session stop

- a) This measurement provides the number of successful MBMS session stop.
- b) CC
- c) Transmission by the RNC of a MBMS SESSION STOP RESPONSE message to CN (see TS 25.413 [5]), each MBMS SESSION STOP RESPONSE message is added to the measurement when MBMS resources have been released in relevant cell,
- d) A single integer value.
- e) MBMS.SuccSessionStop
- f) UtranCellFDD
UtranCellTDDLcr
UtranCellTDDHcr
- g) Valid for packet switched traffic.
- h) UMTS

4.37 Dual-Cell HSDPA related measurements

4.37.1 Dual-Cell HSDPA Scheduling duration in UTRAN cell

- i) This measurement provides the Dual-Cell HSDPA Scheduling duration in UTRAN cell.
- j) DER (n=1)
- k) This measurement is obtained by accumulating the time intervals for each Mac-ehs Scheduling between the start of Dual-Cell Scheduling simultaneously and the end of Dual-Cell Scheduling simultaneously over a granularity period using DER, see TS 25.308 [19].The accumulator shall be reinitialised at the beginning of each granularity period. This measurement shall be accumulated only if the UTRAN cell is the primary cell of a Dual-Cell.
- l) A single integer value. (in milliseconds)
- m) HSDPA.DualCellSchedulingDuration

- n) UtranCellFDD
- o) Valid for packet switched traffic
- p) UMTS

4.37.2 Individual cell HSDPA Scheduling duration in UTRAN cell

- a) This measurement provides the individual cell HSDPA Scheduling duration in UTRAN cell.
- b) DER (n=1)
- c) This measurement is obtained by accumulating the time intervals for each Mac-ehs Scheduling between the start of individual cell Scheduling and the end of individual cell Scheduling over a granularity period using DER, see TS 25.308 [19]. The accumulator shall be reinitialised at the beginning of each granularity period.
- d) A single integer value. (in milliseconds)
- e) HSDPA.IndividualCellSchedulingDuration
- f) UtranCellFDD
- g) Valid for packet switched traffic
- h) UMTS

4.37.3 Attempted Dual-Cell HSDPA establishments

- i) This measurement provides the number of Dual-Cell HSDPA establishment attempts.
- j) CC
- k) On transmission by the RNC of a NBAP message RADIO LINK SETUP REQUEST with the “HS-DSCH Information” and “Additional HS Cell Information RL Setup” IE; Or on transmission by the RNC of a NBAP message RADIO LINK RECONFIGURATION PREPARE with the “HS-DSCH MAC-d Flows To Add” or “HS-DSCH Information” and “Additional HS Cell Information RL Reconf Prep” IE; Or on transmission by the RNC of a NBAP message RADIO LINK RECONFIGURATION REQUEST with the “HS-DSCH MAC-d Flows To Add” or “HS-DSCH Information” and “Additional HS Cell Information RL Reconf Req” IE. See TS 25.433 [7]. This measurement shall be counted only if the UTRAN cell is the primary cell of a Dual-Cell.
- l) A single integer values.
- m) HSDPA.EstabAttDCHSDSCH
- n) UtranCellFDD
- o) Valid for packet switched traffic
- p) UMTS

4.37.4 Successful Dual-Cell HSDPA establishments

- a) This measurement provides the number of successfully established Dual-Cell HSDPA.
- b) CC
- c) Receipt of a RRC message PHYSICAL CHANNEL RECONFIGURATION COMPLETE corresponding to PHYSICAL CHANNEL RECONFIGURATION with “Downlink HS-PDSCH Information” IE and “Downlink secondary cell info FDD” IE, RADIO BEARER SETUP COMPLETE corresponding to RADIO BEARER

SETUP with “Downlink HS-PDSCH Information” IE and “Downlink secondary cell info FDD” IE, RADIO BEARER RECONFIGURATION COMPLETE corresponding to RADIO BEARER RECONFIGURATION with “Downlink HS-PDSCH Information” IE and “Downlink secondary cell info FDD” IE, or TRANSPORT CHANNEL RECONFIGURATION COMPLETE corresponding to TRANSPORT CHANNEL RECONFIGURATION with “Downlink HS-PDSCH Information” IE and “Downlink secondary cell info FDD” IE, sent from the UE to the source RNC, indicating a successful handover/reconfiguration to Dual-cell HS-DSCH or new Dual-cell HS-DSCH setup. See TS 25.331 [4]. This measurement shall be counted only if the UTRAN cell is the primary cell of a Dual-Cell.

- d) A single integer values.
- e) HSDPA.EstabSuccDCHSDSCH
- f) UtranCellFDD
- g) Valid for packet switched traffic
- h) UMTS

4.37.5 Failed Dual-Cell HSDPA establishments

- a) This measurement provides the number of failed Dual-Cell HSDPA establishments. This measurement shall be increased for each failed Dual-Cell HSDPA establishments on Iub/Iur or Uu. For each failure cause a separate measurement is defined. Every failed Dual-Cell HSDPA establishments on Iub/Iur or Uu shall be considered separately. This measurement is valid for FDD mode.
- b) CC
- c) Receipt of a RADIO LINK SETUP FAILURE message (NBAP) sent by NodeB to the controlling RNC in response to a RADIO LINK SETUP REQUEST message with the “HS-DSCH Information” and “Additional HS Cell Information RL Setup” IE. One RADIO LINK SETUP FAILURE message can be related to more than one radio link. Each failed attempt to set up a Dual-Cell HSDPA radio link shall be considered separately. Failure causes are defined within TS 25.433 [7].

Each expected RADIO LINK SETUP RESPONSE or RADIO LINK SETUP FAILURE corresponding to RADIO LINK SETUP REQUEST with the “HS-DSCH Information” and “Additional HS Cell Information RL Setup” IE not received by the controlling RNC is added to the measurement cause 'No Reply' (not specified in TS 25.433 [7]).

Receipt of a RRC message PHYSICAL CHANNEL RECONFIGURATION FAILURE corresponding to PHYSICAL CHANNEL RECONFIGURATION with “Downlink HS-PDSCH Information” IE and “Downlink secondary cell info FDD” IE, RADIO BEARER SETUP FAILURE corresponding to RADIO BEARER SETUP with “Downlink HS-PDSCH Information” IE and “Downlink secondary cell info FDD” IE, RADIO BEARER RECONFIGURATION FAILURE corresponding to RADIO BEARER RECONFIGURATION with “Downlink HS-PDSCH Information” IE and “Downlink secondary cell info FDD” IE, or TRANSPORT CHANNEL RECONFIGURATION FAILURE corresponding to TRANSPORT CHANNEL RECONFIGURATION with “Downlink HS-PDSCH Information” IE and “Downlink secondary cell info FDD” IE, sent from the UE to the source RNC, indicating a failed handover/reconfiguration to Dual-cell HS-DSCH or failed new Dual-cell HS-DSCH setup. Each failed attempt to set up a Dual-Cell HS-DSCH shall be considered separately. Failure causes are defined within TS 25.331 [4].

Each expected PHYSICAL CHANNEL RECONFIGURATION COMPLETE or PHYSICAL CHANNEL RECONFIGURATION FAILURE corresponding to PHYSICAL CHANNEL RECONFIGURATION with “Downlink HS-PDSCH Information” IE and “Downlink secondary cell info FDD” IE, RADIO BEARER SETUP COMPLETE or RADIO BEARER SETUP FAILURE corresponding to RADIO BEARER SETUP with “Downlink HS-PDSCH Information” IE and “Downlink secondary cell info FDD” IE, RADIO BEARER RECONFIGURATION COMPLETE or RADIO BEARER RECONFIGURATION FAILURE corresponding to RADIO BEARER RECONFIGURATION with “Downlink HS-PDSCH Information” IE and “Downlink secondary cell info FDD” IE, TRANSPORT CHANNEL RECONFIGURATION COMPLETE or TRANSPORT CHANNEL RECONFIGURATION FAILURE corresponding to TRANSPORT CHANNEL RECONFIGURATION with “Downlink HS-PDSCH Information” IE and “Downlink secondary cell info FDD” IE

IE not received by the controlling RNC is added to the measurement cause 'No Reply' (not specified in TS 25.331 [4]).

This measurement shall be counted only if the UTRAN cell is the primary cell of a Dual-Cell.

- d) Each measurement is an integer value. The number of measurements is equal to the number of causes supported plus a possible sum value identified by the *.sum* suffix.
- e) The measurement name has the form HSDPA.EstabFailDCHSDSCH.*Cause* where *Cause* identifies the failure cause.
- f) UtranCellFDD
- g) Valid for packet switched traffic
- h) UMTS

4.38 Measurement report related measurements

4.38.1 P-CCPCH RSCP

- a) This measurement provides Received Signal Code Power of serving cell P-CCPCH.
- b) CC
- c) Receipt by the RNC of MEASUREMENT REPORT message, IE Measured results includes Intra-frequency measured results list that includes Cell measured results that includes Primary CCPCH RSCP info that includes Primary CCPCH RSCP. This measurement shall be increased for each reported value P-CCPCH RSCP_LEV. (See in 3GPP TS 25.331 [4])
- d) Each measurement is an integer value.
- e) MR.PccpchRscpLev.y y is an integer from 0 to 54.
 Note:
 0 of Lev indicates from P-CCPCH RSCP_LEV_00 to P-CCPCH RSCP_LEV_16, namely P-CCPCH RSCP < -100dBm,
 1 of y indicates P-CCPCH RSCP_LEV_16, namely -100dBm ≤ P-CCPCH RSCP < -99dBm,
 ...
 53 of y indicates P-CCPCH RSCP_LEV_68, namely -48dBm ≤ P-CCPCH RSCP < -47dBm.
 54 of y indicates from P-CCPCH RSCP_LEV_69 to P-CCPCH RSCP_LEV_91, namely -47dBm ≤ P-CCPCH RSCP. (See in 3GPP TS 25.123 [9])
- f) UtranCellTDDLcr
 UtranCellTDDHcr
- g) Valid for circuit and packet switched traffic
- h) UMTS

4.38.2 UTRAN RSCP

- a) This measurement provides UTRAN RSCP.
- b) CC
- c) Receipt by the RNC of DEDICATED MEASUREMENT INITIATION RESPONSE message, IE Dedicated Measurement Value Information that includes Dedicated Measurement Value that includes RSCP. This measurement shall be increased for each reported value RSCP_LEV. For every one or two or six RSCP_LEV(s) a separate measurement is defined. (See in 3GPP TS 25.433 [7])
- d) Each measurement is an integer value.

- e) MR.UtranRscpLev.Tsx.y x is an integer from 1 to 6 and only valid for uplink. y is an integer from 0 to 26.
 Note:
 0 of y indicates from RSCP_LEV_00 to RSCP_LEV_20, namely $RSCP < -110\text{dBm}$,
 1 of y indicates RSCP_LEV_21 and RSCP_LEV_22, namely $-110 \leq RSCP < -109\text{dBm}$,
 2 of y indicates RSCP_LEV_23 and RSCP_LEV_24, namely $-109 \leq RSCP < -108\text{dBm}$,
 ...
 10 of y indicates RSCP_LEV_39, RSCP_LEV_40, namely $-101 \leq RSCP < -100\text{dBm}$,
 11 of y indicates RSCP_LEV_41, RSCP_LEV_42, namely $-100 \leq RSCP < -99\text{dBm}$,
 12 of y indicates RSCP_LEV_43, RSCP_LEV_48, namely $-99 \leq RSCP < -96\text{dBm}$,
 13 of y indicates from RSCP_LEV_49 to RSCP_LEV_54, namely $-96 \leq RSCP < -93\text{dBm}$,
 ...
 25 of y indicates from RSCP_LEV_121 to RSCP_LEV_126, namely $-60 \leq RSCP < -57\text{dBm}$,
 26 of y indicates RSCP_LEV_127, namely $-57\text{dBm} \leq RSCP$. (See in 3GPP TS25.123 [9])
- f) UtranCellTDDLcr
 UtranCellTDDHcr
- g) Valid for circuit and packet switched traffic.
- h) UMTS

4.38.3 UE timing advance

- a) This measurement provides UE timing advance.
- b) CC
- c) Receipt by the RNC of MEASUREMENT REPORT message, IE Measured results includes UE internal measured results that includes UE timing advance.
 This measurement shall be increased for each reported value TIMING_ADVANCE. For every four or eight TIMING_ADVANCES a separate measurement is defined. (See in 3GPP TS 25.331 [4])
- d) Each measurement is an integer value.
- e) MR.UeTimingAdvance.y y is an integer from 0 to 36.
 Note:
 0 of y indicates from TIMING_ADVANCE_0000 to TIMING_ADVANCE_0003, namely $0 \text{ chip} \leq \text{Timing Advance} < 0.5 \text{ chip}$,
 ...
 7 of y indicates from TIMING_ADVANCE_0028 to TIMING_ADVANCE_0031, namely $3.5 \text{ chips} \leq \text{Timing Advance} < 4 \text{ chips}$,
 8 of y indicates from TIMING_ADVANCE_0032 to TIMING_ADVANCE_0039, namely $4 \text{ chips} \leq \text{Timing Advance} < 5 \text{ chips}$,
 ...
 35 of y indicates from TIMING_ADVANCE_248 to TIMING_ADVANCE_255, namely $31 \text{ chips} \leq \text{Timing Advance} < 32 \text{ chip}$,
 36 of y indicates from TIMING_ADVANCE_256 to TIMING_ADVANCE_2047, namely $32 \text{ chips} \leq \text{Timing Advance}$ (See in 3GPP TS 25.123 [9])
- f) UtranCellTDDLcr
 UtranCellTDDHcr
- g) Valid for circuit and packet switched traffic.
- h) UMTS

4.38.4 UTRAN AOA value

- a) This measurement provides UTRAN AOA value.
- b) CC

- c) Receipt by the RNC of DEDICATED MEASUREMENT INITIATION RESPONSE message, IE Dedicated Measurement Value Information that includes Dedicated Measurement Value that includes AOA value LCR. This measurement shall be increased for each reported value AOA_ANGLE. For every ten AOA_ANGLE(s) a separate measurement is defined. (See in 3GPP TS25.433 [7])
- d) Each measurement is an integer value.
- e) MR.UtranAOA.Tsx.y x is an integer from 1 to 6 and only valid for uplink. y is an integer from 0 to 71.
Note: 0 of y indicates from AOA_ANGLE_000 to AOA_ANGLE_009, namely $0 \leq \text{AOA_ANGLE} < 5$ degree,
...
71 of y indicates from AOA_ANGLE_710 to AOA_ANGLE_719, namely $355 \leq \text{AOA_ANGLE} < 360$ degree. (See in 3GPP TS25.123 [9])
- f) UtranCellTDDLcr
- g) Valid for circuit and packet switched traffic.
- h) UMTS

4.38.5 UE timeslot ISCP

- a) This measurement provides UE timeslot ISCP.
- b) CC
- c) Receipt by the RNC of MEASUREMENT REPORT message, IE Measured results includes Intra-frequency measured results list that includes Cell measured results that includes Timeslot ISCP. This measurement shall be increased for each reported value UE_TS_ISCP_LEV. For every one UE_TS_ISCP_LEV(s) that is less than 57 a separate measurement is defined. (See in 3GPP TS 25.331 [4])
- d) Each measurement is an integer value.
- e) MR.UeTimeslotIscpLev.TSx.y x is an integer from 1 to 6 and only valid for downlink. y is an integer from 0 to 46.
Note:
0 of y indicates UE_TS_ISCP_LEV_00, namely Timeslot_ISCP $< -115\text{dBm}$,
1 of y indicates UE_TS_ISCP_LEV_01, namely $-115\text{dBm} \leq \text{Timeslot_ISCP} < -114\text{dBm}$
...
56 of y indicates UE_TS_ISCP_LEV_56, namely $-60\text{dBm} \leq \text{Timeslot_ISCP} < -59\text{dBm}$
57 of y indicates from UE_TS_ISCP_LEV_57 to UE_TS_ISCP_LEV_91, namely $-59\text{dBm} \leq \text{Timeslot_ISCP}$.
(See in 3GPP TS 25.123 [9])
- f) UtranCellTDDLcr
UtranCellTDDHcr
- g) Valid for circuit and packet switched traffic.
- h) UMTS

4.38.6 UTRAN timeslot ISCP

- a) This measurement provides UTRAN timeslot ISCP of NodeB in uplink.
- b) CC
- c) Receipt by the RNC of COMMON MEASUREMENT REPORT message, IE Common Measurement Value Information that includes Dedicated Measurement Value Information that includes Dedicated Measurement Value that includes UL Timeslot ISCP. This measurement shall be increased for each reported value UTRAN_TS_ISCP_LEV. For every one or two UTRAN_TS_ISCP_LEV(s) a separate measurement is defined. (See in 3GPP TS 25.433 [7])
- d) Each measurement is an integer value.

- e) MR.UtranTimeslotIscp.TSx.y x is an integer from 1 to 6 and only valid for uplink. y is an integer from 0 to 64.
 Note:
 0 of y indicates UTRAN_TS_ISCP_LEV_00, namely Timeslot_ISCP < -120dBm,
 1 of y indicates UTRAN_TS_ISCP_LEV_01 and UTRAN_TS_ISCP_LEV_02, namely -120dBm ≤ Timeslot_ISCP < -119dBm
 2 of y indicates UTRAN_TS_ISCP_LEV_03 and UTRAN_TS_ISCP_LEV_04, namely -119dBm ≤ Timeslot_ISCP < -118dBm
 ...
 63 of y indicates UTRAN_TS_ISCP_LEV_125 and UTRAN_TS_ISCP_LEV_126, namely -58dBm ≤ Timeslot_ISCP < -57dBm
 64 of y indicates UTRAN_TS_ISCP_LEV_127, namely -57 ≤ Timeslot_ISCP. (See in 3GPP TS 25.123 [9])
- f) UtranCellTDDLcr
 UtranCellTDDHcr
- g) Valid for circuit and packet switched traffic.
- h) UMTS

4.38.7 UE transmitted power

- a) This measurement provides UE transmitted power.
- b) CC
- c) Receipt by the RNC of MEASUREMENT REPORT message, IE Measured results includes UE internal measured results that includes UE transmitted power.
 This measurement shall be increased for each reported value UE_TX_POWER. For every three UE_TX_POWERs a separate measurement is defined. (See in 3GPP TS 25.331 [4])
- d) Each measurement is an integer value.
- e) MR.UeTransmittedPower.TSx.y x is an integer from 1 to 6 and only valid for uplink. y is an integer from 0 to 27.
 Note:
 0 of y indicates UE_TX_POWER_021, UE_TX_POWER_022 and UE_TX_POWER_023, namely -50dBm ≤ UE transmitted power < -47dBm,
 ...
 27 of y indicates UE_TX_POWER_102, UE_TX_POWER_103 and UE_TX_POWER_104, namely 31dBm ≤ UE transmitted power < 34dBm. (See in 3GPP TS 25.123 [9])
- f) UtranCellTDDLcr
 UtranCellTDDHcr
- g) Valid for circuit and packet switched traffic
- h) UMTS

4.38.8 UpPTS interference

- a) This measurement provides UpPTS interference of NodeB in downlink.
- b) CC
- c) Receipt by the RNC of COMMON MEASUREMENT REPORT message, IE Common Measurement Value Information includes Common Measurement Value that includes UpPCH interference.
 This measurement shall be increased for each reported value UTRAN_UPPTS_LEV. For every one or two UTRAN_UPPTS_LEV(s) a separate measurement is defined. (See in 3GPP TS 25.433 [7])
- d) Each measurement is an integer value.

- e) MR.UpptsInterferenceLev.y y is an integer from 0 to 64. (See in 3GPP TS 25.123 [9])
 Note:
 0 of y indicates UTRAN_UPPTS_LEV_00, namely UpPTS interference < -120dBm,
 1 of y indicates UTRAN_UPPTS_LEV_01 and UTRAN_UPPTS_LEV_02, namely -120dBm ≤ UpPTS interference < -119dBm
 ...
 63 of y indicates UTRAN_UPPTS_LEV_125 and UTRAN_UPPTS_LEV_126, namely -58dBm ≤ UpPTS interference < -57dBm,
 64 of y indicates UTRAN_UPPTS_LEV_127, namely -57dBm ≤ UpPTS interference. (See in 3GPP TS 25.123 [9]).
- f) UtranCellTDDLcr
- g) Valid for circuit and packet switched traffic.
- h) UMTS

4.38.9 UTRAN SIR

- a) This measurement provides UTRAN SIR of NodeB for uplink.
- b) CC
- c) Receipt by the RNC of DEDICATED MEASUREMENT REPORT message, IE Dedicated Measurement Value includes SIR Value.
 This measurement shall be increased for each reported value UTRAN_SIR. For every one UTRAN_SIR a separate measurement is defined. (See in 3GPP TS 25.433 [7] and TS 25.123 [9])
- d) Each measurement is an integer value.
- e) MR.UtranSir. x x is an integer from 0 to 63.
 Note:
 0 of x indicates UTRAN_SIR_00, namely SIR < -11.0dB,
 1 of x indicates UTRAN_SIR_01, namely -11.0dB ≤ SIR < -10.5dB
 2 of x indicates UTRAN_SIR_02, namely -10.5dB ≤ SIR < -10.0dB
 ...
 61 of x indicates UTRAN_SIR_61, namely 19dB ≤ SIR < 19.5dB
 62 of x indicates UTRAN_SIR_62, namely 19.5dB ≤ SIR < 20.0dB
 63 of x indicates UTRAN_SIR_63, namely 20.0dB ≤ SIR

 (See in 3GPP TS 25.123 [9])
- f) UtranCellTDD
- g) Valid for circuit and packet switched traffic.
- h) UMTS

4.38.10 UE SIR

- a) This measurement provides UE SIR for downlink.
- b) CC
- c) Receipt by the RNC of MEASUREMENT REPORT message, Measured results IE includes Quality measured results list IE that includes SIR.
 This measurement shall be increased for each reported value UE_SIR. For every one UE_SIR a separate measurement is defined. (See in 3GPP TS 25.331 [4])
- d) Each measurement is an integer value.

- e) MR.UeSir. x x is an integer from 0 to 63.
 Note:
 0 of x indicates UE_SIR_00, namely $SIR < -11.0\text{dB}$,
 1 of x indicates UE_SIR_01, namely $-11.0\text{dB} \leq SIR < -10.5\text{dB}$
 2 of x indicates UE_SIR_02, namely $-10.5\text{dB} \leq SIR < -10.0\text{dB}$
 ...
 61 of x indicates UE_SIR_61, namely $19\text{dB} \leq SIR < 19.5\text{dB}$
 62 of x indicates UE_SIR_62, namely $19.5\text{dB} \leq SIR < 20.0\text{dB}$
 63 of x indicates UE_SIR_63, namely $20.0\text{dB} \leq SIR$

(See in 3GPP TS 25.123 [9])

- f) UtranCellTDD
 g) Valid for circuit and packet switched traffic.
 h) UMTS

4.38.11 SIR Target

- a) This measurement provides target value of SIR.
 b) CC
 c) Receipt by the RNC of DEDICATED MEASUREMENT REPORT message, IE Dedicated Measurement Value includes SIR Value.
 This measurement shall be increased for each reported value "UL SIR target". For every three, four or five UL_SIR_TARGETs a separate measurement is defined. (See in 3GPP TS 25.433 [7])
 d) Each measurement is an integer value.

MR.UtranSirt. x x is an integer from 0 to 51.

Note:

0 of x indicates from UL_SIR_TARGET_00 to UL_SIR_Target_02, namely $UTRAN_SIRT < -8.0\text{dB}$,
 1 of x indicates from UL_SIR_TARGET_03 to UL_SIR_TARGET_07, namely $-8.0\text{dB} \leq UTRAN_SIRT < -7.5\text{dB}$

...

50 of x indicates from UL_SIR_TARGET_247 to UL_SIR_TARGET_251, namely $16.5\text{dB} \leq UTRAN_SIRT < 17.0\text{dB}$

51 of x indicates from UL_SIR_TARGET_252 to UL_SIR_TARGET_255, namely $17.0\text{dB} \leq UTRAN_SIRT$ (See in 3GPP TS 25.433 [7])

- e) UtranCellTDD
 f) Valid for circuit and packet switched traffic.
 g) UMTS

4.38.12 Uplink Bit Error Rate for AMR 12.2K

- a) This measurement provides uplink BER (Bit Error Rate) for AMR 12.2K.
 b) CC
 c) Receipt by the RNC of DEDICATED MEASUREMENT REPORT message, IE Dedicated Measurement Type includes Transport channel BER IE.
 This measurement shall be increased for each reported value TrCh_BER_LOG. (See in 3GPP TS 25.433 [7] and TS 25.123 [9])
 d) Each measurement is an integer value.

- e) MR.CsVoiceUIBerLog. x x is an integer from 0 to 10.

Note:

0 of x indicates from TRCH_BER_LOG_000 to TRCH_BER_LOG_018, namely $\text{Log}_{10}(\text{Transport channel BLER}) < -1.9175$,

1 of x indicates from TRCH_BER_LOG_019 to TRCH_BER_LOG_033, namely $-1.925625 \leq \text{Log}_{10}(\text{Transport channel BLER}) < -1.80375$,

2 of x indicates from TRCH_BER_LOG_034 and TRCH_BER_LOG_055, namely $-1.80375 \leq \text{Log}_{10}(\text{Transport channel BLER}) < -1.625$,

3 of x indicates from TRCH_BER_LOG_056 and TRCH_BER_LOG_071, namely $-1.625 \leq \text{Log}_{10}(\text{Transport channel BLER}) < -1.495$,

4 of x indicates from TRCH_BER_LOG_072 to TRCH_BER_LOG_092, namely $-1.495 \leq \text{Log}_{10}(\text{Transport channel BLER}) < -1.324375$,

5 of x indicates from TRCH_BER_LOG_093 and TRCH_BER_LOG_108, namely $-1.324375 \leq \text{Log}_{10}(\text{Transport channel BLER}) < -1.194375$,

6 of x indicates from TRCH_BER_LOG_109 to TRCH_BER_LOG_129, namely $-1.194375 \leq \text{Log}_{10}(\text{Transport channel BLER}) < -1.02375$,

7 of x indicates from TRCH_BER_LOG_130 and TRCH_BER_LOG_145, namely $-1.02375 \leq \text{Log}_{10}(\text{Transport channel BLER}) < -0.89375$,

8 of x indicates from TRCH_BER_LOG_146 and TRCH_BER_LOG_182, namely $-0.89375 \leq \text{Log}_{10}(\text{Transport channel BLER}) < -0.593125$,

9 of x indicates from TRCH_BER_LOG_183 and TRCH_BER_LOG_219, namely $-0.593125 \leq \text{Log}_{10}(\text{Transport channel BLER}) < -0.2925$,

10 of x indicates from TRCH_BER_LOG_220 to TRCH_BER_LOG_225, namely $-0.2925 \leq \text{Log}_{10}(\text{Transport channel BLER}) \leq 0$

- f) UtranCellTDD
- g) Valid for circuit and packet switched traffic.
- h) UMTS

4.38.13 Uplink Bit Error Rate for CS 64K

- a) This measurement provides uplink BER (Bit Error Rate) for CS 64K.
- b) CC
- c) Receipt by the RNC of DEDICATED MEASUREMENT REPORT message, IE Dedicated Measurement Type includes Transport channel BER IE.
This measurement shall be increased for each reported value TrCh_BER_LOG. (See in 3GPP TS 25.433 [7] and TS 25.123 [9])
- d) Each measurement is an integer value.
- e) MR.Cs64UIBerLog. x x is an integer from 0 to 10.

Note:

- 0 of x indicates from TRCH_BER_LOG_000 to TRCH_BER_LOG_018, namely $\text{Log}_{10}(\text{Transport channel BLER}) < -1.9175$,
- 1 of x indicates from TRCH_BER_LOG_019 to TRCH_BER_LOG_033, namely $-1.925625 \leq \text{Log}_{10}(\text{Transport channel BLER}) < -1.80375$,
- 2 of x indicates from TRCH_BER_LOG_034 and TRCH_BER_LOG_055, namely $-1.80375 \leq \text{Log}_{10}(\text{Transport channel BLER}) < -1.625$,
- 3 of x indicates from TRCH_BER_LOG_056 and TRCH_BER_LOG_071, namely $-1.625 \leq \text{Log}_{10}(\text{Transport channel BLER}) < -1.495$,
- 4 of x indicates from TRCH_BER_LOG_072 to TRCH_BER_LOG_092, namely $-1.495 \leq \text{Log}_{10}(\text{Transport channel BLER}) < -1.324375$,
- 5 of x indicates from TRCH_BER_LOG_093 and TRCH_BER_LOG_108, namely $-1.324375 \leq \text{Log}_{10}(\text{Transport channel BLER}) < -1.194375$,
- 6 of x indicates from TRCH_BER_LOG_109 to TRCH_BER_LOG_129, namely $-1.194375 \leq \text{Log}_{10}(\text{Transport channel BLER}) < -1.02375$,
- 7 of x indicates from TRCH_BER_LOG_130 and TRCH_BER_LOG_145, namely $-1.02375 \leq \text{Log}_{10}(\text{Transport channel BLER}) < -0.89375$,
- 8 of x indicates from TRCH_BER_LOG_146 and TRCH_BER_LOG_182, namely $-0.89375 \leq \text{Log}_{10}(\text{Transport channel BLER}) < -0.593125$,
- 9 of x indicates from TRCH_BER_LOG_183 and TRCH_BER_LOG_219, namely $-0.593125 \leq \text{Log}_{10}(\text{Transport channel BLER}) < -0.2925$,
- 10 of x indicates from TRCH_BER_LOG_220 to TRCH_BER_LOG_225, namely $-0.2925 \leq \text{Log}_{10}(\text{Transport channel BLER}) \leq 0$

- f) UtranCellTDD
- g) Valid for circuit and packet switched traffic.
- h) UMTS

4.38.14 Uplink Bit Error Rate for PS

- a) This measurement provides uplink BER (Bit Error Rate) for PS.
- b) CC
- c) Receipt by the RNC of DEDICATED MEASUREMENT REPORT message, IE Dedicated Measurement Type includes Transport channel BER IE.
This measurement shall be increased for each reported value TrCh_BER_LOG. (See in 3GPP TS 25.433 [7] and TS 25.123 [9])
- d) Each measurement is an integer value.
- e) MR.PsUIBerLog. x x is an integer from 0 to 10.

Note:

- 0 of x indicates from TRCH_BER_LOG_000 to TRCH_BER_LOG_018, namely $\text{Log}_{10}(\text{Transport channel BLER}) < -1.9175$,
- 1 of x indicates from TRCH_BER_LOG_019 to TRCH_BER_LOG_033, namely $-1.925625 \leq \text{Log}_{10}(\text{Transport channel BLER}) < -1.80375$,
- 2 of x indicates from TRCH_BER_LOG_034 and TRCH_BER_LOG_055, namely $-1.80375 \leq \text{Log}_{10}(\text{Transport channel BLER}) < -1.625$,
- 3 of x indicates from TRCH_BER_LOG_056 and TRCH_BER_LOG_071, namely $-1.625 \leq \text{Log}_{10}(\text{Transport channel BLER}) < -1.495$,
- 4 of x indicates from TRCH_BER_LOG_072 to TRCH_BER_LOG_092, namely $-1.495 \leq \text{Log}_{10}(\text{Transport channel BLER}) < -1.324375$,
- 5 of x indicates from TRCH_BER_LOG_093 and TRCH_BER_LOG_108, namely $-1.324375 \leq \text{Log}_{10}(\text{Transport channel BLER}) < -1.194375$,
- 6 of x indicates from TRCH_BER_LOG_109 to TRCH_BER_LOG_129, namely $-1.194375 \leq \text{Log}_{10}(\text{Transport channel BLER}) < -1.02375$,
- 7 of x indicates from TRCH_BER_LOG_130 and TRCH_BER_LOG_145, namely $-1.02375 \leq \text{Log}_{10}(\text{Transport channel BLER}) < -0.89375$,
- 8 of x indicates from TRCH_BER_LOG_146 and TRCH_BER_LOG_182, namely $-0.89375 \leq \text{Log}_{10}(\text{Transport channel BLER}) < -0.593125$,
- 9 of x indicates from TRCH_BER_LOG_183 and TRCH_BER_LOG_219, namely $-0.593125 \leq \text{Log}_{10}(\text{Transport channel BLER}) < -0.2925$,
- 10 of x indicates from TRCH_BER_LOG_220 to TRCH_BER_LOG_225, namely $-0.2925 \leq \text{Log}_{10}(\text{Transport channel BLER}) \leq 0$

- f) UtranCellTDD
- g) Valid for circuit and packet switched traffic.
- h) UMTS

4.38.15 Downlink BLER for AMR 12.2K

- a) This measurement provides downlink BLER for AMR 12.2K.
- b) CC
- c) Receipt by the RNC of MEASUREMENT REPORT message, Measured results IE includes Quality measured results list IE that includes DL Transport Channel BLER.
This measurement shall be increased for each reported value BLER_LOG. For every two or three or eight BLER_LOGs that is less than 63 a separate measurement is defined. (See in 3GPP TS 25.331 [4])
- d) Each measurement is an integer value.
- e) MR.CsVoiceDIBlerLog. x x is an integer from 0 to 19.

Note:

- 0 of x indicates from BLER_LOG_00 to BLER_LOG_07, namely $\text{Log}_{10}(\text{Transport channel BLER}) < -3.64$,
- 1 of x indicates from BLER_LOG_08 to BLER_LOG_12, namely $-3.64 \leq \text{Log}_{10}(\text{Transport channel BLER}) < -3.315$,
- 2 of x indicates from BLER_LOG_13 and BLER_LOG_14, namely $-3.315 \leq \text{Log}_{10}(\text{Transport channel BLER}) < -3.185$,
- 3 of x indicates from BLER_LOG_15 and BLER_LOG_16, namely $-3.185 \leq \text{Log}_{10}(\text{Transport channel BLER}) < -3.055$,
- 4 of x indicates from BLER_LOG_17 to BLER_LOG_19, namely $-3.055 \leq \text{Log}_{10}(\text{Transport channel BLER}) < -2.86$,
- 5 of x indicates from BLER_LOG_20 and BLER_LOG_21, namely $-2.86 \leq \text{Log}_{10}(\text{Transport channel BLER}) < -2.73$,
- 6 of x indicates from BLER_LOG_22 to BLER_LOG_24, namely $-2.73 \leq \text{Log}_{10}(\text{Transport channel BLER}) < -2.535$,
- 7 of x indicates from BLER_LOG_25 and BLER_LOG_26, namely $-2.535 \leq \text{Log}_{10}(\text{Transport channel BLER}) < -2.405$,
- 8 of x indicates from BLER_LOG_27 and BLER_LOG_28, namely $-2.405 \leq \text{Log}_{10}(\text{Transport channel BLER}) < -2.275$,
- 9 of x indicates from BLER_LOG_29 and BLER_LOG_30, namely $-2.275 \leq \text{Log}_{10}(\text{Transport channel BLER}) < -2.145$,
- 10 of x indicates from BLER_LOG_31 to BLER_LOG_33, namely $-2.145 \leq \text{Log}_{10}(\text{Transport channel BLER}) < -1.95$,
- 11 of x indicates from BLER_LOG_34 and BLER_LOG_35, namely $-1.95 \leq \text{Log}_{10}(\text{Transport channel BLER}) < -1.82$,
- 12 of x indicates from BLER_LOG_36 to BLER_LOG_38, namely $-1.82 \leq \text{Log}_{10}(\text{Transport channel BLER}) < -1.625$,
- 13 of x indicates from BLER_LOG_39 and BLER_LOG_40, namely $-1.625 \leq \text{Log}_{10}(\text{Transport channel BLER}) < -1.495$,
- 14 of x indicates from BLER_LOG_41 and BLER_LOG_42, namely $-1.495 \leq \text{Log}_{10}(\text{Transport channel BLER}) < -1.365$,
- 15 of x indicates from BLER_LOG_43 and BLER_LOG_44, namely $-1.365 \leq \text{Log}_{10}(\text{Transport channel BLER}) < -1.235$,
- 16 of x indicates from BLER_LOG_45 to BLER_LOG_47, namely $-1.235 \leq \text{Log}_{10}(\text{Transport channel BLER}) < -1.04$,
- 17 of x indicates from BLER_LOG_48 and BLER_LOG_49, namely $-1.04 \leq \text{Log}_{10}(\text{Transport channel BLER}) < -0.91$,
- 18 of x indicates from BLER_LOG_50 to BLER_LOG_53, namely $-0.91 \leq \text{Log}_{10}(\text{Transport channel BLER}) < -0.65$,
- 19 of x indicates from BLER_LOG_54 to BLER_LOG_63, namely $-0.65 \leq \text{Log}_{10}(\text{Transport channel BLER}) \leq 0$

- f) UtranCellTDD
- g) Valid for circuit and packet switched traffic.
- h) UMTS

4.38.16 Downlink BLER for CS 64K

- a) This measurement provides downlink BLER for CS 64K.
- b) CC
- c) Receipt by the RNC of MEASUREMENT REPORT message, Measured results IE includes Quality measured results list IE that includes DL Transport Channel BLER.
This measurement shall be increased for each reported value BLER_LOG. For every two or three or eight BLER_LOGs that is less than 63 a separate measurement is defined. (See in 3GPP TS 25.331 [4])
- d) Each measurement is an integer value.

- e) MR.Cs64DIBlerLog. x x is an integer from 0 to 19.

Note:

0 of x indicates from BLER_LOG_00 to BLER_LOG_07, namely $\text{Log}_{10}(\text{Transport channel BLER}) < -3.64$,
 1 of x indicates from BLER_LOG_08 to BLER_LOG_12, namely $-3.64 \leq \text{Log}_{10}(\text{Transport channel BLER}) < -3.315$,
 2 of x indicates from BLER_LOG_13 and BLER_LOG_14, namely $-3.315 \leq \text{Log}_{10}(\text{Transport channel BLER}) < -3.185$,
 3 of x indicates from BLER_LOG_15 and BLER_LOG_16, namely $-3.185 \leq \text{Log}_{10}(\text{Transport channel BLER}) < -3.055$,
 4 of x indicates from BLER_LOG_17 to BLER_LOG_19, namely $-3.055 \leq \text{Log}_{10}(\text{Transport channel BLER}) < -2.86$,
 5 of x indicates from BLER_LOG_20 and BLER_LOG_21, namely $-2.86 \leq \text{Log}_{10}(\text{Transport channel BLER}) < -2.73$,
 6 of x indicates from BLER_LOG_22 to BLER_LOG_24, namely $-2.73 \leq \text{Log}_{10}(\text{Transport channel BLER}) < -2.535$,
 7 of x indicates from BLER_LOG_25 and BLER_LOG_26, namely $-2.535 \leq \text{Log}_{10}(\text{Transport channel BLER}) < -2.405$,
 8 of x indicates from BLER_LOG_27 and BLER_LOG_28, namely $-2.405 \leq \text{Log}_{10}(\text{Transport channel BLER}) < -2.275$,
 9 of x indicates from BLER_LOG_29 and BLER_LOG_30, namely $-2.275 \leq \text{Log}_{10}(\text{Transport channel BLER}) < -2.145$,
 10 of x indicates from BLER_LOG_31 to BLER_LOG_33, namely $-2.145 \leq \text{Log}_{10}(\text{Transport channel BLER}) < -1.95$,
 11 of x indicates from BLER_LOG_34 and BLER_LOG_35, namely $-1.95 \leq \text{Log}_{10}(\text{Transport channel BLER}) < -1.82$,
 12 of x indicates from BLER_LOG_36 to BLER_LOG_38, namely $-1.82 \leq \text{Log}_{10}(\text{Transport channel BLER}) < -1.625$,
 13 of x indicates from BLER_LOG_39 and BLER_LOG_40, namely $-1.625 \leq \text{Log}_{10}(\text{Transport channel BLER}) < -1.495$,
 14 of x indicates from BLER_LOG_41 and BLER_LOG_42, namely $-1.495 \leq \text{Log}_{10}(\text{Transport channel BLER}) < -1.365$,
 15 of x indicates from BLER_LOG_43 and BLER_LOG_44, namely $-1.365 \leq \text{Log}_{10}(\text{Transport channel BLER}) < -1.235$,
 16 of x indicates from BLER_LOG_45 to BLER_LOG_47, namely $-1.235 \leq \text{Log}_{10}(\text{Transport channel BLER}) < -1.04$,
 17 of x indicates from BLER_LOG_48 and BLER_LOG_49, namely $-1.04 \leq \text{Log}_{10}(\text{Transport channel BLER}) < -0.91$,
 18 of x indicates from BLER_LOG_50 to BLER_LOG_53, namely $-0.91 \leq \text{Log}_{10}(\text{Transport channel BLER}) < -0.65$,
 19 of x indicates from BLER_LOG_54 to BLER_LOG_63, namely $-0.65 \leq \text{Log}_{10}(\text{Transport channel BLER}) \leq 0$

- f) UtranCellTDD
 g) Valid for circuit and packet switched traffic.
 h) UMTS

4.38.17 Downlink BLER for PS

- a) This measurement provides downlink BLER for PS.
 b) CC
 c) Receipt by the RNC of MEASUREMENT REPORT message, Measured results IE includes Quality measured results list IE that includes DL Transport Channel BLER.
 This measurement shall be increased for each reported value BLER_LOG. For every two or three or eight BLER_LOGs that is less than 63 a separate measurement is defined. (See in 3GPP TS 25.331 [4])

- d) Each measurement is an integer value.
- e) MR.PsDIBlerLog. x x is an integer from 0 to 19.

Note:

0 of x indicates from BLER_LOG_00 to BLER_LOG_07, namely $\text{Log}_{10}(\text{Transport channel BLER}) < -3.64$,

1 of x indicates from BLER_LOG_08 to BLER_LOG_12, namely $-3.64 \leq \text{Log}_{10}(\text{Transport channel BLER}) < -3.315$,

2 of x indicates from BLER_LOG_13 and BLER_LOG_14, namely $-3.315 \leq \text{Log}_{10}(\text{Transport channel BLER}) < -3.185$,

3 of x indicates from BLER_LOG_15 and BLER_LOG_16, namely $-3.185 \leq \text{Log}_{10}(\text{Transport channel BLER}) < -3.055$,

4 of x indicates from BLER_LOG_17 to BLER_LOG_19, namely $-3.055 \leq \text{Log}_{10}(\text{Transport channel BLER}) < -2.86$,

5 of x indicates from BLER_LOG_20 and BLER_LOG_21, namely $-2.86 \leq \text{Log}_{10}(\text{Transport channel BLER}) < -2.73$,

6 of x indicates from BLER_LOG_22 to BLER_LOG_24, namely $-2.73 \leq \text{Log}_{10}(\text{Transport channel BLER}) < -2.535$,

7 of x indicates from BLER_LOG_25 and BLER_LOG_26, namely $-2.535 \leq \text{Log}_{10}(\text{Transport channel BLER}) < -2.405$,

8 of x indicates from BLER_LOG_27 and BLER_LOG_28, namely $-2.405 \leq \text{Log}_{10}(\text{Transport channel BLER}) < -2.275$,

9 of x indicates from BLER_LOG_29 and BLER_LOG_30, namely $-2.275 \leq \text{Log}_{10}(\text{Transport channel BLER}) < -2.145$,

10 of x indicates from BLER_LOG_31 to BLER_LOG_33, namely $-2.145 \leq \text{Log}_{10}(\text{Transport channel BLER}) < -1.95$,

11 of x indicates from BLER_LOG_34 and BLER_LOG_35, namely $-1.95 \leq \text{Log}_{10}(\text{Transport channel BLER}) < -1.82$,

12 of x indicates from BLER_LOG_36 to BLER_LOG_38, namely $-1.82 \leq \text{Log}_{10}(\text{Transport channel BLER}) < -1.625$,

13 of x indicates from BLER_LOG_39 and BLER_LOG_40, namely $-1.625 \leq \text{Log}_{10}(\text{Transport channel BLER}) < -1.495$,

14 of x indicates from BLER_LOG_41 and BLER_LOG_42, namely $-1.495 \leq \text{Log}_{10}(\text{Transport channel BLER}) < -1.365$,

15 of x indicates from BLER_LOG_43 and BLER_LOG_44, namely $-1.365 \leq \text{Log}_{10}(\text{Transport channel BLER}) < -1.235$,

16 of x indicates from BLER_LOG_45 to BLER_LOG_47, namely $-1.235 \leq \text{Log}_{10}(\text{Transport channel BLER}) < -1.04$,

17 of x indicates from BLER_LOG_48 and BLER_LOG_49, namely $-1.04 \leq \text{Log}_{10}(\text{Transport channel BLER}) < -0.91$,

18 of x indicates from BLER_LOG_50 to BLER_LOG_53, namely $-0.91 \leq \text{Log}_{10}(\text{Transport channel BLER}) < -0.65$,

19 of x indicates from BLER_LOG_54 to BLER_LOG_63, namely $-0.65 \leq \text{Log}_{10}(\text{Transport channel BLER}) \leq 0$

- f) UtranCellTDD
- g) Valid for circuit and packet switched traffic.
- g) UMTS

4.39 HSPA evolution scheduling related measurements

4.39.1 Number of 64QAM scheduled TTIs in UTRAN cell

- a) This measurement provides the number of 64QAM scheduled TTIs in UTRAN cell.
- b) CC
- c) On transmission by the NodeB of a scheduled message send to UE through HS-SCCH, which can be calculated in NodeB scheduler, see 25.308[19]. Only 64QAM type modulation is calculated.
- d) A single integer value.
- e) HSPA.E.64QAMScheduled
- f) UtranCellFDD
- g) Valid for packet switched traffic.
- h) UMTS

4.39.2 Number of MIMO scheduled TTIs in UTRAN cell

- a) This measurement provides the number of MIMO scheduled TTIs in UTRAN cell.
- b) CC
- c) On transmission by the NodeB of a scheduled message send to UE through HS-SCCH, which can be calculated in NodeB scheduler, see TS 25.308. [19] Both single and dual stream mode are calculated.
- d) A single integer value.
- e) HSPA.E.MIMOScheduled
- f) UtranCellFDD
- g) Valid for packet switched traffic.
- h) UMTS

4.39.3 Number of total modulation mode scheduled TTIs in UTRAN cell

- a) This measurement provides the number of total modulation mode scheduled TTIs in UTRAN cell.
- b) CC
- c) On transmission by the NodeB of a scheduled message send to UE through HS-SCCH, which can be calculated in NodeB scheduler, see 25.308[19]. All TTI except the empty TTI should be counted.
- d) A single integer value.
- e) HSPA.E.ModulScheduled
- f) UtranCellFDD
- g) Valid for packet switched traffic.
- h) UMTS

4.40 lurg related measurements

Performance Measurement definitions in this subclause are based on TS 43.130 [20].

The following procedures are of interest for this purpose:

RNSAP: ENHANCED RELOCATION RESOURCE REQUEST

RNSAP: ENHANCED RELOCATION RESOURCE RESPONSE

RNSAP: RELOCATION COMMIT

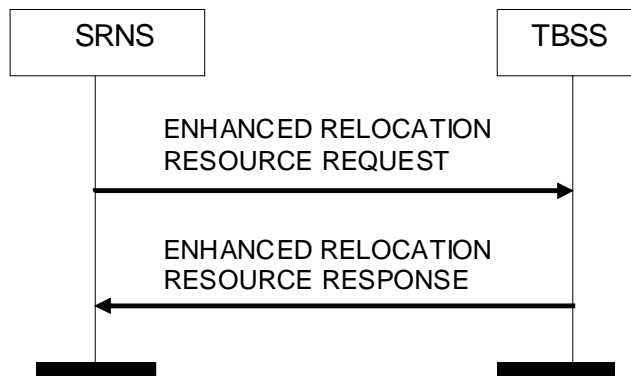

Figure: BSS Radio Resource Reservation Success



Figure: Relocation Commit

4.40.1 Attempted relocation resource reservation for inter-RAT handovers with Iur-g interface

- a) This measurement provides the number of attempted relocation resource reservation for inter-RAT handovers with Iur-g interface.
- b) CC
- c) Transmission of a message ENHANCED RELOCATION RESOURCE REQUEST from the source RNC to BSC, indicating an attempted relocation resource reservation for CS domain handover from UMTS to GSM (See 3GPP TS 43.130[20]).
- d) A single integer value.
- e) IRATHO.AttRelocResReservOutIurg
- f) GsmRelation
- g) Valid for circuit switched traffic.
- h) UMTS

4.40.2 Successful relocation resource reservation for inter-RAT handovers with Iur-g interface

- a) This measurement provides the number of successful relocation resource reservation for inter-RAT handovers with Iur-g interface.
- b) CC
- c) Receipt of a message ENHANCED RELOCATION RESOURCE RESPONSE message sent from BSC to RNC, indicating a successful relocation resource reservation for CS domain handover from UMTS to GSM (See 3GPP TS 43.130[20]).
- d) A single integer value.
- e) IRATHO.SuccRelocResReservOutIurg
- f) GsmRelation
- g) Valid for circuit switched traffic.
- h) UMTS

4.40.3 Attempted outgoing preparation inter-RAT handovers with Iur-g interface (UMTS->GSM)

- a) This measurement provides the number of attempted outgoing preparation inter-RAT handovers with Iur-g interface (UMTS->GSM).
- b) CC ;
- c) Transmission of a message RELOCATION REQUIRED from RNC to CN, indicating an attempted outgoing preparation handovers with Iur-g interface for CS domain handover from UMTS to GSM (See 3GPP TS 25.413[5]).
- d) A single integer value.
- e) IRATHO.AttCNPrepOutCsIurg.Cause
- f) GsmRelation
- g) Valid for circuit switched traffic.
- h) UMTS

4.40.4 Successful outgoing preparation inter-RAT handovers with Iur-g interface (UMTS->GSM)

- a) This measurement provides the number of successful outgoing preparation inter-RAT handovers with Iur-g interface (UMTS->GSM)
- b) CC
- c) Receipt of a message RELOCATION COMMAND from CS CN to RNC, indicating a successful outgoing preparation handovers with Iur-g interface for CS domain handover from UMTS to GSM (See 3GPP TS 25.413[5]).
- d) A single integer value.
- e) IRATHO.SuccCNPrepOutCsIurg
- f) GsmRelation
- g) Valid for circuit switched traffic.

h) UMTS

4.40.5 Attempted outgoing inter-RAT handovers with Iur-g interface (UMTS->GSM)

- a) This measurement provides the number of attempted outgoing inter-RAT handovers with Iur-g interface (UMTS->GSM)
- b) CC ;
- c) Transmission of a message HANOVER FROM UTRAN COMMAND with RNC to UE, indicating an attempted outgoing handovers with Iur-g interface for CS domain handover from UMTS to GSM (3GPP TS 25.331[4]).
- d) A single integer value.
- e) IRATHO.AttEnhancedOutCsIurg
- f) GsmRelation
- g) Valid for circuit switched traffic.
- h) UMTS

4.40.6 Successful outgoing inter-RAT handovers with Iur-g interface (UMTS->GSM)

- a) This measurement provides the number of successful outgoing inter-RAT handovers with Iur-g interface (UMTS->GSM)
- b) CC ;
- c) Receipt of a message IU RELEASE COMMAND from CS CN to RNC, the release reason is "Successful Relocation" or "Normal Release", indicating a successful outgoing handovers with Iur-g interface for CS domain handover from UMTS to GSM (See 3GPP TS 25.413[5]).
- d) A single integer value.
- e) IRATHO.SuccEnhancedOutCsIurg.
- f) GsmRelation.
- g) Valid for circuit switched traffic.
- h) UMTS.

5 Measurements related to the NodeB and RNC

5.1 Power, Energy and Environmental (PEE) measurements

5.1.0 Applicability of measurements The energy efficiency related measurement definitions in the following clauses X.1.n are valid only for NodeBs and RNCs having built-in sensors (cf. ETSI ES 202 336-12 [22]).

5.1.1 Power

5.1.1.1 Average Power

- a) This measurement provides the average power consumed.
- b) SI.
- c) This measurement is obtained according to the method defined in ETSI ES 202 336-12 [22] – clauses 4.4.3.1, 4.4.3.4, Annex A.
- d) Each measurement is a real value in Watt (W).
- e) The measurement name has the form PEE.AvgPower.
- f) NodeBFunction, RNCFunction.
- g) Valid for packet switching.
- h) UMTS.

5.1.1.2 Minimum Power

- a) This measurement provides the minimum power consumed.
- b) SI.
- c) This measurement is obtained according to the method defined in ETSI ES 202 336-12 [22] – clauses 4.4.3.1, 4.4.3.4, Annex A.
- d) Each measurement is a real value in Watt (W).
- e) The measurement name has the form PEE.MinPower.
- f) NodeBFunction, RNCFunction.
- g) Valid for packet switching.
- h) UMTS.

5.1.1.3 Maximum Power

- a) This measurement provides the maximum power consumed.
- b) SI.
- c) This measurement is obtained according to the method defined in ETSI ES 202 336-12 [22] – clauses 4.4.3.1, 4.4.3.4, Annex A.
- d) Each measurement is a real value in Watt (W).
- e) The measurement name has the form PEE.MaxPower.
- f) ENBFunction, RNCFunction.
- g) Valid for packet switching.
- h) UMTS.

5.1.2 Energy

- a) This measurement provides the energy consumed.
- b) SI.

- c) This measurement is obtained according to the method defined in ETSI ES 202 336-12 [22] – clauses 4.4.3.2, 4.4.3.4, Annex A.
- d) Each measurement is a real value in kilo Watt hour (kWh).
- e) The measurement name has the form PEE.Energy.
- f) ENBFunction, RNCFunction.
- g) Valid for packet switching.
- h) UMTS.

5.1.3 Temperature

5.1.3.1 Average Temperature

- a) This measurement provides the average temperature.
- b) SI.
- c) This measurement is obtained according to the method defined in ETSI ES 202 336-12 [22] – clause 4.4.3.4, Annex A.
- d) Each measurement is a real value in Degree Celsius (C°).
- e) The measurement name has the form PEE.AvgTemperature.
- f) ENBFunction, RNCFunction.
- g) Valid for packet switching.
- h) UMTS.

5.1.3.2 Minimum Temperature

- a) This measurement provides the minimum temperature.
- b) SI.
- c) This measurement is obtained according to the method defined in ETSI ES 202 336-12 [22] – clause 4.4.3.4, Annex A.
- d) Each measurement is a real value in Degree Celsius (C°).
- e) The measurement name has the form PEE.MinTemperature.
- f) ENBFunction, RNCFunction.
- g) Valid for packet switching.
- h) UMTS.

5.1.3.3 Maximum Temperature

- a) This measurement provides the maximum temperature.
- b) SI.
- c) This measurement is obtained according to the method defined in ETSI ES 202 336-12 [22] – clause 4.4.3.4, Annex A.
- d) Each measurement is a real value in Degree Celsius (C°).
- e) The measurement name has the form PEE.MaxTemperature.

- f) ENBFunction, RNCFunction.
- g) Valid for packet switching.
- h) UMTS.

5.1.4 Voltage

- a) This measurement provides the voltage.
- b) SI.
- c) This measurement is obtained according to the method defined in ETSI ES 202 336-12 [22] – Clauses 4.4.3.3, 4.4.3.4, Annex B.
- d) Each measurement is a real value in Volt (V).
- e) The measurement name has the form PEE.Voltage.
- f) ENBFunction, RNCFunction.
- g) Valid for packet switching.
- h) UMTS.

5.1.5 Current

- a) This measurement provides the current.
- b) SI.
- c) This measurement is obtained according to the method defined in ETSI ES 202 336-12 [22] – Clauses 4.4.3.3, 4.4.3.4, Annex B.
- d) Each measurement is a real value in Ampere (A).
- e) The measurement name has the form PEE.Current.
- f) ENBFunction, RNCFunction.
- g) Valid for packet switching.
- h) UMTS.

5.1.6 Humidity

- a) This measurement provides the percentage of humidity.
- b) SI.
- c) This measurement is obtained according to the method defined in ETSI ES 202 336-12 [22] – clause 4.4.3.3, Annex B.
- d) Each measurement is a single integer value from 0 to 100.
- e) The measurement name has the form PEE.Humidity.
- f) ENBFunction, RNCFunction.
- g) Valid for packet switching.
- h) UMTS.

Annex A (informative): Use cases for measurement report related measurements

A.1 Use case of P-CCPCH RSCP

P-CCPCH RSCP measurement reflects P-CCPCH of serving cell RSCP signal strength. From the distribution of this measurement during the period of measurement, the coverage quality of cell can be learned. Also it is helpful to do troubleshooting, such as locating coverage blind spot. Much more measurement values with small granularity are necessary to analyze coverage probability for specific area. Such as from ratio of the number of PCCPCH RSCP that is larger than or equal to threshold to the total number of it, coverage probability could be learned. Threshold value is configurable according to the cases to be analyzed, such as, -95dBm for macro cell cases, -80dBm for micro or indoor cell cases, also the threshold may be higher for some cases with specific requirement. So that the coverage probability results can not be given from average, minimum and maximum of measurement value. So it is necessary to define P-CCPCH RSCP measurement.

According to optimization experience, several granularity of this measurement is proposed. Since the receiver sensitivity is nearly -110dBm (TDD mode), so that it is no meaning to collect the measurement value lower than it. For $-110 \text{ dBm} \leq \text{RSCP} < -100 \text{ dBm}$, signal strength is week, it is useful to do trouble shooting, so the granularity is 1dB.

A.2 Use case of UTRAN RSCP

UTRAN RSCP measurement together with UE P-CCPCH RSCP is helpful to analyze coverage probability and coverage balance of uplink and downlink. Much more measurement values with small granularity are need to analyze coverage probability for specific area, such as from ratio of the number of UTRAN RSCP that is larger than or equal to threshold to the total number of it, coverage probability could be learned. Threshold value is configurable according to the cases to be analyzed, such as, -95dBm for macro cell cases, -80dBm for micro or indoor cell cases, also threshold may be higher for some cases with specific requirement. Since the coverage probability results can not be given from average, minimum and maximum of measurement value, it is necessary to define UTRAN RSCP measurement.

According to optimization experience, several granularity of this measurement is proposed. Since the receiver sensitivity is nearly -110dBm (TDD mode), so that it is no meaning to collect the measurement value lower than it. For $-110 \text{ dBm} \leq \text{RSCP} < -100 \text{ dBm}$, signal strength is week, it is useful to do trouble shooting, so the granularity is 1dB. For RSCP is larger than -100dBm, signal strength can be used to analysis balance of uplink and downlink, it is no need too accurately, so the granularity is 3dB.

A.3 Use case of UE timing advance

UE timing advance measurement is useful to analyze distance distribution between UE and serving Base Station and do trouble shooting of extending coverage and blind coverage spot together with other measurements, such as P-CCPCH RSCP, AOA etc measurements. The probability of extending coverage and blind coverage should be analyzed by the ratio of the number of TIMING_ADVANCE that is larger than or equal to threshold to the total number of it. Threshold is configurable according to the cases to be analyzed, cases includes dense urban area macro cell suburban area macro cell and rural area cell.

For LCR TDD mode, propagation distance of 1 chip is nearly 234m. since urban cell radius nearly 500m, and suburban cell radius is nearly 1000m, and rural cell radius is nearly 2000m, according to optimization experience, minimize granularity of TIMING_ADVANCE is 0.5chip is enough to analyze distance distribution for near base station, namely TIMING_ADVANCE is less than 4 chips. For TIMING_ADVANCE is large than 4 chips and less than 32 chips, the corresponding propagation distance is from 936m to 7488m, the granularity is 1 chip is enough to do trouble shooting of extending coverage. For TIMING_ADVANCE is large than 32 chips, how far accurately can not be learned from it because of the complexity of wireless propagation, it is enough that extending coverage is learned from it in this case.

So it is necessary to define UE timing advance measurement with small granularity.

A.4 Use case of UTRAN AOA value

UTRAN AOA value measurement is helpful to analyze UE's direction distribution of coverage to optimize network together with other measurements. So it is necessary to define UTRAN AOA value measurement.

Granularity of measurement is 5 degree, for cell radius is 500m, corresponding length in edge of cell coverage is nearly 44m. For cell radius is 1000m, corresponding length in edge of cell coverage is nearly 88m. According to network optimization experience, a block whose side length is 44m or 88m for urban cell or suburban cell respectively is enough as an area unit to be analyzed.

A.5 Use case of UE timeslot ISCP

UE timeslot ISCP measurement is useful to analyze coverage quality of each cell and do troubleshooting of blind spot together with other measurements, such as P-CCPCH RSCP measurement. So it is necessary to define UE timeslot ISCP measurement.

According to network optimization experience, the granularity of measurement is 1dB when UE_TS_ISCP_LEV is less than 57, and there are very few UE_TS_ISCP_LEV results that is larger than and equal to 57, so one measurement is defined for it. From these measurements, it is easy to get the ratio of the number of UE_TS_ISCP_LEV that is larger than threshold to the total number of it, and the threshold is configurable according to use cases, such as cell coverage analysis, channel estimation analysis etc.

A.6 Use case of UTRAN timeslot ISCP

UTRAN timeslot ISCP measurement is useful to analyze coverage quality of each cell and performance of the DCA (Dynamic Channel Allocation), such as the UTRAN timeslot ISCP is always high then DCA does not work well. So it is necessary to define UTRAN timeslot ISCP measurement.

1dB of UTRAN ISCP measurement granularity is used to compare with UE ISCP, the ISCP distribution can be given with same granularity. In addition, from the ratio of the number of UTRAN_TS_ISCP_LEV that is larger than or less than threshold to the total number of it, inference source or RF equipment question could be located. The threshold is configurable.

A.7 Use case of UE transmitted power

UE transmitted power measurement is useful to analyze coverage quality of each cell and do troubleshooting of blind spot by the distribution of this measurement together with other measurements, such as P-CCPCH RSCP measurement. It is also used to evaluate power control performance and decrease UE transmitted power as possible with QoS is guaranteed for the purpose of energy saving. These questions are determined by the ratio of the number of larger or less than threshold to the total number of it and the threshold is configurable. So it is necessary to define UE transmitted power measurement.

According to network optimization experience, the granularity of measurement 3dB is enough to do trouble shooting of blind spot and evaluation of power control.

A.8 Use case of UpPTS interference

When many NodeBs cover a large area, one NodeBs UpPTS may receive interference from another far nodeB transmission signal for the transmission delay. If the UpPTS interference is too strong, UE can not access network. The solution of interference coordination is determined by the ratio of the number of UpPTS interference that is larger than threshold to the total number of it. So it is necessary to define UpPTS interference measurement.

According to network optimization experience, measurement granularity is 1dB, it is enough to do probability distribution to determine extending coverage or GPS synchronization problem.

A.9 Use case of SIR

SIR measurement is important to evaluate quality of the received signal and range of cell coverage. With the measured SIR compared to the SIR target of each traffic class, it can be determined whether the signal is decoded correctly or not. SIR target is used for out loop power control, and it is useful to learn the effect of power control, such as SIR is converged to SIR target quickly or not.

In order to reduce the number of SIR related measurement, according to network optimization experience, 0.5dB granularity of measurement is enough.

A.10 Use case of Bit Error Rate and BLER

Bit Error Rate and BLER is very useful to evaluate service quality per traffic class, if Bit Error Rate and BLER is higher than threshold, it possibly leads to call drop. It is also useful to evaluate the effect of power control, such as for open loop power control, if initial SIR target is not set properly, Bit Error Rate or BLER will be very high and reduced slowly. So it is necessary to define BLER related measurements.

From above, use case of Bit Error Rate and BLER related measurement is not like radio resource management in RNC equipment, only some performance is learned from Bit Error Rate or BLER distribution. So according to network optimization experience, 10 subcounters for Bit Error Rate or 20 subcounters for BLER are proposed and the granularity is larger than definition of measurement report.

A.11 Monitoring of Energy Saving

Besides monitoring of the energy consumption it is also important to differentiate if the cell unavailability or the failure of the RRC connection establishment happens because of Energy Saving as Energy Saving Management feature is applied by the network operator on purpose. Therefore such failures should be distinguishable from other network failures, i.e. they should be counted separately. With the separate cell unavailability counter due to Energy Saving it is possible to deduct the cell downtime due to Energy Savings from the total cell downtime.

Annex B (informative): Use cases for performance measurements definition

B.0 Introduction

This annex provides the concrete use cases for the UTRAN performance measurements defined in clause 4.

B.1 HSPA evolution related performance

In HSPA evolution different scheduling mechanism are defined. For Network Operators to use the related licenses more efficient it is important to know the utilization of the different scheduling mechanism. Based on the utilization information operator can optimize their license usage by moving licenses to the areas where the utilization is higher.

The utilization of 64QAM and MIMO scheduling mechanism is calculated based in the scheduled TTIs. The measurements required are: how many TTIs using 64QAM technology in UTRAN cell are actually scheduled by NodeB, how many TTIs in UTRAN cell are actually scheduled by NodeB of using MIMO technology and how many TTIs are actually scheduled in total. The first counter can be used to calculate the usage of 64QAM technology in the networks, by comparing this measurement to the total number of scheduled TTIs. The second counter reflects the utilization of MIMO technology in the networks by comparing this measurement to the total number of scheduled TTIs. The last counter reflects the total number of scheduled TTIs where the empty TTIs are excluded.

B.2 RAB establishment related performance

With the dramatic development of 3G network, operators provide much more kinds of streaming service platforms mainly in PS domain, such as VOD (Video on Demand), IVVR (Interactive Voice and Video Response) and Video Surveillance. The streaming services can be distinguished by the data rate since they require different data rate, as same as conversation services in CS domain. For instance, IVVR, VOD and Video Surveillance require different data rate, typically 64kbps, 128kbps, and 384kbps. Only streaming services counted in this measurement is because that operators are more interested in streaming type of service, whose QoS needs to be monitored and guaranteed. The measurements related to RAB establishment in PS domain streaming type according to data rates can reflect different streaming services. It would be helpful for the operators to know the successful ratio of their services' establishments.

B.3 Iurg related measurements

The main purpose of Iurg interface is to enhance mobility performance including paging, cell update and registration area update etc, especially for dual-RAN capable mobiles. It can alleviate the potential problem caused with dual mode mobiles frequently toggling between UTRAN and GERAN coverage areas (e.g. in indoor coverage situations): for instance, common LAIs and RAIs for GERAN and UTRAN cells in the same geographical area.

Resource reservation, preparation and implementation of handover with Iurg interface success rate are very useful to analyze network handover performance and to do trouble shooting when handover success rate is lower than predefined threshold. So it is necessary to define Iurg related measurements.

B.4 RRC connection usage per UE multi-mode/multi-RAT capability related measurement

Network Operator's Business Community aims to utilize their installed equipment as much as possible for efficiency reasons because each additional technology layer constitutes an important portion of total capex expenditures. A generic approach is to configure network parameters so that UEs that support both new and older radio access technology layers would camp on and use services from latest technology with better cost per bit characteristics. Therefore, it is of utmost

importance for an operator to know if new technology capable UEs are served by old radio access technology for areas where new technology is overlaid on top.

RRC connection usage per UE multi-mode/multi-RAT capability related measurement will be helpful for operators to identify how efficient they utilize their deployed radio access technology layers and perform corrective actions when needed.

B.5 Monitoring of Power, Energy and Environmental (PEE) parameters

Power, Energy and Environmental (PEE) parameters, combined with data volume measurements, are valuable information for operators to measure the energy efficiency (EE) of their UTRA network. Hence it is necessary to define performance measurements related to UTRAN PEE parameters such as power, energy, temperature, voltage, current, humidity.

Annex C (informative): Change history

Change history								
Date	TSG #	TSG Doc.	CR	Rev	Subject/Comment	Cat	Old	New
Sep 2007	SA_37	SP-070613	0031	--	Correct ISCP (Interference Signal Code Power) measurements for TDD - Align with 25.123 Requirements for support of radio resource management (TDD)	F	7.5.0	7.6.0
Sep 2007	SA_37	SP-070614	0032	--	Add RNC processor usage related measurements	B	7.6.0	8.0.0
Dec 2007	SA_38	SP-070734	0035	--	Correct measurements about the transmitted carrier power not used for HSPA transmission for TDD - Align with 25.225	A	8.0.0	8.1.0
Dec 2007	SA_38	SP-070744	0036	--	Add measurements related to E-DCH active set	B	8.0.0	8.1.0
Dec 2007	SA_38	SP-070744	0037	--	Add measurements related to serving E-DCH cell change	B	8.0.0	8.1.0
Dec 2007	SA_38	SP-070744	0038	--	Add measurements related to HSUPA users	B	8.0.0	8.1.0
Dec 2007	SA_38	SP-070744	0039	--	Add measurements related to HSUPA setup	B	8.0.0	8.1.0
Mar 2008	SP-39	SP-080069	0040	--	Correct measurement name for abnormal RB releases for HS-DSCH - Replace HS by HSDPA	F	8.1.0	8.2.0
Mar 2008	SP-39	SP-080069	0041	--	Add measurements related to channel switches between E-DCH and RACH/DCH - Channel switch success rate for HSUPA	B	8.1.0	8.2.0
Mar 2008	SP-39	SP-080069	0042	--	Add measurements related to MAC-e feedback decoding - HSUPA retransmission efficiency	B	8.1.0	8.2.0
Mar 2008	SP-39	SP-080069	0043	--	Add measurement related to octets of acknowledged MAC-e PDUs - HSUPA data volume	B	8.1.0	8.2.0
Mar 2008	SP-39	SP-080069	0044	--	Add measurements related to HSUPA release	B	8.1.0	8.2.0
Jun 2008	SP-40	SP-080328	0046	--	Correct measurements related to TDD UTRAN cell Radio Frequency Carrier	A	8.2.0	8.3.0
Sep 2008	SP-41	SP-080465	0047	--	Correct measurements related to Mac-d setups for HSUPA	F	8.3.0	8.4.0
Sep 2008	SP-41	SP-080465	0048	--	Correct measurements related to channel switch between RACH/DCH and E-DCH	F	8.3.0	8.4.0
Sep 2008	SP-41	SP-080465	0049	1	Change name and definition of measurements related to serving E-DCH cell change	F	8.3.0	8.4.0
Sep 2008	SP-41	SP-080465	0050	1	Add measurements related to serving E-DCH cell change	B	8.3.0	8.4.0
Mar 2009	SP-43	SP-090207	0051	--	Add Cell Unavailable Time Measurements	C	8.4.0	8.5.0
Mar 2009	SP-43	SP-090207	0052	--	Addition of MBMS data volume related measurements	B	8.4.0	8.5.0
Mar 2009	SP-43	SP-090207	0053	--	Inclusion of WB-AMR Rates	C	8.4.0	8.5.0
Jun 2009	SP-44	SP-090290	0054	--	Addition of MBMS session related measurements	F	8.5.0	9.0.0
Sep 2009	SP-45	SP-090627	0055	--	Add performance measurements for Dual-Cell HSDPA	B	9.0.0	9.1.0
Dec 2009	SP-46	SP-090719	0056	--	Addition of P-CCPCH RSCP related measurements	B	9.1.0	9.2.0
Dec 2009	SP-46	SP-090719	0057	--	Addition of UTRAN RSCP related measurements	B	9.1.0	9.2.0
Dec 2009	SP-46	SP-090719	0058	--	Addition of UE timing advance related measurements	B	9.1.0	9.2.0
Dec 2009	SP-46	SP-090719	0059	--	Addition of UTRAN AOA value related measurements	B	9.1.0	9.2.0
Dec 2009	SP-46	SP-090719	0060	--	Addition of UE timeslot ISCP related measurements	B	9.1.0	9.2.0
Dec 2009	SP-46	SP-090719	0061	--	Addition of UTRAN timeslot ISCP related measurements	B	9.1.0	9.2.0
Dec 2009	SP-46	SP-090719	0062	--	Addition of UE transmitted power related measurements	B	9.1.0	9.2.0
Dec 2009	SP-46	SP-090719	0063	--	Addition of UpPTS interference related measurements	B	9.1.0	9.2.0
Dec 2009	SP-46	SP-090719	0064	--	Add RAB establishment related performance measurements according to data rates	B	9.1.0	9.2.0
Dec 2009	SP-46	SP-090719	0065	--	Add performance measurements for hspa evolution	B	9.1.0	9.2.0
Mar 2010	SP-47	SP-100036	0066	--	Addition of SIR related measurements	B	9.2.0	10.0.0
Mar 2010	SP-47	SP-100036	0067	--	Addition of Bit Error Rate and BLER related measurements	B	9.2.0	10.0.0
May 2011	SP-52	SP-110286	0068	--	Addition of Iurg related performance measurements	B	10.0.0	11.0.0

Mar 2012	SP-55	SP-120056	0069	1	Add energy saving cause to UTRAN measurements	B	11.0.0	11.1.0
Dec 2012					Correction of History table (MCC)		11.1.0	11.1.1
Sep 2014	SP-65	SP-140556	0074	1	Correction of scope	A	11.1.1	11.2.0
2014-10	-	-	-	-	Update to Rel-12 version (MCC)		11.2.0	12.0.0
2015-09	SP-69	SP-150414	0077	1	Add usage of measurements supporting EE coverage KPI	C	12.0.0	13.0.0
2015-12	SP-70	SP-150785	0078	2	Add measurement on RRC connection usage per UE capability	B	13.0.0	13.1.0
2017-03	SA#75	-	-	-	Promotion to Release 14 without technical change		13.1.0	14.0.0

Change history							
Date	Meeting	TDoc	CR	Rev	Cat	Subject/Comment	New version
2018-03	SA#79	SP-180060	0079	-	B	Introduction of power, energy and environment related measurements and related use case description.	15.0.0
2020-07	-	-	-	-	-	Update to Rel-16 version (MCC)	16.0.0
2022-04	-	-	-	-	-	Update to Rel-17 version (MCC)	17.0.0

History

Document history		
V17.0.0	April 2022	Publication