

ETSI TS 132 409 V7.1.0 (2007-10)

Technical Specification

**Digital cellular telecommunications system (Phase 2+);
Universal Mobile Telecommunications System (UMTS);
Telecommunication management;
Performance Management (PM);
Performance measurements IP Multimedia Subsystem (IMS)
(3GPP TS 32.409 version 7.1.0 Release 7)**



Reference

RTS/TSGS-0532409v710

Keywords

GSM, UMTS

ETSI

650 Route des Lucioles
F-06921 Sophia Antipolis Cedex - FRANCE

Tel.: +33 4 92 94 42 00 Fax: +33 4 93 65 47 16

Siret N° 348 623 562 00017 - NAF 742 C
Association à but non lucratif enregistrée à la
Sous-Préfecture de Grasse (06) N° 7803/88

Important notice

Individual copies of the present document can be downloaded from:

<http://www.etsi.org>

The present document may be made available in more than one electronic version or in print. In any case of existing or perceived difference in contents between such versions, the reference version is the Portable Document Format (PDF). In case of dispute, the reference shall be the printing on ETSI printers of the PDF version kept on a specific network drive within ETSI Secretariat.

Users of the present document should be aware that the document may be subject to revision or change of status. Information on the current status of this and other ETSI documents is available at

<http://portal.etsi.org/tb/status/status.asp>

If you find errors in the present document, please send your comment to one of the following services:

http://portal.etsi.org/chaicor/ETSI_support.asp

Copyright Notification

No part may be reproduced except as authorized by written permission.
The copyright and the foregoing restriction extend to reproduction in all media.

© European Telecommunications Standards Institute 2007.
All rights reserved.

DECTTM, **PLUGTESTS**TM and **UMTS**TM are Trade Marks of ETSI registered for the benefit of its Members.
TIPHONTM and the **TIPHON logo** are Trade Marks currently being registered by ETSI for the benefit of its Members.
3GPPTM is a Trade Mark of ETSI registered for the benefit of its Members and of the 3GPP Organizational Partners.

Intellectual Property Rights

IPRs essential or potentially essential to the present document may have been declared to ETSI. The information pertaining to these essential IPRs, if any, is publicly available for **ETSI members and non-members**, and can be found in ETSI SR 000 314: "*Intellectual Property Rights (IPRs); Essential, or potentially Essential, IPRs notified to ETSI in respect of ETSI standards*", which is available from the ETSI Secretariat. Latest updates are available on the ETSI Web server (<http://webapp.etsi.org/IPR/home.asp>).

Pursuant to the ETSI IPR Policy, no investigation, including IPR searches, has been carried out by ETSI. No guarantee can be given as to the existence of other IPRs not referenced in ETSI SR 000 314 (or the updates on the ETSI Web server) which are, or may be, or may become, essential to the present document.

Foreword

This Technical Specification (TS) has been produced by ETSI 3rd Generation Partnership Project (3GPP).

The present document may refer to technical specifications or reports using their 3GPP identities, UMTS identities or GSM identities. These should be interpreted as being references to the corresponding ETSI deliverables.

The cross reference between GSM, UMTS, 3GPP and ETSI identities can be found under <http://webapp.etsi.org/key/queryform.asp>.

Contents

Intellectual Property Rights	2
Foreword.....	2
Foreword.....	8
Introduction	8
1 Scope	9
2 References	9
3 Measurement family and abbreviations.....	11
3.1 Measurement family.....	11
3.2 Abbreviations	11
4 Functionality related measurements	13
4.1 Measurements related to CSCF.....	13
4.1.1 Registration related measurements	13
4.1.1.1 Initial registration.....	13
4.1.1.1.1 Attempted initial registration procedures	13
4.1.1.1.2 Successful initial registration procedures	13
4.1.1.1.3 Failed initial registration procedures	14
4.1.1.1.4 IMS initial registration set-up time (Mean)	14
4.1.1.2 Re-registration.....	15
4.1.1.2.1 Attempted re-registration procedures	15
4.1.1.2.2 Successful re-registration procedures	15
4.1.1.2.3 Failed re-registration procedures	15
4.1.1.3 De-registration	16
4.1.1.3.1 De-registrations initiated by UE.....	16
4.1.1.3.2 De-registration initiated by HSS.....	17
4.1.1.3.3 De-registration initiated by S-CSCF.....	18
4.1.1.4 Third party registration	19
4.1.1.4.1 Attempted third party registration procedures	19
4.1.1.4.2 Successful third party registration procedures.....	19
4.1.1.4.3 Failed third party registration procedures.....	20
4.1.1.5 User registration status query	20
4.1.1.5.1 Attempted user registration status query procedures	20
4.1.1.5.2 Successful user registration status query procedures.....	20
4.1.1.5.3 Failed user registration status query procedures.....	21
4.1.1.6 S-CSCF registration/deregistration notification	21
4.1.1.6.1 Attempted S-CSCF registration/deregistration notification procedures	21
4.1.1.6.2 Successful S-CSCF registration/deregistration notification procedures	22
4.1.1.6.3 Failed S-CSCF registration/deregistration notification procedures	22
4.1.2 Session control related measurements	23
4.1.2.1 Attempted session establishments	23
4.1.2.2 Successful session establishments.....	23
4.1.2.3 Answered session establishments.....	23
4.1.2.4 Failed session establishments.....	24
4.1.2.5 Simultaneous online and answered sessions (Maximum)	24
4.1.3 User location query related measurements	25
4.1.3.1 Attempted user location query procedures	25
4.1.3.2 Successful user location query procedures.....	25
4.1.3.3 Failed user location query procedures.....	25
4.1.4 Inter-network domain calling related measurements	27
4.1.4.1 Attempted session establishments from users of other network domains	27
4.1.4.2 403 (Forbidden) generated for sessions from users of other network domains.....	27
4.1.4.3 Attempted session establishments to users of other network domains.....	28
4.1.4.4 403 (Forbidden) received for sessions to users of other network domains	28
4.1.5 Roaming users related measurements	29

4.1.5.1	Initial registrations of visiting users from other IMS network domains.....	29
4.1.5.2	Number of SIP 403 (Forbidden) messages for the roamers	29
4.1.5.3	Roaming users to other IMS network domains	30
4.1.6	Authentication related measurements	31
4.1.6.1	Attempted Authentication procedures.....	31
4.1.6.2	Successful Authentication procedures.....	31
4.1.6.3	Failed Authentication procedures.....	31
4.1.7	HSS initiated update of User Profile related measurements	33
4.1.7.1	Attempted HSS initiated User Profile Update procedures	33
4.1.7.2	Successful HSS initiated User Profile Update procedures	33
4.1.7.3	Failed HSS initiated user profile update procedures	33
4.2	Measurements related to HSS	35
4.2.1	HSS database usage related measurements.....	35
4.2.1.1	Provisioning related measurements.....	35
4.2.1.1.1	Number of provisioned IMS subscriptions currently stored in a HSS.....	35
4.2.1.1.2	Number of provisioned Private User Identity stored in a HSS	35
4.2.1.1.3	Number of provisioned Public User Identities with SIP URI format stored in a HSS	35
4.2.1.1.4	Number of provisioned Public User Identities with TEL URI format stored in a HSS	36
4.2.1.1.5	Number of Private Service Identities stored in a HSS.....	36
4.2.1.1.6	Number of Public Service Identities with SIP URI format stored in a HSS.....	36
4.2.1.1.7	Number of Public Service Identities with TEL URI format stored in a HSS	36
4.2.1.2	Registration Status related measurements	37
4.2.1.2.1	Number of Public User Identities in registered state	37
4.2.1.2.2	Number of Public User Identities in unregistered state	37
4.2.1.2.3	Number of Private User Identities in registered state	37
4.2.2	User registration status query related measurements	39
4.2.2.1	Attempted user registration status queries.....	39
4.2.2.2	Successful user registration status queries	39
4.2.2.3	Failed user registration status queries	40
4.2.3	S-CSCF registration/de-registration notification related measurements	41
4.2.3.1	Attempted S-CSCF registration/de-registration notifications	41
4.2.3.2	Successful S-CSCF registration/de-registration notifications	41
4.2.3.3	Failed S-CSCF registration/de-registration notifications	41
4.2.4	Network initiated de-registration by the HSS related measurements.....	43
4.2.4.1	Attempted network initiated de-registrations by HSS.....	43
4.2.4.2	Successful network initiated de-registrations by HSS.....	43
4.2.4.3	Failed network initiated de-registrations by HSS.....	43
4.2.5	User location query related measurements	45
4.2.5.1	Attempted user location queries.....	45
4.2.5.2	Successful user location queries.....	45
4.2.5.3	Failed user location queries.....	45
4.2.6	HSS initiated update of user profile related measurements	47
4.2.6.1	Attempted HSS initiated updates of user profile.....	47
4.2.6.2	Successful HSS initiated updates of user profile.....	47
4.2.6.3	Failed HSS initiated updates of user profile.....	47
4.2.7	Authentication procedure related measurements	49
4.2.7.1	Attempted authentication procedures.....	49
4.2.7.2	Successful authentication procedures.....	49
4.2.7.3	Failed authentication procedures.....	49
4.2.8	Data read (Sh-Pull) procedure related measurements	51
4.2.8.1	Attempted data read (Sh-Pull) procedures	51
4.2.8.2	Successful data read (Sh-Pull) procedures	51
4.2.8.3	Failed data read (Sh-Pull) procedures	51
4.2.9	Data update (Sh-Update) procedure related measurements	53
4.2.9.1	Attempted data update (Sh-Update) procedures.....	53
4.2.9.2	Successful data update (Sh-Update) procedures	53
4.2.9.3	Failed data update (Sh-Update) procedures	53
4.2.10	Subscription to notifications (Sh-Subs-Notif) procedure related measurements	55
4.2.10.1	Attempted subscription to notifications (Sh-Subs-Notif) procedures	55
4.2.10.2	Successful subscription to notifications (Sh-Subs-Notif) procedures	55
4.2.10.3	Failed subscription to notifications (Sh-Subs-Notif) procedures	55
4.2.11	Notification (Sh-Notif) procedure related measurements	57

4.2.11.1	Attempted notification (Sh-Notif) procedures.....	57
4.2.11.2	Successful notification (Sh-Notif) procedures	57
4.2.11.3	Failed notification (Sh-Notif) procedures	57
4.3	Measurements related to BGCF	59
4.3.1	Session Control related measurements	59
4.3.1.1	Overview	59
4.3.1.2	Attempted sessions at BGCF.....	61
4.3.1.3	Attempted sessions forwarded to MGCF	61
4.3.1.4	Attempted sessions forwarded to BGCF	61
4.3.1.5	Successful sessions forwarded to MGCF	62
4.3.1.6	Successful sessions forwarded to BGCF.....	62
4.4	Measurements related to MGCF	63
4.4.1	Call control related measurements.....	63
4.4.1.1	Call control related measurements, CS network originated	63
4.4.1.1.1	Overview	63
4.4.1.1.2	Attempted calls, CS network originated.....	64
4.4.1.1.3	Successful calls, CS network originated.....	64
4.4.1.1.4	Answered calls, CS network originated.....	64
4.4.1.1.5	Failed calls, CS network originated.....	64
4.4.1.1.6	Call set-up time (Mean), CS network originated	65
4.4.1.2	Call control related measurements, IM CN originated.....	65
4.4.1.2.1	Overview	65
4.4.1.2.2	Attempted calls, IM CN originated	66
4.4.1.2.3	Successful calls, IM CN originated	66
4.4.1.2.4	Answered calls, IM CN originated	67
4.4.1.2.5	Failed calls, IM CN originated	67
4.4.1.2.6	Call set-up time (Mean), IM CN originated	67
4.4.1.3	Call control related measurements, call release	68
4.4.1.3.1	Overview	68
4.4.1.3.2	Call release initiated by CS network	68
4.4.1.3.3	Call release initiated by IM CN subsystem	68
4.4.1.3.4	Call release initiated by MGCF	69
4.4.1.3.5	Call release initiated by MGW	70
4.4.1.4	Number of simultaneous online and answered calls (Maximum)	70
4.4.1.5	Number of simultaneous online and answered calls (mean)	70
4.5	Measurements related to IM-MGW	71
4.6	Measurements related to MRFC.....	71
4.6.1	Session control related measurements	71
4.6.1.1	Attempted session establishments	71
4.6.1.2	Successful session establishments.....	71
4.6.1.3	Answered session establishments.....	72
4.6.1.4	Failed session establishments.....	72
4.6.2	Multi-party sessions related measurements	72
4.6.2.1	Attempted session establishments for multi-party sessions	72
4.6.2.2	Successful session establishments for multi-party sessions	73
4.6.2.3	Answered session establishments for multi-party sessions	73
4.6.2.4	Failed session establishments for multi-party sessions	73
4.6.2.5	Attempted event subscription procedures for multi-party sessions	74
4.6.2.6	Successful event subscription procedures for multi-party sessions.....	74
4.6.2.7	Failed event subscription procedures for multi-party sessions.....	75
4.6.3	Announcement service related measurements	75
4.6.3.1	Attempted session establishments for announcements.....	75
4.6.3.2	Successful session establishments for announcements	75
4.6.3.3	Answered session establishments for announcements	76
4.6.3.4	Failed session establishments for announcements	76
4.6.4	Transcoding service related measurements.....	77
4.6.4.1	Attempted session establishments for transcoding service.....	77
4.6.4.2	Successful session establishments for transcoding service	77
4.6.4.3	Answered session establishments for transcoding service	78
4.6.4.4	Failed session establishments for transcoding service	78
4.7	Measurements related to MRFP	79
4.7.1	RTP related measurements	79

4.7.1.1	Number of incoming RTP packets	79
4.7.1.2	Number of outgoing RTP packets	79
4.7.1.3	Number of octets of incoming RTP packets.....	79
4.7.1.4	Number of octets of outgoing RTP packets	80
4.7.1.5	Number of lost incoming RTP packets	80
4.8	Measurements related to PDF	81
4.8.1	Authorization of QoS resources related measurements	81
4.8.1.1	Overview	81
4.8.1.2	Attempted resource authorization procedures at session establishment	82
4.8.1.3	Attempted resource authorization procedures at session modification	82
4.8.1.4	Successful resource authorization procedures at session establishment.....	82
4.8.1.5	Successful resource authorization procedures at session modification	83
4.8.1.6	Failed resource authorization procedures.....	83
4.8.2	Resource reservation related measurements	84
4.8.2.1	Overview	84
4.8.2.2	Attempted resource reservation procedures	85
4.8.2.3	Successful resource reservation procedures	85
4.8.2.4	Failed resource reservation procedures by PDF	85
4.8.2.5	Failed resource reservation procedures by GGSN	85
4.8.3	PDP context modification related measurements	87
4.8.3.1	Attempted authorization of PDP context modification	87
4.8.3.2	Successful authorization of PDP context modification	87
4.8.3.3	Failed authorization of PDP context modification	87
4.8.3.4	Indication of PDP context modification	88
4.9	Measurements related to SLF.....	89
4.9.1	All routing information interrogations related measurements	89
4.9.1.1	Attempted routing information interrogation procedures.....	89
4.9.1.2	Successful routing information interrogation procedures	89
4.9.2	Routing information interrogation from CSCF related measurements	90
4.9.2.1	Overview	90
4.9.2.2	Attempted routing information interrogation procedures from CSCF	90
4.9.2.3	Successful routing information interrogation procedures from CSCF	91
4.9.3	Routing information interrogation from AS related measurements	92
4.9.3.1	Overview	92
4.9.3.2	Attempted routing information interrogation procedures from AS	92
4.9.3.3	Successful routing information interrogation procedures from AS	92
4.10	Measurements related to AS.....	94
4.10.1	Session control related measurements	94
4.10.1.1	IM CN originated session establishments	94
4.10.1.1.1	Attempted IM CN originated session establishments	94
4.10.1.1.2	Successful IM CN originated session establishments.....	94
4.10.1.2	AS originated session establishments	95
4.10.1.2.1	Attempted AS originated session establishments	95
4.10.1.2.2	Successful AS originated session establishments	95
4.10.2	Messaging service related measurements	96
4.10.2.1	Message related measurements, Page-Mode.....	96
4.10.2.1.1	Attempted incoming messages, Page-Mode	96
4.10.2.1.2	Successful incoming messages, Page-Mode.....	96
4.10.2.1.3	Attempted outgoing messages, Page-Mode.....	96
4.10.2.1.4	Successful outgoing messages, Page-Mode.....	97
4.10.2.2	Message related measurements, Session-Mode	97
4.10.2.2.1	Overview	97
4.10.2.2.2	Attempted messaging session establishments, Session Mode	98
4.10.2.2.3	Successful messaging session establishments, Session-Mode.....	99
4.10.3	Conference service related measurements	99
4.10.3.1	Overview	99
4.10.3.2	Attempted creations of conference.....	107
4.10.3.3	Successful creations of conference	107
4.10.3.4	Attempted joining of conference.....	108
4.10.3.5	Successful joining of conference.....	108
4.10.3.6	Attempted invitations for another user to join conference	108
4.10.3.7	Successful invitations for another user to join conference	109

4.10.3.8	Attempted subscriptions for the conference event	109
4.10.3.9	Successful subscriptions for the conference event	109
4.10.3.10	Number of simultaneous online users (Maximum)	110
4.10.3.11	Number of simultaneous online conferences (Maximum)	110
4.10.3.12	Number of simultaneous online users (Mean).....	110
4.10.3.13	Number of simultaneous online conferences (Mean).....	110
4.10.4	Presence service related measurements	112
4.10.4.1	Number of simultaneous online watchers (Maximum)	112
4.10.4.2	Number of simultaneous online presentities (Maximum)	112
4.10.4.3	Number of simultaneous online watchers (Mean).....	112
4.10.4.4	Number of simultaneous online presentities (Mean).....	113
4.10.4.5	Attempted subscriptions for presence	113
4.10.4.6	Successful subscriptions for presence	113
4.10.4.7	Attempted notifications for presence	114
4.10.4.8	Successful notifications for presence	114
4.10.4.9	Attempted publications for presence.....	114
4.10.4.10	Successful publications for presence.....	114
4.10.5	PoC service related measurements.....	116
4.10.5.1	Attempted creations of PoC session.....	116
4.10.5.2	Successful creations of PoC session.....	116
4.10.5.3	Attempted joining of PoC session.....	116
4.10.5.4	Successful joining of PoC session.....	116
4.10.5.5	Attempted invitations for another user to join PoC session	117
4.10.5.6	Successful invitations for another user to join PoC session	117
4.10.5.7	Number of simultaneous online users (Maximum)	117
4.10.5.8	Number of simultaneous online PoC session (Maximum).....	118
4.10.6	Measurements related to XDM Enabler.....	119
4.10.6.1	XCAP operation related measurements	119
4.10.6.1.1	Overview	119
4.10.6.1.2	Attempted HTTP PUT procedures	119
4.10.6.1.3	Successful HTTP PUT procedures	120
4.10.6.1.4	Attempted HTTP GET procedures	120
4.10.6.1.5	Successful HTTP GET procedures.....	120
4.10.6.1.6	Attempted HTTP DELETE procedures.....	121
4.10.6.1.7	Successful HTTP DELETE procedures.....	121
4.10.6.2	SIP related measurements	121
4.10.6.2.1	Overview	121
4.10.6.2.2	Attempted Subscription procedures.....	122
4.10.6.2.3	Successful Subscription procedures	122
4.10.6.2.4	Attempted Notification procedures.....	123
4.10.6.2.5	Successful Notification procedures	123
5	Equipment related measurements.....	124
5.1	Processor usage	124
5.1.1	Mean processor usage.....	124
5.1.2	Peak processor usage	124
Annex A (informative):	Change history	125
History		126

Foreword

This Technical Specification has been produced by the 3rd Generation Partnership Project (3GPP).

The contents of the present document are subject to continuing work within the TSG and may change following formal TSG approval. Should the TSG modify the contents of the present document, it will be re-released by the TSG with an identifying change of release date and an increase in version number as follows:

Version x.y.z

where:

- x the first digit:
 - 1 presented to TSG for information;
 - 2 presented to TSG for approval;
 - 3 or greater indicates TSG approved document under change control.
- y the second digit is incremented for all changes of substance, i.e. technical enhancements, corrections, updates, etc.
- z the third digit is incremented when editorial only changes have been incorporated in the document.

Introduction

The present document is part of a TS-family covering the 3rd Generation Partnership Project; Technical Specification Group Services and System Aspects; Telecommunication Management; as identified below:

TS 32.401:	Performance Management (PM); Concept and requirements
TS 52.402:	Performance Management (PM); Performance measurements - GSM
TS 32.404:	Performance Management (PM); Performance measurements - Definitions and template
TS 32.405:	Performance Management (PM); Performance measurements UTRAN
TS 32.406:	Performance Management (PM); Performance measurements Core Network (CN) PS domain
TS 32.407:	Performance Management (PM); Performance measurements Core Network (CN) CS domain
TS 32.408:	Performance Management (PM); Performance measurements Teleservice
TS 32.409:	Performance Management (PM); Performance measurements IMS

The present document is part of a set of specifications, which describe the requirements and information model necessary for the standardised Operation, Administration and Maintenance (OA&M) of a multi-vendor 3G-system.

During the lifetime of a 3G network, its logical and physical configuration will undergo changes of varying degrees and frequencies in order to optimise the utilisation of the network resources. These changes will be executed through network configuration management activities and/or network engineering, see 3GPP TS 32.600 [3].

Many of the activities involved in the daily operation and future network planning of a 3G network require data on which to base decisions. This data refers to the load carried by the network and the grade of service offered. In order to produce this data performance measurements are executed in the NEs, which comprise the network. The data can then be transferred to an external system, e.g. an Operations System (OS) in TMN terminology, for further evaluation. The purpose of the present document is to describe the mechanisms involved in the collection of the data and the definition of the data itself.

1 Scope

The present document describes the measurements of IMS.

3GPP TS 32.401 [5] describes Performance Management concepts and requirements.

The present document is valid for all measurement types provided by an implementation of an IMS network. These may be measurement types defined within the present document, measurements defined within other standards bodies, or vendor specific measurement types.

Only measurement types that are specific to IMS network are defined within the present documents. I.e. vendor specific measurement types and measurements related to "external" technologies used in IMS network, such as ATM or IP, are not covered. Instead, these could be applied as described by the other, "external" standards bodies (e.g. ITU-T or IETF) or according to manufacturer's documentation.

The definition of the standard measurements is intended to result in comparability of measurement data produced in a multi-vendor network, for those measurement types that can be standardised across all vendors' implementations.

The structure of the present document is as follows:

- Header 1: Network Element (e.g. measurements related to CSCF);
- Header 2: Measurement function (e.g. Registration related measurements);
- Header 3: Measurements.

2 References

The following documents contain provisions which, through reference in this text, constitute provisions of the present document.

- References are either specific (identified by date of publication and/or edition number or version number) or non-specific.
- For a specific reference, subsequent revisions do not apply.
- For a non-specific reference, the latest version applies. In the case of a reference to a 3GPP document (including a GSM document), a non-specific reference implicitly refers to the latest version of that document *in the same Release as the present document*.

- [1] 3GPP TS 32.101: "Telecommunication management; Principles and high level requirements".
- [2] 3GPP TS 32.102: "Telecommunication management; Architecture".
- [3] 3GPP TS 32.600: "Telecommunication management; Configuration Management (CM); Concept and high-level requirements".
- [4] 3GPP TS 32.632: "Telecommunication management; Configuration Management (CM); Core Network Resources Integration Reference Point (IRP): Network Resource Model (NRM)".
- [5] 3GPP TS 32.401: "Telecommunication management; Performance Management (PM); Concept and requirements".
- [6] 3GPP TS 23.003: "Numbering, addressing and identification".
- [7] 3GPP TS 23.228: "IP Multimedia Subsystem (IMS); Stage 2".
- [8] 3GPP TS 24.229: "Internet Protocol (IP) multimedia call control protocol based on Session Initiation Protocol (SIP) and Session Description Protocol (SDP); Stage 3".
- [9] 3GPP TS 29.228: "IP Multimedia (IM) Subsystem Cx and Dx Interfaces; Signalling flows and message".

- [10] 3GPP TS 29.229: "Cx and Dx interfaces based on the Diameter protocol; Protocol details".
- [11] 3GPP TS 29.163: "Interworking between the IP Multimedia (IM) Core Network (CN) subsystem and Circuit Switched (CS) networks".
- [12] 3GPP TS 32.404: "Performance Management (PM); Performance measurements - Definitions and template".
- [13] 3GPP TS 29.207: "Policy control over Go interface".
- [14] 3GPP TS 29.208: "End-to-end Quality of Service (QoS) signalling flows".
- [15] IETF RFC 3588: "Diameter Base Protocol".
- [16] 3GPP TS 23.008: "Organization of subscriber data".
- [17] 3GPP TS 29.328: "IP Multimedia Subsystem (IMS) Sh interface; Signalling flows and message contents".
- [18] 3GPP TS 29.329: "Sh interface based on the Diameter protocol; Protocol details".
- [19] ITU-T Recommendation Q.850: "Usage of cause and location in the Digital Subscriber Signalling System No. 1 and the Signalling System No. 7 ISDN User Part".
- [20] ITU-T Recommendation H.248.1: "Gateway control protocol: Version 3".
- [21] ITU-T Recommendation H.248.8: "Gateway control protocol: Error code and service change reason description".
- [22] IETF RFC 3265: "Session Initiation Protocol (SIP)-Specific Event Notification".
- [23] IETF RFC 3550: "RTP: A Transport Protocol for Real-Time Applications".
- [24] 3GPP TS 24.147: "Conferencing using the IP Multimedia (IM) Core Network (CN) subsystem; Stage 3".
- [25] 3GPP TS 23.141: "Presence service; Architecture and functional description; Stage 2".
- [26] 3GPP TR 23.979: "3GPP enablers for Open Mobile Alliance (OMA); Push-to-talk over Cellular (PoC) services; Stage 2".
- [27] OMA-TS-XDM_Core: "XML Document Management Specification".
- [28] 3GPP TS 33.203: "3G security; Access security for IP-based services".
- [29] 3GPP TS 32.407: "Performance Management (PM); Performance measurements Core Network (CN) Circuit Switched (CS) domain".

3 Measurement family and abbreviations

3.1 Measurement family

The measurement names defined in the present document are all beginning with a prefix containing the measurement family name (e.g. UR.AttInitReg, SC.AttOrigSession). This family name identifies all measurements which relate to a given functionality and it may be used for measurement administration (see 3GPP TS 32.401 [5]).

The list of families currently used in the present document is as follows:

- CC (measurements related to Call Control).
- CONF (measurements related to conference service).
- DBU (measurements related to Database Usage).
- DTR (measurements related to Data Read).
- DTU (measurements related to Data Update).
- EQPT (measurements related to Equipment).
- LIQ (measurements related to Location Information Query).
- MA (measurements related Multimedia Authentication).
- NOTIF (measurements related to Notification).
- PoC (measurements related to PoC service).
- PRES (measurements related to Present service).
- QoS (measurements related to Quality of Service).
- RII (measurements related to Routing Information Interrogation).
- RU (measurements related to Roaming Users).
- SC (measurements related to Session Control).
- SUB (Measurements related to Subscription to notifications).
- UP (measurements related to User Profile).
- UR (measurements related to UE registration).
- XDM (measurements related to XDM enabler).

3.2 Abbreviations

For the purposes of the present document, the following abbreviations apply:

3G	3 rd Generation
3GPP	3G Partnership Project
3rd	Third
CS	Circuit switched
CN	Core Network
CSCF	Call Session Control Function
HSS	Home Subscriber Server
IM	IP Multimedia
IMS	IP Multimedia Subsystem
I-CSCF	Interrogating CSCF
NE	Network Element
NM	Network Manager
OA&M	Operation, Administration and Maintenance
OS	Operations System (EM, NM)
PM	Performance Management
P-CSCF	Proxy CSCF
QoS	Quality of Service
S-CSCF	Serving CSCF
UMTS	Universal Mobile Telecommunications System

You can find below a list of abbreviations used within the measurement types for field E of the measurement template (see 3GPP TS 32.404 [12]).

Ans	Answer(ed)
Att	Attempted

Auth	Authorization
Cs	Circuit switched
DER	Discrete Event Registration
DeReg	De-Registration
Dmn	Domain
Estab	Establish(ment)
Fail	Failed(/Failure)
Fwd	Forward(ed)
Glb	Global
Info	Information
Im	IP Multimedia
Inc	Incoming
Ind	Indication
Init	Initial
Interop	Interoperator
LIA	Location-Info-Answer
LIR	Location-Info-Request
MAA	Multimedia-Authentication-Answer
MAR	Multimedia-Authentication-Request
Max	Maximum
Modf	Modify/Modification
Nbr	Number
Ntwk	Network
Orig	Originated
PM	Page-Mode
PNA	Push-Notification -Answer
PNR	Push-Notification-Request
PPA	Push-Profile-Answer
PPR	Push-Profile-Request
Pri	Private
PUA	Profile-Update-Answer
Pub	Public
PUR	Profile-Update-Request
Reg	Registration
Rej	Rejected
Req	Request
Rel	Release
ReReg	Re-Registration
Res	Resource
Rsv	Reserve/Reservation
Rmg	Roaming
RTA	Registration-Termination-Answer
RTR	Registration-Termination-Request
SAA	Server-Assignment-Answer
SAR	Server-Assignment-Request
SNA	Subscribe-Notifications-Answer
SNR	Subscribe-Notifications-Request
Simul	Simultaneous
SM	Session-Mode
Srv	Service
Succ	Successful
Term	Terminated
UAA	User-Authorization-Answer
UAR	User-Authorization-Request
UDA	User-Data-Answer
UDR	User-Data-Request

4 Functionality related measurements

The measurements defined in this clause are related to the functionality aspect performance. The detailed measurements for each function are defined in the following subclauses.

4.1 Measurements related to CSCF

*Editor's note: with regards to each measurement defined for the CSCF, the functionality (e.g. P-CSCF or S-CSCF) which the measurement is applicable for is illustrated in bullet a) by the words "This measurement is only valid for the CSCF with *** functionality", if there is no such kind of illustration in bullet a), it means that this measurement is applicable for all of the P-CSCF, S-CSCF and I-CSCF functionalities.*

4.1.1 Registration related measurements

4.1.1.1 Initial registration

The measurements defined in subclauses 4.1.1.1.1, 4.1.1.1.2 and 4.1.1.1.3 are subject to the "2 out of 3 approach".

4.1.1.1.1 Attempted initial registration procedures

- a) This measurement provides the number of attempted initial registrations at the CSCF. This measurement is only valid for the CSCF with P-CSCF and/or S-CSCF functionality.
- b) CC.
- c) On receipt by the CSCF of a SIP_REGISTER message for the initial registration (see 3GPP TS 23.228 [7]).
- d) A single integer value.
- e) UR.AttInitReg.
- f) CscfFunction.
- g) Valid for packet switched traffic.
- h) IMS.

4.1.1.1.2 Successful initial registration procedures

- a) This measurement provides the number of successful initial registrations at the CSCF. This measurement is only valid for the CSCF with P-CSCF and/or S-CSCF functionality.
- b) CC.
- c) On transmission by the CSCF of a SIP_200_OK message for the initial registration (see 3GPP TS 23.228 [7]).
- d) A single integer value.
- e) UR.SuccInitReg.
- f) CscfFunction.
- g) Valid for packet switched traffic.
- h) IMS.

4.1.1.1.3 Failed initial registration procedures

- a) This measurement provides the number of failed initial registration procedures at the CSCF. The measurement is split into subcounters per response status codes.
- b) CC.
- c) On transmission by the CSCF of a response message (e.g. SIP_4xx) indicating a failed initial registration, each failed initial registration procedure is added to the relevant measurement according to the status code. Possible status codes are included in 3GPP TS 29.229 [10]. The sum of all supported per status code measurements shall equal the total number of failed initial registration procedures. In case only a subset of per cause measurements is supported, a sum subcounter will be provided first.
- d) Each measurement is an integer value. The number of measurements is equal to the number of measured status codes plus a possible sum measurement identified by the .sum suffix.
- e) The measurement name has the form UR.FailInitReg.Cause where Cause identifies the status code.
- f) CscfFunction
- g) Valid for packet switched traffic.
- h) IMS

4.1.1.1.4 IMS initial registration set-up time (Mean)

- a) This measurement provides the mean setup time of the successful IMS initial registrations. This measurement is only valid for the CSCF with P-CSCF functionality.
- b) DER (n=1).
- c) This measurement is obtained by accumulating the time intervals for every successful IMS initial registration between the receipt by the P-CSCF from the UE of a SIP_REGISTER message and the corresponding SIP_200_OK message for the initial registration over a granularity period using DER. The end value of this time will then be divided by the number of successful IMS initial registrations observed in the granularity period to give the arithmetic mean, the accumulator shall be reinitialised at the beginning of each granularity period. See 3GPP TS 23.228 [7].

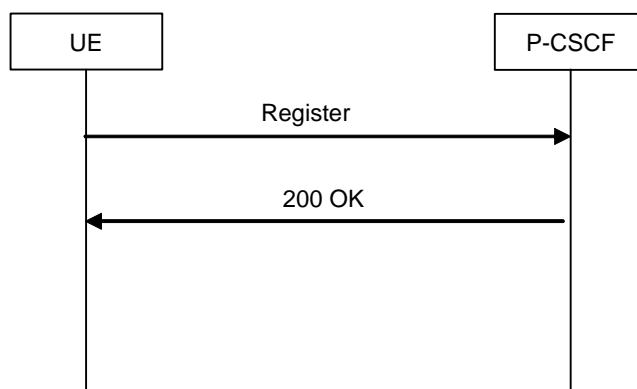

Figure 1: UE registration procedure

- d) A single integer value. (in milliseconds).
- e) UR.MeanInitRegSetupTime.
- f) CscfFunction.
- g) Valid for packet switched traffic.
- h) IMS.

- i) This measurement is mainly dedicated to Vendor Performance Modelling, Operator Traffic Engineering and Vendor Development Engineering communities.

4.1.1.2 Re-registration

The measurements defined in this subclause are subject to the "2 out of 3 approach".

4.1.1.2.1 Attempted re-registration procedures

- a) This measurement provides the number of attempted re-registrations at the CSCF. This measurement is only valid for the CSCF with P-CSCF and/or S-CSCF functionality.
- b) CC.
- c) On receipt by the CSCF of a SIP_REGISTER message for the re-registration (see 3GPP TS 23.228 [7]).
- d) A single integer value.
- e) UR.AttReReg.
- f) CscfFunction.
- g) Valid for packet switched traffic.
- h) IMS.

4.1.1.2.2 Successful re-registration procedures

- a) This measurement provides the number of successful re-registrations at the CSCF. This measurement is only valid for the CSCF with P-CSCF and/or S-CSCF functionality.
- b) CC.
- c) On transmission by the CSCF of a SIP_200_OK message for the re-registration (see 3GPP TS 23.228 [7]).
- d) A single integer value.
- e) UR.SuccReReg.
- f) CscfFunction.
- g) Valid for packet switched traffic.
- h) IMS.

4.1.1.2.3 Failed re-registration procedures

- a) This measurement provides the number of failed re-registration procedures at the CSCF. The measurement is split into subcounters per response status codes. This measurement is only valid for the CSCF with P-CSCF and/or S-CSCF functionality.
- b) CC.
- c) On transmission by the CSCF of a response message(e.g. SIP_4xx) indicating a failed re-registration, each failed re-registration procedure is added to the relevant measurement according to the status code. Possible status codes are included in 3GPP TS 29.229 [10]. The sum of all supported per status code measurements shall equal the total number of failed re-registration procedures. In case only a subset of per cause measurements is supported, a sum subcounter will be provided first.
- d) Each measurement is an integer value. The number of measurements is equal to the number of measured per status code plus a possible *sum* measurement identified by the *.sum* suffix.
- e) The measurement name has the form UR.FailReReg.*Cause* where *Cause* identifies the status code.

- f) CscfFunction.
- g) Valid for packet switched traffic.
- h) IMS

4.1.1.3 De-registration

4.1.1.3.1 De-registrations initiated by UE

The measurements defined in this subclause are subject to the "2 out of 3 approach".

4.1.1.3.1.1 Attempted de-registration procedures initiated by UE

- a) This measurement provides the number of attempted de-registrations initiated by UE at the CSCF.
- b) CC.
- c) On receipt by the CSCF of a SIP_REGISTER message for the de-registration (see 3GPP TS 23.228 [7]).
- d) A single integer value.
- e) UR.AttDeRegUe.
- f) CscfFunction.
- g) Valid for packet switched traffic.
- h) IMS.

4.1.1.3.1.2 Successful de-registration procedures initiated by UE

- a) This measurement provides the number of successful de-registrations initiated by UE at the CSCF.
- b) CC.
- c) On transmission by the CSCF of a SIP_200_OK message corresponding to SIP_REGISTER message for the de-registration (see 3GPP TS 23.228 [7]).
- d) A single integer value.
- e) UR.SuccDeRegUe.
- f) CscfFunction.
- g) Valid for packet switched traffic.
- h) IMS.

4.1.1.3.1.3 Failed de-registration procedures initiated by UE

- a) This measurement provides the number of failed de-registration procedures initiated by UE at the CSCF. The measurement is split into subcounters per response status codes.
- b) CC.
- c) On transmission by the CSCF of a response message(e.g. SIP_4xx) indicating a failed de-registration procedure initiated by UE, each failed de-registration procedure initiated by UE is added to the relevant measurement according to the status code. Possible status codes are included in 3GPP TS 29.229 [10]. The sum of all supported per status code measurements shall equal the total number of failed de-registration procedures initiated by UE. In case only a subset of per cause measurements is supported, a sum subcounter will be provided first.
- d) Each measurement is an integer value. The number of measurements is equal to the number of measured status codes plus a possible sum measurement identified by the *.sum* suffix.

- e) The measurement name has the form UR.FailDeRegUe.Cause where *Cause* identifies the status code.
- f) CscfFunction.
- g) Valid for packet switched traffic.
- h) IMS.

4.1.1.3.2 De-registration initiated by HSS

The measurements defined in this subclause are subject to the "2 out of 3 approach".

4.1.1.3.2.1 Attempted de-registration procedures initiated by HSS

- a) This measurement provides the number of attempted de-registrations initiated by HSS at the CSCF. This measurement is only valid for the CSCF with P-CSCF and/or S-CSCF functionality.
- b) CC.
- c) On receipt by the S-CSCF of a Cx-Deregister message for the de-registration initiated by HSS (see 3GPP TS 29.228 [9]), or on receipt by the P-CSCF from the S-CSCF of a SIP_NOTIFY message indicating a de-registration initiated by HSS (see 3GPP TS 24.229[8]).
- d) A single integer value.
- e) UR.AttDeRegHss.
- f) CscfFunction.
- g) Valid for packet switched traffic.
- h) IMS.

4.1.1.3.2.2 Successful de-registration procedures initiated by HSS

- a) This measurement provides the number of successful de-registrations initiated by HSS at the CSCF. This measurement is only valid for the CSCF with P-CSCF and/or S-CSCF functionality.
- b) CC.
- c) On transmission by the S-CSCF of a "Cx-Deregister Resp" message indicating a successful de-registration initiated by HSS (see 3GPP TS 29.228 [9]), or on transmission by the P-CSCF to the S-CSCF of a SIP_200_OK message corresponding to the SIP_NOTIFY message indicating a de-registration initiated by HSS (see 3GPP TS 24.229[8]).
- d) A single integer value.
- e) UR.SuccDeRegHss.
- f) CscfFunction.
- g) Valid for packet switched traffic.
- h) IMS.

4.1.1.3.2.3 Failed de-registration procedures initiated by HSS

- a) This measurement provides the number of failed de-registration procedures initiated by HSS at the CSCF. The measurement is split into subcounters per diameter result codes.
- b) CC.

- c) On transmission by the CSCF of a response message (e.g. SIP_4xx) indicating a failed de-registration procedure initiated by HSS, each failed de-registration procedure initiated by HSS is added to the relevant measurement according to the status code. Possible status codes are included in 3GPP TS 29.229 [10]. The sum of all supported per status code measurements shall equal the total number of failed de-registration procedures initiated by HSS. In case only a subset of per cause measurements is supported, a sum subcounter will be provided first.
- d) Each measurement is an integer value. The number of measurements is equal to the number of measured result code plus a possible sum measurement identified by the *.sum* suffix.
- e) The measurement name has the form UR.FailDeRegHss.Cause where *Cause* identifies the Diameter result code.
- f) CscfFunction.
- g) Valid for packet switched traffic.
- h) IMS.

4.1.1.3.3 De-registration initiated by S-CSCF

The measurements defined in this subclause are subject to the "2 out of 3 approach".

4.1.1.3.3.1 Attempted de-registration procedures initiated by S-CSCF

- a) This measurement provides the number attempted of de-registrations initiated by S-CSCF at the CSCF. This measurement is only valid for the CSCF with P-CSCF and/or S-CSCF functionality.
- b) CC.
- c) On transmission by the S-CSCF of a SIP_NOTIFY message indicating a de-registration initiated by S-CSCF (see 3GPP TS 24.229 [8]), or on receipt by the P-CSCF from the S-CSCF of a SIP_NOTIFY message indicating a de-registration initiated by S-CSCF (see 3GPP TS 24.229 [8]).
- d) A single integer value.
- e) UR.AttDeRegCscf.
- f) CscfFunction.
- g) Valid for packet switched traffic.
- h) IMS.

4.1.1.3.3.2 Successful de-registration procedures initiated by S-CSCF

- a) This measurement provides the number of successful de-registrations initiated by S-CSCF at the CSCF. This measurement is only valid for the CSCF with P-CSCF and/or S-CSCF functionality.
- b) CC.
- c) On receipt by the S-CSCF of a SIP_200_OK message corresponding to the SIP_NOTIFY message indicating a de-registration initiated by S-CSCF (see 3GPP TS 24.229 [8]), or on transmission by the P-CSCF to the S-CSCF of a SIP_200_OK message corresponding to the SIP_NOTIFY message indicating a de-registration initiated by S-CSCF (see 3GPP TS 24.229 [8]).
- d) A single integer value.
- e) UR.SuccDeRegCscf.
- f) CscfFunction.
- g) Valid for packet switched traffic.
- h) IMS.

4.1.1.3.3.3 Failed de-registration procedures initiated by S-CSCF

- a) This measurement provides the number of failed de-registration procedures initiated by S-CSCF at the CSCF. The measurement is split into subcounters per response status codes.
- b) CC.
- c) On receipt by the CSCF of a response message (e.g. SIP_4xx) indicating a failed de-registration procedure initiated by S-CSCF, each failed de-registration procedure initiated by S-CSCF is added to the relevant measurement according to the status code. Possible status codes are included in 3GPP TS 29.229 [10]. The sum of all supported per status code measurements shall equal the total number of failed de-registration procedures initiated by S-CSCF. In case only a subset of per cause measurements is supported, a sum subcounter will be provided first.
- d) Each measurement is an integer value. The number of measurements is equal to the number of the measured status codes plus a possible sum measurement identified by the *.sum* suffix.
- e) The measurement name has the form UR.FailDeRegCscf.*Cause* where *Cause* identifies the status code.
- f) CscfFunction.
- g) Valid for packet switched traffic.
- h) IMS.

4.1.1.4 Third party registration

The measurements defined in this subclause are subject to the "2 out of 3 approach".

4.1.1.4.1 Attempted third party registration procedures

- a) This measurement provides the number of attempted third-party registrations triggered by CSCF. This measurement is only valid for the CSCF with S-CSCF functionality.
- b) CC.
- c) On transmission by the S-CSCF of a SIP_REGISTER message for the third party registration (see 3GPP TS 24.229 [8]).
- d) A single integer value.
- e) UR.Att3rdPartyReg.
- f) CscfFunction.
- g) Valid for packet switched traffic.
- h) IMS.

4.1.1.4.2 Successful third party registration procedures

- a) This measurement provides the number of successful third-party registrations triggered by CSCF. This measurement is only valid for the CSCF with S-CSCF functionality.
- b) CC.
- c) On receipt by the S-CSCF of a SIP_200_OK message for the third party registration (see 3GPP TS 24.229 [8]).
- d) A single integer value.
- e) UR.Succ3rdPartyReg.
- f) CscfFunction.
- g) Valid for packet switched traffic.

h) IMS.

4.1.1.4.3 Failed third party registration procedures

- a) This measurement provides the number of failed third-party registrations triggered by CSCF.
- b) CC.
- i) On receipt by the CSCF of a response message(e.g. SIP_4xx) indicating a failed third party registration procedure, each failed third party registration procedure is added to the relevant measurement according to the status code. Possible status codes are included in 3GPP TS 29.229 [10]. The sum of all supported per status code measurements shall equal the total number of failed third party registration procedures. In case only a subset of per cause measurements is supported, a sum subcounter will be provided first.
- c) Each measurement is an integer value. The number of measurements is equal to the number of the measured status codes plus a possible sum measurement identified by the *.sum* suffix.
- d) A single integer value. The number of measurements is equal to the number of the measured status codes plus a possible sum measurement identified by the *.sum* suffix.
- e) The measurement name has the form UR.Fail3rdPartyReg.*Cause*. where *Cause* identifies the status code.
- f) CscfFunction.
- g) Valid for packet switched traffic.
- h) IMS.

4.1.1.5 User registration status query

The measurements defined in this subclause are subject to the "2 out of 3 approach".

4.1.1.5.1 Attempted user registration status query procedures

- a) This measurement provides number of attempted User registration status query procedures at the CSCF. This measurement is only valid for the CSCF with I-CSCF functionality.
- b) CC.
- c) On transmission by the I-CSCF of a User-Authorization-Request Diameter command to the HSS (see 3GPP TS 29.229 [9]).
- d) A single integer value.
 - UR.AttUAR.
- e) CscfFunction.
- f) Valid for packet switched traffic.
- g) IMS.

4.1.1.5.2 Successful user registration status query procedures

- a) This measurement provides number of successful user registration status query procedures at the CSCF. This measurement is only valid for the CSCF with I-CSCF functionality.
- b) CC.
- c) On receipt by the I-CSCF of a User-Authorization-Answer Diameter command from HSS indicating that the User Authorization Request is successful with the specific result code, each successful user registration status query procedure is added to the relevant measurement according to the successful result code. Possible successful result codes are included in 3GPP TS 29.229 [10]. The sum of all supported per result code

measurements shall equal the total number of successful User registration status query procedures. In case only a subset of per cause measurements is supported, a sum subcounter will be provided first.

- d) Each measurement is an integer value. The number of measurements is equal to the number of result codes plus a possible sum value identified by the *.sum* suffix.
- e) The measurement name has the form UR.SuccUAA.*ResultCode* where *ResultCode* identifies the successful Result Code.
- f) CscfFunction.
- g) Valid for packet switched traffic.
- h) IMS.

4.1.1.5.3 Failed user registration status query procedures

- a) This measurement provides number of user registration status query procedures rejected by HSS for the specific causes. The measurement is split into subcounters per failure cause. This measurement is only valid for the CSCF with I-CSCF functionality.
- b) CC.
- c) On receipt by the I-CSCF of a User-Authorization-Answer Diameter command from HSS indicating that the User Authorization Request is rejected for the specific cause, each failed user registration status query procedure is added to the relevant measurement according to the failure cause. Possible failure causes are included in 3GPP TS 29.229 [10]. The sum of all supported per cause measurements shall equal the total number of failed User registration status query procedures. In case only a subset of per cause measurements is supported, a sum subcounter will be provided first.
- d) Each measurement is an integer value. The number of measurements is equal to the number of causes plus a possible sum value identified by the *.sum* suffix.
- e) The measurement name has the form UR.FailUAA.*Cause* where *Cause* identifies the failure cause. The following subcounters with specific failure causes (see 3GPP TS 29.229 [10]) are required:
 - UR.NbrFailUAA.5002 Result-Code: DIAMETER_ERROR_IDENTITIES_DONT_MATCH;
 - UR.NbrFailUAA.5004 Result-Code: DIAMETER_ERROR_ROAMING_NOT_ALLOWED;
- f) CscfFunction.
- g) Valid for packet switched traffic.
- h) IMS.

4.1.1.6 S-CSCF registration/deregistration notification

The measurements defined in this subclause are subject to the "2 out of 3 approach".

4.1.1.6.1 Attempted S-CSCF registration/deregistration notification procedures

- a) This measurement provides number of attempted S-CSCF registration/deregistration notification procedures. This measurement is only valid for the CSCF with S-CSCF functionality.
- b) CC.
- c) On transmission by the S-CSCF of a Server-Assignment-Request Diameter command to the HSS (see 3GPP TS 29.228 [9]).
- d) A single integer value.
- e) UR.AttSAR.

- f) CscfFunction.
- g) Valid for packet switched traffic.
- h) IMS.

4.1.1.6.2 Successful S-CSCF registration/deregistration notification procedures

- a) This measurement provides number of successful S-CSCF registration/deregistration notification procedures. This measurement is only valid for the CSCF with S-CSCF functionality.
- b) CC.
- c) On receipt by the S-CSCF of a Server-Assignment-Answer Diameter command from the HSS indicating a successful S-CSCF registration/deregistration notification procedure (see 3GPP TS 29.228 [9]).
- d) A single integer value.
- e) UR.SuccSAA.
- f) CscfFunction.
- g) Valid for packet switched traffic.
- h) IMS.

4.1.1.6.3 Failed S-CSCF registration/deregistration notification procedures

- a) This measurement provides number of failed S-CSCF registration/deregistration notification procedures. The measurement is split into subcounters per failure cause. This measurement is only valid for the CSCF with S-CSCF functionality.
- b) CC.
- c) On receipt by the S-CSCF of a Server-Assignment-Answer Diameter command from HSS indicating the S-CSCF registration/deregistration notification procedure is failed for the specific cause, each failed S-CSCF registration/deregistration notification procedure is added to the relevant measurement according to the failure cause. Possible failure causes are included in TS 29.229 [10]. The sum of all supported per cause measurements shall equal the total number of failed S-CSCF registration/deregistration notification procedures. In case only a subset of per cause measurements is supported, a sum subcounter will be provided first.
- d) Each measurement is an integer value. The number of measurements is equal to the number of causes plus a possible sum value identified by the *.sum* suffix.
- e) The measurement name has the form UR.FailSAA.*Cause* where *Cause* identifies the failure cause.
- f) CscfFunction.
- g) Valid for packet switched traffic.
- h) IMS.

4.1.2 Session control related measurements

The measurements defined in subclauses 4.1.2.1, 4.1.2.2 and 4.1.2.4 are subject to the "2 out of 3 approach".

4.1.2.1 Attempted session establishments

- a) This measurement provides the number of attempted session establishments at CSCF.
- b) CC.
- c) On receipt by the CSCF of an initial SIP_INVITE message (see 3GPP TS 23.228 [7]).
- d) A single integer value.
- e) SC.AttSession.
- f) CscfFunction.
- g) Valid for packet switched traffic.
- h) IMS.

4.1.2.2 Successful session establishments

- a) This measurement provides the number of successful session establishments at the CSCF. The measurement is split into subcounters per message type (e.g. SIP_180) indicating the successful session establishments.
- b) CC.
- c) On transmission by the CSCF of the first response message (e.g. SIP_180) indicating a successful session establishment corresponding to the initial SIP_INVITE message (see 3GPP TS 23.228 [7]), each successful session establishment is added to the relevant measurement according to the message type, the possible response message types are identified in 3GPP TS 24.229 [8]. The sum of all supported per message type measurements shall equal the total number of successful session establishments. In case only a subset of per message type measurements is supported, a sum subcounter will be provided first.
- d) Each measurement is an integer value. The number of measurements is equal to the number of message types plus a possible sum value identified by the *.sum* suffix.
- e) The measurement name has the form SC.SuccSession.*type* where *type* identifies the message type.

The following subcounters with specific message types are the samples of this measurement:

- SC.SuccSession.180 Message type: SIP_180;
- SC.SuccSession.200 Message type: SIP_200_OK only if the SIP_180 has not been sent for this session.

- f) CscfFunction.
- g) Valid for packet switched traffic.
- h) IMS.

4.1.2.3 Answered session establishments

- a) This measurement provides the number of answered session establishments at the CSCF.
- b) CC.
- c) On transmission by the CSCF of a SIP_200_OK response message corresponding to the initial SIP_INVITE messages (see 3GPP TS 23.228 [7]).

- d) A single integer value.
- e) SC.AnsSession.
- f) CscfFunction.
- g) Valid for packet switched traffic.
- h) IMS.

4.1.2.4 Failed session establishments

- a) This measurement provides the number of failed session establishments at the CSCF. The measurement is split into subcounters per response status codes.
- b) CC.
- c) On transmission by the CSCF of a response message (e.g. SIP_430) indicating a failed session establishment corresponding to the initial SIP_INVITE messages (see 3GPP TS 23.228 [7]), each failed session establishment is added to the relevant measurement according to the status code. The sum of all supported per status code measurements shall equal the total number of failed session establishments. In case only a subset of per cause measurements is supported, a sum subcounter will be provided first.
- d) Each measurement is an integer value. The number of measurements is equal to the number of causes plus a possible sum value identified by the *.sum* suffix.
- e) The measurement name has the form SC.FailSession.Cause where *Cause* identifies the status code.
- f) CscfFunction.
- g) Valid for packet switched traffic.
- h) IMS.

4.1.2.5 Simultaneous online and answered sessions (Maximum)

- a) This measurement provides the maximum number of simultaneous online sessions which have been answered at the CSCF.
- b) SI.
- c) This measurement is obtained by sampling at a pre-defined interval the number of simultaneous online sessions which have been answered and then taking the maximum.
- d) A single integer value.
- e) SC.NbrSimulAnsSessionMax.
- f) CscfFunction.
- g) Valid for packet switched traffic.
- h) IMS.

4.1.3 User location query related measurements

The measurements defined in this subclause are subject to the "2 out of 3 approach".

4.1.3.1 Attempted user location query procedures

- a) This measurement provides number of attempted user location query procedures. This measurement is only valid for the CSCF with I-CSCF functionality.
- b) CC.
- c) On transmission by the I-CSCF of a Location-Info-Request Diameter command to the HSS (see 3GPP TS 29.228 [9]).
- d) A single integer value.
- e) LIQ.AttLIR.
- f) CscfFunction.
- g) Valid for packet switched traffic.
- h) IMS.

4.1.3.2 Successful user location query procedures

- a) This measurement provides number of successful user location query procedures. This measurement is only valid for the CSCF with I-CSCF functionality.
- b) CC.
- c) On receipt by the I-CSCF of a Location-Info-Answer Diameter command from the HSS indicating a successful location information query procedure (see 3GPP TS 29.228 [9]).
- d) A single integer value.
- e) LIQ.SuccLIA.
- f) CscfFunction.
- g) Valid for packet switched traffic.
- h) IMS.

4.1.3.3 Failed user location query procedures

- a) This measurement provides number of failed user location query procedures. The measurement is split into subcounters per failure cause. This measurement is only valid for the CSCF with I-CSCF functionality.
- b) CC.
- c) On receipt by the I-CSCF of a Location-Info-Answer Diameter command from HSS indicating the user location query is failed for the specific cause, each failed user location query procedure is added to the relevant measurement according to the failure cause. Possible failure causes are included in 3GPP TS 29.229 [10]. The sum of all supported per cause measurements shall equal the total number of failed user location query procedures. In case only a subset of per cause measurements is supported, a sum subcounter will be provided first.
- d) Each measurement is an integer value. The number of measurements is equal to the number of causes plus a possible sum value identified by the *.sum* suffix.
- e) The measurement name has the form LIQ.FailLIA.*Cause* where *Cause* identifies the failure cause.

- f) CscfFunction.
- g) Valid for packet switched traffic.
- h) IMS.

4.1.4 Inter-network domain calling related measurements

4.1.4.1 Attempted session establishments from users of other network domains

- a) This measurement provides the number of attempted session establishments originated from the users (regardless of whether the user is roaming or not) who are belonging to other network domains at the CSCF in the terminating network. The measurement is split into subcounters per network domain. This measurement is only valid for the CSCF with S-CSCF and/or I-CSCF functionality.
- b) CC.
- c) On receipt by the CSCF of a SIP_INVITE message, and the calling party is belonging to other network domains (i.e. the domain name information of the calling party retrieved from the SIP_INVITE message is different from the domain of this CSCF). Each session whose calling party recognized by the CSCF as belonging to a given network domain is added to the relevant per network domain measurement. The sum of all supported per network domain measurements shall equal the total number of attempted session establishments from users of other network domains. In case only a subset of per network measurements is supported, a sum subcounter will be provided first (see 3GPP TS 23.228 [7]).
- d) Each measurement is an integer value. The number of measurements is equal to the number of network domain plus a possible sum value identified by the *.sum* suffix.
- e) The measurement name has the form *IC.AttSessionFromOtherNtwkDmn.Domain* where *Domain* identifies the network domain, and it is in the format of the domain name information in the SIP messages.
- f) CscfFunction.
- g) Valid for packet switched traffic.
- h) IMS.

4.1.4.2 403 (Forbidden) generated for sessions from users of other network domains

- a) This measurement provides the number of SIP_403 (Forbidden) response messages at the CSCF in the terminating network generated for the sessions from users of other network domains. The measurement is split into subcounters per network domain. This measurement is only valid for the CSCF with S-CSCF and/or I-CSCF functionality.
- b) CC.
- c) On transmission by the CSCF of SIP_403 message corresponding to the SIP_INVITE message of which the calling party is belonging to other network domains received by the CSCF. Each SIP_403 message generated by the CSCF for the session whose calling party is belonging to a given network domain is added to the relevant per network domain measurement. The sum of all supported per network domain measurements shall equal the total number of 403 (Forbidden) generated for sessions from users of other network domains. In case only a subset of per network measurements is supported, a sum subcounter will be provided first (see 3GPP TS 23.228 [7]).
- d) Each measurement is an integer value. The number of measurements is equal to the number of network domain plus a possible sum value identified by the *.sum* suffix.
- e) The measurement name has the form *IC.403SessionFromOtherNtwkDmn.Domain* where *Domain* identifies the network domain, and it is in the format of the domain name information in the SIP messages.
- f) CscfFunction.
- g) Valid for packet switched traffic.
- h) IMS.

4.1.4.3 Attempted session establishments to users of other network domains

- a) This measurement provides the number of attempted session establishments towards users (regardless of whether the user is roaming or not) who are belonging to other network domains at the CSCF in the originating network. The measurement is split into subcounters per network domain. This measurement is only valid for the CSCF with S-CSCF and/or I-CSCF functionality.
- b) CC.
- c) On transmission by the CSCF of a SIP_INVITE messages, and the called party is belonging to other network domains (i.e. the domain name information of the called party retrieved from the SIP_INVITE message is different from the domain of this CSCF). Each session whose called party recognized by the CSCF as belonging to a given network domain is added to the relevant per network domain measurement. The sum of all supported per network measurements shall equal the total number of attempted session establishments to users of other network domains. In case only a subset of per network measurements is supported, a sum subcounter will be provided first (see 3GPP TS 23.228 [7]).
- d) Each measurement is an integer value. The number of measurements is equal to the number of network domain plus a possible sum value identified by the *.sum* suffix.
- e) The measurement name has the form *IC.AttSessionToOtherNtwkDmn.Domain* where *Domain* identifies the network domain, and it is in the format of the domain name information in the SIP messages.
- f) *CscfFunction*.
- g) Valid for packet switched traffic.
- h) IMS.

4.1.4.4 403 (Forbidden) received for sessions to users of other network domains

- a) This measurement provides the number of SIP_403 (Forbidden) response messages received for sessions to users of other network domains at the CSCF in the originating network. The measurement is split into subcounters per network domain. This measurement is only valid for the CSCF with S-CSCF and/or I-CSCF functionality.
- b) CC.
- c) On receipt by the CSCF of SIP_403 message corresponding to the SIP_INVITE message corresponding to the SIP_INVITE message of which the called party is belonging to other network domains transmitted by the CSCF. Each SIP_403 message received by the CSCF for the session whose called party is belonging to a given network domain is added to the relevant per network domain measurement. The sum of all supported per network domain measurements shall equal the total number of 403 (Forbidden) received for sessions to users of other network domains. In case only a subset of per network measurements is supported, a sum subcounter will be provided first (see 3GPP TS 23.228 [7]).
- d) Each measurement is an integer value. The number of measurements is equal to the number of network domain plus a possible sum value identified by the *.sum* suffix.
- e) The measurement name has the form *IC.403SessionToOtherNtwkDmn.Domain* where *Domain* identifies the network domain, and it is in the format of the domain name information in the SIP messages.
- f) *CscfFunction*
- g) Valid for packet switched traffic.
- h) IMS.

4.1.5 Roaming users related measurements

4.1.5.1 Initial registrations of visiting users from other IMS network domains

- a) This measurement provides number of initial registrations of users accessing the visited IMS network but are belonging other IMS network domains. The measurement is split into subcounters per IMS network domain. This measurement is only valid for the CSCF with P-CSCF functionality.
- b) CC.
- c) On receipt by the P-CSCF of the SIP_REGISTER message from the UE who is belonging to other network domains (i.e. the domain name information of the roamer retrieved from the SIP_REGISTER message is different from the domain of this CSCF) for the initial registration. Each roamer recognized by the P-CSCF as belonging to a given IMS network domain is added to the relevant per IMS network domain measurement. The sum of all supported per IMS network domain measurements shall equal the total number of visiting users. In case only a subset of per IMS network domain measurements is supported, a sum subcounter will be provided first (see 3GPP TS 23.228 [7]).
- d) Each measurement is an integer value. The number of measurements is equal to the number of IMS network domain plus a possible sum value identified by the *.sum* suffix.
- e) The measurement name has the form *RU.AttInitRegOfVisitUsers.Domain* where *Domain* identifies the network domain, and it is in the format of the domain name information in the SIP messages.
- f) *CscfFunction*.
- g) Valid for packet switched traffic.
- h) IMS.

4.1.5.2 Number of SIP 403 (Forbidden) messages for the roamers

- a) This measurement provides the number of 403-Forbidden response messages generated to UEs who are belonging to other IMS network domains with whom there are roaming agreements for the registration procedures. The measurement is split into subcounters per network domain. This measurement is only valid for the CSCF with P-CSCF functionality.
- b) CC.
- c) On transmission by the P-CSCF of a SIP_403 (Forbidden) response message to the UE who is belonging to other IMS networks for the initial registration procedure. Each SIP_403 message transmitted by the P-CSCF for the roamer who is belonging to a given network domain is added to the relevant per network domain measurement. The sum of all supported per network domain measurements shall equal the total number of 403 (Forbidden) generated for the roamers who are belonging to other IMS network domains. In case only a subset of per network measurements is supported, a sum subcounter will be provided first (see 3GPP TS 23.228 [7]).
- d) Each measurement is an integer value. The number of measurements is equal to the number of IMS network domain plus a possible sum value identified by the *.sum* suffix.
- e) The measurement name has the form *RU.Nbr403InitRegOfVisitUsers.Domain* where *Domain* identifies the network domain, and it is in the format of the domain name information in the SIP messages.
- f) *CscfFunction*.
- g) Valid for packet switched traffic.
- h) IMS.

4.1.5.3 Roaming users to other IMS network domains

- a) This measurement provides the number of the roamers visiting other IMS network domains. This measurement is only valid for the CSCF with S-CSCF functionality.
- b) CC.
- c) On receipt by the S-CSCF of a SIP_REGISTER message from the P-CSCF which is belonging to other IMS network domains.
- d) A single integer value.
- e) RU.RmgUsersOut.
- f) CscfFunction.
- g) Valid for packet switched traffic.
- h) IMS.

4.1.6 Authentication related measurements

The measurements defined in this subclause are subject to the "2 out of 3 approach".

4.1.6.1 Attempted Authentication procedures

- a) This measurement provides number of attempted Authentication procedures. This measurement is only valid for the CSCF with S-CSCF functionality.
- b) CC.
- c) On transmission by the S-CSCF of a Multimedia-Authentication-Request Diameter command to the HSS (see 3GPP TS 29.228 [9]).
- d) A single integer value.
- e) MA.AttMAR.
- f) CscfFunction.
- g) Valid for packet switched traffic.
- h) IMS.

4.1.6.2 Successful Authentication procedures

- a) This measurement provides number of successful Authentication procedures. This measurement is only valid for the CSCF with S-CSCF functionality.
- b) CC.
- c) On receipt by the S-CSCF of a Multimedia-Authentication-Answer Diameter command from the HSS indicating a successful authentication procedure (see 3GPP TS 29.228 [9]).
- d) A single integer value.
- e) MA.SuccMAA.
- f) CscfFunction.
- g) Valid for packet switched traffic.
- h) IMS.

4.1.6.3 Failed Authentication procedures

- a) This measurement provides number of failed Authentication procedures. The measurement is split into subcounters per failure cause. This measurement is only valid for the CSCF with S-CSCF functionality.
- b) CC.
- c) On receipt by the S-CSCF of a Multimedia-Authentication-Answer Diameter command from HSS indicating the authentication procedure is failed for the specific cause, each failed authentication procedure is added to the relevant measurement according to the failure cause. Possible failure causes are included in 3GPP TS 29.229 [10].
And each expected Multimedia-Authentication-Answer Diameter command not received by the S-CSCF is added into failure cause 'No Reply' (not specified in 3GPP TS 29.229 [10]).
The sum of all supported per cause measurements shall equal the total number of failed authentication procedures. In case only a subset of per cause measurements is supported, a sum subcounter will be provided first.
- d) Each measurement is an integer value. The number of measurements is equal to the number of causes plus a possible sum value identified by the *.sum* suffix.

- e) The measurement name has the form MA.FailMAA.*Cause* where *Cause* identifies the failure cause.
The cause 'No Reply' is identified by the *NoReply* suffix.
- f) CscfFunction.
- g) Valid for packet switched traffic.
- h) IMS.

4.1.7 HSS initiated update of User Profile related measurements

The measurements defined in this subclause are subject to the "2 out of 3 approach".

4.1.7.1 Attempted HSS initiated User Profile Update procedures

- a) This measurement provides number of attempted HSS initiated user profile update procedures. This measurement is only valid for the CSCF with S-CSCF functionality.
- b) CC.
- c) On receipt by the S-CSCF of a Push-Profile-Request Diameter command from the HSS (see 3GPP TS 29.228 [9]).
- d) A single integer value.
- e) UP.AttPPR.
- f) CscfFunction.
- g) Valid for packet switched traffic.
- h) IMS.

4.1.7.2 Successful HSS initiated User Profile Update procedures

- a) This measurement provides number of successful HSS initiated user profile update procedures. This measurement is only valid for the CSCF with S-CSCF functionality.
- b) CC.
- c) On transmission by the S-CSCF to the HSS of a Push-Profile-Answer Diameter command indicating a successful user profile update procedure (see 3GPP TS 29.228 [9]).
- d) A single integer value.
- e) UP.SuccPPA.
- f) CscfFunction.
- g) Valid for packet switched traffic.
- h) IMS.

4.1.7.3 Failed HSS initiated user profile update procedures

- a) This measurement provides number of failed HSS initiated user profile update procedures. The measurement is split into subcounters per failure cause. This measurement is only valid for the CSCF with S-CSCF functionality.
- b) CC.
- c) On transmission by the S-CSCF to the HSS of a Push-Profile-Answer Diameter command indicating the user profile update procedure is failed for the specific cause, each failed user profile update procedure is added to the relevant measurement according to the failure cause. Possible failure causes are included in 3GPP TS 29.229 [10]. The sum of all supported per cause measurements shall equal the total number of failed user profile update procedures. In case only a subset of per cause measurements is supported, a sum subcounter will be provided first.
- d) Each measurement is an integer value. The number of measurements is equal to the number of causes plus a possible sum value identified by the *.sum* suffix.
- e) The measurement name has the form UP.FailPPA.*Cause* where *Cause* identifies the failure cause.

- f) CscfFunction.
- g) Valid for packet switched traffic.
- h) IMS.

4.2 Measurements related to HSS

4.2.1 HSS database usage related measurements

4.2.1.1 Provisioning related measurements

4.2.1.1.1 Number of provisioned IMS subscriptions currently stored in a HSS

- a) This measurement provides the number of provisioned IMS subscriptions currently stored in a HSS.
- b) Gauge.
- c) Incremented when a IMS subscription (3GPP TS 23.228 [7]) is provisioned in the HSS and decremented when a subscription is removed from the HSS.
- d) A single integer value.
- e) DBU.NbrImsSubscription.
- f) HssFunction.
- g) Valid for Circuit switching traffic and packet switching traffic.
- h) IMS.

4.2.1.1.2 Number of provisioned Private User Identity stored in a HSS

- a) This measurement provides the number of provisioned Private User Identity currently stored in a HSS.
- b) Gauge.
- c) Incremented when a Private User Identity is provisioned in the HSS and decremented when a Private User Identity is removed from the HSS (3GPP TS 23.008 [16]).
- d) A single integer value.
- e) DBU.NbrPriUserId.
- f) HssFunction.
- g) Valid for Circuit switching traffic and packet switching traffic.
- h) IMS.

4.2.1.1.3 Number of provisioned Public User Identities with SIP URI format stored in a HSS

- a) This measurement provides the number of provisioned Public User Identities with SIP URI format stored in a HSS.
- b) Gauge.
- c) Incremented when a Public User Identity with SIP URI format (3GPP TS 23.008 [16]) is provisioned in the HSS and decremented when a Public User Identity with SIP URI format is removed from the HSS.
- d) A single integer value.
- e) DBU.NbrSipPubUserId.
- f) HssFunction.
- g) Valid for Circuit switching traffic and packet switching traffic.
- h) IMS.

4.2.1.1.4 Number of provisioned Public User Identities with TEL URI format stored in a HSS

- a) This measurement provides the number of provisioned Public User Identities with TEL URI format stored in a HSS.
- b) Gauge.
- c) Incremented when a Public User Identity with TEL URI format (3GPP TS 23.008 [16]) is provisioned in the HSS and decremented when a Public User identity with TEL URI format is removed from the HSS.
- d) A single integer value.
- e) DBU.NbrTelPubUserId.
- f) HssFunction.
- g) Valid for Circuit switching traffic and packet switching traffic.
- h) IMS.

4.2.1.1.5 Number of Private Service Identities stored in a HSS

- a) This measurement provides the number of Private Service Identities currently stored in a HSS.
- b) Gauge.
- c) Incremented when a Private Service Identity (3GPP TS 23.008 [16]) is provisioned in the HSS and decremented when a Private Service Identity is removed from the HSS.
- d) A single integer value.
- e) DBU.NbrPriSrvId.
- f) HssFunction.
- g) Valid for Circuit switching traffic and packet switching traffic.
- h) IMS.

4.2.1.1.6 Number of Public Service Identities with SIP URI format stored in a HSS

- a) This measurement provides the number of Public Service Identities with SIP URI format stored in a HSS.
- b) Gauge.
- c) Incremented when a Public Service Identity with SIP URI format (3GPP TS 23.008 [16]) is provisioned in the HSS and decremented when a Public Service Identity with SIP URI format is removed from the HSS.
- d) A single integer value.
- e) DBU.NbrSipPubSrvId.
- f) HssFunction.
- g) Valid for Circuit switching traffic and packet switching traffic.
- h) IMS.

4.2.1.1.7 Number of Public Service Identities with TEL URI format stored in a HSS

- a) This measurement provides the number of Public Service Identities with TEL URI format stored in a HSS.
- b) Gauge.

- c) Incremented when a Public Service Identity with TEL URI format (3GPP TS 23.008 [16]) is provisioned in the HSS and decremented when a Public Service Identity with TEL URI format is removed from the HSS.
- d) A single integer value.
- e) DBU.NbrTelPubSrvId.
- f) HssFunction.
- g) Valid for Circuit switching traffic and packet switching traffic.
- h) IMS.

4.2.1.2 Registration Status related measurements

4.2.1.2.1 Number of Public User Identities in registered state

- a) This measurement provides the number of Public User Identities in registered state stored in a HSS. The measurement is split into subcounters per visited network domain.
- b) Gauge.
- c) Incremented when a Public User Identity's Registration Status changes to "registered", and decremented when a Public User Identity's Registration Status changes from "registered".
- d) An integer value.
- e) DBU.NbrRegPubUserId.*RoamingDomain*
where *RoamingDomain* identifies the Domain Name of the visited network that a registration is initiated from.
- f) HssFunction.
- g) Valid for Circuit switching traffic and packet switching traffic.
- h) IMS.

4.2.1.2.2 Number of Public User Identities in unregistered state

- a) This measurement provides the number of Public User Identities in unregistered state stored in a HSS.
- b) Gauge.
- c) Incremented when a Public User Identity's Registration Status changes to "unregistered" and decremented when a Public User Identity's Registration Status changes from "unregistered".
- d) An integer value.
- e) DBU.NbrUnregPubUserId.
- f) HssFunction.
- g) Valid for Circuit switching traffic and packet switching traffic.
- h) IMS.

4.2.1.2.3 Number of Private User Identities in registered state

- a) This measurement provides the number of Private User Identities that have been used in the registration of one or more currently registered Public User Identities stored in a HSS.
- b) Gauge.
- c) Incremented on the emergence of the first registered Public User Identity associated with a Private User Identity and decremented on the deregistration of the last registered Public User Identity associated with a Private User Identity.

- d) An integer value.
- e) DBU.NbrRegPriUsrId.
- f) HssFunction.
- g) Valid for Circuit switching traffic and packet switching traffic.
- h) IMS.

4.2.2 User registration status query related measurements

The measurements defined in this subclause are subject to the '2 out of 3 approach'.

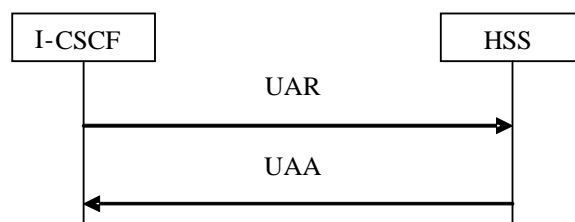

Figure 2

4.2.2.1 Attempted user registration status queries

- This measurement provides the number of attempted user registration status queries received by a HSS from the I-CSCF.
- CC.
- On receipt of a Diameter command User-Authorization-Request (UAR) by the HSS from the I-CSCF. (3GPP TS 29.228 [9]).
- A single integer value.
- UR.AttUAR.
- HssFunction.
- Valid for Circuit Switching traffic and packet switching traffic.
- IMS.

4.2.2.2 Successful user registration status queries

- This measurement provides the number of successfully performed user registration status queries by a HSS. The measurement can be split into subcounters per the success cause.
- CC.
- On transmission by HSS of Diameter command User-Authorization-Answer (UAA) with Result Code of either `DIAMETER_SUCCESS`, `DIAMETER_SUBSEQUENT_REGISTRATION` or `DIAMETER_FIRST_REGISTRATION` to the I-CSCF (3GPP TS 29.228 [9], 3GPP TS 29.229 [10]), each failed user registration status query procedure is added to the relevant measurement according to the success cause. The sum of all supported per cause measurements shall equal the total number of successful User registration status query procedures. In case only a subset of per cause measurements is supported, a sum subcounter will be provided first.
- A single integer value per measurement type defined in e).
- The measurement name has the form `UR.SuccUAA.Cause` where *Cause* identifies the successful cause. The *Cause* shall be the cause code of one of the three success causes defined in bullet c) when constructing the measurement name,
- HssFunction.
- Valid for Circuit Switching traffic and packet switching traffic.
- IMS.

4.2.2.3 Failed user registration status queries

- a) This measurement provides the number of failed user registration status query procedures processed by a HSS. The measurement is split into subcounters per the failure cause.
- b) CC
- c) On transmission by the HSS of Diameter command User-Authorization-Answer (UAA) with a Result Code other than DIAMETER_SUCCESS, DIAMETER_SUBSEQUENT_REGISTRATION or DIAMETER_FIRST_REGISTRATION (3GPP TS 29.228 [9]) to the I-CSCF, each failed user registration status query procedure is added to the relevant measurement according to the failure cause. Possible failure causes are included in 3GPP TS 29.229 [10]. The sum of all supported per cause measurements shall equal the total number of failed User registration status query procedures. In case only a subset of per cause measurements is supported, a sum subcounter will be provided first.
- d) Each measurement (as defined in e) is an integer value. The number of measurements is equal to the number of causes supported plus a possible sum value identified by the *.sum* suffix.
- e) The measurement name has the form UR.FailUAA.*Cause* where *Cause* identifies the failure.cause.
- f) HssFunction.
- g) Valid for Circuit Switching traffic and packet switching traffic.
- h) IMS.

4.2.3 S-CSCF registration/de-registration notification related measurements

The measurements defined in this subclause are subject to the '2 out of 3 approach'.

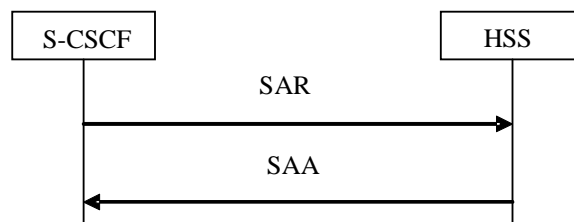

Figure 3

4.2.3.1 Attempted S-CSCF registration/de-registration notifications

- This measurement provides the number of attempted S-CSCF registration/deregistration notifications received by a HSS.
- CC.
- On receipt of Diameter command Server-Assignment-Request (SAR) by the HSS from the S-CSCF (3GPP TS 29.228 [9]).
- A single integer value.
- UR.AttSAR.
- HssFunction.
- Valid for circuit switching traffic and packet switching traffic.
- IMS.

4.2.3.2 Successful S-CSCF registration/de-registration notifications

- This measurement provides the number of successfully performed S-CSCF registration/deregistration notifications by a HSS.
- CC.
- On transmission by HSS of Diameter command Server-Assignment-Answer (UAA) with Result Code of DIAMETER_SUCCESS (3GPP TS 29.228 [9]) to the S-CSCF.
- A single integer value.
- UR.SuccSAA.
- HssFunction.
- Valid for circuit switching traffic and packet switching traffic.
- IMS.

4.2.3.3 Failed S-CSCF registration/de-registration notifications

- This measurement provides the number of failed S-CSCF registration/deregistration notification procedures by a HSS with the S-CSCF. The measurement is split into subcounters per the failure cause.
- CC.

- c) On transmission by the HSS of Diameter command Server-Assignment-Answer (UAA) with a Result Code other than DIAMETER_SUCCESS (3GPP TS 29.228 [9]) to the S-CSCF, each S-CSCF Registration/Deregistration notification procedure is added to the relevant measurement according to the failure cause. Possible failure causes are included in 3GPP TS 29.229 [10]. The sum of all supported per cause measurements shall equal the total number of failed S-CSCF Registration/Deregistration notification procedures. In case only a subset of per cause measurements is supported, a sum subcounter will be provided first.
- d) Each measurement (as defined in e) is an integer value. The number of measurements is equal to the number of causes supported plus a possible sum value identified by the *.sum* suffix.
- e) The measurement name has the form UR.FailSAA.*Cause* where *Cause* identifies the failure cause.
- f) HssFunction.
- g) Valid for circuit switching traffic and packet switching traffic.
- h) IMS.

4.2.4 Network initiated de-registration by the HSS related measurements

The measurements defined in this subclause are subject to the '2 out of 3 approach'.

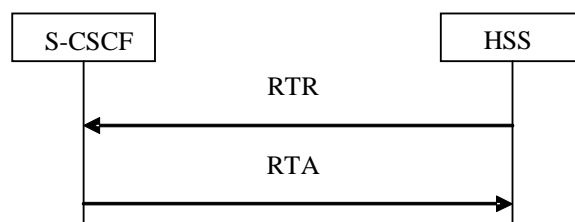

Figure 4

4.2.4.1 Attempted network initiated de-registrations by HSS

- This measurement provides the number of attempted network initiated de-registration procedures by a HSS.
- CC.
- On transmission of Diameter command Registration-Termination-Request (RTR) by the HSS to the S-CSCF (3GPP TS 29.228 [9]).
- A single integer value.
- UR.AttRTR.
- HssFunction.
- Valid for circuit switching traffic and packet switching traffic.
- IMS.

4.2.4.2 Successful network initiated de-registrations by HSS

- This measurement provides the number of successfully performed network initiated de-registration by a HSS.
- CC.
- On receipt by HSS of Diameter command Registration-Termination-Answer (RTA) with Result Code of DIAMETER_SUCCESS (3GPP TS 29.228 [9]) from the S-CSCF.
- A single integer value.
- UR.SuccRTA.
- HssFunction.
- Valid for Circuit switching traffic and packet switching traffic.
- IMS.

4.2.4.3 Failed network initiated de-registrations by HSS

- This measurement provides the number of failed network initiated de-registration procedures perceived by a HSS from the S-CSCF. The measurement is split into subcounters per the failure cause.
- CC.

- c) On receipt by the HSS of Diameter command Registration-Termination-Answer (RTA) with Result Code other than DIAMETER_SUCCESS (3GPP TS 29.228 [9]) from the S-CSCF, each failed network initiated de-registration by HSS is added to the relevant measurement according to the failure cause. Possible failure causes are included in 3GPP TS 29.229 [10].
And each expected Diameter command Registration-Termination-Answer (RTA) not received by the HSS is added into failure cause 'No Reply' (not specified in 3GPP TS 29.229 [10]).
The sum of all supported per cause measurements shall equal the total number of failed network initiated de-registrations. In case only a subset of per cause measurements is supported, a sum subcounter will be provided first.
- d) Each measurement (as defined in e) is an integer value. The number of measurements is equal to the number of causes supported plus a possible sum value identified by the *.sum* suffix.
- e) The measurement name has the form UR.FailRTA.Cause:
where *Cause* identifies the failure cause.
The cause 'No Reply' is identified by the *.NoReply* suffix.
- f) HssFunction.
- g) Valid for Circuit switching traffic and packet switching traffic.
- h) IMS.

4.2.5 User location query related measurements

The measurements defined in this subclause are subject to the "2 out of 3 approach".

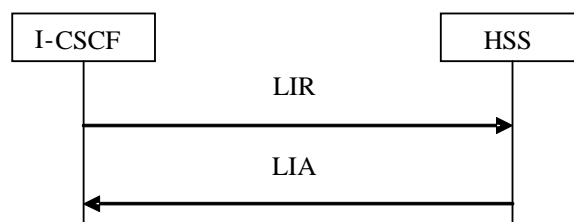

Figure 5

4.2.5.1 Attempted user location queries

- This measurement provides the number of attempted user location queries received by a HSS from the I-CSCF.
- CC.
- On receipt of Diameter command Location-Info-Request (LIR) by the HSS from the I-CSCF (3GPP TS 29.228 [9]).
- A single integer value.
- LIQ.AttLIR.
- HssFunction.
- Valid for Circuit switching traffic and packet switching traffic.
- IMS.

4.2.5.2 Successful user location queries

- This measurement provides the number of successfully performed user location queries by a HSS from the I-CSCF.
- CC.
- On transmission by HSS of Diameter command Location-Info-Answer (LIA) with Result Code of DIAMETER_SUCCESS (3GPP TS 29.228 [9]) to the I-CSCF.
- A single integer value.
- LIQ.SuccLIA.
- HssFunction.
- Valid for Circuit switching traffic and packet switching traffic.
- IMS.

4.2.5.3 Failed user location queries

- This measurement provides the number of failed user location queries procedures by a HSS with the I-CSCF. The measurement is split into subcounters per the failure cause.
- CC.
- On transmission by the HSS of Diameter command Location-Info-Answer (LIA) with a Result Code other than DIAMETER_SUCCESS (3GPP TS 29.228 [9]) to the I-CSCF, each failed user location query procedure is added to the relevant measurement according to the failure cause. Possible failure causes are included in

3GPP TS 29.229 [10]. The sum of all supported per cause measurements shall equal the total number of failed user location query procedures. In case only a subset of per cause measurements is supported, a sum subcounter will be provided first.

- d) Each measurement (as defined in e) is an integer value. The number of measurements is equal to the number of causes supported plus a possible sum value identified by the *.sum* suffix.
- e) The measurement name has the form *LIQ.FailLIA.Cause* where *Cause* identifies the failure cause.
- f) *HssFunction*
- g) Valid for Circuit switching traffic and packet switching traffic
- h) *IMS*

4.2.6 HSS initiated update of user profile related measurements

The measurements defined in this subclause are subject to the "2 out of 3 approach".

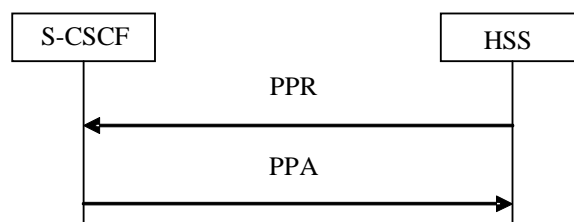

Figure 6

4.2.6.1 Attempted HSS initiated updates of user profile

- This measurement provides the number of attempted HSS initiated update of User Profile by a HSS to the S-CSCF.
- CC.
- On transmission of Diameter command Push-Profile-Request (PPR) by the HSS to the S-CSCF (3GPP TS 29.228 [9]).
- A single integer value.
- UP.AttPPR.
- HssFunction.
- Valid for Circuit switching traffic and packet switching traffic.
- IMS.

4.2.6.2 Successful HSS initiated updates of user profile

- This measurement provides the number of successfully performed HSS initiated update of User Profile by a HSS to the S-CSCF.
- CC.
- On receipt by HSS of Diameter command Push-Profile-Answer (PPA) with Result Code of DIAMETER_SUCCESS (3GPP TS 29.228 [9]) from the S-CSCF.
- A single integer value.
- UP.SuccPPA.
- HssFunction.
- Valid for Circuit switching traffic and packet switching traffic.
- IMS.

4.2.6.3 Failed HSS initiated updates of user profile

- This measurement provides the number of failed HSS initiated update of User Profile procedures by a HSS with the S-CSCF. The measurement is split into subcounters per the failure cause.
- CC.
- On receipt by the HSS of Diameter command Push-Profile-Answer (PPA) with a Result Code other than DIAMETER_SUCCESS (3GPP TS 29.228 [9]) from the S-CSCF, each failed HSS initiated updates of User

Profile procedure is added to the relevant measurement according to the failure cause. Possible failure causes are included in 3GPP TS 29.229 [10].

And each expected Diameter command Push-Profile-Answer (PPA) not received by the HSS is added into failure cause 'No Reply' (not specified in 3GPP TS 29.229 [10]).

The sum of all supported per cause measurements shall equal the total number of failed HSS initiated updates of User Profile procedures. In case only a subset of per cause measurements is supported, a sum subcounter will be provided first.

- d) Each measurement (as defined in e) is an integer value. The number of measurements is equal to the number of causes supported plus a possible sum value identified by the *.sum* suffix.
- e) The measurement name has the form *UP.FailPPA.Cause* where *Cause* identifies the failure cause.
The cause 'No Reply' is identified by the *.NoReply* suffix.
- f) *HssFunction*.
- g) Valid for Circuit switching traffic and packet switching traffic.
- h) *IMS*.

4.2.7 Authentication procedure related measurements

The measurements defined in this subclause are subject to the "2 out of 3 approach".

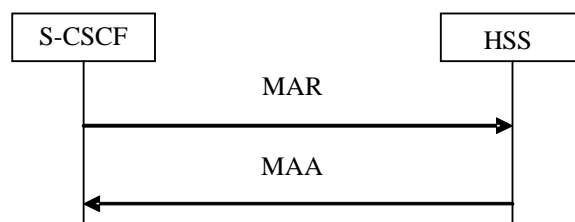

Figure 7

4.2.7.1 Attempted authentication procedures

- This measurement provides the number of attempted authentication procedures received by a HSS from the S-CSCF.
- CC.
- On receipt of Diameter command Multimedia-Auth-Request (MAR) by the HSS from the S-CSCF (3GPP TS 29.228 [9]).
- A single integer value.
- MA.AttMAR.
- HssFunction.
- Valid for Circuit switching traffic and packet switching traffic.
- IMS.

4.2.7.2 Successful authentication procedures

- This measurement provides the number of successfully performed authentication procedures by a HSS with the S-CSCF (3GPP TS 33.203 [28]).
- CC.
- On transmission by HSS of Diameter command Multimedia-Auth-Answer (MAA) with Result Code of DIAMETER_SUCCESS (3GPP TS 29.228 [9]) to the S-CSCF.
- A single integer value.
- MA.SuccMAA.
- HssFunction.
- Valid for Circuit switching traffic and packet switching traffic.
- IMS.

4.2.7.3 Failed authentication procedures

- This measurement provides the number of failed authentication procedures by a HSS with the S-CSCF (3GPP TS 33.203 [28]). The measurement is split into subcounters per the failure cause.
- CC.

- c) On transmission by the HSS of Diameter command Multimedia-Auth-Answer (MAA) with a Result Code other than DIAMETER_SUCCESS (3GPP TS 29.228 [9]) to the S-CSCF, each failed authentication procedure is added to the relevant measurement according to the failure cause. Possible failure causes are included in 3GPP TS 29.229 [10]. The sum of all supported per cause measurements shall equal the total number of failed authentication procedures. In case only a subset of per cause measurements is supported, a sum subcounter will be provided first.
- d) Each measurement (as defined in e) is an integer value. The number of measurements is equal to the number of causes supported plus a sum value identified by the *.sum* suffix.
- e) The measurement name has the form *MA.FailMAA.Cause* where *Cause* identifies the failure cause.
- f) HssFunction.
- g) Valid for Circuit switching traffic and packet switching traffic.
- h) IMS.

4.2.8 Data read (Sh-Pull) procedure related measurements

The measurements defined in this subclause are subject to the "2 out of 3 approach".

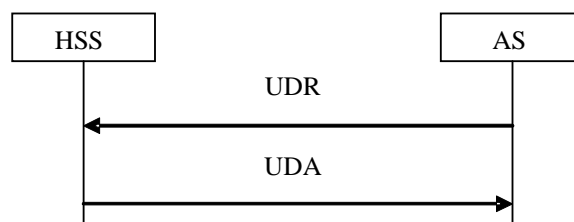

Figure 8

4.2.8.1 Attempted data read (Sh-Pull) procedures

- This measurement provides the number of attempted Data read (Sh-Pull) procedures by a HSS from the AS.
- CC.
- On receipt of Diameter command User-Data-Request (UDR) by the HSS from the AS. (3GPP TS 29.328 [17]).
- A single integer value.
- DTR.AttUDR.
- HssFunction.
- Valid for Circuit switching traffic and packet switching traffic.
- IMS.

4.2.8.2 Successful data read (Sh-Pull) procedures

- This measurement provides the number of successfully Data read (Sh-Pull) procedures by a HSS with the AS.
- CC.
- On transmission by HSS of Diameter command User-Data-Answer (UDA) to the AS with the result code indicating successful execution of a Data read (Sh-Pull) procedure (3GPP TS 29.329 [18]).
- A single integer value.
- DTR.SuccUDA.
- HssFunction.
- Valid for Circuit switching traffic and packet switching traffic.
- IMS.

4.2.8.3 Failed data read (Sh-Pull) procedures

- This measurement provides the number of failed Data read (Sh-Pull) procedures by a HSS with the AS. The measurement is split into subcounters per the failure cause.
- CC.
- On transmission by the HSS of Diameter command User-Data-Answer (UDA) to the AS with the result code indicating a failure (3GPP TS 29.328 [17]), each failed data read procedure is added to the relevant measurement according to the failure cause. Possible failure causes are included in 3GPP TS 29.329 [18]. The sum of all supported per cause measurements shall equal the total number of failed data read procedures. In case only a subset of per cause measurements is supported, a sum subcounter will be provided first.

- d) Each measurement is an integer value. The number of measurements is equal to the number of causes supported plus a possible sum value identified by the *.sum* suffix.
- e) The measurement name has the form *DTR.FailUDA.Cause* where *Cause* identifies the failure cause.
- f) *HssFunction*.
- g) Valid for Circuit switching traffic and packet switching traffic.
- h) *IMS*.

4.2.9 Data update (Sh-Update) procedure related measurements

The measurements defined in this subclause are subject to the "2 out of 3 approach".

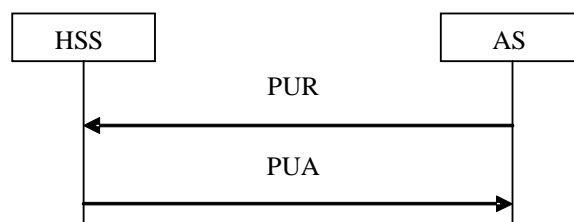

Figure 9

4.2.9.1 Attempted data update (Sh-Update) procedures

- This measurement provides the number of attempted Data update (Sh-Update) procedures by a HSS from the AS.
- CC.
- On receipt of Diameter command Profile-Update-Request (PUR) by the HSS from the AS (3GPP TS 29.328 [17]).
- A single integer value.
- DTU.AttPUR.
- HssFunction.
- Valid for Circuit switching traffic and packet switching traffic.
- IMS.

4.2.9.2 Successful data update (Sh-Update) procedures

- This measurement provides the number of successfully Data update (Sh-Update) procedures by a HSS with the AS.
- CC.
- On transmission by HSS of Diameter command Profile-Update-Answer (PUA) to the AS with the result code indicating successful execution of a data update (Sh-Update) procedure (3GPP TS 29.329 [18]).
- A single integer value.
- DTU.SuccPUA.
- HssFunction.
- Valid for Circuit switching traffic and packet switching traffic.
- IMS.

4.2.9.3 Failed data update (Sh-Update) procedures

- This measurement provides the number of failed data update (Sh-Update) procedures by a HSS with the AS. The measurement is split into subcounters per the failure cause.
- CC.

- c) On transmission by the HSS of Diameter command Profile-Update-Answer (PUA) to the AS with the result code indicating a failure (3GPP TS 29.328 [17]), each failed data update procedure is added to the relevant measurement according to the failure cause. Possible failure causes are included in 3GPP TS 29.329 [18]. The sum of all supported per cause measurements shall equal the total number of failed data update procedures. In case only a subset of per cause measurements is supported, a sum subcounter will be provided first.
- d) Each measurement is an integer value. The number of measurements is equal to the number of causes supported plus a possible sum value identified by the *.sum* suffix.
- e) The measurement name has the form DTU.FailPUA.*Cause* where *Cause* identifies the failure cause.
- f) HssFunction.
- g) Valid for Circuit switching traffic and packet switching traffic.
- h) IMS.

4.2.10 Subscription to notifications (Sh-Subs-Notif) procedure related measurements

The measurements defined in this subclause are subject to the "2 out of 3 approach".

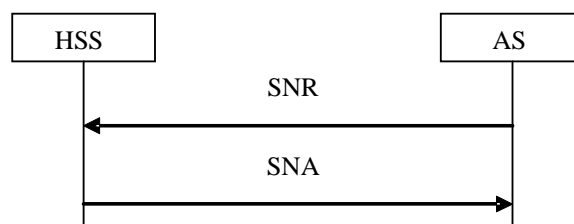

Figure 10

4.2.10.1 Attempted subscription to notifications (Sh-Subs-Notif) procedures

- This measurement provides the number of attempted subscription to notifications (Sh-Subs-Notif) procedures by a HSS from the AS.
- CC.
- On receipt of Diameter command Subscribe-Notifications-Request (SNR) by the HSS from the AS (3GPP TS 29.328 [17]).
- A single integer value.
- SUB.AttSNR.
- HssFunction.
- Valid for Circuit switching traffic and packet switching traffic.
- IMS.

4.2.10.2 Successful subscription to notifications (Sh-Subs-Notif) procedures

- This measurement provides the number of successfully subscription to notifications (Sh-Subs-Notif) procedures by a HSS with the AS.
- CC.
- On transmission by HSS of Diameter Subscribe-Notifications-Answer (SNA) to the AS with the result code indicating successful execution of a subscription to notifications (Sh-Subs-Notif) procedure (3GPP TS 29.329 [18]).
- A single integer value.
- SUB.SuccSNA.
- HssFunction.
- Valid for Circuit switching traffic and packet switching traffic.
- IMS.

4.2.10.3 Failed subscription to notifications (Sh-Subs-Notif) procedures

- This measurement provides the number of failed subscription to notifications (Sh-Subs-Notif) procedures by a HSS with the AS. The measurement is split into subcounters per the failure cause.
- CC.

- c) On transmission by the HSS of Diameter command Subscribe-Notifications-Answer (SNA) to the AS with the result code indicating a failure (3GPP TS 29.328 [17]), each failed subscription to notifications procedure is added to the relevant measurement according to the failure cause. Possible failure causes are included in 3GPP TS 29.329 [18]. The sum of all supported per cause measurements shall equal the total number of failed subscription to notifications procedures. In case only a subset of per cause measurements is supported, a sum subcounter will be provided first.
- d) Each measurement (as defined in e) is an integer value. The number of measurements is equal to the number of causes supported plus a possible sum value identified by the *.sum* suffix.
- e) The measurement name has the form SUB.FailSNA.*Cause* where *Cause* identifies the failure cause.
- f) HssFunction.
- g) Valid for Circuit switching traffic and packet switching traffic.
- h) IMS.

4.2.11 Notification (Sh-Notif) procedure related measurements

The measurements defined in this subclause are subject to the "2 out of 3 approach".

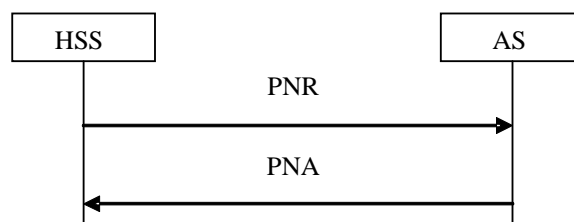

Figure 11

4.2.11.1 Attempted notification (Sh-Notif) procedures

- This measurement provides the number of attempted notification (Sh-Notif) procedures by a HSS to the AS.
- CC.
- On transmission of Diameter command Push-Notification-Request (PNR) by the HSS to the AS (3GPP TS 29.328 [17]).
- A single integer value.
- NOTIF.AttPNR.
- HssFunction.
- Valid for Circuit switching traffic and packet switching traffic.
- IMS.

4.2.11.2 Successful notification (Sh-Notif) procedures

- This measurement provides the number of successfully performed Notification (Sh-Notif) procedures by a HSS to the AS.
- CC.
- On receipt by HSS of Diameter command Push-Notification -Answer (PNA) with the result code indicating successful execution of a notification (Sh-Notif) procedure (3GPP TS 29.329 [18]) from the AS.
- A single integer value.
- NOTIF.SuccPNA.
- HssFunction.
- Valid for Circuit switching traffic and packet switching traffic.
- IMS.

4.2.11.3 Failed notification (Sh-Notif) procedures

- This measurement provides the number of failed notification (Sh-Notif) procedures by a HSS with the AS. The measurement is split into subcounters per the reject cause failure cause.
- CC.

- c) On receipt by the HSS of Diameter command Push-Notification-Answer (PNA) with the result code indicating a failure (3GPP TS 29.328 [17]) from the AS, each failed notification procedure is added to the relevant measurement according to the failure cause. Possible failure causes are included in TS 29.329 [18]. And each expected Diameter command Push-Notification-Answer (PNA) not received by the HSS is added into failure cause 'No Reply' (not specified in 3GPP TS 29.329 [18]).
The sum of all supported per cause measurements shall equal the total number of failed notification procedures. In case only a subset of per cause measurements is supported, a sum subcounter will be provided first.
- d) Each measurement (as defined in e) is an integer value. The number of measurements is equal to the number of causes supported plus a possible sum value identified by the .sum suffix.
- e) The measurement name has the form NOTIF.FailPNA.Cause:
where *Cause* identifies the failure cause.
The cause 'No Reply' is identified by the *NoReply* suffix.
- f) HssFunction.
- g) Valid for Circuit switching traffic and packet switching traffic.
- h) IMS.

4.3 Measurements related to BGCF

4.3.1 Session Control related measurements

4.3.1.1 Overview

The performance measurements defined in subclause 4.3.1 are related to the procedure that BGCF forwards session to the selected the network in which PSTN/CS Domain breakout is to occur. The procedures are shown in figures 12 and 13.

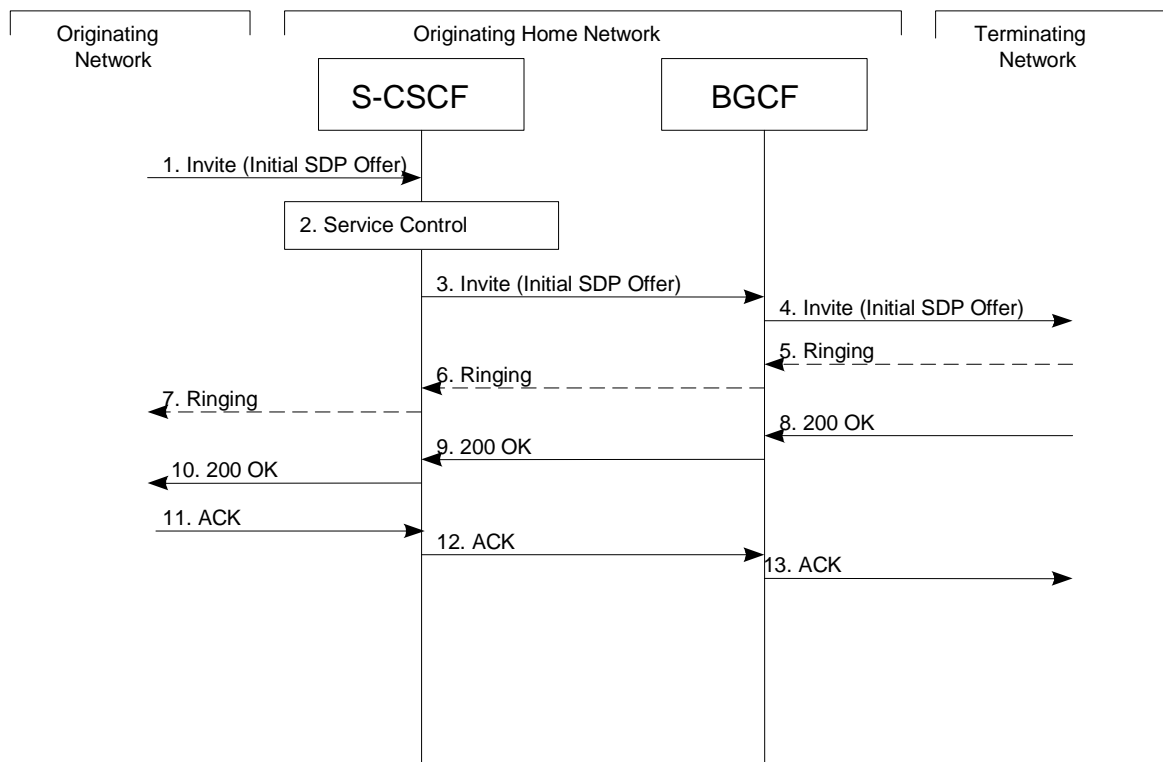

Figure 12: BGCF Forwards session to the MGCF within the same network

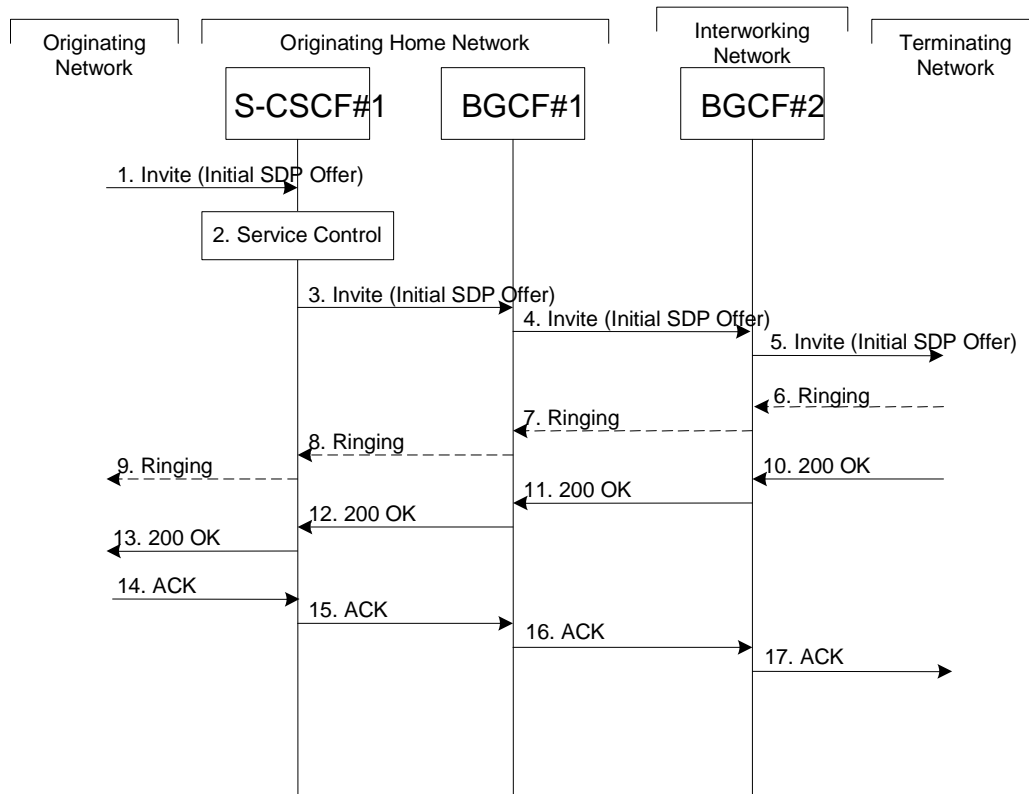

Figure 13: BGCF Forwards session to the BGCF in a different network

4.3.1.2 Attempted sessions at BGCF

- a) This measurement provides the number of attempted sessions at the BGCF when the PSTN/CS Domain breakout is to occur.
- b) CC.
- c) On receipt by the BGCF of an initial SIP_INVITE message (see 3GPP TS 23.228 [7]).
- d) A single integer value.
- e) SC.AttSession.
- f) BgcfFunction.
- g) Valid for packet switched traffic.
- h) IMS.

4.3.1.3 Attempted sessions forwarded to MGCF

- a) This measurement provides the number of attempted sessions forwarded to the MGCF within the same network at the BGCF for calls routing to PSTN/CS domain.
- b) CC.
- c) On transmission by the BGCF of an initial SIP_INVITE message to the MGCF within the same network (see 3GPP TS 23.228 [7]).
- d) A single integer value.
- e) SC.AttSessionFwdToMGCF.
- f) BgcfFunction.
- g) Valid for packet switched traffic.
- h) IMS.

4.3.1.4 Attempted sessions forwarded to BGCF

- a) This measurement provides the number of attempted sessions forwarded to the BGCF in a different network.
- b) CC.
- c) On transmission by the BGCF of an initial SIP_INVITE message to the BGCF in a different network (see 3GPP TS 23.228 [7]).
- d) A single integer value.
- e) SC.AttSessionFwdToBGCF.
- f) BgcfFunction.
- g) Valid for packet switched traffic.
- h) IMS.

4.3.1.5 Successful sessions forwarded to MGCF

- a) This measurement provides the number of successful sessions forwarded to the MGCF at the BGCF for calls routing to PSTN or CS domain.
- b) CC.
- c) On receipt by the BGCF of a response message (e.g. SIP_180 or SIP_200) indicating a successful session from the MGCF in the same network, corresponding to the transmitted initial SIP_INVITE message (see 3GPP TS 23.228 [2]). Each successful session forwarded to MGCF is added to the relevant measurement according to the message type. The sum of all supported per message type measurements shall equal the total number of successful sessions forwarded to MGCF. In case only a subset of per message type measurements is supported, a sum subcounter will be provided first.
- d) Each measurement is an integer value. The number of measurements is equal to the number of message types plus a possible sum value identified by the *.sum* suffix.
- e) *SC.SuccSessionFwdToMGCF.type*
where *type* identifies the message type.

The following subcounters with specific message types are the samples of this measurement:

SC.SuccSessionFwdToMGCF.180	Message type: SIP_180
SC.SuccSessionFwdToMGCF.200	Message type: SIP_200_OK only if the SIP_180 has not been received for this session.

- f) BgcfFunction.
- g) Valid for packet switched traffic.
- h) IMS.

4.3.1.6 Successful sessions forwarded to BGCF

- a) This measurement provides the number of successful forwarded sessions to the BGCF in different network.
- b) CC.
- c) On receipt by the BGCF of a response message (e.g. SIP_180 or SIP_200) indicating a successful session from the BGCF in another network, corresponding to the transmitted initial SIP_INVITE message (see 3GPP TS 23.228 [2]). Each successful session forwarded to BGCF is added to the relevant measurement according to the message type. The sum of all supported per message type measurements shall equal the total number of successful sessions forwarded to BGCF. In case only a subset of per message type measurements is supported, a sum subcounter will be provided first.
- d) Each measurement is an integer value. The number of measurements is equal to the number of message types plus a possible sum value identified by the *.sum* suffix.
- e) *SC.SuccSessionFwdToBGCF.type*
where *type* identifies the message type

The following subcounters with specific message types are the samples of this measurement:

SC.SuccSessionFwdToBGCF.180	Message type: SIP_180
SC.SuccSessionFwdToBGCF.200	Message type: SIP_200_OK only if the SIP_180 has not been received for this session.

- f) BgcfFunction.
- g) Valid for packet switched traffic.
- h) IMS.

4.4 Measurements related to MGCF

4.4.1 Call control related measurements

4.4.1.1 Call control related measurements, CS network originated

The measurements defined in subclauses 4.4.1.1.2, 4.4.1.1.3 and 4.4.1.1.5 are subject to the "2 out of 3 approach".

4.4.1.1.1 Overview

The performance measurements defined in this subclause are related to the CS network originated call that is intentionally routed to IM CN subsystem.

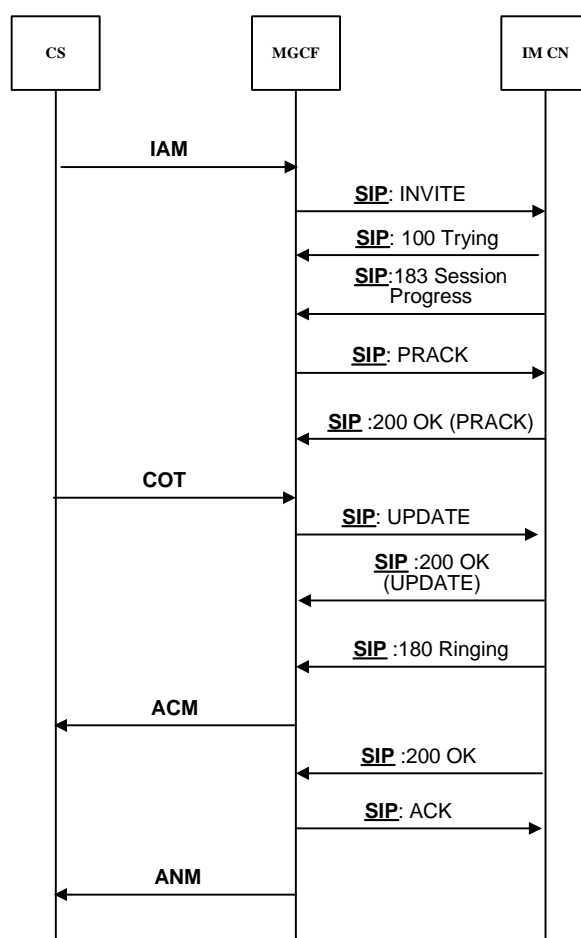

Figure 14: CS network originated, IM CN terminated call procedure

4.4.1.1.2 Attempted calls, CS network originated

- a) This measurement provides the number of attempted calls from CS network.
- b) CC.
- c) On receipt by the MGCF of an "IAM" message(see 3GPP TS 29.163 [11]).
- d) A single integer value.
- e) CC.AttCallCsOrig.
- f) MgcFunction.
- a) Valid for circuit switched traffic.
- g) IMS.

4.4.1.1.3 Successful calls, CS network originated

- a) This measurement provides the number of successful calls from CS network.
 - b) CC.
 - c) On transmission by the MGCF of an "ACM" or "CON" message (see 3GPP TS 29.163 [11]).
- NOTE: If ACM message is not sent, the "CON" message shall be the trigger.
- d) A single integer value.
 - e) CC.SuccCallCsOrig.
 - f) MgcFunction.
 - g) Valid for circuit switched traffic.
 - h) IMS.

4.4.1.1.4 Answered calls, CS network originated

- a) This measurement provides the number of answered calls from CS network.
- b) CC.
- c) On transmission by the MGCF of an "ANM" or "CON" message (see 3GPP TS 29.163 [11]).
- d) A single integer value.
- e) CC.AnsCallCsOrig.
- f) MgcFunction.
- g) Valid for circuit switched traffic.
- h) IMS.

4.4.1.1.5 Failed calls, CS network originated

- a) This measurement provides number of failed calls (the calls are originated from CS network).
- b) CC.
- c) Before MGCF sends 'ACM" or "CON" message (see 3GPP TS 29.163 [11]), the call is released..
- d) A single integer value.

- e) CC.FailCallCsOrig.
- f) MgcFunction.
- g) Valid for circuit switched traffic.
- h) IMS.

4.4.1.1.6 Call set-up time (Mean), CS network originated

- a) This measurement provides the mean setup time of the successful CS network originated calls.
- b) DER (n=1).
- c) This measurement is obtained by accumulating the time intervals for every successful CS network originated calls between the receipt of "IAM" message and the transmission of the corresponding "ACM" message or "CON" message if the "ACM" message is not sent over a granularity period using DER (see 3GPP TS 29.163 [11]). The end value of this time will then be divided by the number of successful CS network originated calls observed in the granularity period to give the arithmetic mean, the accumulator shall be reinitialised at the beginning of each granularity period.
- d) A single integer value (in milliseconds).
- e) CC.SetupTimeCsOrigMean.
- f) MgcFunction.
- g) Valid for circuit switched traffic.
- h) IMS.

4.4.1.2 Call control related measurements, IM CN originated

The measurements defined in subclauses 4.4.1.2.2, 4.4.1.2.3 and 4.4.1.2.5 are subject to the "2 out of 3 approach".

4.4.1.2.1 Overview

The performance measurements defined in this subclause is related to the IM CN subsystem originated call that is intentionally routed to CS network.

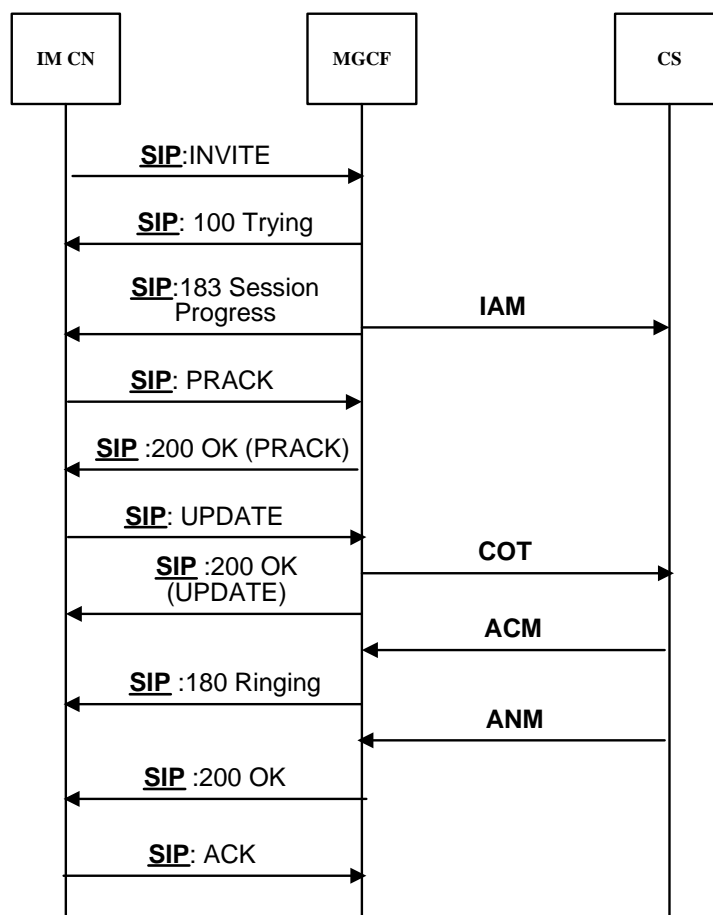

Figure 15: IM CN originated, CS network terminated call procedure

4.4.1.2.2 Attempted calls, IM CN originated

- This measurement provides the number of attempted calls from IM CN subsystem.
- CC.
- On receipt by the MGCF of an initial SIP_INVITE message (see 3GPP TS 29.163 [11]).
- A single integer value.
- CC.AttCallImOrig.
- MgcfFunction.
- Valid for packet switched traffic.
- IMS.

4.4.1.2.3 Successful calls, IM CN originated

- This measurement provides the number of successful calls from IM CN subsystem. The measurement is split into subcounters per message type (e.g. SIP_180) indicating the successful IM CN originated call.
- CC.
- On transmission by the MGCF of a response message (e.g. SIP_180) indicating a successful IM CN subsystem originated call corresponding to the initial SIP_INVITE message (see 3GPP TS 29.163 [11]), each successful IM CN originated call is added to the relevant measurement according to the message type, the possible response message types are identified in 3GPP TS 24.229 [8]. The sum of all supported per message type measurements

shall equal the total number of successful IM CN subsystem originated calls. In case only a subset of per message type measurements is supported, a sum subcounter will be provided first.

- d) Each measurement is an integer value. The number of measurements is equal to the number of message types plus a possible sum value identified by the *.sum* suffix.
- e) The measurement name has the form *CC.SuccCallImOrig.type* where *type* identifies the message type.

The following subcounters with specific message types are the samples of this measurement:

CC.SuccCallImorig.180	Message type: SIP_180. MGCF sends SIP_180.
CC.SuccCallImorig.200	Message type: SIP_200. MGCF sends SIP_200_OK after receiving CON message instead of ACM message.

- f) *MgcfFunction*.
- g) Valid for packet switched traffic.
- h) IMS.

4.4.1.2.4 Answered calls, IM CN originated

- a) This measurement provides the number of answered calls from IM CN subsystem.
- b) CC.
- c) On transmission by the MGCF of a SIP_200_OK message corresponding to an initial SIP_INVITE message. (see 3GPP TS 29.163 [11]).
- d) A single integer value.
- e) *CC.AnsCallImOrig*.
- f) *MgcfFunction*.
- g) Valid for packet switched traffic.
- h) IMS.

4.4.1.2.5 Failed calls, IM CN originated

- a) This measurement provides number of failed calls (the calls are originated from IM CN subsystem).
- b) CC.
- c) Before MGCF sends SIP 180 or SIP 200 without 180 (see 3GPP TS 29.163 [11]), the call is released..
- d) A single integer value.
- e) *CC.FailCallImOrig*.
- f) *MgcfFunction*.
- g) Valid for packet switched traffic.
- h) IMS.

4.4.1.2.6 Call set-up time (Mean), IM CN originated

- a) This measurement provides the mean setup time of the successful IM CN subsystem originated calls.
- b) DER (n=1).
- c) This measurement is obtained by accumulating the time intervals for every successful IM CN subsystem originated calls between the receipt of an initial SIP_INVITE message and the transmission of corresponding SIP_180 or SIP_200_OK without SIP_180 message over a granularity period using DER (see

3GPP TS 29.163 [11]). The end value of this time will then be divided by the number of successful IM CN subsystem originated calls observed in the granularity period to give the arithmetic mean, the accumulator shall be reinitialised at the beginning of each granularity period.

- d) A single integer value (in milliseconds).
- e) CC.SetupTimeImOrigMean.
- f) MgcFunction.
- g) Valid for packet switched traffic.
- h) IMS.

4.4.1.3 Call control related measurements, call release

4.4.1.3.1 Overview

The performance measurements defined in this subclause are related to the call release initiated by CS network, IM CN subsystem, MGCF itself and MGW respectively.

4.4.1.3.2 Call release initiated by CS network

- a) This measurement provides the number of call release initiated by CS network with "REL" or "RSC" or "GRS" message. The measurement is split into subcounters per release message type, and per cause for the REL message.
- b) CC.
- c) On receipt by the MGCF of an ISUP/BICC "REL" or "RSC" or "GRS" message (see 3GPP TS 29.163 [11]).
- d) Each measurement is an integer value. The number of measurements is equal to the number of supported causes in ISUP/BICC "REL" message, plus two values for ISUP/BICC "RSC" and "GRS" message respectively and a possible sum value identified by the *.sum* suffix.
- e) CC.RelCallsInit.*CauseOrMsg*.

Where *CauseOrMsg* identifies the cause in ISUP/BICC "REL" message if the call is released by ISUP/BICC "REL" message (see ITU-T Recommendation Q.850 [19]), or the message type ISUP/BICC "RSC" or "GRS" respectively if the call is released by ISUP/BICC "RSC" or "GRS" message. If the call is released by ISUP/BICC "RSC" or "GRS" message, the *CauseOrMsg* shall be the constant string "RSC" or "GRS" respectively when constructing the measurement name.

- f) MgcFunction.
- g) Valid for circuit switched traffic.
- h) IMS.

4.4.1.3.3 Call release initiated by IM CN subsystem

- a) This measurement provides the number of call release initiated by IM CN subsystem. The measurement is split into subcounters per message type.
- b) CC.
- c) On receipt by the MGCF of a SIP_BYE or SIP_CANCEL or SIP_3XX or SIP_4XX or SIP_5XX or SIP_6XX message (see 3GPP TS 29.163 [11]).
- d) 6 single integer values.
- e) CC.RelCallsImInit.BYE
CC.RelCallsCsInit.CANCEL
CC.RelCallsCsInit.3XX

CC.RelCallsCsInit.4XX
 CC.RelCallsCsInit.5XX
 CC.RelCallsCsInit.6XX

- f) MgcFunction.
- g) Valid for packet switched traffic.
- h) IMS.

4.4.1.3.4 Call release initiated by MGCF

- a) This measurement provides the number of autonomous call release initiated by MGCF itself. The measurement is split into subcounters per message type.
- b) CC.
- c) On transmission of call release message by MGCF due to autonomous call releases (see 3GPP TS 29.163 [11]).

NOTE: MGCF sends call release message to CS network and IM CN subsystem respectively for one call, just count once.

- d) 8 single integer values.
- e) CC.RelCallsMgcfInit.484Imgcf
 CC.RelCallsMgcfInit.480Imgcf
 CC.RelCallsMgcfInit.488Imgcf
 CC.RelCallsMgcfInit.500Imgcf
 CC.RelCallsMgcfInit.CotOmgcf
 CC.RelCallsMgcfInit.47Omgcf
 CC.RelCallsMgcfInit.IsupBiccOmgcf
 CC.RelCallsMgcfInit.SipOmgcf.

The corresponding scenario for these 2 measurements are:

CC.RelCallsMgcfInit.484Imgcf	I-MGCF initiates call release by sending SIP 484 Address Incomplete.
CC.RelCallsMgcfInit.480Imgcf	I-MGCF initiates call release by sending SIP 480 Temporarily Unavailable.
CC.RelCallsMgcfInit.488Imgcf	I-MGCF initiates call release by sending SIP 488 Not Acceptable Here.
CC.RelCallsMgcfInit.500Imgcf	I-MGCF initiates call release by sending SIP 500 Server Internal Error.
CC.RelCallsMgcfInit.CotOmgcf	O-MGCF initiates call release on reception of COT with the Continuity Indicators parameter set to " <i>continuity check failed</i> " or expiry of ISUP/BICC T8.
CC.RelCallsMgcfInit.47Omgcf	O-MGCF initiates call release by sending ISUP/BICC "REL" with cause value (resource unavailable or unspecified).
CC.RelCallsMgcfInit.IsupBiccOmgcf	O-MGCF initiates call release by ISUP/BICC procedure.
CC.RelCallsMgcfInit.SipOmgcf	O-MGCF initiates call release by SIP procedure.

- f) MgcFunction.
- g) Valid for circuit switched and packet switched traffic.
- h) IMS.

4.4.1.3.5 Call release initiated by MGW

- a) This measurement provides the number of call release initiated by MGW. The measurement is split into subcounters per H248 error code and H248 service change reason.
- b) CC.
- c) On receipt by the MGCF of a H248 message which triggers call release (see ITU-T Recommendation H.248.1 [20]).
- d) Each measurement is an integer value. The number of measurements is equal to the number of causes plus a possible sum value identified by the *.sum* suffix.
- e) *CC.RelCallsMgwInit.Cause*.
Where *Cause* identifies the H248 error code or H248 service change reason.(see ITU-T Recommendation H.248.8 [21]).
- f) *MgcfFunction*.
- g) Valid for packet switched traffic.
- h) IMS.

4.4.1.4 Number of simultaneous online and answered calls (Maximum)

- a) This measurement provides the maximum number of simultaneous online calls which have been answered in the MGCF.
- b) SI.
- a) This measurement is obtained by sampling at a pre-defined interval the number of simultaneous online calls which have been answered and then taking the maximum.
- b) A single integer value.
- c) *CC.NbrAnsCallMax*.
- d) *MgcfFunction*.
- e) Valid for circuit switched traffic.
- f) IMS.

4.4.1.5 Number of simultaneous online and answered calls (mean)

- a) This measurement provides the mean number of simultaneous online calls which have been answered in the MGCF.
- b) SI.
- c) This measurement is obtained by sampling at a pre-defined interval the number of simultaneous online calls which have been answered and then taking the arithmetic mean.
- d) A single integer value.
- e) *CC.NbrAnsCallMean*.
- f) *MgcfFunction*.
- g) Valid for circuit switched traffic.
- h) IMS.

4.5 Measurements related to IM-MGW

The measurements related to IM-MGW is the same with CS MGW defined in 3GPP TS 32.407[29].

4.6 Measurements related to MRFC

4.6.1 Session control related measurements

The measurements defined in subclauses 4.6.1.1, 4.6.1.2 and 4.6.1.4 are subject to the "2 out of 3 approach".

4.6.1.1 Attempted session establishments

- a) This measurement provides the number of attempted session establishments at MRFC.
- b) CC.
- c) On receipt by the MRFC of an initial SIP_INVITE message (see 3GPP TS 23.228 [7]).
- d) A single integer value.
- e) SC.AttSession.
- f) MrfcFunction.
- g) Valid for packet switched traffic.
- h) IMS.

4.6.1.2 Successful session establishments

- a) This measurement provides the number of successful session establishments at the MRFC. The measurement is split into subcounters per message type (e.g. SIP_180) indicating the successful session establishments.
- b) CC.
- c) On transmission by the MRFC of a response message (e.g. SIP_180) indicating a successful session establishment corresponding to the initial SIP_INVITE message (see 3GPP TS 23.228 [7]), each successful session is added to the relevant measurement according to the message type, the possible response message types are identified in 3GPP TS 24.229 [8]. The sum of all supported per message type measurements shall equal the total number of successful session establishments. In case only a subset of per message type measurements is supported, a sum subcounter will be provided first.
- d) Each measurement is an integer value. The number of measurements is equal to the number of message types plus a possible sum value identified by the *.sum* suffix.
- e) SC.SuccSession.*type*
where *type* identifies the message type.

The following subcounters with specific message types are the samples of this measurement:

SC.SuccSession.180 Message type: SIP_180

SC.SuccSession.200 Message type: SIP_200_OK only if the SIP_180 has not been sent for this session.

- f) MrfcFunction.
- g) Valid for packet switched traffic.
- h) IMS.

4.6.1.3 Answered session establishments

- a) This measurement provides the number of answered session establishments at the MRFC.
- b) CC.
- c) On transmission by the MRFC of a SIP_200_OK response message corresponding to the initial SIP_INVITE messages (see 3GPP TS 23.228 [7]).
- d) A single integer value.
- e) SC.AnsSession.
- f) MrfcFunction.
- g) Valid for packet switched traffic.
- h) IMS.

4.6.1.4 Failed session establishments

- a) This measurement provides the number of failed session establishments at the MRFC. The measurement is split into subcounters per response status codes.
- b) CC.
- c) On transmission by the MRFC of a response message (e.g. SIP_430) indicating a failed session establishment corresponding to the initial SIP_INVITE messages (see 3GPP TS 23.228 [7]), each failed session establishment is added to the relevant measurement according to the status code. The sum of all supported per status code measurements shall equal the total number of failed session establishments. In case only a subset of per cause measurements is supported, a sum subcounter will be provided first.
- d) Each measurement is an integer value. The number of measurements is equal to the number of status codes plus a possible sum value identified by the *.sum* suffix.
- e) The measurement name has the form *SC.FailSession.Cause* where *Cause* identifies the status code.
- f) MrfcFunction.
- g) Valid for packet switched traffic.
- h) IMS.

4.6.2 Multi-party sessions related measurements

The measurements defined in subclauses 4.6.2.1, 4.6.2.2 and 4.6.2.4 are subject to the "2 out of 3 approach".

The measurements defined in subclauses 4.6.2.5, 4.6.2.6 and 4.6.2.7 are subject to the "2 out of 3 approach".

4.6.2.1 Attempted session establishments for multi-party sessions

- a) This measurement provides the number of attempted session establishments for multi-party sessions at MRFC.
- b) CC.
- c) On receipt by the MRFC of an initial SIP_INVITE message for the multi-party sessions service (see 3GPP TS 23.228 [7]).
- d) A single integer value.
- e) SC.AttMultipartySession.
- f) MrfcFunction.

- g) Valid for packet switched traffic.
- h) IMS.

4.6.2.2 Successful session establishments for multi-party sessions

- a) This measurement provides the number of successful session establishments for multi-party sessions at the MRFC. The measurement is split into subcounters per message type (e.g. SIP_180) indicating the successful session establishments for multi-party sessions.
- b) CC.
- c) On transmission by the MRFC of a response message (e.g. SIP_180) indicating a successful session establishment corresponding to the initial SIP_INVITE message for the multi-party sessions service (see 3GPP TS 23.228 [7]), each successful session is added to the relevant measurement according to the message type, the possible response message types are identified in 3GPP TS 24.229 [8]. The sum of all supported per message type measurements shall equal the total number of successful session establishments for multi-party sessions. In case only a subset of per message type measurements is supported, a sum subcounter will be provided first.
- d) Each measurement is an integer value. The number of measurements is equal to the number of message types plus a possible sum value identified by the *.sum* suffix.
- e) SC.SuccMultipartSession.*type*
where *type* identifies the message type.

The following subcounters with specific message types are the samples of this measurement:

SC.SuccSession.180 Message type: SIP_180

SC.SuccSession.200 Message type: SIP_200_OK only if the SIP_180 has not been sent for this session.

- f) MrfcFunction.
- g) Valid for packet switched traffic.
- h) IMS.

4.6.2.3 Answered session establishments for multi-party sessions

- a) This measurement provides the number of answered session establishments for multi-party sessions at the MRFC.
- b) CC.
- c) On transmission by the MRFC of a SIP_200_OK response message corresponding to the initial SIP_INVITE messages for the multi-party sessions service (see 3GPP TS 23.228 [7]).
- d) A single integer value.
- e) SC.AnsMultipartSession.
- f) MrfcFunction.
- g) Valid for packet switched traffic.
- h) IMS.

4.6.2.4 Failed session establishments for multi-party sessions

- a) This measurement provides the number of failed session establishments for multi-party sessions at the MRFC. The measurement is split into subcounters per response status codes.
- b) CC.
- c) On transmission by the MRFC of a response message (e.g. SIP_430) indicating a failed session establishment corresponding to the initial SIP_INVITE message for the multi-party session service (see 3GPP TS 23.228 [7]),

each failed session establishment is added to the relevant measurement according to the status code. The sum of all supported per status code measurements shall equal the total number of failed session establishments for the multi-party sessions. In case only a subset of per cause measurements is supported, a sum subcounter will be provided first.

- d) Each measurement is an integer value. The number of measurements is equal to the number of status codes plus a possible sum value identified by the *.sum* suffix.
- e) The measurement name has the form *SC.FailMultipartySession.Cause* where *Cause* identifies the status code.
- f) *MrfcFunction*.
- g) Valid for packet switched traffic.
- h) IMS.

4.6.2.5 Attempted event subscription procedures for multi-party sessions

- a) This measurement provides the number of attempted event subscription procedures for multi-party sessions at MRFC.
- b) CC.
- c) On receipt by the MRFC of a SIP_SUBSCRIBE message for the multi-party sessions service (see 3GPP TS 23.228 [7] and RFC3265[22]).
- d) A single integer value.
- e) *SC.AttSubscribe*.
- f) *MrfcFunction*.
- g) Valid for packet switched traffic.
- h) IMS.

4.6.2.6 Successful event subscription procedures for multi-party sessions

- a) This measurement provides the number of successful event subscription procedures for multi-party sessions at MRFC.
- b) CC.
- c) On transmission by the MRFC of a SIP_200_OK message corresponding to the SIP_SUBSCRIBE message for the multi-party sessions service (see 3GPP TS 23.228 [7] and RFC3265[22]).
- d) A single integer value.
- e) *SC.SuccSubscribe*.
- f) *MrfcFunction*.
- g) Valid for packet switched traffic.
- h) IMS.

4.6.2.7 Failed event subscription procedures for multi-party sessions

- a) This measurement provides the number of failed event subscription procedures for multi-party sessions at MRFC. The measurement is split into subcounters per response status codes.
- b) CC.
- c) On transmission by the MRFC of a response message (e.g. SIP_430) indicating a failed event subscription procedure corresponding to the initial SIP_SUBSCRIBE message for the multi-party session service (see 3GPP TS 23.228 [7] and RFC3265[22]), each failed event subscription procedure is added to the relevant measurement according to the status code. The sum of all supported per status code measurements shall equal the total number of failed event subscription procedures for the multi-party sessions. In case only a subset of per cause measurements is supported, a sum subcounter will be provided first.
- d) Each measurement is an integer value. The number of measurements is equal to the number of status codes plus a possible sum value identified by the *.sum* suffix.
- e) The measurement name has the form *SC.FailSubscribe.Cause* where *Cause* identifies the status code.
- f) *MrfcFunction*.
- g) Valid for packet switched traffic.
- h) IMS.

4.6.3 Announcement service related measurements

The measurements defined in subclauses 4.6.3.1, 4.6.3.2 and 4.6.3.4 are subject to the "2 out of 3 approach".

4.6.3.1 Attempted session establishments for announcements

- a) This measurement provides the number of attempted session establishments for announcements at MRFC.
- b) CC.
- c) On receipt by the MRFC of an initial SIP_INVITE message for the announcement service (see 3GPP TS 23.228 [7]).
- d) A single integer value.
- e) *SC.AttAnnounce*.
- f) *MrfcFunction*.
- g) Valid for packet switched traffic.
- h) IMS.

4.6.3.2 Successful session establishments for announcements

- a) This measurement provides the number of successful session establishments for announcements at the MRFC. The measurement is split into subcounters per message type (e.g. SIP_180) indicating the successful session establishments for announcements.
- b) CC.
- c) On transmission by the MRFC of a response message (e.g. SIP_180) indicating a successful session establishment corresponding to the initial SIP_INVITE message for the announcement service (see 3GPP TS 23.228 [7]), each successful session is added to the relevant measurement according to the message type, the possible response message types are identified in 3GPP TS 24.229 [8]. The sum of all supported per message type measurements shall equal the total number of successful session establishments for announcements. In case only a subset of per message type measurements is supported, a sum subcounter will be provided first.

d) Each measurement is an integer value. The number of measurements is equal to the number of message types plus a possible sum value identified by the *.sum* suffix.

e) SC.SuccAnnounce.*type*
where *type* identifies the message type.

The following subcounters with specific message types are the samples of this measurement:

SC.SuccSession.180 Message type: SIP_180

SC.SuccSession.200 Message type: SIP_200_OK only if the SIP_180 has not been sent for this session.

f) MrfcFunction.

g) Valid for packet switched traffic.

h) IMS.

4.6.3.3 Answered session establishments for announcements

a) This measurement provides the number of answered session establishments for announcements at the MRFC.

b) CC.

c) On transmission by the MRFC of a SIP_200_OK response message corresponding to the initial SIP_INVITE messages for the announcement service (see 3GPP TS 23.228 [7]).

d) A single integer value.

e) SC.AnsAnnounce.

f) MrfcFunction.

g) Valid for packet switched traffic.

h) IMS.

4.6.3.4 Failed session establishments for announcements

a) This measurement provides the number of failed session establishments for announcements at the MRFC. The measurement is split into subcounters per response status codes.

b) CC.

c) On transmission by the MRFC of a response message (e.g. SIP_430) indicating a failed session establishment corresponding to the initial SIP_INVITE message for the announcement service (see 3GPP TS 23.228 [7]), each failed session establishment is added to the relevant measurement according to the status code. The sum of all supported per status code measurements shall equal the total number of failed session establishments for the announcements. In case only a subset of per cause measurements is supported, a sum subcounter will be provided first.

d) Each measurement is an integer value. The number of measurements is equal to the number of status codes plus a possible sum value identified by the *.sum* suffix.

e) The measurement name has the form SC.FailAnnounce.*Cause*
where *Cause* identifies the status code.

f) MrfcFunction.

g) Valid for packet switched traffic.

h) IMS.

4.6.4 Transcoding service related measurements

The measurements defined in subclauses 4.6.4.1, 4.6.4.2 and 4.6.4.4 are subject to the "2 out of 3 approach".

4.6.4.1 Attempted session establishments for transcoding service

- a) This measurement provides the number of attempted session establishments for transcoding service at MRFC.
- b) CC.
- c) On receipt by the MRFC of an initial SIP_INVITE message for the transcoding service (see 3GPP TS 23.228 [7]).
- d) A single integer value.
- e) SC.AttTranscoding.
- f) MrfcFunction.
- g) Valid for packet switched traffic.
- h) IMS.

4.6.4.2 Successful session establishments for transcoding service

- a) This measurement provides the number of successful session establishments for transcoding service at the MRFC. The measurement is split into subcounters per message type (e.g. SIP_180) indicating the successful session establishments for transcoding service.
- b) CC.
- c) On transmission by the MRFC of a response message (e.g. SIP_180) indicating a successful session establishment corresponding to the initial SIP_INVITE message for the transcoding service (see 3GPP TS 23.228 [7]), each successful session is added to the relevant measurement according to the message type, the possible response message types are identified in 3GPP TS 24.229 [8]. The sum of all supported per message type measurements shall equal the total number of successful session establishments for transcoding service. In case only a subset of per message type measurements is supported, a sum subcounter will be provided first.
- d) Each measurement is an integer value. The number of measurements is equal to the number of message types plus a possible sum value identified by the *.sum* suffix.
- e) SC.SuccTranscoding.*type*
where *type* identifies the message type.

The following subcounters with specific message types are the samples of this measurement:

SC.SuccSession.180	Message type: SIP_180
SC.SuccSession.200	Message type: SIP_200_OK only if the SIP_180 has not been sent for this session.

- f) MrfcFunction.
- g) Valid for packet switched traffic.
- h) IMS.

4.6.4.3 Answered session establishments for transcoding service

- a) This measurement provides the number of answered session establishments for transcoding service at the MRFC.
- b) CC.
- c) On transmission by the MRFC of a SIP_200_OK response message corresponding to the initial SIP_INVITE messages for the transcoding service (see 3GPP TS 23.228 [7]).
- d) A single integer value.
- e) SC.AnsTranscoding.
- f) MrfcFunction.
- g) Valid for packet switched traffic.
- h) IMS.

4.6.4.4 Failed session establishments for transcoding service

- a) This measurement provides the number of failed session establishments for transcoding service at the MRFC. The measurement is split into subcounters per response status codes.
- b) CC.
- c) On transmission by the MRFC of a response message (e.g. SIP_430) indicating a failed session establishment corresponding to the initial SIP_INVITE message for the transcoding service (see 3GPP TS 23.228 [7]), each failed session establishment is added to the relevant measurement according to the status code. The sum of all supported per status code measurements shall equal the total number of failed session establishments for the transcoding service. In case only a subset of per cause measurements is supported, a sum subcounter will be provided first.
- d) Each measurement is an integer value. The number of measurements is equal to the number of status codes plus a possible sum value identified by the *.sum* suffix.
- e) The measurement name has the form SC.FailTranscoding.*Cause* where *Cause* identifies the status code.
- f) MrfcFunction.
- g) Valid for packet switched traffic.
- h) IMS.

4.7 Measurements related to MRFP

4.7.1 RTP related measurements

Performance Measurement definitions in this subclause are only valid if the RTP protocol is used at the MRFP.

4.7.1.1 Number of incoming RTP packets

- a) This measurement provides the number of incoming RTP packets at MRFP.
- b) CC.
- c) On receipt by the MRFP of a RTP packet (see RFC 3550 [23]).
- d) A single integer value.
- e) RTP.IncPacket.
- f) MrfpFunction.
- g) Valid for packet switched traffic.
- h) IMS.

4.7.1.2 Number of outgoing RTP packets

- a) This measurement provides the number of outgoing RTP packets at MRFP.
- b) CC.
- c) On transmission by the MRFP of a RTP packet (see RFC 3550 [23]).
- d) A single integer value.
- e) RTP.IncPacket.
- f) MrfpFunction.
- g) Valid for packet switched traffic.
- h) IMS.

4.7.1.3 Number of octets of incoming RTP packets

- a) This measurement provides the number of octets of incoming RTP packets at MRFP.
- b) DER (n=1).
- c) This measurement is obtained by accumulating the number of incoming RTP packet octets (bytes) on receipt by the MRFP of a RTP packet (see RFC 3550 [23]).
- d) A single integer value.
- e) RTP.IncOctet.
- f) MrfpFunction.
- g) Valid for packet switched traffic.
- h) IMS.

4.7.1.4 Number of octets of outgoing RTP packets

- a) This measurement provides the number of octets of outgoing RTP packets at MRFP.
- b) DER (n=1).
- c) This measurement is obtained by accumulating the number of outgoing RTP packet octets (bytes) on transmission by the MRFP of a RTP packet (see RFC 3550 [23]).
- d) A single integer value.
- e) RTP.IncOctet.
- f) MrfpFunction.
- g) Valid for packet switched traffic.
- h) IMS.

4.7.1.5 Number of lost incoming RTP packets

- a) This measurement provides the number of lost incoming RTP packets.
- b) CC.
- c) On detection of loss of an incoming RTP packet by the MRFP (see RFC 3550 [23]).
- d) A single integer value.
- e) RTP.LostIncPacket.
- f) MrfpFunction.
- g) Valid for packet switched traffic.
- h) IMS.

4.8 Measurements related to PDF

The measurements related to PDF are restricted to R6 network architecture.

Editor's note: PdfFunction used in following text is a subject for further study of IMS NRM modelling for R7 requirements and working 3GPP/3GPP2 IMS NRM alignment.

4.8.1 Authorization of QoS resources related measurements

The five measurement types defined in this subclause are subject to the "4 out of 5 approach".

4.8.1.1 Overview

The measurements defined in subclause 4.8.1 are related to procedures of QoS resource authorization. AF initiates a Diameter transaction to PDF for authorizing the resources in the session establishment or modification. PDF authorizes the resources based on SBLP and service information.

The procedure is shown in figure 16.

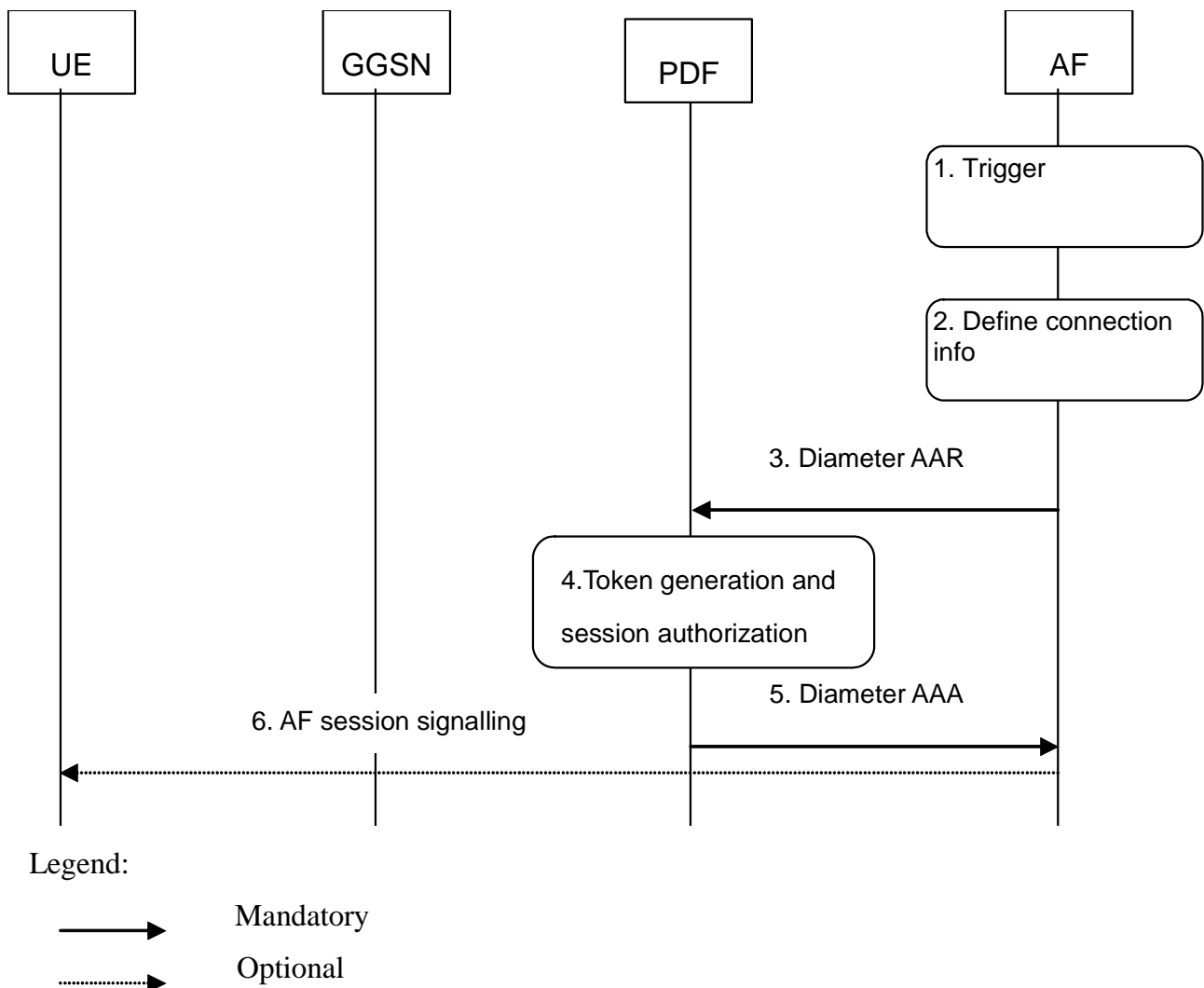

Figure 16: Resource authorization procedure

4.8.1.2 Attempted resource authorization procedures at session establishment

- a) This measurement provides the number of attempted resource authorizations initiated by P-CSCF to PDF when establishing new sessions.
- b) CC.
- c) On receipt by the PDF of an AAR Diameter command from P-CSCF with a new session ID (see 3GPP TS 29.208[14]).
- d) A single integer value.
- e) QoS.AttAARSessionEstab.
- f) PdfFunction.
- g) Valid for packet switched traffic.
- h) IMS

4.8.1.3 Attempted resource authorization procedures at session modification

- a) This measurement provides the number of attempted resource authorizations initiated by P-CSCF to PDF when modifying the existing sessions.
- b) CC.
- c) On receipt by the PDF of an AAR Diameter command from P-CSCF to modify an existing session (see 3GPP TS 29.208 [14]).
- d) A single integer value.
- e) QoS.AttAARSessionModf.
- f) PdfFunction.
- g) Valid for packet switched traffic.
- h) IMS.

4.8.1.4 Successful resource authorization procedures at session establishment

- a) This measurement provides the number of successful resource authorizations initiated by P-CSCF to PDF when establishing new sessions.
- b) CC.
- c) On transmission by the PDF of an AAA Diameter command to P-CSCF with a new stored session ID and "2xxxx" result-code (see 3GPP TS 29.208[14], RFC 3588 [15]).
- d) A single integer value.
- e) QoS.SuccAAASessionEstab.
- f) PdfFunction.
- g) Valid for packet switched traffic.
- h) IMS.

4.8.1.5 Successful resource authorization procedures at session modification

- a) This measurement provides the number of successful resource authorizations initiated by P-CSCF to PDF when modifying the existing sessions.
- b) CC.
- c) On transmission by the PDF of an AAA Diameter command to P-CSCF with an existing session ID and "2xxxx" result-code (see 3GPP TS 29.208 [14], RFC 3588 [15]).
- d) A single integer value.
- e) QoS.SuccAAASessionModf.
- f) PdfFunction.
- g) Valid for packet switched traffic.
- h) IMS.

4.8.1.6 Failed resource authorization procedures

- a) This measurement provides the number of failed resource authorizations initiated by P-CSCF to PDF.
- b) CC.
- c) On transmission by the PDF of an AAA Diameter command to P-CSCF with non-2xxx result-code (see 3GPP TS 29.208 [14], RFC 3588 [15]). Each failed resource authorization procedure will be added to the relevant measurement according to the failure cause. Possible failure causes are included in RFC 3588 [15]. The sum of all supported per cause measurements shall equal the total number of failed resource authorization procedures. In case only a subset of per cause measurements is supported, a sum subcounter will be provided first.
- d) Each measurement is an integer value. The number of measurements is equal to the number of causes plus a possible sum value identified by the *.sum* suffix.
- e) The measurement name has the form QoS.FailAAA.*Cause* where *Cause* identifies the failure cause.
- f) PdfFunction.
- g) Valid for packet switched traffic.
- h) IMS.

4.8.2 Resource reservation related measurements

The four measurement types defined in this subclause are subject to the "3 out of 4 approach".

4.8.2.1 Overview

The measurements defined in subclause 4.8.2 are related to resource reservation procedures.

The procedure is shown in the following figure.

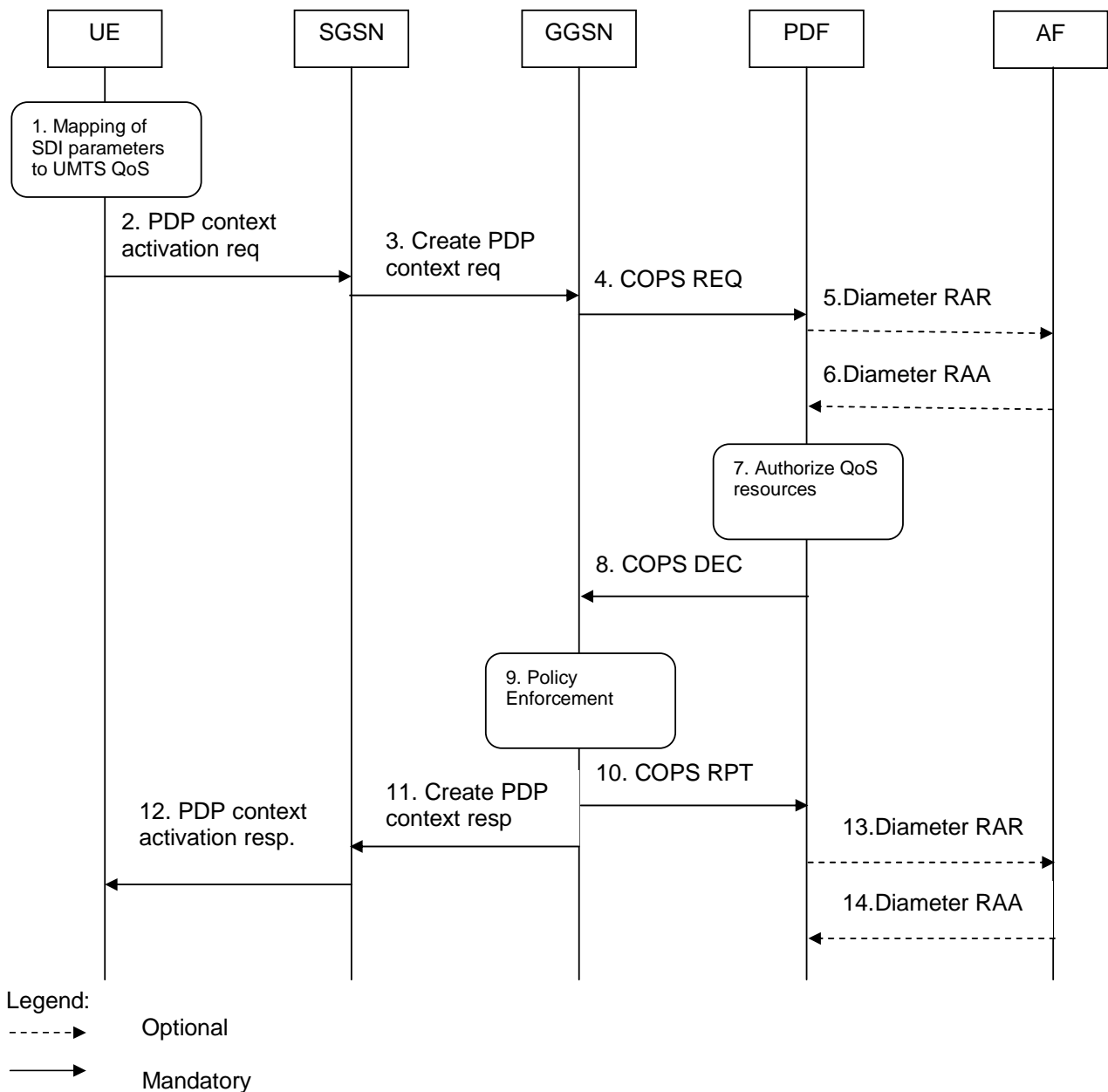

Figure 17: Resource reservation procedure

4.8.2.2 Attempted resource reservation procedures

- a) This measurement provides the number of attempted resource reservation procedures initiated by GGSN to PDF.
- b) CC.
- c) On receipt by the PDF of COPS REQ message from GGSN (see 3GPP TS 29.207[13]).
- d) A single integer value.
- e) QoS.AttResRsv.
- f) PdfFunction.
- g) Valid for packet switched traffic.
- h) IMS.

4.8.2.3 Successful resource reservation procedures

- a) This measurement provides the number of successful resource reservation procedures initiated by GGSN to PDF.
- b) CC.
- c) On receipt by the PDF of a COPS RPT message from GGSN indicating a successful resource reservation procedure (see 3GPP TS 29.207[13]).
- d) A single integer value.
- e) QoS.SuccResRsv.
- f) PdfFunction.
- g) Valid for packet switched traffic.
- h) IMS.

4.8.2.4 Failed resource reservation procedures by PDF

- a) This measurement provides the number of resource reservation failures caused by the authorization failure in PDF. This measurement is split into subcounters per failure cause.
- b) CC.
- c) On transmission by the PDF of a COPS DEC message containing both an INSTALL and a REMOVE decisions to GGSN (see 3GPP TS 29.207[13]).
- d) Three integer values.
- e) QoS.FailResRsvPdf.1 Failure cause "NoCorrespondingSession".
 QoS.FailResRsvPdf.2 Failure cause "InvalidBundling".
 QoS.FailResRsvPdf.3 Failure cause "AuthorisationFailure".
- f) PdfFunction.
- g) Valid for packet switched traffic.
- h) IMS.

4.8.2.5 Failed resource reservation procedures by GGSN

- a) This measurement provides the number of resource reservation failures caused by the enforcement failure in GGSN.

- b) CC.
- c) On receipt by the PDF of a COPS RPT message with a failure result from GGSN, corresponding to the transmission of the COPS DEC message containing only an INSTALL decision to GGSN (see 3GPP TS 29.207 [13]).
- d) A single integer value.
- e) QoS.FailResRsvGgsn.
- f) PdfFunction.
- g) Valid for packet switched traffic.
- h) IMS.

4.8.3 PDP context modification related measurements

The measurements defined in subclauses 4.8.3.1, 4.8.3.2 and 4.8.3.3 are subject to the "2 out of 3 approach".

4.8.3.1 Attempted authorization of PDP context modification

- a) This measurement provides the number of attempted authorizations of PDP context modifications initiated by GGSN.
- b) CC.
- c) On receipt by the PDF of a COPS REQ message from GGSN to authorize a PDP context modification request (see 3GPP TS 29.207 [13]).
- d) A single integer value.
- e) QoS.AttPdpContextModfAuth.
- f) PdfFunction.
- g) Valid for packet switched traffic.
- h) IMS.

4.8.3.2 Successful authorization of PDP context modification

- a) This measurement provides the number of successful authorizations of PDP context modifications initiated by GGSN.
- b) CC.
- c) On transmission by the PDF of a COPS DEC message containing only an INSTALL decision to GGSN, in response to a PDP context modification request from GGSN, indicating a successful authorization of PDP context modification (see 3GPP TS 29.207 [13]).
- d) A single integer value.
- e) QoS.SuccPdpContextModfAuth.
- f) PdfFunction.
- g) Valid for packet switched traffic.
- h) IMS.

4.8.3.3 Failed authorization of PDP context modification

- a) This measurement provides the number of failed authorizations of PDP context modifications initiated by GGSN.
- b) CC.
- c) On transmission by the PDF of a COPS DEC message containing an INSTALL decision and a REMOVE decision to GGSN, corresponding to the receipt of the PDP context modification request from GGSN (see 3GPP TS 29.207 [13]).
- d) A single integer value.
- e) QoS.FailPDPContextModfAuth.
- f) PdfFunction.
- g) Valid for packet switched traffic.
- h) IMS.

4.8.3.4 Indication of PDP context modification

- a) This measurement provides the number of PDP context modifications to/from 0kbps initiated by GGSN.
- b) CC.
- c) On receipt by the PDF of a COPS RPT message indicating the PDP context modification to/from 0kbps from GGSN (see 3GPP TS 29.207 [13]).
- d) A single integer value.
- e) QoS.IndPdpContextModf.
- f) PdfFunction.
- g) Valid for packet switched traffic.
- h) IMS.

4.9 Measurements related to SLF

4.9.1 All routing information interrogations related measurements

4.9.1.1 Attempted routing information interrogation procedures

- a) This measurement provides the number of all routing information interrogation requests received by the SLF via all diameter application interfaces. The diameter interfaces can be Dx interface, Dh interface or Dw interface.
- b) CC.
- c) On receipt by the SLF of a routing information interrogation request diameter message from all diameter interfaces (see 3GPP TS 23.228 [7] and RFC 3588[15]).
- d) A single integer value.
- e) RII.AttAll.
- f) SlfFunction.
- g) Valid for packet switched traffic.
- h) IMS.

4.9.1.2 Successful routing information interrogation procedures

- a) This measurement provides the number of all successful routing information interrogation responses sent by the SLF via all diameter application interfaces. The diameter interfaces can be Dx interface, Dh interface or Dw interface.
- b) CC.
- c) On transmission by the SLF of a routing information interrogation response diameter message with the Result-Code AVP set to DIAMETER_REDIRECT_INDICATION via all diameter interfaces, indicating a successful routing information interrogation (see 3GPP TS 23.228 [7] and RFC 3588 [15]).
- d) A single integer value.
- e) RII.SuccAll
- f) SlfFunction.
- g) Valid for packet switched traffic.
- h) IMS.

4.9.2 Routing information interrogation from CSCF related measurements

4.9.2.1 Overview

The performance measurements defined in subclause 4.9.2 are related to routing information interrogations at the SLF from CSCF.

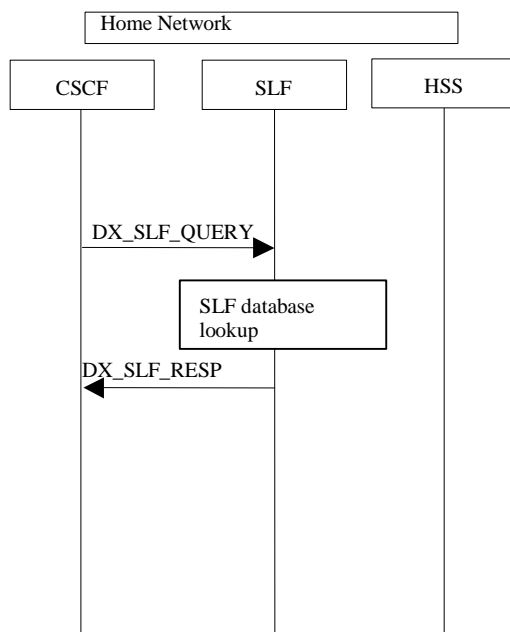

Figure 18: Routing information interrogation procedure from CSCF

4.9.2.2 Attempted routing information interrogation procedures from CSCF

- a) This measurement provides the number of routing information interrogation requests received from CSCF by the SLF.
- b) CC.
- c) On receipt by the SLF of a DX_SLF_QUERY message from CSCF via Dx interface (see 3GPP TS 23.228 [7]).
- d) A single integer value.
- e) RII.AttFromCSCF.
- f) SlfFunction.
- g) Valid for packet switched traffic.
- h) IMS.

4.9.2.3 Successful routing information interrogation procedures from CSCF

- a) This measurement provides the number of successful routing information interrogation responses sent to CSCF by the SLF.
- b) CC.
- c) On transmission by the SLF of a DX_SLF_RESP message with the Result-Code AVP set to DIAMETER_REDIRECT_INDICATION to CSCF via Dx interface (see 3GPP TS 23.228 [7] and RFC 3588[15]).
- d) A single integer value.
- e) RII.SuccFromCSCF.
- f) SlfFunction.
- g) Valid for packet switched traffic.
- h) IMS.

4.9.3 Routing information interrogation from AS related measurements

4.9.3.1 Overview

The performance measurements defined in subclause 4.9.3 are related to routing information interrogations at the SLF from AS.

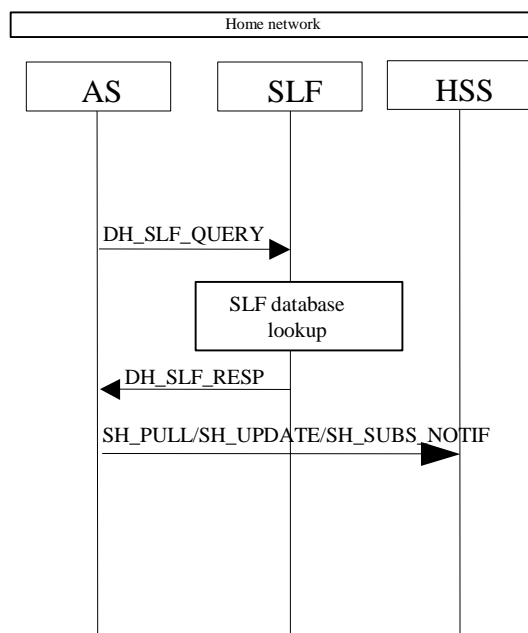

Figure 19: Routing information interrogation procedure from AS

4.9.3.2 Attempted routing information interrogation procedures from AS

- This measurement provides the number of routing information interrogations requests received from AS by the SLF.
- CC.
- On receipt by the SLF of a DH_SLF_QUERY message from AS via Dh interface (see 3GPP TS 23.228 [7]).
- A single integer value.
- RII.AttFromAS.
- SlfFunction.
- Valid for packet switched traffic.
- IMS.

4.9.3.3 Successful routing information interrogation procedures from AS

- This measurement provides the number of successful routing information interrogation responses sent to AS by the SLF.
- CC.
- On transmission by the SLF of a DH_SLF_RESP message with the Result-Code AVP set to DIAMETER_REDIRECT_INDICATION to AS via Dh interface (see 3GPP TS 23.228 [7] and RFC 3588[15]).
- A single integer value.

- e) RII.SuccFromAS.
- f) SlfFunction.
- g) Valid for packet switched traffic.
- h) IMS.

4.10 Measurements related to AS

4.10.1 Session control related measurements

4.10.1.1 IM CN originated session establishments

For the IM CN originated session establishments AS may act as terminating UA, redirect server, a SIP proxy, routing B2BUA or initiating B2BUA. See 3GPP TS 24.229 [8] or 3GPP TS 23.228 [7].

4.10.1.1.1 Attempted IM CN originated session establishments

- a) This measurement provides the number of attempted session establishments originated from the IM CN.
- b) CC.
- c) On receipt by the AS of an initial SIP_INVITE message from the IM CN (see 3GPP TS 23.228 [7]).
- d) A single integer value.
- e) SC.AttSessionImOrig.
- f) ASFunction.
- g) Valid for packet switched traffic.
- h) IMS.

4.10.1.1.2 Successful IM CN originated session establishments

- a) This measurement provides the number of successful session establishments originated from the IM CN.
- b) CC.
- c) On transmission by the AS of the first response message (e.g. SIP_180, SIP_200 or SIP_302 etc. relating with the role of the AS) indicating a successful IM CN originated session establishment corresponding to the initial SIP_INVITE message, each successful session establishment is added to the relevant measurement according to the message type, the possible response message types are identified in 3GPP TS 24.229 [8]. The sum of all supported per message type measurements shall equal the total number of successful IM CN originated session establishments.
- d) Each measurement is an integer value. The number of measurements is equal to the number of message types plus a possible sum value identified by the *.sum* suffix.
- e) SC.SuccSessionImOrig.*type*
where *type* identifies the message type.

The following subcounters with specific message types are the samples of this measurement:

SC.SuccSession.180	Message type: SIP_180
SC.SuccSession.200	Message type: SIP_200_OK only if the SIP_180 has not been sent for this session.

- f) ASFunction.
- g) Valid for packet switched traffic.
- h) IMS.

4.10.1.2 AS originated session establishments

For the AS originated session establishments, AS may act as originating UA, routing B2BUA or initiating B2BUA. See 3GPP TS 24.229 [8] or 3GPP TS 23.228[7].

4.10.1.2.1 Attempted AS originated session establishments

- a) This measurement provides the number of attempted session establishments originated from the AS.
- b) CC.
- c) On transmission by the AS of an initial SIP_INVITE message indicating the AS originated session establishment, each initial SIP_INVITE message originated by the AS shall be counted as one attempted AS originated session establishment.
 If the AS acts as originating UA, it initiates a session by sending a SIP_INVITE message.
 If the AS acts as routing B2BUA, it terminates the request from IM CN and initiates a new session by sending a SIP_INVITE message.
 If the AS acts as initiating B2BUA, it may initiate two new sessions by sending two SIP_INVITE messages, or initiates one new session in the case of receiving the request from the IM CN and the new session is logically connected but unrelated to the incoming request (see 3GPP TS 24.229 [8]).
- d) A single integer value.
- e) SC.AttSessionAsOrig.
- f) ASFunction.
- g) Valid for packet switched traffic.
- h) IMS.

4.10.1.2.2 Successful AS originated session establishments

- a) This measurement provides the number of successful session establishments originated from the AS.
- b) CC.
- c) On receipt of the first response message (e.g. SIP_180, SIP_200, etc.) indicating a successful AS originated session establishment corresponding to the initial SIP_INVITE message originated by the AS, each successful session establishment is added to the relevant measurement according to the message type, the possible response message types are identified in 3GPP TS 24.229 [8]. The sum of all supported per message type measurements shall equal the total number of successful AS originated session establishments.
- d) Each measurement is an integer value. The number of measurements is equal to the number of message types plus a possible sum value identified by the *.sum* suffix.
- e) SC.SuccSessionAsOrig.*type*
 where *type* identifies the message type.

The following subcounters with specific message types are the samples of this measurement:

SC.SuccSession.180 Message type: SIP_180

SC.SuccSession.200 Message type: SIP_200_OK only if the SIP_180 has not been received for this session.

- f) AsFunction.
- g) Valid for packet switched traffic.
- h) IMS.

4.10.2 Messaging service related measurements

4.10.2.1 Message related measurements, Page-Mode

4.10.2.1.1 Attempted incoming messages, Page-Mode

- a) This measurement provides number of attempted incoming messages received by the messaging enabler with page-mode at the AS.
- b) CC.
- c) On receipt by the AS (messaging enabler) of an initial SIP_MESSAGE message (see 3GPP TS 23.228 [7]).
- d) A single integer value.
- e) MSG.AttIncMessagePM.
- f) AsFunction.
- g) Valid for packet switched traffic.
- h) IMS.

4.10.2.1.2 Successful incoming messages, Page-Mode

- a) This measurement provides number of successful incoming messages with page-mode at the AS.
- b) CC.
- c) On transmission by the AS (messaging enabler) of a response SIP_2XX message (see 3GPP TS 24.229 [8]) indicating the incoming message is successfully forwarded.
- d) A single integer value.
- e) MSG.SuccIncMessagePM.
- f) AsFunction.
- g) Valid for packet switched traffic.
- h) IMS.

4.10.2.1.3 Attempted outgoing messages, Page-Mode

- a) This measurement provides number of attempted outgoing messages transmitted by the messaging enabler with page-mode at the AS.
- b) CC.
- c) On transmission by the AS (messaging enabler) of a SIP_MESSAGE message (see 3GPP TS 23.228 [7]).
- d) A single integer value.
- e) MSG.AttOutMessagePM.
- f) AsFunction.
- g) Valid for packet switched traffic.
- h) IMS.

4.10.2.1.4 Successful outgoing messages, Page-Mode

- a) This measurement provides number of successful outgoing messages transmitted by the messaging enabler with page-mode at the AS.
- b) CC.
- c) On receipt by the AS (messaging enabler) of a response SIP_2XX message (see 3GPP TS 24.229 [8]) indicating the message transmitted by the AS is successfully processed.
- d) A single integer value.
- e) MSG.SuccOutMessagePM.
- f) AsFunction.
- g) Valid for packet switched traffic.
- h) IMS.

4.10.2.2 Message related measurements, Session-Mode

4.10.2.2.1 Overview

The performance measurements defined in this subclause are related to message sending with session mode. The following procedure shows the session based messaging with an intermediate AS node. See 3GPP TS 23.228 [7].

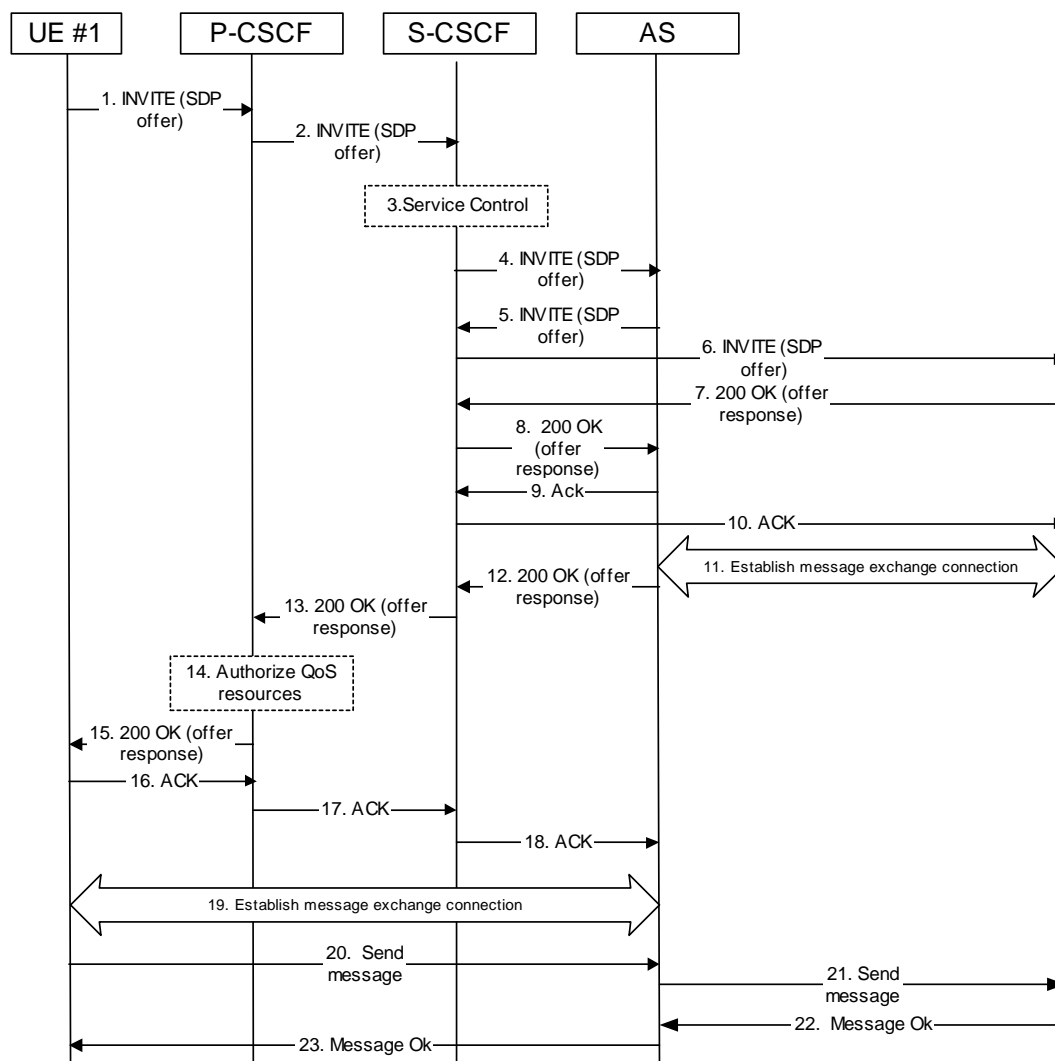

Figure 20: Session based messaging with an intermediate AS node scenario

4.10.2.2.2 Attempted messaging session establishments, Session Mode

- This measurement provides number of attempted messaging session establishments for the two participants received by the messaging enabler with session-mode at the AS.
- CC.
- On receipt by the AS (messaging enabler) of an initial SIP_INVITE message initiated by a participant which requests to establish sessions just for the two participants for the messaging service (see 3GPP TS 29.228 [9]).
- A single integer value.
- MSG.AttSessionSM.
- AsFunction.
- Valid for packet switched traffic.
- IMS.

4.10.2.2.3 Successful messaging session establishments, Session-Mode

- a) This measurement provides number of successful messaging session establishments by the messaging enabler for the two participants with session-mode at the AS.
- b) CC.
- c) On transmission by the AS (messaging enabler) of a SIP_200_OK message indicating a successful messaging session establishment for the two participants of Messaging Service (see 3GPP TS 29.228 [9]).
- d) A single integer value.
- e) MSG.SuccSessionSM.
- f) AsFunction.
- g) Valid for packet switched traffic.
- h) IMS.

4.10.3 Conference service related measurements

4.10.3.1 Overview

The performance measurements defined in this subclause are related to the conference service (see 3GPP TS 24.147 [24]).

The following procedures are of interest for this purpose:

- User creating a conference;
- User joining a conference;
- AS inviting a user to a conference;
- User subscribing to the conference event package.

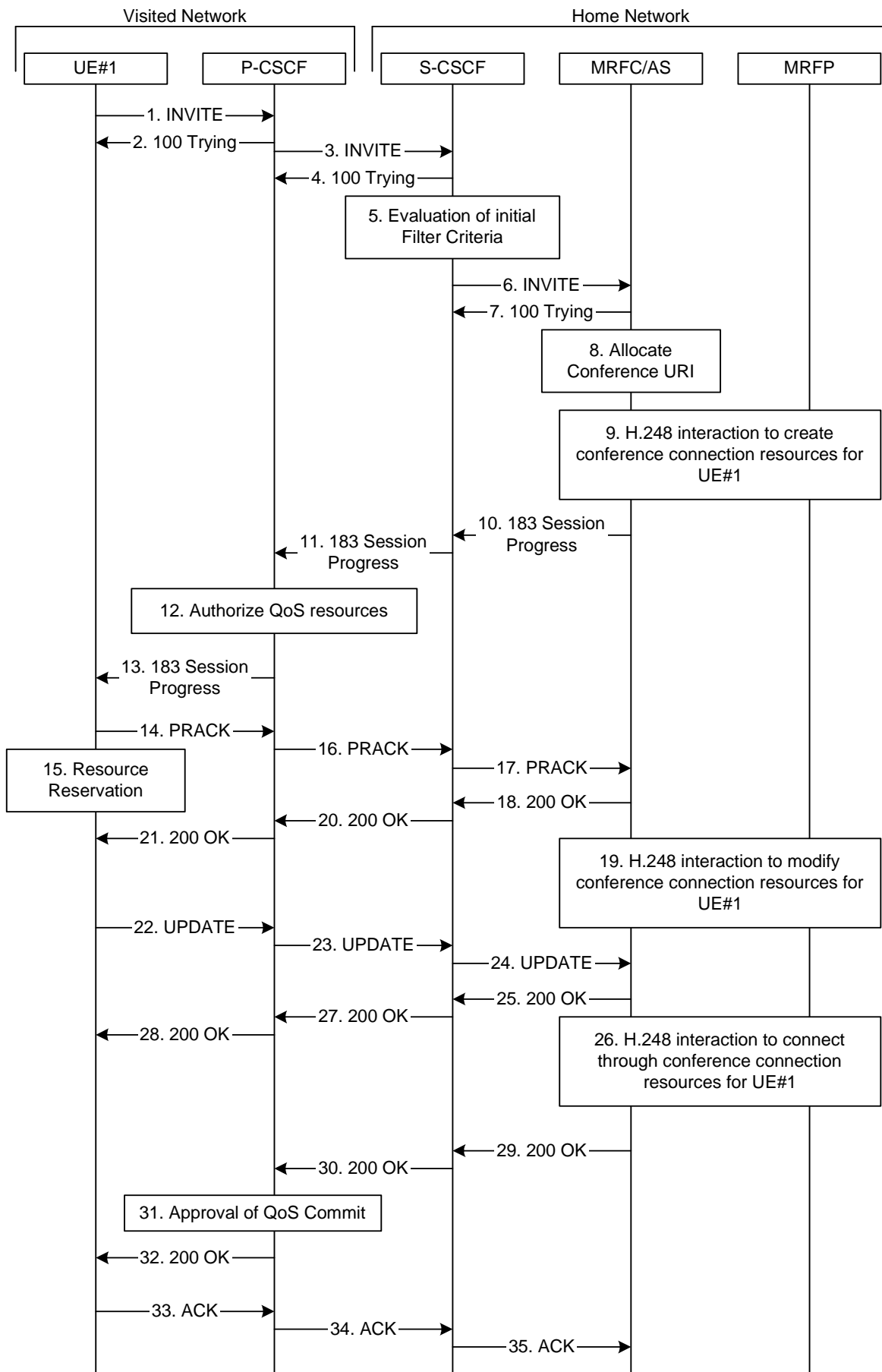

Figure 21: User automatically creating a conference - MRFC/AS is located in user's home network

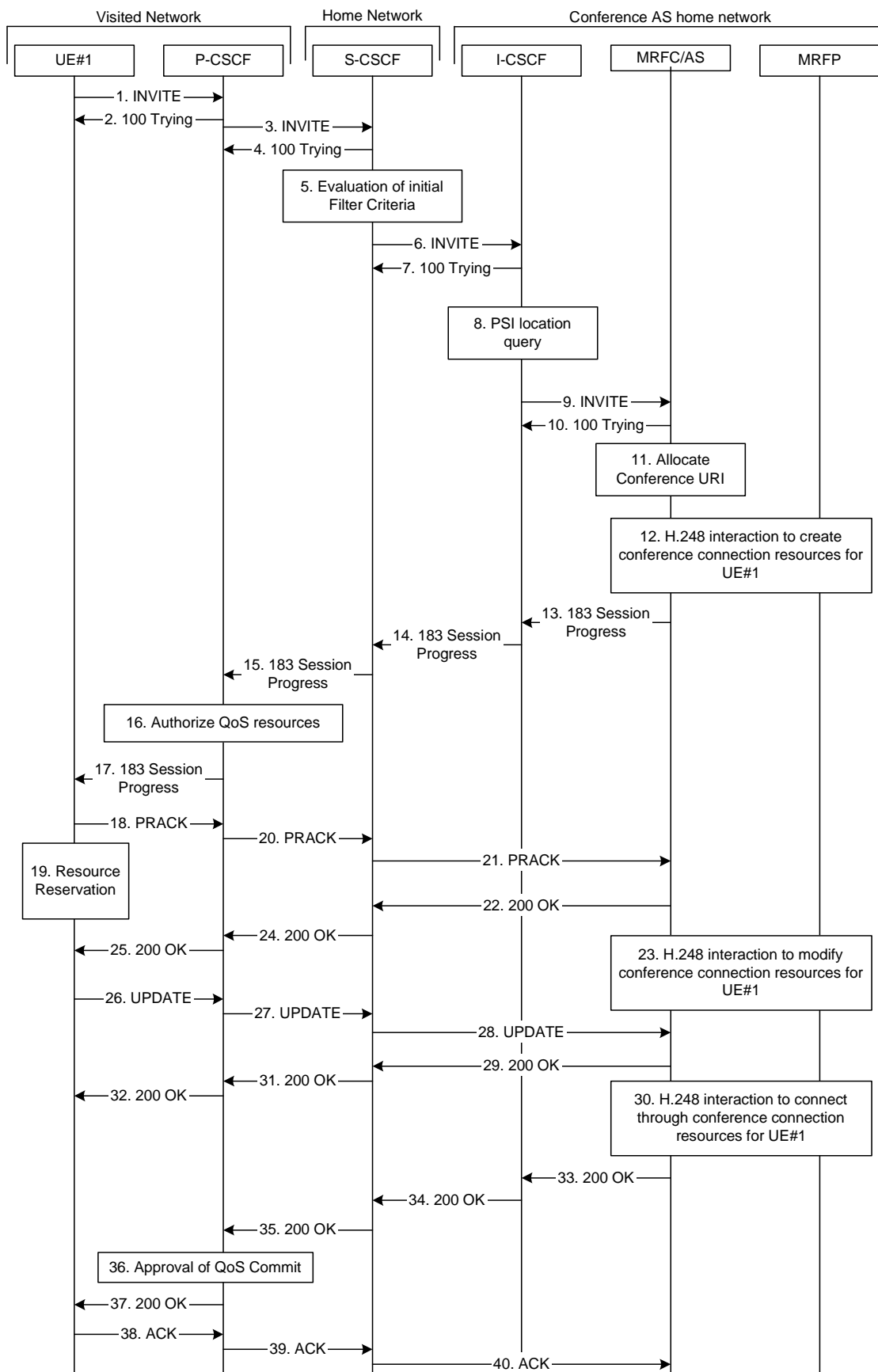

Figure 22: User automatically creating a conference - MRFC/AS is not located in user's home network

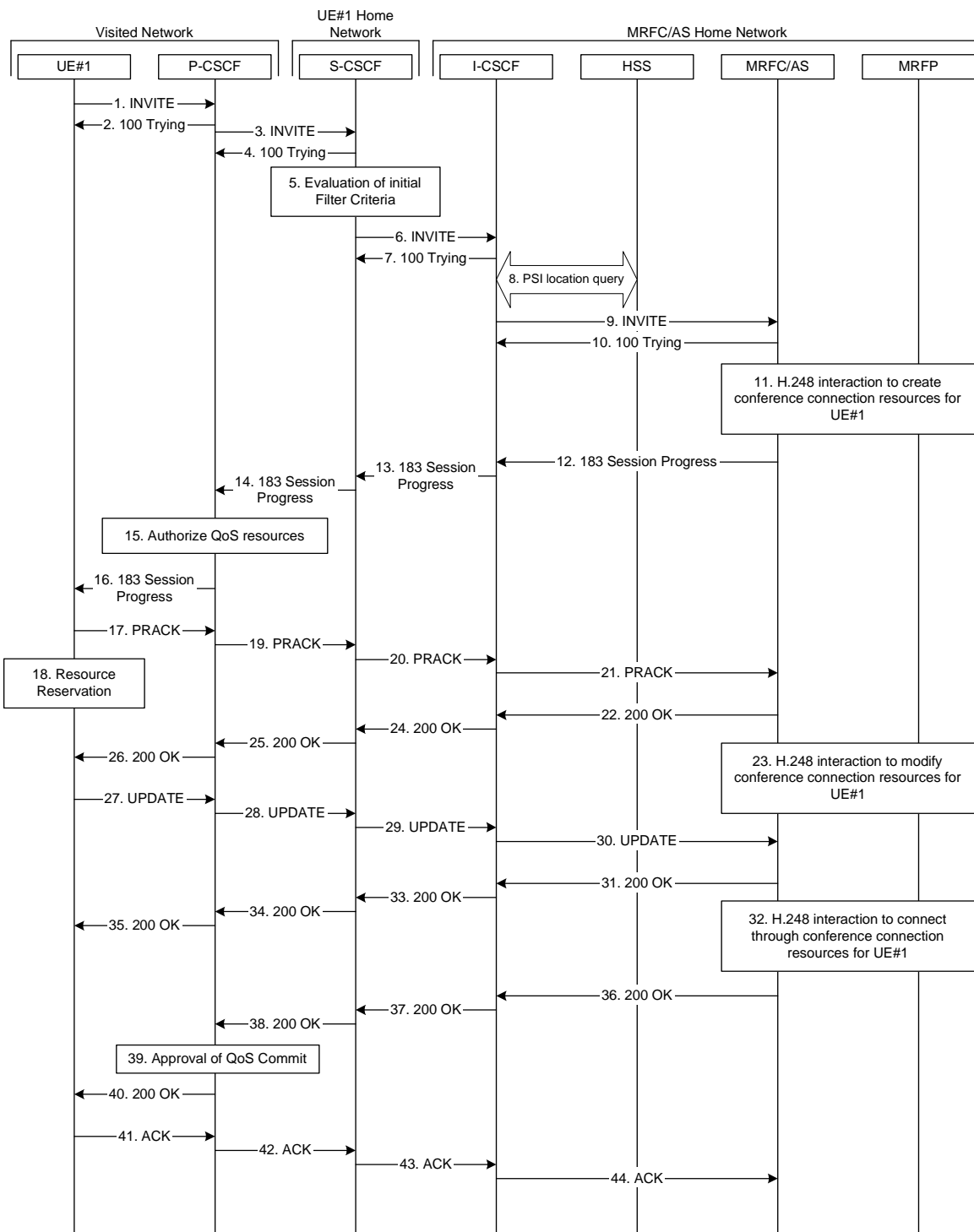

Figure 23: User calling into a conference - network MRFC/AS is not located in user's home network - conference URI resolved by the terminating home network

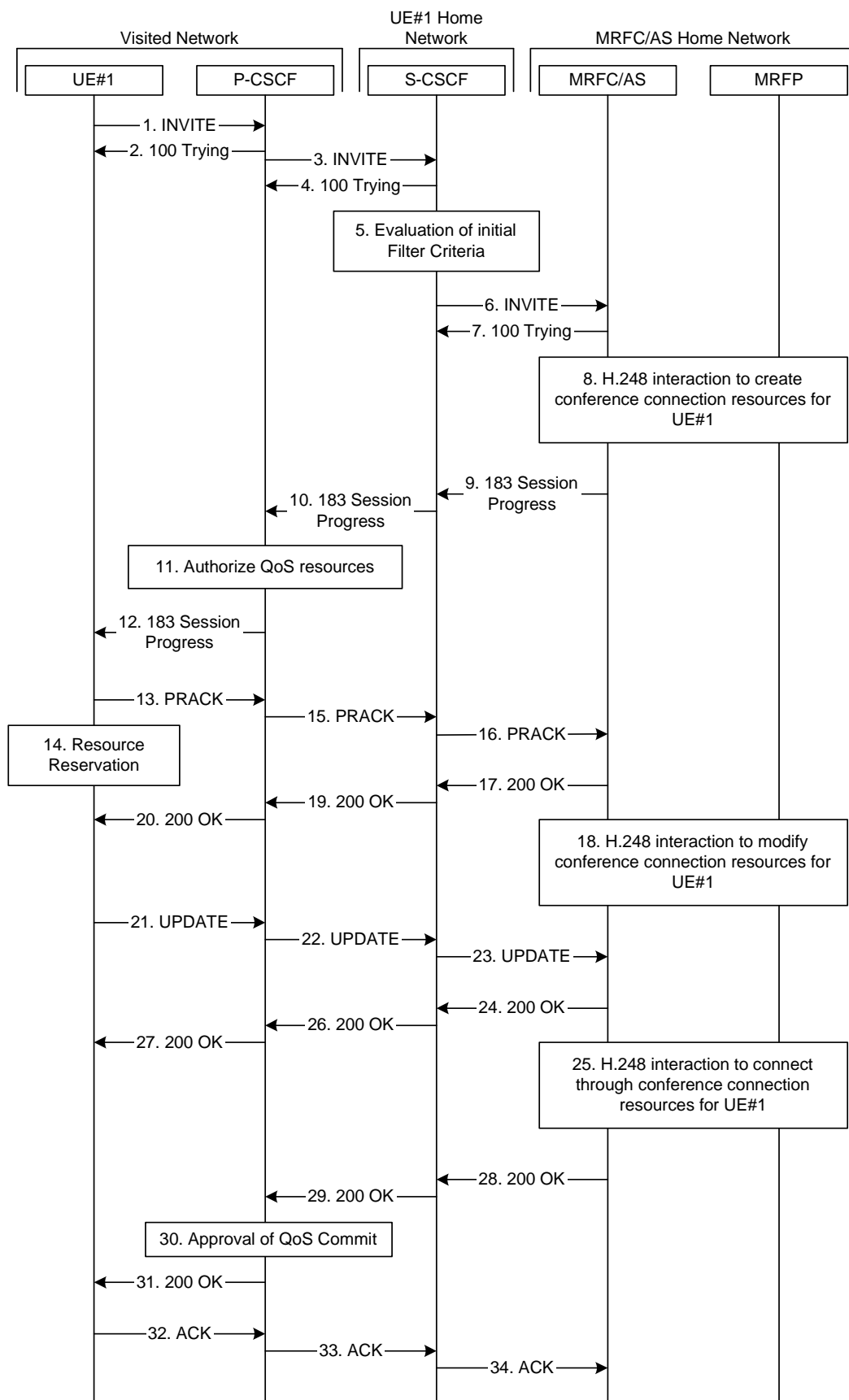

Figure 24: User calling into a conference - MRFC/AS is not located in user's home network - conference URI can be resolved by the originating home network

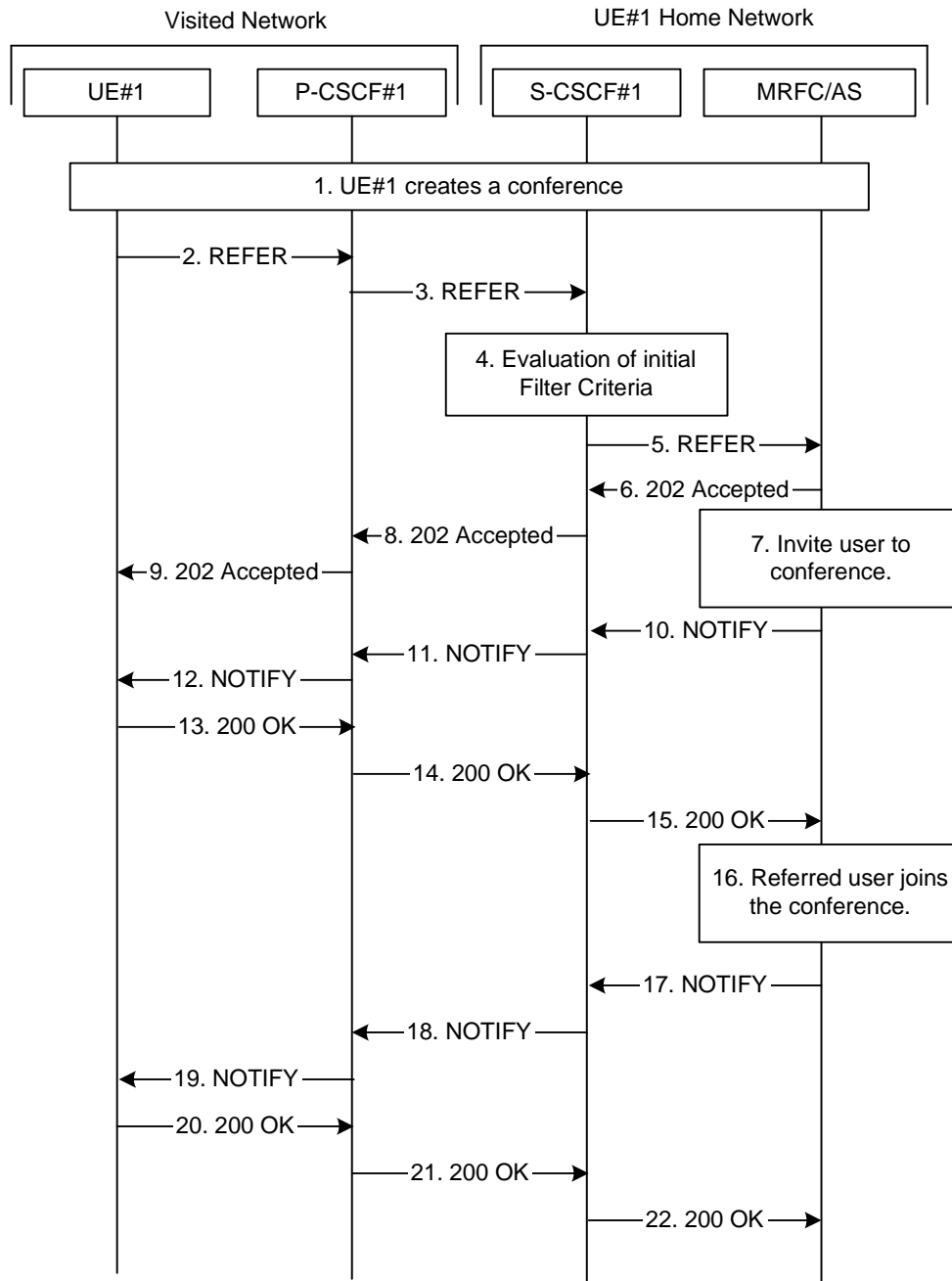

Figure 25: User inviting another user to a conference by sending a REFER request to MRFC/AS

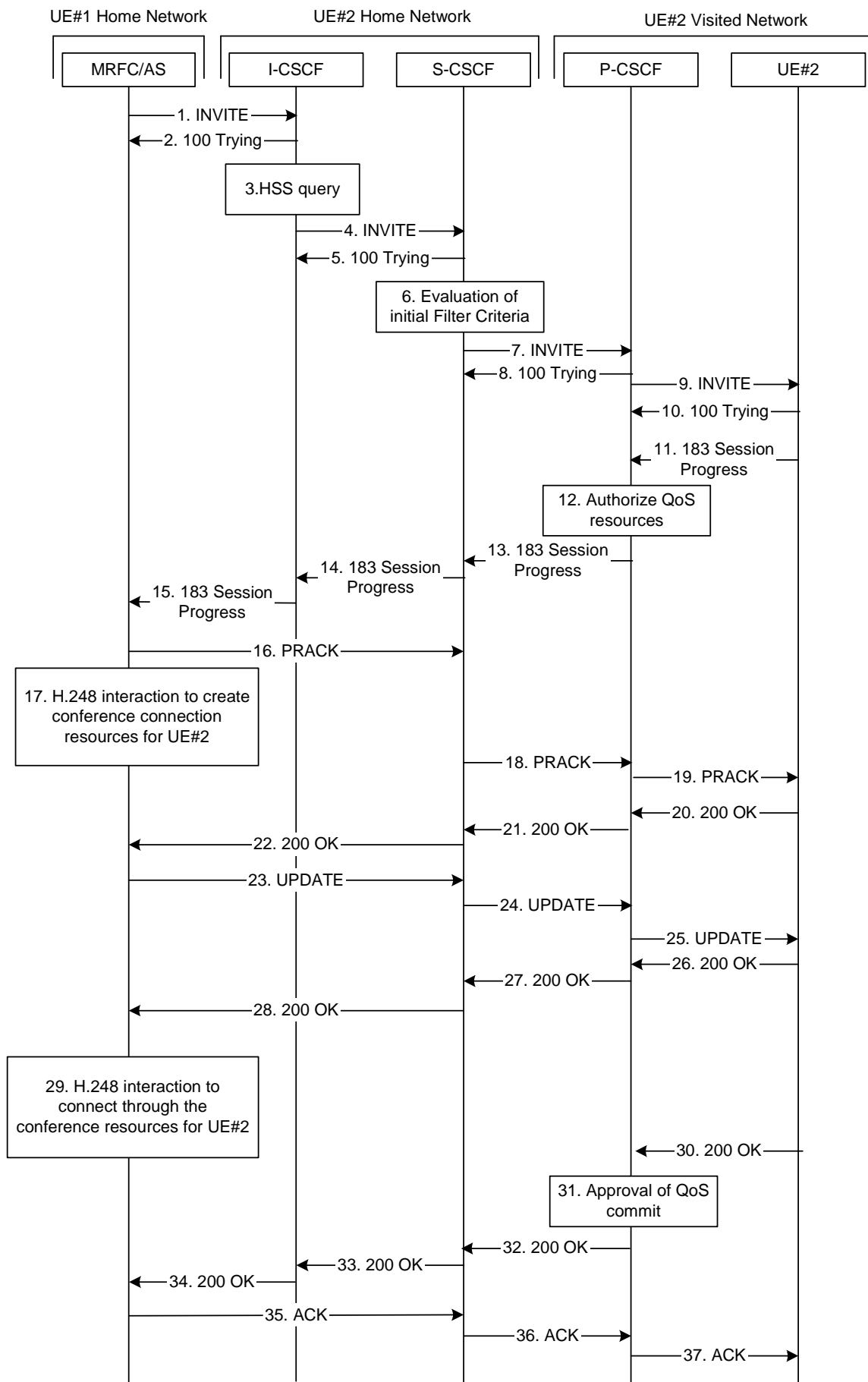

Figure 26: MRFC/AS inviting a user to a conference - MRFC/AS routes directly to I-CSCF

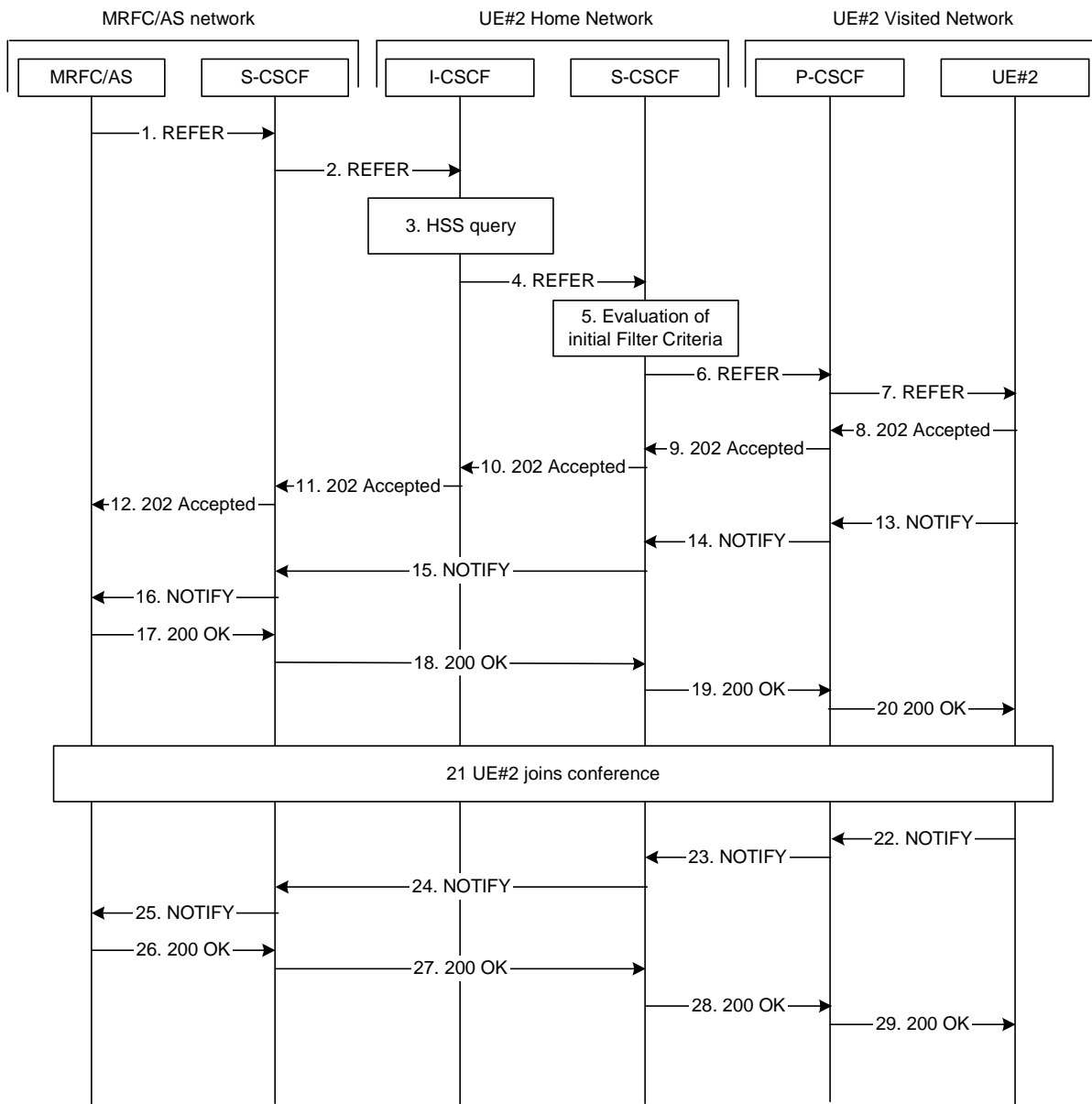

Figure 27: MRFC/AS inviting another user to a conference by sending a REFER request to UE#2

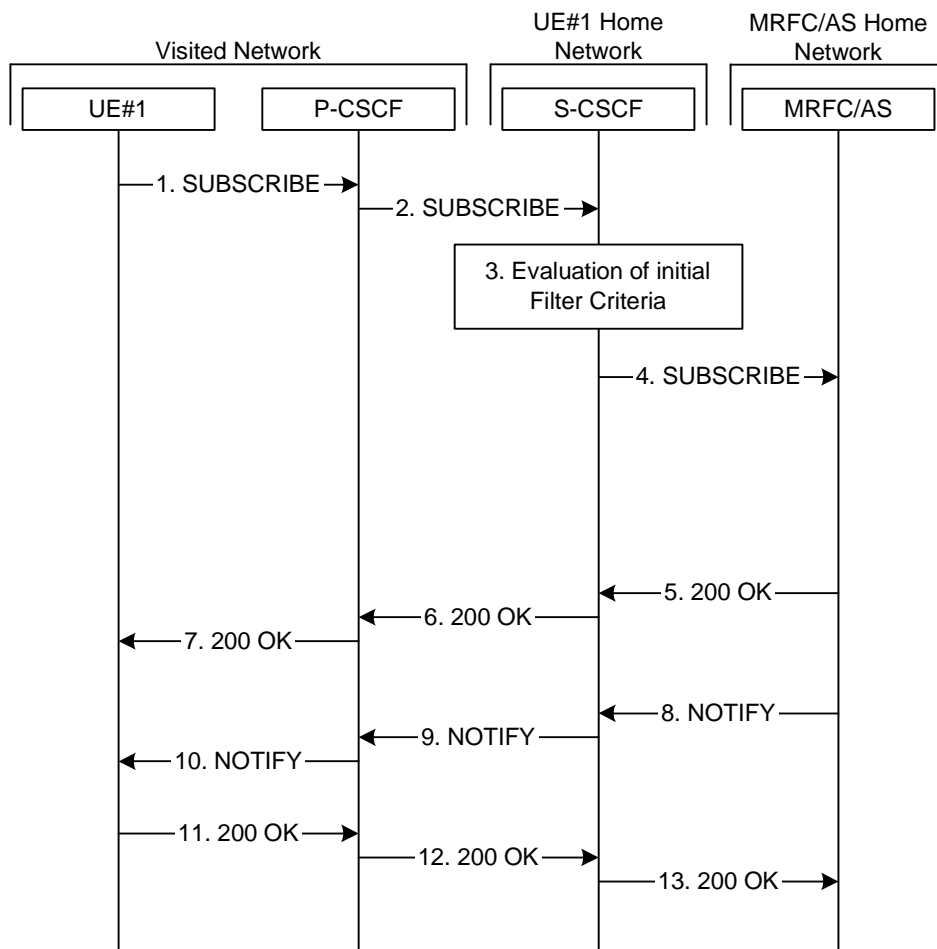

Figure 28: User subscribing to conference event package - MRFC/AS is not located in user's home network

4.10.3.2 Attempted creations of conference

- This measurement provides the number of attempted creations of conference.
- CC.
- On receipt by the Conference AS of a SIP_INVITE message to create the conference (see 3GPP TS 24.147 [24]).
- A single integer value.
- CONF.AttCreation.
- AsFunction.
- Valid for packet switched traffic.
- IMS.

4.10.3.3 Successful creations of conference

- This measurement provides the number of successful creations of conference.
- CC.
- On transmission by the Conference AS of a SIP_200_OK message indicating the conference is successfully created (see 3GPP TS 24.147 [24]).

- d) A single integer value.
- e) CONF.SuccCreation.
- f) AsFunction.
- g) Valid for packet switched traffic.
- h) IMS.

4.10.3.4 Attempted joining of conference

- a) This measurement provides the number of attempted joining of conference.
- b) CC.
- c) On receipt by the Conference AS of a SIP_INVITE message indicating the requests by the user to join the conference (see 3GPP TS 24.147 [24]).
- d) A single integer value.
- e) CONF.AttJoining.
- f) AsFunction.
- g) Valid for packet switched traffic.
- h) IMS.

4.10.3.5 Successful joining of conference

- a) This measurement provides the number of successful joining of conference.
- b) CC.
- c) On transmission by the Conference AS of a SIP_200_OK message indicating the user has successfully joined the conference (see 3GPP TS 24.147 [24]).
- d) A single integer value.
- e) CONF.SuccJoining.
- f) AsFunction.
- g) Valid for packet switched traffic.
- h) IMS.

4.10.3.6 Attempted invitations for another user to join conference

- a) This measurement provides the number of attempted invitations for another user to join conference.
- b) CC.
- c) On transmission by the Conference AS of a SIP_INVITE message to invite a user to join a conference (see 3GPP TS 24.147 [24]).
- d) A single integer value.
- e) CONF.AttInvitation.
- f) AsFunction.
- g) Valid for packet switched traffic.
- h) IMS.

4.10.3.7 Successful invitations for another user to join conference

- a) This measurement provides the number of successful invitations for another user to join conference.
- b) CC.
- c) On receipt by the Conference AS of a response message (e.g. SIP_183 or SIP_200_OK) indicating the invited user has successfully joined the conference (see 3GPP TS 24.147 [24]), each successful invitation is added to the relevant measurement according to the message type, the possible response message types are identified in 3GPP TS 24.229 [8]. The sum of all supported per message type measurements shall equal the total number of successful invitations. In case only a subset of per message type measurements is supported, a sum subcounter will be provided first.
- d) Each measurement is an integer value. The number of measurements is equal to the number of message types plus a possible sum value identified by the *.sum* suffix.
- e) CONF.SuccInviJoinConf.*type*
where *type* identifies the message type.

The following subcounters with specific message types are the samples of this measurement:

CONF.SuccInvitation.183 Message type: SIP_183

CONF.SuccInvitation.200 Message type: SIP_200_OK only if the SIP_183 has not been received for this session.

- f) AsFunction.
- g) Valid for packet switched traffic.
- h) IMS.

4.10.3.8 Attempted subscriptions for the conference event

- a) This measurement provides the number of attempted subscriptions for the conference event.
- b) CC.
- c) On receipt by the Conference AS of SIP_SUBSCRIBE message initiated by the conference participant (see 3GPP TS 24.147 [24]).
- d) A single integer value.
- e) CONF.AttSubscription
- f) AsFunction.
- g) Valid for packet switched traffic.
- h) IMS.

4.10.3.9 Successful subscriptions for the conference event

- a) This measurement provides the number of successful subscriptions for the conference event.
- b) CC.
- c) On transmission by the AS of a SIP_200_OK message indicating the successful subscription for the conference event, corresponding the SIP_SUBSCRIBE request message initiated by the conference participant (see 3GPP TS 24.147 [24]).
- d) A single integer value.
- e) CONF.SuccSubscription.
- f) AsFunction.
- g) Valid for packet switched traffic.

h) IMS.

4.10.3.10 Number of simultaneous online users (Maximum)

- a) This measurement provides the maximum number of simultaneous online conference users.
- b) SI.
- c) This measurement is obtained by sampling at a pre-defined interval the number of simultaneous online users on the conference and then taking the maximum.
- d) A single integer value.
- e) CONF.OnlineUserMax.
- f) AsFunction.
- g) Valid for packet switched traffic.
- h) IMS.

4.10.3.11 Number of simultaneous online conferences (Maximum)

- a) This measurement provides the maximum number of simultaneous online conferences.
- b) SI.
- c) This measurement is obtained by sampling at a pre-defined interval the number of simultaneous online conferences and then taking the maximum.
- d) A single integer value.
- e) CONF.OnlineConfMax.
- f) AsFunction.
- g) Valid for packet switched traffic.
- h) IMS.

4.10.3.12 Number of simultaneous online users (Mean)

- a) This measurement provides the mean number of simultaneous online users.
- b) SI.
- c) This measurement is obtained by sampling at a pre-defined interval the number of simultaneous online users on the conference and then taking the arithmetic mean.
- d) A single integer value.
- e) CONF.OnlineUserMean.
- f) AsFunction.
- g) Valid for packet switched traffic.
- h) IMS.

4.10.3.13 Number of simultaneous online conferences (Mean)

- a) This measurement provides the mean number of simultaneous online conferences.
- b) SI.

- c) This measurement is obtained by sampling at a pre-defined interval the number of simultaneous online conferences and then taking the arithmetic mean.
- d) A single integer value.
- e) CONF.OnlineConfMean.
- f) AsFunction.
- g) Valid for packet switched traffic.
- h) IMS.

4.10.4 Presence service related measurements

4.10.4.1 Number of simultaneous online watchers (Maximum)

- a) This measurement provides the maximum number of simultaneous online watchers at the presence enabler/AS.
- b) SI.
- c) This measurement is obtained by sampling at a pre-defined interval the number of simultaneous online watchers which have been registered and then taking the maximum.
- d) A single integer value.
- e) PRES.OnlineWatcherMax.
- f) AsFunction.
- g) Valid for packet switched traffic.
- h) IMS.

4.10.4.2 Number of simultaneous online presentities (Maximum)

- a) This measurement provides the maximum number of simultaneous online presentities in the presence enabler/AS.
- b) SI.
- c) This measurement is obtained by sampling at a pre-defined interval the number of simultaneous online presentities which have been registered and then taking the maximum.
- d) A single integer value.
- e) PRES.OnlinePresentityMax.
- f) AsFunction.
- g) Valid for packet switched traffic.
- h) IMS.

4.10.4.3 Number of simultaneous online watchers (Mean)

- a) This measurement provides the number of mean number of simultaneous online watchers in the presence enabler/AS.
- b) SI.
- c) This measurement is obtained by sampling at a pre-defined interval the number of simultaneous online watchers which have been registered and then taking the arithmetic mean.
- d) A single integer value.
- e) PRES.MeanOnlineWatcher.
- f) AsFunction.
- g) Valid for packet switched traffic.
- h) IMS.

4.10.4.4 Number of simultaneous online presentities (Mean)

- a) This measurement provides the number of mean number of simultaneous online presentities in the presence enabler/AS.
- b) SI.
- c) This measurement is obtained by sampling at a pre-defined interval the number of simultaneous online presentities which have been registered and then taking the arithmetic mean.
- d) A single integer value.
- e) PRES.MeanOnlinePresentity.
- f) AsFunction.
- g) Valid for packet switched traffic.
- h) IMS.

4.10.4.5 Attempted subscriptions for presence

- a) This measurement provides the number of attempted subscriptions received by the presence enabler/AS.
- b) CC.
- c) On receipt by the AS (presence enabler) of a SIP_SUBSCRIBE message (see 3GPP TS 23.141[25]).
- d) A single integer value.
- e) PRES.AttSubscribe.
- f) AsFunction.
- g) Valid for packet switched traffic.
- h) IMS.

4.10.4.6 Successful subscriptions for presence

- a) This measurement provides the number of successful subscriptions at the presence enabler/AS.
- b) CC.
- c) On transmission by the AS (presence enabler) of a response message (e.g. SIP_200_OK or SIP_202_Accepted) for the subscription request from the IM CN (See 3GPP TS 23.141 [25]), each successful subscription is added to the relevant measurement according to the message type, the possible response message types are identified in 3GPP TS 24.229 [8]. The sum of all supported per message type measurements shall equal the total number of successful subscriptions. In case only a subset of per message type measurements is supported, a sum subcounter will be provided first.
- d) Each measurement is an integer value. The number of measurements is equal to the number of message types plus a possible sum value identified by the *.sum* suffix.
- e) PRES.SuccSubscribe. *type*
where *type* identifies the message type.

The following subcounters with specific message types are the samples of this measurement:

SC.SuccSession.200 Message type: SIP_200_OK

SC.SuccSession.202 Message type: SIP_202 only if the SIP_200_OK has not been sent for this session.

- f) AsFunction.
- g) Valid for packet switched traffic.
- h) IMS.

4.10.4.7 Attempted notifications for presence

- a) This measurement provides the number of attempted notifications sent by the presence enabler/AS.
- b) CC.
- c) On transmission by the AS (presence enabler) of a SIP_NOTIFY message to the IM CN (see 3GPP TS 23.141 [25]).
- d) A single integer value.
- e) PRES.AttNotify.
- f) AsFunction.
- g) Valid for packet switched traffic.
- h) IMS.

4.10.4.8 Successful notifications for presence

- a) This measurement provides the number of successful notifications sent by the presence enabler/AS.
- b) CC.
- c) On receipt by the AS (presence enabler) of a SIP_200_OK message indicating the successful notification corresponding to the SIP_NOTIFY message sent by the AS (see 3GPP TS 23.141 [25]).
- d) A single integer value.
- e) PRES.SuccNotify.
- f) AsFunction.
- g) Valid for packet switched traffic.
- h) IMS.

4.10.4.9 Attempted publications for presence

- a) This measurement provides the number of attempted publications received by the presence enabler/AS.
- b) CC.
- c) On receipt by the AS (presence enabler) of a SIP_PUBLISH message (see 3GPP TS 23.141 [25]).
- d) A single integer value.
- e) PRES.AttPublish.
- f) AsFunction.
- g) Valid for packet switched traffic.
- h) IMS.

4.10.4.10 Successful publications for presence

- a) This measurement provides the number of successful publications at the presence enabler/AS.
- b) CC.
- c) On transmission by the AS (presence enabler) of a SIP_200_OK message indicating the successful publication, corresponding to received SIP_PUBLISH message (see 3GPP TS 23.141 [25]).
- d) A single integer value.

- e) PRES.SuccPub.
- f) ASFunction.
- g) Valid for packet switched traffic.
- h) IMS.

4.10.5 PoC service related measurements

4.10.5.1 Attempted creations of PoC session

- a) This measurement provides the number of attempted creations of PoC session.
- b) CC.
- c) On receipt by the PoC AS of SIP_INVITE message for creation of PoC session (see 3GPP TR 23.979 [26]).
- d) A single integer value.
- e) PoC.AttCreation.
- f) AsFunction.
- g) Valid for packet switched traffic.
- h) IMS.

4.10.5.2 Successful creations of PoC session

- a) This measurement provides the number of successful creation of PoC session.
- b) CC.
- c) On transmission by the PoC AS of a SIP_200_OK message indicating the PoC session is successfully created (see 3GPP TR 23.979 [26]).
- d) A single integer value.
- e) PoC.SuccCreation.
- f) AsFunction.
- g) Valid for packet switched traffic.
- h) IMS.

4.10.5.3 Attempted joining of PoC session

- a) This measurement provides the number of attempted joining PoC session requests which means that the user calls into the PoC session.
- b) CC.
- c) On receipt by the PoC AS of PoC session SIP_INVITE message indicating the requests by the user to join the PoC session (see 3GPP TR 23.979 [26]).
- d) A single integer value.
- e) PoC.AttJoining.
- f) AsFunction.
- g) Valid for packet switched traffic.
- h) IMS.

4.10.5.4 Successful joining of PoC session

- a) This measurement provides the number of successful joining of PoC session.
- b) CC.

- c) On transmission by the PoC AS of a SIP_200_OK message indicating the user has successfully joined the PoC session (see 3GPP TR 23.979 [26]).
- d) A single integer value.
- e) PoC.SuccJoining.
- f) AsFunction.
- g) Valid for packet switched traffic.
- h) IMS.

4.10.5.5 Attempted invitations for another user to join PoC session

- a) This measurement provides the number of attempted invitations for another user to join PoC session.
- b) CC.
- c) On transmission by the PoC AS of a SIP_INVITE message to invite a user to join a PoC session (see 3GPP TR 23.979 [26]).
- d) A single integer value.
- e) PoC.AttInvitation.
- f) AsFunction.
- g) Valid for packet switched traffic.
- h) IMS.

4.10.5.6 Successful invitations for another user to join PoC session

- a) This measurement provides the number of successful invitations for another user to join PoC session.
- b) CC.
- c) On receipt by the PoC AS of a SIP_200_OK message indicating the invited user has successfully joined the PoC session (see 3GPP TR 23.979 [26]).
- d) A single integer value.
- e) PoC.SuccInvitation.
- f) AsFunction.
- g) Valid for packet switched traffic.
- h) IMS.

4.10.5.7 Number of simultaneous online users (Maximum)

- a) This measurement provides the maximum number of simultaneous online PoC users.
- b) SI.
- c) This measurement is obtained by sampling at a pre-defined interval the number of simultaneous online users that have been joined and then taking the maximum.
- d) A single integer value.
- e) PoC.OnlineUserMax.
- f) AsFunction.

- g) Valid for packet switched traffic.
- h) IMS.

4.10.5.8 Number of simultaneous online PoC session (Maximum)

- a) This measurement provides the maximum number of simultaneous online PoC sessions.
- b) SI.
- c) This measurement is obtained by sampling at a pre-defined interval the number of simultaneous online PoC sessions and then taking the maximum.
- d) A single integer value.
- e) PoC.OnlineSessionMax.
- f) AsFunction.
- g) Valid for packet switched traffic.
- h) IMS.

4.10.6 Measurements related to XDM Enabler

4.10.6.1 XCAP operation related measurements

4.10.6.1.1 Overview

The performance measurements defined in this subclause are related to the XCAP operation request from the XDMC for document manipulation (e.g. retrieving/adding/deleting elements/attributes, etc.) stored in XDMS. See "XML Document Management (XDM) Specification", OMA-TS-XDM_Core-V1_0 [27].

The procedures are shown in figure 29.

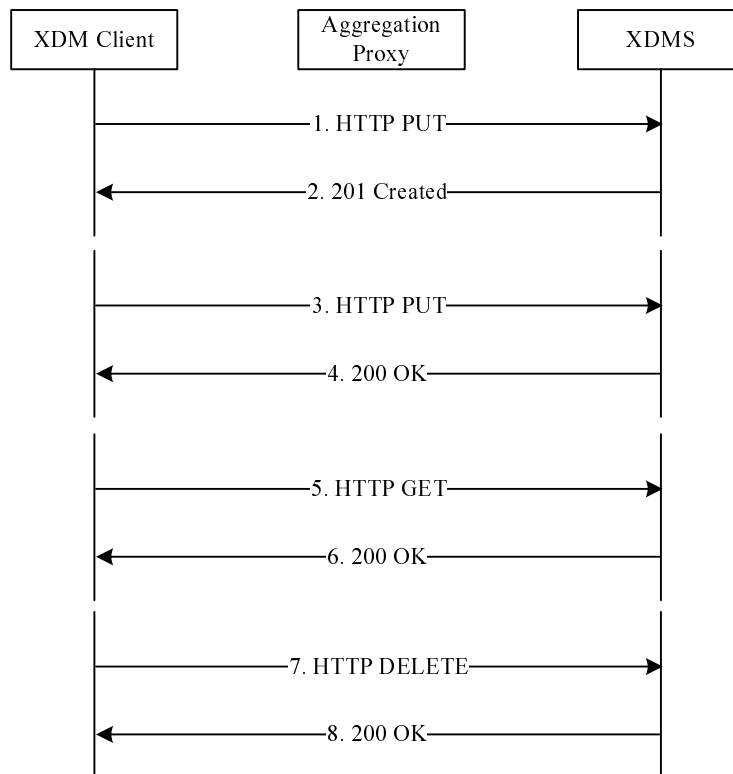

Figure 29: XCAP operation request procedures

4.10.6.1.2 Attempted HTTP PUT procedures

- This measurement provides the number of attempted HTTP PUT procedures.
- CC.
- On receipt by the XDMS of a HTTP_PUT request from the aggregation proxy (see OMA-TS-XDM_Core-V1_0 [27]).
- A single integer value.
- XDM.AttHttpPut.
- AsFunction.
- Valid for packet switched traffic.
- IMS.

4.10.6.1.3 Successful HTTP PUT procedures

- a) This measurement provides the number of successful HTTP PUT procedures.
- b) CC.
- c) On transmission by the XDMS of a response message (e.g. HTTP_200_OK) indicating a successful HTTP PUT procedure, each successful HTTP PUT procedure is added to the relevant measurement according to the message type, the possible response message types are identified in 3GPP TS 24.229 [8]. The sum of all supported per message type measurements shall equal the total number of successful HTTP PUT procedures. In case only a subset of per message type measurements is supported, a sum subcounter will be provided first.
- d) Each measurement is an integer value. The number of measurements is equal to the number of message types plus a possible sum value identified by the *.sum* suffix.
- e) XDM.SuccHttpPut.*type*
where *type* identifies the message type.

The following subcounters with specific message types are the samples of this measurement:

XDM.SuccHttpPut.200 Message type: SIP_200_OK.

- f) AsFunction.
- g) Valid for packet switched traffic.
- h) IMS.

4.10.6.1.4 Attempted HTTP GET procedures

- a) This measurement provides the number of attempted HTTP GET procedures.
- b) CC.
- c) On receipt by the XDMS of a HTTP_GET request from the aggregation proxy (See OMA-TS-XDM_Core-V1_0 [27]).
- d) A single integer value.
- e) XDM.AttHttpGet.
- f) AsFunction.
- g) Valid for packet switched traffic.
- h) IMS.

4.10.6.1.5 Successful HTTP GET procedures

- a) This measurement provides the number of successful HTTP GET procedures.
- b) CC.
- c) On transmission by the XDMS of a response message (e.g. HTTP_200_OK) indicating a successful HTTP GET procedure, each successful HTTP GET procedure is added to the relevant measurement according to the message type, the possible response message types are identified in 3GPP TS 24.229 [8]. The sum of all supported per message type measurements shall equal the total number of successful HTTP GET procedures. In case only a subset of per message type measurements is supported, a sum subcounter will be provided first.
- d) Each measurement is an integer value. The number of measurements is equal to the number of message types plus a possible sum value identified by the *.sum* suffix.
- e) XDM.SuccHttpGet.*type*
where *type* identifies the message type.

The following subcounters with specific message types are the samples of this measurement:

XDM.SuccHttpGet.200 Message type: SIP_200_OK.

- f) AsFunction.
- g) Valid for packet switched traffic.
- h) IMS.

4.10.6.1.6 Attempted HTTP DELETE procedures

- a) This measurement provides the number of attempted HTTP DELETE procedures.
- b) CC.
- c) On receipt by the XDMS of a HTTP_DELETE request from the aggregation proxy (see OMA-TS-XDM_Core-V1_0 [27]).
- d) A single integer value.
- e) XDM.AttHttpDel.
- f) AsFunction.
- g) Valid for packet switched traffic.
- h) IMS.

4.10.6.1.7 Successful HTTP DELETE procedures

- a) This measurement provides the number of successful HTTP DELETE procedures.
- b) CC.
- c) On transmission by the XDMS of a response message (e.g. HTTP_200_OK) indicating a successful HTTP DELETE procedure, each successful HTTP DELETE procedure is added to the relevant measurement according to the message type, the possible response message types are identified in 3GPP TS 24.229 [8]. The sum of all supported per message type measurements shall equal the total number of successful HTTP DELETE procedures. In case only a subset of per message type measurements is supported, a sum subcounter will be provided first.
- d) Each measurement is an integer value. The number of measurements is equal to the number of message types plus a possible sum value identified by the *.sum* suffix.
- e) XDM.SuccHttpDel.*type*
where *type* identifies the message type.

The following subcounters with specific message types are the samples of this measurement:
XDM.SuccHttpDel.200 Message type: SIP_200_OK.

- f) AsFunction.
- g) Valid for packet switched traffic.
- h) IMS.

4.10.6.2 SIP related measurements

4.10.6.2.1 Overview

The performance measurements defined in this subclause are related to SIP procedures for subscribing and notifying the changes in the XML documents stored in the XDMS. See "XML Document Management (XDM) Specification", OMA-TS-XDM_Core-V1_0 [27].

The procedures are shown in figure 30.

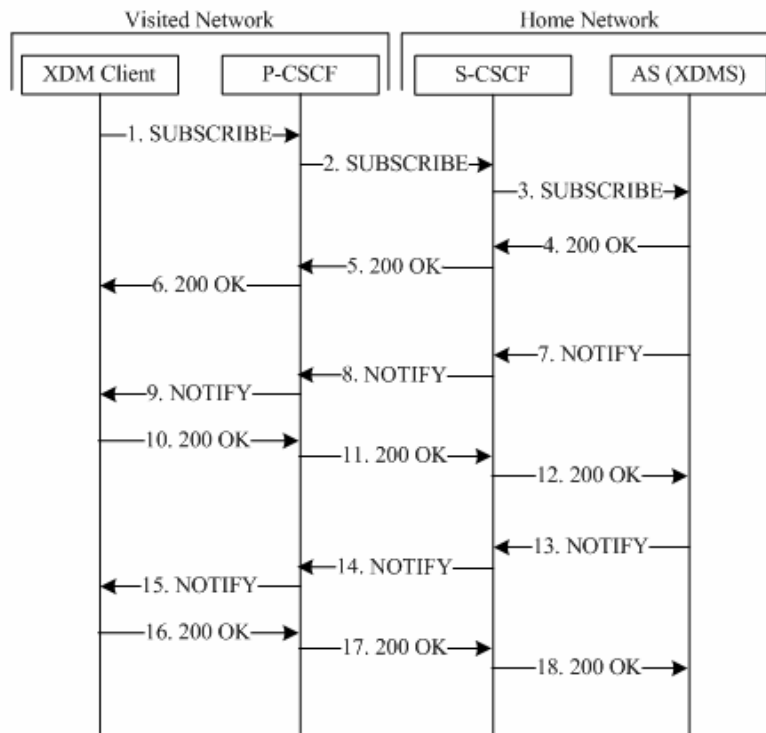

Figure 30: XDM Client subscribes to changes in XDMS Procedures

4.10.6.2.2 Attempted Subscription procedures

- This measurement provides the number of attempted subscription procedures.
- CC.
- On receipt by the XDMS of a SIP_SUBSCRIBE message (See OMA-TS-XDM_Core-V1_0 [27]).
- A single integer value.
- XDM.AttSubscribe.
- AsFunction.
- Valid for packet switched traffic.
- IMS.

4.10.6.2.3 Successful Subscription procedures

- This measurement provides the number of successful subscription procedures.
- CC.
- On transmission by the XDMS of a response SIP_200_OK message indicating a successful subscription procedure (see OMA-TS-XDM_Core-V1_0 [27]).
- A single integer value.
- XDM.SuccSubscribe.
- AsFunction.
- Valid for packet switched traffic.
- IMS.

4.10.6.2.4 Attempted Notification procedures

- a) This measurement provides the number of attempted notification procedures.
- b) CC.
- c) On sending by the XDMS of a SIP_NOTIFY message (see OMA-TS-XDM_Core-V1_0 [27]).
- d) A single integer value.
- e) XDM.AttNotify.
- f) AsFunction.
- g) Valid for packet switched traffic.
- h) IMS.

4.10.6.2.5 Successful Notification procedures

- a) This measurement provides the number of successful notification procedures.
- b) CC.
- c) On receipt by the XDMS of a response SIP_200_OK message indicating the successful XDMS originated notification procedures.
- d) A single integer value.
- e) XDM.SuccNotify.
- f) AsFunction.
- g) Valid for packet switched traffic.
- h) IMS.

5 Equipment related measurements

The measurements defined in this subclause are related to the equipment aspect performance. The measurements defined in the following subclauses are common for all of the equipments in IMS and shall be applied to all of the network elements in IMS.

5.1 Processor usage

5.1.1 Mean processor usage

- a) This measurement provides the mean usage of each key processor during the granularity period. Each equipment may have more than one key processors, the measurement is split into subcounters per key processor.
- b) SI.
- c) This measurement is obtained by sampling at a pre-defined interval the usage of the processor and then taking the arithmetic mean for each key processor.
- d) Each measurement is an integer value (Unit: %).
- e) The measurement name has the form EQPT.MeanProcessorUsage.*ProcessorID* where *ProcessorID* identifies the key processor of this equipment, the format of *ProcessorID* is vendor specific.
- f) ManagedElement.
- g) Valid for circuit switched and packet switched traffic.
- h) IMS.

5.1.2 Peak processor usage

- a) This measurement provides the peak usage of each key processor during the granularity period. Each equipment may have more than one key processors, the measurement is split into subcounters per key processor.
- b) SI.
- c) This measurement is obtained by sampling at a pre-defined interval the usage of the processor and then taking the maximum for each key processor.
- d) Each measurement is an integer value (Unit: %).
- e) The measurement name has the form EQPT.PeakProcessorUsage.*ProcessorID* where *ProcessorID* identifies the key processor of this equipment, the format of *ProcessorID* is vendor specific.
- f) ManagedElement.
- g) Valid for circuit switched and packet switched traffic.
- h) IMS.

Annex A (informative): Change history

Change history								
Date	TSG #	TSG Doc.	CR	Rev	Subject/Comment	Cat	Old	New
Mar 2007	SA_35	SP-070067	--	--	Submitted to SA#35 for for Information	--	--	1.0.0
Mar 2007	--	--	--	--	Editorial clean-up	--	1.0.0	1.0.1
May 2007	SA_36	SP-070287	--	--	Submitted to SA#36 for Approval	--	2.0.0	7.0.0
Sep 2007	SA_37	SP-070613	0001	--	Update IMS Performance Measurements With Missing Granularity And Incorrect CC Performance Measurement Types	F	7.0.0	7.1.0

History

Document history		
V7.0.0	June 2007	Publication
V7.1.0	October 2007	Publication