

ETSI TS 132 423 V17.4.0 (2022-07)



**Digital cellular telecommunications system (Phase 2+) (GSM);
Universal Mobile Telecommunications System (UMTS);
LTE;
Telecommunication management;
Subscriber and equipment trace;
Trace data definition and management
(3GPP TS 32.423 version 17.4.0 Release 17)**



Reference

RTS/TSGS-0532423vh40

Keywords

GSM,LTE,UMTS

ETSI

650 Route des Lucioles
F-06921 Sophia Antipolis Cedex - FRANCE

Tel.: +33 4 92 94 42 00 Fax: +33 4 93 65 47 16

Siret N° 348 623 562 00017 - APE 7112B
Association à but non lucratif enregistrée à la
Sous-Préfecture de Grasse (06) N° w061004871

Important notice

The present document can be downloaded from:

<http://www.etsi.org/standards-search>

The present document may be made available in electronic versions and/or in print. The content of any electronic and/or print versions of the present document shall not be modified without the prior written authorization of ETSI. In case of any existing or perceived difference in contents between such versions and/or in print, the prevailing version of an ETSI deliverable is the one made publicly available in PDF format at www.etsi.org/deliver.

Users of the present document should be aware that the document may be subject to revision or change of status.

Information on the current status of this and other ETSI documents is available at

<https://portal.etsi.org/TB/ETSIDeliverableStatus.aspx>

If you find errors in the present document, please send your comment to one of the following services:

<https://portal.etsi.org/People/CommitteeSupportStaff.aspx>

If you find a security vulnerability in the present document, please report it through our
Coordinated Vulnerability Disclosure Program:

<https://www.etsi.org/standards/coordinated-vulnerability-disclosure>

Notice of disclaimer & limitation of liability

The information provided in the present deliverable is directed solely to professionals who have the appropriate degree of experience to understand and interpret its content in accordance with generally accepted engineering or other professional standard and applicable regulations.

No recommendation as to products and services or vendors is made or should be implied.

No representation or warranty is made that this deliverable is technically accurate or sufficient or conforms to any law and/or governmental rule and/or regulation and further, no representation or warranty is made of merchantability or fitness for any particular purpose or against infringement of intellectual property rights.

In no event shall ETSI be held liable for loss of profits or any other incidental or consequential damages.

Any software contained in this deliverable is provided "AS IS" with no warranties, express or implied, including but not limited to, the warranties of merchantability, fitness for a particular purpose and non-infringement of intellectual property rights and ETSI shall not be held liable in any event for any damages whatsoever (including, without limitation, damages for loss of profits, business interruption, loss of information, or any other pecuniary loss) arising out of or related to the use of or inability to use the software.

Copyright Notification

No part may be reproduced or utilized in any form or by any means, electronic or mechanical, including photocopying and microfilm except as authorized by written permission of ETSI.

The content of the PDF version shall not be modified without the written authorization of ETSI.

The copyright and the foregoing restriction extend to reproduction in all media.

© ETSI 2022.
All rights reserved.

Intellectual Property Rights

Essential patents

IPRs essential or potentially essential to normative deliverables may have been declared to ETSI. The declarations pertaining to these essential IPRs, if any, are publicly available for **ETSI members and non-members**, and can be found in ETSI SR 000 314: "*Intellectual Property Rights (IPRs); Essential, or potentially Essential, IPRs notified to ETSI in respect of ETSI standards*", which is available from the ETSI Secretariat. Latest updates are available on the ETSI Web server (<https://ipr.etsi.org/>).

Pursuant to the ETSI Directives including the ETSI IPR Policy, no investigation regarding the essentiality of IPRs, including IPR searches, has been carried out by ETSI. No guarantee can be given as to the existence of other IPRs not referenced in ETSI SR 000 314 (or the updates on the ETSI Web server) which are, or may be, or may become, essential to the present document.

Trademarks

The present document may include trademarks and/or tradenames which are asserted and/or registered by their owners. ETSI claims no ownership of these except for any which are indicated as being the property of ETSI, and conveys no right to use or reproduce any trademark and/or tradename. Mention of those trademarks in the present document does not constitute an endorsement by ETSI of products, services or organizations associated with those trademarks.

DECT™, **PLUGTESTS™**, **UMTS™** and the ETSI logo are trademarks of ETSI registered for the benefit of its Members. **3GPP™** and **LTE™** are trademarks of ETSI registered for the benefit of its Members and of the 3GPP Organizational Partners. **oneM2M™** logo is a trademark of ETSI registered for the benefit of its Members and of the oneM2M Partners. **GSM®** and the GSM logo are trademarks registered and owned by the GSM Association.

Legal Notice

This Technical Specification (TS) has been produced by ETSI 3rd Generation Partnership Project (3GPP).

The present document may refer to technical specifications or reports using their 3GPP identities. These shall be interpreted as being references to the corresponding ETSI deliverables.

The cross reference between 3GPP and ETSI identities can be found under <http://webapp.etsi.org/key/queryform.asp>.

Modal verbs terminology

In the present document "**shall**", "**shall not**", "**should**", "**should not**", "**may**", "**need not**", "**will**", "**will not**", "**can**" and "**cannot**" are to be interpreted as described in clause 3.2 of the [ETSI Drafting Rules](#) (Verbal forms for the expression of provisions).

"**must**" and "**must not**" are **NOT** allowed in ETSI deliverables except when used in direct citation.

Contents

Intellectual Property Rights	2
Legal Notice	2
Modal verbs terminology.....	2
Foreword.....	6
Introduction	6
1 Scope	7
2 References	7
3 Definitions, symbols and abbreviations	9
3.1 Definitions	9
3.2 Symbols.....	10
3.3 Abbreviations	10
4 Trace record contents	11
4.1 General	11
4.2 MSC Server Trace Record Content	12
4.3 MGW Trace Record Content.....	19
4.4 SGSN Trace Record Content.....	20
4.5 GGSN Trace Record Content.....	29
4.6 UTRAN Trace Record Content	33
4.7 Void.....	40
4.8 Void.....	40
4.9 HSS Trace Record Content	41
4.10 BM-SC Trace Record Content	46
4.11 PGW Trace Record Content	47
4.12 MME Trace Record Content	52
4.13 E-UTRAN Trace Record Content	61
4.14 SGW Trace Record Content.....	67
4.15 EIR Trace Record Content	72
4.16 LTE MDT Trace Record Content.....	73
4.16.1 Trace Record for Immediate MDT measurements.....	73
4.16.2 Trace Record for UE location information	76
4.17 UMTS MDT Trace Record Content	76
4.17.1 Trace Record for Immediate MDT measurements.....	76
4.17.2 Trace Record for UE location information	78
4.18 AMF Trace Record Content	78
4.19 SMF Trace Record Content.....	80
4.20 PCF Trace Record Content.....	80
4.21 AUSF Trace Record Content.....	81
4.22 NEF Trace Record Content	81
4.23 NRF Trace Record Content	82
4.24 NSSF Trace Record Content	82
4.25 UDM Trace Record Content	83
4.26 UPF Trace Record Content	84
4.27 SMSF Trace Record Content.....	85
4.28 AF Trace Record Content.....	85
4.29 Void.....	86
4.30 gNB-CU-CP Trace Record Content	86
4.31 gNB-CU-UP Trace Record Content	87
4.32 gNB-DU Trace Record Content	87
4.33 ng-eNB Trace Record Content	87
4.34 NR MDT Trace Record Content	89
4.34.1 Trace Record for Immediate MDT measurements.....	89
4.34.2 Trace Record for UE location information	91
4.34.3 Trace Record for in-device coexistence interference.....	91

5	Trace format	92
5.1	Introduction	92
5.2	Trace Record	92
5.2.1	Introduction.....	92
5.2.2	Trace Record Header	92
5.2.3	Trace Record Payload.....	93
5.2.4	Trace administrative messages	94
5.2.4.1	Introduction.....	94
5.2.4.2	Trace Session Start administrative message.....	94
5.2.4.3	Trace Session Stop administrative message.....	94
5.2.4.3a	Trace Recording Session Start administrative message	95
5.2.4.3b	Trace Recording Session Stop administrative message	95
5.2.4.4	Trace Stream Heartbeat administrative message.....	95
5.2.4.5	Trace Recording Session Not Started administrative message	95
5.2.4.6	Trace Recording Session Dropped Events administrative message	95
5.2.4.7	Trace File Open administrative message.....	95
5.2.4.8	Trace File Close administrative message	95
5.2.4.9	Trace File Abnormal Closed administrative message	95
5.2.4.10	Trace Recording Session Throttled Start administrative message	95
5.2.4.11	Trace Recording Session Throttled Stop administrative message.....	96
5.2.5	Void	96
5.2.6	Streaming Trace Format	96
5.3	Void.....	96
Annex A (normative): Trace Report File Format		97
A.0	Introduction	97
A.1	Parameter description and mapping table.....	98
A.2	XML file format definition.....	101
A.2.1	XML trace/MDT file diagram.....	101
A.2.2	Trace data file XML schema	102
Annex B (normative): Trace Report File Conventions and Transfer Procedure.....		105
B.0	Introduction	105
B.1	File naming convention.....	105
B.2	File transfer	106
Annex C (informative): Trace Functional Architecture: Reporting.....		107
C.1	Figure of Trace Reporting	107
Annex D (informative): Examples of trace files.....		109
D.1	Examples of trace XML file	109
D.1.1	Example of XML trace file with the maximum level of details	109
D.1.2	Example of XML trace file with the minimum level of details	110
D.1.3	Example of XML trace file for IMSI information from the MME	110
D.1.4	Example of MDT XML file	111
Annex E (informative): Void		112
Annex F (Informative): Void		113
Annex G (normative): Trace Record Protocol Buffer (GPB).....		114
G.1	Transport Protocol Payload Format	114
G.2	Trace Record Protocol Buffer (GPB) definitions.....	114
Annex H (informative): Examples of Protocol Buffer (GPB) encoded Streaming Trace administrative messages.....		116

Annex I (informative): **Change history**117
History120

Foreword

This Technical Specification has been produced by the 3rd Generation Partnership Project (3GPP).

The contents of the present document are subject to continuing work within the TSG and may change following formal TSG approval. Should the TSG modify the contents of the present document, it will be re-released by the TSG with an identifying change of release date and an increase in version number as follows:

Version x.y.z

where:

- x the first digit:
 - 1 presented to TSG for information;
 - 2 presented to TSG for approval;
 - 3 or greater indicates TSG approved document under change control.
- y the second digit is incremented for all changes of substance, i.e. technical enhancements, corrections, updates, etc.
- z the third digit is incremented when editorial only changes have been incorporated in the document.

Introduction

The present document is part of a TS-family covering the 3rd Generation Partnership Project; Technical Specification Group Services and System Aspects; Telecommunication management, as identified below:

TS 32.421: "Subscriber and equipment trace; Trace concepts and requirements";

TS 32.422: "Subscriber and equipment trace; Trace control and configuration management";

TS 32.423: "Subscriber and equipment trace; Trace data definition and management";

Subscriber and MS Trace provide very detailed information at call level on one or more specific mobile(s). This data is an additional source of information to Performance Measurements and allows going further in monitoring and optimisation operations.

Contrary to Performance Measurements, which are a permanent source of information, Trace is activated on user demand for a limited period of time for specific analysis purpose

Trace plays a major role in activities such as determination of the root cause of a malfunctioning mobile, advanced troubleshooting, optimisation of resource usage and quality, RF coverage control and capacity improvement, dropped call analysis, Core Network and TRAN end to end procedure validation.

The capability to log data on any interface at call level for a specific user (e.g. IMSI or SUPI) or mobile type (e.g. IMEI or IMEISV) allows getting information which cannot be deduced from Performance Measurements such as perception of end-user QoS during his call (e.g. requested QoS vs. provided QoS), correlation between protocol messages and RF measurements, or interoperability with specific mobile vendors.

Moreover, Performance Measurements provide values aggregated on an observation period, Subscriber and Equipment Trace give instantaneous values for a specific event (e.g. call, location update, etc.).

If Performance Measurements are mandatory for daily operations, future network planning and primary trouble shooting, Subscriber and MS Trace is the easy way to go deeper into investigation and network optimisation.

In order to produce this data, Subscriber and MS trace are carried out in the NEs, which comprise the network. The data can then be transferred to an external system (e.g. an Operations System (OS) in TMN terminology, for further evaluation).

1 Scope

The present document describes Trace data definition and management. It covers the trace records content, their format and transfer across UMTS networks, EPS networks or 5GS networks. GSM Trace is outside of the scope of this specification..

The present document also describes the data definition for Minimization of Drive Tests (MDT) across 3GPP networks.

The objectives of the present document are:

- To provide the descriptions for a standard set of Trace and MDT data;
- To define the common format of trace and MDT records; and
- To define a method for the reporting of Trace and MDT results across the management interfaces.

Clause 4 details the various Trace records content, Clause 5 defines GPB trace format for NR, Annex A provides Trace and MDT report file format, Annex B provides the trace report file conventions and transfer procedure, Annex C provides the trace reporting functional architecture and Annex D provides some trace and MDT files examples, Annex G provides normative GPB trace record schema and examples.

Trace and MDT concepts and requirements are covered in TS 32.421 [2] while Trace control and configuration management are described in 3GPP TS 32.422 [3].

The definition of Trace and MDT data is intended to result in comparability of Trace and MDT data produced in a multi-vendor wireless 3GPP networks.

The following is beyond the scope of the present document, and therefore the present document does not describe:

- Any notification mechanisms or IRPs for trace. Only file transfer mechanism is specified for trace data transfer;
- Any data compression mechanisms for trace data transfer;
- Any Trace capability limitations (e.g. maximum number of simultaneous traced mobiles for a given NE).

2 References

The following documents contain provisions, which, through reference in this text, constitute provisions of the present document.

- References are either specific (identified by date of publication, edition number, version number, etc.) or non-specific.
- For a specific reference, subsequent revisions do not apply.
- For a non-specific reference, the latest version applies. In the case of a reference to a 3GPP document (including a GSM document), a non-specific reference implicitly refers to the latest version of that document *in the same Release as the present document*.

[1] 3GPP TS 32.101: "Telecommunication management; Principles and high level requirements".

[2] 3GPP TS 32.421: "Telecommunication management; Subscriber and equipment trace: Trace concepts and requirements."

[3] 3GPP TS 32.422: "Telecommunication management; Subscriber and equipment trace: Trace control and configuration management ".

[4] 3GPP TR 21.905: "Vocabulary for 3GPP Specifications".

[5] W3C Recommendation "Extensible Markup Language (XML) 1.0" (Second Edition, 6 October 2000) <http://www.w3.org/TR/2000/REC-xml-20001006>

- [6] W3C Recommendation "Namespaces in XML" (14 January 1999)
<http://www.w3.org/TR/1999/REC-xml-names-19990114>
- [7] W3C Recommendation "XML Schema Part 0: Primer" (2 May 2001)
<http://www.w3.org/TR/2001/REC-xmlschema-0-20010502>
- [8] W3C Recommendation "XML Schema Part 1: Structures" (2 May 2001)
<http://www.w3.org/TR/2001/REC-xmlschema-1-20010502>
- [9] W3C Recommendation "XML Schema Part 2: Datatypes" (2 May 2001)
<http://www.w3.org/TR/2001/REC-xmlschema-2-20010502>
- [10] International Standard ISO 8601: 1988 (E) "Representations of dates and times" (1988-06-15)
<http://www.iso.ch/markete/8601.pdf>
- [11] 3GPP TS 32.300: "Telecommunication management; Configuration Management (CM); Name convention for Managed Objects".
- [12] 3GPP TS 32.622: "Telecommunication management; Configuration Management (CM); Generic network resources Integration Reference Point (IRP): Network Resource Model (NRM)".
- [13] 3GPP TS 29.274: "3GPP Evolved Packet System (EPS); Evolved General Packet Radio Service (GPRS) Tunnelling Protocol for Control plane (GTPv2-C); Stage 3".
- [14] 3GPP TS 29.212: "Policy and Charging Control (PCC); Reference points".
- [15] 3GPP TS 29.273: "Evolved Packet System (EPS); 3GPP EPS AAA interfaces".
- [16] 3GPP TS 36.413: "Evolved Universal Terrestrial Radio Access Network (E-UTRAN); S1 Application Protocol (S1AP)".
- [17] 3GPP TS 36.423 "Evolved Universal Terrestrial Radio Access Network (E-UTRAN); X2 Application Protocol (X2AP)".
- [18] 3GPP TS 23.501: "System Architecture for the 5G System; Stage 2".
- [19] 3GPP TS 23.502: "Procedures for the 5G System; Stage 2"
- [20] 3GPP TS 38.300: "NR and NG-RAN Overall Description; Stage 2".
- [21] 3GPP TS 38.331: "NR; Radio Resource Control (RRC); Protocol specification".
- [22] 3GPP TS 38.401: "NG-RAN; Architecture Description".
- [23] 3GPP TS 38.413: "NG-RAN; NG Application Protocol (NGAP)".
- [24] 3GPP TS 38.423: "NG-RAN; Xn Application Protocol (XnAP)".
- [25] 3GPP TS 38.463: "NG-RAN; E1 Application Protocol (E1AP)".
- [26] 3GPP TS 38.473: "NG-RAN; F1 Application Protocol (F1AP)".
- [27] 3GPP TS 24.501: "Non-Access-Stratum (NAS) protocol for 5G System (5GS); Stage 3".
- [28] 3GPP TS 36.331: "Evolved Universal Terrestrial Radio Access (E-UTRA); Radio Resource Control (RRC); Protocol specification".
- [29] 3GPP TS 23.107: "Quality of Service (QoS) concept and architecture".
- [30] 3GPP TS 25.331: "Radio Resource Control (RRC); Protocol specification".
- [31] 3GPP TS 36.314: "Evolved Universal Terrestrial Radio Access (E-UTRA); Layer 2 - Measurements".
- [32] 3GPP TS 37.320: "Universal Terrestrial Radio Access (UTRA) and Evolved Universal Terrestrial Radio Access (E-UTRA); Radio measurement collection for Minimization of Drive Tests (MDT); Overall description; Stage 2".

- [33] 3GPP TS 36.213: "Evolved Universal Terrestrial Radio Access (E-UTRA); Physical layer procedures".
- [34] 3GPP TS 36.133: "Evolved Universal Terrestrial Radio Access (E-UTRA); Requirements for support of radio resource management".
- [35] 3GPP TS 38.314: "NR; layer 2 measurements ".
- [36] 3GPP TS 28.552: "Management and orchestration; 5G performance measurements".
- [37] 3GPP TS 38.213: "NR; Physical layer procedures for control".
- [38] 3GPP TS 36.214: "Evolved Universal Terrestrial Radio Access (E-UTRA); Physical layer; Measurements".
- [39] 3GPP TS 32.425: "Telecommunication management; Performance Management (PM); Performance measurements Evolved Universal Terrestrial Radio Access Network (E-UTRAN)".
- [40] IETF RFC 6455: "The WebSocket Protocol".
- [41] IETF RFC 7692: "Compression Extensions for WebSocket".
- [42] 3GPP TS 38.215: "NR; Physical layer measurements".
- [43] 3GPP TS 28.532: "Management and orchestration; Generic management services".
- [44] 3GPP TS 38.305: "NG Radio Access Network (NG-RAN); Stage 2 functional specification of User Equipment (UE) positioning in NG-RAN".
- [45] Language Guide (Proto 3): <https://developers.google.com/protocol-buffers/docs/proto3>.

3 Definitions, symbols and abbreviations

3.1 Definitions

For the purposes of the present document, the terms and definitions given in 3GPP TS 32.421 [2], 3GPP TS 32.422 [3], TS 23.501 [18], TS 38.300 [20], TS 38.401 [22], TS 37.320 [32] and the following apply.







Minimum Level of detail: Allows for retrieval of a decoded subset of the IEs contained in the signalling interface messages.

Medium Level of detail: Allows for retrieval of the decoded subset of the IEs contained in the signalling interface messages in the Minimum Level plus a selected set of decoded radio measurement IEs.

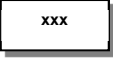
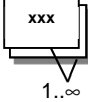
Maximum Level of detail: Allows for retrieval of signalling interface messages within the Trace Scope in encoded format.

3.2 Symbols

For the purposes of the present document, the following symbols apply:

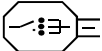
	: Element named xxx The maximum number of occurrence is 1
	: Element named xxx The maximum number of occurrence is unbounded
	: Global element
	The XML element has a value part
	: Required element
	: Optional element
	: Sequence
	: Choice

3.3 Abbreviations

For the purposes of the present document, the abbreviations given in TR 21.905 [4], TS 32.101 [1], TS 23.501 [18], TS 38.300 [20] and TS 38.401 [22] and TS 37.320 [32] apply.

NSA	Non Stand Alone
IDC	In-Device Coexistence

4 Trace record contents

4.1 General

The trace reference, trace type and operation system identification are all provided on trace activation.

Each record may contain an MSC Server, MGW, SGSN, GGSN, S-CSCF, P-CSCF, UTRAN, HSS, MME, Serving GW, E-UTRAN, AUSF, AMF, NEF, NRF, NSSF, PCF, SMF, SMSF, UDM, UPF, AF and , ng-eNB, gNB-CU-CP, gNB-CU-UP and gNB-DU event record. A key is included in the table indicating whether or not the field is mandatory.

The following table shows the template for trace record description for minimum and medium trace depth:

Interface name	Protocol name	IE name	Message name(s)	Trace depth		Notes
				Min	Med	

Interface name: Contains the name of the interface, where the IE is available.

Protocol name: Contains the protocol name on the interface, where the IE is available.

IE name: The name of the Information Element, which should be decoded.

Message name(s): The name of the message(s), where the IE is included.

Trace depth: Shows in which trace depth the IE should be recorded. It also classifies whether the IE is mandatory in the trace record or not (M, O or X: meaning described in the previous table)

M	Mandatory	This field must be in the trace record if it is available, i.e. if the message appears during the trace recording session and the IE is present in the message.
O	Optional	This field is optional and its support is a matter for agreement between equipment manufacturer and network operator.
X	Not applicable	This field is not required in this instance.
CM	Conditional Mandatory	This field must be in the trace record if it is available and the condition is met.

NOTE: Any kind of comments related to the IE can be made here. Also this is the placeholder for referencing the relevant 3GPP specifications, which define the IE.

4.2 MSC Server Trace Record Content

The following table shows the trace record content for MSC Server.
The trace record is the same for management based activation and for signalling based activation.
For MSC Server, the Minimum level of detail shall be supported.

Interface name	Prot. name	IE name	Message name(s)	Trace depth		Notes
				Min	Med	
lu, A	CC	Facility	ALERTING CALL PROCEEDING CONNECT DISCONNECT FACILITY RELEASE RELEASE COMPLETE SETUP	M	M	TS 24.008 TS 24.080
		Bearer capability	CALL CONFIRMED CALL PROCEEDING EMERGENCY SETUP MODIFY MODIFY COMPLETE MODIFY REJECT SETUP	M	M	TS 24.008
		Cause	CALL CONFIRMED CONGESTION CONTROL DISCONNECT HOLD REJECT MODIFY REJECT RELEASE RELEASE COMPLETE RETRIEVE REJECT START DTMF REJECT STATUS	M	M	TS 24.008
		Connected number	CONNECT	M	M	TS 24.008
		Calling party BCD number	SETUP	M	M	TS 24.008
		Called party BCD number	SETUP	M	M	TS 24.008
		Redirecting party BCD number	SETUP	M	M	TS 24.008
lu, A	MM	Reject cause	AUTHENTICATION FAILURE CM SERVICE REJECT ABORT LOCATION UPDATING REJECT MM STATUS	M	M	TS 24.008
		Location area identification	CM RE-ESTABLISHMENT REQUEST LOCATION UPDATING ACCEPT LOCATION UPDATING REQUEST TMSI REALLOCATION COMMAND	M	M	TS 24.008
		Mobile identity	CM RE-ESTABLISHMENT REQUEST CM SERVICE REQUEST IDENTITY REQUEST IDENTITY RESPONSE IMSI DETACH INDICATION LOCATION UPDATING ACCEPT LOCATION UPDATING REQUEST TMSI REALLOCATION COMMAND	M	M	TS 24.008
		CM service type	CM SERVICE REQUEST	M	M	TS 24.008
		Location updating type	LOCATION UPDATING REQUEST	M	M	TS 24.008
		Facility	FACILITY REGISTER RELEASE COMPLETE	M	M	TS 24.008

		Cause	RELEASE COMPLETE	M	M	TS 24.008
lu, A	SMS	TP-Originating-Address	SMS-DELIVER	M	M	TS 23.040
		TP-Service-Centre- Time-Stamp	SMS-DELIVER SMS-SUBMIT-REPORT SMS-STATUS-REPORT	M	M	TS 23.040
		TP-Failure-Cause	SMS-DELIVER-REPORT SMS-SUBMIT-REPORT	M	M	TS 23.040
		TP-Destination-Address	SMS-SUBMIT SMS-COMMAND	M	M	TS 23.040
		TP-Recipient-Address	SMS-STATUS-REPORT	M	M	TS 23.040
		A	BSSMAP	Channel Type	ASSIGNMENT REQUEST HANDOVER REQUEST	M
Circuit	ASSIGNMENT REQUEST			M	M	TS 48.008
Cell Identifier (Serving)	ASSIGNMENT COMPLETE HANDOVER REQUEST HANDOVER COMMAND HANDOVER PERFORMED PERFORM LOCATION REQUEST			M	M	TS 48.008
Chosen Channel	ASSIGNMENT COMPLETE HANDOVER REQUEST ACKNOWLEDGE HANDOVER PERFORMED			M	M	TS 48.008
Speech version (chosen)	ASSIGNMENT COMPLETE HANDOVER REQUEST HANDOVER REQUIRED HANDOVER REQUEST ACKNOWLEDGE HANDOVER PERFORMED			M	M	TS 48.008
Cause	ASSIGNMENT FAILURE HANDOVER REQUEST HANDOVER REQUIRED HANDOVER FAILURE CLEAR REQUEST CLEAR COMMAND HANDOVER PERFORMED HANDOVER REQUIRED REJECT			M	M	TS 48.008
RR Cause	ASSIGNMENT FAILURE HANDOVER COMPLETE HANDOVER FAILURE			M	M	TS 48.008
Cell Identifier (target)	HANDOVER REQUEST			M	M	TS 48.008
Current Channel type 1	HANDOVER REQUEST HANDOVER REQUIRED			M	M	TS 48.008
Cell Identifier List (Preferred)	HANDOVER REQUIRED PAGING			M	M	TS 48.008
IMSI	PAGING COMMON ID			M	M	TS 48.008
Location Type	PERFORM LOCATION REQUEST			M	M	TS 48.008
Location Estimate	PERFORM LOCATION RESPONSE			M	M	TS 48.008
LCS Cause	PERFORM LOCATION RESPONSE PERFORM LOCATION ABORT			M	M	TS 48.008

B	MAP	SS-Code	MAP_REGISTER_SS MAP_ERASE_SS MAP_ACTIVATE_SS MAP_DEACTIVATE_SS MAP_INTERROGATE_SS MAP_REGISTER_PASSWORD MAP_REGISTER_CC_ENTRY MAP_ERASE_CC_ENTRY	M	M	TS 29.002
		Forwarded-to number with subaddress	MAP_REGISTER_SS	M	M	TS 29.002
		Basic service	MAP_REGISTER_SS MAP_ERASE_SS MAP_ACTIVATE_SS MAP_DEACTIVATE_SS MAP_INTERROGATE_SS	M	M	TS 29.002
		SM RP DA	MAP-SEND-INFO-FOR-MT-SMS	M	M	TS 29.002
		Service Centre Address	MAP-SEND-INFO-FOR-MO-SMS	M	M	TS 29.002
		Alert Reason	MAP-READY-FOR-SM	M	M	TS 29.002
		Abort reason	Abort	M	M	TS 29.002 TS 23.018
C	MAP	MSISDN	Complete Call Process Access Request ack Process Call Waiting Send Info For Incoming Call ack MAP-SEND-INFO-FOR-MT-SMS MAP-SEND-INFO-FOR-MO-SMS	M	M	TS 29.002 TS 23.018
		IMEI(SV)	Complete Call Page MS ack Process Access Request Process Access Request ack Provide IMEI ack Search For MS ack	M	M	TS 29.002 TS 23.018
		PLMN bearer capability	Complete Call Process Call Waiting	M	M	TS 29.002 TS 23.018
		ISDN bearer capability	Complete Call Process Call Waiting	M	M	TS 29.002 TS 23.018
		IMSI	Page MS Process Access Request Process Access Request ack Provide IMSI ack Search For MS Send Info For Incoming Call ack MAP-SEND-INFO-FOR-MT-SMS	M	M	TS 29.002 TS 23.018
		Location area ID / Current location area ID	Page MS Page MS ack Process Access Request Search For MS ack	M	M	TS 29.002 TS 23.018
		Page type	Page MS Search For MS	M	M	TS 29.002 TS 23.018
		Serving cell ID	Page MS ack Process Access Request Search For MS ack	M	M	TS 29.002 TS 23.018

		Service area ID	Page MS ack Process Access Request Search For MS ack	M	M	TS 29.002 TS 23.018
		CM service type	Process Access Request	M	M	TS 29.002 TS 23.018
		MSRN	Send Info For Incoming Call	M	M	TS 29.002 TS 23.018
		Bearer service	Send Info For Incoming Call Send Info For Outgoing Call	M	M	TS 29.002 TS 23.018
		Teleservice	Send Info For Incoming Call Send Info For Outgoing Call	M	M	TS 29.002 TS 23.018
		Dialled number	Send Info For Incoming Call	M	M	TS 29.002 TS 23.018
		Number of forwarding	Send Info For Incoming Call	M	M	TS 29.002 TS 23.018
		Forwarded-to number	Send Info For Incoming Call ack	M	M	TS 29.002 TS 23.018
		Forwarding reason	Send Info For Incoming Call ack	M	M	TS 29.002 TS 23.018
		Called number	Send Info For Outgoing Call	M	M	TS 29.002 TS 23.018
		MSISDN	Send Routeing Info	M	M	TS 29.002 TS 23.018
		User error	Every message where it appears	M	M	TS 29.002
		Provider error	Every message where it appears	M	M	TS 29.002
		Service Centre Address	MAP-SEND-ROUTING-INFO-FOR-SM MAP-REPORT-SM-DELIVERY-STATUS MAP-ALERT-SERVICE-CENTRE	M	M	TS 29.002
		SM Delivery Outcome	MAP-REPORT-SM-DELIVERY-STATUS	M	M	TS 29.002
		MSISdn-Alert	MAP-ALERT-SERVICE-CENTRE MAP-INFORM-SERVICE-CEN	M	M	TS 29.002
		Number of forwarding	Send Routeing Info	M	M	TS 29.002 TS 23.018
		ISDN BC	Send Routeing Info	M	M	TS 29.002 TS 23.018
		IMSI	Send Routeing Info ack	M	M	TS 29.002 TS 23.018
		Roaming number	Send Routeing Info ack	M	M	TS 29.002 TS 23.018
		Forwarded-to number	Send Routeing Info ack	M	M	TS 29.002 TS 23.018
		Forwarding reason	Send Routeing Info ack	M	M	TS 29.002 TS 23.018
		MSISDN	Send Routeing Info ack MAP_SEND_ROUTING_INFO_FOR_SM	M	M	TS 29.002 TS 23.018
		User error	Every message where it appears	M	M	TS 29.002
		Provider error	Every message where it appears	M	M	TS 29.002
D	MAP	HLR number	MAP_RESTORE_DATA	M	M	TS 29.002
		MS Not Reachable Flag	MAP_RESTORE_DATA	M	M	TS 29.002

		SS-Code	MAP_REGISTER_SS MAP_ERASE_SS MAP_ACTIVATE_SS MAP_DEACTIVATE_SS MAP_INTERROGATE_SS MAP_REGISTER_PASSWORD MAP_REGISTER_CC_ENTRY MAP_ERASE_CC_ENTRY	M	M	TS 29.002
		Forwarded-to number with subaddress	MAP_REGISTER_SS	M	M	TS 29.002
		Basic service	MAP_REGISTER_SS MAP_ERASE_SS MAP_ACTIVATE_SS MAP_DEACTIVATE_SS MAP_INTERROGATE_SS	M	M	TS 29.002
		Alert Reason	MAP-READY-FOR-SM	M	M	TS 29.002
		MSC Address	MAP_UPDATE_LOCATION	M	M	TS 29.002
		IMSI	Provide Roaming Number Provide Subscriber Info MAP_UPDATE_LOCATION MAP_CANCEL_LOCATION MAP_PURGE_MS MAP-INSERT-SUBSCRIBER-DATA MAP-DELETE-SUBSCRIBER-DATA MAP_RESTORE_DATA	M	M	TS 29.002 TS 23.018
		MSISDN	Provide Roaming Number MAP-INSERT-SUBSCRIBER-DATA	M	M	TS 29.002 TS 23.018
		PLMN bearer capability	Provide Roaming Number	M	M	TS 29.002 TS 23.018
		ISDN BC	Provide Roaming Number	M	M	TS 29.002 TS 23.018
		Roaming number	Provide Roaming Number ack	M	M	TS 29.002 TS 23.018
		Service area ID	Provide Subscriber Info ack	M	M	TS 29.002 TS 23.018
		Cell ID	Provide Subscriber Info ack	M	M	TS 29.002 TS 23.018
		IMEI(SV)	Provide Subscriber Info ack	M	M	TS 29.002 TS 23.018
		User error	Every message where it appears	M	M	TS 29.002
		Provider error	Every message where it appears	M	M	TS 29.002
F	MAP	IMEI(SV)	MAP_CHECK_IMEI	M	M	TS 29.002 TS 23.018
		Equipment status	MAP_CHECK_IMEI	M	M	TS 29.002 TS 23.018
		User error	Every message where it appears	M	M	TS 29.002
		Provider error	Every message where it appears	M	M	TS 29.002
E	MAP	Target Cell Id	MAP_PREPARE_HANDOVER MAP_PREPARE_SUBSEQUENT_HANDOVER	M	M	TS 29.002
		Target RNC Id	MAP_PREPARE_HANDOVER MAP_PREPARE_SUBSEQUENT_HANDOVER	M	M	TS 29.002
		IMSI	MAP_PREPARE_HANDOVER	M	M	TS 29.002

		RAB ID/ Selected RAB id	MAP_PREPARE_HANOVER MAP_PROCESS_ACCESS_SIGNALLING MAP_PREPARE_SUBSEQUENT_HANOVER	M	M	TS 29.002
		Handover Number	MAP_PREPARE_HANOVER MAP_SEND_HANOVER_REPORT	M	M	TS 29.002
		User error	Every message where it appears	M	M	TS 29.002
		Provider error	Every message where it appears	M	M	TS 29.002
		Iu-Selected Codec	MAP_PREPARE_HANOVER MAP_PROCESS_ACCESS_SIGNALLING MAP_FORWARD_ACCESS_SIGNALLING	M	M	TS 29.002
		Iu-Currently Used Codec	MAP_PREPARE_HANOVER MAP_FORWARD_ACCESS_SIGNALLING	M	M	TS 29.002
		Iu-Supported Codecs List	MAP_PREPARE_HANOVER MAP_FORWARD_ACCESS_SIGNALLING	M	M	TS 29.002
		Iu-Available Codecs List	MAP_PREPARE_HANOVER MAP_PROCESS_ACCESS_SIGNALLING	M	M	TS 29.002
		Target MSC Number	MAP_PREPARE_SUBSEQUENT_HANOVER	M	M	TS 29.002
G	MAP	IMSI	MAP_SEND_IDENTIFICATION	M	M	TS 29.002
		MSC Number	MAP_SEND_IDENTIFICATION	M	M	TS 29.002
		User error	Every message where it appears	M	M	TS 29.002
		Provider error	Every message where it appears	M	M	TS 29.002
Mc	Megaco	Context	Every procedure where it appears	M	M	TS 23.205
		Bearer Termination 1	Every procedure where it appears	M	M	TS 23.205
		Bearer Termination 2	Every procedure where it appears	M	M	TS 23.205
		Bearer Characteristics	Establish Bearer	M	M	TS 23.205
		Destination Binding Reference	Establish Bearer	M	M	TS 23.205
		Sender Binding Reference	Prepare Bearer	M	M	TS 23.205
		Codec	Prepare Bearer Modify Bearer Characteristics	M	M	TS 23.205
		Release Cause	Release Bearer Bearer Released	M	M	TS 23.205
Iu	RANAP	RAB ID	RAB ASSIGNMENT REQUEST RAB ASSIGNMENT RESPONSE RAB RELEASE REQUEST IU RELEASE COMPLETE RELOCATION REQUEST RELOCATION REQUEST ACKNOWLEDGE RELOCATION COMMAND	M	M	TS 25.413
		Cause	RAB ASSIGNMENT REQUEST RAB ASSIGNMENT RESPONSE RAB RELEASE REQUEST IU RELEASE REQUEST IU RELEASE COMMAND RELOCATION REQUIRED RELOCATION REQUEST RELOCATION REQUEST ACKNOWLEDGE RELOCATION PREPARATION FAILURE RELOCATION FAILURE RELOCATION CANCEL SECURITY MODE REJECT LOCATION REPORT ERROR INDICATION	M	M	TS 25.413

	Source ID	RELOCATION REQUIRED	M	M	TS 25.413
	Target ID	RELOCATION REQUIRED	M	M	TS 25.413
	Paging Cause	PAGING	M	M	TS 25.413
	Permanent NAS UE Identity	COMMON ID PAGING RELOCATION REQUEST	M	M	TS 25.413
	Area Identity	LOCATION REPORT	M	M	TS 25.413
	Last Known Service Area	LOCATION REPORT	M	M	TS 25.413
	LAI	INITIAL UE MESSAGE DIRECT TRANSFER	M	M	TS 25.413
	SAI	INITIAL UE MESSAGE DIRECT TRANSFER	M	M	TS 25.413
	Global RNC-ID	ERROR INDICATION	M	M	TS 25.413

4.3 MGW Trace Record Content

The following table describes the trace record content for minimum and medium trace depth for Megaco protocol in the Media GateWay (MGW).

Interface name	Prot. name	IE name	Procedure name(s)	Trace depth		Notes
				Min	Med	
Mc	Megaco	Context	Every procedure where it appears	M	M	TS 23.205
		Bearer Termination 1	Every procedure where it appears	M	M	TS 23.205
		Bearer Termination 2	Every procedure where it appears	M	M	TS 23.205
		Bearer Characteristics	Establish Bearer	M	M	TS 23.205
		Destination Binding Reference	Establish Bearer	M	M	TS 23.205
		Destination Bearer Address	Establish Bearer	M	M	TS 23.205
		Sender Binding Reference	Prepare Bearer	M	M	TS 23.205
		Sender Bearer Address	Prepare Bearer	M	M	TS 23.205
		Codec	Prepare Bearer Modify Bearer Characteristics	M	M	TS 23.205
	Release Cause	Release Bearer Bearer Released	M	M	TS 23.205	
Iu-UP, Nb-UP		Error Cause value	Every NACK message	M	M	TS 25.415
Iu-UP, Nb-UP		RFCI indicators	Rate control procedure	M	M	TS 25.415
Iu-UP, Nb-UP		Local_Channel_Type	TFO_TRANS	M	M	TS 28.062
Iu-UP, Nb-UP		Indication whether <ENQUIRY> character is received by the CTM receiver	CTM availability negotiation	M	M	TS 26.226

4.4 SGSN Trace Record Content

The following table shows the trace record content for SGSN.

The trace record is the same for management based activation and for signalling based activation.

For SGSN, the Minimum level of detail shall be supported.

Interface name	Prot. name	IE name	Message name(s)	Trace depth		Notes
				Min	Med	
lu	SM	Requested QoS/Requested new QoS	ACTIVATE PDP CONTEXT REQUEST ACTIVATE SECONDARY PDP CONTEXT REQUEST MODIFY PDP CONTEXT REQUEST	M	M	TS 24.008
		Requested PDP address	ACTIVATE PDP CONTEXT REQUEST	M	M	TS 24.008
		Access point name	ACTIVATE PDP CONTEXT REQUEST REQUEST PDP CONTEXT ACTIVATION	M	M	TS 24.008 TS 23.003
		Negotiated QoS/New QoS	ACTIVATE PDP CONTEXT ACCEPT ACTIVATE SECONDARY PDP CONTEXT ACCEPT MODIFY PDP CONTEXT REQUEST MODIFY PDP CONTEXT ACCEPT	M	M	TS 24.008
		PDP Address	ACTIVATE PDP CONTEXT ACCEPT MODIFY PDP CONTEXT REQUEST	M	M	TS 24.008
		SM cause	ACTIVATE PDP CONTEXT REJECT ACTIVATE SECONDARY PDP CONTEXT REJECT REQUEST PDP CONTEXT ACTIVATION REJECT MODIFY PDP CONTEXT REJECT DEACTIVATE PDP CONTEXT REQUEST SM STATUS	M	M	TS 24.008
		Offered PDP address	REQUEST PDP CONTEXT ACTIVATION	M	M	TS 24.008
lu	MM	MS network capability	ATTACH REQUEST ROUTING AREA UPDATE REQUEST	M	M	TS 24.008
		Attach type	ATTACH REQUEST	M	M	TS 24.008
		IMSI	ATTACH REQUEST	M	M	TS 24.008
		MS Radio Access capability	ATTACH REQUEST ROUTING AREA UPDATE REQUEST	M	M	TS 24.008
		Attach result	ATTACH ACCEPT	M	M	TS 24.008
		Routing area identification	ATTACH ACCEPT ROUTING AREA UPDATE REQUEST ROUTING AREA UPDATE ACCEPT	M	M	TS 24.008
		GMM cause	ATTACH ACCEPT ATTACH REJECT DETACH REQUEST AUTHENTICATION AND CIPHERING FAILURE ROUTING AREA UPDATE ACCEPT ROUTING AREA UPDATE REJECT GMM STATUS	M	M	TS 24.008
		Detach type	DETACH REQUEST	M	M	TS 24.008
		Mobile identity	AUTHENTICATION AND CIPHERING RESPONSE IDENTITY RESPONSE ROUTING AREA UPDATE ACCEPT	M	M	TS 24.008
		Update type	ROUTING AREA UPDATE REQUEST	M	M	TS 24.008
Update result	ROUTING AREA UPDATE ACCEPT	M	M	TS 24.008		
lu	SMS	TP-Originating-Address	SMS-DELIVER	M	M	TS 23.040
		TP-Service-Centre-Time-Stamp	SMS-DELIVER SMS-SUBMIT-REPORT SMS-STATUS-REPORT	M	M	TS 23.040
		TP-Failure-Cause	SMS-DELIVER-REPORT SMS-SUBMIT-REPORT	M	M	TS 23.040
		TP-Destination-Address	SMS-SUBMIT SMS-COMMAND	M	M	TS 23.040

		TP-Recipient-Address	SMS-STATUS-REPORT	M	M	TS 23.040
Gn	GTP	IMSI	CREATE PDP CONTEXT REQUEST UPDATE PDP CONTEXT REQUEST PDU NOTIFICATION REQUEST IDENTIFICATION RESPONSE SGSN CONTEXT REQUEST FORWARD RELOCATION REQUEST RELOCATION CANCEL REQUEST MBMS NOTIFICATION REQUEST CREATE MBMS CONTEXT REQUEST UPDATE MBMS CONTEXT REQUEST DELETE MBMS CONTEXT REQUEST	M	M	TS 29.060
		RAI	CREATE PDP CONTEXT REQUEST UPDATE PDP CONTEXT REQUEST IDENTIFICATION REQUEST SGSN CONTEXT REQUEST CREATE MBMS CONTEXT REQUEST UPDATE MBMS CONTEXT REQUEST	M	M	TS 29.060
		End User Address	CREATE PDP CONTEXT REQUEST CREATE PDP CONTEXT RESPONSE UPDATE PDP CONTEXT REQUEST PDU NOTIFICATION REQUEST PDU NOTIFICATION REJECT REQUEST MBMS NOTIFICATION REQUEST MBMS NOTIFICATION REJECT REQUEST CREATE MBMS CONTEXT REQUEST DELETE MBMS CONTEXT REQUEST MBMS REGISTRATION REQUEST MBMS DE-REGISTRATION REQUEST MBMS SESSION START REQUEST MBMS SESSION STOP REQUEST	M	M	TS 29.060
		Access Point Name	CREATE PDP CONTEXT REQUEST PDU NOTIFICATION REQUEST PDU NOTIFICATION REJECT REQUEST MBMS NOTIFICATION REQUEST MBMS NOTIFICATION REJECT REQUEST CREATE MBMS CONTEXT REQUEST DELETE MBMS CONTEXT REQUEST MBMS REGISTRATION REQUEST MBMS DE-REGISTRATION REQUEST MBMS SESSION START REQUEST MBMS SESSION STOP REQUEST	M	M	TS 29.060
		SGSN Address for signalling	CREATE PDP CONTEXT REQUEST UPDATE PDP CONTEXT REQUEST IDENTIFICATION REQUEST SGSN CONTEXT REQUEST SGSN CONTEXT RESPONSE FORWARD RELOCATION REQUEST FORWARD RELOCATION RESPONSE CREATE MBMS CONTEXT REQUEST UPDATE MBMS CONTEXT REQUEST	M	M	TS 29.060

	SGSN Address for user traffic	CREATE PDP CONTEXT REQUEST UPDATE PDP CONTEXT REQUEST SGSN CONTEXT ACKNOWLEDGE MBMS SESSION START RESPONSE	M	M	TS 29.060
	MSISDN	CREATE PDP CONTEXT REQUEST CREATE MBMS CONTEXT REQUEST	M	M	TS 29.060
	Quality of Service Profile	CREATE PDP CONTEXT REQUEST CREATE PDP CONTEXT RESPONSE UPDATE PDP CONTEXT REQUEST UPDATE PDP CONTEXT RESPONSE MBMS SESSION START REQUEST	M	M	TS 29.060
	RAT Type	CREATE PDP CONTEXT REQUEST UPDATE PDP CONTEXT REQUEST	M	M	TS 29.060
	IMEI(SV)	CREATE PDP CONTEXT REQUEST	M	M	TS 29.060
	User Location Information	CREATE PDP CONTEXT REQUEST UPDATE PDP CONTEXT REQUEST	M	M	TS 29.060
	Cause	CREATE PDP CONTEXT RESPONSE UPDATE PDP CONTEXT RESPONSE DELETE PDP CONTEXT RESPONSE PDU NOTIFICATION RESPONSE PDU NOTIFICATION REJECT REQUEST PDU NOTIFICATION REJECT RESPONSE IDENTIFICATION RESPONSE SGSN CONTEXT RESPONSE SGSN CONTEXT ACKNOWLEDGE FORWARD RELOCATION RESPONSE RELOCATION CANCEL RESPONSE FORWARD RELOCATION COMPLETE ACKNOWLEDGE FORWARD SRNS CONTEXT ACKNOWLEDGE MBMS NOTIFICATION RESPONSE MBMS NOTIFICATION REJECT REQUEST MBMS NOTIFICATION REJECT RESPONSE CREATE MBMS CONTEXT RESPONSE UPDATE MBMS CONTEXT RESPONSE DELETE MBMS CONTEXT RESPONSE MBMS REGISTRATION RESPONSE MBMS DE-REGISTRATION RESPONSE MBMS SESSION START RESPONSE MBMS SESSION STOP RESPONSE	M	M	TS 29.060
	GGSN Address for Control Plane	CREATE PDP CONTEXT RESPONSE UPDATE PDP CONTEXT RESPONSE PDU NOTIFICATION REQUEST MBMS NOTIFICATION REQUEST CREATE MBMS CONTEXT RESPONSE UPDATE MBMS CONTEXT RESPONSE	M	M	TS 29.060
	GGSN Address for user traffic	CREATE PDP CONTEXT RESPONSE UPDATE PDP CONTEXT RESPONSE	M	M	TS 29.060
	GSN Address	ERROR INDICATION	M	M	TS 29.060
	SGSN Number	SGSN CONTEXT REQUEST FORWARD RELOCATION RESPONSE	M	M	TS 29.060
	MBMS UE Context	SGSN CONTEXT RESPONSE FORWARD RELOCATION REQUEST	M	M	TS 29.060

Gs	BSSAP+	RANAP Cause	FORWARD RELOCATION REQUEST FORWARD RELOCATION RESPONSE	M	M	TS 29.060
		Target Identification	FORWARD RELOCATION REQUEST	M	M	TS 29.060
		IMSI	BSSAP+-ALERT-ACK BSSAP+-ALERT-REJECT BSSAP+-ALERT-REQUEST BSSAP+-DOWNLINK-TUNNEL-REQUEST BSSAP+-GPRS-DETACH-ACK BSSAP+-GPRS-DETACH-INDICATION BSSAP+-IMSI-DETACH-ACK BSSAP+-IMSI-DETACH-INDICATION BSSAP+-LOCATION-UPDATE-ACCEPT BSSAP+-LOCATION-UPDATE-REJECT BSSAP+-LOCATION-UPDATE-REQUEST BSSAP+-MOBILE-STATUS BSSAP+-MS-ACTIVITY-INDICATION BSSAP+-MS-UNREACHABLE BSSAP+-PAGING-REJECT BSSAP+-PAGING-REQUEST BSSAP+-TMSI-REALLOCATION-COMPLETE BSSAP+-UPLINK-TUNNEL-REQUEST	M	M	TS 29.018
		Gs Cause	BSSAP+-ALERT-REJECT BSSAP+-MOBILE-STATUS BSSAP+-MS-UNREACHABLE BSSAP+-PAGING-REJECT	M	M	TS 29.018
		VLR number	BSSAP+-DOWNLINK-TUNNEL-REQUEST BSSAP+-PAGING-REQUEST BSSAP+-RESET-ACK BSSAP+-RESET-INDICATION	M	M	TS 29.018
		SGSN number	BSSAP+-GPRS-DETACH-INDICATION BSSAP+-IMSI-DETACH-INDICATION BSSAP+-LOCATION-UPDATE-REQUEST BSSAP+-RESET-ACK BSSAP+-RESET-INDICATION BSSAP+-UPLINK-TUNNEL-REQUEST	M	M	TS 29.018
		IMSI detach from GPRS service type	BSSAP+-GPRS-DETACH-INDICATION	M	M	TS 29.018
		Cell global identity/ New CGI	BSSAP+-GPRS-DETACH-INDICATION BSSAP+-IMSI-DETACH-INDICATION BSSAP+-LOCATION-UPDATE-REQUEST BSSAP+-MS-ACTIVITY-INDICATION BSSAP+-TMSI-REALLOCATION-COMPLETE	M	M	TS 29.018
		Service area identification /New SAI	BSSAP+-GPRS-DETACH-INDICATION BSSAP+-IMSI-DETACH-INDICATION BSSAP+-LOCATION-UPDATE-REQUEST BSSAP+-MS-ACTIVITY-INDICATION BSSAP+-TMSI-REALLOCATION-COMPLETE	M	M	TS 29.018
		Detach type	BSSAP+-IMSI-DETACH-INDICATION	M	M	TS 29.018
		Reject cause	BSSAP+-LOCATION-UPDATE-REJECT	M	M	TS 29.018
		Update type	BSSAP+-LOCATION-UPDATE-REQUEST	M	M	TS 29.018
		LAI/Old LAI	BSSAP+-LOCATION-UPDATE-ACCEPT BSSAP+-LOCATION-UPDATE-REQUEST BSSAP+-PAGING-REQUEST	M	M	TS 29.018
IMEISV	BSSAP+-LOCATION-UPDATE-REQUEST	M	M	TS 29.018		

		Erroneous message	BSSAP+-MOBILE-STATUS	M	M	TS 29.018
Gr	MAP	IMSI	MAP_CANCEL_LOCATION MAP_PURGE_MS MAP_UPDATE_GPRS_LOCATION MAP_NOTE_MM_EVENT MAP-INSERT-SUBSCRIBER-DATA MAP-DELETE-SUBSCRIBER-DATA MAP-READY-FOR-SM	M	M	TS 29.002
		Cancellation Type	MAP_CANCEL_LOCATION	M	M	TS 29.002
		User error	Every message where it appears	M	M	TS 29.002
		Provider error	Every message where it appears	M	M	TS 29.002
		Location Information for GPRS	MAP_NOTE_MM_EVENT	M	M	TS 29.002
		MSISDN	MAP-INSERT-SUBSCRIBER-DATA	M	M	TS 29.002
		Alert Reason	MAP-READY-FOR-SM	M	M	TS 29.002
Gd	MAP	SM RP OA	MAP-MO-FORWARD-SHORT-MESSAGE MAP-MT-FORWARD-SHORT-MESSAGE	M	M	TS 29.002
		SM RP DA	MAP-MO-FORWARD-SHORT-MESSAGE MAP-MT-FORWARD-SHORT-MESSAGE	M	M	TS 29.002
		IMSI	MAP-MO-FORWARD-SHORT-MESSAGE	M	M	TS 29.002
		More Messages To Send	MAP-MT-FORWARD-SHORT-MESSAGE	M	M	TS 29.002
Gf	MAP	IMEI(SV)	MAP_CHECK_IMEI	M	M	TS 29.002
		Equipment status	MAP_CHECK_IMEI	M	M	TS 29.002
		User error	Every message where it appears	M	M	TS 29.002
Iu	RANAP	RAB ID	RAB ASSIGNMENT REQUEST RAB ASSIGNMENT RESPONSE RAB RELEASE REQUEST IU RELEASE COMPLETE RELOCATION REQUEST RELOCATION REQUEST ACKNOWLEDGE RELOCATION COMMAND	M	M	TS 25.413
		Cause	RAB ASSIGNMENT REQUEST RAB ASSIGNMENT RESPONSE RAB RELEASE REQUEST IU RELEASE REQUEST IU RELEASE COMMAND RELOCATION REQUIRED RELOCATION REQUEST RELOCATION REQUEST ACKNOWLEDGE RELOCATION PREPARATION FAILURE RELOCATION FAILURE RELOCATION CANCEL SECURITY MODE REJECT LOCATION REPORT ERROR INDICATION	M	M	TS 25.413
		Source ID	RELOCATION REQUIRED	M	M	TS 25.413
		Target ID	RELOCATION REQUIRED	M	M	TS 25.413
		Paging Cause	PAGING	M	M	TS 25.413
		Permanent NAS UE Identity	COMMON ID PAGING RELOCATION REQUEST	M	M	TS 25.413
		Area Identity	LOCATION REPORT	M	M	TS 25.413

		Last Known Service Area	LOCATION REPORT	M	M	TS 25.413
		RAC	INITIAL UE MESSAGE DIRECT TRANSFER	M	M	TS 25.413
		SAI	INITIAL UE MESSAGE DIRECT TRANSFER	M	M	TS 25.413
		Global RNC-ID	ERROR INDICATION	M	M	TS 25.413
S3	GTPv2C	IMSI	DETACH NOTIFICATION CS PAGING INDICATION RELOCATION CANCEL Request IDENTIFICATION RESPONSE CONTEXT RESPONSE CONTEXT REQUEST FORWARD RELOCATION REQUEST	M	M	TS 29.274
		TMSI	CS PAGING INDICATION	M	M	TS 29.274
		GUTI	CONTEXT REQUEST IDENTIFICATION Request	M	M	TS 29.274
		RAI	IDENTIFICATION Request CONTEXT REQUEST	M	M	TS 29.274
		P-TMSI	IDENTIFICATION Request CONTEXT REQUEST	M	M	TS 29.274
		Indication	FORWARD RELOCATION COMPLETE NOTIFICATION FORWARD RELOCATION REQUEST	M	M	TS 29.274
		BSSGP Cause	FORWARD RELOCATION RESPONSE FORWARD RELOCATION REQUEST	M	M	TS 29.274
		RANAP Cause	FORWARD RELOCATION RESPONSE FORWARD RELOCATION REQUEST	M	M	TS 29.274
		eNodeB Cause	FORWARD RELOCATION RESPONSE	M	M	TS 29.274
		RAT Type	CONTEXT REQUEST	M	M	TS 29.274
		Target Identification	FORWARD RELOCATION REQUEST	M	M	TS 29.274
		Cause	RELOCATION CANCEL RESPONSE FORWARD SRNS CONTEXT ACKNOWLEDGE IDENTIFICATION RESPONSE CONTEXT ACKNOWLEDGE CONTEXT RESPONSE FORWARD RELOCATION COMPLETE ACKNOWLEDGE FORWARD RELOCATION RESPONSE DETACH NOTIFICATION DETACH ACKNOWLEDGE	M	M	TS 29.274
		RAN Cause	FORWARD RELOCATION REQUEST	M	M	TS 29.274
		Selected PLMN ID	FORWARD RELOCATION REQUEST	M	M	TS 29.274
		S4	GTPv2C	Traffic Aggregate Description (TAD)	Bearer Resource Command	M
Linked Bearer Identity (LBI)	Bearer Resource Command Create Bearer Request Delete Bearer Response			M	M	TS 25.413
Linked EPS Bearer ID	Bearer Resource Failure Indication Delete Session Request Delete Bearer Request			M	M	TS 25.413

		Cause	Bearer Resource Failure Indication Create Session Response Create Bearer Response Modify Bearer Response Delete Session Response Delete Bearer Response Downlink Data Notification Acknowledgement Downlink Data Notification Failure Indication Update Bearer Response Create Indirect Data Forwarding Tunnel Response Update Bearer Complete	M	M	TS 25.413
		Bearer Contexts to be modified	Modify Bearer Request	M	M	TS 25.413
		Bearer Contexts to be removed	Modify Bearer Request	M	M	TS 25.413
		IMSI	Create Session Request Update Bearer Request	M	M	TS 25.413
		MSISDN	Create Session Request Modify Bearer Response	M	M	TS 25.413
		Serving Network	Create Session Request	M	M	TS 25.413
		Access Point Name (APN)	Create Session Request	M	M	TS 25.413
		PDN Type	Create Session Request	M	M	TS 25.413
		Bearer Contexts	Create Session Request Create Bearer Request Create Bearer Response Delete Bearer Request Delete Bearer Response Update Bearer Request Update Bearer Response Create Indirect Data Forwarding Tunnel Request Create Indirect Data Forwarding Tunnel Response Update Bearer Complete	M	M	TS 25.413
		RAT Type	Create Session Request Modify Bearer Request	M	M	TS 25.413
		Bearer Contexts created	Create Session Response	M	M	TS 25.413
		Bearer Contexts marked for removal	Create Session Response	M	M	TS 25.413
		Bearer Contexts modified	Modify Bearer Response	M	M	TS 25.413
		Bearer Contexts marked for removal	Modify Bearer Response	M	M	TS 25.413
S6d	Diameter	User Name	NOTIFY REQUEST AUTHENTICATION INFORMATION REQUEST DELETE SUBSCRIBER DATA REQUEST INSERT SUBSCRIBER DATA REQUEST PURGE UE REQUEST CANCEL LOCATION REQUEST UPDATE LOCATION REQUEST	M	M	TS 29.272
		Terminal Information	NOTIFY REQUEST UPDATE LOCATION REQUEST	M	M	TS 29.272
		Result	NOTIFY ANSWER AUTHENTICATION INFORMATION ANSWER DELETE SUBSCRIBER DATA ANSWER INSERT SUBSCRIBER DATA ANSWER PURGE UE ANSWER CANCEL LOCATION ANSWER UPDATE LOCATION ANSWER	M	M	TS 29.272

		RAT Type	UPDATE LOCATION REQUEST	M	M	TS 29.272
		APN	NOTIFY REQUEST	M	M	TS 29.272
		Visited PLMN Id	AUTHENTICATION INFORMATION REQUEST UPDATE LOCATION REQUEST	M	M	TS 29.272
S13'	Diameter	Terminal Information	ME Identity Check Request	M	M	TS 29.272
		Result	ME Identity Check Answer	M	M	TS 29.272

4.5 GGSN Trace Record Content

The following table describes the trace record content for minimum and medium trace depth for GGSN. The record content is same for management based activation and for signalling based activation. For GGSN, the Minimum level of detail shall be supported.

Interface name	Prot. Name	IE name	MESSAGE NAME(S)	Trace depth		Notes
				Min	Med	
Gn	GTP	IMSI	CREATE PDP CONTEXT REQUEST UPDATE PDP CONTEXT REQUEST PDU NOTIFICATION REQUEST SEND ROUTEING INFORMATION FOR GPRS REQUEST SEND ROUTEING INFORMATION FOR GPRS RESPONSE FAILURE REPORT REQUEST NOTE MS PRESENT REQUEST MBMS NOTIFICATION REQUEST CREATE MBMS CONTEXT REQUEST UPDATE MBMS CONTEXT REQUEST DELETE MBMS CONTEXT REQUEST	M	M	TS 29.060
		RAI	CREATE PDP CONTEXT REQUEST UPDATE PDP CONTEXT REQUEST CREATE MBMS CONTEXT REQUEST UPDATE MBMS CONTEXT REQUEST	M	M	TS 29.060
		End User Address	CREATE PDP CONTEXT REQUEST CREATE PDP CONTEXT RESPONSE UPDATE PDP CONTEXT REQUEST PDU NOTIFICATION REQUEST PDU NOTIFICATION REJECT REQUEST MBMS NOTIFICATION REQUEST MBMS NOTIFICATION REJECT REQUEST CREATE MBMS CONTEXT REQUEST DELETE MBMS CONTEXT REQUEST MBMS REGISTRATION REQUEST MBMS DE-REGISTRATION REQUEST MBMS SESSION START REQUEST MBMS SESSION STOP REQUEST	M	M	TS 29.060
		Access Point Name	CREATE PDP CONTEXT REQUEST PDU NOTIFICATION REQUEST PDU NOTIFICATION REJECT REQUEST MBMS NOTIFICATION REQUEST MBMS NOTIFICATION REJECT REQUEST CREATE MBMS CONTEXT REQUEST DELETE MBMS CONTEXT REQUEST MBMS REGISTRATION REQUEST MBMS DE-REGISTRATION REQUEST MBMS SESSION START REQUEST MBMS SESSION STOP REQUEST	M	M	TS 29.060
		SGSN Address for signalling	CREATE PDP CONTEXT REQUEST UPDATE PDP CONTEXT REQUEST CREATE MBMS CONTEXT REQUEST UPDATE MBMS CONTEXT REQUEST	M	M	TS 29.060
		SGSN Address for user traffic	CREATE PDP CONTEXT REQUEST UPDATE PDP CONTEXT REQUEST MBMS SESSION START RESPONSE	M	M	TS 29.060
		MSISDN	CREATE PDP CONTEXT REQUEST CREATE MBMS CONTEXT REQUEST	M	M	TS 29.060

		Quality of Service Profile	CREATE PDP CONTEXT REQUEST CREATE PDP CONTEXT RESPONSE UPDATE PDP CONTEXT REQUEST UPDATE PDP CONTEXT RESPONSE MBMS SESSION START REQUEST	M	M	TS 29.060
		RAT Type	CREATE PDP CONTEXT REQUEST UPDATE PDP CONTEXT REQUEST	M	M	TS 29.060
		IMEI(SV)	CREATE PDP CONTEXT REQUEST	M	M	TS 29.060
		User Location Information	CREATE PDP CONTEXT REQUEST UPDATE PDP CONTEXT REQUEST	M	M	TS 29.060
		Cause	CREATE PDP CONTEXT RESPONSE UPDATE PDP CONTEXT RESPONSE DELETE PDP CONTEXT RESPONSE PDU NOTIFICATION RESPONSE PDU NOTIFICATION REJECT REQUEST PDU NOTIFICATION REJECT RESPONSE SEND ROUTEING INFORMATION FOR GPRS RESPONSE FAILURE REPORT RESPONSE NOTE MS GPRS PRESENT RESPONSE MBMS NOTIFICATION RESPONSE MBMS NOTIFICATION REJECT REQUEST MBMS NOTIFICATION REJECT RESPONSE CREATE MBMS CONTEXT RESPONSE UPDATE MBMS CONTEXT RESPONSE DELETE MBMS CONTEXT RESPONSE MBMS REGISTRATION RESPONSE MBMS DE-REGISTRATION RESPONSE MBMS SESSION START RESPONSE MBMS SESSION STOP RESPONSE	M	M	TS 29.060
		GGSN Address for Control Plane	CREATE PDP CONTEXT RESPONSE UPDATE PDP CONTEXT RESPONSE PDU NOTIFICATION REQUEST MBMS NOTIFICATION REQUEST CREATE MBMS CONTEXT RESPONSE UPDATE MBMS CONTEXT RESPONSE	M	M	TS 29.060
		GGSN Address for user traffic	CREATE PDP CONTEXT RESPONSE UPDATE PDP CONTEXT RESPONSE	M	M	TS 29.060
		MAP Cause	SEND ROUTEING INFORMATION FOR GPRS RESPONSE FAILURE REPORT RESPONSE	M	M	TS 29.060
		GSN Address	SEND ROUTEING INFORMATION FOR GPRS RESPONSE NOTE MS PRESENT REQUEST	M	M	TS 29.060
Gmb	Diameter Gmb	IMSI	MBMS AUTHORIZATION REQUEST (AAR) MBMS AUTHORIZATION RESPONSE (AAA)	M	M	TS 29.061
		RAI	MBMS AUTHORIZATION REQUEST (AAR)	M	M	TS 29.061
		Access Point Name	MBMS AUTHORIZATION REQUEST (AAR)	M	M	TS 29.061
		MSISDN	MBMS AUTHORIZATION REQUEST (AAR)	M	M	TS 29.061
		IMEI(SV)	MBMS AUTHORIZATION REQUEST (AAR)	M	M	TS 29.061
		IP Multicast Address	MBMS AUTHORIZATION REQUEST (AAR)	M	M	TS 29.061
		TMGI	MBMS AUTHORIZATION RESPONSE (AAA)	M	M	TS 29.061

	Result-Code	MBMS AUTHORIZATION RESPONSE (AAA) MBMS USER DEACTIVATION RESPONSE (STA) MBMS SESSION START-STOP INDICATION RESPONSE (RAA) MBMS SERVICE TERMINATION ANSWER (ASR)	M	M	TS 29.061
	Experimental-Result	MBMS AUTHORIZATION RESPONSE (AAA) MBMS SESSION START-STOP INDICATION RESPONSE (RAA)	M	M	TS 29.061
	Error-Reporting-Host	MBMS AUTHORIZATION RESPONSE (AAA) MBMS USER DEACTIVATION RESPONSE (STA) MBMS SESSION START-STOP INDICATION RESPONSE (RAA) MBMS SERVICE TERMINATION ANSWER (ASR)	M	M	TS 29.061

4.6 UTRAN Trace Record Content

For RNC, the Maximum level of detail shall be supported.

Table 4.6.1 : UTRAN Trace Record Content

Interface (specific messages)	Format	Level of details			Description
		Min	Med	Max	
RRC (without rrc dedicated measurements)	Decoded	M	M	O	Message name
		O	O	O	Record extensions
		M	M	X	rnclD of traced RNC
		M	M	X	Dedicated IE extracted from RRC messages between the traced RNC and the UE. A subset of IEs as given in the table 4.6.2. is provided.
	ASN.1	X	X	M	Raw Uu Messages: RRC messages between the traced RNC and the UE. The encoded content of the message is provided
Iub (without nbap dedicated measurements)	Decoded	M	M	O	Message name
		O	O	O	Record extensions
		M	M	X	rnclD of traced RNC cld
		M	M	X	rbld + Dedicated IE extracted from NBAP messages send/received inside traced UEs communication context. A subset of IEs as given in the table 4.6.2.is provided
	ASN.1	X	X	M	Raw Iub Messages: NBAP messages between the traced RNC and the NodeB or cell. The encoded content of the message is provided
Iu	Decoded	M	M	O	Message name
		O	O	O	Record extensions
		M	M	X	rnclD of traced RNC CoreNetworkID CN Domain Indicator
		M	M	X	rabld + Dedicated IE extracted from RANAP messages between the traced RNC and Core Network. A subset of IEs as given in the table 4.6.2. is provided.
	ASN.1	X	X	M	Raw Iu Messages RANAP: messages between the traced RNC and Core Network The encoded content of the message is provided
Iur	Decoded	M	M	O	Message name
		O	O	O	Record extensions
		M	M	X	rnclD of traced RNC rnclD of neighbouring RNC
		M	M	X	rlld + Dedicated IE extracted from RNSAP messages between the traced RNC and the neighbouring RNC. A subset of IEs as given in the table 4.6.2.is provided
	ASN.1	X	X	M	Raw Iur Messages: RNSAP messages between the traced RNC and the neighbouring RNC. The encoded content of the message is provided
nbap (only dedicated measurements)	Decoded	X	M	X	Iub IEs from NBAP measurement reports messages
	ASN.1	X	X	M	NBAP measurement reports messages
rrc (only dedicated measurements)	Decoded	X	M	X	Uu IEs from RRC measurement reports messages
	ASN.1	X	X	M	RRC measurement reports messages

Definitions:

- rncID of traced RNC: The id of the RNC traced, e.g. the RNC which handles the connection of the traced MS, during the Trace Recording Session.
- rncID of neighbouring RNC: The ids of all Neighbouring RNC involved in the Iur procedures during the Trace Recording Session.
- cId: RNSAP messages
The cIds of all cells involved in the Iub and Iur procedures during the Trace Recording Session. The cId is provided with each NBAP and for which the cId is relevant.
- rabId: Specific recorded IE that contains the RAB identifier.
- rliId: Specific recorded IE that contains the Radio Link identifier
- rbiId: Specific recorded IE that contains the Radio Bearer identifier
- Message name: Name of the protocol message
- Record extensions: A set of manufacturer specific extensions to the record
- Decoded: Some IEs shall be decoded (cf. detailed list in table 4.6.2. depending on trace depth)
- ASN.1: Messages in encoded format

Table 4.6.2 : trace record description for minimum and medium trace depth

Interface name	Prot. name	IE name	Message name(s)	Trace depth		Notes
				Min	Med	
Uu	RRC	RAB info type	RADIO BEARER SETUP HO TO UTRAN COMMAND RADIO BEARER RELEASE RADIO BEARER RECONFIGURATION	M	M	TS 25.331
		RB info type	RADIO BEARER RECONFIGURATION RADIO BEARER RELEASE RADIO BEARER SETUP HO TO UTRAN COMMAND	M	M	TS 25.331
		URA identity	RADIO BEARER SETUP RADIO BEARER RELEASE URA UPDATE CONFIRM RADIO BEARER RECONFIGURATION	M	M	TS 25.331
		CN domain	SIGNALLING CONNECTION RELEASE INITIAL DIRECT TRANSFER DL DIRECT TRANSFER UL DIRECT TRANSFER	M	M	TS 25.331
		Logical channel priority	RADIO BEARER SETUP	M	M	TS 25.331
		RRC state indicator	RADIO BEARER SETUP PHYSICAL CHANNEL RECONFIGURATION TRANSPORT CHANNEL RECONFIGURATION RADIO BEARER RECONFIGURATION CELL UPDATE CONFIRM URA UPDATE CONFIRM	M	M	TS 25.331
		Primary CPICH scrambling code of added cell	ACTIVE SET UPDATE	O	O	TS 25.331
		Primary CPICH scrambling code of removed cell	ACTIVE SET UPDATE	O	O	TS 25.331
		Target cell identity	CELL CHANGE ORDER	M	M	TS 25.331
		Cell synchronisation information	RRC/MEASUREMENT REPORT for measurement = intra frequency	X	M	TS 25.331
		Cell parameters Id	RRC/MEASUREMENT REPORT for measurement = intra frequency	O	O	TS 25.331
		Timeslot list	RRC/MEASUREMENT REPORT for measurement = intra frequency	X	O	TS 25.331
		CPICH Ec/No	RRC/MEASUREMENT REPORT for measurement = intra frequency	X	O	TS 25.331
		CPICH RSCP	RRC/MEASUREMENT REPORT for measurement = intra frequency	X	O	TS 25.331
PCCPCH RSCP	RRC/MEASUREMENT REPORT for measurement = intra frequency	X	O	TS 25.331		

	Pathloss	RRC/MEASUREMENT REPORT for measurement = intra frequency	X	M	TS 25.331
	UARFCN uplink (Nu)	RRC/MEASUREMENT REPORT for measurement = inter frequency	X	O	TS 25.331
	UARFCN downlink (Nd)	RRC/MEASUREMENT REPORT for measurement = inter frequency	X	O	TS 25.331
	UARFCN (Nt)	RRC/MEASUREMENT REPORT for measurement = inter frequency	X	O	TS 25.331
	Cell synchronisation information	RRC/MEASUREMENT REPORT for measurement = inter frequency	X	M	TS 25.331
	CPICH Ec/No	RRC/MEASUREMENT REPORT for measurement = inter frequency	X	O	TS 25.331
	CPICH RSCP	RRC/MEASUREMENT REPORT for measurement = inter frequency	X	O	TS 25.331
	PCCPCH RSCP	RRC/MEASUREMENT REPORT for measurement = inter frequency	X	O	TS 25.331
	Pathloss	RRC/MEASUREMENT REPORT for measurement = inter frequency	X	M	TS 25.331
	Cell parameters Id	RRC/MEASUREMENT REPORT for measurement = inter frequency	O	O	TS 25.331
	Timeslot list	RRC/MEASUREMENT REPORT for measurement = inter frequency	X	O	TS 25.331
	BCCH ARFCN	RRC/MEASUREMENT REPORT for measurement = inter RAT	X	M	TS 25.331
	GSM Carrier RSSI	RRC/MEASUREMENT REPORT for measurement = inter RAT	X	M	TS 25.331
	RLC buffer Payload	RRC/MEASUREMENT REPORT for measurement = traffic volume	X	M	TS 25.331
	Average RLC buffer payload	RRC/MEASUREMENT REPORT for measurement = traffic volume	X	M	TS 25.331
	Variance of RLC buffer payload	RRC/MEASUREMENT REPORT for measurement = traffic volume	X	M	TS 25.331
	Logged Connection Establishment Failure Report	UE INFORMATION RESPONSE	X	M	TS 25.331

lub	NBAP	RL identity	RADIO LINK SETUP REQUEST RADIO LINK RECONFIGURATION PREPARE RADIO LINK RECONFIGURATION REQUEST RADIO LINK RECONFIGURATION READY RADIO LINK RECONFIGURATION FAILURE RADIO LINK RECONFIGURATION RESPONSE RADIO LINK ADDITION REQUEST RADIO LINK RECONFIGURATION REQUEST RADIO LINK SETUP RESPONSE RADIO LINK SETUP FAILURE RADIO LINK ADDITION RESPONSE RADIO LINK ADDITION FAILURE RADIO LINK DELETION REQUEST	M	M	TS 25.433
		RL info type	RADIO LINK SETUP FAILURE RADIO LINK ADDITION FAILURE RADIO LINK RECONFIGURATION FAILURE	M	M	TS 25.433
		C-ID	RADIO LINK SETUP REQUEST RADIO LINK ADDITION REQUEST	M	M	TS 25.433
		UL Scrambling Code	RADIO LINK SETUP REQUEST RADIO LINK RECONFIGURATION PREPARE	O	O	TS 25.433
		UL Timeslot information	RADIO LINK SETUP REQUEST RADIO LINK RECONFIGURATION PREPARE	O	O	TS 25.433
		UL SIR target	RADIO LINK SETUP REQUEST RADIO LINK RECONFIGURATION PREPARE	M	M	TS 25.433
		Minimum UL channelization length	RADIO LINK SETUP REQUEST RADIO LINK RECONFIGURATION PREPARE	O	O	TS 25.433
		Initial DL transmission Power	RADIO LINK SETUP REQUEST RADIO LINK ADDITION REQUEST	M	M	TS 25.433
		Maximum DL transmission Power	RADIO LINK SETUP REQUEST RADIO LINK RECONFIGURATION PREPARE RADIO LINK ADDITION REQUEST RADIO LINK RECONFIGURATION REQUEST	M	M	TS 25.433
		Minimum DL transmission Power	RADIO LINK SETUP REQUEST RADIO LINK ADDITION REQUEST RADIO LINK RECONFIGURATION PREPARE RADIO LINK RECONFIGURATION REQUEST	M	M	TS 25.433
		DL scrambling code	RADIO LINK SETUP REQUEST RADIO LINK ADDITION REQUEST RADIO LINK RECONFIGURATION PREPARE RADIO LINK RECONFIGURATION REQUEST	O	O	TS 25.433
DL Code information	RADIO LINK SETUP REQUEST RADIO LINK ADDITION REQUEST RADIO LINK RECONFIGURATION PREPARE RADIO LINK RECONFIGURATION REQUEST	O	O	TS 25.433		

		DL Timeslot information	RADIO LINK SETUP REQUEST RADIO LINK RECONFIGURATION PREPARE RADIO LINK RECONFIGURATION REQUEST	O	O	TS25.433
		Puncture limit	RADIO LINK SETUP REQUEST RADIO LINK RECONFIGURATION PREPARE	M	M	TS 25.433
		UL Time Slot ISCP Info	RADIO LINK SETUP RESPONSE RADIO LINK ADDITION RESPONSE	O	O	TS 25.433
		Received total wide band power	RADIO LINK SETUP RESPONSE RADIO LINK SETUP FAILURE RADIO LINK ADDITION RESPONSE RADIO LINK ADDITION FAILURE	O	O	TS 25.433
lu	RANAP	RAB identity	All messages where it is present	M	M	TS 25.413
		RAB info type	RAB ASSIGNMENT REQUEST RELOCATION REQUEST RAB MODIFY REQUEST RAB ASSIGNMENT RESPONSE	M	M	TS 25.413
		RAB parameters	RAB ASSIGNMENT REQUEST RELOCATION REQUEST	M	M	TS 25.413
		Assigned RAB parameters values	RAB ASSIGNMENT RESPONSE	M	M	TS 25.413
		Requested RAB parameters values	RAB MODIFY REQUEST	M	M	TS 25.413
		Source ID	RELOCATION REQUIRED	M	M	TS 25.413
		Target ID	RELOCATION REQUIRED	M	M	TS 25.413
		LAI	DIRECT TRANSFER	M	M	TS 25.413
		RAC	DIRECT TRANSFER	M	M	TS 25.413
SAI	DIRECT TRANSFER	M	M	TS 25.413		
lur	RNSAP	RL id identity	RADIO LINK SETUP REQUEST RADIO LINK RECONFIGURATION PREPARE RADIO LINK RECONFIGURATION REQUEST RADIO LINK RECONFIGURATION READY RADIO LINK RECONFIGURATION FAILURE RADIO LINK RECONFIGURATION RESPONSE RADIO LINK ADDITION REQUEST RADIO LINK RECONFIGURATION REQUEST RADIO LINK SETUP RESPONSE RADIO LINK SETUP FAILURE RADIO LINK ADDITION RESPONSE RADIO LINK ADDITION FAILURE RADIO LINK DELETION REQUEST	M	M	TS 25.423
		C-ID	RADIO LINK SETUP REQUEST RADIO LINK ADDITION REQUEST	M	M	TS 25.423

	RL info type	RADIO LINK SETUP FAILURE RADIO LINK ADDITION FAILURE RADIO LINK SETUP FAILURE RADIO LINK RECONFIGURATION FAILURE	M	M	TS 25.423
	UL Scrambling Code	RADIO LINK SETUP REQUEST RADIO LINK RECONFIGURATION PREPARE	O	O	TS 25.423
	UL Timeslot information	RADIO LINK SETUP REQUEST RADIO LINK RECONFIGURATION PREPARE	O	O	TS25.423
	UL SIR target	RADIO LINK SETUP REQUEST RADIO LINK RECONFIGURATION PREPARE	M	M	TS 25.423
	Minimum UL channelization length	RADIO LINK SETUP REQUEST RADIO LINK RECONFIGURATION PREPARE	O	O	TS 25.423
	Initial DL transmission Power	RADIO LINK SETUP REQUEST RADIO LINK ADDITION REQUEST	M	M	TS 25.423
	Maximum DL transmission Power	RADIO LINK SETUP REQUEST RADIO LINK RECONFIGURATION PREPARE RADIO LINK ADDITION REQUEST RADIO LINK RECONFIGURATION REQUEST	M	M	TS 25.423
	Minimum DL transmission Power	RADIO LINK SETUP REQUEST RADIO LINK ADDITION REQUEST RADIO LINK RECONFIGURATION PREPARE RADIO LINK RECONFIGURATION REQUEST	M	M	TS 25.423
	DL scrambling code	RADIO LINK SETUP REQUEST RADIO LINK ADDITION REQUEST RADIO LINK RECONFIGURATION PREPARE RADIO LINK RECONFIGURATION REQUEST	O	O	TS 25.423
	DL channelization code	RADIO LINK SETUP REQUEST RADIO LINK ADDITION REQUEST RADIO LINK RECONFIGURATION PREPARE RADIO LINK RECONFIGURATION REQUEST	O	O	TS 25.423
	DL Timeslot information	RADIO LINK SETUP REQUEST RADIO LINK RECONFIGURATION PREPARE RADIO LINK RECONFIGURATION REQUEST	O	O	TS 25.423
	Puncture limit	RADIO LINK SETUP REQUEST RADIO LINK RECONFIGURATION PREPARE	M	M	TS 25.423
	UL Time Slot ISCP Info	RADIO LINK SETUP RESPONSE RADIO LINK ADDITION RESPONSE	O	O	TS 25.423
	Received total wide band power	RADIO LINK SETUP RESPONSE RADIO LINK SETUP FAILURE RADIO LINK ADDITION RESPONSE RADIO LINK ADDITION FAILURE	O	O	TS 25.423

Constraints:

The following optional IE names shall be supported for corresponding modes as described below:

For FDD mode:

- Primary CPICH scrambling code of added cell
- Primary CPICH scrambling code of removed cell
- CPICH Ec/No
- CPICH RSCP
- UL Scrambling Code
- Minimum UL channelization length
- UARFCN downlink (Nd)
- UARFCN uplink (Nu)
- DL Scrambling Code
- DL Code information
- DL channelization code
- Received total wide band power

For TDD mode :

- PCCPCH RSCP
- Cell parameters Id
- UARFCN (Nt)
- Timeslot list
- UL Timeslot information
- DL Timeslot information
- UL Time Slot ISCP Info

4.7 Void

4.8 Void

4.9 HSS Trace Record Content

The following table contains the Trace record description for the minimum and medium trace depth for MAP and Diameter protocol for the C, D, Gr, Gc,Cx, Sh, S6a, N70, N71 and NU1 interfaces in the HSS.

The trace record is the same for management based activation and for signalling based activation.

Interface name	Prot. name	IE name	Message name(s)	Trace depth		Notes
				Min	Med	
D	MAP	IMSI	MAP_UPDATE_LOCATION MAP_CANCEL_LOCATION MAP_PURGE_MS MAP-INSERT-SUBSCRIBER-DATA MAP_RESTORE_DATA MAP-SEND-IMSI MAP-READY-FOR-SM	M	M	TS 29.002
		MSC Address	MAP_UPDATE_LOCATION	M	M	TS 29.002
		VLR number	MAP_UPDATE_LOCATION MAP_PURGE_MS	M	M	TS 29.002
		User error	Every message where it appears	M	M	TS 29.002
		Provider error	Every message where it appears	M	M	TS 29.002
		SGSN number	MAP_PURGE_MS	M	M	TS 29.002
		MSISDN	MAP-INSERT-SUBSCRIBER-DATA MAP-SEND-IMSI	M	M	TS 29.002
		MS Not Reachable Flag	MAP_RESTORE_DATA	M	M	TS 29.002
		SS-Code	MAP_REGISTER_SS MAP_ERASE_SS MAP_ACTIVATE_SS MAP_DEACTIVATE_SS MAP_INTERROGATE_SS MAP_REGISTER_PASSWORD MAP_REGISTER_CC_ENTRY MAP_ERASE_CC_ENTRY	M	M	TS 29.002
		Forwarded-to number with subaddress	MAP_REGISTER_SS	M	M	TS 29.002
		Alert Reason	MAP-READY-FOR-SM	M	M	TS 29.002
		Basic service	MAP_REGISTER_SS MAP_ERASE_SS MAP_ACTIVATE_SS MAP_DEACTIVATE_SS MAP_INTERROGATE_SS	M	M	TS 29.002
		C	MAP	Service Centre Address	MAP-SEND-ROUTING-INFO-FOR-SM	M
Network Node Number	MAP-SEND-ROUTING-INFO-FOR-SM			M	M	TS 29.002
GPRS Node Indicator	MAP-SEND-ROUTING-INFO-FOR-SM			M	M	TS 29.002
User error	Every message where it appears			M	M	TS 29.002
Provider error	Every message where it appears			M	M	TS 29.002
MSISDN	MAP-SEND-ROUTING-INFO-FOR-SM Send Routeing Info ack			M	M	TS 29.002
Number of forwarding	Send Routeing Info			M	M	TS 29.002 TS 23.018
IMSI	Send Routeing Info ack			M	M	TS 29.002 TS 23.018
Roaming number	Send Routeing Info ack			M	M	TS 29.002 TS 23.018

		Forwarded-to number	Send Routeing Info ack	M	M	TS 29.002 TS 23.018
		Forwarding reason	Send Routeing Info ack	M	M	TS 29.002 TS 23.018
		Additional Number	MAP-SEND-ROUTING-INFO-FOR-SM	M	M	TS 29.002
Gr	MAP	SGSN address	MAP_UPDATE_GPRS_LOCATION	M	M	TS 29.002
		IMSI	MAP_CANCEL_LOCATION MAP_PURGE_MS MAP_UPDATE_GPRS_LOCATION MAP-INSERT-SUBSCRIBER-DATA MAP-READY-FOR-SM	M	M	TS 29.002
		SGSN number	MAP_UPDATE_GPRS_LOCATION MAP_PURGE_MS	M	M	TS 29.002
		Alert Reason	MAP-READY-FOR-SM	M	M	TS 29.002
		User error	Every message where it appears	M	M	TS 29.002
		Provider error	Every message where it appears	M	M	TS 29.002
		Gc	MAP	IMSI	MAP_SEND_ROUTING_INFO_FOR_GPRS MAP_FAILURE_REPORT MAP_NOTE_MS_PRESENT_FOR_GPRS	M
SGSN address	MAP_SEND_ROUTING_INFO_FOR_GPRS MAP_NOTE_MS_PRESENT_FOR_GPRS			M	M	TS 29.002
GGSN address	MAP_SEND_ROUTING_INFO_FOR_GPRS MAP_FAILURE_REPORT MAP_NOTE_MS_PRESENT_FOR_GPRS			M	M	TS 29.002
Mobile Not Reachable Reason	MAP_SEND_ROUTING_INFO_FOR_GPRS			M	M	TS 29.002
User error	Every message where it appears			M	M	TS 29.002
Provider error	Every message where it appears			M	M	TS 29.002
Cx	Diameter	Public User Identity	USER-AUTHORIZATION-REQUEST MULTIMEDIA-AUTH-REQUEST LOCATION INFO REQUEST	M	M	TS 29.228
		Private User Identity	USER-AUTHORIZATION-REQUEST MULTIMEDIA-AUTH-REQUEST REGISTRATION-TERMINATION-REQUEST PUSH-PROFILE-REQUEST	M	M	TS 29.228
		Visited Network Identifier	USER-AUTHORIZATION-REQUEST	M	M	TS 29.228
		S-CSCF Name	SERVER-ASSIGNMENT-REQUEST MULTIMEDIA-AUTH-REQUEST	M	M	TS 29.228
		Server Assignment Type	SERVER-ASSIGNMENT-REQUEST	M	M	TS 29.228
		User Data Already Available	SERVER-ASSIGNMENT-REQUEST	M	M	TS 29.228
		Reason for de-registration	REGISTRATION-TERMINATION-REQUEST	M	M	TS 29.228
		Routing Information	REGISTRATION-TERMINATION-REQUEST PUSH-PROFILE-REQUEST	M	M	TS 29.228
		Number Authentication Items	MULTIMEDIA-AUTH-REQUEST	M	M	TS 29.228

		Authentication Data	MULTIMEDIA-AUTH-REQUEST	M	M	TS 29.228
		Authentication Scheme	MULTIMEDIA-AUTH-REQUEST	M	M	TS 29.228
		Registration result	SERVER-ASSIGNMENT-ANSWER	M	M	TS 29.228
		Result	USER-AUTHORIZATION-ANSWER REGISTRATION-TERMINATION-ANSWER LOCATION INFO ANSWER PUSH-PROFILE-ANSWER MULTIMEDIA-AUTH-ANSWER	M	M	TS 29.228
Sh	Diameter	User Identity	USER-DATA-REQUEST PROFILE-UPDATE-REQUEST SUBSCRIBE-NOTIFICATIONS-REQUEST PUSH-NOTIFICATION-REQUEST	M	M	TS 29.328
		Requested data	USER-DATA-REQUEST PROFILE-UPDATE-REQUEST SUBSCRIBE-NOTIFICATIONS-REQUEST	M	M	TS 29.328
		Application Server Identity	USER-DATA-REQUEST PROFILE-UPDATE-REQUEST SUBSCRIBE-NOTIFICATIONS-REQUEST	M	M	TS 29.328
		Data	PROFILE-UPDATE-REQUEST PUSH-NOTIFICATION-REQUEST	M	M	TS 29.328
		Subscription request type	SUBSCRIBE-NOTIFICATIONS-REQUEST	M	M	TS 29.328
		Result	USER-DATA-ANSWER PROFILE-UPDATE-ANSWER SUBSCRIBE-NOTIFICATIONS-ANSWER PUSH-NOTIFICATION-ANSWER	M	M	TS 29.328
S6a	Diameter	User Name	NOTIFY REQUEST AUTHENTICATION INFORMATION REQUEST DELETE SUBSCRIBER DATA REQUEST INSERT SUBSCRIBER DATA REQUEST PURGE UE REQUEST CANCEL LOCATION REQUEST UPDATE LOCATION REQUEST	M	M	TS 29.272
		Terminal Information	NOTIFY REQUEST UPDATE LOCATION REQUEST	M	M	TS 29.272
		Result	NOTIFY ANSWER AUTHENTICATION INFORMATION ANSWER DELETE SUBSCRIBER DATA ANSWER INSERT SUBSCRIBER DATA ANSWER PURGE UE ANSWER CANCEL LOCATION ANSWER UPDATE LOCATION ANSWER	M	M	TS 29.272
		RAT Type	UPDATE LOCATION REQUEST	M	M	TS 29.272
		APN	NOTIFY REQUEST			

		Visited PLMN Id	AUTHENTICATION INFORMATION REQUEST UPDATE LOCATION REQUEST	M	M	TS 29.272
N70	Nhss	Message Name	Nhss_imsUEContextManagement Nhss_imsSubscriberDataManagement Nhss_imsUEAuthentication	M	M	TS 29.562
		URI of the request	Nhss_imsUEContextManagement Nhss_imsSubscriberDataManagement Nhss_imsUEAuthentication	M	M	TS 29.562
		Status code of the response	Nhss_imsUEContextManagement Nhss_imsSubscriberDataManagement Nhss_imsUEAuthentication	M	M	TS 29.562
		ID of the connected NF	Nhss_imsUEContextManagement Nhss_imsSubscriberDataManagement Nhss_imsUEAuthentication	M	M	TS 29.562
		ID of the traced NF	Nhss_imsUEContextManagement Nhss_imsSubscriberDataManagement Nhss_imsUEAuthentication	M	M	TS 29.562
		Record extensions	Nhss_imsUEContextManagement Nhss_imsSubscriberDataManagement Nhss_imsUEAuthentication	O	O	TS 29.562
		IE extracted from the NU1 messages	Nhss_imsUEContextManagement Nhss_imsSubscriberDataManagement Nhss_imsUEAuthentication	O	O	TS 29.562
N71	Nhss	Message Name	Nhss_imsSubscriberDataManagement	M	M	TS 29.562
		URI of the request	Nhss_imsSubscriberDataManagement	M	M	TS 29.562
		Status code of the response	Nhss_imsSubscriberDataManagement	M	M	TS 29.562
		ID of the connected NF	Nhss_imsSubscriberDataManagement	M	M	TS 29.562
		ID of the traced NF	Nhss_imsSubscriberDataManagement	M	M	TS 29.562
		Record extensions	Nhss_imsSubscriberDataManagement	O	O	TS 29.562
		IE extracted from the NU1 messages	Nhss_imsSubscriberDataManagement	O	O	TS 29.562
NU1	Nhss	Message Name	Nhss_UEAuthentication Nhss_SubscriberDataManagement Nhss_UEContextManagement Nhss_EventExposure	M	M	TS 29.563
		URI of the request	Nhss_UEAuthentication Nhss_SubscriberDataManagement Nhss_UEContextManagement Nhss_EventExposure	M	M	TS 29.563
		Status code of the response	Nhss_UEAuthentication Nhss_SubscriberDataManagement Nhss_UEContextManagement Nhss_EventExposure	M	M	TS 29.563
		ID of the connected NF	Nhss_UEAuthentication Nhss_SubscriberDataManagement Nhss_UEContextManagement Nhss_EventExposure	M	M	TS 29.563
		ID of the traced NF	Nhss_UEAuthentication Nhss_SubscriberDataManagement Nhss_UEContextManagement Nhss_EventExposure	M	M	TS 29.563

	Record extensions	Nhss_UEAuthentication Nhss_SubscriberDataManagement Nhss_UEContextManagement Nhss_EventExposure	○	○	TS 29.563
	IE extracted from the NU1 messages	Nhss_UEAuthentication Nhss_SubscriberDataManagement Nhss_UEContextManagement Nhss_EventExposure	○	○	TS 29.563

4.10 BM-SC Trace Record Content

The following table describes the trace record content for minimum and medium trace depth for BM-SC.

The record content is same for management based activation and for signalling based activation.

For BM-SC, the Minimum level of detail shall be supported.

Interface name	Prot. name	IE name	Message name(s)	Trace depth		Notes
				Min	Med	
Gmb	Diameter Gmb	IMSI	MBMS AUTHORIZATION REQUEST (AAR) MBMS AUTHORIZATION RESPONSE (AAA)	M	M	TS 29.061
		RAI	MBMS AUTHORIZATION REQUEST (AAR)	M	M	TS 29.061
		Access Point Name	MBMS AUTHORIZATION REQUEST (AAR)	M	M	TS 29.061
		MSISDN	MBMS AUTHORIZATION REQUEST (AAR)	M	M	TS 29.061
		IMEI(SV)	MBMS AUTHORIZATION REQUEST (AAR)	M	M	TS 29.061
		IP Multicast Address	MBMS AUTHORIZATION REQUEST (AAR)	M	M	TS 29.061
		TMGI	MBMS AUTHORIZATION RESPONSE (AAA)	M	M	TS 29.061
		Result-Code	MBMS AUTHORIZATION RESPONSE (AAA) MBMS USER DEACTIVATION RESPONSE (STA) MBMS SESSION START-STOP INDICATION RESPONSE (RAA) MBMS SERVICE TERMINATION ANSWER (ASR)	M	M	TS 29.061
		Experimental-Result	MBMS AUTHORIZATION RESPONSE (AAA) MBMS SESSION START-STOP INDICATION RESPONSE (RAA)	M	M	TS 29.061
		Error-Reporting-Host	MBMS AUTHORIZATION RESPONSE (AAA) MBMS USER DEACTIVATION RESPONSE (STA) MBMS SESSION START-STOP INDICATION RESPONSE (RAA) MBMS SERVICE TERMINATION ANSWER (ASR)	M	M	TS 29.061

4.11 PGW Trace Record Content

The following table shows the trace record content for PGW.

The trace record is the same for management based activation and for signalling based activation.

PGW shall support at least one of the following trace depth levels – Maximum, Medium or Minimum.

Table 4.11.1 : PGW Trace Record Content

Interface (specific messages)	Format	Level of details			Description
		Min	Med	Max	
S2a/S2b	Decoded	M	M	O	Message name
		O	O	O	Record extensions
		M	M	X	SGSNID of connected SGSN PGW ID of the traced PGW
		M	M	X	Dedicated IE extracted from S2a/S2b messages between the traced PGW and the SGSN. A subset of IEs as given in the table 4.11.2. is provided.
	Encoded*	X	X	M	Raw Messages: S2a/S2b messages between the traced PGW and the SGSN. The encoded content of the message is provided.
S5/S8	Decoded	M	M	O	Message name
		O	O	O	Record extensions
		M	M	X	SGW ID of the connected SGW PGW of the traced PGW
		M	M	X	IE extracted from S5/S8 messages between the traced PGW and SGW. A subset of IEs as given in the table 4.11.2. is provided.
	Encoded*	X	X	M	Raw S5/S8 Messages: messages between the traced PGW and SGW. The encoded content of the message is provided
S6b	Decoded	M	M	O	Message name
		O	O	O	Record extensions
		M	M	X	PGWID of the traced PGW
		M	M	X	Dedicated IE extracted from S6b messages between the traced PGW and the AAA. A subset of IEs as given in the table 4.11.2.is provided
	Encoded*	X	X	M	Raw S6b messages between the traced PGW and the AAA. The encoded content of the message is provided
Gx	Decoded	M	M	O	Message name
		O	O	O	Record extensions
		M	M	X	PCRF ID of the connected PCRF PGW ID of the traced PGW
		M	M	X	Dedicated IE extracted from Gx messages between the traced PGW and another PCRF. A subset of IEs as given in the table 4.11.2.is provided
	Encoded*	X	X	M	Raw Gx messages between the traced PGW and another PCRF. The encoded content of the message is provided

Encoded* - the messages are left encoded in the format it was received.

Table 4.11.2 : PGW trace record description for minimum and medium trace depth

Interface name	Prot. name	IE name	Message name(s)	Trace depth		Notes
				Min	Med	
S2a/S2b	PMIP					
S5/S8	GTPv2C	IMSI	Create Session Request Update Bearer Request	M	M	TS 29.274
		MSISDN	Create Session Request Modify Bearer Response	M	M	TS 29.274
		Serving Network	Create Session Request Modify Bearer Request	M	M	TS 29.274
		Access Point Name (APN)	Create Session Request	M	M	TS 29.274
		PDN Type	Create Session Request	M	M	TS 29.274
		Bearer Contexts	Create Session Request Create Bearer Request Create Bearer Response Delete Bearer Request Delete Bearer Response Modify Bearer Command Modify Bearer Failure Indication Update Bearer Request Update Bearer Response Delete Bearer Command Delete Bearer Failure Indication	M	M	TS 29.274

		Cause	Create Session Response Create Bearer Response Bearer Resource Failure Indication Modify Bearer Response Delete Session Response Delete Bearer Response Modify Bearer Failure Indication Update Bearer Response Delete Bearer Failure Indication	M	M	TS 29.274
		Bearer Contexts created	Create Session Response	M	M	TS 29.274
		Bearer Contexts marked for removal	Create Session Response	M	M	TS 29.274
		APN Restriction	Create Session Response	M	M	TS 29.274
		Linked Bearer Identity (LBI)	Create Bearer Request Bearer Resource Command Delete Bearer Response	M	M	TS 29.274
		Traffic Aggregate Description (TAD)	Bearer Resource Command	M	M	TS 29.274
		Linked EPS Bearer ID	Bearer Resource Failure Indication Delete Session Request Delete Bearer Request	M	M	TS 29.274
		RAT Type	Create Session Request Modify Bearer Request	M	M	TS 29.274
		Bearer Contexts to be modified	Modify Bearer Request	M	M	TS 29.274
		Bearer Contexts to be removed	Modify Bearer Request	M	M	TS 29.274
		Bearer Contexts modified		M	M	TS 29.274
		Bearer Contexts marked for removal		M	M	TS 29.274
S6b	Diameter	MIP Subscriber Profile	AAR AAA	M	M	TS 29.273
		APN	AAR	M	M	TS 29.273
		QoS capabilities	AAR	M	M	TS 29.273
		Result Code	AAA	M	M	TS 29.273
		QoS resources	AAA	M	M	TS 29.273

		3GPP AAA Server Name	AAA	M	M	TS 29.273
S2c	DSMIP					
Gx	Diameter	Bearer-Identifier	CCR	M	M	TS 29.212
		Bearer-Operation	CCR	M	M	TS 29.212
		IP-CAN-Type	CCR	M	M	TS 29.212
		RAT-Type	CCR	M	M	TS 29.212
		QoS-Information	CCR CCA RAR	M	M	TS 29.212
		QoS-Negotiation	CCR	M	M	TS 29.212
		QoS-Upgrade	CCR	M	M	TS 29.212
		Default-EPS-Bearer-QoS	CCR CCA RAR	M	M	TS 29.212
		Supported-Features	CCR CCA RAR RAA	M	M	TS 29.212
		Event-Trigger	CCR CCA RAR	M	M	TS 29.212
		Result Code	RAA	M	M	TS 29.212

		Origin-Realm	CCR CCA RAR RAA	M	M	TS 29.212
		Destination-Realm	CCR RAR	M	M	TS 29.212
SGi						

4.12 MME Trace Record Content

The following table shows the trace record content for MME.

The trace record is the same for management based activation and for signalling based activation.

MME shall support at least one of the following trace depth levels – Maximum, Medium or Minimum.

Table 4.12.1 : MME Trace Record Content

Interface (specific messages)	Format	Level of details			Description
		Min	Med	Max	
S1	Decoded	M	M	O	Message name
		O	O	O	Record extensions
		M	M	X	eNBID of connected eNB MME ID of the traced MME
		M	M	X	Dedicated IE extracted from S1 messages between the traced eNB and the MME. A subset of IEs as given in the table 4.12.2. is provided.
	ASN.1	X	X	M	Raw Messages: S1 messages between the traced eNB and the MME. The encoded content of the message is provided.
S1 NAS PDU IE	3GPP TS 24.301, sections 8 and 9	X	X	M	Hexdata dump of the decrypted NAS message formatted according to 3GPP TS 24.301, sections 8 and 9, recorded as a separate message entry in the call trace file
S3	Decoded	M	M	O	Message name
		O	O	O	Record extensions
		M	M	X	SGSN ID of the connected SGSN MME ID of the traced MME
		M	M	X	IE extracted from S3 messages between the traced MME and SGSN. A subset of IEs as given in the table 4.12.2. is provided.
	Encoded *	X	X	M	Raw S3 Messages: messages between the traced MME and SGSN. The encoded content of the message is provided
S11	Decoded	M	M	O	Message name
		O	O	O	Record extensions
		M	M	X	SGW ID of the connected SGW MME ID of the traced MME
		M	M	X	Dedicated IE extracted from S11 messages between the traced SGW and the MME. A subset of IEs as given in the table 4.12.2.is provided
	Encoded *	X	X	M	Raw S11 messages between the traced SGW and the MME. The encoded content of the message is provided
S6a	Decoded	M	M	O	Message name
		O	O	O	Record extensions
		M	M	X	HSS ID of the connected HSS MME ID of the traced MME
		M	M	X	Dedicated IE extracted from S6a messages between the traced HSS and the MME. A subset of IEs as given in the table 4.12.2.is provided
	Encoded *	X	X	M	Raw S6a messages between the traced HSS and the MME. The encoded content of the message is provided
S10	Decoded	M	M	O	Message name
		O	O	O	Record extensions
		M	M	X	MME ID of the connected MME MME ID of the traced MME
		M	M	X	Dedicated IE extracted from S10 messages between the traced MME and another MME. A subset of IEs as given in the table 4.12.2.is provided
	Encoded *	X	X	M	Raw S10 messages between the traced MME and another MME. The encoded content of the message is provided
N26	Decoded	M	M	O	Message name
		O	O	O	Record extensions
		M	M	X	AMF ID of the connected AMF MME ID of the traced MME
		M	M	X	Dedicated IE extracted from N26 messages between the traced MME and AMF. A subset of IEs as given in the table 4.12.2.is provided
	Encoded *	X	X	M	Raw N26 messages between the traced MME and another MME. The encoded content of the message is provided

Encoded* - the messages are left encoded in the format it was received.

Table 4.12.2 : MME trace record description for minimum and medium trace depth

Interface name	Prot. name	IE name	Message name(s)	Trace depth		Notes
				Min	Med	
S1	MM	EPS attach type	ATTACH REQUEST	M	M	TS 24.301
		GUTI	ATTACH REQUEST ATTACH ACCEPT TRACKING AREA UPDATE REQUEST TRACKING AREA UPDATE ACCEPT DETACH REQUEST GUTI REALLOCATION COMMAND	M	M	TS 24.301
		IMSI	ATTACH REQUEST DETACH REQUEST	M	M	TS 24.301
		Old P-TMSI	ATTACH REQUEST TRACKING AREA UPDATE REQUEST	M	M	TS 24.301
		M-TMSI		M	M	TS 24.301
		Last visited registered TAI	ATTACH REQUEST TRACKING AREA UPDATE REQUEST	M	M	TS 24.301
		UE network capability	ATTACH REQUEST TRACKING AREA UPDATE REQUEST	M	M	TS 24.301
		MS network capability	ATTACH REQUEST	M	M	TS 24.301
		LAI	ATTACH REQUEST ATTACH ACCEPT TRACKING AREA UPDATE REQUEST TRACKING AREA UPDATE ACCEPT	M	M	TS 24.301
		EPS attach result	ATTACH ACCEPT	M	M	TS 24.301
		EMM cause	ATTACH ACCEPT ATTACH REJECT TRACKING AREA UPDATE ACCEPT TRACKING AREA UPDATE REJECT DETACH REQUEST AUTHENTICATION FAILURE SERVICE REJECT SECURITY MODE REJECT EMM STATUS	M	M	TS 24.301
		EPS bearer context status	TRACKING AREA UPDATE REQUEST TRACKING AREA UPDATE ACCEPT	M	M	TS 24.301
		Detach type	DETACH REQUEST	M	M	TS 24.301
		EPS update type	TRACKING AREA UPDATE REQUEST	M	M	TS 24.301
		EPS update result	TRACKING AREA UPDATE ACCEPT	M	M	TS 24.301
		Identity type	IDENTITY REQUEST	M	M	TS 24.301
		Mobile identity	IDENTITY RESPONSE	M	M	TS 24.301
		IMEISV request	SECURITY MODE COMMAND	M	M	TS 24.301
		IMEISV	SECURITY MODE COMPLETE	M	M	TS 24.301
		Selected NAS security algorithms	SECURITY MODE COMMAND	M	M	TS 24.301
		UE security capability	SECURITY MODE COMMAND	M	M	TS 24.301
		Equivalent PLMNs list	ATTACH ACCEPT TRACKING AREA UPDATE ACCEPT	M	M	TS 24.301
		TAI list	ATTACH ACCEPT TRACKING AREA UPDATE ACCEPT GUTI REALLOCATION COMMAND	M	M	TS 24.301

S1	SM	EPS bearer identity	PDN CONNECTIVITY REQUEST PDN CONNECTIVITY REJECT PDN DISCONNECT REQUEST PDN DISCONNECT REJECT ACTIVATE DEFAULT EPS BEARER CONTEXT REQUEST ACTIVATE DEFAULT EPS BEARER CONTEXT ACCEPT ACTIVATE DEFAULT EPS BEARER CONTEXT REJECT ACTIVATE DEDICATED EPS BEARER CONTEXT REQUEST ACTIVATE DEDICATED EPS BEARER CONTEXT ACCEPT ACTIVATE DEDICATED EPS BEARER CONTEXT REJECT ESM STATUS DEACTIVATE EPS BEARER CONTEXT REQUEST DEACTIVATE EPS BEARER CONTEXT ACCEPT MODIFY EPS BEARER CONTEXT REQUEST MODIFY EPS BEARER CONTEXT ACCEPT MODIFY EPS BEARER CONTEXT REJECT BEARER RESOURCE ALLOCATION REQUEST BEARER RESOURCE ALLOCATION REJECT BEARER RESOURCE MODIFICATION REQUEST BEARER RESOURCE MODIFICATION REJECT	M	M	TS 24.301
		Linked EPS bearer identity	PDN DISCONNECT REQUEST ACTIVATE DEDICATED EPS BEARER CONTEXT REQUEST BEARER RESOURCE ALLOCATION REQUEST BEARER RESOURCE MODIFICATION REQUEST	M	M	TS 24.301
		Procedure Transaction Identity	PDN CONNECTIVITY REQUEST PDN CONNECTIVITY REJECT PDN DISCONNECT REQUEST PDN DISCONNECT REJECT ACTIVATE DEFAULT EPS BEARER CONTEXT REQUEST ACTIVATE DEFAULT EPS BEARER CONTEXT ACCEPT ACTIVATE DEFAULT EPS BEARER CONTEXT REJECT ACTIVATE DEDICATED EPS BEARER CONTEXT REQUEST ACTIVATE DEDICATED EPS BEARER CONTEXT ACCEPT ACTIVATE DEDICATED EPS BEARER CONTEXT REJECT ESM STATUS DEACTIVATE EPS BEARER CONTEXT REQUEST DEACTIVATE EPS BEARER CONTEXT ACCEPT MODIFY EPS BEARER CONTEXT REQUEST MODIFY EPS BEARER CONTEXT ACCEPT MODIFY EPS BEARER CONTEXT REJECT BEARER RESOURCE ALLOCATION REQUEST BEARER RESOURCE ALLOCATION REJECT BEARER RESOURCE MODIFICATION REQUEST BEARER RESOURCE MODIFICATION REJECT	M	M	TS 24.301
		Request type	PDN CONNECTIVITY REQUEST	M	M	TS 24.301
		APN	PDN CONNECTIVITY REQUEST ACTIVATE DEFAULT EPS BEARER CONTEXT REQUEST	M	M	TS 24.301
		EPS QoS	ACTIVATE DEFAULT EPS BEARER CONTEXT REQUEST ACTIVATE DEDICATED EPS BEARER CONTEXT REQUEST MODIFY EPS BEARER CONTEXT REQUEST	M	M	TS 24.301
		Negotiated QoS/New QoS	ACTIVATE DEFAULT EPS BEARER CONTEXT REQUEST ACTIVATE DEDICATED EPS BEARER CONTEXT REQUEST MODIFY EPS BEARER CONTEXT REQUEST	M	M	TS 24.301

		PDN address	ACTIVATE DEFAULT EPS BEARER CONTEXT REQUEST	M	M	TS 24.301
		APN-AMBR	ACTIVATE DEFAULT EPS BEARER CONTEXT REQUEST MODIFY EPS BEARER CONTEXT REQUEST	M	M	TS 24.301
		ESM cause	PDN CONNECTIVITY REJECT PDN DISCONNECT REJECT ACTIVATE DEFAULT EPS BEARER CONTEXT REQUEST ACTIVATE DEFAULT EPS BEARER CONTEXT REJECT ACTIVATE DEDICATED EPS BEARER CONTEXT REJECT ESM STATUS DEACTIVATE EPS BEARER CONTEXT REQUEST MODIFY EPS BEARER CONTEXT REJECT BEARER RESOURCE ALLOCATION REJECT BEARER RESOURCE MODIFICATION REQUEST BEARER RESOURCE MODIFICATION REJECT	M	M	TS 24.301
		Traffic flow template	ACTIVATE DEDICATED EPS BEARER CONTEXT REQUEST MODIFY EPS BEARER CONTEXT REQUEST	M	M	TS 24.301
		Traffic flow aggregate	BEARER RESOURCE ALLOCATION REQUEST BEARER RESOURCE MODIFICATION REQUEST	M	M	TS 24.301
		Required traffic flow QoS	BEARER RESOURCE ALLOCATION REQUEST BEARER RESOURCE MODIFICATION REQUEST	M	M	TS 24.301
		PDN type	PDN CONNECTIVITY REQUEST	M	M	TS 24.301
		S3	GTPv2-C	IMSI	DETACH NOTIFICATION CS PAGING INDICATON	M
TMSI	CS PAGING INDICATON			M	M	TS 29.274
Cause	DETACH NOTIFICATION DETACH ACKNOWLEDGE			M	M	TS 29.274
S3/S10	GTPv2-C	IMSI	RELOCATION CANCEL REQUEST IDENTIFICATION RESPONSE CONTEXT RESPONSE CONTEXT REQUEST FORWARD RELOCATION REQUEST	M	M	TS 29.274
		GUTI	CONTEXT REQUEST IDENTIFICATION REQUEST	M	M	TS 29.274
		RAI	IDENTIFICATION REQUEST CONTEXT REQUEST	M	M	TS 29.274
		P-TMSI	IDENTIFICATION REQUEST CONTEXT REQUEST	M	M	TS 29.274
		Indication	FORWARD RELOCATION COMPLETE NOTIFICATION FORWARD RELOCATION REQUEST	M	M	TS 29.274
		BSSGP Cause	FORWARD RELOCATION RESPONSE FORWARD RELOCATION REQUEST	M	M	TS 29.274
		RANAP Cause	FORWARD RELOCATION RESPONSE FORWARD RELOCATION REQUEST	M	M	TS 29.274
		eNodeB Cause	FORWARD RELOCATION RESPONSE	M	M	TS 29.274
		RAT Type	CONTEXT REQUEST	M	M	TS 29.274
Target Identification	FORWARD RELOCATION REQUEST	M	M	TS 29.274		

		Cause	RELOCATION CANCEL RESPONSE FORWARD SRNS CONTEXT ACKNOWLEDGE IDENTIFICATION RESPONSE CONTEXT ACKNOWLEDGE CONTEXT RESPONSE FORWARD RELOCATION COMPLETE ACKNOWLEDGE FORWARD RELOCATION RESPONSE	M	M	TS 29.274
		RAN Cause	FORWARD RELOCATION REQUEST	M	M	TS 29.274
		Selected PLMN ID	FORWARD RELOCATION REQUEST	M	M	TS 29.274
S6a	Diameter	User Name	NOTIFY REQUEST AUTHENTICATION INFORMATION REQUEST DELETE SUBSCRIBER DATA REQUEST INSERT SUBSCRIBER DATA REQUEST PURGE UE REQUEST CANCEL LOCATION REQUEST UPDATE LOCATION REQUEST	M	M	TS 29.272
		Terminal Information	NOTIFY REQUEST UPDATE LOCATION REQUEST	M	M	TS 29.272
		Result	NOTIFY ANSWER AUTHENTICATION INFORMATION ANSWER DELETE SUBSCRIBER DATA ANSWER INSERT SUBSCRIBER DATA ANSWER PURGE UE ANSWER CANCEL LOCATION ANSWER UPDATE LOCATION ANSWER	M	M	TS 29.272
		RAT Type	UPDATE LOCATION REQUEST	M	M	TS 29.272
		APN	NOTIFY REQUEST			
		Visited PLMN Id	AUTHENTICATION INFORMATION REQUEST UPDATE LOCATION REQUEST	M	M	TS 29.272
S11	GTPv2-C	IMSI	CREATE SESSION REQUEST CHANGE NOTIFICATION REQUEST CHANGE NOTIFICATION RESPONSE SUSPEND NOTIFICATION SUSPEND ACKNOWLEDGE RESUME NOTIFICATION RESUME ACKNOWLEDGE	M	M	TS 29.274
		APN	CREATE SESSION REQUEST	M	M	TS 29.274
		Indication Flags	MODIFY BEARER REQUEST DELETE SESSION REQUEST	M	M	TS 29.274
		EPS Bearer ID	CREATE SESSION RESPONSE CREATE BEARER RESPONSE MODIFY BEARER REQUEST MODIFY BEARER RESPONSE DELETE BEARER REQUEST DELETE BEARER RESPONSE UPDATE USER PLANE RESPONSE MODIFY BEARER COMMAND MODIFY BEARER FAILURE INDICATION UPDATE BEARER RESPONSE DELETE BEARER FAILURE INDICATION CREATE INDIRECT DATA FORWARDING TUNNEL RESPONSE UPDATE BEARER COMPLETE	M	M	TS 29.274

		MME-CSID	CREATE SESSION REQUEST CREATE BEARER RESPONSE DELETE BEARER RESPONSE	M	M	TS 29.274
		SGW-CSID	CREATE SESSION REQUEST CREATE SESSION RESPONSE CREATE BEARER REQUEST CREATE BEARER RESPONSE DELETE BEARER REQUEST DELETE BEARER RESPONSE	M	M	TS 29.274
		MSISDN	CREATE SESSION REQUEST MODIFY BEARER RESPONSE	M	M	TS 29.274
		Bearer Level QoS	CREATE SESSION REQUEST CREATE BEARER REQUEST MODIFY BEARER REQUEST MODIFY BEARER RESPONSE MODIFY BEARER COMMAND UPDATE BEARER REQUEST	M	M	TS 29.274
		RAT Type	CREATE SESSION REQUEST MODIFY BEARER REQUEST CHANGE NOTIFICATION REQUEST	M	M	TS 29.274
		MEI	CREATE SESSION REQUEST MODIFY BEARER REQUEST	M	M	TS 29.274
		Cause	CREATE SESSION RESPONSE CREATE BEARER RESPONSE BEARER RESOURCE FAILURE INDICATION MODIFY BEARER RESPONSE DELETE SESSION RESPONSE DELETE BEARER RESPONSE DOWNLINK DATA NOTIFICATION ACKNOWLEDGEMENT DOWNLINK DATA NOTIFICATION INDICATION UPDATE USER PLANE RESPONSE MODIFY BEARER FAILURE INDICATION UPDATE BEARER RESPONSE DELETE BEARER FAILURE INDICATION CREATE INDIRECT DATA FORWARDING TUNNEL RESPONSE UPDATE BEARER COMPLETE CHANGE NOTIFICATION RESPONSE CREATE FORWARDING TUNNEL RESPONSE	M	M	TS 29.274
		PGW-CSID	CREATE BEARER REQUEST DELETE BEARER REQUEST	M	M	TS 29.274
S1	S1AP	E-RAB ID	All messages where it is present	M	M	TS 36.413
		E-RAB Level QoS Parameters	E-RAB SETUP REQUEST E-RAB MODIFY REQUEST INITIAL CONTEXT SETUP REQUEST	M	M	TS 36.413

		Cause	INITIAL CONTEXT SETUP FAILURE UE CONTEXT RELEASE REQUEST UE CONTEXT RELEASE COMMAND UE CONTEXT MODIFICATION FAILURE HANDOVER REQUIRED HANDOVER PREPARATION FAILURE HANDOVER REQUEST HANDOVER FAILURE HANDOVER CANCEL PATH SWITCH REQUEST FAILURE NAS NON DELIVERY INDICATION	M	M	TS 36.413
		Handover Type	HANDOVER REQUIRED HANDOVER COMMAND HANDOVER REQUEST	M	M	TS 36.413
		E-UTRAN CGI	HANDOVER NOTIFY PATH SWITCH REQUEST INITIAL UE MESSAGE UPLINK NAS TRANSPORT	M	M	TS 36.413
		TAI	HANDOVER NOTIFY PATH SWITCH REQUEST UPLINK NAS TRANSPORT PAGING	M	M	TS 36.413
		Target ID	HANDOVER REQUIRED	M	M	TS 36.413
		CDMA2000 HO Status	DOWNLINK S1 CDMA2000 TUNNELING	M	M	TS 36.413
		CDMA2000 RAT Type	DOWNLINK S1 CDMA2000 TUNNELING UPLINK S1 CDMA2000 TUNNELING	M	M	TS 36.413
		CDMA2000 Sector ID	UPLINK S1 CDMA2000 TUNNELING	M	M	TS 36.413
		CDMA2000 HO Required Indication	UPLINK S1 CDMA2000 TUNNELING	M	M	TS 36.413
		S13	Diameter	Terminal Information	ME Identity Check Request	M
Result	ME Identity Check Answer			M	M	TS 29.272

4.13 E-UTRAN Trace Record Content

For eNB, the Maximum level of detail shall be supported. The trace record is the same for management based activation and for signalling based activation.

Table 4.13.1 : E-UTRAN Trace Record Content

Interface (specific messages)	Format	Level of details			Description
		Min	Med	Max	
RRC (without rrc dedicated measurements)	Decoded	M	M	O	Message name
		O	O	O	Record extensions
		M	M	X	Global eNBID of traced eNB
		M	M	X	Dedicated IE extracted from RRC messages between the traced eNB and the UE. A subset of IEs as given in the table 4.13.2. is provided.
	ASN.1	X	X	M	Raw Uu Messages: RRC messages between the traced eNB and the UE. The encoded content of the message is provided
S1	Decoded	M	M	O	Message name
		O	O	O	Record extensions
		M	M	X	Global eNBID of traced eNB MME ID of the connected MME
		M	M	X	E-RabId + Dedicated IE extracted from S1AP messages between the traced eNB and Core Network. A subset of IEs as given in the table 4.13.2. is provided.
	ASN.1	X	X	M	Raw S1 Messages S1AP: messages between the traced eNB and Core Network The encoded content of the message is provided
X2	Decoded	M	M	O	Message name
		O	O	O	Record extensions
		M	M	X	Global eNBID of traced eNB Global eNBID of neighbouring eNB Global gNBID of connected gNB-CU-CP node over X2 (for NSA)
		M	M	X	Dedicated IE extracted from X2AP messages between the traced eNB and the neighbouring eNB/connected gNB-CU-CP. A subset of IEs as given in the table 4.13.2.is provided
	ASN.1	X	X	M	Raw X2 Messages:X2AP messages between the traced eNB and the neighbouring eNB/connected gNB-CU-CP. The encoded content of the message is provided
RRC (only dedicated measurements)	Decoded	X	M	X	Uu IEs from RRC measurement reports messages
	ASN.1	X	X	M	RRC measurement reports messages

NOTE: For the security keys in IEs or part of IEs that are containing security keys used by the eNB (e.g. K_{eNB}), the value 0 shall be written in the trace file.

Definitions:

Global eNBID of traced eNB: The id of the eNB traced, e.g. the eNB which handles the connection of the traced MS, during the Trace Recording Session. The id corresponds to the “Global eNB ID”, as defined in [16] and [17].

Global eNBID of neighbouring eNB: The ids of all Neighbouring eNB involved in the X2 procedures during the Trace Recording Session. The id corresponds to the “Global eNB ID”, as defined in [16] and [17].

Global gNBID of connected gNB-CU-CP node over X2 (for NSA): The ids of all connected NSA nodes involved during the Trace Recording Session. The id corresponds to the “Global gNB ID”, as defined in [16] and [17].

- cell Id: The cell Ids of the cells involved in the X2 procedures during the Trace Recording Session. The cell Ids is provided with each X2AP messages for which the cId is relevant.
- E-RABId: Specific recorded IE that contains the E-RAB identifier.
- Message name: Name of the protocol message
- Record extensions: A set of manufacturer specific extensions to the record
- Decoded: Some IEs shall be decoded (cf. detailed list in table 4.6.2. depending on trace depth)
- ASN.1: Messages in encoded format

Table 4.13.2 : trace record description for minimum and medium trace depth

Interface name	Prot. name	IE name	Message name(s)	Trace depth		Notes
				Min	Med	
Uu	RRC	Cs fallback indicator	MOBILITY FROM EUTRA COMMAND	M	M	TS 36.331
		CN domain	PAGING	O	O	TS 36.331
		S-TMSI	PAGING	O	O	TS 36.331
		ReestablishmentCause	RRC CONNECTION REESTABLISHMENT REQUEST	M	M	TS 36.331
		Wait time	RRC CONNECTION REJECT	CM	M	TS 36.331
		Release Cause	RRC CONNECTION RELEASE	M	M	TS 36.331
		Redirection Information	RRC CONNECTION RELEASE	M	M	TS 36.331
		Establishment Cause	RRC CONNECTION REQUEST	CM	CM	TS 36.331
		Selected PLMN-Identity	RRC CONNECTION SETUP COMPLETE	CM	CM	TS 36.331
		RegisteredMME	RRC CONNECTION SETUP COMPLETE	CM	CM	TS 36.331
		Rat-Type	UE CAPABILITY INFORMATION	M	M	TS 36.331
		Measured Results	MEASUREMENT REPORT	X	M	TS 36.331
		CDMA2000-Type	HANDOVER FROM EUTRA PREPARATION REQUEST UL HANDOVER PREPARATION TRANSFER UL INFORMATION TRANSFER	M	M	TS 36.331
		Target RAT Type	MOBILITY FROM EUTRA COMMAND	M	M	TS 36.331
		ConnEstFailReport-r11	UE INFORMATION RESPONSE	X	M	TS 36.331
RLF-Report-r9	UE INFORMATION RESPONSE	X	M	TS 36.331		
S1	S1AP	E-RAB ID	All messages where it is present	M	M	TS 36.413
		E-RAB Level QoS Parameters	E-RAB SETUP REQUEST E-RAB MODIFY REQUEST INITIAL CONTEXT SETUP REQUEST	M	M	TS 36.413
		Cause	INITIAL CONTEXT SETUP FAILURE UE CONTEXT RELEASE REQUEST UE CONTEXT RELEASE COMMAND UE CONTEXT MODIFICATION FAILURE HANDOVER REQUIRED HANDOVER PREPARATION FAILURE HANDOVER REQUEST HANDOVER FAILURE HANDOVER CANCEL PATH SWITCH REQUEST FAILURE NAS NON DELIVERY INDICATION	M	M	TS 36.413
		Handover Type	HANDOVER REQUIRED HANDOVER COMMAND HANDOVER REQUEST	M	M	TS 36.413

		E-UTRAN CGI	HANDOVER NOTIFY PATH SWITCH REQUEST INITIAL UE MESSAGE UPLINK NAS TRANSPORT	CM	CM	TS 36.413
		TAI	HANDOVER NOTIFY PATH SWITCH REQUEST UPLINK NAS TRANSPORT	M	M	TS 36.413
		Target ID	HANDOVER REQUIRED	M	M	TS 36.413
		CDMA2000 HO Status	DOWNLINK S1 CDMA2000 TUNNELING	M	M	TS 36.413
		CDMA2000 RAT Type	DOWNLINK S1 CDMA2000 TUNNELING UPLINK S1 CDMA2000 TUNNELING	M	M	TS 36.413
		CDMA2000 Sector ID	UPLINK S1 CDMA2000 TUNNELING	M	M	TS 36.413
		CDMA2000 HO Required Indication	UPLINK S1 CDMA2000 TUNNELING	M	M	TS 36.413
X2	X2AP	E-RAB id	All messages where it is present	M	M	TS 36.423
		E-RAB Level QoS	HANDOVER REQUEST SGNB ADDITION REQUEST SGNB ADDITION REQUEST ACKNOWLEDGE SGNB MODIFICATION REQUEST SGNB MODIFICATION REQUEST ACKNOWLEDGE SGNB MODIFICATION REQUIRED	M	M	TS 36.423
		Cause	HANDOVER REQUEST HANDOVER PREPARATION FAILURE HANDOVER CANCEL SGNB ADDITION REQUEST REJECT SGNB RECONFIGURATION COMPLETE SGNB MODIFICATION REQUEST SGNB MODIFICATION REQUEST REJECT SGNB MODIFICATION REQUIRED SGNB MODIFICATION REFUSE SGNB RELEASE REQUEST SGNB RELEASE REQUEST REJECT SGNB RELEASE REQUIRED SGNB CHANGE REQUIRED SGNB CHANGE REFUSE	M	M	TS 36.423
		Target Cell ID	HANDOVER REQUEST	M	M	TS 36.423
		GUMMEI	HANDOVER REQUEST	M	M	TS 36.423
		UE History Information	HANDOVER REQUEST	M	M	TS 36.423
		UE RLF Report Container	RLF INDICATION	X	M	TS 36.423

Constraints:

The condition for capturing the following Information Element is that Cell Traffic Trace is used:

- Wait time from RRC protocol.
- Establishment Cause from RRC protocol.
- Selected PLMN-Identity from RRC protocol.
- RegisteredMME from RRC protocol.
- E-UTRAN CGI from S1 interface from the following messages: Initial UE message, Handover Notify.

4.14 SGW Trace Record Content

The following table shows the trace record content for SGW.

The trace record is the same for management based activation and for signalling based activation.

SGW shall support at least one of the following trace depth levels – Maximum, Medium or Minimum.

Table 4.14.1 : SGW Trace Record Content

Interface (specific messages)	Format	Level of details			Description
		Min	Med	Max	
S11	Decoded	M	M	O	Message name
		O	O	O	Record extensions
		M	M	X	MME ID of the connected MME SGW ID of the traced SGW
		M	M	X	Dedicated IE extracted from S11 messages between the traced MME and the SGW. A subset of IEs as given in the table 4.14.2.is provided
	Encoded*	X	X	M	Raw S11 messages between the traced MME and the SGW. The encoded content of the message is provided
S5/S8	Decoded	M	M	O	Message name
		O	O	O	Record extensions
		M	M	X	PGW ID of the connected PGW SGW of the traced SGW
		M	M	X	IE extracted from S5/S8 messages between the traced SGW and PGW. A subset of IEs as given in the table 4.14.2. is provided.
	Encoded*	X	X	M	Raw S5/S8 Messages: messages between the traced SGW and PGW. The encoded content of the message is provided
S4	Decoded	M	M	O	Message name
		O	O	O	Record extensions
		M	M	X	SGSNID of the connected SGSN SGWID of the traced SGW
		M	M	X	Dedicated IE extracted from S4 messages between the traced SGW and the SGSN. A subset of IEs as given in the table 4.14.2.is provided
	Encoded*	X	X	M	Raw S4 messages between the traced PGW and the AAA. The encoded content of the message is provided
Gxc	Decoded	M	M	O	Message name
		O	O	O	Record extensions
		M	M	X	PCRF ID of the connected PCRF SGW ID of the traced SGW
		M	M	X	Dedicated IE extracted from Gx messages between the traced SGW and another PCRF. A subset of IEs as given in the table 4.14.2.is provided
	Encoded*	X	X	M	Raw Gx messages between the traced SGW and another PCRF. The encoded content of the message is provided

Encoded* - the messages are left encoded in the format it was received.

Table 4.14.2 : SGW trace record description for minimum and medium trace depth

Interface name	Prot. name	IE name	Message name(s)	Trace depth		Notes
				Min	Med	
S11	GTPv2C	IMSI	Create Session Request Suspend Notification Suspend Acknowledge Resume Notification Resume Acknowledge	M	M	TS 29.274
		MSISDN	Create Session Request Modify Bearer Response	M	M	TS 29.274
		RAT type	Create Session Request Modify Bearer Request	M	M	TS 29.274
		Serving Network	Create Session Request Modify Bearer Request	M	M	TS 29.274
		Access Point Name (APN)	Create Session Request	M	M	TS 29.274
		PDN Type	Create Session Request	M	M	TS 29.274
		Bearer Contexts	Create Session Request Create Bearer Request Create Bearer Response Delete Bearer Request Delete Bearer Response Modify Bearer Command Modify Bearer Failure Indication Update Bearer Request Update Bearer Response Delete Bearer Command Delete Bearer Failure Indication Create Indirect Data Forwarding Tunnel Request Create Indirect Data Forwarding Tunnel Response Update Bearer Complete	M	M	TS 29.274
		Cause	Create Session Response Create Bearer Response Bearer Resource Failure Indication Modify Bearer Response Delete Session Response Downlink Data Notification Acknowledgement Downlink Data Notification Failure Indication Modify Bearer Failure Indication Update Bearer Response Delete Bearer Failure Indication Create Indirect Data Forwarding Tunnel Response Update Bearer Complete	M	M	TS 29.274
		Bearer Contexts created	Create Session Response	M	M	TS 29.274
		APN Restriction	Create Session Response	M	M	TS 29.274
		Linked Bearer Identity (LBI)	Create Bearer Request Bearer Resource Command Delete Session Request Delete Bearer Request Delete Bearer Response	M	M	TS 29.274
		Traffic Aggregate Description (TAD)	Bearer Resource Command	M	M	TS 29.274
		Linked EPS Bearer ID	Bearer Resource Command	M	M	TS 29.274
		Bearer Contexts to be removed	Modify Bearer Request	M	M	TS 29.274
		Bearer Contexts modified	Modify Bearer Response	M	M	TS 29.274
Bearer Contexts marked for removal	Modify Bearer Response Update User Plane Response	M	M	TS 29.274		

		Bearer Contexts to be updated	Update User Plane Request	M	M	TS 29.274
		Bearer Contexts to be removed	Update User Plane Request	M	M	TS 29.274
		Bearer Contexts updated	Update User Plane Response	M	M	TS 29.274
		Bearer Contexts to be modified	Modify Bearer Request	M	M	TS 29.274
S4	GTPv2C	Traffic Aggregate Description (TAD)	Bearer Resource Command	M	M	TS 29.274
		Linked Bearer Identity (LBI)	Bearer Resource Command Create Bearer Request Delete Bearer Response	M	M	TS 29.274
		Linked EPS Bearer ID	Bearer Resource Failure Indication Delete Session Request Delete Bearer Request	M	M	TS 29.274
		Cause	Bearer Resource Failure Indication Create Session Response Create Bearer Response Modify Bearer Response Delete Session Response Delete Bearer Response Downlink Data Notification Acknowledgement Downlink Data Notification Failure Indication Update Bearer Response Create Indirect Data Forwarding Tunnel Response Update Bearer Complete	M	M	TS 29.274
		Bearer Contexts to be modified	Modify Bearer Request	M	M	TS 29.274
		Bearer Contexts to be removed	Modify Bearer Request	M	M	TS 29.274
		IMSI	Create Session Request Update Bearer Request	M	M	TS 29.274
		MSISDN	Create Session Request Modify Bearer Response	M	M	TS 29.274
		Serving Network	Create Session Request	M	M	TS 29.274
		Access Point Name (APN)	Create Session Request	M	M	TS 29.274
		PDN Type	Create Session Request	M	M	TS 29.274
		Bearer Contexts	Create Session Request Create Bearer Request Create Bearer Response Delete Bearer Request Delete Bearer Response Update Bearer Request Update Bearer Response Create Indirect Data Forwarding Tunnel Request Create Indirect Data Forwarding Tunnel Response Update Bearer Complete	M	M	TS 29.274
		RAT Type	Create Session Request Modify Bearer Request	M	M	TS 29.274
		Bearer Contexts created	Create Session Response	M	M	TS 29.274
		Bearer Contexts marked for removal	Create Session Response	M	M	TS 29.274
		Bearer Contexts modified	Modify Bearer Response	M	M	TS 29.274
		Bearer Contexts marked for removal	Modify Bearer Response	M	M	TS 29.274
S5/S8	GTPv2C	IMSI	Create Session Request Update Bearer Request	M	M	TS 29.274

		MSISDN	Create Session Request Modify Bearer Response	M	M	TS 29.274
		Serving Network	Create Session Request Modify Bearer Request	M	M	TS 29.274
		Access Point Name (APN)	Create Session Request	M	M	TS 29.274
		PDN Type	Create Session Request	M	M	TS 29.274
		Bearer Contexts	Create Session Request Create Bearer Request Create Bearer Response Delete Bearer Request Delete Bearer Response Modify Bearer Command Modify Bearer Failure Indication Update Bearer Request Update Bearer Response Delete Bearer Command Delete Bearer Failure Indication	M	M	TS 29.274
		Cause	Create Session Response Create Bearer Response Bearer Resource Failure Indication Modify Bearer Response Delete Session Response Delete Bearer Response Modify Bearer Failure Indication Update Bearer Response Delete Bearer Failure Indication	M	M	TS 29.274
		Bearer Contexts created	Create Session Response	M	M	TS 29.274
		Bearer Contexts marked for removal	Create Session Response	M	M	TS 29.274
		APN Restriction	Create Session Response	M	M	TS 29.274
		Linked Bearer Identity (LBI)	Create Bearer Request Bearer Resource Command Delete Bearer Response	M	M	TS 29.274
		Traffic Aggregate Description (TAD)	Bearer Resource Command	M	M	TS 29.274
		Linked EPS Bearer ID	Bearer Resource Failure Indication Delete Session Request Delete Bearer Request	M	M	TS 29.274
		RAT Type	Create Session Request Modify Bearer Request	M	M	TS 29.274
		Bearer Contexts to be modified	Modify Bearer Request	M	M	TS 29.274
		Bearer Contexts to be removed	Modify Bearer Request	M	M	TS 29.274
		Bearer Contexts modified		M	M	TS 29.274
Bearer Contexts marked for removal		M	M	TS 29.274		
Gxc	Diameter	IP-CAN-Type	CCR	M	M	TS 29.212
		RAT-Type	CCR	M	M	TS 29.212
		QoS-Information	CCR CCA RAR	M	M	TS 29.212
		QoS-Negotiation	CCR	M	M	TS 29.212
		QoS-Rule-Report	CCR RAA	M	M	TS 29.212
		Default-EPS-Bearer-QoS	CCR CCA RAR	M	M	TS 29.212

	Supported-Features	CCR CCA RAR RAA	M	M	TS 29.212
	Event-Trigger	CCR CCA RAR	M	M	TS 29.212
	Result Code	RAA	M	M	TS 29.212
	Origin-Realm	CCR CCA RAR RAA	M	M	TS 29.212
	QoS-Rule-Remove	RAR CAA	M	M	TS 29.212
	QoS-Rule-Install	RAR CAA	M	M	TS 29.212
	Destination-Realm	CCR RAR	M	M	TS 29.212

4.15 EIR Trace Record Content

The following table contains the Trace record description for the minimum and medium trace depth for MAP(F), S13, S13', MAP(Gf) interfaces in the EIR.

The trace record is the same for management based activation and for signalling based activation.

Interface name	Prot. name	IE name	Message name(s)	Trace depth		Notes
				Min	Med	
F	MAP	IMEI(SV)	MAP_CHECK_IMEI	M	M	TS 29.002 TS 23.018
		Equipment status	MAP_CHECK_IMEI	M	M	TS 29.002 TS 23.018
		User error	Every message where it appears	M	M	TS 29.002
		Provider error	Every message where it appears	M	M	TS 29.002
S13/S13'	Diameter	Terminal Information	ME Identity Check Request	M	M	TS 29.272
		Result	ME Identity Check Answer	M	M	TS 29.272
Gf	MAP	IMEI(SV)	MAP_CHECK_IMEI	M	M	TS 29.002
		Equipment status	MAP_CHECK_IMEI	M	M	TS 29.002
		User error	Every message where it appears	M	M	TS 29.002
		Provider error	Every message where it appears	M	M	TS 29.002

4.16 LTE MDT Trace Record Content

4.16.1 Trace Record for Immediate MDT measurements

The following table contains the Trace record description for LTE immediate MDT measurements. The trace record is the same for management based activation and for signalling based activation.

MDT measurement name	Measurement attribute name(s)	Measurement attribute definition	Notes
M1	RSRPs	List of RSRP values received in RRC measurement report. One value per measured cell.	TS 32.422 [3] TS 37.320 [32]
	RSRQs	List of RSRQ values received in RRC measurement report. One value per measured cell.	TS 32.422 [3] TS 37.320 [32]
	SINRs	List of SINR values received in RRC measurement report. One value per measured cell.	TS 32.422 [3] TS 36.214 [38]
	PCIs	List of Physical Cell Identity of measured cells. The order of PCI values in the list should be the same as the corresponding measured values in the RSRPs and RSRQs attributes.	TS 36.331 [28]
	Triggering event	Event that triggered the M1 measurement report, used only in case of RRM configured measurements (events A1, A2, A3, A4, A5, A6, B1 or B2)	TS 32.422 [3] TS 37.320 [32]
M2	PH distr	Distribution of the power headroom samples reported by the UE during the collection period. The distribution is the interval of [40; -23] dB.	TS 36.213 [33] TS 32.422 [3] TS 37.320 [32]
M3	RIP distr	Distribution of the measured Received Interference Power samples obtained during the collection period. The distribution is in the interval of [-126, -75] dBm.	TS 36.133 [34] TS 32.422 [3] TS 37.320 [32]
M4	UL volumes	List of measured UL volumes in bytes per E-RAB. One value per E-RAB.	TS 32.422 [3] TS 37.320 [32]
	DL volumes	List of measured DL volumes in bytes per E-RAB. One value per E-RAB.	TS 32.422 [3] TS 37.320 [32]
	QCIs	List of QCIs of the E-RABs for which the volume and throughput measurements apply. The order of QCI values in the list should be the same as the corresponding measured values in the UL volumes and DL volumes attributes.	TS 32.422 [3] TS 37.320 [32]
M5	UL Thp Time	Throughput time used for calculation of the uplink throughput (per UE).	TS 36.314 [31] TS 32.422 [3] TS 37.320 [32]
	UL Thp Volume	Throughput volume used for calculation of the uplink throughput (per UE).	TS 36.314 [31] TS 32.422 [3] TS 37.320 [32]
	UL LastTTI Volume	Volume transmitted in the last TTI and excluded from throughput calculation in the uplink.	TS 36.314 [31] TS 32.422 [3] TS 37.320 [32]
	DL Thp Times	List of throughput times used for calculation of the downlink throughput (per E-RAB). One value per E-RAB.	TS 36.314 [31] TS 32.422 [3] TS 37.320 [32]
	DL Thp Volumes	List of Throughput volumes used for calculation of the downlink throughput (per E-RAB). One value per E-RAB.	TS 36.314 [31] TS 32.422 [3] TS 37.320 [32]

	QCIs	List of QCIs of the E-RABs for which the volume and throughput measurements apply. The order of QCI values in the list should be the same as the corresponding measured values in the DL Thp Volumes and DL Thp Times attributes.	TS 32.422 [3] TS 37.320 [32]
	DL Thp Time UE	Throughput time used for calculation of the downlink throughput (per UE).	TS 36.314 [31] TS 32.422 [3] TS 37.320 [32]
	DL Thp Volume UE	Throughput volume used for calculation of the downlink throughput (per UE).	TS 36.314 [31] TS 32.422 [3] TS 37.320 [32]
	DL LastTTI Volume	Volume transmitted in the last TTI and excluded from the throughput calculation in the downlink (per UE).	TS 36.314 [31] TS 32.422 [3] TS 37.320 [32]
M6	DL packet delay per QCI	L2 Packet Delay for OAM performance observability or for QoS verification of MDT (per QCI).	TS 36.314 [31] TS 37.320 [32]
	UL packet delay per QCI	Excess Packet Delay Ratio in Layer PDCP for QoS verification of MDT (per QCI).	TS 36.314 [31] TS 37.320 [32]
M7	DL packet loss rate per QCI	packets that are lost at Uu transmission, for OAM performance observability.	TS 36.314 [31] TS 37.320 [32]
	UL packet loss rate per QCI	packets that are lost in the UL, for OAM performance observability or QoS verification of MDT.	TS 36.314 [31] TS 37.320 [32]
M8	RSSI (WLAN, Bluetooth®)	RSSI measurement by UE.	TS 36.331 [28] TS 37.320 [32]
M9	RTT (WLAN)	RTT measurement by UE.	TS 36.331 [28] TS 37.320 [32]

4.16.2 Trace Record for UE location information

The following table contains the Trace record description for LTE UE location information. The trace record is the same for management based activation and for signalling based activation.

MDT measurement name	Measurement attribute name(s)	Measurement attribute definition	Notes
UE location	GNSS pos	GNSS based coordinates, including (latitude, longitude), as reported by the UE. The IE can be any of <i>ellipsoidPoint</i> , <i>ellipsoidPointWithUncertaintyCircle</i> , <i>ellipsoidPointWithUncertaintyEllipse</i> , <i>ellipsoidPointWithAltitude</i> , <i>ellipsoidPointWithAltitudeAndUncertaintyEllipsoid</i> , <i>ellipsoidArc</i> , <i>polygon</i> depending on the IE present in the RRC message.	TS 36.331
	UE rx-tx	The UE reported UE rx-tx time difference measurement. The attribute is used to record E-CID positioning measurements, if available.	TS 32.422 TS 37.320 TS 36.331
	eNB rx-tx	The eNB measured eNB rx-tx time difference. The attribute is used to record E-CID positioning measurements, if available.	TS 32.422 TS 37.320 TS 36.214
	AoA	The eNB measured angle of arrival measurement. The attribute is used to record E-CID positioning measurements, if available.	TS 32.422 TS 37.320 TS 36.214

4.17 UMTS MDT Trace Record Content

4.17.1 Trace Record for Immediate MDT measurements

The following table contains the Trace record description for UMTS immediate MDT measurements. The trace record is the same for management based activation and for signalling based activation.

MDT measurement name	Measurement attribute name(s)	Measurement attribute definition	Notes
M1	RSCPs	List of RSCP values received in RRC measurement report. One value per measured cell.	TS 32.422 [3] TS 37.320 [32]
	Ec/Nos	List of Ec/Nos values received in RRC measurement report. One value per measured cell.	TS 32.422 [3] TS 37.320 [32]
	SCs	List of Scrambling Codes of measured cells. The order of SC values in the list should be the same as the corresponding measured values in the RSCPs and Ec/Nos attributes.	TS 25.331 [30]
M2	RSCPs	List of RSCP values received in RRC measurement report. One value per measured cell.	TS 32.422 [3] TS 37.320 [32]
	ISCPs	List of ISCP values received in RRC measurement report. One value per measured cell.	TS 32.422 [3] TS 37.320 [32]
	SCs	List of Scrambling Codes of measured cells. The order of SC values in the list should be the same as the corresponding measured values in the RSCPs and ISCPs attributes.	TS 25.331 [30]
M3	SIR	Distribution of the SIR samples measured by the network during the collection period.	TS 32.422 [3] TS 37.320 [32]
	SIR error	Distribution of the SIRerror samples measured by the network during the collection period.	TS 32.422 [3] TS 37.320 [32]
M4	EDCH PH distr	Distribution of the power headroom samples reported by the UE according to RRM configuration during the collection period.	TS 32.422 [3] TS 37.320 [32]
M5	RTWP distr	Distribution of the measured Total Wideband Power samples obtained during the collection period. The distribution is in the interval of [-112, -50] dBm.	TS 32.422 [3] TS 37.320 [32]
M6	UL volumes	List of measured UL volumes in bytes per RAB. One value per RAB.	TS 32.422 [3] TS 37.320 [32]
	DL volumes	List of measured DL volumes in bytes per RAB. One value per RAB.	TS 32.422 [3] TS 37.320 [32]
	Traffic classes	List of Traffic class parameters (conversational, streaming, interactive, background) of the RABs for which the volume and throughput measurements apply. The order of Traffic class values in the list should be the same as the corresponding measured values in the UL volumes and DL volumes attributes.	TS 25.331 [30]
M7	UL Thps	List of measured UL throughputs in bytes/sec per RAB. One value per RAB.	TS 32.422 [3] TS 37.320 [32]
	DL Thps	List of measured DL throughputs in bytes/sec per RAB. One value per RAB.	TS 32.422 [3] TS 37.320 [32]

	Traffic classes	List of Traffic class parameters (conversational, streaming, interactive, background) of the RABs for which the volume and throughput measurements apply. The order of Traffic class values in the list should be the same as the corresponding measured values in the UL Thps and DL Thps attributes.	TS 23.107 [29]
	UL Thp UE	Measured UL throughput in bytes/sec per UE.	TS 32.422 [3] TS 37.320 [32]
	DL Thp UE	Measured DL throughput in bytes/sec per UE.	TS 32.422 [3] TS 37.320 [32]

4.17.2 Trace Record for UE location information

The following table contains the Trace record description for UMTS UE location information. The trace record is the same for management based activation and for signalling based activation.

MDT measurement name	Measurement attribute name(s)	Measurement attribute definition	Notes
UE location	GNSS pos	GNSS based coordinates, including (latitude, longitude) as reported by the UE.	TS 32.422 TS 37.320

4.18 AMF Trace Record Content

The following table shows the trace record content for AMF.

The trace record is the same for management based activation and for signalling based activation.

AMF shall support at least one of the following trace depth levels – Maximum, Medium or Minimum.

Table 4.18.1 : AMF Trace Record Content

Interface (specific messages)	Format	Level of details			Description
		Min	Med	Max	
N1	Decoded	M	M	O	Message name
		O	O	O	Record extensions
		M	M	X	ID of the connected gNB-CU-CP node/ng-eNB
		O	O	X	ID of the traced AMF
	ASN.1	X	X	M	IE extracted from N1 messages between the traced AMF and the gNB-CU-CP/ng-eNB node.
N1 NAS PDU IE	Encoded*	X	X	M	Raw Messages: N1 messages between the traced AMF and the gNB-CU-CP/ng-eNB node. The encoded content of the message is provided.
N8	Decoded	M	M	O	Hexdata dump of the decrypted NAS message formatted according to 3GPP TS 24.501 [x10], sections 8 and 9, recorded as a separate message entry in the call trace file
		O	O	O	Message name
		M	M	X	Record extensions
		O	O	X	UDM ID of the connected UDM AMF ID of the traced AMF
	Encoded*	X	X	M	IE extracted from N8 messages between the traced AMF and the UDM. Raw N8 messages between the traced AMF and the UDM. The encoded content of the message is provided
N11	Decoded	M	M	O	Message name
		O	O	O	Record extensions
		M	M	X	SMF ID of the connected SMF AMF ID of the traced AMF
		O	O	X	IE extracted from N11 messages between the traced AMF and the SMF.
	Encoded*	X	X	M	Raw N11 messages between the traced AMF and the SMF. The encoded content of the message is provided
N12	Decoded	M	M	O	Message name
		O	O	O	Record extensions
		M	M	X	AUSF ID of the connected AUSF AMF ID of the traced AMF
		O	O	X	IE extracted from N12 messages between the traced AMF and AUSF.
	Encoded*	X	X	M	Raw N12 messages between the traced AMF and AUSF. The encoded content of the message is provided
N14	Decoded	M	M	O	Message name
		O	O	O	Record extensions
		M	M	X	AMF ID of the connected AMF AMF ID of the traced AMF
		O	O	X	IE extracted from N14 messages between the traced AMF and another AMF.
	Encoded*	X	X	M	Raw N14 messages between the traced AMF and another AMF. The encoded content of the message is provided
N15	Decoded	M	M	O	Message name
		O	O	O	Record extensions
		M	M	X	PCF ID of the connected PCF AMF ID of the traced AMF
		O	O	X	IE extracted from N15 messages between the traced AMF and PCF.
	Encoded*	X	X	M	Raw N15 messages between the traced AMF and PCF. The encoded content of the message is provided
N20	Decoded	M	M	O	Message name
		O	O	O	Record extensions
		M	M	X	SMSF ID of the connected SMSF AMF ID of the traced AMF
		O	O	X	IE extracted from N20 messages between the traced AMF and SMSF.
	Encoded*	X	X	M	Raw N20 messages between the traced AMF and SMSF. The encoded content of the message is provided
N22	Decoded	M	M	O	Message name
		O	O	O	Record extensions
		M	M	X	NSSF ID of the connected NSSF AMF ID of the traced AMF
		O	O	X	IE extracted from N22 messages between the traced AMF and NSSF.
	Encoded*	X	X	M	Raw N22 messages between the traced AMF and NSSF. The encoded content of the message is provided
N26	Decoded	M	M	O	Message name
		O	O	O	Record extensions
		M	M	X	MME ID of the connected MME AMF ID of the traced AMF
		O	O	X	IE extracted from N26 messages between the traced AMF and MME.
	Encoded*	X	X	M	Raw N26 messages between the traced AMF and MME. The encoded content of the message is provided

Encoded* - the messages are left encoded in the format it was received.

4.19 SMF Trace Record Content

The following table shows the trace record content for SMF.

The trace record is the same for management based activation and for signalling based activation.

SMF shall support at least one of the following trace depth levels – Maximum, Medium or Minimum.

Table 4.19.1 : SMF Trace Record Content

Interface (specific messages)	Format	Level of details			Description
		Min	Med	Max	
N4	Decoded	M	M	O	Message name
		O	O	O	Record extensions
		M	M	X	UPF ID of the connected UPF node SMF ID of the traced SMF
		O	O	X	IE extracted from N4 messages between the traced SMF and the UPF.
	Encoded*	X	X	M	Raw Messages: N4 messages between the traced SMF node and the UPF. The encoded content of the message is provided.
N7	Decoded	M	M	O	Message name
		O	O	O	Record extensions
		M	M	X	PCF ID of the connected PCF SMF ID of the traced SMF
		O	O	X	IE extracted from N7 messages between the traced SMF and PCF.
	Encoded*	X	X	M	Raw N7 messages between the traced SMF and PCF. The encoded content of the message is provided
N10	Decoded	M	M	O	Message name
		O	O	O	Record extensions
		M	M	X	UDM ID of the connected UDM SMF ID of the traced SMF
		O	O	X	IE extracted from N10 messages between the traced SMF and the UDM.
	Encoded*	X	X	M	Raw N10 messages between the traced SMF and the UDM. The encoded content of the message is provided
N11	Decoded	M	M	O	Message name
		O	O	O	Record extensions
		M	M	X	AMF ID of the connected AMF SMF ID of the traced SMF
		O	O	X	IE extracted from N11 messages between the traced SMF and the AMF.
	Encoded*	X	X	M	Raw N11 messages between the traced SMF and the AMF. The encoded content of the message is provided
S5-C	Decoded	M	M	O	Message name
		O	O	O	Record extensions
		M	M	X	PGW ID of the connected PGW SMF ID of the traced SMF
		O	O	X	IE extracted from S5-C messages between the traced SMF and PGW.
	Encoded*	X	X	M	Raw S5-C messages between the traced SMF and PGW. The encoded content of the message is provided
N16	Decoded	M	M	O	Message name
		O	O	O	Record extensions
		M	M	X	V-SMF ID of the connected V-SMF SMF ID of the traced SMF
		O	O	X	IE extracted from N16 messages between the traced SMF and V-SMF.
	Encoded*	X	X	M	Raw N16 messages between the traced SMF and V-SMF. The encoded content of the message is provided
N16a	Decoded	M	M	O	Message name
		O	O	O	Record extensions
		M	M	X	I-SMF ID of the connected I-SMF SMF ID of the traced SMF
		O	O	X	IE extracted from N16a messages between the traced SMF and I-SMF.
	Encoded*	X	X	M	Raw N16a messages between the traced SMF and I-SMF. The encoded content of the message is provided

Encoded* - the messages are left encoded in the format it was received.

4.20 PCF Trace Record Content

The following table shows the trace record content for PCF.

The trace record is the same for management based activation and for signalling based activation.

PCF shall support at least one of the following trace depth levels – Maximum, Medium or Minimum.

Table 4.20.1 : PCF Trace Record Content

Interface (specific messages)	Format	Level of details			Description
		Min	Med	Max	
N5	Decoded	M	M	O	Message name
		O	O	O	Record extensions
		M	M	X	AF ID of the connected AF PCF ID of the traced PCF
		O	O	X	IE extracted from N5 messages between the traced PCF and the AF.
	ASN.1	X	X	M	Raw Messages: N5 messages between the traced PCF and the AF. The encoded content of the message is provided.
N7	Decoded	M	M	O	Message name
		O	O	O	Record extensions
		M	M	X	SMF ID of the connected SMF PCF ID of the traced PCF
	Encoded*	X	X	M	Raw N7 Messages: messages between the traced PCF and SMF.
N15	Decoded	M	M	O	Message name
		O	O	O	Record extensions
		M	M	X	AMF ID of the connected AMF PCF ID of the traced PCF
		O	O	X	IE extracted from N15 messages between the traced PCF and the AMF.
	Encoded*	X	X	M	Raw N15 messages between the traced PCF and the AMF. The encoded content of the message is provided

Encoded* - the messages are left encoded in the format it was received.

4.21 AUSF Trace Record Content

The following table shows the trace record content for AUSF.

The trace record is the same for management based activation and for signalling based activation.

AUSF shall support at least one of the following trace depth levels – Maximum, Medium or Minimum.

Table 4.21.1 : AUSF Trace Record Content

Interface (specific messages)	Format	Level of details			Description
		Min	Med	Max	
N12	Decoded	M	M	O	Message name
		O	O	O	Record extensions
		M	M	X	AMF ID of the connected AMF AUSF ID of the traced AUSF
		O	O	X	IE extracted from N12 messages between the traced AUSF and the AMF.
	Encoded*	X	X	M	Raw Messages: N12 messages between the traced AUSF and the AMF. The encoded content of the message is provided.
N13	Decoded	M	M	O	Message name
		O	O	O	Record extensions
		M	M	X	UDM of the connected UDM AUSF ID of the traced AUSF
	Encoded*	X	X	M	Raw N13 Messages: messages between the traced AUSF and UDM. The encoded content of the message is provided

Encoded* - the messages are left encoded in the format it was received.

4.22 NEF Trace Record Content

The following table shows the trace record content for NEF.

The trace record is the same for management based activation and for signalling based activation.

NEF shall support at least one of the following trace depth levels – Maximum, Medium or Minimum.

Table 4.22.1 : NEF Trace Record Content

Interface (specific messages)	Format	Level of details			Description
		Min	Med	Max	
N29	Decoded	M	M	O	Message name
		O	O	O	Record extensions
		M	M	X	SMF ID of the connected SMF NEF ID of the traced NEF
		O	O	X	IE extracted from N29 messages between the traced NEF and the SMF.
	Encoded*	X	X	M	Raw Messages: N29 messages between the traced NEF and the SMF. The encoded content of the message is provided.
N30	Decoded	M	M	O	Message name
		O	O	O	Record extensions
		M	M	X	PCF ID of the connected PCF NEF ID of the traced NEF
		O	O	X	IE extracted from N30 messages between the traced NEF and PCF.
	Encoded*	X	X	M	Raw N30 Messages: messages between the traced NEF and PCF. The encoded content of the message is provided
N33	Decoded	M	M	O	Message name
		O	O	O	Record extensions
		M	M	X	AF ID of the connected AF NEF ID of the traced NEF
		O	O	X	IE extracted from N33 messages between the traced NEF and AF.
	Encoded*	X	X	M	Raw N33 Messages: messages between the traced NEF and AF. The encoded content of the message is provided

Encoded* - the messages are left encoded in the format it was received.

4.23 NRF Trace Record Content

The following table shows the trace record content for NRF.

The trace record is the same for management based activation and for signalling based activation.

NRF shall support at least one of the following trace depth levels – Maximum, Medium or Minimum.

Table 4.23.1 : NRF Trace Record Content

Interface (specific messages)	Format	Level of details			Description
		Min	Med	Max	
N27	Decoded	M	M	O	Message name
		O	O	O	Record extensions
		M	M	X	NRF ID of the connected NRF NRF ID of the traced NRF
		O	O	X	IE extracted from N27 messages between the traced NRF and the NRF.
	Encoded*	X	X	M	Raw Messages: N27 messages between the traced NRF and the NRF. The encoded content of the message is provided.

Encoded* - the messages are left encoded in the format it was received.

4.24 NSSF Trace Record Content

The following table shows the trace record content for NSSF.

The trace record is the same for management based activation and for signalling based activation.

NSSF shall support at least one of the following trace depth levels – Maximum, Medium or Minimum.

Table 4.24.1 : NSSF Trace Record Content

Interface (specific messages)	Format	Level of details			Description
		Min	Med	Max	
N22	Decoded	M	M	O	Message name
		O	O	O	Record extensions
		M	M	X	AMF ID of the connected AMF NSSF of the traced NSSF
		O	O	X	IE extracted from N22 messages between the traced NSSF and the AMF.
	Encoded*	X	X	M	Raw Messages: N22 messages between the traced NSSF and the AMF. The encoded content of the message is provided.
N31	Decoded	M	M	O	Message name
		O	O	O	Record extensions
		M	M	X	NSSF ID of the connected NSSF NSSF ID of the traced NSSF
		O	O	X	IE extracted from N31 messages between the traced NSSF and NSSF.
	Encoded*	X	X	M	Raw N31 Messages: messages between the traced NSSF and NSSF. The encoded content of the message is provided

Encoded* - the messages are left encoded in the format it was received.

4.25 UDM Trace Record Content

The following table shows the trace record content for UDM.

The trace record is the same for management based activation and for signalling based activation.

UDM shall support at least one of the following trace depth levels – Maximum, Medium or Minimum.

Table 4.25.1 : UDM Trace Record Content

Interface (specific messages)	Format	Level of details			Description
		Min	Med	Max	
N8	Decoded	M	M	O	Message name
		O	O	O	Record extensions
		M	M	X	AMF ID of the connected AMF UDM ID of the traced UDM
		O	O	X	IE extracted from N8 messages between the traced UDM and AMF.
	Encoded*	X	X	M	Raw N8 Messages: messages between the traced UDM and AMF. The encoded content of the message is provided
N10	Decoded	M	M	O	Message name
		O	O	O	Record extensions
		M	M	X	SMF ID of the connected SMF UDM ID of the traced UDM
		O	O	X	IE extracted from N10 messages between the traced UDM and the SMF.
	Encoded*	X	X	M	Raw N10 messages between the traced UDM and the SMF. The encoded content of the message is provided
N13	Decoded	M	M	O	Message name
		O	O	O	Record extensions
		M	M	X	AUSF ID of the connected AUSF UDM ID of the traced UDM
		O	O	X	IE extracted from N13 messages between the traced UDM and the AUSF
	Encoded*	X	X	M	Raw N13 messages between the traced UDM and the AUSF. The encoded content of the message is provided
N21	Decoded	M	M	O	Message name
		O	O	O	Record extensions
		M	M	X	SMSF ID of the connected SMSF UDM ID of the traced UDM
		O	O	X	IE extracted from N21 messages between the traced UDM and SMSF
	Encoded*	X	X	M	Raw N21 messages between the traced UDM and SMSF. The encoded content of the message is provided
NU1	Decoded	M	M	O	Message name
		O	O	O	Record extensions
		M	M	X	HSS ID of the connected HSS UDM ID of the traced UDM
		O	O	X	IE extracted from NU1 messages between the traced UDM and the HSS
	Encoded	X	X	M	Raw NU1 messages between the traced UDM and the HSS. The encoded content of the message is provided

Encoded* - the messages are left encoded in the format it was received.

4.26 UPF Trace Record Content

The following table shows the trace record content for UPF.

The trace record is the same for management based activation and for signalling based activation.

UPF shall support at least one of the following trace depth levels – Maximum, Medium or Minimum.

Table 4.26.1 : UPF Trace Record Content

Interface (specific messages)	Format	Level of details			Description
		Min	Med	Max	
N4	Decoded	M	M	O	Message name
		O	O	O	Record extensions
		M	M	X	SMF ID of the connected SMF UPF ID of the traced UPF
		O	O	X	IE extracted from N4 messages between the traced UPF and the SMF.
	Encoded*	X	X	M	Raw Messages: N4 messages between the traced UPF and the SMF. The encoded content of the message is provided.

Encoded* - the messages are left encoded in the format it was received.

4.27 SMSF Trace Record Content

The following table shows the trace record content for SMSF.

The trace record is the same for management based activation and for signalling based activation.

SMSF shall support at least one of the following trace depth levels – Maximum, Medium or Minimum.

Table 4.27.1 : SMSF Trace Record Content

Interface (specific messages)	Format	Level of details			Description
		Min	Med	Max	
N20	Decoded	M	M	O	Message name
		O	O	O	Record extensions
		M	M	X	AMF ID of the connected AMF SMSF ID of the traced SMSF
		O	O	X	IE extracted from N20 messages between the traced AMF and the SMSF.
	Encoded*	X	X	M	Raw Messages: N20 messages between the traced AMF and the SMSF. The encoded content of the message is provided.
	N21	Decoded	M	M	O
O			O	O	Record extensions
M			M	X	UDM ID of the connected UDM SMSF ID of the traced SMSF
O			O	X	IE extracted from N21 messages between the traced SMSF and UDM.
Encoded*		X	X	M	Raw N21 Messages: messages between the traced SMSF and UDM. The encoded content of the message is provided

Encoded* - the messages are left encoded in the format it was received.

4.28 AF Trace Record Content

The following table shows the trace record content for AF.

The trace record is the same for management based activation and for signalling based activation.

AF shall support at least one of the following trace depth levels – Maximum, Medium or Minimum.

Table 4.28.1 : AF Trace Record Content

Interface (specific messages)	Format	Level of details			Description
		Min	Med	Max	
N5	Decoded	M	M	O	Message name
		O	O	O	Record extensions
		M	M	X	PCF ID of the connected PCF AF ID of the traced AF
		O	O	X	IE extracted from N5 messages between the traced AF and the PCF.
	Encoded*	X	X	M	Raw Messages: N5 messages between the traced AF and the PCF. The encoded content of the message is provided.
	N33	Decoded	M	M	O
O			O	O	Record extensions
M			M	X	NEF ID of the connected NEF AF ID of the traced AF
O			O	X	IE extracted from N33 messages between the traced AF and NEF.
Encoded*		X	X	M	Raw N33 Messages: messages between the traced AF and NEF. The encoded content of the message is provided

Encoded* - the messages are left encoded in the format it was received.

4.29 Void

4.30 gNB-CU-CP Trace Record Content

The following table shows the trace record content for gNB-CU-CP network element

The trace record is the same for management based activation and for signalling based activation.

gNB-CU-CP shall support at least one of the following trace depth levels – Maximum, Medium or Minimum.

Table 4.30.1 : gNB-CU-CP Trace Record Content

Interface (specific messages)	Format	Level of details			Description
		Min	Med	Max	
Uu	Decoded	M	M	O	Message name
		O	O	O	Record extensions
		M	M	X	ID of traced gNB-CU-CP node
		O	O	X	IE extracted from RRC messages between the traced gNB-CU-CP node and the UE as per 3GPP TS 38.331 [21]
	Encoded*	X	X	M	Raw Uu Messages: RRC messages between the traced gNB-CU-CP node and the UE. The encoded content of the message is provided
NG-C	Decoded	M	M	O	Message name
		O	O	O	Record extensions
		M	M	X	ID of traced gNB-CU-CP node AMF ID of the connected AMF
		O	O	X	IE extracted from NGAP messages between the traced gNB-CU-CP node and Core Network as per 3GPP TS 38.413 [23]
	Encoded*	X	X	M	Raw NG-C Messages NGAP: messages between the traced gNB-CU-CP node and Core Network The encoded content of the message is provided
Xn-C	Decoded	M	M	O	Message name
		O	O	O	Record extensions
		M	M	X	ID of traced gNB-CU-CP node ID of neighbouring gNB-CU-CP/ng-eNB node
		O	O	X	IE extracted from XnAP messages between the traced gNB-CU-CP node and the neighbouring gNB-CU-CP/ng-eNB node as per 3GPP TS 38.423 [24]
	Encoded*	X	X	M	Raw Xn-C Messages: XnAP messages between the traced gNB-CU-CP node and the neighbouring gNB-CU-CP/ng-eNB node. The encoded content of the message is provided
X2-C	Decoded	M	M	O	Message name
		O	O	O	Record extensions
		M	M	X	ID of traced gNB-CU-CP node ID of connected NSA eNB node (Option 3)
		O	O	X	IE extracted from EN-DC X2AP messages between the traced gNB-CU-CP node and the connected NSA eNB node as per 3GPP TS 36.423 [17]
	Encoded*	X	X	M	Raw EN-DC X2-C Messages: EN-DC X2AP messages between the traced gNB-CU-CP node and the connected NSA eNB node. The encoded content of the message is provided
F1-C	Decoded	M	M	O	Message name
		O	O	O	Record extensions
		M	M	X	ID of traced gNB-CU-CP ID of connected gNB-DU
		O	O	X	IE extracted from F1AP messages between the traced gNB-CU-CP and the gNB-DU as per 3GPP TS 38.473 [26]
	Encoded*	X	X	M	Raw F1-C Messages: F1AP messages between the traced gNB-CU-CP and the gNB-DU. The encoded content of the message is provided
E1	Decoded	M	M	O	Message name
		O	O	O	Record extensions
		M	M	X	ID of traced gNB-CU-CP ID of connected gNB-CU-UP
		O	O	X	IE extracted from E1AP messages between the traced gNB-CU-CP and the gNB-CU-UP as per 3GPP TS 38.473 [26]
	Encoded*	X	X	M	Raw E1 Messages: E1AP messages between the traced gNB-CU-CP and the gNB-CU-UP. The encoded content of the message is provided

Encoded* - the messages are left encoded in the format it was received.

4.31 gNB-CU-UP Trace Record Content

The following table shows the trace record content for gNB-CU-UP network element

The trace record is the same for management based activation and for signalling based activation.

gNB-CU-UP shall support at least one of the following trace depth levels – Maximum, Medium or Minimum.

Table 4.31.1 : gNB-CU-UP Trace Record Content

Interface (specific messages)	Format	Level of details			Description
		Min	Med	Max	
E1	Decoded	M	M	O	Message name
		O	O	O	Record extensions
		M	M	X	ID of traced gNB-CU-UP ID of connected gNB-CU-CP
		O	O	X	IE extracted from E1AP messages between the traced gNB-CU-UP and the gNB-CU-CP as per 3GPP TS 38.473 [26]
	Encoded*	X	X	M	Raw E1 Messages: E1AP messages between the traced gNB-CU-UP and the gNB-CU-CP. The encoded content of the message is provided

Encoded* - the messages are left encoded in the format it was received.

4.32 gNB-DU Trace Record Content

The following table shows the trace record content for gNB-DU network element

The trace record is the same for management based activation and for signalling based activation.

gNB-DU shall support at least one of the following trace depth levels – Maximum, Medium or Minimum.

Table 4.32.1 : gNB-DU Trace Record Content

Interface (specific messages)	Format	Level of details			Description
		Min	Med	Max	
F1	Decoded	M	M	O	Message name
		O	O	O	Record extensions
		M	M	X	ID of traced gNB-DU ID of connected gNB-CU-CP
		O	O	X	IE extracted from F1AP messages between the traced gNB-DU and the gNB-CU-CP as per 3GPP TS 38.473 [26]
	Encoded*	X	X	M	Raw F1-C Messages: F1AP messages between the traced gNB-DU and the gNB-CU-CP. The encoded content of the message is provided

Encoded* - the messages are left encoded in the format it was received.

4.33 ng-eNB Trace Record Content

The following table shows the trace record content for ng-eNB network element

The trace record is the same for management based activation and for signalling based activation.

ng-eNB shall support at least one of the following trace depth levels – Maximum, Medium or Minimum.

Table 4.33.1 : ng-eNB Trace Record Content

Interface (specific messages)	Format	Level of details			Description
		Min	Med	Max	
Uu	Decoded	M	M	O	Message name
		O	O	O	Record extensions
		M	M	X	ID of traced ng-eNB node
		O	O	X	IE extracted from RRC messages between the traced ng-eNB node and the UE as per 3GPP TS 36.331 [28]

	Encoded*	X	X	M	Raw Uu Messages: RRC messages between the traced ng-eNB node and the UE. The encoded content of the message is provided
NG-C	Decoded	M	M	O	Message name
		O	O	O	Record extensions
		M	M	X	ID of traced ng-eNB node AMF ID of the connected AMF
		O	O	X	IE extracted from NGAP messages between the traced ng-eNB node and Core Network as per 3GPP TS 38.413 [23]
	Encoded*	X	X	M	Raw NG-C Messages NGAP: messages between the traced ng-eNB node and Core Network The encoded content of the message is provided
Xn-C	Decoded	M	M	O	Message name
		O	O	O	Record extensions
		M	M	X	ID of traced ng-eNB node ID of neighbouring NG-RAN node (i.e. ng-eNB or gNB)
		O	O	X	IE extracted from XnAP messages between the traced ng-eNB and the neighbouring NG-RAN node as per 3GPP TS 38.423 [24]
	Encoded*	X	X	M	Raw Xn-C Messages: XnAP messages between the traced ng-eNB node and the neighbouring NG-RAN node. The encoded content of the message is provided

Encoded* - the messages are left encoded in the format it was received.

4.34 NR MDT Trace Record Content

4.34.1 Trace Record for Immediate MDT measurements

The following table contains the Trace record description for NR immediate MDT measurements. The trace record is the same for management based activation and for signalling based activation.

MDT measurement name	Measurement attribute name(s)	Measurement attribute definition	Notes
M1	RSRPs	List of RSRP values received in RRC measurement report. One value per measured cell. For beam level granularity, one value per measured beam.	TS 32.422 [3] TS 37.320 [32] TS 38.331 [21]
	RSRQs	List of RSRQ values received in RRC measurement report. One value per measured cell. For beam level granularity, one value per measured beam.	TS 32.422 [3] TS 37.320 [32] TS 38.331 [21]
	PCIs	List of Physical Cell Identity of measured cells. The order of PCI values in the list should be the same as the corresponding measured values in the RSRPs, RSRQs and SINRs attributes.	TS 38.331 [21]
	SINRs	List of SINR values received in RRC measurement report. One value per measured cell.	TS 38.215 [42] TS 32.422 [3] TS 37.320 [32]
	Triggering event	Event that triggered the M1 measurement report, used only in case of RRM configured measurements (events A1, A2, A3, A4, A5, A6, B1 or B2)	TS 32.422 [3] TS 37.320 [32]
	UE location	UE positioning information and sensors data	TS 38.331 [21]
	in-device coexistence interference	See clause 4.34.3	TS 38.331 [21]
M2	PH distr	Distribution of the power headroom samples reported by the UE during the collection period.	TS 38.213 [37] TS 32.422 [3] TS 37.320 [32]
	in-device coexistence interference	See clause 4.34.3	TS 38.331 [21]
M3 (Not supported in rel. 16)			
M4	UL volumes	List of measured UL volumes in bytes per DRB. One value per DRB per UE.	TS 32.422 [3] TS 37.320 [32] TS 28.552 [36] TS 32.425 [39]
	DL volumes	List of measured DL volumes in bytes per DRB. One value per DRB per UE.	TS 32.422 [3] TS 37.320 [32] TS 28.552 [36]
	QoS level (QCI in option 3 or mapped 5QI in other options).	List of QoS levels of the DRBs for which the volume and throughput measurements apply. The order of QoS values in the list should be the same as the corresponding measured values in the UL volumes and DL volumes attributes.	TS 32.422 [3] TS 37.320 [32] TS 28.552 [36] TS 32.425 [39] TS 32.425 [39]
	in-device coexistence interference	See clause 4.34.3	TS 38.331 [21]
M5	UL Thp Time	Throughput time used for calculation of the uplink throughput (per UE).	TS 38.314 [35] TS 32.422 [3] TS 37.320 [32]
	UL Thp Volume	Throughput volume used for calculation of the uplink throughput (per UE).	TS 38.314 [35] TS 32.422 [3] TS 37.320 [32]
	UL LastTTI Volume	Volume transmitted in the last TTI and excluded from throughput calculation in the uplink.	TS 38.314 [35] TS 32.422 [3] TS 37.320 [32]
	DL Thp Times	List of throughput times used for calculation of the downlink throughput per DRB per UE. One value per DRB.	TS 38.314 [35] TS 32.422 [3] TS 37.320 [32] TS 32.425 [39]
	DL Thp Volumes	List of throughput times used for calculation of the downlink throughput per DRB per UE. One value per DRB.	TS 38.314 [35] TS 32.422 [3] TS 37.320 [32] TS 32.425 [39]
	QoS level (QCI in option 3 or mapped 5QI in other options).	List of QoS levels of the DRBs for which the volume and throughput measurements apply. The order of QoS values in the list should be the same as the corresponding measured values in the UL volumes and DL volumes attributes.	TS 32.422 [3] TS 37.320 [32] TS 28.552 [36] TS 32.425 [39]
	DL Thp Time UE	Throughput time used for calculation of the downlink throughput (per UE).	TS 38.314 [35] TS 32.422 [3] TS 37.320 [32]
	DL Thp Volume UE	Throughput volume used for calculation of the downlink throughput (per UE).	TS 38.314 [35] TS 32.422 [3] TS 37.320 [32]
	DL LastTTI Volume	Volume transmitted in the last TTI and excluded from the throughput calculation in the downlink (per UE).	TS 38.314 [35] TS 32.422 [3] TS 37.320 [32]

	in-device coexistence interference	See clause 4.34.3	TS 38.331 [21]
M6	DL packet delay per QoS level (per QCI in option 3 or mapped 5QI in other options).	L2 Packet Delay for OAM performance observability or for QoS verification of MDT per DRB per UE	TS 37.320 [32] TS 28.552 [36] TS 32.425 [39]
	UL packet delay per QoS level (per QCI in option 3 or mapped 5QI in other options).	Excess Packet Delay Ratio in Layer PDCP for QoS verification of MDT per DRB per UE .	TS 38.314 [W] TS 37.320 [32] TS 28.552 [36] TS 32.425 [39]
	in-device coexistence interference	See clause 4.34.3	TS 38.331 [21]
M7	DL packet loss rate per QoS level (per QCI in option 3 or mapped 5QI in other options).	packets that are lost at Uu transmission, for OAM performance observability per DRB per UE.	TS 37.320 [32] TS 28.552 [36] TS 32.425 [39]
	UL packet loss rate per QoS level (per QCI in option 3 or mapped 5QI in other options).	packets that are lost in the UL, for OAM performance observability or QoS verification of MDT per DRB per UE.	TS 38.314 [W] TS 37.320 [32] TS 28.552 [36] TS 32.425 [39]
	in-device coexistence interference	See clause 4.34.3	TS 38.331 [21]
M8	RSSI (WLAN, Bluetooth®)	RSSI measurement by UE.	TS 37.320 [32]
	in-device coexistence interference	See clause 4.34.3	TS 38.331 [21]
M9	RTT (WLAN)	RTT measurement by UE.	TS 37.320 [32]
	in-device coexistence interference	See clause 4.34.3	TS 38.331 [21]

4.34.2 Trace Record for UE location information

The following table contains the Trace record description for NR UE location information. The trace record is the same for management based activation and for signalling based activation.

MDT measurement name	Measurement attribute name(s)	Measurement attribute definition	Notes
UE location	GNSS pos	GNSS based coordinates, including (latitude, longitude), as reported by the UE. The IE can be any of ellipsoidPoint, ellipsoidPointWithUncertaintyCircle, ellipsoidPointWithUncertaintyEllipse, ellipsoidPointWithAltitude, ellipsoidPointWithAltitudeAndUncertaintyEllipsoid, ellipsoidArc, polygon depending on the IE present in the RRC message.	TS 32.422 [3] TS 37.320 [32] TS 38.305 [44]
	UE rx-tx	The UE reported UE rx-tx time difference measurement. If available.	TS 32.422 [3] TS 37.320 [32] TS 38.305 [44]
	gNB rx-tx	The gNB measured gNB rx-tx time difference. If available.	TS 32.422 [3] TS 37.320 [32] TS 38.305 [44]
	AoA	The gNB measured angle of arrival measurement. If available.	TS 32.422 [3] TS 37.320 [32] TS 38.305 [44]
	Sensor information	The UE reported sensor data (such as barometric pressure and/or motion). If available: a gyroscope, an accelerometer and a barometer data.	TS 32.422 [3] TS 37.320 [32] TS 38.305 [44]

4.34.3 Trace Record for in-device coexistence interference

The following table contains the Trace record description for NR in-device coexistence interference. The trace record is the same for management based activation and for signalling based activation.

MDT measurement name	Measurement attribute name(s)	Measurement attribute definition	Notes
in-device coexistence interference	IDC assistance information	It is applied as polluted measurement indication in which interference factors of IDC (In-Device Coexistence) shall be included in the case of immediate MDT measurement if available	TS 38.331 [21]

5 Trace format

5.1 Introduction

Trace data reporting consists of trace records that may be written to files or output to streams.

Trace Records are used to carry the captured trace data being reported or to convey various administrative messages associated with the data collection. Administrative messages are intended for the consumer of files from the TCE for the file reporting case, or for the MnS Consumer in the case of stream output. Cases where MnS Consumer may transfer data or convey administrative messages to the MnS Producer are out of scope of the present document.

Encoding of trace records may be performed using XML (binary form) or GPB (Google Protocol Buffers).

GPB encoded trace records are preceded by length indicator to facilitate decoding by the receiver. Streamed trace records use a transport protocol to facilitate framing of the messages.

5.2 Trace Record

5.2.1 Introduction

GPB encoded trace records are formatted in GPB version 3 (proto3) [45]. Individual Trace records are preceded with a GPB variable length 32 bit integer that indicates the size of the GPB encoded trace record.

Logical Layout

Delimiter	Trace Record	Delimiter	Trace Record	Delimiter	Trace Record
-----------	--------------	-----------	--------------	-----------	--------------

The Trace Record comprises a header and payload as shown in Figure 5.2.1-1.

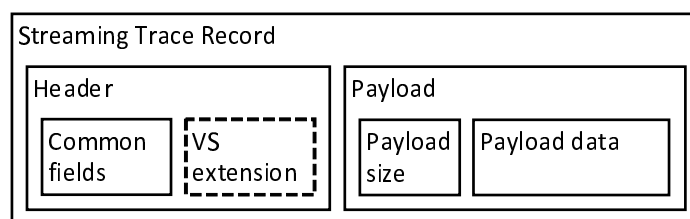

Figure 5.2.1.1: Trace Record

The format of the Trace Record Header in Trace Record specified in the clause 5.2.2. The format of the Payload in Streaming Trace Record specified in the clause 5.2.3.

5.2.2 Trace Record Header

The trace record header contains the common fields as specified in the Table 5.2.2-1, in addition it may also contain vendor specific extensions.

Table 5.2.2.1 : Common fields in the trace record header

Trace Record Header field name	Description
timeStamp (M)	Time stamp (in milliseconds since Epoch) of when the streaming trace record is produced internally in the Producer encoded as (64 bit integer)
nfInstanceId (M)	Unique id of the Producer NF instance that produced this trace record represented by a (String)
nfType (M)	Type of the Producer NF that produced this trace record represented by a (String)
traceReference (M)	Trace Reference (see clause 5.6 of 3GPP TS 32.422 [23]) (represented by a 3 bytes octet string)
traceRecordingSessionReference (M)	Trace Recording Session Reference (see clause 5.7 of 3GPP TS 32.422 [23]) represented by a (2 byte octet string. See Note 1.)
traceRecordTypeId (M)	Identifier of the trace record type (see clause 5.2.4 for details) represented by an ENUM with the following values: NORMAL, TRACE_SESSION_START, TRACE_SESSION_STOP, TRACE_RECORDING_SESSION_START, TRACE_RECORDING_SESSION_STOP, TRACE_STREAM_HEARTBEAT, TRACE_RECORDING_SESSION_NOT_STARTED, TRACE_RECORDING_SESSION_DROPPED_EVENTS, TRACE_FILE_OPEN, TRACE_FILE_CLOSE, TRACE_FILE_ABNORMAL_CLOSED, TRACE_RECORDING_SESSION_THROTTLED_START, TRACE_RECORDING_SESSION_THROTTLED_STOP (See Note 2).
ranUeId (O)	RAN defined UE Id (see 3GPP TS 38.463 [25] and 38.473 [26]) represented as of the UE (8 byte octet string. See Note 3.)
payloadSchemaURI (O)	URI identifying the schema to be used in order to decode the payload represented by a (String. See Note 4.)
globalGnbId (CM)	Global gNB ID, as defined in [23]. Applied for trace reported by gNB-CU-CP, gNB-CU-UP, gNB-DU.
vendorExtension (O)	Vendor-specific extension(s) represented by a (Arraylist of String. See Note 5.)
<p>NOTE 1: The <i>traceRecordingSessionReference</i> must be present for the Streaming Trace Records with non-zero size payload where the payload carries data captured for a Trace Recording Session and in administrative messages related to a Trace Recording Session (e.g. "Trace Recording Session Start" or "Trace Recording Session Stop").</p> <p>NOTE 2: The <i>traceRecordTypeId</i> with value "NORMAL" is used for Streaming Trace Records that do not carry an administrative message.</p> <p>NOTE 3: The <i>ranUeId</i> field is present in the trace record header if it has been captured in the traced signaling messages.</p> <p>NOTE 4: The <i>payloadSchemaURI</i> is not required for Streaming Trace Records with payload of zero-size, or payload using common payload format (e.g. used to convey Streaming Trace administrative messages).</p> <p>NOTE 5: The <i>vendorExtension</i> is typically a generic list of key-value pairs.</p>	

5.2.3 Trace Record Payload

The streaming trace record payload carries the captured Trace data being reported by the MnS Producer to the MnS Consumer and comprises the fields defined in Table 5.2.3-1.

Table 5.2.3.1 : Fields in the trace record payload

Trace Record Payload parameter name	Description
payloadSize (O)	Size of payload, in bytes represented by a (64 bit integer. The field may be omitted if the solution set specific encoding/decoding has its own support for indicating the size.)
payload (M)	Sequence of bytes representing the binary encoded data of the specific trace recordArray of bytes. See Note 1.
NOTE 1: For example, trace record content per clause 4 of the present document with schema indicated in the header field <i>payloadSchemaURI</i> required for decoding.	
NOTE 2: Void	

5.2.4 Trace administrative messages

5.2.4.1 Introduction

The following administrative messages are defined for trace management purposes:

- Trace Session Start
- Trace Session Stop
- Trace Recording Session Start
- Trace Recording Session Stop
- Trace Stream Heartbeat (streaming only)
- Trace Recording Session Not Started
- Trace Recording Session Dropped Events
- Trace File Open (file based only)
- Trace File Close (file based only)
- Trace File Abnormal Closed (file based only)
- Trace Recording Session Throttled Start
- Trace Recording Session Throttled Stop

5.2.4.2 Trace Session Start administrative message

The Trace Session Start administrative message shall be used to convey the start of a Trace Session (see 3GPP TS 32.422 [3] for details). The Trace Record in this case may have zero-size payload. The value of the *traceRecordTypeId* field in the Trace Record Header is set to "TRACE_SESSION_START". The start trace session administrative message is not used for signalling based activation as there is no separate trigger for starting the session and the trace recording session.

5.2.4.3 Trace Session Stop administrative message

The Trace Session Stop administrative message shall be used to convey the stop of a Trace Session (see 3GPP TS 32.422 [3] for details). The Trace Record in this case may have zero-size payload. The value of the *traceRecordTypeId* field in the Trace Record Header is set to "TRACE_SESSION_STOP". The stop trace session administrative message is not used for signalling based activation as there is no separate trigger for stopping the session and the trace recording session.

5.2.4.3a Trace Recording Session Start administrative message

The Trace Recording Session Start administrative message shall be used to convey the start of a Trace Recording Session (see 3GPP TS 32.422 [3] for details). The Trace Record in this case may have zero-size payload. The value of the traceRecordTypeId field in the Streaming Trace Record Header is set to "TRACE_RECORDING_SESSION_START".

5.2.4.3b Trace Recording Session Stop administrative message

The Trace Recording Session Stop administrative message shall be used to convey the stop of a Trace Recording Session (see 3GPP TS 32.422 [3] for details). The Trace Record in this case may have zero-size payload in the normal case, For the abnormal case, the trace record should include the reason for the session stop. One of the reasons could be overloaded. The value of the traceRecordTypeId field in the Streaming Trace Record Header is set to "TRACE_RECORDING_SESSION_STOP".

5.2.4.4 Trace Stream Heartbeat administrative message

The Trace Stream Heartbeat administrative message may be used in absence of the captured trace data and other administrative messages from the MnS Producer to the MnS Consumer. The message is intended to indicate that a streaming trace connection is alive and does not indicate whether there is an ongoing Trace Session or not.

Transport protocol level keep-alive mechanisms may be used as an alternative (e.g. use of Ping and Pong WebSocket frames in IETF RFC 6455 [40]) and are out of scope of the present document.

5.2.4.5 Trace Recording Session Not Started administrative message

The Trace Recording Session Not Started administrative message shall be used to convey that a trace recording session could not be started. For example, the number of simultaneous UE traces may be limited so that UE traces are not started when this limit is reached. It includes the detailed reason as string in the payload.

5.2.4.6 Trace Recording Session Dropped Events administrative message

The Trace Recording Session Dropped Events administrative message shall be used to convey the number of dropped trace records. The message provides indication that trace records are dropped from a particular trace recording session. It includes the number of trace records dropped in the payload.

5.2.4.7 Trace File Open administrative message

The Trace File Open administrative message shall be used to convey that trace file is opened for trace recording at the start of ROP period. The message provides indication when a file is opened.

5.2.4.8 Trace File Close administrative message

The Trace File Close administrative message shall be used to convey that trace file is closed for trace recording at the end of ROP period. The message provides indication when a file is closed.

5.2.4.9 Trace File Abnormal Closed administrative message

The Trace File Abnormal Closed administrative message shall be used to convey that trace file is closed abnormally. For example, the trace file is closed due to resource constraint such as out of memory.

5.2.4.10 Trace Recording Session Throttled Start administrative message

The Trace Recording Session Throttled Start administrative message shall be used to convey that the lower priority trace records are missing. A possible reason is due to overload condition for a Trace Recording Session. The Trace Record in this case may have zero-size payload or include which kind of contents are missing. The value of the traceRecordTypeId field in the Trace Record Header is set to "TRACE_RECORDING_SESSION_THROTTLED_START".

5.2.4.11 Trace Recording Session Throttled Stop administrative message

The Trace Recording Session Throttled Stop administrative message shall be used to convey that throttling is cleared for a Trace Recording Session. The Trace Record in this case may have zero-size payload. The value of the traceRecordTypeId field in the Trace Record Header is set to "TRACE_RECORDING_SESSION_THROTTLED_STOP".

5.2.5 Void

5.2.6 Streaming Trace Format

When streaming trace data individual trace records and their associated length delimiter are carried in the payload of the transport protocol messages Figure 5.2.6.1 illustrates the concept.

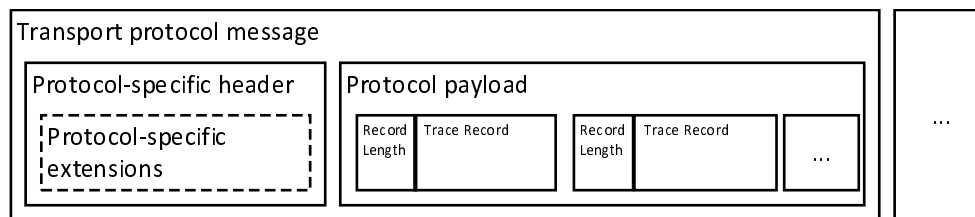

Figure 5.2.6.1: Transport of Trace Records

As depicted in the Figure 5.2.6.1, each protocol-specific message delivers one or more trace records from the MnS Producer to the MnS Consumer. The header of the transport protocol message is protocol-specific. It may contain protocol specific extensions and/or options related to the transport stream. The payload of the transport protocol carries one or more Trace Records. The format of the individual Trace Records is specified in clause 5.2.

The procedures related to the connection establishment and meta-data exchange between the Streaming Trace data reporting MnS Producer and MnS Consumer are out of scope of the present document and are specified in TS 28.532 [43]

5.3 Void

Annex A (normative): Trace Report File Format

A.0 Introduction

This annex describes the format of trace or MDT result files. Those files are to be transferred from the network (NEs or EM) to the NM.

The following conditions have been considered for the definition of this file format:

- The trace data volume and trace duration is not predictable. Depending on the data retrieval and storage mechanisms, several consecutive trace result files could be generated for a single traced call. The file naming convention shall allow rebuilding the temporal file sequences.
- Since the files are transferred via a machine-machine interface, the files should be machine-readable using standard tools.
- The file format should be independent from the data transfer protocol used to carry the file from one system to another.
- The file format should be generic across UMTS and EPS systems.
- The file format should be flexible enough to support further trace data types and decoded IEs, as well as vendor specific trace data.

A.1 Parameter description and mapping table

The following table describes the XML trace file parameters.

Table : XML trace file parameters

XML element / XML attribute specification	Description
traceCollecFile	This is the top-level element. It identifies the file as a collection of trace or MDT data. This element includes: <ul style="list-style-type: none"> - a file header (element "fileHeader") - the collection of trace data items (elements "traceRecSession").
fileHeader	This is the trace file header element. This element includes: <ul style="list-style-type: none"> - a version indicator (attribute specification "fileFormatVersion") - the PLMN for the Participating Operator on who's behalf the Trace Session was performed (element "pOPLMN") - the vendor name of the sending network node (attribute specification "vendorName") - the name of the sending network node (attribute specification "fileSender elementDn") - the type of the sending network node (attribute specification "fileSender elementType") - a time stamp (attribute specification "traceCollec beginTime").
fileHeader fileFormatVersion	This attribute specification identifies the file format version applied by the sender. The format version defined in the present document shall be the abridged number and version of this 3GPP document (see below). The abridged number and version of a 3GPP document is constructed from its version specific full reference "3GPP [...] (yyyy-mm) " by: <ul style="list-style-type: none"> - removing the leading "3GPP TS" - removing everything including and after the version third digit, representing editorial only changes, together with its preceding dot character - from the resulting string, removing leading and trailing white space, replacing every multi character white space by a single space character and changing the case of all characters to uppercase.
fileHeader pOPLMN	Optional element identifies the PLMN for the Participating Operator. This parameter can be used when the node that is recording the data is shared between operators.
fileHeader vendorName	Optional attribute specification that has the following value part: vendor of the equipment that provided the trace file.
fileSender elementDn	Optional attribute specification that uniquely identifies the NE or EM that assembled this trace file, according to the definitions in 3GPP TS 32.300 [11].
fileSender elementType	Optional attribute specification that identifies type of the network node that generated the file. For MDT case, this attribute only has the type of "RNC" or "eNodeB".
traceCollec beginTime	This attribute specification contains a timestamp that refers to the start of the first trace data that is stored in this file. It is a complete timestamp including day, time and delta UTC hour. E.g. "2001-09-11T09:30:47-05:00".
traceRecSession	Optional element that contains the traced data associated to a Trace Recording Session. It includes: <ul style="list-style-type: none"> - the DN prefix (attribute specification "dnPrefix") - the trace session identifier (element specification "traceSessionRef") - the trace recording session identifier (attribute specification "traceRecSessionRef") - the start time of the call (attribute specification "stime") - the ue identifier (element "ue") - the traced messages (elements "msg") for trace or the UE measurements (elements "meas") for MDT
traceRecSession dnPrefix	Optional attribute specification that provides the DN prefix (see 3GPP TS 32.300 [11]).
traceSessionRef	This element provides a unique trace session identifier as described in 3GPP TS 32.421 [2]. Trace Reference is composed of MCC digits, MNC digits, and Trace ID where: <ul style="list-style-type: none"> - MCC is in BCD format, 3 digits in length (element specification "MCC") - MNC is in BCD format, 1 to 3 digits in length, with no filler digit for MNCs less than 3 digits (element specification "MNC") - Trace ID is in hexadecimal format, 6 digits in length, hex letters (A through F) are capitalized(element specification "TRACE_ID").
traceRecSession traceRecSessionRef	Attribute specification that provides a unique trace recording session identifier as described in 3GPP TS 32.421 [2] and 3GPP TS 32.422 [3]. Trace Recording Session Reference is represented in hexadecimal format. No filler digits for hex numbers of less than four digits. All hex letters (A thru F) are capitalized.
traceRecSession stime	Optional attribute specification that provides the start time of the call.
ue	This element gives the ue identifier provided in trace activation messages. It includes: <ul style="list-style-type: none"> - the ue identifier type (attribute specification "idType") - the ue identifier value (attribute specification "idValue") This element shall not be present in the Trace record of E-UTRAN.

XML element / XML attribute specification	Description
ue idType	Attribute specification that provides the ue identifier type (IMSI, IMEI (SV), TAC, or Public User Identity). For management based MDT, IMSI or IMEI(SV) can not be selected as ue idType.
ue idValue	Attribute specification that provides the ue identifier value, represented in decimal. This attribute is optional for management based MDT.
msg	This element contains the information associated to a traced message. This element will not be included if the file is from the MME for retrieving the IMSI/IMEI (SV) information. It includes: <ul style="list-style-type: none"> - the function name associated to the traced message (attribute specification "function") - the time difference with attribute specification "traceCollect beginTime" (attribute specification "changeTime") - a boolean value that indicates if the message is vendor specific (attribute specification "vendorSpecific") - the protocol message name (attribute specification "name") - the NE initiator of the protocol message (element "initiator") - the NE target(s) of the protocol message (element "target") - the encoded protocol message (element "rawMsg") - the traced IEs, either simple (elements "ie") or complex (elements "ieGroup"), in any order This element is trace specific and not used for MDT.
msg function	Attribute specification that provides the function name associated to the traced message (e.g. luu, lu CS, lub, Intra frequency measurement, Gb, ...). This attribute is trace specific and not used for MDT.
msg changeTime	Attribute specification that provides the time difference with attribute specification "traceCollect beginTime". It is expressed in number of seconds and milliseconds (nbsec.ms). This attribute is trace specific and not used for MDT.
msg vendorSpecific	Attribute specification whose value part is a boolean value that indicates if the message is vendor specific (true) or not (false). This attribute is trace specific and not used for MDT.
msg name	Attribute specification that provides the protocol message name. This attribute is trace specific and not used for MDT.
initiator	Optional element that identifies the NE initiator of the protocol message. Each includes: <ul style="list-style-type: none"> - the type of the network node that initiate the message (attribute specification "type") - the LDN of NE initiator of the protocol message (element's content). The element's content may be empty in case the initiator is the sender or the mobile This element is trace specific and not used for MDT.
initiator type	Optional attribute specification that provides the type of the network node that initiate the message, e.g. "RNC", "SGSN". This element is trace specific and not used for MDT.
target	Optional element that identifies the NE target(s) of the protocol message. It includes: <ul style="list-style-type: none"> - the type of the network node that receive the message (attribute specification "type") - the LDN or IP Address of NE target of the protocol message (element's content). The element's content may be empty in case the target is the sender or the mobile This element is trace specific and not used for MDT.
target type	Optional attribute specification that provides the type of the network node that receive the message, e.g. "RNC", "SGSN". This element is trace specific and not used for MDT.
NumOfTargets	Optional attribute specification that provides the number of targets that the message is sent to. This is populated ONLY if the Target is not explicitly specified and is useful when there are a large number of targets that the message is sent to. This attribute is trace specific and not used for MDT.
rawMsg	Optional element that contains the encoded protocol message. It includes: <ul style="list-style-type: none"> - the protocol name associated to the event (attribute specification "protocol") - the protocol version (attribute specification "version") - the hexadecimal encoded form of the message (element's content) This element is available only if the trace depth is maximum. This attribute is trace specific and not used for MDT.
rawMsg protocol	Attribute specification that provides the protocol name associated to the event (e.g. "Ranap"). This attribute is trace specific and not used for MDT.
rawMsg version	Attribute specification that provides the protocol version. This attribute is trace specific and not used for MDT.
ieGroup	Optional element that contains a complex traced IE, i.e. an IE that contains other traced IEs. It includes: <ul style="list-style-type: none"> - the IE group name (attribute specification "name") - the IE group value (attribute specification "value") - zero or more traced IEs, either simple (elements "ie") or complex (elements "ieGroup"), in any order This element is available only if the trace depth is medium or minimum. This attribute is trace specific and not used for MDT.
ieGroup name	Optional attribute specification that provides the IE group name (e.g. "RAB parameters").
ieGroup value	Optional attribute specification that provides the IE group value when it exists (e.g. "RAB identifier"). This attribute is trace specific and not used for MDT.
ie	Optional element that contains a simple traced IE, i.e. an IE decoded from the traced message. It includes: <ul style="list-style-type: none"> - the IE name (attribute specification "name") - the IE value (element's content) This element is available only if the trace depth is medium or minimum. This attribute is trace specific and not used for MDT.
ie name	Attribute specification that provides the IE name (e.g. "Minimum DL Power"). This attribute is trace specific and not used for MDT.

XML element / XML attribute specification	Description
meas	This element contains the information associated to a UE measurement in MDT task. It includes: <ul style="list-style-type: none"> - the measurement name (attribute specification "meas name") - the measurement value (element's content) This element is MDT specific and not used for trace.
meas name	Attribute specification that provides the IE name. The IEs are specified in the Trace Record for Immediate MDT measurements table. This attribute is MDT specific and not used for trace.
meas changeTime	Attribute specification that provides the time difference with attribute specification "traceCollec beginTime". It is expressed in number of seconds and milliseconds (nbsec.ms). This attribute is MDT specific and not used for trace.
meas vendorSpecific	Attribute specification whose value part is a boolean value that indicates if the measurement is vendor specific (true) or not (false). The vendor specific measurements are taken at eNB or RNC. This attribute is MDT specific and not used for trace.
target cell	Attribute identifies the serving cell that the UE measurement is taken. This attribute is MDT specific and not used for trace.
UE location	Optional attribute that identifies the UE location information when the measurement is taken. The IEs are specified in the Trace Record for UE location information table. This attribute is MDT specific and not used for trace.

A.2 XML file format definition

For encoding of the information content, XML (see Extensible Markup Language (XML) 1.0, W3C Recommendation [5] , [6], [7], [8] and [9]) will be used. The XML schema contains the mark-up declarations that provide a grammar for the trace file format. The XML schema is defined below.

A.2.1 XML trace/MDT file diagram

The following figure A.2.1-1 describes the XML element structure of a trace/MDT XML file.

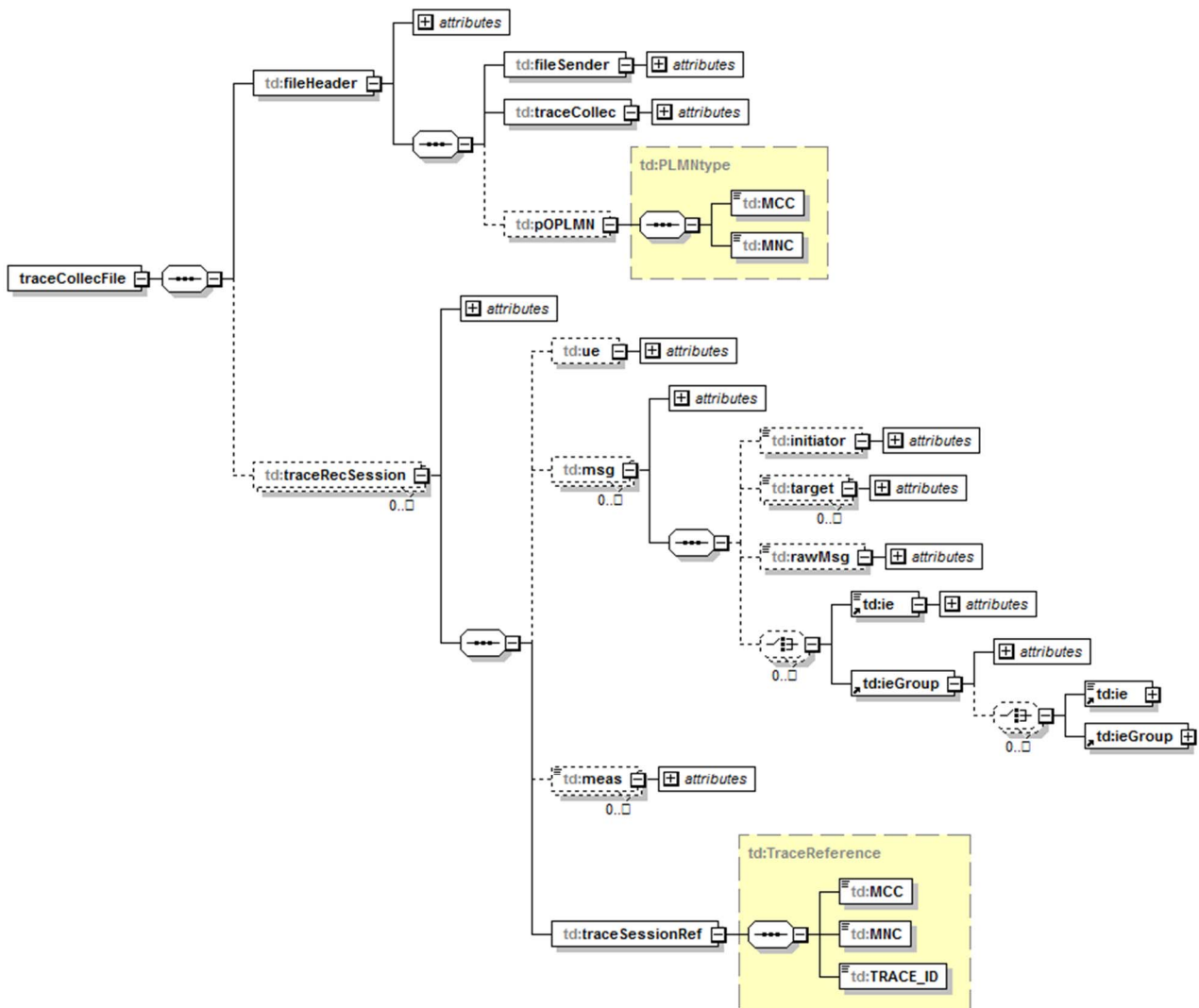

Figure A.2.1-1 : XML trace/MDT file diagram

NOTE: In case a trace only recording session, the elements/attributes (such as "meas") which are specific to MDT but not used for trace should be excluded from the file; In case a MDT only recording session, the elements/attributes (such as "msg") which are specific to trace but not used for MDT should be excluded from the file: In case of a combined trace and MDT recording session, all the elements/attributes are included in the file.

A.2.2 Trace data file XML schema

The following XML schema traceData.xsd is the schema for trace or MDT data XML files:

```
<?xml version="1.0" encoding="UTF-8"?>
<!--
  3GPP TS 32.423 Subscriber and Equipment Trace or MDT data definition and management
  Trace data file XML schema
  traceData.xsd
-->
<schema
  targetNamespace=
"http://www.3gpp.org/ftp/specs/archive/32_series/32.423#traceData"
  elementFormDefault="qualified"
  xmlns="http://www.w3.org/2001/XMLSchema"
  xmlns:td=
"http://www.3gpp.org/ftp/specs/archive/32_series/32.423#traceData"
>
<!-- XML types specific for Trace data file -->
<complexType name="TraceReference">
  <sequence>
    <element name="MCC" type="td:MCCType"/>
    <element name="MNC" type="td:MNCType"/>
    <element name="TRACE_ID" type="td:Trace_IDType"/>
  </sequence>
</complexType>
<simpleType name="traceRecSessionRef">
  <restriction base="hexBinary">
    <maxLength value="2"/>
  </restriction>
</simpleType>

<simpleType name="MCCType">
  <restriction base="string">
    <pattern value="\d{3}"/>
  </restriction>
</simpleType>
<simpleType name="MNCType">
  <restriction base="positiveInteger">
    <maxExclusive value="1000"/>
  </restriction>
</simpleType>
<complexType name="PLMNType">
  <sequence>
    <element name="MCC" type="td:MCCType"/>
    <element name="MNC" type="td:MNCType"/>
  </sequence>
</complexType>
<simpleType name="Trace_IDType">
  <restriction base="hexBinary">
    <length value="3"/>
  </restriction>
</simpleType>
<!-- Trace data file root XML element -->
<element name="traceCollecFile">
  <complexType>
    <sequence>
      <element name="fileHeader">
        <complexType>
          <sequence>
            <element name="fileSender">
              <complexType>
                <attribute name="elementDn" type="string" use="optional"/>
                <attribute name="elementType" type="string" use="optional"/>
              </complexType>
            </element>
            <element name="traceCollec">
              <complexType>
                <attribute name="beginTime" type="dateTime" use="required"/>
              </complexType>
            </element>
            <element name="pOPLMN" type="td:PLMNType" minOccurs="0" maxOccurs="1"/>
          </sequence>
          <attribute name="fileFormatVersion" type="string" use="required"/>
          <attribute name="vendorName" type="string" use="optional"/>
        </complexType>
      </element>
    </sequence>
  </element>

```

```

<element name="traceRecSession" minOccurs="0" maxOccurs="unbounded">
  <complexType>
    <sequence>
      <element name="ue" minOccurs="0">
        <complexType>
          <attribute name="idType" type="string" use="required" />
          <attribute name="idValue" type="long" use="required" />
        </complexType>
      </element>
      <!-- Element specific to trace data file -->
      <element name="msg" minOccurs="0" maxOccurs="unbounded">
        <complexType>
          <sequence>
            <element name="initiator" minOccurs="0">
              <complexType>
                <simpleContent>
                  <extension base="string">
                    <attribute name="type" type="NCName"
use="optional"/>
                  </extension>
                </simpleContent>
              </complexType>
            </element>
            <element name="target" minOccurs="0" maxOccurs="unbounded">
              <complexType>
                <simpleContent>
                  <extension base="string">
                    <attribute name="type" type="NCName"
use="optional"/>
                  </extension>
                </simpleContent>
              </complexType>
            </element>
            <element name="rawMsg" minOccurs="0">
              <complexType>
                <simpleContent>
                  <extension base="hexBinary">
                    <attribute name="protocol" type="string"
use="required"/>
                    <attribute name="version" type="string"
use="required"/>
                    <attribute name="NumOfTargets" type="integer"
use="optional"/>
                  </extension>
                </simpleContent>
              </complexType>
            </element>
            <choice minOccurs="0" maxOccurs="unbounded">
              <element ref="td:ie"/>
              <element ref="td:ieGroup"/>
            </choice>
          </sequence>
          <attribute name="function" type="string" use="required"/>
          <attribute name="name" type="string" use="required"/>
          <attribute name="changeTime" type="float" use="required"/>
          <attribute name="vendorSpecific" type="boolean" use="required"/>
        </complexType>
      </element>
      <!-- Element specific to MDT data file -->
      <element name="meas" minOccurs="0" maxOccurs="unbounded">
        <complexType>
          <simpleContent>
            <extension base="string">
              <attribute name="name" type="string" use="required"/>
              <attribute name="changeTime" type="float" use="required"/>
              <attribute name="vendorSpecific" type="boolean" use="required"/>
              <attribute name="targetCell" type="string" use="required"/>
              <attribute name="ueLocation" type="string" use="optional"/>
            </extension>
          </simpleContent>
        </complexType>
      </element>
      <element name="traceSessionRef" type="td:TraceReference"/>
    </sequence>
    <attribute name="dnPrefix" type="string" use="optional"/>
    <attribute name="traceRecSessionRef" type="td:traceRecSessionRef"
use="required"/>

```



```
        <attribute name="stime" type="dateTime" use="optional"/>
      </complexType>
    </element>
  </sequence>
</complexType>
</element>
<!-- Additional supporting XML elements -->
<element name="ieGroup">
  <complexType>
    <choice minOccurs="0" maxOccurs="unbounded">
      <element ref="td:ie"/>
      <element ref="td:ieGroup"/>
    </choice>
    <attribute name="name" type="string" use="optional"/>
    <attribute name="value" type="string" use="optional"/>
  </complexType>
</element>
<element name="ie">
  <complexType>
    <simpleContent>
      <extension base="string">
        <attribute name="name" type="string" use="required"/>
      </extension>
    </simpleContent>
  </complexType>
</element>
</schema>
```

Annex B (normative): Trace Report File Conventions and Transfer Procedure

B.0 Introduction

This annex describes naming conventions of files containing trace results and the procedure to transfer these files from the network to the NM.

B.1 File naming convention

The following convention shall be applied for trace result file naming:

`<Type><Startdate>.<Starttime>-<SenderType>.<SenderName>.[<TraceReference>].[<TraceRecordingSessionRef>]`

- 1) The Type field indicates if the file contains trace data for single or multiple calls, where:
 - "A" means single Trace Recording Session, single sender NE;
 - "B" means multiple Trace Recording Sessions, single sender NE;
 - "C" means IMSI/IMEI (SV) information for cell traffic trace or IMEI-TAC if area based MDT trace is involved (3GPP TS 32.422 [3] clause 4.4).
- 2) The Startdate field indicates the date of the first record in the trace file. The Startdate field is of the form YYYYMMDD, where:
 - YYYY is the year in four-digit notation;
 - MM is the month in two digit notation (01 - 12);
 - DD is the day in two digit notation (01 - 31).
- 3) The Starttime field indicates the time of the first record in the trace file. The Starttime field is of the form HHMMSSshhmm, where:
 - HH is the two digit hour of the day (local time), based on 24 hour clock (00 - 23);
 - MM is the two digit minute of the hour (local time) (00 - 59);
 - SS is the two digit second of the minute (local time) (00 - 59);
 - s is the sign of the local time differential from UTC (+ or -), in case the time differential to UTC is 0 then the sign may be arbitrarily set to "+" or "-";
 - hh is the two digit number of hours of the local time differential from UTC (00-23);
 - mm is the two digit number of minutes of the local time differential from UTC (00-59).
- 4) SenderType field is the type of NE defined by IOC attribute managedElementType in 3GPP TS 32.622 [12] that recorded and sent the trace file; SenderName field is the identifier of the NE that recorded and sent the trace file.
- 5) TraceRecordingSessionReference field is set only if the type field is A, and is represented in hexa-decimal format. TraceRecordingSessionReference is a 4 digit hexadecimal number and will not include filler digits for values less than 4 digits in length. All hexadecimal letters (A thru F) are capitalized.
- 6) TraceReference field is set if the type field is A. For type B the Trace Reference is optional and will be used when one trace file is created per trace session with multiple trace recording session. Trace Reference is represented in hexadecimal format. Trace Reference as defined in 3GPP TS 32.422 [3] is composed of PLMN ID (MCC, MNC) and Trace ID. The PLMN identity consists of 3 digits for MCC followed by either - a filler digit plus 2 digits from MNC (in case of 2 digit MNC) or 3 digits from MNC (in case of a 3 digit MNC). MCC and MNC are in BCD format.

Example: If MCC: 405, MNC: 139

octet 1: 0x04 (MCC digit 2, MCC digit 1)

octet 2: 0x15 (MNC digit 1, MCC digit 3)

octet 3: 0x93 (MNC digit 3, MNC digit 2)

Also if the MNC is 2 digits (MCC: 405 and MNC 39)

octet 1: 0x04 (MCC digit 2, MCC digit 1)

octet 2: 0xF5 (MNC digit 1, MCC digit 3)

octet 3: 0x93 (MNC digit 3, MNC digit 2)

7) Trace Reference is set if the type field is C.

See bullet 6 above for details regarding the representation of the Trace Reference. Some examples describing file naming convention:

1) file name: A20090928.231500+0200-MME.MME5. 13F23200056.125,

meaning: file produced by MME<MME5> on September 28, 2009, first trace record at 23:15:00 local time with a time differential of +2 hours against UTC. The file contains trace data for the Trace Session with the Trace reference 13F23200056 (where MCC is 312, MNC is 23, and Trace ID is 000056, all in hexadecimal format) and for the Trace Recording Session with the reference 125.

2) file name: B20030115.170000-0300-RNC.RNC02,

meaning: file produced by RNC<RNC02> on January 15, 2003, first trace record at 17:00:00 local time with a time differential of -3 hours against UTC. The file contains trace data for several Trace Recording Sessions.

3) file name: B20030115.170000-0300-RNC.RNC02. 4358070034D7,

meaning: file produced by RNC<RNC02> on January 15, 2003, first trace record at 17:00:00 local time with a time differential of -3 hours against UTC. The file contains trace 4358070034D7 (where MCC is 348, MNC is 570, and Trace ID is 0034D7) data for Trace reference and several Trace Recording Sessions.

4) file name C20030115.170000-0300-MME.MME02. 26F452550021

Meaning: file produced by MME<MME02> on January 15, 2003, first trace record at 17:00:00 local time with a time differential of -3 hours against UTC. The file contains IMSI/IMEI (SV) or IMEI-TAC information for one or more UEs traced at eNB with Trace Reference 26F452550021 (where MCC is 624, MNC is 25, and Trace ID is 550021).

B.2 File transfer

- Data retrieval and storage mechanisms are vendor specific.
- There is no constraint on data retrieval periodicity.

Annex C (informative): Trace Functional Architecture: Reporting

C.1 Figure of Trace Reporting

The following represents the trace reporting procedures.

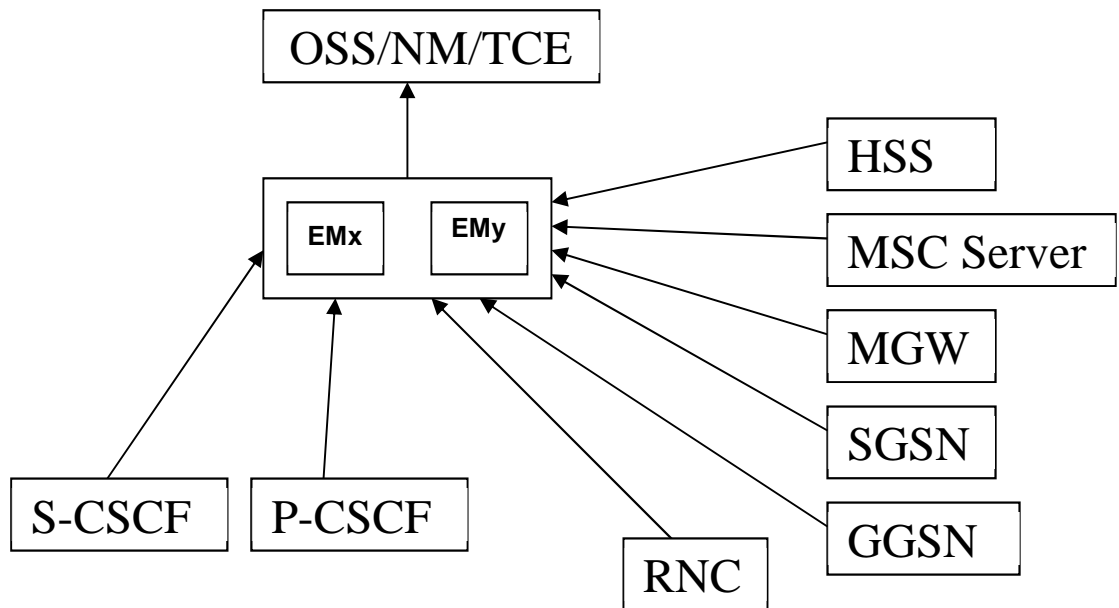

Figure C.1.1: Trace Reporting in System context A

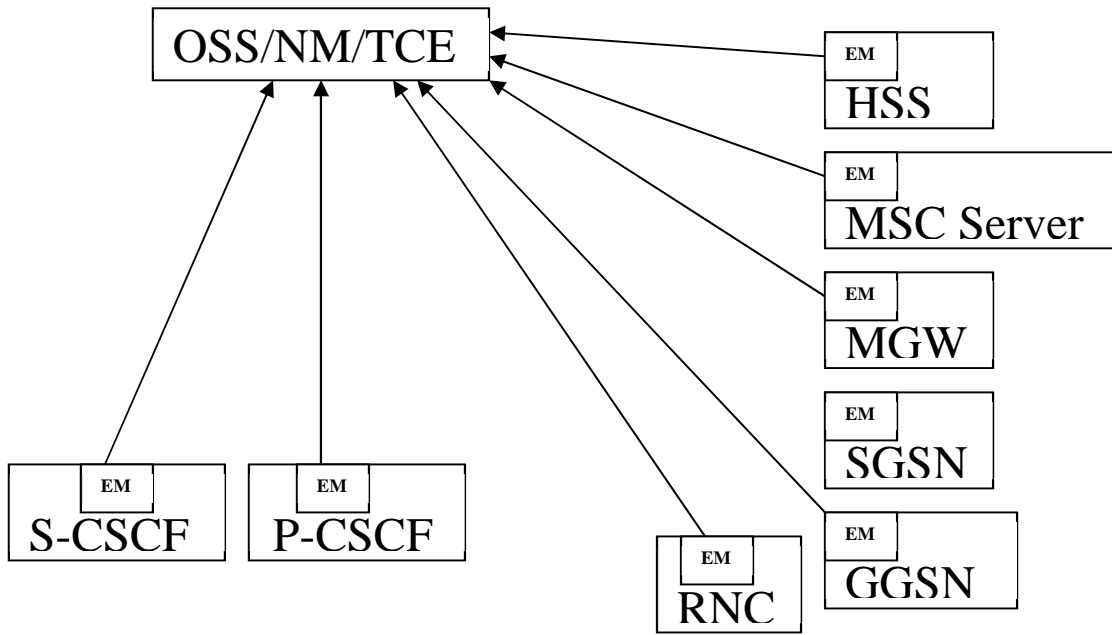

Figure C.1.2: Trace Reporting in System Context B

Annex D (informative): Examples of trace files

D.1 Examples of trace XML file

D.1.1 Example of XML trace file with the maximum level of details

```
<?xml version="1.0" encoding="UTF-8"?>
<traceCollecFile xmlns="http://www.3gpp.org/ftp/specs/archive/32_series/32.423#traceData"
xmlns:xsi="http://www.w3.org/2001/XMLSchema-instance"
xsi:schemaLocation="http://www.3gpp.org/ftp/specs/archive/32_series/32.423#traceData
http://www.3gpp.org/ftp/specs/archive/32_series/32423#traceData">
<fileHeader fileFormatVersion="32.423 V6.0" vendorName="Company NN">
  <pOPLMN>
    <MCC>460</MCC>
    <MNC>10</MNC>
  </pOPLMN>
  <fileSender elementDn="DC=a1.companyNN.com,SubNetwork=1, ManagedElement=RNC-1"
elementType="RNC"/>
  <traceCollec beginTime="2001-09-11T09:30:47-05:00"/>
</fileHeader>
  <traceRecSession dnPrefix="DC=a1.companyNN.com,SubNetwork=1" traceRecSessionRef=" A1"
stime="2001-09-11T09:30:47-05:00">
  <ue idType="IMSI" idValue="32795"/>
  <msg function="Iub" name="Radio LinkSetup Request" changeTime="0.005"
vendorSpecific="false">
    <target type="Cell">SubNetwork=1,ManagedElement=Cell-1</target>
    <rawMsg protocol="Nbap" version="001">A9FD64E12C</rawMsg>
  </msg>
  <traceSessionRef>
    <MCC>460</MCC>
    <MNC>10</MNC>
    <TRACE_ID>000122</TRACE_ID>
  </traceSessionRef>
</traceRecSession>
</traceCollecFile>
```

An additional example added;

```
<?xml version="1.0" encoding="UTF-8"?>
<traceCollecFile xmlns="http://www.3gpp.org/ftp/specs/archive/32_series/32.423#traceData"
xmlns:xsi="http://www.w3.org/2001/XMLSchema-instance"
xsi:schemaLocation="http://www.3gpp.org/ftp/specs/archive/32_series/32.423#traceData
http://www.3gpp.org/ftp/specs/archive/32_series/32423#traceData">
<fileHeader fileFormatVersion="32.423 V9.0" vendorName="Company NN">
  <pOPLMN>
    <MCC>460</MCC>
    <MNC>10</MNC>
  </pOPLMN>
  <fileSender elementDn="DC=a1.companyNN.com,SubNetwork=1, ManagedElement=MME-1 "
elementType="MME"/>
  <traceCollec beginTime="2001-09-11T09:30:47-05:00"/>
</fileHeader>
  <traceRecSession dnPrefix="DC=a1.companyNN.com,SubNetwork=1" traceRecSessionRef=" B2"
stime="2001-09-11T09:30:47-05:00">
  <ue idType="IMSI" idValue="32795"/>
  <msg function="S1AP" name="Handover Request" changeTime="0.005" vendorSpecific="false">
    <target type="Cell">SubNetwork=1,ManagedElement=Cell-1</target>
    <target type="Cell">SubNetwork=1,ManagedElement=Cell-2</target>
    <target type="Cell">123.222.213.5 </target>
    <rawMsg protocol="S1AP" version="001" NumOfTargets="3">A9FD64E12C</rawMsg>
  </msg>
  <traceSessionRef>
    <MCC>460</MCC>
    <MNC>10</MNC>
    <TRACE_ID>000122</TRACE_ID>
  </traceSessionRef>
</traceRecSession>
</traceCollecFile >
```

D.1.2 Example of XML trace file with the minimum level of details

```
<?xml version="1.0" encoding="UTF-8"?>
<traceCollecFile xmlns="http://www.3gpp.org/ftp/specs/archive/32_series/32.423#traceData"
xmlns:xsi="http://www.w3.org/2001/XMLSchema-instance"
xsi:schemaLocation="http://www.3gpp.org/ftp/specs/archive/32_series/32.423#traceData
http://www.3gpp.org/ftp/specs/archive/32_series/32.423#traceData">
  <fileHeader fileFormatVersion="32.423 V6.0" vendorName="Company NN">
    <pOPLMN>
      <MCC>460</MCC>
      <MNC>10</MNC>
    </pOPLMN>
    <fileSender elementDn="DC=a1.companyNN.com,SubNetwork=1, ManagedElement=RNC-1"
elementType="RNC"/>
    <traceCollec beginTime="2001-09-11T09:30:47-05:00"/>
  </fileHeader>
  <traceRecSession dnPrefix="DC=a1.companyNN.com,SubNetwork=1" traceRecSessionRef="C3"
stime="2001-09-11T09:30:47-05:00">
    <ue idType="IMSI" idValue="32795"/>
    <msg function="Iub" name="Radio Link Setup Request" changeTime="0.005"
vendorSpecific="false">
      <target type="Cell">SubNetwork=1,ManagedElement=Cell-1</target>
      <ie name="UL Scrambling Code">54</ie>
      <ie name="UL SIR Target">17.3</ie>
      <ie name="Min UL Channelisation Code Length">8</ie>
      <ie name="Poncture Limit">2</ie>
      <ieGroup name="RadioLink" value="1">
        <ie name="DL Scrambling Code">1</ie>
        <ie name="DL Channelisation Code Number">15</ie>
        <ie name="Maximum DL Power">9.3</ie>
        <ie name="Minimum DL Power">-10.1</ie>
      </ieGroup>
    </msg>
    <msg function="IuPs" name="RAB Assignment Response" changeTime="0.010"
vendorSpecific="false">
      <ieGroup name="RAB" value="1">
        <ieGroup name="RAB Failed To Setup Or Modify">
          <ie name="cause">2</ie>
        </ieGroup>
      </ieGroup>
    </msg>
    <traceSessionRef>
      <MCC>460</MCC>
      <MNC>10</MNC>
      <TRACE_ID>000130</TRACE_ID>
    </traceSessionRef>
  </traceRecSession>
</traceCollecFile>
```

D.1.3 Example of XML trace file for IMSI information from the MME

```
<?xml version="1.0" encoding="UTF-8"?>
<traceCollecFile xmlns=http://www.3gpp.org/ftp/specs/archive/32_series/32.423#traceData
xmlns:xsi="http://www.w3.org/2001/XMLSchema-instance"
xsi:schemaLocation="http://www.3gpp.org/ftp/specs/archive/32_series/32.423#traceData
http://www.3gpp.org/ftp/specs/archive/32_series/32.423#traceData">
<fileHeader fileFormatVersion="32.423 V8.0" vendorName="Company NN">
  <pOPLMN>
    <MCC>460</MCC>
    <MNC>10</MNC>
  </pOPLMN>
  <fileSender elementDn="DC=a1.companyNN.com,SubNetwork=1, ManagedElement=MME"
elementType="MME"/>
  <traceCollec beginTime="2001-09-11T09:30:47-05:00"/>
</fileHeader>
<traceRecSession dnPrefix="DC=a1.companyNN.com,SubNetwork=1" traceRecSessionRef=" A1" stime="2001-
09-11T09:30:47-05:00">
  <ue idType="IMSI" idValue="32795"/>
  <traceSessionRef>
    <MCC>460</MCC>
    <MNC>10</MNC>
    <TRACE_ID>000130</TRACE_ID>
  </traceSessionRef>
</traceRecSession>
<traceRecSession dnPrefix="DC=a1.companyNN.com,SubNetwork=1" traceRecSessionRef=" B2" stime="2001-
09-11T09:30:47-05:00">
  <ue idType="IMSI" idValue="12345"/>
```

```

    <traceSessionRef>
      <MCC>460</MCC>
      <MNC>10</MNC>
      <TRACE_ID>000150</TRACE_ID>
    </traceSessionRef>
  </traceRecSession>
</traceCollecFile>

```

D.1.4 Example of MDT XML file

```

<?xml version="1.0" encoding="UTF-8"?>
<traceCollecFile xmlns="http://www.3gpp.org/ftp/specs/archive/32_series/32.423#traceData"
xmlns:xsi="http://www.w3.org/2001/XMLSchema-instance"
xsi:schemaLocation="http://www.3gpp.org/ftp/specs/archive/32_series/32.423#traceData
http://www.3gpp.org/ftp/specs/archive/32_series/32.423#traceData">
  <fileHeader fileFormatVersion="32.423 V6.0" vendorName="Company NN">
    <pOPLMN>
      <MCC>460</MCC>
      <MNC>10</MNC>
    </pOPLMN>
    <fileSender elementDn="DC=a1.companyNN.com,SubNetwork=1, ManagedElement=RNC-1"
elementType="RNC"/>
    <traceCollec beginTime="2001-09-11T09:30:47-05:00"/>
  </fileHeader>
  <traceRecSession dnPrefix="DC=a1.companyNN.com,SubNetwork=1" traceRecSessionRef=" A1",
stime="2001-09-11T09:30:47-05:00">
    <ue idType="IMSI" idValue="32795"/>
    <meas name="RSRP" changeTime="0.005" vendorSpecific="false" targetCell="Cell-1"> 97 </meas>
    <meas name="RSRQ" changeTime="0.010" vendorSpecific="false" targetCell="Cell-2"> 34 </meas>
    <meas name="Power Headroom" changeTime="0.015" vendorSpecific="false" targetCell="Cell-1"> 5
  </meas>
  <traceSessionRef>
    <MCC>460</MCC>
    <MNC>10</MNC>
    <TRACE_ID>000150</TRACE_ID>
  </traceSessionRef>
</traceRecSession>
</traceCollecFile>

```

Annex E (informative): Void

Annex F (Informative): Void

Annex G (normative): Trace Record Protocol Buffer (GPB)

G.1 Transport Protocol Payload Format

The payload of one transport protocol message can carry one or more trace records as specified in clause 5.1. For GPB trace payload, the overall encoding format shall adhere to the following rules:

- Each trace record is encoded as a single TraceRecord GPBv3 message following the schema in clause G.2.
- Each TraceRecord message is preceded by a length field indicating the size in bytes of the following GPB message. This length field is encoded using the GPB ‘varint’ wire format.
- If the transport message payload includes multiple trace records, the length field for the next TraceRecord message shall immediately follow the preceding message.
- No extra padding (unused bytes) is allowed anywhere in the transport message payload.

NOTE: The total length of the transport message payload is assumed to be available but encoding of this value is specific to the transport protocol in use.

G.2 Trace Record Protocol Buffer (GPB) definitions

Normative GPB Trace Record schema, defined per clause 5.2:

```

syntax = "proto3";

/* Trace Record per 3GPP 32.423 specification.
 * v16
 */

enum TraceRecordType {
    NORMAL = 0;
    TRACE_SESSION_START = 1;
    TRACE_SESSION_STOP = 2;
    TRACE_RECORDING_SESSION_START = 3;
    TRACE_RECORDING_SESSION_STOP = 4;
    TRACE_STREAM_HEARTBEAT = 5;
    TRACE_RECORDING_SESSION_DROPPED_EVENTS = 6;
    TRACE_RECORDING_SESSION_NOT_STARTED = 7;
    TRACE_FILE_OPEN = 8;
    TRACE_FILE_CLOSE = 9;
    TRACE_FILE_ABNORMAL_CLOSED = 10;
    TRACE_RECORDING_SESSION_THROTTLED_START = 11;
    TRACE_RECORDING_SESSION_THROTTLED_STOP = 12;
}

message GlobalGnbId {
    bytes plmn_identity = 1;
    int64 gnb_id = 2;
}

message TraceRecordHeader {
    int64 time_stamp = 1;
    string nf_instance_id = 2;
    string nf_type = 3;
    bytes trace_reference = 4;
    bytes trace_recording_session_ref = 5;
    TraceRecordType trace_rec_type_id = 6;
    bytes ran_ue_id = 7;
    string payload_schema_uri = 8;
    GlobalGnbId global_gnb_id = 9;
    map<string, string> vendor_extension = 10;
}

```

```
message TraceSessionStart {
    map<string, string> vendor_extension = 1;
}

message TraceSessionStop {
    map<string, string> vendor_extension = 1;
}

message TraceRecordingSessionStart {
    map<string, string> vendor_extension = 1;
}

message TraceRecordingSessionStop {
    string reason = 2;
    map<string, string> vendor_extension = 1;
}

message TraceStreamHeartbeat {
    map<string, string> vendor_extension = 1;
}

message TraceRecordingSessionDroppedEvents {
    int64 number_of_dropped_events = 1;
    map<string, string> vendor_extension = 2;
}

message TraceRecordingSessionNotStarted {
    string reason = 1;
    map<string, string> vendor_extension = 2;
}

message TraceFileOpen {
    map<string, string> vendor_extension = 1;
}

message TraceFileClose {
    map<string, string> vendor_extension = 1;
}

message TraceFileAbnormalClosed {
    string reason = 1;
    map<string, string> vendor_extension = 2;
}

message TraceRecordingSessionThrottledStart {
    string reason = 1;
    map<string, string> vendor_extension = 2;
}

message TraceRecordingSessionThrottledStop {
    map<string, string> vendor_extension = 1;
}

message CommonTracePayload {
    oneof record_payload {
        TraceSessionStart trace_session_start = 1;
        TraceSessionStop trace_session_stop = 2;
        TraceRecordingSessionStart trace_recording_session_start = 3;
        TraceRecordingSessionStop trace_recording_session_stop = 4;
        TraceStreamHeartbeat trace_stream_heartbeat = 5;
        TraceRecordingSessionDroppedEvents trace_recording_session_dropped_events = 6;
        TraceRecordingSessionNotStarted trace_recording_session_not_started = 7;
        TraceFileOpen trace_file_open = 8;
        TraceFileClose trace_file_close = 9;
        TraceFileAbnormalClosed trace_file_abnormal_closed = 10;
        TraceRecordingSessionThrottledStart trace_recording_session_throttled_start = 11;
        TraceRecordingSessionThrottledStop trace_recording_session_throttled_stop = 12;
    }
}

message TraceRecord {
    TraceRecordHeader header = 1;
    bytespayload = 2;
}
```

Annex H (informative): Examples of Protocol Buffer (GPB) encoded Streaming Trace administrative messages

The following examples illustrate the use of Protocol Buffer encoding for Streaming Trace administrative messages according to the definitions in clause 5.2.4.

The examples are in compact GPB format, using the schema defined in Annex G.

Example 1, Decoded Trace Session start message:

```
TraceRecord {
  header {
    time_stamp: 1584103023591,
    nf_instance_id: NETWORK_MANAGED_ELEMENT_ID,
    nf_type: RadioNode,
    trace_reference: 'H',
    trace_recording_session_reference: 'H',
    trace_rec_type_id: TRACE_SESSION_START,
    ran_ue_id: 'H',
  },
  payload: 'H'
},
CommonTracePayload
}
```

Example 2, Decoded Trace Session stop message:

```
TraceRecord {
  header {
    time_stamp: 158415623591,
    nf_instance_id: NETWORK_MANAGED_ELEMENT_ID,
    nf_type: RadioNode,
    trace_reference: 'H',
    trace_recording_session_reference: 'H',
    trace_rec_type_id: TRACE_SESSION_STOP,
    ran_ue_id: 'H',
  },
  payload: '0A 01 09 11'H
},
CommonTracePayload {
  trace_session_stop {
  }
}
}
```

Example 3, Decoded Trace Recording Session Dropped Events message:

```
TraceRecord {
  header {
    time_stamp: 1584103023591,
    nf_instance_id: NETWORK_MANAGED_ELEMENT_ID,
    nf_type: RadioNode,
    trace_reference: 'H',
    trace_recording_session_reference: 'H',
    trace_rec_type_id: TRACE_RECORDING_SESSION_DROPPED_EVENTS,
    ran_ue_id: 'H',
  },
  payload: '0A'H
},
CommonTracePayload {
  trace_recording_session_dropped_events {
number_of_dropped_events: 6
  }
}
}
```

Annex I (informative): Change history

Change history									
Date	TSG #	TSG Doc.	CR	Rev	Subject/Comment	Cat	Old	New	
Sep 2005	SA_29	SP-050623	0004	1	Clarify Trace Messages for FDD and TDD modes	B	6.2.0	7.0.0	
Dec 2005	SA_30	SP-050690	0007	--	Differentiate Trace Contents for FDD and TDD	B	7.0.0	7.1.0	
Dec 2005	SA_30	SP-050709	0008	--	Remove SFN-SFN observed time difference - Align with 25.331	A	7.0.0	7.1.0	
Dec 2005	SA_30	SP-050709	0009	--	Correction to name space URI	A	7.0.0	7.1.0	
Jun 2006	SA_32	SP-060258	0011	--	Correction for compilation errors of schema and addition of the missing link	A	7.1.0	7.2.0	
Sep 2006	SA_33	SP-060533	0013	--	Correct UTRA Carrier RSSI for trace contents- Align with RAN2's 25.331	A	7.2.0	7.3.0	
Sep 2006	SA_33	SP-060533	0015	--	Correct CFN-SFN observed time difference for trace IE - Align with RAN2's 25.331	A	7.2.0	7.3.0	
Sep 2006	SA_33	SP-060552	0016	--	Add Trace IEs to differentiate UARFCN for FDD and TDD - Align with RAN2's 25.331	C	7.2.0	7.3.0	
Sep 2006	SA_33	SP-060552	0018	--	Correction in XML schema and examples	F	7.2.0	7.3.0	
Dec 2006	SA_34	SP-060728	0019	--	Correct the errors in figure and examples	F	7.3.0	7.4.0	
Mar 2009	SA_43	SP-090207	0020	--	Constraint of the presence for the "ue" element	F	7.4.0	8.0.0	
Mar 2009	SA_43	SP-090207	0021	--	Adding PGW trace record content	B	7.4.0	8.0.0	
Mar 2009	SA_43	SP-090207	0022	--	Alignment with 32.421 and 32.422. Introduction medium and minimum trace dept IEs for the GTP and S1AP protocols in MME	B	7.4.0	8.0.0	
Mar 2009	SA_43	SP-090207	0023	--	Alignment with 32.421 and 32.422. Introduction of E-UTRAN	B	7.4.0	8.0.0	
Jun 2009	SA_44	SP-090289	0024	--	Alignment with 32.421 and 32.422 - Introduction medium and minimum trace depth IEs in MME.	F	8.0.0	8.1.0	
Jun 2009	SA_44	SP-090289	0025	--	Add missing SGW Trace Record content	F	8.0.0	8.1.0	
Jun 2009	SA_44	SP-090289	0026	--	Add missing PGW Trace Record content for Gx and S6b interfaces	F	8.0.0	8.1.0	
Jun 2009	SA_44	SP-090289	0027	--	Alignment with 32.421 and 32.422 - Introduction medium and minimum trace dept IEs for NAS in MME.	F	8.0.0	8.1.0	
Sep 2009	SA_45	SP-090534	0028	--	Correction in TS 32.423 Trace Depth requirements for MME, SGW and PGW	F	8.1.0	8.2.0	
Sep 2009	SA_45	SP-090534	0030	--	Unable to uniquely identify file name when one file per UE trace	F	8.1.0	8.2.0	
Sep 2009	SA_45	SP-090534	0031	--	Added a file format and example for sending the IMSI/IMEI (SV) information from the MME	F	8.1.0	8.2.0	
Sep 2009	SA-45	SP-090542	0029	--	Correction on XML file format for Trace failure notification	F	8.2.0	9.0.0	
Dec 2009	SA-46	SP-090719	0032	--	Clarify Trace Reference and Trace Recording Session Reference format	F	9.0.0	9.1.0	
Jan 2010	--	--	--	--	Removal of track changes	--	9.1.0	9.1.1	
Mar 2010	SA-47	SP-100034	0034	--	Align with 32.421 and 33.401	A	9.1.1	9.2.0	
Sep 2010	SA-49	SP-100487	0039	--	Correcting references	A	9.2.0	9.3.0	
Sep 2010	SA-49	SP-100489	0036	--	Add Diameter in HSS Trace Record Content	B	9.2.0	9.3.0	
Sep 2010	SA-49	SP-100488	0035	--	Correct call trace file format to allow multiple targets	F	9.3.0	10.0.0	
Dec 2010	SA-50	SP-100833	0040	1	Add trace Record Content in MME trace and SGSN trace - Align with 32.421 and 32.422	C	10.0.0	10.1.0	
Dec 2010	SA-50	SP-100858	0042	--	Correcting the Trace Reference definition - Align with RAN3 TS 36.423, 36.413	A	10.0.0	10.1.0	
Dec 2010	SA-50	SP-100833	0043	--	Adding the S6a trace interface for HSS	B	10.0.0	10.1.0	
Dec 2010	SA-50	SP-100833	0044	--	Correcting the Identification of IMS Subscriber Tracing - Align with 32.421	F	10.0.0	10.1.0	
Dec 2010	SA-50	SP-100831	0047	--	Add missing interfaces S3, S4 and S6d trace record contents of SGSN - Align with 32.422	A	10.0.0	10.1.0	
Mar 2011	SA-51	SP-110095	0049	-	Addition of trace Record Content of EIR Trace	B	10.1.0	10.2.0	
May 2011	SA-52	SP-110292	0050	1	Applying trace data file to MDT data format	B	10.2.0	10.3.0	
Dec 2011	SA-54	SP-110715	0054	--	Correcting the description of meas vendorSpecific attribute in the XML trace file	F	10.3.0	10.4.0	
Dec 2011	SA-54	SP-110716	0047		Clarification of eNB ID in E-UTRAN Trace Record	B	10.4.0	11.0.0	
Dec 2011	SA-54	SP-110716	0053	--	Rel11 CR to 32423 Update the trace record content for Uu and X2 interfaces	C	10.4.0	11.0.0	
March 2012	SA55	SP-120053	0058	1	Correct IMSI retrieval file to include MDT anonymization info	A	11.0.0	11.1.0	
March 2012	SA-55	SP-120044	0061	1	Modify E-UTRAN Trace Record Content	A	11.0.0	11.1.0	
Sep-2012	SA-57	SP-120627	0064	1	Reference list correction to align with the corrected TS 29.212 title	F	11.1.0	11.2.0	
Dic-2012	SA-58	SP-120783	0065	1	Correction of inconsistent specification of data type for Trace Recording Session Reference Length (TRSR)	F	11.2.0	11.3.0	
		SP-120796	0066	1	Specifying trace record content for immediate MDT measurements	B			
		SP-120796	0067	-	Add RCEF in Uu interface trace	C			
		SP-120795	0068	1	Correction on the scope and reference related to MDT	F			
Mar-2013	SA-59	SP-130057	0069	-	RCEF reporting in UMTS	F	11.3.0	11.4.0	
June-2013	SA-60	SP-130265	0072	1	Correct trace file name format	A	11.4.0	11.5.0	
		SP-130304	0073	2	Correct the XML shcema for MDT data	F			
Sep-2013	SA-61	SP-130432	0075	2	Correction on some inconsistent definitions for trace data file parameters	A	11.5.0	11.6.0	
Mar-2014	SA-63	SP-140029	0079	1	Corrections of Trace Session identifier	A	11.6.0	11.7.0	
Jun-2014	SA-64	SP-140344	0083	-	Corrections on the trace record content for immediate MDT measurements	F	11.7.0	11.8.0	
						F	11.7.0	11.8.0	
Sep-2014	SA-65	SP-140560	0092	1	Correct the File naming convention	B	11.8.0	12.0.0	

Dec-2014	SA-66	SP-140798	0093	-	Remove characters in the Trace file name	F		
		SP-140800	0094	1	Introduction of network sharing.	B	12.0.0	12.1.0
Jan 2016					Update to Rel-13 (MCC)		12.1.0	13.0.0

Change history							
Date	Meeting	TDoc	CR	Rev	Cat	Subject/Comment	New version
2017-03	SA#75					Promotion to Release 14 without technical change	14.0.0
2018-06	SA#80	SP-180434	0095	-	B	Add support for 5G Trace	15.0.0
2019-06	SA#84	SP-190385	0097	1	F	Update Trace Record Content to reflect the NR NRM in 28.541 for NSA support	15.1.0
2020-03	SA#87E	SP-200165	0099	1	F	Add missing MDT trace record for LTE measurements	15.2.0
2020-03	SA#87E	SP-200173	0100	1	B	Add MDT trace record for NR measurements	16.0.0
2020-03	SA#87E	SP-200175	0101	1	B	Add streaming format for Trace Record Reporting	16.0.0
2020-07	SA#88E	SP-200488	0112	-	A	clean up of the editor notes	16.1.0
2020-07	SA#88E	SP-200485	0113	1	F	Adding SINR measurement in M1 for Immediate MDT	16.1.0
2020-07	SA#88E	SP-200483	0115	1	F	Correction of the Trace streaming format definitions	16.1.0
2020-09	SA#89e	SP-200723	0116	-	F	Add support for new administration messages when streaming trace data	16.2.0
2020-12	SA#90e	SP-201074	0117	-	F	Correct streaming trace record concept figure	16.3.0
2020-12	SA#90e	SP-201063	0118	-	F	Fix inconsistencies in NR positioning method	16.3.0
2020-12	SA#90e	SP-201052	0119		C	Add GPB trace record for file based support	17.0.0
2021-03	SA#91e	SP-210167	0121	1	C	Add new parameters for trace record header	17.1.0
2021-03	SA#91e	SP-210168	0122	1	A	Correct trace record information for immediate MDT measurement in NR	17.1.0
2021-04	SA#91e					Editorial in clause 5.2.4.7	17.1.1
2021-06	SA#92e	SP-210403	0123	-	C	Add abnormal case for trace recording session stop in GPB trace record format	17.2.0
2021-06	SA#92e	SP-210403	0124	1	B	Add MDT polluted measurement indication for trace record in NR	17.2.0
2021-12	SA#94e	SP-211483	0125	1	B	Add MDT polluted measurement indication for trace record in NR	17.3.0
2021-12	SA#94e	SP-211483	0126		B	Add new administrative messages in GPB trace record format	17.3.0
2021-12	SA#94e	SP-211458	0128	1	A	Introduce missing IEs for HSS and UDM Trace Record	17.3.0
2022-06	SA#96	SP-220516	0130	1	A	Adding missing interface related to SMF for trace record content	17.4.0

History

Document history		
V17.3.0	May 2022	Publication
V17.4.0	July 2022	Publication