

# ETSI TS 132 536 V14.1.0 (2017-07)



**Digital cellular telecommunications system (Phase 2+) (GSM);  
Universal Mobile Telecommunications System (UMTS);  
LTE;  
Telecommunication management;  
Software management Integration Reference Point (IRP);  
Solution Set (SS) definitions  
(3GPP TS 32.536 version 14.1.0 Release 14)**



---

Reference

RTS/TSGS-0532536ve10

---

Keywords

GSM,LTE,UMTS

**ETSI**

650 Route des Lucioles  
F-06921 Sophia Antipolis Cedex - FRANCE

Tel.: +33 4 92 94 42 00 Fax: +33 4 93 65 47 16

Siret N° 348 623 562 00017 - NAF 742 C  
Association à but non lucratif enregistrée à la  
Sous-Préfecture de Grasse (06) N° 7803/88

---

**Important notice**

The present document can be downloaded from:

<http://www.etsi.org/standards-search>

The present document may be made available in electronic versions and/or in print. The content of any electronic and/or print versions of the present document shall not be modified without the prior written authorization of ETSI. In case of any existing or perceived difference in contents between such versions and/or in print, the only prevailing document is the print of the Portable Document Format (PDF) version kept on a specific network drive within ETSI Secretariat.

Users of the present document should be aware that the document may be subject to revision or change of status.

Information on the current status of this and other ETSI documents is available at

<https://portal.etsi.org/TB/ETSIDeliverableStatus.aspx>

If you find errors in the present document, please send your comment to one of the following services:

<https://portal.etsi.org/People/CommiteeSupportStaff.aspx>

---

**Copyright Notification**

No part may be reproduced or utilized in any form or by any means, electronic or mechanical, including photocopying and microfilm except as authorized by written permission of ETSI.

The content of the PDF version shall not be modified without the written authorization of ETSI.

The copyright and the foregoing restriction extend to reproduction in all media.

© ETSI 2017.  
All rights reserved.

DECT™, PLUGTESTS™, UMTS™ and the ETSI logo are trademarks of ETSI registered for the benefit of its Members.  
3GPP™ and LTE™ are trademarks of ETSI registered for the benefit of its Members and  
of the 3GPP Organizational Partners.

oneM2M logo is protected for the benefit of its Members.

GSM® and the GSM logo are trademarks registered and owned by the GSM Association.

---

## Intellectual Property Rights

IPRs essential or potentially essential to the present document may have been declared to ETSI. The information pertaining to these essential IPRs, if any, is publicly available for **ETSI members and non-members**, and can be found in ETSI SR 000 314: *"Intellectual Property Rights (IPRs); Essential, or potentially Essential, IPRs notified to ETSI in respect of ETSI standards"*, which is available from the ETSI Secretariat. Latest updates are available on the ETSI Web server (<https://ipr.etsi.org>).

Pursuant to the ETSI IPR Policy, no investigation, including IPR searches, has been carried out by ETSI. No guarantee can be given as to the existence of other IPRs not referenced in ETSI SR 000 314 (or the updates on the ETSI Web server) which are, or may be, or may become, essential to the present document.

---

## Foreword

This Technical Specification (TS) has been produced by ETSI 3rd Generation Partnership Project (3GPP).

The present document may refer to technical specifications or reports using their 3GPP identities, UMTS identities or GSM identities. These should be interpreted as being references to the corresponding ETSI deliverables.

The cross reference between GSM, UMTS, 3GPP and ETSI identities can be found under <http://webapp.etsi.org/key/queryform.asp>.

---

## Modal verbs terminology

In the present document "**shall**", "**shall not**", "**should**", "**should not**", "**may**", "**need not**", "**will**", "**will not**", "**can**" and "**cannot**" are to be interpreted as described in clause 3.2 of the [ETSI Drafting Rules](#) (Verbal forms for the expression of provisions).

"**must**" and "**must not**" are **NOT** allowed in ETSI deliverables except when used in direct citation.

# Contents

Intellectual Property Rights .....	2
Foreword.....	2
Modal verbs terminology.....	2
Foreword.....	5
Introduction .....	5
1 Scope .....	6
2 References .....	6
3 Definitions and abbreviations.....	7
3.1 Definitions .....	7
3.2 Abbreviations .....	7
4 Solution Set definitions .....	7
<b>Annex A (normative): CORBA Solution Set .....</b>	<b>8</b>
A.1 Architectural Features .....	8
A.1.1 Syntax for Distinguished Names and Versions .....	8
A.2 Mapping .....	8
A.2.1 Operation and Notification mapping .....	8
A.2.2 Operation parameter mapping .....	9
A.2.3 Notification parameter mapping.....	12
A.3 Solution Set definitions .....	14
A.3.1 IDL definition structure .....	14
A.3.2 IDL specification “SwMIRPConstDefs.idl” .....	15
A.3.3 IDL specification “SwMIRPSystem.idl” .....	21
A.3.4 IDL specification “SwMIRPNotifications.idl” .....	25
<b>Annex B (normative): XML definitions .....</b>	<b>31</b>
B.1 Architectural features .....	31
B.1.1 Syntax for Distinguished Names .....	31
B.2 Mapping .....	31
B.3 Solution Set definitions .....	31
B.3.1 XML definition structure.....	31
B.3.2 Graphical Representation .....	32
B.3.3 XML Schema “swManagementIRPNotif.xsd” .....	37
B.3.4 XML Schema “swManagementIRPIOCs.xsd” .....	41
<b>Annex C (normative): SOAP Solution Set .....</b>	<b>44</b>
C.1 Architectural Features .....	44
C.1.1 Syntax for Distinguished Names and versions .....	44
C.1.2 General .....	44
C.2 Mapping .....	44
C.2.1 Operation and Notification mapping .....	44
C.2.2 Operation parameter mapping .....	45
C.2.2.1 Operation listSwMCapabilities .....	45
C.2.2.1.1 Input parameters.....	45
C.2.2.1.2 Output parameters .....	46
C.2.2.1.3 Fault definition .....	46
C.2.2.2 Operation listSwMProfiles.....	46
C.2.2.2.1 Input parameters.....	46

C.2.2.2.2	Output parameters .....	46
C.2.2.3	Operation createSwMProfile .....	47
C.2.2.3.1	Input parameters.....	47
C.2.2.3.2	Output parameters .....	47
C.2.2.4	Operation deleteSwMProfile .....	47
C.2.2.4.1	Input parameters.....	47
C.2.2.4.2	Output parameters .....	47
C.2.2.5	Operation listSwMProcesses .....	48
C.2.2.5.1	Input parameters.....	48
C.2.2.5.2	Output parameters .....	48
C.2.2.6	Operation resumeSwMProcess .....	48
C.2.2.6.1	Input parameters.....	48
C.2.2.6.2	Output parameters .....	48
C.2.2.7	Operation swFallback .....	49
C.2.2.7.1	Input parameters.....	49
C.2.2.7.2	Output parameters.....	49
C.2.2.8	Operation terminateSwMProcess .....	49
C.2.2.8.1	Input parameters.....	49
C.2.2.8.2	Output parameters .....	49
C.2.2.9	Operation changeSwMProfile .....	50
C.2.2.9.1	Input parameters.....	50
C.2.2.9.2	Output parameters .....	50
C.2.2.10	Operation downloadNESw.....	50
C.2.2.10.1	Input parameters.....	50
C.2.2.10.2	Output parameters .....	50
C.2.2.10.3	Fault definition.....	51
C.2.2.11	Operation activateNESw.....	51
C.2.2.11.1	Input parameters.....	51
C.2.2.11.2	Output parameters .....	51
C.2.2.11.3	Fault definition.....	51
C.2.2.12	Operation installNESw.....	52
C.2.2.12.1	Input parameters.....	52
C.2.2.12.2	Output parameters .....	52
C.2.2.12.3	Fault definition.....	52
C.2.2.13	Operation listNaswmProcesses .....	52
C.2.2.13.1	Input parameters.....	52
C.2.2.13.2	Output parameters.....	53
C.2.2.13.3	Fault definition.....	53
C.2.2.14	Operation cancelNaswmProcesses.....	53
C.2.2.14.1	Input parameters.....	53
C.2.2.14.2	Output parameters .....	53
C.2.2.14.3	Fault definition.....	54
C.3	Solution Set definitions .....	54
C.3.1	WSDL definition structure .....	54
C.3.2	Graphical Representation .....	54
C.3.3	WSDL specification “SWMIRPSystem.wsdl” .....	55
<b>Annex D (informative):</b>	<b>Change history .....</b>	<b>68</b>
History .....		69

---

# Foreword

This Technical Specification has been produced by the 3<sup>rd</sup> Generation Partnership Project (3GPP).

The contents of the present document are subject to continuing work within the TSG and may change following formal TSG approval. Should the TSG modify the contents of the present document, it will be re-released by the TSG with an identifying change of release date and an increase in version number as follows:

Version x.y.z

where:

- x the first digit:
  - 1 presented to TSG for information;
  - 2 presented to TSG for approval;
  - 3 or greater indicates TSG approved document under change control.
- y the second digit is incremented for all changes of substance, i.e. technical enhancements, corrections, updates, etc.
- z the third digit is incremented when editorial only changes have been incorporated in the document.

---

# Introduction

The present document is part of a TS-family covering the 3<sup>rd</sup> Generation Partnership Project: Technical Specification Group Services and System Aspects; Telecommunication management; as identified below:

32.531: Telecommunication management; Software management; Concepts and Integration Reference Point (IRP) Requirements

32.532: Telecommunication management; Software management Integration Reference Point (IRP); Information Service (IS)

**32.536: Telecommunication management; Software management Integration Reference Point (IRP); Solution Set (SS) definitions**

Software Management, in general, provides the operator with the ability to manage effectively the software entities residing in the 3G network. Software Management function is useful especially when there is a need to manage a large number of software residing in the managed elements widely distributed geographically. The main focus is the management of new software releases and correction patches [2].

The software management operations are initiated by the operator or by functions in the Operations Systems (OSs) either on single NE or across several NEs of the 3G network.

---

# 1 Scope

The present document specifies the Solution Set definitions for the IRP whose semantics are specified in Software Management IRP Information Service (3GPP TS 32.532 [5]).

This Solution Set definitions specification is related to 3GPP TS 32.532 V14.0.X [5].

---

# 2 References

- The following documents contain provisions which, through reference in this text, constitute provisions of the present document.

- References are either specific (identified by date of publication, edition number, version number, etc.) or non-specific.
- For a specific reference, subsequent revisions do not apply.
- For a non-specific reference, the latest version applies. In the case of a reference to a 3GPP document (including a GSM document), a non-specific reference implicitly refers to the latest version of that document *in the same Release as the present document*.

- [1] 3GPP TR 21.905: "Vocabulary for 3GPP Specifications".
- [2] 3GPP TS 32.101: "Telecommunication management; Principles and high level requirements".
- [3] 3GPP TS 32.102: "Telecommunication management; Architecture".
- [4] 3GPP TS 32.531: "Telecommunication management; Software management; Concepts and Integration Reference Point (IRP) Requirements".
- [5] 3GPP TS 32.532: "Telecommunication management; Software management Integration Reference Point (IRP); Information Service (IS)".
- [6] OMG TC Document telecom/98-11-01: "OMG Notification Service".  
<http://www.omg.org/technology/documents/>
- [7] 3GPP TS 32.336: "Telecommunication management; Notification Log (NL) Integration Reference Point (IRP): Solution Set (SS) definitions".
- [8] 3GPP TS 32.331: "Telecommunication management; Notification Log (NL) Integration Reference Point (IRP): Requirements".
- [9] 3GPP TS 32.150: "Telecommunication management; Integration Reference Point (IRP) Concept and definitions".
- [10] 3GPP TS 32.306: "Telecommunication management; Configuration Management (CM); Notification Integration Reference Point (IRP): Solution Set (SS) definitions".
- [11] W3C SOAP 1.1 specification (<http://www.w3.org/TR/2000/NOTE-SOAP-20000508/>).
- [12] W3C XPath 1.0 specification (<http://www.w3.org/TR/1999/REC-xpath-19991116>)
- [13] W3C WSDL 1.1 specification (<http://www.w3.org/TR/2001/NOTE-wsdl-20010315>)
- [14] W3C SOAP 1.2 specification (<http://www.w3.org/TR/soap12-part1/>)
- [15] 3GPP TS 32.300: "Telecommunication management; Configuration Management (CM); Name convention for Managed Objects".

---

## 3 Definitions and abbreviations

### 3.1 Definitions

For the purposes of the present document, the terms and definitions given in TS 32.101 [2], TS 32.102 [3], 3GPP TS 32.331 [8], 3GPP TS 32.150 [9] and TR 21.905 [1] and the following apply. A term defined in the present document takes precedence over the definition of the same term, if any, in TS 32.532 [5], TS 32.531 [4], 3GPP TS 32.331 [8], 3GPP TS 32.150 [9], TS 32.101 [2], TS 32.102 [3] and TS 21.905 [1], in that order.

### 3.2 Abbreviations

For the purposes of the present document, the abbreviations given in TR 21.905 [1], TS 32.531 [4], 3GPP TS 32.331 [8], 3GPP TS 32.150 [9] and the following apply. An abbreviation defined in the present document takes precedence over the definition of the same abbreviation, if any, in TS 32.532 [5], TS 32.531 [4], 3GPP TS 32.331 [8], 3GPP TS 32.150 [9], TS 32.101 [2], TS 32.102 [3] and TS 21.905 [1], in that order.

IRP	Integration Reference Point
IS	Information Service
NL	Notification Log
NRM	Network Resource Model
SwM	Software Management
UML	Unified Modelling Language
WSDL	Web Service Description Language
XML	eXtensible Markup Language

---

## 4 Solution Set definitions

This specification defines the following 3GPP Software management IRP Solution Set definitions:

- 3GPP Software management IRP CORBA SS (Annex A)
- 3GPP Software management IRP XML definitions (Annex B)
- 3GPP Software management IRP SOAP Solution Set (Annex C)



## Annex A (normative): CORBA Solution Set

This annex contains the CORBA Solution Set for the IRP whose semantics is specified in Software management IRP: Information Service (TS 32.532 [5]).

### A.1 Architectural Features

The overall architectural feature of Software management IRP is specified in 3GPP TS 32.532 [5].

This clause specifies features that are specific to the CORBA SS.

#### A.1.1 Syntax for Distinguished Names and Versions

The syntax of a Distinguished Name is defined in 3GPP TS 32.300 [15].

### A.2 Mapping

#### A.2.1 Operation and Notification mapping

Software Management IRP: IS 3GPP TS (see 3GPP TS 32.532 [5]) defines semantics of operations and notifications visible across the Itf-N. Table A.2.1 indicates mapping of these operations and notifications to their equivalents defined in this SS.

**Table A.2.1: Mapping from IS Notification/Operation to SS equivalents**

IS Operation/ notification Software Management IRP: IS 3GPP TS 32.532[5]	SS Method	Qualifier
listSwMCapabilities	listSwMCapabilities	M
listSwMProfiles	listSwMProfiles	M
createSwMProfile	createSwMProfile	M
deleteSwMProfile	deleteSwMProfile	M
listSwMProcesses	listSwMProcesses	M
resumeSwMProcess	resumeSwMProcess	M
swFallback	swFallback	M
terminateSwMProcess	terminateSwMProcess	M
changeSwMProfile	changeSwMProfile	O
downloadNESw	downloadNESw	M
installNESw	installNESw	O
activateNESw	activateNESw	M
listNaswmProcesses	listNaswmProcesses	CM
cancelNaswmProcesses	cancelNaswmProcesses	CM
notifySwMProfileCreation	notifySwMProfileCreation	M
notifySwMProfileDeletion	notifySwMProfileDeletion	M
notifySwMProcessCreation	notifySwMProcessCreation	M
notifySwMProcessStage	notifySwMProcessStage	M
notifySwMProcessDeletion	notifySwMProcessDeletion	M
notifyNewSwAvailability	notifyNewSwAvailability	M
notifySwMProfileChange	notifySwMProfileChange	O
notifyDownloadNESwStatusChanged	notifyDownloadNESwStatusChanged	M
notifyInstallNESwStatusChanged	notifyInstallNESwStatusChanged	O
notifyActivateNESwStatusChanged	notifyActivateNESwStatusChanged	M

## A.2.2 Operation parameter mapping

Reference 3GPP TS 32.532 [5] defines semantics of parameters carried in operations across the Itf-N. The following set of tables indicate the mapping of these parameters, as per operation, to their equivalents defined in this SS.

**Table A.2.2.1: Mapping from IS listSwMCapabilities parameters to SS equivalents**

IS Operation parameter	SS Method parameter	Qualifier
nEInformation	SwMIRPConstDefs::NEInformation	M
capabilitiesList	SwMIRPConstDefs::SwMCapabilitiesList	M
Result	Exceptions: SwMIRPConstDefs::ListSwMCapabilities, GenericIRPManagementSystem::ParameterNotSupported, GenericIRPManagementSystem::InvalidParameter, GenericIRPManagementSystem::ValueNotSupported, GenericIRPManagementSystem::OperationNotSupported	M

**Table A.2.2.2: Mapping from IS listSwMProfiles parameters to SS equivalents**

IS Operation parameter	SS Method parameter	Qualifier
nEInformation	SwMIRPConstDefs::NEInformation	M
profileList	SwMIRPConstDefs::SwMProfileList	M
result	Exceptions: SwMIRPConstDefs::ListSwMProfile, GenericIRPManagementSystem::ParameterNotSupported, GenericIRPManagementSystem::InvalidParameter, GenericIRPManagementSystem::ValueNotSupported, GenericIRPManagementSystem::OperationNotSupported	M

**Table A.2.2.3: Mapping from IS createSwMProfile parameters to SS equivalents**

IS Operation parameter	SS Method parameter	Qualifier
id	SwMIRPConstDefs::IdOpt	O
nEInformation	SwMIRPConstDefs::NEInformation	M
swVersionToBeInstalled	SwMIRPConstDefs::SwVersionToBeInstalledConditional	CM
stepsAndSelectedStopPointList	SwMIRPConstDefs::StepsAndSelectedStopPointList	M
selectedFinalAdministrativeState	SwMIRPConstDefs::SelectedFinalAdministrativeState	M
result	Exceptions: SwMIRPConstDefs::CreateSwMProfile, GenericIRPManagementSystem::ParameterNotSupported, GenericIRPManagementSystem::InvalidParameter, GenericIRPManagementSystem::ValueNotSupported, GenericIRPManagementSystem::OperationNotSupported	M

**Table A.2.2.4: Mapping from IS deleteSwMProfile parameters to SS equivalents**

IS Operation parameter	SS Method parameter	Qualifier
id	SwMIRPConstDefs::Id	M
result	Exceptions: SwMIRPConstDefs::DeleteSwMProfile, GenericIRPManagementSystem::ParameterNotSupported, GenericIRPManagementSystem::InvalidParameter, GenericIRPManagementSystem::ValueNotSupported, GenericIRPManagementSystem::OperationNotSupported	M

**Table A.2.2.5: Mapping from IS listSwMProcesses parameters to SS equivalents**

IS Operation parameter	SS Method parameter	Qualifier
nEIdentification	SwMIRPConstDefs::NEIdentificationOpt	O
processList	SwMIRPConstDefs::ProcessList	M
result	Exceptions: SwMIRPConstDefs::ListSwMProcesses, GenericIRPManagementSystem::ParameterNotSupported, GenericIRPManagementSystem::InvalidParameter, GenericIRPManagementSystem::ValueNotSupported, GenericIRPManagementSystem::OperationNotSupported	M

**Table A.2.2.6: Mapping from IS resumeSwMProcess parameters to SS equivalents**

IS Operation parameter	SS Method parameter	Qualifier
id	SwMIRPConstDefs::Id	M
startStepName	SwMIRPConstDefs::NameOfStep	M
result	Exceptions: SwMIRPConstDefs::ResumeSwMProcess, GenericIRPManagementSystem::ParameterNotSupported, GenericIRPManagementSystem::InvalidParameter, GenericIRPManagementSystem::ValueNotSupported, GenericIRPManagementSystem::OperationNotSupported	M

**Table A.2.2.7: Mapping from IS swFallback parameters to SS equivalents**

IS Operation parameter	SS Method parameter	Qualifier
filter	SwMIRPConstDefs::Filter	M
nEList	SwMIRPConstDefs::NEList	M
result	Exceptions: SwMIRPConstDefs::SwFallback, GenericIRPManagementSystem::ParameterNotSupported, GenericIRPManagementSystem::InvalidParameter, GenericIRPManagementSystem::ValueNotSupported, GenericIRPManagementSystem::OperationNotSupported	M

**Table A.2.2.8: Mapping from IS terminateSwMProcess parameters to SS equivalents**

IS Operation parameter	SS Method parameter	Qualifier
id	SwMIRPConstDefs::Id	M
result	Exceptions: SwMIRPConstDefs::TerminateSwMProcess, GenericIRPManagementSystem::ParameterNotSupported, GenericIRPManagementSystem::InvalidParameter, GenericIRPManagementSystem::ValueNotSupported, GenericIRPManagementSystem::OperationNotSupported	M

**Table A.2.2.9: Mapping from IS changeSwMProfile parameters to SS equivalents**

IS Operation parameter	SS Method parameter	Qualifier
id	SwMIRPConstDefs::Id	M
neInformation	SwMIRPConstDefs::NEInformation	M
swVersionToBeInstalled	SwMIRPConstDefs::SwVersionToBeInstalledConditional	CM
stepsAndSelectedStopPointList	SwMIRPConstDefs::StepsAndSelectedStopPointList	M
selectedFinalAdministrativeState	SwMIRPConstDefs::SelectedFinalAdministrativeState	M
versionNumber	SwMIRPConstDefs::VersionNumber	M
conflictingProfileId	SwMIRPConstDefs::ConflictingProfileIdConditional	C
result	Exceptions: SwMIRPConstDefs::CreateSwMProfile, GenericIRPManagementSystem::ParameterNotSupported, GenericIRPManagementSystem::InvalidParameter, GenericIRPManagementSystem::ValueNotSupported, GenericIRPManagementSystem::OperationNotSupported	M

**Table A.2.2.10: Mapping from IS downloadNESw parameters to SS equivalents**

IS Operation parameter	SS Method parameter	Qualifier
swToBeDownloaded	SwMIRPConstDefs::SWToBeDownloaded	M
neIdentifier	SwMIRPConstDefs::NEIdentifier	M
downloadProcessId	SwMIRPConstDefs::RequestID	M
reason	SwMIRPConstDefs::Reason	O
listOfStepNumbersAndDurations	SwMIRPConstDefs::ListOfStepNumbersAndDurations	CM *)
result	Exceptions: SwMIRPConstDefs::OperationFailed, SwMIRPConstDefs::ResourceLimitation	M

\*) Note: For the condition see TS 32.532 [5].

**Table A.2.2.11: Mapping from IS installNESw parameters to SS equivalents**

IS Operation parameter	SS Method parameter	Qualifier
swToBeInstalled	SwMIRPConstDefs::SWToBeInstalled	M
neIdentifier	SwMIRPConstDefs::NEIdentifier	M
installProcessId	SwMIRPConstDefs::RequestID	M
reason	SwMIRPConstDefs::Reason	O
listOfStepNumbersAndDurations	SwMIRPConstDefs::ListOfStepNumbersAndDurations	CM *)
result	Exceptions: SwMIRPConstDefs::OperationFailed, SwMIRPConstDefs::ResourceLimitation SwMIRPConstDefs::SWNotAvailable	M

\*) Note: For the condition see TS 32.532 [5].

**Table A.2.2.12: Mapping from IS activateNESw parameters to SS equivalents**

IS Operation parameter	SS Method parameter	Qualifier
swVersionToBeActivated	SwMIRPConstDefs::SWVersion	M
neIdentifier	SwMIRPConstDefs::NEIdentifier	M
activateProcessId	SwMIRPConstDefs::RequestID	M
reason	SwMIRPConstDefs::Reason	O
listOfStepNumbersAndDurations	SwMIRPConstDefs::ListOfStepNumbersAndDurations	CM *)
result	Exceptions: SwMIRPConstDefs::OperationFailed, SwMIRPConstDefs::ResourceLimitation	M

\*) Note: For the condition see TS 32.532 [5].

**Table A.2.2. 13: Mapping from IS listNaswmProcesses parameters to SS equivalents**

IS Operation parameter	SS Method parameter	Qualifier
naswmId	SwMIRPConstDefs::Id	O
naswmOperationType	SwMIRPConstDefs::NaswmOperationType	M
naswmProcessList	SwMIRPConstDefs::NaswmProcessList	M
result	Exceptions: SwMIRPConstDefs::OperationFailed, SwMIRPConstDefs::ResourceLimitation	M
reason	SwMIRPConstDefs::Reason	O

\*) Note: For the condition see TS 32.532 [5].

**Table A.2.2.14: Mapping from IS cancelNaswmProcesses parameters to SS equivalents**

IS Operation parameter	SS Method parameter	Qualifier
processId	SwMIRPConstDefs::Id	M
naswmOperationType	SwMIRPConstDefs::NaswmOperationType	M
result	Exceptions: SwMIRPConstDefs::OperationFailed, SwMIRPConstDefs::ResourceLimitation	M
reason	SwMIRPConstDefs::Reason	O

### A.2.3 Notification parameter mapping

Reference 3GPP TS 32.532 [5] defines semantics of parameters carried in notifications. The following tables indicate the mapping of these parameters to their SS equivalents."

The following tables indicate the mapping of these parameters to their OMG CORBA Structured Event (defined in OMG Notification Service [6]) equivalents. The composition of OMG Structured Event, as defined in the OMG Notification Service [6], is:

```

Header
  Fixed Header
    domain_name
    type_name
    event_name
  Variable Header
Body
  filterable_body_fields
  remaining_body
    
```

The following tables list all OMG Structured Event attributes in the second column. The first column identifies the Software Management IRP: IS [5] defined notification parameters.

**Table A.2.3.1: Mapping for notifySwMProfileCreation**

IS Parameters	<SS> Parameters	Qualifier	Comment
id	SwMIRPConstDefs::Id	M	
versionNumber	SwMIRPConstDefs::VersionNumber	M	
nEInformation	SwMIRPConstDefs::NEInformation	M	
swVersionToBeInstalled	SwMIRPConstDefs::SwVersionToBeInstalledConditional	CM	
stepsAndSelectedStopPointList	SwMIRPConstDefs::StepsAndSelectedStopPointList	M	
selectedFinalAdministrativeState	SwMIRPConstDefs::SelectedFinalAdministrativeState	M	

**Table A.2.3.2: Mapping for notifySwMProfileDeletion**

IS Parameters	<SS> Parameters	Qualifier	Comment
id	SwMIRPConstDefs::Id	M	

**Table A.2.3.3: Mapping for notifySwMProcessCreation**

IS Parameters	<SS> Parameters	Qualifier	Comment
id	SwMIRPConstDefs::Id	M	
nEIdentification	SwMIRPConstDefs::NEIdentification	M	
profileId	SwMIRPConstDefs::ProfileId	M	
matchingNEInformation	SwMIRPConstDefs::MatchingNEInformation	M	
stepInfoList	SwMIRPConstDefs::StepInfoList	M	

**Table A.2.3.4: Mapping for notifySwMProcessStage**

IS Parameters	<SS> Parameters	Qualifier	Comment
id	SwMIRPConstDefs::Id	M	
stepInfoList	SwMIRPConstDefs::StepInfoList	M	

**Table A.2.3.5: Mapping for notifySwMProcessDeletion**

IS Parameters	<SS> Parameters	Qualifier	Comment
id	SwMIRPConstDefs::Id	M	
triggerForDeletion	SwMIRPConstDefs::TriggerForDeletion	M	
additionalInformation	SwMIRPConstDefs::AdditionalInformationOptional	O	

**Table A.2.3.6: Mapping for notifyNewSwAvailability**

IS Parameters	<SS> Parameters	Qualifier	Comment
nEandSWversion	SwMIRPConstDefs::NEandSWversion	M	

**Table A.2.3.7: Mapping for notifySwMProfileChange**

IS Parameters	<SS> Parameters	Qualifier	Comment
id	SwMIRPConstDefs::Id	M	
versionNumber	SwMIRPConstDefs::VersionNumber	M	
nEInformation	SwMIRPConstDefs::NEInformation	M	
swVersionToBeInstalled	SwMIRPConstDefs::SwVersionToBeInstalledConditional	CM	
stepsAndSelectedStopPointList	SwMIRPConstDefs::StepsAndSelectedStopPointList	M	
selectedFinalAdministrativeState	SwMIRPConstDefs::SelectedFinalAdministrativeState	M	

**Table A.2.3.8: Mapping for notifyDownloadNESwStatusChanged**

IS Parameters	<SS> Parameters	Qualifier	Comment
downloadProcessId	SwMIRPConstDefs::DownloadProcessId;	M	
downloadOperationStatus	SwMIRPConstDefs::DownloadNESwOperationStatus	M	
downloadedNESwInfo	SwMIRPConstDefs::DownloadedNESwInfo	O	
failedSwInfo	SwMIRPConstDefs::FailedSwInfo	O	

**Table A.2.3.9: Mapping for notifyInstallNESwStatusChanged**

IS Parameters	<SS> Parameters	Qualifier	Comment
installProcessId	SwMIRPConstDefs::RequestID	M	
installOperationStatus	SwMIRPConstDefs::InstallOperationStatus	M	
installNESwInfo	SwMIRPConstDefs::InstalledNESwInfo	O	
failedSwInfo	SwMIRPConstDefs::FailedSwInfo	O	

**Table A.2.3.10: Mapping for notifyActivateNESwStatusChanged**

IS Parameters	<SS> Parameters	Qualifier	Comment
activateProcessId	SwMIRPConstDefs::RequestID	M	
activateOperationStatus	SwMIRPConstDefs::ActivateOperationStatus	M	
swVersion	SwMIRPConstDefs::SWVersion	M	
failureReason	SwMIRPConstDefs::FailureReason	CM	

---

## A.3 Solution Set definitions

### A.3.1 IDL definition structure

Clause A.3.2 defines the constants and types used by the Software management IRP.

Clause A.3.3 defines the operations which are performed by the Software management IRP agent.

Clause A.3.4 defines the notifications which are performed by the Software management IRP agent.

## A.3.2 IDL specification “SwMIRPConstDefs.idl”

```
// File: SwMIRPConstDefs.idl
#ifndef _SWM_IRP_CONST_DEFS_IDL_
#define _SWM_IRP_CONST_DEFS_IDL_

#include <NotificationIRPConstDefs.idl>
#include <GenericIRPManagementConstDefs.idl>

// This statement must appear after all include statements
#pragma prefix "3gppsa5.org"

/* ## Module: SwMIRPConstDefs */

module SwMIRPConstDefs
{

/*****
/* definition of types used in operations for Software Management : */
*****/

/* types used in several operations: */

    enum Result { SUCCESS, PARTLY_SUCCESSFUL, FAILURE, NE_INFORMATION_INTERSECTION,
STEPNAME_DOES_NOT_MATCH };

    enum ResultChangeOrCreateProfileOperation { SUCCESS, FAILURE, NE_INFORMATION_INTERSECTION,
NOT_ALLOWED_BECAUSE_OF_ONGOING_ACTIVITY };

    enum ResultNaSwmNotification { REQUEST_ACCEPTED, REQUEST_FAILED,
NOT_ALLOWED_BECAUSE_OF_ONGOING_SWM_ACTIVITY };

    enum ResultListNaswmProcesses { SUCCESS, FAILURE};

    enum ResultCancelNaswmProcesses { SUCCESS, OPERATION_IS_ALREADY_COMPLETED, NO_SUCH_PROCESS,
FAILURE };

    typedef GenericIRPManagementConstDefs::DN Id;

    /*
    IdOpt is a type carrying an optional parameter.
    If the boolean is TRUE, then the value is present.
    Otherwise the value is absent.
    */
    union IdOpt switch (boolean)
    {
        case TRUE: GenericIRPManagementConstDefs::DN value;
    };

    /*
    ConflictingProfileIdConditional is a type carrying a conditional parameter.
    The boolean shall be TRUE, if the condition described in TS 32.532 or 32.502 is fulfilled.
    In this case the value is present. Otherwise the value is absent.
    */
    union ConflictingProfileIdConditional switch (boolean)
    {
        case TRUE: Id value;
    };

    typedef string NEInformation;

    typedef NEInformation MatchingNEInformation;

    typedef string AdditionalInformation;

    /*
    AdditionalInformationOpt is a type carrying an optional parameter.
    The boolean shall be TRUE, if the condition described in TS 32.532 is fulfilled.
    In this case the value is present. Otherwise the value is absent.
    */

```



```

union AdditionalInformationOpt switch (boolean)
{
    case TRUE: AdditionalInformation value;
};

typedef GenericIRPManagementConstDefs::DN NEIdentification;

/*
NEIdentificationOpt is a type carrying an optional parameter.
If the boolean is TRUE, then the value is present.
Otherwise the value is absent.
*/
union NEIdentificationOpt switch (boolean)
{
    case TRUE: NEIdentification value;
};

enum SwFallbackStatus { FALLBACK_SUCCESSFUL, FALLBACK_UNSUCCESSFUL };

struct NeListEntry
{
    SwMIRPConstDefs::NEIdentification nEIdentification;
    SwMIRPConstDefs::SwFallbackStatus swFallbackStatus;
};

typedef sequence<NeListEntry> NeList;

typedef string SwVersionToBeInstalled;

/*
SwVersionToBeInstalledConditional is a type carrying a conditional parameter.
The boolean shall be TRUE, if the condition described in TS 32.532 is fulfilled.
In this case the value is present. Otherwise the value may be absent.
*/
union SwVersionToBeInstalledConditional switch (boolean)
{
    case TRUE: SwVersionToBeInstalled value;
};

enum NameOfStep
{
    NE_HEALTH_CHECK,
    SW_DOWNLOAD,
    SW_INSTALLATION,
    SW_ACTIVATION,
    PREPARE_BASIC_CONFIGURATION_AND_OAMLINK,
    RETRIEVE_CONFIGURATION_DATA,
    SETUP_PRECONFIGURED_SIGNALLING_LINKS,
    SET_FINAL_STATE_OF_NE
};
/*
The following values are not used in SWM IRP, but only in inheriting Self-Conf IRP TS 32.502:
PREPARE_BASIC_CONFIGURATION_AND_OAMLINK,
RETRIEVE_CONFIGURATION_DATA,
SETUP_PRECONFIGURED_SIGNALLING_LINKS,
SET_FINAL_STATE_OF_NE
*/

typedef unsigned short SequenceNumberInProgress;

enum StopPointCanBeSetBeforeThisStep { YES, NO };

struct StepsAndOfferedStopPointListEntry
{
    SwMIRPConstDefs::NameOfStep nameOfStep;
    SwMIRPConstDefs::SequenceNumberInProgress sequenceNumberInProgress;
    SwMIRPConstDefs::StopPointCanBeSetBeforeThisStep stopPointCanBeSetBeforeThisStep
};

typedef sequence<StepsAndOfferedStopPointListEntry> StepsAndOfferedStopPointList;

```

```

enum StopPointSetIndication { STOP_POINT_IS_SET_BEFORE_THIS_STEP, STOP_POINT_IS_NOT_SET };

struct StepAndSelectedStopPointListEntry
{
    SwMIRPConstDefs::NameOfStep nameOfStep;
    SwMIRPConstDefs::SequenceNumberInProcess sequenceNumberInProcess;
    SwMIRPConstDefs::StopPointSetIndication stopPointSetIndication
;
};

typedef sequence<StepAndSelectedStopPointListEntry> StepsAndSelectedStopPointList;

enum StepProgress { NOT_YET_STARTED, RUNNING, COMPLETED, AWAITING_RESUME, FAILURE, TERMINATED };

struct StepInfoListEntry
{
    SwMIRPConstDefs::NameOfStep nameOfStep;
    SwMIRPConstDefs::SequenceNumberInProcess sequenceNumberInProcess;
    SwMIRPConstDefs::StopPointSetIndication stopPointSetIndication;
    SwMIRPConstDefs::StepProgress stepProgress;
};

typedef sequence<StepInfoListEntry> StepInfoList;

struct SwMProcessListEntry
{
    SwMIRPConstDefs::Id id;
    SwMIRPConstDefs::NEIdentification nEIdentification;
    SwMIRPConstDefs::StepInfoList stepInfoList;
};

typedef sequence<SwMProcessListEntry> SwMProcessList;

enum FinalAdministrativeStateValue { LOCKED, UNLOCKED, DETERMINED_BY_CONFIGURATION_DATA };

typedef FinalAdministrativeStateValue OfferedFinalAdministrativeStateValue;

typedef sequence<OfferedFinalAdministrativeStateValue>
OfferedFinalAdministrativeStateInformation;

typedef FinalAdministrativeStateValue SelectedFinalAdministrativeStateValue;

typedef sequence<SwVersionToBeInstalled> SwVersionToBeInstalledOfferList;

/*
SwVersionToBeInstalledOfferListConditional is a type carrying a conditional parameter.
The boolean shall be TRUE, if the condition described in TS 32.532 is fulfilled.
In this case the value is present. Otherwise the value may be absent.
*/
union SwVersionToBeInstalledOfferListConditional switch (boolean)
{
    case TRUE: SwVersionToBeInstalledOfferList value;
};

typedef unsigned short VersionNumber;

struct ProfileId
{
    SwMIRPConstDefs::Id id;
    SwMIRPConstDefs::VersionNumber versionNumber;
};

struct SwMCapability
{
    SwMIRPConstDefs::Id id;
    SwMIRPConstDefs::NEInformation nEInformation;
    SwMIRPConstDefs::StepsAndOfferedStopPointList stepsAndOfferedStopPointList;
};

```

```

    SwMIRPConstDefs::OfferedFinalAdministrativeStateInformation
offeredFinalAdministrativeStateInformation;
    SwMIRPConstDefs::SwVersionToBeInstalledOfferListConditional swVersionToBeInstalledOfferList;
};

typedef sequence<SwMCapability> SwMCapabilitiesList;

struct SwMProfile
{
    SwMIRPConstDefs::Id id;
    SwMIRPConstDefs::VersionNumber versionNumber;
    SwMIRPConstDefs::NEInformation neInformation;
    SwMIRPConstDefs::StepsAndSelectedStopPointList stepsAndSelectedStopPointList;
    SwMIRPConstDefs::SelectedFinalAdministrativeStateValue selectedFinalAdministrativeState;
    SwMIRPConstDefs::SwVersionToBeInstalledConditional swVersionToBeInstalled;
};

typedef sequence<SwMProfile> SwMProfilesList;

/*****
/* definition of types in notifications for software management : */
*****/

typedef string Filter;

typedef string NeAndSWVersion;

enum TriggerForDeletion { IRP_AGENT_TERMINATION, IRP_MANAGER_TERMINATION,
AUTOMATED_SWM_SUCCESFULLY_CONCLUDED, SELF_CONFIGURATION_SUCCESFULLY_CONCLUDED };
/*
The following values are not used in SWM IRP, but only in inheriting Self-Conf IRP TS 32.502:
SELF_CONFIGURATION_SUCCESFULLY_CONCLUDED
*/

/*****
* Definitions for Non-Automated Software Management
*****/

typedef GenericIRPManagementConstDefs::DN NEIdentifier;
typedef unsigned long RequestID;
typedef string Reason;

/*
ReasonOpt is a type carrying an optional parameter.
If the boolean is TRUE, then the value is present.
Otherwise the value is absent.
*/
union ReasonOpt switch (boolean)
{
    case TRUE: Reason value;
};

typedef string FileLocation; //The FileLocation may be a directory path or a URL
typedef unsigned long FileSize; //the unit is byte
typedef string FileCompression;
typedef string FileFormat;

struct SWInfo
{
    SwMIRPConstDefs::FileLocation swLocation;
    SwMIRPConstDefs::FileSize swFileSize;
    SwMIRPConstDefs::FileCompression swFileCompression;
    SwMIRPConstDefs::FileFormat swFileFormat;
};

typedef SwMIRPConstDefs::FileLocation SWToBeInstalled;

typedef sequence<SWInfo> SWToBeDownloaded;

typedef string SWVersion;

typedef unsigned short Hours;

typedef unsigned short Minutes;

```

```

typedef unsigned short Seconds;

struct HoursMinutesSeconds
{
    SwMIRPCConstDefs::Hours hours;
    SwMIRPCConstDefs::Minutes minutes;
    SwMIRPCConstDefs::Seconds seconds;
};

/*
HoursMinutesSecondsOpt is a type carrying an optional parameter.
If the boolean is TRUE, then the value is present.
Otherwise the value is absent.
*/
union HoursMinutesSecondsOpt switch (boolean)
{
    case TRUE: GenericIRPManagementConstDefs::HoursMinutesSeconds value;
};

typedef unsigned short ProcessStepNumber;

/*
ProcessStepNumberOpt is a type carrying an optional parameter.
If the boolean is TRUE, then the value is present.
Otherwise the value is absent.
*/
union ProcessStepNumberOpt switch (boolean)
{
    case TRUE: GenericIRPManagementConstDefs::ProcessStepNumber value;
};

struct StepNumberAndDuration
{
    SwMIRPCConstDefs::ProcessStepNumber processStepNumber;
    SwMIRPCConstDefs::HoursMinutesSeconds estimatedDuration;
};

typedef sequence<StepNumberAndDuration> ListOfStepNumbersAndDurations;

/*
ListOfStepNumbersAndDurationsOpt is a type carrying an optional parameter.
If the boolean is TRUE, then the value is present.
Otherwise the value is absent.
*/
union ListOfStepNumbersAndDurationsOpt switch (boolean)
{
    case TRUE: GenericIRPManagementConstDefs::ProcessStepNumber value;
};

enum Naswm OperationType { operationDownloadNESw, operationActivateNESw, operationInstallNESw
};

struct NaswmProcessInfo
{
    SwMIRPCConstDefs::Id naswmId;
    SwMIRPCConstDefs::NEIdentification nEIdentification;
    SwMIRPCConstDefs::NaswmOperationType naswmOperationType;
    SwMIRPCConstDefs::HoursMinutesSeconds estimatedRemainingCompletionTimeForTheOperation;
    SwMIRPCConstDefs::ListOfStepNumbersAndDurationsOpt listOfStepNumbersAndDurations;
    SwMIRPCConstDefs::ProcessStepNumberOpt numberOfCurrentProcessStep;
    SwMIRPCConstDefs::HoursMinutesSecondsOpt estimatedRemainingCompletionTimeForTheCurrentStep;
};

typedef sequence<NaswmProcessInfo> naswmProcessList;

/*****
* Definitions for Non-Automatic Software Management Notifications
*****/
typedef RequestID DownloadProcessId;
typedef RequestID InstallProcessId;
typedef RequestID ActivateProcessId;

typedef string FailureReason;

typedef sequence<FileLocation> DownloadedNESwInfo;
typedef sequence<FileLocation> InstalledNESwInfo;

```

```
struct FailedSwEntry
{
    SwMIRPCConstDefs::FileLocation failedSw;
    SwMIRPCConstDefs::FailureReason failureReason;
};

typedef sequence<FailedSwEntry> FailedSwInfo;
typedef SWVersion swVersionActivated;

enum DownloadNESwOperationStatus {NE_SW_DOWNLOAD_SUCCESSFUL, NE_SW_DOWNLOAD_FAILED,
NE_SW_DOWNLOAD_PARTIALLY_SUCCESSFUL};
enum InstallOperationStatus {NE_SW_INSTALLATION_SUCCESSFUL, NE_SW_INSTALLATION_FAILED,
NE_SW_INSTALLATION_PARTIALLY_SUCCESSFUL};
enum ActivateOperationStatus {NE_SW_ACTIVATION_SUCCESSFUL, NE_SW_ACTIVATION_FAILED,
NE_SWACTIVATION_PARTIALLY_SUCCESSFUL};

interface AttributeNameValue
{
    const string ID = "ID";
    const string VERSION_NUMBER = "VERSION_NUMBER";
    const string NE_INFORMATION = "NE_INFORMATION";
    const string SW_VERSION_TO_BE_INSTALLED = "SW_VERSION_TO_BE_INSTALLED";
    const string STEPS_AND_SELECTED_STOP_POINT_LIST = "STEPS_AND_SELECTED_STOP_POINT_LIST";
    const string SELECTED_FINAL_ADMINISTRATIVE_STATE = "SELECTED_FINAL_ADMINISTRATIVE_STATE";
    const string NE_IDENTIFICATION = "NE_IDENTIFICATION";
    const string PROFILE_ID = "PROFILE_ID";
    const string MATCHING_NE_INFORMATION = "MATCHING_NE_INFORMATION";
    const string STEP_INFO_LIST = "STEP_INFO_LIST";
    const string NE_AND_SW_VERSION = "NE_AND_SW_VERSION";
    const string TRIGGER_FOR_DELETION = "TRIGGER_FOR_DELETION";
    const string ADDITIONAL_INFORMATION = "ADDITIONAL_INFORMATION";
    const string DOWNLOAD_PROCESS_ID = "DOWNLOAD_PROCESS_ID";
    const string DOWNLOAD_OPERATION_STATUS = "DOWNLOAD_OPERATION_STATUS";
    const string DOWNLOADED_NESW_INFO = "DOWNLOADED_NESW_INFO";
    const string INSTALL_PROCESS_ID = "INSTALL_PROCESS_ID";
    const string INSTALL_OPERATION_STATUS = "INSTALL_OPERATION_STATUS";
    const string INSTALLED_NESW_INFO = "INSTALLED_NESW_INFO";
    const string ACTIVATE_PROCESS_ID = "ACTIVATE_PROCESS_ID";
    const string ACTIVATE_OPERATION_STATUS = "ACTIVATE_OPERATION_STATUS";
    const string FAILURE_REASON = "FAILURE_REASON";
    const string SW_VERSION = "SW_VERSION";
    const string FAILED_SW_INFO = "FAILED_SW_INFO"; };
    const string NASWM_ID = "NASWM_ID";
    const string NUMBER_OF_CURRENT_PROCESS_STEP = "NUMBER_OF_CURRENT_PROCESS_STEP";
    const string LIST_OF_STEP_NUMBERS_AND_DURATIONS = "LIST_OF_STEP_NUMBERS_AND_DURATIONS";
    const string ESTIMATED_REMAINING_COMPLETION_TIME_FOR_THE_OPERATION= "
ESTIMATED_REMAINING_COMPLETION_TIME_FOR_THE_OPERATION";
    const string ESTIMATED_REMAINING_COMPLETION_TIME_FOR_THE_CURRENT_STEP =
"ESTIMATED_REMAINING_COMPLETION_TIME_FOR_THE_CURRENT_STEP";
    const string NASWM_OPERATION_TYPE = "NASWM_OPERATION_TYPE";

};

#endif // _SWM_IRP_CONST_DEFS_IDL_
```

### A.3.3 IDL specification “SwMIRPSystem.idl”

```

//File: SwMIRPSystem.idl
#ifndef _SWM_IRP_SYSTEM_IDL_
#define _SWM_IRP_SYSTEM_IDL_

#include <SwMIRPConstDefs.idl>
#include <GenericIRPManagementSystem.idl>

// This statement must appear after all include statements
#pragma prefix "3gppsa5.org"

/* ## Module: SwMIRPSystem */

module SwMIRPSystem
{
    /*
    If the system fails to complete an operation, then it can provide a reason
    to qualify the exception. The semantics carried in this reason are outside
    the scope of the present document.
    */
    exception ListSwMCapabilities { string reason; };
    exception ListSwMProfiles { string reason; };
    exception CreateSwMProfile { string reason; };
    exception DeleteSwMProfile { string reason; };
    exception ListSwMProcesses { string reason; };
    exception ResumeSwMProcess { string reason; };
    exception SwFallback { string reason; };
    exception TerminateSwMProcess { string reason; };
    exception ChangeSwMProfile { string reason; };
    exception OperationFailed { string reason; };
    exception ResourceLimitation { string reason; };
    exception SWNotAvailable { string reason; };
    exception ListNaswmProcesses { string reason; };
    exception CancelNaswmProcesses { string reason; };
    interface SwMIRPOperations_1
    {
        /* for the purpose of this operation see 3GPP TS 32.532 */
        SwMIRPConstDefs::Result listSwMCapabilities
        (
            in SwMIRPConstDefs::NEInformation nEInformation,
            out SwMIRPConstDefs::SwMCapabilitiesList capabilitiesList
        )
        raises
        (
            ListSwMCapabilities,
            GenericIRPManagementSystem::ParameterNotSupported,
            GenericIRPManagementSystem::InvalidParameter,
            GenericIRPManagementSystem::ValueNotSupported,
            GenericIRPManagementSystem::OperationNotSupported
        );

        /* for the purpose of this operation see 3GPP TS 32.532 */
        SwMIRPConstDefs::Result listSwMProfiles
        (
            in SwMIRPConstDefs::NEInformation nEInformation,
            out SwMIRPConstDefs::SwMProfileList profileList
        )
        raises
        (
            ListSwMProfiles,
            GenericIRPManagementSystem::ParameterNotSupported,
            GenericIRPManagementSystem::InvalidParameter,
            GenericIRPManagementSystem::ValueNotSupported,
            GenericIRPManagementSystem::OperationNotSupported
        );

        /* for the purpose of this operation see 3GPP TS 32.532 */
        SwMIRPConstDefs::ResultChangeOrCreateProfileOperation createSwMProfile
        (
            in SwMIRPConstDefs::IdOpt id,
            in SwMIRPConstDefs::NEInformation nEInformation,
            in SwMIRPConstDefs::SwVersionToBeInstalledConditional swVersionToBeInstalled,

```

```
    in SwMIRPCConstDefs::StepsAndSelectedStopPointList stepsAndSelectedStopPointList,
    in SwMIRPCConstDefs::SelectedFinalAdministrativeState selectedFinalAdministrativeState
  )
raises
  (
    CreateSWMPProfile,
    GenericIRPManagementSystem::ParameterNotSupported,
    GenericIRPManagementSystem::InvalidParameter,
    GenericIRPManagementSystem::ValueNotSupported,
    GenericIRPManagementSystem::OperationNotSupported
  );

/* for the purpose of this operation see 3GPP TS 32.532 */
SwMIRPCConstDefs::Result deleteSWMPProfile
  (
    in SwMIRPCConstDefs::Id id
  )
raises
  (
    DeleteSWMPProfile,
    GenericIRPManagementSystem::ParameterNotSupported,
    GenericIRPManagementSystem::InvalidParameter,
    GenericIRPManagementSystem::ValueNotSupported,
    GenericIRPManagementSystem::OperationNotSupported
  );

/* for the purpose of this operation see 3GPP TS 32.532 */
SwMIRPCConstDefs::Result listSwMPProcesses
  (
    in SwMIRPCConstDefs::NEIdentificationOpt nEIdentification,
    out SwMIRPCConstDefs::ProcessList processList
  )
raises
  (
    ListSwMPProcesses,
    GenericIRPManagementSystem::ParameterNotSupported,
    GenericIRPManagementSystem::InvalidParameter,
    GenericIRPManagementSystem::ValueNotSupported,
    GenericIRPManagementSystem::OperationNotSupported
  );

/* for the purpose of this operation see 3GPP TS 32.532 */
SwMIRPCConstDefs::Result resumeSwMPProcess
  (
    in SwMIRPCConstDefs::Id id,
    in SwMIRPCConstDefs::NameOfStep startStepName
  )
raises
  (
    ResumeSwMPProcess,
    GenericIRPManagementSystem::ParameterNotSupported,
    GenericIRPManagementSystem::InvalidParameter,
    GenericIRPManagementSystem::ValueNotSupported,
    GenericIRPManagementSystem::OperationNotSupported
  );

/* for the purpose of this operation see 3GPP TS 32.532 */
SwMIRPCConstDefs::Result swFallback
  (
    in SwMIRPCConstDefs::Filter filter,
    out SwMIRPCConstDefs::NEList nEList
  )
raises
  (
    SwFallback,
    GenericIRPManagementSystem::ParameterNotSupported,
    GenericIRPManagementSystem::InvalidParameter,
    GenericIRPManagementSystem::ValueNotSupported,
    GenericIRPManagementSystem::OperationNotSupported
  );

/* for the purpose of this operation see 3GPP TS 32.532 */
SwMIRPCConstDefs::Result terminateSwMPProcess
```

```

    (
      in SwMIRPConstDefs::Id id
    )
  raises
    (
      TerminateSwMProcess,
      GenericIRPManagementSystem::ParameterNotSupported,
      GenericIRPManagementSystem::InvalidParameter,
      GenericIRPManagementSystem::ValueNotSupported,
      GenericIRPManagementSystem::OperationNotSupported
    );
};

interface SwMIRPOperations_2
{
  /* for the purpose of this operation see 3GPP TS 32.532 */
  SwMIRPConstDefs::ResultChangeOrCreateProfileOperation changeSWMProfile
  (
    in SwMIRPConstDefs::Id id,
    in SwMIRPConstDefs::NEInformation neInformation,
    in SwMIRPConstDefs::SwVersionToBeInstalledConditional swVersionToBeInstalled,
    in SwMIRPConstDefs::StepsAndSelectedStopPointList stepsAndSelectedStopPointList,
    in SwMIRPConstDefs::SelectedFinalAdministrativeState selectedFinalAdministrativeState
    out SwMIRPConstDefs::VersionNumber versionNumber
    out SwMIRPConstDefs::ConflictingProfileIdConditional conflictingProfileId
  )
  raises
    (
      ChangeSWMProfile,
      GenericIRPManagementSystem::ParameterNotSupported,
      GenericIRPManagementSystem::InvalidParameter,
      GenericIRPManagementSystem::ValueNotSupported,
      GenericIRPManagementSystem::OperationNotSupported
    );
};

interface SwMIRPOperations_3
{
  /* for the purpose of this operation see 3GPP TS 32.532 */
  SwMIRPConstDefs::ResultNaSwmNotification downloadNESw
  (
    in SwMIRPConstDefs::SWToBeDownloaded swToBeDownloaded,
    in SwMIRPConstDefs::NEIdentifier neIdentifier,
    out SwMIRPConstDefs::RequestID downloadProcessId,
    out SwMIRPConstDefs::Reason reason
  )
  raises
    (
      OperationFailed,
      ResourceLimitation
    );
  /* for the purpose of this operation see 3GPP TS 32.532 */
  SwMIRPConstDefs::ResultNaSwmNotification activateNESw
  (
    in SwMIRPConstDefs::SWVersion swVersionToBeActivated,
    in SwMIRPConstDefs::NEIdentifier neIdentifier,
    out SwMIRPConstDefs::RequestID requestID,
    out SwMIRPConstDefs::Reason reason
  )
  raises
    (
      OperationFailed,
      ResourceLimitation
    );
};

interface SwMIRPOperations_4
{
  /* for the purpose of this operation see 3GPP TS 32.532 */
  SwMIRPConstDefs::ResultNaSwmNotification installNESw
  (
    in SwMIRPConstDefs::SWToBeInstalled swToBeInstalled,
    in SwMIRPConstDefs::NEIdentifier neIdentifier,
    out SwMIRPConstDefs::RequestID installProcessId,

```



```
        out SwMIRPConstDefs::Reason reason
    )
    raises
    (
        OperationFailed,
        ResourceLimitation,
        SWNotAvailable
    );
};

interface SwMIRPOperations_5
{
    /* for the purpose of this operation see 3GPP TS 32.532 */
    SwMIRPConstDefs::ResultListNaswmProcesses listNaswmProcesses
    (
        in SwMIRPConstDefs::IdOpt naswmId,
        out SwMIRPConstDefs::NaswmProcessList naswmProcessList,
        out SwMIRPConstDefs::ReasonOpt reason
    )
    raises
    (
        OperationFailed,
        ResourceLimitation,
    );
};

interface SwMIRPOperations_6
{
    /* for the purpose of this operation see 3GPP TS 32.532 */
    SwMIRPConstDefs::ResultCancelNaswmProcesses cancel NaswmProcesses
    (
        in SwMIRPConstDefs::Id p rocessId,
        in SwMIRPConstDefs::NaswmOperationType naswmOperationType,
        out SwMIRPConstDefs::ReasonOpt reason
    )
    raises
    (
        OperationFailed,
        ResourceLimitation,
    );
};

};

#endif // _SWM_IRP_SYSTEM_IDL_
```

## A.3.4 IDL specification “SwMIRPNotifications.idl”

```
//File: SwMIRPNotifications.idl
#ifndef _SWM_IRP_NOTIFICATIONS_IDL_
#define _SWM_IRP_NOTIFICATIONS_IDL_

#include <SwMIRPConstDefs.idl>
#include <NotificationIRPNotifications.idl>

// This statement must appear after all include statements
#pragma prefix "3gppsa5.org"

/* ## Module: SwMIRPNotifications
This contains the specification of notifications of Software Management.
=====
*/
module SwMIRPNotifications
{

    /* Constant definitions for the notifySwMProfileCreation notification */

    interface NotifySwMProfileCreation: NotificationIRPNotifications::Notify
    {
        const string EVENT_TYPE = "notifySwMProfileCreation";

        /**
         * This constant defines the name of the Id property,
         * which is transported in the filterable_body_fields.
         * The data type for the value of this property is
         * SwMIRPConstDefs::Id.
         */
        const string ID =
            SwMIRPConstDefs::AttributeNameValue::ID;

        /**
         * This constant defines the name of the VersionNumber property,
         * which is transported in the filterable_body_fields.
         * The data type for the value of this property is
         * SwMIRPConstDefs::VersionNumber.
         */
        const string VERSION_NUMBER =
            SwMIRPConstDefs::AttributeNameValue::VERSION_NUMBER;

        /**
         * This constant defines the name of the NEInformation property,
         * which is transported in the filterable_body_fields.
         * The data type for the value of this property is
         * SwMIRPConstDefs::NEInformation.
         */
        const string NE_INFORMATION =
            SwMIRPConstDefs::AttributeNameValue::NE_INFORMATION;

        /**
         * This constant defines the name of the SwVersionToBeInstalled property,
         * which is transported in the filterable_body_fields.
         * The data type for the value of this property is
         * SwMIRPConstDefs::SwVersionToBeInstalledConditional.
         */
        const string SW_VERSION_TO_BE_INSTALLED =
            SwMIRPConstDefs::AttributeNameValue::SW_VERSION_TO_BE_INSTALLED;

        /**
         * This constant defines the name of the StepsAndSelectedStopPointList property,
         * which is transported in the remaining_body.
         * The data type for the value of this property is
         * SwMIRPConstDefs::StepsAndSelectedStopPointList.
         */
        const string STEPS_AND_SELECTED_STOP_POINT_LIST =
            SwMIRPConstDefs::AttributeNameValue::STEPS_AND_SELECTED_STOP_POINT_LIST;

        /**
         * This constant defines the name of the SelectedFinalAdministrativeState property,
         * which is transported in the remaining_body.
         */
    }
}

```

```
* The data type for the value of this property is
* SwMIRPCConstDefs::SelectedFinalAdministrativeState.
*/
const string SELECTED_FINAL_ADMINISTRATIVE_STATE =
    SwMIRPCConstDefs::AttributeNameValue::SELECTED_FINAL_ADMINISTRATIVE_STATE;
};

/* Constant definitions for the notifySwMProfileDeletion notification */
interface NotifySwMProfileDeletion: NotificationIRPNotifications::Notify
{
    const string EVENT_TYPE = "notifySwMProfileDeletion";

    /**
    * This constant defines the name of the Id property,
    * which is transported in the filterable_body_fields.
    * The data type for the value of this property is
    * SwMIRPCConstDefs::Id.
    */
    const string ID =
        SwMIRPCConstDefs::AttributeNameValue::ID;
};

/* Constant definitions for the notifySwMProcessCreation notification */
interface NotifySwMProcessCreation: NotificationIRPNotifications::Notify
{
    const string EVENT_TYPE = "notifySwMProcessCreation";

    /**
    * This constant defines the name of the Id property,
    * which is transported in the filterable_body_fields.
    * The data type for the value of this property is
    * SwMIRPCConstDefs::Id.
    */
    const string ID =
        SwMIRPCConstDefs::AttributeNameValue::ID;

    /**
    * This constant defines the name of the NEIdentification property,
    * which is transported in the filterable_body_fields.
    * The data type for the value of this property is
    * SwMIRPCConstDefs::NEIdentification.
    */
    const string NE_IDENTIFICATION =
        SwMIRPCConstDefs::AttributeNameValue::NE_IDENTIFICATION;

    /**
    * This constant defines the name of the ProfileId property,
    * which is transported in the remaining_body.
    * The data type for the value of this property is
    * SwMIRPCConstDefs::ProfileId.
    */
    const string PROFILE_ID =
        SwMIRPCConstDefs::AttributeNameValue::PROFILE_ID;

    /**
    * This constant defines the name of the MatchingNEInformation property,
    * which is transported in the remaining_body.
    * The data type for the value of this property is
    * SwMIRPCConstDefs::MatchingNEInformation.
    */
    const string MATCHING_NE_INFORMATION =
        SwMIRPCConstDefs::AttributeNameValue::MATCHING_NE_INFORMATION;

    /**
    * This constant defines the name of the StepInfoList property,
    * which is transported in the remaining_body.
    * The data type for the value of this property is
    * SwMIRPCConstDefs::StepInfoList.
    */
    const string STEP_INFO_LIST =
        SwMIRPCConstDefs::AttributeNameValue::STEP_INFO_LIST;
};
```

```
};

/* Constant definitions for the notifySwMProcessStage notification */
interface NotifySwMProcessStage: NotificationIRPNotifications::Notify
{
    const string EVENT_TYPE = "notifySwMProcessStage";

    /**
     * This constant defines the name of the Id property,
     * which is transported in the filterable_body_fields.
     * The data type for the value of this property is
     * SwMIRPConstDefs::Id.
     */
    const string ID =
        SwMIRPConstDefs::AttributeNameValue::ID;

    /**
     * This constant defines the name of the StepInfoList property,
     * which is transported in the remaining_body.
     * The data type for the value of this property is
     * SwMIRPConstDefs::StepInfoList.
     */
    const string STEP_INFO_LIST =
        SwMIRPConstDefs::AttributeNameValue::STEP_INFO_LIST;
};

/* Constant definitions for the notifySwMProcessDeletion notification */
interface NotifySwMProcessDeletion: NotificationIRPNotifications::Notify
{
    const string EVENT_TYPE = "notifySwMProcessDeletion";

    /**
     * This constant defines the name of the Id property,
     * which is transported in the filterable_body_fields.
     * The data type for the value of this property is
     * SwMIRPConstDefs::Id.
     */
    const string ID =
        SwMIRPConstDefs::AttributeNameValue::ID;

    /**
     * This constant defines the name of the TriggerForDeletion property,
     * which is transported in the remaining_body.
     * The data type for the value of this property is
     * SwMIRPConstDefs::TriggerForDeletion.
     */
    const string ID =
        SwMIRPConstDefs::AttributeNameValue::TRIGGER_FOR_DELETION;

    /**
     * This constant defines the name of the AdditionalInformation property,
     * which is transported in the remaining_body.
     * The data type for the value of this property is
     * SwMIRPConstDefs::AdditionalInformationOptional.
     */
    const string ID =
        SwMIRPConstDefs::AttributeNameValue::ADDITIONAL_INFORMATION;
};

/* Constant definitions for the notifyNewSwAvailability notification */
interface NotifyNewSwAvailability: NotificationIRPNotifications::Notify
{
    const string EVENT_TYPE = "notifyNewSwAvailability";

    /**
     * This constant defines the name of the NEandSWversion property,
     * which is transported in the filterable_body_fields.
     * The data type for the value of this property is
     * SwMIRPConstDefs::NEandSWversion.
     */
};
```

```
const string NE_AND_SW_VERSION =
    SwMIRPCConstDefs::AttributeNameValue::NE_AND_SW_VERSION;
};

/* Constant definitions for the notifySwMProfileChange notification */
interface NotifySwMProfileChange: NotificationIRPNotifications::Notify
{
    const string EVENT_TYPE = "notifySwMProfileChange";

    /**
     * This constant defines the name of the Id property,
     * which is transported in the filterable_body_fields.
     * The data type for the value of this property is
     * SwMIRPCConstDefs::Id.
     */
    const string ID =
        SwMIRPCConstDefs::AttributeNameValue::ID;

    /**
     * This constant defines the name of the VersionNumber property,
     * which is transported in the filterable_body_fields.
     * The data type for the value of this property is
     * SwMIRPCConstDefs::VersionNumber.
     */
    const string VERSION_NUMBER =
        SwMIRPCConstDefs::AttributeNameValue::VERSION_NUMBER;

    /**
     * This constant defines the name of the NEInformation property,
     * which is transported in the filterable_body_fields.
     * The data type for the value of this property is
     * SwMIRPCConstDefs::NEInformation.
     */
    const string NE_INFORMATION =
        SwMIRPCConstDefs::AttributeNameValue::NE_INFORMATION;

    /**
     * This constant defines the name of the SwVersionToBeInstalled property,
     * which is transported in the filterable_body_fields.
     * The data type for the value of this property is
     * SwMIRPCConstDefs::SwVersionToBeInstalledConditional.
     */
    const string SW_VERSION_TO_BE_INSTALLED =
        SwMIRPCConstDefs::AttributeNameValue::SW_VERSION_TO_BE_INSTALLED;

    /**
     * This constant defines the name of the StepsAndSelectedStopPointList property,
     * which is transported in the filterable_body_fields.
     * The data type for the value of this property is
     * SwMIRPCConstDefs::StepsAndSelectedStopPointList.
     */
    const string STEPS_AND_SELECTED_STOP_POINT_LIST =
        SwMIRPCConstDefs::AttributeNameValue::STEPS_AND_SELECTED_STOP_POINT_LIST;

    /**
     * This constant defines the name of the SelectedFinalAdministrativeState property,
     * which is transported in the filterable_body_fields.
     * The data type for the value of this property is
     * SwMIRPCConstDefs::SelectedFinalAdministrativeState.
     */
    const string SELECTED_FINAL_ADMINISTRATIVE_STATE =
        SwMIRPCConstDefs::AttributeNameValue::SELECTED_FINAL_ADMINISTRATIVE_STATE;
};

/* Constant definitions for the notifyDownloadNESwStatusChanged notification */
interface notifyDownloadNESwStatusChanged: NotificationIRPNotifications::Notify
{
    const string EVENT_TYPE = "notifyDownloadNESwStatusChanged";

    /**
     * This constant defines the name of the downloadProcessId property used
     * during downloadNESw operation and transported in the
     * filterable_body_fields. The data type for the value of this property

```

```

* is SwMIRPConstDefs::RequestID.
*/
const string DOWNLOAD_PROCESS_ID =
    SwMIRPConstDefs::AttributeNameValue::DOWNLOAD_PROCESS_ID;

/**
* This constant defines the name of the downloadOperationStatus
* property which is transported in the filterable_body_fields.
* The data type for the value of this property is
* SwMIRPConstDefs::DownloadNESwOperationStatus.
*/
const string DOWNLOAD_OPERATION_STATUS =
    SwMIRPConstDefs::AttributeNameValue::DOWNLOAD_OPERATION_STATUS;

/**
* This constant defines the name of the downloadedNESwInfo
* property, which is transported in the remaining_body.
* The data type for the value of this property is
* SwMIRPConstDefs::DownloadedNESwInfo.
*/
const string DOWNLOADED_NESW_INFO =
    SwMIRPConstDefs::AttributeNameValue::DOWNLOADED_NESW_INFO;

/**
* This constant defines the name of the FailedSwInfo property,
* which is transported in the remaining_body.
* The data type for the value of this property is
* SwMIRPConstDefs::FailedSwInfo.
*/
const string FAILED_SW_INFO =
    SwMIRPConstDefs::AttributeNameValue::FAILED_SW_INFO;
};

/* Constant definitions for the notifyInstallNESwStatusChanged notification */
interface notifyInstallNESwStatusChanged: NotificationIRPNotifications::Notify
{
    const string EVENT_TYPE = "notifyInstallNESwStatusChanged";

    /**
    * This constant defines the name of the InstallProcessId property used
    * during installNESw operation and transported in the
    * filterable_body_fields. The data type for the value of this property
    * is SwMIRPConstDefs::RequestID.
    */
    const string INSTALL_PROCESS_ID =
        SwMIRPConstDefs::AttributeNameValue::INSTALL_PROCESS_ID;

    /**
    * This constant defines the name of the InstallOperationStatus
    * property which is transported in the filterable_body_fields.
    * The data type for the value of this property is
    * SwMIRPConstDefs::InstallOperationStatus.
    */
    const string INSTALL_OPERATION_STATUS =
        SwMIRPConstDefs::AttributeNameValue::INSTALL_OPERATION_STATUS;

    /**
    * This constant defines the name of the InstalledNESwInfo property,
    * which is transported in the remaining_body.
    * The data type for the value of this property is
    * SwMIRPConstDefs::InstalledNESwInfo.
    */
    const string INSTALLED_NESW_INFO =
        SwMIRPConstDefs::AttributeNameValue::INSTALLED_NESW_INFO;

    /**
    * This constant defines the name of the FailedSwInfo property,
    * which is transported in the remaining_body.
    * The data type for the value of this property is
    * SwMIRPConstDefs::FailedSwInfo.
    */
    const string FAILED_SW_INFO =
        SwMIRPConstDefs::AttributeNameValue::FAILED_SW_INFO;
};

/* Constant definitions for the notifyActivateNESwStatusChanged notification */

```

```
interface notifyActivateNESwStatusChanged: NotificationIRPNotifications::Notify
{
    const string EVENT_TYPE = "notifyActivateNESwStatusChanged";

    /**
     * This constant defines the name of the activateProcessId property used
     * during activateNESw operation and transported in the
     * filterable_body_fields. The data type for the value of this property
     * is SwMIRPConstDefs::RequestID.
     */
    const string ACTIVATE_PROCESS_ID =
        SwMIRPConstDefs::AttributeNameValue::ACTIVATE_PROCESS_ID;

    /**
     * This constant defines the name of the ActivateOperationStatus
     * property which is transported in the filterable_body_fields.
     * The data type for the value of this property is
     * SwMIRPConstDefs::ActivateOperationStatus.
     */
    const string ACTIVATE_OPERATION_STATUS =
        SwMIRPConstDefs::AttributeNameValue::ACTIVATE_OPERATION_STATUS;

    /**
     * This constant defines the name of the software version property
     * activated, which is transported in the filterable_body_fields.
     * The data type for the value of this property is
     * SwMIRPConstDefs::SWVersion.
     */
    const string SW_VERSION =
        SwMIRPConstDefs::AttributeNameValue::SW_VERSION;

    /**
     * This constant defines the name of the failureReason property,
     * which is transported in the remaining_body.
     * The data type for the value of this property is
     * SwMIRPConstDefs::FailureReason.
     */
    const string FAILURE_REASON =
        SwMIRPConstDefs::AttributeNameValue::FAILURE_REASON;
};

};

#endif // _SWM_IRP_NOTIFICATIONS_IDL_
```

---

## Annex B (normative): XML definitions

The annex specifies the XML Definitions for the Software management Integration Reference Point (IRP) as it applies to Itf-N, in accordance with Software management IRP IS definitions [5], for usage with the Notification Log IRP XML Definitions [7].

---

### B.1 Architectural features

The overall architectural feature of Software management IRP is specified in 3GPP TS 32.532 [5].

This clause specifies features that are specific to the XML Schema definitions.

#### B.1.1 Syntax for Distinguished Names

The syntax of a Distinguished Name is defined in 3GPP TS 32.300 [15].

---

### B.2 Mapping

Not present in the current version of this specification.

---

### B.3 Solution Set definitions

#### B.3.1 XML definition structure

Clause B.3.2 provides a graphical representation of the XML elements.

Clause B.3.3 provides XML definitions of Software management IRP notifications as defined in 3GPP TS 32.532 [5].

Clause B.3.4 provides XML definitions of Software management IRP IOCs as defined in 3GPP TS 32.532 [5].



### B.3.2 Graphical Representation

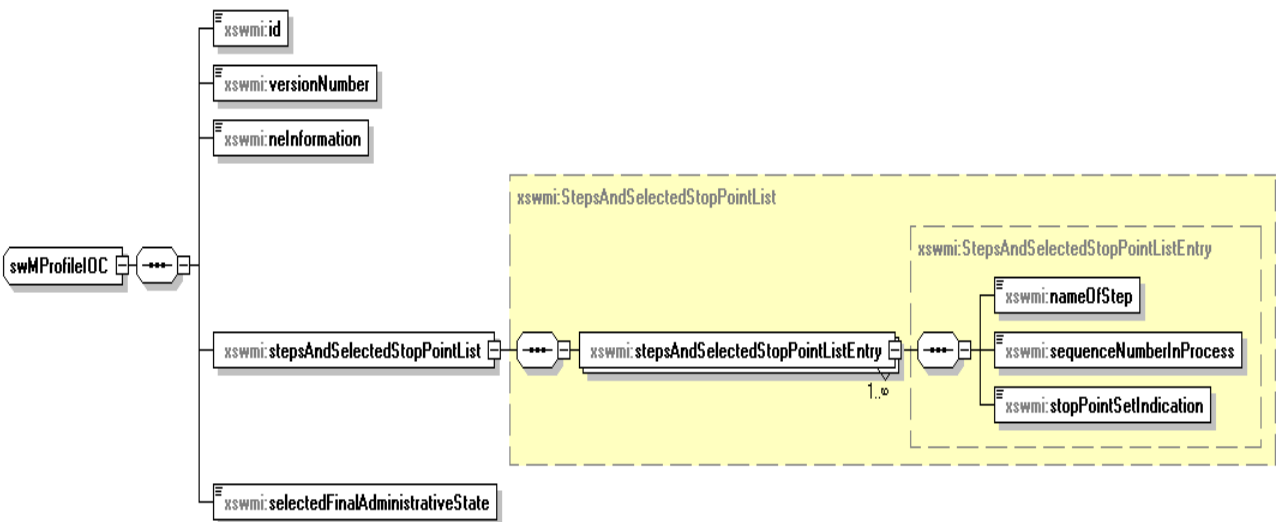
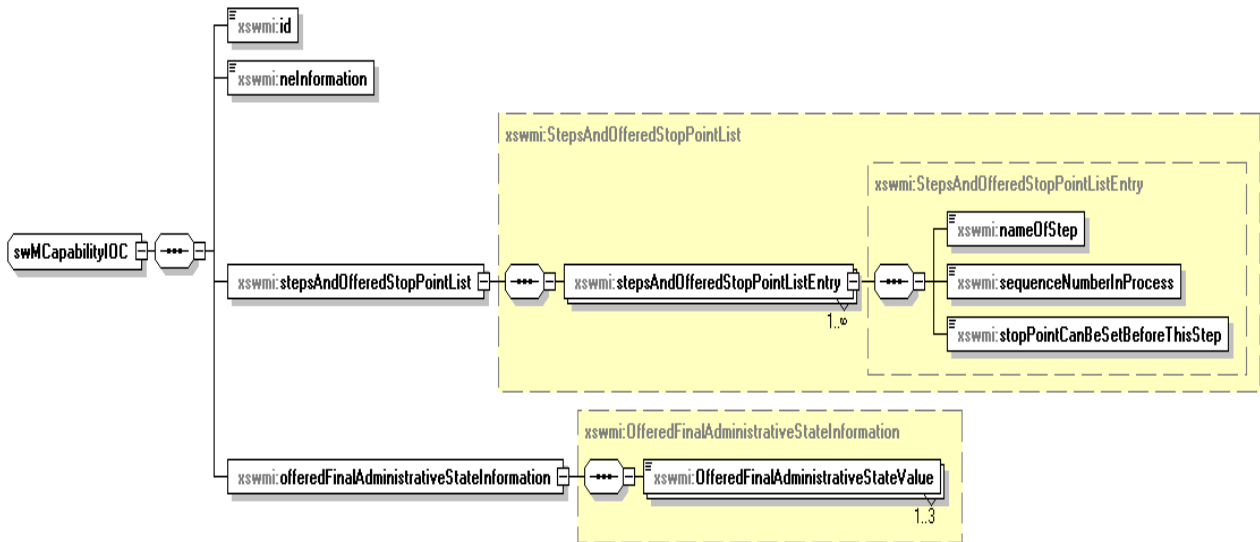



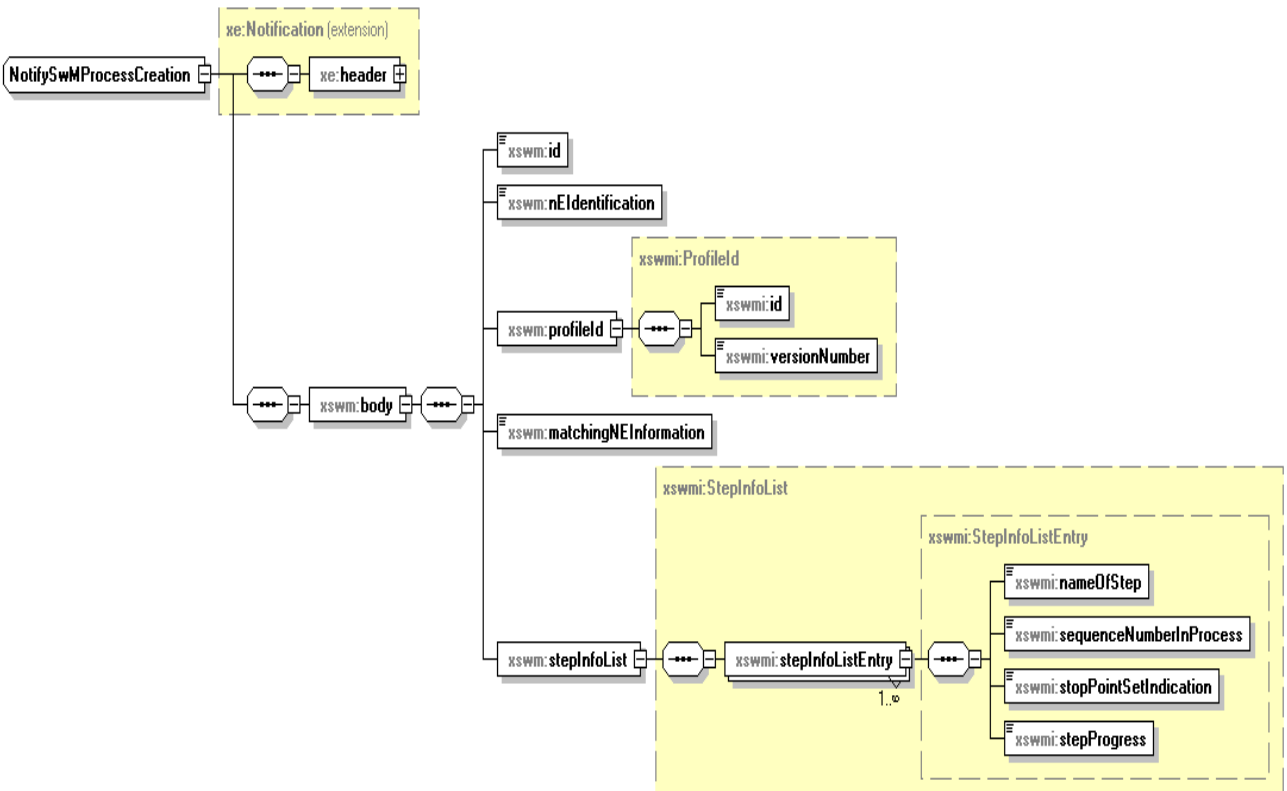

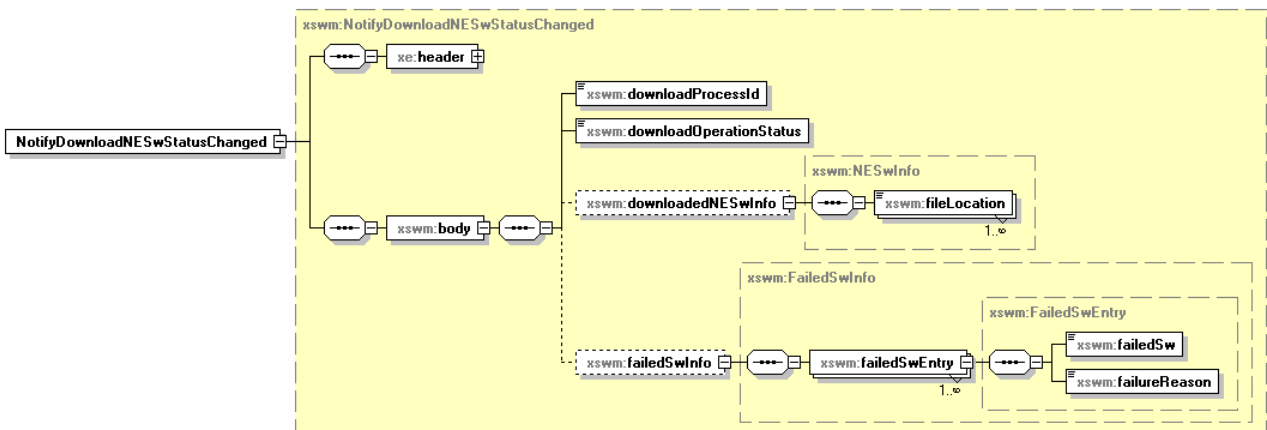
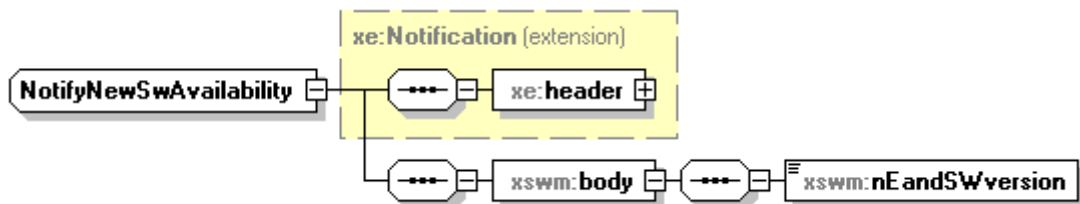
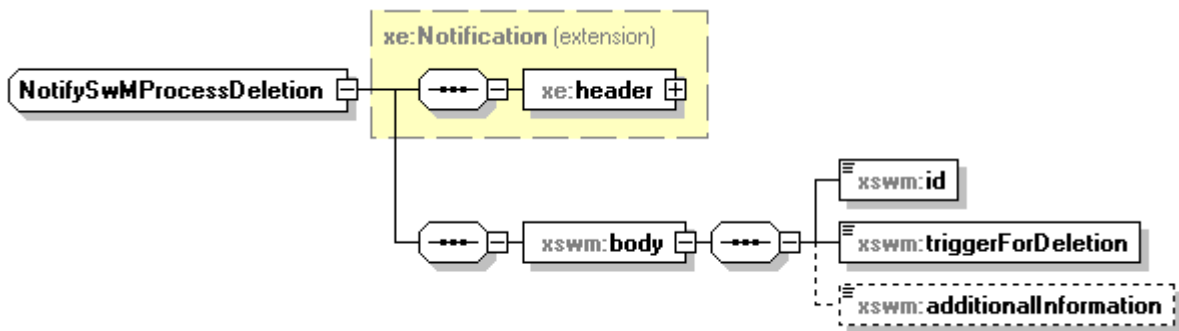
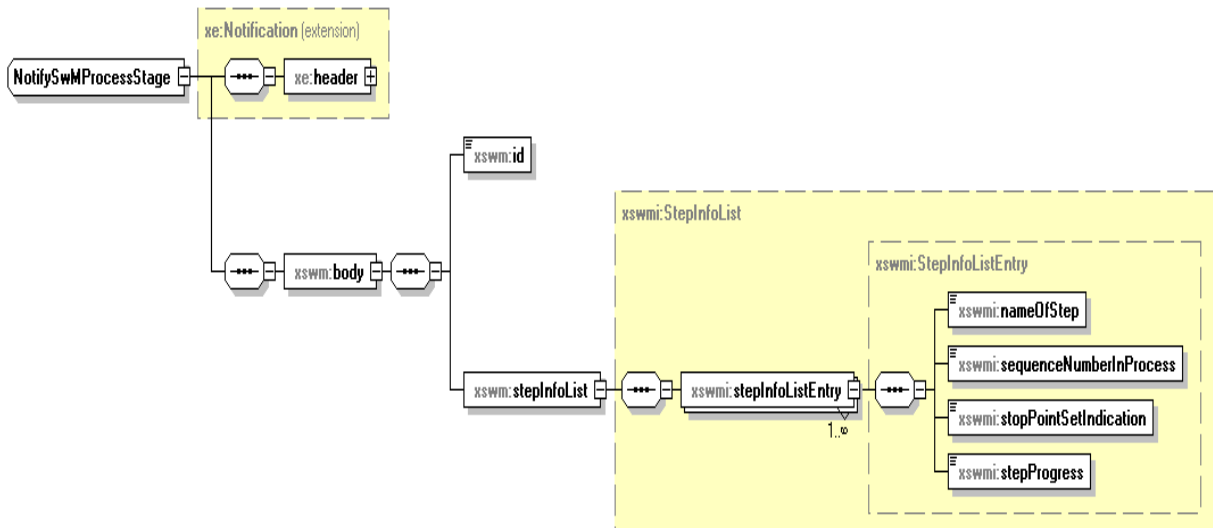

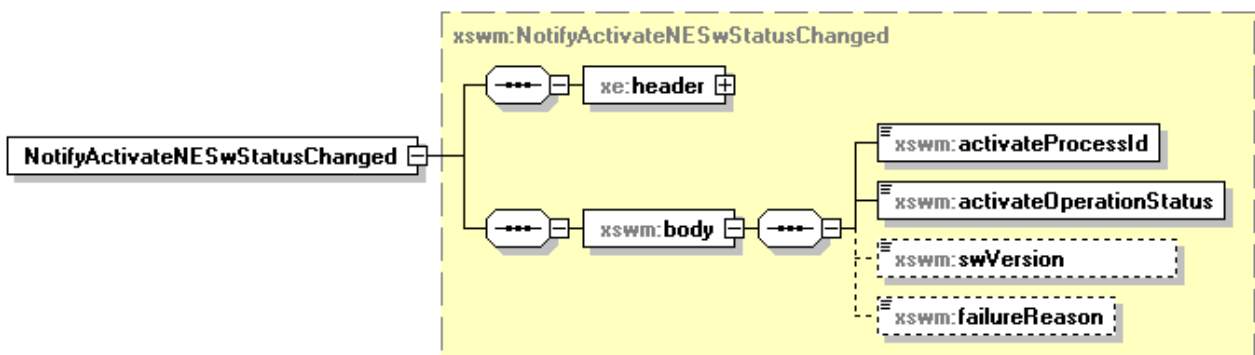
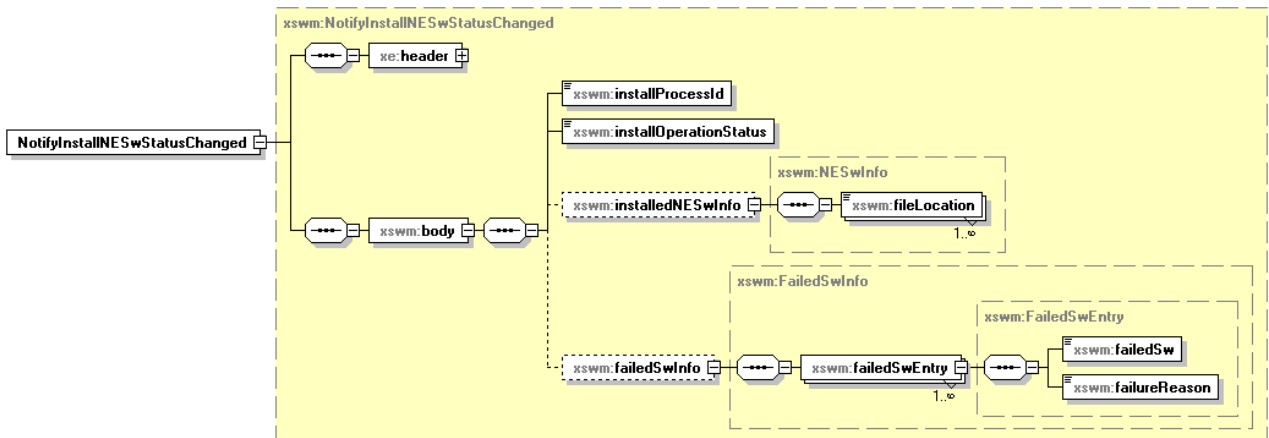

### B.3.3 XML Schema “swManagementIRPNotif.xsd”

```

<?xml version="1.0" encoding="UTF-8"?>
<schema xmlns="http://www.w3.org/2001/XMLSchema"
xmlns:xe="http://www.3gpp.org/ftp/specs/archive/32_series/32.306#notification"
xmlns:xswm="http://www.3gpp.org/ftp/specs/archive/32_series/32.536#swManagementIRPNotif"
xmlns:xswmi="http://www.3gpp.org/ftp/specs/archive/32_series/32.536#swManagementIRPIOCs"
targetNamespace="http://www.3gpp.org/ftp/specs/archive/32_series/32.536#swManagementIRPNotif"
elementFormDefault="qualified" attributeFormDefault="unqualified">
  <import namespace="http://www.3gpp.org/ftp/specs/archive/32_series/32.306#notification"/>
  <import namespace="http://www.3gpp.org/ftp/specs/archive/32_series/32.536#swManagementIRPIOCs"/>
  <simpleType name="SwVersionToBeInstalledConditional">
    <restriction base="string"/>
  </simpleType>
  <complexType name="OfferedFinalAdministrativeStateInformation">
    <sequence>
      <element name="OfferedFinalAdministrativeStateValue"
type="xswmi:FinalAdministrativeStateValue" maxOccurs="3"/>
    </sequence>
  </complexType>
  <simpleType name="TriggerForDeletion">
    <restriction base="string">
      <enumeration value="IRP_AGENT_TERMINATION"/>
      <enumeration value="IRP_MANAGER_TERMINATION"/>
      <enumeration value="AUTOMATED_SWM_SUCCESFULLY_CONCLUDED"/>
      <enumeration value="SELF_CONFIGURATION_SUCCESFULLY_CONCLUDED"/>
    </restriction>
  </simpleType>
  <simpleType name="RequestID">
    <restriction base="unsignedLong"/>
  </simpleType>
  <simpleType name="DownloadNESwOperationStatus">
    <restriction base="string">
      <enumeration value="NE_SWDOWNLOAD_SUCCESSFUL"/>
      <enumeration value="NE_SWDOWNLOAD_FAILED"/>
      <enumeration value="NE_SWDOWNLOAD_PARTIALLY_SUCCESSFUL"/>
    </restriction>
  </simpleType>
  <simpleType name="FileLocation">
    <restriction base="string"/>
  </simpleType>
  <complexType name="NESwInfo">
    <sequence>
      <element name="fileLocation" type="xswm:FileLocation" maxOccurs="unbounded"/>
    </sequence>
  </complexType>
  <complexType name="FailedSwEntry">
    <sequence>
      <element name="failedSw" type="xswm:FileLocation"/>
      <element name="failureReason" type="xswm:FailureReason"/>
    </sequence>
  </complexType>
  <complexType name="FailedSwInfo">
    <sequence>
      <element name="failedSwEntry" type="xswm:FailedSwEntry" maxOccurs="unbounded"/>
    </sequence>
  </complexType>
  <simpleType name="FailureReason">
    <restriction base="string"/>
  </simpleType>
  <simpleType name="InstallNESwOperationStatus">
    <restriction base="string">
      <enumeration value="NE_SW_INSTALLATION_SUCCESSFUL"/>
      <enumeration value="NE_SW_INSTALLATION_FAILED"/>
      <enumeration value="NE_SWINSTALLATION_PARTIALLY_SUCCESSFUL"/>
    </restriction>
  </simpleType>
  <simpleType name="ActivateNESwOperationStatus">
    <restriction base="string">
      <enumeration value="NE_SW_ACTIVATION_SUCCESSFUL"/>
      <enumeration value="NE_SW_ACTIVATION_FAILED"/>
      <enumeration value="NE_SWACTIVATION_PARTIALLY_SUCCESSFUL"/>
    </restriction>
  </simpleType>
  <complexType name="NotifySwMProfileChange">
    <complexContent>

```

```

    <extension base="xe:Notification">
      <sequence>
        <element name="body">
          <complexType>
            <sequence>
              <element name="id" type="xswmi:Id"/>
              <element name="versionNumber" type="xswmi:VersionNumber"/>
              <element name="nEInformation" type="xswmi:NEInformation"/>
              <element name="swVersionToBeInstalled"
type="xswmi:SwVersionToBeInstalledConditional"/>
              <element name="stepsAndSelectedStopPointList">
                <complexType>
                  <complexContent>
                    <extension base="xswmi:StepsAndSelectedStopPointList"/>
                  </complexContent>
                </complexType>
              </element>
              <element name="selectedFinalAdministrativeState"
type="xswmi:FinalAdministrativeStateValue"/>
            </sequence>
          </complexType>
        </element>
      </sequence>
    </extension>
  </complexContent>
</complexType>
<complexType name="NotifyNewSwAvailability">
  <complexContent>
    <extension base="xe:Notification">
      <sequence>
        <element name="body">
          <complexType>
            <sequence>
              <element name="nEandSWversion" type="string"/>
            </sequence>
          </complexType>
        </element>
      </sequence>
    </extension>
  </complexContent>
</complexType>
<complexType name="NotifySwMProcessDeletion">
  <complexContent>
    <extension base="xe:Notification">
      <sequence>
        <element name="body">
          <complexType>
            <sequence>
              <element name="id" type="xswmi:Id"/>
              <element name="triggerForDeletion" type="xswmi:TriggerForDeletion"/>
              <element name="additionalInformation" type="string" minOccurs="0"/>
            </sequence>
          </complexType>
        </element>
      </sequence>
    </extension>
  </complexContent>
</complexType>
<complexType name="NotifySwMProcessStage">
  <complexContent>
    <extension base="xe:Notification">
      <sequence>
        <element name="body">
          <complexType>
            <sequence>
              <element name="id" type="xswmi:Id"/>
              <element name="stepInfoList" type="xswmi:StepInfoList"/>
            </sequence>
          </complexType>
        </element>
      </sequence>
    </extension>
  </complexContent>
</complexType>
<complexType name="NotifySwMProcessCreation">
  <complexContent>
    <extension base="xe:Notification">
      <sequence>

```

```

        <element name="body">
            <complexType>
                <sequence>
                    <element name="id" type="xswmi:Id"/>
                    <element name="nEIdentification" type="xswmi:Id"/>
                    <element name="profileId" type="xswmi:ProfileId"/>
                    <element name="matchingNEInformation" type="xswmi:NEInformation"/>
                    <element name="stepInfoList" type="xswmi:StepInfoList"/>
                </sequence>
            </complexType>
        </element>
    </sequence>
</extension>
</complexContent>
</complexType>
<complexType name="NotifySwMProfileDeletion">
    <complexContent>
        <extension base="xe:Notification">
            <sequence>
                <element name="body">
                    <complexType>
                        <sequence>
                            <element name="id" type="xswmi:Id"/>
                        </sequence>
                    </complexType>
                </element>
            </sequence>
        </extension>
    </complexContent>
</complexType>
<complexType name="NotifySwMProfileCreation">
    <complexContent>
        <extension base="xe:Notification">
            <sequence>
                <element name="body">
                    <complexType>
                        <sequence>
                            <element name="id" type="xswmi:Id"/>
                            <element name="versionNumber" type="xswmi:VersionNumber"/>
                            <element name="nEInformation" type="xswmi:NEInformation"/>
                            <element name="swVersionToBeInstalled"
type="xswm:SwVersionToBeInstalledConditional"/>
                            <element name="stepsAndSelectedStopPointList">
                                <complexType>
                                    <complexContent>
                                        <extension base="xswmi:StepsAndSelectedStopPointList"/>
                                    </complexContent>
                                </complexType>
                            </element>
                            <element name="selectedFinalAdministrativeState"
type="xswmi:FinalAdministrativeStateValue"/>
                        </sequence>
                    </complexType>
                </element>
            </sequence>
        </extension>
    </complexContent>
</complexType>
<complexType name="NotifyDownloadNESwStatusChanged">
    <complexContent>
        <extension base="xe:Notification">
            <sequence>
                <element name="body">
                    <complexType>
                        <sequence>
                            <element name="downloadProcessId" type="xswm:RequestID"/>
                            <element name="downloadOperationStatus"
type="xswm:DownloadNESwOperationStatus"/>
                            <element name="downloadedNESwInfo" type="xswm:NESwInfo"
minOccurs="0"/>
                            <element name="failedSwInfo" type="xswm:FailedSwInfo"
minOccurs="0"/>
                        </sequence>
                    </complexType>
                </element>
            </sequence>
        </extension>
    </complexContent>

```



```

</complexType>
<complexType name="NotifyInstallNESwStatusChanged">
  <complexContent>
    <extension base="xe:Notification">
      <sequence>
        <element name="body">
          <complexType>
            <sequence>
              <element name="installProcessId" type="xswm:RequestID"/>
              <element name="installOperationStatus"
type="xswm:InstallNESwOperationStatus"/>
              <element name="installedNESwInfo" type="xswm:NESwInfo"
minOccurs="0"/>
              <element name="failedSwInfo" type="xswm:FailedSwInfo"
minOccurs="0"/>
            </sequence>
          </complexType>
        </element>
      </sequence>
    </extension>
  </complexContent>
</complexType>
<complexType name="NotifyActivateNESwStatusChanged">
  <complexContent>
    <extension base="xe:Notification">
      <sequence>
        <element name="body">
          <complexType>
            <sequence>
              <element name="activateProcessId" type="xswm:RequestID"/>
              <element name="activateOperationStatus"
type="xswm:ActivateNESwOperationStatus"/>
              <element name="swVersion" type="string"/>
              <element name="failureReason" type="xswm:FailureReason"
minOccurs="0"/>
            </sequence>
          </complexType>
        </element>
      </sequence>
    </extension>
  </complexContent>
</complexType>
<element name="NotifySwMPProfileCreation" type="xswm:NotifySwMPProfileCreation"/>
<element name="NotifySwMPProfileDeletion" type="xswm:NotifySwMPProfileDeletion"/>
<element name="NotifySwMPProcessCreation" type="xswm:NotifySwMPProcessCreation"/>
<element name="NotifySwMPProcessStage" type="xswm:NotifySwMPProcessStage"/>
<element name="NotifySwMPProcessDeletion" type="xswm:NotifySwMPProcessDeletion"/>
<element name="NotifyNewSwAvailability" type="xswm:NotifyNewSwAvailability"/>
<element name="NotifySwMPProfileChange" type="xswm:NotifySwMPProfileChange"/>
<element name="NotifyDownloadNESwStatusChanged" type="xswm:NotifyDownloadNESwStatusChanged"/>
<element name="NotifyActivateNESwStatusChanged" type="xswm:NotifyActivateNESwStatusChanged"/>
<element name="NotifyInstallNESwStatusChanged" type="xswm:NotifyInstallNESwStatusChanged"/>
</schema>

```

## B.3.4 XML Schema “swManagementIRPIOCs.xsd”

```

<?xml version="1.0" encoding="UTF-8"?>
<schema xmlns="http://www.w3.org/2001/XMLSchema"
xmlns:xswmi="http://www.3gpp.org/ftp/specs/archive/32_series/32.536#swManagementIRPIOCs"
xmlns:xn="http://www.3gpp.org/ftp/specs/archive/32_series/32.626#genericNrm"
targetNamespace="http://www.3gpp.org/ftp/specs/archive/32_series/32.536#swManagementIRPIOCs"
elementFormDefault="qualified" attributeFormDefault="unqualified">
  <import namespace="http://www.3gpp.org/ftp/specs/archive/32_series/32.626#genericNrm"
schemaLocation="genericNrm.xsd"/>
  <simpleType name="NEInformation">
    <restriction base="string"/>
  </simpleType>
  <simpleType name="Id">
    <restriction base="xn:dn"/>
  </simpleType>
  <simpleType name="VersionNumber">
    <restriction base="unsignedShort"/>
  </simpleType>
  <complexType name="ProfileId">
    <sequence>
      <element name="id" type="xswmi:Id"/>
      <element name="versionNumber" type="xswmi:VersionNumber"/>
    </sequence>
  </complexType>
  <simpleType name="FinalAdministrativeStateValue">
    <restriction base="string">
      <enumeration value="LOCKED"/>
      <enumeration value="UNLOCKED"/>
      <enumeration value="DETERMINED_BY_CONFIGURATION_DATA"/>
    </restriction>
  </simpleType>
  <complexType name="OfferedFinalAdministrativeStateInformation">
    <sequence>
      <element name="OfferedFinalAdministrativeStateValue"
type="xswmi:FinalAdministrativeStateValue" maxOccurs="3"/>
    </sequence>
  </complexType>
  <complexType name="StepsAndOfferedStopPointListEntry">
    <sequence>
      <element name="nameOfStep" type="xswmi:NameOfStep"/>
      <element name="sequenceNumberInProgress" type="xswmi:SequenceNumberInProgress"/>
      <element name="stopPointCanBeSetBeforeThisStep"
type="xswmi:StopPointCanBeSetBeforeThisStep"/>
    </sequence>
  </complexType>
  <complexType name="StepsAndOfferedStopPointList">
    <sequence>
      <element name="stepsAndOfferedStopPointListEntry"
type="xswmi:StepsAndOfferedStopPointListEntry" maxOccurs="unbounded"/>
    </sequence>
  </complexType>
  <simpleType name="StopPointCanBeSetBeforeThisStep">
    <restriction base="boolean"/>
  </simpleType>
  <complexType name="StepsAndSelectedStopPointListEntry">
    <sequence>
      <element name="nameOfStep" type="xswmi:NameOfStep"/>
      <element name="sequenceNumberInProgress" type="xswmi:SequenceNumberInProgress"/>
      <element name="stopPointSetIndication" type="xswmi:StopPointSetIndication"/>
    </sequence>
  </complexType>
  <complexType name="StepsAndSelectedStopPointList">
    <sequence>
      <element name="stepsAndSelectedStopPointListEntry"
type="xswmi:StepsAndSelectedStopPointListEntry" maxOccurs="unbounded"/>
    </sequence>
  </complexType>
  <simpleType name="StopPointSetIndication">
    <restriction base="string">
      <enumeration value="STOP_POINT_IS_SET_BEFORE_THIS_STEP"/>
      <enumeration value="STOP_POINT_IS_NOT_SET"/>
    </restriction>
  </simpleType>
  <simpleType name="SequenceNumberInProgress">
    <restriction base="unsignedShort"/>
  </simpleType>

```

```

</simpleType>
<simpleType name="NameOfStep">
  <restriction base="string">
    <enumeration value="NE_HEALTH_CHECK" />
    <enumeration value="SW_DOWNLOAD" />
    <enumeration value="SW_INSTALLATION" />
    <enumeration value="SW_ACTIVATION" />
    <enumeration value="PREPARE_BASIC_CONFIGURATION_AND_OAMLINK" />
    <enumeration value="RETRIEVE_CONFIGURATION_DATA" />
    <enumeration value="SETUP_PRECONFIGURED_SIGNALLING_LINKS" />
    <enumeration value="SET_FINAL_STATE_OF_NE" />
  </restriction>
</simpleType>
<simpleType name="StepProgress">
  <restriction base="string">
    <enumeration value="NOT_YET_STARTED" />
    <enumeration value="RUNNING" />
    <enumeration value="COMPLETED" />
    <enumeration value="AWAITING_RESUME" />
    <enumeration value="FAILURE" />
    <enumeration value="TERMINATED" />
  </restriction>
</simpleType>
<complexType name="StepInfoListEntry">
  <sequence>
    <element name="nameOfStep" type="xswmi:NameOfStep" />
    <element name="sequenceNumberInProgress" type="xswmi:SequenceNumberInProgress" />
    <element name="stopPointSetIndication" type="xswmi:StopPointSetIndication" />
    <element name="stepProgress" type="xswmi:StepProgress" />
  </sequence>
</complexType>
<complexType name="StepInfoList">
  <sequence>
    <element name="stepInfoListEntry" type="xswmi:StepInfoListEntry" maxOccurs="unbounded" />
  </sequence>
</complexType>
<complexType name="swMCapabilityIOC">
  <sequence>
    <element name="id" type="xswmi:Id" />
    <element name="neInformation" type="xswmi:NEInformation" />
    <element name="stepsAndOfferedStopPointList" type="xswmi:StepsAndOfferedStopPointList" />
    <element name="offeredFinalAdministrativeStateInformation"
type="xswmi:OfferedFinalAdministrativeStateInformation" />
  </sequence>
</complexType>
<simpleType name="ProcessStepNumber">
  <restriction base="unsignedShort" />
</simpleType>
<simpleType name="Hours">
  <restriction base="unsignedShort" />
</simpleType>
<simpleType name="Minutes">
  <restriction base="unsignedShort">
    <maxInclusive value="59" />
  </restriction>
</simpleType>
<simpleType name="Seconds">
  <restriction base="unsignedShort">
    <maxInclusive value="59" />
  </restriction>
</simpleType>
...<complexType name="HoursMinutesSeconds">
  <sequence>
    <element name="hours" type="xswmi:Hours" />
    <element name="minutes" type="xswmi:Minutes" />
    <element name="seconds" type="xswmi:Seconds" />
  </sequence>
</complexType>
<simpleType name="Naswm OperationType">
  <restriction base="string">
    <enumeration value="OPERATION_DOWNLOAD_NE_SW" />
    <enumeration value="OPERATION_ACTIVATE_NE_SW" />
    <enumeration value="OPERATION_INSTALL_NE_SW" />
  </restriction>
</simpleType>
...<complexType name="StepNumberAndDuration">
  <sequence>
    <element name="processStepNumber" type="xswmi:ProcessStepNumber" />

```

```

.....<element name="estimatedDuration" type="xswmi:HoursMinutesSeconds"/>
.....</sequence>
.....</complexType>
...<complexType name="ListOfStepNumbersAndDurations">
.....<sequence>
.....<element name="stepNumberAndDuration" type="xswmi:StepNumberAndDuration"
maxOccurs="unbounded"/>
.....</sequence>
.....</complexType>
...<complexType name="NaswmProcessInfo">
.....<sequence>
.....<element name="naswmId" type="xswmi:Id"/>
.....<element name="neIdentification" type="xswmi:NEInformation"/>
.....<element name="naswmOperationType" type="xswmi:NaswmOperationType"/>
.....<element name="estimatedRemainingCompletionTimeForTheOperation"
type="xswmi:HoursMinutesSeconds"/>
.....<element name="listOfStepNumbersAndDurations" type="xswmi:ProcessStepNumberOpt"
minOccurs="0"/>
.....<element name="numberOfCurrentProcessStep" type="xswmi:NumberOfCurrentProcessStep"
minOccurs="0"/>
.....<element name="estimatedRemainingCompletionTimeForTheCurrentStep"
type="xswmi:HoursMinutesSeconds" minOccurs="0"/>
.....</sequence>
.....</complexType>
...<complexType name="NaswmProcessList">
.....<sequence>
.....<element name="naswmProcessInfo" type="xswmi:NaswmProcessInfo" maxOccurs="unbounded"/>
.....</sequence>
.....</complexType>
.....<complexType name="swMProfileIOC">
.....<sequence>
.....<element name="id" type="xswmi:Id"/>
.....<element name="versionNumber" type="xswmi:VersionNumber"/>
.....<element name="neInformation" type="xswmi:NEInformation"/>
.....<element name="stepsAndSelectedStopPointList"
type="xswmi:StepsAndSelectedStopPointList"/>
.....<element name="selectedFinalAdministrativeState"
type="xswmi:FinalAdministrativeStateValue"/>
.....</sequence>
.....</complexType>
.....<complexType name="swMProcessIOC">
.....<sequence>
.....<element name="id" type="xswmi:Id"/>
.....<element name="neIdentification" type="xswmi:NEInformation"/>
.....<element name="profileId" type="xswmi:ProfileId"/>
.....<element name="stepInfoList" type="xswmi:StepInfoList"/>
.....</sequence>
.....</complexType>
</schema>

```

---

## Annex C (normative): SOAP Solution Set

The overall architectural feature of the Software Management IRP is specified in 3GPP TS 32.532 [5]. This clause specifies features that are specific to the SOAP solution set.

---

### C.1 Architectural Features

#### C.1.1 Syntax for Distinguished Names and versions

The syntax of a Distinguished Name is defined in 3GPP TS 32.300 [15].

#### C.1.2 General

The SOAP 1.1 specification [11] and WSDL 1.1 specification [13] are supported.

The SOAP 1.2 specification [14] is supported optionally.

This specification uses "document" style in WSDL file.

This specification uses "literal" encoding style in WSDL file.

The filter language used in the SS is the XPath Language (see W3C XPath 1.0 specification [12]). IRP Agents may throw a FilterComplexityLimit fault when a given filter is too complex.

Relevant definitions are imported from the Software Management XML definitions of Annex B.

This specification uses a number of namespace prefixes throughout that are listed in Table C.1.2.

**Table C.1.2: Prefixes and Namespaces used in this specification**

PREFIX	NAMESPACE
(no prefix)	<a href="http://schemas.xmlsoap.org/wsdl/">http://schemas.xmlsoap.org/wsdl/</a>
soap	<a href="http://schemas.xmlsoap.org/wsdl/soap/">http://schemas.xmlsoap.org/wsdl/soap/</a>
swMIRPSystem	<a href="http://www.3gpp.org/ftp/specs/archive/32_series/32.536#swMIRPSystem">http://www.3gpp.org/ftp/specs/archive/32_series/32.536#swMIRPSystem</a>
swMIRPData	<a href="http://www.3gpp.org/ftp/specs/archive/32_series/32.536#swMIRPData">http://www.3gpp.org/ftp/specs/archive/32_series/32.536#swMIRPData</a>
xswmi	<a href="http://www.3gpp.org/ftp/specs/archive/32_series/32.536#swManagementIRPIOCs">http://www.3gpp.org/ftp/specs/archive/32_series/32.536#swManagementIRPIOCs</a>
genericIRPSystem	<a href="http://www.3gpp.org/ftp/specs/archive/32_series/32.316#GenericIRPSystem">http://www.3gpp.org/ftp/specs/archive/32_series/32.316#GenericIRPSystem</a>
ntfIRPNtfSystem	<a href="http://www.3gpp.org/ftp/specs/archive/32_series/32.536#NotificationSwNtfSystem">http://www.3gpp.org/ftp/specs/archive/32_series/32.536#NotificationSwNtfSystem</a>

---

### C.2 Mapping

#### C.2.1 Operation and Notification mapping

The Software Management IRP IS (3GPP TS 32.532 [5]) defines the operations and their semantics.

Table C.2.1 maps the operations defined in the Software Management IRP IS to their equivalent port type and binding operations in this Solution Set (SS).

Table C.2.1 also maps the notifications of the Software Management IRP IS, as well as inherited operations.

Table C.2.1 also qualifies if an operation is Mandatory (M) or Optional (O).

Table C.2.1: Mapping from IS Operation to SS Equivalents

IS Operation in 3GPP TS 32.532 [5]	SS: Operation for WSDL port type and WSDL binding	SS: Port of EntryPointIRPService	Qualifier
listSwMCapabilities	listSwMCapabilities (NOTE1)	SwMIRPOperation1	M
listSwMProfiles	listSwMProfiles (NOTE1)	SwMIRPOperation1	M
createSwMProfile	createSwMProfile (NOTE1)	SwMIRPOperation1	M
deleteSwMProfile	deleteSwMProfile (NOTE1)	SwMIRPOperation1	M
listSwMProcesses	listSwMProcesses (NOTE1)	SwMIRPOperation1	M
resumeSwMProcess	resumeSwMProcess (NOTE1)	SwMIRPOperation1	M
swFallback	swFallback (NOTE1)	SwMIRPOperation1	M
terminateSwMProcess	terminateSwMProcess (NOTE1)	SwMIRPOperation1	M
changeSwMProfile	changeSwMProfile (NOTE1)	SwMIRPOperation2	O
downloadNESw	downloadNESw (NOTE1)	SwMIRPOperation3	M
activateNESw	activateNESw (NOTE1)	SwMIRPOperation3	O
installNESw	installNESw (NOTE1)	SwMIRPOperation4	M
notifySwMProfileCreation	notifySwMProfileCreation (NOTE2)	NotificationIRPNtfPort	M
notifySwMProfileDeletion	notifySwMProfileDeletion (NOTE2)	NotificationIRPNtfPort	M
notifySwMProcessCreation	notifySwMProcessCreation (NOTE2)	NotificationIRPNtfPort	M
notifySwMProcessStage	notifySwMProcessStage (NOTE2)	NotificationIRPNtfPort	M
notifySwMProcessDeletion	notifySwMProcessDeletion (NOTE2)	NotificationIRPNtfPort	M
notifyNewSwAvailability	notifyNewSwAvailability (NOTE2)	NotificationIRPNtfPort	M
notifySwMProfileChange	notifySwMProfileChange (NOTE2)	NotificationIRPNtfPort	O
notifyDownloadNESwStatusChanged	notifyDownloadNESwStatusChanged (NOTE2)	NotificationIRPNtfPort	M
notifyInstallNESwStatusChanged	notifyInstallNESwStatusChanged (NOTE2)	NotificationIRPNtfPort	O
notifyActivateNESwStatusChanged	notifyActivateNESwStatusChanged (NOTE2)	NotificationIRPNtfPort	M
NOTE 1: The operation is under the port type SwMIRPSystem:SwMIRPPortType and under the binding SwMIRPSystem:SwMIRPBinding.			
NOTE 2: The IS equivalent maps to an XML definition specified in Annex B, and this being an input parameter to the operation notify under the port type ntfIRPNtfSystem:NotificationIRPNtf and under the binding ntfIRPNtfSystem:NotificationIRPNtf of 3GPP TS 32.306 [10]. This binding is linked to a port of the SwMIRPService as indicated in the table above.			

## C.2.2 Operation parameter mapping

The SwMIRP IS (3GPP TS 32.532 [5]) defines semantics of parameters carried in the operations. The tables below show the mapping of these parameters, as per operation, to their equivalents defined in this SS.

### C.2.2.1 Operation listSwMCapabilities

#### C.2.2.1.1 Input parameters

Table C.2.2.1.1: Mapping from IS listSwMCapabilities input parameters to SS equivalents

IS Operation parameter	SS WSDL type sub-element used in corresponding input message under corresponding port type operation as indicated in Table C.2.1	Qualifier
nEInformation	nEInformation	M

## C.2.2.1.2 Output parameters

**Table C.2.2.1.2: Mapping from IS listSwMCapabilities output parameters to SS equivalents**

IS Operation parameter	SS WSDL type sub-element used in corresponding output message under corresponding port type operation as indicated in Table C.2.1	Qualifier
capabilityList	capabilityList	M
result	result	M

## C.2.2.1.3 Fault definition

**Table C.2.2.1.3: Mapping from IS listSwMCapabilities exceptions to SS equivalents**

Assertion name	SS WSDL type enumeration value used in corresponding fault message under corresponding port type operation as indicated in Table C.2.1	Qualifier
operation_failed	operation_failed	M

## C.2.2.2 Operation listSwMProfiles

## C.2.2.2.1 Input parameters

**TableC.2.2.2.1: Mapping from IS listSwMProfiles input parameters to SS equivalents**

IS Operation parameter	SS WSDL type sub-element used in corresponding input message under corresponding port type operation as indicated in Table C.2.1	Qualifier
nEInformation	nEInformation	M

## C.2.2.2.2 Output parameters

**TableC.2.2.2.2: Mapping from IS listSwMProfiles output parameters to SS equivalents**

IS Operation parameter	SS WSDL type sub-element used in corresponding output message under corresponding port type operation as indicated in Table C.2.1	Qualifier
swMProfileList	swMProfileList	M
result	result	M

### C.2.2.3 Operation createSwMProfile

#### C.2.2.3.1 Input parameters

**TableC.2.2.3.1: Mapping from IS createSwMProfile input parameters to SS equivalents**

IS Operation parameter	SS WSDL type sub-element used in corresponding input message under corresponding port type operation as indicated in Table C.2.1	Qualifier
id	id	O
nEInformation	nEInformation	M
swVersionToBeInstalled	swVersionToBeInstalled	M
stepsAndSelectedStopPointList	stepsAndSelectedStopPointList	M
selectedFinalAdministrativeState	selectedFinalAdministrativeState	M

#### C.2.2.3.2 Output parameters

**Table C.2.2.3.2: Mapping from IS createSwMProfile output parameters to SS equivalents**

IS Operation parameter	SS WSDL type sub-element used in corresponding output message under corresponding port type operation as indicated in Table C.2.1	Qualifier
id	id	CM
result	result	M

### C.2.2.4 Operation deleteSwMProfile

#### C.2.2.4.1 Input parameters

**TableC.2.2.4.1: Mapping from IS deleteSwMProfile input parameters to SS equivalents**

IS Operation parameter	SS WSDL type sub-element used in corresponding input message under corresponding port type operation as indicated in Table C.2.1	Qualifier
id	id	M

#### C.2.2.4.2 Output parameters

**Table C.2.2.4.2: Mapping from IS deleteSwMProfile output parameters to SS equivalents**

IS Operation parameter	SS WSDL type sub-element used in corresponding output message under corresponding port type operation as indicated in Table C.2.1	Qualifier
result	result	M



## C.2.2.5 Operation `listSwMProcesses`

### C.2.2.5.1 Input parameters

**Table C.2.2.5.1: Mapping from IS `listSwMProcesses` input parameters to SS equivalents**

IS Operation parameter	SS WSDL type sub-element used in corresponding input message under corresponding port type operation as indicated in Table C.2.1	Qualifier
<code>nEIdentification</code>	<code>nEIdentification</code>	O

### C.2.2.5.2 Output parameters

**Table C.2.2.5.2: Mapping from IS `listSwMProcesses` output parameters to SS equivalents**

IS Operation parameter	SS WSDL type sub-element used in corresponding output message under corresponding port type operation as indicated in Table C.2.1	Qualifier
<code>swMprocessList</code>	<code>swMprocessList</code>	M
<code>result</code>	<code>result</code>	M

## C.2.2.6 Operation `resumeSwMProcess`

### C.2.2.6.1 Input parameters

**Table C.2.2.6.1: Mapping from IS `resumeSwMProcess` input parameters to SS equivalents**

IS Operation parameter	SS WSDL type sub-element used in corresponding input message under corresponding port type operation as indicated in Table C.2.1	Qualifier
<code>id</code>	<code>id</code>	M
<code>startStepName</code>	<code>startStepName</code>	M

### C.2.2.6.2 Output parameters

**Table C.2.2.6.2: Mapping from IS `resumeSwMProcess` output parameters to SS equivalents**

IS Operation parameter	SS WSDL type sub-element used in corresponding output message under corresponding port type operation as indicated in Table C.2.1	Qualifier
<code>result</code>	<code>result</code>	M

## C.2.2.7 Operation `swFallback`

### C.2.2.7.1 Input parameters

**Table C.2.2.7.1: Mapping from IS `swFallback` input parameters to SS equivalents**

IS Operation parameter	SS WSDL type sub-element used in corresponding input message under corresponding port type operation as indicated in Table C.2.1	Qualifier
<code>filter</code>	<code>filter</code>	M

### C.2.2.7.2 Output parameters

**Table C.2.2.7.2: Mapping from IS `swFallback` output parameters to SS equivalents**

IS Operation parameter	SS WSDL type sub-element used in corresponding output message under corresponding port type operation as indicated in Table C.2.1	Qualifier
<code>nEList</code>	<code>nEList</code>	M
<code>result</code>	<code>result</code>	M

## C.2.2.8 Operation `terminateSwMProcess`

### C.2.2.8.1 Input parameters

**Table C.2.2.8.1: Mapping from IS `terminateSwMProcess` input parameters to SS equivalents**

IS Operation parameter	SS WSDL type sub-element used in corresponding input message under corresponding port type operation as indicated in Table C.2.1	Qualifier
<code>id</code>	<code>id</code>	M

### C.2.2.8.2 Output parameters

**Table C.2.2.8.2: Mapping from IS `terminateSwMProcess` output parameters to SS equivalents**

IS Operation parameter	SS WSDL type sub-element used in corresponding output message under corresponding port type operation as indicated in Table C.2.1	Qualifier
<code>result</code>	<code>result</code>	M

## C.2.2.9 Operation changeSwMProfile

### C.2.2.9.1 Input parameters

**Table C.2.2.9.1: Mapping from IS changeSwMProfile input parameters to SS equivalents**

IS Operation parameter	SS WSDL type sub-element used in corresponding input message under corresponding port type operation as indicated in Table C.2.1	Qualifier
id	id	M
nEInformation	nEInformation	M
swVersionToBeInstalled	swVersionToBeInstalled	M
stepsAndSelectedStopPointList	stepsAndSelectedStopPointList	M
selectedFinalAdministrativeState	selectedFinalAdministrativeState	M

### C.2.2.9.2 Output parameters

**Table C.2.2.9.2: Mapping from IS changeSwMProfile input parameters to SS equivalents**

IS Operation parameter	SS WSDL type sub-element used in corresponding output message under corresponding port type operation as indicated in Table C.2.1	Qualifier
result	result	M
versionNumber	versionNumber	M
conflictingProfileId	conflictingProfileId	C

## C.2.2.10 Operation downloadNESw

### C.2.2.10.1 Input parameters

**Table C.2.2.10.1: Mapping from IS downloadNESw input parameters to SS equivalents**

IS Operation parameter	SS WSDL type sub-element used in corresponding input message under corresponding port type operation as indicated in Table C.2.1	Qualifier
swToBeDownloaded	swToBeDownloaded	M
neIdentifier	neIdentifier	M

### C.2.2.10.2 Output parameters

**Table C.2.2.10.2: Mapping from IS downloadNESw output parameters to SS equivalents**

IS Operation parameter	SS WSDL type sub-element used in corresponding output message under corresponding port type operation as indicated in Table C.2.1	Qualifier
downloadProcessId	downloadProcessId	M
result	result	M
reason	reason	O
listOfStepNumbersAndDurations	listOfStepNumbersAndDurations	<b>CM *)</b>

\*) Note: For the condition see TS 32.532 [5].

## C.2.2.10.3 Fault definition

**Table C.2.2.10.3: Mapping from IS downloadNESw exceptions to SS equivalents**

Assertion name	SS WSDL type enumeration value used in corresponding fault message under corresponding port type operation as indicated in Table C.2.1	Qualifier
operationFailed	operationFailed	M
resourceLimitation	resourceLimitation	M

## C.2.2.11 Operation activateNESw

## C.2.2.11.1 Input parameters

**Table C.2.2.11.1: Mapping from IS activateNESw input parameters to SS equivalents**

IS Operation parameter	SS WSDL type sub-element used in corresponding input message under corresponding port type operation as indicated in Table C.2.1	Qualifier
swVersionToBeActivated	swVersionToBeActivated	M
neIdentifier	neIdentifier	M

## C.2.2.11.2 Output parameters

**Table C.2.2.11.2: Mapping from IS activateNESw output parameters to SS equivalents**

IS Operation parameter	SS WSDL type sub-element used in corresponding output message under corresponding port type operation as indicated in Table C.2.1	Qualifier
activateProcessId	activateProcessId	M
result	result	M
reason	reason	O
listOfStepNumbersAndDurations	listOfStepNumbersAndDurations	CM *)

\*) Note: For the condition see TS 32.532 [5].

## C.2.2.11.3 Fault definition

**Table C.2.2.11.3: Mapping from IS activateNESw exceptions to SS equivalents**

Assertion name	SS WSDL type enumeration value used in corresponding fault message under corresponding port type operation as indicated in Table C.2.1	Qualifier
operationFailed	operationFailed	M
resourceLimitation	resourceLimitation	M

## C.2.2.12 Operation `installNESw`

### C.2.2.12.1 Input parameters

**Table C.2.2.12.1: Mapping from IS `installNESw` input parameters to SS equivalents**

IS Operation parameter	SS WSDL type sub-element used in corresponding input message under corresponding port type operation as indicated in Table C.2.1	Qualifier
<code>swTobeInstalled</code>	<code>swTobeInstalled</code>	M
<code>neIdentifier</code>	<code>neIdentifier</code>	M

### C.2.2.12.2 Output parameters

**Table C.2.2.12.2: Mapping from IS `installNESw` output parameters to SS equivalents**

IS Operation parameter	SS WSDL type sub-element used in corresponding output message under corresponding port type operation as indicated in Table C.2.1	Qualifier
<code>installProcessId</code>	<code>installProcessId</code>	M
<code>result</code>	<code>result</code>	M
<code>reason</code>	<code>reason</code>	O
<code>listOfStepNumbersAndDurations</code>	<code>listOfStepNumbersAndDurations</code>	CM *)

\*) Note: For the condition see TS 32.532 [5].

### C.2.2.12.3 Fault definition

**Table C.2.2.12.3: Mapping from IS `installNESw` exceptions to SS equivalents**

Assertion name	SS WSDL type enumeration value used in corresponding fault message under corresponding port type operation as indicated in Table C.2.1	Qualifier
<code>operationFailed</code>	<code>operationFailed</code>	M
<code>resourceLimitation</code>	<code>resourceLimitation</code>	M
<code>swNotAvailable</code>	<code>swNotAvailable</code>	M

## C.2.2.13 Operation `listNaswmProcesses`

### C.2.2.13.1 Input parameters

**Table C.2.2.13.1: Mapping from IS `listNaswmProcesses` input parameters to SS equivalents**

IS Operation parameter	SS WSDL type sub-element used in corresponding input message under corresponding port type operation as indicated in Table C.2.1	Qualifier
<code>naswmId</code>	<code>id</code>	O
<code>naswmOperationType</code>	<code>naswmOperationType</code>	M

## C.2.2.13.2 Output parameters

Table C.2.2.13.2: Mapping from IS `listNaswmProcesses` output parameters to SS equivalents

IS Operation parameter	SS WSDL type sub-element used in corresponding output message under corresponding port type operation as indicated in Table C.2.1	Qualifier
<code>naswmProcessList</code>	<code>naswmProcessList</code>	M
<code>result</code>	<code>result</code>	M
<code>reason</code>	<code>reason</code>	O

## C.2.2.13.3 Fault definition

Table C.2.2.13.3: Mapping from IS `listNaswmProcesses` exceptions to SS equivalents

Assertion name	SS WSDL type enumeration value used in corresponding fault message under corresponding port type operation as indicated in Table C.2.1	Qualifier
<code>operationFailed</code>	<code>operationFailed</code>	M
<code>resourceLimitation</code>	<code>resourceLimitation</code>	M
<code>operationIsAlreadyCompleted</code>	<code>operationIsAlreadyCompleted</code>	M
<code>noSuchProcess</code>	<code>noSuchProcess</code>	M

C.2.2.14 Operation `cancelNaswmProcesses`

## C.2.2.14.1 Input parameters

Table C.2.2.14.1: Mapping from IS `cancelNaswmProcesses` input parameters to SS equivalents

IS Operation parameter	SS WSDL type sub-element used in corresponding input message under corresponding port type operation as indicated in Table C.2.1	Qualifier
<code>processId</code>	<code>Id</code>	M
<code>naswmOperationType</code>	<code>NaswmOperationType</code>	M

## C.2.2.14.2 Output parameters

Table C.2.2.14.2: Mapping from IS `cancelNaswmProcesses` output parameters to SS equivalents

IS Operation parameter	SS WSDL type sub-element used in corresponding output message under corresponding port type operation as indicated in Table C.2.1	Qualifier
<code>Result</code>	<code>Result</code>	M
<code>Reason</code>	<code>Reason</code>	O

C.2.2.14.3 Fault definition

Table C.2.2.14.3: Mapping from IS cancelNaswmmProcesses exceptions to SS equivalents

Assertion name	SS WSDL type enumeration value used in corresponding fault message under corresponding port type operation as indicated in Table C.2.1	Qualifier
operationFailed	operationFailed	M
resourceLimitation	resourceLimitation	M

## C.3 Solution Set definitions

### C.3.1 WSDL definition structure

Clause C.3.2 provides a graphical representation of the Software management IRP service.

Clause C.3.3 defines the services which are supported the Software management IRP agent.

### C.3.2 Graphical Representation

The WSDL structure is depicted in Figure C.3.2 below, depicting port type, binding and service. The port type contains port type operations, which again contains input, output and fault messages. The binding contains binding operations, which have the same name as the port type operations. The binding connects to a port inside the service.

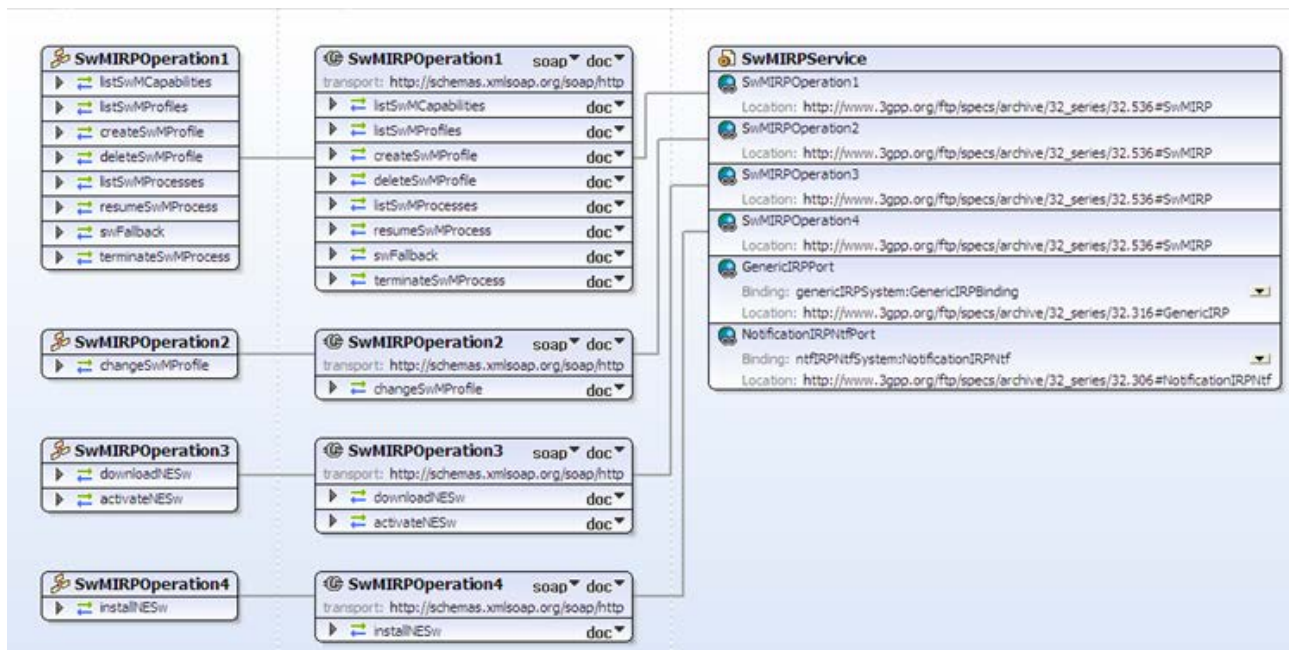

Figure C.3.2: Software Management IRP SOAP Solution Set WSDL structure

### C.3.3 WSDL specification "SWMIRPSYSTEM.wsdl"

```

<?xml version="1.0" encoding="UTF-8"?>
<!--
  3GPP TS 32.536 Software Management IRP SOAP Solution Set
-->
<definitions xmlns="http://schemas.xmlsoap.org/wsdl/"
  xmlns:soap="http://schemas.xmlsoap.org/wsdl/soap/"
  xmlns:swMIRPSYSTEM="http://www.3gpp.org/ftp/specs/archive/32_series/32.536#SWMIRPSYSTEM"
  xmlns:swMIRPData="http://www.3gpp.org/ftp/specs/archive/32_series/32.536#swMIRPData"
  xmlns:xswmi="http://www.3gpp.org/ftp/specs/archive/32_series/32.536#swMIRPIOCs"
  xmlns:xn="http://www.3gpp.org/ftp/specs/archive/32_series/32.626#genericNrm"
  xmlns:genericIRPSYSTEM="http://www.3gpp.org/ftp/specs/archive/32_series/32.316#GenericIRPSYSTEM"
  xmlns:ntfIRPNtfSystem="http://www.3gpp.org/ftp/specs/archive/32_series/32.306#NotificationIRPNtfSystem"
  xmlns:ns="http://www.w3.org/2001/XMLSchema"
  targetNamespace="http://www.3gpp.org/ftp/specs/archive/32_series/32.536#SWMIRPSYSTEM">
  <import
    namespace="http://www.3gpp.org/ftp/specs/archive/32_series/32.306#NotificationIRPNtfSystem"/>
    <import namespace="http://www.3gpp.org/ftp/specs/archive/32_series/32.316#GenericIRPSYSTEM"/>
    <types>
      <schema xmlns="http://www.w3.org/2001/XMLSchema"
        xmlns:xswmi="http://www.3gpp.org/ftp/specs/archive/32_series/32.536#swManagementIRPIOCs"
        targetNamespace="http://www.3gpp.org/ftp/specs/archive/32_series/32.536#SWMIRPData">
        <import
          namespace="http://www.3gpp.org/ftp/specs/archive/32_series/32.536#swManagementIRPIOCs"/>
          <import namespace="http://www.3gpp.org/ftp/specs/archive/32_series/32.626#genericNrm"/>
          <!-- The following types are defined for the SW IRP operations -->
          <complexType name="capability">
            <sequence>
              <element name="Id" type="xswmi:Id"/>
              <element name="NEInformation" type="xswmi:NEInformation"/>
              <element name="StepsAndOfferedStopPointList"
                type="xswmi:StepsAndOfferedStopPointList"/>
              <element name="OfferedFinalAdministrativeStateInformation"
                type="xswmi:OfferedFinalAdministrativeStateInformation"/>
            </sequence>
          </complexType>
          <complexType name="capabilityList">
            <sequence>
              <element name="capability" type="swMIRPData:capability" maxOccurs="unbounded"/>
            </sequence>
          </complexType>
          <complexType name="swMProfile">
            <sequence>
              <element name="Id" type="xswmi:Id"/>
              <element name="VersionNumber" type="xswmi:VersionNumber"/>
              <element name="NEInformation" type="xswmi:NEInformation"/>
              <element name="StepsAndSelectedStopPointList"
                type="xswmi:StepsAndSelectedStopPointList"/>
              <element name="FinalAdministrativeStateValue"
                type="xswmi:FinalAdministrativeStateValue"/>
              <element name="swVersionToBeInstalled" type="xswmi:VersionNumber"
                minOccurs="0"/>
            </sequence>
          </complexType>
          <complexType name="swMProfileList">
            <sequence>
              <element name="swMProfile" type="swMIRPData:swMProfile" maxOccurs="unbounded"/>
            </sequence>
          </complexType>
          <complexType name="swMprocess">
            <sequence>
              <element name="Id" type="xswmi:Id"/>
              <element name="NEInformation" type="xswmi:NEInformation"/>
              <element name="ProfileId" type="xswmi:ProfileId"/>
              <element name="StepInfoList" type="xswmi:StepInfoList"/>
            </sequence>
          </complexType>
          <complexType name="swMprocessList">
            <sequence>
              <element name="swMprocess" type="swMIRPData:swMprocess" maxOccurs="unbounded"/>
            </sequence>
          </complexType>
          <complexType name="startStepName">
            <sequence>
              <element name="startStepName" type="xswmi:NameOfStep"/>
            </sequence>
          </complexType>
        </schema>
    </types>
  </definitions>

```



```

    </sequence>
  </complexType>
  <complexType name="nEList">
    <sequence>
      <element name="nEIdentification" type="xswmi:Id"/>
      <element name="swFallbackStatus">
        <simpleType>
          <restriction base="string">
            <enumeration value="fallbackSuccessful"/>
            <enumeration value="fallbackUnsuccessful"/>
          </restriction>
        </simpleType>
      </element>
      <element name="VersionNumber" type="xswmi:VersionNumber"/>
    </sequence>
  </complexType>
  <complexType name="StepsAndSelectedStopPointListEntry">
    <sequence>
      <element name="nameOfStep" type="xswmi:NameOfStep"/>
      <element name="sequenceNumberInProgress" type="xswmi:SequenceNumberInProgress"/>
      <element name="stopPointSetIndication" type="xswmi:StopPointSetIndication"/>
    </sequence>
  </complexType>
  <complexType name="StepsAndSelectedStopPointList">
    <sequence>
      <element name="stepsAndSelectedStopPointListEntry"
type="swMIRPData:StepsAndSelectedStopPointListEntry" maxOccurs="unbounded"/>
    </sequence>
  </complexType>
  <complexType name="SelectedFinalAdministrativeState">
    <sequence>
      <element name="SelectedFinalAdministrativeState"
type="xswmi:FinalAdministrativeStateValue" maxOccurs="3"/>
    </sequence>
  </complexType>
  <simpleType name="swLocation">
    <restriction base="string"/>
  </simpleType>
  <simpleType name="swFileSize">
    <restriction base="unsignedLong"/>
  </simpleType>
  <simpleType name="swFileCompression">
    <restriction base="string"/>
  </simpleType>
  <simpleType name="swFileFormat">
    <restriction base="string"/>
  </simpleType>
  <simpleType name="swVersion">
    <restriction base="string"/>
  </simpleType>
  <complexType name="swToBeDownloaded">
    <sequence>
      <element name="swLocation" type="swMIRPData:swLocation"/>
      <element name="swFileSize" type="swMIRPData:swFileSize"/>
      <element name="swFileCompression" type="swMIRPData:swFileCompression"/>
      <element name="swFileFormat" type="swMIRPData:swFileFormat"/>
    </sequence>
  </complexType>
  <complexType name="swVersionToBeActivated">
    <sequence>
      <element name="swVersion" type="swMIRPData:swVersion"/>
    </sequence>
  </complexType>
  <complexType name="swTobeInstalled">
    <sequence>
      <element name="swLocation" type="swMIRPData:swLocation"/>
    </sequence>
  </complexType>
  <!--listSwMCapabilities Request-->
  <element name="listSwMCapabilitiesRequest">
    <complexType>
      <sequence>
        <element name="nEInformation" type="xswmi:NEInformation"/>
      </sequence>
    </complexType>
  </element>
  <!--listSwMCapabilities Response -->
  <element name="listSwMCapabilitiesResponse">

```

```

    <complexType>
      <sequence>
        <element name="result">
          <simpleType>
            <restriction base="string">
              <enumeration value="success"/>
              <enumeration value="failure"/>
              <enumeration value="stepNameNotMatch"/>
              <enumeration value="nEInformationIntersection"/>
            </restriction>
          </simpleType>
        </element>
        <element name="capabilityList" type="swMIRPData:capabilityList"/>
      </sequence>
    </complexType>
  </element>
  <!--listSwMCapabilities Fault -->
  <element name="listSwMCapabilitiesFault">
    <simpleType>
      <restriction base="string">
        <enumeration value="operationfailed"/>
      </restriction>
    </simpleType>
  </element>
  <!--listSwMProfiles Request -->
  <element name="listSwMProfilesRequest">
    <complexType>
      <sequence>
        <element name="nEInformation" type="xswmi:NEInformation"/>
      </sequence>
    </complexType>
  </element>
  <!--listSwMProfiles Response -->
  <element name="listSwMProfilesResponse">
    <complexType>
      <sequence>
        <element name="swMProfileList" type="swMIRPData:swMProfileList"/>
        <element name="result">
          <simpleType>
            <restriction base="string">
              <enumeration value="success"/>
              <enumeration value="failure"/>
              <enumeration value="stepNameNotMatch"/>
              <enumeration value="nEInformationIntersection"/>
            </restriction>
          </simpleType>
        </element>
      </sequence>
    </complexType>
  </element>
  <!--createSwMProfile Request -->
  <element name="createSwMProfileRequest">
    <complexType>
      <sequence>
        <element name="id" type="xswmi:Id" minOccurs="0"/>
        <element name="nEInformation" type="xswmi:NEInformation"/>
        <element name="swVersionToBeInstalled" type="swMIRPData:swVersion"/>
        <element name="stepsAndSelectedStopPointList"
type="swMIRPData:StepsAndSelectedStopPointList"/>
        <element name="selectedFinalAdministrativeState"
type="swMIRPData:SelectedFinalAdministrativeState"/>
      </sequence>
    </complexType>
  </element>
  <!--createSwMProfile Response -->
  <element name="createSwMProfileResponse">
    <complexType>
      <sequence>
        <element name="id" type="xswmi:Id" minOccurs="0"/>
        <element name="result">
          <simpleType>
            <restriction base="string">
              <enumeration value="Success"/>
              <enumeration value="Failure"/>
              <enumeration value="nEInformationIntersection"/>
              <enumeration value="notAllowedBecauseOfOngoingSwmActivity"/>
            </restriction>
          </simpleType>
        </element>
      </sequence>
    </complexType>
  </element>

```

```

        </element>
      </sequence>
    </complexType>
  </element>
  <!--deleteSwMPProfile Request -->
  <element name="deleteSwMPProfileRequest">
    <complexType>
      <sequence>
        <element name="id" type="xswmi:Id"/>
      </sequence>
    </complexType>
  </element>
  <!--deleteSwMPProfile Response -->
  <element name="deleteSwMPProfileResponse">
    <complexType>
      <sequence>
        <element name="result">
          <simpleType>
            <restriction base="string">
              <enumeration value="success"/>
              <enumeration value="failure"/>
              <enumeration value="stepNameNotMatch"/>
              <enumeration value="nEInformationIntersection"/>
            </restriction>
          </simpleType>
        </element>
      </sequence>
    </complexType>
  </element>
  <!--listSwMPProcesses Request -->
  <element name="listSwMPProcessesRequest">
    <complexType>
      <sequence>
        <element name="nEIdentification" type="xswmi:Id" minOccurs="0"/>
      </sequence>
    </complexType>
  </element>
  <!--listSwMPProcesses Response -->
  <element name="listSwMPProcessesResponse">
    <complexType>
      <sequence>
        <element name="swMprocessList" type="swMIRPData:swMprocessList"/>
        <element name="result">
          <simpleType>
            <restriction base="string">
              <enumeration value="success"/>
              <enumeration value="failure"/>
              <enumeration value="stepNameNotMatch"/>
              <enumeration value="nEInformationIntersection"/>
            </restriction>
          </simpleType>
        </element>
      </sequence>
    </complexType>
  </element>
  <!--resumeSwMPProcess Request -->
  <element name="resumeSwMPProcessRequest">
    <complexType>
      <sequence>
        <element name="id" type="xswmi:Id"/>
        <element name="startStepName" type="swMIRPData:startStepName"/>
      </sequence>
    </complexType>
  </element>
  <!--resumeSwMPProcess Response -->
  <element name="resumeSwMPProcessResponse">
    <complexType>
      <sequence>
        <element name="result">
          <simpleType>
            <restriction base="string">
              <enumeration value="success"/>
              <enumeration value="failure"/>
              <enumeration value="stepNameNotMatch"/>
              <enumeration value="nEInformationIntersection"/>
            </restriction>
          </simpleType>
        </element>
      </sequence>
    </complexType>
  </element>

```

```

        </sequence>
      </complexType>
    </element>
    <!--swFallback Request -->
    <element name="swFallbackRequest">
      <complexType>
        <sequence>
          <element name="filter" type="string"/>
        </sequence>
      </complexType>
    </element>
    <!--swFallback Response -->
    <element name="swFallbackResponse">
      <complexType>
        <sequence>
          <element name="nEList" type="swMIRPData:nEList"/>
          <element name="result">
            <simpleType>
              <restriction base="string">
                <enumeration value="Success"/>
                <enumeration value="Partly successful"/>
                <enumeration value="Failure"/>
              </restriction>
            </simpleType>
          </element>
        </sequence>
      </complexType>
    </element>
    <!--terminateSwMProcess Request -->
    <element name="terminateSwMProcessRequest">
      <complexType>
        <sequence>
          <element name="id" type="xswmi:Id"/>
        </sequence>
      </complexType>
    </element>
    <!--terminateSwMProcess Response -->
    <element name="terminateSwMProcessResponse">
      <complexType>
        <sequence>
          <element name="result">
            <simpleType>
              <restriction base="string">
                <enumeration value="success"/>
                <enumeration value="failure"/>
                <enumeration value="stepNameNotMatch"/>
                <enumeration value="nEInformationIntersection"/>
              </restriction>
            </simpleType>
          </element>
        </sequence>
      </complexType>
    </element>
    <!--changeSwMProfile Request -->
    <element name="changeSwMProfileRequest">
      <complexType>
        <sequence>
          <element name="id" type="xswmi:Id"/>
          <element name="nEInformation" type="xswmi:NEInformation"/>
          <element name="swVersionTobeInstalled" type="swMIRPData:swTobeInstalled"/>
          <element name="stepsAndSelectedStopPointList"
type="swMIRPData:StepsAndSelectedStopPointList"/>
          <element name="selectedFinalAdministrativeState"
type="swMIRPData:SelectedFinalAdministrativeState"/>
        </sequence>
      </complexType>
    </element>
    <!--changeSwMProfile Response -->
    <element name="changeSwMProfileResponse">
      <complexType>
        <sequence>
          <element name="result">
            <simpleType>
              <restriction base="string">
                <enumeration value="Success"/>
                <enumeration value="Failure"/>
                <enumeration value="nEInformationIntersection"/>
                <enumeration value="notAllowedBecauseOfOngoingSwmActivity"/>
              </restriction>
            </simpleType>
          </element>
        </sequence>
      </complexType>
    </element>

```

```

        </restriction>
      </simpleType>
    </element>
  <element name="versionNumber" type="xswmi:VersionNumber"/>
  <element name="conflictingProfileId" minOccurs="0">
    <simpleType>
      <restriction base="string">
        <enumeration value="swMprofileId"/>
        <enumeration value="swMprofileAId"/>
        <enumeration value="swMprofileBId"/>
        <enumeration value="empty"/>
      </restriction>
    </simpleType>
  </element>
</sequence>
</complexType>
</element>
<!--downloadNESw Request -->
<element name="downloadNESwRequest">
  <complexType>
    <sequence>
      <element name="swToBeDownloaded" type="swMIRPData:swToBeDownloaded"/>
      <element name="neIdentifier" type="xswmi:Id"/>
    </sequence>
  </complexType>
</element>
<!--downloadNESw Response -->
<element name="downloadNESwResponse">
  <complexType>
    <sequence>
      <element name="downloadProcessId" type="integer"/>
      <element name="listOfStepNumbersAndDurations"
type="xswmi:ListOfStepNumbersAndDurations" minOccurs="0"/>
      <element name="result">
        <simpleType>
          <restriction base="string">
            <enumeration value="requestAccepted"/>
            <enumeration value="requestFailed"/>
            <enumeration value="notAllowedBecauseOfOngoingSwmActivity"/>
          </restriction>
        </simpleType>
      </element>
      <element name="reason" minOccurs="0">
        <simpleType>
          <restriction base="string"/>
        </simpleType>
      </element>
    </sequence>
  </complexType>
</element>
<!--downloadNESw Fault -->
<element name="downloadNESwFault">
  <simpleType>
    <restriction base="string">
      <enumeration value="operationFailed"/>
      <enumeration value="resourceLimitation"/>
    </restriction>
  </simpleType>
</element>
<!--installNESw Request -->
<element name="installNESwRequest">
  <complexType>
    <sequence>
      <element name="swTobeInstalled" type="swMIRPData:swTobeInstalled"/>
      <element name="neIdentifier" type="xswmi:Id"/>
    </sequence>
  </complexType>
</element>
<!--installNESw Response -->
<element name="installNESwResponse">
  <complexType>
    <sequence>
      <element name="installProcessId" type="integer"/>
      <element name="listOfStepNumbersAndDurations"
type="xswmi:ListOfStepNumbersAndDurations" minOccurs="0"/>
      <element name="result">
        <simpleType>
          <restriction base="string">

```

```

        <enumeration value="requestAccepted"/>
        <enumeration value="requestFailed"/>
        <enumeration value="notAllowedBecauseOfOngoingSwmActivity"/>
    </restriction>
</simpleType>
</element>
<element name="reason" minOccurs="0">
    <simpleType>
        <restriction base="string"/>
    </simpleType>
</element>
</sequence>
</complexType>
</element>
<!--installNESw Fault -->
<element name="installNESwFault">
    <simpleType>
        <restriction base="string">
            <enumeration value="operationFailed"/>
            <enumeration value="resourceLimitation"/>
            <enumeration value="swNotAvailable"/>
        </restriction>
    </simpleType>
</element>
<!--activateNESw Request -->
<element name="activateNESwRequest">
    <complexType>
        <sequence>
            <element name="swVersionToBeActivated"
type="swMIRPData:swVersionToBeActivated"/>
            <element name="neIdentifier" type="xswmi:Id"/>
        </sequence>
    </complexType>
</element>
<!--activateNESw Response -->
<element name="activateNESwResponse">
    <complexType>
        <sequence>
            <element name="activateProcessId" type="integer"/>
            <element name="listOfStepNumbersAndDurations"
type="xswmi:ListOfStepNumbersAndDurations" minOccurs="0"/>
            <element name="result">
                <simpleType>
                    <restriction base="string">
                        <enumeration value="requestAccepted"/>
                        <enumeration value="requestFailed"/>
                        <enumeration value="notAllowedBecauseOfOngoingSwmActivity"/>
                    </restriction>
                </simpleType>
            </element>
            <element name="reason" minOccurs="0">
                <simpleType>
                    <restriction base="string"/>
                </simpleType>
            </element>
        </sequence>
    </complexType>
</element>
<!--activateNESw Fault -->
<element name="activateNESwFault">
    <simpleType>
        <restriction base="string">
            <enumeration value="operationFailed"/>
            <enumeration value="resourceLimitation"/>
        </restriction>
    </simpleType>
</element>
<!--listNaswmProcesses Request -->
<element name="listNaswmProcesses">
    <complexType>
        <sequence>
            <element name="naswmId" type="xswmi:Id" minOccurs="0"/>
            <element name="naswmOperationType" type="xswmi:NaswmOperationType"/>
        </sequence>
    </complexType>
</element>
<!--listNaswmProcesses Response -->
<element name="listNaswmProcessesResponse">

```

```

    <complexType>
      <sequence>
        <element name="naswmProcessList" type="xswmi:NaswmProcessList"/>
        <element name="result">
          <simpleType>
            <restriction base="string">
              <enumeration value="success"/>
              <enumeration value="failure"/>
            </restriction>
          </simpleType>
        </element>
        <element name="reason" minOccurs="0">
          <simpleType>
            <restriction base="string"/>
          </simpleType>
        </element>
      </sequence>
    </complexType>
  </element>
  <!--listNaswmProcesses Fault -->
  <element name="listNaswmProcessesFault">
    <simpleType>
      <restriction base="string">
        <enumeration value="operationFailed"/>
        <enumeration value="resourceLimitation"/>
      </restriction>
    </simpleType>
  </element>
  <!--cancelNaswmProcesses Request -->
  <element name="cancelNaswmProcessesRequest">
    <complexType>
      <sequence>
        <element name="naswmId" type="xswmi:Id"/>
        <element name="naswmOperationType" type="xswmi:NEaswmOperationType"/>
      </sequence>
    </complexType>
  </element>
  <!-- cancel NaswmProcesses Response -->
  <element name="cancelNaswmProcessesResponse">
    <complexType>
      <sequence>
        <element name="result">
          <simpleType>
            <restriction base="string">
              <enumeration value="success"/>
              <enumeration value="failure"/>
              <enumeration value="operationIsAlreadyCompleted"/>
              <enumeration value="noSuchProcess"/>
            </restriction>
          </simpleType>
        </element>
        <element name="reason" minOccurs="0">
          <simpleType>
            <restriction base="string"/>
          </simpleType>
        </element>
      </sequence>
    </complexType>
  </element>
  <!-- cancelNaswmProcesses Fault -->
  <element name="cancelNaswmProcessesFault">
    <simpleType>
      <restriction base="string">
        <enumeration value="operationFailed"/>
        <enumeration value="resourceLimitation"/>
      </restriction>
    </simpleType>
  </element>
</schema>
</types>
<message name="listSwMCapabilitiesRequest">
  <part name="parameter" element="swMIRPData:listSwMCapabilitiesRequest"/>
</message>
<message name="listSwMCapabilitiesResponse">
  <part name="parameter" element="swMIRPData:listSwMCapabilitiesResponse"/>
</message>
<message name="listSwMCapabilitiesFault">
  <part name="parameter" element="swMIRPData:listSwMCapabilitiesFault"/>

```

```
</message>
<message name="listSwMProfilesRequest">
  <part name="parameter" element="swMIRPData:listSwMProfilesRequest"/>
</message>
<message name="listSwMProfilesResponse">
  <part name="parameter" element="swMIRPData:listSwMProfilesResponse"/>
</message>
<message name="createSwMProfileRequest">
  <part name="parameter" element="swMIRPData:createSwMProfileRequest"/>
</message>
<message name="createSwMProfileResponse">
  <part name="parameter" element="swMIRPData:createSwMProfileResponse"/>
</message>
<message name="deleteSwMProfileRequest">
  <part name="parameter" element="swMIRPData:deleteSwMProfileRequest"/>
</message>
<message name="deleteSwMProfileResponse">
  <part name="parameter" element="swMIRPData:deleteSwMProfileResponse"/>
</message>
<message name="listSwMProcessesRequest">
  <part name="parameter" element="swMIRPData:listSwMProcessesRequest"/>
</message>
<message name="listSwMProcessesResponse">
  <part name="parameter" element="swMIRPData:listSwMProcessesResponse"/>
</message>
<message name="resumeSwMProcessRequest">
  <part name="parameter" element="swMIRPData:resumeSwMProcessRequest"/>
</message>
<message name="resumeSwMProcessResponse">
  <part name="parameter" element="swMIRPData:resumeSwMProcessResponse"/>
</message>
<message name="swFallbackRequest">
  <part name="parameter" element="swMIRPData:swFallbackRequest"/>
</message>
<message name="swFallbackResponse">
  <part name="parameter" element="swMIRPData:swFallbackResponse"/>
</message>
<message name="terminateSwMProcessRequest">
  <part name="parameter" element="swMIRPData:terminateSwMProcessRequest"/>
</message>
<message name="terminateSwMProcessResponse">
  <part name="parameter" element="swMIRPData:terminateSwMProcessResponse"/>
</message>
<message name="changeSwMProfileRequest">
  <part name="parameter" element="swMIRPData:changeSwMProfileRequest"/>
</message>
<message name="changeSwMProfileResponse">
  <part name="parameter" element="swMIRPData:changeSwMProfileResponse"/>
</message>
<message name="downloadNESwRequest">
  <part name="parameter" element="swMIRPData:downloadNESwRequest"/>
</message>
<message name="downloadNESwResponse">
  <part name="parameter" element="swMIRPData:downloadNESwResponse"/>
</message>
<message name="downloadNESwFault">
  <part name="parameter" element="swMIRPData:downloadNESwFault"/>
</message>
<message name="installNESwRequest">
  <part name="parameter" element="swMIRPData:installNESwRequest"/>
</message>
<message name="installNESwResponse">
  <part name="parameter" element="swMIRPData:installNESwResponse"/>
</message>
<message name="installNESwFault">
  <part name="parameter" element="swMIRPData:installNESwFault"/>
</message>
<message name="activateNESwRequest">
  <part name="parameter" element="swMIRPData:activateNESwRequest"/>
</message>
<message name="activateNESwResponse">
  <part name="parameter" element="swMIRPData:activateNESwResponse"/>
</message>
<message name="activateNESwFault">
  <part name="parameter" element="swMIRPData:activateNESwFault"/>
</message>
<message name="listNaswmProcessesResponse">
  <part name="parameter" element="swMIRPData:listNaswmProcessesResponse"/>
</message>
```



```

</message>
<message name="listNaswmProcessesResponse">
  <part name="parameter" element="swMIRPData:listNaswmProcessesResponse"/>
</message>
<message name="listNaswmProcessesFault">
  <part name="parameter" element="swMIRPData:listNaswmProcessesFault"/>
</message>
<message name="cancelNaswmProcesses">
  <part name="parameter" element="swMIRPData:cancelNaswmProcessesResponse"/>
</message>
<message name="cancelNaswmProcessesResponse">
  <part name="parameter" element="swMIRPData:cancelNaswmProcessesResponse"/>
</message>
<message name="cancelNaswmProcessesFault">
  <part name="parameter" element="swMIRPData:cancelNaswmProcesses Fault"/>
</message>
<portType name="SwMIRPOperation1">
  <operation name="listSwMCapabilities">
    <input message="swMIRPSystem:listSwMCapabilitiesRequest"/>
    <output message="swMIRPSystem:listSwMCapabilitiesResponse"/>
    <fault name="listSwMCapabilitiesFault" message="swMIRPSystem:listSwMCapabilitiesFault"/>
  </operation>
  <operation name="listSwMProfiles">
    <input message="swMIRPSystem:listSwMProfilesRequest"/>
    <output message="swMIRPSystem:listSwMProfilesResponse"/>
  </operation>
  <operation name="createSwMProfile">
    <input message="swMIRPSystem:createSwMProfileRequest"/>
    <output message="swMIRPSystem:createSwMProfileResponse"/>
  </operation>
  <operation name="deleteSwMProfile">
    <input message="swMIRPSystem:deleteSwMProfileRequest"/>
    <output message="swMIRPSystem:deleteSwMProfileResponse"/>
  </operation>
  <operation name="listSwMProcesses">
    <input message="swMIRPSystem:listSwMProcessesRequest"/>
    <output message="swMIRPSystem:listSwMProcessesResponse"/>
  </operation>
  <operation name="resumeSwMProcess">
    <input message="swMIRPSystem:resumeSwMProcessRequest"/>
    <output message="swMIRPSystem:resumeSwMProcessResponse"/>
  </operation>
  <operation name="swFallback">
    <input message="swMIRPSystem:swFallbackRequest"/>
    <output message="swMIRPSystem:swFallbackResponse"/>
  </operation>
  <operation name="terminateSwMProcess">
    <input message="swMIRPSystem:terminateSwMProcessRequest"/>
    <output message="swMIRPSystem:terminateSwMProcessResponse"/>
  </operation>
</portType>
<portType name="SwMIRPOperation2">
  <operation name="changeSwMProfile">
    <input message="swMIRPSystem:changeSwMProfileRequest"/>
    <output message="swMIRPSystem:changeSwMProfileResponse"/>
  </operation>
</portType>
<portType name="SwMIRPOperation3">
  <operation name="downloadNESw">
    <input message="swMIRPSystem:downloadNESwRequest"/>
    <output message="swMIRPSystem:downloadNESwResponse"/>
    <fault name="downloadNESwFault" message="swMIRPSystem:downloadNESwFault"/>
  </operation>
  <operation name="activateNESw">
    <input message="swMIRPSystem:activateNESwRequest"/>
    <output message="swMIRPSystem:activateNESwResponse"/>
    <fault name="activateNESwFault" message="swMIRPSystem:activateNESwFault"/>
  </operation>
</portType>
<portType name="SwMIRPOperation4">
  <operation name="installNESw">
    <input message="swMIRPSystem:installNESwRequest"/>
    <output message="swMIRPSystem:installNESwResponse"/>
    <fault name="installNESwFault" message="swMIRPSystem:installNESwFault"/>
  </operation>
</portType>
<binding name="SwMIRPOperation1" type="swMIRPSystem:SwMIRPOperation1">
  <soap:binding style="document" transport="http://schemas.xmlsoap.org/soap/http"/>

```

```

    <operation name="listSwMCapabilities">
      <soap:operation
soapAction="http://www.3gpp.org/ftp/specs/archive/32_series/32.536#listSwMCapabilities"
style="document" />
      <input>
        <soap:body use="literal" />
      </input>
      <output>
        <soap:body use="literal" />
      </output>
      <fault name="listSwMCapabilitiesFault" />
    </operation>
    <operation name="listSwMProfiles">
      <soap:operation
soapAction="http://www.3gpp.org/ftp/specs/archive/32_series/32.536#listSwMProfiles"
style="document" />
      <input>
        <soap:body use="literal" />
      </input>
      <output>
        <soap:body use="literal" />
      </output>
    </operation>
    <operation name="createSwMProfile">
      <soap:operation
soapAction="http://www.3gpp.org/ftp/specs/archive/32_series/32.536#createSwMProfile"
style="document" />
      <input>
        <soap:body use="literal" />
      </input>
      <output>
        <soap:body use="literal" />
      </output>
    </operation>
    <operation name="deleteSwMProfile">
      <soap:operation
soapAction="http://www.3gpp.org/ftp/specs/archive/32_series/32.536#deleteSwMProfile"
style="document" />
      <input>
        <soap:body use="literal" />
      </input>
      <output>
        <soap:body use="literal" />
      </output>
    </operation>
    <operation name="listSwMProcesses">
      <soap:operation
soapAction="http://www.3gpp.org/ftp/specs/archive/32_series/32.536#listSwMProcesses"
style="document" />
      <input>
        <soap:body use="literal" />
      </input>
      <output>
        <soap:body use="literal" />
      </output>
    </operation>
    <operation name="resumeSwMProcess">
      <soap:operation
soapAction="http://www.3gpp.org/ftp/specs/archive/32_series/32.536#resumeSwMProcess"
style="document" />
      <input>
        <soap:body use="literal" />
      </input>
      <output>
        <soap:body use="literal" />
      </output>
    </operation>
    <operation name="swFallback">
      <soap:operation
soapAction="http://www.3gpp.org/ftp/specs/archive/32_series/32.536#swFallback" style="document" />
      <input>
        <soap:body use="literal" />
      </input>
      <output>
        <soap:body use="literal" />
      </output>
    </operation>
    <operation name="terminateSwMProcess">

```

```

        <soap:operation
soapAction="http://www.3gpp.org/ftp/specs/archive/32_series/32.536#terminateSwMProcess"
style="document" />
        <input>
            <soap:body use="literal" />
        </input>
        <output>
            <soap:body use="literal" />
        </output>
    </operation>
</binding>
<binding name="SwMIRPOperation2" type="swMIRPSystem:SwMIRPOperation2">
    <soap:binding style="document" transport="http://schemas.xmlsoap.org/soap/http" />
    <operation name="changeSwMProfile">
        <soap:operation
soapAction="http://www.3gpp.org/ftp/specs/archive/32_series/32.536#changeSwMProfile"
style="document" />
        <input>
            <soap:body use="literal" />
        </input>
        <output>
            <soap:body use="literal" />
        </output>
    </operation>
</binding>
<binding name="SwMIRPOperation3" type="swMIRPSystem:SwMIRPOperation3">
    <soap:binding style="document" transport="http://schemas.xmlsoap.org/soap/http" />
    <operation name="downloadNESw">
        <soap:operation
soapAction="http://www.3gpp.org/ftp/specs/archive/32_series/32.536#downloadNESw" style="document" />
        <input>
            <soap:body use="literal" />
        </input>
        <output>
            <soap:body use="literal" />
        </output>
        <fault name="downloadNESwFault" />
    </operation>
    <operation name="activateNESw">
        <soap:operation
soapAction="http://www.3gpp.org/ftp/specs/archive/32_series/32.536#activateNESw" style="document" />
        <input>
            <soap:body use="literal" />
        </input>
        <output>
            <soap:body use="literal" />
        </output>
        <fault name="activateNESwFault" />
    </operation>
</binding>
<binding name="SwMIRPOperation4" type="swMIRPSystem:SwMIRPOperation4">
    <soap:binding style="document" transport="http://schemas.xmlsoap.org/soap/http" />
    <operation name="installNESw">
        <soap:operation
soapAction="http://www.3gpp.org/ftp/specs/archive/32_series/32.536#installNESw" style="document" />
        <input>
            <soap:body use="literal" />
        </input>
        <output>
            <soap:body use="literal" />
        </output>
        <fault name="installNESwFault" />
    </operation>
</binding>
<binding name="SwMIRPOperation5" type="swMIRPSystem:SwMIRPOperation5">
    <soap:binding style="document" transport="http://schemas.xmlsoap.org/soap/http" />
    <operation name="listNaswmProcesses">
        <soap:operation
soapAction="http://www.3gpp.org/ftp/specs/archive/32_series/32.536#listNaswmProcesses"
style="document" />
        <input>
            <soap:body use="literal" />
        </input>
        <output>
            <soap:body use="literal" />
        </output>
        <fault name="listNaswmProcessesFault" />
    </operation>

```

```

</binding>
<binding name="SwMIRPOperation6" type="swMIRPSystem:SwMIRPOperation6">
  <soap:binding style="document" transport="http://schemas.xmlsoap.org/soap/http"/>
  <operation name="cancelNaswmProcesses">
    <soap:operation
soapAction="http://www.3gpp.org/ftp/specs/archive/32_series/32.536#cancelNaswmProcesses"
style="document" />
    <input>
      <soap:body use="literal"/>
    </input>
    <output>
      <soap:body use="literal"/>
    </output>
    <fault name="cancelNaswmProcesses Fault"/>
  </operation>
</binding>
<service name="SwMIRPService">
  <port name="SwMIRPOperation1" binding="swMIRPSystem:SwMIRPOperation1">
    <soap:address location="http://www.3gpp.org/ftp/specs/archive/32_series/32.536#SwMIRP"/>
  </port>
  <port name="GenericIRPPort" binding="genericIRPSystem:GenericIRPBinding">
    <soap:address
location="http://www.3gpp.org/ftp/specs/archive/32_series/32.316#GenericIRP"/>
  </port>
  <port name="NotificationIRPNtfPort" binding="ntfIRPNtfSystem:NotificationIRPNtf">
    <soap:address
location="http://www.3gpp.org/ftp/specs/archive/32_series/32.306#NotificationIRPNtf"/>
  </port>
  <port name="SwMIRPOperation2" binding="swMIRPSystem:SwMIRPOperation2">
    <soap:address location="http://www.3gpp.org/ftp/specs/archive/32_series/32.536#SwMIRP"/>
  </port>
  <port name="SwMIRPOperation3" binding="swMIRPSystem:SwMIRPOperation3">
    <soap:address location="http://www.3gpp.org/ftp/specs/archive/32_series/32.536#SwMIRP"/>
  </port>
  <port name="SwMIRPOperation4" binding="swMIRPSystem:SwMIRPOperation4">
    <soap:address location="http://www.3gpp.org/ftp/specs/archive/32_series/32.536#SwMIRP"/>
  </port>
  <port name="SwMIRPOperation5" binding="swMIRPSystem:SwMIRPOperation5">
    <soap:address location="http://www.3gpp.org/ftp/specs/archive/32_series/32.536#SwMIRP"/>
  </port>
  <port name="SwMIRPOperation6" binding="swMIRPSystem:SwMIRPOperation6">
    <soap:address location="http://www.3gpp.org/ftp/specs/archive/32_series/32.536#SwMIRP"/>
  </port>
</service>
</definitions>

```

## Annex D (informative): Change history

Change history							
Date	TSG #	TSG Doc.	CR	Rev	Subject/Comment	Old	New
2010-09	SA#49	SP-100511	--	--	Presentation to SA for Information and Approval	---	1.0.0
2010-10	--	--	--	--	Publication	1.0.0	10.0.0
2010-12	SA#50	SP-10833	002	1	Modify the input parameters of notifyActivateNESwStatusChanged - Align with 32.532 IS	10.0.0	10.1.0
2010-12	SA#50	SP-10833	003	1	Add NE health check step in automatic software management – Align with 32.532 IS	10.0.0	10.1.0
2010-12	SA#50	SP-10831	004	--	Align support qualifier of notifyNewSwAvailability with 32.532	10.0.0	10.1.0
2012-09	SA#57	SP-120645	009	1	Addition of progress reporting and cancellation of Non-Automated Software Management operations	10.1.0	11.0.0
2014-09	SA#65	SP-140559	010	-	Update the link from Solution Set to Information Service due to the end of Release 12	11.0.0	12.0.0
2016-01	-	-	-	-	Update to Rel-13 version (MCC)	12.0.0	<b>13.0.0</b>

Change history							
Date	Meeting	TDoc	CR	Rev	Cat	Subject/Comment	New version
2016-06	SA#72	SP-160407	0011	-	F	Update the link from IRP Solution Set to IRP Information Service	13.1.0
2017-04	SA#75	-	-	-	-	Promotion to Release 14 without technical change	<b>14.0.0</b>
2017-06	SA#76	SP-170502	0012	-	F	Update the link from IRP Solution Set to IRP Information Service	<b>14.1.0</b>

---

# History

<b>Document history</b>		
V14.0.0	April 2017	Publication
V14.1.0	July 2017	Publication