

ETSI TS 133 128 V17.11.0 (2024-01)



**Digital cellular telecommunications system (Phase 2+) (GSM);
Universal Mobile Telecommunications System (UMTS);
LTE;
5G;
Security;
Protocol and procedures for Lawful Interception (LI);
Stage 3
(3GPP TS 33.128 version 17.11.0 Release 17)**



Reference

RTS/TSGS-0333128vhb0

Keywords

5G,GSM,LTE,UMTS

ETSI

650 Route des Lucioles
F-06921 Sophia Antipolis Cedex - FRANCE

Tel.: +33 4 92 94 42 00 Fax: +33 4 93 65 47 16

Siret N° 348 623 562 00017 - APE 7112B
Association à but non lucratif enregistrée à la
Sous-Préfecture de Grasse (06) N° w061004871

Important notice

The present document can be downloaded from:

<https://www.etsi.org/standards-search>

The present document may be made available in electronic versions and/or in print. The content of any electronic and/or print versions of the present document shall not be modified without the prior written authorization of ETSI. In case of any existing or perceived difference in contents between such versions and/or in print, the prevailing version of an ETSI deliverable is the one made publicly available in PDF format at www.etsi.org/deliver.

Users of the present document should be aware that the document may be subject to revision or change of status.

Information on the current status of this and other ETSI documents is available at

<https://portal.etsi.org/TB/ETSIDeliverableStatus.aspx>

If you find errors in the present document, please send your comment to one of the following services:

<https://portal.etsi.org/People/CommitteeSupportStaff.aspx>

If you find a security vulnerability in the present document, please report it through our
Coordinated Vulnerability Disclosure Program:

<https://www.etsi.org/standards/coordinated-vulnerability-disclosure>

Notice of disclaimer & limitation of liability

The information provided in the present deliverable is directed solely to professionals who have the appropriate degree of experience to understand and interpret its content in accordance with generally accepted engineering or other professional standard and applicable regulations.

No recommendation as to products and services or vendors is made or should be implied.

No representation or warranty is made that this deliverable is technically accurate or sufficient or conforms to any law and/or governmental rule and/or regulation and further, no representation or warranty is made of merchantability or fitness for any particular purpose or against infringement of intellectual property rights.

In no event shall ETSI be held liable for loss of profits or any other incidental or consequential damages.

Any software contained in this deliverable is provided "AS IS" with no warranties, express or implied, including but not limited to, the warranties of merchantability, fitness for a particular purpose and non-infringement of intellectual property rights and ETSI shall not be held liable in any event for any damages whatsoever (including, without limitation, damages for loss of profits, business interruption, loss of information, or any other pecuniary loss) arising out of or related to the use of or inability to use the software.

Copyright Notification

No part may be reproduced or utilized in any form or by any means, electronic or mechanical, including photocopying and microfilm except as authorized by written permission of ETSI.

The content of the PDF version shall not be modified without the written authorization of ETSI.

The copyright and the foregoing restriction extend to reproduction in all media.

© ETSI 2024.
All rights reserved.

Intellectual Property Rights

Essential patents

IPRs essential or potentially essential to normative deliverables may have been declared to ETSI. The declarations pertaining to these essential IPRs, if any, are publicly available for **ETSI members and non-members**, and can be found in ETSI SR 000 314: "*Intellectual Property Rights (IPRs); Essential, or potentially Essential, IPRs notified to ETSI in respect of ETSI standards*", which is available from the ETSI Secretariat. Latest updates are available on the ETSI Web server (<https://ipr.etsi.org/>).

Pursuant to the ETSI Directives including the ETSI IPR Policy, no investigation regarding the essentiality of IPRs, including IPR searches, has been carried out by ETSI. No guarantee can be given as to the existence of other IPRs not referenced in ETSI SR 000 314 (or the updates on the ETSI Web server) which are, or may be, or may become, essential to the present document.

Trademarks

The present document may include trademarks and/or tradenames which are asserted and/or registered by their owners. ETSI claims no ownership of these except for any which are indicated as being the property of ETSI, and conveys no right to use or reproduce any trademark and/or tradename. Mention of those trademarks in the present document does not constitute an endorsement by ETSI of products, services or organizations associated with those trademarks.

DECT™, **PLUGTESTS™**, **UMTS™** and the ETSI logo are trademarks of ETSI registered for the benefit of its Members. **3GPP™** and **LTE™** are trademarks of ETSI registered for the benefit of its Members and of the 3GPP Organizational Partners. **oneM2M™** logo is a trademark of ETSI registered for the benefit of its Members and of the oneM2M Partners. **GSM®** and the GSM logo are trademarks registered and owned by the GSM Association.

Legal Notice

This Technical Specification (TS) has been produced by ETSI 3rd Generation Partnership Project (3GPP).

The present document may refer to technical specifications or reports using their 3GPP identities. These shall be interpreted as being references to the corresponding ETSI deliverables.

The cross reference between 3GPP and ETSI identities can be found under <https://webapp.etsi.org/key/queryform.asp>.

Modal verbs terminology

In the present document "**shall**", "**shall not**", "**should**", "**should not**", "**may**", "**need not**", "**will**", "**will not**", "**can**" and "**cannot**" are to be interpreted as described in clause 3.2 of the [ETSI Drafting Rules](#) (Verbal forms for the expression of provisions).

"**must**" and "**must not**" are **NOT** allowed in ETSI deliverables except when used in direct citation.

Contents

Intellectual Property Rights	2
Legal Notice	2
Modal verbs terminology.....	2
Foreword.....	14
Introduction	14
1 Scope	15
2 References	15
3 Definitions, symbols and abbreviations	18
3.1 Definitions	18
3.2 Symbols.....	19
3.3 Abbreviations	19
4 General	20
4.1 Introduction	20
4.2 Basic principles for internal interfaces	21
4.3 Basic principles for external handover interfaces.....	21
4.4 Service scoping	22
4.4.1 General.....	22
4.4.2 CSP service type	22
4.4.3 Delivery type	22
4.4.4 Location Reporting	23
4.4.5 LALS Triggering	23
4.4.6 Roaming Interception	23
5 Transport and Communications Protocol.....	23
5.1 General	23
5.2 Protocols for LI_X1 and LI_T interfaces	23
5.2.1 General usage of ETSI TS 103 221-1	23
5.2.2 Usage for realising LI_X1	24
5.2.3 Usage for realising LI_X1 (management)	24
5.2.4 Service scoping	24
5.2.5 Usage for realising LI_T2.....	25
5.2.6 Usage for realising LI_T3.....	25
5.2.7 Usage for realising LI_XEM1	25
5.3 Protocols for LI_X2 and LI_X3	26
5.3.1 General usage of ETSI TS 103 221-2	26
5.3.2 Usage for realising LI_X2	26
5.3.3 Usage for realising LI_X3	27
5.3.4 Service scoping	27
5.4 Protocols for LI_HI1	27
5.4.1 General.....	27
5.4.2 Service scoping	28
5.5 Protocols for LI_HI2 and LI_HI3.....	28
5.5.1 General.....	28
5.5.2 Usage for realising LI_HI2	28
5.5.3 Usage for realising LI_HI3	28
5.5.4 Service scoping	28
5.5.5 IRI Target Identifiers	29
5.6 Protocols for LI_HI4	29
5.6.1 General.....	29
5.6.2 Usage for realising LI_HI4	29
5.7 Protocols for LI_HIQR.....	29
5.7.1 General.....	29
5.7.2 Usage for realising LI_HIQR.....	29

5.7.2.1	Request structure	29
5.7.2.2	Request parameters	30
5.7.2.3	Response structure	31
5.8	Protocols for LI_XQR	33
5.8.1	General	33
5.8.2	Identity association requests	33
5.8.3	Ongoing identity association requests	33
5.9	Protocols for LI_XER	34
5.10	Protocols for LI_ST interface	34
5.10.1	Overview	34
5.10.2	Storage	34
5.10.3	Retrieval	34
5.10.4	Removal	34
6	Network Layer Based Interception	35
6.1	Introduction	35
6.2	5G	35
6.2.1	General	35
6.2.2	LI at AMF	35
6.2.2.1	Provisioning over LI_X1	35
6.2.2.2	Generation of xIRI over LI_X2	36
6.2.2.2.1	General	36
6.2.2.2.2	Registration	36
6.2.2.2.3	Deregistration	37
6.2.2.2.4	Location update	38
6.2.2.2.5	Start of interception with registered UE	39
6.2.2.2.6	AMF unsuccessful procedure	40
6.2.2.2.7	AMF identifier association	41
6.2.2.2.8	Positioning info transfer	41
6.2.2.2.9	UE Configuration Update	42
6.2.2.3	Generation of IRI over LI_HI2	43
6.2.2.4	Identity privacy	44
6.2.2A	Identifier Reporting for AMF	44
6.2.2A.1	Activation of reporting over LI_XEM1	44
6.2.2A.2	Generation of records over LI_XER	44
6.2.2A.2.2	Association Events	45
6.2.2A.2.3	Transmission to the ICF	46
6.2.3	LI for SMF/UPF	46
6.2.3.1	Provisioning over LI_X1	46
6.2.3.1.1	General	46
6.2.3.1.2	Provisioning of the IRI-POI, IRI-TF and CC-TF in the SMF	46
6.2.3.1.3	Provisioning of the MDF2	47
6.2.3.1.4	Provisioning of the MDF3	48
6.2.3.2	Generation of xIRI at IRI-POI in SMF over LI_X2	49
6.2.3.2.1	General	49
6.2.3.2.2	PDU session establishment	49
6.2.3.2.3	PDU session modification	54
6.2.3.2.4	PDU session release	56
6.2.3.2.5	Start of interception with an established PDU session	57
6.2.3.2.6	SMF unsuccessful procedure	61
6.2.3.2.7	MA PDU sessions	62
6.2.3.2.8	PDU to MA PDU session modification	75
6.2.3.3	Triggering of the CC-POI from CC-TF over LI_T3	76
6.2.3.3.1	LI_T3 interface specifics	76
6.2.3.3.2	CC interception with multi-homed PDU session	78
6.2.3.3.3	CC Interception only at PDU Session Anchor UPFs	79
6.2.3.4	IRI-POI in UPF triggering over LI_T2	79
6.2.3.5	Generation of xIRI at UPF over LI_X2	80
6.2.3.5.1	Packet data header reporting	80
6.2.3.5.2	Fragmentation	80
6.2.3.5.3	Packet Data Header Report (PDHR)	80
6.2.3.5.4	Packet Data Summary Report (PDSR)	80

6.2.3.6	Generation of xCC at CC-POI in the UPF over LI_X3.....	80
6.2.3.7	Generation of IRI over LI_HI2	81
6.2.3.8	Generation of CC over LI_HI3	82
6.2.3.9	Packet header information reporting	82
6.2.3.9.1	General	82
6.2.3.9.2	Provisioning details	83
6.2.3.9.3	PDHeaderReport record	83
6.2.3.9.4	PDSummaryReport record	84
6.2.3.10	Sharing LI state information over LI_ST.....	88
6.2.3.10.1	Overview	88
6.2.3.10.2	Storing LI state	88
6.2.3.10.3	Retrieving LI state	89
6.2.3.10.4	Removing LI state	89
6.2.4	LI at UDM for 5G.....	89
6.2.4.1	General description	89
6.2.5	LI at SMSF	89
6.2.5.1	Provisioning over LI_X1.....	89
6.2.5.2	Generation of xIRI over LI_X2.....	91
6.2.5.3	SMS Message.....	91
6.2.5.4	Generation of IRI over LI_HI2	94
6.2.6	LI support at NRF.....	94
6.3	4G.....	94
6.3.1	General.....	94
6.3.2	LI at MME	95
6.3.2.1	Provisioning over LI_X1.....	95
6.3.2.2	Generation of xIRI over LI_X2.....	96
6.3.2.2.1	General	96
6.3.2.2.2	MME identifier association	96
6.3.2.2.3	Attach	97
6.3.2.2.4	Detach.....	98
6.3.2.2.5	Tracking Area/EPS Location update	99
6.3.2.2.6	Start of interception with EPS attached UE.....	100
6.3.2.2.7	MME unsuccessful procedure	101
6.3.2.2.8	Positioning info transfer	102
6.3.2.3	Generation of IRI over LI_HI2	103
6.3.2.3.1	General	103
6.3.2.3.2	Option A	103
6.3.2.3.3	Option B and Option C.....	104
6.3.3	LI at SGW/PGW and ePDG	104
6.3.3.0	General	104
6.3.3.1	Provisioning over LI_X1.....	104
6.3.3.1.1	General	104
6.3.3.1.2	Non-CUPS Architecture	105
6.3.3.1.3	CUPS Architecture	106
6.3.3.1.4	Provisioning of the MDF2.....	106
6.3.3.1.5	Provisioning of the MDF3.....	107
6.3.3.2	Generation of xIRI over LI_X2.....	108
6.3.3.2.1	General	108
6.3.3.2.2	PDU Session Establishment message reporting PDU session establishment or PDN Connection establishment.....	108
6.3.3.2.3	PDU Session Modification message reporting PDU session modification, PDN Connection modification or inter-system handover	114
6.3.3.2.4	PDU Session Release message reporting PDU session release, PDN Connection release.....	119
6.3.3.2.5	SMF Start of Interception with Already Established PDU Session message reporting Start of Interception with Already Established PDU Session or Start of Interception with Already Established PDN Connection	120
6.3.3.2.6	MA PDU Session Establishment message reporting MA PDU session establishment or PDN Connection establishment as part of an MA PDU Session.....	122
6.3.3.2.7	MA PDU Session Modification message reporting MA PDU session modification, modification of a PDN Connection associated to MA PDU session or inter-system handover	122
6.3.3.2.8	MA PDU Session Release message reporting MA PDU session release or the release of a PDN Connection associated to an MA PDU session.....	123

6.3.3.2.9	SMF Start of Interception with Already Established MA PDU Session message reporting Start of Interception with Already Established MA PDU Session or Start of Interception with Already Established PDN Connection associated to an MA PDU Session	123
6.3.3.2A	Triggering of the CC-POI from CC-TF over LI_T3	124
6.3.3.3	Generation of xCC at CC-POI in the SGW/PGW and ePDG over LI_X3.....	124
6.3.3.3.1	Non-CUPS architecture	124
6.3.3.3.2	CUPS architecture	124
6.3.3.4	Generation of IRI over LI_HI2	124
6.3.3.5	Generation of CC over LI_HI3	125
6.4	3G.....	125
7	Service Layer Based Interception.....	125
7.1	Introduction	125
7.2	Central Subscriber Management	125
7.2.1	General description	125
7.2.2	LI at UDM	125
7.2.2.1	General description	125
7.2.2.2	Provisioning over LI_X1.....	125
7.2.2.3	Generation of xIRI over LI_X2.....	126
7.2.2.3.1	General description.....	126
7.2.2.3.2	Serving system	126
7.2.2.3.3	Subscriber record change.....	126
7.2.2.3.4	Cancel location	128
7.2.2.3.5	Location information request.....	129
7.2.2.3.6	Location information result	129
7.2.2.3.7	UE information response	130
7.2.2.3.8	UE Authentication response	131
7.2.2.4	Generation of IRI over LI_HI2	132
7.2.3	LI at HSS	132
7.2.3.1	General	132
7.2.3.2	Provisioning over LI_X1.....	132
7.2.3.3	Generation of xIRI over LI_X2.....	132
7.2.3.4	Generation of IRI over LI_HI2	133
7.3	Location.....	133
7.3.1	Lawful Access Location Services (LALS)	133
7.3.1.1	General description	133
7.3.1.2	Provisioning over LI_X1.....	133
7.3.1.2.1	Target positioning service	133
7.3.1.2.2	Triggered location service.....	134
7.3.1.3	Triggering over LI_T2	135
7.3.1.4	Generation of xIRI over LI_X2.....	136
7.3.1.5	Generation of IRI over LI_HI2	137
7.3.2	Cell database information reporting.....	137
7.3.2.1	General description	137
7.3.2.2	Delivery of cell site information over LI_HI2	137
7.3.3	Use of the Location structure	137
7.3.3.1	General description	137
7.3.4	Separated location reporting	138
7.3.4.1	General description	138
7.4	Messaging.....	138
7.4.1	Introduction.....	138
7.4.2	LI at the MMS Proxy-Relay	138
7.4.2.1	Provisioning over LI_X1.....	138
7.4.2.2	Generation of xIRI over LI_X2.....	139
7.4.2.3	Generation of xCC over LI_X3.....	139
7.4.2.4	MMS Record Generation Cases	139
7.4.3	MMS Records.....	139
7.4.3.1	MMSSend	139
7.4.3.2	MMSSendByNonLocalTarget	141
7.4.3.3	MMSNotification	143
7.4.3.4	MMSSendToNonLocalTarget.....	143
7.4.3.5	MMSNotificationResponse.....	145

7.4.3.6	MMSRetrieval.....	145
7.4.3.7	MMSDeliveryAck.....	147
7.4.3.8	MMSForward.....	147
7.4.3.9	MMSDeleteFromRelay.....	149
7.4.3.10	MMSMBoxStore.....	150
7.4.3.11	MMSMBoxUpload.....	150
7.4.3.12	MMSMBoxDelete.....	151
7.4.3.13	MMSDeliveryReport.....	151
7.4.3.14	MMSDeliveryReportNonLocalTarget.....	152
7.4.3.15	MMSReadReport.....	153
7.4.3.16	MMSReadReportNonLocalTarget.....	154
7.4.3.17	MMSCancel.....	155
7.4.3.18	MMSMBoxViewRequest.....	155
7.4.3.19	MMSMBoxViewResponse.....	156
7.4.3.20	MMSBoxDescription.....	157
7.4.3.21	MMS Content.....	159
7.4.4	IRI and CC Generation.....	159
7.4.4.1	Generation of IRI over LI_HI2.....	159
7.4.4.2	Generation of CC over LI_HI3.....	159
7.5	PTC service.....	159
7.5.1	Introduction.....	159
7.5.1.1	Provisioning over LI_X1.....	160
7.5.1.2	Generating xIRI over LI_X2.....	160
7.5.1.3	Generation of xCC over LI_X3.....	160
7.5.2	IRI events.....	160
7.5.2.1	PTC registration.....	160
7.5.2.2	PTC session initiation.....	160
7.5.2.3	PTC session abandon attempt.....	161
7.5.2.4	PTC session start.....	162
7.5.2.5	PTC session end.....	163
7.5.2.6	PTC start of interception.....	164
7.5.2.7	PTC pre-established session.....	165
7.5.2.8	PTC instant personal alert.....	165
7.5.2.9	PTC party join.....	165
7.5.2.10	PTC party drop.....	166
7.5.2.11	PTC party hold.....	167
7.5.2.12	PTC media modification.....	167
7.5.2.13	PTC group advertisement.....	168
7.5.2.14	PTC floor control.....	168
7.5.2.15	PTC target presence.....	170
7.5.2.16	PTC participant presence.....	171
7.5.2.17	PTC list management.....	171
7.5.2.18	PTC access policy.....	172
7.5.3	IRI and CC Generation.....	173
7.5.3.1	Generation of IRI over LI_HI2.....	173
7.5.3.2	Generation of CC over LI_HI3.....	174
7.6	Identifier Association Reporting.....	174
7.6.1	General.....	174
7.6.2	ICF.....	174
7.6.2.1	General.....	174
7.6.2.2	ICF receipt of records over LI_XER.....	174
7.6.2.3	ICF Query and Response over LI_XQR.....	174
7.6.2.4	ICF Identifier Association Event Handling.....	174
7.6.3	IQF.....	175
7.6.3.1	General.....	175
7.6.3.2	IQF Query and Response over LI_HIQR.....	176
7.6.3.3	IQF Query and Response over LI_XQR.....	176
7.7	LI at NEF.....	176
7.7.1	Provisioning over LI_X1.....	176
7.7.1.1	General.....	176
7.7.1.2	Provisioning of the IRI-POI and CC-POI in NEF.....	176
7.7.2	LI for NIDD using NEF.....	177

7.7.2.1	Generation of xIRI at IRI-POI in NEF over LI_X2	177
7.7.2.1.1	General	177
7.7.2.1.2	PDU session establishment	177
7.7.2.1.3	PDU session modification	177
7.7.2.1.4	PDU session release	178
7.7.2.1.5	Unsuccessful procedure	178
7.7.2.1.6	Start of interception with established PDU session	179
7.7.2.2	Generation of xCC at CC-POI in NEF over LI_X3	179
7.7.2.3	Generation of IRI over LI_HI2	180
7.7.2.4	Generation of CC over LI_HI3	180
7.7.3	LI for device triggering	180
7.7.3.1	Generation of xIRI LI_X2 at IRI-POI in NEF over LI_X2	180
7.7.3.1.1	General	180
7.7.3.1.2	Device trigger	180
7.7.3.1.3	Device trigger replace	181
7.7.3.1.4	Device trigger cancellation	181
7.7.3.1.5	Device trigger report notification	182
7.7.3.2	Generation of IRI over LI_HI2	182
7.7.4	LI for MSISDN-less MO SMS	183
7.7.4.1	Generation of xIRI LI_X2 at IRI-POI in NEF over LI_X2	183
7.7.4.1.1	General	183
7.7.4.1.2	MSISDN-less MO SMS	183
7.7.4.2	Generation of IRI over LI_HI2	183
7.7.5	LI for parameter provisioning	184
7.7.5.1	Generation of xIRI LI_X2 at IRI-POI in NEF over LI_X2	184
7.7.5.1.1	General	184
7.7.5.1.2	Expected UE behavior update	184
7.7.5.2	Generation of IRI over LI_HI2	184
7.8	LI at SCEF	185
7.8.1	Provisioning over LI_X1	185
7.8.1.1	General	185
7.8.1.2	Provisioning of the IRI-POI and CC-POI in SCEF	185
7.8.2	LI for NIDD using SCEF	185
7.8.2.1	Generation of xIRI at IRI-POI in SCEF over LI_X2	185
7.8.2.1.1	General	185
7.8.2.1.2	SCEF PDN connection establishment	186
7.8.2.1.3	PDN connection update	186
7.8.2.1.4	PDN connection release	187
7.8.2.1.5	Unsuccessful procedure	188
7.8.2.1.6	Start of interception with established PDN connection	189
7.8.2.2	Generation of xCC at CC-POI in SCEF over LI_X3	189
7.8.2.3	Generation of IRI over LI_HI2	190
7.8.2.4	Generation of CC over LI_HI3	190
7.8.3	LI for device triggering	190
7.8.3.1	Generation of xIRI LI_X2 at IRI-POI in SCEF over LI_X2	190
7.8.3.1.1	General	190
7.8.3.1.2	Device trigger	190
7.8.3.1.3	Device trigger replacement	191
7.8.3.1.4	Device trigger cancellation	191
7.8.3.1.5	Device trigger report notification	192
7.8.3.2	Generation of IRI over LI_HI2	192
7.8.4	LI for MSISDN-less MO SMS	193
7.8.4.1	Generation of xIRI LI_X2 at IRI-POI in SCEF over LI_X2	193
7.8.4.1.1	General	193
7.8.4.1.2	MSISDN-less MO SMS	193
7.8.4.2	Generation of IRI over LI_HI2	193
7.8.5	LI for parameter provisioning	194
7.8.5.1	Generation of xIRI LI_X2 at IRI-POI in SCEF over LI_X2	194
7.8.5.1.1	General	194
7.8.5.1.2	Communication pattern update	194
7.8.5.2	Generation of IRI over LI_HI2	195
7.9	LI for services encrypted by CSP-provided keys	195

7.9.1	LI for general AKMA-based service	195
7.9.1.1	General	195
7.9.1.2	Provisioning over LI_X1	196
7.9.1.2.1	General	196
7.9.1.2.2	Provisioning of the IRI-POI and IRI-TF in AAnF	196
7.9.1.2.3	Triggering of the IRI-POI in AF	196
7.9.1.3	Generation of xIRI at IRI-POI in AAnF over LI_X2	197
7.9.1.3.1	General	197
7.9.1.3.2	AAnF Anchor Key Register	197
7.9.1.3.3	AAnF AKMA application key get	197
7.9.1.3.4	AAnF Start of intercept with established AKMA key material	198
7.9.1.3.5	AAnF AKMA context removal	198
7.9.1.4	Generation of xIRI at IRI-POI in AF over LI_X2	198
7.9.1.4.1	General	198
7.9.1.4.2	AF Application key refresh	198
7.9.1.4.3	AF Start of intercept with established AKMA application key	199
7.9.1.4.4	AF Auxiliary security parameter establishment	199
7.9.1.4.5	AF Application key removal	199
7.9.1.5	Generation of IRI over LI_HI2	200
7.10	LI in VPLMN for IMS-based services with home-routed roaming	200
7.10.1	Background	200
7.10.2	Backward compatibility	201
7.10.3	HR LI Phase 1	201
7.10.3.1	Overview	201
7.10.3.2	Provisioning over LI_X1	202
7.10.3.2.1	General	202
7.10.3.2.2	Provisioning of BBIFF-C and BBIFF	202
7.10.3.2.3	Provisioning of LMISF-IRI	202
7.10.3.3	Generation of xIRI over LI_X2_LITE	203
7.10.3.3.1	General	203
7.10.3.3.2	N9HR LI	203
7.10.3.3.3	S8HR LI	205
7.10.3.4	LMISF-IRI handling of xIRIs received over LI_X2_LITE	206
7.10.3.4.1	Handling of xIRIs	206
7.10.3.4.2	Handling of the stored record	206
7.10.3.5	Triggering of BBIFF-U from BBIFF-C over LI_T3	207
7.10.3.5.1	General	207
7.10.3.5.2	N9HR LI	207
7.10.3.5.3	S8HR LI	208
7.10.3.6	Generation of xCC over LI_X3_LITE_S	209
7.10.3.6.1	BBIFF-U	209
7.10.3.6.2	BBIFF	209
7.10.3.6.3	X3 PDU format	209
7.10.3.7	LMISF-IRI handling of xCC received over LI_X3_LITE_S	210
7.10.4	HR LI Phase 2	210
7.10.4.1	Overview	210
7.10.4.2	Provisioning over LI_X1	210
7.10.4.2.1	General	210
7.10.4.2.2	Provisioning of LMISF-IRI	211
7.10.4.2.3	Provisioning of the MDF2	211
7.10.4.2.4	Provisioning of the MDF3	212
7.10.4.3	Generation of xIRI over LI_X2	213
7.10.4.3.1	General concepts	213
7.10.4.3.2	Target match	213
7.10.4.3.2.1	General	213
7.10.4.3.2.2	Service type of voice	214
7.10.4.3.2.3	Service type of messaging	214
7.10.4.3.3	xIRIs	214
7.10.4.4	Triggering of BBIFF-C from LMISF over LI_T1	215
7.10.4.4.1	General	215
7.10.4.4.2	N9HR LI	215
7.10.4.4.3	S8HR LI	216

7.10.4.5	Triggering of BBIFF-U from BBIFF-C over LI_T3	216
7.10.4.5.1	General	216
7.10.4.5.2	N9HR LI	217
7.10.4.5.3	S8HR LI	217
7.10.4.6	Generation of xCC over LI_X3_LITE_M	218
7.10.4.7	Generation of xCC over LI_X3	218
7.10.4.8	Correlation identifier	218
7.10.4.9	Generation of IRI over LI_HI2	219
7.10.4.10	Generation of CC over LI_HI3	219
7.11	STIR/SHAKEN and RCD/eCNAM	220
7.11.1	Provisioning over LI_X1	220
7.11.1.1	General	220
7.11.1.2	Provisioning of the IRI-POI in the IMS network functions	220
7.11.1.3	Provisioning of the MDF2	221
7.11.2	Generation of xIRI at IRI-POI in the IMS Network Functions over LI_X2	221
7.11.2.1	General	221
7.11.2.2	Signature generation	221
7.11.2.3	Signature validation	224
7.11.2.4	IMS Network Function that interacts with signing AS	226
7.11.2.5	IMS Network Function that interacts with the verification AS	226
7.11.3	Generation of IRI over LI_HI2	226
7.12	LI for IMS based services	227
7.12.1	General	227
7.12.2	Overview	227
7.12.2.1	General	227
7.12.2.2	Target type and target identifiers	227
7.12.2.3	Roaming considerations	228
7.12.2.4	Service specific aspects	228
7.12.2.4.1	General	228
7.12.2.4.2	LI for normal sessions	228
7.12.2.4.3	LI for redirected sessions	228
7.12.2.4.4	LI for conferencing	229
7.12.2.4.5	STIR/SHAKEN	229
7.12.2.4.6	RCD/eCNAM	229
7.12.2.5	Service scoping	229
7.12.2.5.1	General	229
7.12.2.5.2	LI for voice	229
7.12.2.5.3	LI for Messaging	230
7.12.2.5.4	LI for voice-mail	230
7.12.2.5.5	LI for RCS	230
7.12.2.5.6	LI for PTC service	231
7.12.2.5.7	LALS triggering	231
7.12.2.6	Location reporting	231
7.12.2.7	Deployment considerations	231
7.12.2.8	Identifying the intercepted IMS-based communications	231
7.12.2.8.1	General concepts	231
7.12.2.8.2	Target match	231
7.12.2.8.2.1	General	231
7.12.2.8.2.2	Session based IMS services	232
7.12.2.8.2.3	Session independent IMS services	233
7.12.2.9	Handling of correlation information	233
7.12.3	Provisioning over LI_X1	234
7.12.3.1	General	234
7.12.3.2	Provisioning of IRI-POI	234
7.12.3.2.1	Session-based IMS services	234
7.12.3.2.2	Session-independent IMS services	235
7.12.3.3	Provisioning of CC-TF	235
7.12.3.4	Provisioning of the MDF2	236
7.12.3.5	Provisioning of the MDF3	237
7.12.4	Generation of xIRIs over LI_X2	238
7.12.4.1	IRI-POIs in IMS signaling functions	238
7.12.4.1.1	General	238

7.12.4.1.2	IRI-POI in P-CSCF.....	238
7.12.4.1.2.1	Session-based IMS communications	238
7.12.4.1.2.2	Session-independent IMS communications	238
7.12.4.1.3	IRI-POI in S-CSCF.....	239
7.12.4.1.3.1	Session-based IMS communications	239
7.12.4.1.3.2	Session-independent IMS communications	239
7.12.4.1.4	IRI-POI in E-CSCF	239
7.12.4.1.5	IRI-POI in IBCF	239
7.12.4.1.5.1	Session-based IMS communications	239
7.12.4.1.5.2	Session-independent IMS communications	240
7.12.4.1.6	IRI-POI in MGCF.....	240
7.12.4.1.6.1	Session-based IMS communications	240
7.12.4.1.6.2	Session-independent IMS communications	240
7.12.4.1.7	IRI-POI in AS.....	240
7.12.4.1.7.1	Session-based IMS communications	240
7.12.4.1.7.2	Session-independent IMS communications	241
7.12.4.2	IMS records.....	241
7.12.4.2.1	IMS Message	241
7.12.4.2.2	Start of interception with Active IMS session	242
7.12.4.2.3	IMS CC Unavailable	242
7.12.5	Triggering of CC-POI by CC-TF over LI_T3	243
7.12.5.1	CC-TFs in IMS signaling functions	243
7.12.5.1.1	General	243
7.12.5.1.2	CC-TF in P-CSCF	243
7.12.5.1.3	CC-TF in IBCF.....	243
7.12.5.1.4	CC-TF in MGCF	244
7.12.5.1.5	CC-TF in AS/MRFC	244
7.12.5.2	LI_T3 triggering details	244
7.12.5.2.1	General	244
7.12.5.2.2	Activation Task	245
7.12.5.2.2.1	Overview.....	245
7.12.5.2.2.2	Activation of CC-POI in IMS-AGW, TrGW, IM-MGW.....	247
7.12.5.2.2.3	CC-POI in MRFP.....	250
7.12.5.2.2.4	Activation of CC-POI when media interceptions are done at both sides IMS media function	251
7.12.5.2.3	ModifyTask	253
7.12.5.2.4	DeactivateTask	254
7.12.6	Generation of xCC over LI_X3	254
7.12.6.1	General	254
7.12.6.2	Media capture.....	254
7.12.6.3	Payload format	255
7.12.6.4	Payload direction.....	255
7.12.6.5	SDP session description	255
7.12.6.6	Additional XID related information.....	256
7.12.7	Generation of IRI over LI_HI2	256
7.12.7.1	General	256
7.12.7.2	Handling of multiple instances of list of mediation details	256
7.12.7.3	Mid-session activation for additional warrants at MDF2	257
7.12.7.4	Location reporting	257
7.12.8	Generation of CC over LI_HI3	257
7.12.8.1	General	257
7.12.8.2	Handling of multiple instances of list of mediation details	257
7.12.8.3	Handling of additional XID related information	257
7.12.8.4	SDP session description	257
7.12.8.5	Mid-session activation for additional warrants at MDF3	258
7.13	RCS	258
7.13.1	Provisioning over LI_X1	258
7.13.1.1	General	258
7.13.1.2	Provisioning of the POIs and TFs in the RCS Server and the POIs in the HTTP Content Server and S-CSCF by the LIPF.....	258
7.13.1.3	Provisioning of the MDF2	259
7.13.1.4	Provisioning of the MDF3	260

7.13.2	Triggering of the IRI-POI and CC-POI in the HTTP Content Server.....	261
7.13.2.1	Triggering of the IRI-POI in the HTTP Content Server over LI_T2	261
7.13.2.1.1	LI_T2 interface Specifics	261
7.13.2.2	Triggering of the CC-POI in the HTTP Content Server over LI_T3	262
7.13.2.2.1	LI_T3 interface Specifics	262
7.13.3	Generation of xIRI at IRI-POI in the RCS Server over LI_X2.....	263
7.13.3.1	General.....	263
7.13.3.2	Registration.....	263
7.13.3.3	RCS Message.....	264
7.13.3.4	Session establishment.....	264
Annex A (normative):	ASN.1 Schema for the Internal and External Interfaces	265
Annex B (normative):	LI Notification.....	266
Annex C (normative):	XSD Schema for LI_X1 extensions	268
Annex D (informative):	Drafting Guidance	269
D.1	Introduction.....	269
D.2	Drafting conventions.....	269
D.3	Naming conventions.....	269
D.4	ASN.1 Syntax conventions.....	270
Annex E (normative):	XSD Schema for Identity Association.....	272
Annex F (normative):	ASN.1 Schema for LI_XER messages.....	273
Annex G (informative):	LIPF logic	274
G.1	Background.....	274
G.2	Governing scenarios.....	274
G.3	Top-level LIPF provisioning logic.....	275
G.4	Data.....	276
G.4.1	Scope of interception.....	276
G.4.2	Top-level view.....	276
G.4.3	5GC.....	277
G.4.3.1	The flow-chart	277
G.4.3.2	Interception.....	279
G.4.3.2.1	PDHR.....	279
G.4.3.2.2	LALS triggering.....	279
G.4.3.2.3	UDM.....	279
G.4.3.2.4	Summary.....	279
G.4.4	EPC.....	280
G.4.4.1	The flow-chart	280
G.4.4.2	Interception.....	283
G.4.4.2.1	PDHR.....	283
G.4.4.2.2	LALS triggering.....	283
G.4.4.2.3	SGW/PGW deployment options	283
G.4.4.2.4	HSS.....	283
G.4.4.2.5	Summary.....	283
G.5	Voice.....	285
G.5.1	Scope of interception.....	285
G.5.2	Initial configuration for N9HR/S8HR.....	286
G.5.3	Top level LIPF logic for service type voice	286
G.5.4	LIPF logic for targets that are not non-local ID	287
G.5.4.1	The flowchart.....	287
G.5.4.2	Interception.....	293
G.5.4.2.1	IMS deployment.....	293

G.5.4.2.2	LALS triggering	293
G.5.4.2.3	Summary	293
G.5.4.2.4	STIR/SHAKEN	295
G.5.5	LIPF logic for targets that are non-local ID	297
G.5.5.1	The flowchart	297
G.5.5.2	Interception	301
G.5.5.2.1	IMS deployment	301
G.5.5.2.2	Summary	302
G.5.5.2.3	STIR/SHAKEN	303
G.6	Messaging	303
G.6.1	Scope of interception	303
G.6.2	LIPF logic for service type messaging	304
G.6.2.1	Flowcharts	304
G.6.2.2	Interception	308
G.6.2.2.1	IMS deployment	308
G.6.2.2.2	LALS triggering	308
G.6.2.2.3	Summary	308
G.7	PTC	309
G.7.1	Scope of interception	309
G.7.2	LIPF logic for service type of PTC	310
G.8	LALS	311
G.8.1	Scope of interception	311
G.8.2	LIPF logic for service type of LALS	311
Annex H (normative):	XSD Schema for State Transfers	312
Annex Z (informative):	Change history	313
History		318

Foreword

This Technical Specification has been produced by the 3rd Generation Partnership Project (3GPP).

The contents of the present document are subject to continuing work within the TSG and may change following formal TSG approval. Should the TSG modify the contents of the present document, it will be re-released by the TSG with an identifying change of release date and an increase in version number as follows:

Version x.y.z

where:

- x the first digit:
 - 1 presented to TSG for information;
 - 2 presented to TSG for approval;
 - 3 or greater indicates TSG approved document under change control.
- y the second digit is incremented for all changes of substance, i.e. technical enhancements, corrections, updates, etc.
- z the third digit is incremented when editorial only changes have been incorporated in the document.

Introduction

The present document has been produced by the 3GPP TSG SA to standardise Lawful Interception of telecommunications. The present document describes protocols and procedures for Lawful Interception based on 3GPP specifications. These protocols and procedures cover both internal 3GPP interfaces (those required to intercept communications and manage interception within a 3GPP network) and external handover interfaces (those used for delivery of intercepted communications to Law Enforcement, or handling of warrants).

Lawful Interception needs to be done in accordance with the applicable national or regional laws and technical regulations. Such national laws and regulations define the extent to which capabilities in the present document are applicable in specific jurisdictions.

1 Scope

The present document specifies the protocols and procedures required to perform Lawful Interception within a 3GPP network. The present document addresses both internal interfaces used internally with a 3GPP network and external handover interfaces used to handover intercepted communications to law enforcement.

The present document describes the detailed targeting of communications in each point of interception within a 3GPP network and the information that a point of interception needs to be able to capture. Furthermore, the detailed data formats for both the internal and external interfaces are also defined.

National regulations determine the applicable set of information that needs to be handed over or excluded from handover to law enforcement for a given 3GPP operator service.

2 References

The following documents contain provisions which, through reference in this text, constitute provisions of the present document.

- References are either specific (identified by date of publication, edition number, version number, etc.) or non-specific.
- For a specific reference, subsequent revisions do not apply.
- For a non-specific reference, the latest version applies. In the case of a reference to a 3GPP document (including a GSM document), a non-specific reference implicitly refers to the latest version of that document *in the same Release as the present document*.

- [1] 3GPP TR 21.905: "Vocabulary for 3GPP Specifications".
- [2] 3GPP TS 23.501: "System Architecture for the 5G System".
- [3] 3GPP TS 33.126: "Lawful Interception Requirements".
- [4] 3GPP TS 23.502: "Procedures for the 5G System; Stage 2".
- [5] 3GPP TS 33.127: "Lawful Interception (LI) Architecture and Functions".
- [6] ETSI TS 103 120: "Lawful Interception (LI); Interface for warrant information".
- [7] ETSI TS 103 221-1: "Lawful Interception (LI); Internal Network Interfaces; Part 1: X1".
- [8] ETSI TS 103 221-2: "Lawful Interception (LI); Internal Network Interfaces; Part 2: X2/X3".
- [9] ETSI TS 102 232-1: "Lawful Interception (LI); Handover Interface and Service-Specific Details (SSD) for IP delivery; Part 1: Handover specification for IP delivery".
- [10] ETSI TS 102 232-7: "Lawful Interception (LI); Handover Interface and Service-Specific Details (SSD) for IP delivery; Part 7: Service-specific details for Mobile Services".
- [11] 3GPP TS 33.501: "Security Architecture and Procedures for the 5G System".
- [12] 3GPP TS 33.108: "3G security; Handover interface for Lawful Interception (LI)".
- [13] 3GPP TS 24.501: "Non-Access-Stratum (NAS) protocol for 5G System (5GS)".
- [14] 3GPP TS 24.007: "Mobile radio interface signalling layer 3; General Aspects".
- [15] 3GPP TS 29.244: "Interface between the Control Plane and the User Plane nodes".
- [16] 3GPP TS 29.502: "5G System; Session Management Services; Stage 3".
- [17] 3GPP TS 29.571: "5G System; Common Data Types for Service Based Interfaces; Stage 3".

- [18] 3GPP TS 23.040: "Technical realization of the Short Message Service (SMS)".
- [19] 3GPP TS 23.003: "Numbering, addressing and identification".
- [20] OMA-TS-MLP-V3_5-20181211-C: "Open Mobile Alliance; Mobile Location Protocol, Candidate Version 3.5", https://www.openmobilealliance.org/release/MLS/V1_4-20181211-C/OMA-TS-MLP-V3_5-20181211-C.pdf.
- [21] 3GPP TS 29.540: "5G System; SMS Services; Stage 3".
- [22] 3GPP TS 29.518: "5G System; Access and Mobility Management Services; Stage 3".
- [23] 3GPP TS 38.413: "NG Application Protocol (NGAP)".
- [24] 3GPP TS 29.572: "Location Management Services; Stage 3".
- [25] 3GPP TS 29.503: "5G System; Unified Data Management Services".
- [26] IETF RFC 815: "IP datagram reassembly algorithms".
- [27] IETF RFC 2460: "Internet Protocol, Version 6 (IPv6) Specification".
- [28] IETF RFC 793: "Transmission Control Protocol".
- [29] IETF RFC 768: "User Datagram Protocol".
- [30] IETF RFC 4340: "Datagram Congestion Control Protocol (DCCP)".
- [31] IETF RFC 4960: "Stream Control Transmission Protocol".
- [32] IANA (www.iana.org): Assigned Internet Protocol Numbers, "Protocol Numbers".
- [33] IETF RFC 6437: "IPv6 Flow Label Specification".
- [34] IETF RFC 791: "Internet Protocol".
- [35] Open Geospatial Consortium OGC 05-010: "URNs of definitions in ogc namespace".
- [36] 3GPP TS 33.107: "3G security; Lawful interception architecture and functions".
- [37] 3GPP TS 37.340: "Evolved Universal Radio Access (E-UTRA) and NR-Multi-connectivity; Stage 2".
- [38] 3GPP TS 36.413: "S1 Application Protocol (S1AP)".
- [39] OMA-TS-MMS_ENC-V1_3-20110913-A: "Multimedia Messaging Service Encapsulation Protocol".
- [40] 3GPP TS 23.140: "Multimedia Messaging Protocol. Functional Description. Stage 2".
- [41] 3GPP TS 38.415: "NG-RAN; PDU Session User Plane Protocol".
- [42] 3GPP TS 23.273: "5G System (5GS) Location Services (LCS); Stage 2".
- [43] IETF RFC 4566: "SDP: Session Description Protocol".
- [44] 3GPP TS 24.193: "Stage 3: Access Traffic Steering, Switching and Splitting (ATSSS)".
- [45] 3GPP TS 29.509: "5G System; Authentication Server Services; Stage 3".
- [46] 3GPP TS 24.011: "Point-to-Point (PP) Short Message Service (SMS) support on mobile radio interface".
- [47] 3GPP TS 29.002: "Mobile Application Part (MAP) specification".
- [48] 3GPP TS 29.504: "5G System; Unified Data Repository Services; Stage 3".

- [49] 3GPP TS 29.505: "5G System; Usage of the Unified Data Repository services for Subscription Data; Stage 3".
- [50] 3GPP TS 23.401 "General Packet Radio Service (GPRS) enhancements for Evolved Universal Terrestrial Radio Access Network (E-UTRAN) access".
- [51] 3GPP TS 24.301 "Non-Access-Stratum (NAS) protocol for Evolved Packet System (EPS), Stage 3".
- [52] 3GPP TS 23.271 "Functional stage 2 description of Location Services (LCS)".
- [53] 3GPP TS 29.172 "Evolved Packet Core (EPC) LCS Protocol (ELP) between the Gateway Mobile Location Centre (GMLC) and the Mobile Management Entity (MME); SLg interface".
- [54] 3GPP TS 29.171 "LCS Application Protocol (LCS-AP) between the Mobile Management Entity (MME) and Evolved Serving Mobile Location Centre (E-SMLC); SLs interface".
- [55] 3GPP TS 24.379: "Mission Critical Push to Talk (MCPTT) call control; protocol specification".
- [56] OMA-TS-PoC-System_Description-V2_1-20110802-A: "OMA PoC System Description".
- [57] 3GPP TS 29.541: "5G System; Network Exposure (NE) function services for Non-IP Data Delivery (NIDD); Stage 3".
- [58] 3GPP TS 29.522: "5G System; Network Exposure Function Northbound APIs; Stage 3".
- [59] 3GPP TS 29.338: "Diameter based protocols to support Short Message Service (SMS) capable Mobile Management Entities (MMEs); Stage 3".
- [60] 3GPP TS 29.337: "Diameter-based T4 interface for communications with packet data networks and applications".
- [61] 3GPP TS 24.250: "Protocol for Reliable Data Service; Stage 3".
- [62] 3GPP TS 29.128: "Mobility Management Entity (MME) and Serving GPRS Support Node (SGSN) interfaces for interworking with packet data networks and applications".
- [63] 3GPP TS 29.122: "T8 reference point for Northbound APIs".
- [64] 3GPP TS 29.598: "5G System; Unstructured Data Storage Services; Stage3".
- [65] 3GPP TS 33.535: "Authentication and Key Management for Applications (AKMA) based on 3GPP credentials in the 5G System (5GS)".
- [66] IETF RFC 5246: "The Transport Layer Security (TLS) Protocol Version 1.2".
- [67] GSMA IR.88: "IR.88 LTE and EPC Roaming Guidelines".
- [68] GSMA NG.114 "IMS Profile for Voice, Video and Messaging over 5GS".
- [69] IETF RFC 8225: "PASSporT: Personal Assertion Token".
- [70] IETF RFC 8224: "Authenticated Identity Management in the Session Initiation Protocol (SIP)".
- [71] IETF RFC 8588: "Personal Assertion Token (PaSSporT) Extension for Signature-based Handling of Asserted information using toKENs (SHAKEN)".
- [72] 3GPP TS 24.196: "Enhanced Calling Name (eCNAM)".
- [73] IETF draft-ietf-stir-passport-rcd-17: "PASSporT Extension for Rich Call Data".
- NOTE: The above document cannot be formally referenced until it is published as an RFC.
- [74] 3GPP TS 24.229: "IP multimedia call control protocol based on Session Initiation Protocol (SIP) and Session Description Protocol (SDP); Stage 3".

- [75] IANA Session Initiation Protocol (SIP) Parameters: <https://www.iana.org/assignments/sip-parameters/sip-parameters.xhtml>
- [76] IETF RFC 8946: "Personal Assertion Token (PASSporT) Extension for Diverted Calls".
- [77] 3GPP TS 23.204: "3rd Generation Partnership Project; Technical Specification Group Services and System Aspects; Support of Short Message Service (SMS) over generic 3GPP Internet Protocol (IP) access; Stage 2".
- [78] GSMA RCC.07: "Rich Communication Suite – Advanced Communications Services and Client Specification".
- [79] IETF RFC 4975: "The Message Session Relay Protocol (MSRP)".
- [80] IETF RFC 3862: "Common Presence and Instant Messaging (CPIM): Message Format".
- [81] IETF RFC 5438: "Instant Message Disposition Notification (IMDN)".
- [82] OMA-TS-CPM_System_Description-V2_2-20170926-C: "OMA Converged IP Messaging System Description".
- [83] IETF RFC 4566: "SDP: Session Description Protocol".
- [84] 3GPP TS 36.455: "Evolved Universal Terrestrial Radio Access (E-UTRA); LTE Positioning Protocol A (LPPa) ".
- [85] 3GPP TS 37.355: "LTE Positioning Protocol (LPP) ".
- [86] 3GPP TS 38.455: "NG-RAN; NR Positioning Protocol A (NRPPa)".
- [87] 3GPP TS 29.274: "3GPP Evolved Packet System (EPS); Evolved General Packet Radio Service (GPRS) Tunnelling Protocol for Control plane (GTPv2-C); Stage 3".
- [88] 3GPP TS 29.513: "5G System; Policy and Charging Control signalling flows and QoS parameter mapping".
- [89] 3GPP TS 29.512: "5G System; Session Management Policy Control Service; Stage 3".
- [90] 3GPP TS 29.508: "5G System; Session Management Event Exposure Service; Stage 3".
- [91] 3GPP TS 29.514: "5G System; Policy Authorization Service; Stage 3".
- [92] 3GPP TS 29.214: "Policy and Charging Control over Rx reference point".
- [93] 3GPP TS 24.008: "Mobile radio interface Layer 3 specification; Core network protocols; Stage 3".
- [94] 3GPP TS 29.551: "5G System; Packet Flow Description Management Service; Stage 3".
- [95] 3GPP TS 24.341: "Support of SMS over IP networks, Stage 3".
- [96] 3GPP TS 29.272 " Mobility Management Entity (MME) and Serving GPRS Support Node (SGSN) related interfaces based on Diameter protocol".
- [97] 3GPP TS 32.299: "Telecommunication management; Charging management; Diameter charging applications".

3 Definitions, symbols and abbreviations

3.1 Definitions

For the purposes of the present document, the terms and definitions given in 3GPP TR 21.905 [1] and the following apply. A term defined in the present document takes precedence over the definition of the same term, if any, in 3GPP TR 21.905 [1].

3.2 Symbols

For the purposes of the present document, the following symbols apply:

<symbol> <Explanation>

3.3 Abbreviations

For the purposes of the present document, the abbreviations given in 3GPP TR 21.905 [1] and the following apply. An abbreviation defined in the present document takes precedence over the definition of the same abbreviation, if any, in 3GPP TR 21.905 [1].

ADMF	LI Administration Function
CC	Content of Communication
CSP	Communication Service Provider
CUPS	Control and User Plane Separation
DNAI	Data Network Access Identifier
ICF	Identity Caching Function
IEF	Identity Event Function
IQF	Identity Query Function
IRI	Intercept Related Information
LALS	Lawful Access Location Services
LEA	Law Enforcement Agency
LEMF	Law Enforcement Monitoring Facility
LI	Lawful Interception
LICF	Lawful Interception Control Function
LI_HI1	LI_Handover Interface 1
LI_HI2	LI_Handover Interface 2
LI_HI3	LI_Handover Interface 3
LI_HI4	LI_Handover Interface 4
LI_HIQR	Lawful Interception Handover Interface Query Response
LIPF	Lawful Interception Provisioning Function
LIR	Location Immediate Request
LI_SI	Lawful Interception System Information Interface
LISSE	Lawful Interception State Storage Function
LI_ST	Lawful Interception State Transfer Interface
LI_X1	Lawful Interception Internal Interface 1
LI_X2	Lawful Interception Internal Interface 2
LI_X3	Lawful Interception Internal Interface 3
LI_XEM1	Lawful Interception Internal Interface Event Management Interface 1
LI_XER	Lawful Interception Internal Interface Event Record
LI_XQR	Lawful Interception Internal Interface Query Response
LTF	Location Triggering Function
MDF	Mediation and Delivery Function
MDF2	Mediation and Delivery Function 2
MDF3	Mediation and Delivery Function 3
MM	Multimedia Message
MMS	Multimedia Message Service
NAT	Network Address Translation
NPLI	Network Provided Location Information
O&M	Operations and Management
POI	Point Of Interception
RCS	Rich Communication Suite
SDP	Session Description Protocol
SIP	Session Initiation Protocol
SIRF	System Information Retrieval Function
SOI	Start Of Interception

TF	Triggering Function
TNGF	Trusted Non-3GPP Gateway Function
TWIF	Trusted WLAN Interworking Function
xCC	LI_X3 Communications Content.
xIRI	LI_X2 Intercept Related Information

4 General

4.1 Introduction

The present document provides details of the internal and external interfaces required for a network operator, access provider and/or service provider to provide the necessary information to a Law Enforcement Agency (LEA) required to meet LI requirements. LI requirements for 3GPP networks and services are given in TS 33.126 [3].

The high-level architecture that defines the necessary interfaces is specified in TS 33.127 [5]. The generic high-level architecture is as follows:

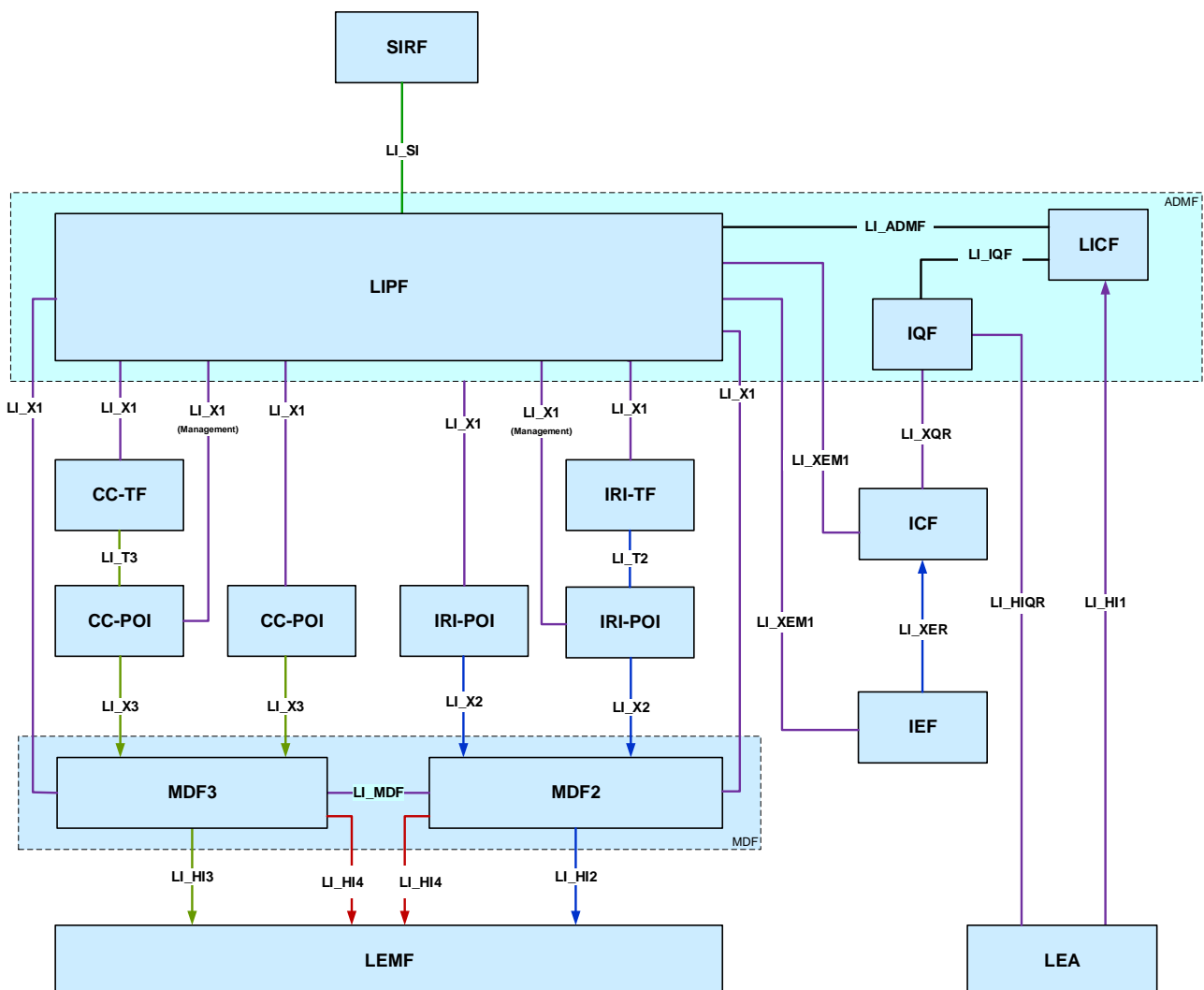

Figure 4.1-1: High-level architecture diagram with key point-to-point LI interfaces

The specification of the interfaces is split into two parts:

- Internal interfaces used between an operator's network functions are described in clause 4.2.

- External interfaces used in communicating with a LEA are described in clause 4.3.

4.2 Basic principles for internal interfaces

This clause lists the internal interfaces shown in clause 4.1, indicates the protocol used to realise each interface, and gives a reference to the relevant clauses of the present document that specify how the protocol is to be used for the given interface.

Table 4.2-1: Internal interfaces and related protocols

Interface	Description	Protocol used to realise interface	Usage
LI_ADMF	Used to pass intercept provisioning information from the LICF to the LIPF.	Out of scope of the present document.	
LI_IQF	Used to pass information related to IEFs and ICF to IQF.	Out of scope of the present document.	
LI_MDF	Used by MDF2 and MDF3 in interactions necessary to correctly generate CC and IRI from xCC and xIRI.	Out of scope of the present document.	
LI_SI	Used to provide system information to the LIPF from the SIRF.	Out of scope of the present document.	
LI_ST	Used to transfer LI state information to and from the LISSF.	3GPP TS 29.598 [64].	See clauses 5.10 and 6.2.3.10
LI_T2	Used to pass triggering information from the IRI-TF to a Triggered IRI-POI.	ETSI TS 103 221-1 [7].	See clause 5.2.4
LI_T3	Used to pass triggering information from a CC-TF to a Triggered CC-POI.	ETSI TS 103 221-1 [7].	See clause 5.2.4
LI_X1	Used to configure and audit Directly-provisioned POIs, TFs and MDFs.	ETSI TS 103 221-1 [7].	See clause 5.2.2
LI_X1 (Management)	Used to audit Triggered POIs.	ETSI TS 103 221-1 [7].	See clause 5.2.3
LI_X2	Used to pass xIRI from IRI-POIs to the MDF2.	ETSI TS 103 221-2 [8].	See clause 5.3.2
LI_X3	Used to pass xCC from CC-POIs to the MDF3.	ETSI TS 103 221-2 [8].	See clause 5.3.3
LI_XEM1	Used by the LICF/LIPF to manage IEFs and ICF.	ETSI TS 103 221-1 [7].	See clause 5.2.7
LI_XER	Used to pass identifier association event records from IEFs to ICF.	See Clause 5.9.	See clause 5.9
LI_XQR	Used to pass queries from IQF to ICF and responses from ICF to IQF.	ETSI TS 103 221-1 [7].	See clause 5.8

4.3 Basic principles for external handover interfaces

This clause lists the external handover interfaces shown in clause 4.1, indicates the protocol used to realise each interface, and gives a reference to the relevant clauses of the present document that specify how the protocol is to be used for the given interface.

Table 4.3-1: External handover interfaces and related protocols

Interface	Description	Protocol used to realise interface	Usage
LI_HI1	Used to send warrant and other interception request information from LEA to operator.	ETSI TS 103 120 [6] shall be supported. Other methods (e.g. manual exchange) may be used depending on national regulatory requirements.	See clause 5.4
LI_HI2	Used to send IRI from the MDF2 to the LEMF.	ETSI TS 102 232-1 [9] and ETSI TS 102 232-7 [10] shall be supported.	See clause 5.5
LI_HI3	Used to send CC from the MDF3 to the LEMF.	ETSI TS 102 232-1 [9] and ETSI TS 102 232-7 [10] shall be supported.	See clause 5.5
LI_HI4	Used to send LI notification information from MDF2/MDF3 to LEMF.	ETSI TS 102 232-1 [9] and ETSI TS 102 232-7 [10] shall be supported.	See clause 5.6
LI_HIQR	Used to send warrant and other identifier association query information from LEA to CSP and used by the CSP to send query responses to the LEA.	ETSI TS 103 120 [6] shall be supported.	See clause 5.7

4.4 Service scoping

4.4.1 General

The interception product shall be delivered to the LEMF over LI_HI2 and LI_HI3, observing the service scoping described in the following clauses.

4.4.2 CSP service type

The LIPF shall be able to provision the POIs, TFs and MDF2/MDF3 according to the requirements of the warrant with the following CSP service type(s):

- Voice.
- Data.
- Messaging (e.g. SMS/MMS).
- Push-to-Talk (including MCPTT).
- LALS (the Target Positioning service, per TS 33.127 [5], clause 7.3.3.2).
- RCS.

When multiple service types are applicable to a target due to multiple warrants, the MDF2/MDF3 shall be able to deliver interception product to each LEMF based on the CSP service type(s) of the respective warrant.

When no service type is provisioned, the POIs shall generate and deliver applicable interception product for all services specified for the NF where the POI is located.

When no service type is provisioned, the MDF2/MDF3 shall deliver all interception product it receives from the POIs.

4.4.3 Delivery type

- IRI.
- CC.
- IRI and CC.

The LIPF shall be able to provision the POI, TF and the MDF2/MDF3 according the delivery type(s) applicable to a warrant.

When different delivery types are applicable to a target due to multiple warrants, the MDF2/MDF3 shall be able to deliver IRI/CC to each LEMF based on the delivery type(s) of the respective warrant.

4.4.4 Location Reporting

The LIPF shall be able to provision the POIs and MDF2 according to the requirements of the warrant with the following location reporting types:

- Report location only at the beginning and end of a session.
- Do not report location.

When no location reporting type is provisioned, the POIs and MDF2/MDF3 shall report location every time the target location information is received at the POI (including location update with no physical change of location).

When different location reporting types are applicable to a target due to multiple warrants, then POI may be provisioned as if the reporting of all location information occurrences at the POI is required, with MDF2 restricting the delivery of location to the LEMF as per the provisioned information for a warrant.

4.4.5 LALS Triggering

- This option is used to activate the LALS triggered location service (TS 33.127 [5], clause 7.3.3.3) for the target.

The LIPF shall be able to provision the LTF associated with a POI or MDF2 with the LALS triggered location service parameters provided in the warrant or use a default set of parameters.

4.4.6 Roaming Interception

- Stop interception when the target is roaming outbound internationally.

NOTE 1: The definition of international roaming for LI purposes could vary per jurisdiction.

NOTE 2: The method used to achieve the roaming related service scoping is not described in the present document.

5 Transport and Communications Protocol

5.1 General

This clause describes the protocols used for each of the interfaces at a level which is agnostic of the subject service or network. Additional specific fields or behaviours are given in the relevant parts of clauses 6 and 7.

5.2 Protocols for LI_X1 and LI_T interfaces

5.2.1 General usage of ETSI TS 103 221-1

Functions having an LI_X1, LI_T2 or LI_T3 interface shall support the use of ETSI TS 103 221-1 [7] to realise the interface.

In the event of a conflict between ETSI TS 103 221-1 [7] and the present document, the terms of the present document shall apply.

The LIPF and MDF2/MDF3 shall maintain a mapping between internal interception identifiers (XIDs) and external interception identifiers (LIIDs), as defined by ETSI TS 103 221-1 [7] clause 5.1.2. In case of multiple interceptions for a single target identifier, it is an implementation decision for the LIPF/TF whether multiple XIDs are used (i.e. a one-to-one mapping between XID and LIID is maintained) or whether the single XID is used and mapped to multiple LIIDs at the MDF2/MDF3. Clauses 6 and 7 give further details for specific networks or services (e.g. minimum supported target identifier formats).

In the event of a request issued over the interface fails, or an error is reported, the LIPF should raise an alert in the appropriate LI Operations and Management (O&M) system. Further procedures (e.g. retrying a failed request) are left to CSP policy to define.

A failure of LI shall not impact the target's or other users' services.

In general, and unless otherwise specified, the function playing the role of the NE (i.e. IRI-POI, IRI-TF, CC-TF, CC-POI, MDF2 or MDF3) shall:

- Accept CreateDestination and ModifyDestination messages regardless of the DeliveryType.
- Reject ActivateTask/ModifyTask messages that contain destination identifiers (DIDs) that reference Destinations that have not been created via a CreateDestination message; Destinations shall be created before they are used.
- Reject ActivateTask/ModifyTask messages that do not result in at least one valid DID for their DeliveryType (e.g. at least one valid DID for an X2 delivery destination for an "X2Only" Task). Additional DIDs for Destinations of other DeliveryTypes (e.g. a DID for an X3 Destination for an "X2Only" Task) shall be accepted, but a ReportTaskIssue message may be sent to indicate the mismatch.

5.2.2 Usage for realising LI_X1

For the purposes of realising LI_X1 between the LIPF and a POI, MDF or TF, the LIPF plays the role of the ADMF as defined in ETSI TS 103 221-1 [7] reference model (clause 4.2), and the POI, MDF or TF plays the role of the NE.

In general, and unless otherwise specified, the ADMF shall:

- When the provisioning of an IRI-POI/IRI-TF/MDF2 is needed to meet the requirements of the warrant, send an ActivateTask (and subsequent ModifyTask if/as needed) with the DeliveryType set to "X2Only" and the ListOfDIDs containing at least one DID for an X2 or LI_HI2 delivery destination over LI_X1 to each of the relevant functions.
- When the provisioning of a CC-POI/CC-TF/MDF3 is needed to meet the requirements of the warrant, send an ActivateTask (and subsequent ModifyTask if/as needed) with the DeliveryType set to "X3Only" and the ListOfDIDs containing at least one DID for X3 or LI_HI3 delivery destination over LI_X1 to each of the relevant functions.

When both the above are required to meet the requirements of the warrant, the ADMF shall send each independently to each relevant function.

When it is required to cease interception, the ADMF shall send a DeactivateTask message to each relevant function, unless the Task has already been removed by other means (e.g. by the use of the ImplicitDeactivationAllowed flag, see ETSI TS 103 221-1 [7] clause 6.2.1.2).

Other deployments compliant with ETSI TS 103 221-1 [7] may be used subject to local agreement.

5.2.3 Usage for realising LI_X1 (management)

For the purposes of realising LI_X1 between the LIPF and a triggered POI, the LIPF plays the role of the "ADMF" as defined in ETSI TS 103 221-1 [7] reference model (clause 4.2), and the triggered POI plays the role of the "NE".

5.2.4 Service scoping

The LIPF shall be able to provision the POI, TFs and the MDF2/MDF3 according to the service scoping (see clause 4.4) applicable to a warrant as described in clause 6.2.1.2 and Annex C of ETSI TS 103 221-1 [7].

If there is a need to explicitly identify specific CSP service types to be intercepted by the task, the LIPF shall include the ListOfServiceTypes parameter in the TaskDetails of the provisioning message sent to the POIs/TFs. If no service type is provisioned, the POIs shall generate and deliver applicable interception product for all services specified for the NF where the POI is located as described in clause 4.4.2.

If there is a need to explicitly identify specific CSP service types to be delivered by the task, the LIPF shall populate the ServiceType in the ServiceScoping parameter in the MediationDetails of the provisioning message sent to the

MDF2/MDF3. If the LIPF includes the ListOfServiceTypes parameter in the TaskDetails of the provisioning message sent to the MDF2/MDF3, the MDF2/MDF3 shall ignore this parameter.

5.2.5 Usage for realising LI_T2

For the purposes of realising LI_T2 between an IRI-TF and a triggered IRI-POI, the IRI-TF plays the role of the "ADMF" as defined in the ETSI TS 103 221-1 [7] reference model (clause 4.2), and the triggered IRI-POI plays the role of the "NE".

In case the IRI-TF receives from the triggered IRI-POI an error in the answer to a triggering message, the IRI-TF shall send a ReportTaskIssue message to the LIPF. In such case, the failure of LI shall not impact the target's or other users' services.

Unless otherwise specified, an IRI-TF shall set the ProductID field in any ActivateTask or ModifyTask message issued to a triggered IRI-POI (see ETSI TS 103 221-1 [7] clause 6.2.1.2). The IRI-TF shall set the ProductID to the XID of the Task object associated with the interception at the IRI-TF in order to allow correlation of LI product at the MDF2.

Unless otherwise specified, the TF shall include the MDF2 as the X2 delivery destination in the trigger sent using the ActivateTask/ModifyTask with "X2Only".

When the IRI-TF determines that it is required to remove a Task at a particular IRI-POI (e.g. having detected the end of a session) it shall send a DeactivateTask message for the relevant Task to that IRI-POI, unless the Task has already been removed by other means (e.g. by the use of the ImplicitDeactivationAllowed flag, see ETSI TS 103 221-1 [7] clause 6.2.12).

When the IRI-TF receives a DeactivateTask message or ModifyTask message from the LIPF, the IRI-TF shall send DeactivateTask or ModifyTask messages to all applicable triggered IRI-POIs for all tasks associated to the Task object in the message from the LIPF.

5.2.6 Usage for realising LI_T3

For the purposes of realising LI_T3 between a CC-TF and a triggered CC-POI, the CC-TF plays the role of the "ADMF" as defined in the ETSI TS 103 221-1 [7] reference model (clause 4.2), and the triggered CC-POI plays the role of the "NE".

In case the CC-TF receives from the triggered CC-POI an error in the answer to a triggering message, the CC-TF shall send a ReportTaskIssue message to the LIPF. In such case, the failure of LI shall not impact the target's or other users' services.

Unless otherwise specified, a CC-TF shall set the ProductID field in any ActivateTask or ModifyTask message issued to a triggered CC-POI (see ETSI TS 103 221-1 [7] clause 6.2.1.2). The CC-TF shall set the ProductID to the XID of the Task object associated with the interception at the CC-TF in order to allow correlation of LI product at the MDF3.

Unless otherwise specified, the TF shall include MDF3 as the X3 delivery destination in the trigger sent using the ActivateTask/ModifyTask with "X3Only".

When the CC-TF determines that it is required to remove a Task at a particular CC-POI (e.g. having detected the end of a session) it shall send a DeactivateTask message for the relevant Task to that CC-POI, unless the Task has already been removed by other means (e.g. by the use of the ImplicitDeactivationAllowed flag, see ETSI TS 103 221-1 [7] clause 6.2.12).

When the CC-TF receives a DeactivateTask message or ModifyTask message from the LIPF, the CC-TF shall send DeactivateTask or ModifyTask messages to all applicable triggered CC-POIs for all tasks associated to the Task object in the message from the LIPF.

5.2.7 Usage for realising LI_XEM1

For the purposes of realising LI_XEM1 between the LIPF and an IEF, the LIPF plays the role of the ADMF as defined in ETSI TS 103 221-1 [7] reference model (clause 4.2), and the IEF plays the role of the NE.

The IEF shall be enabled by sending the following ActivateTask message from the LIPF.

NOTE: The terms identifier and identity are used interchangeably in clause 5.2.7.

Table 5.2.7-1: ActivateTask message for activating an IEF

ETSI TS 103 221-1 field name	Description	M/C/O
XID	Shall be set to a value assigned by the LIPF.	M
TargetIdentifiers	Shall contain a single Target Identifier of type "IdentityAssociation" (see table 5.2.7-2)	M
DeliveryType	Set to "X2Only".	M
ListOfDIDs	Shall give the DID of the delivery endpoint of the ICF(s) to which identity association events should be delivered. These delivery endpoints are configured using the CreateDestination message as described in ETSI TS 103 221-1 [7] clause 6.3.1 prior to the task activation.	M

The following Target Identifier Type is defined for the use of LI_XEM1. Unless otherwise specified, use of any other Target Identifier Type (including adding a target identifier more than once) shall result in the ActivateTask message being rejected with the appropriate error.

Table 5.2.7-2: Target Identifier Type for LI_XEM1

Identifier type	Owner	ETSI TS 103 221-1 [7] TargetIdentifier type	Definition
IdentityAssociationTargetIdentifier	3GPP	TargetIdentifierExtension / IdentityAssociationTargetIdentifier	Empty tag (see XSD schema)

The IEF may be reconfigured to send identity associations to a different ICF using a ModifyTask message to modify the delivery destinations.

The IEF shall be disabled by sending the following DeactivateTask message from the LIPF.

Table 5.2.7-3: DeactivateTask message for de-activating an IEF

ETSI TS 103 221-1 field name	Description	M/C/O
XID	Shall be set to the value assigned by the LIPF	M

The LIPF should send one ActivateTask command to each IEF.

NOTE: The IEF may receive multiple ActivateTask messages conforming to table 5.2.7-1, each of which can be independently deactivated. The IEF shall remain active as long as at least one valid Task remains active.

5.3 Protocols for LI_X2 and LI_X3

5.3.1 General usage of ETSI TS 103 221-2

Functions having an LI_X2 or LI_X3 interface shall support the use of ETSI TS 103 221-2 [8] to realise the interface.

In the event of a conflict between ETSI TS 103 221-2 [8] and the present document, the terms of the present document shall apply.

The xIRI and the xCC sent using ETSI TS 103 221-2 [8] shall contain the appropriate XID as received in the relevant LI_X1 provisioning message (or LI_T2/LI_T3 triggering message, as appropriate), noting that the appropriate XID may be given in the ProductID field.

5.3.2 Usage for realising LI_X2

The POI sending xIRI over the LI_X2 interface shall set the PDU type field within the xIRI to "X2 PDU". (see ETSI TS 103 221-2 [8] clause 5.1).

Where a single xIRI is sent as a result of a network procedure (i.e. as result of several signaling messages exchanged between the target UE and the network), the POI sending the xIRI shall set the Payload Direction field (see ETSI TS 103 221-2 [8] clause 5.2.6) based on the initiator of the network procedure.

Unless otherwise specified by the relevant clause, the payload shall consist of a BER-encoded TS33128Payloads.XIRIPayload structure. The payload format (see ETSI TS 103 221-2 [8] clause 5.4) shall be set according to the relevant clause of the present document (the value 2 is used for TS 33128Payloads.XIRIPayload). The TLS transport profile (see ETSI TS 103 221-2 [8] clause 6) shall be supported and used by default.

Unless otherwise specified, xIRI shall include the timestamp and sequence number conditional attribute fields, with the timestamp value set to the time at which the event occurred.

Unless otherwise specified, the "Matched Target Identifier" conditional attribute shall be set to indicate what target identity was matched to generate the xIRI (see ETSI TS 103 221-2 [8] clause 5.3.18).

Unless otherwise specified, the "Other Target Identifier" conditional attribute shall be set with all other target identities present at the NF that contains the POI (see ETSI TS 103 221-2 [8] clause 5.3.19).

Unless otherwise specified, the NFID conditional attribute (see ETSI TS 103 221-2 [8] clause 5.3.7) should be set to indicate the NF that contains the POI. The NFID is defined as a unique identifier assigned to the NF by the network (e.g. FQDN) per carrier implementation and referred to in the following clauses.

Unless otherwise specified, the IPID (see ETSI TS 103 221-2 [8] clause 5.3.8) should be set to indicate the POI (within the NF) that generated the xIRI for the conditional attribute field.

5.3.3 Usage for realising LI_X3

The POI sending xCC over the LI_X3 interface shall set the PDU type field in the xCC to "X3 PDU" (see ETSI TS 103 221-2 [8] clause 5.1).

The payload format shall be specified according to the relevant clause of the present document.

Unless otherwise specified, the NFID conditional attribute (see ETSI TS 103 221-2 [8] clause 5.3.7) should be set to indicate the NF that contains the POI. The NFID is defined as a unique identifier assigned to the NF by the network (e.g. FQDN) per carrier implementation and referred to in the following clauses.

Unless otherwise specified, the IPID (see ETSI TS 103 221-2 [8] clause 5.3.8) should be set to indicate the POI (within the NF) that generated the xCC for the conditional attribute field.

If defined by LI for a specific 3GPP-defined-network deployment (see clause 6) or a specific 3GPP-defined service (see clause 7), the POI may use the Additional XID Related Information attributes to facilitate efficient delivery of xCC, as specified in ETSI TS 103 221-2 [8] clause 5.3.22.

NOTE: ETSI TS 103 221-2 [8] specifies in clause 6 a default profile which is mandatory to support, but allows further profiles to be defined. In scenarios where it may not be possible to achieve the necessary LI data rates based on the default profile, alternative profiles may be considered (e.g. based on UDP, multi path TCP or other protocols). Any alternative profile needs to ensure that LI reliability, security and completeness requirements as specified in TS 33.126 [3] are met.

5.3.4 Service scoping

When applicable, the POIs shall deliver the xIRIs/xCC to MDF2/MDF3 over LI_X2/LI_X3 according to the service scoping as provisioned by the LIPF to them (see clause 5.2.4).

5.4 Protocols for LI_HI1

5.4.1 General

Functions having an LI_HI1 interface shall support the use of ETSI TS 103 120 [6] to realise the interface.

In the event of a conflict between ETSI TS 103 120 [6] and the present document, the terms of the present document shall apply.

5.4.2 Service scoping

Functions having an LI_HI1 interface (i.e. the ADMF) shall be able to receive the service scoping as applicable to the warrant from the LEA over the LI_HI1 interface (see clause 4.4).

5.5 Protocols for LI_HI2 and LI_HI3

5.5.1 General

Functions having an LI_HI2 or LI_HI3 interface shall support the use of ETSI TS 102 232-1 [9] and ETSI TS 102 232-7 [10] to realise the interface.

In the event of a conflict between either specification and the present document, the terms of the present document shall apply.

5.5.2 Usage for realising LI_HI2

The IRI messages sent over LI_HI2 are structured as a header and a payload. The header contains general information like LIID, timestamp, correlation information (as for example defined in ETSI TS 102 232-1 [9]). The payload contains intercept related information based on information that the MDF2 has received from sources in the network, such as the IRI-POI as described in clauses 6 and 7 of the present document. Details of the IRI messages can be found in Annex A of the present document. Messages defined as passing over the LI_HI2 interface shall be passed as the payload of the threeGPP33128DefinedIRI field (see TS ETSI 102 232 -7 [10] clause 15).

If the LI_X2 contains the NFID conditional attribute (see ETSI TS 103 221-2 [8] clause 5.3.7), this shall be mapped into the PSHeader networkFunctionIdentifier (see ETSI TS 102 232-1 [9] clause 5.2.14 and ETSI TS 102 232-7 [10] clause 15.3).

If the LI_X2 contains the IPID conditional attribute (see ETSI TS 103 221-2 [8]), the EIPID parameter (see ETSI TS 102 232-1 [9] clause 5.2.13) shall be populated by the MDF2 with the IPID value.

5.5.3 Usage for realising LI_HI3

The CC sent over LI_HI3 is structured as a header and a payload. The header contains general information like LIID, timestamp, correlation information (as for example defined in ETSI TS 102 232-1 [9]). The payload contains content of communication based on information that the MDF3 has received from sources in the network, such as the CC-POI as described in clauses 6 and 7 of the present document. Details of the CC can be found in Annex A of the present document. CC defined as passing over the LI_HI3 interface shall be passed as the payload of the threeGPP33128DefinedCC field (see ETSI TS 102 232-7 [10] clause 15).

If the LI_X3 contains the NFID conditional attribute (see ETSI TS 103 221-2 [8] clause 5.3.7), this shall be mapped into the PSHeader networkFunctionIdentifier (see ETSI Ts 102 232-1 [9] clause 5.2.14 and ETSI TS 102 232-7 [10] clause 15.3).

If the LI_X3 contains the IPID conditional attribute (see ETSI TS 103 221-2 [8]), the EIPID parameter (see ETSI TS 102 232-1 [9] clause 5.2.13) shall be populated by the MDF3 with the IPID value.

NOTE: ETSI TS 102 232-1 [9] specifies in clause 6.4 a transport layer based on TCP. However, based on agreement between network operator and LEA, in scenarios where it may not be possible to achieve the necessary LI data rates based on the transport layer based on single TCP connection, alternative profiles may be considered (e.g. based on UDP, multi path TCP or other protocols). Any alternative profile needs to ensure that LI reliability, security and completeness requirements as specified in TS 33.126 [3] are met.

5.5.4 Service scoping

The MDF2 and MDF3 shall be able to deliver the IRI messages and the CC to the LEMF over LI_HI2 and LI_HI3 respectively, according to the provisioned service scoping (see clause 5.2.4).

5.5.5 IRI Target Identifiers

The MDF shall populate the TargetIdentifiers field of the IRIPayload defined in Annex A with all Target Identifiers available at the MDF. For all Identifiers received in the LI_X2 "Matched Target Identifier" conditional attribute (see clause 5.3.2), the MDF shall include the relevant Identifier with the provenance set to "matchedOn". For all Identifiers received in the the LI_X2 "Other Target Identifier" conditional attribute (see clause 5.3.2), the MDF shall include the relevant Identifier with the provenance set to "other". For all Identifiers present in the xIRI payload, the MDF shall include the relevant Identifier with the provenance set to "observed". For all Identifiers present in the provisioning message received over X1, the MDF shall include the relevant Identifier with the provenance set to "IEAProvided". For all Identifiers present in the MDF that are not reported as other TargetIdentifiers, the MDF shall include the relevant Identifier with the provenance set to "other".

5.6 Protocols for LI_HI4

5.6.1 General

Functions having an LI_HI4 shall support the use of ETSI TS 102 232-1 [9] to realise the interface.

In the event of a conflict between ETSI TS 102 232-1 [9] and the present document, the terms of the present document shall apply.

5.6.2 Usage for realising LI_HI4

The LI Notification messages sent over LI_HI4 are structured as a header and a payload. The header contains general information like LIID, timestamp (as for example defined in ETSI TS 102 232-1 [9]). The payload contains the administrative information such as notification. Details of the LI Notification messages can be found in Annex B of the present document.

Where the LI_HI4 interface is present alongside an LI_HI2 interface or LI_HI3 interface, the LI Notification messages shall be transmitted along the same connection as the IRI messages or CC. Where ETSI TS 102 232-1 [9] is used for LI_HI2 or LI_HI3, messages defined as passing over the LI_HI4 interface shall be passed in the hi4Payload sequence.

The MDF2/MDF3 shall support generation LI Notification messages for at least the following events:

- Activation of an interception at the MDF2/MDF3 via LI_X1.
- Modification of an interception at the MDF2/MDF3 via LI_X1.
- Deactivation of an interception at the MDF2/MDF3 via LI_X1.

5.7 Protocols for LI_HIQR

5.7.1 General

Functions having an LI_HIQR interface shall support the use of ETSI TS 103 120 [6] to realise the interface.

In the event of a conflict between ETSI TS 103 120 [6] and the present document, the terms of the present document shall apply.

NOTE: The terms identifier and identity are used interchangeably in clause 5.7.

5.7.2 Usage for realising LI_HIQR

5.7.2.1 Request structure

LI_HIQR requests are represented by issuing a CREATE request for an LDTaskObject (see ETSI TS 103 120 [6] clause 8.3), populated as follows:

Table 5.7.2-1: LDTaskObject representation of LI_HIQR request

Field	Value	M/C/O
Reference	Reference to the authorization under which the request is made. The format of this field, and any procedures for allocating or validating it, are for national agreement.	M
DesiredStatus	Shall be set to "AwaitingDisclosure".	M
RequestDetails	Set according to table 5.7.2-2 below.	M
DeliveryDetails	Shall be set to indicate the delivery destination for the LI_HIQR records (see clause 5.7.2.3 and ETSI TS 103 120 [6] clause 8.3.6.2) unless the delivery destination is known via other means.	C

The use of any other LDTaskObject parameter is outside the scope of the present document.

Table 5.7.2-2: RequestDetails structure

Field	Value	M/C/O
Type	Shall be set to one of the RequestType values as defined in table 5.7.2-3.	M
ObservedTime	When the RequestValues provides a temporary identity, this field shall be set to the observation time of that temporary identity. When the RequestValues provides a permanent identity, this is the time at which the LEA requires that the permanent to temporary association is applicable. Shall not be present for requests of type "OngoingIdentityAssociation".	C
RequestValues	Set to the target identifier plus additional information required (see clause 5.7.2.2).	M

NOTE: If the observed time is in the past, providing a successful query response is subject to associations still being available in the cache when the query is made to the ICF.

Table 5.7.2-3: RequestType Dictionary for LI_HIQR

Dictionary Owner	Dictionary Name
3GPP	RequestType
Defined DictionaryEntries	
Value	Meaning
IdentityAssociation	A request for a single IdentityResponseDetails response to the query provided.
OngoingIdentityAssociation	A request for an ongoing series of IdentityResponseDetails responses matching the query provided. May only be used when the RequestValues contains a permanent identifier. The request shall be terminated by updating the LDTaskObject DesiredStatus to "Disclosed".

Table 5.7.2-3 is formatted in accordance with ETSI TS 103 120 [6] Annex F.

5.7.2.2 Request parameters

The RequestValues field shall contain one of the following:

- SUPI, given in either SUPIIMSI or SUPINAI formats as defined in ETSI TS 103 120 [6] clause C.2.
- SUCI, given as defined in table 5.7.2-4 below.
- 5G-S-TMSI, given as defined in table 5.7.2-4 below.
- 5G-GUTI, given as defined in table 5.7.2-4 below.

If the RequestType is "OngoingIdentityAssociation" (see table 5.7.2-3), SUPI is the only valid identity type in the RequestValues field. If the RequestType is "OngoingIdentityAssociation" and any other identity type is provided, the IQF shall signal the error by setting the LDTaskObject Status to "Invalid" (see ETSI TS 103 120 [6] clause 8.3.3).

If a temporary identity is provided, the following shall also be present as RequestValues:

- NRCellIdentity, given as defined in table 5.7.2-4 below.
- TrackingAreaCode, given as defined in table 5.7.2-4 below.

The following RequestValue FormatTypes (see ETSI TS 103 120 [6] clause 8.3.5.4) are defined (which are not otherwise defined elsewhere).

Table 5.7.2-4: RequestValue FormatType extensions for LI_HIQR Requests

Format Owner	Format Name	Description	Format
3GPP	SUCI	Subscription Concealed Identifier as per TS 23.003 [19] clause 2.2B.	TS 29.509 [45] clause 6.1.6.3.2
3GPP	5GSTMSI	Shortened form of the 5G-GUTI as defined in TS 23.003 [19] clause 2.11. Given as a hyphen-separated concatenation of: <ul style="list-style-type: none"> - The string "5gstmsi". - The AMF Set ID given as three hexadecimal digits (10 bits). - The AMF Pointer given as two hexadecimal digits (6 bits). - The 5G-TMSI given as eight hexadecimal digits (32 bits) 	Matches regular expression: $\wedge(5gstmsi-([0-3][0-9A-Fa-f]{2})-([0-3][0-9A-Fa-f])-([0-9A-Fa-f]{8}))\wedge$
3GPP	5GGUTI	As defined in TS 23.003 [19] clause 2.10. Given as a hyphen separated concatenation of: <ul style="list-style-type: none"> - The string "5gguti". - MCC given as a three decimal digits. - MNC given as a two or three digit decimal digits - AMF Region ID given as two hexadecimal digits (8 bits). - The AMF Set ID, AMF Pointer and 5G-TMSI as defined above in 5GSTMSI 	Matches regular expression: $\wedge(5gguti-([0-9]{3})-([0-9]{2,3})-([0-9A-Fa-f]{2})-([0-3][0-9A-Fa-f]{2})-([0-3][0-9A-Fa-f])-([0-9A-Fa-f]{8}))\wedge$
3GPP	NRCellIdentity	NR Cell ID (NCI), as defined in TS 23.003 [19] clause 19.6A	TS 29.571 [17] clause 5.4.2
3GPP	TrackingAreaCode	Tracking area code as defined in TS 23.003 [19] clause 19.4.2.3	TS 29.571 [17] clause 5.4.2

The LDTaskObject may also contain the "IncludeNCGIInResponse" LDTask flag (see table 5.7.2-4A). If this flag is present for such a query, then the response shall contain the NR Cell Global Identity associated with the SUPI at the time of association (see table 5.7.2-5).

Table 5.7.2-4A: LDTaskFlags for LI_HIQR Requests

Dictionary Owner	Dictionary Name
3GPP	LIHIQRFlags
Defined DictionaryEntries	
Value	Meaning
IncludeNCGIInResponse	A request for returning the NCGL in the response.

5.7.2.3 Response structure

The LI_HIQR request is used to generate a request to the ICF over LI_XQR (see clause 5.8). The response received over LI_XQR is then transformed into an LI_HIQR response.

LI_HIQR responses and updates are represented as XML following the IdentityResponseDetails type definition (see Annex E).

Responses and updates are delivered within a DELIVER Request (see ETSI TS 103 120 [6] clause 6.4.10) containing a DeliveryObject (see ETSI TS 103 120 [6] clause 10).

IdentityResponseDetails contain IdentityAssociation records. The fields of each IdentityAssociationRecord shall be set as follows:

Table 5.7.2-5: IdentityAssociationRecord

Field	Value	M/C/O
SUPI	SUPI associated with the provided identity.	M
SUCI	SUCI associated with the provided identity, if available.	C
5G-GUTI	5G GUTI associated with the provided identity, provided in the form given in the request (see table 5.7.2-4).	M
PEI	PEI associated with the provided identity during the association period, if known.	C
AssociationStartTime	The time that the association between the SUPI and the temporary identity became valid. (see NOTE).	M
AssociationEndTime	The time that the association between the SUPI and the temporary identity ceased to be valid. Shall be omitted if the association is still valid (see NOTE).	C
FiveGSTAIList	List of tracking areas associated with the registration area within which the UE was or is registered in the lifetime of the reported association, if available. See clause 7.6.2.4 for details.	C
GPSI	GPSI associated with the provided identity during the association period, if known.	C
NCGI	NR Cell Global Identity associated with the SUPI at the time of association between the SUPI and the temporary identity. Shall be sent if the "IncludeNCGIInResponse" flag is set.	C
NOTE: The AssociationStartTime and AssociationEndTime represent the lifespan of the SUPI to 5G-GUTI association. When a SUCI is present, the AssociationStartTime also represents the time of the SUCI's validity.		

If no association is found which matches the criteria provided in the LI_XQR request, then the LI_XQR response contains zero IdentityAssociationRecords. Similarly, the LI_HIQR response contains zero IdentityAssociationRecords.

For responses or updates providing a currently valid SUPI to 5G-GUTI identity association, the AssociationEndTime shall be absent. The AssociationStartTime shall indicate when the 5G-GUTI became associated with the SUPI. The SUCI field shall be populated if it was present in the IEF record for the association (see clause 6.2.2A.2.1). The PEI and TAI List fields may be populated as well, see clause 7.6.2.4 for details.

In the case of ongoing updates, the presence of the AssociationEndTime indicates the SUPI to 5G-GUTI identity disassociation. Such updates shall only happen when no new association is replacing the outgoing one.

The DeliveryObject Reference field (see ETSI TS 103 120 [6] clause 10.2.1) shall be set to the Reference of the LDTaskObject used in the request, to provide correlation between request and response. The DeliveryID, SequenceNumber and LastSequence fields shall be set according to ETSI TS 103 120 [6] clause 10.2.1.

The content manifest (see ETSI TS 103 120 [6] clause 10.2.2) shall be set to indicate the present document, using the following Specification Dictionary extension.

Table 5.7.2-6: Specification Dictionary

Dictionary Owner	Dictionary Name
3GPP	ManifestSpecification.
Defined DictionaryEntries	
Value	Meaning
LIHIQRResponse	The delivery contains IdentityResponseDetails (see Annex E)

5.8 Protocols for LI_XQR

5.8.1 General

LI_XQR requests are realised using ETSI TS 103 221-1 [7] to transport the IdentityAssociationRequest and IdentityAssociationResponse messages (which are derived from the X1RequestMessage and X1ResponseMessage definitions in ETSI TS 103 221-1 [7]) as described in Annex E.

NOTE: The terms identifier and identity are used interchangeably in clause 5.8.

5.8.2 Identity association requests

For requests with RequestType "IdentityAssociation" (see table 5.7.2-3), the IQF issues an IdentityAssociationRequest message populated with a RequestDetails structure as follows:

Table 5.8-1: RequestDetails structure for LI_XQR

ETSI TS 103 221-1 [7] field name	Description	M/C/O
Type	Shall be set to the RequestType value "IdentityAssociation" as defined in Table 5.7.2-3.	M
ObservedTime	Observation time as provided over LI_HIQR (see clause 5.7.2).	M
RequestValues	Set to the target identifier plus additional information specified in the LI_HIQR request (see clause 5.7.2).	M

Successful LI_XQR responses are returned using the IdentityAssociationResponse message. Error conditions are reported using the normal error reporting mechanisms described in TS 103 221-1 [7].

LI_XQR query responses are represented in XML following the IdentityAssociationResponse schema (see Annex E). The fields of the IdentityAssociationResponse record shall be populated as described in Table 5.7.2-5.

5.8.3 Ongoing identity association requests

For requests with RequestType "OngoingIdentityAssociation", the IQF shall activate a request for ongoing updates at the ICF by sending it an ActivateOngoingIdentityAssociationUpdates message populated as follows:

Table 5.8-2: ActivateAssociationUpdates message for LI_XQR

Field name	Description	M/C/O
OngoingAssociationTaskID	Unique identifier for this request allocated by the IQF.	M
SUPI	Permanent identifier for which ongoing identity association updates shall be issued.	M

The ICF shall acknowledge the receipt of the ActivateAssociationUpdates message by responding with an ActivateAssociationUpdatesAcknowledgement response (see Annex E) containing an IdentityAssociationRecord representing the association active at the time the ICF receives the ActivateAssociationUpdates message. If no such active association exists, the ActivateAssociationUpdatesAcknowledgement response shall not contain an IdentityAssociationRecord. Error conditions are reported using the normal error reporting mechanisms described in ETSI TS 103 221-1 [7].

When a request with RequestType "OngoingIdentityAssociation" is terminated over LI_HIQR (see table 5.7.2-3), the IQF shall issue a DeactivateAssociationUpdates message (see Annex E) with the appropriate OngoingAssociationTaskID populated. On termination of the request, the ICF shall respond with a DeactivateAssociationUpdatesAcknowledgement message.

While a request with RequestType "OngoingIdentityAssociation" is active, the ICF shall generate an IdentityAssociationUpdate message every time the ICF receives an IEFAssociationRecord or IEFDeassociationRecord over LI_IEF for the relevant identifier. The message shall contain an IdentityAssociationRecord as described in table 5.7.2-5, and the relevant OngoingAssociationTaskID. The IdentityAssociationUpdate message is sent to the IQF over LI_XQR with the ICF becoming the "requester" as defined in ETSI TS 103 221-1 [7] clause 4.2. The IQF shall respond with an IdentityAssociationUpdateAcknowledgement message.

5.9 Protocols for LI_XER

LI_XER records are realised using a TLS connection as defined in clause 6.2.2A.2.3, with records BER-encoded as defined in Annex F.

5.10 Protocols for LI_ST interface

5.10.1 Overview

LI_ST shall be realised using a dedicated separate instance of the Nudsf_DataRepository service as defined in TS 29.598 [64] subject to the following terms.

The LISSF shall adopt the role of the NF Service Provider as described in TS 29.598 [64] clause 5.2.1. The LISSF may be realised as a standalone function or within the ADMF. In either case it shall meet the requirements set out in TS 33.127 [5] clause 6.2.3.8.

An LI function may only store state over LI_ST using an LISSF identified by the LIPF via LI_X0. The LIPF shall provide the necessary details for connection, including the relevant apiRoot, apiVersion, realmId and storageId values (see TS 29.598 [64] clause 6.1.3.1) and any necessary keys for authentication.

5.10.2 Storage

When an LI function wishes to store LI state in the LISSF, it shall perform the Record Create service operation as described in TS 29.598 [64] clause 5.2.2.3.1. Unless otherwise specified, the recordId shall be a randomly-assigned UUID. The record metadata shall include at least the following information as tag value pairs (see TS 29.598 [64] clause 6.1.6.2.3)

Table 5.10.2-1: Minimum information elements for RecordMeta structure

Field Name	Description	M/C/O
NFInstanceID	The NF instance ID associated with the NF in which the LI function is located, if applicable (see TS 29.571 [17] clause 5.3.2).	C
NEID	The LI_X1 identifier associated with the LI function.	M
XID	XID for the task that the state is associated with, if applicable.	C
DID	DID for the destination that the state is associated with, if applicable.	C

Further details on the contents of the Record Blocks is given in the relevant clauses.

The LIPF shall always be able to store records in the LISSF.

5.10.3 Retrieval

When an LI function wishes to retrieve records from the LISSF and knows the RecordID of the relevant state information, it shall perform a Record Retrieval operation as described in TS 29.598 [64] clause 5.2.2.2.2. If the LI function does not know the RecordID, it shall perform a search as described in TS 29.598 [64] clause 5.2.2.2.6 using appropriate search criteria. The details for choosing search criteria are specific to each LI function and are therefore given in later clauses specific to that LI function.

The LIPF shall always be able to retrieve records from the LISSF.

5.10.4 Removal

When an LI function wishes to remove records from the LISSF, it shall perform a Record Delete service operation as described in TS 29.598 [64] clause 5.2.2.5.

The LIPF shall always be able to remove records from the LISSF.

6 Network Layer Based Interception

6.1 Introduction

This clause describes any remaining fields, behaviours or details necessary to implement the required LI interfaces for specific 3GPP-defined network deployments which are not described in clauses 4 and 5.

6.2 5G

6.2.1 General

This clause describes the LI interfaces specific to LI for 5G networks.

6.2.2 LI at AMF

6.2.2.1 Provisioning over LI_X1

The IRI-POI present in the AMF is provisioned over LI_X1 by the LIPF using the X1 protocol as described in clause 5.2.2.

The POI in the AMF shall support the following target identifier formats in the ETSI TS 103 221-1 [7] messages (or equivalent if ETSI TS 103 221-1 [7] is not used):

- SUPIIMSI.
- SUPINAI.
- PEIIMEI.
- PEIIMEISV.
- GPSIMSISDN.
- GPSINAI.

Table 6.2.2-0A shows the minimum details of the LI_X1 ActivateTask message used for provisioning the IRI-POI in the AMF.

Table 6.2.2-0A: ActivateTask message for the IRI-POI in the AMF

ETSI TS 103 221-1 [7] field name	Description	M/C/O
XID	XID assigned by LIPF.	M
TargetIdentifiers	One of the target identifiers listed in the paragraph above.	M
DeliveryType	Set to "X2Only".	M
ListOfDIDs	Delivery endpoints for LI_X2 for the IRI-POI in the AMF. These delivery endpoints are configured using the CreateDestination message as described in ETSI TS 103 221-1 [7] clause 6.3.1 prior to the task activation.	M
TaskDetailsExtensions/ IdentifierAssociationExtensions	This field shall be included if the IRI POI is required to generate AMFIdentifierAssociation records (see clause 6.2.2.2.1). If the field is absent, AMFIdentifierAssociation records shall not be generated.	C
ListOfServiceTypes	Shall be included when the explicit identification of specific CSP service types to be intercepted by the task as described in clause 5.2.4 is required. This parameter is defined in ETSI TS 103 221-1 [7], clause 6.2.1.2, table 4.	C

Table 6.2.2-0B: IdentifierAssociationExtensions Parameters

Field Name	Description	M/C/O
EventsGenerated	<p>One of the following values:</p> <ul style="list-style-type: none"> - IdentifierAssociation - All <p>See clause 6.2.2.2.1 for the interpretation of this field.</p>	M

6.2.2.2 Generation of xIRI over LI_X2

6.2.2.2.1 General

The IRI-POI present in the AMF shall send the xIRIs over LI_X2 for each of the events listed in TS 33.127 [5] clause 6.2.2.4, the details of which are described in the following clauses.

If the AMF receives one or more cell IDs in an N2 message (as specified in TS 38.413 [23]), the IRI-POI in the AMF shall report all of them.

The IRI-POI in the AMF shall only generate xIRI containing AMFIdentifierAssociation records when the IdentifierAssociationExtensions parameter has been received over LI_X1 (see clause 6.2.2.1). The IRI-POI in the AMF shall generate records according to the value of the EventsGenerated sub-parameter (see table 6.2.2-0B) as follows:

- IdentifierAssociation: AMFIdentifierAssociation and AMFLocationUpdate records shall be generated. No other record types shall be generated for that target.
- All: All AMF record types shall be generated.

6.2.2.2.2 Registration

The IRI-POI in the AMF shall generate an xIRI containing an AMFRegistration record when the IRI-POI present in the AMF detects that a UE matching one of the target identifiers provided via LI_X1 has successfully registered to the 5GS via 3GPP NG-RAN or non-3GPP access. Accordingly, the IRI-POI in the AMF generates the xIRI when the following event is detected:

- AMF sends a N1: REGISTRATION ACCEPT message to the target UE and the UE 5G Mobility Management (5GMM) state for the access type (3GPP NG-RAN or non-3GPP access) within the AMF is changed to 5GMM-REGISTERED.

Table 6.2.2-1: Payload for AMFRegistration record

Field name	Description	M/C/O
registrationType	Specifies the type of registration, see TS 24.501 [13] clause 9.11.3.7. This is derived from the information received from the UE in the REGISTRATION REQUEST message.	M
registrationResult	Specifies the result of registration, see TS 24.501 [13] clause 9.11.3.6.	M
slice	Provide, if available, one or more of the following: <ul style="list-style-type: none"> - allowed NSSAI (see TS 24.501 [13] clause 9.11.3.37). - configured NSSAI (see TS 24.501 [13] clause 9.11.3.37). - rejected NSSAI (see TS 24.501 [13] clause 9.11.3.46). This is derived from the information sent to the UE in the REGISTRATION ACCEPT message.	C
sUPI	SUPI associated with the registration (see clause 6.2.2.4).	M
sUCI	SUCI used in the registration, if available.	C
pEI	PEI provided by the UE during the registration, if available.	C
gPSI	GPSI obtained in the registration, if available as part of the subscription profile.	C
gUTI	5G-GUTI provided as outcome of initial registration or used in other cases, see TS 24.501 [13] clause 5.5.1.2.2.	M
location	Location information determined by the network during the registration, if available. Encoded as a <i>userLocation</i> parameter (<i>location>locationInfo>userLocation</i>) and, when Dual Connectivity is activated, as an <i>additionalCellIDs</i> parameter (<i>location>locationInfo>additionalCellIDs</i>), see Annex A.	C
non3GPPAccessEndpoint	UE's local IP address used to reach the N3IWF, TNGF or TWIF, if available. IP addresses are given as 4 octets (for IPv4) or 16 octets (for IPv6) with the most significant octet first (network byte order).	C
fiveGSTAIList	List of tracking areas associated with the registration area within which the UE is current registered, see TS 24.501 [13] clause 9.11.3.9 (see NOTE)	C
sMSoverNASIndicator	Indicates whether SMS over NAS is supported. Provide, if included in registrationResult, see TS 24.501 [13] clause 9.11.3.6.	C
oldGUTI	GUTI or 5G-GUTI, if provided in the REGISTRATION REQUEST message, see TS 24.501 [13] clause 5.5.1.2.2.	C
eMM5GRegStatus	UE Status, if provided in the REGISTRATION REQUEST message, see TS 24.501 [13] clause 9.11.3.56.	C
nonIMEISVPEI	MACAddress or EU1-64 used as UE equipment identity if IMEI or IMEISV based PEI is not available. Provide if known, see TS 24.501 [13] clause 8.2.26.4.	C
macRestIndicator	Indicates whether the non-IMEISV PEI MACAddress can be used as an equipment identifier. Required if non-IMEISVPEI is used, see TS 24.501 [13] clause 9.11.3.4.	C
pagingRestrictionIndicator	Indicates if paging is restricted or the type of paging allowed, Include if sent in the REGISTRATION REQUEST message. Encoded per TS 24.501 [13] clause 9.11.3.77.2, omitting the first two octets.	C
rATType	RAT Type shall be present if known by the AMF. RAT Type is determined by the AMF during registration. See TS 23.501 [2] clause 5.3.2.3	C
NOTE: List shall be included each time there is a change to the registration area.		

6.2.2.2.3 Deregistration

The IRI-POI in the AMF shall generate an xIRI containing an AMFDeregistration record when the IRI-POI present in the AMF detects that a UE matching one of the target identifiers provided via LI_X1 has deregistered from the 5GS over at least one access type. Accordingly, the IRI-POI in AMF generates the xIRI when any of the following events is detected:

- For network initiated de-registration, when the AMF receives the N1: DEREGISTRATION ACCEPT message from the target UE or when implicit deregistration timer expires; and in both cases the UE 5GMN state for the access type (3GPP NG-RAN or non-3GPP access) within the AMF is changed to 5GMM-DEREGISTERED.
- For UE initiated de-registration, when the AMF sends the N1: DEREGISTRATION ACCEPT message to the target UE or when the AMF receives the N1: DEREGISTRATION REQUEST message from the target UE with deregistration type value of “switch off”; and in both cases the UE 5GMN state for the access type (3GPP NG-RAN or non-3GPP access) within the AMF is changed to 5GMM-DEREGISTERED.

- For network initiated AMF UE relocation, the AMFDeregistration xIRI shall not be sent unless the 5GMM COMMON PROCEDURE INITIATED (see TS 24.501 [13] clause 5.1.3.2.3.3) results in deregistration.

Table 6.2.2-2: Payload for AMFDeregistration record

Field name	Description	M/C/O
deregistrationDirection	Indicates whether the deregistration was initiated by the network or by the UE.	M
accessType	Indicates the access for which the deregistration is handled, see TS 24.501 [13] clause 9.11.3.20.	M
sUPI	SUPI associated with the deregistration (see clause 6.2.2.4), if available.	C
sUCI	SUCI used in the deregistration, if available (see NOTE).	C
pEI	PEI used in the deregistration, if available (see NOTE).	C
gPSI	GPSI associated to the deregistration, if available as part of the subscription profile.	C
gUTI	5G-GUTI used in the deregistration, if available, see TS 24.501 [13] clause 5.5.2.2.1 (see NOTE).	C
cause	Indicates the 5GMM cause value for network-initiated deregistration, see TS 24.501 [13] clause 9.11.3.2.	C
location	Location information determined by the network during the deregistration, if available. Encoded as a <i>userLocation</i> parameter (<i>location>locationInfo>userLocation</i>), see Annex A.	C
switchOffIndicator	Indicates whether the deregistration type is normal or switch off, if available, see TS 24.501 [13] clause 9.1.3.20.1.	C
reRegRequiredIndicator	Indicates whether UE re-registration is required in the DEREGISTRATION REQUEST message, if available, see TS 24.501 [13] clause 9.1.3.20.1.	C
NOTE: At least one among SUCI, PEI and GUTI shall be provided.		

6.2.2.2.4 Location update

The IRI-POI in the AMF shall generate an xIRI containing an AMFLocationUpdate record each time the IRI-POI present in an AMF detects that the target's UE location is updated due to target UE mobility or as a part of an AMF service procedure and the reporting of location information is not restricted by service scoping. The generation of such separate xIRI is not required if the updated UE location information is obtained as a part of a procedure producing some other xIRIs (e.g. mobility registration). In that case the location information is included into the respective xIRI.

The UE mobility events resulting in generation of an AMFLocationUpdate xIRI include the *N2 Path Switch Request (Xn based inter NG-RAN handover)* procedure described in TS 23.502 [4] clause 4.9.1.2) and the *N2 Handover Notify (Inter NG-RAN node N2 based handover)* procedure described in TS 23.502 [4] clause 4.9.1.3).

The AMFLocationUpdate xIRI is also generated when the AMF receives an NG-RAN NGAP *PDU Session Resource Modify Indication* message as a result of Dual Connectivity activation/release for the target UE, as described in TS 37.340 [37] clause 10.

Optionally, based on operator policy, other NG-RAN NGAP messages that do not generate separate xIRI but carry location information (e.g. RRC INACTIVE TRANSITION REPORT) may trigger the generation of an xIRI AMFLocationUpdate record.

Additionally, based on regulatory requirements and operator policy, the location information obtained by AMF from NG-RAN or LMF in the course of some service operation (e.g. emergency services, LCS) may generate xIRI AMFLocationUpdate record. The AMF services providing the location information in these cases include the AMF Location Service (ProvideLocInfo, ProvidePosInfo, NotifiedPosInfo and EventNotify service operations) and the AMF Exposure Service (AmfEventReport with LOCATION_REPORT) (see TS 29.518 [22]). Additionally, the AMF Communication Service (Namf_Communication_N1MessageNotify service operation) may be monitored to capture the location information in the scenarios described in TS 23.273 [42] clause 6.3.1. Also, in the case of Mobile Originated LCS service invoked by the target, the location information may be derived from a N1mf_Location_DetermineLocation Response to AMF (see TS 23.273 [42] clause 6.2).

Table 6.2.2-3: Payload for AMFLocationUpdate record

Field name	Description	M/C/O
sUPI	SUPI associated with the location update (see clause 6.2.2.4).	M
sUCI	SUCI associated with the location update, if available, see TS 24.501 [13].	C
pEI	PEI associated with the location update, if available.	C
gPSI	GPSI associated with the location update, if available as part of the subscription profile.	C
gUTI	5G-GUTI associated with the location update, if available, see TS 24.501 [13].	C
location	Updated location information determined by the network. Depending on the service or message type from which the location information is extracted, it may be encoded in several forms (Annex A): 1) as a <i>userLocation</i> parameter (<i>location>locationInfo>userLocation</i>) in the case the information is obtained from an NGAP message, except the LOCATION REPORT message (see TS 38.413 [23]); 2) as a <i>locationInfo</i> parameter (<i>location>locationInfo</i>) in the case the information is obtained from a ProvideLocInfo (TS 29.518 [22] clause 6.4.6.2.6); 3) as a <i>locationPresenceReport</i> parameter (<i>location>locationPresenceReport</i>) in the case the information is obtained from an AmfEventReport (TS 29.518 [22] clause 6.2.6.2.5) with event type Location-Report or Presence-In-AOI-Report ; 4) as a <i>positionInfo</i> parameter (<i>location>positioningInfo>positionInfo</i>) in the case the information is obtained from a ProvidePosInfo (TS 29.518 [22] clause 6.4.6.2.3) or a NotifiedPosInfo (TS 29.518 [22] clause 6.4.6.2.4).	M
sMSoverNASIndicator	No longer used in present version of this specification.	C
oldGUTI	No longer used in the present version of the specification.	C

6.2.2.2.5 Start of interception with registered UE

The IRI-POI in the AMF shall generate an xIRI containing an AMFStartOfInterceptionWithRegisteredUE record when the IRI-POI present in the AMF detects that interception is activated on a UE that has already been registered in the 5GS (see clause 6.2.2.4 on identity privacy). A UE is considered already registered to the 5GS when the 5GMM state for the access type (3GPP NG-RAN or non-3GPP access) for that UE is 5GMM-REGISTERED. Therefore, the IRI-POI present in the AMF shall generate the xIRI AMFStartOfInterceptionWithRegisteredUE record when it detects that a new interception for a UE is activated (i.e. provisioned by the LIPF) and the 5G mobility management state for the access type (3GPP NG-RAN or non-3GPP access) within the AMF for that UE is 5GMM-REGISTERED. If the UE is registered over both 3GPP NG-RAN and non-3GPP access, the IRI-POI present in the AMF shall generate an xIRI containing an AMFStartOfInterceptionWithRegisteredUE record for each access type.

Table 6.2.2-4: Payload for AMFStartOfInterceptionWithRegisteredUE record

Field name	Description	M/C/O
registrationResult	Specifies the result of registration, see TS 24.501 [13] clause 9.11.3.6.	M
registrationType	Specifies the type of registration, see TS 24.501 [13] clause 9.11.3.7, if available.	C
slice	Provide, if available, one or more of the following: <ul style="list-style-type: none"> - allowed NSSAI (see TS 24.501 [13] clause 9.11.3.37). - configured NSSAI (see TS 24.501 [13] clause 9.11.3.37). 	C
sUPI	SUPI associated with the target UE.	M
sUCI	SUCI used in the registration, if available.	C
pEI	PEI associated with the target UE, if available.	C
gPSI	GPSI associated with the target UE, if available.	C
gUTI	Latest 5G-GUTI assigned to the target UE by the AMF.	M
location	Location information associated with the access type for the target UE, if available. Encoded as a <i>userLocation</i> parameter (<i>location>locationInfo>userLocation</i>) and, when Dual Connectivity is activated, as an <i>additionalCellIDs</i> parameter (<i>location>locationInfo>additionalCellIDs</i>), see Annex A.	C
non3GPPAccessEndpoint	UE's local IP address used to reach the N3IWF, TNGF or TWIF, if available. IP addresses are given as 4 octets (for IPv4) or 16 octets (for IPv6) with the most significant octet first (network byte order).	C
timeOfRegistration	Time at which the last registration occurred, if available. This is the time stamp when the REGISTRATION ACCEPT message was sent to the UE or (when applicable) when the REGISTRATION COMPLETE was received from the UE. Shall be given qualified with time zone information (i.e. as UTC or offset from UTC, not as local time).	C
fiveGSTAIList	List of tracking areas associated with the target UE for the access type.	C
sMSoverNASIndicator	Indicates whether SMS over NAS is supported. Provide, if included in the UE Context.	C
oldGUTI	Latest GUTI or 5G-GUTI received from the target UE if different than the latest GUTI assigned by the AMF and the target UE has not acknowledged the latest GUTI assignment.	C
eMM5GRegStatus	UE Status, if this parameter can be derived from information available in the UE Context at the AMF.	C
NOTE: The values of the parameters in the table above are derived from the UE Context at the AMF, see TS 23.502 clause 5.2.2.2.2.		

The IRI-POI present in the AMF generating an xIRI containing an AMFStartOfInterceptionWithRegisteredUE record shall set the Payload Direction field in the PDU header to *not applicable* (Direction Value 5, see ETSI TS 103 221-2 [8] clause 5.2.6).

6.2.2.2.6 AMF unsuccessful procedure

The IRI-POI in the AMF shall generate an xIRI containing an AMFUnsuccessfulProcedure record when the IRI-POI present in the AMF detects an unsuccessful procedure for a UE matching one of the target identifiers provided via LI_X1.

Accordingly, the IRI-POI in the AMF generates the xIRI when any of the following events is detected:

- AMF sends a N1: REGISTRATION REJECT message to the target UE and the UE 5G Mobility Management (5GMM) state for the access type (3GPP NG-RAN or non-3GPP access) within the AMF is changed to 5GMM-DEREGISTERED.
- AMF aborts a registration procedure before the UE 5G Mobility Management (5GMM) state for the access type (3GPP NG-RAN or non-3GPP access) within the AMF is changed to 5GMM-REGISTERED.
- AMF sends a SERVICE REJECT message to the target UE including a PDU session establishment reject message type.
- AMF aborts a UE-initiated NAS transport procedure with payload container type IE set to "SMS".

Unsuccessful registration shall be reported only if the target UE has been successfully authenticated.

Table 6.2.2-5: Payload for AMFUnsuccessfulProcedure record

Field name	Description	M/C/O
failedprocedureType	Specifies the procedure which failed at the AMF.	M
failureCause	Provides the value of the 5GSM or 5GMM cause, see TS 24.501 [13] clauses 9.11.3.2 and 9.11.4.2.	M
requestedSlice	Slice requested for the procedure, if available, given as a NSSAI (a list of S-NSSAI values as described in TS 24.501 [13] clause 9.11.3.37).	C
sUPI	SUPI associated with the procedure, if available (see NOTE).	C
sUCI	SUCI used in the procedure, if applicable and if available (see NOTE).	C
pEI	PEI used in the procedure, if available (see NOTE).	C
gPSI	GPSI used in the procedure, if available (see NOTE).	C
gUTI	5G-GUTI used in the procedure, if available, see TS 24.501 [13] clause 9.11.3.4 (see NOTE).	C
location	Location information determined during the procedure, if available. Encoded as a <i>userLocation</i> parameter (<i>location>locationInfo>userLocation</i>), see Annex A.	C
NOTE: At least one identity shall be provided, the others shall be provided if available.		

6.2.2.2.7 AMF identifier association

The IRI-POI present in the AMF shall generate an xIRI containing an AMFIdentifierAssociation record when the IRI-POI present in the AMF detects a new identifier association for a UE matching one of the target identifiers provided via LI_X1. Generation of this record is subject to this record type being enabled for a specific target (see clause 6.2.2.2.1).

Table 6.2.2-6: Payload for AMFIdentifierAssociation record

Field name	Description	M/C/O
sUPI	SUPI associated with the procedure (see NOTE 1).	M
sUCI	SUCI used in the procedure, if applicable and if available.	C
pEI	PEI used in the procedure, if available (see NOTE 1).	C
gPSI	GPSI used in the procedure, if available (see NOTE 1).	C
gUTI	5G-GUTI used in the procedure, see TS 24.501 [13] clause 9.11.3.4.	M
location	Location information available when identifier association occurs. Encoded as a <i>userLocation</i> parameter (<i>location>locationInfo>userLocation</i>) and, when Dual Connectivity is activated, as an <i>additionalCellIDs</i> parameter (<i>location>locationInfo>additionalCellIDs</i>), see Annex A.	M
fiveGSTAIList	List of tracking areas associated with the registration area within which the UE is current registered, see TS 24.501 [13], clause 9.11.3.9. (see NOTE 2)	C
NOTE 1: SUPI shall always be provided, in addition to the warrant target identifier if different to SUPI. Other identifiers shall be provided if available.		
NOTE 2: List shall be included each time there is a change to the registration area.		

The IRI-POI present in the AMF generating an xIRI containing an AMFIdentifierAssociation record shall set the Payload Direction field in the PDU header to *not applicable* (Direction Value 5, see ETSI TS 103 221-2 [8] clause 5.2.6).

6.2.2.2.8 Positioning info transfer

The IRI-POI present in the AMF shall generate an xIRI containing an AMFPositioningInfoTransfer when the IRI-POI present in the AMF detects one of the following events :

- an NRPPa (see TS 38.455 [86]) message related to a target UE has been exchanged between the LMF and NG-RAN via the AMF.
- a LPP (see TS 37.355 [85]) message related to a target UE has been exchanged between the LMF and the target UE via the AMF.

Accordingly, the IRI-POI in AMF generates the xIRI when any of the following events is detected:

- AMF receives an Namf_Communication_N1N2MessageTransfer (see TS 29.518 [22]) from LMF to request the transfer of a NRPPa request to the serving NG-RAN node for a target UE as part of a UE associated NRPPa positioning activity. The NRPPa request may be E-CID MEASUREMENT INITIATION REQUEST or OTDOA INFORMATION REQUEST.
- AMF sends a Namf_Communication_N2InfoNotify [22] to the LMF to forward the NRPPa response or report received from the NG-RAN for a target UE. The NRPPa response or report may be E-CID MEASUREMENT INITIATION RESPONSE, E-CID MEASUREMENT REPORT or OTDOA INFORMATION RESPONSE.
- AMF receives an Namf_Communication_N1N2MessageTransfer ([22]) from LMF to request the transfer of a LPP message to a target UE as part of a LPP positioning activity.
- AMF sends an Namf_Communication_N1MessageNotify ([22]) to LMF to forward a LPP message received from the target UE.

Table 6.2.2-6A: Payload for AMFPositioningInfoTransfer record

Field name	Description	M/C/O
sUPI	SUPI associated with the procedure (see NOTE 1 in table 6.2.2-6).	M
sUCI	SUCI used in the procedure, if applicable and if available.	C
pEI	PEI used in the procedure, if available (see NOTE 1 in table 6.2.2-6).	C
gPSI	GPSI used in the procedure, if available (see NOTE 1 in table 6.2.2-6).	C
gUTI	5G-GUTI used in the procedure, see TS 24.501 [13] clause 9.11.3.4.	C
nRPPaMessage	Any UE associated NRPPa message exchanged between the LMF and NG-RAN via AMF.	C
lPPMessage	Any LPP message exchanged between the LMF and the target UE via AMF.	C
lcsCorrelationId	LCS correlation ID (see TS 29.572 [24] clause 6.1.6.3.2) related to a location session, found in the Namf_CommunicationN1N2MessageTransfer and corresponding Namf_Communication_N2InfoNotify or Namf_CommunicationN1MessageNotify. All the AMFPositioningInfoTransfer records related to the same location session have the same lcsCorrelationId.	M

6.2.2.2.9 UE Configuration Update

The IRI-POI in the AMF shall generate an xIRI containing a AMFUEConfigurationUpdate record when the IRI-POI present in the AMF detects that a UE matching one of the target identifiers provided via LI_X1 has been commanded to update its configuration. Accordingly, the IRI-POI in the AMF generates the xIRI when the following event is detected:

- AMF sends a CONFIGURATION UPDATE COMMAND message to the target UE.

Table 6.2.2-6B: Payload for AMFUEConfigurationUpdate record

Field name	Description	M/C/O
userIdentifiers	List of identifiers, including the target identifier, associated with the target UE registration stored in the AMF context. See TS 29.518 [22] clause 6.1.6.2.25.	M
gUTI	Current 5G-GUTI associated with the UE context. If the AMF includes a new 5G-GUTI as a part of the configuration update, this parameter shall be set to the new GUTI and the oldGUTI parameter shall be populated, see TS 24.501 [13] clause 8.2.19.3.	M
oldGUTI	Old 5G-GUTI associated with the UE context. If the AMF includes a new 5G-GUTI as a part of the configuration update, this parameter shall be set to the old GUTI.	C
fiveGSTAIList	List of tracking areas associated with the registration area within which the UE is current registered, see TS 24.501 [13] clause 9.11.3.9. Shall be included each time there is a change to the registration area and omitted if the registration area does not change.	C
slice	Provide, if available, one or more of the following: <ul style="list-style-type: none"> - allowed NSSAI (see TS 24.501 [13] clause 9.11.3.37). - configured NSSAI (see TS 24.501 [13] clause 9.11.3.37). - rejected NSSAI (see TS 24.501 [13] clause 9.11.3.46). This is derived from the information sent to the UE in the CONFIGURATION UPDATE COMMAND message.	C
serviceAreaList	Includes a list of allowed service areas or non-allowed service areas, encoded per TS 24.501 [13] clause 9.11.3.49, omitting the first two octets. Shall be included if present in the CONFIGURATION UPDATE COMMAND message, see TS 24.501 [13] clause 8.2.19.	C
registrationResult	Specifies the result of registration, see TS 24.501 [13] clause 9.11.3.6. Shall be included if present in the CONFIGURATION UPDATE COMMAND message, see TS 24.501 [13] clause 8.2.19.	C
sMSoverNASIndicator	Indicates whether SMS over NAS is supported. Shall be present if the SMS indication is present in the CONFIGURATION UPDATE COMMAND message, see TS 24.501 [13] clause 8.2.19.	C

6.2.2.3 Generation of IRI over LI_HI2

When an xIRI is received over LI_X2 from the IRI-POI in AMF, the MDF2 shall generate the corresponding IRI message and deliver over LI_HI2 without undue delay. The IRI message shall contain a copy of the relevant record received in the xIRI over LI_X2. This record may be enriched with any additional information available at the MDF (e.g. additional location information).

The timestamp field of the PSHeader structure shall be set to the time at which the AMF event was observed (i.e. the timestamp field of the X2 PDU).

The IRI type parameter (see ETSI TS 102 232-1 [9] clause 5.2.10) shall be included and coded according to table 6.2.2-7.

Table 6.2.2-7: IRI type for IRI messages

IRI message	IRI type
AMFRegistration	REPORT
AMFDeregistration	REPORT
AMFLocationUpdate	REPORT
AMFStartOfInterceptionWithRegisteredUE	REPORT
AMFUnsuccessfulProcedure	REPORT
AMFIdentifierAssociation	REPORT
AMFPositioningInfoTransfer	REPORT
AMFUEConfigurationUpdate	REPORT

These IRI messages shall omit the CIN (see ETSI TS 102 232-1 [9] clause 5.2.4).

The threeGPP33128DefinedIRI field in ETSI TS 102 232-7 [10] clause 15 shall be populated with the BER-encoded IRIPayload.

When an additional warrant is activated on a target UE and the LIPF uses the same XID for the additional warrant, the MDF2 shall be able to generate and deliver the IRI message containing the AMFStartOfInterceptionWithRegisteredUE record to the LEMF associated with the additional warrant without receiving a corresponding xIRI. The payload of the AMFStartOfInterceptionWithRegisteredUE record is specified in table 6.2.2-4.

If the MDF2 did not receive from the IRI-POI the value of timeOfRegistration parameter in a previous corresponding AMFStartOfInterceptionWithRegisteredUE for the same registration, the MDF2 shall include in that parameter the time provided in the timestamp previously received in the header of the related AMFRegistration xIRI.

6.2.2.4 Identity privacy

The AMF shall ensure for every registration (including re-registration) that SUPI has been provided by the UDM to the AMF and that the SUCI to SUPI mapping has been verified as defined in TS 33.501 [11]. This shall be performed regardless of whether the SUPI is a target of interception, and whether the null encryption algorithm is used for the SUCI. The AMF shall maintain the SUPI to SUCI mapping for at least the lifetime of the registration in order to allow interception based on SUPI after the initial registration.

6.2.2A Identifier Reporting for AMF

6.2.2A.1 Activation of reporting over LI_XEM1

The IEF in the AMF is activated and deactivated over LI_XEM1 by the LIPF using the LI_XEM1 protocol described in clause 5.2.7.

NOTE: Since the IEF reports association events for all UEs registered in the IEF's parent AMF, unlike POIs there is no concept of provisioning an IEF with target identifiers.

Upon receiving a valid activate task message over LI_XEM1, the IEF shall start generating records as defined in clause 6.2.2A.2.

Upon receiving a valid deactivate task message over LI_XEM1, the IEF shall stop generating records as defined in clause 6.2.2A.2.

6.2.2A.2 Generation of records over LI_XER

6.2.2A.2.1 Events

The IEF in the AMF shall generate an IEFIdentifierAssociation record whenever the IEF present in the AMF detects a change in association between a SUPI and a 5G-GUTI for any UE registered with the AMF. The IEF shall send the IEFIdentifierAssociation records to the ICF over LI_XER as defined in clause 5.9.

Accordingly, the IEF in the AMF generates IEFIdentifierAssociation records when any of the following events are detected:

- IEFAssociationRecord: Association of a 5G-GUTI to a SUPI, (this may also include SUCI to SUPI association).
- IEFDeassociationRecord: De-association of a 5G-GUTI from a SUPI.

NOTE1: The de-association of 5G-GUTI from a SUPI event record is only generated if a new 5G-GUTI is not allocated to a SUPI to update a previous association (e.g. at inter-AMF handover).

NOTE 2: As SUCIs are single use and only valid for a single authentication, they are only valid at the single point in time when the association event is detected and reported to the ICF by the IEF.

In addition, when an IEF is activated as per clause 6.2.2A.1, the IEF shall generate associations event for all SUPIs which are registered in the AMF, where those identifier associations allocated prior to IEF activation remain current and are still available in the AMF (See NOTE 2).

NOTE 3: Only identifier associations which have been maintained by the AMF as part of normal network operations will be available.

In the case where the IEF in the AMF detects that a REGISTRATION ACCEPT message or a CONFIGURATION UPDATE (5G-GUTI) message as defined in TS 24.501 [13] has been sent by the AMF towards a UE, the IEF shall immediately generate an IEFIdentifierAssociation record. This record shall be generated regardless of whether the CONFIGURATION UPDATE (5G-GUTI) or REGISTRATION ACCEPT procedure is subsequently successfully completed or not.

6.2.2A.2.2 Association Events

For each association event, the IEF shall create an IEFAssociationRecord, as defined below.

Table 6.2.2A-1: Payload for IEFAssociationRecord

Field name	Description	M/C/O
sUPI	SUPI associated with detected association event.	M
fiveGGUTI	5G-GUTI shall be provided. Encoded as per TS 24.501 [13] figure 9.11.3.4.1, omitting the first four octets.	M
timeStamp	Time at which the identifier association event occurred. Shall be given qualified with time zone information (i.e. as UTC or offset from UTC, not as local time).	M
tAI	Last known TAI associated with the SUPI. Encoded as per TS 24.501 [13] clause 9.11.3.8, omitting the first octet.	M
nCGI	Last known nCGI(s) available when identifier association event detected. Given as a sequence of PLMNID (encoded as per TS 38.413 [23] clause 9.3.3.5) and NCI (encoded as per TS 38.413 [23] clause 9.3.1.7).	M
nCGITime	ueLocationTimestamp(s) of nCGIs if available in AMF as per TS 29.571 [17] clause 5.4.4.9. If ueLocationTimestamp(s) is not available, shall be populated with timeStamp(s) of when last known nCGI(s), were obtained and stored by the AMF.	M
sUCI	SUCI shall be provided when event is triggered by association of a SUCI to a SUPI. Encoded as per TS 24.501 [13] clause 9.11.3.4, omitting the first 3 octets.	C
pEI	PEI, (see NOTE 1).	C
fiveGSTAIList	List of tracking areas associated with the registration area within which the UE is current registered, see TS 24.501 [13], clause 9.11.3.9. (see NOTE 2)	C
gPSI	GPSI, (see NOTE 1).	C
NOTE 1: Shall be provided in first association record to ICF after PEI or GPSI is available and following any change of PEI or GPSI.		
NOTE 2: As a minimum, list of tracking areas shall be included in the first association event for each SUPI registered (per UE session) with the AMF and additionally whenever the TAI list changes due to a change in registration area.		

For each de-association event, the IEF shall create an IEFDeassociationRecord, as defined below.

Table 6.2.2A-2: Payload for IEFDeassociationRecord

Field name	Description	M/C/O
sUPI	SUPI associated with detected de-association event.	M
fiveGGUTI	5G-GUTI shall be provided. Encoded as per TS 24.501 [13] figure 9.11.3.4.1, omitting the first four octets.	M
timeStamp	Time at which the identifier de-association event occurred. Shall be given qualified with time zone information (i.e. as UTC or offset from UTC, not as local time).	M
nCGI	Last known nCGI(s) available when identifier de-association event detected. Given as a sequence of PLMNID (encoded as per TS 38.413 [23] clause 9.3.3.5) and NCI (encoded as per TS 38.413 [23] clause 9.3.1.7).	M
nCGITime	ueLocationTimestamp(s) of nCGIs if available in AMF as per TS 29.571 [17] clause 5.4.4.9. If ueLocationTimestamp(s) is not available, shall be populated with timeStamp(s) of when last known nCGI(s), were obtained and stored by the AMF.	M

6.2.2A.2.3 Transmission to the ICF

When activated (see clause 5.2.7), the IEF shall establish a TLS connection to the ICF as given over LI_XEM1. If the IEF fails to establish a TLS connection, it shall report an error over LI_XEM1 using the error reporting mechanisms described in ETSI TS 103 221-1 [7] and attempt to reconnect after a configurable period of time.

When a record has been generated as described in clause 6.2.2A.2.2, the IEF shall encode the IEFAssociationRecord or IEFDeassociationRecord as a BER-encoded IEFMessage structure, following the ASN.1 schema given in Annex F, and transmit it to the ICF over the established TLS connection.

The IEF may transmit a keepalive request using the keepalive record defined in Annex F. Upon receiving a keepalive request, the ICF shall respond with a keepaliveResponse record containing the same sequence number used in the request. The circumstances under which the IEF transmits keepalive requests is out of scope of the present document.

6.2.3 LI for SMF/UPF

6.2.3.1 Provisioning over LI_X1

6.2.3.1.1 General

If the warrant is for IRI and CC, then the IRI-POI and the CC-TF in the SMF shall be provisioned in accordance with clause 6.2.3.1.2, the MDF2 shall be provisioned in accordance with clause 6.2.3.1.3, and the MDF3 shall be provisioned in accordance with clause 6.2.3.1.4.

If the warrant is for IRI only, the IRI-POI in the SMF shall be provisioned in accordance with clause 6.2.3.1.2 and the MDF2 shall be provisioned in accordance with clause 6.2.3.1.3.

If approach 1 described in clause 6.2.3.9 is used for packet header information reporting, the IRI-TF in the SMF shall be provisioned in accordance with clause 6.2.3.1.2 and the MDF2 shall be provisioned in accordance with clause 6.2.3.1.3. If approach 2 described in clause 6.2.3.9 is used for packet header information reporting, the CC-TF in the SMF shall be provisioned in accordance with clause 6.2.3.1.2, the MDF2 shall be provisioned in accordance with clause 6.2.3.1.3, and the MDF3 shall be provisioned in accordance with clause 6.2.3.1.4.

If the SMF is part of a combined SMF+PGW-C, the requirements in clause 6.3.3 shall apply.

6.2.3.1.2 Provisioning of the IRI-POI, IRI-TF and CC-TF in the SMF

The IRI-POI, IRI-TF and CC-TF present in the SMF are provisioned over LI_X1 by the LIPF using the X1 protocol as described in clause 5.2.2.

The POI/TF in the SMF shall support the following target identifier formats in the ETSI TS 103 221-1 [7] messages (or equivalent if ETSI TS 103 221-1 [7] is not used):

- SUPIIMSI.
- SUPINAI.
- PEIIMEI.
- PEIIMEISV.
- GPSIMSIDN.
- GPSINAI.

Table 6.2.3-0A shows the minimum details of the LI_X1 ActivateTask message used for provisioning the IRI-POI, in the SMF.

Table 6.2.3-0A: ActivateTask message for SMF IRI-POI, CC-TF and IRI-TF

ETSI TS 103 221-1 [7] field name	Description	M/C/O
XID	XID assigned by LIPF. If the CC-TF or IRI-TF is also being tasked for the same interception, the same XID shall be used.	M
TargetIdentifiers	One or more of the target identifiers listed in the paragraph above.	M
DeliveryType	Set to "X2Only", "X3Only" or "X2andX3" as needed to meet the requirements of the warrant. (NOTE: "X2Only" for IRI-POI, IRI-TF and "X3Only" for CC-TF can also be used).	M
TaskDetailsExtensions/ HeaderReporting	Header reporting-specific tag to be carried in the <i>TaskDetailsExtensions</i> field of ETSI TS 103 221-1 [7]. See table 6.2.3.9.2-1. Unless there is a CSP/LEA agreement to not report packet header information, this field shall be present to enable packet header information reporting.	C
ListOfDIDs	Delivery endpoints of LI_X2 or LI_X3. These delivery endpoints shall be configured using the <i>CreateDestination</i> message as described in ETSI TS 103 221-1 [7] clause 6.3.1 prior to first use.	M
ListOfServiceTypes	Shall be included when the task should only intercept specific CSP service types as described in clause 5.2.4. This parameter is defined in ETSI TS 103 221-1 [7], clause 6.2.1.2, table 4.	C

To enable packet header information reporting, parameters specified in table 6.2.3.9.2-1: PDHRReportingExtensions parameters shall be provided as the TaskDetailsExtensions/HeaderReporting field of the LI_X1 provisioning message.

6.2.3.1.3 Provisioning of the MDF2

The MDF2 listed as the delivery endpoint for xIRI generated by the IRI-POI in the SMF or the IRI-POI in the UPF shall be provisioned over LI_X1 by the LIPF using the X1 protocol as described in clause 5.2.2. Table 6.2.3-0B shows the minimum details of the LI_X1 ActivateTask message used for provisioning the MDF2.

The MDF2 shall support the following target identifier formats in the ETSI TS 103 221-1 [7] messages (or equivalent if ETSI TS 103 221-1 [7] is not used):

- SUPIIMSI.
- SUPINAI.
- PEIIMEI.
- PEIIMEISV.
- GPSIMSISDN.
- GPSINAI.

Table 6.2.3-0B: ActivateTask message for MDF2

ETSI TS 103 221-1 [7] field name	Description	M/C/O
XID	XID assigned by LIPF.	M
TargetIdentifiers	One or more of the target identifiers listed in the paragraph above.	M
DeliveryType	Set to "X2Only", "X3Only" or "X2andX3" as needed to meet the requirements of the warrant. (Ignored by the MDF2).	M
TaskDetailsExtensions/ HeaderReporting	Header reporting-specific tag to be carried in the <i>TaskDetailsExtensions</i> field of ETSI TS 103 221-1 [7]. See table 6.2.3.9.2-1. Unless there is a CSP/LEA agreement to not report packet header information, this field shall be present to enable packet header information reporting.	C
ListOfDIDs	Delivery endpoints of LI_HI2. These delivery endpoints shall be configured using the <i>CreateDestination</i> message as described in ETSI TS 103 221-1 [7] clause 6.3.1 prior to first use.	M
ListOfMediationDetails	Sequence of Mediation Details, See table 6.2.3-0C.	M

Table 6.2.3-0C: Mediation Details for MDF2

ETSI TS 103 221-1 [7] field name	Description	M/C/O
LIID	Lawful Intercept ID associated with the task.	M
DeliveryType	Set to "HI2Only".	M
ListOfDIDs	Details of where to send the IRI for this LIID. Shall be included if deviation from the ListofDIDs in the ActivateTask message is necessary. If included, the ListOfDIDs in the Mediation Details shall be used instead of any delivery destinations authorised by the ListOfDIDs field in the ActivateTask Message.	C
ServiceScoping	Shall be included to Identify the service(s) and associated service-related delivery settings for this LIID. May include more than one instance of this parameter to allow for different combinations of subparameters associated with a single LIID. This parameter is defined in ETSI TS 103 221-1 [7] Annex C table C.2.	C
MediationDetailsExtensions/ HeaderReporting	Header reporting-specific tag to be carried in the MediationDetailsExtensions field of ETSI TS 103 221-1 [7]. See table 6.2.3.9.2-1. This field shall be included if deviation from the taskDetails HeaderReporting TaskDetailsExtensions is required. If included, the details shall be used instead of the HeaderReporting instructions specified in the HeaderReporting field in the TaskDetails structure.	C

6.2.3.1.4 Provisioning of the MDF3

The MDF3 listed as the delivery endpoint for the xCC generated by the CC-POI in the UPF shall be provisioned over LI_X1 by the LIPF using the X1 protocol as described in clause 5.2.2. Table 6.2.3-0D shows the minimum details of the LI_X1 ActivateTask message used for provisioning the MDF3. If packet header information reporting is authorised and approach 2 described in clause 6.2.3.9.1 is used, the endpoint for the MDF3 shall be the MDF2 over LI_MDF.

The MDF3 shall support the following target identifier formats in the ETSI TS 103 221-1 [7] messages (or equivalent if ETSI TS 103 221-1 [7] is not used):

- SUPIIMSI.
- SUPINAI.
- PEIIMEI.
- PEIIMEISV.
- GPSIMSISDN.
- GPSINAI.

Table 6.2.3-0D: ActivateTask message for MDF3

ETSI TS 103 221-1 [7] field name	Description	M/C/O
XID	XID assigned by LIPF.	M
TargetIdentifiers	One or more of the target identifiers listed in the paragraph above.	M
DeliveryType	Set to "X2Only", "X3Only" or "X2andX3" as needed to meet the requirements of the warrant.	M
TaskDetailsExtensions/ HeaderReporting	Header reporting-specific tag to be carried in the <i>TaskDetailsExtensions</i> field of ETSI TS 103 221-1 [7]. See table 6.2.3.9.2-1. Unless there is a CSP/LEA agreement to not report packet header information, this field shall be present to enable packet header information reporting is.	C
ListOfDIDs	Delivery endpoints of LI_HI3 or LI_MDF. These delivery endpoints shall be configured using the <i>CreateDestination</i> message as described in ETSI TS 103 221-1 [7] clause 6.3.1 prior to first use.	M
ListOfMediationDetails	Sequence of Mediation Details, see table 6.2.3-0E.	M

Table 6.2.3-0E: Mediation Details for MDF3

ETSI TS 103 221-1 [7] field name	Description	M/C/O
LIID	Lawful Intercept ID associated with the task.	M
DeliveryType	Set to "HI3Only".	M
ListOfDIDs	Details of where to send the CC for this LIID. Shall be included if deviation from the ListofDIDs in the ActivateTask message is necessary. If included, the ListOfDIDs in the Mediation Details shall be used instead of any delivery destinations authorised by the ListOfDIDs field in the ActivateTask Message.	C
ServiceScoping	Shall be included to Identify the service(s) and associated service-related delivery settings for this LIID. May include more than one instance of this parameter to allow for different combinations of subparameters associated with a single LIID. This parameter is defined in ETSI TS 103 221-1 [7] Annex C table C.2.	C
MediationDetailsExtensions/ HeaderReporting	Header reporting-specific tag to be carried in the MediationDetailsExtensions field of ETSI TS 103 221-1 [7]. See table 6.2.3.9.2-1. This field shall be included if deviation from the taskDetails HeaderReporting TaskDetailsExtensions is required. If included, the details shall be used instead of the HeaderReporting instructions specified in the HeaderReporting field in the TaskDetails structure.	C

6.2.3.2 Generation of xIRI at IRI-POI in SMF over LI_X2

6.2.3.2.1 General

The IRI-POI present in the SMF shall send the xIRIs over LI_X2 for each of the events listed in TS 33.127 [5] clause 6.2.3.3, the details of which are described in the following clauses. In the case where the SMF is part of a combined SMF+PGW-C, the details of the events are specified in clause 6.3.3.2. The IRI-POI present in the SMF shall also send a SeparatedLocationReporting xIRI (as described in clause 7.3.4.1) when the IRI-POI provisioned in the H-SMF detects that the V-SMF has sent location data via the HsmfUpdateData service operation to the H-SMF that does not otherwise trigger an existing SMF record type.

As specified in TS 23.501 [2] clause 5.6.1, a PDU session may support either a single-access PDU Connectivity Service (referred to as a single-access PDU Session) or a multi-access PDU Connectivity Service (referred to as a Multi-Access PDU (MA PDU) session).

The details of the messages for single-access PDU sessions are provided below in clauses 6.2.3.2.2, 6.2.3.2.3, 6.2.3.2.4, 6.2.3.2.5 and 6.2.3.2.6.

The details of the messages for multi-access PDU sessions are provided below in clauses 6.2.3.2.7 and 6.2.3.2.8.

6.2.3.2.2 PDU session establishment

The IRI-POI in the SMF shall generate an xIRI containing an SMF PDU Session Establishment record when the IRI-POI present in the SMF detects that a single-access PDU session has been established for the target UE. The IRI-POI present in the SMF shall generate the xIRI for the following events:

- For a non-roaming scenario, the SMF (or for a roaming scenario, V-SMF in the VPLMN), sends the N1 NAS message (via AMF) PDU SESSION ESTABLISHMENT ACCEPT to the UE and the 5G Session Management (5GSM) state within the SMF is changed to PDU SESSION ACTIVE (see TS 24.501 [13]).
- For a home-routed roaming scenario, the SMF in the HPLMN (i.e. H-SMF) sends the N16: Nsmf_PDU_Session_Create response message with n1SmfInfoToUe IE containing the PDU SESSION ESTABLISHMENT ACCEPT (see TS 29.502 [16]).

If the Npcf_SMPolicyControl_Create response received from the PCF for the target UE in response to Npcf_SMPolicyControl_Create request includes PCC rules in which the traffic control policy data contains either a routeToLocs IE or trafficSteeringPolIdDI IE and/or trafficSteeringPolIdUI IE, then the SMF shall include those PCC rules in the xIRI. These PCC rules correspond to policies that influence the target UE's traffic flows (see TS 29.513 [88] clause 5.5.3).

Table 6.2.3-1: Payload for SMF PDUSessionEstablishment record

Field name	Description	M/C/O
sUPI	SUPI associated with the PDU session (e.g. as provided by the AMF in the associated Nsmf_PDU_Session_CreateSMContext service operation). Shall be present except for PEI-only unauthenticated emergency sessions (see NOTE).	C
sUPIUnauthenticated	Shall be present if a SUPI is present in the message and set to "true" if the SUPI has not been authenticated, or "false" if it has been authenticated.	C
pEI	PEI associated with the PDU session if available (see NOTE).	C
gPSI	GPSI associated with the PDU session if available (see NOTE).	C
pDUSessionID	PDU Session ID See TS 24.501 [13] clause 9.4.	M
gTPTunnelID	Contains the F-TEID identifying the UPF endpoint of the GTP tunnel used to encapsulate the traffic derived from the UL NG-U UP TNL Information (see TS 38.413 clause 9.3.4.1), as defined in TS 29.244 [15] clause 8.2.3. Non-GTP encapsulation is for further study.	M
pDUSessionType	Identifies selected PDU session type, see TS 24.501 [13] clause 9.11.4.11.	M
sNSSAI	Slice identifiers associated with the PDU session, if available. See TS 23.003 [19] clause 28.4.2 and TS 23.501 [2] clause 5.15.2.	C
uEEndpoint	UE endpoint address(es) assigned to the PDU Session if available (see TS 29.244 [15] clause 5.21).	C
non3GPPAccessEndpoint	UE's local IP address used to reach the N3IWF, TNGF or TWIF, if available. IP addresses are given as 4 octets (for IPv4) or 16 octets (for IPv6) with the most significant octet first (network byte order).	C
location	Location information provided by the AMF or present in the context at the SMF, if available.	C
dNN	Data Network Name requested by the target UE, as defined in TS 23.003[19] clause 9A and described in TS 23.502 [4] clause 4.3.2.2. Shall be given in dotted-label presentation format as described in TS 23.003 [19] clause 9.1.	M
aMFID	Identifier of the AMF associated with the target UE, as defined in TS 23.003 [19] clause 2.10.1 if available.	C
hSMFURI	URI of the Nsmf_PDU_Session service of the selected H-SMF, if available. See TS 29.502 [16] clause 6.1.6.2.2.	C
requestType	Type of request as described in TS 24.501 [13] clause 9.11.3.47 provided within the Nsmf_PDU_Session_CreateSMContext Request (TS 29.502 [16]) message shall be reported. In the case where the network does not support Multi Access (MA) PDU sessions, but receives a MA PDU session request, a request type of "Initial request" shall be reported. In the case where the network does not provide a request type value for a non-MA PDU session, a request type of "initial request", according to TS 24.501 [13] clause 6.4.1.2 shall be reported.	M
accessType	Access type associated with the session (i.e. 3GPP or non-3GPP access) if provided by the AMF (see TS 24.501 [13] clause 9.11.2.1A).	C
rATType	RAT Type associated with the access if provided by the AMF as part of session establishment (see TS 23.502 [4] clause 4.3.2). Values given as per TS 29.571 [17] clause 5.4.3.2.	C
sMPDUDNRequest	Contents of the SM PDU DN Request container, if available, as described in TS 24.501 [13] clause 9.11.4.15.	C
uEEPSPDNConnection	This IE shall be present, if available, during an EPS to 5GS Idle mode mobility or handover using the N26 interface. If present, it shall contain the EPS bearer context(s) information present in the uEEPSPDNConnection parameter of the intercepted SmContextCreateData message. (see TS 29.502 [16] clause 6.1.6.2.2).	C
ePS5GSCombolInfo	Provides detailed information about PDN Connections associated with the reported PDU Session. Shall be included if the AMF has selected a SMF+PGW-C to serve the PDU session. This parameter shall include the additional IEs in Table 6.2.3-1A, if present.	C
selectedDNN	Shall be present if a DNN other than the UE requested DNN is selected for the PDU Session. Shall be given in dotted-label presentation format as described in TS 23.003 [19] clause 9.1.	C
servingNetwork	PLMN ID of the serving core network operator, and, for a Non-Public Network (NPN), the NID that together with the PLMN ID identifies the NPN. Shall be present if this IE is in the SMContextCreateData or PDUSessionCreateData message sent to the SMF or the PDU Session Context or SM Context at the SMF (see TS 29.502 [16] clauses 6.1.6.2.2, 6.1.6.2.9 and 6.1.6.2.39).	C
oldPDUSessionID	Shall be present if this IE is in the SMContextCreateData or PDUSessionCreateData message sent to the SMF or the PDU Session Context or SM Context at the SMF (see TS 29.502 [16] clauses 6.1.6.2.2, 6.1.6.2.9 and 6.1.6.2.39).	C

handoverState	Indicates whether the PDU Session Establishment being reported was due to a handover. Shall be present if this IE is in the SMContextCreatedData sent by the SMF (see TS 29.502 [16] clause 6.1.6.2.3).	C
gTPTunnelInfo	Contains the information for the User Plane GTP Tunnels for the PDU Session (see TS 29.502 [16] clauses 6.1.6.2.2, 6.1.6.2.9 and 6.1.6.2.39). See Table 6.2.3-1B.	M
pCCRules	Set of PCC rules related to traffic influence. Each PCC rule influences the routing of a given traffic flow. If several flows are concerned, then several PCC rules shall be handled by the SMF. Traffic influence policies are originated by an AF. PCF translates these rules into PCC rules for traffic influence. The payload of a PCC rule for traffic influence is defined in Table 6.2.3-1E.	C
ePSPDNConnectionEstablishment	Provides details about PDN Connections when the SMF PDN Session Establishment xIRI message is used to report PDN Connection establishment. See Table 6.3.3-1 and clause 6.3.3.2.2.	C
NOTE: At least one of the SUPI, PEI or GPSI fields shall be present.		

Table 6.2.3-1A: Payload for ePS5GSCombolInfo

ePSInterworkingIndication	Indicates whether and how the PDU Session may be moved to EPS. Shall be derived from the EpsInterworkingIndication associated with the PDU Session at the SMF+PGW-C (see TS 29.502 [16] clause 6.1.6.3.11).	M
ePSSubscriberIDs	Includes the Subscriber Identities associated with the EPS PDN Connection in the UE Context sent from the MME to the AMF or known in the context at the SMF+PGW-C. See TS 29.274 [87] clause 7.2.1 and TS 23.502 [4] clause 4.11.1.	M
ePSPdnCnxInfo	Shall be present if there are any EPS PDN connections associated to the PDU Session in the SM Context or PDU Session Context at the SMF+PGW-C. Contains information about the EPS PDN connection associated with the PDU Session. See TS 29.502 [16] clause 6.1.6.2.31.	C
ePSBearerInfo	Shall be present if there are any EPS Bearers associated to the PDU Session in the SM Context or PDU Session Context at the SMF+PGW-C. Contains information about the EPS Bearer context(s) associated with the PDU Session. See TS 29.502 [16] clause 6.1.6.2.4.	C

Table 6.2.3-1B: gTPTunnelInfo field

Field name	Description	M/C/O
fiveGSGTPTunnels	Shall include the 5GS GTP Tunnels (See Table 6.2.3-1C) when the xIRI message is used to report PDU Session related events.	C
ePSGTPTunnels	Shall include the information for the User Plane GTP Tunnels for the bearer context if present in the Request or Response (see TS 29.274 [87] clauses 7.2.2, 7.2.4 and 8.15) or known at the context at the SGW or PGW (see TS 23.401 [50] clause 5.6.4) when the xIRI message is used to report PDN Connection related events. See Table 6.3.3-6.	C

Table 6.2.3-1C: fiveGSGTPTunnels field

Field name	Description	M/C/O
uLNGUUPtunnelInformation	Shall include the F-TEID for the UPF endpoint of the NG-U transport bearer (See TS 38.413 [23] clause 9.3.4.1).	C
additionalULNGUUPtunnelInformation	Shall include the F-TEID for the UPF endpoint of any additional NG-U transport bearers (See TS 38.413 [23] clause 9.3.4.1).	C
dLRANTunnelInformation	Shall include the RAN tunnel and QOS Flow information for the PDU Session (See TS 29.502 [16] clause 6.1.6.2.39 and TS 38.413 [23] clause 9.3.4.1). See Table 6.2.3-1D.	C

Table 6.2.3-1D: dLRANTunnelInformation field

Field name	Description	M/C/O
dLQOSFlowTunnelInformation	Shall include the F-TEID NG-RAN endpoint of the NG-U transport bearer together with associated QoS flows (See TS 38.413 [23] clause 9.3.4.2 and TS 29.502 [16] clause 6.1.6.2.39).	C
additionalDLQOSFlowTunnelInformation	Shall include the F-TEID NG-RAN endpoint of any additional NG-U transport bearers together with associated QoS flows (See TS 38.413 [23] clause 9.3.4.2 and TS 29.502 [16] clause 6.1.6.2.39).	C
redundantDLQOSFlowTunnelInformation	Shall include the F-TEID NG-RAN endpoint of redundant NG-U transport bearers together with associated QoS flows (See TS 38.413 [23] clause 9.3.4.2 and TS 29.502 [16] clause 6.1.6.2.39).	C
additionalredundantDLQOSFlowTunnelInformation	Shall include the F-TEID NG-RAN endpoint of any additional redundant NG-U transport bearers together with associated QoS flows (See TS 38.413 [23] clause 9.3.4.2 and TS 29.502 [16] clause 6.1.6.2.39).	C

Each PCC rule for traffic influence has the payload defined in Table 6.2.3-1E.

Table 6.2.3-1E: Payload of PCCrule for traffic influence

Field name	Description	M/C/O
pCCRuleID	Policy rule identifier. This IE is defined in TS 29.512 [89], table 5.6.2.6-1.	M
appld	Identifies an application (NOTE 1). This IE is defined in TS 29.512 [89], table 5.6.2.6-1 (NOTE 1), if available.	C
pFD	Packet flow description (PFD) associated with the appld. It is defined in TS 29.551 [94] table 5.6.2.5-1 (NOTE 1).	C
flowInfos	A set of flow information, if available. A flow information is an Ethernet or IP flow packet filter information (NOTE 1). This IE is defined in TS 29.512 [89], table 5.6.2.6-1 (NOTE 1). FlowInfos may be IP flow or Ethernet flow. IP flow is specified in TS 29.214, section 5.3.8 [92]. Ethernet Flow is specified in TS 29.514 [91] Table 5.6.2.17-1.	C
appReloc	Indicates that the application cannot be relocated once a location of the application is selected by the 5GC when it is included and set to "true". The default value is "false".	C
simConnInd	Indication of simultaneous connectivity temporarily maintained for the source and target PSA (PDU Session Anchor). If it is included and set to "true", temporary simultaneous connectivity should be kept. The default value "false" applies, if the IE is not present. This IE is defined in TS 29.512 [89], table 5.6.2.9-1.	C
simConnTerm	Indication of the minimum time interval to be considered for inactivity of the traffic routed via the source PSA during the edge re-location procedure. It may be included when the "simConnInd" attribute is set to true. This IE is defined in TS 29.512 [89], table 5.6.2.9-1.	C
maxAllowedUpLat	Indicates the target user plane latency in units of milliseconds used by SMF to decide whether edge relocation is needed to ensure that the user plane latency does not exceed the value. This IE is defined in TS 29.512 [89], table 5.6.2.9-1.	C
routeToLocs	A set of traffic routes. A traffic route provides information to route to/from a DNAI. This IE is defined in TS 29.512 [89], table 5.6.2.9-1 (NOTE 2).	C
trafficSteeringPolIdDI	Traffic steering policy for downlink traffic at the SMF, if available. This IE is defined in TS 29.512 [89], table 5.6.2.9-1 (NOTE 2).	C
trafficSteeringPolIdUI	Traffic steering policy for downlink traffic at the SMF, if available. This IE is defined in TS 29.512 [89], table 5.6.2.9-1 (NOTE 2).	C
sourceDNAI	No longer used in present version of the present document.	C
targetDNAI	No longer used in present version of the present document.	C
dNAIChangeType	No longer used in present version of the present document.	C
sourceUEIPAddress	No longer used in present version of the present document.	C
targetUEIPAddress	No longer used in present version of the present document.	C
eASIPReplacInfos	Contains EAS IP replacement information for a Source and a Target EAS, if available. This IE is defined in TS 29.571 [17], table 5.4.4.79.	C
NOTE 1: Either appld/pFD or flowInfos shall be supplied.		
NOTE 2: TrafficSteeringPolIdDI attribute and/or trafficSteeringPolIdUI attribute and routeToLocs attribute are mutually exclusive.		

6.2.3.2.3 PDU session modification

The IRI-POI in the SMF shall generate an xIRI containing an SMFPDUSessionModification record when the IRI-POI present in the SMF detects that a single-access PDU session has been modified for the target UE. The IRI-POI present in the SMF shall generate the xIRI for the following events:

- For a non-roaming scenario, the SMF (or for a roaming scenario, V-SMF in the VPLMN), receives the N1 NAS message (via AMF) PDU SESSION MODIFICATION COMPLETE from the UE and the 5GSM state within the SMF is returned to PDU SESSION ACTIVE (see TS 24.501 [13]). This applies to the following two cases:
 - UE initiated PDU session modification.
 - Network initiated PDU session modification.
- For a non-roaming scenario, the SMF (or for a roaming scenario, V-SMF in the VPLMN), sends the N1 NAS message (via AMF) PDU SESSION ESTABLISHMENT ACCEPT to the UE and the 5GSM state within the SMF remains in the PDU SESSION ACTIVE (see TS 24.501 [13]). This applies to the following case:
 - Handover from one access type to another access type happens (e.g. 3GPP to non-3GPP).
- For a home-routed roaming scenario, the SMF in the HPLMN (i.e. H-SMF) receives the N16: Nsmf_PDU_Session_Update Response message with n1SmInfoFromUe IE containing the PDU SESSION MODIFICATION COMPLETE (see TS 29.502 [16]). This applies to the following three cases:
 - UE initiated PDU session modification.
 - Network (VPLMN) initiated PDU session modification.
 - Network (HPLMN) initiated PDU session modification.
- For a home-routed roaming scenario, the SMF in the HPLMN (i.e. H-SMF) sends the N16: Nsmf_PDU_Session_Create Response message with n1SmInfoToUe IE containing the PDU SESSION ESTABLISHMENT ACCEPT (see TS 29.502 [16]) while it had received a N16 Nsmf_PDU_Session_Create Request message with an existing PDU Session Id with access type being changed. This applies to the following case:
 - Handover from one access type to another access type happens (e.g. 3GPP to non-3GPP) where the V-SMF is used for the PDU session on the new access type only.
- For a home-routed roaming scenario, the SMF in the HPLMN (i.e. H-SMF) sends the N16: Nsmf_PDU_Session_Update Response message with n1SmInfoToUe IE containing the PDU SESSION ESTABLISHMENT ACCEPT (see TS 29.502 [16]) while it had received a N16 Nsmf_PDU_Session_Update Request message with an existing PDU Session Id with access type being changed. This applies to the following case:
 - Handover from one access type to another access type happens (e.g. 3GPP to non-3GPP) where the same V-SMF is used for the PDU session on both access types.
- For a non-roaming scenario, SMF sends a Nsmf_EventExposure_Notify request to the NEF or AF for the target UE for the event "UP Path Change" related to a corresponding subscription from AF (see TS 29.508 [90] clause 4.2.2).
- For a non-roaming scenario, SMF sends a Nsmf_EventExposure_AppRelocationInfo response to the NEF or AF for the target UE in response to Nsmf_EventExposure_AppRelocationInfo request sent by NEF or AF to SMF (see TS 29.508 [90] clause 4.2.5).
- For a non-roaming scenario, SMF receives a Nnef_PFDManagement_Fetch response from the NEF for the target UE in response to Nnef_PFDManagement_Fetch request sent by SMF to NEF (see TS 29.551 [94] clause 4.2.2).

If the Npcf_SMPolicyControlUpdateNotify response sent to the PCF for the target UE in response to an Npcf_SMPolicyControlUpdateNotify request includes PCC rules in which the traffic control policy data contains either a routeToLocs IE or trafficSteeringPolIdDI IE and/or trafficSteeringPolIdUI IE, then the SMF shall include those PCC rules in the xIRI. These PCC rules correspond to policies that influence the target UE's traffic flows (see TS 29.513 [88] clause 5.5.3).

Table 6.2.3-2: Payload for SMF PDUSessionModification record

Field name	Description	M/C/O
sUPI	SUPI associated with the PDU session (e.g. as provided by the AMF in the associated Nsmf_PDU_Session_CreateSMContext service operation). Shall be present except for PEI-only unauthenticated emergency sessions.	C
sUPIUnauthenticated	Shall be present if a SUPI is present in the message and set to "true" if the SUPI was not authenticated, or "false" if it has been authenticated.	C
pEI	PEI associated with the PDU session if available.	C
gPSI	GPSI associated with the PDU session if available.	C
sNSSAI	Slice identifier associated with the PDU session, if available. See TS 23.003 [19] clause 28.4.2 and TS 23.501 [2] clause 5.15.2.	C
non3GPPAccessEndpoint	UE's local IP address used to reach the N3IWF, TNGF or TWIF, if available. IP addresses are given as 4 octets (for IPv4) or 16 octets (for IPv6) with the most significant octet first (network byte order).	C
location	Location information provided by the AMF or present in the context at the SMF, if available.	C
requestType	For both a UE- as well as a network-requested PDU session the POI (SMF) shall set the request type parameter to "modification request".	M
accessType	Access type associated with the session (i.e. 3GPP or non-3GPP access) if provided by the AMF (see TS 24.501 [13] clause 9.11.2.1A).	C
rATType	RAT type associated with the access, if available. Values given as per TS 29.571 [17] clause 5.4.3.2.	C
pDUSessionID	PDU Session ID See TS 24.501 [13] clause 9.4. This parameter is conditional only for backwards compatibility.	C
ePS5GSCombolInfo	Provides detailed information about PDN Connections associated with the reported PDU Session. Shall be included when the AMF has selected a SMF+PGW-C to serve the PDU session. This parameter may include the additional IEs in Table 6.2.3-1A, when available.	C
uEEndpoint	UE IP address(es) assigned to the PDU Session if available (See TS 29.244 [15] clause 5.21).	C
servingNetwork	Shall be present if this IE is in the SMContextUpdateData, HsmfUpdateData or message sent to the SMF or the PDU Session Context or SM Context at the SMF (see TS 29.502 [16] clauses 6.1.6.2.3, 6.1.6.2.11 and 6.1.6.2.39).	C
handoverState	Indicates whether the PDU Session Modification being reported was due to a handover. Shall be present if this IE is in the SMContextUpdatedData or sent by the SMF (see TS 29.502 [16] clause 6.1.6.2.3).	C
gTPTunnelInfo	Contains the information for the User Plane GTP Tunnels for the PDU Session (see TS 29.502 [16] clauses 6.1.6.2.2, 6.1.6.2.9 and 6.1.6.2.39). See Table 6.2.3-1B.	M
pCCRules	Set of PCC rules related to traffic influence. Each PCC rule influences the routing of a given traffic flow. If several flows are concerned, then several PCC rules shall be handled by the SMF. Traffic influence policies are originated by an AF. PCF translates these rules into PCC rules for traffic influence. The payload of a PCC rule for traffic influence is defined in Table 6.2.3-1E.	C
ePSPDNConnectionModification	Provides details about PDN Connections when the SMF PDUSessionModification xIRI message is used to report PDN Connection Modification. See Table 6.3.3-8 and clause 6.3.3.2.3.	C
uPPathChange	Notification of the UPPathChange event, if available. This IE is defined in TS 29.508 [90], Table 5.6.2.5-1.	C
pFDDataForApp	Represents the packet flow descriptions (PFDs) for an application identifier (AppId), if available. This IE is defined in TS 29.551 [94], Table 5.6.2.2-1.	C

Table 6.2.3-2A: Payload of UPPathChange

Field name	Description	M/C/O
sourceDNAI	Source DNAI, if the DNAI has changed. DNAI represents the location of applications towards which the traffic routing should apply.	C
targetDNAI	Target DNAI if the DNAI has changed.	C
dNAIChangeType	Type of a DNAI change. Possible values are "early", "late" and "earlyAndLate" notification of UP path reconfiguration.	C
sourceUEIPAddress	The IPv4 Address of the served UE for the source DNAI, if available.	C
targetUEIPAddress	The IPv4 Address of the served UE for the target DNAI, if available.	C
sourceTrafficRouting	N6 traffic routing information for the source DNAI, if available.	C
targetTrafficRouting	N6 traffic routing information for the target DNAI, if available.	C
MACAddress	The MAC address of the served UE, if available.	C

Table 6.2.3-2B: Payload of PFDDataForApp

Field name	Description	M/C/O
appld	Identifier of an application	M
pFDs	PFDs for an application identifier, if available. PFD is defined in TS 29.551 [94], Table 5.6.2.5-1.	C

Table 6.2.3-2C: Payload of PFD

Field name	Description	M/C/O
pFDId	PFD identifier	M
pFDflowDescription	Represents a set of 3-tuple with protocol, server IP address and server port for UL/DL application traffic, if available.	C
uRLs	Represents a set of URL, if available.	C
domainNames	Represents a set of FQDN, if available.	C
dnProtocol	Indicates the additional protocol and protocol field for domain names to be matched, if available. This IE is defined in 29.122 [63], Table 5.14.2.2.4-1.	C

6.2.3.2.4 PDU session release

The IRI-POI in the SMF shall generate an xIRI containing an SMFPDUSessionRelease record when the IRI-POI present in the SMF detects that a single-access PDU session has been released. The IRI-POI present in the SMF shall generate the xIRI for the following events:

- For a non-roaming scenario, the SMF (or for a roaming scenario, V-SMF in the VPLMN), receives the N1 NAS message (via AMF) PDU SESSION RELEASE COMPLETE from the UE and the 5GSM state within the SMF is changed to PDU SESSION INACTIVE (see TS 24.501 [13]). This applies to the following two cases:
 - UE initiated PDU session release.
 - Network initiated PDU session release.
- For a non-roaming scenario, the SMF (or for a roaming scenario, V-SMF in the VPLMN), receives the N1 NAS message (via AMF) STATUS from the UE with the cause values listed in TS 24.501 [13], clause 6.5.3 and the 5GSM state within the SMF is changed to PDU SESSION INACTIVE. One of the cases where this applies is of UE finding that the PDU session ID received in a PDU SESSION MODIFICATION COMMAND is invalid.
- For a non-roaming scenario, the SMF (or for a roaming scenario, the V-SMF in the VPLMN) sends the Nsmf_PDUSession_ReleaseSMContext Response to the AMF (see TS 29.502 [16], clause 5.2.2.4). This applies to the case where the PDU session is released without any N1 or N2 messages (e.g. AMF initiates the PDU session release when it finds that the PDU session is no longer associated with the UE, see TS 23.502 [4], clause 4.2.2.4).
- For a non-roaming scenario, the SMF (or for a roaming scenarios, V-SMF in the VPLMN) sends Nsmf_PDUSession_SMContextStatusNotify (see TS 29.502 [16], clause 6.1.6.2.8) with RELEASED in the ResourceStatus IE (see TS 29.502 [16], clause 6.1.6.3.1) to the AMF. This applies to the case where PDU session release is neither initiated by a NAS message nor by Nsmf_PDUSessionReleaseSMContext Request message (see TS 29.502 [16], clause 5.2.2.5).

- For a home-routed roaming scenario, the SMF in the HPLMN (i.e. H-SMF) receives the N16: Nsmf_PDU_Session_Update response message with n1SmInfoFromUe IE containing the PDU SESSION RELEASE COMPLETE (see TS 29.502 [16]) from the V-SMF. This applies to the following three cases:
 - UE initiated PDU session release.
 - Network (VPLMN) initiated PDU session release.
 - Network (HPLMN) initiated PDU session release.
- For a roaming scenario, H-SMF in the HPLMN sends the Nsmf_PDU_Session_Release Response to the V-SMF (see TS 29.502 [16], clause 5.2.2.9). This applies to the case where the PDU session is released without any N1 or N2 messages (e.g. AMF in the VPLMN initiates the PDU session release when it finds that the PDU session is no longer associated with the UE, see TS 23.502 [4], clause 4.3.4.3).
- For a roaming scenario, H-SMF in the HPLMN sends a Nsmf_PDU_Session_Status_Notify (see TS 29.502 [16], clause 6.1.6.2.17) with RELEASED in the ResourceStatus IE (see TS 29.502 [16], clause 6.1.6.3.1) to the V-SMF. This applies to the case where PDU session release is neither initiated by a NAS message nor by Nsmf_PDU_Session_Release Request message (see TS 29.502 [16], clause 5.2.2.9).

Table 6.2.3-3: Payload for SMFPDU_Session_Release record

Field name	Description	M/C/O
sUPI	SUPI associated with the PDU session.	M
pEI	PEI associated with the PDU session if available.	C
gPSI	GPSI associated with the PDU session if available.	C
pDU_Session_ID	PDU Session ID as assigned by the AMF.	M
timeOfFirstPacket	Time of first packet for the PDU session.	C
timeOfLastPacket	Time of last packet for the PDU session.	C
uplinkVolume	Number of uplink octets for the PDU session.	C
downlinkVolume	Number of downlink octets for the PDU session.	C
location	Location information, if available.	C
cause	Indicates the NF Service Consumer cause for the requested PDU session release (see TS 29.502 [16] clause 6.1.6.3.8 for enumerated cause information). Include if known.	C
ePS5GSCombolInfo	Provides detailed information about PDN Connections associated with the reported PDU Session. This parameter may include the additional IEs in Table 6.2.3-1A, when available.	C
nGAPCause	Indicates the NGAP cause for the requested SM context release (see TS 29.502 [16] clause 6.1.6.2.6). Shall be derived as described in TS 29.571 [17] clause 5.4.4.12.	C
fiveGMMCause	Indicates the 5GMM cause for a PDU Session released due to any 5GMM failure (see 29.502 [16] clause 6.1.6.2.6). Shall be sent as an integer derived as described in TS 29.571 [17] clause 5.4.2.	C
pCCRuleIDs	PCC rule IDs of the PCC rules related to traffic influence that are associated to the PDU session and active at the time the PDU session is released.	C
ePSPDNConnectionRelease	Provides details about PDN Connections when the SMFPDU_Session_Release xIRI message is used to report PDN Connection Release. See Table 6.3.3-13 and clause 6.3.3.2.4.	C

6.2.3.2.5 Start of interception with an established PDU session

The IRI-POI in the SMF shall generate an xIRI containing an SMFStartOfInterceptionWithEstablishedPDU_Session record when the IRI-POI present in the SMF detects that a single-access PDU session has already been established for the target UE when interception starts.

In a non-roaming scenario, the IRI-POI in the SMF (or in a roaming scenario, the IRI-POI in the V-SMF in the VPLMN) shall generate the xIRI containing the SMFStartOfInterceptionWithEstablishedPDU_Session record when it detects that a new interception for a UE is activated (i.e. provisioned by the LIPF) for the following case:

- The 5GSM state within the SMF for that UE is 5GSM: PDU SESSION ACTIVE or PDU SESSION MODIFICATION PENDING.

NOTE: The above trigger happens when the SMF (V-SMF in VPLMN) had not sent an N1 NAS message PDU SESSION RELEASE COMMAND to the UE for a PDU session and the SMF (V-SMF in the VPLMN) had previously sent an N1 NAS message PDU SESSION ESTABLISHMENT ACCEPT to that UE for the same PDU session.

In a home-routed roaming scenario, the IRI-POI in the H-SMF shall generate the xIRI containing the SMFStartOfInterceptionWithEstablishedPDUSession record when it detects that a new interception for a UE is activated (i.e. provisioned by the LIPF) for the following case:

- The H-SMF had not sent a Nsmf_PDU_Session_Update Request (n1SmInfoToUe: PDU SESSION RELEASE COMMAND) to the V-SMF for a PDU session and H-SMF had previously sent a Nsmf_PDU_Session_Create response (n1SmInfoToUE: PDU SESSION ESTABLISHMENT ACCEPT) to the V-SMF for that PDU session.

The IRI-POI in the SMF shall generate the xIRI containing the SMFStartOfInterceptionWithEstablishedPDUSession record for each of the PDU sessions (that meets the above criteria) associated with the newly identified target UEs.

Table 6.2.3-4: Payload for SMFStartOfInterceptionWithEstablishedPDUSession record

Field name	Description	M/C/O
sUPI	SUPI associated with the PDU session (e.g. as provided by the AMF in the associated Nsmf_PDU_Session_CreateSMContext service operation). Shall be present except for PEI-only unauthenticated emergency sessions.	C
sUPIUnauthenticated	Shall be present if a SUPI is present in the message and set to "true" if the SUPI has not been authenticated, or "false" if it has been authenticated.	C
pEI	PEI associated with the PDU session if available.	C
gPSI	GPSI associated with the PDU session if available.	C
pDUSessionID	PDU Session ID as assigned by the AMF, as defined in TS 24.007 [14] clause 11.2.3.1b.	M
gTPTunnelID	Contains the F-TEID identifying the UPF endpoint of the GTP tunnel used to encapsulate the traffic derived from the UL NG-U UP TNL Information (see TS 38.413 clause 9.3.4.1), as defined in TS 29.244 [15] clause 8.2.3. Non-GTP encapsulation is for further study.	M
pDUSessionType	Identifies selected PDU session type, see TS 24.501 [13] clause 9.11.4.11.	M
sNSSAI	Slice identifier associated with the PDU session, if available. See TS 23.003 [19] clause 28.4.2 and TS 23.501 [2] clause 5.15.2.	C
uEEndpoint	UE endpoint address(es) if available. IP addresses are given as 4 octets (for IPv4) or 16 octets (for IPv6) with the most significant octet first (network byte order). MAC addresses are given as 6 octets with the most significant octet first (see TS 29.244 [15] clause 5.21).	C
non3GPPAccessEndpoint	UE's local IP address used to reach the N3IWF, TNGF or TWIF, if available. IP addresses are given as 4 octets (for IPv4) or 16 octets (for IPv6) with the most significant octet first (network byte order).	C
location	Location information provided by the AMF at session establishment or present in the context at the SMF, if available.	C
dNN	Data Network Name associated with the target traffic, as defined in TS 23.003 [19] clause 9A and described in TS 23.502 [4] clause 4.3.2.2. Shall be given in dotted-label presentation format as described in TS 23.003 [19] clause 9.1.	M
aMFID	Identifier of the AMF associated with the target UE, as defined in TS 23.003 [19] clause 2.10.1, if available.	C
hSMFURI	URI of the Nsmf_PDU_Session service of the selected H-SMF, if available. See TS 29.502 [16] clause 6.1.6.2.2.	C
requestType	Type of request as initially set within the PDU SESSION ESTABLISHMENT as described in TS 24.501 [13] clause 9.11.3.47. If the initial value is no longer available the request type shall be set to "existing PDU session".	M
accessType	Access type associated with the session (i.e. 3GPP or non-3GPP access) if provided by the AMF (see TS 24.501 [13] clause 9.11.2.1A).	C
rATType	RAT type associated with the access if provided by the AMF as part of session establishment (see TS 23.502 [4] clause 4.3.2). Values given as per TS 29.571 [17] clause 5.4.3.2.	C
sMPDUDNRequest	Contents of the SM PDU DN request container, if available, as described in TS 24.501 [13] clause 9.11.4.15.	C
timeOfSessionEstablishment	Time at which the session establishment occurred, if available. Shall be given qualified with time zone information (i.e. as UTC or offset from UTC, not as local time).	C
ePS5GSCombolInfo	Provides detailed information about PDN Connections associated with the reported PDU Session. Shall be included when the AMF has selected a SMF+PGW-C to serve the PDU session. This parameter may include the additional IEs in table 6.2.3-1A, if available.	C
uEESPDPDNConnection	This IE shall be present, if available, during an EPS to 5GS Idle mode mobility or handover using the N26 interface. If present, it shall contain the EPS bearer context(s) information present in the uEESPDPDNConnection parameter of the intercepted SmContextCreateData message. (see TS 29.502 [16] clause 6.1.6.2.2).	C
servingNetwork	Indicates the serving core network operator PLMN, and for an SNPN, the NID. Shall be present if present in the PDU Session Context or SM Context at the SMF (see TS 29.502 [16] clause 6.1.6.2.39).	C
gTPTunnelInfo	Contains the information for the User Plane GTP Tunnels for the PDU Session (see TS 29.502 [16] clauses 6.1.6.2.2, 6.1.6.2.9 and 6.1.6.2.39). See Table 6.2.3-1B.	M
pCCRules	Set of PCC rules related to traffic influence. Each PCC rule influences the routing of a given traffic flow. If several flows are concerned, then several PCC rules shall be handled by the SMF. Traffic influence policies are originated by an AF. PCF translates these rules into PCC rules for traffic influence. The payload of a PCC rule for traffic influence is defined in Table 6.2.3-1E.	C

ePSSStartOfInterceptionWithEstablishedPDNConnection	Provides details about PDN Connections when the SMFStartOfInterceptionWithEstablishedPDUSession xIRI message is used to report the start of interception on a target who already has existing PDN Connections. See Table 6.3.3-14 and clause 6.3.3.2.5.	C
pFDDataForApps	Represents a set of associations between application identifier and packet flow descriptions (PFDs).	C

The IRI-POI present in the SMF generating an xIRI containing a SMFStartOfInterceptionWithEstablishedPDUSession record shall set the Payload Direction field in the PDU header to *not applicable* (Direction Value 5, see ETSI TS 103 221-2 [8] clause 5.2.6).

6.2.3.2.6 SMF unsuccessful procedure

The IRI-POI in the SMF shall generate an xIRI containing an SMFUnsuccessfulProcedure record when the IRI-POI present in the SMF detects an unsuccessful procedure or error condition for a UE matching one of the target identifiers provided via LI_X1.

Accordingly, the IRI-POI in the SMF generates the xIRI when one of the following events are detected:

- SMF sends a PDU SESSION ESTABLISHMENT REJECT message to the target UE.
- SMF sends a PDU SESSION MODIFICATION REJECT message to the target UE.
- SMF sends a PDU SESSION RELEASE REJECT message to the target UE.
- SMF receives a PDU SESSION MODIFICATION COMMAND REJECT message from the target UE.
- An ongoing SM procedure is aborted at the SMF, due to e.g. a 5GSM STATUS message sent from or received by the SMF.

Table 6.2.3-5: Payload for SMFUnsuccessfulProcedure record

Field name	Description	M/C/O
failedProcedureType	Specifies the procedure which failed or is aborted at the SMF.	M
failureCause	Provides the value of the 5GSM cause, see TS 24.501 [13] clause 9.11.4.2. In case the procedure is aborted due to a 5GSM STATUS message, the 5GSM cause is the one included in the 5GSM status message.	M
requestedSlice	Slice requested for the procedure, if available, given as a NSSAI (a list of S-NSSAI values as described in TS 24.501 [13] clause 9.11.3.37).	C
initiator	Specifies whether the network (SMF) or the UE is initiating the rejection or indicating the failure.	M
sUPI	SUPI associated with the procedure, if available (see NOTE).	C
sUPIUnauthenticated	Shall be present if a SUPI is present in the message and set to "true" if the SUPI has not been authenticated, or "false" if it has been authenticated.	C
pEI	PEI used in the procedure, if available (see NOTE).	C
gPSI	GPSI used in the procedure, if available (see NOTE).	C
pDUSessionID	PDU Session ID See clause 9.4 of TS 24.501 [13], if available.	C
uEEndpoint	UE endpoint address(es) if available.	C
non3GPPAccessEndpoint	UE's local IP address used to reach the N3IWF, TNGF or TWIF, if available.	C
location	Location information provided by the AMF or present in the context at the SMF, if available.	C
dNN	Data Network Name associated with the target traffic, as defined in TS 23.003 [19] clause 9A and described in TS 23.501 [2] clause 4.3.2.2, if available. Shall be given in dotted-label presentation format as described in TS 23.003 [19] clause 9.1.	C
aMFID	Identifier of the AMF associated with the target UE, as defined in TS 23.003 [19] clause 2.10.1 when available.	C
hSMFURI	URI of the Nsmf_PDUSession service of the selected H-SMF, if available. See TS 29.502 [16] clause 6.1.6.2.2.	C
requestType	Type of request as described in TS 24.501 [13] clause 9.11.3.47, if available. Otherwise depending on the REJECT event the following request type shall be reported: PDU SESSION ESTABLISHMENT REJECT: The request type shall be set to the one reported within the PDU SESSION ESTABLISHMENT or if there hasn't been one reported or is no longer available it should be set to "initial request". PDU SESSION MODIFICATION REJECT: "modification request". PDU SESSION RELEASE REJECT: no request type shall be set. PDU SESSION MODIFICATION COMMAND REJECT: "modification request".	C
accessType	Access type associated with the session (i.e. 3GPP or non-3GPP access) if provided by the AMF (see TS 24.501 [13] clause 9.11.2.1A).	C
rATType	RAT Type associated with the access if provided by the AMF as part of session establishment (see TS 23.502 [4] clause 4.3.2). Values given as per TS 29.571 [17] clause 5.4.3.2.	C
sMPDUDNRequest	Contents of the SM PDU DN Request container, if available, as described in TS 24.501 [13] clause 9.11.4.15.	C
NOTE: At least one identity shall be provided, the others shall be provided if available.		

6.2.3.2.7 MA PDU sessions

6.2.3.2.7.1 General

In the present document, an MA PDU session will include two general types of PDU sessions as defined below:

- MA-Confirmed: This is an MA PDU session where the UE signals Upgrade Allowed to MA and the network immediately upgrades the session to an MA PDU session or the UE explicitly requests an MA PDU session (using a Request Type of MA PDU).
- MA-Upgrade-Allowed: This is a PDU session where the UE indicated that upgrade to an MA PDU session is allowed, but the network does not immediately confirm the upgrade. The network may at some later point upgrade the session to an MA PDU session.

NOTE: The above terms are not defined or used in other 3GPP Stage 2 or Stage 3 specifications, but have been introduced here to clarify and distinguish LI event reporting for the respective situations.

An MA-Confirmed MA PDU session may be established over a single access or over multiple accesses. The establishment over multiple accesses may occur concurrently or may occur at different points in time.

An MA-Upgrade-Allowed MA PDU session is established over a single access and nearly all aspects appears to be an ordinary non-MA PDU session with the key difference that the network may upgrade the session to an MA-confirmed MA PDU session.

6.2.3.2.7.2 MA PDU session establishment

The IRI-POI in the SMF shall generate an xIRI containing an SMFMAPDUSessionEstablishment record when the IRI-POI present in the SMF detects that a PDU session has been established for the target UE that is an MA PDU session (Request Type set to MA PDU session or upgraded at establishment), or where the upgrade allowed parameter is set to upgrade allowed and session is established as an ordinary PDU session (not upgraded at establishment, but may occur later on). The IRI-POI present in the SMF shall generate the xIRI for the following events:

- For a non-roaming scenario, the SMF sends the N1 NAS message (via AMF) PDU Session Establishment Accept to the UE for a new PDU session and the 5G Session Management (5GSM) state within the SMF is changed to PDU SESSION ACTIVE (see TS 24.501 [13]) in response to a PDU Session Establishment request received along with:
 - PDU Session ID which does not identify an existing PDU session, and
 - Request Type = MA PDU request, or
 - Request Type = initial request and MA PDU session information set to "MA PDU session network upgrade is allowed", with either upgrade occurring at establishment or upgrade does not occur at establishment but may occur later.
- For a home-routed roaming scenario, the SMF in the HPLMN (i.e. H-SMF) sends the N16: Nsmf_PDU_Session_Create response message with n1SmInfoToUe IE containing the PDU SESSION ESTABLISHMENT ACCEPT (see TS 29.502 [16]) for a new PDU session in response to a PDU Session Establishment request received along with:
 - PDU Session ID which does not identify an existing PDU session, and
 - Request Type = MA PDU request, or
 - Request Type = initial request and MA PDU session information set to "MA PDU session network upgrade is allowed", with either upgrade occurring at establishment or upgrade does not occur at establishment but may occur later.

If the Npcf_SMPolicyControl_Create response received from the PCF for the target UE in response to Npcf_SMPolicyControl_Create request includes PCC rules in which the traffic control policy data contains either a routeToLocs IE or trafficSteeringPolIdDI IE and/or trafficSteeringPolIdUI IE, then the SMF shall include those PCC rules in the xIRI. These PCC rules correspond to policies that influence the target UE's traffic flows (see TS 29.513 [88] clause 5.5.3).

Table 6.2.3-5A: Payload for SMFMAPDUSessionEstablishment record

Field name	Description	M/C/O
sUPI	SUPI associated with the PDU session (e.g. as provided by the AMF in the associated Nsmf_PDU_Session_CreateSMContext service operation). Shall be present except for PEI-only unauthenticated emergency sessions (see NOTE).	C
sUPIUnauthenticated	Shall be present if a SUPI is present in the message and set to "true" if the SUPI has not been authenticated, or "false" if it has been authenticated.	C
pEI	PEI associated with the PDU session if available (see NOTE).	C
gPSI	GPSI associated with the PDU session if available (see NOTE).	C
pDUSessionID	PDU Session ID See clause 9.4 of TS 24.501 [13]. Identifies a new PDU session.	M
pDUSessionType	Identifies selected PDU session type, see TS 24.501 [13] clause 9.11.4.11.	M
accessInfo	Identifies the access(es) associated with the PDU session including the information for each specific access (see table 6.2.3-5B)	M
sNSSAI	Slice identifiers associated with the PDU session, if available. See TS 23.003 [19] clause 28.4.2 and TS 23.501 [2] clause 5.15.2.	C
uEEndpoint	UE endpoint address(es) assigned to the PDU Session if available (see TS 29.244 [15] clause 5.21).	C
location	Location information provided by the AMF or present in the context at the SMF, if available.	C
dNN	Data Network Name requested by the target UE, as defined in TS 23.003 [19] clause 9A and described in TS 23.502 [4] clause 4.3.2.2. Shall be given in dotted-label presentation format as described in TS 23.003 [19] clause 9.1.	M
aMFID	Identifier of the AMF associated with the target UE, as defined in TS 23.003 [19] clause 2.10.1 when available.	C
hSMFURI	URI of the Nsmf_PDU_Session service of the selected H-SMF, if available. See TS 29.502 [16] clause 6.1.6.2.2.	C
requestType	Type of request as described in TS 24.501 [13] clause 9.11.3.47 provided within the Nsmf_PDU_Session_CreateSMContext Request (TS 29.502 [16]) message shall be reported. In the case where the network does not provide a request type value for a MA PDU session and the network does support MA PDU sessions, the request type shall be set to "MA PDU request" according to TS 24.501 [13] clause 6.4.1.2.	M
sMPDUDNRequest	Contents of the SM PDU DN Request container, if available, as described in TS 24.501 [13] clause 9.11.4.15.	C
servingNetwork	PLMN ID of the serving core network operator, and, for a Non-Public Network (NPN), the NID that together with the PLMN ID identifies the NPN.	M
oldPDUSessionID	The old PDU Session ID received from the UE. See TS 23.502 [4] clauses 4.3.2.2.1 and 4.3.5.2 and TS 24.501 [13] clause 6.4.1.2. Shall be present if this IE is in the SMContextCreateData or PDUSessionCreateData message sent to the SMF or the PDU Session Context or SM Context at the SMF (see TS 29.502 [16] clauses 6.1.6.2.2, 6.1.6.2.9 and 6.1.6.2.39).	C
maUpgradeIndication	Indicates whether the PDU session is allowed to be upgraded to MA-Confirmed MA PDU session (see TS 23.502 [4] clause 4.22.3). Include if known.	C
ePSPDNCnxInfo	Indicates if the PDU session may be moved to EPS during its lifetime (see TS 29.502 [16] clause 6.1.6.2.31). Include if known.	C
maAcceptedIndication	Indicates that a request to establish an MA PDU session was accepted or if a single access PDU session request was upgraded into a MA PDU session (see TS 23.502 [4] clauses 4.22.2 and 4.22.3). It shall be set as follows: - true: MA-Confirmed MA PDU session was established - false: single access MA-Upgrade-Allowed MA PDU session was established that may be upgraded to an MA-Confirmed MA PDU session.	M
aTSSSSContainer	Identifies the steering, switching, and splitting features for the MA-Confirmed MA PDU session. Also indicates whether MPTCP or ATSSS-LL is to be used for ATSSS. See TS 24.501[13] clause 9.11.4.22.	C
uEEPSPDNConnection	This IE shall be present, if available, during an EPS to 5GS Idle mode mobility or handover using the N26 interface. If present, it shall contain the EPS bearer context(s) information present in the uEEPSPDNConnection parameter of the intercepted SmContextCreateData message. (see TS 29.502 [16] clause 6.1.6.2.2).	C
ePS5GSComboInfo	Provides detailed information about PDN Connections and PDU Sessions during EPS to 5GS idle mode mobility or handover using the N26 interface. Shall be included if the AMF has selected a SMF+PGW-C to serve the PDU session. This parameter shall include the additional IEs in Table 6.2.3-1A, if present.	C
selectedDNN	Shall be present if a DNN other than the UE requested DNN is selected for the PDU Session. Shall be given in dotted-label presentation format as described in TS 23.003 [19] clause 9.1.	C

handoverState	Indicates whether the PDU Session Establishment being reported was due to a handover. Shall be present if this IE is in the SMContextCreatedData sent by the SMF (see TS 29.502 [16] clause 6.1.6.2.3).	C
pCCRules	Set of PCC rules related to traffic influence. Each PCC rule influences the routing of a given traffic flow. If several flows are concerned, then several PCC rules shall be handled by the SMF. Traffic influence policies are originated by an AF. PCF translates these rules into PCC rules for traffic influence. The payload of a PCC rule for traffic influence is defined in Table 6.2.3-1E.	C
ePSPDNConnectionEstablishment	Provides details about PDN Connections when the SMFMAPDUSessionEstablishment xIRI message is used to report PDN Connection establishment. See Table 6.3.3-1 and clause 6.3.3.2.2.	C
NOTE: At least one of the SUPI, PEI or GPSI fields shall be present.		

Table 6.2.3-5B: Contents of Access Info parameter

Field name	Description	M/C/O
accessType	Access type associated with the session (i.e. 3GPP or non-3GPP access) as provided by the AMF (see TS 24.501 [13] clause 9.11.2.1A).	M
rATType	RAT Type associated with the access as provided by the AMF as part of session establishment (see TS 23.502 [4] clause 4.3.2). Values given as per TS 29.571 [17] clause 5.4.3.2.	C
gTPTunnelID	Contains the F-TEID identifying the GTP tunnel used to encapsulate the traffic, as defined in TS 29.244 [15] clause 8.2.3. Non-GTP encapsulation is for further study.	M
non3GPPAccessEndpoint	UE's local IP address used to reach the N3IWF, TNGF or TWIF, if available. IP addresses are given as 4 octets (for IPv4) or 16 octets (for IPv6) with the most significant octet first (network byte order).	C
establishmentStatus	Indicates whether the access type is established or released.	M
aNTypeToReactivate	Indicates the Access Network Type for which the UP connection is requested to be re-activated, for an MA PDU session. Applicable to session modification reporting.	C
gTPTunnelInfo	Contains the information for the User Plane GTP Tunnels for the PDU Session (see TS 29.502 [16] clauses 6.1.6.2.2, 6.1.6.2.9 and 6.1.6.2.39). See Table 6.2.3-1B.	M

6.2.3.2.7.3 MA PDU session modification

The IRI-POI in the SMF shall generate an xIRI containing an SMFMAPDUSessionModification record when the IRI-POI present in the SMF detects that an MA PDU session has been modified for the target UE. The IRI-POI present in the SMF shall generate the xIRI for the following events:

- For a non-roaming scenario, the SMF (or for a roaming scenario, V-SMF in the VPLMN), receives the N1 NAS message (via AMF) PDU SESSION MODIFICATION COMPLETE from the UE and the 5GSM state within the SMF is returned to PDU SESSION ACTIVE (see TS 24.501 [13]). This applies to the following cases for an MA-Upgrade-Allowed PDU session:
 - UE initiated MA PDU session modification.
 - Network initiated MA PDU session modification.
- For a non-roaming scenario, the SMF (or for a roaming scenario, V-SMF in the VPLMN), receives the N1 NAS message (via AMF) PDU SESSION RELEASE COMPLETE from the UE in response to a PDU SESSION RELEASE COMMAND message containing an Access type IE identifying a single access to be released of an MA PDU session which was established over both accesses and the 5GSM state within the SMF remains in the PDU SESSION ACTIVE (see TS 24.501 [13]). This applies to the following case:
 - A single access type is released from an MA PDU session, but the MA PDU session continues.
- For a non-roaming scenario, the SMF (or for a roaming scenario, V-SMF in the VPLMN), sends the N1 NAS message (via AMF) PDU SESSION ESTABLISHMENT ACCEPT to the UE and the 5GSM state within the SMF remains in the PDU SESSION ACTIVE (see TS 24.501 [13]). This applies to the following cases:

- Handover from one access type to another access type happens (e.g. 3GPP to non-3GPP) for an MA-Upgrade-Allowed MA PDU session.
- MA PDU Session establishment over second access type.
- For a home-routed roaming scenario, the SMF in the HPLMN (i.e. H-SMF) receives the N16: Nsmf_PDU_Session_Update Response message with n1SmInfoFromUe IE containing the PDU SESSION MODIFICATION COMPLETE (see TS 29.502 [16]). This applies to the following cases for an MA-Upgrade-Allowed PDU session:
 - UE initiated MA PDU session modification.
 - Network (VPLMN) initiated MA PDU session modification.
 - Network (HPLMN) initiated MA PDU session modification.
- For a non-roaming scenario, SMF sends a Nsmf_EventExposure_Notify request to the NEF or AF for the target UE for the event "UP Path Change" related to a corresponding subscription from AF (see TS 29.508 [90] clause 4.2.2).
- For a non-roaming scenario, SMF sends a Nsmf_EventExposure_AppRelocationInfo response to the NEF or AF for the target UE in response to Nsmf_EventExposure_AppRelocationInfo request sent by NEF or AF to SMF (see TS 29.508 [90] clause 4.2.5).
- For a non-roaming scenario, SMF receives a Nnef_PFDManagement_Fetch response from the NEF for the target UE in response to Nnef_PFDManagement_Fetch request sent by SMF to NEF (see TS 29.551 [94] clause 4.2.2).
- For a home-routed roaming scenario, the SMF in the HPLMN (i.e. H-SMF) receives the N16: Nsmf_PDU_Session_Update Response message with n1SmInfoFromUe IE containing the PDU SESSION RELEASE COMPLETE message, a response to a PDU SESSION RELEASE COMMAND message containing an Access type IE identifying a single access to be released of an MA PDU session which was established over both accesses and the 5GSM state within the SMF remains in the PDU SESSION ACTIVE (see TS 29.502 [16]). This applies to the following cases:
 - A single access type is released from an MA PDU session, but the MA PDU session continues.
- For a home-routed roaming scenario, the SMF in the HPLMN (i.e. H-SMF) sends the N16: Nsmf_PDU_Session_Create Response message with n1SmInfoToUe IE containing the PDU SESSION ESTABLISHMENT ACCEPT (see TS 29.502 [16]) while it had received an N16 Nsmf_PDU_Session_Create request message with an existing PDU Session Id with access type being changed. This applies to the following cases:
 - Handover from one access type to another access type happens (e.g. 3GPP to non-3GPP) for an MA-Upgrade-Allowed PDU session. In this case, the V-SMF is used for the PDU session on the new access type only.
 - MA PDU Session establishment over second access type.
- For a home-routed roaming scenario, the SMF in the HPLMN (i.e. H-SMF) sends the N16: Nsmf_PDU_Session_Update Response message with n1SmInfoToUe IE containing the PDU SESSION ESTABLISHMENT ACCEPT (see TS 29.502 [16]) while it had received a N16 Nsmf_PDU_Session_Update Request message with an existing PDU Session Id with access type being changed. This applies to the following cases:
 - Handover from one access type to another access type happens (e.g. 3GPP to non-3GPP) where the same V-SMF is used for the PDU session on both access types.
 - MA PDU Session establishment over second access type.

For a non-roaming scenario, SMF sends a Npcf_SMPolicyControlUpdateNotify response to the PCF for the target UE in response to an Npcf_SMPolicyControlUpdateNotify request sent by PCF to SMF including PCC rules which traffic control policy data contains either a routeToLocs IE or trafficSteeringPolIdDI IE and/or trafficSteeringPolIdUI IE. These PCC rules correspond to policies that influence the target UE's traffic flows (see TS 29.513 [88] clause 5.5.3).

Table 6.2.3-5C: Payload for SMFMAPDUSessionModification record

Field name	Description	M/C/O
sUPI	SUPI associated with the PDU session (e.g. as provided by the AMF in the associated Nsmf_PDU_Session_CreateSMContext service operation). Shall be present except for PEI-only unauthenticated emergency sessions.	C
sUPIUnauthenticated	Shall be present if a SUPI is present in the message, and set to "true" if the SUPI was not authenticated, or "false" if it has been authenticated.	C
pEI	PEI associated with the PDU session if available.	C
gPSI	GPSI associated with the PDU session if available.	C
pDUSessionID	PDU Session ID, see TS 24.501 [13] clause 9.4.	M
accessInfo	Identifies the access(es) associated with the PDU session including the information for each specific access (see table 6.2.3-5B) being modified.	C
sNSSAI	Slice identifier associated with the PDU session, if available. See TS 23.003 [19] clause 28.4.2 and TS 23.501 [2] clause 5.15.2.	C
location	Location information provided by the AMF or present in the context at the SMF, if available.	C
requestType	For both a UE- as well as a network-requested PDU session, the POI (SMF) shall set the request type parameter to "modification request".	C
servingNetwork	PLMN ID of the serving core network operator, and, for a Non-Public Network (NPN), the NID that together with the PLMN ID identifies the NPN.	M
oldPDUSessionID	The old PDU Session ID received from the UE. See TS 23.502 [4] clauses 4.3.2.2.1 and 4.3.5.2 and TS 24.501 [13] clause 6.4.1.2. Shall be present if this IE is in the SMContextCreateData or PDUSessionCreateData message sent to the SMF or the PDU Session Context or SM Context at the SMF (see TS 29.502 [16] clauses 6.1.6.2.2, 6.1.6.2.9 and 6.1.6.2.39).	C
mAUpgradeIndication	Indicates whether the PDU session is allowed to be upgraded to MA PDU session (see TS 23.502 [4] clause 4.22.3). Include if known.	C
ePSPDNCnxInfo	Indicates if the PDU session may be moved to EPS during its lifetime (see TS 29.502 [16] clause 6.1.6.2.31). Include if known.	C
MAAcceptedIndication	Indicates that a request to establish an MA PDU session was accepted or if a single access PDU session request was upgraded into a MA PDU session (see clauses 4.22.2 and 4.22.3 of TS 23.502 [4]). It shall be set as follows: - true: MA-Confirmed MA PDU session was established - false: single access MA-Upgrade-Allowed MA PDU session was established that may be upgraded to an MA-Confirmed MA PDU session.	M
aTSSSSContainer	Identifies the steering, switching, and splitting features for the MA-Confirmed MA PDU session. Also indicates whether MPTCP or ATSSS-LL is to be used for ATSSS. See clause 9.11.4.22 of TS 24.501 [13].	C
uEEPSPDNConnection	This IE shall be present, if available, during an EPS to 5GS Idle mode mobility or handover using the N26 interface. If present, it shall contain the EPS bearer context(s) information present in the uEEPSPDNConnection parameter of the intercepted SmContextCreateData message (see TS 29.502 [16] clause 6.1.6.2.2).	C
ePS5GSCombInfo	Provides detailed information about PDN Connections and PDU Sessions during EPS to 5GS idle mode mobility or handover using the N26 interface. Shall be included if the AMF has selected a SMF+PGW-C to serve the PDU session. This parameter shall include the additional IEs in Table 6.2.3-1A, if present.	C
handoverState	Indicates whether the PDU Session Establishment being reported was due to a handover. Shall be present if this IE is in the SMContextCreatedData sent by the SMF (see TS 29.502 [16] clause 6.1.6.2.3).	C
pCCRules	Set of PCC rules related to traffic influence. Each PCC rule influences the routing of a given traffic flow. If several flows are concerned, then several PCC rules shall be handled by the SMF. Traffic influence policies are originated by an AF. PCF translates these rules into PCC rules for traffic influence. The payload of a PCC rule for traffic influence is defined in Table 6.2.3-1E.	C
uPPathChange	Notification of the UPPathChange event, if available. This IE is defined in TS 29.508 [90], Table 5.6.2.5-1.	C
pFDDataForApp	Represents the packet flow descriptions (PFDs) for an application identifier (Appld), if available. This IE is defined in TS 29.551 [94], Table 5.6.2.2-1.	C
ePSPDNConnectionModification	Provides details about PDN Connections when the SMFMAPDUSessionModification xIRI message is used to report PDN Connection Establishment or Modification. See Table 6.3.3-8 and clause 6.3.3.2.3.	C

6.2.3.2.7.4 MA PDU session release

The IRI-POI in the SMF shall generate an xIRI containing an SMFMAPDUSessionRelease record when the IRI-POI present in the SMF detects that an MA PDU session has been released. The IRI-POI present in the SMF shall generate the xIRI for the following events:

- For a non-roaming scenario, the SMF (or for a roaming scenario, V-SMF in the VPLMN), receives the N1 NAS message (via AMF) PDU SESSION RELEASE COMPLETE from the UE and the 5GSM state within the SMF is changed to PDU SESSION INACTIVE (see TS 24.501 [13]) for a PDU session that is either MA-Confirmed or MA-Upgrade-Allowed. This applies to the following two cases:
 - UE initiated MA PDU session release.
 - Network initiated MA PDU session release.
- For a roaming scenario, V-SMF in the VPLMN receives the N1 NAS message (via AMF) PDU SESSION RELEASE COMPLETE from the UE and the 5GSM state within the V-SMF is changed to PDU SESSION INACTIVE (see TS 24.501 [13]) for a PDU session that is either MA-Confirmed or MA-Upgrade-Allowed. This applies to the following two cases:
 - UE initiated PDU session release of a single access for an MA PDU session; (VPLMN considers MA PDU session fully released while HPLMN considers MA PDU session active).
 - Network initiated PDU session release of a single access for an MA PDU session; (VPLMN considers MA PDU session fully released while HPLMN considers MA PDU session active).
- For a non-roaming scenario, the SMF (or for a roaming scenario, V-SMF in the VPLMN), receives the N1 NAS message (via AMF) STATUS from the UE with the cause values listed in TS 24.501 [13], clause 6.5.3 and the 5GSM state within the SMF is changed to PDU SESSION INACTIVE for a PDU session that is either MA-Confirmed or MA-Upgrade-Allowed. One of the cases where this applies is of UE finding that the PDU session ID received in a PDU SESSION MODIFICATION COMMAND is invalid.
- For a non-roaming scenario, the SMF (or for a roaming scenario, the V-SMF in the VPLMN) sends the Nsmf_PDUSession_ReleaseSMContext Response to the AMF (see TS 29.502 [16], clause 5.2.2.4) for a PDU session that is either MA-Confirmed or MA-Upgrade-Allowed. This applies to the case where the MA PDU session is released without any N1 or N2 messages (e.g. AMF initiates the PDU session release when it finds that the PDU session is no longer associated with the UE, see TS 23.502 [4], clause 4.2.2.4).
- For a non-roaming scenario, the SMF (or for a roaming scenarios, V-SMF in the VPLMN) sends Nsmf_PDUSession_SMContextStatusNotify (see TS 29.502 [16], clause 6.1.6.2.8) with RELEASED in the ResourceStatus IE (see TS 29.502 [16], clause 6.1.6.3.1) to the AMF for a PDU session that is either MA-Confirmed or MA-Upgrade-Allowed. This applies to the case where MA PDU session release is neither initiated by a NAS message nor by Nsmf_PDUSessionReleaseContext Request message (see TS 29.502 [16], clause 5.2.2.5).
- For a home-routed roaming scenario, the SMF in the HPLMN (i.e. H-SMF) receives the N16: Nsmf_PDU_Session_Update response message with n1SmInfoFromUe IE containing the PDU SESSION RELEASE COMPLETE (see TS 29.502 [16]) from the V-SMF. This applies to the following three cases for an MA PDU session that is either MA-Confirmed or MA-Upgrade-Allowed:
 - UE initiated PDU session release.
 - Network (VPLMN) initiated PDU session release.
 - Network (HPLMN) initiated PDU session release.
- For a roaming scenario, H-SMF in the HPLMN sends the Nsmf_PDUSession_Release Response to the V-SMF (see TS 29.502 [16], clause 5.2.2.9) for a PDU session that is either MA-Confirmed or MA-Upgrade-Allowed. This applies to the case where the MA PDU session is released without any N1 or N2 messages (e.g. AMF in the VPLMN initiates the PDU session release when it finds that the PDU session is no longer associated with the UE, see TS 23.502 [4], clause 4.3.4.3).
- For a roaming scenario, H-SMF in the HPLMN Nsmf_PDUSession_StatusNotify (see TS 29.502 [16], clause 6.1.6.2.17) with RELEASED in the ResourceStatus IE (see TS 29.502 [16], clause 6.1.6.3.1) to the V-SMF for a PDU session that is either MA-Confirmed or MA-Upgrade-Allowed. This applies to the case where MA PDU

session release is neither initiated by a NAS message nor by Nsmf_PDUSessionRelease Request message (see TS 29.502 [16], clause 5.2.2.9).

Table 6.2.3-5D: Payload for SMFMAPDUSessionRelease record

Field name	Description	M/C/O
sUPI	SUPI associated with the PDU session.	M
pEI	PEI associated with the PDU session if available.	C
gPSI	GPSI associated with the PDU session if available.	C
pDUSessionID	PDU Session ID as assigned by the AMF.	M
timeOfFirstPacket	Time of first packet for the PDU session.	C
timeOfLastPacket	Time of last packet for the PDU session.	C
uplinkVolume	Number of uplink octets for the PDU session.	C
downlinkVolume	Number of downlink octets for the PDU session.	C
location	Location information, if available.	C
cause	Indicates the NF Service Consumer cause for the requested PDU session release (see TS 29.502 [16] clause 6.1.6.3.8 for enumerated cause information). Include if known.	C
nGAPCause	Indicates the NGAP cause for the requested SM context release (see TS 29.502 [16] clause 6.1.6.2.6). Shall be derived as described in TS 29.571 [17] clause 5.4.4.12.	C
fiveGMMCause	Indicates the 5GMM cause for a PDU Session released due to any 5GMM failure (see 29.502 [16] clause 6.1.6.2.6). Shall be sent as an integer derived as described in TS 29.571 [17] clause 5.4.2.	C
pCCRulesIDs	PCC rule IDs of the PCC rules related to traffic influence that are associated to the PDU session and active at the time the PDU session is released.	C
ePSPDNConnectionRelease	Provides details about PDN Connections when the SMFMAPDUSessionRelease xIRI message is used to report PDN Connection Release. See Table 6.3.3-13 and clause 6.3.3.2.4.	C

6.2.3.2.7.5 Start of interception with an established MA PDU session

The IRI-POI in the SMF shall generate an xIRI containing an SMFStartOfInterceptionWithEstablishedMAPDUSession record when the IRI-POI present in the SMF detects that a MA PDU session has already been established for the target UE when interception starts.

In a non-roaming scenario, the IRI-POI in the SMF (or in a roaming scenario, the IRI-POI in the V-SMF in the VPLMN) shall generate the xIRI containing the SMFStartOfInterceptionWithEstablishedMAPDUSession record when it detects that a new interception for a UE is activated (i.e. provisioned by the LIPF) for the following case for an MA PDU session that is either MA-Confirmed or MA-Upgrade-Allowed:

- The 5GSM state within the SMF for that UE is 5GSM: PDU SESSION ACTIVE or PDU SESSION MODIFICATION PENDING.

NOTE: The above trigger happens when the SMF (V-SMF in VPLMN) had not sent an N1 NAS message PDU SESSION RELEASE COMMAND to the UE to release the entire MA PDU session and the SMF (V-SMF in the VPLMN) had previously sent an N1 NAS message PDU SESSION ESTABLISHMENT ACCEPT to that UE for the same MA PDU session.

In a home-routed roaming scenario, the IRI-POI in the H-SMF shall generate the xIRI containing the SMFStartOfInterceptionWithEstablishedMAPDUSession record when it detects that a new interception for a UE is activated (i.e. provisioned by the LIPF) for the following case for an MA PDU session that is either MA-Confirmed or MA-Upgrade-Allowed:

- The H-SMF had not sent an Nsmf_PDU_Session_Update Request (n1SmInfoToUe: PDU SESSION RELEASE COMMAND to release the entire MA PDU session) to the V-SMF for a PDU session and H-SMF had previously sent an Nsmf_PDU_Session_Create response (n1SmInfoToUE: PDU SESSION ESTABLISHMENT ACCEPT) to the V-SMF for that PDU session.

The IRI-POI in the SMF shall generate the xIRI containing the SMFStartOfInterceptionWithEstablishedMAPDUSession record for each of the MA PDU sessions (that meets the above criteria) associated with the newly identified target UEs.

The IRI-POI present in the SMF generating an xIRI containing a SMFStartOfInterceptionWithEstablishedMAPDUSession record shall set the Payload Direction field in the PDU header to not applicable (Direction Value 5, see ETSI TS 103 221-2 [8] clause 5.2.6).

Table 6.2.3-5E: Payload for SMFStartOfInterceptionWithEstablishedMAPDUSession record

Field name	Description	M/C/O
sUPI	SUPI associated with the PDU session (e.g. as provided by the AMF in the associated Nsmf_PDU_Session_CreateSMContext service operation). Shall be present except for PEI-only unauthenticated emergency sessions.	C
sUPIUnauthenticated	Shall be present if a SUPI is present in the message and set to "true" if the SUPI has not been authenticated, or "false" if it has been authenticated.	C
pEI	PEI associated with the PDU session if available.	C
gPSI	GPSI associated with the PDU session if available.	C
pDUSessionID	PDU Session ID as assigned by the AMF, as defined in TS 24.007 [14] clause 11.2.3.1b.	M
pDUSessionType	Identifies selected PDU session type, see TS 24.501 [13] clause 9.11.4.11.	M
accessInfo	Identifies the access(es) associated with the PDU session including the information for each specific access (see table 6.2.3-5B).	M
sNSSAI	Slice identifier associated with the PDU session, if available. See TS 23.003 [19] clause 28.4.2 and TS 23.501 [2] clause 5.15.2.	C
uEEndpoint	UE endpoint address(es) if available. IP addresses are given as 4 octets (for IPv4) or 16 octets (for IPv6) with the most significant octet first (network byte order). MAC addresses are given as 6 octets with the most significant octet first (see TS 29.244 [15] clause 5.21).	C
location	Location information provided by the AMF at session establishment or present in the context at the SMF, if available.	C
dNN	Data Network Name associated with the target traffic, as defined in TS 23.003 [19] clause 9A and described in TS 23.502 [4] clause 4.3.2.2. Shall be given in dotted-label presentation format as described in TS 23.003 [19] clause 9.1.	M
aMFID	Identifier of the AMF associated with the target UE, as defined in TS 23.003 [19] clause 2.10.1, if available.	C
hSMFURI	URI of the Nsmf_PDU_Session service of the selected H-SMF, if available. See TS 29.502 [16] clause 6.1.6.2.2.	C
requestType	Type of request as initially set within PDU SESSION ESTABLISHMENT as described in TS 24.501 [13] clause 9.11.3.47. If the initial value is no longer available the request type shall be set to "existing PDU session".	C
sMPDUDNRequest	Contents of the SM PDU DN request container, if available, as described in TS 24.501 [13] clause 9.11.4.15.	C
servingNetwork	PLMN ID of the serving core network operator, and, for a Non-Public Network (NPN), the NID that together with the PLMN ID identifies the NPN.	M
oldPDUSessionID	The old PDU Session ID received from the UE. See TS 23.502 [4] clauses 4.3.2.2.1 and 4.3.5.2 and TS 24.501 [13] clause 6.4.1.2. Include if known.	C
maUpgradeIndication	Indicates whether the PDU session is allowed to be upgraded to MA PDU session (see TS 23.502 [4] clause 4.22.3). Include if known.	C
ePSPDNCnxInfo	Indicates if the PDU session may be moved to EPS during its lifetime (see TS 29.502 [16] clause 6.1.6.2.31). Include if known.	C
maAcceptedIndication	Indicates that a request to establish an MA PDU session was accepted or if a single access PDU session request was upgraded into an MA PDU session (see TS 23.502 [4] clauses 4.22.2 and 4.22.3). It shall be set as follows: - true: MA-Confirmed MA PDU session was established. - false: single access MA-Upgrade-Allowed MA PDU session was established that may be upgraded to an MA-Confirmed MA PDU session.	M
aTSSSContainer	Identifies the steering, switching, and splitting features for the MA-Confirmed MA PDU session. Also indicates whether MPTCP or ATSSS-LL is to be used for ATSSS. See TS 24.501 [13] clause 9.11.4.22.	C
ePS5GSComboInfo	Provides detailed information about PDN Connections and PDU Sessions during EPS to 5GS idle mode mobility or handover using the N26 interface. Shall be included when the AMF has selected a SMF+PGW-C to serve the PDU session. This parameter may include the additional IEs in table 6.2.3-1A, if available.	C
uEEPSPDNConnection	This IE shall be present, if available, during an EPS to 5GS Idle mode mobility or handover using the N26 interface. If present, it shall contain the EPS bearer context(s) information present in the uEEPSPDNConnection parameter of the intercepted SmContextCreateData message. (see TS 29.502 [16] clause 6.1.6.2.2).	C
pCCRules	Set of PCC rules related to traffic influence. Each PCC rule influences the routing of a given traffic flow. If several flows are concerned, then several PCC rules shall be handled by the SMF. Traffic influence policies are originated by an AF. PCF translates these rules into PCC rules for traffic influence. The payload of a PCC rule for traffic influence is defined in Table 6.2.3-1E.	C

pFDDDataForApps	Represents a set of associations between application identifier and packet flow descriptions (PFDs), if available.	C
ePSSStartOfInterceptionWithEstablishedPDNConnection	Provides details about PDN Connections when the SMFStartOfInterceptionWithEstablishedMAPDUSession xIRI message is used to report the start of interception on a target who already has existing PDN Connections. See Table 6.3.3-14 and clause 6.3.3.2.5.	C

6.2.3.2.7.6 SMF MA unsuccessful procedure

The IRI-POI in the SMF shall generate an xIRI containing an SMFMAUnsuccessfulProcedure record when the IRI-POI present in the SMF detects an unsuccessful procedure or error condition for a UE matching one of the target identifiers provided via LI_X1.

Accordingly, the IRI-POI in the SMF generates the xIRI when one of the following events are detected:

- SMF sends a PDU SESSION ESTABLISHMENT REJECT message to the target UE for MA-Confirmed and MA-Upgrade-Allowed MA PDU sessions.
- SMF sends a PDU SESSION MODIFICATION REJECT message to the target UE for MA-Confirmed and MA-Upgrade-Allowed MA PDU sessions.
- SMF sends a PDU SESSION RELEASE REJECT message to the target UE for MA-Confirmed and MA-Upgrade-Allowed MA PDU sessions.
- SMF receives a PDU SESSION MODIFICATION COMMAND REJECT message from the target UE for MA-Confirmed and MA-Upgrade-Allowed MA PDU sessions.
- An ongoing SM procedure is aborted at the SMF, due to e.g. a 5GSM STATUS message sent from or received by the SMF for MA-Confirmed and MA-Upgrade-Allowed MA PDU sessions.

Table 6.2.3-5F: Payload for SMFMAUnsuccessfulProcedure record

Field name	Description	M/C/O
failedProcedureType	Specifies the procedure which failed or is aborted at the SMF.	M
failureCause	Provides the value of the 5GSM cause, see TS 24.501 [13], clause 9.11.4.2. In case the procedure is aborted due to a 5GSM STATUS message, the 5GSM cause is the one included in the 5GSM status message.	M
requestedSlice	Slice requested for the procedure, if available, given as a NSSAI (a list of S-NSSAI values as described in TS 24.501 [13] clause 9.11.3.37).	C
initiator	Specifies whether the network (SMF) or the UE is initiating the rejection or indicating the failure.	M
sUPI	SUPI associated with the procedure, if available (see NOTE).	C
sUPIUnauthenticated	Shall be present if a SUPI is present in the message and set to "true" if the SUPI has not been authenticated, or "false" if it has been authenticated.	C
pEI	PEI used in the procedure, if available (see NOTE).	C
gPSI	GPSI used in the procedure, if available (see NOTE).	C
pDUSessionID	PDU Session ID, see TS 24.501 [13] clause 9.4, if available.	C
accessInfo	Identifies the access(es) associated with the PDU session including the information for each specific access (see table 6.2.3-5B).	M
uEEndpoint	UE endpoint address(es) if available.	C
location	Location information provided by the AMF or present in the context at the SMF, if available.	C
dNN	Data Network Name associated with the target traffic, as defined in TS 23.003 [19] clause 9A and described in TS 23.501 [2] clause 4.3.2.2, if available. Shall be given in dotted-label presentation format as described in TS 23.003 [19] clause 9.1.	C
aMFID	Identifier of the AMF associated with the target UE, as defined in TS 23.003 [19] clause 2.10.1 when available.	C
hSMFURI	URI of the Nsmf_PDUSession service of the selected H-SMF, if available. See TS 29.502 [16] clause 6.1.6.2.2.	C
requestType	Type of request as described in TS 24.501 [13] clause 9.11.3.47, if available. Otherwise depending on the REJECT event the following request type shall be reported: PDU SESSION ESTABLISHMENT REJECT: The request type shall be set to the one reported within the PDU SESSION ESTABLISHMENT or if there hasn't been one reported it should be set to "MA PDU request". PDU SESSION MODIFICATION REJECT: "modification request". PDU SESSION RELEASE REJECT: no request type shall be set. PDU SESSION MODIFICATION COMMAND REJECT: "modification request".	C
sMPDUDNRequest	Contents of the SM PDU DN Request container, if available, as described in TS 24.501 [13] clause 9.11.4.15.	C
NOTE: At least one identity shall be provided, the others shall be provided if available.		

6.2.3.2.8 PDU to MA PDU session modification

The IRI-POI in the SMF shall generate an xIRI containing an SMFPDUtoMAPDUSessionModification record when the IRI-POI present in the SMF detects that an existing PDU session for the target UE has been successfully modified to an MA PDU session using the PDU session modification procedures as described in TS 24.501 [13]. A PDU session is considered to be successfully modified to a MA PDU session, when all of the following are true:

1. The UE is registered to both 3GPP access and non-3GPP access:
 - In the same PLMN (non-roaming UE).
 - In the different PLMNs (roaming UE).
2. SMF receives the PDU SESSION MODIFICATION REQUEST from the UE (TS 24.501 [13] clause 8.2.10) that includes one of the following:
 - *modification request* and includes MA PDU session information IE set to *MA PDU session network upgrade allowed*.
 - *MA PDU request*.

3. SMF sends a PDU SESSION MODIFICATION COMMAND to the UE that includes the ATSSS IE (TS 24.501 [13] clause 6.4.2.3).
4. SMF receives the PDU SESSION MODIFICATION COMPLETE from the UE (TS 24.501 [13] clause 8.3.10.1).
5. The 5GSM state within the SMF is PDU Session Active.

Once the SMF PDUtoMAPDUSessionModification record has been generated by the IRI-POI in the SMF, the IRI-POI shall follow clause 6.2.3.2.7 of the present document for further reporting for this MA PDU session.

Table 6.2.3-5G: Payload for SMF PDUtoMAPDUSessionModification record

Field name	Description	M/C/O
sUPI	SUPI associated with the PDU session (e.g. as provided by the AMF in the associated Nsmf_PDU_Session_CreateSMContext service operation). Shall be present except for PEI-only unauthenticated emergency sessions.	C
sUPIUnauthenticated	Shall be present if a SUPI is present in the message and set to <i>true</i> if the SUPI was not authenticated, or <i>false</i> if it has been authenticated.	C
pEI	PEI associated with the PDU session if available.	C
gPSI	GPSI associated with the PDU session if available.	C
sNSSAI	Slice identifier associated with the PDU session, if available. See TS 23.003 [19] clause 28.4.2 and TS 23.501 [2] clause 5.15.2.	C
non3GPPAccessEndpoint	UE's local IP address used to reach the N3IWF, TNGF or TWIF, if available. IP addresses are given as 4 octets (for IPv4) or 16 octets (for IPv6) with the most significant octet first (network byte order).	C
location	Location information provided by the AMF or present in the context at the SMF, if available.	C
requestType	In accordance with the request type as described in TS 24.501 [13] clause 6.4.2.2 and clause 9.11.3.47 a request type of "modification request" shall be reported.	M
accessType	Access type associated with the session (i.e. 3GPP or non-3GPP access) if provided by the AMF (see TS 24.501 [13] clause 9.11.2.1A).	C
rATType	RAT type associated with the access, if available. Values given as per TS 29.571 [17] clause 5.4.3.2.	C
pDUSessionID	PDU Session ID, see TS 24.501 [13] clause 9.4.	M
requestIndication	Indicates the request type for PDU session modification as indicated by the requestIndication sent in the PDU SESSION MODIFICATION REQUEST (see TS 29.502 [16] clause 6.1.6.3.6).	M
aTSSSContainer	Identifies the steering, switching, and splitting features for the MA-Confirmed MA PDU session. Also indicates whether MPTCP or ATSSS-LL is to be used for ATSSS. See TS 24.501 [13] clause 9.11.4.22.	M
uEEndpoint	UE IP address(es) assigned to the PDU Session if available (See TS 29.244 [15] clause 5.21).	C
servingNetwork	Shall be present if this IE is in the SMContextUpdateData, HsmfUpdateData or message sent to the SMF or the PDU Session Context or SM Context at the SMF (see TS 29.502 [16] clauses 6.1.6.2.3, 6.1.6.2.11 and 6.1.6.2.39).	C
handoverState	Indicates whether the PDU Session Modification being reported was due to a handover. Shall be present if this IE is in the SMContextUpdatedData or sent by the SMF (see TS 29.502 [16] clause 6.1.6.2.3).	C
gTPTunnelInfo	Contains the information for the User Plane GTP Tunnels for the PDU Session (see TS 29.502 [16] clauses 6.1.6.2.2, 6.1.6.2.9 and 6.1.6.2.39). See Table 6.2.3-1B.	M
ePSPDNConnectionModification	Provides details about PDN Connections when the SMF PDUtoMAPDUSessionModification xIRI message is used to report PDN Connection Modification. See Table 6.3.3-8 and clause 6.3.3.2.3.	C

6.2.3.3 Triggering of the CC-POI from CC-TF over LI_T3

6.2.3.3.1 LI_T3 interface specifics

When interception of communication contents is authorised or the delivery of packet header information is authorised and approach 2 described in clause 6.2.3.5 is used, the CC-TF present in the SMF sends a trigger to the CC-POI present in the UPF over the LI_T3 interface.

When the CC-TF in the SMF detects that a PDU session is being established (i.e. when the SMF sends the N4: PFCP Session Establishment Request to the UPF, see TS 29.244 [15], clause 6.3.2) for a target UE, it shall send an activation message to the CC-POI in the UPF over the LI_T3 interface. The activation message shall contain the correlation identifiers that the CC-POI in the UPF shall use with the xCC. This can be achieved by sending an ActivateTask message as defined in ETSI TS 103 221-1 [7] clause 6.2.1 with the following details.

Table 6.2.3-6: ActivateTask message for triggering the CC-POI in the UPF

ETSI TS 103 221-1 [7] field name	Description	M/C/O
XID	Allocated by the CC-TF as per ETSI TS 103 221-1 [7].	M
TargetIdentifiers	Packet detection criteria as determined by the CC-TF in the SMF, which enables the UPF to isolate target traffic. The CC-POI in the UPF shall support at least the identifier types given in table 6.2.3-7. NOTE: This value is the target identifier for the CC-POI in the UPF and may be different from the target identifier specified in the warrant.	M
DeliveryType	Set to "X3Only".	M
ListOfDIDs	Delivery endpoints for LI_X3. These delivery endpoints shall be configured by the CC-TF in the SMF using the CreateDestination message as described in ETSI TS 103 221-1 [7] clause 6.3.1 prior to first use.	M
CorrelationID	Correlation ID to assign to X3 PDUs generated by the CC-POI in the UPF. This field is populated with the same CorrelationID the IRI-POI in the SMF uses for the associated xIRI.	M
ProductID	Shall be set to the XID of the Task Object associated with the interception at the CC-TF. This value shall be used by the CC-POI in the UPF to fill the XID of X3 PDUs.	M

The CC-TF in the SMF shall not send the ListOfServiceTypes parameter of the ActivateTask message to the CC-POI in the UPF.

Table 6.2.3-7: Target Identifier Types for LI_T3

Identifier type	Owner	ETSI TS 103 221-1 [7] TargetIdentifier type	Definition
GTP Tunnel ID	3GPP	gtpuTunnelId	F-TEID (see XSD schema)
UE IP Address	ETSI	IPv4Address or IPv6Address	See ETSI TS 103 221-1 [7]
UE TCP/UDP Port	ETSI	TCPPort or UDPPort	See ETSI TS 103 221-1 [7]
PFCP Session ID	3GPP	TargetIdentifierExtension / FSEID	F-SEID (see XSD schema)
PDR ID	3GPP	TargetIdentifierExtension / PDRID	32 bit unsigned integer (see XSD schema)
QER ID	3GPP	TargetIdentifierExtension / QERID	32 bit unsigned integer (see XSD schema)
Network Instance	3GPP	TargetIdentifierExtension / NetworkInstance	Octet string (see XSD schema)
GTP Tunnel Direction	3GPP	TargetIdentifierExtension / GTPTunnelDirection	Enumeration (see XSD schema)

When the CC-TF in the SMF detects that a targeted PDU session is changing (i.e. when the SMF sends the N4: PFCF Session Modification Request to the UPF, see TS 29.244 [15], clause 6.3.3) in a way that requires changes to the interception already activated by the CC-POI in the UPF, the CC-TF shall modify the interception at the CC-POI in the UPF over the LI_T3 interface. This is achieved by sending a ModifyTask message as defined in ETSI TS 103 221-1 [7] clause 6.2.2. The ModifyTask message contains the same details as the ActivateTask message with the following fields updated as appropriate.

Table 6.2.3-8: Parameters that may be changed in a ModifyTask message when updating interception at the CC-POI in the UPF

ETSI TS 103 221-1 [7] field name	Description	M/C/O
TargetIdentifiers	Updated packet detection criteria as determined by the CC-TF in the SMF. NOTE: See notes on TargetIdentifiers in table 6.2.3-6.	M

When the CC-TF in the SMF detects that a targeted PDU session is changing (i.e. when the SMF sends the N4: PFCF Session Modification Request to the UPF, see TS 29.244 [15], clause 6.3.3) for which the interception had not been previously activated in the CC-POI in the UPF (e.g. in case of previous unsuccessful LI activation at the CC-POI in the UPF by the CC-TF in the SMF), the CC-TF shall send an activation message to the CC-POI in the UPF over the LI_T3 interface. The activation message shall contain the correlation identifiers that the CC-POI in the UPF shall use with the xCC. This can be achieved by sending an ActivateTask message as defined in ETSI TS 103 221-1 [7] clause 6.2.1 with the details provided by Table 6.2.3-6.

When the CC-TF in the SMF detects that the PDU session has been released (i.e. when the SMF sends the N4: PFCF Session Deletion Request to the UPF, see TS 29.244 [15], clause 6.3.4) for a target UE, it shall send a deactivation message to the CC-POI in the UPF over the LI_T3 interface. When using ETSI TS 103 221-1 [7] this is achieved by sending a DeactivateTask message with the XID field set to the XID associated with the interception, as described in ETSI TS 103 221-1 [7] clause 6.2.3.

By default, interception shall occur at the anchor UPF as described in clause 6.2.3.3.3.

When a warrant that includes the service scoping of CC is activated for a target UE with an established PDU session and when the IRI-POI present in the SMF generates the xIRI containing an SMFStartOfInterceptionWithEstablishedPDUSESSION record (see clause 6.2.3.2.5), the CC-TF present in the SMF shall send an activation message to the CC-POI present in the UPF to generate the xCC.

6.2.3.3.2 CC interception with multi-homed PDU session

When a target UE accesses multiple Data Networks (DNs) via a multi-homed PDU session (see TS 23.501 [2] clause 5.6.4.3), multiple UPFs are involved in providing the PDU Session Anchors, with one UPF providing the Branching Point functionality. The Branching Point UPF may, or may not, be a PDU Session Anchor UPF (see TS 33.127 [5] Annex A3.2). The CC-TF present in the SMF shall send the CC intercept trigger to the CC-POI present in an UPF if and only if that UPF is selected to provide the CC-POI functions.

When the target UE is involved in multi-homed PDU session, the CC-TF present in the SMF (i.e. in the SMF that establishes the PDU session) shall determine which UPF(s) is(are) more suitable to provide the CC-POI functions adhering to the following requirements specified in TS 33.127 [5]:

- All applicable user plane packets are captured and delivered.
- Duplicate delivery of CC is suppressed to the extent possible.

This clause assumes that a PDU session contains only one Branching Point UPF (with N3 reference point toward the target UE) and one PDU Session Anchor UPF for each DN connection.

Since the present document requires the interception of all DN connections, the SMF may choose either all the PDU Session Anchor UPFs or the Branching Point UPF to provide the CC-POI functions.

The Branching Point UPF may be chosen when all user plane packets pass through the Branching Point UPF, and the CC-TF present in the SMF may choose the Branching Point UPF to provide the CC-POI function and accordingly, send the CC interception trigger to the CC-POI present in the Branching Point UPF. The CC intercept trigger shall include the packet detection rules. An example of these rules is:

- Generate the xCC from all the incoming and outgoing user plane packets to the target UE.

In this case, the CC-TF present in the SMF shall not select any of the PDU Session Anchor UPFs to provide the CC-POI functions.

When a Branching Point UPF is chosen to provide the CC-POI functions, and if the Branching Point UPF is removed from the user plane path during a PDU session, then the CC POI functions will have to be moved to the PDU Session Anchor UPFs.

The xCC delivered to the MDF3 shall be correlated to the PDU session related xIRI. The use of Correlation Id shall be on a user-plane path basis, which means that the xCC generated at different UPFs that belong to different PDU sessions may need to have separate Correlation IDs, each correlating to their own PDU session related xIRI.

6.2.3.3.3 CC Interception only at PDU Session Anchor UPFs

An option is to intercept a copy of the packets sent and received on the N6 interface [2] side of the PDU Anchor UPF (for each UL classifier in case of selective routing or *Service and Session Continuity* mode 3) for all DNs the subject is connected to. In the in-bound roaming case for home-routed roaming, the CSP shall deliver a copy of the packets sent and received on the N9 side of the PDU Anchor UPF towards the serving network.

6.2.3.4 IRI-POI in UPF triggering over LI_T2

When interception of packet header information is authorised, if approach 1 described in clause 6.2.3.9.1 is used for packet header information reporting, the IRI-TF in the SMF shall send a trigger to the IRI-POI in the UPF over the LI_T2 interface when the IRI-TF in the SMF detects that a PDU session has been established (i.e. when the SMF sends the N4: PFCP Session Establishment Request to the UPF, see TS 29.244 [15], clause 6.3.2) for a target UE. The activation message shall contain the correlation ID that the IRI-POI in the UPF shall use when generating xIRI. This shall be achieved by sending an ActivateTask message as defined in TS 103 221-1 [7] clause 6.2.1 with the following details.

Table 6.2.3-9: ActivateTask message for triggering the UPF IRI-POI

ETSI TS 103 221-1 [7] field name	Description	M/C/O
XID	Allocated by the IRI-TF as per ETSI TS 103 221-1 [7].	M
TargetIdentifiers	Packet detection criteria as determined by the IRI-TF in the SMF, which enable the UPF IRI-POI to isolate target traffic. The IRI-POI in the UPF shall support at least the identifier types given in table 6.2.3-7. NOTE: This value is the target identifier for the IRI-POI in the UPF and may be different from the target identifier specified in the warrant.	M
DeliveryType	Set to "X2Only".	M
TaskDetailsExtensions/ HeaderReporting	Header reporting-specific tag to be carried in the <i>TaskDetailsExtensions</i> field of ETSI TS 103 221-1 [7]. See table 6.2.3.9.2-1.	M
ListOfDIDs	Delivery endpoints of LI_X2. These delivery endpoints shall be configured by the IRI-TF in the SMF using the <i>CreateDestination</i> message as described in ETSI TS 103 221-1 [7] clause 6.3.1 prior to first use.	M
CorrelationID	Correlation ID to assign for xIRI generated by the IRI-POI in the UPF. This field is populated with the same CorrelationID the IRI-POI in the SMF uses for the associated xIRI.	M
ProductID	Shall be set to the XID of the Task Object associated with the interception at the IRI-TF. This value shall be used by the IRI-POI in the UPF to fill the XID of X2 PDUs.	M

The IRI-TF in the SMF shall not send the ListOfServiceTypes parameter of the ActivateTask message to the IRI-POI in the SMF.

Table 6.2.3-10: Void

When the IRI-TF in the SMF detects that a targeted PDU session has changed (i.e. when the SMF sends the N4: PFCP Session Modification Request to the UPF, see TS 29.244 [15], clause 6.3.3) in a way which requires changes to the interception by the IRI-POI in the UPF, the IRI-TF in the SMF shall modify the interception at the IRI-POI in the UPF over the LI_T2 interface. This is achieved by sending a ModifyTask message as defined in ETSI TS 103 221-1 [7] clause 6.2.2. The ModifyTask message contains the same details as the ActivateTask message with the following fields updated as appropriate.

Table 6.2.3-11: Parameters that may be changed in a ModifyTask message when updating interception at the IRI-POI in the UPF

Field name	Description	M/C/O
TargetIdentifiers	Updated packet detection criteria as determined by the IRI-TF in the SMF. NOTE: See notes on TargetIdentifiers in table 6.2.3-6.	M

When the IRI-TF in the SMF detects that the PDU session has been released (i.e. when the SMF sends the N4: PFCP Session Deletion Request to the UPF, see TS 29.244 [15], clause 6.3.4) for a target UE, it shall send a deactivation message to the IRI-POI in the UPF over the LI_T2 interface. When using ETSI TS 103 221-1 [7] this is achieved by sending a DeactivateTask message with the XID field set to the XID associated with the interception, as described in ETSI TS 103 221-1 [7] clause 6.2.3.

When a PDU session involves multiple UPFs, the selection of UPF to provide the IRI-POI functions shall be done in the same way an UPF is selected to provide the CC-POI functions as described in clauses 6.2.3.3.2 and 6.2.3.3.3.

When interception of packet header information is authorised for a target UE, if approach 1 described in clause 6.2.3.9.1 is used for packet header information reporting, the IRI-TF present in the SMF shall send an activation message to the IRI-POI present in the UPF when the IRI-POI present in the SMF generates the xIRI containing an SMFStartOfInterceptionWithEstablishedPDUSession record to generate the packet header information reporting related xIRIs from the user plane packets of that PDU session.

6.2.3.5 Generation of xIRI at UPF over LI_X2

6.2.3.5.1 Packet data header reporting

When packet header information reporting is authorised, packet header information reports are generated either by the IRI-POI in the UPF (if approach 1 from clause 7.12.2.3 of TS 33.127 [5] is used) or by the MDF2 (if approach 2 from clause 7.12.2.3 of TS 33.127 [5] is used). Depending on the requirements of the warrant, the packet header information reports can be in per-packet form, as Packet Data Header Reports (PDHRs), or in summary form, as Packet Data Header Summary Reports (PDSRs).

6.2.3.5.2 Fragmentation

If the IRI-POI in the UPF is placed on a link which fragmented the original IP packet (see IETF RFC 791[34] for basic fragmentation rules, and IETF RFC 815 [26] for more complex re-assembly rules), a situation may occur in which only the first fragment can be sensibly reported in a PDHR, while the subsequent fragments may be missing essential fields that are mandatory, which may cause simplistic implementations to mis-report them, or omit them altogether.

In this case, the IRI-POI in the UPF shall report the first fragment of a fragmented IP packet, including the port numbers when they are included within this first fragment, using the length of the fragment to determine if the port numbers are indeed encoded within this first fragment. The subsequent fragments are reported without port information. This technique relieves the IRI-POI in the UPF from having to reassemble the original IP packet (at line speed) at the cost of accuracy of the reported fields.

6.2.3.5.3 Packet Data Header Report (PDHR)

If the per-packet form of packet header information reporting, i.e. PDHR, is authorised, the PDHeaderReport xIRI shall be generated as described in clause 6.2.3.9.3.

6.2.3.5.4 Packet Data Summary Report (PDSR)

If the summary form of the packet header information reporting, i.e. PDSR, is authorised, the PDSummaryReport xIRI shall be generated as described in clause 6.2.3.9.4.

6.2.3.6 Generation of xCC at CC-POI in the UPF over LI_X3

The CC-POI present in the UPF shall send xCC over LI_X3 for each IP packet matching the criteria specified in the Triggering message (i.e. ActivateTask message) received over LI_T3 from the CC-TF in the SMF.

NOTE: Implementers are reminded of the completeness and non-duplication requirements (see TS 33.127 [5]).

Each X3 PDU shall contain the contents of the user plane packet given using the GTP-U, IP or Ethernet payload format.

The CC-POI present in the UPF shall set the payload format to indicate the appropriate payload type (5 for IPv4 Packet, 6 for IPv6 Packet, 7 for Ethernet frame or 12 for GTP-U Packet as described in ETSI TS 103 221-2 [8] clauses 5.4 and 5.4.13.

If handover of the entire GTP-U packet is required over LI_HI3 (see clause 6.2.3.8), then consideration shall be made of the correct choice of LI_X3 payload type to ensure that the MDF3 has the necessary CC information. Support for delivery of LI_X3 as payload type 12 (GTP-U packet) is mandatory.

The CC-POI present in the UPF may use the Additional XID Related Information attributes to facilitate efficient delivery of xCC, as specified in ETSI TS 103 221-2 [8] clause 5.3.22.

6.2.3.7 Generation of IRI over LI_HI2

When an xIRI is received over LI_X2 from the IRI-POI in the SMF or the IRI-POI in the UPF, the MDF2 shall send the IRI message over LI_HI2 without undue delay. The IRI message shall contain a copy of the relevant record received from LI_X2. The record may be enriched by other information available at the MDF (e.g. additional location information).

The timestamp field of the ETSI TS 102 232-1 [9] PSHeader structure shall be set to the time at which the SMF event was observed (i.e. the timestamp field of the xIRI).

The IRI type parameter (see ETSI TS 102 232-1 [9] clause 5.2.10) shall be included and coded according to table 6.2.3-14.

Table 6.2.3-14: IRI type for IRI messages

Record type	IRI Type
SMF PDUSessionEstablishment	BEGIN
SMF PDUSessionRelease	END
SMF PDUSessionModification	CONTINUE
SMF StartOfInterceptionWithEstablishedPDUSession	BEGIN
SMF UnsuccessfulProcedure	REPORT
SMF MAPDUSessionEstablishment	BEGIN
SMF MAPDUSessionRelease	END
SMF MAPDUSessionModification	CONTINUE
SMF StartOfInterceptionWithEstablishedMAPDUSession	BEGIN
SMF MA UnsuccessfulProcedure	REPORT
SMF PDUtoMAPDUSessionModification	CONTINUE
PDHeaderReport	REPORT
PDSummaryReport	REPORT

IRI messages associated with the same PDU Session shall be assigned the same CIN (see ETSI TS 102 232-1 [9] clause 5.2.4).

The threeGPP33128DefinedIRI field (see ETSI TS 102 232-7 [10] clause 15) shall be populated with the BER-encoded IRIPayload.

When an additional warrant is activated on a target UE and the LIPF uses the same XID for the additional warrant, the MDF2 shall be able to generate and deliver the IRI message containing the SMFStartOfInterceptionWithEstablishedPDUSession record and the SMFStartOfInterceptionWithEstablishedMAPDUSession record to the LEMF associated with the additional warrant without receiving a corresponding xIRI. The payload of the SMFStartOfInterceptionWithEstablishedPDUSession record is specified in table 6.2.3-4, while the payload of the SMFStartOfInterceptionWithEstablishedMAPDUSession record is specified in table 6.2.3-9. The MDF2 shall generate and deliver the IRI message containing the SMFStartOfInterceptionWithEstablishedPDUSession record for each of the established PDU sessions to the LEMF associated with the new warrant. The MDF2 shall generate and deliver the IRI message containing the SMFStartOfInterceptionWithEstablishedMAPDUSession record for each of the established MA PDU sessions to the LEMF associated with the new warrant.

If the MDF2 did not receive from the IRI-POI the value of timeOfSessionEstablishment parameter in a previous corresponding SMFStartOfInterceptionWithEstablishedPDUSession or SMFStartOfInterceptionWithEstablishedMAPDUSession xIRI for the same session, the MDF2, when generating the SMFStartOfInterceptionWithEstablishedPDUSession or the SMFStartOfInterceptionWithEstablishedMAPDUSession IRI shall include in that parameter the time provided in the timestamp previously received in the header of the related SMFPDUSessionEstablishment or SMFMAPDUSessionEstablishment xIRI.

When the delivery of packet header information is authorised and approach 2 described in clause 6.2.3.9.1 is used, the MDF2 shall generate the IRI message and send it over LI_HI2 without undue delay when xCC is received over LI_MDF from the MDF3. The MDF2 shall generate packet header information reporting as described in clause 6.2.3.5.

6.2.3.8 Generation of CC over LI_HI3

When the xCC is received over LI_X3, the MDF3 shall emit the CC over LI_HI3 without undue delay.

The timestamp field of the ETSI TS 102 232-1 [9] PSHeader structure shall be set to the time that the UPF observed the data (i.e. the timestamp field of the xCC). The LIID and CID fields shall correctly reflect the target identity and communication session to which the CC belongs.

The MDF3 shall populate the threeGPP33128DefinedCC field (see clause 5.5.3 of the present document) with a BER-encoded CCPayload structure containing either:

1. The uPFCCPDU field containing the GTP-U packet received over LI_X3. It shall only be used if the content of the GTP-U packet is an IPv4 or IPv6 packet.
2. The extendedUPFCCPDU field as described in table 6.2.3-15.

The MDF3 shall support delivery using either option.

Table 6.2.3-15: ExtendedUPFCCPDU structure

Field name	Description	M/C/O
payload	Payload of the GTP-U packet without GTP-U encapsulation. Content shall be supplied according to table 6.2.3-16.	M
qFI	Shall be populated with the QoS Flow Identifier value from the GTP-U header extension (see TS 38.415 [41] clause 5.5.3.3) if present over LI_X3.	C

Table 6.2.3-16: UPFCCPDUPayload structure

Field name	Description
uPFIPCC	Contains an IPv4 or IPv6 packet
uPFEthernetCC	Contains an Ethernet frame
uPFUnstructuredCC	Contains an unstructured packet

6.2.3.9 Packet header information reporting

6.2.3.9.1 General

As described in TS 33.127 [5] clause 7.12.2, warrants that do not require the interception of communication contents but do require packet header information reporting will require access to the user plane packets. Packet header information reporting includes the following two IRI messages:

- Packet Data Header Reporting (PDHR) in the form of PDHeaderReport records.
- Packet Data Summary Reporting (PDSR) in the form of PDSummaryReport records.

TS 33.127 [5] clause 7.12.2 provides two approaches for the generation of such IRI messages.

In approach 1, the IRI-POI present in the UP Entity constructs and delivers the packet header information reporting related xIRIs to the MDF2 as described in clause 6.2.3.4.

In approach 2, the CC-POI present in the UP Entity intercepts, constructs and delivers the xCC to the MDF3 as described in clause 6.2.3.6. The MDF3 forwards the xCC to the MDF2 over the LI_MDF interface and the MDF2 generates the IRI messages containing the packet header information reporting related records from the xCC.

In both approaches, the payload of the PDHeaderReport and PDSummaryReport records are as described in clauses 6.2.3.9.3, 6.2.3.9.4, tables 6.2.3.9.3-1 and 6.2.3.9.4-1. Note that in approach 2, the MDF2 generates these IRI messages containing PDHeaderReport and PDSummaryReport records without receiving the equivalent xIRI from an IRI-POI. The actions of the MDF2, the MDF3, the CC-TF in the CP Entity in 5GS and CUPS EPS, and the CC-POI in non-CUPS EPS are managed as part of the intercept data provisioned to them over the LI_X1 interface.

6.2.3.9.2 Provisioning details

Table 6.2.3.9.2-1 shows the details of the HeaderReporting TaskDetailsExtension used in the LI_X1 ActivateTask message used for provisioning LI functions when packet header information reporting is authorised.

Table 6.2.3.9.2-1: PDHRReportingExtensions parameters

Field name	Description	M/C/O
pDHType	This field shall be set to either: <ul style="list-style-type: none"> - "PDHR," for packet-by-packet reporting. - "PDSR," for summarized reporting. 	M
pDSRParameters	If pDHType is PDSR, this field shall be set. See table 6.2.3.9.2-2.	C

Table 6.2.3.9.2-2: PDSRParameters

Field name	Description	M/C/O
pDSRTriggerType	This field shall be set to at least one of the following triggers: <ul style="list-style-type: none"> a) timer expiry (along with a timer value and unit). b) packet count (along with a value for the number of packets detected before a summary is to be triggered). c) byte count (along with a value for the cumulative byte size reached across all packets belonging to the summary before said summary is to be triggered). Summary reports shall not be cumulative, i.e. each summary report shall describe only the packets contained in its respective range, and each new summary shall start its count (of whichever attribute from the numbered list above applies) from zero, i.e. the information in the (n+1)'th summary report starts immediately after the end of the n'th summary report.	M
useSessionTriggers	If useSessionTriggers is present and set to true, the trigger described in the pDSRTriggerType parameter shall be applied at the session level instead of per-flow.	C

6.2.3.9.3 PDHeaderReport record

If the per-packet form of packet header information reporting, i.e. PDHR, is used, the LI function responsible for generating the xIRI extracts the information shown in table 6.2.3.9.3-1 from each packet.

Table 6.2.3.9.3-1: PDHeaderReport record

Field name	Description	M/C/O
pDUSessionID	The PDU Session ID value 255 shall be used by the sender; the receiver shall ignore the parameter (see NOTE).	M
sourceIPAddress	Shall contain the source address of the packet from the 32-bit "Source Address" field in IPv4, as defined in IETF RFC 791 [34], or from the 128-bit "Source Address" field in IPv6, as defined in IETF RFC 2460 [27].	M
sourcePort	Shall contain the "Source Port" number that indicates an application or service running on top of the transport, if the "Protocol" IP field (see the <i>nextLayerProtocol</i> field below in this table) is one of: <ul style="list-style-type: none"> a) Transmission Control Protocol (TCP), IP "Protocol" field decimal "6"; see IETF RFC 793 [28]. b) User Datagram Protocol (UDP), IP "Protocol" field decimal "17"; see IETF RFC 768 [29]. c) Datagram Congestion Control Protocol (DCCP), IP "Protocol" field decimal "33"; see IETF RFC 4340 [30]. d) Stream Control Transmission Protocol (SCTP), IP "Protocol" field decimal "132"; see IETF RFC 4960 [31]. For further details on Layer four protocols, see IANA [32].	C
destinationIPAddress	Shall contain the destination address of the packet from the 32-bit "Destination Address" field in IPv4, as defined in IETF RFC 791 [34], or from the 128-bit "Destination Address" field, as defined in IETF RFC 2460 [27].	M
destinationPort	Shall contain the "Destination Port" number that indicates an application or service running on top of the transport, if the "Protocol" IP field (see the <i>nextLayerProtocol</i> field below in this table) is one of: <ul style="list-style-type: none"> e) Transmission Control Protocol (TCP), IP "Protocol" field decimal "6"; see IETF RFC 793 [28]. f) User Datagram Protocol (UDP), IP "Protocol" field decimal "17"; see IETF RFC 768 [29]. g) Datagram Congestion Control Protocol (DCCP), IP "Protocol" field decimal "33"; see IETF RFC 4340 [30]. h) Stream Control Transmission Protocol (SCTP), IP "Protocol" field decimal "132"; see IETF RFC 4960 [31]. For further details on Layer four protocols, see IANA [32].	C
nextLayerProtocol	Shall contain the contents of the IP "Protocol" field as defined in IETF RFC 791 [34] (bits 72...79 in the IP header), and is one of the assigned Internet protocol numbers defined in IANA [32].	M
IPv6flowLabel	If the IP addresses in the report are IPv6, this field shall contain the 20-bit IPv6 "Flow Label" as defined in: <ul style="list-style-type: none"> - IPv6 IETF RFC 2460 [27], and - IPV6 Flow Label Specification IETF RFC 6437 [33]. 	C
direction	Shall contain the direction of the intercepted packet, and it indicates either "from target" or "to target."	M
packetSize	Shall contain the value of the "Total Length" IP header field if IPv4 is used, as defined in IETF RFC 791 [34], or the value of the "Payload Length" field if IPv6 is used, as defined in IETF RFC 2460 [27].	M
NOTE:	This is a placeholder value used to fill the pDUSessionID field, given that the UPF does not receive the PDU Session ID used for the session by the SMF, so this information is not available at the UPF. The PDU Session ID can be retrieved by the LEMF from the IRIs generated by the IRI-POI at the SMF and delivered by the MDF2.	

6.2.3.9.4 PDSummaryReport record

If the summary form of the packet header reporting, i.e. PDSR, is used, the LI function responsible for generating the xIRI extracts the information shown in table 6.2.3.9.4-1 from each packet and aggregates it in summaries according to the pDSRType field defined in the PDHRReportingExtensions parameters of the ActivateTask message used to provision the LI function. In addition, the current summary is sent when the LI function responsible for generating the xIRI receives a DeactivateTask message for the Task that generated the PDSR regardless of whether the trigger in the pDSRType field of the ActivateTask message was met. In this case, the pDSRSummaryTrigger field of the PDSR record shall be set to endOfFlow.

A PDSR shall be generated each time a flow (Source IP, Source Port, Destination IP, Destination Port, Next Level Protocol, Direction) starts or ends.

If the useSessionTriggers flag (see table 6.2.3.9.2-2) is absent or set to false and the provisioned pDSRTriggerType is:

- Packet count, a PDSR shall be generated whenever the number of packets detected as a part of the flow reaches the provisioned trigger value.
- Byte count, a PDSR shall be generated whenever the value for the cumulative byte size across all packets belonging to the flow reaches the provisioned trigger value.
- Timer expiry, a separate timer should be used for each flow. A PDSR shall be generated for a flow whenever the timer for that flow expires.

If the useSessionTriggers flag (see table 6.2.3.9.2-2) is set to true and the provisioned pDSRTriggerType is:

- Packet count, a PDSR shall be generated for each open flow whenever the number of packets sent and received in the PDU Session/PDN Connection is reaches the provisioned trigger value.
- Byte count, a PDSR shall be generated for each open flow whenever the value for the cumulative byte size across all packets belonging to the PDU Session/PDN Connection is reaches the provisioned trigger value.
- Timer expiry, a single timer should be used for each PDU Session/PDN Connection. A PDSR shall be generated for each open flow whenever the timer expires.

Table 6.2.3.9.4-1: PDSummaryReport record

Field name	Description	M/C/O
pDUSessionID	The PDU Session ID value 255 shall be used; the receiver shall ignore the parameter (see NOTE).	M
sourceIPAddress	Shall contain the source address of the packet from the 32-bit "Source Address" field in IPv4, as defined in IETF RFC 791 [34], or from the 128-bit "Source Address" field in IPv6, as defined in IETF RFC 2460 [27].	M
sourcePort	Shall contain the "Source Port" number that indicates an application or service running on top of the transport, if the "Protocol" IP field (see the <i>nextLayerProtocol</i> field below in this table) is one of: <ul style="list-style-type: none"> a) Transmission Control Protocol (TCP), IP "Protocol" field decimal "6"; see IETF RFC 793 [28]. b) User Datagram Protocol (UDP), IP "Protocol" field decimal "17"; see IETF RFC 768 [29]. c) Datagram Congestion Control Protocol (DCCP), IP "Protocol" field decimal "33"; see IETF RFC 4340 [30]. d) Stream Control Transmission Protocol (SCTP), IP "Protocol" field decimal "132"; Stream Control Transmission Protocol [31]. For further details on Layer four protocols, see IANA [32].	C
destinationIPAddress	Shall contain the destination address of the packet from the 32-bit "Destination Address" field in IPv4, as defined in IETF RFC 791 [34], or from the 128-bit "Destination Address" field, as defined in IETF RFC 2460 [27].	M
destinationPort	Shall contain the "Destination Port" number that indicates an application or service running on top of the transport, if the "Protocol" IP field (see the <i>nextLayerProtocol</i> field below in this table) is one of: <ul style="list-style-type: none"> a) Transmission Control Protocol (TCP), IP "Protocol" field decimal "6"; see IETF RFC 793 [28]. b) User Datagram Protocol (UDP), IP "Protocol" field decimal "17"; see IETF RFC 768 [29]. c) Datagram Congestion Control Protocol (DCCP), IP "Protocol" field decimal "33"; see IETF RFC 4340 [30]. d) Stream Control Transmission Protocol (SCTP), IP "Protocol" field decimal "132"; Stream Control Transmission Protocol [31]. For further details on Layer four protocols, see IANA [32].	C
nextLayerProtocol	Shall contain the contents of the IP "Protocol" field as defined in IETF RFC 791 [34] (bits 72..79 in the IP header), and is one of the assigned Internet protocol numbers defined in IANA [32].	M
IPv6flowLabel	If the IP addresses in the report are IPv6, this field shall contain the 20-bit IPv6 "Flow Label" as defined in IPv6 IETF RFC 2460 [27] and the <i>IPv6 Flow Label Specification</i> IETF RFC 6437 [33].	C
direction	Shall contain the direction of the intercepted packet, and it indicates either "from target" or "to target."	M
pDSRSummaryTrigger	Shall contain the trigger that caused the summary report to be generated, which is one of the following: <ul style="list-style-type: none"> a) timer expiry. b) packet count. c) byte count. d) start of a flow. e) end of a flow. 	M
firstPacketTimestamp	Shall contain the timestamp that represents the time that the IRI-POI in the UPF detected the first packet in the set represented by this summary.	M
lastPacketTimestamp	Shall contain the timestamp that represents the time that the IRI-POI in the UPF detected the last packet in the set represented by this summary.	M
packetCount	Shall contain the number of packets detected during the creation of this summary.	M
byteCount	Shall contain the number of bytes summed across all packets that belong to this summary. For IPv4 it is the sum of the "Total Length" fields across all packets in the summary as defined in <i>Internet Protocol</i> IETF RFC 791 [34], while for IPv6 it is the sum of the "Payload Length" fields across all packets in the summary as defined in <i>Internet Protocol, Version 6 (IPv6) Specification</i> , IETF RFC 2460 [27].	M
perSessionTrigger	Shall be present and set to true if the trigger that caused the summary report to be generated was applied to the Session. If the trigger that caused the summary report to be generated was applied per flow, this parameter may be omitted but shall be set to false if present.	C
NOTE: This is a placeholder value used to fill the pDUSessionID field, given that the UPF does not receive the PDU Session ID used for the session by the SMF, so this information is not available at the UPF. The PDU Session ID can be retrieved by the LEMF from the IRIs generated by the IRI-POI at the SMF and delivered by the MDF2.		

6.2.3.10 Sharing LI state information over LI_ST

6.2.3.10.1 Overview

TFs in SMFs in SMF sets need to share LI state information to avoid losing track of the XIDs and CorrelationIDs used in the tasks activated in the POI in the UPF when the triggered task control is transferred from one TF to another.

POIs in SMFs in SMF sets need to share LI state information to avoid losing track of the CorrelationIDs and sequence numbers used in the generation of xIRI and xCC when the interception is moved to another POI in the same SMF set.

The LIPF may request, store or remove any LI state records at any moment. The LIPF may revoke the credentials of any LI function to use the LI_ST function via LI_X0.

6.2.3.10.2 Storing LI state

The TF in the SMF shall store the LI state (related to a task active in the UPF POI) in the LISSF whenever the parent SMF stores session state for the relevant PDU session in the UDSF and whenever the parent SMF sends session state for the relevant PDU session to another SMF.

The POI in the SMF shall store the LI state (related to a task active in the SMF POI) in the LISSF whenever the parent SMF stores session state for the relevant PDU session in the UDSF and whenever the parent SMF sends session state for the relevant PDU session to another SMF.

When storing state, the LI function in the SMF shall use the state storage procedure specified in clause 5.10.2. During this procedure, the LI function shall add the metadata shown in table 6.2.3.10.2-1 to the RecordMeta for the record.

Table 6.2.3.10.2-1: Additional metadata for the RecordMeta

Field Name	Description	M/C/O
PDUSessionID	Identifier for the PDU session related to task.	M
UDSFRecordID	The recordID used by the parent SMF to store the associated SMF session information in the UDSF.	M
LIStateRecordType	Identifier for the record type which can be "TFLIState" or "POILIState".	M

The TF shall store the following information as the first record block (see TS 29.598 [64] clause 6.1.3.3.3.2), encoded as XML following the XSD schema given in Annex H.

Table 6.2.3.10.2-2: TFLIState structure for storing TF state information in the LISSF

Field Name	Description	M/C/O
PDUSessionID	Identifier for the PDU session related to task.	M
XID	XID of the task object associated with the interception at the TF in SMF.	M
CorrelationID	Correlation ID to assign to interception product generated by the POI in the UPF.	M
TriggeredTasks	Collection of information about tasks that the TF in SMF has activated in triggered POIs in UPF due to interception for this PDU session. As a list of TriggeredTask, see table 6.2.3.10.2-3 below.	M

Table 6.2.3.10.2-3: TriggeredTask

Field Name	Description	M/C/O
XID	XID of the task object associated with the interception at the triggered.	M
NEID	NEID used in LI_T2/LI_T3 communication by the triggered POI in UPF.	M

The TF shall specify the XID in order to avoid removing the LI state related to the same ProductID but a different task in the UPF POI, for example if there is more than one PDU session.

The SMF POI shall store the information shown in table 6.2.3.10.2-4 as the first record block (see TS 29.598 [64] clause 6.1.3.3.2), encoded as XML following the XSD schema given in Annex H.

Table 6.2.3.10.2-4: POIState structure for storing POI state information in the LISSF

Field Name	Description	M/C/O
PDUSessionID	Identifier for the PDU session related to task.	M
XID	XID of the task object associated with the interception at the POI in SMF.	M
SequenceNumber	Last sequence number used in the generation of xIRI/xCC.	M
CorrelationID	Correlation ID to assign to interception product generated by the POI in the SMF.	M

6.2.3.10.3 Retrieving LI state

When the TF in an SMF in an SMF set is provisioned by the LIPF with a specific XID and access to an LISSF function, the TF shall use the LISSF to retrieve LI state information.

If the implementation of the SMF set does not ensure that active SM contexts are always present in some SMF of the SMF set, when a task previously provisioned by the LIPF in the TF is deactivated, the TF shall request the records associated to the XID (received from the LIPF) from the LISSF, by performing a search as described in clause 5.10.3, using the XID as a search criteria. If no records are found, the TF may assume that no previous interception has occurred and proceed accordingly.

When a TF detects that its parent SMF is retrieving state for a targetted PDU session from the UDSF, the TF shall request records associated with that PDU session from the LISSF by performing a search as described in clause 5.10.3 and using the UDSFRecordID used by the SMF as a search criteria. When a TF detects that its parent SMF is receiving state for a targetted PDU session from another SMF, the TF shall request records associated with that PDU session from the LISSF by performing a search as described in clause 5.10.3 and using the XID of the task related to the target of that PDU session. If no records are found, the TF may assume that no previous interception has occurred and proceed accordingly. Implementers should be aware that multiple records may be returned.

When an SMF POI detects that its parent SMF is retrieving state for a targetted PDU session from the UDSF, the POI shall request records associated with that PDU session from the LISSF by performing a search as described in clause 5.10.3 and using the UDSFRecordID used by the SMF as a search criteria. When an SMF POI detects that its parent SMF is receiving state for a targetted PDU session from another SMF, the SMF POI shall request records associated with that target PDU session from the LISSF by performing a search as described in clause 5.10.3 and using the XID of the task related to the target of that PDU session. If no records are found, the SMF POI may assume that no previous interception has occurred and proceed accordingly.

6.2.3.10.4 Removing LI state

When a task is deactivated successfully in the UPF POI, the TF shall remove the LI state record from the LISSF as described in clause 5.10.4.

When a task is deactivated in the SMF POI, the POI shall remove the LI state record from the LISSF as described in clause 5.10.4.

6.2.4 LI at UDM for 5G

6.2.4.1 General description

In 5G packet core network, the UDM provides the unified data management for UE. The UDM shall have LI capabilities to generate the target UE's service area registration related xIRI. See clause 7.2.2 for the details.

6.2.5 LI at SMSF

6.2.5.1 Provisioning over LI_X1

The IRI-POI present in the SMSF is provisioned over LI_X1 by the LIPF using the X1 protocol as described in clause 5.2.2.

The IRI-POI in the SMSF shall support the following target identifier formats in the ETSI TS 103 221-1 [7] messages:

- SUPIIMSI.
- SUPINAI.
- PEIIMEI.
- PEIIMEISV.
- GPSIMSIDN.
- GPSINAI.

If service scoping is to be performed at the IRI-POI in the SMSF, the IRI-POI in the SMSF shall support the following CSP service types (see clauses 4.4.2 and 5.2.4):

- Messaging.

If the IRI-POI in the SMSF receives an ActivateTask message and the ListOfServiceTypes parameter contains a ServiceType that is not supported, the IRI-POI in the SMSF shall reject the task with an appropriate error as described in ETSI TS 103 221-1 [7] clause 6.2.1.2.

Table 6.2.5-1 shows the minimum details of the LI_X1 ActivateTask message used for provisioning the IRI-POI in the SMSF.

Table 6.2.5-1: ActivateTask message for the IRI-POI in the SMSF

ETSI TS 103 221-1 [7] field name	Description	M/C/O
XID	XID assigned by LIPF.	M
TargetIdentifiers	One of the target identifiers listed in the paragraph above.	M
DeliveryType	Set to "X2Only".	M
ListOfDIDs	Delivery endpoints for LI_X2 for the IRI-POI in the SMSF. These delivery endpoints are configured using the CreateDestination message as described in ETSI TS 103 221-1 [7] clause 6.3.1 prior to the task activation.	M
TaskDetailsExtensions/ SMSFExtensions	This field shall be included if the delivery of the full TPDU is not authorised. See table 6.2.5-2.	C
ListOfServiceTypes	Shall be included when the task should only intercept specific CSP service types as described in clause 5.2.4. This parameter is defined in ETSI TS 103 221-1 [7], clause 6.2.1.2, table 4.	C

Table 6.2.5-2: TruncateTPUserData Parameters

Field Name	Description	M/C/O
TruncateTPUserData	If included, the truncatedSMSTPDU field of the sMSTPDUData (as described in table 6.2.5-7) structure shall be used when applicable (see text below table). If absent, the sMSTPDU field of the sMSTPDUData structure shall be used.	C

If the TruncateTPUserData field of the LI_X1 ActivateTask message is included, the IRI-POI in the SMSF shall use the truncatedSMSTPDU field in xIRI generated at the IRI-POI in the SMSF for SMS-SUBMIT and SMS-DELIVER TPDU's, otherwise, the sMSTPDU field shall be used.

The MDF2 listed as the delivery endpoint for the LI_X2 generated by the IRI-POI in the SMSF shall be provisioned over LI_X1 by the LIPF using the X1 protocol as described in clause 5.2.2. If SMS Content delivery is not authorized, the MDF2 shall be provisioned with the TruncateTPUserData included, otherwise it shall be left absent.

Table 6.2.5-3 shows the minimum details of the LI_X1 ActivateTask message used for provisioning the MDF2.

Table 6.2.5-3: ActivateTask message for MDF2

ETSI TS 103 221-1 [7] field name	Description	M/C/O
XID	XID assigned by LIPF.	M
TargetIdentifiers	One of the target identifiers listed in clause 6.2.5.1.	M
DeliveryType	Set to "X2Only". (Ignored by the MDF2).	M
ListOfDIDs	Delivery endpoints for LI_HI2. These delivery endpoints are configured using the CreateDestination message as described in ETSI TS 103 221-1 [7] clause 6.3.1 prior to the task activation.	M
ListOfMediationDetails	Sequence of Mediation Details, see table 6.2.5-4.	M
TaskDetailsExtensions/ SMSFExtensions	This field shall be included if the delivery of the full TPDU is not authorised. See table 6.2.5-2.	C

Table 6.2.5-4: Mediation Details for MDF2

ETSI TS 103 221-1 [7] field name	Description	M/C/O
LIID	Lawful Interception ID associated with the task.	M
DeliveryType	Set to "HI2Only".	M
ListOfDIDs	Details of where to send the IRI for this LIID. Shall be included if deviation from the ListofDIDs in the ActivateTask message is necessary. If included, the ListOfDIDs in the Mediation Details shall be used instead of any delivery destinations specified in the ListOfDIDs field in the ActivateTask Message.	C
ServiceScoping	Shall be included to identify the service(s) and associated service-related delivery settings for this LIID. May include more than one instance of this parameter to allow for different combinations of sub-parameters associated with a single LIID. This parameter is defined in ETSI TS 103 221-1 [7] Annex C table C.2.	C

6.2.5.2 Generation of xIRI over LI_X2

The IRI-POI present in the SMSF shall send xIRI over LI_X2 for the event listed in TS 33.127 [5] clause 6.2.5.3, the details of which are described in the following clause.

6.2.5.3 SMS Message

The IRI-POI in the SMSF shall generate an xIRI containing an SMSMessage record for the following cases:

SMS-MO case:

- When a target UE originates an SMS message or when any UE originates an SMS message destined to a target non-local ID.

SMS-MT case:

- When an SMS message delivery to a target UE is attempted or when an SMS message delivery originated from a target non-local ID is attempted to any UE.
- When an SMS message is successfully delivered to a target UE or when an SMS message originated from a target non-local ID is successfully delivered to any UE.

The SMS-MT case can also apply to the scenario when a receipt of SMS delivery from the far end is delivered successfully to the target UE or when a receipt of SMS delivery from a target non-Local ID is successfully delivered to the originating UE.

The IRI-POI present in the SMSF shall generate the xIRI containing the SMSMessage record when it detects following events:

- The SMSF receives an SMCP message CP-DATA_RP-DATA [SMS-SUBMIT, SMS-COMMAND] (via AMF in Nsmsf_SMSservice_UplinkSMS message) from a target UE.
- The SMSF receives an SMCP message CP-DATA_RP-DATA [SMS-SUBMIT] (via AMF in Nsmsf_SMSservice_UplinkSMS message) from any UE with TP-DA field within the SMS-SUBMIT containing a target non-Local ID and SMSF returns the SMCP: CP-ACK to that originating UE.

- The SMSF receives an SMCP message CP-DATA_RP-DATA [SMS-COMMAND] (via AMF in Nsmsf_SMSservice_UplinkSMS message) from any UE with TP-DA field within the SMS-COMMAND containing a target non-Local ID and SMSF returns the SMCP: CP-ACK to that originating UE.
- The SMSF receives a TCAP message MAP MT-FORWARD-SHORT-MESSAGE Request [SMS-DELIVER, SMS-STATUS-REPORT] destined to a target UE.
- The SMSF receives a TCAP message MAP MT-FORWARD-SHORT-MESSAGE Request [SMS-DELIVER] destined to any UE with the TP-OA field within the SMS-DELIVER containing a target non-Local ID.
- The SMSF receives a TCAP message MAP MT-FORWARD-SHORT-MESSAGE Request [SMS-STATUS-REPORT] destined to any UE with the TP-RA field within the SMS-STATUS-REPORT containing a target non-Local ID.

The IRI-POI present in the SMSF shall generate the xIRI containing the SMSReport record when it detects following events:

- The SMSF sends a SMCP message CP-DATA_RP-ACK [SMS-SUBMIT-REPORT] (via AMF in Namf_Communication_N1N2MessageTransfer message) in response to a previously intercepted CP-DATA_RP-DATA.
- The SMSF sends a SMCP message CP-DATA_RP-ERROR [SMS-SUBMIT-REPORT] (via AMF in Namf_Communication_N1N2MessageTransfer message) in response to a previously intercepted CP-DATA_RP-DATA.
- The SMSF sends a TCAP message MAP MT-FORWARD-SHORT-MESSAGE Response [SMS-DELIVER-REPORT] in response to a previously intercepted MAP MT-FORWARD-SHORT-MESSAGE Request.

NOTE 1: In the above-mentioned descriptions, the requirements of target Non-Local ID do not apply when both originating and terminating users of an SMS message are served by the same CSP. The method used to identify a target non-Local ID is different from the method used to identify a local target ID.

If the IRI-POI is provisioned with the TruncateTPUserData parameter included and the IRI-POI is generating xIRI for the SMS-SUBMIT type (TS 23.040 [18] clause 9.2.2.2) or SMS-DELIVER type (TS 23.040 [18] clause 9.2.2.1) TPDU's, the IRI-POI shall use the truncatedSMSTPDU (as described in table 6.2.5-7), otherwise, the IRI-POI shall use the sMSTPDU.

Table 6.2.5-5: Payload for SMSMessage record

Field name	Description	M/C/O
originatingSMSParty	Identity of the originating SMS party. See NOTE 2.	M
terminatingSMSParty	Identity of the terminating SMS party. See NOTE 3.	M
direction	Direction of the SMS with respect to the target. See NOTE 4.	M
linkTransferStatus	Indicates whether the SMSF sent the TPDU to the next network element. See NOTE 5.	M
otherMessage	In the event of a server-initiated transfer, indicates whether the server will send another SMS. May be omitted if the transfer is target-initiated. See NOTE 6.	C
location	Location information associated with the target sending or receiving the SMS, if available and authorised. See NOTE 7. Encoded as a <i>userLocation</i> parameter (<i>location>locationInfo>userLocation</i>), see Annex A.	C
peerNFAddress	Address of the other network function (SMS-GMSC/IWMSC/SMS-Router) involved in the communication of the SMS, if available.	C
peerNFType	Type of the other network function (SMS-GMSC/IWMSC/SMS-Router) involved in the communication of the SMS, if available.	C
sMSTPDUData	See table 6.2.5-7. This is conditional only for backwards compatibility.	C
messageType	See table 6.2.5-8. This is conditional only for backwards compatibility.	C
rPMessageReference	The SM-RL Message Reference of the message per TS 24.011 [46] clause 7.3. This is conditional only for backwards compatibility.	C

The sMSTPDU field shall always be used for the sMSTPDUData field of the SMSReport record.

Table 6.2.5-6: Payload for SMSReport record

Field name	Description	M/C/O
location	Location information associated with the target sending or receiving the SMS, if available and authorised. See NOTE 7.	C
sMSTPDUData	SMS TPDU, encoded as per TS 23.040 [18] clause 9.	M
messageType	See table 6.2.5-8.	M
rPMessageReference	The SM-RL Message Reference of the message per TS 24.011 [46] clause 7.3.	M

Table 6.2.5-7: SMSTPDUData field

Field name	Description
sMSTPDU	SM-TL PDU encoded per the PDUs defined in TS 23.040 [18] clause 9.2.2. Shall be chosen if the TruncateTPUserData Parameter is absent.
truncatedSMSTPDU	SM-TL PDU encoded per the PDUs defined in TS 23.040 [18] clause 9.2.2 but truncated to remove TP-User-Data (TS 23.040 [18] clause 9.2.3.24). Shall be chosen if the TruncateTPUserData Parameter is set.

Table 6.2.5-8: SMSMessageType values

messageType value	RP MTI Value	RP Message Type	TP-MTI Value	SMS TPDU Message Type
deliver	001	RP-DATA (network→UE)	00	SMS-DELIVER
deliverReportAck	010	RP-ACK (UE→network)	00	SMS-DELIVER-REPORT
deliverReportError	100	RP-ERROR (UE→network)	00	SMS-DELIVER-REPORT
statusReport	001	RP-DATA (network→UE)	10	SMS-STATUS-REPORT
command	000	RP-DATA (UE→network)	10	SMS-COMMAND
submit	000	RP-DATA (UE→network)	01	SMS-SUBMIT
submitReportAck	011	RP-ACK (network→UE)	01	SMS-SUBMIT-REPORT
submitReportError	101	RP-ERROR (network→UE)	01	SMS-SUBMIT-REPORT
reserved		Reserved	11	Reserved

The IRI-POI in the SMSF shall populate the messageType field with the values listed in table 6.2.5-8 based on the SMS TPDU message type (see TS 23.040 [18] clause 9.2.2) and the RP Message Type (see TS 24.011 [46] clause 8.2.2) that triggered the generation of the xIRI. The SMS TPDU Message Type is indicated by the value of the TP-Message Type Indicator (TP-MTI) (see TS 23.040 [18] clause 9.2.3.1) as described in TS 23.040 [18] clause 9.2.3.1. The RP Message Type is indicated by the value of the RP MTI (See TS 24.011 [46] clause 8.2.2).

NOTE 2: For the SMS-MO case, the originating party is the address of the UE from which the SMSF receives the CP-DATA_RP-DATA [SMS-SUBMIT, SMS-COMMAND] message (via AMF in the Nsmsf_SMSservice_UplinkSMS). The GPSI is one of the data fields used in the Nsmsf related messages (see TS 29.540 [21]). Alternatively, the SMSF may find the originating party address in the same way it finds the address when generating charging records. For SMS-MT case, this is derived from TP-OA field (TS 23.040 [18]) for SMS-DELIVER TPDUs or the TP-RA field (TS 23.040 [18]) for SMS-STATUS-REPORT TPDUs. In cases where the originatingSMSParty is not a GPSI, PEI, or SUPI, the sMSAddress parameter is populated with the octets received in the field used to derive the address (as per TS 23.040 [18] clause 9.1.2.5).

NOTE 3: For SMS-MT case, the terminating party is the address of the UE to which the SMSF sends the CP-DATA_RP-DATA [SMS-DELIVER, SMS-STATUS-REPORT] message (via AMF in Namf_Communications_N1N2MessageTransfer). The GPSI is one of the data fields used in the Namf related messages (TS 29.518 [22]). Alternatively, the SMSF may find the terminating party address in the same way it finds the address when generating charging records. For SMS-MO case, this is derived from the TP-DA field (TS 23.040 [18]). In cases where the terminatingSMSParty is not a GPSI, PEI, or SUPI, the sMSAddress parameter is populated with the octets received in the field used to derive the address (as per TS 23.040 [18] clause 9.1.2.5).

NOTE 4: For the SMS-MO case, for SMS originated from the target UE, the value fromTarget is used and for SMS destined to target Non-local ID, the toTarget is used. For SMS-MT case, for SMS terminated to the target UE, the value toTarget is used and for SMS originated from a target Non-local ID, the fromTarget is used.

NOTE 5: This field is set to transferSucceeded or transferFailed as follows:

- SMS-MO case:
 - To transferSucceeded: when the IRI-POI in the SMSF detects that SMSF sends the MO-FORWARD-SHORT-MESSAGE-Request [SMS-SUBMIT] message to the SMS-IWMSC.
 - To transferFailed: when the IRI-POI in SMSF detects the scenarios where SMSF cannot send the MO-FORWARD-SHORT-MESSAGE-Request [SMS-SUBMIT] to the SMS-IWMSC, but still generates an xIRI containing the SMSMessage record.
- SMS-MT case:
 - To transferSucceeded: when the IRI-POI in the SMSF detects that SMSF sends the MT-FORWARD-SHORT-MESSAGE-Response [SMS-DELIVER-REPORT] message to the SMS-GMSC.
 - To transferFailed: when the IRI-POI in SMSF detects the scenarios where SMSF cannot send the MT-FORWARD-SHORT-MESSAGE-Response [SMS-DELIVER-REPORT] to the SMS-GMSC, but an xIRI containing the SMSMessage record is still generated.

NOTE 6: This is only applicable to the SMS-MT case and can be derived from the TP-MMS (More Message to Send) field present in the SMS-DELIVER sent to the UE (via AMF in the Namf_Communications_N1N2MessageTransfer).

NOTE 7: This is derived from the ueLocation field of SmsRecord IE received from the AMF in the Nsmsf_SMSservice_UplinkSMS message (TS 29.540 [21]). For the SMSMessage record, the SMCP message is CP-DATA_RP-DATA [SMS-SUBMIT, SMS-COMMAND] and for the SMSReport record, the SMCP message is CP-DATA-RP-ACK [SMS-DELIVER-REPORT]. This value is encoded as a *userLocation* parameter (*location>locationInfo>userLocation*), see Annex A.

6.2.5.4 Generation of IRI over LI_HI2

When an xIRI containing the SMSMessage record is received over LI_X2 from the IRI-POI in SMSF, the MDF2 shall send the IRI message over LI_HI2 without undue delay. The IRI message shall contain a copy of the SMSMessage record received over LI_X2. The SMSMessage record may be enriched by other information available at the MDF (e.g. additional location information).

If the MDF2 is provisioned with the TruncateTPUserData parameter included, the truncatedSMSTPDU field shall be used in SMSMessage IRI message, otherwise, the sMSTPDU field shall be used.

The threeGPP33128DefinedIRI field (see ETSI TS 102 232-7 [10] clause 15) shall be populated with the BER-encoded IRIPayload.

The timestamp field of the PSHeader structure shall be set to the time that the SMSF event was observed (i.e. the timestamp field of the xIRI).

Each SMSMessage record shall be delivered as an IRI REPORT (see ETSI TS 102 232-1 [9] clause 5.2.10) with a new CIN assigned (see ETSI TS 102 232-1 [9] clause 5.2.4).

Each SMSReport record shall be delivered as a separate IRI REPORT (see ETSI TS 102 232-1 [9] clause 5.2.10) with the same CIN as the IRI REPORT of the associated SMSMessage record.

6.2.6 LI support at NRF

The SIRF present within the NRF provides SBA-related information to the LIPF over the LI_SI interface. Details for this interface are not considered in the present document and are for further study.

6.3 4G

6.3.1 General

The present document allows three options for EPC LI stage 3 interfaces for 4G / LTE:

- Option A: Use LI_X1, LI_X2 and LI_X3 interfaces specified below in clauses 6.3.2 and 6.3.3 for the events listed in TS 33.127 [5] clauses 6.3.2.3 and 6.3.3.3, and the events related to SMS over NAS as specified in TS 33.107 [36] clause 18.2.4.
- Option B: Use LI_X1, LI_X2 and LI_X3 interfaces as specified in clause 6.3.2 and 6.3.3 for the events listed in TS 33.107 [36] clause 12.2.1.2 and for the events related to the MMEIdentifierAssociation record described in clause 6.3.2.2.2.
- Option C: Use TS 33.107 [36] clause 12 natively as defined in that document.

For implementations that include EPS/5GS interworking, Option A shall be used.

In all cases, the present document specifies the stage 3 for the LI_HI1, LI_HI2 and LI_HI3 interfaces.

6.3.2 LI at MME

6.3.2.1 Provisioning over LI_X1

The IRI-POI present in the MME is provisioned over LI_X1 by the LIPF using the X1 protocol as described in clause 5.2.2.

The POI in the MME shall support the following target identifier formats:

- IMSI (using the IMSI target identifier format from ETSI TS 103 221-1 [7]).
- MSISDN (using the E164Number target identifier format from ETSI TS 103 221-1 [7]).
- ME Identity (using the IMEI target identifier format from ETSI TS 103 221-1 [7]).

Table 6.3.2-0A shows the minimum details of the LI_X1 ActivateTask message used for provisioning the IRI-POI in the MME.

Table 6.3.2-0A: ActivateTask message for the IRI-POI in the MME

ETSI TS 103 221-1 [7] field name	Description	M/C/O
XID	XID assigned by LIPF.	M
TargetIdentifiers	One of the target identifiers listed in the paragraph above.	M
DeliveryType	Set to "X2Only".	M
ListOfDIDs	Delivery endpoints for LI_X2 for the IRI-POI in the MME. These delivery endpoints are configured using the CreateDestination message as described in ETSI TS 103 221-1 [7] clause 6.3.1 prior to the task activation.	M
TaskDetailsExtensions/ IdentifierAssociationExtensions	This field shall be included if the IRI-POI is required to generate MMEIdentifierAssociation records (see clause 6.3.2.2.1). If the field is absent, MMEIdentifierAssociation records shall not be generated.	C
ListOfServiceTypes	Shall be included when the task should only intercept specific CSP service types as described in clause 5.2.4. This parameter is defined in ETSI TS 103 221-1 [7], clause 6.2.1.2, table 4.	C

Table 6.3.2-0B: IdentifierAssociationExtensions Parameters

Field Name	Description	M/C/O
EventsGenerated	One of the following values: <ul style="list-style-type: none"> - IdentifierAssociation - All See clause 6.3.2.2.1 for the interpretation of this field.	M

6.3.2.2 Generation of xIRI over LI_X2

6.3.2.2.1 General

If the MME receives one or more cell IDs in an S1 message (as specified in TS 36.413 [38]), the POI associated with the MME shall report all of them.

The IRI-POI in the MME shall only generate xIRI containing the MMEIdentifierAssociation record in the following scenarios:

- IdentifierAssociation: MMEIdentifierAssociation and Tracking Area/EPS Location Update (see TS 33.107 [36] clause 12.2.1.2) records shall be generated. No other record types shall be generated for that target.
- All: All MME record types shall be generated.

When Option A specified in clause 6.3.1 is used:

- The IRI-POI present in the MME shall send the xIRIs over LI_X2 for each of the events listed in TS 33.127 [5] clause 6.3.2.3, the details of which are described in the following clauses.
- In addition to the xIRI events listed in TS 33.127 [5] clause 6.3.2.3, the MME shall support xIRI generation in case of SMS over NAS as specified in TS 33.107 [36] clause 18.2.4. For records related to SMS over NAS in EPS:
 - The IRI-POI present in the MME shall set the payload format to EpsHI2Operations.EpsIRIContent (value 14), see clause 5.3 and ETSI TS 103 221-2 [8] clause 5.4. The payload field shall contain an EpsHI2Operations.EpsIRIContent structure encoded according to TS 33.108 [12] clauses 10.5, 15.2 and B.9.
 - As the LIID may be not available at the MME but is mandatory in EpsHI2Operations.EpsIRIContent according to TS 33.108 [12] Annex B.9, its value in the lawfulInterceptionIdentifier field of the encoded PDU shall be set to the fixed string "LIIDNotPresent".

When Option B specified in clause 6.3.1 is used:

- The IRI-POI present in the MME shall send the xIRIs over LI_X2 for each of the events listed in TS 33.107 [36] clause 12.2.1.1, the details of which are specified in clause 12.2.3 of the same TS, and in case of SMS over NAS as specified in TS 33.107 [36] clause 18.2.4.
- For all records except MMEIdentifierAssociation (see clause 6.3.2.2.2), the IRI-POI present in the MME shall set the payload format to EpsHI2Operations.EpsIRIContent (value 14), see clause 5.3 and ETSI TS 103 221-2 [8] clause 5.4. The payload field shall contain an EpsHI2Operations.EpsIRIContent structure encoded according to TS 33.108 [12] clauses 10.5, 15.2 and B.9.
- As the LIID may be not available at the MME but is mandatory in EpsHI2Operations.EpsIRIContent according to TS 33.108 [12] Annex B.9, its value in the lawfulInterceptionIdentifier field of the encoded PDU shall be set to the fixed string "LIIDNotPresent".
- In addition to the xIRI events listed in TS 33.107 [36], the MME shall support xIRI containing the MMEIdentifierAssociation record in clause 6.3.2.2.2.

6.3.2.2.2 MME identifier association

The IRI-POI present in the MME shall generate an xIRI containing an MMEIdentifierAssociation record when the IRI-POI present in the MME detects a new identifier association for a UE matching one of the target identifiers provided via LI_X1. Generation of this record is subject to this record type being enabled for a specific target (see clause 6.3.2.2.1).

Table 6.3.2-1: Payload for MMEIdentifierAssociation record

Field name	Description	M/C/O
iMSI	IMSI associated with the procedure. (see NOTE 1).	M
iMEI	IMEI used in the procedure, if available (see NOTE 1).	C
mSISDN	MSISDN used in the procedure, if available (see NOTE 1).	C
gUTI	LTE GUTI used in the procedure.	M
location	Location information available when identifier association occurs. Shall include all location information for the target UE available at the MME encoded as one of the following: - <i>ePSUserLocationInformation</i> parameter (<i>location</i> > <i>fourGLocationInfo</i> > <i>ePSUserLocationInformation</i>). - <i>ePSLocationInformation</i> parameter (<i>location</i> > <i>fourGLocationInfo</i> > <i>ePSLocationInformation</i>). When Dual Connectivity is activated, the <i>additionalCellIDs</i> parameter (<i>location</i> > <i>fourGLocationInfo</i> > <i>ePSLocationInformation</i> > <i>mMELocationInformation</i> > <i>additionalCellIDs</i>) shall also be populated, see clause 7.3.3 and Annex A.	M
tAllList	List of tracking areas associated with the registration area within which the UE is current registered. (see NOTE 2).	C
NOTE 1: IMSI shall always be provided, in addition to the warrant target identifier if different to IMSI. Other identifiers shall be provided if available.		
NOTE 2: List shall be included each time there is a change to the registration area.		

The IRI-POI present in the MME generating an xIRI containing an MMEIdentifierAssociation record shall set the Payload Direction field in the PDU header to *not applicable* (Direction Value 5, see ETSI TS 103 221-2 [8] clause 5.2.6).

When transmitting the xIRI, the IRI-POI present in the MME shall set the payload format to 2, and provide the payload as a BER-encoded TS33128Payloads.XIRIPayloads structure.

6.3.2.2.3 Attach

The IRI-POI in the MME shall generate an xIRI containing an MMEAttach record when the IRI-POI present in the MME detects that a UE matching one of the target identifiers provided via LI_X1 has successfully attached to EPS. Accordingly, the IRI-POI in the MME generates the xIRI when the following event is detected:

- MME sends an S1: ATTACH ACCEPT message to the target UE and the UE EPS Mobility Management (EMM) state within the MME is changed to EMM-REGISTERED.

Table 6.3.2-2: Payload for MMEAttach record

Field name	Description	M/C/O
attachType	Specifies the type of EPS Attach, see TS 24.301 [51] clause 9.9.3.11. This is derived from the information received from the UE in the Attach Request message.	M
attachResult	Specifies the result of the attach procedure, see TS 24.301 [51] clause 9.9.3.10.	M
iMSI	IMSI associated with the registration.	M
iMEI	IMEI associated with the registration, if available.	C
mSISDN	mSISDN associated with the registration, if available.	C
gUTI	GUTI provided as outcome of initial attach or used in other cases, see TS 24.301 [51] clause 5.5.1.2.4.	M
location	Location information determined by the network during the registration or known at the MME, if available. Shall include all location information for the target UE available at the MME encoded as one of the following: - <i>ePSUserLocationInformation</i> parameter (<i>location</i> > <i>fourGLocationInfo</i> > <i>ePSUserLocationInformation</i>). - <i>ePSLocationInformation</i> parameter (<i>location</i> > <i>fourGLocationInfo</i> > <i>ePSLocationInformation</i>).	C
ePSTAIList	List of tracking areas associated with the registration area within which the UE is currently registered, see TS 24.301 [51] clause 9.9.3.33. (see NOTE)	C
sMSServiceStatus	Indicates the availability of SMS Services. Shall be provided if present in the ATTACH ACCEPT.	C
oldGUTI	Old GUTI used in the registration, if available.	C
eMM5GRegStatus	UE Status, if provided in the REGISTRATION REQUEST message, see TS 24.501 [13] clause 9.11.3.56.	C
NOTE: List shall be included each time there is a change to the registration area.		

6.3.2.2.4 Detach

The IRI-POI in the MME shall generate an xIRI containing an MMEDetach record when the IRI-POI present in the MME detects that a UE matching one of the target identifiers provided via LI_X1 has deregistered from the EPS. Accordingly, the IRI-POI in the MME generates the xIRI when any of the following events is detected:

- For network initiated de-registration, when the MME receives the S1: DETACH ACCEPT message from the target UE, when the MME receives an S3: DETACH NOTIFICATION about the target UE from the SGSN or when implicit deregistration timer expires; and in all cases the UE EMM state within the MME is changed to EMM-DEREGISTERED.
- For UE initiated de-registration, when the MME sends the S1: DETACH ACCEPT message to the target UE or when the MME receives the S1: DETACH REQUEST message from the target UE with deregistration type value of “switch off”; and in both cases the UE EMM state within the MME is changed to EMM-DEREGISTERED.

Table 6.3.2-3: Payload for MMEDetach record

Field name	Description	M/C/O
deregistrationDirection	Indicates whether the deregistration was initiated by the network or by the UE.	M
detachType	Indicates the type of detach as determined by the direction of the detach request and the value of the DetachType information element, see table 6.3.2-4.	M
iMSI	iMSI associated with the detach.	M
iMEI	iMEI associated with the detach, if available.	C
mSISDN	mSISDN associated with the detach, if available.	C
gUTI	GUTI associated with the detach, if available.	C
cause	Indicates the EMM cause value for network-initiated detach, see TS 24.301 [51] clause 9.9.3.9.	C
location	Location information determined by the network during the deregistration or known at the MME, if available. Shall include all location information for the target UE available at the MME encoded as one of the following: - <i>ePSUserLocationInformation</i> parameter (<i>location</i> > <i>fourGLocationInfo</i> > <i>ePSUserLocationInformation</i>). - <i>ePSLocationInformation</i> parameter (<i>location</i> > <i>fourGLocationInfo</i> > <i>ePSLocationInformation</i>). When Dual Connectivity is activated, the <i>additionalCellIDs</i> parameter (<i>location</i> > <i>fourGLocationInfo</i> > <i>ePSLocationInformation</i> > <i>mMELocationInformation</i> > <i>additionalCellIDs</i>) shall also be populated, see clause 7.3.3 and Annex A.	C
switchOffIndicator	If Bit 4 of the Detach type information element sent in the Detach Request is set to 0, this parameter shall be set to "normalDetach". If Bit 4 of the Detach type information element sent in the Detach Request is set to 1, this parameter shall be set to "switchOff". See TS 24.301 [51] clause 9.9.3.7. This parameter is conditional only for backwards compatibility.	C

Table 6.3.2-4: detachType values

Type of detach value	Direction	detachType value
001	UE→network	ePSDetach
010	UE→network	iMSIDetach
011	UE→network	combinedEPSIMSIDetach
110	UE→network	reserved
111	UE→network	reserved
Any Other	UE→network	combinedEPSIMSIDetach
001	network→UE	reAttachRequired
010	network→UE	reAttachNotRequired
011	network→UE	iMSIDetach
110	network→UE	reserved
111	network→UE	reserved
Any Other	network→UE	reAttachNotRequired

The IRI-POI in the MME shall populate the ePSDetachType field with the values listed in table 6.3.2-4 based on the Detach Type sent in the Detach Request message (see TS 24.301 [51] clause 9.9.3.7) and the direction of the Detach Request associated to the event that triggered the generation of the xIRI.

If the Detach Request message associated to the event that triggered the generation of the xIRI has the EMM Cause field populated, the IRI-POI in the MME shall set the value of the cause field of the MMEDetach record to the integer value of the EMM Cause, see TS 24.301 [51] clause 9.9.3.9.

6.3.2.2.5 Tracking Area/EPS Location update

When the reporting of location information is authorised, the IRI-POI in the MME shall generate an xIRI containing an MMELocationUpdate record each time the IRI-POI present in an MME detects that the target UE location is updated due to target UE mobility or as a part of an MME service procedure. The generation of such separate xIRI is not required if the updated UE location information is obtained as a part of a procedure producing some other xIRIs (e.g. mobility registration). In that case the location information is included into the respective xIRI.

In addition to the Tracking Area Update described in TS 23.401 [50], clause 5.3.3, the UE mobility events resulting in generation of an MMELocationUpdate xIRI include the *S1 Path Switch Request (intra E-UTRAN handover X2 based handover)* procedure described in TS 23.401 [50] clause 5.5.1.1) and the *S1 Handover Notify (Intra E-UTRAN S1 based handover)* procedure described in TS 23.401 [50] clause 5.5.1.2).

The MMELocationUpdate xIRI is also generated when the MME receives an E-UTRAN S1AP *ERAB Modification Indication* message as a result of Dual Connectivity activation/release for the target UE, as described in TS 37.340 [37] clause 10.

Based on regulatory requirements and operator policy, the location information obtained by the MME from E-UTRAN or the E-SMLC in the course of some service operations may result in the generation of the MMELocationUpdate xIRI record. Additionally, the IRI-POI in the MME shall capture the location information in the scenarios described in TS 23.271 [52] clause 4.4.2. Also, in the case of Mobile Originated LCS service invoked by the target, the location information may be derived from the Location Service Response sent to the target UE via the MME (see TS 23.271 [52] clause 9.2.6).

Optionally, based on regulatory and operator policy, other MME messages that do not generate separate xIRI but carry location information such as emergency services or LCS may trigger the generation of an MMELocationUpdate xIRI record.

Table 6.3.2-5: Payload for MMELocationUpdate record

Field name	Description	M/C/O
iMSI	iMSI associated with the location update.	M
iMEI	iMEI associated with the location update, if available.	C
mSISDN	mSISDN associated with the location update, if available as part of the subscription profile.	C
gUTI	GUTI assigned during the location update, if available, see TS 24.301 [50].	C
location	Updated location information determined by the network. Depending on the service or message type from which the location information is extracted, it may be encoded in several forms (Annex A).	M
oldGUTI	GUTI used to initiate the location update, if available, see TS 24.301 [50].	C
sMSServiceStatus	Indicates the availability of SMS Services. Shall be provided if present in the TRACKING AREA UPDATE ACCEPT.	C

6.3.2.2.6 Start of interception with EPS attached UE

The IRI-POI in the MME shall generate an xIRI containing an MMESStartOfInterceptionWithEPSAttachedUE record when the IRI-POI present in the MME detects that interception is activated on a UE that has already attached to the EPS. A UE is considered already attached to the EPS when the EMM state for that UE is EMM-REGISTERED. Therefore, the IRI-POI present in the MME shall generate the xIRI MMESStartOfInterceptionWithEPSAttachedUE record when it detects that a new interception for a UE is activated (i.e. provisioned by the LIPF) and the EPS mobility management state within the MME for that UE is EMM-REGISTERED.

Table 6.3.2-6: Payload for MMStartOfInterceptionWithEPSAttachedUE record

Field name	Description	M/C/O
attachType	Specifies the type of EPS Attach, see TS 24.301 [51] clause 9.9.3.11. This is derived from the information stored in the UE Context at the MME, see TS 23.401 [50] clause 5.7.2.	M
attachResult	Specifies the result of the attach procedure, see TS 24.301 [51] clause 9.9.3.10. This is derived from the information stored in the UE Context at the MME, see TS 23.401 [50] clause 5.7.2.	M
iMSI	iMSI associated with the target UE Context at the MME, see TS 23.401 [50] clause 5.7.2.	M
iMEI	iMEI associated with the target UE Context at the MME, if available, see TS 23.401 [50] clause 5.7.2.	C
mSISDN	mSISDN associated with the target UE Context at the MME, if available.	C
gUTI	Current GUTI associated with the target UE context at the MME, if available, see TS 23.401 [50] clause 5.7.2.	C
location	Location information stored in the UE Context at the MME, if available, see TS 23.401 [50] clause 5.7.2. Shall include all location information for the target UE available at the MME encoded as one of the following: - <i>ePSUserLocationInformation</i> parameter (<i>location</i> > <i>fourGLocationInfo</i> > <i>ePSUserLocationInformation</i>). - <i>ePSLocationInformation</i> parameter (<i>location</i> > <i>fourGLocationInfo</i> > <i>ePSLocationInformation</i>). When Dual Connectivity is activated, the <i>additionalCellIDs</i> parameter (<i>location</i> > <i>fourGLocationInfo</i> > <i>ePSLocationInformation</i> > <i>mMELocationInformation</i> > <i>additionalCellIDs</i>) shall also be populated, see clause 7.3.3 and Annex A.	C
ePSTAIList	List of tracking areas associated with the registration area within which the UE is currently registered, see TS 24.301 [51], clause 9.9.3.33 and TS 23.401 [50] clause 5.7.2.	C
sMSServiceStatus	Indicates the availability of SMS Services. Shall be provided if present in the UE Context at the MME, see TS 23.401 [50] clause 5.7.2.	C
eMM5GRegStatus	UE Status, if present in the UE Context at the MME, see TS 24.501 [13] clause 9.11.3.56.	C

The IRI-POI present in the MME generating an xIRI containing an MMStartOfInterceptionWithEPSAttachedUE record shall set the Payload Direction field in the PDU header to *not applicable* (see ETSI TS 103 221-2 [8] clause 5.2.6).

6.3.2.2.7 MME unsuccessful procedure

The IRI-POI in the MME shall generate an xIRI containing an MMEUnsuccessfulProcedure record when the IRI-POI present in the MME detects an unsuccessful procedure for a UE matching one of the target identifiers provided via LL_X1.

Accordingly, the IRI-POI in the MME generates the xIRI when any of the following events is detected:

- MME sends a reject to any EMM request message to the target UE and the UE EPS Mobility Management (EMM) within the MME is changed to EMM-DEREGISTERED.
- MME aborts a registration procedure before the UE EPS Mobility Management (EMM) state within the MME is changed to EMM-REGISTERED.
- MME sends a reject to any ESM request message to the target UE.

Unsuccessful attach attempts shall be reported only if the target UE has been successfully authenticated.

Table 6.3.2-7: Payload for MMEUnsuccessfulProcedure record

Field name	Description	M/C/O
failedprocedureType	Specifies the procedure which failed at the MME.	M
failureCause	Provides the value of the ESM or EMM cause, see TS 24.301 [51] clauses 9.9.3.9 and 9.9.4.4.	M
iMSI	IMSI associated with the procedure, if available (see NOTE).	C
iMEI	IMEI associated with the procedure, if available.	C
mSISDN	mSISDN associated with the procedure, if available.	C
gUTI	GUTI provided used in the procedure, if available.	C
location	Location information determined by the network during the procedure or known at the MME, if available. Shall include all location information for the target UE available at the MME encoded as one of the following: - <i>ePSUserLocationInformation</i> parameter (<i>location>fourGLocationInfo>ePSUserLocationInformation</i>). - <i>ePSLocationInformation</i> parameter (<i>location>fourGLocationInfo>ePSLocationInformation</i>). When Dual Connectivity is activated, the <i>additionalCellIDs</i> parameter (<i>location>fourGLocationInfo>ePSLocationInformation>mMELocationInformation>additionalCellIDs</i>) shall also be populated, see clause 7.3.3 and Annex A.	C
NOTE: At least one identity shall be provided, the others shall be provided if available.		

6.3.2.2.8 Positioning info transfer

The IRI-POI present in the MME shall generate an xIRI containing an MMEPositioningInfoTransfer when the IRI-POI present in the MME detects one of the following events:

- a LPPa (see TS 36.455 [84]) message related to a target UE has been exchanged between the E-SMLC and the eNB via the MME.
- a LPP (see TS 37.355 [85]) message related to a target UE has been exchanged between the E-SMLC and the target UE via the MME.

Accordingly, the IRI-POI in MME generates the xIRI when any of the following events is detected:

- MME receives an SLs CONNECTION ORIENTED INFORMATION message (see TS 29.171 [54]) from E-SMLC to request the transfer of a LPPa request to the serving eNB for a target UE as part of a UE associated LPPa positioning activity. The LPPa request may be E-CID MEASUREMENT INITIATION REQUEST or OTDOA INFORMATION REQUEST.
- MME sends an SLs CONNECTION ORIENTED INFORMATION message to the E-SMLC to forward the LPPa response or report received from the eNB for a target UE. The LPPa response or report may be E-CID MEASUREMENT INITIATION RESPONSE, E-CID MEASUREMENT REPORT or OTDOA INFORMATION RESPONSE.
- MME receives an SLs CONNECTION ORIENTED INFORMATION message from E-SMLC to request the transfer of a LPP request to the target UE.
- MME sends an SLs CONNECTION ORIENTED INFORMATION message to E-SMLC to forward a LPP message received from the target UE.

Table 6.3.2-7A: Payload for MMEPositioningInfoTransfer record

Field name	Description	M/C/O
iMSI	IMSI associated with the location update.	M
iMEI	IMEI associated with the location update, if available.	C
mSISDN	MSISDN associated with the location update, if available as part of the subscription profile.	C
gUTI	GUTI assigned during the location update, if available, see TS 24.301 [50].	C
IPPaMessage	Any UE associated LPPa message exchanged between the LMF and eNB via MME.	C
IPPMMessage	Any LPP message exchanged between the E-SMLC and the target UE via MME.	C
mMELCSCorrelationId	MMELCSCorrelationId is made of Correlation Id, described in clause 7.4.28 of TS 29.171 [54], related to a location session, found in the SLs CONNECTION ORIENTED INFORMATION sent by E-SMLC to MME and corresponding SLs CONNECTION ORIENTED INFORMATION sent by MME to E-SMLC. All the MMEPositioningInfoTransfer records related to the same location session have the same CorrelationId.	M

6.3.2.3 Generation of IRI over LI_HI2

6.3.2.3.1 General

When Option A or Option B specified in clause 6.3.1 are used and an xIRI is received over LI_X2 from the IRI-POI in the MME, the MDF2 shall generate the corresponding IRI message and deliver it over LI_HI2 without undue delay. The IRI message shall contain a copy of the relevant record received in the xIRI over LI_X2.

When Option C specified in clause 6.3.1 is used the MDF2 shall generate IRI messages based on the proprietary information received from the MME and provide it over LI_HI2 without undue delay.

The IRI record may be enriched with any additional information available at the MDF (e.g. additional location information).

The IRI messages shall be delivered over LI_HI2 according to ETSI TS 102 232-7 [10] clause 10. When Option A specified in clause 6.3.1 is used, LI_HI2 shall be realised as described in clause 6.3.2.3.2.

When Option B or Option C specified in clause 6.3.1 is used, LI_HI2 shall be realised as described in clause 6.3.2.3.3.

6.3.2.3.2 Option A

The IRI message the MDF2 generates shall contain a copy of the relevant record received in the xIRI over LI_X2 and provide it over LI_HI2 without undue delay.

The timestamp field of the PSHeader structure shall be set to the time at which the MME event was observed (i.e. the timestamp field of the X2 PDU).

The IRI type parameter (see ETSI TS 102 232-1 [9] clause 5.2.10) shall be included and coded according to table 6.3.2-8.

Table 6.3.2-8: IRI type for IRI messages

IRI message	IRI type
MMEAttach	REPORT
MMEDetach	REPORT
MMELocationUpdate	REPORT
MMEStartOfInterceptionWithEPSAttachedUE	REPORT
MMEUnsuccessfulProcedure	REPORT
MMEIdentifierAssociation	REPORT
MMEPositioningInfoTransfer	REPORT

These IRI messages shall omit the CIN (see ETSI TS 102 232-1 [9] clause 5.2.4).

The threeGPP33128DefinedIRI field in ETSI TS 102 232-7 [10] clause 15 shall be populated with the BER-encoded IRIPayload.

When an additional warrant is activated on a target UE and the LIPF uses the same XID for the additional warrant, the MDF2 shall be able to generate and deliver the IRI message containing the MMESStartOfInterceptionWithEPSAttachedUE record to the LEMF associated with the additional warrant without receiving a corresponding xIRI. The payload of the MMESStartOfInterceptionWithEPSAttachedUE record is specified in table 6.3.2-6.

For records related to SMS over NAS in EPS, the process detailed in clause 6.3.2.3.3 shall be used.

6.3.2.3.3 Option B and Option C

For all messages except MMEIdentifierAssociation, the IRI messages shall include an IRI payload encoded according to TS 33.108 [12] Annex B.9.

The MDF2 shall encode the correct value of LIID in the IRI message, replacing the value "LIIDNotPresent" given in the xIRI (see clause 6.3.2.2).

For MMEIdentifierAssociation messages, the IRI message shall be encoded as an IRIEvent structure according to Annex B and used to populate the threeGPP33128DefinedIRI field in ETSI TS 102 232-7 [10] clause 15.

6.3.3 LI at SGW/PGW and ePDG

6.3.3.0 General

Unless otherwise specified, the following clauses apply to both CUPS and non-CUPS EPS architectures. When CUPS architecture is used, unless otherwise specified, the term SGW/PGW refers to both the SGW-U/PGW-U and the SGW-C/PGW-C.

Unless otherwise specified, the following clauses apply in the case of EPC-5GC interworking via combined SMF+PGW-C and UPF+PGW-U.

6.3.3.1 Provisioning over LI_X1

6.3.3.1.1 General

If the warrant is for IRI and CC, then the LI functions in the SGW/PGW shall be provisioned in accordance with clause 6.3.3.1.2 for non-CUPS architecture and clause 6.3.3.1.3 for CUPS architecture, the MDF2 shall be provisioned in accordance with clause 6.3.3.1.4, and the MDF3 shall be provisioned in accordance with clause 6.3.3.1.5.

If the warrant is for IRI only, the IRI-POI in the SGW/PGW shall be provisioned in accordance with clause 6.3.3.1.2 for non-CUPS architecture and clause 6.3.3.1.3 for CUPS architecture and the MDF2 shall be provisioned in accordance with clause 6.3.3.1.4. If approach 1 described in clause 6.2.3.9 is used for packet header information reporting:

- For non-CUPS architecture, the IRI-POI in the SGW/PGW shall be provisioned in accordance with clause 6.3.3.1.2 and the MDF2 shall be provisioned in accordance with clause 6.3.3.1.4.
- For CUPS architecture, the IRI-TF in the SGW-C/PGW-c shall be provisioned in accordance with clause 6.3.3.1.3 and the MDF2 shall be provisioned in accordance with clause 6.3.3.1.4.

If approach 2 described in clause 6.2.3.9 is used for packet header information reporting:

- For non-CUPS architecture, the CC-POI in the SGW/PGW shall be provisioned in accordance with clause 6.3.3.1.2, the MDF2 shall be provisioned in accordance with clause 6.3.3.1.4, and the MDF3 shall be provisioned in accordance with clause 6.3.3.1.5.
- For CUPS architecture, the CC-TF in the SGW-C/PGW-C shall be provisioned in accordance with clause 6.3.3.1.3, the MDF2 shall be provisioned in accordance with clause 6.3.3.1.4, and the MDF3 shall be provisioned in accordance with clause 6.3.3.1.5.

The LI functions in the SGW/PGW and ePDG, the MDF2 and the MDF3 shall support the following target identifier formats in the ETSI TS 103 221-1 [7] messages (or equivalent if ETSI TS 103 221-1 [7] is not used):

- IMSI.
- MSISDN (using the E164Number target identifier format from ETSI TS 103 221-1 [7]).
- IMEI.

In the case of EPC-5GC interworking via combined SMF+PGW-C and UPF+PGW-U, the LI functions in the SMF+PGW-C, MDF2 and MDF3 shall support the following target identifier formats in the ETSI TS 103 221-1 [7] messages (or equivalent if ETSI TS 103 221-1 [7] is not used):

- SUPINAI.
- SUPIIMSI.
- IMSI.
- GPSINAI.
- GPSIMSISDN.
- MSISDN (using the E164Number target identifier format from ETSI TS 103 221-1 [7]).
- PEIIMEISV.
- PEIIMEI.
- IMEI.

When the target identifier is an IMSI, the LI functions in the SMF+PGW-C shall also trigger when events associated to a SUPI in the form of an IMSI with a value matching the provisioned IMSI target identifier value are detected. Likewise, when the target identifier is a SUPIIMSI, the LI functions in the SMF+PGW-C shall also trigger when events associated to an IMSI with a value matching the provisioned SUPIIMSI target identifier value are detected.

When the target identifier is an MSISDN, the LI functions in the SMF+PGW-C shall also trigger when events associated to a GPSI in the form of an MSISDN with a value matching the provisioned MSISDN target identifier value are detected. Likewise, when the target identifier is a GPSIMSISDN, the LI functions in the SMF+PGW-C shall also trigger when events associated to an MSISDN with a value matching the provisioned GPSIMSISDN target identifier value are detected.

When the target identifier is an IMEI, the LI functions in the SMF+PGW-C shall also trigger when events associated to a PEI in the form of an IMEI with a value matching the provisioned IMEI target identifier value are detected. Likewise, when the target identifier is a PEIIMEI, the LI functions in the SMF+PGW-C shall also trigger when events associated to an IMEI with a value matching the provisioned PEIIMEI target identifier value are detected.

NOTE: When both a 4G identifier and its equivalent 5G identifier are provisioned by means of separate tasks in the LI functions present in the SMF+PGW-C, interception will be triggered independently for each of the two identifiers.

6.3.3.1.2 Non-CUPS Architecture

When the EPS is implemented using non-CUPS architecture, the IRI-POI and CC-POI present in the SGW/PGW and ePDG are provisioned over LI_X1 by the LIPF using the X1 protocol as described in clause 5.2.2. A single task may be used.

Table 6.3.3.1-1 shows the minimum details of the LI_X1 ActivateTask message used for provisioning the IRI-POI and the CC-POI in the SGW/PGW.

Table 6.3.3.1-1: ActivateTask message for the IRI-POI and CC-POI in the SGW/PGW and ePDG in non-CUPS architecture

ETSI TS 103 221-1 [7] field name	Description	M/C/O
XID	XID assigned by LIPF.	M
TargetIdentifiers	One of the target identifiers listed in the clause above.	M
DeliveryType	Set to "X2Only", "X3Only" or "X2andX3" as needed to meet the requirements of the warrant.	M
ListOfDIDs	Delivery endpoints of LI_X2 or LI_X3. These delivery endpoints shall be configured using the <i>CreateDestination</i> message as described in ETSI TS 103 221-1 [7] clause 6.3.1 prior to first use.	M
TaskDetailsExtensions/ HeaderReporting	Header reporting-specific tag to be carried in the <i>TaskDetailsExtensions</i> field of ETSI TS 103 221-1 [7]. See table 6.2.3.9.2-1. Unless there is a CSP/LEA agreement to not report packet header information, this field shall be present to enable packet header information reporting.	C

To enable packet header information reporting, parameters specified in table 6.2.3.9.2-1: PDHRReportingExtensions parameters shall be provided as the TaskDetailsExtensions/HeaderReporting field of the LI_X1 provisioning message.

6.3.3.1.3 CUPS Architecture

When the EPS is implemented using CUPS architecture, the IRI-POI, IRI-TF and CC-TF present in the SGW-C/PGW-C and the IRI-POI and CC-POI present in the ePDG are provisioned over LI_X1 by the LIPF using the X1 protocol as described in clause 5.2.2.

Table 6.3.3.1-2 shows the minimum details of the LI_X1 ActivateTask message used for provisioning the IRI-POI, CC-TF and IRI-TF in the SGW-C/PGW-C. If the ePDG is used, the minimum details of the LI_X1 ActivateTask message used for provisioning the IRI-POI and the CC-POI in the ePDG are detailed in Table 6.3.3.1-1.

Table 6.3.3.1-2: ActivateTask message for the IRI-POI, CC-TF and IRI-TF in the SGW-C/PGW-C in CUPS architecture

ETSI TS 103 221-1 [7] field name	Description	M/C/O
XID	XID assigned by LIPF. If the CC-TF or IRI-TF is also being tasked for the same interception, the same XID shall be used.	M
TargetIdentifiers	One or more of the target identifiers listed in clause 6.3.3.1.1.	M
DeliveryType	Set to "X2Only", "X3Only" or "X2andX3" as needed to meet the requirements of the warrant. NOTE: "X2Only" for IRI-POI, IRI-TF and "X3Only" for CC-TF can also be also be used.	M
TaskDetailsExtensions/ HeaderReporting	Header reporting-specific tag to be carried in the <i>TaskDetailsExtensions</i> field of ETSI TS 103 221-1 [7]. See table 6.2.3.9.2-1. Unless there is a CSP/LEA agreement to not report packet header information, this field shall be present to enable packet header information reporting.	C
ListOfDIDs	Delivery endpoints of LI_X2 or LI_X3. These delivery endpoints shall be configured using the <i>CreateDestination</i> message as described in ETSI TS 103 221-1 [7] clause 6.3.1 prior to first use.	M

To enable packet header information reporting, parameters specified in table 6.2.3.9.2-1: PDHRReportingExtensions parameters shall be provided as the TaskDetailsExtensions/HeaderReporting field of the LI_X1 provisioning message.

6.3.3.1.4 Provisioning of the MDF2

The MDF2 listed as the delivery endpoint for xIRI generated by the IRI-POI in the CP entity of the SGW/PGW or ePDG shall be provisioned over LI_X1 by the LIPF using the X1 protocol as described in clause 5.2.2. Table 6.3.3.1-3 shows the minimum details of the LI_X1 ActivateTask message used for provisioning the MDF2.

Table 6.3.3.1-3: ActivateTask message for MDF2

ETSI TS 103 221-1 [7] field name	Description	M/C/O
XID	XID assigned by LIPF.	M
TargetIdentifiers	One or more of the target identifiers listed in the paragraph above.	M
DeliveryType	Set to "X2Only", "X3Only" or "X2andX3" as needed to meet the requirements of the warrant. (Ignored by the MDF2).	M
TaskDetailsExtensions/ HeaderReporting	Header reporting-specific tag to be carried in the <i>TaskDetailsExtensions</i> field of ETSI TS 103 221-1 [7]. See table 6.2.3.9.2-1. Unless there is a CSP/LEA agreement to not report packet header information, this field shall be present to enable packet header information reporting.	C
ListOfDIDs	Delivery endpoints of LI_HI2. These delivery endpoints shall be configured using the <i>CreateDestination</i> message as described in ETSI TS 103 221-1 [7] clause 6.3.1 prior to first use.	M
ListOfMediationDetails	Sequence of Mediation Details, See Table 6.3.3.1-4.	M

Table 6.3.3.1-4: Mediation Details for MDF2

ETSI TS 103 221-1 [7] field name	Description	M/C/O
LIID	Lawful Intercept ID associated with the task.	M
DeliveryType	Set to "HI2Only".	M
ListOfDIDs	Details of where to send the IRI for this LIID. Shall be included if deviation from the ListOfDIDs in the ActivateTask message is necessary. If included, the ListOfDIDs in the Mediation Details shall be used instead of any delivery destinations authorised by the ListOfDIDs field in the ActivateTask Message.	C
ServiceScoping	Shall be included to identify the service(s) and associated service-related delivery settings for this LIID. May include more than one instance of this parameter to allow for different combinations of subparameters associated with a single LIID. This parameter is defined in ETSI TS 103 221-1 [7], Annex C, table C.2.	C
MediationDetailsExtensions/ HeaderReporting	Header reporting-specific tag to be carried in the <i>MediationDetailsExtensions</i> field of ETSI TS 103 221-1 [7]. See table 6.2.3.9.2-1. This field shall be included if deviation from the taskDetails HeaderReporting TaskDetailsExtensions is required. If included, the details shall be used instead of the HeaderReporting instructions specified in the HeaderReporting field in the TaskDetails structure.	C

6.3.3.1.5 Provisioning of the MDF3

The MDF3 listed as the delivery endpoint for the xCC generated by the CC-POI in the UP entity of the SGW/PGW or ePDG shall be provisioned over LI_X1 by the LIPF using the X1 protocol as described in clause 5.2.2. Table 6.3.3.1-5 shows the minimum details of the LI_X1 ActivateTask message used for provisioning the MDF3. If packet header reporting is authorised and approach 2 described in clause 6.2.3.9 is used, the endpoint for the MDF3 shall be the MDF2 over LI_MDF.

Table 6.3.3.1-5: ActivateTask message for MDF3

ETSI TS 103 221-1 [7] field name	Description	M/C/O
XID	XID assigned by LIPF.	M
TargetIdentifiers	One or more of the target identifiers listed in the paragraph above.	M
DeliveryType	Set to "X2Only", "X3Only" or "X2andX3" as needed to meet the requirements of the warrant.	M
TaskDetailsExtensions/ HeaderReporting	Header reporting-specific tag to be carried in the <i>TaskDetailsExtensions</i> field of ETSI TS 103 221-1 [7]. See table 6.2.3.9.2-1. Unless there is a CSP/LEA agreement to not report packet header information, this field shall be present to enable packet header information reporting.	C
ListOfDIDs	Delivery endpoints of LI_HI3 or LI_MDF. These delivery endpoints shall be configured using the <i>CreateDestination</i> message as described in ETSI TS 103 221-1 [7] clause 6.3.1 prior to first use.	M
ListOfMediationDetails	Sequence of Mediation Details, See table 6.3.3.1-6.	M

Table 6.3.3.1-6: Mediation Details for MDF3

ETSI TS 103 221-1 [7] field name	Description	M/C/O
LIID	Lawful Intercept ID associated with the task.	M
DeliveryType	Set to "HI3Only".	M
ListOfDIDs	Details of where to send the CC for this LIID. Shall be included if deviation from the ListofDIDs in the ActivateTask message is necessary. If included, the ListOfDIDs in the Mediation Details shall be used instead of any delivery destinations authorised by the ListOfDIDs field in the ActivateTask Message.	C
ServiceScoping	Shall be included to Identify the service(s) and associated service-related delivery settings for this LIID. May include more than one instance of this parameter to allow for different combinations of subparameters associated with a single LIID. This parameter is defined in ETSI TS 103 221-1 [7], Annex C, table C.2.	C
MediationDetailsExtensions/ HeaderReporting	Header reporting-specific tag to be carried in the MediationDetailsExtensions field of ETSI TS 103 221-1 [7]. See table 6.2.3.9.2-1. This field shall be included if deviation from the taskDetails HeaderReporting TaskDetailsExtensions is required. If included, the details shall be used instead of the HeaderReporting instructions specified in the HeaderReporting field in the TaskDetails structure.	C

6.3.3.2 Generation of xIRI over LI_X2

6.3.3.2.1 General

When Option A specified in clause 6.3.1 is used:

- For architectures with EPC/5GC interworking:
 - For home routed roaming interception in the visited network, in this version of the specification, the IRI-POI present in the SGW shall be implemented in accordance with Option B or Option C specified in clause 6.3.1.
 - For all other cases, the IRI-POI present in the SMF+PGW-C shall send the xIRIs over LI_X2 for each of the events listed in TS 33.127 [5] clause 6.3.3.3.1.2, as described in clause 6.3.1.
 - As described in TS 23.501 [2] clause 5.32.7.1, a PDN Connection in EPS can be one leg of an MA PDU session. The details of the messages for single-access PDU sessions are provided in clauses 6.3.3.2.2, 6.3.3.2.3, 6.3.3.2.4 and 6.3.3.2.5. The details for the messages for MA PDU sessions are provided in clauses 6.3.3.2.6, 6.3.3.2.7, 6.3.3.2.8 and 6.3.3.2.9.

NOTE: The details of the events triggers used to generate the xIRIs are specified at high-level in support of possible hitherto implementation variations for EPS LI.

When Option B specified in clause 6.3.1 is used:

- The IRI-POI present in the SGW/PGW and ePDG shall send the xIRIs over LI_X2 for each of the events listed in TS 33.107 [36] clause 12.2.1.2, the details of which are specified in clause 12.2.3 of the same TS.
- The IRI-POI present in the SGW/PGW and ePDG shall set the payload format to EpsHI2Operations.EpsIRIContent (value 14), see clause 5.3 and ETSI TS 103 221-2 [8] clause 5.4. The payload field shall contain an EpsHI2Operations.EpsIRIContent structure encoded according to TS 33.108 [12] clauses 10.5 and B.9.
- As the LIID may not be available at the SGW/PGW and ePDG but is mandatory in EpsHI2Operations.EpsIRIContent according to TS 33.108 [12] Annex B.9, its value in the lawfulInterceptionIdentifier field of the encoded PDU shall be set to the fixed string "LIIDNotPresent".

6.3.3.2.2 PDU Session Establishment message reporting PDU session establishment or PDN Connection establishment

The IRI-POI in the SMF+PGW-C shall generate an xIRI containing an SMFSDUSessionEstablishment record (see clause 6.2.3.2.2) when the IRI-POI present in the SMF+PGW-C detects that a single-access PDU Session or PDN

Connection has been established for the target UE. The IRI-POI present in the SMF+PGW-C shall generate the xIRI for the following events:

- The SMF+PGW-C creates a new PDN Connection in the target UE context of the SMF+PGW-C (see TS 23.401 [50] clause 5.7.4).
- The SMF+PGW-C creates a new PDU Session context or SM Context for the target UE (see TS 29.502 [16] clause 5.2.2.2 and clause 5.2.2.7).

When the SMF PDUSessionEstablishment record (see clause 6.2.3.2.2) is used to report the creation of a new PDN Connection:

- The ePSPDNConnectionEstablishment field shall be populated with the information in Table 6.3.3-1.
- If there is no SUPI associated to the SM context for the target UE, the SUPI field of the SMF PDUSessionEstablishment record shall be populated with the value of the IMSI from the target UE context.
- If there is no PDU Session ID present in the PCO of the request or response messages or associated to the context for the PDN connection, the pDUSessionID field of the SMF PDUSessionEstablishment record shall be populated with the EBI of the default bearer for the PDN Connection.
- If there is no 5G UP tunnel present in the context associated to the PDN Connection, the gTPTunnelID field of the SMF PDUSessionEstablishment record shall be populated with the F-TEID for the PGW S5 or S8 interface for the default bearer of the PDN Connection.

Table 6.3.3-1: Payload for ePSPDNConnectionEstablishment Field

Field name	Description	M/C/O
ePSSubscriberIDs	EPS Subscriber Identities associated with the PDN connection (e.g. as provided by the MME or SGW in the associated Create Session Request or as associated with the PDN connection in the context known at the NF). The IMSI shall be present except for unauthenticated emergency sessions.	M
iMSIUnauthenticated	Shall be present if an IMSI is present in the ePSSubscriberIDs and set to "true" if the IMSI has not been authenticated, or "false" if it has been authenticated.	C
defaultBearerID	Shall contain the EPS Bearer Identity of the default bearer associated with the PDN connection.	M
gTPTunnelInfo	Contains the information for the Control Plane GTP Tunnels present in the Create Session Request or known in the context at the SGW or PGW. See Table 6.2.3-1B.	C
pDNConnectionType	Identifies selected PDN session type, see TS 29.274 [87] clause 8.34.	M
uEEndpoints	UE endpoint address(es) if available. Derived from the PDN Address portion of the PDN Address Allocation parameter (see TS 29.274 [87] clause 8.14) present in the Create Session Request or the IP Address associated to the PDN Connection in the context known at the NF (see TS 23.401 [50] clauses 5.7.3 and 5.7.4).	C
non3GPPAccessEndpoint	UE's local IP address used to reach the ePDG, if present in the Create Session Request (see TS 29.274 [87], clause 7.2.1) or known at the context at the SGW or PGW.	C
location	Location information present in the Create Session Request (see TS 29.274 [87], clause 7.2.1) or known in the context at the SGW or PGW.	C
additionalLocation	Additional location information present in the Create Session Request, known in the context at the SGW or PGW, or known at the MDF.	C
aPN	Access Point Name associated with the PDN connection present in the Create Session Request (see TS 29.274 [87] clauses 7.2.1 and 8.6) or known at the context at the SGW or PGW (see TS 23.401 [50] clause 5.6.4), as defined in TS 23.003[19] clause 9.1.	M
requestType	Type of request as derived from the Request Type described in TS 24.301 [50] clause 9.9.4.14 and TS 24.008 [93] clause 10.5.6.17, if available.	C
accessType	Access type associated with the PDN connection (i.e. 3GPP or non-3GPP access). Shall be set to nonThreeGPPAccess by the ePDG or by the PGW when the Create Session Request for the PDN connection is received from an ePDG. Shall be set to threeGPPAccess by the SGW or by the PGW when the Create Session Request for the PDN connection is received from an SGW.	C
rATType	RAT Type associated with the PDN connection. Shall be present if included in the Create Session Request (see TS 29.274 [87] clause 7.2.1) or known at the context at the SGW or PGW (see TS 23.401 [50] clause 5.6.4).	C
protocolConfigurationOptions	Shall be present if the Create Session Request or the Create Session Response (see TS 29.274 [87] clause 7.2.2 and clause 7.2.3) contains the Protocol Configuration, Additional Protocol Configuration Options or extended Protocol Configuration Options IE. See Table 6.3.3-4.	C
servingNetwork	Shall be present if this IE is in the Create Session Request or the context for the PDN connection at the SGW/PGW.	C
sMPDUDNRequest	Contents of the SM PDU DN Request container, if available, as described in TS 24.501 [13] clause 9.11.4.15.	C
bearerContextsCreated	Shall include a list of the Bearer Contexts created sent in the Create Session Response message (see TS 29.274 [87] clause 7.2.2). See Table 6.3.3-2.	M
bearerContextsMarkedForRemoval	Shall include a list of the Bearer Contexts to be removed sent in the Create Session Response message (see TS 29.274 [87] clause 7.2.2). See Table 6.3.3-3.	C
indicationFlags	Shall be included if the Indication Flags field is present in the Create Session Request (see TS 29.274 [87] clause 7.2.1). The value of this parameter shall be set to the value of the Indication IE (see TS 29.274 [87] clause 8.12) starting with octet 5.	C
handoverIndication	Shall be present if the Handover Indication is set to 1 in the Create Session Request (see TS 29.274 [87] clauses 7.2.1 and 8.12).	C
nBIFOMSupport	Shall be present if the NBIFOM Support Indication is set to 1 in the Create Session Request (see TS 29.274 [87] clauses 7.2.1 and 8.12).	C
fiveGSInterworkingInfo	Shall be present if the 5GS Interworking Indication is present in the Create Session Request (see TS 29.274 [87] clauses 7.2.1 and 8.12). See Table 6.3.3-5.	C

cSRMFI	Shall be present if the Create Session Request Message Forwarded Indication (CSRMF) is present in the Create Session Request (see TS 29.274 [87] clauses 7.2.1 and 8.12). Indicates the Create Session Request message has been forwarded by a PGW.	C
restorationOfPDNConnectionsSupport	Shall be present if the Restoration of PDN connection after an PGW-C/SMF Change Support Indication is present in the Create Session Request (see TS 29.274 [87] clauses 7.2.1 and 8.12).	C
pGWChangeIndication	Shall be present if the PGW Change Indication is present in the Create Session Request (see TS 29.274 [87] clauses 7.2.1 and 8.12).	C
pGWRNSI	Shall be present if the PGW Redirection due to mismatch with Network Slice subscribed by the UE Support Indication is present in the Create Session Request (see TS 29.274 [87] clauses 7.2.1 and 8.12).	C

Table 6.3.3-2: Payload for bearerContextsCreated Field

Field name	Description	M/C/O
ePSBearerID	Shall include the EPS bearer ID for the EPS Bearer (See TS 29.274 [87] clauses 7.2.2 and 7.2.4).	M
cause	Shall indicate whether the bearer handling was successful and if not, it gives information on the reason (see TS 29.274 [87] clause 7.2.2 and 7.2.4). Sent as an integer cause value (see TS 29.274 [87] Table 8.4-1)	M
gTPTunnelInfo	Contains the information for the User Plane GTP Tunnels for the bearer context if present in the Request or Response (see TS 29.274 [87] clauses 7.2.2, 7.2.4 and 8.15) or known at the context at the SGW or PGW (see TS 23.401 [50] clause 5.6.4). See Table 6.2.3-1B.	C
bearerQOS	Shall include the QOS information for the bearer if present in the Request or Response (see TS 29.274 [87] clauses 7.2.2, 7.2.15 and 8.15) or known at the context at the SGW or PGW (see TS 23.401 [50] clause 5.6.4). See Table 6.3.3-7.	C
protocolConfigurationOptions	Shall be present if the Bearer Context reported (see TS 29.274 [87] clauses 7.2.2, 7.2.3, and 7.2.4) contains the Protocol Configuration, Additional Protocol Configuration Options or extended Protocol Configuration Options IE. See Table 7.6.3.3-4.	C

Table 6.3.3-3: Payload for bearerContextsMarkedForRemoval Field

Field name	Description	M/C/O
ePSBearerID	Shall include the EPS bearer ID for the EPS Bearer (See TS 29.274 [87] clause 7.2.2, 7.2.8 and 7.2.10).	M
cause	Shall indicate whether the bearer handling was successful and if not, it gives information on the reason (see TS 29.274 [87] clause 7.2.2, 7.2.8 and 7.2.10).	M

Table 6.3.3-4: Payload for protocolConfigurationOptions Field

Field name	Description	M/C/O
requestPCO	Shall be present if the Protocol Configuration Options IE is present in the request message. The value of this parameter shall contain a copy of the value field of the PCO IE of the request message (see 29.274 [87] clause 8.13 starting with octet 5).	C
requestAPCO	Shall be present if the Additional Protocol Configuration Options IE is present in the request message. The value of this parameter shall contain a copy of the value field of the PCO IE of the request message (see 29.274 [87] clause 8.94 starting with octet 5).	C
requestEPCO	Shall be present if the Extended Protocol Configuration Options IE is present in the request message. The value of this parameter shall contain a copy of the value field of the PCO IE of the request message (see 29.274 [87] clause 8.128 starting with octet 5).	C
responsePCO	Shall be present if the Protocol Configuration Options IE is present in the response message. The value of this parameter shall contain a copy of the value field of the PCO IE of the response message (see 29.274 [87] clause 8.13 starting with octet 5).	C
responseAPCO	Shall be present if the Additional Protocol Configuration Options IE is present in the response message. The value of this parameter shall contain a copy of the value field of the PCO IE of the response message (see 29.274 [87] clause 8.94 starting with octet 5).	C
responseEPCO	Shall be present if the Extended Protocol Configuration Options IE is present in the response message. The value of this parameter shall contain a copy of the value field of the PCO IE of the response message (see 29.274 [87] clause 8.128 starting with octet 5).	C

Table 6.3.3-5: Payload for fiveGSInterworkingInfo Field

Field name	Description	M/C/O
fiveGSInterworkingIndicator	Shall be set to TRUE if the 5GSIWKI flag in the Indication IE of the request or response is set to 1. Indicates that the UE supports N1 mode and the PDN connection is not restricted from interworking by the 5GS user subscription. See TS 29.274 [87] clauses 7.2.1 and 8.12.	M
fiveGSInterworkingWithoutN26	Shall be set to TRUE if the 5GS Interworking without N26 Indication flag in the Indication IE of the request or response is set to 1. If the 5GS Interworking without N26 Indication flag in the Indication IE of the request or response is set to 0 or not present, this parameter shall be set to FALSE. See TS 29.274 [87] clauses 7.2.1 and 8.12.	M
fiveGCNotRestrictedSupport	Shall be set to True if the 5GCNRS (5GC Not Restricted Support) flag in the Indication IE of the request or response is set to 1. If the 5GCNRS flag in the Indication IE of the request or response is set to 0 or not present, this parameter shall be set to FALSE. See TS 29.274 [87] clauses 7.2.1 and 8.12.	M

Table 6.3.3-6: Payload for ePSGTPTunnels Field

Field name	Description	M/C/O
controlPlaneSenderFTEID	Shall include the Sender F-TEID for the control plane if present in the Request or response (See TS 29.274 [87] clause 7.2.1, 7.2.2, 7.2.3, 7.2.4, 7.2.7, 7.2.8, 7.2.15, 7.2.16) or known in the context at the SGW or PGW.	C
controlPlanePGWS5S8FTEID	Shall include the PGW F-TEID for the control plane if present in the Request or response (See TS 29.274 [87] clause 7.2.1, 7.2.2, 7.2.3, 7.2.4, 7.2.7, 7.2.8, 7.2.15, 7.2.16) or known in the context at the SGW or PGW.	C
s1UeNodeBFTEID	Shall include the F-TEID for the eNodeB S1-U interface for the bearer if present in the Request or response (See TS 29.274 [87] clause 7.2.1, 7.2.2, 7.2.3, 7.2.4, 7.2.7, 7.2.8, 7.2.15, 7.2.16) or known in the context at the SGW or PGW.	C
s5S8SGWFTEID	Shall include the F-TEID for the SGW S5 or S8 interface for the bearer if present in the Request or response (See TS 29.274 [87] clause 7.2.1, 7.2.2, 7.2.3, 7.2.4, 7.2.7, 7.2.8, 7.2.15, 7.2.16) or known in the context at the SGW or PGW.	C
s5S8PGWFTEID	Shall include the F-TEID for the PGW S5 or S8 interface for the bearer if present in the Request or response (See TS 29.274 [87] clause 7.2.1, 7.2.2, 7.2.3, 7.2.4, 7.2.7, 7.2.8, 7.2.15, 7.2.16) or known in the context at the SGW or PGW.	C
s2bUePDGFTEID	Shall include the F-TEID for the ePDG on the S2b-U interface for the bearer if present in the Request or response (See TS 29.274 [87] clause 7.2.1, 7.2.2, 7.2.3, 7.2.4, 7.2.7, 7.2.8, 7.2.15, 7.2.16) or known in the context at the PGW or ePDG.	C
s2aUePDGFTEID	Shall include the F-TEID for the ePDG on the S2a-U interface for the bearer if present in the Request or response (See TS 29.274 [87] clause 7.2.1, 7.2.2, 7.2.3, 7.2.4, 7.2.7, 7.2.8, 7.2.15, 7.2.16) or known in the context at the PGW or ePDG.	C

Table 6.3.3-7: Payload for bearerQOS Field

Field name	Description	M/C/O
qCl	Shall include the QCI for the bearer if present in the Request or response (See TS 29.274 [87] clause 7.2.1, 7.2.2, 7.2.3 and 7.2.15), or known in the context at the SGW or PGW.	C
maximumUplinkBitRate	Shall include the maximum uplink bitrate encoded as kilobits per second in binary value (see TS 29.274 [87] clause 8.15) if present in the Request or response (See TS 29.274 [87] clause 7.2.1, 7.2.2, 7.2.3 and 7.2.15), or known in the context at the SGW or PGW.	C
maximumDownlinkBitRate	Shall include the maximum downlink bitrate encoded as kilobits per second in binary value (see TS 29.274 [87] clause 8.15) if present in the Request or response (See TS 29.274 [87] clause 7.2.1, 7.2.2, 7.2.3 and 7.2.15), or known in the context at the SGW or PGW.	C
guaranteedUplinkBitRate	Shall include the guaranteed uplink bitrate encoded as kilobits per second in binary value (see TS 29.274 [87] clause 8.15) if present in the Request or response (See TS 29.274 [87] clause 7.2.1, 7.2.2, 7.2.3 and 7.2.15), or known in the context at the SGW or PGW.	C
guaranteedDownlinkBitRate	Shall include the guaranteed downlink bitrate encoded as kilobits per second in binary value (see TS 29.274 [87] clause 8.15) if present in the Request or response (See TS 29.274 [87] clause 7.2.1, 7.2.2, 7.2.3 and 7.2.15), or known in the context at the SGW or PGW.	C
priorityLevel	Shall include the priority level assigned to the bearer as an integer value (see TS 29.274 [87] clause 8.15) if present in the Request or response (See TS 29.274 [87] clause 7.2.1, 7.2.2, 7.2.3 and 7.2.15), or known in the context at the SGW or PGW.	C

6.3.3.2.3 PDU Session Modification message reporting PDU session modification, PDN Connection modification or inter-system handover

The IRI-POI in the SMF+PGW-C shall generate an xIRI containing an SMF-PDU-Session-Modification record (see clause 6.2.3.2.3) when the IRI-POI present in the SMF+PGW-C detects that a single-access PDU Session or PDN Connection has been modified for the target UE. The IRI-POI present in the SMF+PGW-C shall generate the xIRI for the following events:

- The SMF+PGW-C modifies an existing PDN Connection in the target UE context of the SMF+PGW-C (see TS 23.401 [50] clause 5.7.4).
- The SMF+PGW-C modifies an existing PDU Session context or SM Context for the target UE (see TS 29.502 [16] clause 5.2.2.3 and clause 5.2.2.8).
- The SMF+PGW-C transfers an existing PDU Session to EPS (see TS 23.502 [4] clauses 4.11.1.2.1 and 4.11.2.2).
- The SMF+PGW-C transfers an existing PDN Connection to 5GS (see TS 23.502 [4] clauses 4.11.1.2.2 and 4.11.2.3).

When the SMF PDUSessionModification record (see clause 6.2.3.2.3) is used to report the modification of a PDN Connection:

- The ePSPDNConnectionModification field shall be populated with the information in Table 6.3.3-8.
- If there is no SUPI associated to the SM context for the target UE, the SUPI field of the SMF PDUSessionModification record shall be populated with the value of the IMSI from the target UE context.
- If there is no PDU Session ID present in the PCO of the request or response messages or associated to the context for the PDN connection, the pDUSessionID field of the SMF PDUSessionModification record shall be populated with the EBI of the default bearer for the PDN Connection.
- If there is no 5G UP tunnel present in the context associated to the PDN Connection, the gTPTunnelID field of the SMF PDUSessionModification record shall be populated with the F-TEID for the PGW S5 or S8 interface for the default bearer of the PDN Connection.

Table 6.3.3-8: Payload for ePSPDNConnectionModification Field

Field name	Description	M/C/O
ePSSubscriberIDs	EPS Subscriber Identities associated with the PDN connection (e.g. as provided by the MME or SGW in the associated network message or as associated with the PDN connection in the context known at the NF). The IMSI shall be present except for unauthenticated emergency sessions.	M
iMSIUnauthenticated	Shall be present if an IMSI is present in the ePSSubscriberIDs and set to "true" if the IMSI has not been authenticated, or "false" if it has been authenticated.	C
defaultBearerID	Shall contain the EPS Bearer Identity of the default bearer associated with the PDN connection.	M
gTPTunnelInfo	Contains the information for the Control Plane GTP Tunnels present in the network message or known in the context at the SGW or PGW. See Table 6.2.3-1B. If the gTPTunnelInfo received in the network message is different than the gTPTunnelInfo in the context for the PDN Connection, this message shall be populated with the new information.	C
pDNConnectionType	Identifies selected PDN session type, see TS 29.274 [13] clause 8.34.	M
uEEndpoints	UE endpoint address(es) if available. Derived from the PDN Address portion of the PDN Address Allocation parameter (see TS 29.274 [87] clause 8.14) present in the network message or the IP Address associated to the PDN Connection in the context known at the NF (see TS 23.401 [50] clauses 5.7.3 and 5.7.4).	C
non3GPPAccessEndpoint	UE's local IP address used to reach the ePDG, if present in the network message (see TS 29.274 [87], clauses 7.2.4, 7.2.7 and 7.2.16) or known at the context at the SGW or PGW.	C
location	Location information present in the network message (see TS 29.274 [87], clause 8.21) or known in the context at the SGW or PGW.	C
additionalLocation	Additional location information present in the network message, known in the context at the SGW or PGW, or known at the MDF.	C
aPN	Access Point Name associated with the PDN connection present in the network message (see TS 29.274 [87] clause 8.6) or known at the context at the SGW or PGW (see TS 23.401 [50] clause 5.6.4), as defined in TS 23.003[19] clause 9.1.	M
requestType	Type of request as derived from the Request Type described in TS 24.301 [50] clause 9.9.4.14 and TS 24.008 [93] clause 10.5.6.17, if available.	C
accessType	Access type associated with the PDN connection (i.e. 3GPP or non-3GPP access).	C
rATType	RAT Type associated with the PDN connection. Shall be present if included in the network message (see TS 29.274 [87] clauses 7.2.3, 7.2.4, 7.2.7, 7.2.8, 7.2.9, 7.2.10, 7.2.15 and 7.2.16) or known at the context at the SGW or PGW (see TS 23.401 [50] clause 5.6.4).	C
protocolConfigurationOptions	Shall be present if the network message (see TS 29.274 [87]) contains the Protocol Configuration Options, Additional Protocol Configuration Options or extended Protocol Configuration Options IE. See Table 6.3.3-4.	C
servingNetwork	Shall be present if this IE is in the network message or the context for the PDN connection at the SGW/PGW.	C
sMPDUDNRequest	Contents of the SM PDU DN Request container, if available, as described in TS 24.501 [13] clause 9.11.4.15.	C
bearerContextsCreated	Shall include a list of the Bearer Contexts created if the event that resulted in the generation of the message was the activation of a dedicated Bearer. Shall contain the contents of the Bearer Context field of the Create Bearer Response message (see TS 29.274 [87] clause 7.2.4). See Table 6.3.3-2.	C
bearerContextsModified	If the event that resulted in the generation of the message was the modification of an existing bearer, shall be populated from the contents of the Bearer Contexts Modified field of the Modify Bearer Response message (see TS 29.274 [87] clause 7.2.8) or the Bearer Contexts within the Update Bearer Response message (see TS 29.274 [87] clause 7.2.16). If the event that resulted in the generation of the message was the establishment or release of a dedicated bearer context, then this field shall be populated with the information for the default bearer. See Table 6.3.3-9.	M
bearerContextsMarkedForRemoval	Shall include a list of the Bearer Contexts to be removed if the event that resulted in the generation of the message included the removal of an existing bearer. (see TS 29.274 [87] clause 7.2.8 and 7.2.10). See Table 6.3.3-3.	C
bearersDeleted	Shall include a list of the Bearers to be deleted if the event that resulted in the generation of the message included a Delete Bearer Request or Response. (see TS 29.274 [87] clauses 7.2.9 and 7.2.10). See Table 6.3.3-10	C

indicationFlags	Shall be included if the Indication Flags field is present in the network message (see TS 29.274 [87] clauses 7.2.3, 7.2.4, 7.2.7, 7.2.8, 7.2.9, 7.2.10, 7.2.15 and 7.2.16). The value of this parameter shall be set to the value of the Indication IE (see TS 29.274 [87] clause 8.12) starting with octet 5.	C
handoverIndication	Shall be present if the Handover Indication is set to 1 in the Modify Bearer Request (see TS 29.274 [87] clauses 7.2.7 and 8.12).	C
nBIFOMSupport	Shall be present if the NBIFOM Support Indication is set to 1 in the message that triggered the generation of the xIRI or known at the context (see TS 29.274 [87] clauses 7.2.1, 7.2.7 and 8.12).	C
fiveGSInterworkingInfo	Shall be present if the 5GS Interworking Indication is present in the Create Session Request (see TS 29.274 [87] clauses 7.2.1 and 8.12). See Table 6.3.3-5.	C
cSRMFI	Shall be present if the Create Session Request Message Forwarded Indication (CSRMI) is present in the Create Session Request (see TS 29.274 [87] clauses 7.2.1 and 8.12). Indicates the Create Session Request message has been forwarded by a PGW.	C
restorationOfPDNConnectionsSupport	Shall be present if the Restoration of PDN connection after an PGW-C/SMF Change Support Indication is present in the message that triggered the generation of the xIRI or known at the context (see TS 29.274 [87] clauses 7.2.1, 7.2.7 and 8.12).	C
pGWChangeIndication	Shall be present if the PGW Change Indication is present in the Create Session Request (see TS 29.274 [87] clauses 7.2.1 and 8.12).	C
pGWRNSI	Shall be present if the PGW Redirection due to mismatch with Network Slice subscribed by the UE Support Indication is present in the Create Session Request (see TS 29.274 [87] clauses 7.2.1 and 8.12).	C

Table 6.3.3-9: Payload for bearerContextsModified Field

Field name	Description	M/C/O
ePSBearerID	Shall include the EPS bearer ID for the EPS Bearer (See TS 29.274 [87] clauses 7.2.7, 7.2.8, 7.2.15 and 7.2.16).	M
cause	Shall indicate whether the bearer handling was successful and if not, it gives information on the reason (See TS 29.274 [87] clauses 7.2.7, 7.2.8, 7.2.15 and 7.2.16). Sent as an integer cause value (see TS 29.274 [87] Table 8.4-1)	M
gTPTunnelInfo	Contains the information for the User Plane GTP Tunnels for the bearer context if present in the Request or Response (see TS 29.274 [87] clauses 7.2.7, 7.2.8, 7.2.15, 7.2.16 and 8.15) or known at the context at the SGW or PGW (see TS 23.401 [50] clause 5.6.4). See Table 6.2.3-1B.	C
bearerQOS	Shall include the QOS information for the bearer if present in the Request or Response (see TS 29.274 [87] clauses 7.2.7, 7.2.8, 7.2.15, 7.2.16 and 8.15) or known at the context at the SGW or PGW (see TS 23.401 [50] clause 5.6.4). See Table 6.3.3-7.	C
protocolConfigurationOptions	Shall be present if the Bearer Context reported (see TS 29.274 [87] clauses 7.2.7, 7.2.8, 7.2.15, 7.2.16 and 8.15) contains the Protocol Configuration, Additional Protocol Configuration Options or extended Protocol Configuration Options IE. See Table 6.3.3-4.	C
linkedEPSBearerIDs	Shall be present if there are any linked EPS bearers. If the bearer context being reported is the default bearer, then this list shall be populated with all dedicated bearers linked to that default bearer. If the bearer being reported is a dedicated bearer, then this field shall be populated with the default bearer.	C

Table 6.3.3-10: Payload for bearersDeleted Field

Field name	Description	M/C/O
linkedEPSBearerID	Shall include the EBI for the default bearer associated with the PDN being disconnected if all bearers belonging to a PDN connection are being released (See TS 29.274 [87] clause 7.2.9).	C
ePSBearerIDs	Shall include a list of the EPS Bearer IDs to be deleted if only some of the EPS Bearers belonging to a PDN Connection are being released(See TS 29.274 [87] clause 7.2.9).	C
protocolConfigurationOptions	Shall be present if the Delete Bearer Request or Response reported (see TS 29.274 [87] clauses 7.2.9) contains the Protocol Configuration, Additional Protocol Configuration Options or extended Protocol Configuration Options IE. See Table 6.3.3-4.	C
cause	Shall indicate the reason the EPS Bearers are being deleted (See TS 29.274 [87] clause 7.2.9). Sent as an integer cause value (see TS 29.274 [87] Table 8.4-1)	C
deleteBearerResponse	Shall contain information from the Delete Bearer Response (See TS 29.274[87] clause 7.2.10). See Table 6.3.3-11.	M

Table 6.3.3-11: Payload for deleteBearerResponse Field

Field name	Description	M/C/O
cause	Indicates whether the bearers requested for deletion were successfully deleted (See TS 29.274 [87] clause 7.2.10).	M
linkedEPSBearerID	Shall include the EBI for the default bearer associated with the PDN being disconnected if all bearers belonging to a PDN connection are being released (See TS 29.274 [87] clause 7.2.10).	C
bearerContexts	Shall include a list of the EPS Bearer Contexts requested for deletion along with details on whether they were successfully deleted. Shall be included if only some of the EPS Bearers belonging to a PDN Connection are being released(See TS 29.274 [87] clause 7.2.10). See Table 6.3.3-12.	C
protocolConfigurationOptions	Shall be present if the Delete Bearer Request or Response reported (see TS 29.274 [87] clauses 7.2.9) contains the Protocol Configuration, Additional Protocol Configuration Options or extended Protocol Configuration Options IE. See Table 6.3.3-4.	C

Table 6.3.3-12: Payload for bearerContexts Field in deleteBearerResponse

Field name	Description	M/C/O
cause	Indicates whether the bearers requested for deletion were successfully deleted (See TS 29.274 [87] clause 7.2.10).	M
ePSBearerID	Shall include the EBI for the bearer (See TS 29.274 [87] clause 7.2.10).	M
protocolConfigurationOptions	Shall be present if the Delete Bearer Request or Response reported (see TS 29.274 [87] clauses 7.2.9) contains the Protocol Configuration, Additional Protocol Configuration Options or extended Protocol Configuration Options IE. See Table 6.3.3-4.	C
rANNASCause	Shall be present if the RAN/NAS Release Cause is present in the delete session response bearer context (see TS 29.274 [87] clause 7.2.10). Shall be sent as an Octet String encoded as specified in TS 29.274 [87] clause 8.103.	C

6.3.3.2.4 PDU Session Release message reporting PDU session release, PDN Connection release

The IRI-POI in the SMF+PGW-C shall generate an xIRI containing an SMF+PDUSessionRelease record (see clause 6.2.3.2.4) when the IRI-POI present in the SMF+PGW-C detects that a single-access PDU Session or PDN Connection has been released for the target UE. The IRI-POI present in the SMF+PGW-C shall generate the xIRI for the following events:

- The SMF+PGW-C releases an existing PDN Connection in the target UE context of the SMF+PGW-C (see TS 23.401 [50] clause 5.7.4).

- The SMF+PGW-C releases an existing PDU Session context or SM Context for the target UE (see TS 29.502 [16] clause 5.2.2.4 and clause 5.2.2.9).

When the SMF PDUSessionRelease record (see clause 6.2.3.2.4) is used to report the release of a PDN Connection:

- The ePSPDNConnectionRelease field shall be populated with the information in Table 6.3.3-13.
- If there is no SUPI associated to the SM context for the target UE, the SUPI field of the SMF PDUSessionRelease record shall be populated with the value of the IMSI from the target UE context.
- If there is no PDU Session ID present in the PCO of the request or response messages or associated to the context for the PDN connection, the pDUSessionID field of the SMF PDUSessionRelease record shall be populated with the EBI of the default bearer for the PDN Connection.
- If there is no 5G UP tunnel present in the context associated to the PDN Connection, the gTPTunnelID field of the SMF PDUSessionRelease record shall be populated with the F-TEID for the PGW S5 or S8 interface for the default bearer of the PDN Connection.

Table 6.3.3-13: Payload for ePSPDNConnectionRelease Field

Field name	Description	M/C/O
ePSSubscriberIDs	EPS Subscriber Identities associated with the PDN connection (e.g. as provided by the MME or SGW in the associated network message or as associated with the PDN connection in the context known at the NF). The IMSI shall be present except for unauthenticated emergency sessions.	M
iMSIUnauthenticated	Shall be present if an IMSI is present in the ePSSubscriberIDs and set to "true" if the IMSI has not been authenticated, or "false" if it has been authenticated.	C
defaultBearerID	Shall contain the EPS Bearer Identity of the default bearer associated with the PDN connection.	M
location	Location information present in the network message (see TS 29.274 [87], clause 8.21) or known in the context at the SGW or PGW.	C
gTPTunnelInfo	Contains the information for the Control Plane GTP Tunnels present in the network message or known in the context at the SGW or PGW. See Table 6.2.3-1B. If the gTPTunnelInfo received in the network message is different than the gTPTunnelInfo in the context for the PDN Connection, this message shall be populated with the new information.	C
rANNASCause	Shall be present if the RAN/NAS Release Cause is present in the delete session request (see TS 29.274 [87] clause 7.2.9).	C
pDNConnectionType	Identifies selected PDN session type, see TS 29.274 [13] clause 8.34.	M
indicationFlags	Shall be included if the Indication Flags field is present in the network message (see TS 29.274 [87] clauses 7.2.3, 7.2.4, 7.2.7, 7.2.8, 7.2.9, 7.2.10, 7.2.15 and 7.2.16). The value of this parameter shall be set to the value of the Indication IE (see TS 29.274 [87] clause 8.12) starting with octet 5.	C
scopeIndication	This flag shall be present and set to True, if the request corresponds to TAU/RAU/Handover with SGW change/SRNS Relocation Cancel Using S4 with SGW change, Inter RAT handover Cancel procedure with SGW change, S1 Based handover Cancel procedure with SGW change. If this parameter is absent, it shall be interpreted as False.	C
bearersDeleted	Shall include a list of the Bearers to be deleted if the event that resulted in the generation of the message included a Delete Bearer Request or Response. (see TS 29.274 [87] clauses 7.2.9 and 7.2.10). See Table 6.3.3-10.	C

6.3.3.2.5 SMF Start of Interception with Already Established PDU Session message reporting Start of Interception with Already Established PDU Session or Start of Interception with Already Established PDN Connection

The IRI-POI in the SMF+PGW-C shall generate an xIRI containing an SMFStartOfInterceptionWithEstablishedPDUSession record (see clause 6.2.3.2.5) when the IRI-POI present in the SMF+PGW-C detects that a PDU Session or PDN Connection has already been established for the target UE when interception starts. The IRI-POI present in the SMF+PGW-C shall generate the xIRI for the following events:

- The SMF+PGW-C has an existing PDN Connection in the target UE context of the SMF+PGW-C (see TS 23.401 [50] clause 5.7.4).
- The SMF+PGW-C has an existing PDU Session context or SM Context for the target UE (see TS 29.502 [16] clause 5.2.2.2 and clause 5.2.2.7).

When the SMFStartOfInterceptionWithEstablishedPDUSession record (see clause 6.2.3.2.5) is used to report an existing PDN Connection:

- The ePSSStartOfInterceptionWithEstablishedPDNConnection field shall be populated with the information in Table 6.3.3-14.
- If there is no SUPI associated to the SM context for the target UE, the SUPI field of the SMFStartOfInterceptionWithEstablishedPDNConnection record shall be populated with the value of the IMSI from the target UE context.
- If there is no PDU Session ID associated to the context for the PDN connection, the pDUSessionID field of the SMFStartOfInterceptionWithEstablishedPDNConnection record shall be populated with the EBI of the default bearer for the PDN Connection.
- If there is no 5G UP tunnel present in the context associated to the PDN Connection, the gTPTunnelID field of the SMFStartOfInterceptionWithEstablishedPDNConnection record shall be populated with the F-TEID for the PGW S5 or S8 interface for the default bearer of the PDN Connection.

Table 6.3.3-14: Payload for ePSSStartOfInterceptionWithEstablishedPDNConnection Field

Field name	Description	M/C/O
ePSSsubscriberIDs	EPS Subscriber Identities associated with the PDN connection (as associated with the PDN connection in the context known at the NF). The IMSI shall be present except for unauthenticated emergency sessions.	M
iMSIUnauthenticated	Shall be present if an IMSI is present in the ePSSsubscriberIDs and set to "true" if the IMSI has not been authenticated, or "false" if it has been authenticated.	C
defaultBearerID	Shall contain the EPS Bearer Identity of the default bearer associated with the PDN connection.	M
gTPTunnelInfo	Contains the information for the Control Plane GTP Tunnels known in the context at the SGW or PGW. See Table 6.2.3-1B.	C
pDNConnectionType	Identifies selected PDN session type, see TS 29.274 [87] clause 8.34.	M
uEEndpoints	UE endpoint address(es) if available. Derived from the PDN Address portion of the PDN Address Allocation parameter (see TS 29.274 [87] clause 8.14) associated to the PDN Connection in the context known at the NF (see TS 23.401 [50] clauses 5.7.3 and 5.7.4).	C
non3GPPAccessEndpoint	UE's local IP address used to reach the ePDG, if known at the context at the SGW or PGW.	C
location	Location information known in the context at the SGW or PGW.	C
additionalLocation	Additional location information known in the context at the SGW or PGW, or known at the MDF.	C
aPN	Access Point Name associated with the PDN known at the context at the SGW or PGW (see TS 23.401 [50] clause 5.6.4), as defined in TS 23.003[19] clause 9.1.	M
requestType	Type of request as derived from the Request Type described in TS 24.301 [50] clause 9.9.4.14 and TS 24.008 [93] clause 10.5.6.17, if available.	C
accessType	Access type associated with the PDN connection (i.e. 3GPP or non-3GPP access).	C
rATType	RAT Type associated with the PDN connection. Shall be present if known at the context at the SGW or PGW (see TS 23.401 [50] clause 5.6.4).	C
protocolConfigurationOptions	Shall be present the Protocol Configuration, Additional Protocol Configuration Options or extended Protocol Configuration Options are known in the context at the SGW or PGW. See Table 6.3.3-4.	C
servingNetwork	Shall be present if this IE is in the context for the PDN connection at the SGW/PGW.	C
bearerContexts	Shall include a list of the Bearer Contexts present in the UE Context (see TS 23.401 [50] clauses 5.7.3 and 5.7.4). See Table 6.3.3-2.	M

6.3.3.2.6 MA PDU Session Establishment message reporting MA PDU session establishment or PDN Connection establishment as part of an MA PDU Session

The IRI-POI in the SMF+PGW-C shall generate an xIRI containing an SMFMAPDUSessionEstablishment record (see clause 6.2.3.2.7) when the IRI-POI present in the SMF+PGW-C detects that a PDN Connection has been established for the target UE and associated to a multi-access PDU Session. The IRI-POI present in the SMF+PGW-C shall generate the xIRI for the following events:

- The SMF+PGW-C creates a new PDN Connection in the target UE context of the SMF+PGW-C (see TS 23.401 [50] clause 5.7.4) and it is associated to an MA PDU session as described in TS 23.502 [4] clause 4.22.2.3.
- The SMF+PGW-C creates a new multi-access PDU Session context or SM Context for the target UE (see TS 29.502 [16] clause 5.2.2.2 and clause 5.2.2.7).

When the SMFMAPDUSessionEstablishment record (see clause 6.2.3.2.7) is used to report the creation of a new PDN Connection:

- The ePSPDNConnectionEstablishment field shall be populated with the information in Table 6.3.3-1.
- If there is no SUPI associated to the SM context for the target UE, the SUPI field of the SMFMAPDUSessionEstablishment record shall be populated with the value of the IMSI from the target UE context.
- If there is no PDU Session ID present in the PCO of the request or response messages or associated to the context for the PDN connection, the pDUSessionID field of the SMFMAPDUSessionEstablishment record shall be populated with the EBI of the default bearer for the PDN Connection.
- If there is no 5G UP tunnel present in the context associated to the PDN Connection, the gTPTunnelID field of the SMFMAPDUSessionEstablishment record shall be populated with the F-TEID for the PGW S5 or S8 interface for the default bearer of the PDN Connection.

6.3.3.2.7 MA PDU Session Modification message reporting MA PDU session modification, modification of a PDN Connection associated to MA PDU session or inter-system handover

The IRI-POI in the SMF+PGW-C shall generate an xIRI containing an SMFMAPDUSessionModification record (see clause 6.2.3.2.7) when the IRI-POI present in the SMF+PGW-C detects that an MA PDU Session or PDN Connection associated to an MA PDU Session has been modified for the target UE. The IRI-POI present in the SMF+PGW-C shall generate the xIRI for the following events:

- The SMF+PGW-C modifies an existing PDN Connection associated to an MA PDU Session in the target UE context of the SMF+PGW-C (see TS 23.401 [50] clause 5.7.4).
- The SMF+PGW-C modifies an existing MA PDU Session context or SM Context for the target UE (see TS 29.502 [16] clause 5.2.2.3 and clause 5.2.2.8).
- The SMF+PGW-C transfers the 3GPP Access Leg of an existing MA PDU Session to EPS (see TS 23.502 [4] clause 4.22.6).
- The SMF+PGW-C transfers an existing PDN Connection associated to an MA PDU Session to 5GS (see TS 23.502 [4] clause 4.22.6).

When the SMFMAPDUSessionModification record (see clause 6.2.3.2.7) is used to report the modification of a PDN Connection:

- The ePSPDNConnectionModification field shall be populated with the information in Table 6.3.3-8.
- If there is no SUPI associated to the SM context for the target UE, the SUPI field of the SMFMAPDUSessionModification record shall be populated with the value of the IMSI from the target UE context.
- If there is no PDU Session ID present in the PCO of the request or response messages or associated to the context for the PDN connection, the pDUSessionID field of the SMFMAPDUSessionModification record shall be populated with the EBI of the default bearer for the PDN Connection.

- If there is no 5G UP tunnel present in the context associated to the PDN Connection, the gTPTunnelID field of the SMFMAPDUSessionModification record shall be populated with the F-TEID for the PGW S5 or S8 interface for the default bearer of the PDN Connection.

6.3.3.2.8 MA PDU Session Release message reporting MA PDU session release or the release of a PDN Connection associated to an MA PDU session

The IRI-POI in the SMF+PGW-C shall generate an xIRI containing an SMFMAPDUSessionRelease record (see clause 6.2.3.2.7) when the IRI-POI present in the SMF+PGW-C detects that an MA PDU Session or PDN Connection associated to an MA PDU Session has been released for the target UE. The IRI-POI present in the SMF+PGW-C shall generate the xIRI for the following events:

- The SMF+PGW-C releases an existing PDN Connection associated to an MA PDU Session in the target UE context of the SMF+PGW-C (see TS 23.401 [50] clause 5.7.4).
- The SMF+PGW-C releases an existing MA PDU Session context or SM Context for the target UE (see TS 29.502 [16] clause 5.2.2.4 and clause 5.2.2.9).

When the SMFMAPDUSessionRelease record (see clause 6.2.3.2.7) is used to report the release of a PDN Connection:

- The ePSPDNConnectionRelease field shall be populated with the information in Table 6.3.3-13.
- If there is no SUPI associated to the SM context for the target UE, the SUPI field of the SMFMAPDUSessionRelease record shall be populated with the value of the IMSI from the target UE context.
- If there is no PDU Session ID present in the PCO of the request or response messages or associated to the context for the PDN connection, the pDUSessionID field of the SMFMAPDUSessionRelease record shall be populated with the EBI of the default bearer for the PDN Connection.
- If there is no 5G UP tunnel present in the context associated to the PDN Connection, the gTPTunnelID field of the SMFMAPDUSessionRelease record shall be populated with the F-TEID for the PGW S5 or S8 interface for the default bearer of the PDN Connection.

6.3.3.2.9 SMF Start of Interception with Already Established MA PDU Session message reporting Start of Interception with Already Established MA PDU Session or Start of Interception with Already Established PDN Connection associated to an MA PDU Session

The IRI-POI in the SMF+PGW-C shall generate an xIRI containing an SMFStartOfInterceptionWithEstablishedMAPDUSession record (see clause 6.2.3.2.7) when the IRI-POI present in the SMF+PGW-C detects that an MA PDU Session or PDN Connection associated to an MA PDU Session has already been established for the target UE when interception starts. The IRI-POI present in the SMF+PGW-C shall generate the xIRI for the following events:

- The SMF+PGW-C has an existing PDN Connection associated to an MA PDU Session in the target UE context of the SMF+PGW-C (see TS 23.401 [50] clause 5.7.4).
- The SMF+PGW-C has an existing MA PDU Session context or SM Context for the target UE (see TS 29.502 [16] clause 5.2.2.2 and clause 5.2.2.7).

When the SMFStartOfInterceptionWithEstablishedMAPDUSession record (see clause 6.2.3.2.7) is used to report an existing PDN Connection:

- The ePSStartOfInterceptionWithEstablishedPDNConnection field shall be populated with the information in Table 6.3.3-14.
- If there is no SUPI associated to the SM context for the target UE, the SUPI field of the SMFStartOfInterceptionWithEstablishedMAPDUSession record shall be populated with the value of the IMSI from the target UE context.
- If there is no PDU Session ID associated to the context for the PDN connection, the pDUSessionID field of the SMFStartOfInterceptionWithEstablishedMAPDUSession record shall be populated with the EBI of the default bearer for the PDN Connection.

- If there is no 5G UP tunnel present in the context associated to the PDN Connection, the gTPTunnelID field of the SMFStartOfInterceptionWithEstablishedMAPDUSession record shall be populated with the F-TEID for the PGW S5 or S8 interface for the default bearer of the PDN Connection.

6.3.3.2A Triggering of the CC-POI from CC-TF over LI_T3

When CUPS architecture is used and the interception of user plane packets is required, the CC-TF present in the SGW-C/PGW-C sends a trigger to the CC-POI present in the SGW-U/PGW-U over the LI_T3 interface.

6.3.3.3 Generation of xCC at CC-POI in the SGW/PGW and ePDG over LI_X3

6.3.3.3.1 Non-CUPS architecture

The CC-POI present in the SGW/PGW and ePDG shall send xCC over LI_X3 for each IP packet belonging to the target's communication.

Each X3 PDU shall contain the contents of the user plane packet given using the GTP-U, IP or Ethernet payload format.

The CC-POI present in the SGW/PGW and ePDG shall set the payload format to indicate the appropriate payload type (5 for IPv4 Packet, 6 for IPv6 Packet, 7 for Ethernet frame or 12 for GTP-U packet as per ETSI TS 103 221-2 [8] clause 5.4).

If it is required to send the ICE-type for the xCC, the CC-POI shall set the NFID attribute (see ETSI TS 103 221-2 [8] clause 5.3.7) to the appropriate value from the ICE-type enumeration in TS 33.108 [12] Annex B.10 as a single octet. As an example, an ICE-type of "sgw" is indicated by setting the attribute to value 3.

6.3.3.3.2 CUPS architecture

When CUPS architecture is used, the CC-POI in the SGW-U/PGW-U is provisioned by the CC-TF in the SGW-C/PGW-C using a Triggering message (i.e. ActivateTask message) as described in clause 6.3.3.0.

The CC-POI present in the SGW-U/PGW-U shall send xCC over LI_X3 for each IP packet matching the criteria specified in the Triggering message (i.e. ActivateTask message) received over LI_T3 from the CC-TF in the SGW-C/PGW-C.

NOTE: Implementers are reminded of the completeness and non-duplication requirements (see TS 33.127 [5]).

Each X3 PDU shall contain the contents of the user plane packet given using the GTP-U, IP or Ethernet payload format.

The CC-POI present in the SGW-U/PGW-U shall set the payload format to indicate the appropriate payload type (5 for IPv4 Packet, 6 for IPv6 Packet, 7 for Ethernet frame or 12 for GTP-U Packet as described in ETSI TS 103 221-2 [8] clauses 5.4 and 5.4.13).

If handover of the entire GTP-U packet is required over LI_HI3 (see clause 6.2.3.8), then consideration shall be made of the correct choice of LI_X3 payload type to ensure that the MDF3 has the necessary CC information. Support for delivery of LI_X3 as payload type 12 (GTP-U packet) is mandatory.

6.3.3.4 Generation of IRI over LI_HI2

When an xIRI is received over LI_X2 from the IRI-POI in the SGW/PGW or ePDG, the MDF2 shall generate the corresponding IRI message and deliver it over LI_HI2 without undue delay. The IRI message shall contain a copy of the relevant record received in the xIRI over LI_X2.

When option 2 specified in clause 6.3.1 is used, the MDF2 shall generate IRI messages based on the proprietary information received from the SGW/PGW or ePDG and provide it over LI_HI2 without undue delay.

The IRI messages shall include an IRI payload encoded according to clause 10.5 and TS 33.108 [12] Annex B.9. The MDF2 shall encode the correct value of LIID in the IRI message, replacing the value "LIIDNotPresent" given in the xIRI (see clause 6.3.2.2).

The IRI messages shall be delivered over LI_HI2 according to ETSI TS 102 232-7 [10] clause 10.

6.3.3.5 Generation of CC over LI_HI3

When xCC is received over LI_X3 from the CC-POI in the SGW/PGW or ePDG, the MDF3 shall generate the corresponding CC and deliver it over LI_HI3 without undue delay. The CC message shall contain a copy of the relevant xCC received over LI_X3.

When option 2 specified in clause 6.3.1 is used, the MDF3 shall generate CC based on the proprietary information received from the SGW/PGW or ePDG and provide it over LI_HI3 without undue delay.

The CC shall include a CC payload encoded according to TS 33.108 [12] Annex B.10.

The CC shall be delivered over LI_HI3 according to ETSI TS 102 232-7 [10] clause 10.

6.4 3G

The Present document does not specify details of the LI interfaces for 3G / UMTS. Details for this release are specified in TS 33.108 [12].

7 Service Layer Based Interception

7.1 Introduction

This clause describes any remaining fields, behaviours or details necessary to implement the required LI interfaces for specific 3GPP-defined services which are not described in clauses 4 and 5.

7.2 Central Subscriber Management

7.2.1 General description

This clause describes interception at central subscriber management functions or databases (e.g. UDM and HSS).

7.2.2 LI at UDM

7.2.2.1 General description

In 3GPP network, the UDM provides the unified data management for UE. The UDM shall have LI capabilities to generate the target UE's service area registration and subscription management related xIRI.

7.2.2.2 Provisioning over LI_X1

The IRI-POI present in the UDM is provisioned over LI_X1 by the LIPF using the X1 protocol as described in clause 5.2.2.

The POI in the UDM shall support the following target identifier formats in the ETSI TS 103 221-1 [7] messages:

- SUPIIMSI.
- SUPINAI.
- PEIIMEI.
- PEIIMEISV.
- GPSIMSISDN.
- GPSINAI.

7.2.2.3 Generation of xIRI over LI_X2

7.2.2.3.1 General description

The IRI-POI present in the UDM shall send xIRI over LI_X2 for each of the events listed in TS 33.127 [5] clause 7.2.2.4, the details of which are described in the following clauses.

7.2.2.3.2 Serving system

The IRI-POI in the UDM shall generate an xIRI containing the UDMServingSystemMessage record when it detects the following events:

- When the UDM receives the amf3GPPAccessRegistration from the AMF as part of the Nudm_UEContextManagement_Registration service operation (see TS 29.503 [25] clause 5.3.2.2.2).
- When the UDM receives the amfNon3GPPAccessRegistration from the AMF as part of the Nudm_UEContextManagement_Registration service operation (see TS 29.503 [25] clause 5.3.2.2.3).

When a target UE registers to both 3GPP and non-3GPP access, two separate xIRIs each containing the UDMServingSystemMessage record may be generated by the IRI-POI in the UDM.

Table 7.2.2.3-1: Payload for UDMServingSystemMessage record

Field name	Description	M/C/O
sUPI	SUPI associated with the target UE, see TS 29.571 [17].	M
pEI	PEI associated with the target UE, when known, see TS 29.571 [17].	C
gPSI	GPSI associated with the target UE, when known, see TS 29.571 [17].	C
gUAMI	Serving AMF's GUAMI, when known., see NOTE 1.	C
gUMMEI	Serving MME's GUMMEI, see NOTE 2.	C
pLMNID	Serving PLMN Id. See TS 29.571 [17]. See NOTE 3.	C
servingSystemMethod	Identifies method used to access the serving system, see NOTE 4.	M
servicelD	Identifies the target UE's 5G service identifiers (e.g. SNSSAI, CAGID) when the AMF Registration is executed, when known, see TS 29.571 [17].	C
roamingIndicator	Boolean which indicates if the serving PLMN is different from the HPLMN. See TS 29.503 [25] clause 6.4.6.2.8.	M

NOTE 1: GUAMI is the global unique identifier of an AMF [2] and its format is defined in TS 29.571 [17]. As defined in TS 23.501 [2] clause 5.9.4, GUAMI consists of <MCC> <MNC> <AMF Region ID> <AMF Set ID> <AMF Pointer>. The GUAMI is reported if the UDM receives the same from the AMF.

NOTE 2: GUMMEI is the global unique identifier of an MME and its format is defined in TS 23.003 [19]. As defined in TS 23.003 [19] clause 2.8.1, GUMMEI consists of <MCC> <MNC> <MME Identifier>. The GUMMEI is reported if the UDM has this information (e.g. in a combined UDM/HSS).

NOTE 3: PLMN Id provides the VPLMN Id when the target UE is roaming.

NOTE 4: This identifies whether the xIRI containing the UDMServingSystemMessage record is generated due to the reception of an amf3GPPAccessRegistration, or an amfNon3GPPAccessRegistration. See TS 29.503 [25].

TS 29.571 [17] requires that the encoding of 3GPP defined identifiers (e.g. IMSI, NAI) shall be prefixed with its corresponding prefix (e.g. with reference to SUPI it requires 'imsi-', 'nai-'). However, identifiers and parameters shall be coded over the LI_X2 and LI_HI2 according to Annex A of the present document, so without the prefix specified in TS 29.571 [17].

The IRI-POI present in the UDM generating an xIRI containing an UDMServingSystemMessage record shall set the Payload Direction field in the PDU header to *not applicable* (Direction Value 5, see ETSI TS 103 221-2 [8] clause 5.2.6).

7.2.2.3.3 Subscriber record change

The IRI-POI in the UDM shall generate an xIRI containing the UDMSubscriberRecordChangeMessage record when it detects the following events:

- When the UDM receives the Amf3GppAccessRegistration from the AMF as part of the Nudm_UEContextManagement Registration service operation (see TS 29.503 [25] clause 5.3.2.2.2) and detects a change in the SUPI/GPSI/PEI association for a target.
- When the UDM receives the AmfNon3GppAccessRegistration from the AMF as part of the Nudm_UEContextManagement Registration service operation (see TS 29.503 [25] clause 5.3.2.2.3) and detects a change in the SUPI/GPSI/PEI association for a target.
- When the UDM receives the Amf3GppAccessRegistrationModification from the AMF as part of Nudm_UEContextManagement Update service operation (see TS 29.503 [25] clause 5.3.2.6.2) and detects a change in the SUPI/GPSI/PEI association for a target.
- When the UDM receives the AmfNon3GppAccessRegistrationModification from the AMF as part of Nudm_UEContextManagement Update service operation (see TS 29.503 [25] clause 5.3.2.6.3) and detects a change in the SUPI/GPSI/PEI association for a target.
- When the UDM receives the PeiUpdateInfo from the HSS as part of the Nudm_UEContextManagement PEI Update service operation (see TS 29.503 [25] clause 5.3.2.10.2) and detects a change in the SUPI/GPSI/PEI association for a target.
- Upon detection of modification between SUPI and GPSI association (if UDR is deployed, when UDM receives the DataChangeNotify from the UDR including the modified GPSI as part of the Nudr_DataRepository Notification service operation (see TS 29.504 [48] clause 5.2.2.8.3 and TS 29.505 [49] clause 5.4.2.6); if UDR is not deployed, when the modification is detected as result of UDM provisioning).
- Upon UE de-provisioning (if UDR is deployed, when UDM receives the DataChangeNotify from the UDR including the deleted SUPI as part of the Nudr_DataRepository Notification service operation (see TS 29.504 [48] clause 5.2.2.8.3 and TS 29.505 [49] clause 5.4.2.6); if UDR is not deployed, when the modification is detected as result of UDM deprovisioning).
- When a new SUPI is provisioned (if UDR is deployed, when UDM receives the DataChangeNotify from the UDR including the new and the old SUPI as part of the Nudr_DataRepository Notification service operation (see TS 29.504 [48] clause 5.2.2.8.3 and TS 29.505 [49] clause 5.4.2.6); if UDR is not deployed, when the modification is detected as result of UDM provisioning).
- When the UDM receives the Amf3GppAccessRegistrationModification from the AMF as part of Nudm_UEContextManagement Update service operation (see TS 29.503 [25] clause 5.3.2.2.2) and detects a change in the ServiceID association for a target.
- Upon detection of modification in the Service ID association (if UDR is deployed, when UDM receives the DataChangeNotify from the UDR including the modified Service ID as part of the Nudr_DataRepository Notification service operation (see TS 29.504 [48] clause 5.2.2.8.3 and TS 29.505 [49] clause 5.4.2.6); if UDR is not deployed, when the modification is detected as a result of UDM provisioning).

When a target UE registers to both 3GPP and non-3GPP access, two separate xIRIs each containing the UDMSubscriberRecordChangeMessage report record may be generated by the IRI-POI in the UDM.

Table 7.2.2.3-2: Payload for UDMSUBSCRIBERRECORDCHANGEMESSAGE record

Field name	Description	M/C/O
sUPI	SUPI currently associated with the target UE, see TS 29.571 [17], see NOTE 1	C
pEI	PEI currently associated with the target UE, when known, see TS 29.571 [17].	C
gPSI	GPSI currently associated with the target UE, when known, see TS 29.571 [17].	C
oldSUPI	Old SUPI associated with the target UE, when known.	C
oldServiceID	Identifies the target UE's old service identifiers (e.g. SNSSAI, CAGID), when known, see TS 29.571 [17].	C
oldPEI	Old PEI associated with the target UE, when known.	C
oldGPSI	Old GPSI associated with the target UE, when known.	C
subscriberRecordChangeMethod	Identifies the trigger of Subscriber Record Change operation, see NOTE 2.	M
serviceID	Identifies the target UE's 5G service identifiers that have been modified (e.g. SNSSAI, CAGID), when known, see TS 29.571 [17].	C

NOTE 1: When an identity is changed, both the old one and the current one are reported; the target identity is always reported either as current identity or old identity depending on the change, together with the other current identities (e.g. ServiceIDs), if available. If the target identity is changed, the old identity represents the target otherwise the current identity represents the target (as examples, when SUPI is the target and PEI is changing, SUPI (target), PEI and old PEI, along with GPSI, if available, are reported; when SUPI is the target and SUPI is changed, SUPI and oldSUPI (target), along with PEI and GPSI, if available, are reported).

NOTE 2: This identifies whether the xIRI containing the UDMSUBSCRIBERRECORDCHANGEMESSAGE record is generated due to a PEI change, a GPSI, a SUPI modification or ServiceID change, or a UE de-provisioning.

The IRI-POI present in the UDM generating an xIRI containing an UDMSUBSCRIBERRECORDCHANGEMESSAGE record shall set the Payload Direction field in the PDU header to *not applicable* (Direction Value 5, see ETSI TS 103 221-2 [8] clause 5.2.6).

TS 29.571 [17] requires that the encoding of 3GPP defined identifiers (e.g. IMSI, NAI) shall be prefixed with its corresponding prefix (e.g. with reference to SUPI it requires 'imsi-', 'nai-'). However, identifiers and parameters shall be coded over the LI_X2 and LI_HI2 according to Annex A of the present document, so without the prefix specified in TS 29.571 [17].

7.2.2.3.4 Cancel location

The IRI-POI in the UDM shall generate an xIRI containing the UDMCANCELLLOCATION record when it detects the following events:

- When the UDM sends DeregistrationData to AMF as part of the Nudm_UEContextManagement DeregistrationNotification service operation (see TS 29.503 [25] clause 5.3.2.3.2).
- When the UDM receives the Amf3GppAccessRegistrationModification with PurgeFlag set from the AMF as part of Nudm_UEContextManagement Deregistration service operation (see TS 29.503 [25] clause 5.3.2.4.2).
- When UDM receives the AmfNon3GppAccessRegistrationModification with PurgeFlag set from the AMF as part of Nudm_UEContextManagement Deregistration service operation (see TS 29.503 [25] clause 5.3.2.4.3).

When a target UE deregisters from both 3GPP and non-3GPP access, two separate xIRIs each containing the UDMCANCELLLOCATION report record may be generated by the IRI-POI in the UDM.

NOTE: Invocation of the Nudm_UEContextManagement Deregistration service operation in the case of UE deregistration is an implementation option (see TS 23.502 [4], clause 4.5.3). Consequently, the UDMCancel Location xIRI in such case is only generated if this option is supported by the serving network.

Table 7.2.2.3.4-1: Payload for UDMCancelLocationMessage record

Field name	Description	M/C/O
sUPI	SUPI associated with the target UE, see TS 29.571 [17].	M
pEI	PEI associated with the target UE, when known, see TS 29.571 [17].	C
gPSI	GPSI associated with the target UE, when known, see TS 29.571 [17].	C
gUAMI	Previous serving AMF's GUAMI, when known. See NOTE 1.	C
pLMNID	Previous serving PLMN ID. See TS 29.571 [17]. See NOTE 2.	C
cancelLocationMethod	Identifies method used to access the serving system, see NOTE 3.	M

NOTE 1: GUAMI is the global unique identifier of an AMF [2] and its format is defined in TS 29.571 [17]. As defined in TS 23.501 [2] clause 5.9.4, GUAMI consists of <MCC> <MNC> <AMF Region ID> <AMF Set ID> <AMF Pointer>. The GUAMI is reported if the UDM receives the same from the AMF.

NOTE 2: PLMN ID provides the vPLMN ID when the target UE is roaming.

NOTE 3: This identifies whether the xIRI containing the UDMCancelLocationMessage record is generated due to the reception of a UDM deregistration, and AMF 3GPP Access deregistration, or an AMF Non 3GPP access deregistration.

The IRI-POI present in the UDM generating an xIRI containing an UDMCancelLocationMessage record shall set the Payload Direction field in the PDU header to *not applicable* (Direction Value 5, see ETSI TS 103 221-2 [8] clause 5.2.6).

TS 29.571 [17] requires that the encoding of 3GPP defined identifiers (e.g. IMSI, NAI) shall be prefixed with its corresponding prefix (e.g. with reference to SUPI it requires 'imsi-', 'nai-'). However, identifiers and parameters shall be coded over the LI_X2 and LI_HI2 according to Annex A of the present document, so without the prefix specified in TS 29.571 [17].

7.2.2.3.5 Location information request

Location information request is not supported in the present document.

7.2.2.3.6 Location information result

The IRI-POI in the UDM shall generate an xIRI containing the UDMLocationInformationResult record when it detects the following events:

- When UDM receives the LocationInfoRequest from an NF service consumer (i.e. HSS) as part of Nudm_MT_ProvideLocationInfo service operation (see TS 29.503 [25], clause 6.7.6.2.3) and the UDM sends the LocationInfoResult as part of Nudm_MT_ProvideLocationInfo service operation (see TS 29.503 [25], clause 6.7.6.2.4).

When a target UE is registered to both 3GPP and non-3GPP access, two separate xIRIs each containing the LocationInfoResult report record may be generated by the IRI-POI in the UDM.

Table 7.2.2.3.6-1: Payload for UDMLocationInformationResult record

Field name	Description	M/C/O
sUPI	SUPI currently associated with the target, see TS 29.571 [17].	M
pEI	PEI currently associated with the target UE, when known, see TS 29.571 [17].	C
gPSI	GPSI currently associated with the target UE, when known, see TS 29.571 [17].	C
locationInfoRequest	Indicates the information received from the HSS in the LocationInfoRequest. At least one of the parameters in Table 7.2.2.3.6-2 shall be included. See NOTE below table 7.2.2.3.6-2.	M
vPLMNid	PLMNID of the visited PLMN, if UE is currently registered to visited network.	C
currentLocationIndicator	Shall indicate if the UE location is current or last known. Include if provided in the LocationInfoResult.	C
aMFInstanceID	Provides the NF instance ID of the serving AMF for 3GPP access. Shall be included if provided in the LocationInfoResult.	C
sMSFInstanceID	Provides the NF instance ID of the serving SMSF. Shall be included if provided in the LocationInfoResult.	C
location	Location information available at the UDM at the time of the LocationInfoRequest, include if in LocationInfoResult.	C
rATType	Shall provide the current RAT type of the UE, if present in the LocationInfoResult.	C
problemDetails	Indicates the reason for LocationInfoResult failure. See TS 29.571 [17], clause 5.2.4.1. Shall be included if provided in the LocationInfoResult.	C

Table 7.2.2.3.6-2: Payload for LocationInfoRequest parameter

Field name	Description
req5GSLocation	Boolean that indicates if 5GS location is requested.
reqCurrentLocation	Boolean that indicates if current location is requested.
reqRatType	Boolean indicates if Rat Type is requested.
reqTimeZone	Boolean indicates if time zone is requested.
reqServingNode	Boolean indicates if serving node instance ID is requested.

NOTE: The absence of one or more of the parameters in table 7.2.2.3.6-2 assumes that it was not included in the LocationInfoRequest.

7.2.2.3.7 UE information response

The IRI-POI in the UDM shall generate an xIRI containing the UDMUEInformationResponse record when it detects the following events:

- When the UDM receives the ProvideUeInfo GET request from the NF service consumer as part of Nudm_MT_ProvideUeInfo service operation (see TS 29.503 [25], clause 6.7.6.2.2) and the UDM returns a UeInfo response.

Table 7.2.2.3.7-1: Payload for UDMUEInformationResponse record

Field name	Description	M/C/O
sUPI	SUPI currently associated with the target UE, see TS 29.571 [17].	M
tADSInfo	Contains the UE Context Information as known at the UDM. See TS 29.518 [22], clause 6.3.6.2.4. Shall be included if UE Context is returned in the UeInfo response.	C
fiveGSUserStateInfo	Describes the 5GS user state of the UE as known at the UDM. See TS 29.518 [22], clause 6.2.6.3.11. Shall be included if 5GS user state is returned in the UeInfo response.	C
fiveGSRVCCInfo	Indicates whether the UE supports 5G SRVCC. See TS 29.503 [25], clause 6.7.6.2.5. Shall be included if returned in the UeInfo response.	C
problemDetails	Indicates the reason for UeInfo response failure. See TS 29.571 [17], clause 5.2.4.1. Shall be included if provided in the UeInfo response.	C

7.2.2.3.8 UE Authentication response

The IRI-POI in the UDM shall generate an xIRI containing the UDMUEAuthenticationResponse record when it detects the following events:

- When the UDM receives the AuthenticationInfoRequest from the AUSF as part of Nudm_UEAuthentication service operation (see TS 29.503 [25], clause 6.3.6.2.2) and the UDM sends the AuthenticationInfoResult to the AUSF as part of the Nudm_UEAuthentication service operation (see TS 29.503 [25], clause 6.3.6.2.3).
- When the UDM receives the HSSAuthenticationInfoRequest from the HSS as part of the Nudm_UEAuthentication service operation (see TS 29.503 [25], clause 6.3.6.2.10) and the UDM sends the HSSAuthenticationInfoResult to the AUSF as part of the Nudm_UEAuthentication service operation (see TS 29.503 [25], clause 6.3.6.2.11).

When a target UE registers from both 3GPP and non-3GPP access, two separate xIRIs each containing the UDMUEAuthentication report record may be generated by the IRI-POI in the UDM.

Table 7.2.2.3.8-1: Payload for UDMUEAuthenticationResponse record

Field name	Description	M/C/O
sUPI	SUPI currently associated with the target UE, see TS 29.571 [17].	M
authenticationInfoRequest	Indicates information provided in the UEAuthenticationInfoRequest. See Table 7.2.2.3.8-2 for details of payload.	M
aKMAIndicator	Indicates whether AKMA keys are needed for the UE, Shall be included if AKMA keys are requested in the AuthenticationInfoRequest.	C
problemDetails	Shall Indicate reason for AuthenticationInfoResultfailure. Shall be included if failure occurs. See TS 29.571 [17], clause 5.2.4.1.	C

Table 7.2.2.3.8-2: Payload for AuthenticationInfoRequest parameter

Field name	Description	M/C/O
infoRequestType	Indicates whether the AuthenticationInfoRequest was sent by the HSS, AUSF or other.	M
rGAuthCtx	Contains the UE ID (i.e. SUPI, SUCI) provided in the authentication indication, at least one shall be present.	M
authType	Indicates the authentication method provided by the HSS or AUSF in the AuthenticationInfoRequest.	M
servingNetworkName	Serving network name. See TS 33.501 [11] clause 6.1.1.4.	M
aUSFInstanceID	Identifies the AUSF instance which generated the AuthenticationInfoRequest. Shall be included if known.	C
cellCagInfo	Provides CAG cell information (e.g. CAGId) if UE is attempting registration from a CAG.	C
n5GCIndicator	Boolean value that indicates whether the device is a N5GC device. Include if provided in the AuthenticationInfoRequest.	C

7.2.2.4 Generation of IRI over LI_HI2

When an xIRI is received over LI_X2 from the IRI-POI in UDM, the MDF2 shall send an IRI message over LI_HI2 without undue delay.

The timestamp field of the PSHeader structure shall be set to the time that the UDM event was observed (i.e. the timestamp field of the xIRI).

The IRI type parameter (see ETSI TS 102 232-1 [9] clause 5.2.10) shall be included and coded according to table 7.2.2-4.

Table 7.2.2-4: IRI type for IRI messages

IRI message	IRI type
UDMServingSystemMessage	REPORT
UDMSubscriberRecordChangeMessage	REPORT
UDMCancelLocationMessage	REPORT
UDMLocationInformationResult	REPORT
UDMUEInformationResponse	REPORT
UDMUEAuthenticationResponse	REPORT

These IRI messages shall omit the CIN (see ETSI TS 102 232-1 [9] clause 5.2.4).

7.2.3 LI at HSS

7.2.3.1 General

The HSS provides the support functions in the mobility management, session setup and user authentication and access authorization.

The present document allows two options for HSS LI stage 3 interfaces:

1. Use LI_X1 and LI_X2 interfaces specified below in the present document for stage 3.
2. Use TS 33.107 [36] natively as defined in that document.

In both cases, the present document specifies the stage 3 for the LI_HI1 and LI_HI2 interfaces.

7.2.3.2 Provisioning over LI_X1

The IRI-POI present in the HSS is provisioned over LI_X1 by the LIPF using the X1 protocol as described in clause 5.2.2 of the present document.

The IRI-POI in the HSS shall support the target identifiers specified in TS 33.107 [36]:

- IMSI (using the IMSI target identifier format from ETSI TS 103 221-1 [7]).
- MSISDN (using the E164Number target identifier format from ETSI TS 103 221-1 [7]).
- IMEI (using the IMEI target identifier format from ETSI TS 103 221-1 [7]).
- IMPU (using the IMPU target identifier format from ETSI TS 103 221-1 [7]).
- IMPI (using the IMPI target identifier format from ETSI TS 103 221-1 [7]).

7.2.3.3 Generation of xIRI over LI_X2

The IRI-POI present in the HSS shall send the xIRIs over LI_X2 for each of the events listed in TS 33.107 [36], the details of which are also specified in TS 33.107 [36].

The IRI-POI present in the HSS shall set the payload format to EpsHI2Operations.EpsIRIContent (value 14), see clause 5.3 of the present document and ETSI TS 103 221-2 [8] clause 5.4. The payload field shall contain an EpsHI2Operations.EpsIRIContent structure encoded according to TS 33.108 [12] clause B.9.

As the LIID may be not available at the HSS but is mandatory in EpsHI2Operations.EpsIRIContent according to TS 33.108 [12] clause B.9, its value in the lawfulInterceptionIdentifier field of the encoded PDU shall be set to the fixed string "LIIDNotPresent".

7.2.3.4 Generation of IRI over LI_HI2

When an xIRI is received over LI_X2 from the IRI-POI in the HSS, the MDF2 shall generate the corresponding IRI message and deliver it over LI_HI2 without undue delay. The IRI message shall contain a copy of the relevant record received in the xIRI over LI_X2.

When Option 2 specified in clause 7.2.3.1 above is used, the MDF2 shall generate IRI messages based on the proprietary information received from the HSS and provide it over LI_HI2 without undue delay.

The IRI messages shall include an IRI payload encoded according to TS 33.108 [12] clause B.9. The MDF2 shall encode the correct value of LIID in the IRI message, replacing the value "LIIDNotPresent" given in the xIRI (see clause 7.2.3.3 above).

The IRI messages shall omit the CIN (see ETSI TS 102 232-1 [9] clause 5.2.4).

The IRI messages shall be delivered over LI_HI2 according to ETSI TS 102 232-7 [10] clause 10.

7.3 Location

7.3.1 Lawful Access Location Services (LALS)

7.3.1.1 General description

The LALS architecture and functionality is specified in TS 33.127 [5] clause 7.3.3.

7.3.1.2 Provisioning over LI_X1

7.3.1.2.1 Target positioning service

For the LALS target positioning service (TS 33.127 [5] clause 7.3.3.2) the IRI-POI provided by the LI-LCS Client is directly provisioned over LI_X1 by the LIPF using the LI_X1 protocol as described in clause 5.2.2 with the TaskDetailsExtensions field of the ActivateTask message specifying the type of the target positioning request, immediate vs. periodic, and, in the latter case, the periodicity of the positioning requests.

Based on national regulatory requirements and CSP policy, the TaskDetailsExtensions may also include the QoS parameters (specified in OMA-TS-MLP-V3_5-20181211-C [20]) for the use on the Le interface towards the LCS Server/GMLC. Alternatively, the QoS parameters may be statically configured in the LI-LCS Client.

Table 7.3.1.2-1 shows the details of the LI_X1 ActivateTask message used for the LI-LCS Client provisioning for the target positioning service.

The LI_X1 DeactivateTask shall be issued by the LIPF to terminate the target positioning service and withdraw the associated provisioning data, except for the Immediate target positioning service in which case the LI_X1 DeactivateTask is not used.

Table 7.3.1.2-1: ActivateTask message for LI-LCS Client target positioning provisioning

ETSI TS 103 221-1 field name	Description	M/C/O
XID	XID assigned by LIPF.	M
TargetIdentifiers	One of the following (see ETSI TS 103 221-1 [7]): - SUPIMSI. - SUPINAI. - GPSIMSISDN. - GPSINAI. - IMSI. - MSISDN (E164Number target ID format, per ETSI TS 103 221-1 [7]). - IMPU.	M
DeliveryType	Set to "X2Only".	M
ListOfDIDs	Delivery endpoints of LI_X2 interface. These delivery endpoints are configured in LI-LCS Client using the CreateDestination message as described in ETSI TS 103 221-1 [7] clause 6.3.1 prior to the task activation.	M
TaskDetailsExtensions/ PositioningServiceType	"Immediate" or "Periodic".	M
TaskDetailsExtensions/ PositioningPeriodicity	Time interval between the positioning requests in case of Periodic positioning, in seconds.	C
TaskDetailsExtensions/ PositioningParameters	Set of optional parameters for MLP SLIR message, per OMA-TS-MLP-V3_5-20181211-C [20]: - requested location type (clause 5.3.60). - requested response type (clause 5.3.112.1). - max location age (clause 5.3.65). - response timing required (clause 5.3.106). - response timer (clause 5.3.107). - horizontal accuracy with QoS class (clause 5.3.44). - altitude accuracy with QoS class (clause 5.3.6). - motion state request (clause 5.3.70).	O

7.3.1.2.2 Triggered location service

For the LALS triggered location service (TS 33.127 [5] clause 7.3.3.3) the LTF, as an IRI-TF, is provisioned by the LIPF using the LI_X1 protocol as described in clause 5.2.2. The "TaskDetailsExtensions" parameter of the ActivateTask message in this case will carry the address of LI-LCS Client to be used for the service and, optionally, the positioning parameters for use on the Le interface, similar to the target positioning provisioning.

Prior to issuing one or more "ActivateTask" requests towards an LTF, the LIPF shall provision the LTF with the LI_X2 destinations by using the "CreateDestination" operation(s), as per clause 5.2.2.

Table 7.3.1.2-2 defines the details of the LI_X1 ActivateTask message used for the LTF provisioning for the Triggered Location service.

Table 7.3.1.2-2: ActivateTask message for LTF triggered location service provisioning

ETSI TS 103 221-1 field name	Description	M/C/O
XID	XID assigned by LIPF.	M
TargetIdentifiers	One or more of the following (see ETSI TS 103 221-1 [7]): <ul style="list-style-type: none"> - SUPIIMSI. - SUPINAI. - GPSIMSISDN. - GPSINAI. - IMSI. - MSISDN (E164Number target ID format, per ETSI TS 103 221-1 [7]). - IMPU. <p style="text-align: center;">NOTE: An ActivateTask for an LTF may be issued by the LIPF if and only if at least one of the identifiers in the above list was specified in the warrant.</p>	M
DeliveryType	Set to "X2Only".	M
ListOfDIDs	Delivery endpoints for LI-LCS Client LI_X2. These delivery endpoints are configured in LTF using the CreateDestination message as described in ETSI TS 103 221-1 [7] clause 6.3.1 prior to the task activation.	M
TaskDetailsExtensions/ LILCSClientAddress	The IP address of the LI-LCS Client for triggering.	M
TaskDetailsExtensions/ PositioningParameters	Set of optional parameters for MLP SLIR message, per OMA-TS-MLP-V3_5-20181211-C [20]: <ul style="list-style-type: none"> - requested location type (clause 5.3.60). - requested response type (clause 5.3.112.1). - max location age (clause 5.3.65). - response timing required (clause 5.3.106). - response timer (clause 5.3.107). - horizontal accuracy with QoS class (clause 5.3.44). - altitude accuracy with QoS class (clause 5.3.6). - motion state request (clause 5.3.70). 	O

7.3.1.3 Triggering over LI_T2

An LTF, as an IRI-TF, provisioned as described in clause 7.3.1.2.2, triggers the LI-LCS Client (which plays the role of a triggered IRI-POI) using the LI_T2 protocol as described in clause 5.2.4. The "TaskDetailsExtensions" in the LI_T2 "ActivateTask" message carries the positioning parameters mapped from information the LTF receives from the ADMF over the LI_X1. The LI_T2 "ActivateTask" message header may include a correlation ID from the triggering xIRI, if available.

Prior to issuing one or more "ActivateTask" requests towards an LI-LCS Client, the LTF shall provision the LI-LCS Client with the LI_X2 destinations by using the "CreateDestination" operation(s), as per clause 5.2.2. The LI-LCS Client shall deactivate the task on its own upon issuing the final xIRI for the trigger. There is no DeactivateTask operation on the LI_T2 for the LI-LCS Client.

Table 7.3.1.3-1 shows the details of the LI_T2 ActivateTask message used by the LTF to trigger LI-LCS Client for the triggered location service.

Table 7.3.1.3-1: ActivateTask message from LTF to LI-LCS Client for the triggered location service triggering

ETSI TS 103 221-1 field name	Description	M/C/O
XID	The same value as in the LTF provisioning (clause 7.3.3.2.2).	M
TargetIdentifiers	One of the following (see ETSI TS 103 221-1 [7]): <ul style="list-style-type: none"> - SUPIIMSI. - SUPINAI. - GPSIMSISDN. - GPSINAI. - IMSI. - MSISDN (E164Number target ID format, per ETSI TS 103 221-1 [7]). - IMPU. <p style="margin-left: 40px;">NOTE: The target identifier used shall correspond to one of the target identifiers in the xIRI observed by the LTF, and shall be one of the identifiers provided in the ActivateTask for the LTF (clause 7.3.1.2.2).</p>	M
DeliveryType	Set to "X2Only".	M
ListOfDIDs	Delivery endpoints for LI-LCS Client LI_X2. These delivery endpoints are configured in LI-LCS Client by the LTF using the CreateDestination message as described in ETSI TS 103 221-1 [7], clause 6.3.1 prior to the task activation.	M
CorrelationID	Correlates the requested location to the triggering xIRI, if available.	C
TaskDetailsExtensions/ PositioningParameters	Set of optional parameters for MLP SLIR message, per OMA-TS-MLP-V3_5-20181211-C [20]: <ul style="list-style-type: none"> - requested location type (clause 5.3.60). - requested response type (clause 5.3.112.1). - max location age (clause 5.3.65). - response timing required (clause 5.3.106). - response timer (clause 5.3.107). - horizontal accuracy with QoS class (clause 5.3.44). - altitude accuracy with QoS class (clause 5.3.6). - motion state request (clause 5.3.70). 	O

7.3.1.4 Generation of xIRI over LI_X2

The IRI-POI provided by the LI-LCS client shall deliver the target location reports to respective MDF(s) as xIRI over the LI_X2 interface.

Table 7.3.1.4-1: LALSReport record

Field name	Description	M/C/O
sUPI	SUPI of the target, if used for the service (see NOTE).	C
gPSI	GPSI of the target, if used for the service (see NOTE).	C
iMSI	IMSI of the target, if used for the service (see NOTE).	C
mSISDN	MSISDN of the target, if used for the service (see NOTE).	C
iMPU	IMPU of the target, if used for the service (see NOTE).	C
location	Location of the target, if obtained successfully. Encoded as a <i>positioningInfo</i> parameter (<i>location>positioningInfo</i>). Both the <i>positionInfo</i> (<i>location>positioningInfo>positionInfo</i>) and the <i>mLPPositionData</i> (<i>location>positioningInfo>rawMLPResponse>mLPPositionData</i>) are present in the case of successful positioning. In the case of positioning failure only the <i>mLPErrCode</i> (<i>location>positioningInfo>rawMLPResponse>mLPErrCode</i>) is present. See Annex A.	C
NOTE: One and only one of SUPI, GPSI, IMSI, MSISDN, IMPU shall be present and it shall correspond to the target identifier included in the respective ActivateTask message for the LI-LCS Client.		

The LI-LCS Client generating an xIRI containing an LALSReport record shall set the Payload Direction field in the PDU header to *not applicable* (Direction Value 5, see ETSI TS 103 221-2 [8] clause 5.2.6).

The LI_X2 header (as per clause 5.3.2) of the LALSReport record presented in table 7.3.1.4-1 shall contain the correlation ID (if provided) from a respective LI_T2 ActivationTask message.

7.3.1.5 Generation of IRI over LI_HI2

The LALSReport payload, defined in clause 7.3.1.4, shall be used as the payload of the respective LALSReport record, no payload mediation is required.

A LALSReport message shall be assigned the same CIN (see ETSI TS 102 232-1 [9] clause 5.2.4) as the IRI message that triggered the LALS reporting, if that triggering IRI message is assigned a CIN. Otherwise, i.e. when the LALSReport is a result of the LALS Target Positioning, or the triggering IRI message has no CIN assigned, the CIN in the LALSReport shall be omitted.

NOTE: In some specific scenarios the amount of LALS reports data may overload the LI_HI2 and/or LI_X2 interfaces. To prevent the overload, a flow control for LALS triggered location reports may be implemented in MDF and/or LI-LCS client, e.g. by limiting the frequency of the reports for individual targets.

7.3.2 Cell database information reporting

7.3.2.1 General description

When the location information present within an xIRI includes the cell identity, the MDF2 that receives the xIRI may retrieve the cell site information for that cell from a CSP database and deliver the same to the LEMF either within the IRI message generated from the received xIRI or in a separate IRI message containing the MDFCellSiteReport record.

For each intercept, if the MDF2 reports the cell site information, then it shall provide such information at least on the initial appearance of the cell identity in the related xIRI.

NOTE: The CSP needs to ensure that the most recent cell site information is reported to the LEA.

7.3.2.2 Delivery of cell site information over LI_HI2

The cell site information is encoded as the cellSiteInformation ASN.1 parameter and delivered either within the location field of an IRI message carrying the respective cell identity, or in a stand-alone IRI message containing the MDFCellSiteReport record.

The MDF2 shall use the IRI message containing the MDFCellSiteReport record to convey cell site information retrieved asynchronously with the sending of the IRI message that caused the retrieval. The MDFCellSiteReport record shall be delivered as an IRI REPORT (see ETSI TS 102 232-1 [9] clause 5.2.10) and allocated the same CIN, if any, as the IRI message that caused the retrieval.

When the cell site information is readily available at MDF2 or is retrieved synchronously (i.e. blocking the sending of the IRI message until the retrieval is complete), the cell site information shall be conveyed within the location field of the IRI message that caused the retrieval.

The cell site information for multiple cell identities can be delivered to the LEMF within an IRI message that carries the respective cell identities or within the IRI message containing the MDFCellSiteReport record (see Annex A).

The MDF2 generating the IRI message MDFCellSiteReport shall set the Payload Direction field in the PDU header to *not applicable* (Direction Value 5, see ETSI TS 103 221-2 [8] clause 5.2.6).

7.3.3 Use of the Location structure

7.3.3.1 General description

The *Location* structure is used to convey geolocation information.

When the reference datum used for a latitude and longitude given in the *GeographicalCoordinates* structure is known by the operator, the reference datum shall be identified in the *mapDatumInformation* field. The reference datum identity shall be specified as an Open Geospatial Consortium URN, as defined in OGC 05-010 [35].

7.3.4 Separated location reporting

7.3.4.1 General description

When location information cannot be reported via an existing message generation at the IRI-POI, a separate xIRI may be generated from any provisioned IRI-POI that has access to location information and included in the SeparatedLocationReporting record.

The following information needs to be transferred from the IRI-POI to the MDF2 to enable a MDF2 to perform its functionality:

- Target identity.
- Event date/time.
- Target location(s).
- Date/time of UE location(s).
- Nature and identity of the POI.
- Location source(s).

Details of how the IRI-POI in the SMF generates this record can be found in clause 6.2.3.2.1.

Details of how the IRI-POI in the NEF generates this record can be found in clause 7.7.2.1.1.

Table 7.3.4.1-1: Payload for SeparatedLocationReporting record

Field name	Description	M/C/O
sUPI	SUPI associated with the registration (see clause 6.2.2.4).	M
sUCI	SUCI used in the registration, if available.	C
pEI	PEI provided by the UE during the registration, if available.	C
gPSI	GPSI obtained in the registration, if available as part of the subscription profile.	C
gUTI	5G-GUTI provided as outcome of initial registration or used in other cases, see TS 24.501 [13] clause 5.5.1.2.2.	C
location	Location information determined by the network at the time of message generation.	M
non3GPPAccessEndpoint	For Non-3GPP access, UE's local IP address used to reach the N3IWF, TNGF or TWIF. IP addresses are given as 4 octets (for IPv4) or 16 octets (for IPv6) with the most significant octet first (network byte order).	C
rATType	RAT Type associated with the data for which location information is provided, see TS 23.502 [4] clause 4.3.2. Values given as per TS 29.571 [17] clause 5.4.3.2.	C

7.4 Messaging

7.4.1 Introduction

Stage 3 intercept capabilities for SMS at an SMSF are defined in clause 6.2.5. Stage 3 for MMS interception follows in clause 7.4.3.

7.4.2 LI at the MMS Proxy-Relay

7.4.2.1 Provisioning over LI_X1

The IRI-POI present in the MMS Proxy-Relay is provisioned over LI_X1 by the LIPF using the X1 protocol as described in clause 5.2.2.

The POI in the MMS Proxy-Relay shall support the following target identifier formats in the ETSI TS 103 221-1 [7] messages:

- E164Number.
- EmailAddress.
- GPSIMSDN.
- IMPI.
- IMPU.
- IMSI.
- SUPIMSI.
- NAI.
- SUPINAI.

7.4.2.2 Generation of xIRI over LI_X2

The IRI-POI present in the MMS Proxy-Relay shall send xIRI over LI_X2 for the events listed in TS 33.127 [5] clause 7.5.2.3, which is further expanded in the present document in clause 7.4.2.4 below.

7.4.2.3 Generation of xCC over LI_X3

The CC-POI present in the MMS Proxy-Relay shall send xCC over LI_X3 for any MMS event where CC is available and authorized for reporting for the events listed in clause TS 33.127 [5] 7.5.2.3.

The xCC payload shall consist of the MMS contents given as a MIME encoded document (RFC 2045) according to OMA-TS-MMS_ENC [39]. The payload format shall be set to "MIME document" (value 15).

7.4.2.4 MMS Record Generation Cases

The triggers for MMS record generation are detailed in each of clauses 7.4.3.1 through 7.4.3.20. All triggers are defined by the detection of messages at the local MMS Proxy-Relay. They belong to one of two following high-level categories:

- at the local MMS Proxy-Relay, the sending or arrival of a message, either to or from the local target UE, using OMA-TS-MMS_ENC [39] definitions, or
- at the local MMS Proxy-Relay, the sending or arrival of a message to or from a non-local MMS Proxy-Relay, pertaining to messages either to or from a non-local target UE served by that non-local MMS Proxy-Relay, using the inter-proxy MM4 reference point, TS 23.140 [40] clause 8.4 definitions.

The present document assumes that the intercepted MMS complies with version 1.3 of OMA-TS-MMS_ENC [39]. If the intercepted messages do not comply fully, or the version is other than 1.3, parameters are required to be provided only if available.

In the following tables, the acronym Multimedia Message (MM) refers to a message in particular, while Multimedia Message Service (MMS) refers to the service in general.

7.4.3 MMS Records

7.4.3.1 MMSSend

The IRI-POI in the MMS Proxy-Relay shall generate an xIRI containing an MMSSend record when the MMS Proxy-Relay sends *m-send-conf* (as defined in OMA-TS-MMS_ENC [39] clause 6.1.1) to local target UE.

Table 7.4.3-1 contains parameters generated by the IRI-POI, along with parameters derived from the *m-send-req* message (from the local target UE to the MMS Proxy-Relay), and the *m-send-conf* message (from MMS Proxy-Relay to the local target UE).

Table 7.4.3-1: Payload for MMSSend

Field name	Description	M/C/O
transactionID	An ID used to correlate an MMS request and response between the target and the MMS Proxy-Relay. As defined in OMA-TS-MMS_ENC [39] clause 7.3.63.	M
version	The version of MM, to include major and minor version.	M
dateTime	Date and Time when the MM was last handled (either originated or forwarded). For origination, included by the sending MMS client or the originating MMS Proxy-Relay.	M
originatingMMSParty	ID(s) of the originating party in one or more of the formats described in 7.4.2.1. When address translation occurs (such as the case of a token sent by the client and replaced with a proper address by the MMS Proxy-Relay), both the pre and post translated addresses (with appropriate correlation) are included.	M
terminatingMMSParty	ID(s) of the terminating party in one or more of the formats described in 7.4.2.1. When address translation occurs (such as the case of a token sent by the client and replaced with a proper address by the MMS Proxy-Relay), both the pre and post translated addresses (with appropriate correlation) are included. This parameter is included if the corresponding MM includes a "TO" field. At least one of the terminatingMMSParty, cCRecipients, or bCRecipients must be included.	C
cCRecipients	Address of a recipient; the "CC" field may include addresses of multiple recipients. When address translation occurs, both the pre and post translated addresses (with appropriate correlation) are included. This parameter is included if the corresponding MM includes a "CC" field. At least one of the terminatingMMSParty, cCRecipients, or bCRecipients must be included.	C
bCRecipients	Address of a recipient; the "BCC" field may include addresses of multiple recipients. When address translation occurs, both the pre and post translated addresses (with appropriate correlation) are included. This parameter is included if the corresponding MM includes a "BCC" field. At least one of the terminatingMMSParty, cCRecipients, or bCRecipients must be included.	C
direction	Indicates the direction of the MM. This shall be encoded as "from target."	M
subject	The subject of the MM. Include if sent to the MMS Proxy-Relay.	C
messageClass	Class of the MM. For example, a value of "auto" is automatically generated by the UE. If the field is not present, the class should be interpreted as "personal." Include if sent to the MMS Proxy-Relay.	C
expiry	Length of time in seconds the MM will be stored in MMS Proxy-Relay or time to delete the MM. The field has two formats, either absolute or relative.	M
desiredDeliveryTime	Date and Time of desired delivery. Indicates the earliest possible delivery of the MM to the recipient. Include if sent to the MMS Proxy-Relay.	C
priority	Priority of the MM assigned by the originator MMS Client. Include if sent to the MMS Proxy-Relay.	C
senderVisibility	An indication that the sender's address should not be delivered to the recipient. Sent by the target to indicate the target's visibility to the other party or if not signalled by the target and the default is to not make target visible to the other party. The values given in OMA-TS-MMS_ENC [39] clause 7.3.52 shall be encoded as follows: "Show" = True, "Hide" = False. Include if sent to the MMS Proxy-Relay.	C
deliveryReport	Specifies whether the originator MM UE requests a delivery report from each recipient. Sent by the target to indicate the desired delivery report. The values given in OMA-TS-MMS_ENC [39] clause 7.3.13. shall be encoded as follows: "Yes" = True, "No" = False. Include if sent to the MMS Proxy-Relay.	C
readReport	Specifies whether the originator MM UE requests a read report from each recipient. Sent by the target to indicate the desired read report. The values given in OMA-TS-MMS_ENC [39] clause 7.3.37 shall be encoded as follows: "Yes" = True, "No" = False. Include if sent to the MMS Proxy-Relay.	C
store	Specifies whether the originator MM UE wants the submitted MM to be saved in the user's MMBox, in addition to sending it. Sent by the target to indicate the MM is to be stored. The values given in OMA-TS-MMS_ENC [39] clause 7.3.56 shall be encoded as follows: "Yes" = True, "No" = False. Include if sent to the MMS Proxy-Relay.	C

state	Identifies the value of the MM State associated with a to be stored or stored MM. See OMA-TS-MMS_ENC [39] clause 7.3.33. Include if sent to the MMS Proxy-Relay.	C
flags	Identifies a keyword to add or remove from the list of keywords associated with a stored MM. See OMA-TS-MMS_ENC [39] clause 7.3.32. Include if sent to the MMS Proxy-Relay.	C
replyCharging	If this field is present its value is set to "accepted" or "accepted text only" and the MMS-version-value of the M-Notification.ind PDU is higher than 1.0, this header field will indicate that a reply to this particular MM is free of charge for the recipient. If the Reply-Charging service is offered and the request for reply-charging has been accepted by the MMS service provider the value of this header field SHALL be set to "accepted" or "accepted text only". See OMA-TS-MMS_ENC [39] clause 7.3.43. Include if sent to the MMS Proxy-Relay.	C
applicID	Identification of the originating application of the original MM. Sent by the target to identify the destination application as defined in OMA-TS-MMS_ENC [39] clause 7.3.2. Include if sent to the MMS Proxy-Relay.	C
replyApplicID	Identification of an application to which replies, delivery reports, and read reports are addressed. Sent by the target to identify the application to which replies, delivery reports, and read reports are addressed as defined in OMA-TS-MMS_ENC [39] clause 7.3.42. Include if sent to the MMS Proxy-Relay.	C
auxApplicInfo	Auxiliary application addressing information as indicated in the original MM. As defined in OMA-TS-MMS_ENC [39] clause 7.3.4. Include if sent to the MMS Proxy-Relay.	C
contentClass	Classifies the content of the MM to the smallest content class to which the message belongs. Sent by the target to identify the class of the content. See OMA-TS-MMS_ENC [39] clause 7.3.9. Include if sent to the MMS Proxy-Relay.	C
dRMContent	Indicates if the MM contains any DRM-protected element. Provide when sent by the target to indicate if the MM contains any DRM-protected element. The values given in OMA-TS-MMS_ENC [39] clause 7.3.16 shall be encoded as follows: "Yes" = True, "No" = False. Include if sent to the MMS Proxy-Relay.	C
adaptationAllowed	Provide when sent by the target to identify whether the target wishes the MM to be adapted or not. If overridden, an indication shall be included in the parameter. Include if sent to the MMS Proxy-Relay.	C
contentType	The content type of the MM. See OMA-TS-MMS_ENC [39] clause 7.3.11	M
responseStatus	MMS specific status. See OMA-TS-MMS_ENC [39] clause 7.3.48.	M
responseStatusText	Text that qualifies the Response Status. Include if sent to the target. As defined in OMA-TS-MMS_ENC [39] clause 7.3.49. Include if sent by the MMS Proxy-Relay.	C
messageID	An ID assigned by the MMS Proxy-Relay to uniquely identify an MM. As defined in OMA-TS-MMS_ENC [39] clause 7.3.29.	M

7.4.3.2 MMSSendByNonLocalTarget

The IRI-POI in the MMS Proxy-Relay shall generate an xIRI containing an MMSSendByNonLocalTarget record when the MMS Proxy-Relay receives *MM4_forward.REQ* (as defined in TS 23.140 [40] clause 8.4.1) from the non-local MMS Proxy-Relay, that contains a non-local target ID.

Table 7.4.3-2 contains parameters generated by the IRI-POI, along with parameters derived from the *MM4_forward.REQ* message (from the non-local MMS Proxy-Relay to the local MMS Proxy-Relay).

Table 7.4.3-2: Payload for MMSendByNonLocalTarget

Field name	Description	M/C/O
version	The version of MM, to include major and minor version.	M
transactionID	An ID used to correlate an MMS request and response between the proxies. As defined in TS 23.140 [40] clause 8.4.1.4.	M
messageID	An ID assigned by the MMS Proxy-Relay to uniquely identify an MM. As defined in TS 23.140 [40] clause 8.4.1.4.	M
terminatingMMSParty	ID(s) of the terminating party in one or more of the formats described in 7.4.2.1.	M
originatingMMSParty	ID(s) of the originating party in one or more of the formats described in 7.4.2.1.	M
direction	Indicates the direction of the MM. This shall be encoded as "from target."	M
contentType	The content type of the MM. See OMA-TS-MMS_ENC [39] clause 7.3.11	M
messageClass	Class of the MM. For example, a value of "auto" is automatically generated by the UE. If the field is not present, the class should be interpreted as "personal." Include if sent to the MMS Proxy-Relay.	C
dateTime	Date and Time when the MM was last handled (either originated or forwarded).	M
expiry	Length of time in seconds the MM will be stored in MMS Proxy-Relay or time to delete the MM. The field has two formats, either absolute or relative. Include if sent to the MMS Proxy-Relay.	C
deliveryReport	Specifies whether the originator MM UE requests a delivery report from each recipient. Indicates the desired delivery report. The values given in TS 23.140 [40] clause 8.4.1.4 shall be encoded as follows: "Yes" = True, "No" = False. Include if it exists in the MMS Proxy-Relay message. Include if sent to the MMS Proxy-Relay.	C
priority	Priority of the MM assigned by the originator MMS Client. Reported if sent by the target. Include if sent to the MMS Proxy-Relay.	C
senderVisibility	An indication that the sender's address should not be delivered to the recipient. Indicates the target's visibility to the other party or if not signalled by the target and the default is to not make target visible to the other party. The values given in TS 23.140 [40] clause 8.4.1.4 shall be encoded as follows: "Show" = True, "Hide" = False. Include if sent to the MMS Proxy-Relay.	C
readReport	Specifies whether the originator MM UE requests a read report from each recipient. Provide when sent by the target to indicate the desired read report. The values given in TS 23.140 [40] clause 8.4.1.4 shall be encoded as follows: "Yes" = True, "No" = False. Include if sent to the MMS Proxy-Relay.	C
subject	The subject of the MM. Include if sent by the target.	C
forwardCount	The number of times the MM was forwarded	C
previouslySentBy	History of UEs that have forwarded (including originally submitted) the MM. Include if sent to the MMS Proxy-Relay.	C
previouslySentByDateTime	The timestamp associated with the previous forward events. Include if sent to the MMS Proxy-Relay.	C
applicID	Identification of the originating application of the original MM. Provide when sent by the target to identify the destination application as defined in TS 23.140 [40] clause 8.4.1.4. Include if sent to the MMS Proxy-Relay.	C
replyApplicID	Identification of an application to which replies, delivery reports, and read reports are addressed. Provide when sent by the target to identify the application to which replies, delivery reports, and read reports are addressed as defined in TS 23.140 [40] clause 8.4.1.4. Include if sent to the MMS Proxy-Relay.	C
auxApplicInfo	Auxiliary application addressing information as indicated in the original MM. As defined in OMA-TS-MMS_ENC [39] clause 7.3.4. Include if sent to the MMS Proxy-Relay.	C
contentClass	Classifies the content of the MM to the smallest content class to which the message belongs. Identifies the class of the content. Include if sent to the MMS Proxy-Relay.	C
dRMContent	Indicates if the MM contains any DRM-protected element. Indicates if the MM contains any DRM-protected element. The values given as defined in TS 23.140 [40] clause 8.4.1.4 shall be encoded as follows: "Yes" = True, "No" = False. Include if sent to the MMS Proxy-Relay.	C
adaptationAllowed	Identifies whether the target wishes the MM to be adapted or not. If overridden, an indication shall be included in the parameter. Include if sent to the MMS Proxy-Relay.	C

7.4.3.3 MMSNotification

The IRI-POI in the MMS Proxy-Relay shall generate an xIRI containing an MMSNotification record when the MMS Proxy-Relay sends a *m-notification-ind* (as defined in OMA-TS-MMS_ENC [39] clause 6.2) to the MMS client in the local target UE.

Table 7.4.3-3 contains parameters generated by the IRI-POI, along with parameters derived from the *m-notification-ind* message (from the local MMS Proxy-Relay to the local target).

Table 7.4.3-3: Payload for MMSNotification

Field name	Description	M/C/O
transactionID	An ID used to correlate an MMS request and response between the target and the MMS Proxy-Relay. As defined in OMA-TS-MMS_ENC [AA] clause 7.3.63.	M
version	The version of MM, to include major and minor version.	M
originatingMMSParty	ID(s) of the originating party in one or more of the formats described in 7.4.2.1 When address translation occurs (such as the case of a token sent by the client and replaced with a proper address by the MMS Proxy-Relay), both the pre and post translated addresses (with appropriate correlation) are included. If the originating MMS client requested address hiding, but the MMS Proxy-Relay has access to the "From" field, this shall be reported, regardless of the fact that it may be hidden from the recipient.	C
direction	Indicates the direction of the MM. This shall be encoded as "to target."	M
subject	The subject of the MM. Include if sent by the MMS Proxy-Relay.	C
deliveryReportRequested	Specifies whether the originator MMS UE requests a delivery report from each recipient. The values given in OMA-TS-MMS_ENC [39] clause 7.3.13 shall be encoded as follows: "Yes" = True, "No" = False. Include if sent by the MMS Proxy-Relay.	C
stored	Specifies whether the MM was stored in the target's MMBox, and that the <i>content-location-value</i> field is a reference to it. "Stored" is coded as True, and "not Stored" is coded as False. As defined in OMA-TS-MMS_ENC [39] clause 7.3.57. Include if sent by the MMS Proxy-Relay.	C
messageClass	Class of the MM. For example, a value of "auto" is automatically generated by the UE.	M
priority	Priority of the MM assigned by the originator MMS Client. Include if sent by the MMS Proxy-Relay.	C
messageSize	Specifies the size of the MM that was viewed or uploaded. Specified in bytes.	M
expiry	Length of time in seconds the MM will be stored in MMS Proxy-Relay or time to delete the MM. The field has two formats, either absolute or relative.	M
replyCharging	If this field is present its value is set to "accepted" or "accepted text only" and the MMS-version-value of the M-Notification.ind PDU is higher than 1.0, this header field will indicate that a reply to this particular MM is free of charge for the recipient. If the Reply-Charging service is offered and the request for reply-charging has been accepted by the MMS service provider the value of this header field SHALL be set to "accepted" or "accepted text only". See OMA-TS-MMS_ENC [39] clause 7.3.43. Include if sent by the MMS Proxy-Relay.	C

7.4.3.4 MMSSendToNonLocalTarget

The IRI-POI in the MMS Proxy-Relay shall generate an xIRI containing an MMSSendToNonLocalTarget record when the local MMS Proxy-Relay sends a *MM4_forward.REQ* (as defined in TS 23.140 [40] clause 8.4.1) to the non-local MMS Proxy-Relay, that contains a non-local target ID.

Table 7.4.3-4 contains parameters generated by the IRI-POI, along with parameters derived from the *MM4_forward.REQ* message (from the non-local MMS Proxy-Relay to the local MMS Proxy-Relay).

Table 7.4.3-4: Payload for MMSSendToNonLocalTarget

Field name	Description	M/C/O
version	The version of MM, to include major and minor version.	M
transactionID	An ID used to correlate an MMS request and response between the proxies. As defined in TS 23.140 [40] clause 8.4.1.4.	M
messageID	An ID assigned by the MMS Proxy-Relay to uniquely identify an MM. As defined in TS 23.140 [40] clause 8.4.1.4.	M
terminatingMMSParty	ID(s) of the terminating party in one or more of the formats described in 7.4.2.1.	M
originatingMMSParty	ID(s) of the originating party in one or more of the formats described in 7.4.2.1.	M
direction	Indicates the direction of the MM. This shall be encoded as "to target."	M
contentType	The content type of the MM. See OMA-TS-MMS_ENC [39] clause 7.3.11	M
messageClass	Class of the MM. For example, a value of "auto" is automatically generated by the UE. If the field is not present, the class should be interpreted as "personal." Include if sent by the MMS Proxy-Relay message.	C
dateTime	Date and Time when the MM was last handled (either originated or forwarded).	M
expiry	Length of time in seconds the MM will be stored in MMS Proxy-Relay or time to delete the MM. The field has two formats, either absolute or relative. Include if sent by the MMS Proxy-Relay message.	C
deliveryReportRequested	Specifies whether the originator MMS UE requests a delivery report from each recipient. Indicates the desired delivery report. The values given in TS 23.140 [40] clause 8.4.1.4 shall be encoded as follows: "Yes" = True, "No" = False. Include if sent by the MMS Proxy-Relay message.	C
priority	Priority of the MM assigned by the originator MMS Client. Reported if sent by the target. Include if sent by the MMS Proxy-Relay message.	C
senderVisibility	Indicates whether the sender's address should not be delivered to the recipient. Indicates the target's visibility to the other party or if not signalled by the target and the default is to not make target visible to the other party. The values given in TS 23.140 [40] clause 8.4.1.4 shall be encoded as follows: "Show" = True, "Hide" = False. Include if sent by the MMS Proxy-Relay message.	C
readReport	Specifies whether the originator MMS UE requests a read report from each recipient. Indicates the desired read report. The values given in TS 23.140 [40] clause 8.4.1.4 shall be encoded as follows: "Yes" = True, "No" = False. Include if sent by the MMS Proxy-Relay message.	C
subject	The subject of the MM. Include if sent to the target.	C
forwardCount	The number of times the MM was forwarded	C
previouslySentBy	History of UEs that have forwarded (including originally submitted) the MM. Include if sent by the MMS Proxy-Relay message.	C
previouslySentByDateTime	The timestamp associated with the previous forward events. Include if sent by the MMS Proxy-Relay message.	C
applicID	Identification of the originating application of the original MM. Provide when sent by the target to identify the destination application as defined in TS 23.140 [40] clause 8.4.1.4. Include if sent by the MMS Proxy-Relay message.	C
replyApplicID	Identification of an application to which replies, delivery reports, and read reports are addressed. Identifies the application to which replies, delivery reports, and read reports are addressed as defined in TS 23.140 [40] clause 8.4.1.4. Include if sent by the MMS Proxy-Relay message.	C
auxApplicInfo	Auxiliary application addressing information as indicated in the original MM. As defined in OMA-TS-MMS_ENC [39] clause 7.3.4. Include if sent by the MMS Proxy-Relay message.	C
contentClass	Classifies the content of the MM to the smallest content class to which the message belongs. Identifies the class of the content. Include if sent by the MMS Proxy-Relay message.	C
dRMContent	Indicates if the MM contains any DRM-protected element. Indicates if the MM contains any DRM-protected element. The values given as defined in TS 23.140 [40] clause 8.4.1.4 shall be encoded as follows: "Yes" = True, "No" = False. Include if sent by the MMS Proxy-Relay message.	C
adaptationAllowed	identifies whether the target wishes the MM to be adapted or not. If overridden, an indication shall be included in the parameter. Include if sent by the MMS Proxy-Relay message.	C
store	Specifies whether the originator MMS UE wants the submitted MM to be saved in the user's MMBox, in addition to sending it. Indicates whether the MMS is to be stored. The values given in TS 23.140 [40] clause 8.4.1.4 shall be encoded as follows: "Yes" = True, "No" = False. Include if sent by the MMS Proxy-Relay message.	C

applicID	Identification of the originating application of the original MM. Identifies the destination application as defined in TS 23.140 [40] clause 8.4.1.4. Include if sent by the MMS Proxy-Relay message.	C
replyApplicID	Identification of an application to which replies, delivery reports, and read reports are addressed. Identifies the application to which replies, delivery reports, and read reports are addressed as defined in TS 23.140 [40] clause 8.4.1.4. Include if sent by the MMS Proxy-Relay message.	C
auxApplicInfo	Auxiliary application addressing information as indicated in the original MM. As defined in OMA-TS-MMS_ENC [39] clause 7.3.4. Include if sent by the MMS Proxy-Relay message.	C
contentClass	Classifies the content of the MM to the smallest content class to which the message belongs. Identifies the class of the content. Include if sent by the MMS Proxy-Relay message.	C
dRMContent	Indicates if the MM contains any DRM-protected element. Indicates whether the MM contains any DRM-protected element. The values given as defined in TS 23.140 [40] clause 8.4.1.4 shall be encoded as follows: "Yes" = True, "No" = False. Include if sent by the MMS Proxy-Relay message.	C

7.4.3.5 MMSNotificationResponse

The IRI-POI in the MMS Proxy-Relay shall generate an xIRI containing an MMSNotificationResponse record when the MMS Proxy-Relay receives a *m-notifyresp-ind* (as defined in OMA-TS-MMS_ENC [39] clause 6.2, table 4) from the MMS client in the target UE for the deferred retrieval case only. The immediate retrieval trigger on *m-notifyresp-ind* is in clause 7.4.3.7.

Table 7.4.3-5 contains parameters generated by the IRI-POI, along with parameters derived from the *m-notifyresp-ind* message (from the local target UE to the MMS Proxy-Relay).

Table 7.4.3-5: Payload for MMSNotificationResponse

Field name	Description	M/C/O
transactionID	An ID used to correlate an MMS request and response between the target and the MMS Proxy-Relay. As defined in OMA-TS-MMS_ENC [39] clause 7.3.63.	M
version	The version of MM, to include major and minor version.	M
direction	Indicates the direction of the MM. This shall be encoded as "to target"	M
status	Provides a MM status. A status of "retrieved" is only signalled by the retrieving UE after retrieval of the MM.	M
reportAllowed	Indication whether or not the sending of delivery report is allowed by the recipient MMS Client. The values given in OMA-TS-MMS_ENC [39] clause 7.3.47 shall be encoded as follows: "Yes" = True, "No" = False. Include if sent to the MMS Proxy-Relay.	C

7.4.3.6 MMSRetrieval

The IRI-POI in the MMS Proxy-Relay shall generate an xIRI containing an MMSRetrieval record when the MMS Proxy-Relay sends a *m-retrieve-conf* (as defined in OMA-TS-MMS_ENC [39] clause 6.3) to the MMS client in the target UE.

Table 7.4.3-6 contains parameters generated by the IRI-POI, along with parameters derived from the *m-retrieve-conf* message (from the MMS Proxy-Relay to the local target UE).

Table 7.4.3-6: Payload for MMSRetrieval

Field name	Description	M/C/O
transactionID	An ID used to correlate an MMS request and response between the target and the MMS Proxy-Relay. As defined in OMA-TS-MMS_ENC [39] clause 7.3.63.	M
version	The version of MM, to include major and minor version.	M
messageID	An ID assigned by the MMS Proxy-Relay to uniquely identify an MM. As defined in OMA-TS-MMS_ENC [39] clause 7.3.29.	M
dateTime	Date and Time when the MM was last handled (either originated or forwarded). For origination, included by the sending MMS client or the originating MMS Proxy-Relay.	M
originatingMMSParty	ID(s) of the originating party in one or more of the formats described in 7.4.2.1 When address translation occurs (such as the case of a token sent by the client and replaced with a proper address by the MMS Proxy-Relay), both the pre and post translated addresses (with appropriate correlation) are included. Include if sent by the MMS Proxy-Relay.	C
previouslySentBy	History of UEs that have forwarded (including originally submitted) the MM. Include if sent by the MMS Proxy-Relay.	C
previouslySentByDateTime	The timestamp associated with the previous forward events. Include if sent by the MMS Proxy-Relay.	C
terminatingMMSParty	ID(s) of the terminating party in one or more of the formats described in 7.4.2.1 When address translation occurs (such as the case of a token sent by the client and replaced with a proper address by the MMS Proxy-Relay), both the pre and post translated addresses (with appropriate correlation) are included. Include if sent by the MMS Proxy-Relay. At least one of the terminatingMMSParty or cCRecipients must be included.	C
cCRecipients	Address of a recipient; the "CC" field may include addresses of multiple recipients. When address translation occurs, both the pre and post translated addresses (with appropriate correlation) are included. Include if sent by the MMS Proxy-Relay. At least one of the terminatingMMSParty or cCRecipients must be included.	C
direction	Indicates the direction of the MM. This shall be encoded as "to target," or "fromTarget," as appropriate.	M
subject	The subject of the MM. Include if sent by the MMS Proxy-Relay.	C
state	Identifies the value of the MM State associated with a to be stored or stored MM. See OMA-TS-MMS_ENC [39] clause 7.3.33. Include if sent by the MMS Proxy-Relay.	C
flags	Identifies a keyword to add or remove from the list of keywords associated with a stored MM. Include if sent. See OMA-TS-MMS_ENC [39] clause 7.3.32. Include if sent by the MMS Proxy-Relay.	C
messageClass	Class of the MM. For example, a value of "auto" is automatically generated by the UE. If the field is not present, the class should be interpreted as "personal." Include if sent by the MMS Proxy-Relay.	C
priority	Priority of the MM assigned by the originator MMS Client. Include if sent by the MMS Proxy-Relay.	C
deliveryReport	Specifies whether the originator MM UE requests a delivery report from each recipient. Indicates whether a delivery report is desired. The values given in OMA-TS-MMS_ENC [39] clause 7.3.13. shall be encoded as follows: "Yes" = True, "No" = False. Include if sent by the MMS Proxy-Relay.	C
readReport	Specifies whether the originator MM UE requests a read report from each recipient. Indicates whether a read report is desired. The values given in OMA-TS-MMS_ENC [39] clause 7.3.37 shall be encoded as follows: "Yes" = True, "No" = False. Include if sent by the MMS Proxy-Relay.	C
replyCharging	If this field is present its value is set to "accepted" or "accepted text only" and the MMS-version-value of the PDU is higher than 1.0, this header field will indicate that a reply to this particular MM is free of charge for the recipient. If the Reply-Charging service is offered and the request for reply-charging has been accepted by the MMS service provider the value of this header field SHALL be set to "accepted" or "accepted text only". See OMA-TS-MMS_ENC [39] clause 7.3.43. Include if sent by the MMS Proxy-Relay.	C
retrieveStatus	MMS specific status. It is used by the recipient MMS Proxy-Relay to inform the recipient MMS Client about errors, if any that occurred during the preceding retrieval operation. Include if sent by the MMS Proxy-Relay.	C
retrieveStatusText	Text that qualifies the Retrieve Status. As defined in OMA-TS-MMS_ENC [39] clause 7.3.55. Include if sent by the MMS Proxy-Relay.	C

applicID	Identification of the originating application of the original MM. Sent by the target to identify the destination application as defined in OMA-TS-MMS_ENC [39] clause 7.3.2. Include if sent by the MMS Proxy-Relay.	C
replyApplicID	Identification of an application to which replies, delivery reports, and read reports are addressed. Sent by the target to identify the application to which replies, delivery reports, and read reports are addressed as defined in OMA-TS-MMS_ENC [39] clause 7.3.42. Include if sent by the MMS Proxy-Relay.	C
auxApplicInfo	Auxiliary application addressing information as indicated in the original MM. As defined in OMA-TS-MMS_ENC [39] clause 7.3.4. Include if sent by the MMS Proxy-Relay.	C
contentClass	Classifies the content of the MM to the smallest content class to which the message belongs. Sent by the target to identify the class of the content. See OMA-TS-MMS_ENC [39] clause 7.3.9. Include if sent by the MMS Proxy-Relay.	C
dRMContent	Indicates if the MM contains any DRM-protected element. Provide when sent by the target to indicate if the MM contains any DRM-protected element. The values given in OMA-TS-MMS_ENC [39] clause 7.3.16 shall be encoded as follows: "Yes" = True, "No" = False. Include if sent by the MMS Proxy-Relay.	C
replaceID	Indicates the message ID of the message this one is intended to replace. Include if sent by the MMS Proxy-Relay.	C
contentType	The content type of the MM. See OMA-TS-MMS_ENC [39] clause 7.3.11.	M

7.4.3.7 MMSDeliveryAck

The IRI-POI in the MMS Proxy-Relay shall generate an xIRI containing an MMSDeliveryAck record when:

- the MMS Proxy-Relay receives an *m-acknowledge-ind* (as defined in OMA-TS-MMS_ENC [39] clause 6.4) from the MMS client in the target UE (for deferred retrieval), or
- the MMS Proxy-Relay receives an *m-notifyresp-ind* (as defined in OMA-TS-MMS_ENC [39] clause 6.4) from the MMS client in the target UE (for immediate retrieval).

Table 7.4.3-7 contains parameters generated by the IRI-POI, along with parameters derived from the *m-acknowledge-ind* message (from the local target UE to the MMS Proxy-Relay), and the *m-notifyresp-ind* message (from the local target UE to the MMS Proxy-Relay).

Table 7.4.3-7: Payload for MMSDeliveryAck

Field name	Description	M/C/O
transactionID	An ID used to correlate an MMS request and response between the target and the MMS Proxy-Relay. As defined in OMA-TS-MMS_ENC [39] clause 7.3.63.	M
version	The version of MM, to include major and minor version.	M
reportAllowed	Indicates whether the target allows sending of a delivery report. Encoded as "Yes" = True, "No" = False. Include if received by the MMS Proxy-Relay.	C
status	Provides a MM status. A status of "retrieved" is only signalled by the retrieving UE after retrieval of the MM. Include if received by the MMS Proxy-Relay and if generated from a <i>m-notifyresp-ind</i> .	C
direction	Indicates the direction of the MM. This shall be encoded as "to target."	M

7.4.3.8 MMSForward

The IRI-POI in the MMS Proxy-Relay shall generate an xIRI containing an MMSForward record when the MMS Proxy-Relay sends an *m-forward-conf* (as defined in OMA-TS-MMS_ENC [39] clause 6.5.2) to the MMS client in the target UE.

Table 7.4.3-8 contains parameters generated by the IRI-POI, along with parameters derived from the *m-forward-req* message (from the local target UE to the MMS Proxy-Relay), and the *m-forward-conf* message (from the MMS Proxy-Relay to the local target UE).

Table 7.4.3-8: Payload for MMSForward

Field name	Description	M/C/O
transactionID	An ID used to correlate an MMS request and response between the target and the MMS Proxy-Relay. As defined in OMA-TS-MMS_ENC [39] clause 7.3.63.	M
version	The version of MM, to include major and minor version.	M
dateTime	Date and Time when the MM last handled (either originated or forwarded). For origination, included by the sending MMS client or the originating MMS Proxy-Relay. Include if sent to the MMS Proxy-Relay.	C
originatingMMSParty	ID(s) of the originating (forwarding) party in one or more of the formats described in 7.4.2.1 When address translation occurs (such as the case of a token sent by the client and replaced with a proper address to the MMS Proxy-Relay), both the pre and post translated addresses (with appropriate correlation) are included.	M
terminatingMMSParty	ID(s) of the terminating party in one or more of the formats described in 7.4.2.1 When address translation occurs (such as the case of a token sent by the client and replaced with a proper address by the MMS Proxy-Relay), both the pre and post translated addresses (with appropriate correlation) are included. Include if sent to the MMS Proxy-Relay. At least one of the terminatingMMSParty, cCRecipients, or bCCRecipients must be included.	C
cCRecipients	Address of a recipient; the "CC" field may include addresses of multiple recipients. When address translation occurs, both the pre and post translated addresses (with appropriate correlation) are included. This parameter is included if the corresponding MM includes a "CC" field. Include if sent to the MMS Proxy-Relay. At least one of the terminatingMMSParty, cCRecipients, or bCCRecipients must be included.	C
bCCRecipients	Address of a recipient; the "BCC" field may include addresses of multiple recipients. When address translation occurs, both the pre and post translated addresses (with appropriate correlation) are included. This parameter is included if the corresponding MM includes a "BCC" field. Include if sent to the MMS Proxy-Relay. At least one of the terminatingMMSParty, cCRecipients, or bCCRecipients must be included.	C
direction	Indicates the direction of the MM. This shall be encoded as "from target."	M
expiry	Length of time in seconds the MM will be stored in MMS Proxy-Relay or time to delete the MM. The field has two formats, either absolute or relative. Include either the signalled expiry or the default, whichever applies. Include if sent to the MMS Proxy-Relay.	C
desiredDeliveryTime	Date and Time of desired delivery. Indicates the earliest possible delivery of the MM to the recipient. Include if sent to the MMS Proxy-Relay.	C
deliveryReportAllowed	An indication that the target requested reporting to the original sender or the default, whichever applies. The values given in OMA-TS-MMS_ENC [39] clause 7.3.47 shall be encoded as follows: "Yes" = True, "No" = False. Include if sent to the MMS Proxy-Relay.	C
deliveryReport	Specifies whether the originator MMS UE requests a delivery report from each recipient. The values given in OMA-TS-MMS_ENC [39] clause 7.3.13. shall be encoded as follows: "Yes" = True, "No" = False. Include if sent to the MMS Proxy-Relay.	C
store	Specifies whether the originator MMS UE wants the submitted MM to be saved in the user's MMBox, in addition to sending it. Sent by the target to have the forwarded MM stored. The values given in OMA-TS-MMS_ENC [39] clause 7.3.56 shall be encoded as follows: "Yes" = True, "No" = False. Include if sent to the MMS Proxy-Relay.	C
state	Identifies the value of the MM State associated with a MM to be stored or stored MM. Sets the state for the forwarded MM when it is stored. As defined in OMA-TS-MMS_ENC [39] clause 7.3.33. Include if sent to the MMS Proxy-Relay.	C

flags	Identifies a keyword to add or remove from the list of keywords associated with a stored MM. Include if sent to the MMS Proxy-relay. See OMA-TS-MMS_ENC [39] clause 7.3.32.	C
contentLocationReq	The content-location-value field defines the URL for the MMS server location of the content to be retrieved as it appears in the m-forward-req. As defined in OMA-TS-MMS_ENC [39] clause 7.3.10.	M
replyCharging	If this field is present its value is set to "accepted" or "accepted text only" and the MMS-version-value is higher than 1.0, this header field will indicate that a reply to this particular MM is free of charge for the recipient. If the Reply-Charging service is offered and the request for reply-charging has been accepted by the MMS service provider the value of this header field SHALL be set to "accepted" or "accepted text only". See OMA-TS-MMS_ENC [39] clause 7.3.43. Include if sent to the MMS Proxy-Relay.	C
responseStatus	MMS specific status. See OMA-TS-MMS_ENC [39] clause 7.3.48.	M
responseStatusText	Text that qualifies the Response Status. Include if sent to the target. As defined in OMA-TS-MMS_ENC [39] clause 7.3.49. Include if sent by the MMS Proxy-Relay.	C
messageID	An ID assigned by the MMS Proxy-Relay to uniquely identify an MM. As defined in OMA-TS-MMS_ENC [39] clause 7.3.29. Include if sent by the MMS Proxy-Relay.	C
contentLocationConf	The <i>content-location-value</i> field defines the URL for the MMS server location of the MM as it appears in the <i>m-forward-conf</i> . As defined in OMA-TS-MMS_ENC [39] clause 7.3.10. Include if sent by the MMS Proxy-Relay.	C
storeStatus	Indicates if the MM was successfully stored in the MMBox. Include if sent by the MMS Proxy-Relay.	C
storeStatusText	Text that qualifies the Store Status. As defined in OMA-TS-MMS_ENC [39] clause 7.3.59. Include if sent by the MMS Proxy-Relay.	C

7.4.3.9 MMSDeleteFromRelay

The IRI-POI present in the MMS Proxy-Relay shall generate an xIRI containing an MMSDeleteFromRelay record when the MMS Proxy-Relay sends a *m-delete-conf* (defined in OMA-TS-MMS_ENC [39]) to the MMS client in the target UE.

Table 7.4.3-9 contains parameters generated by the IRI-POI, along with parameters derived from the *m-delete-req* message (from the local target UE to the MMS Proxy-Relay), and the *m-delete-conf* message (from the MMS Proxy-Relay to the local target UE).

Table 7.4.3-9: Payload for MMSDeleteFromRelay

Field name	Description	M/C/O
transactionID	An ID used to correlate an MMS request and response between the target and the MMS Proxy-Relay.	M
version	The version of MM, to include major and minor version.	M
direction	Indicates the direction of the MM. This shall be encoded as "to target," or "fromTarget," as appropriate.	M
contentLocationReq	The <i>content-location-value</i> field defines the URL for the MMS server location of the MM as it appears in the <i>m-delete-conf</i> , as defined in OMA-TS-MMS_ENC [39] clause 7.3.10. Include if sent to the MMS Proxy-Relay.	M
contentLocationConf	The <i>content-location-value</i> field defines the URL for the MMS server location of the MM as it appears in the <i>m-delete-conf</i> , as defined in OMA-TS-MMS_ENC [39] clause 7.3.10. Include if sent by the MMS Proxy-Relay.	C
deleteResponseStatus	The delete response, as defined in OMA-TS-MMS_ENC [39] clause 7.3.48.	M
deleteResponseText	The delete response, as defined in OMA-TS-MMS_ENC [39] clause 7.3.49. Include if sent by the MMS Proxy-Relay.	C

7.4.3.10 MMSMBoxStore

The IRI-POI in the MMS Proxy-Relay shall generate an xIRI containing an MMSMBoxStore record when the MMS Proxy-Relay sends a *m-mbox-store-conf* (defined in OMA-TS-MMS_ENC [39] clause 6.8) to the MMS client in the target UE.

Table 7.4.3-10 contains parameters generated by the IRI-POI, along with parameters derived from the *m-mbox-store-req* message (from the local target UE to the MMS Proxy-Relay), and from the *m-mbox-store-conf* message (from the MMS Proxy-Relay to the local target UE).

Table 7.4.3-10: Payload for MMSMBoxStore

Field name	Description	M/C/O
transactionID	An ID used to correlate an MMS request and response between the target and the MMS Proxy-Relay. As defined in OMA-TS-MMS_ENC [39] clause 7.3.63.	M
version	The version of MM, to include major and minor version.	M
direction	Indicates the direction of the MM. This shall be encoded as "to target."	M
contentLocationReq	The <i>content-location-value</i> field defines the URL for the MMS server location of the MM as it appears in the <i>m-mbox-store-req</i> . As defined in OMA-TS-MMS_ENC [39] clause 7.3.10. Include if sent by the MMS Proxy-Relay.	M
state	Identifies the value of the MM State associated with a MM to be stored or stored MM. Sets the state for the forwarded MM when it is stored. As defined in OMA-TS-MMS_ENC [39] clause 7.3.33. Include if sent by the MMS Proxy-Relay.	C
flags	Identifies a keyword to add or remove from the list of keywords associated with a stored MM. See OMA-TS-MMS_ENC [39] clause 7.3.32. Include if sent by the MMS Proxy-Relay.	C
contentLocationConf	The <i>content-location-value</i> field defines the URL for the MMS server location of the MM as it appears in the <i>m-mbox-store-conf</i> . As defined in OMA-TS-MMS_ENC [39] clause 7.3.10. Include if sent by the MMS Proxy-Relay.	C
storeStatus	Indicates if the MM was successfully stored in the MMBox.	M
storeStatusText	Text that qualifies the Store Status. Include if sent to the target. As defined in OMA-TS-MMS_ENC [39] clause 7.3.59. Include if sent by the MMS Proxy-Relay.	C

7.4.3.11 MMSMBoxUpload

The IRI-POI present in the MMS Proxy-Relay shall generate an xIRI containing an MMSMBoxUpload record when the MMS Proxy-Relay sends a *m-mbox-upload-conf* (defined in OMA-TS-MMS_ENC [39] clause 6.10) to the MMS client in the target UE.

Table 7.4.3-11 contains parameters generated by the IRI-POI, along with parameters derived from the *m-mbox-upload-req* message (from the local target UE to the MMS Proxy-Relay), and from the *m-mbox-upload-conf* message (from the MMS Proxy-Relay to the local target UE).

Table 7.4.3-11: Payload for MMSBoxUpload

Field name	Description	M/C/O
transactionID	An ID used to correlate an MMS request and response between the target and the MMS Proxy-Relay. As defined in OMA-TS-MMS_ENC [39] clause 7.3.63.	M
version	The version of MM, to include major and minor version.	M
direction	Indicates the direction of the MM. This shall be encoded as "to target," or "fromTarget," as appropriate.	M
state	Identifies the value of the MM State associated with a MM to be stored or stored MM. Sets the state for the forwarded MM when it is stored. As defined in OMA-TS-MMS_ENC [39] clause 7.3.33. Include if sent by the MMS Proxy-Relay.	C
flags	Identifies a keyword to add or remove from the list of keywords associated with a stored MM. See OMA-TS-MMS_ENC [39] clause 7.3.32. Include if sent by the MMS Proxy-Relay.	C
contentType	The content type of the MM. See OMA-TS-MMS_ENC [39] clause 7.3.11	M
contentLocation	The <i>content-location-value</i> field defines the URL for the MMS server location of the MM. As defined in OMA-TS-MMS_ENC [39] clause 7.3.10. Include if sent by the MMS Proxy-Relay.	C
storeStatus	Indicates if the MM was successfully stored in the MMSBox.	M
storeStatusText	Text that qualifies the Store Status. Include if sent to the target. As defined in OMA-TS-MMS_ENC [39] clause 7.3.59. Include if sent by the MMS Proxy-Relay.	C
mMMSBoxDescription	The MMSBox description PDU as defined in 7.4.3.20 corresponds to the particular MM. include if sent by the MMS Proxy-Relay.	C

7.4.3.12 MMSBoxDelete

The IRI-POI present in the MMS Proxy-Relay shall generate an xIRI containing an MMSBoxDelete record when the MMS Proxy-Relay sends a *m-mbox-delete.conf* (defined in OMA-TS-MMS_ENC [39]) to the MMS client in the target UE.

Table 7.4.3-12 contains parameters generated by the IRI-POI, along with parameters derived from the *m-mbox-delete-req* message (from the local target UE to the MMS Proxy-Relay), and from the *m-mbox-delete-conf* message (from the MMS Proxy-Relay to the local target UE).

Table 7.4.3-12: Payload for MMSBoxDelete

Field name	Description	M/C/O
transactionID	An ID used to correlate an MMS request and response between the target and the MMS Proxy-Relay. As defined in OMA-TS-MMS_ENC [39] clause 7.3.63.	M
version	The version of MM, to include major and minor version.	M
direction	Indicates the direction of the MM. This shall be encoded as "to target," or "fromTarget," as appropriate.	M
contentLocationReq	The <i>content-location-value</i> field defines the URL for the MMS server location of the MM as it appears in the <i>m-mbox-delete-req</i> . As defined in OMA-TS-MMS_ENC [39] clause 7.3.10.	M
contentLocationConf	The <i>content-location-value</i> field defines the URL for the MMS server location of the MM as it appears in the <i>m-mbox-delete-conf</i> . As defined in OMA-TS-MMS_ENC [39] clause 7.3.10. Include if sent by the MMS Proxy-Relay.	C
responseStatus	MMS specific status.	M
responseStatusText	Text that qualifies the Response Status. As defined in OMA-TS-MMS_ENC [39] clause 7.3.49.	C

7.4.3.13 MMSDeliveryReport

The IRI-POI present in the MMS Proxy-Relay shall generate an xIRI containing an MMSDeliveryReport record when the MMS Proxy-Relay sends an *m-delivery-ind* (as defined in OMA-TS-MMS_ENC [39] clause 6.11) to the MMS client in the target UE.

Table 7.4.3-13 contains parameters generated by the IRI-POI, along with parameters derived from the *m-delivery-ind* message (from the MMS Proxy-Relay to the local target UE).

Table 7.4.3-13: Payload for MMSDeliveryReport

Field name	Description	M/C/O
version	The version of MM, to include major and minor version.	M
messageID	An ID assigned by the MMS Proxy-Relay to uniquely identify an MM. As defined in OMA-TS-MMS_ENC [39] clause 7.3.29. Include if sent by the MMS Proxy-Relay.	M
terminatingMMSParty	ID(s) of the terminating party of the original message this Delivery Report refers to, in one or more of the formats described in 7.4.2.1 When address translation occurs (such as the case of a token sent by the client and replaced with a proper address by the MMS Proxy-Relay), both the pre and post translated addresses (with appropriate correlation) are included.	M
dateTime	Date and Time when the MM was last handled (either originated or forwarded). Include if sent by the MMS Proxy-Relay.	M
responseStatus	MMS specific status.	M
responseStatusText	Text that qualifies the Response Status. As defined in OMA-TS-MMS_ENC [39] clause 7.3.49. Include if sent by the MMS Proxy-Relay.	C
applicID	Identification of the originating application of the original MM. Sent by the target to identify the destination application as defined in OMA-TS-MMS_ENC [39] clause 7.3.2. Include if sent by the MMS Proxy-Relay.	C
replyApplicID	Identification of an application to which replies, delivery reports, and read reports are addressed. Sent by the target to identify the application to which replies, delivery reports, and read reports are addressed as defined in OMA-TS-MMS_ENC [39] clause 7.3.42. Include if sent by the MMS Proxy-Relay.	C
auxApplicInfo	Auxiliary application addressing information as indicated in the original MM. As defined in OMA-TS-MMS_ENC [39] clause 7.3.4. Include if sent by the MMS Proxy-Relay.	C

7.4.3.14 MMSDeliveryReportNonLocalTarget

The IRI-POI in the MMS Proxy-Relay shall generate an xIRI containing an MMSDeliveryReportNonLocalTarget record when the MMS Proxy-Relay:

- sends MM4_delivery_report.REQ (as defined in TS 23.140 [40] clause 8.4.2), that contains a non-local target ID, to the non-local MMS Proxy-Relay, or
- receives MM4_delivery_report.REQ, that contains a non-local target ID, from the non-local MMS Proxy-Relay.

Table 7.4.3-14 contains parameters generated by the IRI-POI, along with parameters derived from the *MM4_delivery_report.REQ* message (from the local MMS Proxy-Relay to the non-local MMS Proxy-Relay, or inversely).

Table 7.4.3-14: Payload for MMSDeliveryReportNonLocalTarget

Field name	Description	M/C/O
version	The version of MM, to include major and minor version.	M
transactionID	An ID used to correlate an MMS request and response between the proxies. As defined in TS 23.140 [40] clause 8.4.1.4.	M
messageID	An ID assigned by the MMS Proxy-Relay to uniquely identify an MM. As defined in TS 23.140 [40] clause 8.4.1.4.	M
terminatingMMSParty	ID(s) of the terminating party of the original message this Delivery Report refers to, in one or more of the formats described in 7.4.2.1.	M
originatingMMSParty	ID(s) of the originating party of the original message this Delivery Report refers to, in one or more of the formats described in 7.4.2.1.	M
direction	Indicates the direction of the MM. This shall be encoded as "toTarget," or "from target," as appropriate.	M
dateTime	Date and Time when the MM was last handled (either originated or forwarded).	M
forwardToOriginator	Indicates whether the MMS Proxy-Relay is allowed to forward the delivery report to the originating UE. "Yes" is coded as True, and "No" is coded as False. Include if sent to/by the MMS Proxy-Relay.	C
mMStatus	Provides a MM status. A status of "retrieved" is only signalled by the retrieving UE after retrieval of the MM.	M
mMStatusExtension	Extension of the MMStatus, that provides more granularity. Include if sent to/by the MMS Proxy-Relay.	C
mMStatusText	Text that qualifies the MM Status. As defined in OMA-TS-MMS_ENC [39] clause 7.3.55. Include if sent to/by the MMS Proxy-Relay.	C
applicID	Identification of the originating application of the original MM. Identifies the destination application as defined in TS 23.140 [40] clause 8.4.1.4. Include if sent to/by the MMS Proxy-Relay.	C
replyApplicID	Identification of an application to which replies, delivery reports, and read reports are addressed. Identifies the application to which replies, delivery reports, and read reports are addressed as defined in TS 23.140 [40] clause 8.4.1.4. Include if sent to/by the MMS Proxy-Relay.	C
auxApplicInfo	Auxiliary application addressing information as indicated in the original MM. As defined in OMA-TS-MMS_ENC [39] clause 7.3.4. Include if sent to/by the MMS Proxy-Relay.	C

7.4.3.15 MMSReadReport

The IRI-POI present in the MMS Proxy-Relay shall generate an xIRI containing an MMSReadReport record when the MMS Proxy-Relay:

- sends a *m-read-orig-ind* (as defined in OMA-TS-MMS_ENC [39] clause 6.7.2) to the MMS client in the target UE, or
- receives a *m-read-rec-ind* (as defined in OMA-TS-MMS_ENC [39] clause 6.7.2) from the MMS client in the target UE.

Table 7.4.3-15 contains parameters generated by the IRI-POI, along with parameters derived from the *m-read-orig-ind* message (from the MMS Proxy-Relay to the local target UE), and from the *m-read-rec-ind* message (from the local target UE to the MMS Proxy-Relay).

Table 7.4.3-15: Payload for MMSReadReport

Field name	Description	M/C/O
version	The version of MM, to include major and minor version.	M
messageID	An ID assigned by the MMS Proxy-Relay to uniquely identify an MM. As defined in OMA-TS-MMS_ENC [39] clause 7.3.29.	M
terminatingMMSParty	ID(s) of the terminating party (i.e. the intended recipient of the read report or the originator of the initial MM message to which the read report applies) in one or more of the formats described in 7.4.2.1 When address translation occurs (such as the case of a token sent by the client and replaced with a proper address by the MMS Proxy-Relay), both the pre and post translated addresses (with appropriate correlation) are included.	M
originatingMMSParty	ID(s) of the originating party (i.e. the originator of the read report or the recipient the initial MM message to which the read report applies) in one or more of the formats described in 7.4.2.1 When address translation occurs (such as the case of a token sent by the client and replaced with a proper address by the MMS Proxy-Relay), both the pre and post translated addresses (with appropriate correlation) are included.	M
direction	Indicates the direction of the original MM (not of this message). This shall be encoded either as "from target," or "to target," as appropriate.	M
dateTime	Date and Time when the MM was last handled (either originated or forwarded). Include if sent to/by the MMS Proxy-Relay.	C
readStatus	Status of the MMS (e.g.read or deleted without reading.)	M
applicID	Identification of the originating application of the original MM. As defined in OMA-TS-MMS_ENC [39] clause 7.3.2. Include if sent to/by the MMS Proxy-Relay.	C
replyApplicID	Identification of an application to which replies, delivery reports, and read reports are addressed. As defined in OMA-TS-MMS_ENC [39] clause 7.3.42. Include if sent to/by the MMS Proxy-Relay.	C
auxApplicInfo	Auxiliary application addressing information as indicated in the original MM. As defined in OMA-TS-MMS_ENC [39] clause 7.3.4. Include if sent to/by the MMS Proxy-Relay.	C

7.4.3.16 MMSReadReportNonLocalTarget

The IRI-POI present in the MMS Proxy-Relay shall generate an xIRI containing an MMSReadReportNonLocalTarget record when the MMS Proxy-Relay:

- sends a MM4_read_reply_report.REQ (as defined in TS 23.140 [40] clause 8.4.3), that contains a non-local target ID, to the non-local MMS Proxy-Relay, or
- receives a MM4_read_reply_report.REQ (as defined in TS 23.140 [40] clause 8.4.3), that contains a non-local target ID, from the non-local MMS Proxy-Relay.

Table 7.4.3-16 contains parameters generated by the IRI-POI, along with parameters derived from the **MM4_read_reply_report.REQ** message (from the local MMS Proxy-Relay to the non-local MMS Proxy-Relay, or inversely).

Table 7.4.3-16: Payload for MMSReadReportNonLocalTarget

Field name	Description	M/C/O
version	The version of MM, to include major and minor version.	M
transactionID	An ID used to correlate an MMS request and response between the proxies. As defined in TS 23.140 [40] clause 8.4.1.4.	M
terminatingMMSParty	ID(s) of the terminating party in one or more of the formats described in 7.4.2.1 When address translation occurs (such as the case of a token sent by the client and replaced with a proper address by the MMS Proxy-Relay), both the pre and post translated addresses (with appropriate correlation) are included.	M
originatingMMSParty	ID(s) of the originating party in one or more of the formats described in 7.4.2.1 When address translation occurs (such as the case of a token sent by the client and replaced with a proper address by the MMS Proxy-Relay), both the pre and post translated addresses (with appropriate correlation) are included.	M
direction	Indicates the direction of the original MM (not of this message). This shall be encoded either as "from target" = True, or "to target" = False.	M
messageID	An ID assigned by the MMS Proxy-Relay to uniquely identify an MM. As defined in TS 23.140 [40] clause 8.4.1.4.	M
dateTime	Date and Time when the MM was last handled (either originated or forwarded).	M
readStatus	Status of the MMS (e.g.read or deleted without reading.)	M
readStatusText	Text explanation corresponding to the Read Status. Include if sent to/by the MMS Proxy-Relay.	C
applicID	Identification of the originating application of the original MM. Identifies the destination application as defined in TS 23.140 [40] clause 8.4.1.4. Include if sent to/by the MMS Proxy-Relay.	C
replyApplicID	Identification of an application to which replies, delivery reports, and read reports are addressed. Identifies the application to which replies, delivery reports, and read reports are addressed, as defined in TS 23.140 [40] clause 8.4.1.4. Include if sent to/by the MMS Proxy-Relay.	C
auxApplicInfo	Auxiliary application addressing information as indicated in the original MM. As defined in OMA-TS-MMS_ENC [39] clause 7.3.4. Include if sent to/by the MMS Proxy-Relay.	C

7.4.3.17 MMSCancel

The IRI-POI present in the MMS Proxy-Relay shall generate an xIRI containing an MMSCancel record when the MMS Proxy-Relay sends a *m-cancel-req* (as defined in OMA-TS-MMS_ENC [39] clause 6.13) to the MMS client in the target UE.

Table 7.4.3-17 contains parameters generated by the IRI-POI, along with parameters derived from the *m-cancel-req* message (from the MMS Proxy-Relay to the local target UE).

Table 7.4.3-17: Payload for MMSCancel

Field name	Description	M/C/O
transactionID	An ID used to correlate an MMS request and response between the target and the MMS Proxy-Relay. As defined in OMA-TS-MMS_ENC [39] clause 7.3.63.	M
version	The version of MM, to include major and minor version.	M
cancelID	This field includes the Message ID identifying the message to be cancelled. As defined in OMA-TS-MMS_ENC [39] clause 7.3.6.	M
direction	Indicates the direction of the original MM. This shall be encoded as "to target."	M

7.4.3.18 MMSMBoxViewRequest

The IRI-POI present in the MMS Proxy-Relay shall generate an xIRI containing an MMSViewRequest record when the MMS Proxy-Relay receives a *m-mbox-view-req* (as defined in OMA-TS-MMS_ENC [39] clause 6.9) from the MMS client in the target UE.

Table 7.4.3-18 contains parameters generated by the IRI-POI, along with parameters derived from the *m-mbox-view-req* message (from the local target UE to the MMS Proxy-Relay).

Table 7.4.3-18: Payload for MMSMBoxViewRequest

Field name	Description	M/C/O
transactionID	An ID used to correlate an MMS request and response between the target and the MMS Proxy-Relay. As defined in OMA-TS-MMS_ENC [39] clause 7.3.63.	M
version	The version of MM, to include major and minor version.	M
contentLocation	The <i>content-location-value</i> field defines the URL for the MMS Proxy-Relay location of the content to be retrieved. As defined in OMA-TS-MMS_ENC [39] clause 7.3.10. Include if sent to the MMS Proxy-Relay.	C
state	Specifies a MM State value to use in selecting the messages to return. As defined in OMA-TS-MMS_ENC [39] clause 7.3.33. Include if sent to the MMS Proxy-Relay.	C
flags	Specifies a MM Flags keyword to use in selecting the messages to return in the response. See OMA-TS-MMS_ENC [39] clause 7.3.32. Include if sent to the MMS Proxy-Relay.	C
start	A number, indicating the index of the first MM of those selected to have information returned in the response. Include if sent to the MMS Proxy-Relay.	C
limit	A number indicating the maximum number of selected MMs whose information are to be returned in the response. If this is absent, information elements from all remaining MMs are to be returned. If this is zero, then no MM-related information are to be returned. Include if sent to the MMS Proxy-Relay.	C
mMSAttributes	A list of information elements that should appear in the view for each selected message. Include if sent to the MMS Proxy-Relay.	C
mMSTotals	Indicates a request for or the actual count of messages currently stored in the MMSBox. The values given in OMA-TS-MMS_ENC [39] clause 7.3.62. shall be encoded as follows: "Yes" = True, "No" = False. Include if sent to the MMS Proxy-Relay.	C
mMSQuotas	Indicates a request for or the actual quotas for the user's MMSBox in messages or bytes. The values given in OMA-TS-MMS_ENC [39] clause 7.3.36. shall be encoded as follows: "Yes" = True, "No" = False. Include if sent to the MMS Proxy-Relay.	C

7.4.3.19 MMSMBoxViewResponse

The IRI-POI present in the MMS Proxy-Relay shall generate an xIRI containing an MMSViewConfirm record when the MMS Proxy-Relay sends a *m-mbox-view.conf* (as defined in OMA-TS-MMS_ENC [39] clause 6.9) to the MMS client in the target UE.

Table 7.4.3-19 contains parameters generated by the IRI-POI, along with parameters derived from the *m-mbox-view.conf* message (from the local target UE to the MMS Proxy-Relay).

Table 7.4.3-19: Payload for MMSMBoxViewResponse

Field name	Description	M/C/O
version	The version of MM, to include major and minor version.	M
responseStatus	MMS specific status.	M
responseStatusText	Text that qualifies the Response Status. As defined in OMA-TS-MMS_ENC [39] clause 7.3.49.	C
contentLocation	The <i>content-location-value</i> field defines the URL for the MMS server location of the content to be retrieved. As defined in OMA-TS-MMS_ENC [39] clause 7.3.10. Include if sent by the MMS Proxy-Relay.	C
state	Specifies a MM State value to use in selecting the messages to return. As defined in OMA-TS-MMS_ENC [39] clause 7.3.33. Include if sent by the MMS Proxy-Relay.	C
flags	Specifies a MM Flags keyword to use in selecting the messages to return in the response. See OMA-TS-MMS_ENC [39] clause 7.3.32. Include if sent by the MMS Proxy-Relay.	C
start	A number, indicating the index of the first MM of those selected to have information returned in the response. Include if sent by the MMS Proxy-Relay.	C
limit	A number indicating the maximum number of selected MMs whose information are to be returned in the response. If this is absent, information elements from all remaining MMs are to be returned. If this is zero then no MM-related information are to be returned. Include if sent by the MMS Proxy-Relay.	C
mMSAttributes	A list of information elements that should appear in the view for each selected message. Include if sent by the MMS Proxy-Relay.	C
mMSTotals	Indicates a request for or the actual count of messages currently stored in the MMSBox. The values given in OMA-TS-MMS_ENC [39] clause 7.3.62. shall be encoded as follows: "Yes" = True, "No" = False. Include if sent by the MMS Proxy-Relay.	C
mMSQuotas	Indicates a request for or the actual quotas for the user's MMSBox in messages or bytes. The values given in OMA-TS-MMS_ENC [39] clause 7.3.36. shall be encoded as follows: "Yes" = True, "No" = False. Include if sent by the MMS Proxy-Relay.	C
mMBoxDescription	The MMSBox description PDU as defined in 7.4.3.20 corresponds to the particular MM.	M

7.4.3.20 MMSBoxDescription

The MMSBoxDescription used in MMSMBoxViewResponse and MMSMBoxUpload records is defined in table 7.4.3-20.

Table 7.4.3-20: Payload for MMBoxDescription

Field name	Description	M/C/O
contentLocation	The <i>content-location-value</i> field defines the URL for the MMS Proxy-relay location of the content to be retrieved. As defined in OMA-TS-MMS_ENC [39] clause 7.3.10. Include if sent by the MMS Proxy-Relay.	C
messageID	An ID assigned by the MMS Proxy-Relay to uniquely identify an MM. Included unconditionally for the MMS View Confirm report and is included for the MMS Upload report if a Message ID was previously assigned to the MM. In this latter case, if a Message ID was not previously assigned, this parameter is excluded. As defined in OMA-TS-MMS_ENC [39] clause 7.3.29. Include if sent by the MMS Proxy-Relay.	C
state	Identifies the value of the MM State associated with a MM to be stored or stored MM. Include for the MMS View Confirm. Include for the MMS View Request if provided by the target. As defined in OMA-TS-MMS_ENC [39] clause 7.3.33. Include if sent by the MMS Proxy-Relay.	C
flags	Identifies a keyword to add or remove from the list of keywords associated with a stored MM. This parameter may convey all the keywords associated with the MM. Include if at least one keyword is associated with the MM. If no keywords are associated with the MM, then this parameter may be excluded. Include if sent by the MMS Proxy-Relay.	C
dateTime	Date and Time when the MM request was detected. Include if sent by the MMS Proxy-Relay.	C
originatingMMSParty	ID(s) of the originating party in one or more of the formats described in 7.4.2.1 When address translation occurs (such as the case of a token sent by the client and replaced with a proper address by the MMS Proxy-Relay), both the pre and post translated addresses (with appropriate correlation) are included. Include if sent by the MMS Proxy-Relay.	C
terminatingMMSParty	ID(s) of the terminating party in one or more of the formats described in 7.4.2.1 When address translation occurs (such as the case of a token sent by the client and replaced with a proper address by the MMS Proxy-Relay), both the pre and post translated addresses (with appropriate correlation) are included. Include if sent by the MMS Proxy-Relay.	C
cCRecipients	Address of a recipient; the "CC" field may include addresses of multiple recipients. When address translation occurs, both the pre and post translated addresses (with appropriate correlation) are included. This parameter is included if the corresponding MM includes a "CC" field. Include if sent by the MMS Proxy-Relay.	C
bCCRecipients	Address of a recipient; the "BCC" field may include addresses of multiple recipients. When address translation occurs, both the pre and post translated addresses (with appropriate correlation) are included. This parameter is included if the corresponding MM includes a "BCC" field. Include if sent by the MMS Proxy-Relay.	C
messageClass	Class of the MM. For example, a value of "auto" is automatically generated by the UE. If the field is not present, the class should be interpreted as "personal". Include if sent by the MMS Proxy-Relay.	C
subject	The subject of the MM. Include if sent by the MMS Proxy-Relay.	C
priority	Priority of the MM assigned by the originator MMS Client. Reported if sent by the target. Include if sent by the MMS Proxy-Relay.	C
deliveryTime	Date and Time of delivery. Include if sent by the MMS Proxy-Relay.	C

readReport	Specifies whether the originator MMS UE requests a read report from each recipient. The values given in OMA-TS-MMS_ENC [39] clause 7.3.37. shall be encoded as follows: "Yes" = True, "No" = False. Include if sent by the MMS Proxy-Relay.	C
messageSize	Specifies the size of the MM that was viewed or uploaded. Specified in bytes. Include if sent by the MMS Proxy-Relay.	C
replyCharging	If this field is present its value is set to "accepted" or "accepted text only" and the MMS-version-value of the M-Notification.ind PDU is higher than 1.0, this header field will indicate that a reply to this particular MM is free of charge for the recipient. If the Reply-Charging service is offered and the request for reply-charging has been accepted by the MMS service provider the value of this header field SHALL be set to "accepted" or "accepted text only". See OMA-TS-MMS_ENC [39] clause 7.3.43. Include if sent by the MMS Proxy-Relay.	C
previouslySentBy	Address of the MMS Client that forwarded or previously sent the message. along with a sequence number and timestamp. A higher sequence number indicates a forwarding event at a later point in time. The sequence number indicates the correspondence to the MMS Client's address in the "X-Mms-Previously- Sent-By" header field with the same sequence number. This header field MAY appear multiple times. Include if sent by the MMS Proxy-Relay.	C
previouslySentByDateTime	Date/Time MM was previously sent. This header field MAY appear multiple times. Include if sent by the MMS Proxy-Relay.	C
contentType	The content type of the MM. Include if sent by the MMS Proxy-Relay.	C

7.4.3.21 MMS Content

If content delivery is authorized, the CC-POI in the MMS Proxy-Relay shall generate an xCC as per clause 7.4.2.3 when any of the events in clauses 7.4.3.1 through 7.4.3.19 are detected.

7.4.4 IRI and CC Generation

7.4.4.1 Generation of IRI over LI_HI2

When an IRI-POI in the MMS Proxy-Relay generated xIRI is received over LI_X2, the MDF2 shall send an xIRI over LI_HI2 without undue delay. The xIRI shall contain a copy of the record received over LI_X2. The record may be enriched by other information available at the MDF (e.g. additional location information).

The threeGPP33128DefinedCC field (see ETSI TS 102 232-7 [10] clause 15) shall be populated with the BER-encoded IRIPayload.

The timestamp field of the PSHeader structure shall be set to the time that the MMS event was observed (i.e. the timestamp field of the xIRI). The LIID and CID fields shall correctly reflect the target identity and communication session to which the IRI belongs.

7.4.4.2 Generation of CC over LI_HI3

When a CC-POI in the MMS Proxy-Relay generated xCC message is received over LI_X3, the MDF3 shall send a CC message over LI_HI3 without undue delay. The CC message shall contain a copy of the MMS received over LI_X3. The record may be enriched with other information available at the MDF.

7.5 PTC service

7.5.1 Introduction

The Stage 3 intercept capabilities defined in this clause for the Push to Talk over Cellular (PTC) service apply when supported by a CSP. The term PTC represents either a Push to Talk over Cellular (PoC) or Mission Critical Push to Talk (MCPTT) type service. The use of the term PTC server represents either a MCPTT function or PoC server.

7.5.1.1 Provisioning over LI_X1

The IRI-POI present in the PTC server is provisioned over LI_X1 by the LIPF using the X1 protocol as described in clause 5.2.2 of the present document.

The POI in the PTC Server shall support the identifier types given in table 7.5.1-1.

Table 7.5.1-1: TargetIdentifier Types for PTC service

Identifier	Owner	ETSI TS 103 221-1 [7] TargetIdentifier type	Definition
iMPU	ETSI	IMPU	See ETSI TS 103 221-1 [7]
iMPI	ETSI	IMPI	See ETSI TS 103 221-1 [7]
mCPTTID	ETSI	TargetIdentifierExtension	See XSD schema
instanceIdentifierURN	3GPP	TargetIdentifierExtension	See XSD schema
pTCChatGroupID	3GPP	TargetIdentifierExtension	See XSD schema

7.5.1.2 Generating xIRI over LI_X2

The IRI-POI present in the PTC server shall send xIRI over LI_X2 for each of the events listed in TS 33.127 [5] clause 7.6.3, each of which is described in the following clauses. The IRI events are based on the use of 3GPP MCPTT features as defined in TS 24.379 [55] and OMA PoC features as defined in OMA-TS-PoC_System_Description-V2_1-20110802-A [56].

7.5.1.3 Generation of xCC over LI_X3

The CC-POI present in the PTC server shall send xCC over LI_X3.

The CC-POI shall set the payload format to indicate the appropriate payload type (5 for IPv4 Packet, 6 for IPv6 Packet) per clause 6.2.3.6 of the present document.

7.5.2 IRI events

7.5.2.1 PTC registration

The IRI-POI present in the PTC server shall generate an xIRI containing a PTCRegistration record when the IRI-POI present in the PTC server detects that a PTC target matching one of the PTC target identifiers, referenced in clause 7.5.1.1, provided via LI_X1 has registered, re-registered, or de-registered for PTC services, regardless of whether it is successful or unsuccessful. Accordingly, the IRI-POI in the PTC server generates the xIRI when the following event is detected:

- when the PTC server receives a SIP REGISTER from a PTC target.

Table 7.5.2-1: Payload for PTCRegistration record

Field name	Description	M/C/O
pTCTargetInformation	Provide PTC target identity. At least one among MCPTT ID, IMPU, IMPI, InstanceIdentifierURN and PTCChatGroupID shall be provided for PTCTargetInformation.	M
pTCServerURI	Shall include the identity of the PTC server serving the PTC target.	M
pTCRegistrationRequest	Identifies the type of registration request (register, re-register, or de-register).	M
pTCRegistrationOutcome	Identifies success or failure of the registration.	M

7.5.2.2 PTC session initiation

The IRI-POI present in the PTC server shall generate an xIRI containing a PTCSessionInitiation record when the IRI-POI present in the PTC server detects that the PTC target initiates an on-demand session or the target receives an invitation to join an on-demand session regardless of the success or the final disposition of the invitation. The

PTCSessionInitiation record shall also be reported when a chat group is the PTC target. Accordingly, the IRI-POI in the PTC server generates the xIRI when the following events are detected:

- when the PTC server receives a SIP INVITE from a PTC target.
- when the PTC Server sends a SIP INVITE to the PTC target.
- when the PTC Server hosting a PTC chat group session, where the PTC chat group is the target, receives a SIP INVITE from a participating PTC server to initiate a PTC chat group session.

Table 7.5.2-2: Payload for PTCSessionInitiation record

Field name	Description	M/C/O
pTCTargetInformation	Provide PTC target identity. At least one among MCPTT ID, IMPU, IMPI, InstanceIdentifierURN and PTChatGroupID shall be provided for PTCTargetInformation.	M
pTCDirection	Indicates the direction of the session relative to the target: "toTarget" or "fromTarget."	M
pTCServerURI	Shall include the identity of the PTC server serving the PTC target.	M
pTCSessionInfo	Shall provide PTC session information such as PTC Session URI and PTC Session type (e.g. on-demand, pre-established, ad-hoc, pre-arranged, group session).	M
pTCOriginatingID	Shall identify the originating party.	M
pTCParticipants	Shall identify the individual PTC participants of the communication session, when known.	C
pTCParticipantPresenceStatus	Shall provide the Participant Presence Status, which is a list of: <ul style="list-style-type: none"> - <i>PresenceID</i>: Identity of PTC client(s) or PTC group, when known. - <i>PresenceType</i>: Identifies type of ID [PTC client(s) or PTC group]. - <i>PresenceStatus</i>: Presence state of each ID. True indicates PTC client is available, while false indicates PTC client is unavailable. Report when the Presence functionality is supported by the PTC server and the PTC server assumes the role of the watcher on behalf of the PTC target or in the case of a target PTC chat group, when the PTC server assumes the role of the watcher on behalf of any member of the chat group.	C
location	Shall include the PTC target's location when reporting of the PTC target's location information is authorized and available.	C
pTCBearerCapability	Shall provide when known the media characteristics information elements of the PTC session, encoded in SDP format as per RFC 4566 [43] clause 5.	C
pTCHost	Shall identify the PTC participant who has the authority to initiate and administrate a PTC session, if known.	C

7.5.2.3 PTC session abandon attempt

The IRI-POI present in the PTC server shall generate an xIRI containing a PTCSessionAbandon record when the IRI-POI present in the PTC server detects that the PTC Session is not established and the request is abandoned before the PTC session starts. Accordingly, the IRI-POI in the PTC server generates the xIRI when the following events are detected:

- when the PTC server serving the PTC target receives a SIP CANCEL from the PTC target or sends a SIP CANCEL to the PTC target.

Table 7.5.2-3: Payload for PTCSessionAbandonAttempt record

Field name	Description	M/C/O
pTCTargetInformation	Provide PTC target identity. At least one among MCPTT ID, IMPU, IMPI, InstanceIdentifierURN and PTChatGroupID shall be provided for PTCtargetInformation.	M
pTCDirection	Indicates the direction of the session relative to the target: "toTarget" or "fromTarget."	M
pTCSessionInfo	Shall provide PTC session information such as PTC Session URI and PTC Session type (e.g. on-demand, pre-established, ad-hoc, pre-arranged, group session).	M
location	Shall include the PTC target's location when reporting of the PTC target's location information is authorized and available.	C
pTCAbandonCause	Shall identify the reason for the abandoned PTC session based on the warning header field code provided in a response to a SIP INVITE per TS 24.379 [55] clause 4.4.2.	M

7.5.2.4 PTC session start

The IRI-POI present in the PTC server shall generate an xIRI containing a PTCSessionStart record when the IRI-POI present in the PTC server detects that the PTC Session is initiated and communication begins for both an on-demand and pre-established PTC session. The PTCSessionStart record shall also be reported when a chat group is the PTC target. Accordingly, the IRI-POI in the PTC server generates the xIRI when the following events are detected:

- when the PTC server sends a SIP 200 OK to the PTC target in response to a SIP INVITE from the PTC target for an on-demand PTC session where the PTC target originates the PTC session.
- when the PTC server receives a SIP 200 OK from the PTC target in response to a SIP INVITE for an on-demand PTC session where the PTC target receives an invitation to join a PTC session.
- when the PTC server receives a SIP 200 OK from the participant PTC server in response to a SIP INVITE previously sent to that participating PTC server for PTC sessions initiated by the PTC target with a pre-established PTC session (PTC server sends a TBCP Connect to the PTC target with a pre-established session).
- when the PTC server sends a SIP 200 OK to the participant PTC server in response to a SIP INVITE previously received from that participating PTC server for PTC sessions terminated to the PTC target with a pre-established PTC session (PTC server sends a TBCP Connect to the PTC target with a pre-established session).
- when the PTC server hosting a PTC chat group session, where PTC chat group is the PTC target, sends a SIP 200 OK in response to a SIP INVITE previously received from the participant PTC server to initiate a PTC chat group session.

Table 7.5.2-4: Payload for PTCSessionStart record

Field name	Description	M/C/O
pTCTargetInformation	Provide PTC target identity. At least one among MCPTT ID, IMPU, IMPI, InstanceIdentifierURN and PTCChatGroupID shall be provided for PTCtargetInformation.	M
pTCDirection	Indicates the direction of the session relative to the target: "toTarget" or "fromTarget."	M
pTCServerURI	Shall include the identity of the PTC server serving the PTC target.	M
pTCSessionInfo	Shall provide PTC session information such as PTC Session URI and PTC Session type (e.g. on-demand, pre-established, ad-hoc, pre-arranged, group session).	M
pTCOriginatingID	Shall identify the originating party.	M
pTCParticipants	Shall identify the individual PTC participants of the communication session, when known.	C
pTCParticipantPresenceStatus	Shall provide the Participant Presence Status, which is a list of: <ul style="list-style-type: none"> - <i>PresenceID</i>: Identity of PTC client(s) or PTC group, when known. - <i>PresenceType</i>: Identifies type of ID [PTC client(s) or PTC group]. - <i>PresenceStatus</i>: Presence state of each ID. True indicates PTC client is available, while false indicates PTC client is unavailable. Report when the Presence functionality is supported by the PTC server and the PTC server assumes the role of the watcher on behalf of the PTC target.	C
location	Shall include the PTC target's location when reporting of the PTC target's location information is authorized and available.	C
pTCHost	Shall identify the PTC participant who has the authority to initiate and administrate a PTC Session, if known.	C
pTCBearerCapability	Shall provide the media characteristics information elements of the PTC session, encoded in SDP format as per RFC 4566 [43] clause 5 when known.	C

7.5.2.5 PTC session end

The IRI-POI present in the PTC server shall generate an xIRI containing a PTCSessionEnd record when the IRI-POI present in the PTC server detects that the PTC session is released for any reason (i.e. normal or abnormal release) and voice communications ends. Accordingly, the IRI-POI in the PTC server generates the xIRI when the following events are detected:

- when the PTC server receives a SIP BYE from the PTC target to end the session.
- when the PTC server receives a SIP 200 OK from the PTC target in response to a SIP BYE.
- when the PTC server sends a SIP BYE to the participating PTC server to end the PTC session of a PTC target with a pre-established PTC session (PTC server also sends a TBCP Disconnect to the PTC target with a pre-established PTC session).
- when the PTC server receives a SIP BYE from the participant PTC server to end the PTC session of a PTC target with a pre-established PTC session (PTC server sends a TBCP Disconnect to the PTC target with a pre-established PTC session).
- when the PTC server hosting a PTC chat group session, where PTC chat group is the PTC target, sends a SIP 200 OK in response to a SIP BYE received from the participating PTC server of the last participant in the PTC chat group session.
- when the PTC server sends a SIP 487 to the PTC target in response to a SIP CANCEL to end the session.

Table 7.5.2-5: Payload for PTCSessionEnd record

Field name	Description	M/C/O
pTCTargetInformation	Provide PTC target identity. At least one among MCPTT ID, IMPU, IMPI, InstanceIdentifierURN and PTCChatGroupID shall be provided for PTCtargetInformation.	M
pTCDirection	Indicates the direction of the session relative to the target: "toTarget" or "fromTarget."	M
pTCServerURI	Shall include the identity of the PTC server serving the PTC target.	M
pTCSessionInfo	Shall provide PTC session information such as PTC Session URI and PTC Session type (e.g. on-demand, pre-established, ad-hoc, pre-arranged, group session).	M
pTCParticipants	Shall identify the individual PTC participants of the communication session, when known.	C
location	Shall include the PTC target's location when reporting of the PTC target's location information is authorized and available.	C
pTCSessionEndCause	Shall identify the reason for the PTC session end based on the following events per OMA-TS-PoC_System_Description-V2_1-20110802-A [56] clause 4.5.7: <ul style="list-style-type: none"> - PTC session initiator leaves session - Defined participant leaves session - Number of participants less than certain value - PTC Session timer expired - PTC Speech inactive for specified time - All Media types inactive for specified time 	M

7.5.2.6 PTC start of interception

The IRI-POI present in the PTC server shall generate an xIRI containing a PTCStartOfInterception record when a PTC target or a PTC chat group as a target has an active PTC session in progress. If multiple PTC Sessions are active at the start of interception, a PTCStartOfInterception record is generated for each active session. Accordingly, the IRI-POI in the PTC server generates the xIRI when the following event is detected:

- when the PTC server detects that LI is enabled on a PTC participant or a PTC chat group with an active PTC session.

Table 7.5.2-6: Payload for PTCStartOfIntercept record

Field name	Description	M/C/O
pTCTargetInformation	Provide PTC target identity. At least one among MCPTT ID, IMPU, IMPI, InstanceIdentifierURN and PTCChatGroupID shall be provided for PTCtargetInformation.	M
pTCDirection	Indicates the direction of the session relative to the target: "toTarget" or "fromTarget."	M
pTCPreEstSessionID	Identifies the PTC Pre-Established Session Identity when available.	C
pTCOriginatingID	Shall identify the originating party.	M
pTCSessionInfo	Shall provide PTC session information such as PTC Session URI and PTC Session type (e.g. on-demand, pre-established, ad-hoc, pre-arranged, group session) when available.	C
pTCHost	Shall identify the PTC participant who has the authority to initiate and administrate a PTC session, if known.	C
pTCParticipants	Shall identify the individual PTC participants of the communication session, when known.	C
location	Shall include the PTC target's location when reporting of the PTC target's location information is authorized and available.	C
pTCMediaStreamAvail	Shall include this parameter to indicate if the PTC target is able/not able to receive media streams immediately. True indicates available for media, while false indicates not able to accept media.	M
pTCBearerCapability	Shall provide when known the media characteristics information elements of the PTC session, encoded in SDP format as per RFC 4566 [43] clause 5.	C

7.5.2.7 PTC pre-established session

The IRI-POI present in the PTC server shall generate an xIRI containing a PTCPreEstablishedSession record when the IRI-POI present in the PTC server detects that a pre-established session is setup/modified/released between the PTC target and the PTC server associated with the PTC target. Accordingly, the IRI-POI in the PTC server generates the xIRI when the following events are detected:

- when the PTC Server receives a SIP INVITE from the PTC target to setup a pre-established session.
- when the PTC Server receives a SIP BYE from the PTC target to release a pre-established session.
- when the PTC Server receives a SIP UPDATE or SIP re-INVITE from the PTC target for a pre-established session to modify the current session.

Table 7.5.2-7: Payload for PTCPreEstablishedSession record

Field name	Description	M/C/O
pTCTargetInformation	Provide PTC target identity. At least one among MCPTT ID, IMPU, IMPI, InstanceIdentifierURN and PTCChatGroupID shall be provided for PTCTargetInformation.	M
pTCServerURI	Shall include the identity of the PTC server serving the PTC target.	M
rTPSetting	The IP address and the port number of the PTC target at the PTC server for the RTP Session.	M
pTCMediaCapability	The codec(s) and media parameters selected by the PTC server from those contained in the original SDP offer from the PTC target's SIP REFER and encoded in SDP format as per RFC 4566 [43] clause 5.	M
pTCPreEstSessionID	Identifies the PTC Pre-Established Session Identity.	M
pTCPreEstStatus	Indicates if the pre-established session is established (setup completed), modified, or released.	M
pTCMediaStreamAvail	Shall include for a pre-established session to indicate if the PTC target's PTC client is able/not able to receive media streams immediately, when the pre-established session is established. True indicates available for media, while false indicates not able to accept media.	M
location	Shall include the PTC target's location when reporting of the PTC target's location information is authorized and available.	C
pTCFailureCode	Provide when the pre-established session cannot be established or modified.	C

7.5.2.8 PTC instant personal alert

The IRI-POI present in the PTC server shall generate an xIRI containing a PTCInstantPersonalAlert record when the IRI-POI present in the PTC server detects that an Instant Personal Alert (IPA) (i.e. a request for one participant to initiate a one-to-one PTC session) is initiated by or sent to the PTC target. Accordingly, the IRI-POI in the PTC server generates the xIRI when the following events are detected:

- when the PTC server receives a SIP MESSAGE from a PTC target for an IPA.
- when the PTC Server sends a SIP MESSAGE to the PTC target for an IPA.

Table 7.5.2-8: Payload for PTCInstantPersonalAlert record

Field name	Description	M/C/O
pTCTargetInformation	Provide PTC target identity. At least one among MCPTT ID, IMPU, IMPI, InstanceIdentifierURN and PTCChatGroupID shall be provided for PTCTargetInformation.	M
pTCIPAPartyID	Identifies the PTC participant that receives or has sent the Instant Personal Alert to the target.	M
pTCIPADirection	Identifies the direction (To PTC target or From PTC target) of the Instant Personal Alert.	M

7.5.2.9 PTC party join

The IRI-POI present in the PTC server hosting the PTC chat group session when the PTC chat group is the PTC target, shall generate an xIRI containing a PTCPartyJoin record when the IRI-POI present in that PTC server detects when a

PTC participant joins (or re-joins) an on-going PTC chat group session. The PTCPartyJoin record shall also be generated when the IRI-POI present in the participating PTC server of the PTC target detects when a PTC Participant joins (or re-joins) an on-going PTC chat group session. Accordingly, the IRI-POI in the participating PTC server generates the xIRI when the following event is detected:

- when the PTC server hosting a PTC chat group session sends a SIP 200 OK in response to a SIP INVITE indicating a PTC participant joining the PTC chat group session.
- when the participating PTC server of a PTC target forwards a SIP NOTIFY (received from the PTC server hosting the PTC chat group session) to the PTC target containing information about a PTC participant joining the PTC chat group session.

Table 7.5.2-9: Payload for PTCPartyJoin record

Field name	Description	M/C/O
pTCTargetInformation	Provide PTC target identity. At least one among MCPTT ID, IMPU, IMPI, InstanceIdentifierURN and PTCChatGroupID shall be provided for PTCTargetInformation.	M
pTCDirection	Indicates the direction of the session relative to the target: "toTarget" or "fromTarget."	M
pTCSessionInfo	Shall provide PTC session information such as PTC Session URI and PTC Session type (e.g. on-demand, pre-established, ad-hoc, pre-arranged, group session).	M
pTCParticipants	Shall identify the individual PTC participants of the communication session, when known.	C
participantPresenceStatus	Shall provide the Participant Presence Status, which is a list of: <ul style="list-style-type: none"> - <i>PresenceID</i>: Identity of PTC client(s) or PTC group, when known. - <i>PresenceType</i>: Identifies type of ID [PTC client(s) or PTC group]. - <i>PresenceStatus</i>: Presence state of each ID. True indicates PTC client is available, while false indicates PTC client is unavailable. Report when the Presence functionality is supported by the PTC server and the PTC server assumes the role of the watcher on behalf of the PTC target.	C
pTCMediaStreamAvail	Shall include this parameter to indicate if the PTC target is able/not able to receive media streams immediately. True indicates available for media, while false indicates not able to accept media.	M
pTCBearerCapability	Shall provide when known the media characteristics information elements of the PTC session, encoded in SDP format as per RFC 4566 [43] clause 5.	C

7.5.2.10 PTC party drop

The IRI-POI present in the PTC server hosting the PTC chat group session, when the PTC chat group is the PTC target, shall generate an xIRI containing a PTCPartyDrop record when the IRI-POI present in that PTC server detects that a PTC participant leaves the PTC chat group session that still remains active with other PTC participants. The PTCPartyDrop record shall also be generated when the IRI-POI present in the participating PTC server of the PTC target detects when a PTC Participant leaves an on-going PTC chat group session. Accordingly, the IRI-POI in the participating PTC server generates the xIRI when the following event is detected:

- when the PTC server hosting a PTC chat group session, where the PTC chat group is the target, sends a SIP 200 OK in response to a SIP BYE with the PTC chat group session remaining active with other PTC participants.
- when the participating PTC server of a PTC target forwards a SIP NOTIFY (received from the PTC server hosting the PTC chat group session) to the PTC target containing information about a PTC participant leaving the PTC chat group session.

Table 7.5.2-10: Payload for PTCPartyDrop record

Field name	Description	M/C/O
pTCTargetInformation	Provide PTC target identity. At least one among MCPTT ID, IMPU, IMPI, InstanceIdentifierURN and PTChatGroupID shall be provided for PTCtargetInformation.	M
pTCDirection	Indicates the direction of the session relative to the target: "toTarget" or "fromTarget."	M
PTCSessionInfo	Shall provide PTC session information such as PTC Session URI and PTC Session type (e.g. on-demand, pre-established, ad-hoc, pre-arranged, group session).	M
pTCPartyDrop	Shall provide the identity of the participant that leaves the PTC session.	M
pTCParticipantPresenceStatus	Shall provide the Participant Presence Status, which is a list of: <ul style="list-style-type: none"> - <i>PresenceID</i>: Identity of PTC client(s) or PTC group, when known. - <i>PresenceType</i>: Identifies type of ID [PTC client(s) or PTC group]. - <i>PresenceStatus</i>: Presence state of each ID. True indicates PTC client is available, while false indicates PTC client is unavailable. Report when the Presence functionality is supported by the PTC server and the PTC server assumes the role of the watcher on behalf of the PTC target.	C

7.5.2.11 PTC party hold

The IRI-POI present in the PTC server shall generate an xIRI containing a PTCPartyHold record when the IRI-POI present in the PTC server detects that an on-going PTC session is placed on hold or retrieved from hold by the PTC target or by a PTC participant in a PTC chat group, where the PTC chat group is the PTC target. Accordingly, the IRI-POI in the PTC server generates the xIRI when the following event is detected:

- when the PTC server receives a SIP UPDATE or SIP re-INVITE from the PTC target and returns a SIP 200 OK to the PTC target for hold/resume operations.
- when the PTC server hosting a PTC chat group, where PTC chat group is the PTC target, receives a SIP UPDATE or SIP re-INVITE from a PTC participant for hold/resume operations.

Table 7.5.2-11: Payload for PTCPartyHold record

Field name	Description	M/C/O
pTCTargetInformation	Provide PTC target identity. At least one among MCPTT ID, IMPU, IMPI, InstanceIdentifierURN and PTChatGroupID shall be provided for PTCtargetInformation.	M
pTCDirection	Indicates the direction of the session relative to the target: "toTarget" or "fromTarget."	M
PTCSessionInfo	Shall provide PTC session information such as PTC Session URI and PTC Session type (e.g. on-demand, pre-established, ad-hoc, pre-arranged, group session).	M
pTCParticipants	Shall identify the individual PTC participants of the communication session, when known.	C
pTCHoldID	The identity of the PTC participant that placed the PTC session on hold or retrieved the held PTC session.	M
pTCHoldRetrievalInd	Shall indicate the PTC session is put on hold (i.e. deactivate Media Bursts or a PTC session is locked for talking/listening) or retrieved from hold. True indication equals placed on hold, false indication was retrieved from hold.	M

7.5.2.12 PTC media modification

The IRI-POI present in the PTC server shall generate an xIRI containing a PTCMediaModification record when the IRI-POI present in the PTC server detects that a re-negotiation of the media parameters occurs during a PTC session involving the PTC target. Accordingly, the IRI-POI in the PTC server generates the xIRI when the following event is detected:

- when the PTC server receives a SIP UPDATE or SIP reINVITE to indicate a PTC media modification on a PTC session being intercepted.

Table 7.5.2-12: Payload for PTCMediaModification record

Field name	Description	M/C/O
pTCTargetInformation	Provide PTC target identity. At least one among MCPTT ID, IMPU, IMPI, InstanceIdentifierURN and PTCChatGroupID shall be provided for PTCTargetInformation.	M
pTCDirection	Indicates the direction of the session relative to the target: "toTarget" or "fromTarget."	M
pTCSessionInfo	Shall provide PTC session information such as PTC Session URI and PTC Session type (e.g. on-demand, pre-established, ad-hoc, pre-arranged, group session).	M
pTCMediaStreamAvail	Shall include this parameter to indicate if the PTC target is able/not able to receive media streams immediately. True indicates available for media, while false indicates not able to accept media.	M
pTCBearerCapability	Shall provide when known the media characteristics information elements of the PTC session, encoded in SDP format as per RFC 4566 [43] clause 5.	C

7.5.2.13 PTC group advertisement

The IRI-POI present in the PTC server shall generate an xIRI containing a PTCGroupAdvertisement record when the IRI-POI present in the PTC server detects when a PTC target sends group advertisement information to a single PTC participant, a list of PTC participants, or to all members of a PTC chat group, as well as when a PTC target receives group advertisement information from a single PTC participant, a list of PTC participants, or from members of a PTC chat group using the group identity. Accordingly, the IRI-POI in the PTC server generates the xIRI when the following events are detected:

- when the PTC server receives a SIP MESSAGE (containing group advertisement information) from a PTC target.
- when the PTC server sends a SIP MESSAGE (containing group advertisement information) to the PTC target.

Table 7.5.2-13: Payload for PTCGroupAdvertisement record

Field name	Description	M/C/O
pTCTargetInformation	Provide PTC target identity. At least one among MCPTT ID, IMPU, IMPI, InstanceIdentifierURN and PTCChatGroupID shall be provided for PTCTargetInformation.	M
pTCDirection	Indicates the direction of the session relative to the target: "toTarget" or "fromTarget."	M
pTCIDList	Shall provide Identities of each participant from the target's contact list (i.e. individuals) and PTC group list (i.e. list of pre-identified individuals using a group identification) for a group call when available.	C
pTCGroupAuthRule	Identifies the action requested by the PTC target to the PTC Group Authorization Rules: <ul style="list-style-type: none"> - Report when action requested to the PTC Group Authorization Rules by the PTC target. - Report when the PTC target attempts a change or queries the access control list(s). 	C
pTCGroupAdSender	Identifies the sender of the group advertisement.	M
pTCGroupNickname	The nickname is a human-readable tag (e.g. "display-name" in a SIP header associated with a PTC client or PTC group per OMA-TS-PoC_System_Description-V2_1-20110802-A [56]).	C

7.5.2.14 PTC floor control

The IRI-POI present in the PTC server shall generate an xIRI containing a PTCFloorControl record when the IRI-POI present in the PTC server detects when the PTC target requests floor control (i.e. send media), when floor control is granted to PTC target, when floor control request from the PTC target is rejected/released, when the floor becomes open (e.g. idle), when the floor control request from the PTC target is queued, when the floor control request from the PTC target is dequeued, or when the floor control request is revoked. In addition, when the PTC chat group is the PTC target, the IRI-POI present in the PTC server hosting the PTC chat group shall generate an xIRI containing a PTCFloorControl record when the IRI-POI present in the PTC server detects any of the previously mentioned scenarios for all PTC

participants participating in the PTC chat group session. Accordingly, the IRI-POI in the PTC server generates the xIRI when the following events are detected:

- when the PTC server receives a TBCP Talk Burst Request from the PTC target.
- when the PTC server hosting the PTC chat group, where the PTC chat group is the PTC target, receives a TBCP Talk Burst Request from a PTC participant.
- when the PTC server sends a TBCP Talk Burst Granted to a PTC target.
- when the PTC server hosting the PTC chat group, where the PTC chat group is the PTC target, sends a TBCP Talk Burst Granted to a PTC participant.
- when the PTC server sends a TBCP Talk Burst Taken to a PTC target.
- when the PTC server hosting the PTC chat group, where the PTC chat group is the PTC target, sends a TBCP Talk Burst Taken to a PTC participant.
- when the PTC server sends a TBCP Talk Burst Deny to a PTC target.
- when the PTC server hosting the PTC chat group, where the PTC chat group is the PTC target, sends a TBCP Talk Burst Deny to a PTC participant.
- when the PTC server sends a TBCP Talk Burst Release to a PTC target.
- when the PTC server hosting the PTC chat group, where the PTC chat group is the PTC target, sends a TBCP Talk Burst Release to a PTC participant.
- when the PTC server sends a TBCP Talk Burst Idle to a PTC target.
- when the PTC server hosting the PTC chat group, where the PTC chat group is the PTC target, sends a TBCP Talk Burst Idle to a PTC participant.
- when the PTC server sends a TBCP Talk Burst Request Queue Status Response to a PTC target.
- when the PTC server hosting the PTC chat group, where the PTC chat group is the PTC target, sends a TBCP Talk Burst Request Queue Status Response to a PTC participant.
- when the PTC server receives a TBCP Talk Burst Cancel from a PTC target.
- when the PTC server hosting the PTC chat group, where the PTC chat group is the PTC target, receives a TBCP Talk Burst Cancel from a PTC participant.
- when the PTC server sends a TBCP Talk Burst Revoke to a PTC target.
- when the PTC server hosting the PTC chat group, where the PTC chat group is the PTC target, sends a TBCP Talk Burst Revke to a PTC participant.

Table 7.5.2-14: Payload for PTCFloorControl record

Field name	Description	M/C/O
pTCTargetInformation	Provide PTC target identity. At least one among MCPTT ID, IMPU, IMPI, InstanceIdentifierURN and PTChatGroupID shall be provided for PTCTargetInformation.	M
pTCDirection	Indicates the direction of the session relative to the target: "toTarget" or "fromTarget."	M
pTCSessionInfo	Shall provide PTC session information such as PTC Session URI and PTC Session type (e.g. on-demand, pre-established, ad-hoc, pre-arranged, group session).	M
pTCFloorActivity	Sequence of: <ul style="list-style-type: none"> a) "TBCP_Request": Received by the PTC server to request permission for the PTC target or PTC participant to send a talk burst. b) "TBCP_Granted": Used by the PTC server to notify the PTC target or PTC participant that it has been granted permission to send a talk burst. c) "TBCP_Deny": Used by the PTC server to notify a PTC target or PTC participant that it has been denied permission to send a talk burst. d) "TBCP_Idle": Used by the PTC server to notify the PTC target or PTC participant that no one has the permission to send a Talk Burst at the moment and that it may accept the TBCP talk burst request message. e) "TBCP_Taken": Used by the PTC server to notify the PTC target or PTC participant that another PTC participant has been given permission to send a talk burst. f) "TBCP_Revoke": Used by the PTC server to revoke the media resource from the PTC target or PTC participant and can be used for pre-emption functionality but is also used by the system to prevent overly long use of the media resource. g) "TBCP_Queued": Indicates the request to talk is queued, if queued floor control is supported. Include identification of the PTC target or PTC participant that has the queued talk burst, if known. h) "TBCP_Release": Indicates the request to talk has completed. 	M
pTCFloorSpeakerID	Include identification of the PTC participant that has initiated the talk burst, if known.	C
pTCMaxTBTime	Include the maximum duration value for the talk burst before the permission is revoked. This parameter is defined in seconds. Provide when known.	C
pTCQueuedFloorControl	Indicates if queuing is supported by the PTC server and the PTC target's device.	C
pTCQueuedPosition	Include if queue position in the TBCP is detected by the IRI-POI.	C
pTCTalkBurstPriority	If more than one level of priority is supported, indicates the talk burst priority level of the PTC target.	C
pTCTalkBurstReason	The reason for the denial or revoke of a Talk Burst. Provide when known.	C

7.5.2.15 PTC target presence

The IRI-POI present in the PTC server shall generate an xIRI containing a PTCTargetPresence record when the IRI-POI present in the PTC server detects that the PTC server publishes network presence information to the Presence server on behalf of the PTC target. Accordingly, the IRI-POI in the PTC server generates the xIRI when the following event is detected:

- when the PTC server sends a SIP PUBLISH message to the Presence server based on the PTC target's PTC session involvement.

Table 7.5.2-15: Payload for PTCTargetPresence record

Field name	Description	M/C/O
pTCTargetInformation	Provide PTC target identity. At least one among MCPTT ID, IMPU, IMPI, InstanceIdentifierURN and PTChatGroupID shall be provided for PTCTargetInformation.	M
pTCTargetPresenceStatus	Shall provide the PTC target presence status, which is a list of: <ul style="list-style-type: none"> - <i>PresenceID</i>: Identity of PTC client(s) or PTC group, when known. - <i>PresenceType</i>: Identifies type of ID [PTC client(s) or PTC group]. - <i>PresenceStatus</i>: Presence state of each ID. True indicates PTC target is available, while false indicates PTC target is unavailable. 	M

7.5.2.16 PTC participant presence

The IRI-POI present in the PTC server shall generate an xIRI containing a PTCParticipantPresence record when the IRI-POI present in the PTC server (when it supports the Presence functionality and assumes the role of the Watcher on behalf of the PTC target) detects that the PTC server receives presence status notifications from the Presence servers after having subscribed to the PTC presence status of other PTC participants (i.e. participants in communication with the PTC target). Accordingly, the IRI-POI in the PTC server generates the xIRI when the following event is detected:

- when the PTC server receives a SIP NOTIFY in response to a SIP SUBSCRIBE updating presence information for a participant.

Table 7.5.2-16: Payload for PTCParticipantPresence record

Field name	Description	M/C/O
pTCTargetInformation	Provide PTC target identity. At least one among MCPTT ID, IMPU, IMPI, InstanceIdentifierURN and PTChatGroupID shall be provided for PTCTargetInformation.	M
pTCParticipantPresenceStatus	Shall provide the Participant Presence Status, which is a list of: <ul style="list-style-type: none"> - <i>PresenceID</i>: Identity of PTC client(s) or PTC group, when known. - <i>PresenceType</i>: Identifies type of ID [PTC client(s) or PTC group]. - <i>PresenceStatus</i>: Presence state of each ID. True indicates PTC client is available, while false indicates PTC client is unavailable. Report when the Presence functionality is supported by the PTC server and the PTC server assumes the role of the watcher on behalf of the PTC target.	M

7.5.2.17 PTC list management

The IRI-POI present in the PTC server shall generate an xIRI containing a PTCListManagement record when the IRI-POI present in the PTC server detects that the PTC target attempts to change their contact list/group list(s) or those lists are updated by the network. Accordingly, the IRI-POI in the PTC server generates the xIRI when the following events are detected:

- when the PTC server receives a SIP PUBLISH from a PTC target to change the PTC target's contact list or group list(s).
- when the PTC server receives a SIP NOTIFY from other PTC participants updating the PTC target's contact list or group list(s) (e.g. participant reachability).

Table 7.5.2-17: Payload for PTCListManagement record

Field name	Description	M/C/O
pTCTargetInformation	Provide PTC target identity. At least one among MCPTT ID, IMPU, IMPI, InstanceIdentifierURN and PTCChatGroupID shall be provided for PTCtargetInformation.	M
pTCDirection	Indicates the direction of the session relative to the target: "toTarget" or "fromTarget."	M
pTCListManagementType	The "List Management Attempts" identify the type of list being managed by the target when available: <ul style="list-style-type: none"> a) ContactListManagementAttempt b) GroupListManagementAttempt c) ContactListManagementResult d) GroupListManagementResult e) Request unsuccessful For example, a) and b) are reported when PTC target attempts changes to their contact list and their PTC group list(s). The "List Management Results" identify the network response to a modification by the PTC target. For example, c), d), or e) is reported when the network notifies the PTC target of changes to their contact list or their PTC group list(s).	C
pTCListManagementAction	Identifies the action requested by the PTC target to the contact lists or PTC group list(s). Report when PTC target attempts changes to his contact list or PTC group list(s): <ul style="list-style-type: none"> a) Create b) Modify c) Retrieve d) Delete e) Notify Also report when a notification is sent to the PTC target due to changes occurring to his contact list or PTC group list(s).	C
pTCListManagementFailure	Report when list management request is unsuccessful.	C
pTCContactID	Identity of the contact in the list. One contact per contact list or PTC group list. Report if known.	C
pTCIDList	Shall provide identities of each participant from the PTC target's contact list (i.e. individuals) and PTC group list (i.e. list of pre-identified individuals using a group identification) for a group call. Report if known.	C
pTCHost	Identifies the PTC participant who has authority to initiate and administrate an active PTC group session. Provide when known.	C

7.5.2.18 PTC access policy

The IRI-POI present in the PTC server shall generate an xIRI containing a PTCAccessPolicy record when the IRI-POI present in the PTC server detects when the PTC target attempts to change the access control lists (e.g. PTC user access policy and PTC group authorization rules) located in the PTC XML Document Management Server (XDMS).

Accordingly, the IRI-POI in the PTC server generates the xIRI when the following event is detected:

- when the PTC server receives a SIP PUBLISH from a PTC target to change the access control lists.

Table 7.5.2-18: Payload for PTCAccessPolicy record

Field name	Description	M/C/O
pTCTargetInformation	Provide PTC target identity. At least one among MCPTT ID, IMPU, IMPI, InstanceIdentifierURN and PTCChatGroupID shall be provided for PTCtargetInformation.	M
pTCDirection	Indicates the direction of the session relative to the target: "toTarget" or "fromTarget."	M
pTCAccessPolicyType	Identifies the type of access policy list being managed or queried by the target when known: <ul style="list-style-type: none"> a) PTCUserAccessPolicyAttempt b) GroupAuthorizationRulesAttempt c) PTCUserAccessPolicyQuery d) GroupAuthorizationRulesQuery e) PTCUserAccessPolicyResult f) GroupAuthorizationRulesResult g) Request unsuccessful <ul style="list-style-type: none"> - Report a), b), c), or d) when the PTC target attempts a change or queries the Access Control list(s). - Report e), f), or g) when the network notifies the target of changes to the access control list(s) or the request was unsuccessful. 	C
PTCUserAccessPolicy	Identifies the action requested by the PTC target to the PTC user or group access policy: <ul style="list-style-type: none"> a) Allow Incoming PTC session request b) Block Incoming PTC session request c) Allow Auto Answer Mode d) Allow Override Manual Answer Mode <ul style="list-style-type: none"> - Report when action requested to the PTC user access policy. - Report when the PTC target attempts a change or queries the access control list(s). 	C
pTCGroupAuthRule	Identifies the action requested by the PTC target to the PTC Group Authorization Rules: <ul style="list-style-type: none"> a) Allow Initiating PTC session b) Block Initiating PTC session c) Allow Joining PTC session d) Block Joining PTC session e) Allow Add Participants f) Block Add Participants g) Allow Subscription PTC session state h) Block Subscription PTC session state i) Allow Anonymity j) Forbid Anonymity <ul style="list-style-type: none"> - Report when action requested to the PTC group authorization rules by the PTC target. - Report when the PTC target attempts a change or queries the access control List(s). 	C
pTCContactID	Identity of the contact in the list. One contact per contact list or PTC group list. Report if known.	C
pTCAccessPolicyFailure	Reports the reason for failure when access policy request is unsuccessful.	C

7.5.3 IRI and CC Generation

7.5.3.1 Generation of IRI over LI_HI2

When an xIRI is received over LI_X2 from the IRI-POI in the PTC server, the MDF2 shall generate the corresponding IRI message and deliver it over LI_HI2 without undue delay. The IRI shall contain a copy of the record received over LI_X2. This record may be enriched with any additional information available at the MDF2 (e.g. additional location information).

7.5.3.2 Generation of CC over LI_HI3

When xCC is received over LI_X3 from the CC-POI in the PTC server, the MDF3 shall populate the threeGPP33128DefinedCC field with a CCPayload structure containing PTCCCPDU and send it over LI_HI3 interface to LEMF without undue delay.

The PTC media contents are structured in a CC payload as formatted in clause 5.5.3 of the present document.

7.6 Identifier Association Reporting

7.6.1 General

The IEF, ICF and IQF are responsible for detecting, storing and providing to the LEA permanent to temporary identifier associations, requested by the LEA in authorised requests. The IEF as defined in clause 6.2.2A is responsible for detecting and generating identifier associations records. The ICF is responsible for caching identifier associations for short duration and the IQF is responsible for handling requests from the LEA and providing those requests to the ICF in order to identify the matching identifier associations.

7.6.2 ICF

7.6.2.1 General

The ICF is responsible for caching identifier associations provided in event records from the IEF over LI_XER and handling queries and subsequent responses from the IQF for responses over LI_XQR.

7.6.2.2 ICF receipt of records over LI_XER

When the ICF receives an identifier association event record over LI_XER from an IEF (see clause 5.9), the ICF shall use the records to update the identifier associations cached by the ICF. The ICF shall handle the event records as described in clause 7.6.2.4.

7.6.2.3 ICF Query and Response over LI_XQR

When the ICF receives an identifier association query request from the IQF, the ICF shall search the cached identifier associations to establish a match, based on RequestValues received in the request (see clause 5.8), subject to clause 7.6.2.4.

Upon successful matching of one or more identifier associations which were active at or around (within a pre-defined search time window) the observed time specified in the query, the ICF shall provide a response to the IQF using the IdentityAssociationResponse message as defined in clause 5.8. Where the ICF is not able to provide a single identifier association based on the RequestValues, the IQF is responsible for any subsequent handling of multiple identifier associations in terms of whether to provide all associations to the LEA over LI_HIQR.

7.6.2.4 ICF Identifier Association Event Handling

Upon receipt of an Association event as defined in clause 6.2.2A.2, the ICF shall cache the identifier association(s) contained within the record as followings:

- SUPI to 5G-GUTI association received, in an IEFAssociationRecord is stored by ICF as an active association. The previous active association for the same SUPI, if any, is marked as a previously active association and cached until the cache time limit is reached.
- If the IEFAssociationRecord also contains a SUCI, the SUCI is stored as a part of the received SUPI to 5G-GUTI association, for the lifetime of that association.
- Where the IEFDeassociationRecord corresponds to an active SUPI to 5G-GUTI association at ICF, the association is marked as a previously active association and cached until the cache time limit is reached.

The ICF shall have a CSP defined maximum active association lifetime (upon expiry of which the association is deleted from the ICF).

NOTE 1: This is needed to prevent an association from not being deleted from ICF under some error conditions (e.g. a loss of IEF message carrying IEFDeassociationRecord caused by the implicit deregistration of an out-of-service UE). The selection of the maximum active association lifetime value needs to ensure that no valid active associations are deleted upon the lifetime expiry, i.e. the longest possible association refresh time supported by CSP's network needs to be accommodated.

For previous associations placed in the cache, the ICF shall store the times of association and disassociation, respectively.

Where an IEFAssociationRecord contains a PEI, GPSI, NCGI or a TAI list, the ICF shall store the received values and associate them both the current received SUPI to 5G-GUTI association and any future association until:

- A subsequent IEFAssociationRecord is received which updates the PEI, GPSI, NCGI or TAI list values.
- The old PEI / GPSI / NCGI / TAI list shall be retained in association with previous SUPI to 5G-GUTI associations until those associations are deleted from cache.
- New PEI / GPSI / NCGI / TAI list shall be used in association with both the association(s) with which it was received and any subsequent associations until another update is received.
- All SUPI associations for which the PEI / GPSI / NCGI / TAI list is valid are deleted from the cache.

When the ICF receives a query request from the IQF as defined in clause 7.6.2.3, the ICF shall search available identifier associations (both active associations and those marked for deletion in the cache) for a match. The ICF shall be able to use both time and TAI (as a single TAI and in relation to a TAI list) to identify the correct SUPI to 5G-GUTI association(s). For associations which have been disassociated (and will be deleted once the cache time limit is reached), the time of disassociation is used by the ICF to identify the correct association match (based on observed time in LEA request), where multiple associations are held in the cache.

NOTE 2: Use of nCGI to match associations based on physical location for SUCI / 5G-S-TMSI to SUPI requests, is out of scope of the present document.

As the LEA and CSP are unlikely to have synchronised the time of identifier observation / association provided by the LEA in the query request, with NF time of the IEFs, the ICF shall search the cached identifier associations using a short window time duration both before and after (subject to overall cache duration) the observed time provided by the LEA in the RequestValues over LI_XQR.

NOTE 3: While the search window duration before and after the LEA provided observed time value is outside the scope of the present document, selection of this value by the CSP needs to take into consideration, among other aspects, the duration of a potential period of recovery from a 5G-GUTI update error, in order to prevent missing of otherwise matching associations due to discrepancies between their stored association/disassociation time and the observed time provided by LEA.

NOTE 4: While the value of the short-term caching time is outside the scope of the present document, selection of this value by the CSP needs to take into consideration, among other aspects, the duration of potential period of recovery from a 5G-GUTI update error, in order to prevent previous associations being deleted before they have been fully disassociated by both the UE and AMF.

7.6.3 IQF

7.6.3.1 General

The IQF is responsible for receiving and responding to LEA requests over LI_HIQR. Following receipt of a request over LI_HIQR, the IQF shall validate the request and ensure that the request is within the cache period of associations stored in the ICF. If the request is valid and within the ICF cache period, the IQF shall send an association search request to the ICF over LI_XQR. If the request is not within the ICF cache period or otherwise invalid, the IQF shall reject the request and respond to the LEA over LI_HIQR.

Following receipt of an association search request response from the ICF over LI_XQR, the IQF shall forward any matching identifier association(s) to the LEA over LI_HIQR. If the ICF indicates zero matches were found based on the

information provided in the initial request over LI_HIQR, the IQF shall respond to the LEA over LI_HIQR indicating that no identifier associations were found based on the request from the LEA.

If the ICF responds with multiple associations of 5G-GUTIs / SUCIs to a single SUPI, the IQF shall provide all matched associations to the LEA over LI_HIQR. Handling in the case of multiple SUPIs to a single 5G-GUTI (where the initial request over LI_HIQR is based on 5G-S-TMSI or SUCI) is outside the scope of the present document.

7.6.3.2 IQF Query and Response over LI_HIQR

The IQF is responsible for receiving query requests from and providing query responses to the LEA over LI_HIQR. Further details of LI_HIQR messages are defined in clause 5.7.

7.6.3.3 IQF Query and Response over LI_XQR

The IQF is responsible for generating queries to and receiving query responses requests from the ICF over LI_XQR, based on queries received from the LEA over LI_HIQR. Further details of LI_XQR messages are defined in clause 5.8.

7.7 LI at NEF

7.7.1 Provisioning over LI_X1

7.7.1.1 General

For NIDD using NEF:

- If delivery type for the warrant is "IRI and CC", then the IRI-POI and the CC-POI in the NEF, the MDF2 and MDF3 shall be provisioned.
- If delivery type for the warrant is "IRI", then the IRI-POI in the NEF and the MDF2 shall be provisioned.
- Delivery type "CC" is not applicable to the warrant.

For device triggering, MSISDN-less MO SMS and Parameter Provisioning:

- the delivery type for the warrant is "IRI"; the IRI-POI in the NEF and the MDF2 shall be provisioned.

7.7.1.2 Provisioning of the IRI-POI and CC-POI in NEF

The IRI-POI and CC-POI present in the NEF are provisioned over LI_X1 by the LIPF using the X1 protocol as described in clause 5.2.2.

The POI in the NEF shall support the following target identifier formats in the ETSI TS 103 221-1 [7] messages (or equivalent if ETSI TS 103 221-1 [7] is not used):

- SUPIIMSI.
- SUPINAI.
- GPSIMSISDN.
- GPSINAI.

NOTE: For Parameter Provisioning, only GPSIMSISDN and GPSINAI are applicable.

7.7.2 LI for NIDD using NEF

7.7.2.1 Generation of xIRI at IRI-POI in NEF over LI_X2

7.7.2.1.1 General

The IRI-POI present in the NEF shall send the xIRIs over LI_X2 for each of the events listed in TS 33.127 [5] clause 7.9.2.3, the details of which are described in the following clauses. Each event will be based on PDU session between NEF and target UE, except for Unsuccessful Procedure event. The IRI-POI in the NEF shall also send a SeparatedLocationReporting xIRI (as described in clause 7.3.4.1) when the IRI-POI provisioned in the NEF receives updated UE location information via the Nnef_Location_LocationUpdateNotify service operation destined for an external AF.

7.7.2.1.2 PDU session establishment

The IRI-POI in the NEF shall generate an xIRI containing an NEFPDUSessionEstablishment record when the IRI-POI present in the NEF detects that an unstructured PDU session using NEF has been established for the target UE. The IRI-POI present in the NEF shall generate the xIRI for the following event:

- NEF returns Nnef_SMContext_Create Response towards the SMF confirming the establishment of the unstructured PDU session to the NEF for the target UE (as defined in TS 29.541 [57] clause 5.2.2.2) and connection to the AF is established.

Table 7.7.2-1: NEFPDUSessionEstablishment record

Field name	Value	M/C/O
sUPI	SUPI associated with the PDU session (e.g. as provided by the SMF in the associated Nnef_SMContext_Create Request).	M
gPSI	GPSI associated with the PDU session.	M
pDUSessionID	PDU Session ID.	M
sNSSAI	Slice identifier associated with the PDU session.	C
nEFID	NEF identity handling the PDU session.	M
dNN	Data Network Name associated with the target traffic. Shall be given in dotted-label presentation format as described in TS 23.003 [19] clause 9.1.	M
rDSSupport	True if Reliable Data Service is supported in the PDU session, otherwise False.	M
sMFID	Identifier of the SMF associated with the target UE for that that PDU Session.	M
aFID	Identifier of the AF.	M

7.7.2.1.3 PDU session modification

The IRI-POI in the NEF shall generate an xIRI containing an NEFPDUSessionModification record when the IRI-POI present in the NEF detects that an unstructured PDU session using NEF has been modified for the target UE. The IRI-POI present in the NEF shall generate the xIRI for the following events:

- NEF returns Nnef_SMContext_Update Response to SMF to confirm the modification of the connection between SMF and NEF (see TS 29.541 [57] clause 5.2.2.5).
- NEF returns a RDS MANAGE PORT Response to a UE with a "Status" field set to "Success" in response to a RDS MANAGE PORT command sent by UE with an "Action" field set to "Reserve port" to confirm the reservation of a combination of source and destination port numbers for use for a traffic to be sent by the UE to a specific application on an AF (see TS 24.250 [61] clause 5.4.2.6.2).
- NEF receives a RDS MANAGE PORT Response from a UE with a "Status" field set to "Success" in response to a RDS MANAGE PORT command sent by the NEF with an "Action" field set to "Reserve port" to confirm the reservation of a combination of source and destination port numbers for use for a traffic to be sent by an AF to a specific application on the UE (see TS 24.250 [61] clause 5.4.2.6.2).
- NEF returns a RDS MANAGE PORT Response to a UE with a "Status" field set to "Success" in response to a RDS MANAGE PORT command sent by UE with an "Action" field set to "Release port" to confirm the release of a combination of source and destination port numbers for an application on an AF (see TS 24.250 [61] clause 5.4.2.6.3).

- NEF receives a RDS MANAGE PORT Response from a UE with a "Status" field set to "Success" in response to a RDS MANAGE PORT command sent by the NEF with an "Action" field set to "Release port" to confirm the release of a combination of source and destination port numbers for an application on the UE (see TS 24.250 [61] clause 5.4.2.6.3).

Table 7.7.2-2: NEFPDUSessionModification record

Field name	Value	M/C/O
sUPI	SUPI associated with the PDU session	M
gPSI	GPSI associated with the PDU session	M
sNSSAI	Slice identifier associated with the PDU session	M
Initiator	Initiator of the modification of the PDU session, UE, SMF or NEF	M
rDSSourcePortNumber	RDS source port number	C
rDSDestinationPortNumber	RDS destination port number	C
applicationID	Application identifier on the UE or on the AF if RDS is used	C
aFID	Identifier of the AF if RDS is used	C
rDSAction	Action if RDS is used. Possible values: "ReservePort", "ReleasePort"	C
serializationFormat	Data format exchanged between UE and AF if RDS is used	C
pDUSessionID	PDU Session ID (see NOTE below)	M
NOTE: For the backward compatibility purposes the parameter is coded as OPTIONAL in the ASN.1 schema (Annex A).		

7.7.2.1.4 PDU session release

The IRI-POI in the NEF shall generate an xIRI containing a NEFPDUSessionRelease record when the IRI-POI present in the NEF detects that an unstructured PDU session using NEF related to the target UE needs to be released. The IRI-POI present in the NEF shall generate the xIRI for the following events:

- NEF notifies the SMF that the SMF-NEF Connection for NIDD via NEF is no longer valid using Nnef_SMContext_DeleteNotify service operation when NEF receives a notification from the UDM that the NIDD authorization has ended. NEF releases the SM Context for NIDD on NEF as described in TS 29.541 [57] clause 5.2.2.4. This corresponds to NEF Initiated SMF-NEF Connection Release procedure.
- NEF returns Nnef_SMContext_Delete Response towards SMF confirming release of the SMF-NEF session for the target UE. In this scenario, SMF releases the SM Context for NIDD on NEF as specified in TS 29.541 [57] clause 5.2.2.3).

Table 7.7.2-3: NEFPDUSessionRelease record

Field name	Value	M/C/O
sUPI	SUPI associated with the PDU session	M
gPSI	GPSI associated with the PDU session	M
pDUSessionID	PDU Session ID as assigned by the AMF	M
timeOfFirstPacket	Time of first packet for the PDU session	C
timeOfLastPacket	Time of last packet for the PDU session	C
uplinkVolume	Number of uplink octets for the PDU session	C
downlinkVolume	Number of downlink octets for the PDU session	C
releaseCause	Cause of PDU Session Release	M

7.7.2.1.5 Unsuccessful procedure

The IRI-POI in the NEF shall generate an xIRI containing a NEFUnsuccessfulProcedure record when the IRI-POI present in the NEF detects an unsuccessful procedure or error condition for a UE matching one of the target identifiers provided via LI_X1.

Accordingly, the IRI-POI in the NEF generates the xIRI when one of the following events are detected as described in TS 29.541 [57] clause 6.1.7.3 and TS 24.250 [61] clause 5.4.2.6:

- NEF sends a Nnef_SMContext_Create Reject message to the SMF with a reject cause set to "USER_UNKNOWN" or "NIDD_CONFIGURATION_NOT_AVAILABLE".

- NEF returns a RDS MANAGE PORT Response to a UE with a "Status" field set to "Port not free" in response to a RDS MANAGE PORT command sent by UE with an "Action" field set to "Reserve port".
- NEF receives a RDS MANAGE PORT Response from a UE with a "Status" field set to "Port not free" in response to a RDS MANAGE PORT command sent by NEF with an "Action" field set to "Reserve port".
- NEF returns a RDS MANAGE PORT Response to a UE with a "Status" field set to "Port not associated with specified application" in response to a RDS MANAGE PORT command sent by UE with an "Action" field set to "Release port".
- NEF receives a RDS MANAGE PORT Response from a UE with a "Status" field set to "Port not associated with specified application" in response to a RDS MANAGE PORT command sent by NEF with an "Action" field set to "Release port".

Table 7.7.2-4: NEFUnsuccessfulProcedure record

Field name	Value	M/C/O
failureCause	Provides the value of the failure cause.	M
sUPI	SUPI associated with the procedure.	M
gPSI	GPSI used in the procedure, if available.	C
pDUSessionID	PDU Session ID.	C
dNN	Data Network Name associated with the target traffic, if available. Shall be given in dotted-label presentation format as described in TS 23.003 [19] clause 9.1.	C
sNSSAI	Slice requested for the procedure, if available.	C
rDSDestinationPortNumber	RDS destination port number.	C
applicationID	Application associated with the RDS destination port number.	C
aFID	Application Function identifier. If the Application Function identifier is not available, the placeholder value "Unknown" shall be used.	M

7.7.2.1.6 Start of interception with established PDU session

The IRI-POI in the NEF shall generate an xIRI containing an NEFStartOfInterceptionWithEstablishedPDUSession record when the IRI-POI present in the NEF detects that an unstructured PDU session using NEF has already been established, at the time the POI on NEF is provisioned with a new target ID.

The IRI-POI in the NEF shall generate the xIRI containing the NEFStartOfInterceptionWithEstablishedPDUSession record for each of the PDU sessions for NIDD using NEF associated with the target UE with a different value of correlation information.

Table 7.7.2-5: NEFStartOfInterceptionWithEstablishedPDUSession record

Field name	Value	M/C/O
sUPI	SUPI associated with the PDU session (e.g. as provided by the SMF in the associated Nnef_SMContext_Create Request).	M
gPSI	GPSI associated with the PDU session.	M
pDUSessionID	PDU Session ID.	M
sNSSAI	Slice identifier associated with the PDU session.	M
dNN	Data Network Name associated with the target traffic. Shall be given in dotted-label presentation format as described in TS 23.003 [19] clause 9.1.	M
nEFID	NEF identity handling the PDU session.	M
rDSSupport	True if Reliable Data Service is supported in the PDU session, otherwise False.	M
sMFID	Identifier of the SMF associated with the target UE for that that PDU Session.	M
aFID	String Identifying the AF the traffic will be delivered to.	M

The IRI-POI present in the SMF generating an xIRI containing a NEFStartOfInterceptionWithEstablishedPDUSession record shall set the Payload Direction field in the PDU header to *not applicable* (see ETSI TS 103 221-2 [8] clause 5.2.6).

7.7.2.2 Generation of xCC at CC-POI in NEF over LI_X3

The CC-POI present in the NEF shall send xCC over LI_X3 for each NIDD packet.

Each X3 PDU shall contain the contents of the user plane packet (i.e. NIDD) using an unstructured payload format.

The CC-POI present in the NEF shall set the payload format to indicate the appropriate payload type (i.e. unstructured payload) as described in ETSI TS 103 221-2 [8] clause 5.4.

7.7.2.3 Generation of IRI over LI_HI2

When an xIRI is received over LI_X2 from the IRI-POI in the NEF, the MDF2 shall send the IRI message over LI_HI2 without undue delay. The IRI message shall contain a copy of the relevant record received from LI_X2. The record may be enriched by other information available at the MDF (e.g. additional location information).

The timestamp field of the ETSI TS 102 232-1 [9] PSHeader structure shall be set to the time at which the NEF event was observed (i.e. the timestamp field of the xIRI).

The IRI type parameter (see ETSI TS 102 232-1 [9] clause 5.2.10) shall be included and coded according to table 7.7.2-6.

Table 7.7.2-6: IRI type for IRI messages

Record type	IRI Type
NEFPDUSessionEstablishment	BEGIN
NEFPDUSessionRelease	END
NEFPDUSessionModification	CONTINUE
NEFStartOfInterceptionWithEstablishedPDUSession	BEGIN
NEFUnsuccessfulProcedure	REPORT or CONTINUE

IRI messages associated with the same PDU Session shall be assigned the same CIN (see ETSI TS 102 232-1 [9] clause 5.2.4).

The threeGPP33128DefinedIRI field (see ETSI TS 102 232-7 [10] clause 15) shall be populated with the BER-encoded IRIPayload.

7.7.2.4 Generation of CC over LI_HI3

When xCC is received over LI_X3 from the CC-POI in the NEF, the MDF3 shall populate the threeGPP33128DefinedCC field with a CCPayload structure containing NIDDCCPDU and send it over LI_HI3 interface to LEMF without undue delay.

The timestamp field of the ETSI TS 102 232-1 [9] PSHeader structure shall be set to the time that the NEF observed the data (i.e. the timestamp field of the xCC). The LIID and CID fields shall correctly reflect the target identity and communication session to which the CC belongs.

7.7.3 LI for device triggering

7.7.3.1 Generation of xIRI LI_X2 at IRI-POI in NEF over LI_X2

7.7.3.1.1 General

The IRI-POI present in the NEF shall send the xIRIs over LI_X2 for each of the events listed in TS 33.127 [5] clause 7.9.3.4, the details of which are described in the following clauses.

7.7.3.1.2 Device trigger

The IRI-POI in the NEF shall generate an xIRI containing a NEFDeviceTrigger record when the IRI-POI present in the NEF detects that an AF has sent a Device trigger to a target UE matching one of the target identifiers.

Accordingly, the IRI-POI in the NEF generates the xIRI when any of the following events is detected:

- NEF sends a Nnef_Trigger_Delivery Response to the AF to acknowledge the reception of Nnef_Trigger_Delivery Request with GPSI matching the target identifier (see TS 23.502 [4] clause 4.13.2.1 and TS 29.522 [58] clause 4.4.3).
- NEF sends a T4 Device-Trigger-Request (DTR) to SM-SC with Trigger-Action AVP set to TRIGGER and User-Identifier AVP matching the SUPI of the target UE as described in TS 29.337 [60] clause 5.2.1.

Table 7.7.3-1: NEFDeviceTrigger record

Field name	Value	M/C/O
sUPI	SUPI associated with the UE.	M
gPSI	GPSI used with the UE.	M
triggerId	Identity of the Device trigger that should be provided in the deviceTriggeringDeliveryReportNotification IRI, Device trigger replacement IRI and Device trigger cancellation IRI.	M
aFID	The AF sending the Device trigger.	M
triggerPayload	The Device triggering payload.	C
validityPeriod	The validity time in seconds for the specific action requested.	C
priorityDT	The priority indication for a trigger payload.	C
sourcePortId	Application identity on the AF which delivers the Device trigger.	C
destinationPortId	Used to uniquely identify the triggering application addressed in the device.	C

7.7.3.1.3 Device trigger replace

The IRI-POI in the NEF shall generate an xIRI containing a NEFDeviceTriggerReplace record when the IRI-POI present in the NEF detects that an AF has sent a Device trigger replacement for a previously sent Device trigger to a UE matching one of the target identifiers provided via LI_X1 to the IRI-POI in the NEF. It replaces a previously submitted Device trigger message which has not yet been delivered to the UE.

Accordingly, the IRI-POI in the NEF generates the xIRI when any of the following events is detected:

- NEF receives a Nnef_Trigger_Delivery Request (for a device trigger replacement) from an AF as described in TS 29.522 [58] clause 4.4.3 with GPSI matching the target identifier.
- NEF sends a T4 Device-Trigger-Request (DTR) to SM-SC with Trigger-Action AVP set to REPLACE and User-Identifier AVP matching the SUPI of the target UE as specified in 29.337 [60] clause 5.2.1.

Table 7.7.3-2: NEFDeviceTriggerReplace record

Field name	Value	M/C/O
sUPI	SUPI associated with the target UE.	M
gPSI	GPSI used with the target UE.	M
triggerId	Identity of the corresponding Device trigger to be replaced.	M
aFID	The AF replacing an existing Device trigger which has not been delivered yet to the device (e.g. because the device is unreachable) by a new Device trigger.	M
triggerPayload	The device triggering payload.	C
validityPeriod	The validity time in seconds for the specific action requested.	C
priorityDT	Priority indication for a trigger payload.	C
sourcePortId	Port on the AF which delivers the device trigger.	C
destinationPortId	Port on the device which is the recipient of the device trigger.	C

7.7.3.1.4 Device trigger cancellation

The IRI-POI in the NEF shall generate an xIRI containing a NEFDeviceTriggerCancellation record when the IRI-POI present in the NEF detects that an AF has sent a Device trigger cancellation for a previously sent Device trigger to a UE matching one of the target identifiers provided via LI_X1 to the IRI-POI in the NEF. It cancels previously submitted Device trigger message which has not yet been delivered to the target UE.

Accordingly, the IRI-POI in the NEF generates the xIRI when any of the following events is detected:

- NEF receives a Nnef_Trigger_Delivery Request (for a device trigger cancellation) with GPSI matching the target identifier as described in TS 29.522 [58] clause 4.4.3.
- NEF sends a T4 Device-Trigger-Request (DTR) to SM-SC with Trigger-Action AVP set to RECALL and User-Identifier AVP matching the SUPI of the target UE as specified in TS 29.337 [60] clause 5.2.1.

Table 7.7.3-3: NEFDeviceTriggerCancellation record

Field name	Value	M/C/O
sUPI	SUPI associated with the target UE.	M
gPSI	GPSI used with the target UE.	M
triggerId	Identity of the corresponding device trigger to be cancelled.	M

7.7.3.1.5 Device trigger report notification

The IRI-POI in the NEF shall generate an xIRI containing a NEFDeviceTriggerReportNotify record when the IRI-POI present in the NEF detects that the NEF has returned a Device trigger report to the AF with a cause value indicating the trigger delivery outcome (e.g. succeeded, unknown or failed).

Accordingly, the IRI-POI in the NEF generates the xIRI when any of the following events is detected:

- NEF sends a Nnef_Trigger_DeliveryNotify service operation with the GPSI of the target UE to inform the AF on the delivery outcome of the device trigger as described in TS 29.522 [58] clause 4.4.3.
- SM-SC sends a T4 Delivery-Report-Request (DRR) to the NEF with User-Identifier matching the SUPI of the target UE as specified in 29.337 [60] clause 5.2.2.

Table 7.7.3-4: NEFDeviceTriggerReportNotify record

Field name	Value	M/C/O
sUPI	SUPI associated with the target UE.	M
gPSI	GPSI used with the target UE.	M
triggerId	Identity of the corresponding Device trigger.	M
deviceTriggerDeliveryResult	Delivery result represents the result of the delivery of a device triggering request: <ul style="list-style-type: none"> - SUCCESS: The value indicates that the device action request was successfully completed. - UNKNOWN: The value indicates any unspecified errors. - FAILURE: The value indicates that this trigger encountered a delivery error and is deemed permanently undeliverable. - TRIGGERED: The value indicates that Device triggering request is accepted by the NEF. - EXPIRED: The value indicates that the validity period expired before the trigger could be delivered. - UNCONFIRMED: The value indicates that the delivery of the device action request is not confirmed. - REPLACED: The value indicates that the device triggering replacement request is accepted by the NEF. - TERMINATE: The NEF includes this value in the response for a successful device triggering cancellation request. The value indicates that the delivery of the device action request is terminated by the AF. 	M

7.7.3.2 Generation of IRI over LI_HI2

When an xIRI is received over LI_X2 from the IRI-POI in the NEF, the MDF2 shall send the IRI message over LI_HI2 without undue delay. The IRI message shall contain a copy of the relevant record received from LI_X2. The record may be enriched by other information available at the MDF (e.g. additional location information).

The timestamp field of the ETSI TS 102 232-1 [9] PSHeader structure shall be set to the time at which the NEF event was observed (i.e. the timestamp field of the xIRI).

The IRI type parameter (see ETSI TS 102 232-1 [9] clause 5.2.10) shall be included and coded according to table 7.7.3-5.

Table 7.7.3-5: IRI type for IRI messages

Record type	IRI Type
NEFDeviceTrigger	REPORT
NEFDeviceTriggerReplace	REPORT
NEFDeviceTriggerCancellation	REPORT
NEFDeviceTriggerReportNotify	REPORT

7.7.4 LI for MSISDN-less MO SMS

7.7.4.1 Generation of xIRI LI_X2 at IRI-POI in NEF over LI_X2

7.7.4.1.1 General

The IRI-POI present in the NEF shall send the xIRIs over LI_X2 for each of the events listed in TS 33.127 [5] clause 7.9.4.4, the details of which are described in the following clauses.

7.7.4.1.2 MSISDN-less MO SMS

The IRI-POI in the NEF shall generate an xIRI containing a NEFMSISDNLessMOSMS record when the IRI-POI present in the NEF detects that a target UE has sent a MSISDN-less MO SMS to an AF.

Accordingly, the IRI-POI in the NEF generates the xIRI when any of the following events is detected:

- NEF receives a SGd MO-Forward-Short-Message-Request (OFR) from an SM-SC with SUPI matching the target identifier (see TS 29.338 [59] clause 6.2.1).
- NEF sends a Nnef_MSISDN-less_MO_SMSNotify service operation to the AF with the GPSI of the target UE sending the MSISDN-less SMS as described in TS 29.522 [58] clause 4.4.10.

Table 7.7.4-1: NEFMSISDNLessMOSMS record

Field name	Value	M/C/O
sUPI	SUPI associated with the target UE.	M
gPSI	GPSI in the form of an external identifier as username@realm and corresponding to the identity of the originating SMS party.	M
terminatingSMSParty	Identity of the AF receiving the SMS.	M
sMS	SMS TPDU.	C
sourcePort	port identifying the application of the target UE sending the MSISN-less MO SMS.	C
destinationPort	port identifying the application of the AF which is the recipient of the MSISN-less MO SMS.	C

7.7.4.2 Generation of IRI over LI_HI2

When an xIRI is received over LI_X2 from the IRI-POI in the NEF, the MDF2 shall send the IRI message over LI_HI2 without undue delay. The IRI message shall contain a copy of the relevant record received from LI_X2. The record may be enriched by other information available at the MDF (e.g. additional location information).

The timestamp field of the ETSI TS 102 232-1 [9] PSHeader structure shall be set to the time at which the NEF event was observed (i.e. the timestamp field of the xIRI).

The IRI type parameter (see ETSI TS 102 232-1 [9] clause 5.2.10) shall be included and coded according to table 7.7.4-2.

Table 7.7.4-2: IRI type for IRI messages

Record type	IRI Type
NEFMSISDNLessMOSMS	REPORT

7.7.5 LI for parameter provisioning

7.7.5.1 Generation of xIRI LI_X2 at IRI-POI in NEF over LI_X2

7.7.5.1.1 General

The IRI-POI present in the NEF shall send the xIRIs over LI_X2 for each of the events listed in TS 33.127 [5] clause 7.9.5.4, the details of which are described in the following clauses.

7.7.5.1.2 Expected UE behavior update

The IRI-POI in the NEF shall generate an xIRI containing an NEFExpectedUEBehaviorUpdate record when the IRI-POI present in the NEF detects that an AF has updated the UE Expected behavior data.

Accordingly, the IRI-POI in the NEF generates the xIRI when any of the following events is detected (see TS 29.503 [25] clauses 5.6.2.1 and 6.1.6.2.49):

- NEF receives a NEF_ParameterProvision_Create Request or NEF_ParameterProvision_Update Request from an AF, related to the target UE.
- NEF receives a NEF_ParameterProvision_Delete Request from an AF to delete the existing UE Expected Behaviour parameters related to the target UE.
- NEF returns a NEF_ParameterProvision_Get Response containing the UE Expected Behavior of the target UE to the querying AF.

Table 7.7-5-1: NEFExpectedUEBehaviorUpdate record

Field name	Value	M/C/O
gPSI	GPSI of the target UE to which the expected UE behavior applies.	M
expectedUEMovingTrajectory	Identifies the UE's expected geographical movement.	O
stationaryIndication	Identifies whether the UE is stationary or mobile.	O
communicationDurationTime	Indicates for how long the UE will normally stay in CM-Connected for data transmission expressed in seconds.	O
periodicTime	Interval Time of periodic communication in seconds.	O
scheduledCommunicationTime	Time and day of the week when the UE is available for communication, as defined in TS 29.571 [17].	O
batteryIndication	Identifies power consumption criticality for the UE: if the UE is battery powered but the battery is not rechargeable/not replaceable, battery powered with rechargeable/replaceable battery, or not battery powered.	O
trafficProfile	Identifies the type of data transmission: single packet transmission (UL or DL), dual packet transmission (UL with subsequent DL or DL with subsequent UL), multiple packets transmission.	O
scheduledCommunicationType	Indicates that the Scheduled Communication Type is Downlink only or Uplink only or Bi-directional.	O
expectedTimeAndDayOfWeekInTrajectory	Identifies the time and day of week when the UE is expected to be at each location included in the Expected UE Moving Trajectory.	O
aFID	AF identity requesting expected UE behavior update.	M
validityTime	Identifies when the expected UE behavior parameter set expires and shall be deleted. If absent, it indicates that there is no expiration time for this parameter set.	O

7.7.5.2 Generation of IRI over LI_HI2

When an xIRI is received over LI_X2 from the IRI-POI in the NEF, the MDF2 shall send the IRI message over LI_HI2 without undue delay. The IRI message shall contain a copy of the relevant record received from LI_X2. The record may be enriched by other information available at the MDF (e.g. additional location information).

The timestamp field of the ETSI TS 102 232-1 [9] PSHeader structure shall be set to the time at which the NEF event was observed (i.e. the timestamp field of the xIRI).

The IRI type parameter (see ETSI TS 102 232-1 [9] clause 5.2.10) shall be included and coded according to table 7.7.4-2.

Table 7.7.5-2: IRI type for IRI messages

Record type	IRI Type
NEFExpectedUEBehaviorUpdate	REPORT

7.8 LI at SCEF

7.8.1 Provisioning over LI_X1

7.8.1.1 General

For NIDD using SCEF:

- If delivery type for the warrant is "IRI and CC", then the IRI-POI and the CC-POI in the SCEF, the MDF2 and MDF3 shall be provisioned.
- If delivery type for the warrant is "IRI", then the IRI-POI in the SCEF and the MDF2 shall be provisioned.
- Delivery type "CC" is not applicable to the warrant.

For device triggering, MSISDN-less MO SMS and Parameter Provisioning:

- the delivery type for the warrant is "IRI"; the IRI-POI in the SCEF and the MDF2 shall be provisioned.

7.8.1.2 Provisioning of the IRI-POI and CC-POI in SCEF

The IRI-POI and CC-POI present in the SCEF are provisioned over LI_X1 by the LIPF using the X1 protocol as described in clause 5.2.2.

The POI in the SCEF shall support the following target identifier formats in the ETSI TS 103 221-1 [7] messages (or equivalent if ETSI TS 103 221-1 [7] is not used):

- IMSI.
- MSISDN.
- External Identifier.

NOTE: For Parameter Provisioning, only MSISDN and External Identifier are applicable.

7.8.2 LI for NIDD using SCEF

7.8.2.1 Generation of xIRI at IRI-POI in SCEF over LI_X2

7.8.2.1.1 General

The IRI-POI present in the SCEF shall send the xIRIs over LI_X2 for each of the events listed in TS 33.127 [5] clause 7.11.2.3, the details of which are described in the following clauses. Each event will be based on PDN Connection between SCEF and target UE, except in case of Unsuccessful Procedure.

7.8.2.1.2 SCEF PDN connection establishment

The IRI-POI in the SCEF/IWK-SCEF shall generate an xIRI containing an SCEFPDNConnectionEstablishment record when the IRI-POI present in the SCEF/IWK-SCEF detects that a Non-IP PDN Connection using SCEF has been established by the target UE. The IRI-POI present in the SCEF/IWK-SCEF shall generate the xIRI for the following events (see TS 29.128 [62], clause 5.8):

- the SCEF/IWK-SCEF sends a T6a/T6ai Connection Management Answer to MME as a response to a T6a/T6ai Connection Management Request received with User-Identifier AVP including the set of identities of the UE, i.e. IMSI/MSISDN/External Identifier matching the target Identifier and Connection-Action AVP set to CONNECTION_ESTABLISHMENT to confirm the establishment of a Non-IP PDN connection.
- in roaming situation SCEF sends a T7 Connection Management Answer to IWK-SCEF as a confirmation to the T7 Connection Management Request received with User-Identifier AVP including the set of identities of the UE, i.e. IMSI/MSISDN/External Identifier matching the target Identifier and with Connection-Action AVP set to CONNECTION_ESTABLISHMENT.

Table 7.8.2-1: SCEFPDNConnectionEstablishment record

Field name	Value	M/C/O
iMSI	IMSI associated with the Non-IP PDN Connection of the target UE (e.g. as provided by the MME in the associated Connection Management Request).	C
mSISDN	MSISDN associated with the PDN Connection if available.	C
externalIdentifier	External Identifier associated with the PDN Connection if available, defined as NAI in ASN.1.	C
iMEI	IMEI associated to the device if available.	C
ePSBearerID	Identity of the EPS bearer that MME allocated to the Non-IP PDN connection.	M
sCEFID	SCEF identity handling the EPS Bearer.	M
aPN	Access Point Name used to establish the PDN Connection. Shall be given in dotted-label presentation format as described in TS 23.003 [19] clause 9.1.	M
rDSSupport	True if Reliable Data Service is supported in the PDN Connection, otherwise False	M
sCSASID	String Identifying the AF the traffic will be delivered to.	M

7.8.2.1.3 PDN connection update

The IRI-POI in the SCEF/IWK-SCEF shall generate an xIRI containing an SCEFPDNConnectionUpdate record when the IRI-POI present in the SCEF/IWK-SCF detects that a Non-IP PDN Connection has been updated for the target UE. The IRI-POI present in the SCEF/IWK-SCEF shall generate the xIRI for the following events:

- SCEF/IWK-SCEF sends a T6a/T6ai Connection Management Answer to confirm the T6a/T6ai Connection Management Request received with User-Identifier AVP including the set of identities of the UE, i.e. IMSI/MSISDN/External Identifier matching the target Identifier and with Connection-Action AVP set to CONNECTION_UPDATE as described in TS 29.128 [62] clause 5.7.
- SCEF/IWK-SCEF receives a T6a/T6ai Connection Management Answer from MME which confirms the T6a/T6ai Connection Management Request sent by SCEF/IWK-SCEF with User-Identifier AVP including the set of identities of the UE, i.e. IMSI/MSISDN/External Identifier matching the target Identifier and with Connection-Action AVP set to CONNECTION_UPDATE as described in TS 29.128 [62] clause 5.8.
- in roaming situation SCEF sends a T7 Connection Management Answer to IWK-SCEF to confirm the T7 Connection Management Request received with User-Identifier AVP including the set of identities of the UE, i.e. IMSI/MSISDN/External Identifier matching the target Identifier and with Connection-Action AVP set to CONNECTION_UPDATE as described in TS 29.128 [62] clause 5.7.
- in roaming situation SCEF receives a T7 Connection Management Answer from IWK-SCEF which confirms the T7 Connection Management Request with User-Identifier AVP including the set of identities of the UE, i.e. IMSI/MSISDN/External Identifier matching the target Identifier and with Connection-Action AVP set to CONNECTION_UPDATE as described in TS 29.128 [62] clause 5.8.
- SCEF returns a RDS MANAGE PORT Response to a UE with a "Status" field set to "Success" in response to a RDS MANAGE PORT command sent by UE with an "Action" field set to "Reserve port" to confirm the

reservation of a combination of source and destination port numbers for use for a traffic to be sent by the UE to a specific application on an SCS/AS (see TS 24.250 [61] clause 5.4.2.6.2).

- SCEF receives a RDS MANAGE PORT Response from a UE with a "Status" field set to "Success" in response to a RDS MANAGE PORT command sent by the SCEF with an "Action" field set to "Reserve port" to confirm the reservation of a combination of source and destination port numbers for use for a traffic to be sent by an SCS/AS to a specific application on the UE (see TS 24.250 [61] clause 5.4.2.6.2).
- SCEF returns a RDS MANAGE PORT Response to a UE with a "Status" field set to "Success" in response to a RDS MANAGE PORT command sent by UE with an "Action" field set to "Release port" to confirm the release of a combination of source and destination port numbers for an application on an SCS/AS (see TS 24.250 [61] clause 5.4.2.6.3).
- SCEF receives a RDS MANAGE PORT Response from a UE with a "Status" field set to "Success" in response to a RDS MANAGE PORT command sent by the SCEF with an "Action" field set to "Release port" to confirm the release of a combination of source and destination port numbers for an application on the UE (see TS 24.250 [61] clause 5.4.2.6.3).

Table 7.8.2-2: SCEFPDNConnectionUpdate record

Field name	Value	M/C/O
iMSI	IMSI associated with the Non-IP PDN Connection of the target UE (e.g. as provided by the MME in the associated Connection Management Request).	C
mSISDN	MSISDN associated with the PDN Connection if available.	C
externalIdentifier	External Identifier associated with the PDN Connection if available, defined as NAI in ASN.1.	C
initiator	Initiator of the modification of the PDN Connection, UE, MME or SCEF.	M
rDSSourcePortNumber	RDS source port number.	C
rDSDestinationPortNumber	RDS destination port number.	C
applicationID	Application identifier on the UE or on the SCS/AS if RDS is used.	C
sCSASID	Identifier of the SCS/AS if RDS is used.	C
rDSAction	Action if RDS is used. Possible values: "ReservePort", "ReleasePort".	C
serializationFormat	Data format exchanged between UE and SCS/AS if RDS is used.	C
ePSBearerID	Identity of the EPS bearer that MME allocated to the Non-IP PDN connection (see NOTE below).	M
NOTE: For backward compatibility purposes the parameter is coded as OPTIONAL in the ASN.1 schema (Annex A).		

7.8.2.1.4 PDN connection release

The IRI-POI in the SCEF/IWK-SCEF shall generate an xIRI containing an SCEFPDNConnectionRelease record when the IRI-POI present in the SCEF/IWK-SCEF detects that a Non-IP PDN Connection needs to be released for the target UE. The IRI-POI present in the SCEF/IWK-SCEF shall generate the xIRI for the following events:

- SCEF/IWK-SCEF informs MME that the Non-IP PDN Connection for NIDD is no longer valid using T6a Connection Management Request with User-Identifier AVP including the set of identities of the UE, i.e. IMSI/MSISDN/External Identifier matching the target Identifier and Connection-Action AVP set to CONNECTION_RELEASE. SCEF initiates the release of the Non-IP PDN connection when it is notified by the HSS about the end of NIDD authorization for the target UE (see TS 29.128 [62] clause 5.8).
- SCEF sends a T6a Connection Management Answer to MME to confirm the T6a Connection Management Request received with User-Identifier AVP including the set of identities of the UE, i.e. IMSI/MSISDN/External Identifier matching the target Identifier and with Action-Action AVP set to CONNECTION_RELEASE (see TS 29.128 [62] clause 5.7).
- SCEF informs IWK-SCEF that the Non-IP PDN Connection for NIDD is no longer valid using T6a Connection Management Request with User-Identifier AVP including the set of identities of the UE, i.e. IMSI/MSISDN/External Identifier matching the target Identifier and Connection-Action AVP set to CONNECTION_RELEASE (see TS 29.128 [62] clause 5.8).
- SCEF sends a T7 Connection Management Answer to IWK-SCEF to confirm the T7 Connection Management Request with User-Identifier AVP including the set of identities of the UE, i.e. IMSI/MSISDN/External

Identifier matching the target Identifier and with Action AVP set to CONNECTION_RELEASE (see TS 29.128 [62] clause 5.7).

Table 7.8.2-3: SCEFPDNConnectionRelease record

Field name	Value	M/C/O
iMSI	IMSI associated with the Non-IP PDN Connection of the target UE (e.g. as provided by the MME in the associated Connection Management Request).	C
mSISDN	MSISDN associated with the PDN Connection if available.	C
externalIdentifier	External Identifier associated with the PDN Connection if available, defined as NAI in ASN.1.	C
ePSBearerID	Identity of the EPS bearer that MME allocates to the Non-IP PDN Connection.	M
timeOfFirstPacket	Time of first packet for the PDN Connection.	C
timeOfLastPacket	Time of last packet for the PDN Connection.	C
uplinkVolume	Number of uplink octets for the PDN Connection.	C
downlinkVolume	Number of downlink octets for the PDN Connection.	C
releaseCause	Reason for PDN Connection release.	M

7.8.2.1.5 Unsuccessful procedure

The IRI-POI in the SCEF/IWK-SCEF shall generate an xIRI containing an SCEFUnsuccessfulProcedure record when the IRI-POI present in the SCEF/IWK-SCEF detects an unsuccessful procedure or error condition for a target UE matching one of the target identifiers provided via LI_X1.

Accordingly, the IRI-POI in the SCEF/IWK-SCEF generates the xIRI when any of the following events is detected (see TS 29.128 [62] clause 6.3.3 and TS 24.250 [61] clause 5.4.2.6):

- SCEF sends a T6a Connection Management Answer with Experimental-Result AVP set to DIAMETER_ERROR_USER_UNKNOWN.
- SCEF sends a T6a Connection Management Answer with Experimental-Result AVP set to DIAMETER_ERROR_OPERATION_NOT_ALLOWED when Action AVP of the T6a Connection Management Request received by the SCEF is not set to CONNECTION_ESTABLISHMENT, CONNECTION_UPDATE or CONNECTION_RELEASE.
- SCEF sends a T6a Connection Management Answer with Experimental-Result AVP set to DIAMETER_ERROR_NIDD_CONFIGURATION_NOT_AVAILABLE when Action AVP of the T6a Connection Management Request received by the SCEF is set to CONNECTION_ESTABLISHMENT and the NIDD configuration for the target UE does not exist or fails at SCEF.
- SCEF sends a T6a Connection Management Answer with Experimental-Result AVP set to DIAMETER_ERROR_INVALID_EPS_BEARER when Action AVP of the T6a Connection Management Request received by the SCEF is set to CONNECTION_UPDATE or CONNECTION_RELEASE and the EPS Bearer Identity does not exist.
- SCEF returns a RDS MANAGE PORT Response to a UE with a "Status" field set to "Port not free" in response to a RDS MANAGE PORT command sent by UE with an "Action" field set to "Reserve port".
- SCEF receives a RDS MANAGE PORT Response from a UE with a "Status" field set to "Port not free" in response to a RDS MANAGE PORT command sent by SCEF with an "Action" field set to "Reserve port".
- SCEF returns a RDS MANAGE PORT Response to a UE with a "Status" field set to "Port not associated with specified application" in response to a RDS MANAGE PORT command sent by UE with an "Action" field set to "Release port".
- SCEF receives a RDS MANAGE PORT Response from a UE with a "Status" field set to "Port not associated with specified application" in response to a RDS MANAGE PORT command sent by SCEF with an "Action" field set to "Release port".

Table 7.8.2-4: SCEFUnsuccessfulProcedure record

Field name	Value	M/C/O
failureCause	Cause of unsuccessful procedure.	M
iMSI	IMSI associated with the Non-IP PDN Connection of the target UE (e.g. as provided by the MME in the associated Connection Management Request).	C
mSISDN	MSISDN associated with the PDN Connection if available.	C
iMEI	IMEI associated to the device if available.	C
externalIdentifier	External Identifier associated with the PDN Connection if available, defined as NAI in ASN.1.	C
ePSBearerID	Identity of the EPS bearer that MME allocated to the Non-IP PDN connection.	M
aPN	Access Point Name associated with the target traffic. Shall be given in dotted-label presentation format as described in TS 23.003 [19] clause 9.1 (see NOTE).	M
rDSDestinationPortNumber	RDS destination port number.	C
applicationID	Application identifier associated with the RDS port number.	C
sCSASID	SCS/AS Identifier. If the SCS/AS Identifier is not available, the placeholder value "Unknown" shall be used.	M
NOTE: If the APN is not available, the placeholder value ".unknown." shall be used.		

7.8.2.1.6 Start of interception with established PDN connection

The IRI-POI in the SCEF/IWK-SCEF shall generate an xIRI containing an SCEFStartOfInterceptionWithEstablishedPDNConnection record when the IRI-POI present in the SCEF detects that a Non-IP PDN Connection using SCEF has already been established for the target UE when interception starts.

In a non-roaming scenario, the IRI-POI in the SCEF (or in a roaming scenario, the IRI-POI in the IWK-SCEF in the VPLMN) shall generate the xIRI containing the SCEFStartOfInterceptionWithEstablishedPDNConnection record when it detects that a new interception for a UE is activated (i.e. provisioned by the LIPF) for the following case:

- A PDN connection to the SCEF for the target UE exists, uniquely identified by an EPS Bearer Identity, APN, and UE Identity.

The IRI-POI in the SCEF/IWK-SCEF shall generate the xIRI containing the SCEFStartOfInterceptionWithEstablishedPDNConnection record for each of the PDN Connections for NIDD using SCEF associated with the target UE.

Table 7.8.2-5: SCEFStartOfInterceptionWithEstablishedPDNConnection record

Field name	Value	M/C/O
iMSI	IMSI associated with the Non-IP PDN Connection of the target UE (e.g. as provided by the MME in the associated Connection Management Request).	C
mSISDN	MSISDN associated with the PDN Connection if available.	C
externalIdentifier	External Identifier associated with the PDN Connection if available, defined as NAI in ASN.1.	C
iMEI	IMEI associated to the device if available.	C
ePSBearerID	Identity of the EPS bearer that MME allocated to the Non-IP PDN connection.	M
sCEFID	SCEF identity handling the EPS Bearer.	M
aPN	Access Point Name associated with the target traffic. Shall be given in dotted-label presentation format as described in TS 23.003 [19] clause 9.1.	M
rDSSupport	True if Reliable Data Service is supported in the PDN Connection, otherwise False.	M
sCSASID	String Identifying the SCS/AS the traffic will be delivered to.	M

The IRI-POI present in the SMF generating an xIRI containing a SCEFStartOfInterceptionWithEstablishedPDUSession record shall set the Payload Direction field in the PDU header to *not applicable* (see ETSI TS 103 221-2 [8] clause 5.2.6).

7.8.2.2 Generation of xCC at CC-POI in SCEF over LI_X3

The CC-POI present in the SCEF shall send xCC over LI_X3 for each NIDD packet.

Each X3 PDU shall contain the contents of the user plane packet (i.e. NIDD) using an unstructured payload.

The CC-POI present in the SCEF shall set the payload format to indicate the appropriate payload type (i.e. unstructured payload) as described in ETSI TS 103 221-2 [8] clause 5.4.

7.8.2.3 Generation of IRI over LI_HI2

When an xIRI is received over LI_X2 from the IRI-POI in the SCEF/IWK-SCEF, the MDF2 shall send the IRI message over LI_HI2 without undue delay. The IRI message shall contain a copy of the relevant record received from LI_X2. The record may be enriched by other information available at the MDF (e.g. additional location information).

The timestamp field of the ETSI TS 102 232-1 [9] PSHeader structure shall be set to the time at which the SCEF event was observed (i.e. the timestamp field of the xIRI).

The IRI type parameter (see ETSI TS 102 232-1 [9] clause 5.2.10) shall be included and coded according to table 7.8.2-6.

Table 7.8.2-6: IRI type for IRI messages

Record type	IRI Type
SCEFPDNConnectionEstablishment	BEGIN
SCEFPDNConnectionRelease	END
SCEFPDNConnectionUpdate	CONTINUE
SCEFStartOfInterceptionWithEstablishedPDNConnection	BEGIN
SCEFUnsuccessfulProcedure	REPORT

IRI messages associated with the same PDU Session shall be assigned the same CIN (see ETSI TS 102 232-1 [9] clause 5.2.4).

The threeGPP33128DefinedIRI field (see ETSI TS 102 232-7 [10] clause 15) shall be populated with the BER-encoded IRIPayload.

7.8.2.4 Generation of CC over LI_HI3

When xCC is received over LI_X3 from the CC-POI in the SCEF, the MDF3 shall populate the threeGPP33128DefinedCC field with a CCPayload structure containing NIDDCCPDU and send it over LI_HI3 interface to LEMF without undue delay.

The timestamp field of the ETSI TS 102 232-1 [9] PSHeader structure shall be set to the time that the SCEF observed the data (i.e. the timestamp field of the xCC). The LIID and CID fields shall correctly reflect the target identity and communication session to which the CC belongs.

7.8.3 LI for device triggering

7.8.3.1 Generation of xIRI LI_X2 at IRI-POI in SCEF over LI_X2

7.8.3.1.1 General

The IRI-POI present in the SCEF shall send the xIRIs over LI_X2 for each of the events listed in TS 33.127 [5] clause 7.11.3.4, the details of which are described in the following clauses.

7.8.3.1.2 Device trigger

The IRI-POI in the SCEF shall generate an xIRI containing a SCEFDeviceTrigger record when the IRI-POI present in the SCEF detects that an SCS/AS has sent a Device triggering request to a target UE matching one of the target identifiers.

Accordingly, the IRI-POI in the SCEF generates the xIRI when any of the following events is detected:

- SCEF sends a Device triggering response to the SCS/AS to acknowledge the reception of a Device triggering request with MSISDN or External Identifier matching the target identifier (See TS 29.122 [63] clause 5.7).

- SCEF sends a T4 Device-Trigger-Request (DTR) to SM-SC with Trigger-Action AVP set to TRIGGER and User-Identifier AVP matching the IMSI of the target UE as specified in TS 29.337 [60] clause 5.2.1.

Table 7.8.3-1: SCEFDeviceTrigger record

Field name	Value	M/C/O
iMSI	IMSI associated with the UE	C
mSISDN	MSISDN used with the UE	C
externalIdentifier	External Identifier used with the UE	C
triggerId	Identity of the Device trigger that should be provided in the deviceTriggeringDeliveryReportNotification IRI, Device trigger replacement IRI and Device trigger cancellation IRI	M
sCSASID	The SCS/AS sending the Device trigger	M
triggerPayload	The Device triggering payload	C
validityPeriod	The validity time in seconds for the specific action requested	C
priorityDT	The priority of the Device trigger	C
sourcePortId	Application identity on the SCS/AS which delivers the Device trigger	C
destinationPortId	Used to uniquely identify the triggering application addressed in the device	C

7.8.3.1.3 Device trigger replacement

The IRI-POI in the SCEF shall generate an xIRI containing a SCEFDeviceTriggerReplace record when the IRI-POI present in the SCEF detects that an SCS/AS has sent a Device triggering replacement for a previously sent Device triggering request to a UE matching one of the target identifiers provided via LI_X1 to the IRI POI in the SCEF. It replaces a previously submitted Device triggering request which has not yet been delivered to the UE.

Accordingly, the IRI-POI in the SCEF generates the xIRI when any of the following events is detected:

- SCEF receives a Device triggering request (for a Device trigger replacement) from an SCS/AS with MSISDN or External Identifier matching the target identifier (See TS 29.122 [63] clause 5.7).
- SCEF sends a T4 Device-Trigger-Request (DTR) to SM-SC with Trigger-Action AVP set to REPLACE and User-Identifier AVP matching the IMSI of the target UE as specified in TS 29.337 [60] clause 5.2.1.

Table 7.8.3-2: SCEFDeviceTriggerReplace record

Field name	Value	M/C/O
iMSI	IMSI associated with the target UE	C
mSISDN	MSISDN used with the target UE	C
externalIdentifier	External Identifier used with the target UE	C
triggerId	Identity of the corresponding Device trigger to be replaced	M
sCSASID	Identity of the SCS/AS replacing an existing Device trigger which has not been delivered yet to the device (e.g. because the device is unreachable) by a new Device trigger	M
triggerPayload	The device triggering payload	C
validityPeriod	The validity time in seconds for the specific action requested	C
priorityDT	The priority of the device trigger	C
sourcePortId	Port on the SCSAS which delivers the device trigger	C
destinationPortId	Port on the device which is the recipient of the device trigger	C

7.8.3.1.4 Device trigger cancellation

The IRI-POI in the SCEF shall generate an xIRI containing a SCEFDeviceTriggerCancellation record when the IRI-POI present in the SCEF detects that an SCS/AS has sent a Device triggering cancellation for a previously sent Device triggering request to a UE matching one of the target identifiers provided via LI_X1 to the IRI-POI in the SCEF. It cancels previously submitted Device triggering request which has not yet been delivered to the target UE.

Accordingly, the IRI-POI in the SCEF generates the xIRI when any of the following events is detected:

- SCEF receives a Device triggering request (for a device trigger cancellation) from SCS/AS related to a previously received Device triggering request with MSISDN or External Identifier matching the target identifier (See TS 29.122 [63] clause 5.7).
- SCEF sends a T4 Device-Trigger-Request (DTR) to SM-SC with Trigger-Action AVP set to RECALL and User-Identifier AVP matching the IMSI of the target UE as specified in TS 29.337 [60] clause 5.2.1.

Table 7.8.3-3: SCEFDeviceTriggerCancellation record

Field name	Value	M/C/O
iMSI	IMSI associated with the target UE	C
mSISDN	MSISDN used with the target UE	C
externalIdentifier	External Identifier used with the target UE	C
triggerId	Identity of the corresponding device trigger to be cancelled	M

7.8.3.1.5 Device trigger report notification

The IRI-POI in the SCEF shall generate an xIRI containing a SCEFDeviceTriggerReportNotify record when the IRI-POI present in the SCEF detects that the SCEF has returned a Device triggering delivery report notification to the SCS/AS with a cause value indicating the trigger delivery outcome (e.g. succeeded, unknown or failed).

Accordingly, the IRI-POI in the SCEF generates the xIRI when any of the following events is detected:

- SCEF sends a Device triggering delivery report notification to inform the SCS/AS on the delivery outcome of the device trigger (see TS 29.122 [63] clause 5.7).
- SM-SC sends a T4 Delivery-Report-Request (DRR) to the SCEF with User-Identifier matching the IMSI of the target UE as specified in TS 29.337 [60] clause 5.2.2.

Table 7.8.3-4: SCEFDeviceTriggerReportNotify record

Field name	Value	M/C/O
iMSI	IMSI associated with the target UE	M
mSISDN	MSISDN used with the target UE	C
externalIdentifier	External Identifier used with the target UE	C
triggerId	Identity of the corresponding Device trigger	M
deviceTriggerDeliveryResult	Delivery result represents the result of the delivery of a device triggering request: <ul style="list-style-type: none"> - SUCCESS: The value indicates that the device action request was successfully completed. - UNKNOWN: The value indicates any unspecified errors. - FAILURE: The value indicates that this trigger encountered a delivery error and is deemed permanently undeliverable. - TRIGGERED: The value indicates that Device triggering request is accepted by the SCEF. - EXPIRED: The value indicates that the validity period expired before the trigger could be delivered. - UNCONFIRMED: The value indicates that the delivery of the device action request is not confirmed. - REPLACED: The value indicates that the device triggering replacement request is accepted by the SCEF. - TERMINATE: The SCEF includes this value in the response for a successful device triggering cancellation request. The value indicates that the delivery of the device action request is terminated by the SCS/AS. 	M

7.8.3.2 Generation of IRI over LI_HI2

When an xIRI is received over LI_X2 from the IRI-POI in the SCEF, the MDF2 shall send the IRI message over LI_HI2 without undue delay. The IRI message shall contain a copy of the relevant record received from LI_X2. The record may be enriched by other information available at the MDF (e.g. additional location information).

The timestamp field of the ETSI TS 102 232-1 [9] PSHeader structure shall be set to the time at which the SCEF event was observed (i.e. the timestamp field of the xIRI).

Table 7.8.3-5 shows the IRI type (see ETSI TS 102 232-1 [9] clause 5.2.10) to be used for each record type.

Table 7.8.3-5: IRI type for messages

Record type	IRI Type
SCEFDeviceTrigger	REPORT
SCEFDeviceTriggerReplace	REPORT
SCEFDeviceTriggerCancellation	REPORT
SCEFDeviceTriggerReportNotify	REPORT

7.8.4 LI for MSISDN-less MO SMS

7.8.4.1 Generation of xIRI LI_X2 at IRI-POI in SCEF over LI_X2

7.8.4.1.1 General

The IRI-POI present in the SCEF shall send the xIRIs over LI_X2 for each of the events listed in TS 33.127 [5] clause 7.11.4.4, the details of which are described in the following clauses.

7.8.4.1.2 MSISDN-less MO SMS

The IRI-POI in the SCEF shall generate an xIRI containing a SCEFMSISDNLessMOSMS record when the IRI-POI present in the SCEF detects that a target UE has sent a MSISDN-less MO SMS to an SCS/AS.

Accordingly, the IRI-POI in the SCEF generates the xIRI when any of the following events is detected:

- SCEF receives a SGd MO-Forward-Short-Message-Request (OFR) from an SM-SC with IMSI matching the target identifier (see TS 29.338 [59] clause 6.2.1).
- SCEF sends a MsisdnLessMoSmsNotification to the SCS/AS with the External Identifier of the UE sending the MSISDN-less SMS (see TS 29.122 [63] clause 5.15).

Table 7.8.4-1: SCEFMSISDNLessMOSMS record

Field name	Value	M/C/O
iMSI	IMSI associated with the target UE	C
externalIdentifier	External Identifier in the form of username@realm and corresponding to the identity of the originating SMS party	C
terminatingSMSParty	Identity of the SCS/AS receiving the SMS	M
sMS	SMS TPDU	C
sourcePort	port identifying the application of the target UE sending the MSISN-less MO SMS	C
destinationPort	port identifying the application of the SCS/AS which is the recipient of the MSISN-less MO SMS	C

7.8.4.2 Generation of IRI over LI_HI2

When an xIRI is received over LI_X2 from the IRI-POI in the SCEF, the MDF2 shall send the IRI message over LI_HI2 without undue delay. The IRI message shall contain a copy of the relevant record received from LI_X2. The record may be enriched by other information available at the MDF (e.g. additional location information).

The timestamp field of the ETSI TS 102 232-1 [9] PSHeader structure shall be set to the time at which the SCEF event was observed (i.e. the timestamp field of the xIRI).

The IRI type parameter (see ETSI TS 102 232-1 [9] clause 5.2.10) shall be included and coded according to table 7.8.4-2.

Table 7.8.4-2: IRI type for IRI messages

Record type	IRI Type
SCEFMSISDNLessMOSMS	REPORT

7.8.5 LI for parameter provisioning

7.8.5.1 Generation of xIRI LI_X2 at IRI-POI in SCEF over LI_X2

7.8.5.1.1 General

The IRI-POI present in the SCEF shall send the xIRIs over LI_X2 for each of the events listed in corresponding in TS 33.127 [5] clause 7.11.5.4, the details of which are described in the following clauses.

7.8.5.1.2 Communication pattern update

The IRI-POI in the SCEF shall generate an xIRI containing an SCEFCommunicationPatternUpdate record when the IRI-POI present in the SCEF detects that an SCS/AS has updated the Communication pattern data.

Accordingly, the IRI-POI in the SCEF generates the xIRI when any of the following events is detected (See TS 29.122 [63] clause 5.10):

- SCEF receives a request to provision the communication pattern parameters from an SCS/AS related to the target UE (PUT).
- SCEF receives a request to delete the existing communication patterns parameters from an SCS/AS related to the target UE (DELETE).
- SCEF returns a response (200 OK) containing the communication pattern parameters of the target UE to the querying SCS/AS (GET).

Table 7.8.5-1: SCEFCommunicationPatternUpdate record

Field name	Value	M/C/O
mSISDN	MSISDN of the target UE the communication pattern applies to	C
externalIdentifier	External Identifier of the target UE the communication pattern applies to	C
periodicCommunicationIndicator	Identifies whether UE communicates periodically or on demand	O
communicationDurationTime	Indicates for how long the UE will normally stay in CM-Connected for data transmission expressed in seconds	O
periodicTime	Interval Time of periodic communication in seconds	O
scheduledCommunicationTime	Time and day of the week when the UE is available for communication, as defined in TS 29.571	O
scheduledCommunicationType	Indicates that the Scheduled Communication Type is Downlink only or Uplink only or Bi-directional	O
stationaryIndication	Identifies whether the UE is stationary or mobile	O
batteryIndication	Identifies power consumption criticality for the UE: if the UE is battery powered but the battery is not rechargeable/not replaceable, battery powered with rechargeable/replaceable battery, or not battery powered.	O
trafficProfile	Identifies the type of data transmission: single packet transmission (UL or DL), dual packet transmission (UL with subsequent DL or DL with subsequent UL), multiple packets transmission	O
expectedUEMovingTrajectory	Identifies the UE's expected geographical movement	O
expectedTimeAndDayOfWeekInTrajectory	Identifies the time and day of week when the UE is expected to be at each location included in the Expected UE Moving Trajectory	O
sCSASID	SCS/AS identity requesting communication pattern update	M
validityTime	Identifies when the expected UE behavior parameter set expires and shall be deleted. If absent, it indicates that there is no expiration time for this parameter set	O

7.8.5.2 Generation of IRI over LI_HI2

When an xIRI is received over LI_X2 from the IRI-POI in the SCEF, the MDF2 shall send the IRI message over LI_HI2 without undue delay. The IRI message shall contain a copy of the relevant record received from LI_X2. The record may be enriched by other information available at the MDF (e.g. additional location information).

The timestamp field of the ETSI TS 102 232-1 [9] PSHeader structure shall be set to the time at which the SCEF event was observed (i.e. the timestamp field of the xIRI).

The IRI type parameter (see ETSI TS 102 232-1 [9] clause 5.2.10) shall be included and coded according to table 7.8.5-2.

Table 7.8.5-2: IRI type for IRI messages

Record type	IRI Type
SCEFCommunicationPatternUpdate	REPORT

7.9 LI for services encrypted by CSP-provided keys

7.9.1 LI for general AKMA-based service

7.9.1.1 General

This clause describes basic IRI-intercept for a generic, encrypted service between a target UE and an application in the CSP network, making use of AKMA-provided cryptographic keys according to TS 33.535 [65].

7.9.1.2 Provisioning over LI_X1

7.9.1.2.1 General

The IRI-POI in the AAnF (AKMA Anchor Function), the IRI-TF in the AAnF, and the MDF2 shall be provisioned.

Details of provisioning of an IRI-POI at a network internal AF (Application Function) making use of AKMA services of the AAnF is in general service specific and not part of the present clause. Generally, triggering, rather than provisioning, could in some cases be necessary for the AF. An application independent generic triggering mechanism is defined in clause 7.9.1.2.3.

Provisioning of CC-intercept at the AF is service specific and not covered in the present document.

7.9.1.2.2 Provisioning of the IRI-POI and IRI-TF in AAnF

The IRI-POI and IRI-TF present in the AAnF are provisioned over LI_X1 by the LIPF using the X1 protocol as described in clause 5.2.2.

The IRI-POI and IRI-TF in the AAnF shall support the following target identifier formats:

- SUPI, given in either SUPIIMSI or SUPINAI formats as defined in ETSI TS 103 120 [6] clause C.2.

Table 7.9.1.2-1 shows the minimum details of the LI_X1 ActivateTask message used for provisioning the IRI-POI and IRI-TF in the AAnF.

Table 7.9.1.2-1: ActivateTask message for the IRI-POI and IRI-TF in the AAnF

ETSI TS 103 221-1 [7] field name	Description	M/C/O
XID	XID assigned by LIPF.	M
TargetIdentifiers	One of the target identifiers listed in the paragraph above.	M
DeliveryType	Set to "X2Only".	M
ListOfDIDs	Delivery endpoints for LI_X2 for the IRI-POI in the AMF. These delivery endpoints are configured using the CreateDestination message as described in ETSI TS 103 221-1 [7] clause 6.3.1 prior to the task activation.	M

7.9.1.2.3 Triggering of the IRI-POI in AF

The IRI-POI present in the AF shall be triggered by the IRI-TF present in the AAnF over LI_T2 using the X1 protocol as described in clause 5.2.2. An AAnF can provide services for several different types of applications. Triggering could be service/application specific, which can effect whether or not certain conditional fields are included in the xIRI described in clause 7.9.1.4 below.

For all AFs a priori known to match the scope of the warrant, when the IRI-TF in the AAnF detects that an A-KID has been associated with a SUPI (see clause 7.9.1.3.2), it shall send an ActivateTask message to the IRI-POI present in the AF. The same shall apply if the AAnF detects that the A-KID of a target changes due to primary authentication. For AFs not a priori known at the AAnF, the ActivateTask message shall instead be sent when the IRI-TF in the AAnF detects that the AF performs an AKMA application key get associated with the A-KID. The ActivateTask message shall contain at least the following information.

NOTE: AFs providing services based on SUPI could, as an alternative to triggering, be directly provisioned by the LIPF as part of service-specific provisioning. This is however outside the scope of the present document.

Table 7.9.1.2-2: ActivateTask message for triggering the IRI-POI in the AF

ETSI TS 103 221-1 [7] field name	Description	M/C/O
XID	Allocated by the IRI-TF as per ETSI TS 103 221-1 [7].	M
TargetIdentifiers	A-KID associated with the AKMA Anchor Key (see table 7.9.1.3-3 below).	M
DeliveryType	Set to "X2Only".	M
ListOfDIDs	Delivery endpoints for LI_X2. These delivery endpoints shall be configured by the IRI-TF in the SMF using the CreateDestination message as described in ETSI TS 103 221-1 [7] clause 6.3.1 prior to first use.	M
implicitDeactivationAllowed	Shall be set to "True".	M
ProductID	Shall be set to the XID of the Task Object associated with the interception at the CC-TF. This value shall be used by the CC-POI in the UPF to fill the XID of X3 PDUs.	M

Table 7.9.1.2-3: Target Identifier Types for LI_T3

Identifier type	Owner	ETSI TS 103 221-1 [7] TargetIdentifier type	Definition
A-KID	3GPP	TargetIdentifierExtension / AKID	AKID (see XSD schema)

When the IRI-POI present in the AF detects that a UE has requested the use of a targeted A-KID, it shall continue to generate xIRI events for that A-KID until it detects that the UE has requested the use of a different A-KID, at which point it shall implicitly deactivate the previous Task. In addition, the AAnF may at any time issue a DeactivateTask message against the Task, at which point the AF shall cease interception of the A-KID and remove the Task as per ETSI TS 103 221-1 [7] clause 6.2.3.

7.9.1.3 Generation of xIRI at IRI-POI in AAnF over LI_X2

7.9.1.3.1 General

The IRI-POI present in the AAnF shall send the xIRIs over LI_X2 for each of the events listed in TS 33.127 [5] clause 7.9.3.1, the details of which are described in the following clauses.

7.9.1.3.2 AAnF Anchor Key Register

The IRI-POI in the AAnF shall generate an xIRI containing an AAnFAnchorKeyRegister record when the IRI-POI present in the AAnF detects reception of an AKMA-context, i.e. an (A-KID, K_{AKMA})-pair associated with a target, from the AUSF, see TS 33.535 [65] clause 7.1.2.

Table 7.9.1.3-1: AAnFAnchorKeyRegister record

Field name	Value	M/C/O
aKID	AKMA Anchor Key Identifier (see TS 33.535 [65] clause 4.4.2).	M
SUPI	SUPI associated with the A-KID.	M
kAKMA	AKMA Anchor Key (see TS 33.535 [65] clause 5.1). Shall be included if available NOTE: Whether kAKMA is included could also depend on whether provisioning is general or service specific.	C

7.9.1.3.3 AAnF AKMA application key get

The IRI-POI in the AAnF shall generate an xIRI containing an AAnFAKMAApplicationKeyGet record when the IRI-POI present in the AAnF detects an AKMA application key get from an AF (directly or via NEF), see TS 33.535 [65], clauses 7.1.3 and 7.3.1.

Table 7.9.1.3-2: AAnFKAKMAApplicationKeyGet record

Field name	Value	M/C/O
Type	Indicates whether the AF requesting the key is internal to the network or external.	M
aKID	AKMA Anchor Key Identifier.	M
keyInfo	Key information for the requested derived AF-specific key (see table 7.9.1.3-3).	M

Table 7.9.1.3-3: AFKeyInfo structure

Field name	Value	M/C/O
aFID	AKMA AF identifier of the AF associated with the derived AF-specific key.	M
kAF	Derived AF-specific key (see TS 33.535 [65] clauses 5.1 and A.4).	M
kAFExpTime	Expiry time associated with the derived AF-specific key.	M

7.9.1.3.4 AAnF Start of intercept with established AKMA key material

The IRI-POI in the AAnF shall generate an xIRI containing an AAnFStartOfInterceptWithEstablishedAKMAKeyMaterial record when the IRI-POI present in the AAnF detects that interception is activated on a target UE that has already established AKMA key material.

Table 7.9.1.3-4: AAnFStartOfInterceptWithEstablishedAKMAKeyMaterial record

Field name	Value	M/C/O
aKID	AKMA Anchor Key Identifier (currently valid).	M
kAKMA	AKMA Anchor Key associated with aKID.	C
aFKeyList	List of all available (aFID, kAF, kAFExpTime)-tuples which are available, have not expired and complies with provisioning.	C

7.9.1.3.5 AAnF AKMA context removal

The IRI-POI in the AAnF shall generate an xIRI containing an AAnFAKMAContextRemovalRecord when the IRI-POI present in the AAnF receives a request from an NF to delete AKMA context, see TS 33.535 [65] clause 7.1.4.

Table 7.9.1.3-5: AAnFAKMAContextRemovalRecord record

Field name	Value	M/C/O
aKID	AKMA Anchor Key Identifier.	M
nFInstanceID	Identity of NF originating the request encoded as per TS 29.571 [17] clause 5.3.2.	M

7.9.1.4 Generation of xIRI at IRI-POI in AF over LI_X2

7.9.1.4.1 General

The IRI-POI present in the AF shall send the xIRIs over LI_X2 for each of the events listed in TS 33.127 [5] clause 7.9.3.1, the details of which are described in the following clauses.

7.9.1.4.2 AF Application key refresh

The IRI-POI in the AF shall generate an xIRI containing an AFAKMAApplicationKeyRefresh record when the IRI-POI present in the AF detects that a K_{AF} -key previously obtained from an AAnF is being locally refreshed by the Ua^* security protocol in use, see TS 33.535 [65] clause 6.4.3.

Table 7.9.1.4-1: AFAKMAApplicationKeyRefresh record

Field name	Value	M/C/O
aFID	AKMA AF identifier.	M
aKID	AKMA Anchor Key Identifier.	M
kAF	New value of the AF-specific key, after refresh.	M
uaStarParams	Set of new Ua* security protocol parameters associated with kAF, if updated.	C

7.9.1.4.3 AF Start of intercept with established AKMA application key

The IRI-POI in the AF shall generate an xIRI containing an AFStartOfInterceptWithEstablishedAKMAApplicationKey record when the IRI-POI present in the AF detects interception is being triggered on a target UE that has already established AKMA application key.

Table 7.9.1.4-2: AFStartOfInterceptWithEstablishedAKMAApplicationKey record

Field name	Value	M/C/O
aFFQDN	FQDN-part of AKMA AF identifier.	M
aKID	AKMA Anchor Key Identifier.	M
kAFParamList	List of all available all AFSecurityParams (see table 7.9.1.4-3) which have not expired and where the Ua* security protocol parameters corresponds to the set of security parameters used on the Ua* security protocol instance associated with K _{AF} , see TS 33.127 [5] clause 7.9.3.1.5. NOTE: At least one such tuple exists when this event occurs.	M

Table 7.9.1.4-3: AFSecurityParams structure

Field name	Value	M/C/O
aFID	AF identifier.	M
aKID	AKMA Anchor Key Identifier.	M
kAF	AKMA derived AF-specific key associated with aKID and Ua* security protocol.	M
uaStarParams	Set of Ua* security protocol parameters after complete establishment/update. NOTE: Generic and TLS 1.2 [66] specific formats are provided in Annex A.	M

7.9.1.4.4 AF Auxiliary security parameter establishment

The IRI-POI in the AF shall generate an xIRI containing an AFAuxiliarySecurityParameterEstablishment record when the IRI-POI present in the AF detects that security parameters for the Ua* security protocol in use have been established with the target UE, or, when they have been updated without the associated AKMA application key having been refreshed according to clause 7.9.1.4.3.

Table 7.9.1.4-4: AFAuxiliarySecurityParameterEstablishment record

Field name	Value	M/C/O
aFSecurityParams	Auxiliary security parameters established (see table 7.9.1.4-3).	M

7.9.1.4.5 AF Application key removal

The IRI-POI in the AF shall generate an xIRI containing an AFApplicationKeyRemoval record when the IRI-POI present in the AF detects that an AKMA-derived AF-specific key is deleted or otherwise decommissioned.

Table 7.9.1.4-5: AFApplicationKeyRemoval record

Field name	Value	M/C/O
aFID	AF identifier.	M
aKID	AKMA Anchor Key Identifier associated with removed key.	M
removalCause	Reason for the removal of the application key.	M

7.9.1.5 Generation of IRI over LI_HI2

When an xIRI is received over LI_X2 from the IRI-POI in the AAnF or AF, the MDF2 shall send the IRI message over LI_HI2 without undue delay. The IRI message shall contain a copy of the relevant record received from LI_X2. The record may be enriched by other information available at the MDF.

The timestamp field of the ETSI TS 102 232-1 [9] PSHeader structure shall be set to the time at which the AAnF/AF event was observed (i.e. the timestamp field of the xIRI).

Table 7.9.1.5-1 shows the IRI type (see ETSI TS 102 232-1 [9] clause 5.2.10) to be used for each record type.

Table 7.9.1.5-1: IRI type for AAnF originated messages

Record type	IRI Type
AAnFAnchorKeyRegister	BEGIN
AAnFKAKMAApplicationKeyGet	CONTINUE
AAnFStartOfInterceptWithEstablishedAKMAKeyMaterial	BEGIN
AAnFAKMAContextRemovalRecord	END

IRI messages associated with the same A-KID from the same AAnF shall be assigned the same CIN.

Table 7.9.1.5-2: IRI type for AF originated messages

Record type	IRI Type
AFAKMAApplicationKeyGet	BEGIN
AFAKMAApplicationKeyRefresh	CONTINUE
AFStartOfInterceptWithEstablishedAKMAApplicationKey	BEGIN
AFAuxiliarySecurityParameterEstablishment	CONTINUE
AFApplicationKeyRemoval	END

IRI messages associated with the same A-KID from the same AF shall be assigned the same CIN.

7.10 LI in VPLMN for IMS-based services with home-routed roaming

7.10.1 Background

This clause defines protocol and procedures to support the LI in the VPLMN for IMS-based services with home-routed roaming architecture where IMS signaling (e.g. CSCFs) and media functions (e.g. IMS-AGW) are in the HPLMN. The scope of LI functions defined here are the following in the VPLMN:

- IMS-based voice services.
- SMS over IP.

For IMS-based voice services and the SMS over IP, the target can be an inbound roaming UE or a non-local ID.

As defined in TS 33.127 [5] clause 7.4.7.4.2, LMISF-IRI, LMISF-CC, BBIFF-C and BBIFF-U handle the LI in the VPLMN for IMS-based services with home routed roaming architecture.

NOTE 1: When N9 is the interface between the two PLMNs for the user plane data, the LI architecture is referred to as N9HR LI. With N9HR LI, the BBIF-C is present in the SMF and the BBIF-U is present in the UPF.

NOTE 2: When S8 is the interface between the two PLMNs for the user plane data, the LI architecture is referred to as S8HR LI. With S8HR LI, the BBIF-C and BBIF-U are combined into BBIF and is present in the SGW. When SGW is deployed with CUPS, the S8U is the interface between the two PLMNs for the user plane data and in this case, the BBIF-C is present in the SGW-C and BBIF-U is present in the SGW-U.

This clause uses the term "HR LI" in referring to the common functions associated with the N9HR LI and S8HR LI collectively.

The HR LI includes two phases of LI processing with the following scope:

- Phase 1 - Initial configuration and target checking, applies to all in-bound roaming UEs with home-routed roaming and using IMS-based services. No interception is done in this phase.
- Phase 2 - Applies to specific target UEs or UEs in communication with a target non-local ID. Interception is done in this phase.

The details of the above two phases of LI processes are described in TS 33.127 [5] clause 7.4.7.4.11.

7.10.2 Backward compatibility

The present document provides two options for stage 3 definitions for implementing S8HR LI:

- Use LI_X1, LI_X2 and LI_X3 interfaces specified below in the present document.
- Use TS 33.107 [36] natively as defined in that document.

In both cases, the present document specifies the stage 3 for the LI_HI1 and LI_HI2 interfaces. Only the first option indicated above is used for N9HR LI.

7.10.3 HR LI Phase 1

7.10.3.1 Overview

The Phase-1 of HR LI that applies to all inbound roaming UEs with home-routed roaming using the IMS-based services include the functions that revolve around the following interfaces (see TS 33.127 [5]):

- LI_X1: Used by the LIPF to provision the BBIF-C/BBIF and optionally, the LMISF-IRI to enable the same for HR LI (aka initial configuration of HR LI).
- LI_T3: Used by the BBIF-C to instruct the BBIF-U to capture and deliver the IMS signaling related user plane packets of inbound roaming UEs to the LMISF-IRI.
- LI_X2_LITE: Used by the BBIF-C/BBIF to carry the control plane information (e.g. packet data connection related notifications, UE location) to LMISF-IRI for inbound roaming UEs.
- LI_X3_LITE_S: Used by the BBIF-U/BBIF to forward the IMS signalling related user plane packets of inbound roaming UEs to the LMISF-IRI.

The triggering interface LI_T3 is not used in the case of BBIF in SGW. The LI_X3_LITE_S is also used in HR LI Phase-2.

The LI_X2_LITE shall be realized using the X2 protocol as defined in ETSI TS 103 221-2 [8]. Likewise, the LI_X3_LITE_S and LI_X3_LITE_M shall be realized using the X3 protocol as defined in ETSI TS 103 221-2 [8].

7.10.3.2 Provisioning over LI_X1

7.10.3.2.1 General

For Phase-1 of HR LI, the following LI functions are provisioned over LI_X1 by the LIPF using the X1 protocol defined in ETSI TS 103 221-1 [7] with the LIPF playing the role of ADMF and the following LI functions playing the role of NE as per the reference model depicted in ETSI TS 103 221-1 [7]:

- BBIFF-C present in the SMF.
- BBIFF-C present in the SGW-C.
- BBIFF present in the SGW.
- LMISF-IRI.

As described in clause 7.10.1, the Phase-1 of HR LI applies to all inbound roaming UEs that use the IMS-based services with home-routed roaming. The target identities "HR" and "IMSSignaling" are used for Phase-1 of HR LI.

7.10.3.2.2 Provisioning of BBIFF-C and BBIFF

The minimum details of LI_X1 ActivationTask message is shown in table 7.10.3.2-2.

Table 7.10.3.2-1: Void

Table 7.10.3.2-2: ActivateTask message for activating BBIFF-C and BBIFF

ETSI TS 103 221-1 field name	Description	M/C/O
XID	Shall be set to a value assigned by the LIPF. This shall be same as the XID used for ActivateTask as shown in table 7.10.3.2-4 when LMISF-IRI is configured using the ActivateTask.	M
TargetIdentifiers	Shall contain Target Identifiers of type "HR" and "IMSSignaling" (see table 7.10.3.2-3).	M
DeliveryType	Set to "X2andX3".	M
ListOfDIDs	Shall give the DID of the LMISF-IRI to which the xIRI and xCC should be delivered. The delivery endpoint is configured using the CreateDestination message as described in ETSI TS 103 221-1 [7] clause 6.3.1 prior to the task activation.	M

Table 7.10.3.2-3: Target Identifier Type for enabling HR LI

Identifier type	ETSI TS 103 221-1 [7] TargetIdentifier type	Definition
HR	TargetIdentifierExtension /HR	Empty tag (see XSD schema)
IMSSignaling	TargetIdentifierExtension/IMSSignaling	Empty tag (see XSD schema)

7.10.3.2.3 Provisioning of LMISF-IRI

The LMISF-IRI is listed as the delivery endpoint over LI_X2_LITE for xIRI generated by the BBIFF-C/BBIFF and for the xCC generated by the BBIFF-U/BBIFF.

The provisioning of LMISF-IRI is to enable it to receive the xIRIs and xCC sent from the BBIFF-C (SMF, SGW-C), BBIFF-U (UPF, SGW-U) and BBIFF (SGW). As an alternate deployment option, LMISF-IRI may be presumed to be enabled to receive such xIRI/xCC by default. This clause does not apply to such alternate deployment option.

Table 7.10.3.2-4 shows the minimum details of the LI_X1 ActivateTask message used for provisioning the LMISF-IRI for Phase-1.

Table 7.10.3.2-4: ActivateTask message for activating the LMISF-IRI for Phase-1

ETSI TS 103 221-1 field name	Description	M/C/O
XID	Shall be set to a value assigned by the LIPF. This shall be same as the XID used for ActivateTask as shown in table 7.10.3.2-2.	M
TargetIdentifiers	Shall contain two Target Identifiers of type "HR" and "IMSSignaling" (see table 7.10.3.2-3).	M
DeliveryType	Set to "X2andX3". LMISF-IRI shall use this only to enable the receiving of xIRI and xCC from the BBIFF-C/BBIFF.	M
ListOfDIDs	Shall be given as an empty list, since DIDs are not required in LMISF-IRI for Phase-1.	M

7.10.3.3 Generation of xIRI over LI_X2_LITE

7.10.3.3.1 General

LI_X2_LITE is an interface between the BBIFF-C/BBIFF to the LMISF-IRI. The xIRIs are generated at the BBIFF-C/BBIFF and are sent over LI_X2_LITE interface to the LMISF-IRI. These xIRIs are applicable to HR LI Phase-1 only.

For N9HR LI, the BBIFF-C present in the SMF shall generate the xIRIs as described in clause 7.10.3.3.2. For S8HR LI, the BBIFF-C present in the SGW-C and BBIFF present in the SGW shall generate the xIRIs as defined in clause 7.10.3.3.3.

The xIRIs are generated only when the following prior conditions are met:

- ActivateTask with target identity "HR" and "IMSSignaling" is received with X2 being included in the delivery type.
- The MCC + MNC of the Operator Identifier field of the DNN (for N9HR) or APN (for S8HR) is different from the MCC+MNC configured in the SMF (N9HR) or SGW-C/SGW (S8HR) - see TS 29.502 [16], clause 6.1.6.2.2 and 23.003 [19] clause 9.1.2.
- The Network Identifier field of DNN (for N9HR) or APN (for S8HR) contains "IMS" (IMS services) - see GSMA IR.88 [67].

The first point is indicating that HR LI is enabled (see clause 7.10.3.2.2). The second point is telling that the UE is an inbound roamer with home-routed based roaming. The third point is telling that the PDU session/PDN connection is for IMS services.

7.10.3.3.2 N9HR LI

The BBIFF-C present in the SMF shall generate the following xIRI when the prior conditions defined in clause 7.10.3.3.1 are met:

- N9HRPDUSessionInfo.

The main purpose of the xIRI is to report the UE location, PDU session ID and the SMF identity. The scenarios that result in the above xIRI are listed below and apply to all inbound roaming UEs with home-routed roaming and using IMS services:

- PDU session is established with the creation of a default QoS flow for IMS signaling.
- PDU session is modified with the creation of a dedicated QoS flow used for IMS media.
- PDU session is modified with the updates to the QoS flow.
- PDU session is modified with the deleting of dedicated QoS flow used for IMS media.
- PDU session is deleted.
- MA PDU session is created, modified or deleted.

- SMF relocation.
- New UE location due to UE requested or network initiated service request.
- New UE location due to hand-over situations including EPS to 5GS handover.
- New UE location due to tracking area updates or routing area updates.
- New SMF from the SMF set is taking over the PDU session.
- HR LI is enabled with an established PDU session.

The exact trigger for the xIRI is subject to implementation, however, the following can be used as a general guidance along with observing the prior conditions listed in clause 7.10.3.3.1:

- SMF receives the Nsmf_PDU_Session_Create response message with n1SmInfoToUe IE containing the PDU SESSION ESTABLISHMENT ACCEPT (see TS 29.502 [16]) from the H-SMF and sends the NAS message (via AMF) PDU SESSION ESTABLISHMENT ACCEPT to the UE as a part of PDU session establishment procedures. This may also happen with MA PDU session establishment procedures, or during handover procedures with access type change, or as a part of SMF relocation procedures.
- SMF receives an Nsmf_PDUSession_UpdateSMContext request from the AMF with a new UE location. This may happen whenever a PDU session or a MA PDU session is modified with the addition, modification or deletion of a dedicated QoS flow. This may also happen for UE-initiated or network-initiated service request procedures, or as a part of the handover procedures, or as a part of the tracking area update procedures.
- When a new SMF (e.g. in the SMF set) takes over the control for the PDU session.
- When an ActivateTask is received from the LIPF over LI_X1 (see clause 7.10.3.2.2) to enable the HR LI, the BBIFF-C present in the SMF detects that a PDU session for IMS services is already established for an inbound roaming UE with home-routed roaming.

NOTE: The sending of xIRI for each already established PDU session may result in a significant number of xIRI messages from the BBIFF-C to the LMISF-IRI.

The contents of xIRI N9HRPDUSessionInfo record is shown in table 7.10.3.3-1 below.

Table 7.10.3.3-1: Payload of N9HRPDUSessionInfo record

Field name	Description	M/C/O
sUPI	SUPI associated with the PDU session (e.g. as provided by the AMF in the associated Nsmf_PDU_Session_CreateSMContext service operation).	M
pEI	PEI associated with the PDU session, if available.	C
pDUSessionID	PDU Session ID. See TS 24.501 [13] clause 9.4.	M
location	UE location information provided by the AMF.	C
sNSSAI	Slice identifiers associated with the PDU session, if available. See TS 23.003 [19] clause 28.4.2 and TS 23.501 [2] clause 5.12.2.2.	C
dNN	Data Network Name associated with the UE traffic, as defined in TS 23.003[19] clause 9A and described in TS 23.501 [2] clause 4.3.2.2. Shall be given in dotted-label presentation format as described in TS 23.003 [19] clause 9.1.	C
messageCause	Included to indicate why the xIRI is generated (see table 7.10.3.3-2).	M

Table 7.10.3.3-2: messageCause details

Field name	Description
pDUSessionEstablished	Indicates that the PDU session is established.
pDUSessionModified	Indicates that the PDU session is being modified.
pDURelaxed	Indicates that the PDU session is being released.
updatedLocationAvailable	Indicates that an updated UE location is available
sMFChanged	Indicates that the SMF that is handling the PDU session is changed.
other	Indicates that cause is other than those listed elsewhere in this table.
hRLIEnabled	Indicates that the HR LI is enabled after the PDU session for IMS services is established.

The xIRIs shall include the Network Function ID (NFID), a conditional attribute field as defined in ETSI TS 103 221-2 [8], with the V-SMF identity.

Handling of this xIRI within the LMISF-IRI is described in clause 7.10.3.4.

7.10.3.3.3 S8HR LI

The BBIFF-C present in the SGW-C and BBIFF present in the SGW shall generate the following xIRI for the purpose of S8HR LI when the prior conditions defined in clause 7.10.3.3.1 are met:

- S8HRBearerInfo.

The main purpose of the xIRI is to report the UE location and the SGW/SGW-C identity to the LMISF-IRI. This xIRI is generated for the following scenarios that apply to all inbound roaming UEs with home-routed roaming and using IMS services:

- PDN connection is established with the creation of a default bearer for IMS signaling.
- Dedicated bearer is activated for the for IMS media.
- Dedicated bearer is updated for IMS media.
- Dedicated bearer is deactivated for IMS media.
- PDN is disconnected.
- SGW-C/SGW relocation.
- New UE location due to UE requested or network initiated service request.
- New UE location due to hand-over situations including 5GS to EPS handover.
- New UE location due to tracking area updates or routing area updates.
- HR LI is enabled with an established PDN connection with the creation of a default bearer.

The exact trigger for the xIRI is subject to implementation, however, the following can be used as a general guidance observing the prior conditions listed in clause 7.10.3.3.1:

- SGW-C/SGW receives a Create Session Response from the PGW-C/PGW and forwards the same to the MME as a part of PDN connection establishment procedures that creates the default bearer used for IMS signaling or as a part of the handover procedures that results in the SGW-C/SGW relocation or 5GS to EPS relocation.
- SGW-C/SGW receives a Create Session Response from the MME and forwards the same to the PGW-C/PGW as a part of dedicated bearer activation procedure on a PDN connection used for IMS media.
- SGW-C/SGW receives an Update Bearer Response from MME and forwards the same to the PGW-C/PGW as a part of bearer update procedures with or without the bearer update QoS.
- SGW-C/SGW receives a Delete Bearer Response from MME and forwards the same to the PGW-C/PGW as a part of bearer deactivation procedure.
- SGW-C/SGW receives a Delete Session Request from the MME and forwards the same to the PGW-C/PGW as a part of PDN disconnection procedures. The procedures potentially have the last known UE location.
- SGW-C/SGW receives a Create Session Request from the MME and sends a Modify Bearer Request to the PGW-C/PGW as a part of tracking area/routing area update procedures with a change of SGW-C/SGW. The procedures potentially have a new UE location.
- SGW-C/SGW receives a Modify Bearer Request from the MME and sends the same to the PGW-C/PGW as a part of Service Request handling procedures, or hand-over procedures, or tracking area/routing area update procedures without a change in the SGW-C/SGW. The procedures potentially have a new UE location.
- When an ActivateTask is received from the LIPF over LI_X1 (see clause 7.10.3.2.2) to enable the HR LI, the BBIFF-C/BBIFF present in the SGW-C/SGW detects that a PDN connection with a default bearer used for IMS services is already established for an inbound roaming UE with home-routed roaming.

NOTE: The sending of xIRI for each already established PDN connection may result in a significant number of xIRI messages from the BBIFF-C/BBIFF to the LMISF-IRI.

The details of the xIRI S8HRBearerInfo record is defined in table 7.10.3.3-3 below.

Table 7.10.3.3-3: Payload for S8HRBearerInfo record

Field name	Description	M/C/O
iMSI	IMSI associated with the PDN connection on which a bearer is created.	M
iMEI	IMEI associated with the PDN connection on which a bearer is created, if available.	C
bearerID	The identity of the EPS bearer.	M
linkedBearerID	The identity of the default bearer when the bearerID is for dedicated bearer.	C
location	Location information provided by the MME.	C
aPN	Packet Data Network to which the connection is being made, as defined in TS 23.003[19] clause 9A and described in TS 23.401 [50] clause 4.3.2.2. Applicable for PDN connection establishment. Shall be given in dotted-label presentation format as described in TS 23.003 [19] clause 9.1.	C
sGWIPAddress	IP Address of the SGW-C or SGW as applicable and when available.	C
messageCause	Included to indicate why the xIRI is generated (see table 7.10.3.3-4).	M

Table 7.10.3.3-4: messageCause details

Field name	Description
bearerActivated	Indicates that the bearer is activated (default or dedicated).
bearerModified	Indicates that the bearer is being modified.
bearerDeleted	Indicates that the bearer is being deactivated.
pDNDisconnected	Indicates that the PDN is disconnected.
updatedLocationAvailable	Indicates that an updated UE location is available.
sGWChanged	Indicates that the SGW that is handling the PDN connection is changed.
other	Indicates that cause is other than those listed elsewhere in this table.
hRLIEnabled	Indicates that the HR LI is enabled after the PDN connection with default bearer for IMS services is established.

All of the xIRIs listed above shall also include the Network Function ID (NFID), a conditional attribute field as defined in ETSI TS 103 221-2 [8], with the SGW-C/SGW identity.

Handling of this xIRI within the LMISF-IRI is described in clause 7.10.3.4.

7.10.3.4 LMISF-IRI handling of xIRIs received over LI_X2_LITE

7.10.3.4.1 Handling of xIRIs

The LMISF-IRI that receives the xIRI, N9HRPDUSessionInfo record shall store or update the record with the information received in the xIRI (e.g. UE location) as applicable, for the future handling.

The LMISF-IRI that receives the xIRI, S8HRBearerInfo record shall store or update the record with the information received in the xIRI (e.g. UE location) as applicable, for the future handling.

The stored record is referred to LI_X2_LITE record in the present document.

7.10.3.4.2 Handling of the stored record

For the N9HR LI related LI_X2_LITE records, the LMISF-IRI shall use the SUPI and PDU Session ID to uniquely associate a record with the inbound roaming UE.

For S8HR LI related LI_X2_LITE records, the LMISF-IRI shall use the IMSI, Linked Bearer ID or the Bearer ID (when the Linked Bearer ID is not present) to uniquely associate a record with the inbound roaming UE.

7.10.3.5 Triggering of BBIFF-U from BBIFF-C over LI_T3

7.10.3.5.1 General

With HR LI Phase-1, the user plane packets from the IMS signaling channel are delivered to the LMISF-IRI for all inbound roaming UEs with home-routed roaming.

When BBIFF is separated into BBIFF-C and BBIFF-U, these user plane packets are captured at the BBIFF-U. In order to enable the BBIFF-U to do that function, the BBIFF-C triggers the BBIFF-U over the LI_T3 interface.

The BBIFF-U delivers the user plane from the IMS signaling channel over the LI_X3_LITE-S interface to the LMISF-IRI.

7.10.3.5.2 N9HR LI

When the BBIFF-C present in the SMF detects that a PDU session is established with IMS signaling related QoS Flow for an inbound roaming UE with home-routed roaming, it shall send an activation message to the BBIFF-U present in the UPF over the LI_T3 interface with the associated QFI value.

The exact point at which the trigger is sent is left to the implementation (preferably, when the SMF receives the N4: PFCF Session Establishment/Modification Response from the UPF, see TS 29.244 [15] clauses 6.3.2 and 6.3.3), however, the BBIFF-C can send the trigger only when the following conditions are met:

- ActivateTask with target identity "HR" and "IMSSignaling" is received with X3 being included in the delivery type.
- The MCC + MNC of the Operator Identifier field of the DNN is different from the MCC+MNC configured in the SMF - see TS 29.502[16] clause 6.1.6.2.2 and 23.203 [19] clause 9.1.2.
- The Network Identifier field of DNN contains "IMS" (IMS services) - see GSMA IR.88 [67].
- The 5QI value associated with the QoS Flow is 5 – see GSMA NG.114 [68].

The first point is indicating that N9HR LI is enabled (see clause 7.10.3.3.1) with a need to capture and deliver the IMS signaling related user plane packets. The second point is telling that the UE is an inbound roamer with Home Routed based roaming. The third point is telling that the PDU session is established for IMS services. The fourth point is telling that the IMS signaling related QoS Flow is established.

If the PDU session for IMS services is already established for an inbound roaming UE with Home-Routed based roaming when the above indicated ActivateTask is received, then the BBIFF-C shall send the trigger at the time Activation Task is received from the LIPF.

The details of ActivateTask sent to the BBIFF-U are shown in table 7.10.3.5-1.

Table 7.10.3.5-1: ActivateTask message for triggering the BBIF-U in the UPF

ETSI TS 103 221-1 [7] field name	Description	M/C/O
XID	Shall be set to the XID of the Task Object associated with the interception at the BBIF-C.	M
TargetIdentifiers	Packet detection criteria as determined by the BBIF-C in the SMF, which enables the BBIF-U to isolate user-plane packets. The BBIF-U in the UPF shall support the identifier types given in table 6.2.3-7. The target identity type of PDR ID shall be mandatory. The BBIF-C in SMF shall use the QFI associated with the IMS signaling (5QI = 5) related QoS flow to populate the QFI field within the PDI of PDR ID.	M
DeliveryType	Set to "X3Only".	M
ListOfDIDs	Shall give the DID of the LMISF-IRI to which the xCC should be delivered. The delivery endpoint is configured using the CreateDestination message as described in ETSI TS 103 221-1 [7] clause 6.3.1 prior to the task activation.	M
CorrelationID	Correlation ID to assign to X3 PDUs generated by the BBIF-U in the UPF. This field is populated with the same CorrelationID the BBIF-C in the SMF uses for the associated xIRI.	M

When the BBIF-C present in the SMF detects that the PDU session is released (e.g. when SMF receives the N4: PFCF Session Deletion Response from the UPF, see TS 29.244 [15], clause 6.3.4), it shall send a deactivation message to the BBIF-U present in the UPF over the LI_T3 interface, if the task is still active in the BBIF-U.

The BBIF-C shall also send the deactivation message to the BBIF-U when a DeactivateTask is received from the LIPF for the XID if the task is still active in the BBIF-U.

7.10.3.5.3 S8HR LI

When the BBIF-C present in the SGW-C detects that the default bearer used for IMS signaling is activated on the PDN connection for an inbound roaming UE with home-routed roaming, it shall send an activation message to the BBIF-U present in the SGW-U over the LI_T3 interface.

The exact point at which the trigger is sent is left to the implementation (preferably, when the SGW-C receives the Sx: Session Establishment/Modification Response from the SGW-U). However, the BBIF-C can send the trigger only when the following conditions are met:

- ActivateTask with target identity "HR" and "IMSSignaling" is received with X3 being included in the delivery type.
- The MCC + MNC of the Operator Identifier field of the APN is different from the MCC+MNC configured in the SGW/SGW-C - see TS 29.502 [16] clause 6.1.6.2.2 and 23.203 [19] clause 9.1.2.
- The Network Identifier field of APN contains "IMS" (IMS services) - see GSMA IR.88 [67].
- The QCI value associated with the default bearer is 5 – see GSMA NG.114 [68].

The first point is indicating that S8HR LI is enabled (see clause 7.10.3.3.1) with a need to capture and deliver the IMS signaling related user plane packets. The second point is telling that the UE is an inbound roamer with Home Routed based roaming. The third point is telling that the PDN connection is established for IMS services. The fourth point is telling that the IMS signaling bearer is activated.

If the default bearer (for IMS signaling bearer) on the PDN connection is already established for an inbound roaming UE with Home-Routed based roaming when the above indicated ActivateTask is received, then the BBIF-C shall send the trigger at the time Activation Task is received from the LIPF.

The details of ActivateTask sent to the BBIF-U present in the SGW-U are shown in table 7.10.3.5-2.

Table 7.10.3.5-2: ActivateTask message for triggering the BBIFF-U in the SGW-U

ETSI TS 103 221-1 [7] field name	Description	M/C/O
XID	Shall be set to the XID of the Task Object associated with the interception at the BBIFF-C.	M
TargetIdentifiers	Packet detection criteria as determined by the BBIFF-C in the SGW-C, which enables the BBIFF-U in SGW-U to isolate user-plane packets. The BBIFF-U in the SGW-U shall support the identifier types given in table 6.2.3-7. The target identity type of PDR ID shall be mandatory. The BBIFF-C in SGW-C shall use the F-TIEDs associated with the IMS signaling (QCI = 5) related default bearer to populate the F-TEID field within the PDI of PDR ID.	M
DeliveryType	Set to "X3Only".	M
ListOfDIDs	Shall give the DID of the LMISF-IRI to which the xCC should be delivered. The delivery endpoint is configured using the CreateDestination message as described in ETSI TS 103 221-1 [7] clause 6.3.1 prior to the task activation.	M
CorrelationID	Correlation ID to assign to X3 PDUs generated by the BBIFF-U in the SGW-U. This field is populated with the same CorrelationID the BBIFF-C in the SGW-C uses for the associated xIRI.	M

When the BBIFF-C present in the SGW-C detects that the PDN connection is released (e.g. when SGW-C receives the Sx: Session Release Response from the SGW-U), it shall send a deactivation message to the BBIFF-U present in the SGW-U over the LI_T3 interface, if the task is still active in the BBIFF-U.

The BBIFF-C present in the SGW-C shall also send the deactivation message to the BBIFF-U present in the SGW-U when a DeactivateTask is received from the LIPF for the XID if the task is still active in the BBIFF-U.

7.10.3.6 Generation of xCC over LI_X3_LITE_S

7.10.3.6.1 BBIFF-U

The BBIFF-U in UPF and the BBIFF-U in SGW-U shall send the xCC over LI_X3_LITE_S for each of the packet matching the criteria specified in the Triggering message (i.e. Activate Task message) received over the LI_T3 from the BBIFF-C.

7.10.3.6.2 BBIFF

The BBIFF present in the SGW shall send the xCC over LI_X3_LITE_S for each of the packet from the default bearer with the QCI value of 5 (GSMA NG.114 [68]) with following other conditions:

- ActivateTask with target identity "HR" and "IMSSignaling" is received with delivery type "X3Only".
- The MCC + MNC of the Operator Identifier field of the APN is different from the MCC+MNC configured in the SGW - see TS 29.502 [16], clause 6.1.6.2.2 and 23.203 [19] clause 9.1.2.
- The Network Identifier field of APN contains "IMS" (IMS services) - see GSMA IR.88 [67].

The first point is indicating that S8HR LI is enabled (see clause 7.10.3.2.2) with a need to capture and deliver the IMS signaling related user plane packets. The second point is telling that the UE is an inbound roamer with Home Routed based roaming. The third point is telling that the PDN connection is established for IMS services.

The BBIFF in SGW uses the QCI value of 5 (GSMA NG.114 [68]) to identify that the packets are from the IMS signaling bearer.

7.10.3.6.3 X3 PDU format

Each X3 PDU shall contain the contents of the user plane packet given using the GTP-U, IP or Ethernet payload format.

The BBIFF-U/BBIFF shall set the payload format to indicate the appropriate payload type (5 for IPv4 Packet, 6 for IPv6 Packet, 12 for GTP-U Packet as described in ETSI TS 103 221-2 [8] clauses 5.4 and 5.4.13.

7.10.3.7 LMISF-IRI handling of xCC received over LI_X3_LITE_S

The LMISF-IRI shall extract the IMS signaling messages (i.e. SIP messages) from the xCC received over the LI_X3_LITE_S from the BBIFF-U/BBIFF.

The LMISF-IRI shall examine the extracted SIP message for a target match as described in clause 7.10.4.2. If no match is found, then the LMISF-IRI shall store the extracted SIP message for a later use. If a match is found, then the LMISF-IRI shall proceed according to clause 7.10.4.3.

The record that stores the SIP message is referred to as LI_X2_LITE_S record.

7.10.4 HR LI Phase 2

7.10.4.1 Overview

The Phase-2 of HR LI that applies to inbound roaming target UEs that use IMS-based services with home-routed roaming or the inbound roaming UEs that use IMS-based services with home-routed roaming to communicate with the target non-local ID include the functions that revolve around the following interfaces.

- LI_X1: Used by the LIPF to provision the LMISF-IRI, MDF2 and MDF3 with the LI information for a target.
- LI_T1: Used by the LMISF-IRI to instruct the BBIFF-C/BBIFF that IMS media related user plane packets of target's communication need to be captured and delivered to the LMISF-CC.
- LI_T3: Used by the BBIFF-C to instruct the BBIFF-U to capture and deliver the IMS media related user plane packets of target's communication to the LMISF-CC.
- LI_X3_LITE_S: Used by the BBIFF-U/BBIFF to forward the IMS signalling related user plane packets of inbound roaming UEs to the LMISF-IRI.
- LI_X3_LITE_M: Used by the BBIFF-U/BBIFF to forward the IMS media related user plane packets of target's communication to the LMISF-CC.

The triggering interface LI_T3 is not used in the case of BBIFF in SGW. The LI_X3_LITE_S is also used for HR LI Phase-1.

7.10.4.2 Provisioning over LI_X1

7.10.4.2.1 General

For Phase-2 of HR LI, the following LI functions are provisioned over LI_X1 by the LIPF using the X1 protocol defined in ETSI TS 103 221-1 [7] with the LIPF playing the role of ADMF and the following LI functions playing the role of NE as per the reference model depicted in ETSI TS 103 221-1 [7].

- LMISF-IRI.
- MDF2.
- MDF3.

As described in clause 7.10.1, the Phase-2 of HR LI applies to inbound roaming target UEs that use IMS-based services with home-routed roaming or the inbound roaming UEs that use IMS-based services with home-routed roaming to communicate with the target non-local ID. The following target identities are used for Phase-2 of HR LI:

- IMPU.
- IMPI.
- PEIIMEI.
- IMEI.

The target identity in the IMPI format may contain a value derived from a SUPI or an IMSI. The target identity in the IMPU format containing a SIP URI or TEL URI may contain a value derived from a GPSI, MSISDN, an E.164 number, or IMSI. Only IMPU is used for target non-local ID. For triggered LALS, the LTF function associated with LMISF-IRI (see clause 7.3.1 and Annex G) is provisioned with the target identity of IMPU.

7.10.4.2.2 Provisioning of LMISF-IRI

The LMISF-IRI shall be provisioned over LI_X1 by the LIPF for target based interception of IMS services in the VPLMN with home-routed roaming.

The target identities listed in clause 7.10.4.2.1 shall apply for the provisioning of LMISF-IRI with LMISF-IRI playing the combined role of IRI-POI and CC-TF for the interception of IMS-based services in the VPLMN with home-routed roaming.

The LMISF-IRI shall support the following service scoping from the structure defined in ETSI TS 103 221-1 [7]:

- The enumerated value of "voice" or "messaging" in the service type field.
- When location reporting is required, one or both of "reportBeginingAndEnd", "reportUponChange".
- "SuspendOnOutboundInternationalRoaming".

Table 7.10.4.2-1 shows the minimum details of the LI_X1 ActivateTask message used for provisioning the LMISF-IRI for Phase-2.

Table 7.10.4.2-1: ActivateTask message for activating LMISF-IRI for Phase-2

ETSI TS 103 221-1 [7] field name	Description	M/C/O
XID	XID assigned by LIPF. The value used here is different from the value used in ActivateTask shown in table 7.10.3.2-4.	M
TargetIdentifiers	One or more of the target identifiers listed in clause 7.10.4.2.1.	M
DeliveryType	Set to "X2Only", "X3Only" or "X2andX3" as needed to meet the requirements of the warrant.	M
ListOfDIDs	Delivery endpoints of LI_X2 or LI_X3. These delivery endpoints shall be configured using the <i>CreateDestination</i> message as described in ETSI TS 103 221-1 [7] clause 6.3.1 prior to first use.	M
ServiceScoping	Using the format defined in ETS TS 103 221 [7] based on the service scoping listed above the table. When multiple intercepts are activated on a target identifier, the service scoping shall be the union of all of them.	C

7.10.4.2.3 Provisioning of the MDF2

The MDF2 listed as the delivery endpoint over LI_X2 for xIRI generated by the LMISF-IRI shall be provisioned over LI_X1 by the LIPF.

The target identities listed in clause 7.10.4.2.1 shall apply for the provisioning of MDF2.

The MDF2 shall support the following service scoping from the structure defined in ETSI TS 103 221-1 [7]:

- The enumerated value of "voice" or "messaging" in the service type field.
- When location reporting is required, one or both of "reportBeginingAndEnd", "reportUponChange".

Table 7.10.4.2-2 shows the minimum details of the LI_X1 ActivateTask message used for provisioning the MDF2.

Table 7.10.4.2-2 ActivateTask message for MDF2

ETSI TS 103 221-1 [7] field name	Description	M/C/O
XID	XID assigned by LIPF.	M
TargetIdentifiers	One or more of the target identifiers listed in clause 7.10.4.2.1.	M
DeliveryType	This value shall be Ignored by the MDF2.	M
ListOfDIDs	Delivery endpoints of LI_HI2. These delivery endpoints shall be configured using the <i>CreateDestination</i> message as described in ETSI TS 103 221-1 [7] clause 6.3.1 prior to first use.	M
ListOfMediationDetails	Sequence of Mediation Details, See table 7.10.4.2-3.	M

Table 7.10.4.2-3: Mediation Details for MDF2

ETSI TS 103 221-1 [7] field name	Description	M/C/O
LIID	Lawful Intercept ID associated with the task.	M
DeliveryType	Set to "HI2Only".	M
ListOfDIDs	Details of where to send the IRI for this LIID. Shall be included if deviation from the ListofDIDs in the ActivateTask message is necessary. If included, the ListOfDIDs in the Mediation Details shall be used instead of any delivery destinations authorised by the ListOfDIDs field in the ActivateTask Message.	C
ServiceScoping	Using the format defined in ETS TS 103 221 [7] include the service scoping as applicable to this LIID based on the service scoping listed above the table.	C

7.10.4.2.4 Provisioning of the MDF3

The MDF3 listed as the delivery endpoint over LI_X3 for xCC generated by the LMISF-CC shall be provisioned over LI_X1 by the LIPF.

The target identities listed in clause 7.10.4.2.1 shall apply for the provisioning of MDF3.

The MDF3 shall support the following service scoping from the structure defined in ETSI TS 103 221-1 [7]:

- The enumerated value of "voice" or "messaging" in the service type field.
- When location reporting is required, one or both of "reportBeginingAndEnd", "reportUponChange".

Table 7.10.4.2-4 shows the minimum details of the LI_X1 ActivateTask message used for provisioning the MDF3.

Table 7.10.4.2-4 ActivateTask message for MDF3

ETSI TS 103 221-1 [7] field name	Description	M/C/O
XID	XID assigned by LIPF.	M
TargetIdentifiers	One or more of the target identifiers listed in clause 7.10.4.2.1.	M
DeliveryType	This value shall be Ignored by the MDF3.	M
ListOfDIDs	Delivery endpoints of LI_HI3. These delivery endpoints shall be configured using the <i>CreateDestination</i> message as described in ETSI TS 103 221-1 [7] clause 6.3.1 prior to first use.	M
ListOfMediationDetails	Sequence of Mediation Details, See table 7.10.4.2-5.	M

Table 7.10.4.2-5: Mediation Details for MDF3

ETSI TS 103 221-1 [7] field name	Description	M/C/O
LIID	Lawful Intercept ID associated with the task.	M
DeliveryType	Set to "HI3Only".	M
ListOfDIDs	Details of where to send the IRI for this LIID. Shall be included if deviation from the ListofDIDs in the ActivateTask message is necessary. If included, the ListOfDIDs in the Mediation Details shall be used instead of any delivery destinations authorised by the ListOfDIDs field in the ActivateTask Message.	C
ServiceScoping	Using the format defined in ETS TS 103 221 [7] include the service scoping as applicable to this LIID based on the service scoping listed above the table.	C

7.10.4.3 Generation of xIRI over LI_X2

7.10.4.3.1 General concepts

The LMISF-IRI extracts the SIP messages that it receives within the xCC from the BBIFF-U/BBIFF over the LI_X3_LITE_S.

On the originating end of a voice session, the LMISF-IRI examines the SIP message, the stored LI_X2_LITE record and the stored LI_X3_LITE_S record to check for the following:

- Whether the calling party identity is a target.
- Whether the called party identity is a target non-local ID.

On the terminating end of a voice session, the LMISF-IRI examines the SIP message, the stored LI_X2_LITE record and the stored LI_X3_LITE_S record to check for the following:

- Whether the called party identity is a target.
- Whether the calling party identity is a target non-local ID.
- Whether the redirecting party identity is a target non-local ID.

The SIP headers used for identifying a calling party identity, called party identity, redirecting party identity can be same identities used by the IMS signaling functions with the following additions:

- P-Preferred Identity as calling party identity.

When any of the conditions listed above are true, the LMISF-IRI concludes that target is involved in an IMS session that shall be intercepted. Accordingly, the LMISF-IRI generates the xIRIs and delivers the same to the MDF2 over the LI_X2.

For IMS-based voice services, if media interception is required, the LMISF-IRI sends a trigger for the same to the BBIFF-C/BBIFF over the LI_T1 interface.

7.10.4.3.2 Target match

7.10.4.3.2.1 General

When an IMS UE performs an IMS registration (using SIP REGISTER) request, the LMISF-IRI examines the following for a target match:

- From header and To header of the SIP REGISTER when the target identity is IMPU.
- SUPI or IMSI stored in the LI_X2_LITE record when the target identity is IMPI.
- +sip.instance-id of Contact header of the SIP REGISTER when the target identity is PEIIMEI or IMEI.

The LMISF-IRI shall store the +sip.instance-id in the LI_X2_LITE_S record for later use.

7.10.4.3.2.2 Service type of voice

When an IMS UE originates an IMS session (using SIP INVITE), the LMISF-IRI examines the following to verify for a target match:

- P-Preferred Identity header and From header present in the SIP INVITE when the target identity is IMPU.
- Request URI header and To header present in the SIP INVITE when the target identity is IMPU and target is non-local ID.
- SUPI or IMSI stored in the LI_X2_LITE record when the target identity is IMPI.
- +sip.instance-id of Contact header received in the SIP REGISTER request when the target identity is PEIIMEI or IMEI.

When an IMS UE receives an incoming IMS session (using SIP INVITE), the LMISF-IRI examines the following to verify for a target match:

- Request URI and To header present in the SIP INVITE when the target identity is IMPU.
- P-Asserted-Id, From header, History Info header and Diversion header present in the SIP header when the target identity is IMPU and target is non-local ID.
- SUPI or IMSI stored in the LI_X2_LITE record when the target identity is IMPI.
- +sip.instance-id of Contact header received in the SIP REGISTER request when the target identity is PEIIMEI or IMEI.

LMISF-IRI may use the Via header or the Route header to determine whether the SIP INVITE is for an originating IMS session or a terminating IMS session. LMISF-IRI stores the SIP Call Id to associate the subsequent SIP messages received on the same session for a target match.

For subsequent SIP messages, the LMISF-IRI may use the stored LI_X3_LITE_S record to determine for a target match.

7.10.4.3.2.3 Service type of messaging

When the Service Type received in the LI_X1 provisioning is "messaging", the LMISF-IRI examines the SIP MESSAGE for a target match as shown below:

- For MO-SMS over IP, P-Preferred Identity header and From header present in the SIP MESSAGE when the target identity is IMPU.
- For MO-SMS over IP, TP-DA field of SMS-SUBMIT within the Message-body of SIP MESSAGE when the target identity IMPU for target non-local ID.
- For MT-SMS over IP, the Request URI and To header present in the SIP MESSAGE when the target identity is IMPU.
- For MT-SMS over IP, the TP-OA field or TP-RA field of SMS-SUBMIT within the Message-body SIP MESSAGE when the target identity IMPU for target non-local ID.
- SUPI or IMSI stored in the LI_X2_LITE record when the target identity is IMPI.
- +sip.instance-id of Contact header received in the SIP REGISTER request when the target identity is PEIIMEI or IMEI.

LMISF-IRI may use the Via header or the Route header to determine whether the SIP MESSAGE is for MO-SMS over IP or MT-SMS over IP.

7.10.4.3.3 xIRIs

The xIRIs generated at the LMISF-IRI shall be same as the xIRIs generated in the IRI-POIs present in the IMS signaling functions (see clause 7.12.4.12).

As defined in TS 33.127 [5] the LMISF-IRI generates the following xIRIs:

- Encapsulated SIP message.
- Start of interception with an established IMS session.

The xIRI CC Unavailable defined in TS 33.127 [5] for IMS-based services is not applicable to N9HR LI and S8HR LI. The encapsulated SIP message is sent using the xIRI IMSMessage record.

Further details of the xIRIs are defined in clause 7.12.4.12.

7.10.4.4 Triggering of BBIFF-C from LMISF over LI_T1

7.10.4.4.1 General

When the intercepted IMS-session requires the media interception, the LMISF-IRI sends a trigger to the BBIFF-C/BBIFF over to the LI_T1 interface (see TS 33.127 [5]) with LMISF-CC as the delivery end point.

The LMISF-IRI upon discovering through the xIRIs received over the LI_X2_LITE interface that a change in SMF or SGW-C/SGW has occurred for an interception involving an IMS-session shall send the trigger to BBIFF-C/BBIFF present in the new SMF or SGW-C/SGW over LI_T1 interface with LMISF-CC as the delivery end point to continue the IMS media interception when required.

When the IMS session is completely released (e.g. all session-legs are released), the LMISF-IRI sends a trigger to the BBIFF-C/BBIFF to stop the media interception. The LMISF-IRI may also send the trigger to stop the media interception when the target information is deprovisioned in the LMISF-IRI by the LIPF.

NOTE: When multiple warrants are active on a target, the activation or deactivation of a warrant may not result in a trigger to BBIFF-C/BBIFF (e.g. if a trigger has already been sent due to other warrants).

The present document supports the media interception of IMS voice media.

7.10.4.4.2 N9HR LI

The LI_T1 trigger that the LMISF-IRI sends to the BBIFF-C present in the SMF shall include at least the following information:

- The XID that LMISF-IRI receives from the LIPF over LI_X1 for the target related activation.
- Target identity: SUPI, PDU session ID, IMS voice media.
- Delivery end point: LMISF-CC.

The details of ActivateTask sent to the BBIFF-C in SMF over LI_T1 are shown in table 7.10.4.4-1.

Table 7.10.4.4-1: ActivateTask message for triggering the BBIFF-C in the SMF over LI_T1

ETSI TS 103 221-1 [7] field name	Description	M/C/O
XID	Allocated by the LMISF-IRI as per ETSI TS 103 221-1 [7].	M
TargetIdentifiers	Information that identifies the need to intercept the IMS voice media. The target identifiers as shown in table 7.10.4.4-2.	M
DeliveryType	Set to "X3Only".	M
ListOfDIDs	Shall give the DID of the LMISF-CC to which the xCC should be delivered. The delivery endpoint is configured using the CreateDestination message as described in ETSI TS 103 221-1 [7] clause 6.3.1 prior to the task activation.	M
CorrelationID	This value is set by the LMISF-IRI and shall be same as the value to be used in the xCC generated at the LMISF-CC. The BBIFF-C passes this field to the BBIFF-U over LI_T3.	M
ProductID	Shall be set to the XID of the Task Object associated with the interception at the LMISF-IRI. This value shall be passed to the BBIFF-U over LI_T3.	M

Table 7.10.4.4-2: Target Identifier Types for LI_T1 (BBIFF-C in SMF)

Identifier type	ETSI TS 103 221-1 [7] TargetIdentifier type	Definition
SUPI	SUPI	ETSI TS 103 221-1 [7]
PDUSessionID	TargetIdentifierExtension/PDUSessionID	Integer (see XSD schema)

IMSVoiceMedia	TargetIdentifierExtension/IMSVoiceMedia	Empty tag (see XSD schema)
NOTE: The LMISF-IRI shall use the SUPI and PDU Session ID received over the LI_X2_LITE interface to populate the target identifiers SUPI and PDU Session ID respectively. The SUPI is in either SUPIMSI or IMSI format (ETSI TS 103-221-1 [7]).		

The DeactivateTask message that the LMISF-IRI sends to the BBIFF-C present in the SMF shall include the XID of the Task created by the ActivateTask message (see table 7.10.4.4-1).

7.10.4.4.3 S8HR LI

The LI_T1 trigger that the LMISF-IRI sends to the BBIFF-C present in the SGW-C/SGW shall include at least the following information:

- The XID that LMISF-IRI receives from the LIPF over LI_X1 for the target related activation.
- Target identity: IMSI, Bearer ID, IMS voice media.
- Delivery end point: LMISF-CC.

The details of ActivateTask sent to the BBIFF-C in SGW-C over LI_T1 are shown in table 7.10.4.4-3.

Table 7.10.4.4-3: ActivateTask message for triggering BBIFF-C/BBIFF in the SGW-C/SGW over LI_T1

ETSI TS 103 221-1 [7] field name	Description	M/C/O
XID	Allocated by the LMISF-IRI as per ETSI TS 103 221-1 [7].	M
TargetIdentifiers	Information that identifies the need to intercept the IMS voice media. See table 7.10.4.4-4.	M
DeliveryType	Set to "X3Only".	M
ListOfDIDs	Shall give the DID of the LMISF-CC to which the xCC should be delivered. The delivery endpoint is configured using the CreateDestination message as described in ETSI TS 103 221-1 [7] clause 6.3.1 prior to the task activation.	M
CorrelationID	This value is set by the LMISF-IRI and shall be same as the value to be used in the xCC generated at the LMISF-CC. The BBIFF-C in passes this field to the BBIFF-U over LI_T3.	M
ProductID	Shall be set to the XID of the Task Object associated with the interception at the LMISF-IRI. This value shall be passed to the BBIFF-U over LI_T3.	M

Table 7.10.4.4-4: Target Identifier Types for LI_T1 (BBIFF-C/BBIFF in SGW-C/SGW)

Identifier type	ETSI TS 103 221-1 [7] TargetIdentifier type	Definition
IMSI	IMSI	ETSI TS 103 221-1 [7]
BearerID	TargetIdentifierExtension/BearerID	Integer (see XSD schema)
IMSVoiceMedia	TargetIdentifierExtension/IMSVoiceMedia	Empty tag (see XSD schema)
NOTE: The LMISF-IRI shall use the IMSI and Bearer ID received over the LI_X2_LITE interface to populate the target identifiers IMSI and BearerID respectively.		

The DeactivateTask message that the LMISF-IRI sends to the BBIFF-C/BBIFF present in the SGW-C/SGW shall include the XID of the Task created by the ActivateTask message (see table 7.10.4.4-3).

7.10.4.5 Triggering of BBIFF-U from BBIFF-C over LI_T3

7.10.4.5.1 General

When the trigger is received over the LI_T1 for activating the media interception, the BBIFF-C present in the SGW-C shall send a trigger over LI_T3 to the BBIFF-U present in the SGW-U when a dedicated bearer for the IMS media is established on the PDN connection.

When the trigger is received over the LI_T1 for activating the media interception, the BBIFF-C present in the SMF shall send a trigger over LI_T3 to the BBIFF-U present in the UPF when the PDU session is modified for adding IMS media related QoS flow.

If the trigger over LI_T1 is received for activating the media interception after the IMS media related changes has happened (i.e. dedicated bearer is established for IMS media, PDU session is modified for adding the IMS media related QoS flow), then the BBIFF-C shall send the trigger to the BBIFF-U over LI_T3 immediately.

The BBIFF-C shall trigger the BBIFF-U to stop the delivery of xCC to the LMISF-CC when it receives the trigger from the LMISF-IRI over LI_T1 for stopping the media interception, independent of whether the IMS media related changes have happened or not.

7.10.4.5.2 N9HR LI

The LI_T3 trigger that the BBIFF-C in SMF sends to the BBIFF-U present in the UPF shall include at least the following information:

- XID assigned locally by the BBIFF-C in the SMF.
- The ProductID that includes the XID it receives from the LMISF-IRI over LI_T1.
- Target identity: PFCP Session ID, PDR ID with the QFI associated with the IMS voice media (5Q = 1) related QoS flow.
- Delivery end point: LMISF-CC

The details of ActivateTask sent to the BBIFF-U in UPF over LI_T3 are shown in table 7.10.4.5-1.

Table 7.10.4.5-1: ActivateTask message for triggering the BBIFF-U in the UPF over LI_T3

ETSI TS 103 221-1 [7] field name	Description	M/C/O
XID	Allocated by the BBIFF-C as per ETSI TS 103 221-1 [7].	M
TargetIdentifiers	Packet detection criteria as determined by the BBIFF-C in the SMF, which enables the BBIFF-U to isolate user-plane packets of IMS voice media. The BBIFF-U in the UPF shall support the identifier types given in Table 6.2.3-7. The target identity type of PDR ID shall be mandatory. The BBIFF-C in SMF shall use the QFI associated with the IMS voice media (5QI = 1) related QoS flow to populate the QFI field within the PDI of PDR ID.	M
DeliveryType	Set to "X3Only".	M
ListOfDIDs	Shall give the DID of the LMISF-CC to which the xCC should be delivered. The delivery endpoint is configured using the CreateDestination message as described in ETSI TS 103 221-1 [7] clause 6.3.1 prior to the task activation.	M
CorrelationID	Correlation ID to assign to X3 PDUs generated by the BBIFF-U in the UPF. This field is populated with the same CorrelationID received over the LI_T1 interface (see table 7.10.4.4.1).	M
ProductID	Shall be set to the XID of the Task Object associated with the interception as received in the ProductID field over LI_T1 interface (see table 7.10.4.4.1). This value shall be used by the BBIFF-U in the UPF to fill the XID of X3 PDUs.	M

The DeactivateTask sent to the BBIFF-U present in the UPF over LI_T3 shall include the XID of the Task created by the ActivateTask message (see table 7.10.4.5-1).

7.10.4.5.3 S8HR LI

The LI_T3 trigger that the BBIFF-C in SGW-C sends to the BBIFF-U present in the SGW-U shall include at least the following information:

- XID assigned locally by the BBIFF-C in the SGW-C.
- The ProductID that includes the XID it receives from the LMISF-IRI over LI_T1.
- Target identity: PFCP Session ID, PDR ID with the F-TEID associated with the IMS voice media (QCI = 1) related dedicated bearer.

- Delivery end point: LMISF-CC.

The details of ActivateTask sent to the BBIFF-U in SGW-U over LI_T3 are shown in table 7.10.4.5-2.

Table 7.10.4.5-2: ActivateTask message for triggering the BBIFF-U in the SGW-U

ETSI TS 103 221-1 [7] field name	Description	M/C/O
XID	Allocated by the BBIFF-C as per ETSI TS 103 221-1 [7].	M
TargetIdentifiers	Packet detection criteria as determined by the BBIFF-C in the SGW-C, which enables the BBIFF-U in SGW-U to isolate user-plane packets. The BBIFF-U in the SGW-U shall support the identifier types given in Table 6.2.3-7. The target identity type of PDR ID shall be mandatory. The BBIFF-C in SGW-C shall use the F-TEIDs associated with the IMS voice media (QCI = 1) related dedicated bearer to populate the F-TEID field within the PDI of PDR ID.	M
DeliveryType	Set to "X3Only".	M
ListOfDIDs	Shall give the DID of the LMISF-CC to which the xCC should be delivered. The delivery endpoint is configured using the CreateDestination message as described in ETSI TS 103 221-1 [7] clause 6.3.1 prior to the task activation.	M
CorrelationID	Correlation ID to assign to X3 PDUs generated by the BBIFF-U in the SGW-U. This field is populated with the same CorrelationID received over the LI_T1 interface (see table 7.10.4.4.3).	M
ProductID	Shall be set to the XID of the Task Object associated with the interception as received in the ProductID field over LI_T1 interface (see table 7.10.4.4.3). This value shall be used by the BBIFF-U in the SGW-U to fill the XID of X3 PDUs.	M

The DeactivateTask sent to the BBIFF-U present in the SGW-U over LI_T3 shall include the XID of the Task created by the ActivateTask message (see table 7.10.4.5-2).

7.10.4.6 Generation of xCC over LI_X3_LITE_M

The BBIFF-U in UPF and the BBIFF-U in SGW-U shall send the xCC over LI_X3_LITE_M for each of the packet matching the criteria specified in the Triggering message (i.e. Activate Task message) received over the LI_T3 from the BBIFF-C.

The BBIFF in SGW shall identify the IMS voice media (QCI = 1) related dedicated bearer associated with the IMS signaling related bearer as indicated in the trigger received over the LI_T1 from the LMISF-IRI and then send xCC over LI_X3_LITE_M for each of the packet captured from that dedicated bearer.

The BBIFF-U/BBIFF shall set the payload format to indicate the appropriate payload type (5 for IPv4 Packet, 6 for IPv6 Packet, or 12 for GTP-U Packet as described in ETSI TS 103 221-2 [8] clauses 5.4 and 5.4.13).

7.10.4.7 Generation of xCC over LI_X3

The xCC generated at the LMISF-CC shall be same as the xCC generated in the CC-POIs present in the IMS media functions. Further details of this are not specified in the present document.

The correlation identifier value included in the xCC of an IMS session can be dependent on the UDP port numbers associated with the voice-media related RTP streams. This is the case when a user is involved in multiple IMS sessions. An illustrated of this is shown in clause 7.10.4.8

7.10.4.8 Correlation identifier

The xIRIs generated at the LMISF-IRI shall be correlated using the correlation identifier field defined ETSI TS 103 221-2 [8]. This correlation identifier value can be independent of the correlation identifier value received in the xCC from the BBIFF-U/BBIFF over the LI_X3_LITE_S interface.

Furthermore, the xIRIs generated at the LMISF_IRI shall include the correlation identifier value used in the xCC generated at the LMISF-CC. Any intra-LMISF interactions required to associate the correlation identifier values used by the LMISF-IRI and LMISF-CC are outside the scope of the present document.

Each session-leg of an IMS session may have to be correlated separately. This is accomplished using the RTP/RTCP port numbers present in the SDP of IMS signaling message and the UDP port numbers present in the IMS voice media related RTP as illustrated in figure 7.10.4.8-1 below.

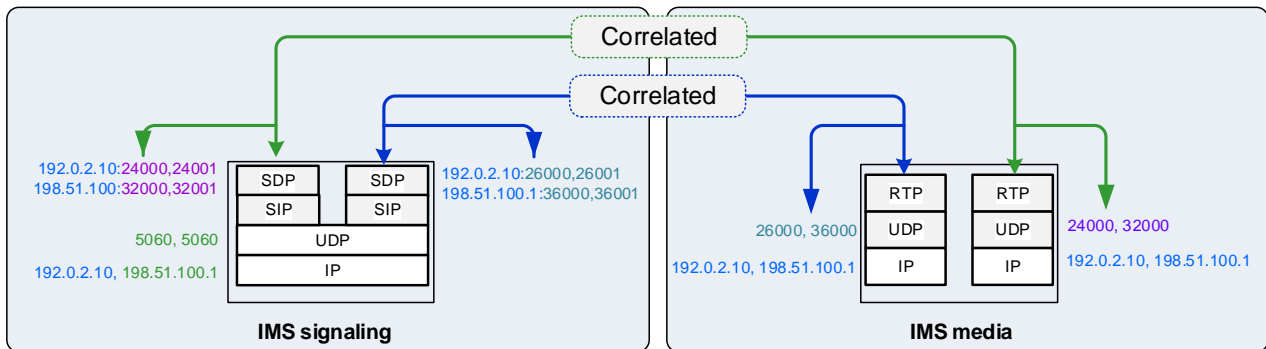

Figure 7.10.4.8-1: Correlation at the session-leg level (an illustration)

Figure 7.10.4.8-1 illustrates an example where an IMS session includes two session-legs.

Session-leg 1:

- Source IP address: 192.0.2.10 and source port number: 24000 (RTP), 24001 (RTCP).
- Destination IP address: 198.51.100.1 and destination port number: 32000 (RTP), 32001 (RTCP).

Session-leg 2:

- Source IP address: 192.0.2.10 and source port number: 26000 (RTP), 26001 (RTCP).
- Destination IP address: 198.51.100.1 and destination port number: 36000 (RTP), 36001 (RTCP).

The IP address of the two end-points happen to be the same for the two session legs. The RTP port numbers present in the SDP of IMS signaling message and the UDP port numbers of the associated with the IMS voice-media related RTP happen to be the same for a session-leg.

Therefore, in general, multiple session-legs can be identified using the RTP port numbers present in the SDP of IMS signaling message and the UDP port numbers associated with the IMS voice-media related RTP.

7.10.4.9 Generation of IRI over LI_HI2

When an xIRI is received over LI_X2 from the LMISF-IRI, the MDF2 shall send the IRI message over LI_HI2 without undue delay. The IRI message shall contain a copy of the relevant record received from LI_X2. The record may be enriched by other information available at the MDF (e.g. additional location information).

The IRI messages delivered over the LI_HI2 for HR LI are same as the IRI messages delivered over the LI_HI2 for LI IMS-based voice services. Further details of this are outside the scope of the present document.

7.10.4.10 Generation of CC over LI_HI3

When the xCC is received over LI_X3 from the LMISF-CC, the MDF3 shall deliver the CC over LI_HI3 without undue delay.

The CC delivered over the LI_HI3 for HR LI is the same as the CC delivered over the LI_HI3 for LI IMS-based voice services. Further details of this are outside the scope of the present document.

7.11 STIR/SHAKEN and RCD/eCNAM

7.11.1 Provisioning over LI_X1

7.11.1.1 General

When the interception of STIR/SHAKEN is required, the LIPF shall provision the IRI-POI present in the following IMS NFs for the reporting of signing and verification results, as applicable:

- IBCF.
- Telephony AS.

If the IRI-POI functions in IBCF or Telephony AS are already provisioned for IMS-based services, then separate provisioning is not required. However, the "ReportDiversionPASSporTInfo" shall be included, as specified in clause 7.11.1.2, as a part of provisioning the IRI-POIs in Telephony AS and IBCF for IMS-based services.

NOTE: The P-CSCF and LMISF-IRI may also provide IRI-POI functions for reporting of STIR/SHAKEN validation results when the target (or user communicating with the target non-local ID) is roaming (P-CSCF with LBO and LMIF-IRI with home-routed). However, separate provisioning of those IRI-POIs for STIR/SHAKEN is not required.

7.11.1.2 Provisioning of the IRI-POI in the IMS network functions

The LIPF provisions the IRI-POIs present in the NFs mentioned in 7.11.1.1 using the X1 protocol as described in clause 5.2.2 with the following target identifier formats as defined in the ETSI TS 103 221-1 [7] messages (or equivalent if ETSI TS 103 221-1 [7] is not used):

- IMPU.

The "div" PASSporT information for the redirecting party (ies) when the IMS session is redirected later on the signaling path may have to be reported to some LEAs. To identify the need for such reporting, a parameter "ReportDiversionPASSporTInfo" shall be included as part of ActivateTask message.

Table 7.11.1.2-1 shows the minimum details of the LI_X1 ActivateTask message used for provisioning the IRI-POI in the Telephony AS, IBCF, for separate provisioning case, for STIR/SHAKEN and RCD/eCNAM.

Table 7.11.1.2-1: ActivateTask message for IRI-POI in the IMS Network Functions for STIR/SHAKEN and RCD/eCNAM

ETSI TS 103 221-1 [7] field name	Description	M/C/O
XID	XID assigned by LIPF.	M
TargetIdentifiers	The target identifier listed in the paragraph above.	M
DeliveryType	Set to "X2Only".	M
ListOfDIDs	Delivery endpoints of LI_X2. These delivery endpoints shall be configured using the <i>CreateDestination</i> message as described in ETSI TS 103 221-1 [7] clause 6.3.1 prior to first use.	M
TaskDetailsExtensions/ STIRSHAKENProvisioning	Shall be included if the interception of STIR/SHAKEN is required. See table 7.11.1.2-2.	C

Table 7.11.1.2-2: STIRSHAKENProvisioning extension

Extensions field name	Description	M/C/O
ReportDiversionPASSporTInfo	Indicates whether "div" PASSporT information of redirecting party (ies) when the IMS session is redirected later on the signaling path is to be reported. When set to "true", it shall be reported. When set to "false", it shall not be reported.	M

When the IRI-POIs in Telephony AS or IBCF are provisioned for IMS-based services, then the minimal details of LI_X1 ActivateTask message shall be as defined in clause 7.12.3.2.1 (table 7.12.3.2-2) with the addition of "ReportDiversionPASSporTInfo" parameter.

7.11.1.3 Provisioning of the MDF2

This clause is applicable when the MDF2 is not provisioned for IMS-based interception.

The MDF2 listed as the delivery endpoint for xIRI generated by the IRI-POI in the IMS Network Functions for STIR/SHAKEN and RCD/eCNAM shall be provisioned over LI_X1 by the LIPF using the X1 protocol as described in clause 5.2.2. Table 7.11.1.3-1 shows the minimum details of the LI_X1 ActivateTask message used for provisioning the MDF2.

The MDF2 shall support the following target identifier formats in the ETSI TS 103 221-1 [7] messages (or equivalent if ETSI TS 103 221-1 [7] is not used):

- IMPU.

Table 7.11.1.3-1: ActivateTask message for MDF2

ETSI TS 103 221-1 [7] field name	Description	M/C/O
XID	XID assigned by LIPF.	M
TargetIdentifiers	The target identifier listed in the paragraph above.	M
DeliveryType	Set to "X2Only". (Ignored by the MDF2).	M
ListOfDIDs	Delivery endpoints of LI_HI2. These delivery endpoints shall be configured using the CreateDestination message as described in ETSI TS 103 221-1 [7] clause 6.3.1 prior to first use.	M
ListOfMediationDetails	Sequence of Mediation Details, see table 7.11.1.3-2.	M

Table 7.11.1.3-2: Mediation Details for MDF2

ETSI TS 103 221-1 [7] field name	Description	M/C/O
LIID	Lawful Intercept ID associated with the task.	M
DeliveryType	Set to "HI2Only".	M
ListOfDIDs	Details of where to send the IRI for this LIID. Shall be included if deviation from the ListofDIDs in the ActivateTask message is necessary. If included, the ListOfDIDs in the Mediation Details shall be used instead of any delivery destinations authorised by the ListOfDIDs field in the ActivateTask Message.	C

7.11.2 Generation of xIRI at IRI-POI in the IMS Network Functions over LI_X2

7.11.2.1 General

The IRI-POI present in the IMS Network Functions for STIR/SHAKEN and RCD/eCNAM shall send xIRI over LI_X2 for each of the events listed in TS 33.127 [5] clause 7.14.3, each of which is described in the following clauses.

- NOTE: The clauses below on signing and verification shall be applied for diverted call based on the RFC 8946 [76]. LI system has to generate xIRI containing all the pASSporT objects of the SIP messages and signature validation or generation results, even those of the History-Info field.

7.11.2.2 Signature generation

The IRI-POI present in the Telephony AS or IBCF, shall generate an xIRI containing a STIRSHAKENSignatureGeneration record under the following conditions:

- Telephony AS or IBCF is interacting with the SIGNING AS. Whether it is the Telephony AS or IBCF for sessions is based on network configuration and local policy of the CSP as described in clause 7.11.2.4.
- When P-Asserted Identity or From header of SIP INVITE request received from S-CSCF is a target identity with the conditions mentioned below:
 - The identities in one or both of those headers are used to interact with the SIGNING AS.
 - The "shaken" PASSporT is not received in the SIP INVITE request from the S-CSCF.

- The "shaken" PASSporT is received from the SIGNING AS.
- The "shaken" PASSporT is included in the outgoing SIP INVITE.
- When the "ReportDiversionPASSporTInfo" parameter is set to "True" in the ActivateTask with P-Asserted Identity or From header of SIP INVITE request received from S-CSCF is a target identity with the conditions mentioned below:
 - The identities in one or both of those headers are used to interact with the SIGNING AS.
 - A "shaken" PASSporT or a "div" PASSporT with those identities are included in the "orig" claim of "shaken" or "div" PASSporT received from the SIGNING AS.
 - The "shaken" PASSporT or a "div" PASSporT with those identities are included in the "orig" claim of "shaken" or "div" PASSporT in the outgoing SIP INVITE.
- When Diversion header or the History Info of SIP INVITE request received from the S-CSCF includes a target identity with the conditions mentioned below:
 - The identities in one or both of those headers are used to interact with the SIGNING AS.
 - The "div" PASSporT with those identities in the "div" claim is not received in the SIP INVITE request from the S-CSCF.
 - The "div" PASSporT with those identities in the "div" claim is received from the SIGNING AS.
 - The "div" PASSporT with those identities in the "div" claim is included in the outgoing SIP INVITE.
- When the "ReportDiversionPASSporTInfo" parameter is set to "True" in the ActivateTask with Diversion or HistoryInfo header of SIP INVITE request received from S-CSCF includes the target identity with the conditions mentioned below:
 - The identities in P-Asserted Identity or From of SIP INVITE received from the S-CSCF are used to interact with the SIGNING AS.
 - A "div" PASSporT with the identities in P-Asserted Identity or From of SIP INVITE request received from S-CSCF are included in the "orig" claim of "div" PASSporT received from the SIGNING AS.
 - The "div" PASSporT with the identities in P-Asserted Identity or From of SIP INVITE request received from S-CSCF are included in the "orig" claim of "div" PASSporT in the outgoing SIP INVITE.
- When Request URI of outgoing SIP INVITE is a target non-local ID and is present in the "dest" claim of "shaken" or "div" PASSporT received from the SIGNING AS and the same is included in the outgoing SIP INVITE.
- When Telephony AS is interacting with the SIGNING AS, and when Request URI of SIP INVITE received from the S-CSCF is a target identity with the conditions mentioned below:
 - The identity is used to interact with the SIGNING AS.
 - The "div" PASSporT with that identity in the "div" claim is received from the SIGNING AS.
 - The "div" PASSporT with that identity in the "div" claim is included in the outgoing SIP INVITE.

When the target is not a non-local ID, the STIRSHAKENSsignatureGeneration includes only the PASSporT received in the SIGNING AS response with the following rules:

- When the "ReportDiversionPASSporTInfo" parameter is set to "True" in the ActivateTask, all of the PASSporT received from the SIGNING AS.
- When the "ReportDiversionPASSporTInfo" parameter is set to "False" in the ActivateTask:
 - If P-Asserted Identity or From header in the SIP INVITE received from the S-CSCF is a target identity, then only "shaken" PASSporT received from the SIGNING AS with those identities in the "orig" claim of the "shaken" PASSporT.

- If Diversion or HistoryInfo header in the SIP INVITE received from the S-CSCF is a target identity, then only the "div" PASSporT received from the SIGNING AS with those identities in the "div" claim of "div" PASSporT.
- If REQUEST URI or To header in the SIP INVITE received from the S-CSCF is a target identity, then only the "div" PASSporT received from the SIGNING AS with those identities in the "div" claim of "div" PASSporT.

When the target is non-local ID, STIRSHAKENSignatureGeneration includes all of the PASSporT included in the outgoing SIP message.

The following table contains parameters, with IRITargetIdentifier, generated by the IRI-POI.

Table 7.11.2.2-1: Payload for STIRSHAKENSignatureGeneration record

Field name	Description	M/C/O
pASSporTs	Identifies the content of the SIP Identity headers added by the originating network and transit networks. This is a set of PASSporT parameter. See table 7.11.2.2-2.	M
encapsulatedSIPMessage	Encapsulated SIP INVITE request that includes SIP Identity header carrying the PASSporT (Outgoing SIP request) based on the structure defined in table 7.12.4.2-2 (see NOTE below).	M
NOTE 1: For the backward compatibility purposes the parameter is coded as OPTIONAL in the ASN.1 schema (Annex A.).		
NOTE 2: The same SIP message may be encapsulated in the xIRI IMSMessage as well.		

Table 7.11.22-2: Details for PASSporT parameter

Field name	Description	M/C/O
pASSporTHeader	PASSporT Header as defined in RFC 8224 [70] clause 4 for "shaken" PASSporT, in RFC 8946 [76] clause 3 for "div" PASSporT and in TS 24.229 [74]. See table 7.11.2.2-3.	M
pASSporTPayload	PASSporT Payload as defined in RFC 8224 [70] clause 4 for "shaken" PASSporT, in RFC 8946 [76] clause 3 for "div" PASSporT and in TS 24.229 [74]. See table 7.11.2.2-4.	M
pASSporTSignature	PASSporT Signature as defined in RFC 8224 [70] clause 4 for "shaken" PASSporT, in RFC 8946 [76] clause 3 for "div" PASSporT and in TS 24.229 [74].	M

Table 7.11.2.2-3: Details for pASSporTHeader parameter

Field name	Description	M/C/O
type	Shall be populated with the type contained in the PASSporT Header as defined in RFC 8225 [69] clause 4.1 for "shaken" PASSporT and in RFC 8946 [76] clause 3 for "div" PASSporT.	M
algorithm	Shall be derived from the value of the 'alg' parameter of the PASSporT Header as defined in RFC 8225 [69] clause 4.2 for "shaken" PASSporT and in RFC 8946 [76] clause 3 for "div" PASSporT.	M
ppt	Shall be derived from the value of the 'ppt' parameter of the PASSporT Header as defined in RFC 8225 [69] clause 8.1 for "shaken" PASSporT if the PASSporT Header contains a ppt parameter and in RFC 8946 [76] clause 3 for "div" PASSporT.	C
x5u	Shall be populated with the URI contained in the 'x5u' parameter of the PASSporT Header as defined in RFC 8225 [69] clause 4.3 for "shaken" PASSporT and in RFC 8946 [76] clause 3 for "div" PASSporT.	M

Table 7.11.2.2-4: Details for pASSporTPayload parameter

Field name	Description	M/C/O
issuedAtTime	Shall be populated with the GenrealizedTime format timestamp converted from the NumericDate contained in the 'iat' parameter of the PASSporT Payload as defined in RFC 8225 [69] clause 5.1.1 and in RFC 8946 [76] clause 3.	M
originator	Shall be populated with the value of the "orig" claim of the PASSporT Payload as defined in RFC 8225 [69] clause 5.2.1 and in RFC 8946 [76] clause 3.	M
destination	Shall contain the list of destinations contained in the "dest" claim of the PASSporT Payload as defined in RFC 8225 [69] clause 5.2.1 and in RFC 8946 [76] clause 3.	M
diversion	Shall be populated with the "div" claim of the "div" PASSporT payload. For first diversion this contains the original identifier of the destination as defined in RFC 8946 [76] clause 3 for "div" PASSporT.	C
attestation	Indicates the attestation level as defined in RFC 8588 [71] clause 4 for the "shaken" PASSporT. The different values of attestation level are A = Full Attestation, B= Partial Attestation, C = Gateway Attestation (see NOTE 3 below).	M
origID	Shall be populated with the value of the origID contained in the 'origid' parameter of the PASSporT Payload as defined in RFC 8588 [71] clause 5 for the "shaken" PASSporT (see NOTE 4 below).	M
<p>NOTE 3: For the backward compatibility purposes the parameter is coded as MANDATORY in the ASN.1 schema (Annex A). 'attestation' is mandatory for "shaken" PASSporT and absent for "div" PASSporT. Therefore, for div PASSporT, since "attestation" is not available, the placeholder value "Not available" shall be used.</p> <p>NOTE 4: For the backward compatibility purposes the parameter is coded as MANDATORY in the ASN.1 schema (Annex A). This parameter is mandatory for "shaken" PASSporT and absent for the "div" PASSporT. Therefore, for div PASSporT, since "origID" is not available, the placeholder value "Not available" shall be used.</p>		

7.11.2.3 Signature validation

The IRI-POI present in the Telephony AS or IBCF, shall generate an xIRI containing a STIRSHAKENSignatureValidation record when the following conditions are met:

- Either IBCF or Telephony AS, is interacting with the VERIFICATION AS. Whether it is the Telephony AS or IBCF for sessions is based on network configuration and local policy of the CSP as described in clause 7.11.2.5.
- With one or more of the following are true:
 - Request URI and To Headers of SIP INVITE request received from S-CSCF (in the case of Telephony AS) or from the previous IP network (in the case of IBCF) is a target identity.
 - One or more of P-Asserted Identity, From, Diversion, History-Info Headers of SIP INVITE request received from S-CSCF (in the case of Telephony AS) or from the previous IP network (in the case of IBCF) is a target non-local identity without any prior intra-network diversions.
- If PASSporTs are received in the SIP INVITE request, they are submitted by the IBCF to the VERIFICATION AS for validation and the result is included in an outgoing SIP INVITE request together with possible RCD data or eCNAM data as Call-Info headers.
- If PASSporTs are received in the SIP INVITE request, they are submitted by the Telephony AS to the VERIFICATION AS for validation and the validation result is received from the Verification AS and the outgoing SIP INVITE possibly includes RCD data or eCNAM data as Call-Info headers.

NOTE: The IRI-POI may use the Via headers, Record-route headers to determine any prior intra-network diversions.

The IRI-POI present in the Telephony AS shall also generate an xIRI containing a STIRSHAKENSignatureValidation record when it detects the following conditions:

- Session is redirected.
- Request URI header of outgoing SIP INVITE is a target identity.

- Validation result is included in the outgoing SIP INVITE with the possible the RCD data and the eCNAM data as Call-Info headers.

The IRI-POI present in the LMISF-IRI or P-CSCF shall generate an xIRI containing a STIRSHAKENSignatureValidation record when the following conditions are met:

- With one or more of the following are true:
 - Request URI or To header of SIP INVITE request sent to the UE is a target identity.
 - One or more of P-Asserted Identity, From, Diversion, History-Info Headers of SIP INVITE request sent to the UE is a target non-local identity.
- SIP INVITE request sent to the UE includes SIP Call-Info headers containing possible RCD data or eCNAM data, and the result of the PASSporT verification.

In the above paragraphs, a validation result (i.e. result of all PASSporT verification) is included means a "verstat" parameter within the P-Asserted Identity header is included in the outgoing SIP INVITE.

The following table contains parameters, with IRITargetIdentifier, generated by the IRI-POI.

Table 7.11.2.3-1: Payload for STIRSHAKENSignatureValidation record

Field name	Description	M/C/O
pASSporTs	Identifies the content of the SIP Identity headers added by the originating network and transit networks. See TS 24.229 [74] and RFC 8224 [70]. This is a set of PASSporT parameter. See table 7.11.2.2-2.	C
rCDTerminalDisplayInfo	RCD display information when applicable. See IETF draft-ietf-stir-passport-rcd-12 [73].	C
eCNAMTerminalDisplayInfo	eCNAM display information when applicable. See TS 24.196 [72].	C
sHAKENValidationResult	SHAKEN validation result: TN-Validation-Passed, TN-Validation-Failed, No-TN-Validation. See TS 24.229 [74] and IETF RFC 8588 [71].	M
sHAKENFailureStatusCode	SHAKEN status code when validation fails in the terminating network. See IETF RFC 8224 [70].	C
encapsulatedSIPMessage	Encapsulated SIP INVITE request that carries P-Asserted Identifier or From header that includes the SHAKEN validation result (Outgoing SIP request) based on the structure defined in table 7.12.4.2-2. (see NOTE below).	C
NOTE: The same SIP message may be encapsulated in the xIRI IMSMessage as well.		

When the termination network performs SHAKEN verification, one of the following values shall be assigned to the SHAKEN validation result parameter as part of the display information: "TN-Validation-Passed", "TN-Validation-Failed", or "No-TN-Validation". In case of TN-Validation-Failed, the SHAKEN failure status code shall be present and coded as an integer. The SHAKEN failure status codes are at least, according to RFC 8224 and to IANA Session Initiation Protocol (SIP) Parameters [75]:

- 403 "Stale Date" response code is sent when the verification service receives a request with a Date header field value that is older than the local policy of the CSP for freshness permits. The same response may be used when the "iat" has a value older than the local policy of the CSP for freshness permits.
- 428 "Use Identity Header" response code is sent when the verification service receives a SIP request that lacks an Identity header. This is to indicate that the request should be re-sent with an Identity header.
- 436 "Bad Identity-Info" response code is used to indicate an inability to acquire the credentials needed by the verification service for validating the signature in an Identity header field.
- 437 "Unsupported Credential" response code is used when the verification service cannot validate the certificate referenced by the URI of the Identity-Info header, for reasons such as failing to trust the issuing certification authority (CA) or failing to support the algorithm with which the credential was signed.
- 438 "Invalid Identity Header" response code is used to indicate that of the set of Identity header fields in a request, no header field with a valid and supported Identity token has been received.

7.11.2.4 IMS Network Function that interacts with signing AS

The Telephony AS interacts with the SIGNING AS when any of the following is true:

- RCD is supported.
- Intra-CSP session signing is required.
- CSP choice for signing is AS.

The IBCF interacts with the SIGNING AS when all of the following are true:

- RCD is not supported.
- Intra-CSP session signing is not required.
- CSP choice for signing is IBCF.

The IBCF also interacts with the SIGNING AS for an IMS emergency session.

The presence of RCD is on a per call basis.

7.11.2.5 IMS Network Function that interacts with the verification AS

The Telephony AS interacts with the VERIFICATION AS when any of the following is true:

- Intra-CSP session verification is required.
- CSP choice for verification is AS.
- CSP choice for emergency session callback verification is AS.

The IBCF interacts with the VERIFICATION AS when all of the following are true:

- Intra-CSP session verification is not required.
- CSP choice for verification is IBCF.

The IBCF also interacts with the VERIFICATION AS for an IMS emergency session callback when the CSP choice for verification for emergency callback session is IBCF.

7.11.3 Generation of IRI over LI_HI2

When an xIRI is received over LI_X2 from an IRI-POI, the MDF2 shall generate the corresponding IRI message and deliver over LI_HI2 without undue delay. The IRI message shall contain a copy of the relevant record (STIRSHAKENSignatureGeneration or STIRSHAKENSignatureValidation) received in the xIRI over LI_X2.

The MDF2 shall be able to remove information regarded as content from RCD or eCNAM parameters in the case of an IRI-only warrant. The details of what needs to be removed and under what circumstances are outside the scope of the present document.

The timeStamp field of the ETSI TS 102 232-1 [9] PSHeader structure shall be set to the time present in the timeStamp field of the xIRI.

The threeGPP33128DefinedIRI field (see ETSI TS 102 232-7 [10] clause 15) shall be populated with the BER-encoded IRIPayload.

The STIRSHAKENSignatureGeneration and STIRSHAKENSignatureValidation IRI messages shall have the same CIN as in the other IRI messages delivered for the IMS session (see ETSI TS 102 232-1 [9] clause 5.2.4).

The IRI type parameter (see ETSI TS 102 232-1 [9] clause 5.2.10) shall be included and coded according to table 7.11.3-1.

Table 7.11.3-1: IRI type for IRI messages

Record type	IRI Type
STIRSHAKENSignatureGeneration	REPORT
STIRSHAKENSignatureValidation	REPORT

7.12 LI for IMS based services

7.12.1 General

The present document provides two options for stage 3 definitions for implementing IMS LI:

- Use LI_X1, LI_X2 and LI_X3 interfaces specified below in the present document.
- Use TS 33.107 [36] and TS 33.108 [12] natively as defined in that document.

In both cases, the present document specifies the stage 3 for the LI_HI1, LI_HI2 and LI_HI3 interfaces.

7.12.2 Overview

7.12.2.1 General

This clause defines protocol and procedures to support the LI for IMS-based services. The scope of LI functions defined here are based on the IMS LI architecture defined in TS 33.127 [5] that includes:

- Target type – local ID, non-local ID.
- Roaming considerations – local break-out (LBO), home-routed (HR).
- Service specific aspects - normal sessions, redirected sessions, conferencing, STIR/SHAKEN, RCD/eCNAM.
- Location reporting.

The IMS LI shall apply to all IMS-based services unless restricted by the service scoping as defined in clause 4.4 of the present document. When restricted by the service scoping, the IMS LI applies only to service types listed in table C.2 of ETSI TS 103 221-1 [7]). Clause 7.12.2.5 provides further details of IMS LI with service scoping.

As defined in TS 33.127 [5], the NFs that provide the IRI-POI and CC-TF are in the IMS signaling functions that handle the SIP messages and the NFs that provide the CC-POI are in the IMS media functions. The media interception in the packet core network (EPC or 5GC) is outside the scope of the present document.

For some of the services listed above, an alternate deployment option in addition to the default option is also specified in TS 33.127 [5]. The NFs that provide the IRI-POI, CC-TF and CC-POI in the alternate deployment option can be different.

The LIPF provisioning scenarios for IMS LI is illustrated in Annex G LIPF Logic of the present document.

7.12.2.2 Target type and target identifiers

An IMS user served by the CSP can be the target or can be in communication with a target non-local ID. In the former case, the target can also be an outbound roaming IMS user or an inbound roaming IMS user (see clause 7.12.2.3).

NOTE: A target non-local ID is identified distinctly through the provisioning.

The following target identifier formats (ETSI TS 103 221-1 [7]) can be used to identify a target for IMS based services:

- IMPU.
- IMPI.
- PEIIMEI.

- IMEI.

When service scoping is applicable, additional target identities may be used in LI for IMS based specific services (e.g. MCPTT ID for PTC). The details of such additional target identities are provided in the service specific clauses of the present document.

The target identity in the IMPI format may contain a value derived from a SUPI or an IMSI. The target identity in the IMPU format containing a SIP URI or TEL URI may contain a value derived from a SIP URI, TEL URI, GPSI, MSISDN, an E.164 number or IMSI. Only IMPU is used for target non-local ID.

7.12.2.3 Roaming considerations

An IMS user who is the target, or in communication with the target non-local ID, can be part of the following roaming scenarios for the LI purpose:

- Non-roaming.
- Outbound roaming with HR.
- Outbound roaming with LBO.
- Inbound roaming with HR.
- Inbound roaming with LBO.

The details of LI functions for the case of inbound roaming with HR are described in clause 7.10.

7.12.2.4 Service specific aspects

7.12.2.4.1 General

The NFs that provide the IRI-POI, CC-TF and CC-POI functions can be different depending on the IMS session scenarios the target, or the IMS user in communication with a target non-local ID, is involved in.

An IMS user shall be considered to be in communications with a target non-local ID even if the session is redirected from that target non-local ID.

7.12.2.4.2 LI for normal sessions

This includes LI for session originations and session terminations.

LI for session originations applies when an IMS session is originated by an IMS user whose communications are intercepted either because that originating IMS user happens to be a target or because that originating IMS user happens to be in communications with a target non-local ID. The originating IMS user can also be inbound roaming (LBO or HR) or outbound roaming (LBO or HR).

LI for session terminations applies when an IMS session is terminated to an IMS user whose communications are intercepted either because that terminating IMS user happens to be a target or because that terminating IMS user happens to be in communications with a target non-local ID. The terminating IMS user can also be inbound roaming (LBO or HR) or outbound roaming (LBO or HR).

The other party can be within the same CSP domain (intra-CSP sessions) or in another CSP domain (inter-CSP sessions). In the latter case, the other CSP can be CS-based or IP-based. For target non-local ID, the session is always an inter-CSP session.

7.12.2.4.3 LI for redirected sessions

This includes LI for the incoming IMS sessions that are redirected.

LI for redirected sessions applies when a terminating session to a target is redirected to (or forwarded to) another user. Either the target (i.e. redirecting party) or the redirected-to party can be outbound roaming (LBO or HR).

The redirected-to party can be in the same CSP domain as that of initial terminating party (i.e. redirecting party) or can be a another CSP domain. In the latter case, the other CSP can be CS-based or IP-based. The LI for redirected sessions in the VPLMN are handed as LI for session terminations.

7.12.2.4.4 LI for conferencing

This includes the LI for conferencing services.

LI for conferencing services applies when a target initiates a multi-party conferencing session or when a target joins a "meet-me" conferencing session or when a "meet me" conferencing session is established with conferencing URI itself being the target.

When a target happens to be one of the participant of a conference initiated by another IMS user, the LI for normal sessions (see clause 7.12.2.4.2) applies.

7.12.2.4.5 STIR/SHAKEN

This includes the LI for STIR/SHAKEN when signature is signed or verified in an IMS session involving a target as described in TS 33.127 [5].

The further details of LI for STIR/SHAKEN are described in clause 7.11.

7.12.2.4.6 RCD/eCNAM

This includes the LI for RCD/eCNAM when enhanced calling name is included in a terminating IMS session involving a target as described in TS 33.127 [5].

The further details of LI for RCD/eCNAM are described in clause 7.11.

7.12.2.5 Service scoping

7.12.2.5.1 General

LI for IMS-based services shall support service scoping with the following specific service types:

- Voice.
- PTC.
- Messaging.
- RCS.
- LALS.

When an NF is involved in the handling of one or more of the above mentioned IMS-based services (e.g. voice, messaging at the S-CSCF), the LI functions within that NF shall limit the interception to the service type to which the warrant applies. However, type of service used by a UE may not be known when an IMS session begins, or if known, may change while, or after, the session is established. Therefore, the present document limits the applicability of service-based interception to the media only.

The present document supports service-based interception to signaling as well media when the NF is involved in the handling of a specific service mentioned above (e.g. PTC server for PTC).

When service scoping is not applicable, the delivery of IRI and CC for IMS-based services are done independent of service types. Location reporting aspects that are also part of the service scoping are described in clause 7.12.2.6.

7.12.2.5.2 LI for voice

This includes the LI for IMS-based voice services.

LI for IMS-based voice services applies to the interception of IMS-based voice media for the IMS sessions involving the targets if and only if the m-line in the SDP answer includes either one of the following:

- Audio.
- Text.

For the generation and delivery of IRI for the IMS sessions, the LI for IMS-based voice is handled independent of the m-line in the SDP.

If the m-line includes "audio" and "video" then only audio part of the media is intercepted.

It is possible that SDP offer and SDO answer may have different information in m-line. The determination on whether to intercept the voice media is based on the final outcome of SDP offer and answer, which happens to be in the SDP answer.

The media associated with an IMS session may also change in the middle of a session using the re-INVITE procedures invoked by either of the parties involved in the session. Accordingly, the interception of voice media may resume or cease in the middle of an IMS session based media type negotiated at the conclusion the related SDP offer and answer.

NOTE: The present document excludes the m-line values of video, msrp, image, application and other, for Service Type of "voice" while determining the media interception (i.e. CC delivery).

7.12.2.5.3 LI for Messaging

This includes LI for SMS over IP and MSRP originated from, or terminated to, a target.

LI for SMS over IP originated from a target applies to the interception of a SIP MESSAGE originated from an IMS user who happens to be a target or happens to be receiving a SIP MESSAGE that has originated from a target non-local ID. That IMS user can also be inbound roaming (LBO or HR) or outbound roaming (LBO or HR).

LI for SMS over IP terminated to a target applies to the interception of a SIP MESSAGE terminated to an IMS user who happens to be a target or happens to be sending the SIP MESSAGE to a target non-local ID. That IMS user can also be inbound roaming (LBO or HR) or outbound roaming (LBO or HR).

LI for MSRP applies to the interception of media for the IMS sessions involving the targets if and only if MSRP is included in the m-line of the SDP answer. For the generation and delivery of IRI for the IMS sessions, the LI for messaging is handled independent of the m-line in the SDP.

When service scoping applies, the LI for Messaging (i.e. SMS over IP or MSRP) is provided if and only if the "messaging" service type is included as a part of LI provisioning. If no service type is provisioned, service scoping does not apply and the LI for messaging shall be provided (per clause 4.4.2).

7.12.2.5.4 LI for voice-mail

This includes LI for IMS-based voice services (see clause 7.12.2.5.3) when an incoming voice session to an IMS user who happens to be a target or an incoming voice session to an IMS user from a target non-local ID is redirected to a voice mail server.

When the incoming session happens to be from a target non-local ID to an IMS user, the retrieval of the voice message from the voice mail server is not intercepted. However, when the IMS user who happens to be the target, the retrieval of the voice message from the voice-mail server may be intercepted in the network that handles the IMS session initiated from the target used to retrieve the voice message.

When service scoping applies, LI for voice-mail is provided if and only if "voice" service type is included as a part of LI provisioning. If no service type is provisioned, service scoping does not apply and the LI for voice-mail shall be provided (per clause 4.4.2).

7.12.2.5.5 LI for RCS

This includes the LI for RCS services when a target executes one of the RCS related services described in TS 33.127 [5].

The further details of LI for RCS are described in clause 7.13.

7.12.2.5.6 LI for PTC service

This includes LI for PTC when a target is engaged in a PTC service as described in TS 33.127 [5].

The further details of LI for PTC are described in clause 7.5.

7.12.2.5.7 LALS triggering

This includes the reporting of location by the LI-LCS Client triggered by the LTF as described in TS 33.127 [5].

The further details of LALS triggering are defined in clause 7.3.

7.12.2.6 Location reporting

When the location reporting is only required at the beginning and end of an IMS session, the location is reported when an IMS session is originated (SIP INVITE) from a target or terminating session is answered (SIP 200 OK for INVITE) from the target or either of the two sessions are released (SIP BYE from the target or SIP 200 OK for BYE from the target).

7.12.2.7 Deployment considerations

As described in TS 33.127 [5], some of the service types may have two deployment options denoted as "default option" and "alternate option".

As illustrated in Annex G, the LIPF provisions the LI functions in a NF based on the option the CSP has deployed within the network.

7.12.2.8 Identifying the intercepted IMS-based communications

7.12.2.8.1 General concepts

An IMS based communication is intercepted when one of the following is true:

- The calling party identity on session originations or SMS originations is a target.
- The called party identity on session originations is a target non-local ID.
- The destination party identity in SMS originations is a target non-local ID.
- The called party identity on session terminations or SMS terminations is a target.
- The calling party identity on session terminations is a target non-local ID.
- The origination party identity in SMS terminations is target non-local ID.
- The redirecting party identity on session terminations is a target non-local ID.
- In the alternate deployment option for redirected sessions (see TS 33.127 [5]), redirecting party is a target.
- The redirected-to party identity is a target non-local ID.
- The conference URI in a conferencing session is a target.

The above identities are used to identify that an IMS session is intercepted in the IRI-POI and in the CC-TF, the latter when the LI requires CC interception. In addition, the CC-TF uses the redirecting party identity to trigger the CC-POI even if the target is not a non-local ID.

7.12.2.8.2 Target match

7.12.2.8.2.1 General

When an IMS UE performs an IMS registration (using SIP REGISTER) request, the IRI-POI/CC-TF examines the following for a target match:

- From header and To header of the SIP REGISTER when the target identity is IMPU.
- +sip.instance-id of Contact header of the SIP REGISTER when the target identity is PEIIMEI or IMEI.
- Digest username of Authorization header of the SIP REGISTER when the target identity is IMPI.

NOTE: The SIP REGISTER that carries the Authorization header is sent in response when the initial Registration is challenged.

A target match for SIP REGISTER can only be done when the NF where the IRI-POI resides is in the path of the SIP REGISTER flow (e.g. P-CSCF, S-CSCF).

7.12.2.8.2.2 Session based IMS services

This clause describes the method used to identify a session-based IMS service such as IMS-based voice service.

When an IMS session is originated from an IMS UE (using SIP INVITE), the IRI-POI/CC-TF examines the following to verify for a target match:

- P-Asserted Identity header and From header present in the SIP INVITE when the target identity is IMPU.
- Request URI header and To header present in the SIP INVITE when the target identity is IMPU and target is non-local ID.
- Digest username of Authorization header of the SIP REGISTER when the target identity is IMPI.
- +sip.instance-id of Contact header received in the SIP REGISTER request when the target identity is PEIIMEI or IMEI.

The use of Request URI header and To header present in the SIP INVITE for matching target non-local ID is done on the redirected sessions irrespective of whether the session is originated from an IMS UE.

When an IMS session is terminated at an IMS UE (using SIP INVITE), the IRI-POI/CC-TF examines the following to verify for a target match:

- Request URI and To header present in the SIP INVITE when the target identity is IMPU.
- P-Asserted-Identity, From header, History Info header and Diversion header present in the SIP INVITE when the target identity is IMPU and target is non-local ID.
- Digest username of Authorization header of the SIP REGISTER when the target identity is IMPI.
- +sip.instance-id of Contact header received in the SIP REGISTER request when the target identity is PEIIMEI or IMEI.

NOTE: IRI-POI/CC-TF that uses the information received in the SIP REGISTER to perform a target match cannot do such a target match unless the NF is on the signaling path of SIP REGISTER flow.

In addition, the IRI-POI in the alternate deployment option (TS 33.127 [5]) and CC-TF, examine the following to verify a target match when an IMS session is terminated to an IMS UE:

- History Info header and Diversion header present in the SIP INVITE when the target identity is IMPU and the target is not a non-local ID.

For conference sessions, the IRI-POI and CC-TF examine the following to verify a target match:

- P-Asserted-Identity, From header present in the SIP INVITE when a target initiates a conference session or when the target joins a "meet-me" conference session.
- Conference URI present in the SIP INVITE when the conference URI is the target.

IRI-POI/CC-TF may use the Via header or the Route header to determine whether the SIP INVITE is for an originating IMS session or a terminating IMS session. IRI-POI/CC-TF stores (locally) the SIP Call Id to associate the subsequent SIP messages received on the same session for a target match.

7.12.2.8.2.3 Session independent IMS services

This clause describes the method used to identify a session-independent IMS service (i.e. SMS over IP).

For SMS over IP, the SIP MESSAGE includes "vnd.3gpp.sms" as the MIME Content Type in the payload with RP-DATA or RP-ACK as the content, see 3GPP TS 24.341 [95].

For MSISDN-less SMS over IP (i.e. SIP URI instead of MSISDN), SIP MESSAGE additionally includes "vnd.3gpp.sms+xml" as the MIME Content Type in the payload with destination or origination addresses, see 3GPP TS 24.341 [95].

The target match for the SIP MESSAGE is done as shown below:

- For MO-SMS over IP, the P-Asserted Identity header and From header present in the SIP MESSAGE when the target identity is IMPU.
- For MO-SMS over IP, the TP-DA field of SMS-SUBMIT within the Message-body of SIP MESSAGE when the target identity is IMPU for target non-local ID.
- For MO-SMS over IP, the <To> field within the XML body of the content type "vnd.3gpp.sms+xml" present in the Message-body of SIP MESSAGE when the target identity is IMPU for target non-local ID. In this case, the TP_DA field of SMS-SUBMIT is be set to dummy MSISDN, see 3GPP TS 24.341 [95].
- For MT-SMS over IP, the Request URI and To header present in the SIP MESSAGE when the target identity is IMPU.
- For MT-SMS over IP, the TP-OA field or TP-RA field of SMS-DELIVER or SMS-STATUS-REPORT within the Message-body SIP MESSAGE when the target identity IMPU for target non-local ID.
- For MSISDN-less MT-SMS over IP, the <From> field within the XML body of the content type "vnd.3gpp.sms+xml" present in the Message-body of SIP MESSAGE when the target identity is IMPU for target non-local ID. In this case, the TP_OA of SMS-DELIVER or TP-RA field of SMS-STATUS-REPORT may be set to dummy MSISDN, see 3GPP TS 24.341 [95].- Digest username of Authorization header of the SIP REGISTER when the target identity is IMPI.
- Digest username of Authorization header of the SIP REGISTER when the target identity is IMPI.
- +sip.instance-id of Contact header received in the SIP REGISTER request when the target identity is PEIIMEI or IMEI.

NOTE: IRI-POI/CC-TF that uses the information received in the SIP REGISTER to perform a target match cannot do such a target match unless the NF is on the signaling path of SIP REGISTER flow.

IRI-POI may use the Via header or the Route header to determine whether the SIP MESSAGE is for MO-SMS over IP or MT-SMS over IP.

7.12.2.9 Handling of correlation information

The IRI records delivered to the LEMF over the LI_HI2 and the CC delivered to the LEMF over LI_HI3 shall be correlated.

According to the protocol defined in ETSI TS 103 221-1 [7] and ETSI TS 103 221-2 [8], the xIRI messages and the xCC carry the CorrelationID which enables the MDF2 and MDF3 to provide the needed correlation between the IRI and CC.

When the CC-POI is triggered by a CC-TF, the CC-TF sends the CorrelationID to the CC-POI over the LI_T3 interface in the ActivateTask message. The CC-POI uses that CorrelationID in the xCC sent to the MDF3.

NOTE: The IRI-POI and CC-POI may be provided within the same NF (e.g. PTC Server, RCS Server). When the CC-POI is triggered from a CC-TF, the IRI-POI and CC-TF may be provided within the same NF (e.g. P-CSCF, AS/MRFC) or in different NFs (e.g. IRI-POI in S-CSCF and CC-TF in P-CSCF).

When the IRI-POI and CC-POI (or CC-TF in a triggered CC-POI case) are in the same NF, the procedures can be similar to the way the correlation of xIRI and xCC are done in the packet core system (e.g. IRI-POI and CC-TF in the SMF). The details of any needed interactions between those LI functions are not defined in the present document.

When the IRI-POI and CC-TF are in separate NFs, any additional procedures that may be needed are also implementation specific and the details of the same are not described in the present document.

7.12.3 Provisioning over LI_X1

7.12.3.1 General

The LIPF shall provision the IRI-POIs, CC-TFs, MDF2 and MDF3 over LI_X1 for IMS-based services using the X1 protocol as described in clause 5.2.2.

The clause 7.12.2.2 provides a list of target identifiers that shall be supported for IMS based services in a general sense.

The target identifiers used during the provisioning over LI_X1 for a specific IMS-based service (e.g. PTC) are listed in the respective service specific clauses.

7.12.3.2 Provisioning of IRI-POI

7.12.3.2.1 Session-based IMS services

The table 7.12.3.2-1 below shows the applicability of NFs in which the IRI-POIs are provisioned with the target identifiers listed in clause 7.12.2.2 for session based IMS sessions (e.g. voice). See TS 33.127 [5] and Annex G.

When the service scoping is applicable, the IRI-POIs in the NFs shown in table 7.12.3.2-1 are provisioned only when the type of service is voice/text or messaging (i.e. MSRP-based).

Table 7.12.3.2-1: IRI-POIs in the NFs that need to be provisioned for session-based IMS service

NF (IMS signaling function)	Not a target non-local ID		Target non-local ID		Reference
	Default	Alternate option	Default	Alternate option	
P-CSCF	YES	YES	YES	NO	In this clause
S-CSCF	YES	NO	NO	YES	In this clause
E-CSCF	YES	NO	NO	NO	In this clause
IBCF	NO	YES	YES	YES	In this clause
MGCF	NO	YES	YES	NO	In this clause
AS	YES	YES	YES	YES	In this clause
HSS	YES	YES	NO	NO	7.2.3

Table 7.12.3.2-2 shows the minimum details of the LI_X1 ActivateTask message used for provisioning the IRI-POIs in the NFs listed in tables 7.12.3.2-1 for session based IMS-based services.

Table 7.12.3.2-2: ActivateTask message for activating IRI-POI for session-based IMS service

ETSI TS 103 221-1 [7] field name	Description	M/C/O
XID	XID assigned by LIPF. The value used here shall be the same when IRI-POIs in multiple NFs are provisioned for a warrant. The value used here shall also be same as the value used for provisioning the CC-TFs (see table 7.12.3.3-1), MDF2 (see 7.12.3.4-1) and MDF3 (see table 7.12.3.5-1).	M
TargetIdentifiers	One or more of the target identifiers listed in the clause 7.12.2.2 with the embedded conditions implied.	M
DeliveryType	Set to "X2Only".	M
ListOfDIDs	Delivery endpoints of LI_X2. These delivery endpoints shall be configured using the <i>CreateDestination</i> message as described in ETSI TS 103 221-1 [7] clause 6.3.1 prior to first use.	M
ListOfServiceTypes	Present if interception is to be done on one or more a specific service type. Using the format defined in ETS TS 103 221 [7] based on the service scoping listed below this table. When multiple intercepts are activated on a target identifier, the service scoping shall be the union of all of them.	C

When service scoping is required, the IRI-POIs present in the NFs listed in table 7.12.3.2-1 shall support the following service types from the structure defined in ETSI TS 103 221-1 [7]:

- The enumerated value of "voice" or "messaging" in the service type field.

The ModifyTask and DeactivateTask messages that the LIPF may send to the IRI-POIs present in the NFs listed in table 7.12.3.2-1 shall include the XID of the Task created by the above ActivateTask message.

7.12.3.2.2 Session-independent IMS services

Table 7.12.3.2-3 below shows the applicability of NFs in which the IRI-POIs are provisioned with the target identifiers listed in clause 7.12.2.2 for session independent services (e.g. SMS over IP). See TS 33.127 [5] and Annex G.

When the service scoping is applicable, the IRI-POIs in the NFs shown in table 7.12.3.2-3 are provisioned only when the service type is messaging (i.e. SMS over IP).

Table 7.12.3.2-3: IRI-POIs in the NFs that need to be provisioned for session-independent IMS-based service

NF (IMS signaling function)	Not a target non-local ID		Target non-local ID		Reference
	Default	Alternate option	Default	Alternate option	
P-CSCF	YES	YES	YES	YES	In this clause
S-CSCF	YES	NO	YES	NO	In this clause
E-CSCF	YES	NO	NO	NO	In this clause
IBCF	NO	YES	NO	YES	In this clause
MGCF	NO	NO	NO	NO	In this clause
AS	NO	NO	NO	NO	In this clause
HSS	YES	YES	NO	NO	7.2.3

Table 7.12.3.2-4 shows the minimum details of the LI_X1 ActivateTask message used for provisioning the IRI-POIs in the NFs listed in table 7.12.3.2-3 for session independent IMS-based voice services.

Table 7.12.3.2-4: ActivateTask message for activating IRI-POI for session independent IMS-based service

ETSI TS 103 221-1 [7] field name	Description	M/C/O
XID	XID assigned by LIPF. The value used here shall be the same when IRI-POIs in multiple NFs are provisioned for a warrant.	M
TargetIdentifiers	One or more of the target identifiers listed in the clause 7.12.2.2 with the embedded conditions implied.	M
DeliveryType	Set to "X2Only".	M
ListOfDIDs	Delivery endpoints of LI_X2. These delivery endpoints shall be configured using the <i>CreateDestination</i> message as described in ETSI TS 103 221-1 [7] clause 6.3.1 prior to first use.	M
ListOfServiceTypes	Present if interception of one or more listed service types is required. Using the format defined in ETS TS 103 221 [7] based on the service scoping listed below this table. When multiple intercepts are activated on a target identifier, the service scoping shall be the union of all of them.	C

When service scoping is required, the IRI-POIs present in the NFs listed in table 7.12.3.2-3 shall support the following service types from the structure defined in ETSI TS 103 221-1 [7]:

- The enumerated value of "messaging" in the service type field.

The ModifyTask and DeactivateTask messages that the LIPF may send to the IRI-POIs present in the NFs listed in table 7.12.3.2-3 shall include the XID of the Task created by the above ActivateTask message.

7.12.3.3 Provisioning of CC-TF

The table 7.12.3.3-1 below shows the applicability of NFs in which the CC-TFs are provisioned with the target identifiers listed in clause 7.12.2.2 for session-based IMS services (e.g. voice). See TS 33.127 [5] and Annex G.

Table 7.12.3.3-1: CC-TFs in the NFs that need to be provisioned for session-based IMS service

NF (IMS signaling function)	Not a target non-local ID		Target non-local ID	
	Default	Alternate option	Default	Alternate option

P-CSCF	YES	YES	YES	NO
IBCF	YES	YES	YES	YES
MGCF	YES	YES	YES	NO
AS/MRFC	YES	YES	YES	YES
Conferencing AS/MRFC	YES	YES	YES	YES

Table 7.12.3.3-2 shows the minimum details of the LI_X1 ActivateTask message used for provisioning the CC-TFs in the NFs listed in table 7.12.3.3-1 for session-based IMS services.

Table 7.12.3.3-2: ActivateTask message for activating CC-TF for session-based IMS services

ETSI TS 103 221-1 [7] field name	Description	M/C/O
XID	XID assigned by LIPF. The value used here shall be the same when IRI-POIs in multiple NFs are provisioned for a warrant. The value used here shall also be same as the value used for provisioning the IRI-POIs (see table 7.12.3.2-2), MDF2 (see 7.12.3.4-1) and MDF3 (see table 7.12.3.5-1).	M
TargetIdentifiers	One or more of the target identifiers listed in the clause 7.12.2.2 with the embedded conditions implied.	M
DeliveryType	Set to "X3Only.	M
ListOfDIDs	Delivery endpoints of LI_X3. These delivery endpoints shall be configured using the <i>CreateDestination</i> message as described in ETSI TS 103 221-1 [7] clause 6.3.1 prior to first use.	M
ListOfServiceTypes	Present if interception of one or more listed service types is required. The value provisioneUsing the format defined in ETS TS 103 221 [7] based on the service scoping listed below this table. When multiple intercepts are activated on a target identifier, the service scoping shall be the union of all of them.	C

When service scoping is required, the CC-TF present in the NFs listed in table 7.12.3.3-1 shall support the following service scoping from the structure defined in ETSI TS 103 221-1 [7]:

- The enumerated value of "voice" or "messaging" in the service type field.

The ModifyTask and DeactivateTask messages that the LIPF may send to the CC-TFs present in the NFs listed in table 7.12.3.3-1 shall include the XID of the Task created by the above ActivateTask message.

7.12.3.4 Provisioning of the MDF2

The MDF2 listed as the delivery endpoint over LI_X2 for xIRI generated by the IRI-POIs shall be provisioned over LI_X1 by the LIPF.

Table 7.12.3.4-1 shows the minimum details of the LI_X1 ActivateTask message used for provisioning the MDF2.

Table 7.12.3.4-1 ActivateTask message for MDF2

ETSI TS 103 221-1 [7] field name	Description	M/C/O
XID	XID assigned by LIPF. The value used here shall also be same as the value used for provisioning the IRI-POIs, CC-TFs, and and MDF3 (see table 7.12.3.5-1).	M
TargetIdentifiers	One or more of the target identifiers listed in the clause 7.12.2.2 with the embedded conditions implied.	M
DeliveryType	Not used.	M
ListOfDIDs	Delivery endpoints of LI_HI2. These delivery endpoints shall be configured using the <i>CreateDestination</i> message as described in ETSI TS 103 221-1 [7] clause 6.3.1 prior to first use.	M
ListOfMediationDetails	Sequence of Mediation Details, see table 7.12.3.4-2.	M

Table 7.12.3.4-2: Mediation Details for MDF2

ETSI TS 103 221-1 [7] field name	Description	M/C/O
LIID	Lawful Intercept ID associated with the task.	M
DeliveryType	Set to "HI2Only".	M
ListOfDIDs	Details of where to send the IRI for this LIID. Shall be included if deviation from the ListofDIDs in the ActivateTask message is necessary. If included, the ListOfDIDs in the Mediation Details shall be used instead of any delivery destinations authorised by the ListOfDIDs field in the ActivateTask Message.	C
ServiceScoping	Present if service scoping is required. Using the format defined in ETS TS 103 221 [7] include the service scoping as applicable to this LIID based on the service scoping listed below the table.	C

The MDF2 shall support the following service scoping from the structure defined in ETSI TS 103 221-1 [7]:

- The enumerated value of "voice" or "messaging" in the service type field.
- When location reporting is required, one or both of "reportBeginingAndEnd", "reportUponChange".

The ModifyTask and DeactivateTask messages that the LIPF may send to the MDF2 present in the NFs listed in table 7.12.3.4-1 shall include the XID of the Task created by the above ActivateTask message.

7.12.3.5 Provisioning of the MDF3

The MDF3 listed as the delivery endpoint over LI_X3 for xCC generated by the IRI-POIs shall be provisioned over LI_X1 by the LIPF.

Table 7.12.3.5-1 shows the minimum details of the LI_X1 ActivateTask message used for provisioning the MDF3.

Table 7.12.3.5-1 ActivateTask message for MDF3

ETSI TS 103 221-1 [7] field name	Description	M/C/O
XID	XID assigned by LIPF. The value used here shall also be same as the value used for provisioning the IRI-POIs, CC-TFs, and MDF2 (see table 7.12.3.4-1).	M
TargetIdentifiers	One or more of the target identifiers listed in the clause 7.12.2.2 with the embedded conditions implied.	M
DeliveryType	Not used.	M
ListOfDIDs	Delivery endpoints of LI_HI3. These delivery endpoints shall be configured using the <i>CreateDestination</i> message as described in ETSI TS 103 221-1 [7] clause 6.3.1 prior to first use.	M
ListOfMediationDetails	Sequence of Mediation Details, See table 7.12.3.5-2.	M

Table 7.12.3.5-2: Mediation Details for MDF3

ETSI TS 103 221-1 [7] field name	Description	M/C/O
LIID	Lawful Intercept ID associated with the task.	M
DeliveryType	Set to "HI3Only".	M
ListOfDIDs	Details of where to send the CCI for this LIID. Shall be included if deviation from the ListofDIDs in the ActivateTask message is necessary. If included, the ListOfDIDs in the Mediation Details shall be used instead of any delivery destinations authorised by the ListOfDIDs field in the ActivateTask Message.	C
ServiceScoping	Present if service scoping is required. Using the format defined in ETS TS 103 221 [7] include the service scoping as applicable to this LIID based on the service scoping listed below the table.	C

When service scoping is required, the MDF3 shall support the following service scoping from the structure defined in ETSI TS 103 221-1 [7]:

- The enumerated value of "voice" or "messaging" in the service type field.

The ModifyTask and DeactivateTask messages that the LIPF may send to the MDF3 shall include the XID of the Task created by the above ActivateTask message.

7.12.4 Generation of xIRIs over LI_X2

7.12.4.1 IRI-POIs in IMS signaling functions

7.12.4.1.1 General

The IRI-POIs present in the NFs provisioned as shown in table 7.12.3.3-1 generate the xIRIs according to the conditions described in TS 33.127 [5] and illustrated in Annex G.

As described in TS 33.127 [5], clause 7.12.3.2.2 and illustrated in Annex G, the present document supports two deployment options:

- Default option.
- Alternate option.

The options used for LI involving a specific IMS service may be different from the option used for LI involving another IMS service. For example, a default option may be used for target non-local ID and an alternate option may be used for a local target ID.

NOTE: One of the obvious conditions not stated in the subsequent clauses is that an NF can provide an IRI-POI functions if and only if the SIP signaling messages pass through that NF.

When a condition (e.g. inbound roaming with LBO) under which an NF provides the IRI-POI functions is dependent on the handling of SIP REGISTER message, the IRI-POIs may have to scan the SIP REGISTER for all IMS users to address the case when that IMS user engages in a communication with a target non-local ID.

7.12.4.1.2 IRI-POI in P-CSCF

7.12.4.1.2.1 Session-based IMS communications

In the default deployment option, the P-CSCF provides the IRI-POI functions when any of the following conditions are met:

- The target is inbound roaming (with LBO) IMS user and is not registered for emergency services. The E-CSCF provides the IRI-POI functions when the target is registered for the emergency services.
- An inbound roaming (with LBO) IMS user is in communication with a target non-local ID.

In the alternate deployment option, the P-CSCF always provides the IRI-POI functions except for the following cases:

- A non-roaming or outbound roaming (with HR) IMS user in communication with a target non-local ID. The S-CSCF provides the IRI-POI functions for such a case.
- An inbound roaming (with LBO) IMS user is in communication with a target non-local ID when the media is home-routed. The IBCF provides the IRI-POI functions for such a case.

With the above conditions met, the IRI-POI present in the P-CSCF identifies that an IMS-based communication is to be intercepted according to clause 7.12.2.8.

7.12.4.1.2.2 Session-independent IMS communications

In the default deployment option, the P-CSCF provides the IRI-POI functions when any of the following conditions are met:

- The target is inbound roaming (with LBO) IMS user and is not registered for emergency services. If applicable, E-CSCF provides the IRI-POI functions when IMS user is registered for emergency services.
- An inbound roaming (with LBO) IMS user is in communication with a target non-local ID.

In the alternate deployment option, the P-CSCF always provides the IRI-POI functions.

With the above conditions met, the IRI-POI present in the P-CSCF identifies that an IMS-based communication is to be intercepted according to clause 7.12.2.8.

7.12.4.1.3 IRI-POI in S-CSCF

7.12.4.1.3.1 Session-based IMS communications

In the default deployment option, the S-CSCF always provides the IRI-POI functions except for the following conditions:

- The target is registered for emergency services and E-CSCF provides the IRI-POI for IMS-based emergency services.
- IMS user is in communication with a target non-local ID. The MGCF or IBCF provide the IRI-POI functions for such a case.
- The S-CSCF is not serving the target.

In the alternate deployment option, the S-CSCF provides the IRI-POI functions when any of the the following condition is met:

- IMS user is in communication with a target non-local ID.
- The S-CSCF is serving the IMS user in communication with the target non-local ID.

With the above conditions met, the IRI-POI present in the S-CSCF identifies that an IMS-based communication is to be intercepted according to clause 7.12.2.8.

7.12.4.1.3.2 Session-independent IMS communications

In the default deployment option, the S-CSCF always provides the IRI-POI functions except for the following conditions:

- The target is registered for emergency services and E-CSCF provides the IRI-POI for IMS-based emergency services.
- The S-CSCF is neither serving the target nor the IMS user in communication with a target non-local ID.

In the alternate deployment option, the S-CSCF does not provide the IRI-POI functions.

When the above conditions are met, the IRI-POI present in the S-CSCF identifies that an IMS-based communication is to be intercepted according to clause 7.12.2.8.

7.12.4.1.4 IRI-POI in E-CSCF

In the default deployment option, the E-CSCF provides the IRI-POI functions except for the following condition (see Annex G):

- S-CSCF provides the IRI-POI for emergency services.

In the alternate deployment option, the E-CSCF does not provide the IRI-POI functions.

When the above conditions are met, the IRI-POI present in the E-CSCF identifies that an IMS-based communication is to be intercepted according to clause 7.12.2.8.

7.12.4.1.5 IRI-POI in IBCF

7.12.4.1.5.1 Session-based IMS communications

In the default deployment option, the IBCF provides the IRI-POI functions when any of the following conditions are met (see Annex G):

- A non-roaming IMS user is in communication with a target non-local ID.
- An outbound roaming IMS user is in communication with a target non-local ID.

In the alternate deployment option, the IBCF shall provide the IRI-POI functions when any of the following conditions are met:

- The target involved is an outbound roaming (with LBO) IMS user.
- The IMS session to a target is redirected to a user in the IP domain.
- IMS session to a target is redirected to an outbound roaming (with LBO) IMS user.
- An inbound roaming (with LBO) IMS user is in communication with a target non-local ID on an IMS session that employs home-routed media.

When the above conditions are met, the IRI-POI present in the IBCF identifies that an IMS-based communication is to be intercepted according to clause 7.12.2.8.

7.12.4.1.5.2 Session-independent IMS communications

In the default deployment option, the IBCF does not provide the IRI-POI functions.

In the alternate deployment option, the IBCF provides the IRI-POI functions except for the following condition:

- The target is an inbound roaming (with LBO) IMS user. The P-CSCF provides the IRI-POI functions for such a case.
- The inbound roaming (with LBO) IMS user is in communication with a non-local target. The P-CSCF provides the IRI-POI functions for such a case.

When the above conditions are met, the IRI-POI present in the IBCF identifies that an IMS-based communication is to be intercepted according to clause 7.12.2.8.

7.12.4.1.6 IRI-POI in MGCF

7.12.4.1.6.1 Session-based IMS communications

In the default deployment option, the MGCF provides the IRI-POI functions when any of the following conditions are met:

- A non-roaming IMS user is in communication with a target non-local ID.
- An outbound roaming IMS user is in communication with a target non-local ID.

For session-based IMS communications, in the alternate deployment option, the MGCF shall provide the IRI-POI functions when the following condition is met:

- The IMS session to a target is redirected to a user in the CS domain.

When the above conditions are met, the IRI-POI present in the MGCF identifies that an IMS-based communication is to be intercepted according to clause 7.12.2.8.

7.12.4.1.6.2 Session-independent IMS communications

For session-independent IMS communications, the MGCF does not provide the IRI-POI functions.

7.12.4.1.7 IRI-POI in AS

7.12.4.1.7.1 Session-based IMS communications

In both default and alternate deployment options, the AS provides the IRI-POI when the interception of IMS sessions involving special services such as conferencing is required.

The IRI-POI present in the AS identifies that an IMS-based communication is to be intercepted according to clause 7.12.2.8.

7.12.4.1.7.2 Session-independent IMS communications

For session-independent IMS communications, the AS does not provide the IRI-POI functions.

7.12.4.2 IMS records

7.12.4.2.1 IMS Message

For an intercepted IMS based communication (see clause 7.12.2.8), the IRI-POI present in the IMS Signaling Function shall generate the xIRI IMSMessage from the SIP message used to handle that IMS based communication. All SIP messages use the same xIRI record as shown in table 7.12.4.2-1.

Table 7.12.4.2-1: Payload for IMSMessage record

Field name	Description	M/C/O
payload	One of the following payload types (other payload types may be added in future versions of the specification): <ul style="list-style-type: none"> encapsulatedSIPMessage: See table 7.12.4.2-2. 	M
sessionDirection	Indicates the direction of the SIP session: fromTarget, toTarget, combined (if target calls him/herself) or indeterminate if the direction cannot be determined reliable (see NOTE).	M
volPRoamingIndication	Indicates whether the roaming mode is inbound LBO, S8HR or N9HR when the target is in roaming situation.	C
location	Location (e.g. PANI Header) with timestamp, if available.	C
NOTE: When an incoming call to a target is redirected to another user, the sessionDirection field shall be set to toTarget. When an incoming call from a target non-local ID to an IMS user is redirected to, the sessionDirection field shall be set to fromTarget.		

Table 7.12.4.2-2: Structure of the encapsulatedSIPMessage parameter

Field name	Description	M/C/O
iPSourceAddress	Indicates the conditional source IPv4 address or source IPv6 address field in the PDU header to the source IP address of the intercepted SIP message (see ETSI TS 103 221-2 [8] clause 5.3).	M
iPDestinationAddress	Indicates the conditional destination IPv4 address or destination IPv6 address field in the PDU header to the destination IP address of the intercepted SIP message (see ETSI TS 103 221-2 [8] clause 5.3).	M
sIPContent	The relevant SIP message, or SIP message header if the warrant requires IRI-only. In addition, for IRI-only intercepts, specific content (e.g. SIP MESSAGE method) may have to be deleted.	M

The IRI-POI present in the IMS signaling function generating an xIRI containing an IMSMessage record shall set:

- The Payload Direction field in the PDU header to the direction of the signaling message carried in the IRI payload (see ETSI TS 103 221-2 [8] clause 5.2.6). If the signalling message was sent from the target, the Direction Value "3" (sent from the target) shall be used, if the signalling message was sent to the target, the Direction Value "2" (sent to the target) shall be used; if the direction could not be determined reliably, the Direction Value "1" (not known to the POI) shall be used. If the SIP message is sent from and to the target, the Direction Value "4" (more than one direction) shall be used. For the SIP messages generated by the network, the Direction Value "5" (not applicable) shall be used.
- The conditional source IPv4 address or source IPv6 address field in the PDU header to the source IP address of the intercepted SIP message (see ETSI TS 103 221-2 [8] clause 5.3). It shall contain the source address of the packet from the 32-bit "Source Address" field in IPv4, as defined in IETF RFC 791 [34], or from the 128-bit "Source Address" field in IPv6, as defined in IETF RFC 2460 [27].
- The conditional destination IPv4 address or destination IPv6 address field in the PDU header to the destination IP address of the intercepted SIP message (see ETSI TS 103 221-2 [8] clause 5.3). It shall contain the destination

address of the packet from the 32-bit "Source Address" field in IPv4, as defined in IETF RFC 791 [34], or from the 128-bit "Source Address" field in IPv6, as defined in IETF RFC 2460 [27].

7.12.4.2.2 Start of interception with Active IMS session

The IRI-POI present in the IMS signaling function shall generate the xIRI StartOfInterceptionForActiveIMSSession when all of the following conditions are met:

- The IRI-POI receives an LI_X1: ActivateTask from the LIPF.
- The IRI-POI detects the IMS user identified by one or more of the target identifier (s) included in the ActivateTask is on an active IMS session.
- The IRI-POI in the IMS signaling functions meets the criteria mentioned in TS 33.127 [5] for providing the IRI-POI functions.

The generation of the xIRI shall be independent of the IMS media associated with the session. If multiple IMS sessions are active at the start of interception, a StartOfInterceptionForActiveIMSSession record shall be generated for each active session.

The following table contains parameters, with IRITargetIdentifier, generated by the IRI-POI.

Table 7.12.4.2.-3: Payload for StartOfInterceptionForActiveIMSSession record

Field name	Description	M/C/O
originatingId	Identities of the originator of the session.	M
terminatingId	Identities of the termination of the service.	M
SDPState	Latest state of session from IMS signaling function (including LMISF) will provide the agreed SDP answer and related modification (encoded in SDP format as per RFC 4566 [43] clause 5 when known.) for each media stream of the target.	C
diversionIdentity	Provided if available and applicable.	C
volPRoamingIndication	Indicates whether the roaming mode is LBO, S8HR or N9HR when the target is in roaming situation.	C
location	Location (e.g. PANI Header) with timestamp, if available.	C

7.12.4.2.3 IMS CC Unavailable

The IRI-POI present in the IMS signaling function that also has the CC-TF (which would have triggered the media interception at the CC-POI) shall generate the xIRI IMSCCUnavailable when the media is not available for interception in the CSP's network.

Accordingly, the IRI-POI present in the IMS signaling function that has the CC-TF shall generate the xIRI IMSCCUnavailable when the following conditions are met:

- The target of interception is on an IMS session with established SDP offer and answer.
- The media does not enter the IMS network of the CSP that has received the warrant. In other words, the CC-TF does not send the LI_T3 ActivateTask to the CC-POI.
- The CSP is required to send a notification to the LEMF when the media interception is required but not available for the interception.

NOTE: The details of any interactions required between the IRI-POI and CC-TF present in the same IMS Signaling Function (e.g. IBCF) is outside the scope of the present document.

The payload of the IMSCCUnavailable xIRI is as shown in table 7.12.4.2-4.

Table 7.12.4.2.-4: Payload for IMSCCUnavailable record

Field name	Description	M/C/O
cCUnavailableReason	Provides the reason for the unavailability of CC.	M
sDPState	The latest SDP information, if known.	C

7.12.5 Triggering of CC-POI by CC-TF over LI_T3

7.12.5.1 CC-TFs in IMS signaling functions

7.12.5.1.1 General

The CC_TFs present in the NFs provisioned as shown in table 7.12.3.3-1 activate the CC-POIs according to the conditions described in TS 33.127 [5] and illustrated in Annex G.

NOTE 1: One of the obvious conditions not stated in the subsequent clauses is that an NF can provide the CC-TF functions if and only if the SIP signaling messages pass through that NF.

NOTE 2: The CC-TF functions apply only for session-based IMS communications.

When a condition (e.g. inbound roaming with LBO) under which an NF provides the CC-TF functions is dependent on the handling of SIP REGISTER message, the CC-TFs may have to scan the SIP REGISTER for all IMS users to address the case when that IMS user engages in a communication with a target non-local ID.

7.12.5.1.2 CC-TF in P-CSCF

The P-CSCF provides the CC-TF functions when the CC-POI functions are provided at the IMS-AGW.

The P-CSCF always provides the CC-TF functions (based on the call direction, of-course) except for the following cases:

- A non-roaming IMS user in communication with a target non-local ID. IBCF or MGCF provide the CC-TF functions for that case.
- An outbound roaming (with LBO) IMS user is in communication with a target non-local ID. IBCF or MGCF provide the CC-TF functions for that case.

When an inbound roaming (LBO) IMS user is in communication with a target non-local ID, two deployment options are defined (see TS 33.127 [5]) for providing the CC-TFs functions. The P-CSCF provides the CC-TF functions except for the following case:

- An inbound roaming (with LBO) IMS user is in communication with a target non-local ID when the media is home-routed. IBCF provides the CC-TF functions for that case.

With the above conditions met, the CC-TF present in the P-CSCF identifies that an IMS-based communication is to be intercepted according to clause 7.12.2.8.

7.12.5.1.3 CC-TF in IBCF

The IBCF provides the CC-TF functions when the CC-POI functions are provided at the TrGW.

The IBCF provides the CC-TF functions when any of the following conditions are met:

- A non-roaming IMS user is in communication with a target non-local ID in the IP domain.
- An outbound roaming IMS user is in communication with a target non-local ID in the IP domain.
- IMS session is to an outbound roaming (with LBO) target.
- An IMS session to a target is redirected to a user in the IP domain.
- An IMS session to a target is redirected to an outbound roaming (with LBO) IMS user.

- An inbound roaming (with LBO) IMS user is in communication with a target non-local ID on an IMS session that employs home-routed media and alternate deployment option is used for media interception.

When the above conditions are met, the CC-TF present in the IBCF identifies that an IMS-based communication is to be intercepted according to clause 7.12.2.8.

7.12.5.1.4 CC-TF in MGCF

The MGCF provides the CC-TF functions when the CC-POI functions are provided at the IM-MGW.

The MGCF provides the CC-TF functions when any of the following conditions are met (see Annex G):

- A non-roaming IMS user is in communication with a target non-local ID in the CS domain.
- An outbound roaming IMS user is in communication with a target non-local ID in the CS domain.
- An IMS session to a target is redirected to a user in the CS domain.

When the above conditions are met, the CC-TF present in the MGCF identifies that an IMS-based communication is to be intercepted according to clause 7.12.2.8.

7.12.5.1.5 CC-TF in AS/MRFC

The AS/MRFC provides the CC-TF functions when the CC-POI functions are provided at the MRFP.

The AS/MRFC provides the CC-TF functions when the interception of IMS sessions involving special services such as conferencing, music or tones is required.

The CC-TF present in the AS/MRFC identifies that an IMS-based communication is to be intercepted according to clause 7.12.2.8.

7.12.5.2 LI_T3 triggering details

7.12.5.2.1 General

As described in clause 7.12.5.1, the CC-POI may reside in the IMS-AGW, TrGW, IM-MGW or the MRFP. The trigger to perform the media interception is provided by the CC-TF present in the P-CSCF, IBCF, MGCF, AS/MRFC respectively.

NOTE 1: The present document assumes that the above NFs that have the CC-TF and the NFs that have the CC-POI interact with each other using the H.248 messages.

When the IRI-POI and the CC-TF are provided by two different NFs, the interception of media is performed at the core-network side of the NF that has the CC-POI. This is to align the media interception with the SDP information reported in the xIRI.

When the IRI-POI and the CC-TF are provided by the same NF, based on the deployment option, the interception of media can be done at the access side or core network side of an IMS-AGW, at the peer network side or the core network side of an TrGW. For the IM-MGW, the media interception is always done on the core network side since the peer network is in CS domain. For the MRFP, all sides are core network and therefore, the media interception is always on the core network side.

The possibilities of such media interception points are illustrated in figure 7.12.5.2-1.

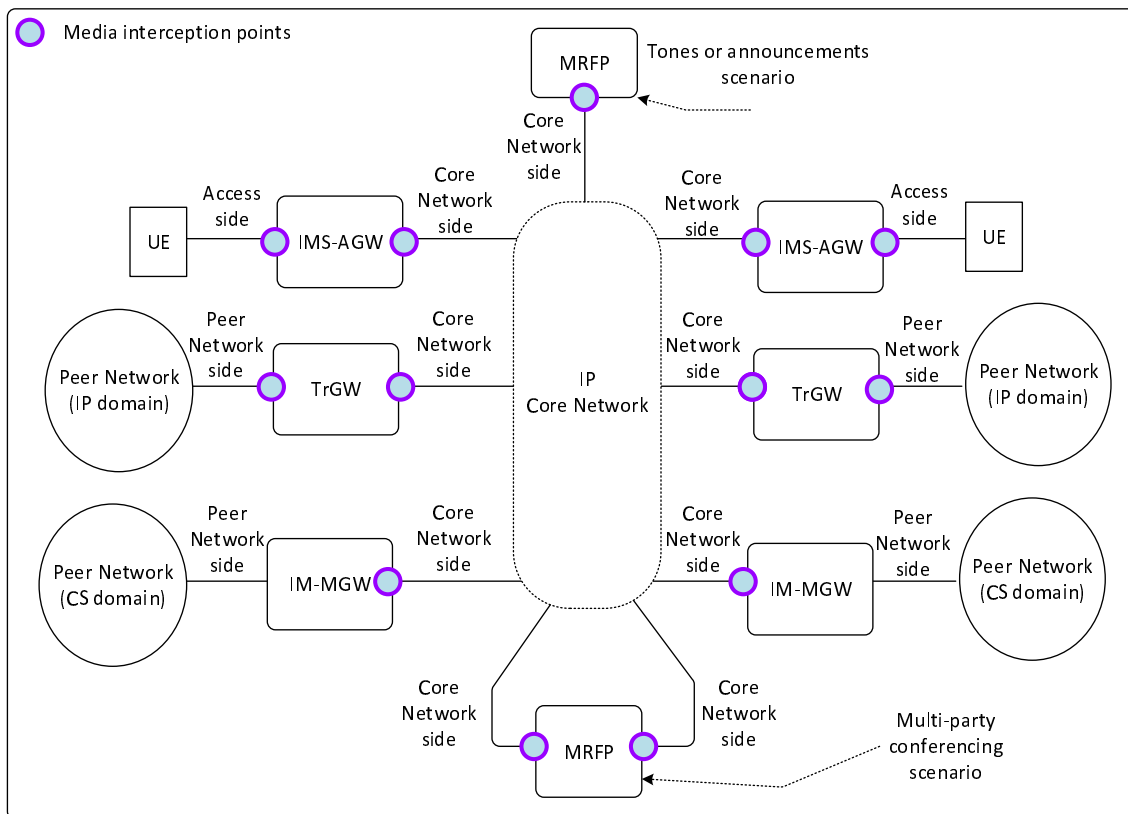

Figure 7.12.5.2-1: Media interception point options in the CC-POIs

NOTE 2: Even when the option of access side or peer network side is chosen, for certain session scenarios (e.g. hold), media interception may have to be moved to the core network side.

The time at which trigger is sent to the CC-POI has a relationship to the NF (that has the CC-TF) handling of SIP messages that carry the SDP offer and SDP answer as those SIP messages result in the NF (that has the CC-TF) creating/modifying the media contexts at the NF that handles the media.

The procedures used to activate (i.e. trigger) the media interception at the CC-POI present in IMS-AGW, TrGW and IM-MGW are the same. The procedures used to activate (i.e. trigger) the media interception at the MRFP can be different due to the nature of media functions provided by the MRFP can be different (e.g. conferencing, announcements).

7.12.5.2.2 Activation Task

7.12.5.2.2.1 Overview

The ActivateTask message over the LI_T3 interface is sent from CC-TF to CC-POI as a trigger to start the media interception at the CC-POI. The details of the ActivateTask are as shown in table 7.12.5.2.2-1:

Table 7.12.5.2.2-1: ActivateTask message for triggering the CC-POI over LI_T3

ETSI TS 103 221-1 [7] field name	Description	M/C/O
XID	Allocated by the CC-TF as per ETSI TS 103 221-1 [7].	M
TargetIdentifiers	IP address and the UDP port number are to be used at the CC-POI in identifying the IMS media that needs to be intercepted. See table 7.12.5.2.2-2.	M
DeliveryType	Set to "X3Only".	M
ListOfDIDs	Shall give the DID of the MDF3 to which the xCC should be delivered. The delivery endpoint is configured using the CreateDestination message as described in ETSI TS 103 221-1 [7] clause 6.3.1 prior to the task activation.	M
CorrelationID	This value is set by the CC-TF and shall be same as the value to be used in the xCC generated at the CC-POI.	M
ProductID	Shall be set to the XID of the Task Object associated with the interception at the CC-TF. This value shall be used by the CC-POI to fill the XID field of xCC sent over LI_X3 to the MDF3.	M
TaskDetailsExtensions/SDP	See table 7.12.5.2.2-3.	M

Along with the IP address and UDP port number, a few additional identifiers are needed for the media interception. These are shown as TargetIdentifierExtension in table 7.12.5.2.2-2 and TaskDetailsExtensions in table 7.12.5.2.2-3.

Table 7.12.5.2.2-2: Target identifiers and extensions for LI_T3

Identifier type	Owner	ETSI TS 103 221-1 [7] TargetIdentifier type	Definition
IPv4 Address	ETSI	IPv4Address	ETSI TS 103 221-1 [7]
IPv6 Address	ETSI	IPv6Address	ETSI TS 103 221-1 [7]
UDP Port Number	ETSI	UDPPort	ETSI TS 103 221-1 [7]
H248 Context ID	3GPP	TargetIdentifierExtension/ H248ContextID	H248ContextID (see XSD Schema)
Payload Direction Assignment	3GPP	TargetIdentifierExtension/ PayloadDirectionAssignment	PayloadDirectionAssign ment (see XSD Schema)
Trigger Scope	3GPP	TargetIdentifierExtension/ TriggerScope	TriggerScope (see XSD Schema)

Table 7.12.5.2.2-3: SDP task details extensions for LI_T3

Extensions field name	Description	M/C/O
LocalSDP	SDP sent to the remote end of the session (see paragraph below)	C
RemoteSDP	SDP received from the remote end of the session (see paragraph below)	C

The IP address and the UDP port number as target identifiers give the destination address at the UDP layer of the to-be intercepted media. For symmetric media, the same IP address and UDP port number give the source address at the UDP layer of the to-be-intercepted media in the reverse direction.

The H248ContextID identifies the identity of the media context created at the IMS Media Function using the H.248 Add Context message.

The TriggerScope indicates whether IP address and UDP port number included as the target identifiers in the LI_T3 ActivateTask are to be used for bidirectional media or unidirectional media. In the latter case, a separate trigger shall be sent to intercept media in the reverse direction. "Bidirectional" and "Unidirectional" are the values that can be set for the TriggerScope by the CC-TF in the ActivateTask message.

When the TriggerScope is "Unidirectional", the IP address and UDP port number identify the destination IP address and the UDP port number of the intercepted IMS media stream. When the TriggerScope is "Bidirectional", the IP address and UDP port number identify the destination IP address and UDP port number of the incoming intercepted IMS media and the source IP address and UDP port number of the outgoing IMS media.

The PayloadDirectionAssignment field indicates the direction of the media stream destined to the IP address and UDP port number (indicated as target identifiers in the ActivateTask) from the perspective of the target. "FromTarget", "ToTarget" and "NotDetermined" are the values that can be set for this by the CC-TF in the ActivateTask message.

The LocalSDP provides the SDP information to be sent in a SIP message by the NF that has the CC-TF. The RemoteSDP provides the SDP information received in a SIP message at the NF that has the CC-TF. In some cases, both LocalSDP and RemoteSDP may be included in the ActivateTask message. The CC-POI is expected to use the LocalSDP to populate the SDP Session Description field of the X3 PDUs for the incoming media streams and to use the RemoteSDP to populate the SDP Session Description field of the X3 PDUs for the outgoing media streams.

7.12.5.2.2.2 Activation of CC-POI in IMS-AGW, TrGW, IM-MGW

The CC-TF shall send a trigger to the CC-POI using the ActivateTask message over the LI_T3 interface for an intercepted IMS session (as determined according to the clause 7.12.2.8) that requires the CC interception when the following occur:

- The NF that has the CC-TF receives the acknowledgement (i.e. H.248 Reply) to the H.248: Add Context from the NF that has the CC-POI. The H.248: Add Context is sent when the SIP message that contains the SDP offer is handled.
- The CC-TF receives an ActivateTask from the LIPF over LI_X1 with CC interception required for an IMS session with an already established SDP offer and possibly SDP answer as well. This process is part of a mid-session activation of interception.

When the media streams are asymmetric, the CC-TF shall send a second trigger to the CC-POI using the ActivateTask message over the LI_T3 interface to intercept the media in the reverse direction when the following occur:

- When the SDP offer is received from the side where the media interception is done, the NF that has the CC-TF receives the acknowledgement (i.e. H.248 Reply) to the H.248: Add Context from the NF that has the CC-POI. The H.248: Add Context is sent when the SIP message that contains the SDP offer is handled. This happens at the same time the first trigger (LI_T3 ActivateTask) is sent.
- When the SDP answer is received from the side where the media interception is done, the NF that has the CC-TF receives the acknowledgement (i.e. H.248 Reply) to the H.248 Mod Context from the NF that has the CC-POI. The H.248: Mod Context is sent when the SIP message that contains the SDP answer is handled.
- The CC-TF receives an ActivateTask from the LIPF over LI_X1 with CC interception required for an IMS session with an already established SDP offer and possibly SDP answer as well. This process is part of a mid-session activation of interception.

The details of ActivateTask sent from the CC-TF to the CC-POI over LI_T3 are shown in table 7.12.5.2.2-1.

For the trigger (for the asymmetric media case, it is the first trigger):

- The CC-TF shall use the IP address and UDP port number present in the local descriptor part of the acknowledgement (i.e. H.248 Reply) to an H.248 Add context message. The same IP address and the UDP port numbers are also present in the SIP messages that carry the SDP offer or SDP answer (depending on the SIP message direction and the session scenario).

NOTE 1: The SDP offer may be present in a forward SIP message (e.g. SIP INVITE) or in a response SIP message (e.g. SIP 200 OK). In the latter case, the trigger to perform media interception is sent when the response SIP message is handled.

When the CC-TF and IRI-POI are present in different NFs, the IP address and the UDP port number are associated with the core network side of the NF that has the CC-POI.

When the CC-TF and the IRI-POI are in the same NF, as a deployment option, the CC-TF may choose the side for media interception and hence, includes the IP address and the UDP port number that correspond to the side at which the media interception is to be done. The sides thus chosen based on the IP address and UDP port number can be the access side or core network side when the CC-POI is in IMS-AGW, the side can be peer network side or core network side when the CC-POI is in TrGW, and the side is always the core network side when the CC-POI is in the

IM-MGW (see figure 7.12.5.2-1). The CC-POI is expected to perform the media interception on the side as determined by that IP address and the UDP port number.

For the second trigger that applies to asymmetric media case:

- The CC-TF shall use the IP address and UDP port number present in the remote descriptor part of the of the H.248 transaction that happens between the NF that has the CC-TF and the NF that has the CC-POI. The same IP address and the UDP port numbers are also present in the SIP messages that carry the SDP offer or SDP answer (depending on the SIP message direction and the session scenario).

The remote IP address and the UDP port number are on the same side where the local IP address and UDP port number were provided in the first trigger.

The values that the CC-TF sets for the PayloadDirectionAssignment and TriggerScope shall be determined as described in tables 7.12.5.2.2-4 and 7.12.5.2.2-5.

Table 7.12.5.2.2-4: PayloadDirectionAssignment and TriggerScope values (target identifier from local descriptor)

Media interception side		PayloadDirectionAssignment		TriggerScope	
		Not a non-local ID	Non-local ID	Symmetric media	Asymmetric media
IMS-AGW	Access	FromTarget	ToTarget	"Bidirectional"	n/a
	Core network	ToTarget	FromTarget	"Bidirectional"	"Unidirectional"
TrGW	Peer network	FromTarget	FromTarget	"Bidirectional"	"Unidirectional"
	Core network	ToTarget	ToTarget	"Bidirectional"	"Unidirectional"
IM-MGW	Core network	ToTarget	ToTarget	"Bidirectional"	"Unidirectional"

Table 7.12.5.2.2-5: PayloadDirectionAssignment and TriggerScope values (target identifier from remote descriptor)

Media interception side		PayloadDirectionAssignment		TriggerScope	
		Not a non-local ID	Non-local ID	Symmetric media	Asymmetric media
IMS-AGW	Access	n/a	n/a	n/a	n/a
	Core network	FromTarget	ToTarget	n/a	"Unidirectional"
TrGW	Peer network	ToTarget	ToTarget	n/a	"Unidirectional"
	Core network	FromTarget	FromTarget	n/a	"Unidirectional"
IM-MGW	Core network	FromTarget	FromTarget	n/a	"Unidirectional"

NOTE 2: The media interception of target non-local ID is done in the IMS-AGW only when the IMS user is in communication with the target non-local ID is an inbound roamer with LBO with the alternate deployment option (see TS 33.127 [5]).

NOTE 3: When media is neither sent to nor received from the target (e.g. call waiting scenario, held session), and when the CC-TF is aware of the scenario, the value of "NotDetermined" is used as the PayloadDirectionAssignment value. The CC-TF changes the PayloadDirectionAssignment value using a LI_T3 ModifyTask (see clause 7.12.5.2.3) when the media is cross connected to the target (e.g. held session is retrieved).

The table 7.12.5.2.2-6 shows how the CC-POI is expected to set the Payload Direction field in the xCC based on the PayloadDirectionAssignment and TriggerScope values received in the LI_T3 ActivateTask message.

Table 7.12.5.2.2-6: Expected payload direction value in the xCC

TriggerScope	PayloadDirectionAssignment	RTP stream (media stream) direction	
		To the target identifier	From the target identifier
Bidirectional	FromTarget	"3" from the target	"2" to the target
	ToTarget	"2" to the target	"3" from the target
	NotDetermined	"5" not applicable to this xCC	"5" not applicable to this xCC
Unidirectional	FromTarget	"3" from the target	n/a
	ToTarget	"2" to the target	n/a
	NotDetermined	"5" not applicable to this xCC	n/a

NOTE 4: When the TriggerScope value is "Unidirectional", two LI_T3 triggers are sent to the CC-POI and in this case, the CC-POI is expected to set the Payload Direction field separately according to the PayloadDirectionAssignment received in the corresponding LI_T3 trigger.

The following paragraphs describe the algorithm the CC-TF shall use for the inclusion of the LocalSDP and RemoteSDP in the LI_T3 ActivateTask message.

- When the TriggerScope value is "Bidirectional":
 - When the SDP offer is received at the NF that has the CC-TF (on the side where the media interception is done) before the sending of a ActivateTask to the CC-POI, the CC-TF shall use the SDP information received in the SDP offer as RemoteSDP and the SDP information that will be sent later in the SDP answer of a SIP message as LocalSDP.
 - When the SDP offer is sent by the NF that has the CC-TF (on the side where the media interception is done) after the sending of a ActivateTask to the CC-POI, the CC-TF shall use the SDP information that will be included in the SDP offer of a SIP message as LocalSDP. In this case, the RemoteSDP is sent in the LI_T3 ModifyTask when the SDP answer is received in a SIP message (see clause 7.12.5.2.3).
- When the TriggerScope value is "Unidirectional":
 - When the SDP offer is received at the NF that has the CC-TF (on the side where the media interception is done) before the sending of a ActivateTask to the CC-POI, the CC-TF shall use the SDP information that will be sent later in the SDP answer of a SIP message as the LocalSDP in the first LI_T3 trigger. The SDP information received in the SDP offer as the RemoteSDP in the second LI_T3 trigger.
 - When the SDP offer is sent by the NF that has the CC-TF (on the side where the media interception is done) after the sending of a ActivateTask to the CC-POI, the CC-TF shall use the SDP information that will be included in the SDP offer of a SIP message as LocalSDP in the first trigger.
 - When the SDP answer is received at the NF that has the CC-TF (on the side where the media interception is done), the CC-TF shall use the SDP information received in the SDP answer of SIP message as RemoteSDP of the second LI_T3 trigger.

For the mid-session interception case, the CC-TF shall include both the LocalSDP and RemoteSDP in the trigger (LI_T3 ActivateTask) when the TriggerScope is "Bidirectional".

For mid-session interception case when the TriggerScopeValue is "Unidirectional", the CC-TF shall include the LocalSDP in the first trigger (LI_T3 ActivateTask) and the RemoteSDP in the second trigger (LI_T3 ActivateTask).

The CC-POI is expected to populate the SDP Session Description field of X3 PDU with the SDP information received in the LocalSDP, for the xCC that represent the incoming media streams destined to the IP address and UDP port number specified as the target identifiers.

The CC-POI is expected to populate the SDP Session Description field of X3 PDU with the SDP information received in the RemoteSDP, for the xCC that represent the outgoing media streams. In the case where TriggerScope value is "Bidirectional", the outgoing media streams will be from the IP address and UDP port number specified as the target identifiers. In the case where TriggerScope value is "Unidirectional", the outgoing media streams will be destined to the IP address and UDP port number specified as the target identifiers.

7.12.5.2.2.3 CC-POI in MRFP

The CC-TF present in the AS/MRFC shall send a trigger to the CC-POI present in the MRFP using the ActivateTask message over the LI_T3 interface for an intercepted IMS session (as determined according to the clause 7.12.2.8) that requires the CC interception when the following occurs:

- The AS/MRFC that has the CC-TF receives the acknowledgement (i.e. H.248 Reply) to the H.248: Add Context from the MRFP.

When the media streams are asymmetric, the CC-TF present in the AS/MRFC shall send a second trigger to the CC-POI present in the MRFP using the ActivateTask message over the LI_T3 interface to intercept the media in the reverse direction when the following occur:

- When the SDP offer is received, the AS/MRFC receives the acknowledgement (i.e. H.248 Reply) to the H.248: Add Context from the MRFP. The H.248: Add Context is sent when the SIP message that contains the SDP offer is handled. This happens at the same time the first trigger (LI_T3 ActivateTask) is sent.
- When the SDP answer is received, the AS/MRFC receives the acknowledgement (i.e. H.248 Reply) to the H.248 Mod Context from the MRFP. The H.248: Mod Context is sent when the SIP message that contains the SDP answer is handled.

For a conferencing scenario, the AS/MRFC is expected to send the H.248: Add Context to the MRFP when it handles a SIP message that includes a Conference Factory URI in the Request URI field. Only one LI_T3 ActivateTask is required to intercept the media for a conference.

Additionally, in support of the mid-session interception, the CC-TF present in the AS/MRFC shall send a trigger to the CC-POI present in the MRFP using the ActivateTask message over the LI_T3 interface when the following occur:

- The CC-TF present in the AS/MRFC receives an ActivateTask from the LIPF over LI_X1 with CC interception required, when an incoming IMS session to the target identifier included in the LI_X1 ActivateTask was redirected to voice mail server with an already established SDP offer and possibly SDP answer as well.
- The CC-TF present in the AS/MRFC receives an ActivateTask from the LIPF over LI_X1 with CC interception required, when announcement or tones are being applied to the caller of an incoming IMS session to the target identifier included in the LI_X1 ActivateTask message.
- The CC-TF present in the AS/MRFC receives an ActivateTask from the LIPF over LI_X1 with CC interception required, when the user represented through the target identifier included in the LI_X1 Activate Task is one of the participants in an established conference session.
- The CC-TF present in the AS/MRFC receives an ActivateTask from the LIPF over LI_X1 with CC interception required, when the Conference URI associated with an established conference session is included as a target identifier in the LI_X1 Activate Task message.

When the media streams are asymmetric, the CC-TF present in the AS/MRFC shall send a second trigger to the CC-POI present in the MRFP using the ActivateTask message over the LI_T3 interface to intercept the media in the reverse direction to any of the events except the last two in the above list occurs.

The details of LI_T3 ActivateTask are shown in table 7.12.5.2.2-1.

For the trigger (for the asymmetric media case, it is the first trigger):

- The CC-TF shall use the IP address and UDP port number present in the local descriptor part of the acknowledgement (i.e. H.248 Reply) to an H.248 Add context message. The same IP address and the UDP port numbers are also present in the SIP messages that carry the SDP offer or SDP answer (depending on whether the AS/MRFC receives or sends the SDP offer).

For the second trigger that applies to asymmetric media case:

- The CC-TF shall use the IP address and UDP port number present in the remote descriptor part of the of the H.248 transaction that happens between AS/MRFC and the MRFP. The same IP address and the UDP port numbers are also present in the SIP messages that carry the SDP offer or SDP answer (depending on whether the AS/MRFC receives or sends the SDP offer).

The values that the CC-TF sets for the PayloadDirectionAssignment and TriggerScope shall be determined as described in tables 7.12.5.2.2-7 and 7.12.5.2.2-8.

Table 7.12.5.2.2-7: PayloadDirectionAssignment and TriggerScope values (target identifier from local descriptor)

Service type	PayloadDirectionAssignment			TriggerScope	
	Not a non-local ID	Non-local ID	Conference URI	Symmetric media	Asymmetric media
Redirected	NotDetermined	FromTarget	n/a	"Bidirectional"	"Unidirectional"
Conference	NotDetermined	n/a	NotDetermined	"Bi-directional"	n/a

Table 7.12.5.2.2-8: PayloadDirectionAssignment and TriggerScope values (target identifier from remote descriptor)

Service type	PayloadDirectionAssignment			TriggerScope	
	Not a non-local ID	Non-local ID	Conference URI	Symmetric media	Asymmetric media
Redirected	NotDetermined	ToTarget	n/a	n/a	"Unidirectional"
Conference	NotDetermined	n/a	n/a	n/a	n/a

Tables 7.12.5.2.2-5 and 7.12.5.2.2-6 (clause 7.12.5.2.2) shows how the CC-POI is expected to set the Payload Direction field in the xCC based on the PayloadDirectionAssignment and TriggerScope values received in the LI_T3 ActivateTask message.

For an intercepted conference session, the CC-POI shall perform the media interception in a mixed mode including the media from all conference participants. The concept of Payload Direction, therefore, does not apply to the corresponding xCC.

The CC-TF present in the in the AS/MRFC shall follow the algorithm described in clause 7.12.5.2.2.2 to populate the LocalSDP and RemoteSDP fields of LI_T3 ActivateTask.

7.12.5.2.2.4 Activation of CC-POI when media interceptions are done at both sides IMS media function

This is a special case where the media interception is done at both sides of an IMS Media Function. In this case, the CC-POI would intercept the outgoing media streams on both sides of IMS Media Function as shown in figure 7.12.5.2-2 below.

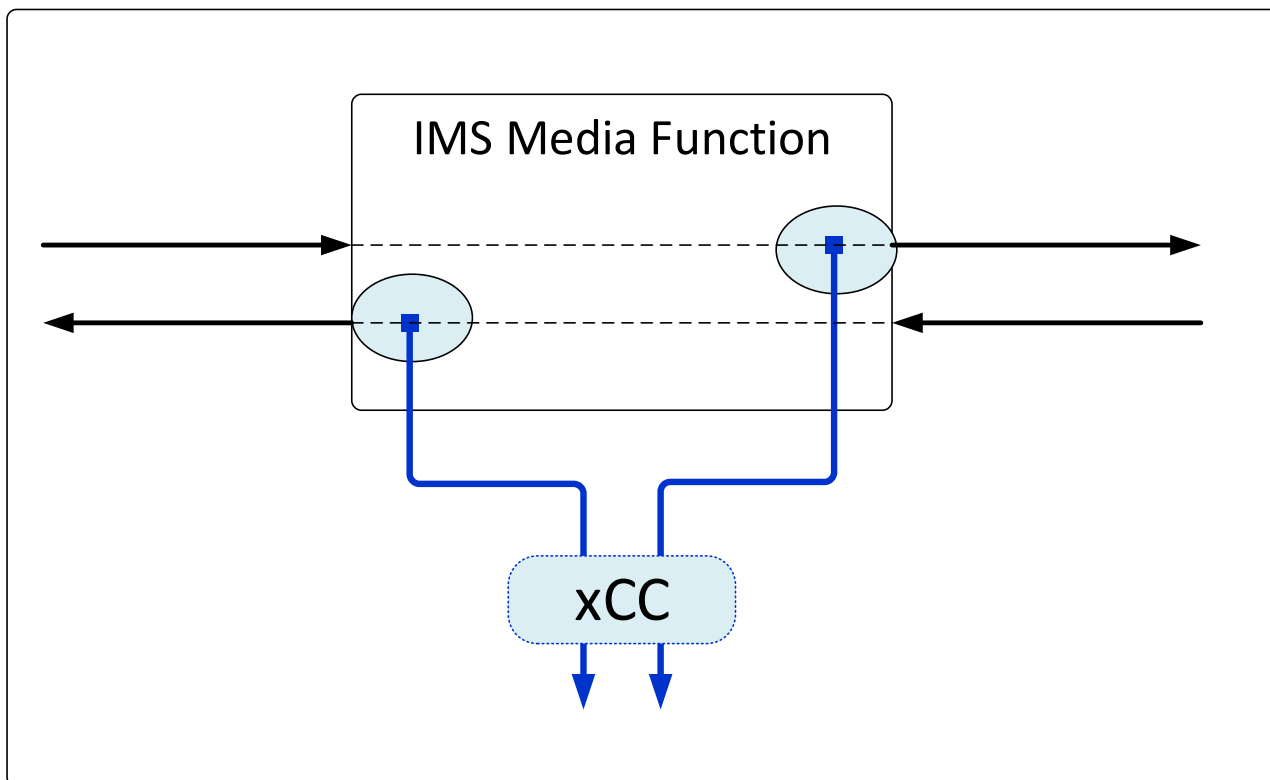

Figure 7.12.5.2.2-2: Media interception on both sides of the IMS Media Function

The CC-POI would capture the media streams destined to the remote IP address and UDP port number for the generation of xCC both sides. For this case, even if the media streams are symmetric, the TriggerScope shall be set to "Unidirectional". Accordingly, the CC-TF shall send the two triggers to CC-POI using the ActivateTask message over the LI_T3 interface when the following occur:

- When the SDP offer is received from the side where the media interception is done, the NF that has the CC-TF receives the acknowledgement (i.e. H.248 Reply) to the H.248: Add Context from the NF that has the CC-POI.
- When the SDP answer is received from the side where the media interceptions is done, the NF that has the CC-TF receives the acknowledgement (i.e. H.248 Reply) to the H.248: Mod Context from the NF that has the CC-POI.
- The CC-TF receives an ActivateTask from the LIPF over LI_X1 with CC interception required for an IMS session with an already established SDP offer and possibly SDP answer as well. This process is part of a mid-session activation of interception.

The details of ActivateTask sent from the CC-TF to the CC-POI over LI_T3 are shown in table 7.12.5.2.2-1.

The CC-TF shall use the IP address and UDP port number present in the remote descriptor part of the of the H.248 transaction that happens between the NF that has the CC-TF and the NF that has the CC-POI. The same IP address and the UDP port numbers are also present in the SIP messages that carry the SDP offer or SDP answer (depending on the SIP message direction and the session scenario).

The CC-TF shall set the PayloadDirectionAssignment value described in table 7.12.5.2.2-9:

Table 7.12.5.2.2-9: PayloadDirectionAssignment values

Target side	First trigger	Second trigger
On the side from which the SDP offer is received	ToTarget	FromTarget
On the side from which the SDP answer is received	FromTarget	ToTarget

NOTE: When the media is neither sent to nor received from the target (e.g. call waiting scenario, held session), and when the CC-TF is aware of the scenario, the value of "NotDetermined" is used as the PayloadDirectionAssignment value. The CC-TF changes the PayloadDirectionAssignment value using a LI_T3 ModifyTask (see clause 7.12.5.2.3) when the media is cross connected to the target (e.g. held session is retrieved).

For this case, the CC-TF shall include the SDP information in the RemoteSDP of TaskDetailsExtensions of LI_T3 ActivateTask for both triggers as described below:

- When the SDP offer is received at the NF that has the CC-TF (on the side where the media interception is done), the CC-TF shall use the SDP information received in the SDP offer of SIP message as RemoteSDP of the first LI_T3 trigger.
- When the SDP answer is received at the NF that has the CC-TF (on the side where the media interception is done), the CC-TF shall use the SDP information received in the SDP answer of SIP message as RemoteSDP of the second LI_T3 trigger.

The CC-POI is expected to populate the SDP Session Description field of X3 PDU with the SDP information received in the RemoteSDP, for the xCC that represent the outgoing media streams on both sides. The outgoing media streams will be destined to the IP address and UDP port number specified as the target identifiers.

7.12.5.2.3 ModifyTask

The ModifyTask message (s) that a CC-TF may send to a CC-POI shall include the XID of the Task (s) created by the ActivateTask message(s) (see table 7.12.5.2.2-1). The details of the ModifyTask are as shown in the table 7.12.5.2.2-10:

Table 7.12.5.2.2-10: ModifyTask message to update the previous trigger the CC-POI over LI_T3

ETSI TS 103 221-1 [7] field name	Description	M/C/O
XID	Shall be same as in the ActivateTask message (see 7.12.5.2.1).	M
TargetIdentifiers	Shall be same as in the ActivateTask message (see 7.12.5.2.1).	M
DeliveryType	Set to "X3Only".	M
ListOfDIDs	Shall give the DID of the MDF3 to which the xCC should be delivered. The delivery endpoint is configured using the CreateDestination message as described in ETSI TS 103 221-1 [7] clause 6.3.1 prior to the task activation.	M
CorrelationID	Shall be same as in the ActivateTask message (see 7.12.5.2.1).	M
ProductID	Shall be same as in the ActivateTask message (see 7.12.5.2.1).	M
TaskDetailsExtensions/SDP	See table 7.12.5.2-2.	M

The LI_T3 ModifyTask shall also use the same correlation ID, the same target identifiers as used in the LI_T3 ActivateTask.

The examples of few scenarios that may necessitate the sending of a ModifyTask over LI_T3 to the CC-POI are the following:

- When the TriggerScope value used in the LI_T3 ActivateTask is "Bidirectional", the SDP answer is received in a SIP message on the side where the media interception is done. The SDP information received in the SDP answer of SIP message shall be included as RemoteSDP in the LI_T3 ModifyTask. The LI_T3 ModifyTask shall also include the LocalSDP which was previously sent to the CC-POI in the LI_T3 ActivateTask message.

NOTE: The same SDP information is sent to the CC-POI when the TriggerScope value is "Unidirectional" as RemoteSDP in a second LI_T3 ActivateTask trigger (see clause 7.12.5.2.2.2).

- The SDP is changed through a new SDP offer and answer during the session establishment phase.
- The cases such as IP address or UDP port numbers are being changed on an established IMS session (using H.248 Modify Context (which may also include a Add Request to an existing context)).
- When a session is placed on hold, if the media interception sides have to be switched (e.g. from access side of IMS-AGW to core network side of IMS-AGW).
- When a session is placed on hold or retrieved from hold, if the PayloadDirectionAssignment value for the Target Identifier (associated with a previously sent LI_T3 Activate Task or LI_T3 Modify Task) are to be changed.

- When the media interception has to begin only when the media is cross-connected within the NF that has the CC-POI (e.g. call waiting).

Usually, the LI_T3 ModifyTask is sent when the NF that has the CC-TF sends a H.248: Modify Context (or a H.248 Add Request to an existing context) message to the NF that has the CC-POI, if certain aspects of media interception require to be changed.

As an alternate implementation, the CC-TF could use a LI_T3 DeactivateTask (clause 7.12.5.2.4) and LI_T3 ActivateTask (clause 7.12.5.2.1) to handle the held/retrieval scenario. Similarly, as an alternate implementation, the CC-TF could delay the LI_T3 ActivateTask till the media is cut-through within the NF that has the CC-POI in the call waiting scenario.

If two LI_T3 ActivateTask messages were used (asymmetric media stream case), then two LI-T3 ModifyTask messages may be required (depending on the scenario).

7.12.5.2.4 DeactivateTask

The DeactivateTask message(s) that the CC-TF sends to the CC-POI shall include the XID of the Task created by the associated ActivateTask message (see table 7.12.5.2.2-1).

The examples of few scenarios that may necessitate the sending of a DeactivateTask over LI_T3 to the CC-POI are the following:

- Media interception of an IMS session ends.

Usually, the LI_T3 DeactivateTask is sent when the NF that has the CC-TF sends a H.248: Subtract Context to the NF that has the CC-POI which in turn normally happens when the SIP BYE is handled. Also, as an alternate implementation, the CC-TF could send a LI_T3 DeactivateTask when a session is placed on hold.

If two LI_T3 ActivateTask messages were used (asymmetric media stream case), then two LI-T3 DeactivateTask messages are required.

7.12.6 Generation of xCC over LI_X3

7.12.6.1 General

The CC-POI shall generate the xCC for the IMS media based on the LI_T3 trigger received from the CC-TF. The CC-POI shall then deliver the xCC to the MDF3 (destination end point indicated in the LI_T3 trigger).

As described in clause 7.12.5.1, the CC-POI may reside in the IMS-AGW, TrGW, IM-MGW, the MRFP or the LMISF.

7.12.6.2 Media capture

The CC-POI shall use the H248ContextID received in the LI_T3 ActivateTask trigger to match the Context ID seen in the H.248 transactions with the NF that has the CC-TF.

In addition, the CC-POI shall use the IP address and UDP port number received as the target identifiers in the LI_T3 trigger along with the TriggerScope also received in the LI_T3 trigger to identify the media packets to be intercepted for the generation of xCC using the following algorithm:

- When the TriggerScope value received in the LI_T3 trigger is "Unidirectional", the IP address and UDP port number received in the LI_T3 ActivateTask as target identifiers shall match the destination IP address and UDP port number of the media packets.
- When the TriggerScope value received in the LI_T3 trigger is "Bidirectional", the IP address and UDP port number received in the LI_T3 ActivateTask as target identifiers shall match the destination IP address and UDP port number of the incoming media packets and shall match the source IP address and UDP port number of outgoing media packets in the reverse direction.

The CC-POI shall expect to receive two LI_T3 ActivateTask triggers when the value of TriggerScope is "Unidirectional". The two triggers provide the information necessary to identify the media in two directions of the media flow. The H248ContextID in the two triggers are the same. The CorrelationID in the two triggers are the same.

The media packets destined to the local IP address and UDP port number are referred to as incoming media packets. The media packets destined to the remote IP address and UDP port number are referred to as outgoing media packets.

7.12.6.3 Payload format

The CC-POI shall set the payload format to indicate the appropriate payload type (5 for IPv4 packet, 6 for IPv6 packet) as described in ETSI TS 103 221-2 [8] (clauses 5.4 and 5.4.13).

7.12.6.4 Payload direction

The CC-POI shall set the payload direction to indicate the direction of the media packets included in the xCC delivered to the MDF3 as described in ETSI TS 103 221-2 [8] clause 5.2.6 and the following paragraph.

The PayloadDirectionAssignment field received in the LI_T3 ActivateTask message instructs the CC-POI how to populate the Payload Direction for each xCC PDU that it generates. If an intercepted media stream (i.e. IP packet) is destined for the IP address and port given in the LI_T3 ActivateTask message, the CC-POI shall set the Payload Direction of the xCC packet to the value that has the same meaning as the value given in the PayloadDirectionAssignment field. For an intercepted IP packet travelling in the other direction, the CC POI should use the opposite direction value. Specific instructions on how to set the xCC Payload Direction field for given combinations of IP packet direction and TriggerScope value are given in table 7.12.6.4-1 below.

7.12.6.4-1: Payload direction value in the xCC

TriggerScope (LI_T3 trigger)	PayloadDirectionAssignment (LI_T3 trigger)	RTP stream (media stream) direction	
		Media to the LI_T3 target identifier	Media from the LI_T3 target identifier
Bidirectional	FromTarget	"3" from the target	"2" to the target
	ToTarget	"2" to the target	"3" from the target
	NotDetermined	"5" not applicable to this xCC	"5" not applicable to this xCC
Unidirectional	FromTarget	"3" from the target	n/a
	ToTarget	"2" to the target	n/a
	NotDetermined	"5" not applicable to this xCC	n/a

NOTE: When the TriggerScope value is "Unidirectional", two LI_T3 triggers are received from the CC-TF and in this case, the CC-POI sets the Payload Direction field separately according to the PayloadDirectionAssignment received in the corresponding LI_T3 trigger.

In some session scenarios, the media packets destined to the IP address and UDP port number specified as target identifiers in the LI_T3 Activate Task may not be delivered to the intercept target (e.g. call waiting scenario, hold scenario). When the CC-TF is aware of this, it would have used the value "NotDetermined" as the PayloadDirectionAssignment field.

When the xCC is delivered in a combined form (e.g. conference), independent of the PayloadDirectionAssignment value received in the LI_T3 Activate Task, the CC-POI shall use the Payload Direction value 4: *sent to and received from the target*.

7.12.6.5 SDP session description

The CC-POI shall generate the SDP Session Description field (as specified in ETSI TS 103 221-2 [8] clause 5.3.23) of xCC from the the LocalSDP and RemoteSDP received in the LI_T3 trigger from the CC-TF as described below.

When the TriggerScope value is "Bidirectional", the CC-POI may receive the Local SDP and RemoteSDP in one LI_T3 trigger or in two separate LI_T3 triggers. When the TriggerScope value is "Unidirectional", the Local SDP and RemoteSDP are received in two separate triggers.

NOTE 1: When the TriggerScope value in the LI_T3 trigger is "Unidirectional", the CC-TF includes LocalSDP in the LI_T3 trigger that has the local IP address and UDP port number as target identifiers and RemoteSDP in the LI_T3 trigger that has the remote IP address and the UDP port number as the target identifiers.

NOTE 2: When the media interception is done at two sides of the IMS Media Function, the CC-POI receives RemoteSDP in both LI_T3 triggers with the TriggerScope value set to "Unidirectional".

The CC-POI shall include the LocalSDP in the SDP Session Description field of the xCC generated from the incoming media packets. The CC-POI shall include the RemoteSDP in the Session Description field of xCC from the outgoing media media packets. Clause 7.12.6.2 describes how the CC-POI identifies the incoming and outgoing media packets.

NOTE 3: The LocalSDP provides the SDP information (e.g. codec information) expected by the IMS Media Function that has the CC-POI. The media packets sent by the remote end of the media flow are based on this SDP information. Therefore, the LocalSDP is associated to the incoming media packets.

NOTE 4: The RemoteSDP address provides the SDP information (e.g. codec information) expected by the remote end of the media flow. The media packets sent to that remote end of the media flow are based on this SDP information. Therefore, the RemoteSDP is associated to the outgoing media packets.

The SDP Session Description field shall be included in the xCC each time a new LocalSDP or RemoteSDP is received in the LI_T3 trigger from the CC-TF.

7.12.6.6 Additional XID related information

The CC-POI may use the Additional XID Related Information attribute to facilitate efficient delivery of xCC, as specified in ETSI TS 103 221-2 [8] clause 5.3.22.

7.12.7 Generation of IRI over LI_HI2

7.12.7.1 General

When an xIRI is received over LI_X2 from the IRI-POI, the MDF2 shall send the IRI message over LI_HI2 according to clause 5.5.2 of the present document without undue delay.

The IRI message shall contain a copy of the relevant record received from LI_X2. The record may be enriched by other information available at the MDF2 (e.g. additional location information).

The timeStamp field of the ETSI TS 102 232-1 [9] PSHeader structure shall be set to the time present in the timeStamp field of the xIRI.

The threeGPP33128DefinedIRI field (see ETSI TS 102 232-7 [10] clause 15) shall be populated with the BER-encoded IRIPayload.

IRI messages associated with the same IMS session shall have the same CIN (see ETSI TS 102 232-1 [9] clause 5.2.4).

The IRI type parameter (see ETSI TS 102 232-1 [9] clause 5.2.10) shall be included and coded according to table 7.12.7.1-1.

Table 7.12.7.1-1: IRI type for IRI messages

Record type	IRI Type
IMSMMessage	REPORT
StartOfInterceptionForActiveIMSSession	REPORT
IMSCCUnavailable	REPORT

7.12.7.2 Handling of multiple instances of list of mediation details

The MDF2 may have to deliver IRI messages to more than one LEMFs when more than one instances of ListOfMediationDetails are associated with a task (i.e. XID) provisioned at the MDF2.

The MDF2 shall populate the LIID field in the IRI messages delivered over the LI_HI2 accordingly.

7.12.7.3 Mid-session activation for additional warrants at MDF2

When a new warrant is to be activated on a target identity (i.e. the associated IMS user is already the target of interception due to another warrant), the LIPF may use the same XID for the new warrant (e.g. when there is no need to receive two separate copies of xIRI messages over LI_X2). In this case, the LIPF may activate the new warrant only at the MDFs using an LI_X1 ModifyTask message with a new instance of ListOfMediationDetails.

The MDF2 that receives a LI_X1 ModifyTask with a new instance of ListOfMediationDetails shall be able to generate and deliver the IRI message containing the StartOfInterceptionForActiveIMSSession record to the LEMF as represented in the new instance of ListOfMediationDetails without receiving a corresponding xIRI from the IRI-POI. The MDF2 shall generate and deliver such an IRI message for each of the established IMS session legs to the LEMF represented within the ListOfMediationDetails.

The timeStamp field of the ETSI TS 102 232-1 [9] PSHeader structure shall be set to the present time known to the MDF2.

The payload of the StartOfInterceptionForActiveIMSSession record is specified in table 7.12.4.2-3 (see also clause 7.12.7.1).

7.12.7.4 Location reporting

The MDF2 shall include the location information in the IRI messages sent over the LI_HI2 according to the service scoping received within the ListOfMediationDetails of the LI_X1 ActivateTask. For example, if service scoping does not allow the reporting of location to an LEMF, then the MDF2 shall not copy the location information if received in an xIRI to the IRI message sent to that LEMF.

The MDF2 shall also remove the location information (e.g. PANI header) from the SIP message contents included as a part of the IRI message, when the service scoping does not allow the reporting of location to the LEMF.

7.12.8 Generation of CC over LI_HI3

7.12.8.1 General

When xCC is received over LI_X3 from a CC-POI, the MDF3 shall deliver the CC over LI_HI3 to the LEMF according to the clause 5.5.3 of the present document without undue delay.

The MDF3 shall populate the threeGPP33128DefinedCC field with a CCPayload structure containing IMSCCPDU. The IMSCCPDUPayload shall contain the IPv4 or IPv6 packet received over LI_X3.

The MDF3 shall populate the timeStamp field of the ETSI TS 102 232-1 [9] PSHeader structure of CC with the xCC timeStamp and the Payload Direction of the CCPayload structure to reflect the value received on xCC. The LIID and CID fields shall correctly reflect the target identity and communication session to which the CC belongs.

7.12.8.2 Handling of multiple instances of list of mediation details

The MDF3 may have to deliver the received xCC to more than one LEMFs when more than one instances of ListOfMediationDetails are associated with a task (i.e. XID) provisioned at the MDF3. The MDF3 shall populate the LIID field in the CC delivered over the LI_HI3 accordingly.

7.12.8.3 Handling of additional XID related information

In addition to the XID present in the XID field of xCC, the MDF3 shall deliver a copy of the CC to the LEMFs represented in one or more instances of ListOfMediationDetails associated with the XID values present in the Additional XID Related Information received in the xCC.

7.12.8.4 SDP session description

The MDF3 shall deliver the SDP session description received in the xCC over LI_X3 using the SDPInfo element of the IMSCCPDU to the LEMF over LI_HI3. This shall be done each time the SDP Session Description is present on the xCC.

7.12.8.5 Mid-session activation for additional warrants at MDF3

When a new warrant is to be activated on a target identity (i.e. the associated IMS user is already the target of interception due to another warrant), the LIPF may use the same XID for the new warrant (e.g. when there is no need to receive two separate copies of xCC over LI_X3). In this case, the LIPF may activate the new warrant only at the MDFs using an LI_X1 ModifyTask message with a new instance of ListOfMediationDetails.

The MDF3 that receives a LI_X1 ModifyTask with a new instance of ListOfMediationDetails, shall deliver the CC to the LEMF represented in this new instance of ListOfMediationDetails upon the reception of next xCC from the CC-POI.

7.12.8.6 Media handling at the MDF and LEMF

The MDF and LEMF perform protocol level correlation between intercepted signalling and media. LI_T3 ensures that the SDP in the intercepted SIP signalling or in LI_X3 matches the IP/UDP destination IP-address and port for every intercepted RTP stream.

In a scenario where NAT is used, the protocol level correlation may not be possible. In all other scenarios the implementation shall ensure that it is.

To support the interception scenario where transmission of CC occurs before the IRI, the LEMF may use SDP Session Description field in the CC to process the media.

7.13 RCS

7.13.1 Provisioning over LI_X1

7.13.1.1 General

If the warrant is for IRI only, the IRI-POI and IRI-TF in the RCS Servers and the IRI-POI in the HTTP Content Server and the S-CSCF shall be provisioned in accordance with clause 7.13.1.2.

If the warrant is for IRI and CC, then the IRI-POI, IRI-TF, CC-POI and CC-TF in the RCS Servers defined in TS 33.127 [5] clause 7.13.2.1 (see RCS definition in GSMA RCC.07 [78]) and the IRI-POI and the CC-POI in the HTTP Content Server and S-CSCF shall be provisioned in accordance with clause 7.13.1.2.

In both cases, the MDF2 shall be provisioned in accordance with clause 7.13.1.3, and the MDF3 shall be provisioned in accordance with clause 7.13.1.4.

The POIs in the HTTP content server may be provisioned directly by the LIPF as described in clause 7.13.1.2. or may be triggered by the TFs in the RCS Server as described in clause 7.13.2.

7.13.1.2 Provisioning of the POIs and TFs in the RCS Server and the POIs in the HTTP Content Server and S-CSCF by the LIPF

The IRI-POI, CC-POI, IRI-TF and CC-TF present in the RCS Server and the IRI-POI and CC-POI in the HTTP Content Server and S-CSCF are provisioned over LI_X1 by the LIPF using the X1 protocol as described in clause 5.2.2.

The POIs and TFs in the RCS Server and the IRI-POIs in the S-CSCF shall support the following target identifier formats in the ETSI TS 103 221-1 [7] messages (or equivalent if ETSI TS 103 221-1 [7] is not used).

- IMPU.
- IMPI.
- IMEI.
- PEIIMEI.

The POIs in the HTTP Content Server shall support the following additional target identifier formats in the ETSI TS 103 221-1 [7] messages (or equivalent if ETSI TS 103 221-1 [7] is not used).

- SIPURI.
- TELURI.
- GPSIMSDN.
- GPSINAI.
- IMSI.
- SUPIIMSI.
- SUPINAI.
- Email Address.

Table 7.13.1.2-1 shows the minimum details of the LI_X1 ActivateTask message used for provisioning the IRI-POI, CC-POI, IRI-TF and CC-TF in the RCS Servers and the IRI-POI and CC-POI in the HTTP Content Server and S-CSCF.

Table 7.13.1.2-1: ActivateTask message for the IRI-POI, CC-POI, IRI-TF and CC-TF in the RCS Servers and the IRI-POI and CC-POI in the HTTP Content Server and S-CSCF

ETSI TS 103 221-1 [7] field name	Description	M/C/O
XID	XID assigned by LIPF. If the CC-TF or IRI-TF is also being tasked for the same interception, the same XID shall be used. The same XID shall be used at the RCS Servers, the S-CSCF and the HTTP Content Server for the same interception.	M
TargetIdentifiers	One or more of the target identifiers listed in the paragraphs above.	M
DeliveryType	Set to "X2Only", "X3Only" or "X2andX3" as needed to meet the requirements of the warrant. (NOTE: "X2Only" for IRI-POI, IRI-TF and "X3Only" for CC-TF and CC-POI can also be used).	M
ListOfDIDs	Delivery endpoints of LI_X2 or LI_X3. These delivery endpoints shall be configured using the <i>CreateDestination</i> message as described in ETSI TS 103 221-1 [7] clause 6.3.1 prior to first use.	M
ListOfServiceTypes	Shall be included when the task should only intercept specific CSP service types as described in clause 5.2.4. This parameter is defined in ETSI TS 103 221-1 [7], clause 6.2.1.2, table 4.	C

7.13.1.3 Provisioning of the MDF2

The MDF2 listed as the delivery endpoint for xIRI generated by the IRI-POI in the RCS Servers, the IRI-POI in the HTTP Content Server, or the IRI-POI in the S-CSCF shall be provisioned over LI_X1 by the LIPF using the X1 protocol as described in clause 5.2.2. Table 7.13.1.3-1 shows the minimum details of the LI_X1 ActivateTask message used for provisioning the MDF2.

The MDF2 shall support the following target identifier formats in the ETSI TS 103 221-1 [7] messages (or equivalent if ETSI TS 103 221-1 [7] is not used):

- IMPU.
- IMPI.
- IMEI.
- GPSIMSDN.
- GPSINAI.
- IMSI.
- SUPIIMSI.
- SUPINAI.
- Email Address.

Table 7.13.1.3-1: ActivateTask message for MDF2

ETSI TS 103 221-1 [7] field name	Description	M/C/O
XID	Same XID used by the LIPF for provisioning the LI functions of the RCS Servers, the S-CSCF and the HTTP Content Servers for this intercept.	M
TargetIdentifiers	One or more of the target identifiers listed in the paragraph above.	M
DeliveryType	Set to "X2Only", "X3Only" or "X2andX3" as needed to meet the requirements of the warrant. (Ignored by the MDF2).	M
ListOfDIDs	Delivery endpoints of LI_HI2. These delivery endpoints shall be configured using the <i>CreateDestination</i> message as described in ETSI TS 103 221-1 [7] clause 6.3.1 prior to first use.	M
ListOfMediationDetails	Sequence of Mediation Details, see table 7.13.1.3-2.	M

Table 7.13.1.3-2: Mediation Details for MDF2

ETSI TS 103 221-1 [7] field name	Description	M/C/O
LIID	Lawful Intercept ID associated with the task.	M
DeliveryType	Set to "HI2Only".	M
ListOfDIDs	Details of where to send the IRI for this LIID. Shall be included if deviation from the ListofDIDs in the ActivateTask message is necessary. If included, the ListOfDIDs in the Mediation Details shall be used instead of any delivery destinations authorised by the ListOfDIDs field in the ActivateTask Message.	C
ServiceScoping	Shall be included to identify the service(s) and associated service-related delivery settings for this LIID. May include more than one instance of this parameter to allow for different combinations of subparameters associated with a single LIID. This parameter is defined in ETSI TS 103 221-1 [7] Annex C table C.2.	C

7.13.1.4 Provisioning of the MDF3

The MDF3 listed as the delivery endpoint for the xCC generated by the CC-POI in the RCS Servers, the CC-POI in the HTTP Content Servers and the CC-POI in the S-CSCF shall be provisioned over LI_X1 by the LIPF using the X1 protocol as described in clause 5.2.2. Table 7.13.1.4-1 shows the minimum details of the LI_X1 ActivateTask message used for provisioning the MDF3.

The MDF3 shall support the following target identifier formats in the ETSI TS 103 221-1 [7] messages (or equivalent if ETSI TS 103 221-1 [7] is not used):

- IMPU.
- IMPI.
- IMEI.
- GPSIMISDN.
- GPSINAI.
- IMSI.
- SUPIMSI.
- SUPINAI.
- EmailAddress.

Table 7.13.1.4-1: ActivateTask message for MDF3

ETSI TS 103 221-1 [7] field name	Description	M/C/O
XID	Same XID used by the LIPF for provisioning the POIs, TFs of the RCS Servers and the POIs of the HTTP Content Servers and the S-CSCF.	M
TargetIdentifiers	One or more of the target identifiers listed in the paragraph above.	M
DeliveryType	Set to "X2Only", "X3Only" or "X2andX3" as needed to meet the requirements of the warrant (Ignored by the MDF3).	M
ListOfDIDs	Delivery endpoints of LI_HI3 or LI_MDF. These delivery endpoints shall be configured using the <i>CreateDestination</i> message as described in ETSI TS 103 221-1 [7] clause 6.3.1 prior to first use.	M
ListOfMediationDetails	Sequence of Mediation Details, see table 7.13.1.4-2.	M

Table 7.13.1.4-2: Mediation Details for MDF3

ETSI TS 103 221-1 [7] field name	Description	M/C/O
LIID	Lawful Intercept ID associated with the task.	M
DeliveryType	Set to "HI3Only".	M
ListOfDIDs	Details of where to send the CC for this LIID. Shall be included if deviation from the ListofDIDs in the ActivateTask message is necessary. If included, the ListOfDIDs in the Mediation Details shall be used instead of any delivery destinations authorised by the ListOfDIDs field in the ActivateTask Message.	C
ServiceScoping	Shall be included to Identify the service(s) and associated service-related delivery settings for this LIID. May include more than one instance of this parameter to allow for different combinations of subparameters associated with a single LIID. This parameter is defined in ETSI TS 103 221-1 [7] Annex C table C.2.	C

7.13.2 Triggering of the IRI-POI and CC-POI in the HTTP Content Server

7.13.2.1 Triggering of the IRI-POI in the HTTP Content Server over LI_T2

7.13.2.1.1 LI_T2 interface Specifics

In order to allow the IRI-POI in the HTTP content server to detect all events related to files uploaded or downloaded by a target, the IRI-TF in the RCS Server sends a trigger to the IRI-POI present in the HTTP Content Server with the necessary information over the LI_T2 interface.

When the IRI-TF in the RCS Server detects that a file is being uploaded or downloaded by a target UE it shall send an activation message to the IRI-POI in the HTTP Content Server over the LI_T2 interface. The activation message shall contain the correlation identifiers that the IRI-POI in the HTTP Content Server shall use with the xIRI. This can be achieved by sending an ActivateTask message as defined in ETSI TS 103 221-1 [7] clause 6.2.1 with the following details.

Table 7.13.2.1-1: ActivateTask message from the IRI-TF in the RCS Server for the IRI-POI in the HTTP Content Server

ETSI TS 103 221-1 [7] field name	Description	M/C/O
XID	Allocated by the IRI-TF as per ETSI TS 103 221-1 [7].	M
TargetIdentifiers	File detection criteria as determined by the IRI-TF in the RCS Server, which enables the IRI-POI in the HTTP Content Server to isolate target files. The IRI-POI in the HTTP Content Server shall support the identifier types given in table 7.13.2.1-2. NOTE: This value is the target identifier for the IRI-POI in the HTTP Content Server and may be different from the target identifier specified in the warrant.	M
DeliveryType	Set to "X2Only".	M
ListOfDIDs	Delivery endpoints for LI_X2. These delivery endpoints shall be configured by the IRI-TF in the RCS Server using the CreateDestination message as described in ETSI TS 103 221-1 [7] clause 6.3.1 prior to first use.	M
CorrelationID	Correlation ID to assign to xIRI generated by the IRI-POI in the HTTP Content Server. This field is populated with the same CorrelationID the IRI-POI in the RCS Server uses for the associated xIRI.	M
ProductID	Shall be set to the XID of the Task Object associated with the interception at the IRI-TF. This value shall be used by the IRI-POI in the HTTP Content Server to fill the XID of X2 messages.	M
ListOfServiceTypes	Shall be included when the task should only intercept specific CSP service types as described in clause 5.2.4. This parameter is defined in ETSI TS 103 221-1 [7], clause 6.2.1.2, table 4.	C

Table 7.13.2.1-2: Target Identifier Types for LI_T2

Identifier type	Owner	ETSI TS 103 221-1 [7] TargetIdentifier type	Definition
RCS Content URI (See Note)	3GPP	TargetIdentifierExtension / RCSCContentURI	RCSCContentURI (see XSD schema)
NOTE: If the TargetIdentifier used is an RCS Content URI, only one RCS Content URI shall be included per ActivateTask message.			

7.13.2.2 Triggering of the CC-POI in the HTTP Content Server over LI_T3

7.13.2.2.1 LI_T3 interface Specifics

To support the use-cases where the IRI-POI in the HTTP Content Server does not get the identity of the user involved in the file-transfer (and therefore, the CC-POI in the HTTP Content Server cannot perform the interception based on the target identity provisioned by the LIPF), the CC-TF present in the RCS Server sends a trigger to the CC-POI present in the HTTP Content Server. When the CC-TF in the RCS Server detects that a file is being uploaded or downloaded by a target UE, it shall send an activation message to the CC-POI in the HTTP Content Server over the LI_T3 interface. The activation message shall contain the correlation identifiers that the CC-POI in the HTTP Content Server shall use with the xCC. This can be achieved by sending an ActivateTask message as defined in ETSI TS 103 221-1 [7] clause 6.2.1 with the following details.

Table 7.13.2.2-1: ActivateTask message from the CC-TF in the RCS Server for the CC-POI in the HTTP Content Server

ETSI TS 103 221-1 [7] field name	Description	M/C/O
XID	Allocated by the CC-TF as per ETSI TS 103 221-1 [7].	M
TargetIdentifiers	File detection criteria as determined by the CC-TF in the RCS Server, which enables the CC-POI in the HTTP Content Server to isolate target files. The CC-POI in the HTTP Content Server shall support the identifier types given in table 7.13.2.1-2.	M
DeliveryType	Set to "X3Only".	M
ListOfDIDs	Delivery endpoints for LI_X3. These delivery endpoints shall be configured by the CC-TF in the RCS Server using the CreateDestination message as described in ETSI TS 103 221-1 [7] clause 6.3.1 prior to first use.	M
CorrelationID	Correlation ID to assign to xCC generated by the CC-POI in the HTTP Content Server. This field is populated with the same CorrelationID the IRI-POI in the RCS Server uses for the associated xIRI.	M
ProductID	Shall be set to the XID of the Task Object associated with the interception at the CC-TF. This value shall be used by the CC-POI in the HTTP Content Server to fill the XID of X3 messages.	M
ListOfServiceTypes	Shall be included when the task should only intercept specific CSP service types as described in clause 5.2.4. This parameter is defined in ETSI TS 103 221-1 [7], clause 6.2.1.2, table 4.	C

7.13.3 Generation of xIRI at IRI-POI in the RCS Server over LI_X2

7.13.3.1 General

The IRI-POI present in the RCS Servers shall send xIRI over LI_X2 for the events listed in TS 33.127 [5] clause 7.13.4, the details of which are described in the following clauses.

7.13.3.2 Registration

The xIRI containing an RCSRegistration record shall be generated when the IRI-POI in the S-CSCF or in an RCS Server detects that an RCS target matching one of the RCS identifiers, provided via LI_X1 has registered, re-registered or de-registered for RCS services. Accordingly, the IRI-POI in the RCS Server generates the xIRI when the following event is detected:

- When the IRI-POI is located in the S-CSCF:
 - If the S-CSCF uses third-party registrations to notify the RCS Server when a UE registers, when the S-CSCF receives a 200 OK from the RCS Server in response to a third-party SIP REGISTER request registering, re-registering or de-registering a target with the RCS Server.
 - If the S-CSCF is the NF responsible for handling RCS Registrations:
 - When the S-CSCF sends a 200 OK to a target in response to a SIP REGISTER request that includes any of the service feature tags listed in GSMA RCC.07 [78] clause 2.4.4.1 table 3.
 - When the S-CSCF sends a 200 OK to a target in response to a SIP REGISTER request for de-registration when the service features supported by the target include any of the service features listed in GSMA RCC.07 [78] clause 2.4.4.1 table 3.
- When the IRI-POI is located in the RCS Server:
 - When the RCS Server sends a 200 OK to a target in response to a SIP REGISTER request that includes any of the service feature tags listed in GSMA RCC.07 [78] clause 2.4.4.1 table 3.
 - When the RCS Server sends a 200 OK to a target in response to a SIP REGISTER request for de-registration when the service features supported by the target include any of the service features listed in GSMA RCC.07 [78] clause 2.4.4.1 table 3.

7.13.3.3 RCS Message

The IRI-POI present in the RCS Server shall generate an xIRI containing an RCSMessage record when the IRI-POI present in the RCS Server detects that an RCS target has sent or received an RCS message. In this specification, an RCS message refers to any message sent or received in the context of pager mode standalone messaging, large message mode messaging, 1-to-1 chat or group chat. This xIRI is also generated when the target sends or receives a delivery notification or display notification.

Accordingly, the IRI-POI in the RCS Server shall generate the RCSMessage xIRI when it detects the following events:

- The RCS Server receives a SIP MESSAGE from the target or destined to the target, determined by the direction attribute present in the CPM Header, and:
 - The "Contact" or "Accept-Contact" header includes +g.3gpp.icsi-ref="urn%3Aurn-7%3A3gpp-service.ims.icsi.oma.cpm.msg".
 - The SIP "Content-Type" header is "message/cpim".
- The RCS Server receives an MSRP packet from the target or destined to the target and:
 - The content of the MSRP packet is a CPIM (Common Presence and Instant Messaging) object (see definition in IETF RFC 3862 [80]).

7.13.3.4 Session establishment

The IRI-POI present in the RCS Server shall generate an xIRI containing an RCSSessionEstablishment record when the IRI-POI in the RCS Server detects that a SIP session has been established for a large message mode standalone message delivery, a 1-to-1 chat session or a group chat session.

Accordingly, the IRI-POI in the RCS Server shall generate the RCSSessionEstablishment xIRI when it detects the following events:

- The RCS Server receives a SIP 200 OK from the target in response to a SIP INVITE sent to the target with service feature tag +g.gsma.rcs.cpm.pager-large or +g.3gpp.icsi-ref="urn%3Aurn-7%3A3gpp-service.ims.icsi.oma.cpm.largemsg" in the SIP "Contact" header.
- The RCS Server returns a SIP 200 OK to the target in response to a SIP INVITE received from the target with service feature tag +g.gsma.rcs.cpm.pager-large or +g.3gpp.icsi-ref="urn%3Aurn-7%3A3gpp-service.ims.icsi.oma.cpm.largemsg" in the SIP "Contact" header.
- The RCS Server receives a SIP 200 OK from the target in response to a SIP INVITE sent to the target with service feature tag +g.3gpp.icsi-ref="urn%3Aurn-7%3A3gpp-service.ims.icsi.oma.cpm.session" in the SIP "Contact" header.
- The RCS Server returns a SIP 200 OK to the target in response to a SIP INVITE received from the target with service feature tag +g.3gpp.icsi-ref="urn%3Aurn-7%3A3gpp-service.ims.icsi.oma.cpm.session" in the SIP "Contact" header.
- The RCS Server receives a SIP 200 OK from the target in response to a SIP INVITE sent to the target with service feature tag +g.3gpp.icsi-ref="urn%3Aurn-7%3A3gpp-service.ims.icsi.oma.cpm.filetransfer" in the SIP "Contact" header.
- The RCS Server returns a SIP 200 OK to the target in response to a SIP INVITE received from the target with service feature tag +g.3gpp.icsi-ref="urn%3Aurn-7%3A3gpp-service.ims.icsi.oma.cpm.filetransfer" in the SIP "Contact" header.

Annex A (normative): ASN.1 Schema for the Internal and External Interfaces

The ASN.1 module describing the structures used for LI_X2, LI_X3, LI_HI2 and LI_HI3 ("TS33128Payloads") is given in the file *TS33128Payloads.asn* which accompanies the present document.

Annex B (normative): LI Notification

Based on clause 5.6 of the present document, this annex defines a system of management notification of LI system with the LI_HI4 interface.

The LI_HI4 interface shall be used to transport specific LI service O&M information (referred to as LI Notification) from the CSP to the LEMF. The individual parameters of the LI Notification message shall be coded using ASN.1 and the basic encoding rules (BER). The delivery of LI Notification shall be performed directly using the same mechanism as used for delivery of IRI messages over LI_HI2 and CC over LI_HI3.

The LI Notification shall be used to send electronic notification to the LEMF in the following cases:

- 1) after the activation of lawful interception;
- 2) after the deactivation of lawful interception;
- 3) after the modification of an active lawful interception.

Table B.1-1: LI Notification message

Field name	Description	M/C/O
notificationType	Information on the type of notification: activation, deactivation or modification	M
deliveryInformation	Delivery Information which has been decided by the LEA in terms of delivery numbers, IP addresses for LI_HI2 and LI_HI3	O
appliedTargetID	Target Identifier applied in the ADMF for the warrant	O
appliedStartTime	Start time applied to the ADMF for the warrant	C
appliedEndTime	End time applied to the ADMF for the warrant	C

Conditional parameters shall be set as follows:

LI Activation Notification		
Field name	Description	M/C/O
notificationType	Activation	M
appliedStartTime	Always present and represents: The Start Date/Time in the warrant or, The Date/Time of the CSP activation in the ADMF or, The scheduled future Start Date/Time.	C
appliedEndTime	<u>Absence means</u> the interception has been activated with no predefined End Date/Time. <u>Presence means</u> the End time is scheduled to be applied at that (future) time.	C

LI Modification Notification		
Field name	Description	M/C/O
notificationType	Modification	M
appliedStartTime	Present and provides the new Start Date/Time if modified by the LI Modification command	C
appliedEndTime	Present and provides the new End Date/Time if modified by the LI Modification command	C

LI Deactivation Notification		
Field name	Description	M/C/O
notificationType	Deactivation	M
appliedStartTime	Absent	C
appliedEndTime	Present and provides the actual End Date/Time, e.g. timed stop as per initial warrant or as per new warrant, or as pre-emptive audited stop from the LEA, or major LI failure.	C

The individual notifications parameters shall be sent to the LEMF as soon as possible with the lowest latency at least once (if available).

The MDF2/MDF3 will deliver the LInotification message to LEMF.

Annex C (normative): XSD Schema for LI_X1 extensions

The XSD schema describing the extensions used for LI_X1 is given in the file *urn_3GPP_ns_li_3GPPX1Extensions.xsd* which accompanies the present document.

Annex D (informative): Drafting Guidance

D.1 Introduction

This annex provides drafting guidance for contributors wishing to propose changes to the present document.

D.2 Drafting conventions

Table D.2-1: Drafting conventions

D.2.1	The details for each field, including a complete description of the usage, format, cardinality and conditionality of that field, are given in the prose in the main body of the document.
D.2.2	The field names used in the main body of the document match those used in the ASN.1.
D.2.3	ASN.1 comments are not used, except for to indicate where to find a description of the field or structure in the main body of the specification.
D.2.4	If a field is made conditional, the condition for its presence or absence is specified.

D.3 Naming conventions

Table D.3-1: Naming conventions

D.3.1	To meet ASN.1 syntax rules, the first character of each ASN.1 field name are lower-cased.
D.3.2	To meet ASN.1 syntax rules, the first character of an ASN.1 type name are upper-cased.
D.3.3	To meet ASN.1 syntax rules, the first character of a field or a type name is not a number.
D.3.4	Only the character ranges A-Z, a-z and 0-9 are used in names.
D.3.5	Names are be CamelCased, where the first character of each word is upper-cased (except for the first character of the name – see rule D.3.1).
D.3.6	Any acronyms in a name should be entirely upper-cased (except for the first character of the name – see rule D.3.1).

```

ExampleBadStructure ::= SEQUENCE
{
  FirstField      [1] FirstFieldType,      -- D.3.1 First letter of field is upper case
  secondField    [2] secondFieldType,     -- D.3.2 First letter of type is lower case
  3rdField       [3] 3rdFieldType,        -- D.3.3 Names starts with digit
  fourth_field   [4] Fourth_Field_Type,   -- D.3.4 Names include hyphen and underscore
  fifthfield     [5] Fifthfieldtype,      -- D.3.5 Names are not camelCased
  msisdN        [6] MSISDN,              -- D.3.6 Acronyms in field name not wholly upper-cased
  mSISDN        [7] MsisdN               -- D.3.6 Acronyms in type name not wholly upper-cased
}

```

Figure 1 – Naming convention counter-examples

D.4 ASN.1 Syntax conventions

Table D.4-1: ASN.1 Syntax conventions

D.4.1	Modules are defined with EXTENSIBILITY IMPLIED unless there is a specific reason to limit extensibility.
D.4.2	The AUTOMATIC TAGS module directive is not used.
D.4.3	SEQUENCE and CHOICE tag numbers start at one.
D.4.4	ENUMERATED tag numbers start at one.
D.4.5	Anonymous types are not used. Non-trivial fields are assigned their own named type.
D.4.6	Consideration should be given to making types re-usable and independent of a particular release. Re-using or extending an existing type, where the intent is similar, is preferable to creating a new type.
D.4.7	Consideration should be given to making types extensible by declaring them as a SEQUENCE or CHOICE where possible.
D.4.8	Multiple smaller messages or structures with fewer OPTIONAL fields are preferred to larger structures with many OPTIONAL fields, as this increases the ability of the ASN.1 schema to enforce the intent of the specification.
D.4.9	Field names, tag numbers, field types and optional flags are space-aligned where possible. An indent of four spaces is used.
D.4.10	Field and type names (when defining a type) are not in bold.
D.4.11	Braces are given their own line.
D.4.12	OIDs containing a version number are updated when the structure that uses the OID is changed, even if the change is solely to correct a syntactic error. Other OIDs in the same module need not be updated if they are not associated with structures that have been changed.
D.4.13	For backward compatibility, fields added to existing SEQUENCE or SET are defined as OPTIONAL, irrespective of their M/C/O designation in the main body of the specification.

```

ConformatModule
{itu-t(0) identified-organization(4) etsi(0) securityDomain(2) lawfulIntercept(2) ... }

DEFINITIONS EXTENSIBILITY IMPLIED ::=

BEGIN

Structure1 ::= SEQUENCE
{
    field1 [1] Field1,
    field2 [2] Field2
}

Field1 ::= ENUMERATED
{
    choice1(1),
    choice2(2),
    choice3(3)
}

Field2 ::= OCTET STRING

END

```

Figure 2 – Syntax convention example

```

NonconformantModule
{itu-t(0) identified-organization(4) etsi(0) securityDomain(2) lawfulIntercept(2) ... }

DEFINITIONS AUTOMATIC TAGS ::=
-- D.4.1 Not declared with EXTENSIBILITY IMPLIED
-- D.4.2 Declared AUTOMATIC TAGS

BEGIN

Structure1 ::= SEQUENCE {
    field1 [0] ::= ENUMERATED
    {
        choice1(0),
        choice2(2),
        choice3(3)
    },
    field2 [2] Field2
}
-- D.4.11 Braces not given their own line
-- D.4.3 SEQUENCE tags don't start at 1
-- D.4.5 Anonymous type used
-- D.4.4 ENUMERATED tag numbers don't start at 1
-- D.4.10 Field name is bold

```

```
Field2 ::= OCTET STRING           -- D.4.10 Type names in definitions is bold
END
```

Figure 3 – Syntax convention counter-examples

Annex E (normative): XSD Schema for Identity Association

The XSD schema describing the extensions used for Identity Association is given in the file *urn_3GPP_ns_li_3GPPIdentityExtensions.xsd* which accompanies the present document.

Annex F (normative): ASN.1 Schema for LI_XER messages

The ASN.1 schema describing the structures used for LI_XER is given in the file *TS33128IdentityAssociation.asn* which accompanies the present document.

Annex G (informative): LIPF logic

G.1 Background

According to TS 33.126 [3] clause 6.4, the CSP is expected to only deliver Interception Product relating to specific CSP services which are specified implicitly or explicitly in the warrant. In other words, the CSP is expected to perform the interception only for the services indicated in the warrant.

NOTE: The term "interception" used in this annex refers to the step that involves actual capturing and then delivery of the Intercept Product to the LEMF.

This annex considers the following possibilities in the analysis:

- The intended target may have subscribed to only a specific service and in this case, by default, the interception would apply only to such service when specified in the warrant. The CSP network would provide the interception as and when the service is accessed by the target.
- The intended target may have subscribed to multiple services and in this case, the interception would have to be done based on the service type(s) specified in the warrant as and when CSP network detects that such services are accessed by the target.
- A NF may be involved in providing only a particular service and in this case, by default, the interception performed by the POI present in that NF would apply to such service when specified in the warrant.
- A NF may be involved in providing multiple services and in this case, the interception performed by the POI present in that NF would have to be based on the service type applicable to the warrant.
- There may be multiple warrants with differing service types active on a target, in this case, all applicable services would have to be intercepted at the POIs, and the MDFs would have to then deliver Interception Product based on the service type (s) applicable to the warrant.

In supporting the above scenarios, as per clause 4.4 (of the present document), the LIPF will have to provision the POIs, TFs and the MDF2/MDF3 according to the CSP service type(s) applicable to a warrant.

To cover all the scenarios mentioned above, the service type may have to be part of LI provisioning data sent to the MDFs. Whether a service type will have to be provisioned to the POIs and TFs as an indication will depend on the services provided by the NFs that have such POIs and TFs.

In addition to the CSP service type, a few other factors present in the warrant may influence the LIPF logic in provisioning the POIs, TFs and MDF2/MDF3. Few examples are:

- Delivery type.
- LALS triggering.
- CSP deployment options.
- The target type (local Vs non-local ID).

For the target non-local ID, Voice and Messaging type of services are supported in the present document. In this case, the other party communicating with the target non-local ID happens to access the service provided by the CSP.

This annex illustrates the LIPF logic through a series of flow-charts in provisioning the POIs and the TFs. The provisioning aspect of MDF2/MDF3 are not shown.

G.2 Governing scenarios

With respect to the interception performed within the CSP network, there are five scenarios:

1. The target (or party communicating with a target non-local ID) is non-roaming.
2. The target (or party communicating with a target non-local ID) is outbound roaming with HR.
3. The target (or party communicating with a target non-local ID) is outbound roaming with LBO.
4. The target (or party communicating with a target non-local ID) is inbound roaming with HR.
5. The target (or party communicating with a target non-local ID) is inbound roaming with LBO.

The scenario 4 is also referred to as N9HR or S8HR, depending on whether the packet core is 5GC or EPC. As indicated clause G.1, a target can be a non-local ID only when the service type is Voice or Messaging.

The same NF that provides an LI function may be present in one or more of the above scenarios. The LIPF logic, even though may not be aware of the roaming nature of a target, will have to accommodate the above five scenarios while provisioning the LI functions.

G.3 Top-level LIPF provisioning logic

The flow-chart in figure G.3-1 shows a top-level logic within the LIPF to branch off into separate processes according to the service type defined in the present document.

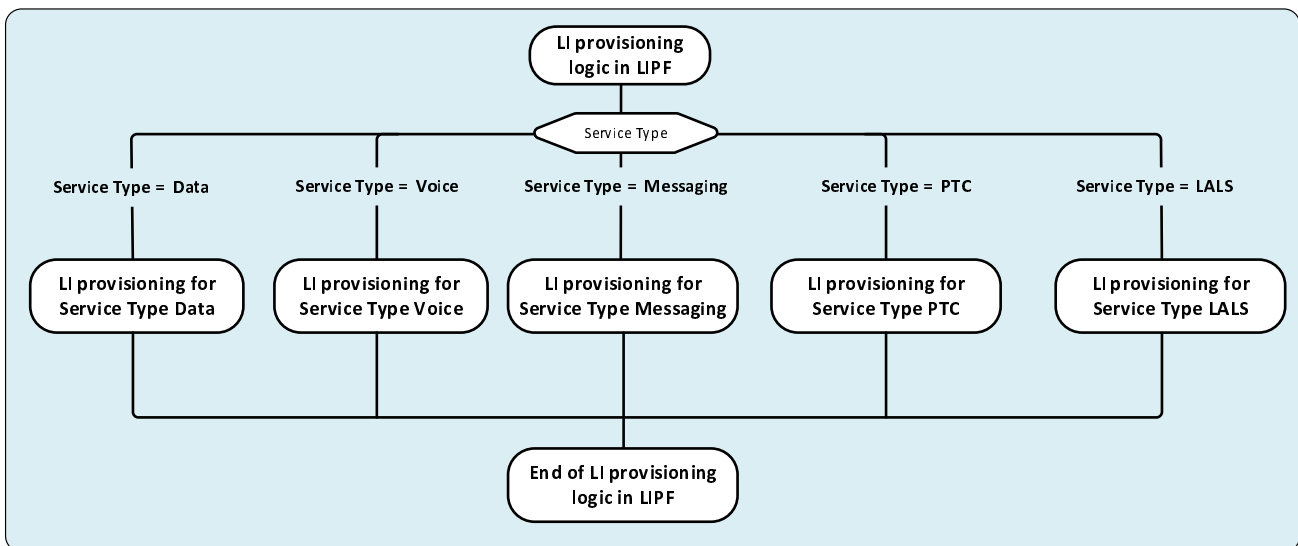

Figure G.3-1: Top-level view of LIPF logic in handling the service type

Based on the LI functionality defined in the present document:

- For the service type of Data, it is assumed that the NFs in the packet core network are involved and hence, provide the IRI and CC interception.
- For the service type of Voice, it is assumed that the NFs in the IMS domain are involved and hence, provide the IRI and CC interception.
- For the service type of Messaging (that includes SMS and MMS), the NFs in the packet core network, IMS or MMS Proxy Relay are involved and hence, provide the IRI and CC interception. The interception of SMS has only the IRIs.
- For the service type of PTC, the PTC Server is involved and hence, provides the IRI and CC interception.
- For the service type of LALS, the LI-LCS Client provides the IRI interception, and the CC interception does not apply to LALS.

The UDM and HSS are also the NFs that have the IRI-POI and the provisioning of IRI-POI in UDM and HSS is independent of the service type indicated in the warrant as long as the target is not indicated as a non-local ID.

G.4 Data

G.4.1 Scope of interception

For the service type of Data, the NFs present in the packet core network provide the LI functions. This annex illustrates the LIPF logic for 5GC and EPC as the two packet core networks.

The interception of service type of Data includes:

- Delivery of IRI, or CC based on the delivery type indicated in the warrant.
- When required, the delivery of packet data header reporting.
- When required, the delivery of LALS reports based on the LALS triggering.

The CSP may have differing implementation options for the packet data header reporting and LALS triggering.

In the case of EPC, the CSP may also have differing deployment options in choosing the NFs (SGW-based Vs PGW-based) that provide the interception.

G.4.2 Top-level view

When the target identifier is one or more of IMSI, IMEI, MSISDN, the LI functions in EPC are provisioned. When the target identifier is one or more variants of SUPI, PEI, GPSI, the LI functions in 5GC are provisioned.

Figure G.4-1 provides the top-level view of LIPF logic for the service type of Data.

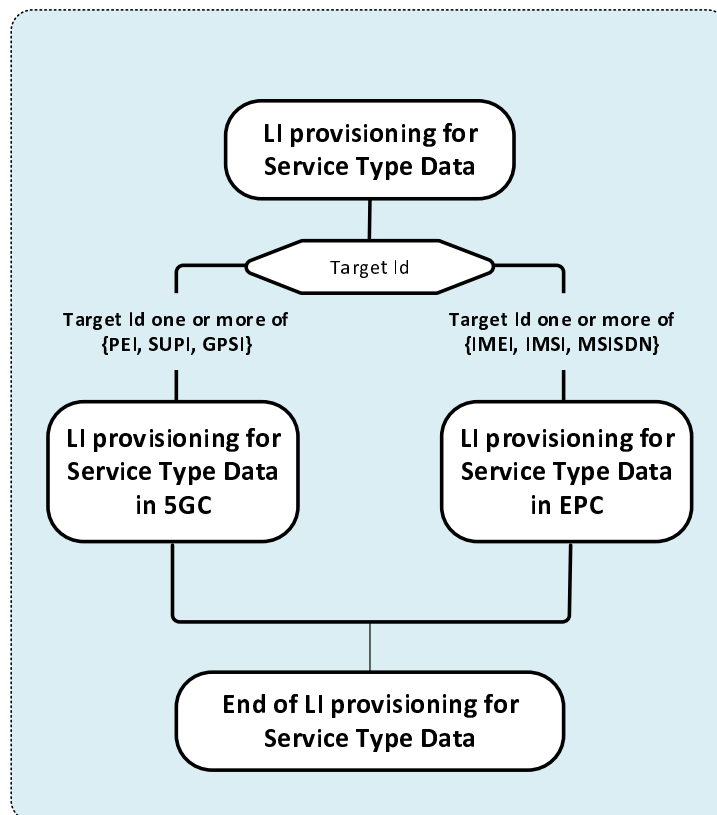

Figure G.4-1: Top-level view of LIPF logic for the service type Data

Within figure G.4-1, PEI collectively represents PEIIMEI and PEIIMEISV. Likewise, SUPI represents SUPIIMSI and SUPINAI whereas GPSI represents GPSIMISDN and GPSINAI.

G.4.3 5GC

G.4.3.1 The flow-chart

Figure G.4-2 shows the LIPF logic in provisioning the LI functions for the 5GC for the service type of Data.

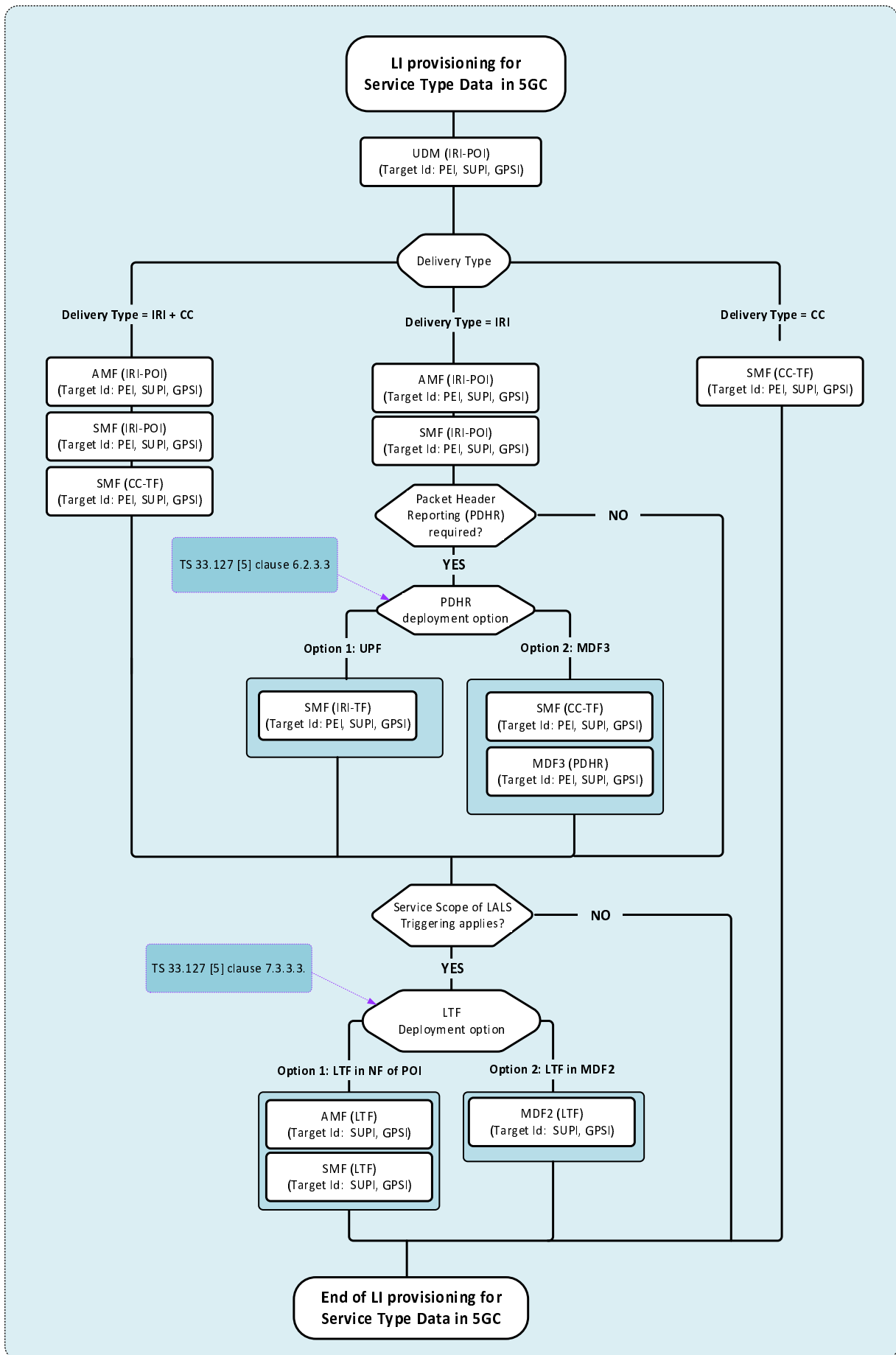

Figure G.4-2: LIPF logic for the service type Data in 5G

For the delivery type of IRI + CC, the IRI-POIs and the CC-TFs are provisioned. For the delivery type of IRI, the IRI-POIs and the IRI-TFs are provisioned. For the delivery type of CC, the CC-TFs are provisioned.

G.4.3.2 Interception

G.4.3.2.1 PDHR

There are two deployment options for the packet data header reporting. It is expected that the CSP implements one of the two deployment options.

In PDHR option 1, the IRI-POI in the UPF (based on a trigger from IRI-TF present in the SMF) generates the xIRI. Accordingly, the IRI-TFs in SMFs are provisioned.

In PDHR option 2, the CC-POI present in the UPF (based on a trigger from CC-TF present in the SMF) delivers the UP packets as xCC to the MDF3, which in turn, forwards the same to the MDF2 and MDF2 would then generate the IRI messages from the received xCC. Accordingly, the CC-TFs in SMFs, and the PDHR handling function in MDF3 are provisioned.

G.4.3.2.2 LALS triggering

There are two deployment options for LALS triggering. It is expected that the CSP implements one of the two deployment options.

In LALS triggering option 1, the LTF present in the host NF that has the associated IRI-POI triggers the LI-LCS Client. Accordingly, the LTFs in AMFs and SMFs are provisioned.

In LALS triggering option 2, the LTF present in the MDF2 triggers the LI-LCS Client. Accordingly, the LTF in MDF2 is provisioned.

G.4.3.2.3 UDM

The UDM is expected to provide the IRI-POI functions in the HPLMN only.

G.4.3.2.4 Summary

Table G.4-1 provides the scope of NF domain that provides the IRI-POI/CC-TF/CC-POI functions for the service type of Data in the 5GC for various scenarios.

Table G.4-1: Scope of NF domain in 5GC providing the LI functions

NFs with LI function			Non-roaming	Roaming with LBO		Roaming with HR	
				VPLMN	HPLMN	VPLMN	HPLMN
UDM			IRI-POI	n/a	IRI-POI	n/a	IRI-POI
AMF			IRI-POI	IRI-POI	n/a	IRI-POI	n/a
SMF			IRI-POI	IRI-POI	n/a	IRI-POI	IRI-POI
SMF			CC-TF	CC-TF	n/a	CC-TF	CC-TF
UPF			CC-POI	CC-POI	n/a	CC-POI	CC-POI
PDHR	Option 1	SMF	IRI-TF	IRI-TF	n/a	IRI-TF	IRI-TF
		UPF	IRI-POI	IRI-POI	n/a	IRI-POI	IRI-POI
	Option 2	SMF	CC-TF	CC-TF	n/a	CC-TF	CC-TF
		UPF	CC-POI	CC-POI	n/a	CC-POI	CC-POI
		MDF3	PDHR	PDHR	n/a	PDHR	PDHR
LALS triggering	Option 1	AMF	LTF	LTF	n/a	LTF	n/a
		SMF	LTF	LTF	n/a	LTF	LTF
	Option 2	MDF2	LTF	LTF	n/a	LTF	LTF

NOTE 1: The use of "n/a" in the above table implies that the LI function is not applicable to the NF for the indicated scenario.

NOTE 2: The LIPF is not aware of the above role played by the host NFs in providing the LI functions.

NOTE 3: MDF2, MDF3 and LI-LCS Client which are also involved in providing the LI functions are not shown in the tables above.

G.4.4 EPC

G.4.4.1 The flow-chart

Figure G.4-3 shows the LIPF logic in determining the host NFs in EPC that have the LI functions for the service type of Data.

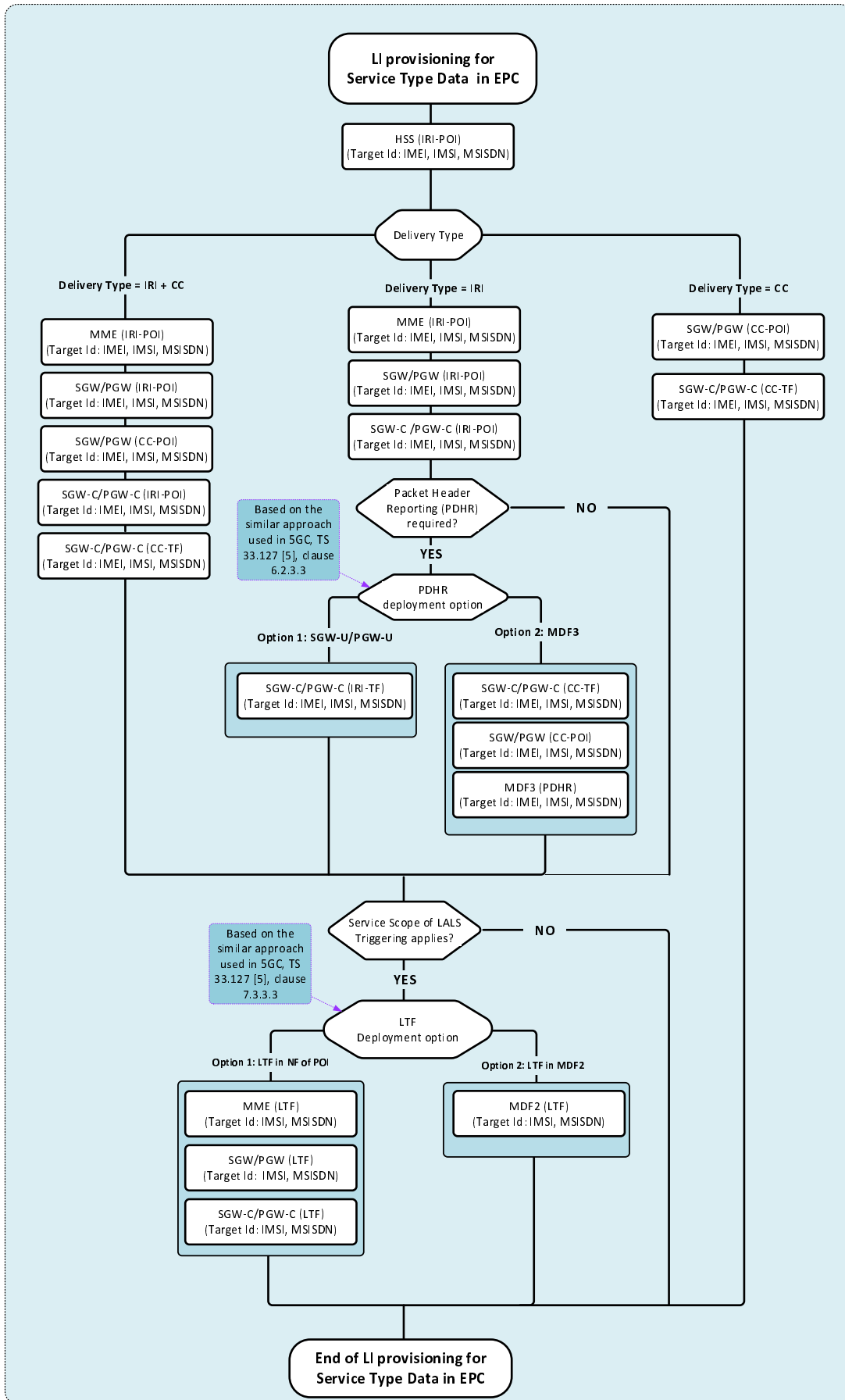

Figure G.4-3: LIPF logic for the service type Data in EPC

For the delivery type of IRI + CC, the IRI-POIs, the CC-TFs and the CC-POIs (when EPC is deployed without CUPS) are provisioned. For the delivery type of IRI, the IRI-POIs and the IRI-TFs (when EPC is deployed with CUPS) are provisioned. For the delivery type of CC, the CC-TFs and the CC-POIs (when EPC is deployed without CUPS) are provisioned.

For the LI within the EPC, the CSP may deploy either an SGW-based interception or a PGW-based interception. The LIPF logic in supporting the two deployment options is illustrated in figure G.4-4.

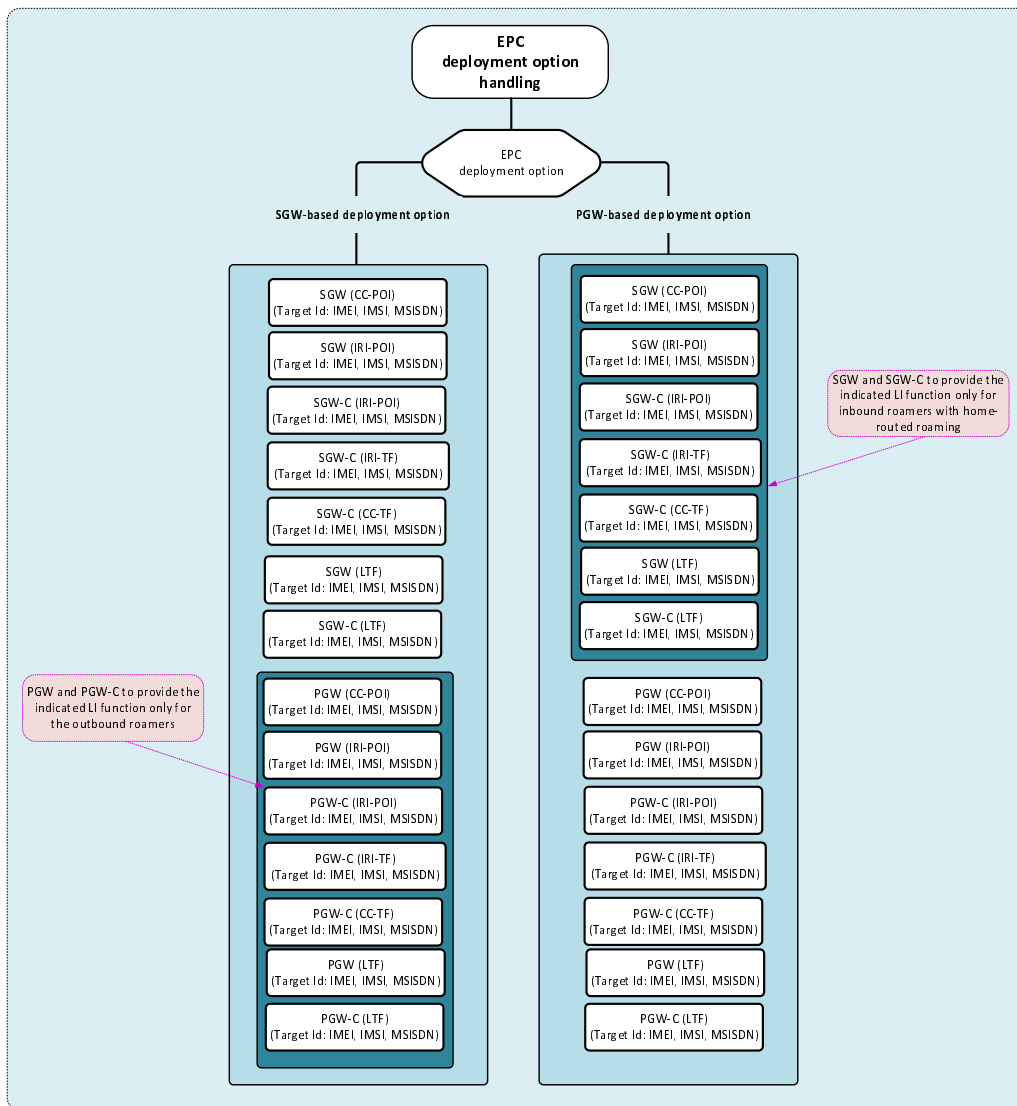

Figure G.4-4: Two deployment options in EPC

The LIPF includes a parameter while provisioning the SGW/SGW-C and PGW/PGW-C.

To PGW/PGW-C, with the SGW based deployment option:

- Provide LI functions only for the targets that are outbound roaming with HR.

SGW/SGW-C, with the PGW based deployment option:

- Provide LI functions only for the targets that are inbound roaming with HR.

The above parameter is needed to avoid both SGW/SGW-C and PGW/PGW-C end up performing the interceptions for the same packet data session.

G.4.4.2 Interception

G.4.4.2.1 PDHR

There are two deployment options for the packet data header reporting. It is expected that the CSP implements one of the two deployment options.

In PDHR option 1, the IRI-POI present in the SGW-U/PGW-U (based on a trigger from IRI-TF present in the SGW-C/PGW-C) or the IRI-POI present in the SGW/PGW generates the xIRI. Accordingly, the IRI-TFs in SGW-C/PGW-C and IRI-POI in SGW/PGW are provisioned.

In PDHR option-2, the CC-POI present in the SGW-U/PGW-U (based on a trigger from CC-TF present in the SGW-C/PGW-C) or the CC-POI present in the SGW/PGW delivers the UP packets as xCC to the MDF3, which in turn, forward the same to the MDF2, and MDF2 would then would generate the IRI messages from the received xCC. Accordingly, the CC-TF in SGW-C/PGW-C, CC-POI in SGW/PGW and the PDHR handling function in MDF3 are provisioned.

G.4.4.2.2 LALS triggering

There are two deployment options for LALS triggering. It is expected that the CSP implements one of the two deployment options.

In LALS triggering option 1, the LTF present in the host NF that has the associated IRI-POI triggers the LI-LCS client. Accordingly, the LTFs in MME, SGW, PGW, SGW-C and PGW-C (when EPC is deployed with CUPS) are provisioned.

In LALS triggering option 2, the LTF present in the MDF2 triggers the LI-LCS Client. Accordingly, the LTF in MDF2 is provisioned.

G.4.4.2.3 SGW/PGW deployment options

For the IRI/CC generation, two deployment options are considered:

- SGW-based.
- PGW-based.

The CSP expected to implement one of the two options.

When SGW/SGW-C is provisioned, if the deployment option is PGW-based approach, then the SGW/SGW-C does not perform an interception unless the target is inbound roaming with HR. Similarly, when the PGW/PGW-C is provisioned, if the deployment option is SGW-based approach, then the PGW/PGW does not perform the interception unless the target is outbound roaming with HR.

G.4.4.2.4 HSS

The HSS is expected to provide the IRI-POI functions in the HPLMN only.

G.4.4.2.5 Summary

Table G.4-2 provides the scope of NF domain that provides the IRI-POI/CC-TF/CC-POI functions for the service type of Data in the EPC for an SGW-based deployment option.

Table G.4-2: Scope of NF domain in EPC providing the LI functions (SGW-based deployment)NFs with LI function			Non-roaming	Roaming with LBO		Roaming with HR	
				VPLMN	HPLMN	VPLMN	HPLMN
HSS			IRI-POI	n/a	IRI-POI	n/a	IRI-POI
MME			IRI-POI	IRI-POI	n/a	IRI-POI	n/a
SGW			IRI-POI	IRI-POI	n/a	IRI-POI	n/a
SGW			CC-POI	CC-POI	n/a	CC-POI	n/a
PGW			n/a	n/a	n/a	n/a	IRI-POI
PGW			n/a	n/a	n/a	n/a	CC-POI
SGW-C			IRI-POI	IRI-POI	n/a	IRI-POI	n/a
SGW-C			CC-TF	CC-TF	n/a	CC-TF	n/a
SGW-U			CC-POI	CC-POI	n/a	CC-POI	n/a
PGW-C			n/a	n/a	n/a	n/a	IRI-POI
PGW-C			n/a	n/a	n/a	n/a	CC-TF
PGW-U			n/a	n/a	n/a	n/a	CC-POI
PDHR	Option 1	SGW	IRI-POI	IRI-POI	n/a	IRI-POI	n/a
		SGW-C	IRI-TF	IRI-TF	n/a	IRI-TF	n/a
		SGW-U	IRI-POI	IRI-POI	n/a	IRI-POI	n/a
		PGW	n/a	n/a	n/a	n/a	IRI-POI
		PGW-C	n/a	n/a	n/a	n/a	IRI-TF
		PGW-U	n/a	n/a	n/a	n/a	IRI-POI
	Option 2	SGW	CC-POI	CC-POI	n/a	CC-POI	n/a
		SGW-C	CC-TF	CC-TF	n/a	CC-TF	n/a
		SGW-U	CC-POI	CC-POI	n/a	CC-POI	n/a
		PGW	n/a	n/a	n/a	n/a	CC-POI
		PGW-C	n/a	n/a	n/a	n/a	CC-TF
		PGW-U	n/a	n/a	n/a	n/a	CC-POI
		MDF3	PDHR	PDHR	n/a	PDHR	PDHR
LALS triggering	Option 1	SGW	LTF	LTF	n/a	LTF	n/a
		SGW-C	LTF	LTF	n/a	LTF	n/a
		PGW	n/a	n/a	n/a	n/a	LTF
		PGW-C	n/a	n/a	n/a	n/a	LTF
	Option 2	MDF2	LTF	LTF	n/a	LTF	LTF

Table G.4-3 provides the scope of NF domain that provides the IRI-POI/CC-TF/CC-POI functions for the service type of Data in the EPC for a PGW-based deployment option.

Table G.4-3: Scope of NF domain in EPC providing the LI functions (PGW-based deployment)

NFs with LI function		Non-roaming	Roaming with LBO		Roaming with HR		
			VPLMN	HPLMN	VPLMN	HPLMN	
HSS		IRI-POI	n/a	IRI-POI	n/a	IRI-POI	
MME		IRI-POI	IRI-POI	n/a	IRI-POI	n/a	
SGW		n/a	n/a	n/a	IRI-POI	n/a	
SGW		n/a	n/a	n/a	CC-POI	n/a	
PGW		IRI-POI	IRI-POI	n/a	n/a	IRI-POI	
PGW		CC-POI	CC-POI	n/a	n/a	CC-POI	
SGW-C		n/a	n/a	n/a	IRI-POI	n/a	
SGW-C		n/a	n/a	n/a	CC-TF	n/a	
SGW-U		n/a	n/a	n/a	CC-POI	n/a	
PGW-C		IRI-POI	IRI-POI	n/a	n/a	IRI-POI	
PGW-C		CC-TF	CC-TF	n/a	n/a	CC-TF	
PGW-U		CC-POI	CC-POI	n/a	n/a	CC-POI	
PDHR	Option 1	SGW	n/a	n/a	n/a	IRI-POI	n/a
		SGW-C	n/a	n/a	n/a	IRI-TF	n/a
		SGW-U	n/a	n/a	n/a	IRI-POI	n/a
		PGW	IRI-POI	IRI-POI	n/a	n/a	IRI-POI
		PGW-C	IRI-TF	IRI-TF	n/a	n/a	IRI-TF
		PGW-U	IRI-POI	IRI-POI	n/a	n/a	IRI-POI
	Option 2	SGW	n/a	n/a	n/a	CC-POI	n/a
		SGW-C	n/a	n/a	n/a	CC-TF	n/a
		SGW-U	n/a	n/a	n/a	CC-POI	n/a
		PGW	CC-POI	CC-POI	n/a	n/a	CC-POI
		PGW-C	CC-TF	CC-TF	n/a	n/a	CC-TF
		PGW-U	CC-POI	CC-POI	n/a	n/a	CC-POI
LALS triggering	Option 1	MDF3	PDHR	PDHR	n/a	PDHR	PDHR
		SGW	n/a	n/a	n/a	LTF	n/a
		SGW-C	n/a	n/a	n/a	LTF	n/a
		PGW	LTF	LTF	n/a	n/a	LTF
	Option 2	PGW-C	LTF	LTF	n/a	n/a	LTF
		MDF2	LTF	LTF	n/a	LTF	LTF

NOTE 1: The use of "n/a" in the above table implies that the LI function is not applicable to the NF for the indicated scenario.

NOTE 2: The LIPF is not aware of the above role played by the host NFs in providing the LI functions.

NOTE 3: MDF2, MDF3 and LI-LCS Client which are also involved in providing the LI functions are not shown in the tables above.

G.5 Voice

G.5.1 Scope of interception

For the service type of Voice, the NFs present in IMS domain provide the LI functions except for the case of inbound roaming targets with home routed roaming architecture.

A target can be a subscriber of the CSP, an inbound roamer or a non-local ID. In the case where a target is a non-local ID, the party communicating with the target can be non-roaming, inbound roamer or outbound roamer. When a target is non-local ID, provisioning of HSS and LTF are not applicable.

The interception of service type of Voice includes:

- Delivery of IRI, or CC based on the delivery type indicated in the warrant.
- When required, the delivery of LALS reports based on the LALS triggering.
- Whether a target is non-local ID.

- IMS services such as redirection, conferencing, application of media such as music or announcements.

The CSP may have differing implementation options for the interception of IRI and CC, for local as well as non-local ID targets. The CSP may also have differing implementation options for LALS triggering.

The CSP may have either an LBO based roaming architecture or a home-routed based roaming architecture.

G.5.2 Initial configuration for N9HR/S8HR

To support the N9HR/S8HR (i.e. scenario 4 listed in clause G.2), the LIPF will have to configure the BBIFC/BBIFC-C present in the packet core network. This applies to all inbound roaming users using the IMS service.

Figure G.5-1 provides the LIPF logic for N9HR/S8HR that is applicable to all inbound roaming users using IMS services.

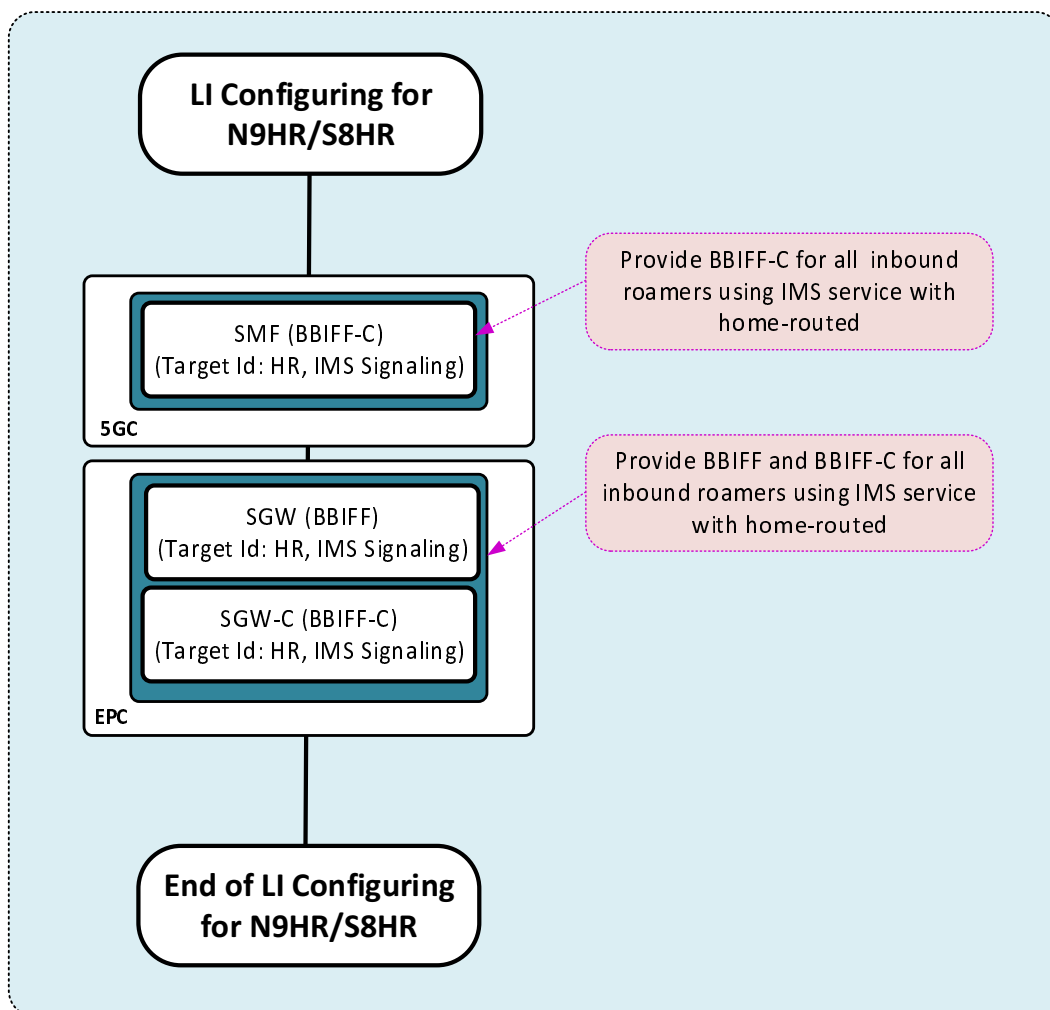

Figure G.5-1: LIPF logic for initial configuration for N9HR/S8HR

When the packet core network is 5GC, the BBIFC-C function is provided by the SMF and when the packet core network is EPC, the BBIFC-C/BBIFC function is provided by the SGW-C/SGW.

G.5.3 Top level LIPF logic for service type voice

When a target ID is an IMPU, the warrant may specify whether a target is non-local ID. The host NFs that provide the LI functions when the target is non-local ID can be different from the host NFs that provide the LI functions when the target is not a non-local ID. The provisioning of IRI-POI in HSS and provisioning of LTF in support of LALS triggering applies only when the target is not a non-local ID.

Figure G.5-2 provides the top-level view of LIPF logic for the service type of Voice.

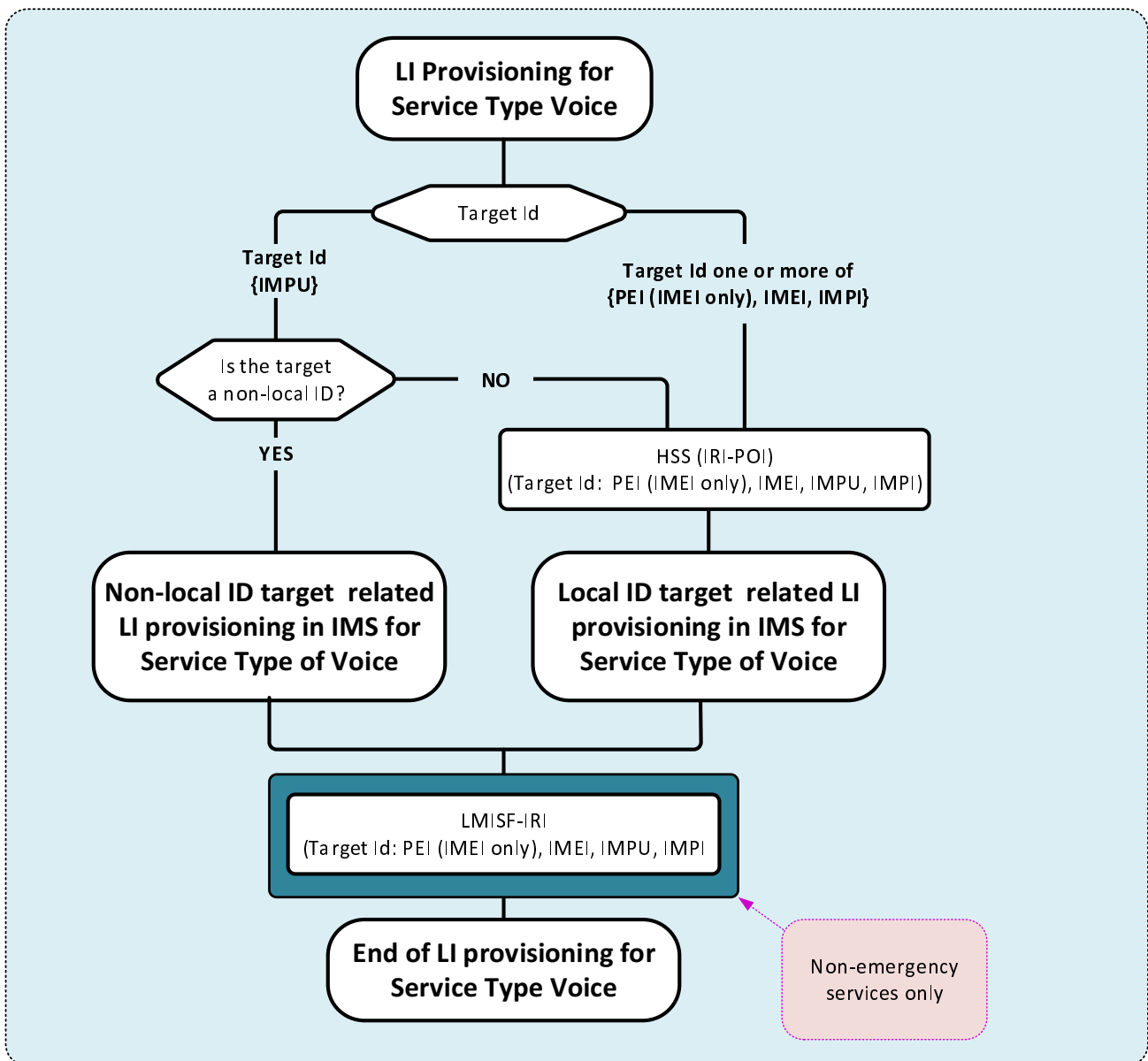

Figure G.5-2: Top level view of LIPF logic for service type of Voice

Within figure G.5-2, PEI (IMEI only) represents PEIIMEI. The target identity in the IMPU format may contain a value derived from a SUPI or an IMSI. The target identity in the IMPU format containing a SIP URI or TEL URI may contain a value derived from a GPSI, MSISDN, an E.164 number, or IMSI. Only IMPU is used for target non-local ID.

The LMISF-IRI is provisioned to support the interception of inbound roaming target (or party communicating with a target non-local ID target is inbound roaming) with HR that uses IMS services. The LMISF-IRI is expected to provide the LI functions only for non-emergency services.

G.5.4 LIPF logic for targets that are not non-local ID

G.5.4.1 The flowchart

Figures G.5-3, G.5-4, G.5-5 and G.5-6 show the LIPF logic for the service type of Voice when the target is not a non-local ID.

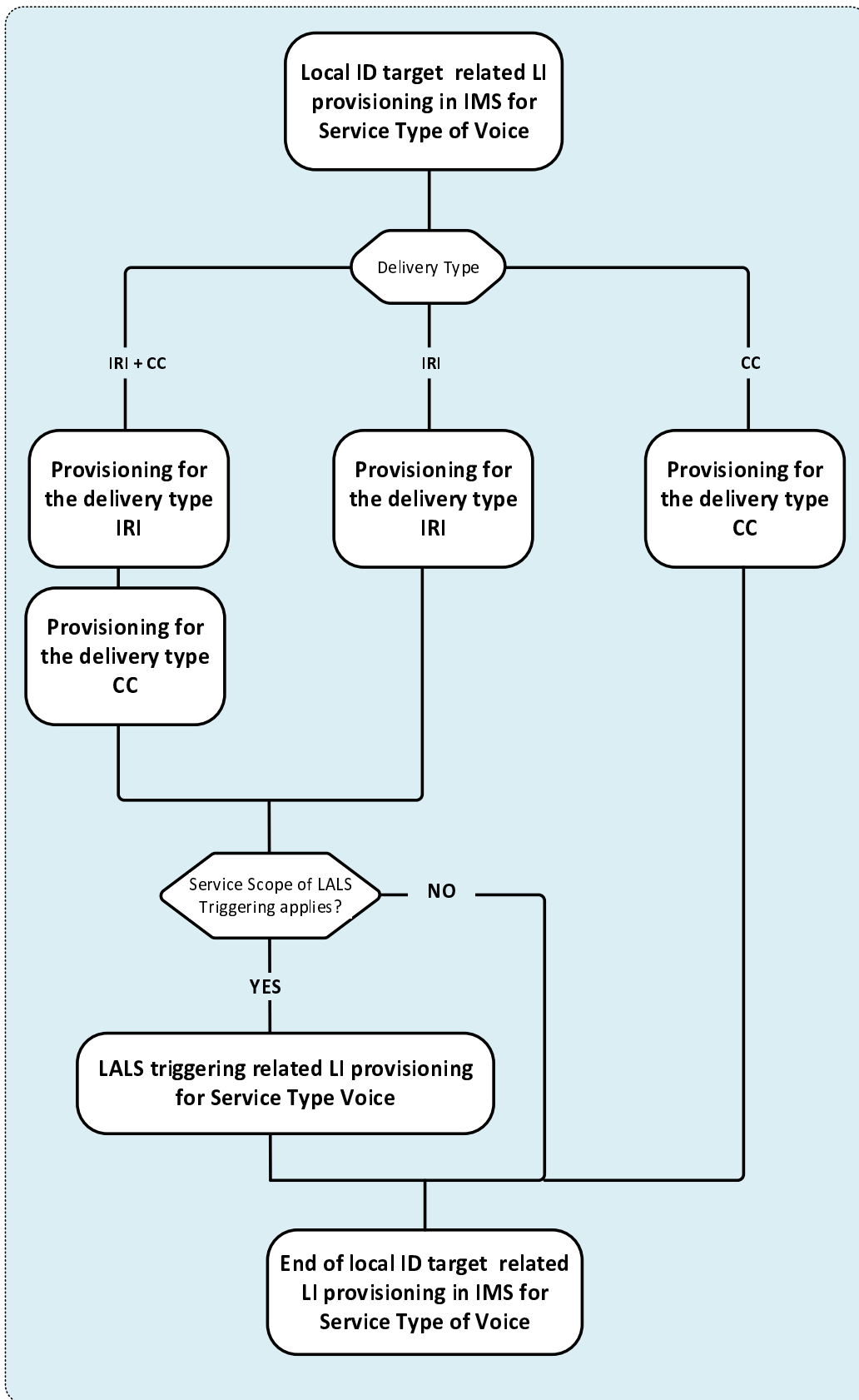

Figure G.5-3: Top level LIPF logic for service type of Voice when target is not a non-local ID

For the delivery type of IRI + CC, the IRI-POIs and the CC-TFs are provisioned. For the delivery type of IRI, the IRI-POIs are provisioned. For the delivery type of CC, the CC-TFs are provisioned.

Figure G.5-4 shows the LIPF logic for the provisioning of IRI-POIs and figure G.5-5 shows the LIPF logic for the provisioning of CC-TFs.

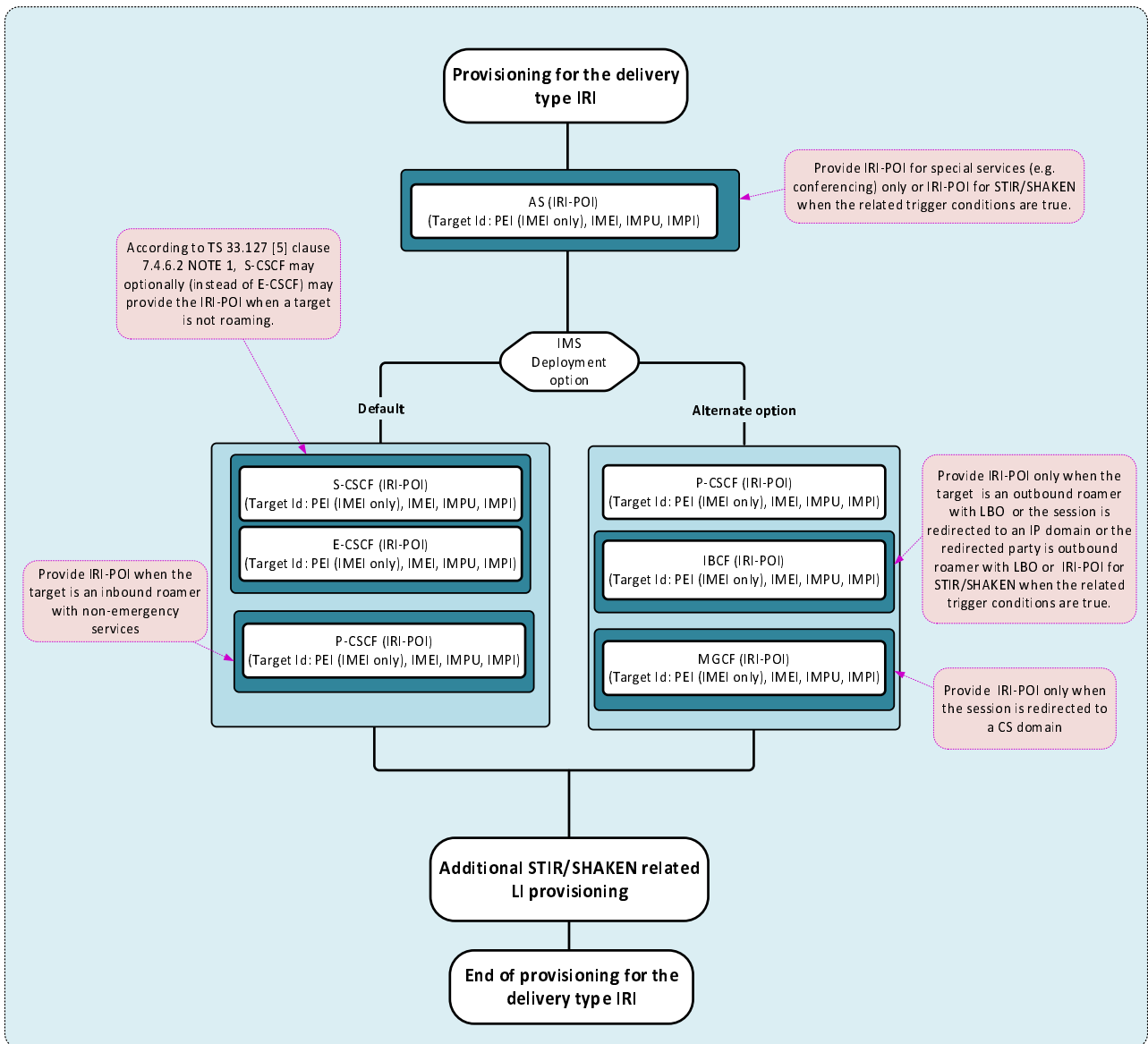

Figure G.5-4: LIPF logic for delivery type of IRI for service type of Voice when target is not a non-local ID

The S-CSCF, E-CSCF, P-CSCF, IBCF, MGCF and AS (in figure G.5-4) provide IRI-POI functions under certain conditions as noted within the illustration. To prevent those IRI-POIs from providing the LI functions when not supposed to, the LIPF may have to include a parameter during the provisioning. If STIR/SHAKEN is required to be intercepted in the network, then the provisioning of IRI-POIs in IBCF and AS include the parameter ReportDiversionPASSporTInfo if the target identity is IMPU. Additional STIR/SHAKEN related provisioning is illustrated in figure G.5-6A.

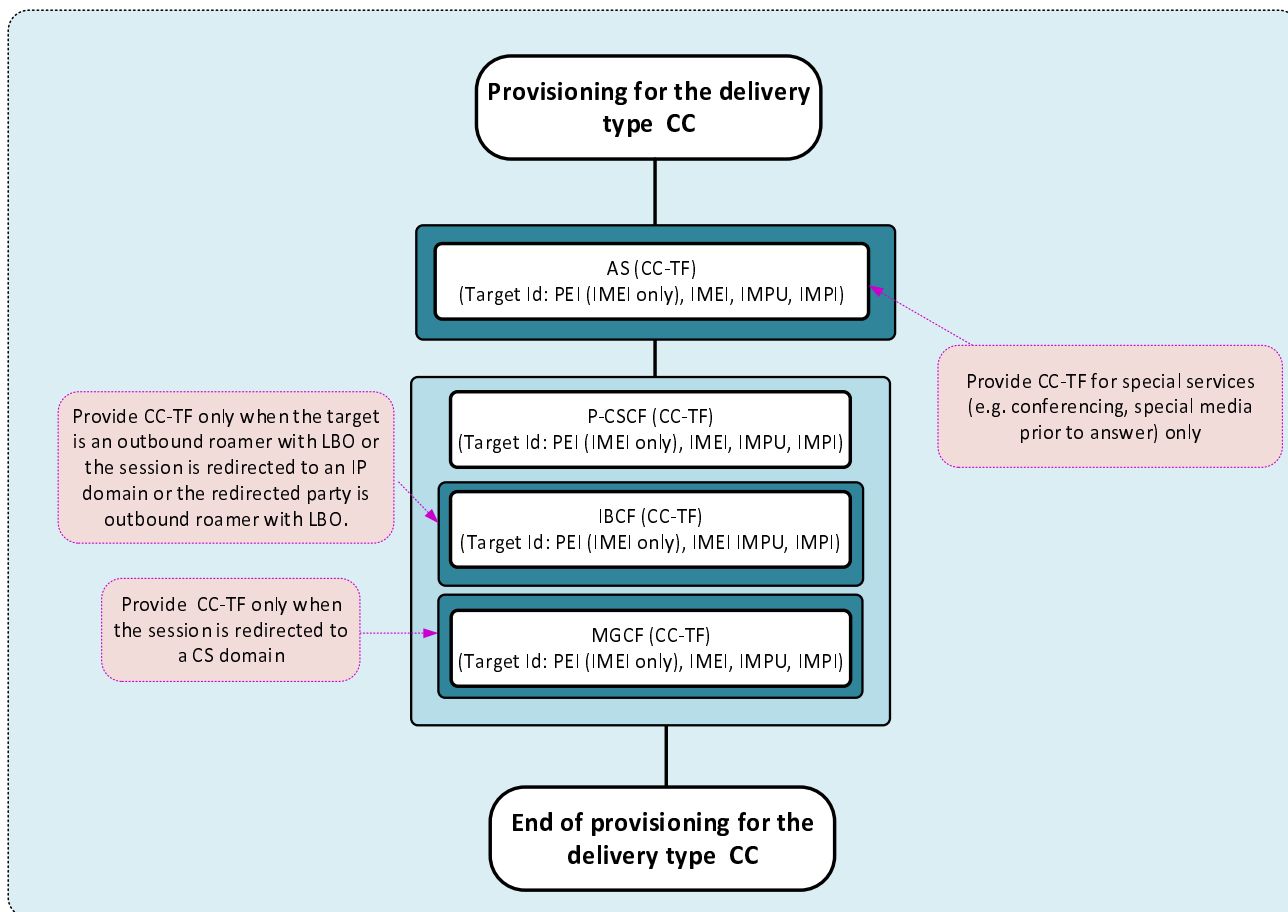

Figure G.5-5: LIPF logic for delivery type of CC for service type of Voice when target is not a non-local ID

The IBCF, MGCF and AS (in figure G.5-5) provide CC-TF functions under certain conditions as noted within the illustration. To prevent those CC-TFs from triggering the CC-POIs when not supposed to, the LIPF may have to include a parameter during the provisioning.

Figure G.5-6 illustrates the LIPF logic for LALS triggering.

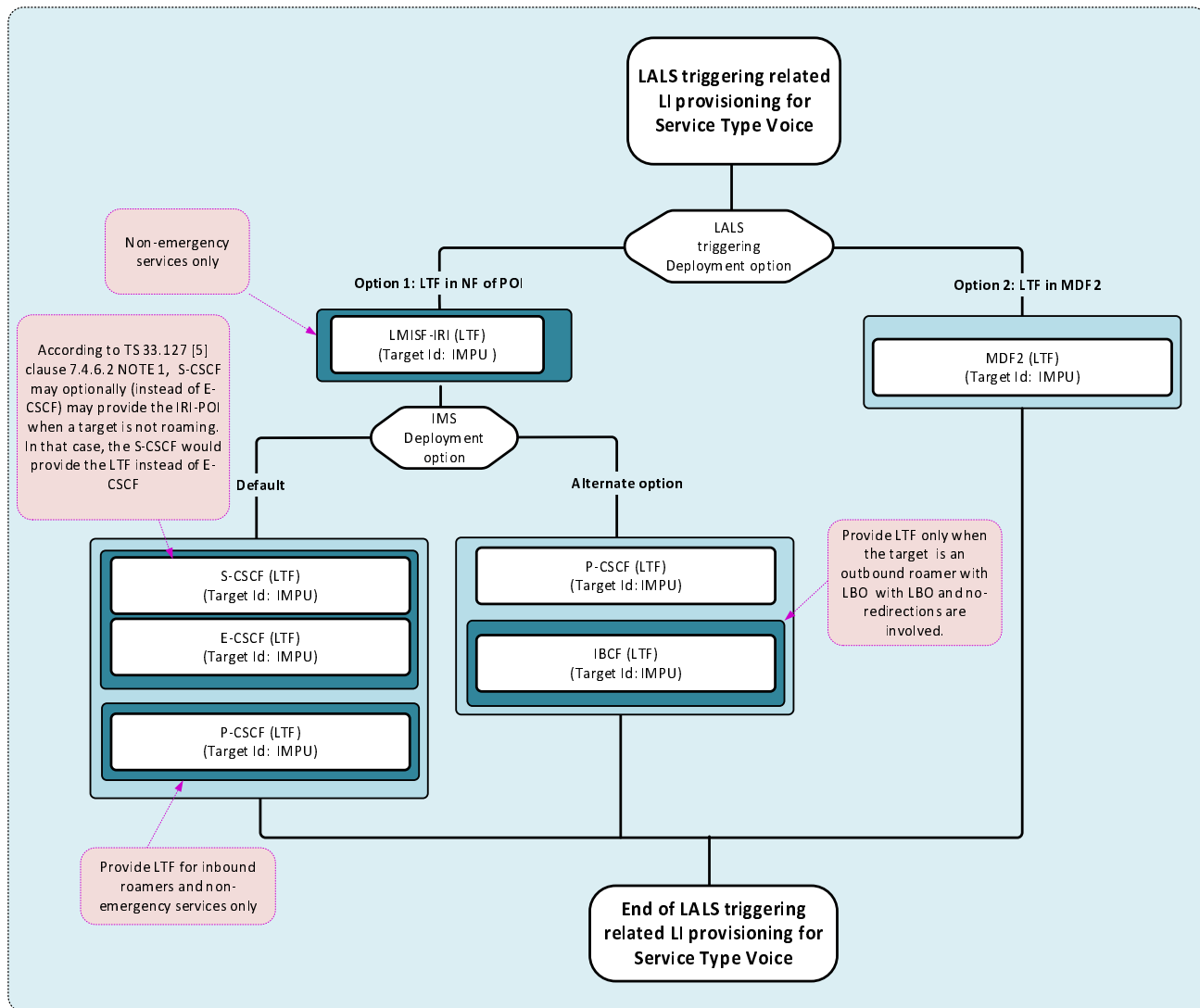

Figure G.5-6: LIPF logic for LALS triggering for the service type of Voice

In LALS triggering option 1, the host NF that provides the LTF is same as the NF that provides the IRI-POI functions. And therefore, the host NFs that provide the LTF can be different based on the IMS deployment options.

The P-CSCF, IBCF and LMISF-IRI (in figure G.5-6) provide LTF under certain conditions as noted within the illustration. Under special scenario, the S-CSCF may provide the IRI-POI for emergency services (instead of E-CSCF) as specified in TS 33.127 [5]. To prevent those LTFs from providing the LI functions when not supposed to, the LIPF may have to include a parameter during the provisioning.

Figure G.5-6A illustrates the LIPF logic for additional STIR/SHAKEN related provisioning.

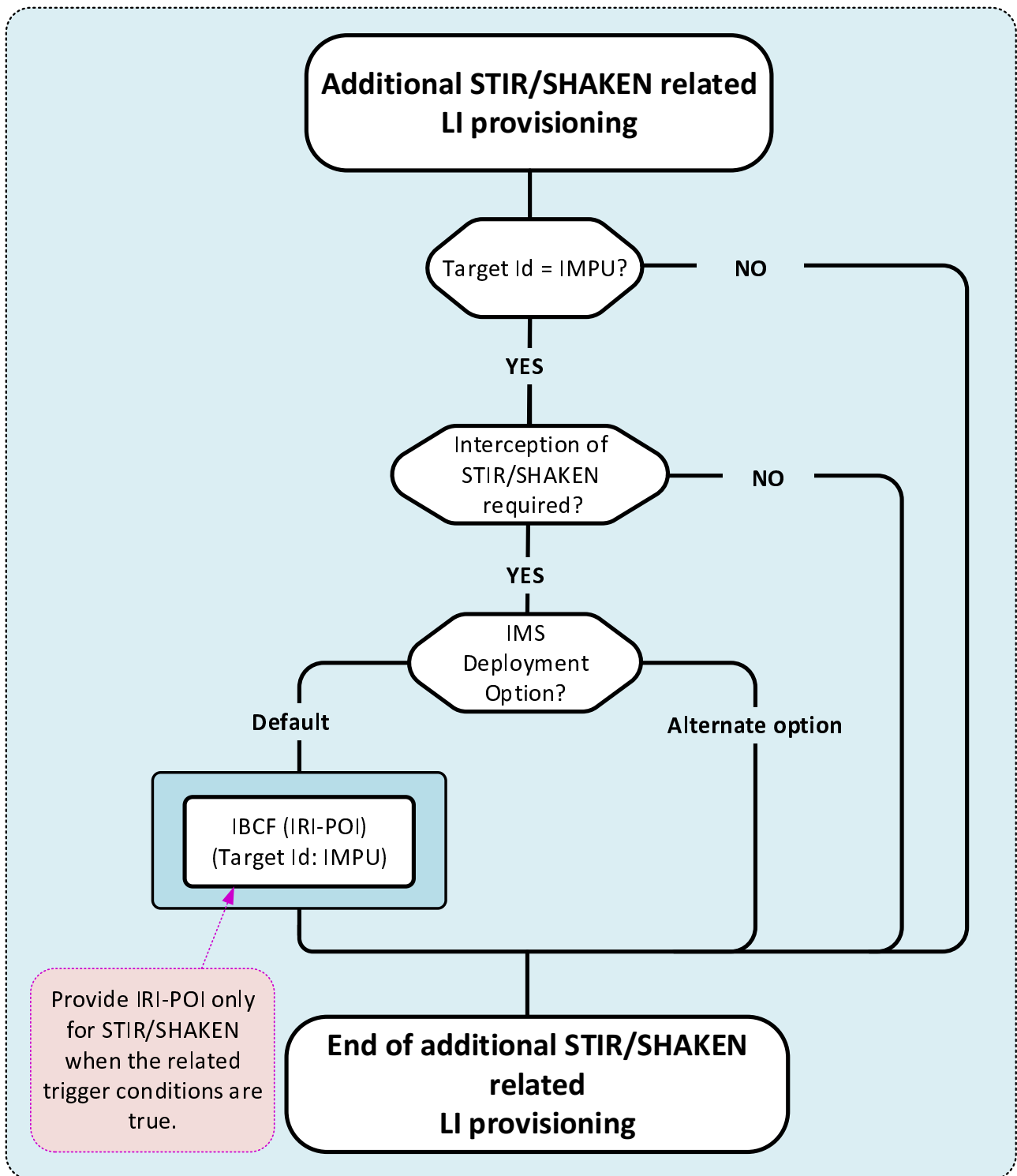

Figure G.5-6A: LIPF logic for additional STIR/SHAKEN related provisioning

For STIR/SHAKEN related reporting, IBCF, AS, P-CSCF (VPLMN with LBO), LMISF-IRI (VPLMN with HR) provide the IRI-POI functions. The LIPF logic shown in figure G.5-6A is additional logic required to support the LI for STIR/SHAKEN.

As illustrated in figure G.5-4, the IRI-POIs in P-CSCF, LMISF-IRI and AS are provisioned as part IMS-based voice LI. Likewise, the IRI-POI in IBCF is also provisioned for IMS-based voice LI when the alternate option is used.

When the STIR/SHAKEN is required to be intercepted in the network, the IRI-POIs in IBCF and AS are to be provisioned with ReportDiversionPASSporTInfo value when the target identity is IMPU.

G.5.4.2 Interception

G.5.4.2.1 IMS deployment

There are two deployment options for IMS for intercepting the service type of Voice (TS 33.127 [5]):

- Default.
- Alternate option.

It is expected that the CSP implements one of the two deployment options.

The conditions under which IRI-POI or CC-TF functions have to be provisioned are illustrated within the drawing and are further clarified in table G.5-1 and G.5-2.

G.5.4.2.2 LALS triggering

There are two deployment options for LALS triggering. It is expected that the CSP implements one of the two deployment options.

In LALS triggering option 1, the LTF present in the host NF that has the associated IRI-POI triggers the LI-LCS Client. In LALS triggering option 2, the LTF presents in the MDF2 triggers the LI-LCS Client.

G.5.4.2.3 Summary

Table G.5-1 provides the scope of NF domain that provides the IRI-POI/CC-TF/CC-POI functions for the service type of Voice with the IMS deployment option Default.

Table G.5-1: Scope of NF domain in IMS providing the LI functions with Default option

NFs with LI function		Non-roaming	Roaming with LBO		Roaming with HR		
			VPLMN	HPLMN	VPLMN	HPLMN	
HSS		IRI-POI	n/a	IRI-POI	n/a	IRI-POI	
AS (NOTE 6, NOTE 12)		IRI-POI	n/a	IRI-POI	n/a	IRI-POI	
AS (NOTE 7)		CC-TF	n/a	CC-TF	n/a	CC-TF	
MRFP (NOTE 7)		CC-POI	n/a	CC-POI	n/a	CC-POI	
S-CSCF (NOTE 8)		IRI-POI	n/a	IRI-POI	n/a	IRI-POI	
E-CSCF (NOTE 8)		IRI-POI	IRI-POI	n/a	IRI-POI	n/a	
P-CSCF		n/a	IRI-POI (NOTE 1)	n/a	n/a	n/a	
P-CSCF		CC-TF	CC-TF	n/a	CC-TF (NOTE 2)	n/a	
IMS-AGW		CC-POI	CC-POI	n/a	CC-POI (NOTE 2)	n/a	
MGCF (NOTE 3)		CC-TF	n/a	CC-TF	n/a	CC-TF	
IM-MGW (NOTE 3)		CC-POI	n/a	CC-POI	n/a	CC-POI	
IBCF (NOTE 14)		IRI-POI	IRI-POI	IRI-POI	IRI-POI	IRI-POI	
IBCF (NOTE 4)		CC-TF	n/a	CC-TF	n/a	CC-TF	
TrGW (NOTE 4)		CC-POI	n/a	CC-POI	n/a	CC-POI	
LMISF-IRI (NOTE 1)		n/a	n/a	n/a	IRI-POI	n/a	
LMISF-CC (NOTE 1)		n/a	n/a	n/a	CC-POI	n/a	
LALS triggering	Option 1	S-CSCF	LTF	n/a	LTF	n/a	LTF
		E-CSCF	LTF	LTF	n/a	LTF	n/a
		P-CSCF	n/a	LTF (NOTE 1)	n/a	n/a	n/a
		LMISF-IRI	n/a	n/a	n/a	LTF (NOTE 1)	n/a
	Option 2	MDF2	LTF	LTF	LTF	LTF	LTF

Table G.5-2 provides the scope of NF domain that provides the IRI-POI/CC-TF/CC-POI functions for the service type of Voice with the IMS deployment option Alternate option.

Table G.5-2: Scope of NF domain in IMS providing the LI functions with Alternate option

NFs with LI function		Non-roaming	Roaming with LBO		Roaming with HR		
			VPLMN	HPLMN	VPLMN	HPLMN	
HSS		IRI-POI	n/a	IRI-POI	n/a	IRI-POI	
AS (NOTE 6, NOTE 12)		IRI-POI	n/a	IRI-POI	n/a	IRI-POI	
AS (NOTE 7)		CC-TF	n/a	CC-TF	n/a	CC-TF	
MRFP (NOTE 7)		CC-POI	n/a	CC-POI	n/a	CC-POI	
P-CSCF		IRI-POI	IRI-POI	n/a	IRI-POI (NOTE 2)	IRI-POI	
P-CSCF		CC-TF	CC-TF	n/a	CC-TF (NOTE 2)	CC-TF	
IMS-AGW		CC-POI	CC-POI	n/a	CC-POI (NOTE 2)	CC-POI	
MGCF (NOTE 3)		IRI-POI	n/a	IRI-POI	n/a	IRI-POI	
MGCF (NOTE 3)		CC-TF	n/a	CC-TF	n/a	CC-TF	
IM-MGW (NOTE 3)		CC-POI	n/a	CC-POI	n/a	CC-POI	
IBCF		IRI-POI (NOTE 13)	IRI-POI (NOTE 2, 14)	IRI-POI (NOTE 13)	IRI-POI (NOTE 2, 14)	IRI-POI (NOTE 13)	
IBCF (NOTE 4)		CC-TF	n/a	CC-TF	n/a	CC-TF	
TrGW (NOTE4)		CC-POI	n/a	CC-POI	n/a	CC-POI	
LMISF-IRI (NOTE 1)		n/a	n/a	n/a	IRI-POI	n/a	
LMISF-CC (NOTE 1)		n/a	n/a	n/a	CC-POI	n/a	
LALS Triggering	Option 1	P-CSCF	LTF	LTF	n/a	LTF (NOTE 2)	LTF
		IBCF	n/a	n/a	LTF (NOTE 5)	n/a	n/a
		LMISF-IRI	n/a	n/a	n/a	LTF (NOTE 1)	n/a
	Option 2	MDF2	LTF	LTF	LTF	LTF	LTF

NOTE 1: For non-emergency sessions only.

NOTE 2: For emergency sessions only.

NOTE 3: Only when an incoming session to a target is redirected over a CS domain.

NOTE 4: Only when target is outbound roaming or when an incoming session to a target is redirected over an IP domain, or to an outbound roaming party with LBO.

NOTE 5: Only when the target is outbound roaming without a redirection.

NOTE 6: When the interception of conferencing services is required.

NOTE 7: When the content interception of conferencing, or application of music/ is required.

NOTE 8: For IMS emergency sessions in fixed networks when the S-CSCF is on the signaling path, S-CSCF may optionally (instead of E-CSCF) provide the IRI-POI functions with the default option.

NOTE 9: The use of "n/a" in the above table implies that the LI function is not applicable to the NF for the indicated scenario.

NOTE 10: The LIPF is not aware of the above role played by the host NFs in providing the LI functions.

NOTE 11: MDF2, MDF3 and LI-LCS Client which are also involved in providing the LI functions are not shown in the tables above.

NOTE 12: When the interception of STIR/SHAKEN is required.

NOTE 13: Only when target is outbound roaming or when an incoming session to a target is redirected over an IP domain, or to an outbound roaming party with LBO, or when the interception of STIR/SHAKEN is required.

NOTE 14: Only when the interception of STIR/SHAKEN is required.

G.5.4.2.4 STIR/SHAKEN

Since the IRI-POI in AS, in support of LI for special services such as conferencing, is always provisioned, the LIPF logic has to ensure that when the STIR/SHAKEN is required to be intercepted and the target Id is IMPU, the ReportDiversionPASSporTInfo is included as part of that provisioning.

Likewise, the IRI-POI in IBCF is also provisioned except for the case when the default option for IMS LI is deployed. The diagram shown in figure G.5-6A illustrates that when STIR/SHAKEN is required to be intercepted and the target Id is IMPU, the IRI-POI in IBCF is provisioned even with the default option of IMS LI with ReportDiversionPASSporTInfo is included.

In general, when the STIR/SHAKEN is required to be intercepted in the network, and the target Id is IMPU, the IRI-POIs in AS and the IBCF are provisioned with ReportDiversionPASSporTInfo parameter included.

The diagram shown in figure G.5-6B below illustrates the LI provisioning just from STIR/SHAKEN perspective. However, from an overall provisioning perspective, it is embedded within the LIPF logic of IMS LI provisioning as illustrated in clause G.5.4.1.

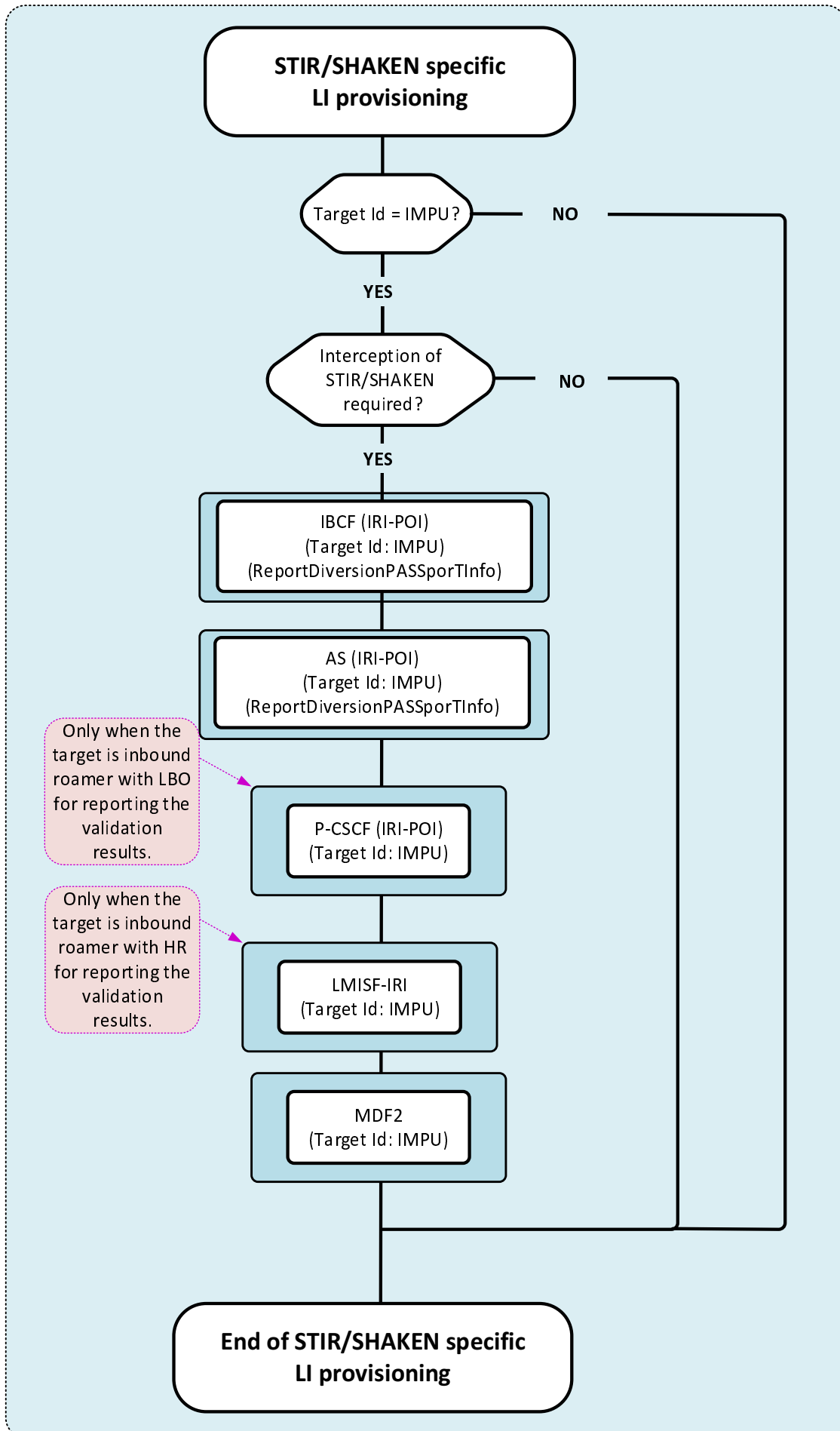

Figure G.5-6B: Localized LI provisioning view from STIR/SHAKEN perspective

The inclusion of ReportDiversionPASSporTInfo for provisioning of IRI-POI in P-CSCF and LMISF-IRI is not required.

Table G.5-2A shows the NFs that will have to provide the STIR/SHAKEN LI (signing) for various scenarios and the table G.5-2B shows the NFs that will have to provide the STIR/SHAKEN LI (verification) for various scenarios.

The signing for STIR/SHAKEN happens in the HPLMN except for the emergency sessions it can also happen in the VPLMN. In these tables the indicated scenarios are from the perspective of target.

Table G.5-2A: Scope of NF domain in IMS providing the LI functions for STIR/SHAKEN (signing)

Scenario	HPLMN		VPLMN
	CSP choice AS	CSP choice is IBCF	
Emergency call	IBCF	IBCF	IBCF
RCD present	AS	AS	n/a
Intra-CSP session signing/verification required	AS	AS	n/a
Intra-CSP session signing/verification not required	Intra-CSP session	n/a	n/a
	Inter-CSP session	AS	IBCF

Table G.5-2B: Scope of NF domain in IMS providing the LI functions for STIR/SHAKEN (verification)

Scenario	HPLMN		VPLMN
	CSP choice AS	CSP choice is IBCF	
Emergency callback	AS	IBCF	See NOTE 1
Inbound roaming with LBO	n/a	n/a	P-CSCF
Inbound roaming with Home-Routed	n/a	n/a	LMISF-IRI
Intra-CSP session signing/verification required	AS	AS	See NOTE 1
Intra-CSP session signing/verification not required	Intra-CSP session	AS (see NOTE 2)	See NOTE 1
	Inter-CSP session	AS	IBCF (see NOTE 3)

NOTE 1: Same as in the row for inbound roaming (LBO) and inbound roaming (HR).

NOTE 2: This is the case where the redirection happens with the outgoing SIP INVITE containing the validation result and the REQUEST URI is a target identity (see clause 7.11.2.3). The AS may or may not interact with the Verification AS.

NOTE 3: The IRI-POI is in IBCF. The IRI-POI can be in AS for the special redirection case depicted in NOTE 2 (see clause 7.11.2.3).

The indicated CSP choice is applicable when the signing/verification of only inter-CSP session is required. The CSP choice for signing and verification need not be the same.

G.5.5 LIPF logic for targets that are non-local ID

G.5.5.1 The flowchart

Figures G.5-7, G.5-8 and G.5-9 show the LIPF logic for the service type of Voice when the target is a non-local ID.

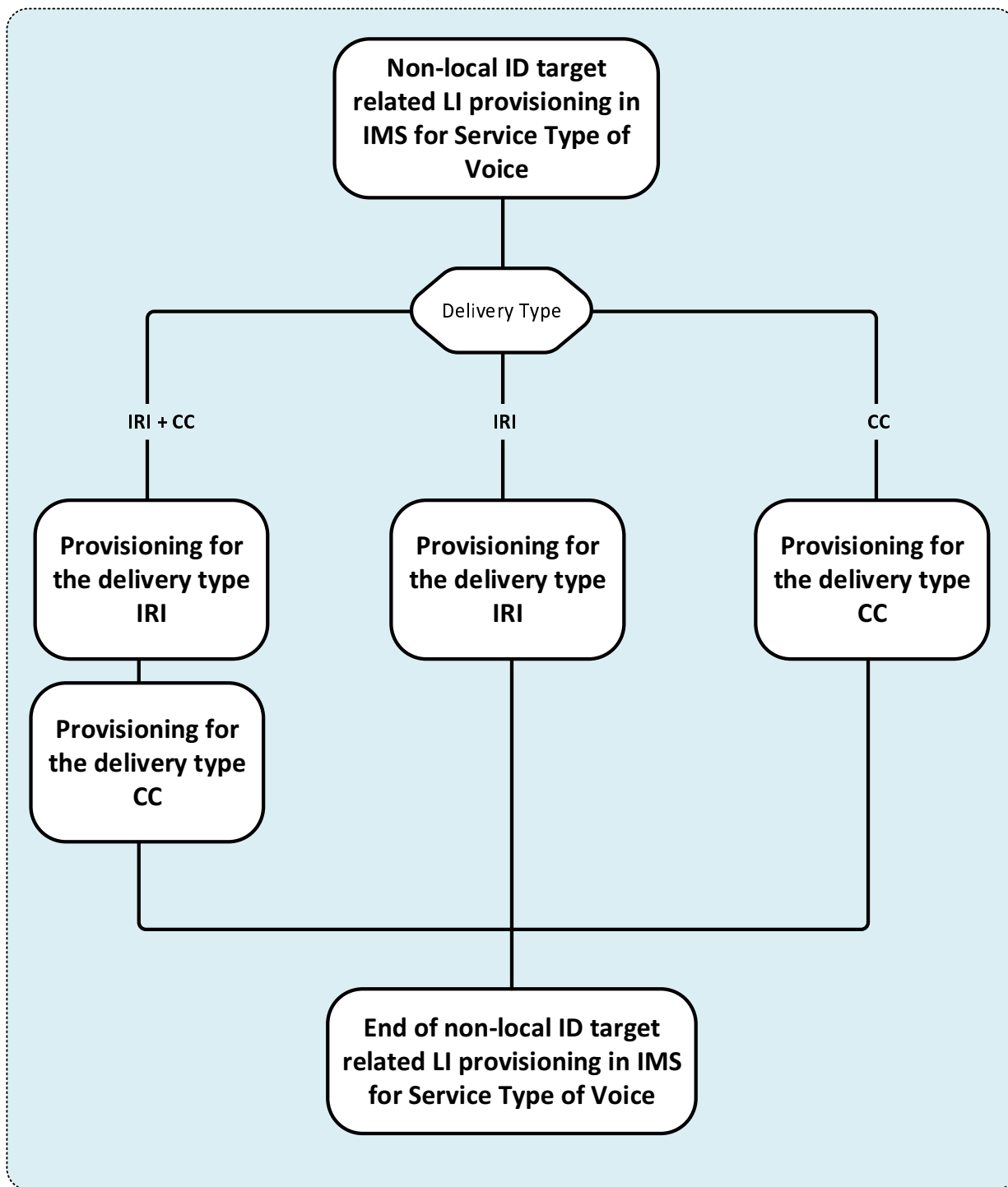

Figure G.5-7: LIPF logic for service type of Voice when target is a non-local ID

For the delivery type of IRI + CC, the IRI-POIs and the CC-TFs are provisioned. For the delivery type of IRI, the IRI-POIs are provisioned. For the delivery type of CC, the CC-TFs are provisioned.

Figure G.5-8 shows the LIPF logic for the provisioning of IRI-POIs and figure G.5-9 shows the LIPF logic for the provisioning of CC-TFs.

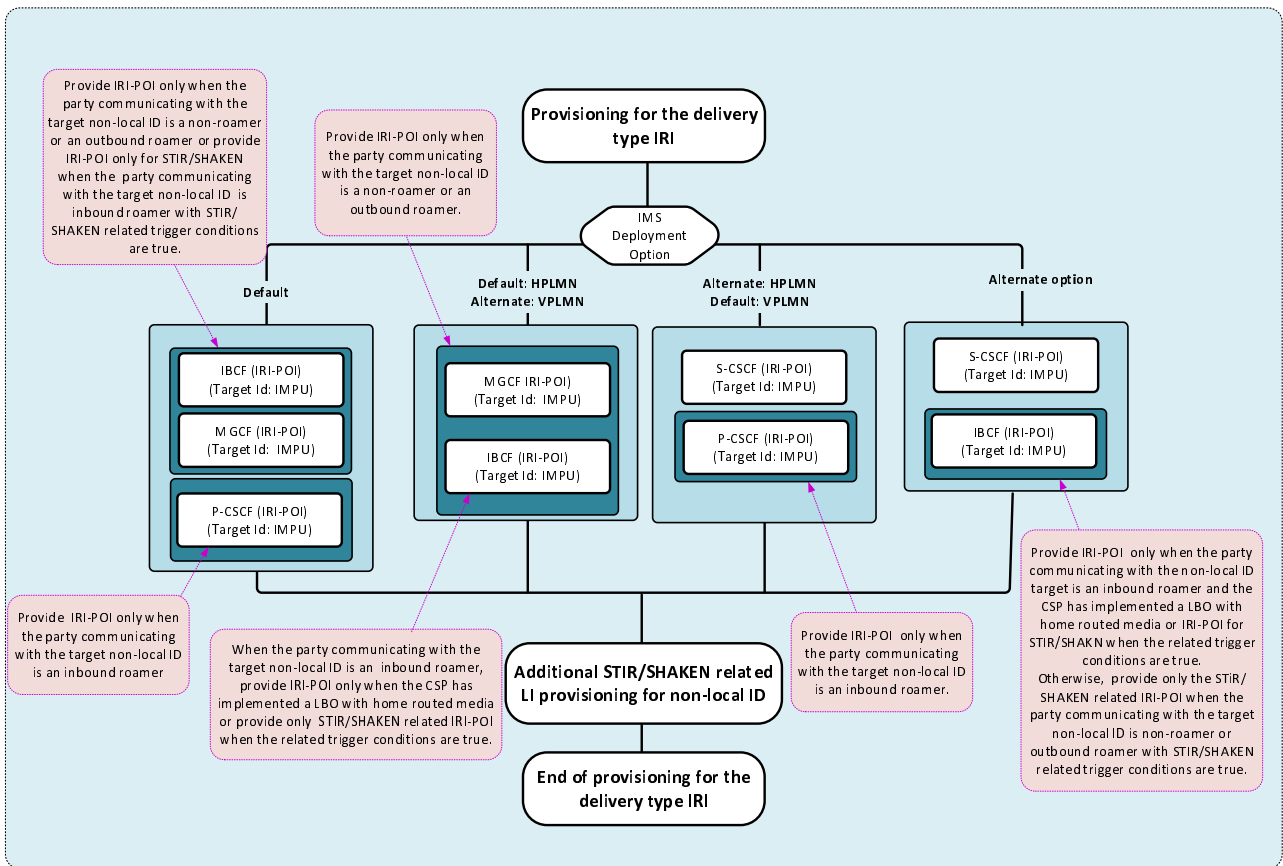

Figure G.5-8: LIPF logic for delivery type of IRI for service type of Voice when target is a non-local ID

The P-CSCF, IBCF and MGCF (in figure G.5-8) provide IRI-POI functions under certain conditions as noted within the illustration. To prevent those IRI-POIs from providing the LI functions when not supposed to, the LIPF may have to include a parameter during the provisioning.

If STIR/SHAKEN is required to be intercepted in the network, the provisioning of IRI-POI in IBCF include the parameter ReportDiversionPASSporTInfo. Additional STIR/SHAKEN related provisioning for target non-local ID is illustrated in figure G.5-9A.

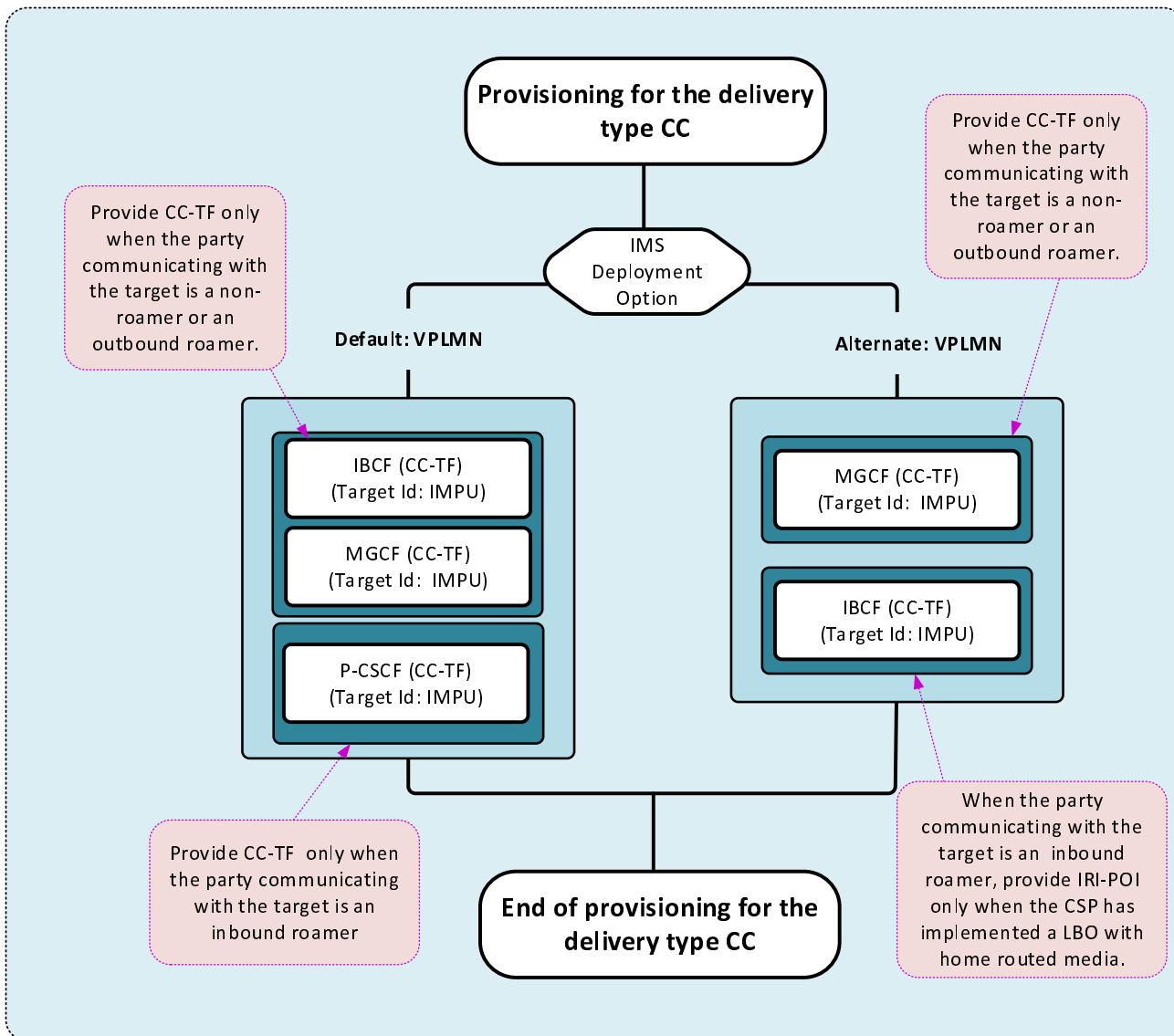

Figure G.5-9: LIPF logic for delivery type of CC for service type of Voice when target is a non-local ID

The P-CSCF, IBCF and MGCF (in figure G.5-9) provide CC-TF functions under certain conditions as noted within the illustration. To prevent those CC-TFs from triggering the CC-POI when not supposed to, the LIPF may have to include a parameter during the provisioning.

Figure G.5-9A illustrates the LIPF logic for additional STIR/SHAKEN related provisioning for target non-local ID.

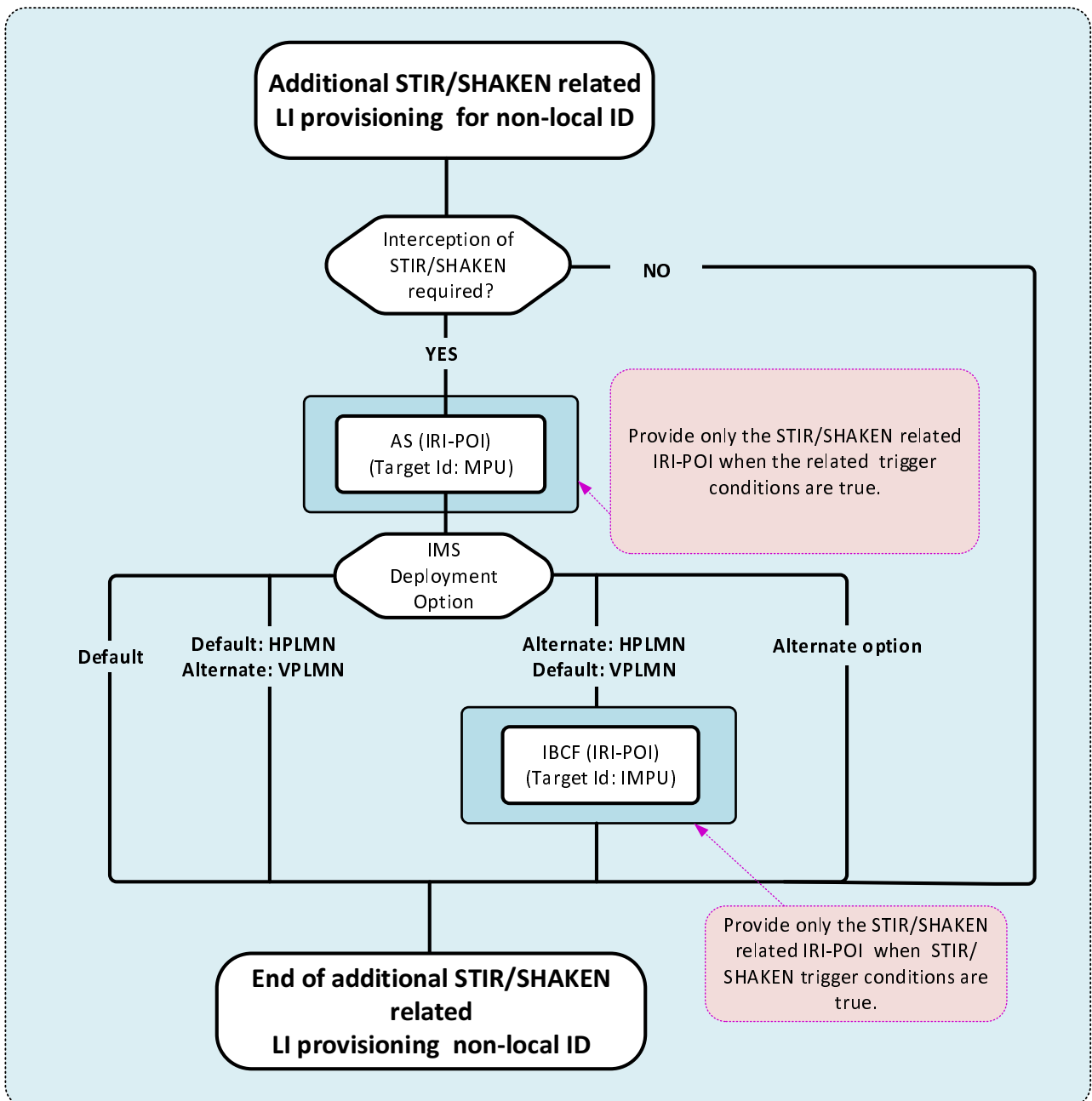

Figure G.5-9A: LIPF logic for additional STIR/SHAKEN related provisioning for target non-local ID

For STIR/SHAKEN related reporting IBCF, AS, P-CSCF (VPLMN with LBO), LMISF-IRI-POI (VPLMN with HR) provide the IRI-POI functions. The LIPF logic shown in figure G.5-9A is additional logic required to support the STIR/SHAKEN when the target is non-local ID.

As illustrated in figure G.5-8, the IRI-POIs in P-CSCF, LMISF-IRI are provisioned as part IMS-based voice LI. Likewise, the IRI-POI in IBCF is also provisioned for IMS-based voice LI when default option is used in HPLMN, or when alternate options are used in both HPLMN and VPLMN.

When the interception of STIR/SHAKEN is required in the network, the IRI-POIs in IBCF and AS are to be provisioned with ReportDiversionPASSporTInfo value.

G.5.5.2 Interception

G.5.5.2.1 IMS deployment

There are two deployment options for IMS for intercepting the service type of Voice (TS 33.127 [5]):

- Default.
- Alternate option.

It is expected that the CSP implements one of the two deployment options.

The conditions under which IRI-POI or CC-TF functions have to be provided are illustrated within the drawing and are further clarified in table G.5-3 and G.5-4. The LIPF may have to indicate to the IRI-POI and CC-TF the condition in which they have to provide the respective functions.

G.5.5.2.2 Summary

Table G.5-3 provides the scope of NF domain that provides the IRI-POI/CC-TF/CC-POI functions for the service type of Voice with the IMS deployment option Default in HPLMN.

Table G.5-3: Scope of NF domain in IMS providing the LI functions with Default in HPLMN

NF with LI function	Non-roaming	Roaming with LBO			Roaming with HR	
		VPLMN		HPLMN	VPLMN	HPLMN
		Default	Alternate			
P-CSCF	n/a	IRI-POI	n/a	n/a	n/a	n/a
P-CSCF	n/a	CC-TF	n/a	n/a	n/a	n/a
IMS-AGW	n/a	CC-POI	n/a	n/a	n/a	n/a
AS (NOTE 5)	IRI-POI	n/a	n/a	IRI-POI	n/a	IRI-POI
MGCF	IRI-POI	n/a	n/a	IRI-POI	n/a	IRI-POI
MGCF	CC-TF	n/a	n/a	CC-TF	n/a	CC-TF
IM-MGW	CC-POI	n/a	n/a	CC-POI	n/a	CC-POI
IBCF	IRI-POI	IRI-POI (NOTE 5)	IRI-POI	IRI-POI	IRI-POI (NOTE5)	IRI-POI
IBCF	CC-TF	n/a	CC-TF	CC-TF	n/a	CC-TF
TrGW	CC-POI	n/a	CC-POI	CC-POI	n/a	CC-POI
LMISF-IRI	n/a	n/a	n/a	n/a	IRI-POI	n/a
LMISF-CC	n/a	n/a	n/a	n/a	CC-POI	n/a

Table G.5-4 provides the scope of NF domain that provides the IRI-POI/CC-TF/CC-POI functions for the service type of Voice with the IMS deployment option Alternate option in HPLMN.

Table G.5-4: Scope of NF domain in IMS providing the LI functions with Alternate option in HPLMN

NF with LI function	Non-roaming	Roaming with LBO			Roaming with HR	
		VPLMN		HPLMN	VPLMN	HPLMN
		Default	Alternate			
P-CSCF	n/a	IRI-POI	n/a	n/a	n/a	n/a
P-CSCF	n/a	CC-TF	n/a	n/a	n/a	n/a
IMS-AGW	n/a	CC-POI	n/a	n/a	n/a	n/a
AS (NOTE 5)	IRI-POI	n/a	n/a	IRI-POI	n/a	IRI-POI
S-CSCF	IRI-POI	n/a	n/a	IRI-POI	n/a	IRI-POI
MGCF	CC-TF	n/a	n/a	CC-TF	n/a	CC-TF
IM-MGW	CC-POI	n/a	n/a	CC-POI	n/a	CC-POI
IBCF (NOTE 5)	IRI-POI	IRI-POI	IRI-POI	IRI-POI	IRI-POI	IRI-POI
IBCF	CC-TF	n/a	CC-TF	CC-TF	n/a	CC-TF
TrGW	CC-POI	n/a	CC-POI	CC-POI	n/a	CC-POI
LMISF-IRI	n/a	n/a	n/a	n/a	IRI-POI	n/a
LMISF-CC	n/a	n/a	n/a	n/a	CC-POI	n/a

NOTE 1: In tables G.5-3 and G.5-4, the use of the phrase non-roaming/roaming applies to the party communicating with the target non-local ID.

NOTE 2: The use of "n/a" in the above table implies that the LI function is not applicable to the NF for the indicated scenario.

NOTE 3: The LIPF is not aware of the above role played by the host NFs in providing the LI functions.

NOTE 4: MDF2, MDF3 and LI-LCS Client which are also involved in providing the LI functions are not shown in the tables above.

NOTE 5: Only when the interception of STIR/SHAKEN is required.

G.5.5.2.3 STIR/SHAKEN

When the target is non-local ID, the IRI-POI in AS is not provisioned for IMS-LI. The IRI-POI in IBCF is provisioned except for the case where the alternate option is deployed in the HPLMN for IMS LI (target non-local ID) and default option is used for IMS-LI in the VPLMN (target non-local ID).

The diagram shown in figure G.5-9A illustrates that when the interception of STIR/SHAKEN is required in the network, and the target Id is IMPU, and the target is non-local ID, the IBCF is provisioned even when the alternate option for IMS LI is used in the HPLMN and default option is used for IMS LI in the VPLMN.

The diagram shown in figure G.5-6A (clause G.5.4.1) illustrates the LI provisioning just from STIR/SHAKEN perspective. However, from an overall provisioning perspective for target non-local ID, it is embedded within the LIPF logic of IMS LI provisioning as illustrated in clause G.5.5.1.

Table G.5-5 shows the NFs that will have to provide the STIR/SHAKEN LI (signing) for various scenarios and table G.5-6 shows the NFs that will have to provide the STIR/SHAKEN LI (verification) for various scenarios.

The signing for STIR/SHAKEN happens in the HPLMN. In these tables the indicated scenarios are from the perspective of the party communicating with the target non-local ID.

Table G.5-5: Scope of NF domain in IMS providing the LI functions for STIR/SHAKEN (signing)

Scenario		CSP choice AS	CSP choice is IBCF
RCD present		AS	AS
Intra-CSP session		n/a	n/a
Inter-CSP session	Intra-CSP session signing/verification is required	AS	AS
	Intra-CSP session signing/verification not required	AS	IBCF

Table G.5-6: Scope of NF domain in IMS providing the LI functions for STIR/SHAKEN (verification)

Scenario		HPLMN		VPLMN	
		CSP choice AS	CSP choice is IBCF	Default	Alternate
Inbound roaming with LBO		n/a	n/a	P-CSCF	IBCF
Inbound roaming with Home-Routed		n/a	n/a	LMISF-IRI	LMISF-IRI
Intra-CSP session		n/a	n/a	n/a	n/a
Inter-CSP session	Intra-CSP session signing/verification is required	AS	AS	See NOTE	See NOTE
	Intra-CSP session signing/verification not required	AS	IBCF	See NOTE	See NOTE

NOTE: Same as in the rows for inbound roaming (LBO) and inbound roaming (HR).

The indicated CSP choice is applicable when the signing/verification of only inter-CSP session is required. The CSP choice for signing and verification need not be the same.

G.6 Messaging

G.6.1 Scope of interception

The illustrations shown in the annex for the service type Messaging includes:

- MMS.

- SMS.

The interception for the MMS is done by the IRI-POI and CC-POI present in the MMS Proxy Relay. The interception for the SMS is done by the IRI-POI present in the SMSF and the MME (when MME provides the SMS service) and the IMS domain for SMS over IMS.

A target can be a subscriber of the CSP, an inbound roamer or a non-local ID. In the case where a target is a non-local ID, the party communicating with the target can be non-roaming, inbound roamer or outbound roamer. When a target is non-local ID, provisioning of HSS and LTF are not applicable.

For N9HR/S8HR, the LI functions for the inbound roamers are provided in the LMISF-IRI. To support the interception in LMISF-IRI, the initial configuration for N9HR/S8HR will have to be done as illustrated in clause G.5.2.

The interception of service type of Messaging includes:

- Delivery of IRI or CC based on the delivery type indicated in the warrant (the delivery of CC is applicable to MMS only).
- Whether a target is non-local ID.
- When required, the delivery of LALS reports based on the LALS triggering (applicable to SMS only).

In view of SMS over IMS, the CSP may have either an LBO based roaming architecture or a home-routed based roaming architecture. The CSP may have differing implementation options for LALS triggering.

Table G.6-1 shows the target identities that are applicable to different type of SMS use.

Table G.6-1: Target IDs as applicable to the interception of service type Messaging

SMS method	GPSI	SUPI	PEI	MSISDN	IMSI	IMEI	IMPU	IMPI
MMS	YES	n/a	n/a	YES	n/a	n/a	n/a	n/a
MMS (target non-local ID)	YES	n/a	n/a	YES	n/a	n/a	n/a	n/a
SMS over IMS (local)	YES (NOTE)	As IMPI	As IMEI	YES (NOTE)	As IMPI	YES	YES	YES
SMS over IMS (non-local ID)	YES	n/a	n/a	YES	n/a	n/a	YES	n/a
SMS over 5GS	YES	YES	YES	As GPSI	As SUPI	As PEI	n/a	n/a
SMS over 5GS (target non-local ID)	YES	n/a	n/a	As GPSI	n/a	n/a	n/a	n/a
SMS over EPS	n/a	n/a	n/a	YES	YES	YES	n/a	n/a
SMS over EPS (target non-local ID)	n/a	n/a	n/a	YES	n/a	n/a	n/a	n/a

The target identity PEI collectively represents PEIIMEI and PEIIMEISV. Likewise, SUPI represents SUPIMSI and SUPINAI whereas GPSI represents GPSIMISDN and GPSINAI. The target identity in the IMPI format may contain a value derived from a SUPI or an IMSI. The target identity in the IMPU format containing a SIP URI or TEL URI may contain a value derived from a GPSI, MSISDN, an E.164 number, or IMSI.

NOTE: The GPSI and MSISDN may also be the target IDs as an IMPU.

A part of LIPF logic is based on the target identity applicability shown in table G.6-1.

G.6.2 LIPF logic for service type messaging

G.6.2.1 Flowcharts

Figure G.6-1 provides the top-level view of LIPF logic for the service type of Messaging.

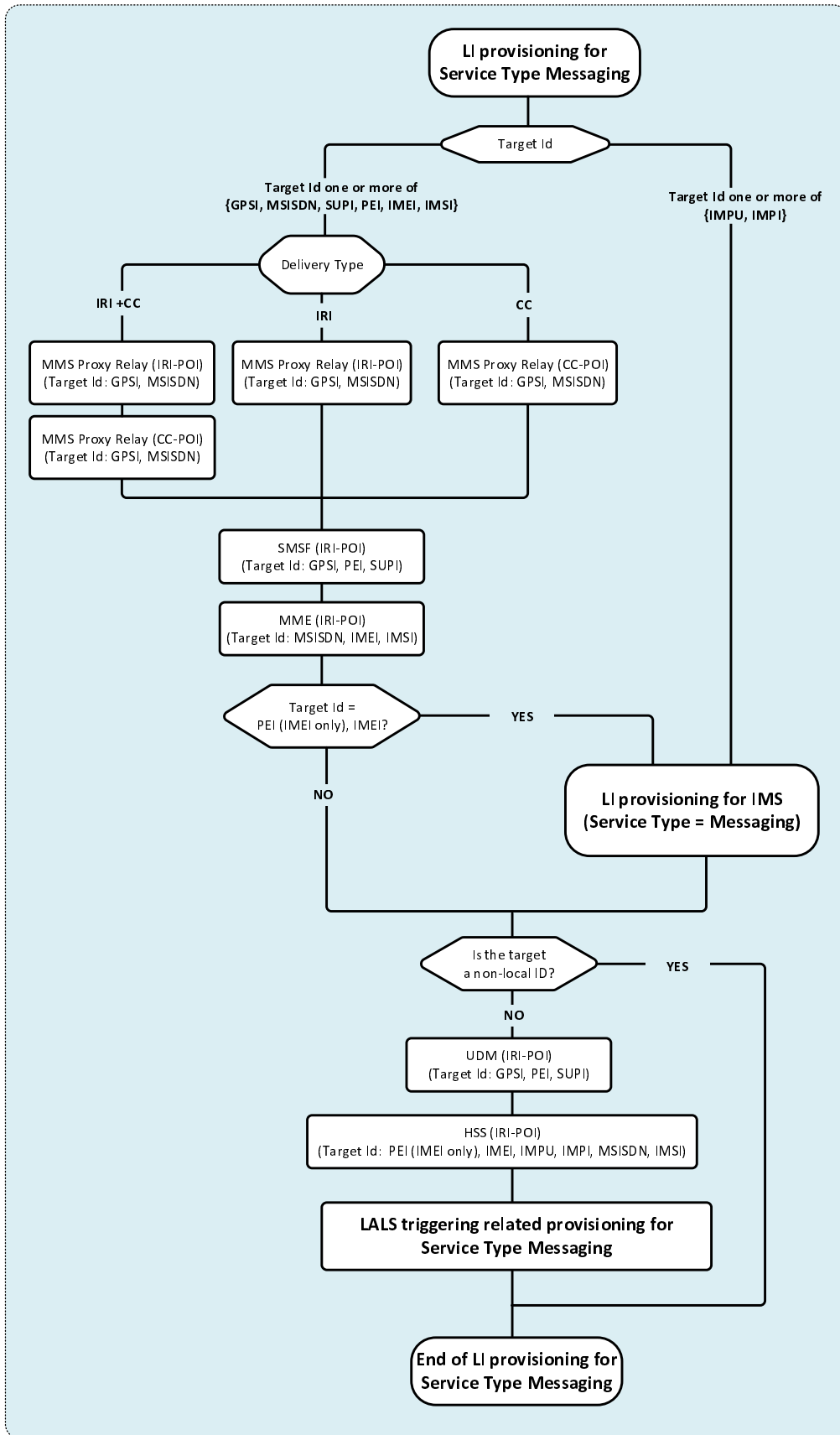

Figure G.6-1: Top-level view of LIPF logic for service type of Messaging

The IRI-POI in HSS, UDM and LMISF-IRI are provisioned only when a target is not a non-local ID.

Figure G.6-2 shows the LIPF logic for service type Messaging with SMS over IMS.

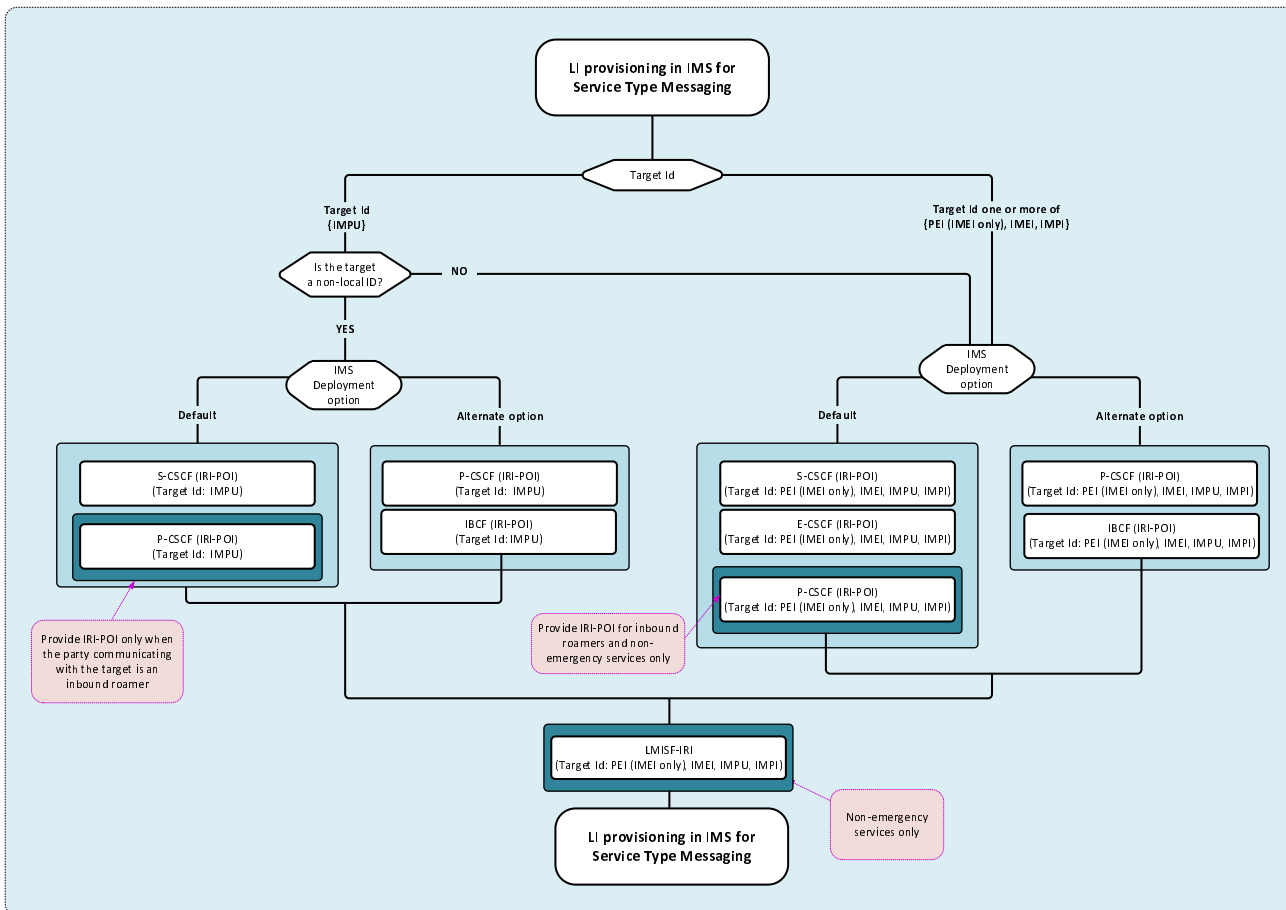

Figure G.6-2: LIPF logic for service type of Messaging for SMS over IMS

The P-CSCF (in figure G.6-2) provides IRI-POI functions under certain conditions as noted within the illustration. To prevent the IRI-POI in P-CSCF from providing the LI functions when not supposed to, the LIPF may have to include a parameter during the provisioning.

Figure G.6-3 shows the LIPF logic for LALS triggering with service type of Messaging.

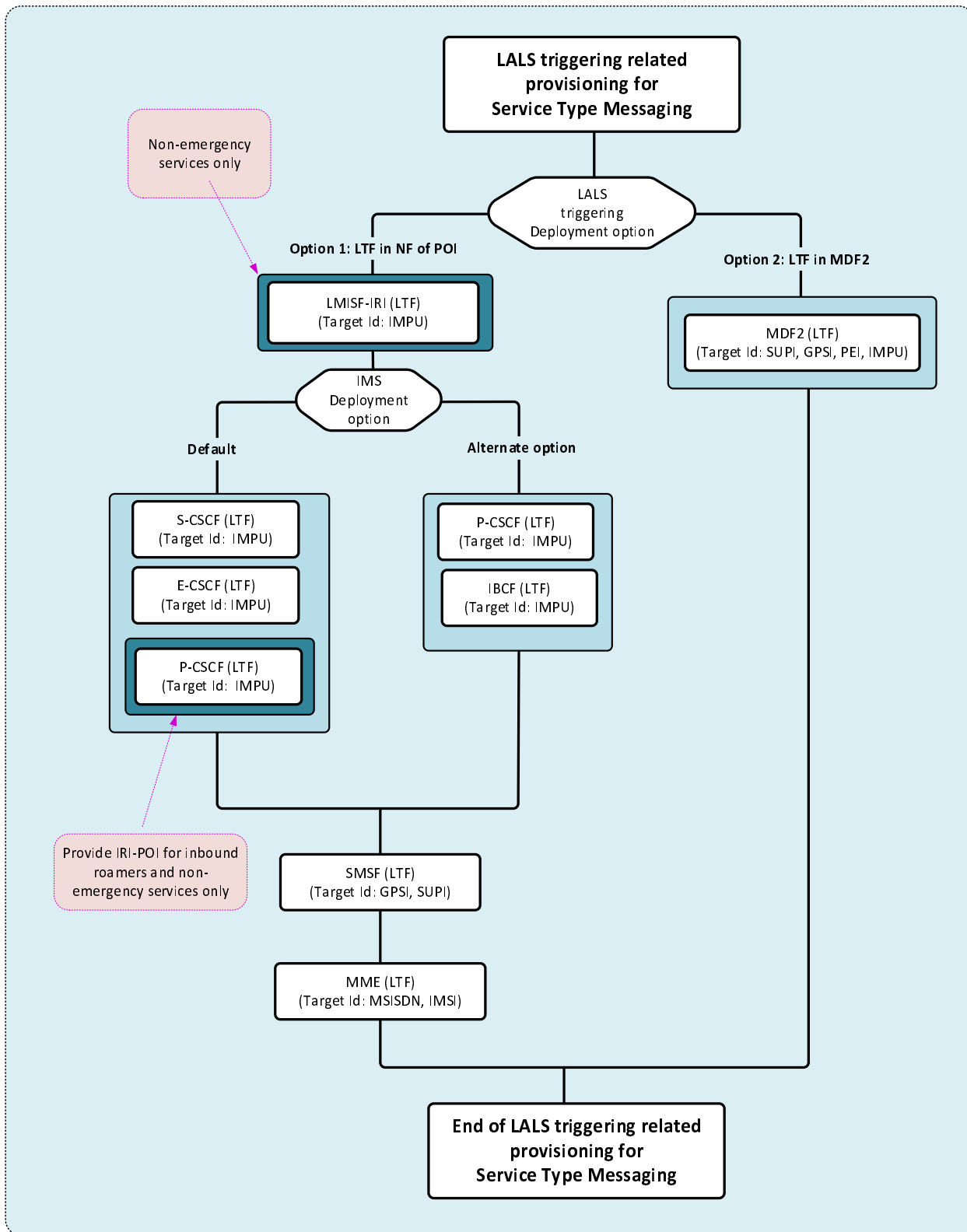

Figure G.6-3: LIPF logic for LALS triggering for the service type of Messaging

The P-CSCF (in figure G.6-3) provides LTF functions under certain conditions as noted within the illustration. To prevent LTF in P-CSCF from providing the LI functions when not supposed to, the LIPF may have to include a parameter during the provisioning.

G.6.2.2 Interception

G.6.2.2.1 IMS deployment

There are two deployment options for IMS for intercepting the service type of Messaging for SMS over IMS:

- Default.
- Alternate option.

It is expected that the CSP implements one of the two deployment options.

The conditions under which IRI-POI functions have to be provisioned are illustrated within the drawing and are further clarified in tables from G.6-3 to G.6-6.

G.6.2.2.2 LALS triggering

There are two deployment options for LALS triggering. It is expected that the CSP implements one of the two deployment options.

In LALS triggering option 1, the LTF present in the host NF that has the associated IRI-POI triggers the LI-LCS Client. In LALS triggering option 2, the LTF presents in the MDF2 triggers the LI-LCS Client.

G.6.2.2.3 Summary

Table G.6-2 provides the scope of NF domain that provides the IRI-POI/CC-POI/LTF functions for the service type of Messaging.

Table G.6-2: Scope of NF domain providing the LI functions for service type Messaging

NFs with LI function			Non-roaming	Roaming with LBO		Roaming with HR	
				VPLMN	HPLMN	VPLMN	HPLMN
MMS Proxy Relay			IRI-POI	n/a	IRI-POI	n/a	IRI-POI
MMS Proxy Relay			CC-POI	n/a	CC-POI	n/a	CC-POI
SMSF			IRI-POI	IRI-POI	n/a	IRI-POI	n/a
MME (with SMS service)			IRI-POI	IRI-POI	n/a	IRI-POI	n/a
IMS NFs			See table G.6-3, table G.6-4, table 6.5 and table 6.6.				
LALS triggering	Option 1	SMSF	LTF	LTF	n/a	LTF	n/a
		MME	LTF	LTF	n/a	LTF	n/a
		IMS NFs	See table G.6-3 and table 6.4				
	Option 2	MDF2	LTF	LTF	LTF	LTF	LTF

Table G.6-3 provides the scope of NF domain in the IMS that provides the IRI-POI/LTF for SMS over IMS when the target is not a non-local ID with default IMS deployment option.

Table G.6-3: Scope of NF domain in IMS providing the LI functions for SMS over IMS (local ID) with Default

NFs with LI function			Non-roaming	Roaming with LBO		Roaming with HR	
				VPLMN	HPLMN	VPLMN	HPLMN
P-CSCF			n/a	IRI-POI (NOTE 1)	n/a	n/a	n/a
E-CSCF			IRI-POI	IRI-POI	n/a	IRI-POI	n/a
S-CSCF			IRI-POI	n/a	IRI-POI	n/a	IRI-POI
LMISF-IRI			n/a	n/a	n/a	IRI-POI (NOTE 1)	n/a
LALS triggering	Option 1	P-CSCF	n/a	LTF (NOTE 1)	n/a	n/a	n/a
		E-CSCF	n/a	LTF	n/a	LTF	n/a
		S-CSCF	LTF	n/a	LTF	n/a	LTF
		LMISF-IRI	n/a	n/a	n/a	LTF (NOTE1)	n/a
	Option 2	MDF2	LTF	LTF	LTF	LTF	LTF

Table G.6-4 provides the scope of NF domain in the IMS that provides the IRI-POI/LTF for SMS over IMS when the target is not a non-local ID with Alternate IMS deployment option.

Table G.6-4: Scope of NF domain in IMS providing the LI functions for SMS over IMS (local ID) with Alternate option

NFs with LI function		Non-roaming	Roaming with LBO		Roaming with HR		
			VPLMN	HPLMN	VPLMN	HPLMN	
P-CSCF		IRI-POI	IRI-POI	n/a	IRI-POI (NOTE 2)	IRI-POI	
IBCF		n/a	n/a	IRI-POI	n/a	n/a	
LMISF-IRI		n/a	n/a	n/a	IRI-POI (NOTE 1)	n/a	
LALS triggering	Option 1	P-CSCF	LTF	LTF	n/a	LTF (NOTE 2)	n/a
		IBCF	n/a	n/a	LTF	n/a	n/a
		LMISF-IRI	n/a	n/a	n/a	LTF (NOTE 1)	n/a
	Option 2	MDF2	LTF	LTF	LTF	LTF	

Table G.6-5 provides the scope of NF domain in the IMS that provides the IRI-POI/LTF for SMS over IMS when the target is a non-local ID with default IMS deployment option.

Table G.6-5: Scope of NF domain in IMS providing the LI functions for SMS over IMS (non-local ID) with Default

NFs with LI function		Non-roaming	Roaming with LBO		Roaming with HR	
			VPLMN	HPLMN	VPLMN	HPLMN
P-CSCF		n/a	IRI-POI	n/a	n/a	n/a
S-CSCF		IRI-POI	n/a	IRI-POI	n/a	IRI-POI
LMISF-IRI		n/a	n/a	n/a	IRI-POI	n/a

Table G.6-6 provides the scope of NF domain in the IMS that provides the IRI-POI/LTF for SMS over IMS when the target is a non-local ID with Alternate IMS deployment option.

Table G.6-6: Scope of NF domain in IMS providing the LI functions for SMS over IMS (non-local ID) with Alternate option

NFs with LI function		Non-roaming	Roaming with LBO		Roaming with HR	
			VPLMN	HPLMN	VPLMN	HPLMN
P-CSCF		IRI-POI	IRI-POI	n/a	n/a	IRI-POI
IBCF		n/a	n/a	IRI-POI	n/a	n/a
LMISF-IRI		n/a	n/a	n/a	IRI-POI	n/a

NOTE 1: Only for SMS over IMS not involving the emergency center.

NOTE 2: Only for SMS over IMS to emergency centers.

NOTE 3: The use of "n/a" in the above table implies that the LI function is not applicable to the NF for the indicated scenario.

NOTE 4: The LIPF is not aware of the above role played by the host NFs in providing the LI functions

NOTE 5: MDF2, MDF3 and LI-LCS Client which are also involved in providing the LI functions are not shown in the tables above.

G.7 PTC

G.7.1 Scope of interception

The illustrations shown in this clause are for the service type PTC.

The interception of service type of PTC is done by the IRI-POI and CC-POI present in the PTC server and includes delivery of IRI or CC based on the delivery type indicated in the warrant.

The following target identifiers are applicable to the service type of PTC for provisioning the IRI-POI/CC-POI at the PTC Server:

- IMPU.
- IMPI.
- MCPTT ID.
- Instant ID URN.
- Chat group ID.

The following target identifiers are applicable to the service type of PTC for provisioning the IRI-POI at the HSS:

- IMPU.
- IMPI.

The target identity in the IMPU format may contain a SIP URI, TEL URI.

G.7.2 LIPF logic for service type of PTC

Figure G.7-1 illustrates the LIPF logic for the provisioning of IRI-POI/CC-POI in the PTC server.

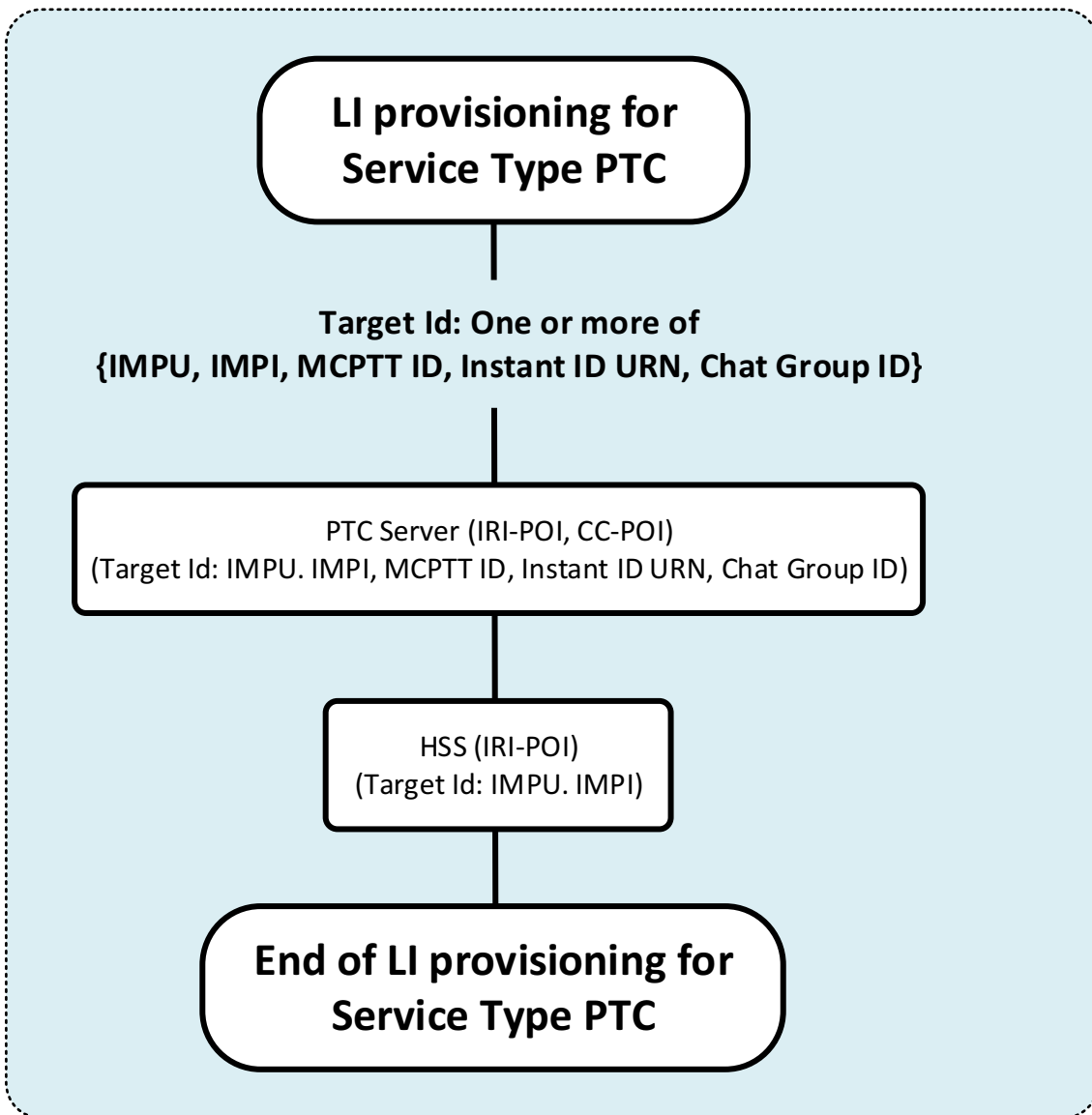

Figure G.7-1: LIPF logic for provisioning the IRI-POI/CC-POI in PTC Server for the service type of PTC

When the Chat Group ID is used as the target ID, the PTC server happens to intercept when the indicated chat group ID is used for a PTC chat session.

G.8 LALS

G.8.1 Scope of interception

The illustrations shown in this clause are for the service type LALS.

The interception of service type of LALS includes the delivery of target's location information either immediate (at the time of provisioning) or periodic by the LI-LCS Client.

G.8.2 LIPF logic for service type of LALS

Figure G.8-1 illustrates the LIPF logic for the provisioning of LI-LCS Client.

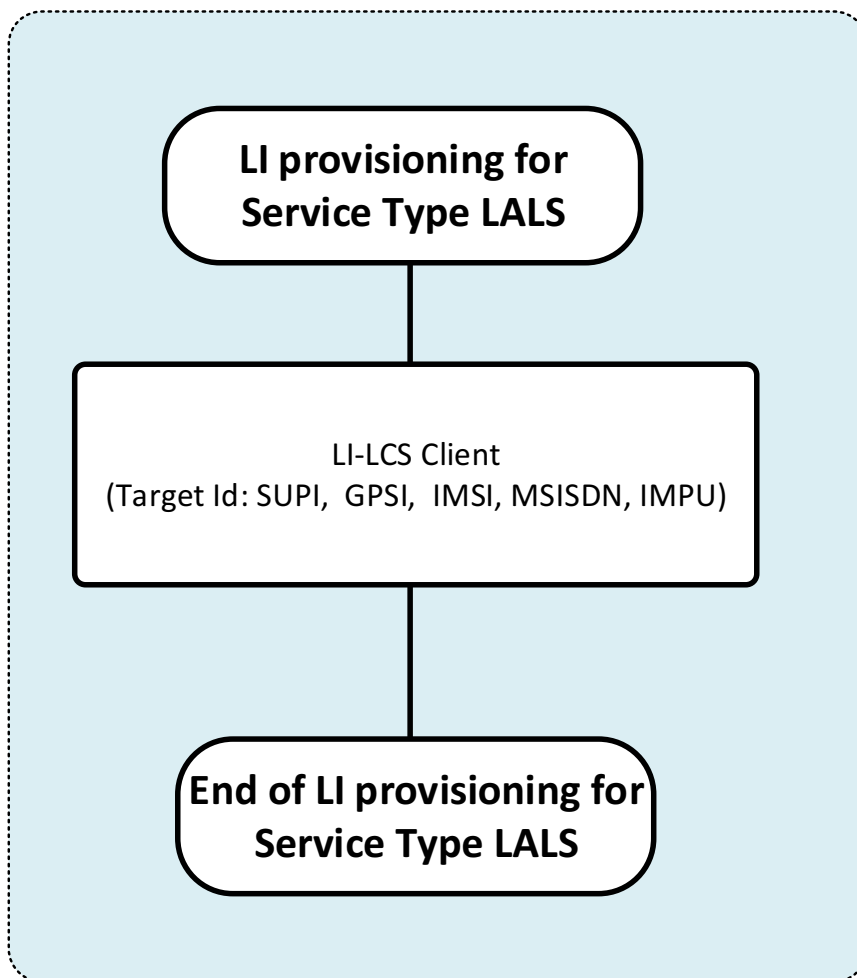

Figure G.8-1: LIPF logic the provisioning of LI-LCS Client for the service type of LALS

Annex H (normative): XSD Schema for State Transfers

The XSD schema describing the structures used for state transfer is given in the file *urn_3GPP_ns_li_3GPPStateTransfer.xsd* which accompanies the present document.

Annex Z (informative): Change history

Change history							
Date	Meeting	TDoc	CR	Rev	Cat	Subject/Comment	New version
2019-03	SA#83	SP-190044				Release 15 draft Approved at TSG SA#83	15.0.0
2019-06	SA#84	SP-190343	0004	1	F	Missing trigger for the start of interception with established PDU session	15.1.0
2019-06	SA#84	SP-190343	0006	1	F	Missing Stage 3 text - Start of Interception with registered UE from MDF2	15.1.0
2019-06	SA#84	SP-190343	0007	1	F	Missing stage 3 text - Start of Interception with established PDU session from MDF2	15.1.0
2019-06	SA#84	SP-190343	0008	1	F	Typos	15.1.0
2019-06	SA#84	SP-190343	0009	-	F	Additional identifiers to support UPF LI_T2/3	15.1.0
2019-06	SA#84	SP-190343	0010	1	F	In-bound roaming interception at anchor UPFs	15.1.0
2019-06	SA#84	SP-190343	0013	1	F	Roaming toggle correction	15.1.0
2019-06	SA#84	SP-190343	0014	1	F	Anchor UPF interception clarification	15.1.0
2019-06	SA#84	SP-190343	0015	1	F	Branching UPF interception correction	15.1.0
2019-06	SA#84	SP-190343	0019	-	F	ASN.1 Editorial Changes for the drafting rules compliance	15.1.0
2019-06	SA#84	SP-190343	0020	-	F	Clarifications on the Location information derivation and delivery	15.1.0
2019-06	SA#84	SP-190345	0021	-	F	Corrections on LI_T3 triggering	15.1.0
2019-06	SA#84	SP-190345	0022	2	F	Handling of error scenarios in LI_T2 and LI_T3 procedures	15.1.0
2019-06	SA#84	SP-190345	0023	2	B	Secondary Cell Group cells reporting	15.1.0
2019-09	SA#85	SP-190634	0029	1	F	Rapporteur fixes with consistency checking	15.2.0
2019-09	SA#85	SP-190634	0030	1	F	Errors in the clauses of Cell Site Report	15.2.0
2019-09	SA#85	SP-190634	0033	1	F	LI activation at the CC-POI after previous failure	15.2.0
2019-09	SA#85	SP-190634	0046	-	F	Start of interception - Reporting SUCI	15.2.0
2019-09	SA#85	SP-190635	0036	1	F	AMF Registration Update	16.0.0
2019-09	SA#85	SP-190635	0037	1	F	AMF Deregistration Update	16.0.0
2019-09	SA#85	SP-190635	0038	-	F	Location update triggering	16.0.0
2019-09	SA#85	SP-190635	0040	1	F	Reporting SUPI in Unsuccessful Registration	16.0.0
2019-09	SA#85	SP-190635	0041	1	F	SUPI Unauthenticated Clarification	16.0.0
2019-09	SA#85	SP-190635	0042	1	F	Mandatory Inclusion of OtherMessage Parameter	16.0.0
2019-09	SA#85	SP-190635	0044	1	F	Task Details Required for Positioning	16.0.0
2019-09	SA#85	SP-190635	0045	1	F	LALS Report Record Note	16.0.0
2019-09	SA#85	SP-190662	0050	3	C	Addition of map datum for geographicalCoordinates	16.0.0
2019-09	SA#85	SP-190662	0051	2	F	Stage 3 text to service scoping	16.0.0
2019-12	SA#86	SP-190984	0053	1	A	Inclusion of Product XID in triggering scenarios	16.1.0
2019-12	SA#86	SP-190984	0055	1	A	LALS Reference Correction	16.1.0
2019-12	SA#86	SP-190985	0057	-	F	Rapporteur fixes in TS 33.128	16.1.0
2019-12	SA#86	SP-190985	0059	1	D	Editorial name change for ETSI TS 103 221-x references	16.1.0
2020-03	SA#87-e	SP-200030	0061	-	A	Wrong ASN.1 coding of parameters AMFPointer and AMFSetID	16.2.0
2020-03	SA#87-e	SP-200031	0062	-	F	Coding of payload direction in xIRIs	16.2.0
2020-03	SA#87-e	SP-200031	0063	-	F	Clarification on 3GPP identifier coding over LI_X2 and LI_HI2	16.2.0
2020-03	SA#87-e	SP-200030	0065	1	A	A clarification to the xIRI SMF PDUSessionRelease record	16.2.0
2020-03	SA#87-e	SP-200031	0066	-	F	Coding of "other target identifier" conditional attributes in xIRIs	16.2.0
2020-03	SA#87-e	SP-200031	0070	1	F	UDM Serving System based on serving MME	16.2.0
2020-07	SA#88-e	SP-200407	0073	1	B	EPC porting	16.3.0
2020-07	SA#88-e	SP-200407	0074	1	F	Corrections to target identifier formats	16.3.0
2020-07	SA#88-e	SP-200407	0075	1	B	IRI fields for ATSSS	16.3.0
2020-07	SA#88-e	SP-200407	0076	1	B	Drafting rule update	16.3.0
2020-07	SA#88-e	SP-200407	0077	1	F	Fixing ASN.1 to match drafting rules	16.3.0
2020-07	SA#88-e	SP-200407	0078	2	F	Clarification and Correction of LALS Service Scoping	16.3.0
2020-07	SA#88-e	SP-200407	0083	1	C	Enhanced AMF Location Update Reporting with Dual Connectivity	16.3.0
2020-07	SA#88-e	SP-200407	0084	1	F	Correction on provisioning of SMF over LI_X	16.3.0
2020-09	SA#89-e	SP-200807	0088	2	F	MMS	16.4.0
2020-09	SA#89-e	SP-200807	0090	1	F	Missing reporting of SMS over NAS in EPC (MME)	16.4.0
2020-09	SA#89-e	SP-200807	0091	1	F	Corrections to the text that describe the service scoping	16.4.0
2020-09	SA#89-e	SP-200807	0092	1	B	Alignment to TS29.571 & TS29.572 R16 parameters	16.4.0
2020-09	SA#89-e	SP-200807	0093	1	F	Clarification on references in EPC LI	16.4.0
2020-09	SA#89-e	SP-200807	0094	5	B	Support for PTC Stage 3	16.4.0
2020-09	SA#89-e	SP-200807	0095	-	F	Reporting Unsupported MA PDU Session requests	16.4.0
2020-09	SA#89-e	SP-200807	0098	1	F	Access Type Reference Correction	16.4.0
2020-09	SA#89-e	SP-200807	0101	1	F	Clarifying IRI Type for SMF-UPF IRI records	16.4.0
2020-09	SA#89-e	SP-200807	0102	1	F	Clarifying IRI Type for SMSF IRI records	16.4.0
2020-09	SA#89-e	SP-200807	0103	1	F	Clarifying IRI Type for UDM IRI records	16.4.0

Change history							
Date	Meeting	TDoc	CR	Rev	Cat	Subject/Comment	New version
2020-09	SA#89-e	SP-200807	0104	1	F	Clarifying IRI Type for LALS IRI records	16.4.0
2020-09	SA#89-e	SP-200807	0105	1	F	Clarifying IRI Type for Cell Site IRI records	16.4.0
2020-09	SA#89-e	SP-200807	0106	1	F	Correction of field name in LI_X2/T2	16.4.0
2020-09	SA#89-e	SP-200807	0110	1	F	Clarifying IRI Type for AMF IRI messages	16.4.0
2020-09	SA#89-e	SP-200807	0111	1	F	Correcting a typo in the ASN.1 TargetIdentifier choice	16.4.0
2020-09	SA#89-e	SP-200807	0112	1	F	HSS LI (stage 3) porting	16.4.0
2020-09	SA#89-e	SP-200806	0116	-	A	Clarification on contents of UPF CC	16.4.0
2020-09	SA#89-e	SP-200807	0117	-	F	Reference correction for xCC payload format	16.4.0
2020-12	SA#90-e	SP-200940	0120	1	B	PDSR triggers for start and end of flow	16.5.0
2020-12	SA#90-e	SP-200940	0121	-	F	Additional details on Location Update at AMF	16.5.0
2020-12	SA#90-e	SP-200940	0122	-	F	Corrections on UDM Serving System	16.5.0
2020-12	SA#90-e	SP-200940	0130	1	F	Clarification on the contents of the IRI TargetIdentifiers field	16.5.0
2020-12	SA#90-e	SP-200940	0131	-	F	Aligning the CC payload form of 5G with LTE	16.5.0
2020-12	SA#90-e	SP-200940	0133	1	F	PDU session ID in PDHR and PDSR	16.5.0
2020-12	SA#90-e	SP-200940	0136	4	B	MA PDU Session Stage 3	16.5.0
2020-12	SA#90-e	SP-200940	0138	1	B	Identifier Association	16.5.0
2020-12	SA#90-e	SP-200940	0139	1	B	Update to LI at the SMSF	16.5.0
2020-12	SA#90-e	SP-200940	0140	1	F	Update to Provisioning for LI at the SMF/UPF	16.5.0
2020-12	SA#90-e	SP-200940	0141	-	F	Clarification to PDHR/PDSR	16.5.0
2020-12	SA#90-e	SP-200940	0142	1	F	Stage 3 details for SMF/UPF LI_X1	16.5.0
2020-12	SA#90-e	SP-200939	0143	1	A	Missing session establishment time in SMF IRI	16.5.0
2020-12	SA#90-e	SP-200940	0144	-	F	Update to Activate Task Message for IRI-TF and CC-TF in the SMF	16.5.0
2020-12	SA#90-e	SP-200940	0145	-	F	Clarification to trigger for PDSR Delivery	16.5.0
2020-12	SA#90-e	SP-200940	0147	1	B	Update Serving System and support of Subscriber Record Change and Cancel Location (x)IRIs	16.5.0
2020-12	SA#90-e	SP-200940	0150	1	F	Fixing Target Identity Extensions	16.5.0
2021-03	SA#91-e	SP-210031	0153	2	F	GUTI allocation procedure reporting correction	16.6.0
2021-03	SA#91-e	SP-210031	0155	1	F	Removal of note in LI at the UDM clause that no longer applies	16.6.0
2021-03	SA#91-e	SP-210031	0156	1	F	Corrections to MA PDU LI reporting at the SMF	16.6.0
2021-03	SA#91-e	SP-210031	0157	-	F	Identity Association Corrections	16.6.0
2021-03	SA#91-e	SP-210031	0158	1	F	Alignment of positioning methods	16.6.0
2021-03	SA#91-e	SP-210031	0159	1	F	Removal of Reference to Deleted Note	16.6.0
2021-03	SA#91-e	SP-210031	0160	1	F	Identity Association correction and clarification LI_HIQR and LI_XQR	16.6.0
2021-03	SA#91-e	SP-210031	0161	1	F	Correction of FiveGGUTI ASN1 in LI_XER	16.6.0
2021-03	SA#91-e	SP-210032	0163	1	F	Port of EPC MME Target Identifiers	17.0.0
2021-06	SA#92-e	SP-210303	0164	1	C	Clarification of ID Association Provisioning at the MME	17.1.0
2021-06	SA#92-e	SP-210303	0165	1	C	Addition of EPS/5G Interworking Parameters to ASN.1	17.1.0
2021-06	SA#92-e	SP-210303	0166	1	C	Enhancements to LI at the AM	17.1.0
2021-06	SA#92-e	SP-210302	0168	1	A	LALS: Correcting the error that infers as if LIPF provisions the triggered LI-LCS Client	17.1.0
2021-06	SA#92-e	SP-210302	0170	1	A	LI_T: Clarification on the need to have create destination over LI-T2 and LI_T3	17.1.0
2021-06	SA#92-e	SP-210302	0172	1	A	Addition of ModifyTask to LI_X1 realization	17.1.0
2021-06	SA#92-e	SP-210302	0175	1	A	Avoiding multiple copies of xCC over LI_X3: Additional XID Related Information	17.1.0
2021-06	SA#92-e	SP-210302	0181	2	A	Alignment of N3GPP Access Location	17.1.0
2021-06	SA#92-e	SP-210302	0182	1	A	LALS Target Identities	17.1.0
2021-06	SA#92-e	SP-210303	0184	1	F	UDM: clarification on the payload direction field for UDM related xIRI	17.1.0
2021-06	SA#92-e	SP-210303	0185	1	F	ID Association: clarification on the payload direction field	17.1.0
2021-06	SA#92-e	SP-210303	0186	1	F	Location: clarification on the payload direction field	17.1.0
2021-06	SA#92-e	SP-210303	0196	3	C	Port of EPC MME LI	17.1.0
2021-06	SA#92-e	SP-210303	0198	1	D	Corrections to references for clause 7.5 PTC Services	17.1.0
2021-06	SA#92-e	SP-210303	0199	1	B	LIPF logic: new informative annex	17.1.0
2021-06	SA#92-e	SP-210303	0201	1	B	LI for NEF Services (NIDD included)	17.1.0
2021-06	SA#92-e	SP-210303	0202	1	B	LI for SCEF services	17.1.0
2021-06	SA#92-e	SP-210303	0204	1	F	Editorial improvements	17.1.0
2021-06	SA#92-e	SP-210302	0208	1	A	Ongoing reporting for LI_XQR	17.1.0
2021-06	SA#92-e	SP-210303	0210	1	B	Correction to LI for the SGW/PGW and addition of CUPS EP	17.1.0
2021-06	SA#92-e	SP-210303	0211	1	B	Change of reference for PDHR/PDSR approac	17.1.0
2021-06	SA#92-e	SP-210301	0214	1	A	Explicit ModifyTask and DeactivateTask for LI_TF	17.1.0
2021-06	SA#92-e	SP-210303	0215	-	B	LI state transfers in SMF sets	17.1.0
2021-09	SA#93-e	SP-210829	0217	-	F	Correction to details for SMSF parameter	17.2.0
2021-09	SA#93-e	SP-210829	0218	1	C	Change of common XSD type references	17.2.0
2021-09	SA#93-e	SP-210829	0219	-	F	Correction of ASN.1 typos for R17	17.2.0
2021-09	SA#93-e	SP-210829	0220	2	B	CR adding LI for AKMA (stage 3)	17.2.0
2021-09	SA#93-e	SP-210829	0221	1	C	Addition of non-IMEISV PEI reporting at the AMF	17.2.0
2021-09	SA#93-e	SP-210829	0222	-	D	Editorial correction to xIRI generation lists at the MME	17.2.0
2021-09	SA#93-e	SP-210828	0223	1	A	Generation of xCC over LI_X3 for PTC service	17.2.0

Change history							
Date	Meeting	TDoc	CR	Rev	Cat	Subject/Comment	New version
2021-09	SA#93-e	SP-210828	0225	1	A	Generation of CC over LI_HI3 for PTC service	17.2.0
2021-09	SA#93-e	SP-210829	0228	1	F	Update of stage 3 language and alignment of packet header information reporting	17.2.0
2021-09	SA#93-e	SP-210829	0232	1	D	Few editorials – consistency purpose	17.2.0
2021-09	SA#93-e	SP-210829	0234	1	C	Correction to MME Record Types	17.2.0
2021-09	SA#93-e	SP-210829	0235	1	C	Addition of HeaderReporting options to MediationDetails	17.2.0
2021-09	SA#93-e	SP-210828	0238	-	A	Correction of TAC length in Annex E	17.2.0
2021-09	SA#93-e	SP-210829	0239	1	B	N9HRLI and S8HR LI – Part I (Phase 1 – LI_X1)	17.2.0
2021-09	SA#93-e	SP-210829	0240	1	B	N9HRLI and S8HR LI – Part II (Phase 1 – LI_X2_LITE)	17.2.0
2021-09	SA#93-e	SP-210829	0241	1	B	N9HRLI and S8HR LI – Part III (Phase 1 – BBIFF-U triggering)	17.2.0
2021-09	SA#93-e	SP-210829	0242	1	B	N9HRLI and S8HR LI – Part IV (Phase 1 – LI_X3_LITE_S)	17.2.0
2021-09	SA#93-e	SP-210829	0243	1	B	N9HRLI and S8HR LI – Part V (Phase 2 – LI_X1)	17.2.0
2021-09	SA#93-e	SP-210829	0244	1	B	N9HRLI and S8HR LI – Part VI (Phase 2 – LI_X2)	17.2.0
2021-09	SA#93-e	SP-210829	0245	1	B	N9HRLI and S8HR LI – Part VII (Phase 2 – LI_T1 & LI_T3)	17.2.0
2021-09	SA#93-e	SP-210829	0246	1	B	N9HRLI and S8HR LI – Part VIII (Phase 2 – LI_X3_LITE_M)	17.2.0
2021-09	SA#93-e	SP-210829	0247	1	B	N9HRLI and S8HR LI – Part IX (Phase 2 – LI_X3)	17.2.0
2021-09	SA#93-e	SP-210829	0248	1	B	N9HR LI and S8HR LI – Part X (Phase 2 – X3, LI_HI2 and LI_HI3)	17.2.0
2021-09	SA#93-e	SP-210829	0249	1	B	N9HR LI and S8HR LI – Part XI (ASN.1 changes)	17.2.0
2021-09	SA#93-e	SP-210829	0250	1	B	N9HR LI and S8HR LI: New XSD definitions	17.2.0
2021-09	SA#93-e	SP-210829	0251	1	F	Update requirement for IRI type	17.2.0
2021-09	SA#93-e	SP-210829	0253	1	C	Update to start of interception with registered UE record at the AMF	17.2.0
2021-12	SA#94-e	SP-211409	0255	1	F	HR LI: Deactivating triggers over LI_T1 and LI_T3 when the IMS session ends	17.3.0
2021-12	SA#94-e	SP-211409	0256	1	F	HR LI: Deactivating LI_T3 when PDU session/PDN connection is released or HR is disabled	17.3.0
2021-12	SA#94-e	SP-211409	0257	1	F	HR LI: The case of post PDU session/PDN connection HR LI enabling	17.3.0
2021-12	SA#94-e	SP-211409	0258	8	B	STIR SHAKEN Stage 3	17.3.0
2021-12	SA#94-e	SP-211408	0260	1	A	DeactiveTask messages	17.3.0
2021-12	SA#94-e	SP-211409	0261	1	B	Addition of PDN Info to SMF Tables	17.3.0
2021-12	SA#94-e	SP-211408	0263	1	A	Clarification to default behaviour for ServiceScoping at the MDF	17.3.0
2021-12	SA#94-e	SP-211408	0265	1	A	Clarification of PEI in ASN.1	17.3.0
2021-12	SA#94-e	SP-211408	0267	1	A	LI_HIQR Clarifications	17.3.0
2021-12	SA#94-e	SP-211408	0269	1	A	Clarification to default behaviour for Location Type at the MDF	17.3.0
2021-12	SA#94-e	SP-211409	0270	1	F	HR LI: Only one Activate Task to the BBIFF-C from LIPF	17.3.0
2021-12	SA#94-e	SP-211409	0271	1	F	Target identifier clarification – IMS LI and HR LI	17.3.0
2021-12	SA#94-e	SP-211409	0272	1	B	Records in IMS stage 3	17.3.0
2021-12	SA#94-e	SP-211409	0273	1	B	Separated Location Reporting	17.3.0
2021-12	SA#94-e	SP-211409	0274	1	B	RCS Stage 3 Provisioning	17.3.0
2021-12	SA#94-e	SP-211409	0275	1	B	RCS Stage 3 Triggering	17.3.0
2021-12	SA#94-e	SP-211409	0276	1	B	RCS Stage 3 Registration, Message and Session establishment LI messages	17.3.0
2021-12	SA#94-e	SP-211408	0278	1	A	Update requirements for IPID and EIPID	17.3.0
2021-12	SA#94-e	SP-211409	0279	-	F	A Clarification on LALS Triggering with LMISF-IRI	17.3.0
2021-12	SA#94-e	SP-211409	0288	1	C	GPSI for AIC - Stage 3	17.3.0
2021-12	SA#94-e	SP-211409	0290	-	B	IMS LI Stage 3 Details	17.3.0
2022-03	SA#95-e	SP-220258	0291	-	C	IMS LI Stage 3 – missing points in the target match principles	17.4.0
2022-03	SA#95-e	SP-220258	0292	1	C	IMS LI Stage 3 – references to the LI details specified in other clauses	17.4.0
2022-03	SA#95-e	SP-220258	0293	-	C	HR LI Stage 3 – out-of-scope to in-scope on xIRI details	17.4.0
2022-03	SA#95-e	SP-220257	0295	-	A	Missing "Owner" field in the IdentityAssociationTargetIdentifier parameter definition	17.4.0
2022-03	SA#95-e	SP-220258	0296	1	F	HR LI Stage 3 – fixing the errors in the reserved IP addresses	17.4.0
2022-03	SA#95-e	SP-220257	0299	1	A	Corrections on SUCI coding	17.4.0
2022-03	SA#95-e	SP-220258	0301	1	F	Fixing parameter names	17.4.0
2022-03	SA#95-e	SP-220258	0302	1	B	Clarification of LI at the UDM	17.4.0
2022-03	SA#95-e	SP-220258	0303	1	B	Addition of SAT and REDCAP RatTypes	17.4.0
2022-03	SA#95-e	SP-220258	0304	-	B	Adding TransportProtocol to N3GALocation	17.4.0
2022-03	SA#95-e	SP-220258	0309	1	D	Few editorial fixes	17.4.0
2022-03	SA#95-e	SP-220258	0310	-	F	Aligning CSP service types for Service Scoping	17.4.0
2022-03	SA#95-e	SP-220258	0313	1	F	Correction on the payload direction in PDU header for IMS Message record	17.4.0
2022-03	SA#95-e	SP-220258	0314	1	B	IMS LI Stage 3 – CC Unavailable xIRI	17.4.0
2022-03	SA#95-e	SP-220258	0315	-	C	Update to Service Scoping Details for IMS	17.4.0
2022-03	SA#95-e	SP-220258	0316	1	C	Addition of ListOfServiceTypes to ActivateTask messages	17.4.0
2022-03	SA#95-e	SP-220258	0319	1	C	Clarification to Service Scoping requirements for LI_HI1	17.4.0
2022-03	SA#95-e	SP-220257	0321	1	A	Addition of NFID for xIRI and xCC	17.4.0
2022-03	SA#95-e	SP-220257	0324	-	A	Corrections to LI_X2 text	17.4.0
2022-03	SA#95-e	SP-220257	0326	-	A	Correction of RequestValues in LI_HIQR	17.4.0

Change history							
Date	Meeting	TDoc	CR	Rev	Cat	Subject/Comment	New version
2022-03	SA#95-e	SP-220258	0327	3	C	STIR SHAKEN Correction	17.4.0
2022-03	SA#95-e	SP-220258	0328	2	C	Measurement Report with LI/LALS in EPC	17.4.0
2022-03	SA#95-e	SP-220258	0329	2	C	Measurement Report with LI/LALS in 5GC	17.4.0
2022-03	SA#95-e	SP-220258	0330	-	F	Clarification of DNN and APN encoding	17.4.0
2022-03	SA#95-e	SP-220258	0332	1	F	Corrections and Editorial changes	17.4.0
2022-03	SA#95-e	SP-220257	0334	1	A	Time of registration/session establishment in Start of Interception related xIRIs	17.4.0
2022-06	SA#96	SP-220386	0336	1	F	Inconsistent use of the terms "identity" and "identifier" in context with the topic "identifier association"	17.5.0
2022-06	SA#96	SP-220386	0337	1	B	IMS LI stage 3: LI_T3 details	17.5.0
2022-06	SA#96	SP-220386	0338	1	B	IMS LI Stage 3 – LI_X3 details	17.5.0
2022-06	SA#96	SP-220386	0339	1	B	IMS LI Stage 3 – LI_HI2 details	17.5.0
2022-06	SA#96	SP-220386	0340	1	B	IMS LI stage 3: LI_HI3 details	17.5.0
2022-06	SA#96	SP-220386	0343	1	F	Alignment of ASN.1 values with TS 29.572 V17.4.0 and corrections	17.5.0
2022-06	SA#96	SP-220386	0347	1	F	Erasing an XSD error in Annex C	17.5.0
2022-06	SA#96	SP-220385	0349	1	A	Backward Compatibility in ASN.1 Schema	17.5.0
2022-06	SA#96	SP-220386	0350	1	F	Correction to IRI types table 7.2.2-4	17.5.0
2022-06	SA#96	SP-220386	0351	-	D	Homogenization of terms designating UE	17.5.0
2022-06	SA#96	SP-220386	0354	1	F	Interception at SMF+PGW-C	17.5.0
2022-06	SA#96	SP-220386	0355	-	B	LI for Edge-unaware UE, and SMF reporting updates	17.5.0
2022-09	SA#97-e	SP-220755	0357	-	F	Correction To AMF Registration ASN.1	17.6.0
2022-09	SA#97-e	SP-220755	0361	-	F	Nudm_UEContextManagement Deregistration service operatio	17.6.0
2022-09	SA#97-e	SP-220755	0363	1	F	Correction To AMF Deregistration xIRI	17.6.0
2022-09	SA#97-e	SP-220754	0367	1	A	Alignment of the requestType Paramter usage within SMF events	17.6.0
2022-09	SA#97-e	SP-220755	0369	3	C	Addition of EUI64 and Paging Restriction Indicator to AMFRegistration Record	17.6.0
2022-09	SA#97-e	SP-220755	0371	1	B	IRI Events for reporting PDN Connection events from the combined SMF+PGW-C	17.6.0
2022-09	SA#97-e	SP-220755	0372	1	B	Location Reporting for Identity Association Record	17.6.0
2022-09	SA#97-e	SP-220755	0379	1	F	Correction to UDMServingSystemMessage Record	17.6.0
2022-09	SA#97-e	SP-220754	0382	1	A	Alignment of target identifiers with services in ASN.1	17.6.0
2022-09	SA#97-e	SP-220755	0384	1	F	STIR/SHAKEN: Enhancements to stage 3 LI descriptions (LI_X1 provisioning)	17.6.0
2022-09	SA#97-e	SP-220755	0386	1	F	STIR/SHAKEN: Enhancements to stage 3 LI descriptions (LI_X2)	17.6.0
2022-09	SA#97-e	SP-220755	0388	3	F	Correction and enrichment of LI events related to Edge unaware UE	17.6.0
2022-09	SA#97-e	SP-220755	0391	1	F	STIR/SHAKEN: Missing details in the MDF2 clause	17.6.0
2022-09	SA#97-e	SP-220755	0393	1	C	LIPF logic diagram updates to include the STIR/SHAKEN related aspects	17.6.0
2022-09	SA#97-e	SP-220755	0398	2	C	Adding support for Session Based Triggers to PDSR	17.6.0
2022-09	SA#97-e	SP-220754	0407	-	A	Resolve inconsistency in HI4 payload	17.6.0
2022-12	SA#98-e	SP-221030	0410	1	F	LIPF Logic in Annex G – updates to fix a few errors related to STIR/SHAKEN tables	17.7.0
2022-12	SA#98-e	SP-221030	0413	-	F	Document compatibility issues with PTC and NIDD	17.7.0
2022-12	SA#98-e	SP-221030	0420	-	A	Correction to table 6.2.3-14 SMF IRI Types	17.7.0
2022-12	SA#98-e	SP-221030	0423	1	F	Correction of AMFLocationUpdate Record	17.7.0
2022-12	SA#98-e	SP-221030	0430	1	F	Protocols for LI_X2_LITE, LI_X3_LITE_S and LI_X3_LITE_M	17.7.0
2022-12	SA#98-e	SP-221030	0433	1	D	Fixing an editorial error in the latest version of TS 33.128	17.7.0
2022-12	SA#98-e	SP-221030	0434	-	F	Addition of 5GS-EPS reporting parameters to MAPDU messages	17.7.0
2022-12	SA#98-e	SP-221030	0440	-	F	Moving schemas to attachments	17.7.0
2022-12	SA#98-e	SP-221030	0443	1	F	Clarification on the provisioning of equivalent 4G and 5G identifier as target in the IRI-POI and CC-TF present in the SMF+PGW-C	17.7.0
2022-12	SA#98-e	SP-221030	0445	-	F	Correction on references	17.7.0
2022-12	SA#98-e	SP-221030	0448	1	F	Clarification on MMELocationUpdate	17.7.0
2022-12	SA#98-e	SP-221030	0450	1	C	Enhance the target match algorithm - SMS over IP (SIP URI)	17.7.0
2022-12	SA#98-e	SP-221030	0452	1	F	S-CSCF based IRI-POI - clarification of the scope	17.7.0
2022-12	SA#98-e	SP-221030	0454	1	C	STIR/SHAKEN - changes to correct a scenario that never happens	17.7.0
2022-12	SA#98-e	SP-221030	0457	1	F	Addition of UE Configuration Update Record and change to AMFLocation Update Record	17.7.0
2023-03	SA#99	SP-230239	0464	1	F	LIPF logic diagram uses IBCF (LTF) instead of IBCF (IRI-POI)	17.8.0
2023-03	SA#99	SP-230239	0467	-	D	Editorial: Incorrect spelling of LMISF	17.8.0
2023-03	SA#99	SP-230239	0468	1	F	Corrections to fix the incorrect use of SM-SC term	17.8.0
2023-03	SA#99	SP-230239	0471	-	F	Correction to S-NSSAI parameter	17.8.0
2023-03	SA#99	SP-230239	0473	-	F	Addition of RATTtype to AMF Registration Record	17.8.0
2023-03	SA#99	SP-230239	0478	1	F	Addition of GERA and UTRA Location to UserLocation structure	17.8.0
2023-03	SA#99	SP-230239	0481	1	A	Addition of Ignore NCGI, Ignore ECGI and Ignore TAI parameter to Location structures	17.8.0
2023-03	SA#99	SP-230239	0487	1	A	Correction to the encoding of Uncertainty in Location	17.8.0
2023-03	SA#99	SP-230239	0493	1	F	Alignment of the EPS Location reporting types	17.8.0
2023-06	SA#100	SP-230444	0502	-	F	Correction to avoid a trigger generating two different xIRIs	17.9.0

Change history							
Date	Meeting	TDoc	CR	Rev	Cat	Subject/Comment	New version
2023-06	SA#100	SP-230444	0506	1	F	Modifying the name of an undefined NAS message to a defined NAS message	17.9.0
2023-06	SA#100	SP-230444	0509	1	F	Use of correct PFCP message name that triggers LI_T3: DeactivateTask	17.9.0
2023-06	SA#100	SP-230444	0514	-	F	Missing trigger for xIRI PDU session modification when access type changes	17.9.0
2023-06	SA#100	SP-230444	0516	-	F	Cleaning up the text to move an out of text paragraph	17.9.0
2023-06	SA#100	SP-230444	0518	-	F	sCASID and aFID in SCEF/NEF Unsuccessful Procedure xIRI	17.9.0
2023-06	SA#100	SP-230444	0522	1	F	Corrections on some parameters reported by the combined SMF+PGW-C	17.9.0
2023-06	SA#100	SP-230444	0524	1	F	Correction of ASN.1 for TLS AKMA IRI	17.9.0
2023-06	SA#100	SP-230444	0538	1	C	Missed cases for PDU session release	17.9.0
2023-09	SA#101	SP-230826	0544	-	F	The undetectable events for xIRI NEFUnsuccessfulProcedure record_R17	17.10.0
2023-09	SA#101	SP-230826	0551	1	F	Clarifications for AKMA LI Stage 3	17.10.0
2023-09	SA#101	SP-230826	0558	1	F	Correction to EPS PDN Connection Modification record	17.10.0
2023-12	SA#102	SP-231602	0565	1	F	Missing PDU session ID/EPS bearer ID in xIRIs generated at the NEF/SCEF	17.11.0
2023-12	SA#102	SP-231602	0570	1	F	APN unavailability in SCEFUnsuccessfulProcedure record	17.11.0
2023-12	SA#102	SP-231602	0574	1	F	Correction to RCS trigger XID, and other XID clarifications	17.11.0
2023-12	SA#102	SP-231602	0594	1	A	Addition of missing parameters to SUCI definition	17.11.0

History

Document history		
V17.4.0	May 2022	Publication
V17.5.0	July 2022	Publication
V17.6.0	September 2022	Publication
V17.7.0	January 2023	Publication
V17.8.0	April 2023	Publication
V17.9.0	July 2023	Publication
V17.10.0	October 2023	Publication
V17.11.0	January 2024	Publication