

ETSI TS 133 310 V9.2.1 (2010-04)

Technical Specification

**Universal Mobile Telecommunications System (UMTS);
LTE;
Network Domain Security (NDS);
Authentication Framework (AF)
(3GPP TS 33.310 version 9.2.1 Release 9)**



Reference

RTS/TSGS-0333310v921

Keywords

LTE, SECURITY, UMTS

ETSI

650 Route des Lucioles
F-06921 Sophia Antipolis Cedex - FRANCE

Tel.: +33 4 92 94 42 00 Fax: +33 4 93 65 47 16

Siret N° 348 623 562 00017 - NAF 742 C
Association à but non lucratif enregistrée à la
Sous-Préfecture de Grasse (06) N° 7803/88

Important notice

Individual copies of the present document can be downloaded from:

<http://www.etsi.org>

The present document may be made available in more than one electronic version or in print. In any case of existing or perceived difference in contents between such versions, the reference version is the Portable Document Format (PDF). In case of dispute, the reference shall be the printing on ETSI printers of the PDF version kept on a specific network drive within ETSI Secretariat.

Users of the present document should be aware that the document may be subject to revision or change of status. Information on the current status of this and other ETSI documents is available at

<http://portal.etsi.org/tb/status/status.asp>

If you find errors in the present document, please send your comment to one of the following services:

http://portal.etsi.org/chaicor/ETSI_support.asp

Copyright Notification

No part may be reproduced except as authorized by written permission.
The copyright and the foregoing restriction extend to reproduction in all media.

© European Telecommunications Standards Institute 2010.
All rights reserved.

DECT™, **PLUGTESTS™**, **UMTS™**, **TIPHON™**, the TIPHON logo and the ETSI logo are Trade Marks of ETSI registered for the benefit of its Members.

3GPP™ is a Trade Mark of ETSI registered for the benefit of its Members and of the 3GPP Organizational Partners.

LTE™ is a Trade Mark of ETSI currently being registered

for the benefit of its Members and of the 3GPP Organizational Partners.

GSM® and the GSM logo are Trade Marks registered and owned by the GSM Association.

Intellectual Property Rights

IPRs essential or potentially essential to the present document may have been declared to ETSI. The information pertaining to these essential IPRs, if any, is publicly available for **ETSI members and non-members**, and can be found in ETSI SR 000 314: *"Intellectual Property Rights (IPRs); Essential, or potentially Essential, IPRs notified to ETSI in respect of ETSI standards"*, which is available from the ETSI Secretariat. Latest updates are available on the ETSI Web server (<http://webapp.etsi.org/IPR/home.asp>).

Pursuant to the ETSI IPR Policy, no investigation, including IPR searches, has been carried out by ETSI. No guarantee can be given as to the existence of other IPRs not referenced in ETSI SR 000 314 (or the updates on the ETSI Web server) which are, or may be, or may become, essential to the present document.

Foreword

This Technical Specification (TS) has been produced by ETSI 3rd Generation Partnership Project (3GPP).

The present document may refer to technical specifications or reports using their 3GPP identities, UMTS identities or GSM identities. These should be interpreted as being references to the corresponding ETSI deliverables.

The cross reference between GSM, UMTS, 3GPP and ETSI identities can be found under <http://webapp.etsi.org/key/queryform.asp>.

Contents

Intellectual Property Rights	2
Foreword.....	2
Foreword.....	6
Introduction	6
1 Scope	7
2 References	8
3 Definitions and abbreviations.....	9
3.1 Definitions	9
3.2 Abbreviations	9
4 Introduction to Public Key Infrastructure (PKI)	9
4.1 Manual Cross-certification	9
4.2 Cross-certification with a Bridge CA	10
5 Architecture and use cases of the NDS/AF	10
5.1 PKI architecture for NDS/AF.....	10
5.1.1 General architecture.....	11
5.1.1.1 NDS/IP case	11
5.1.1.2 TLS case.....	12
5.2 Use cases	13
5.2.1 Operator Registration: Creation of interconnect agreement	13
5.2.2 Establishment of secure communications	15
5.2.2.1 NDS/IP case	15
5.2.2.1.1 NDS/IP case for the Za interface.....	15
5.2.2.1.2 NDS/IP case for the Zb-interface	15
5.2.2.2 TLS case.....	16
5.2.3 Operator deregistration: Termination of interconnect agreement	17
5.2.3a Interconnection CA registration.....	17
5.2.3b Interconnection CA deregistration.....	17
5.2.3c Interconnection CA certification creation.....	17
5.2.3d Interconnection CA certification revocation.....	18
5.2.3e Interconnection CA certification renewal	18
5.2.4 SEG/TLS CA registration.....	18
5.2.5 SEG/TLS CA deregistration	18
5.2.6 SEG/TLS CA certificate creation	18
5.2.7 SEG/TLS CA certificate revocation	19
5.2.8 SEG/TLS CA certificate renewal.....	19
5.2.9 End entity registration.....	19
5.2.9.1 SEG registration.....	19
5.2.9.2 TLS client registration.....	19
5.2.9.3 TLS server registration.....	19
5.2.9.4 NE registration	20
5.2.10 End entity deregistration.....	20
5.2.10.1 SEG deregistration	20
5.2.10.2 TLS client deregistration.....	20
5.2.10.3 TLS server deregistration.....	20
5.2.10.4 NE deregistration	20
5.2.11 End entity certificate creation	20
5.2.12 End entity certificate revocation	20
5.2.13 End entity certificate renewal	20
5.2.14 NE CA deregistration.....	20
5.2.15 NE CA certification creation	20
5.2.16 NE CA certificate revocation.....	21
5.2.17 NE CA certificate renewal.....	21

6	Profiling.....	21
6.1	Certificate profiles.....	21
6.1.1	Common rules to all certificates.....	21
6.1.2	Interconnection CA Certificate profile.....	22
6.1.3	SEG Certificate profile.....	22
6.1.3a	TLS entity certificate profile.....	22
6.1.3b	NE Certificate profile.....	23
6.1.4	SEG CA certificate profile.....	23
6.1.4a	TLS client/server CA certificate profile.....	23
6.1.4b	NE CA certificate profile.....	24
6.2	IKE negotiation and profiling.....	24
6.2.1	IKEv1 Phase 1 profile.....	24
6.2.1b	IKEv2 profile.....	24
6.2.2	Potential interoperability issues.....	25
6.2a	TLS profiling.....	25
6.2a.1	TLS profile.....	25
6.2a.2	Potential interoperability issues.....	25
6.3	Path validation.....	25
6.3.1	Path validation profiling.....	25
7	Detailed description of architecture and mechanisms.....	26
7.1	Repositories.....	26
7.2	Life cycle management.....	29
7.3	Cross-certification.....	30
7.4	Revoking a SEG/TLS CA cross-certificate.....	30
7.5	Establishing secure connections between NDS/IP end entities using IKE on the Za interface.....	30
7.5a	Establishing secure connections using TLS.....	31
7.5b	Establishing secure connections between NDS/IP entities on the Zb interface.....	31
7.6	CRL management.....	31
8	Backward compatibility for NDS/IP NE's and SEGs.....	32
9	Certificate Enrolment for Base Stations.....	33
9.1	General.....	33
9.2	Architecture.....	33
9.3	Security Mechanisms.....	34
9.4	Certificate Profiles.....	34
9.4.1	General.....	34
9.4.2	Vendor Root CA Certificate.....	34
9.4.3	Vendor CA Certificate.....	34
9.4.4	Vendor Base Station Certificate.....	34
9.4.5	Operator Root CA Certificate.....	34
9.4.6	Operator RA/CA Certificate.....	34
9.4.7	Intermediate Operator CA Certificate.....	35
9.4.8	Operator Base Station Certificate.....	35
9.5	CMPv2 Profiling.....	35
9.5.1	General Requirements.....	35
9.5.2	Profile for the PKIMessage.....	36
9.5.3	Profile for the PKIHeader Field.....	36
9.5.4	Profile for the PKIBody Field.....	37
9.5.4.1	General.....	37
9.5.4.2	Initialization Request.....	37
9.5.4.3	Initialization Response.....	38
9.5.4.4	Key Update Request and Key Update Response.....	38
9.5.4.5	Certificate Confirm Request and Confirmation Response.....	38
9.6	CMPv2 Transport.....	38
Annex A (normative):	Critical and non critical Certificate Extensions.....	39
Annex B (informative):	Decision for the simple trust model.....	40
B.1	Introduction.....	40
B.2	Requirements for trust model in NDS/AF.....	40

B.3	Cross-certification approaches	40
B.3.1	Manual Cross-certification	40
B.3.2	Cross-certification with a Bridge CA	41
B.4	Issues with the Bridge CA approach	41
B.4.1	Need for nameConstraint support in certificates or strong legal bindings and auditing	41
B.4.2	Preventing name collisions	42
B.4.3	Two redundant steps required for establishing trust	42
B.4.4	Long certificate chains connected with IKE implementation issues	42
B.4.5	Lack of existing relevant Bridge CA experiences	43
B.5	Feasibility of the direct cross-certification approach	43
B.5.1	Benefits of direct cross-certification	43
B.5.2	Memory and processing power requirements	44
B.5.3	Shortcomings	44
B.5.4	Possible evolution path to a Bridge CA	44
Annex C (informative):	Decision for the CRL repository access protocol for SEGs	45
Annex D (informative):	Decision for storing the cross-certificates in CR	46
Annex E (normative):	TLS protocol profile	47
Annex F (informative):	Manual handling of TLS certificates	48
F.1	TLS certificate enrolment	48
F.2	TLS Certificate revocation	48
Annex G (informative):	Example CMPv2 Message Flow for Initial Enrolment	49
Annex H (informative):	Change history	51
History		52

Foreword

This Technical Specification has been produced by the 3rd Generation Partnership Project (3GPP).

The contents of the present document are subject to continuing work within the TSG and may change following formal TSG approval. Should the TSG modify the contents of the present document, it will be re-released by the TSG with an identifying change of release date and an increase in version number as follows:

Version x.y.z

where:

- x the first digit:
 - 1 presented to TSG for information;
 - 2 presented to TSG for approval;
 - 3 or greater indicates TSG approved document under change control.
- y the second digit is incremented for all changes of substance, i.e. technical enhancements, corrections, updates, etc.
- z the third digit is incremented when editorial only changes have been incorporated in the document.

Introduction

For 3GPP systems there is a need for truly scalable entity Authentication Framework (AF) since an increasing number of network elements and interfaces are covered by security mechanisms.

This specification provides a highly scalable entity authentication framework for 3GPP network nodes. This framework is developed in the context of the Network Domain Security work item, which effectively limits the scope to the control plane entities of the core network. Thus, *the Authentication Framework will provide entity authentication for the nodes that are using NDS/IP.*

Feasible trust models (i.e. how CAs are organized) and their effects are provided. Additionally, requirements are presented for the used protocols and certificate profiles, to make it possible for operator IPsec and PKI implementations to interoperate.

1 Scope

The scope of this Technical Specification is limited to authentication of network elements, which are using NDS/IP or TLS.

In the case of NDS/IP this specification includes both the authentication of Security Gateways (SEG) at the corresponding Za-interfaces and the authentication between NEs and between NEs and SEGs at the Zb-interface. Authentication of end entities (i.e. NEs and SEGs) in the intra-operator domain is considered an internal issue for operators. This is quite much in line with [1] which states that only Za is mandatory and that the security domain operator can decide if the Zb-interface is deployed or not, as the Zb-interface is optional for implementation. Validity of certificates may be restricted to the operator's domain in case of Zb interface or in case of Za-interface between two security domains of the same operator.

NOTE: In case two SEGs interconnect separate network regions under a single administrative authority (e.g. owned by the same mobile operator) then the Za-interface is not subject to interconnect agreements, but the decision on applying Za-interface is left to operators.

The NDS architecture for IP-based protocols is illustrated in figure 1.

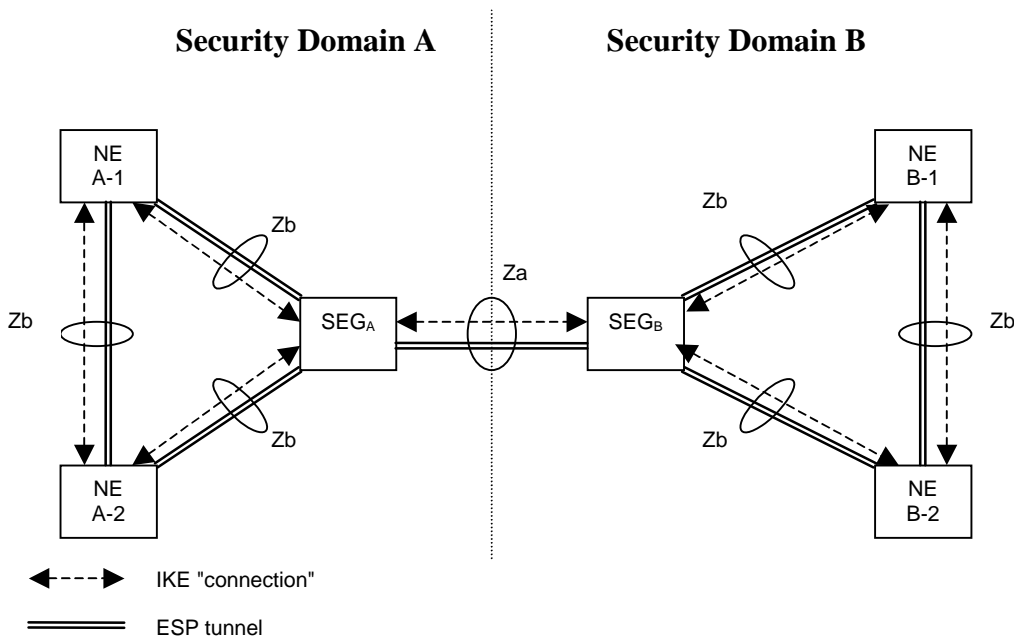

Figure 1: NDS architecture for IP-based protocols [1]

In the case of TLS this Specification concentrates on authentication of TLS entities across inter-operator links. For example, TLS is specified for inter-operator communications between IMS and non-IMS networks TS 33.203 [9] and on the Zn' interface in GBA TS 33.220 [10]. Authentication of TLS entities across intra-operator links is considered an internal issue for operators. However, NDS/AF can easily be adapted to the intra-operator use case since it is just a simplification of the inter-operator case when all TLS NEs and the PKI infrastructure belong to the same operator. Validity of certificates may be restricted to the operator's domain. An Annex contains information on the manual handling of TLS certificates in case automatic enrolment and revocation according to NDS/AF for TLS is not implemented.

2 References

The following documents contain provisions which, through reference in this text, constitute provisions of the present document.

- References are either specific (identified by date of publication, edition number, version number, etc.) or non-specific.
- For a specific reference, subsequent revisions do not apply.
- For a non-specific reference, the latest version applies. In the case of a reference to a 3GPP document (including a GSM document), a non-specific reference implicitly refers to the latest version of that document *in the same Release as the present document*.

- [1] 3GPP TS 33.210: "3rd Generation Partnership Project; Technical Specification Group Services and System Aspects; 3G Security; Network domain security; IP network layer security".
- [2] IETF RFC 2986: "PKCS#10 Certification Request Syntax Specification Version 1.7".
- [3] Void.
- [4] IETF RFC 4210: "Internet X.509 Public Key Infrastructure Certificate Management Protocol".
- [5] IETF RFC 2252: "Lightweight Directory Access Protocol (v3): Attribute Syntax Definitions".
- [6] IETF RFC 1981: "Path MTU Discovery for IP version 6".
- [7] "PKI basics – A Technical Perspective", November 2002,
http://www.pkiforum.org/pdfs/PKI_Basics-A_technical_perspective.pdf
- [8] 3GPP TR 21.905: "Vocabulary for 3GPP Specifications".
- [9] 3GPP TS 33.203: "Access security for IP-based services".
- [10] 3GPP TS 33.220: "Generic Authentication Architecture: Generic Bootstrapping Architecture".
- [11] Void.
- [12] IETF RFC 2560 (1999): "X.509 Internet Public Key Infrastructure Online Certificate Status Protocol - OCSP".
- [13] Void.
- [14] IETF RFC 5280: "Internet X.509 Public Key Infrastructure Certificate and Certificate Revocation List (CRL) Profile".
- [15] IETF RFC 4945: "The Internet IP Security PKI Profile of IKEv1/ISAKMP, IKEv2, and PKIX".
- [16] IETF RFC 5246: "The Transport Layer Security (TLS) Protocol Version 1.2".
- [17] IETF RFC 4346: "The Transport Layer Security (TLS) Protocol Version 1.1".
- [18] IETF Draft draft-ietf-pkix-cmp-transport-protocols-07.txt: "Internet X.509 Public Key Infrastructure -- Transport Protocols for CMP", October 2009.

Editor's note: The above document cannot be formally referenced until it is published as an RFC.

- [19] IETF RFC 4211: "Internet X.509 Public Key Infrastructure Certificate Request Message Format (CRMF)".
- [20] IETF RFC 2818: "HTTP Over TLS".

3 Definitions and abbreviations

3.1 Definitions

For the purposes of the present document, the definitions given in TR 21.905 [8] and the following definitions apply:

Interconnection CA: The CA that issues cross-certificates on behalf of a particular operator to the SEG CAs of other domains with which the operator's SEGs have interconnection.

Interconnect Agreement: In the context of this specification an interconnect agreement is an agreement by two operators to establish secure communications. This may be for the purpose of protecting various forms of communications between the operators, e.g. GPRS roaming, MMS interconnect, WLAN roaming and IMS interconnect.

Local CR: Repository that contains cross-certificates.

Local CRL: Repository that contains cross-certificate revocations.

PSK: Pre-Shared Key. Method of authentication used by IKE between SEG in NDS/IP [1].

Public CRL: Repository that contains revocations of SEG and CA certificates and can be accessed by other operators.

SEG CA: The CA that issues end entity certificates to SEGs within a particular operator's domain.

3.2 Abbreviations

For the purposes of the present document, the abbreviations given in TR 21.905 [8] and the following abbreviations apply:

AF	Authentication Framework
CA	Certification Authority
CR	Certificate Repository
CRL	Certificate Revocation List
GBA	Generic Bootstrapping Architecture
IMS	IP Multimedia Subsystem
NDS	Network Domain Security
PKI	Public Key Infrastructure
PSK	Pre-Shared Key
RA	Registration Authority
SEG	Security Gateway
VPN	Virtual Private Network
Za	Interface between SEGs belonging to different networks/security domains (a Za interface may be an intra or an inter operator interface).
Zb	Interface between SEGs and NEs and interface between NEs within the same network/security domain

4 Introduction to Public Key Infrastructure (PKI)

PKI Forum's "PKI basics – A Technical Perspective" [7] provides a concise vendor neutral introduction to the PKI technology. Thus only two cross-certification aspects are described in this introduction section.

Cross-certification is a process that establishes a trust relationship between two authorities. When an authority A is cross-certified with authority B, the authority A has chosen to trust certificates issued by the authority B. Cross-certification process enables the users under both authorities to trust the other authority's certificates. Trust in this context equals being able to authenticate.

4.1 Manual Cross-certification

Mutual cross-certifications are established directly between the authorities. This approach is often called manual cross-certification. In manual cross-certification the authority makes decisions about trust locally. When an authority A

chooses to trust an authority B, the authority A signs the certificate of the authority B and distributes the new certificate (B's certificate signed by A) locally.

The disadvantage of this approach is that it often results in scenarios where there needs to be a lot of certificates available for the entities doing the trust decisions: There needs to be a certificate signed by the local authority for each security domain the local authority wishes to trust. However, all the certificates can be configured locally and are locally signed, so the management of them is often flexible.

4.2 Cross-certification with a Bridge CA

The bridge CA is a concept that reduces the amount of certificates that needs to be configured for the entity that does the certificate checking. The name "bridge" is descriptive; when two authorities are mutually cross-certified with the bridge, the authorities do not need to know about each other. Authorities can still trust each other because the trust in this model is transitive (A trusts bridge, bridge trusts B, thus A trusts B and vice versa). The bridge CA acts like a bridge between the authorities. However, the two authorities shall also trust that the bridge does the right thing for them. All the decisions about trust can be delegated to the bridge, which is desirable in some use cases. If the bridge decides to cross-certify with an authority M, the previously cross-certified authorities start to trust M automatically.

Bridge CA style cross-certifications are useful in scenarios where all entities share a common authority that everybody believes to work correctly for them. If an authority needs to restrict the trust or access control derived from the bridge CA, it additionally needs to implement those restrictions.

5 Architecture and use cases of the NDS/AF

The following types of certification authority are defined:

- SEG CA: A CA that issues end entity certificates to SEGs within a particular operator's domain.
- NE CA: A CA that issues end entity IPsec certificates to NE's within a particular operator's domain. Certificates issued by an NE CA shall be restricted to the Zb-interface.
- TLS client CA: A CA that issues end entity TLS client certificates to TLS entities within a particular operator's domain.
- TLS server CA: A CA that issues end entity TLS server certificates to TLS entities within a particular operator's domain.
- Interconnection CA: A CA that issues cross-certificates on behalf of a particular operator to the SEG CAs, TLS client CAs and TLS server CAs of other domains with which the operator's SEGs and TLS entities have interconnection.

The public key of the interconnection CA shall be stored securely in each SEG and TLS entity within the operator's domain. This allows the SEG and TLS entity to verify cross-certificates issued by its operator's Interconnection CA. It is assumed that each operator domain could include 10s, but not 100s of SEGs or TLS entities.

An operator may choose to combine two or more of the above CAs. For example, the same CA may be used to issue end entity TLS and IPsec certificates. Furthermore, the same CA may be used to issue both end entity certificates and cross-certificates.

The NDS/AF is initially based on a simple trust model (see Annex B) that avoids the introduction of transitive trust and/or additional authorisation information. The simple trust model implies manual cross-certification.

5.1 PKI architecture for NDS/AF

This chapter defines the PKI architecture for the NDS/AF. The goal is to define a flexible, yet simple architecture, which is easily interoperable with other implementations.

The architecture described below uses a simple access control method, i.e. every element which is authenticated is also provided service. More fine-grained access control may be implemented, but it is out of scope of this specification.

The architecture does not rely on bridge CAs, but instead uses direct cross-certifications between the security domains. This enables easy policy configurations in the SEGs and TLS entities.

5.1.1 General architecture

Unless the operator chooses to combine CAs, each security domain has at least one SEG CA, NE CA, TLS client CA or TLS server CA, and one Interconnection CA dedicated to it.

The SEG CA of the domain issues certificates to the SEGs in the domain that have interconnection with SEGs in other domains i.e. Za-interface. The SEG certificate can be used also in communication with an NE over the Zb-interface. An NE CA issues certificates to NE's for communication between NEs and between NE and SEGs within the responsible domain i.e. Zb interface. The TLS client CA of the domain issues certificates to the TLS clients in that domain that need to establish TLS connections with TLS servers in other domains. The TLS server CA of the domain issues certificates to the TLS servers in that domain that need to establish TLS connections with TLS clients in other domains. The Interconnection CA of the domain issues certificates to the SEG CAs, TLS client CA or TLS server CA, of other domains with which the operator's SEGs and TLS entities have interconnection. This specification describes the profile for the various certificates that are needed. Also a method for creating the cross-certificates is described.

In general, all of the certificates shall be based on the Internet X.509 certificate profile [3].

5.1.1.1 NDS/IP case

In the following, the architecture for issuing IPsec certificates using SEG CAs is described.

The SEG CA shall issue certificates for SEGs that implement the Za interface. When SEG of the security domain A establishes a secure connection with the SEG of the domain B, they shall be able to authenticate each other. The mutual authentication is checked using the certificates the SEG CAs issued for the SEGs. When an interconnect agreement is established between the domains, the Interconnection CA cross-certifies the SEG CA of the peer operator. The created cross-certificates need only to be configured locally to each domain. The cross-certificate, which Interconnection CA of security domain A created for the SEG CA of security domain B, shall be available for the domain A SEG which provides the Za interface towards domain B. Equally the corresponding certificate, which the Interconnection CA of the security domain B created for the SEG CA of security domain A, shall be available for the domain B SEG which provides Za interface towards domain A.

The general architecture for IPsec certificate based authentication of SEGs and NEs is illustrated in Figure 2.

NOTE 1: A potential NE CA_A has not been depicted in the Figure 2, in order not to overload it.

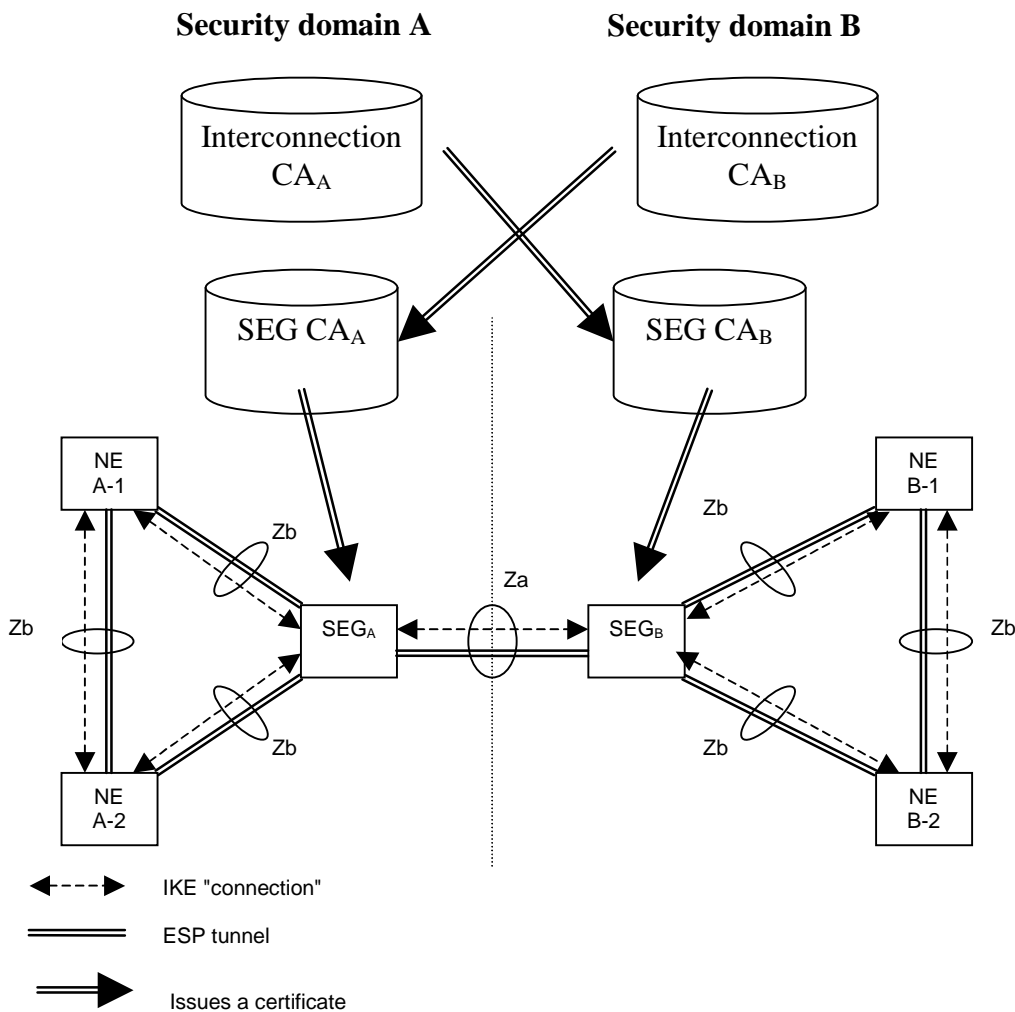

Figure 2: Trust validation path in the context of NDS/IP

After cross-certification, the SEG_A is able to verify the path: SEG_B -> SEG CA_B -> Interconnection CA_A. Only the certificate of the Interconnection CA_A in domain A needs to be trusted by entities in security domain A.

Equally the SEG_B is able to verify the path: SEG_A -> SEG CA_A -> Interconnection CA_B. The path is verifiable in domain B, because the path terminates to a trusted certificate (Interconnection CA_B of the security domain B in this case).

The Interconnection CA signs the second certificate in the path. For example, in domain A, the certificate for SEG CA B is signed by the Interconnection CA of domain A when the cross-certification is done.

5.1.1.2 TLS case

In the following, the architecture for issuing TLS certificates using TLS CAs is described.

The TLS client CA shall issue certificates for TLS clients in its domain. Similarly the TLS server CA shall issue certificates for TLS servers in its domain. When a TLS entity of the security domain A establishes a secure connection with a TLS entity of the domain B, they shall be able to authenticate each other. The mutual authentication is checked using the certificates the TLS client/server CAs issued for the TLS entities. When an interconnect agreement is established between the domains, the Interconnection CA cross-certifies the TLS client/server CAs of the peer operator. The created cross-certificates need only to be configured locally to each domain. The cross-certificate, which Interconnection CA of security domain A created for the TLS client/server CAs of security domain B, shall be available for the domain A TLS entities which need to communicate with domain B. Equally the corresponding certificate, which the Interconnection CA of the security domain B created for the TLS client/server CAs of security domain A, shall be available for the domain B TLS entities which need to communicate with domain A.

The general architecture for authentication of TLS entities is illustrated in Figure 2a.

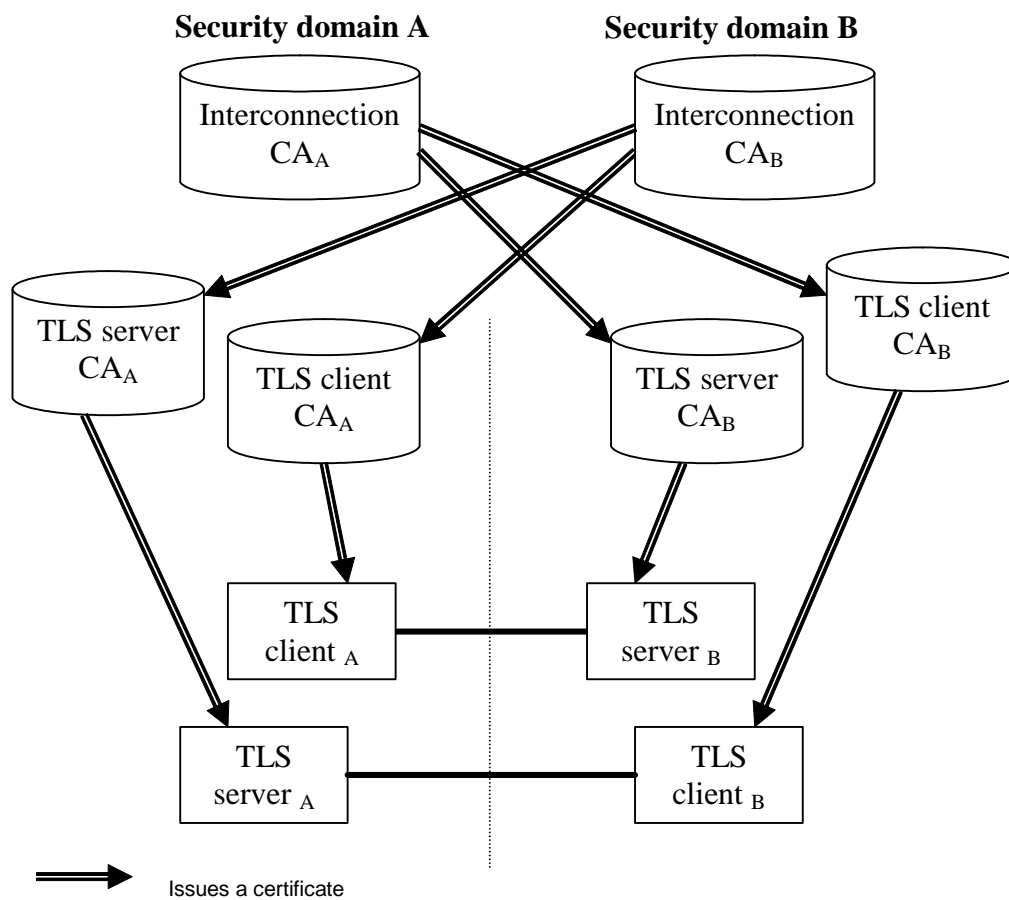

Figure 2a: Trust validation path in the context of TLS

After cross-certification, the TLS client_A is able to verify the path: TLS server_B -> TLS server CA_B -> Interconnection CA_A. Only the certificate of the Interconnection CA_A in domain A needs to be trusted by entities in security domain A.

Equally the TLS server_B is able to verify the path: TLS client_A -> TLS client CA_A -> Interconnection CA_B. The path is verifiable in domain B, because the path terminates to a trusted certificate (Interconnection CA_B of the security domain B in this case).

The Interconnection CA signs the second certificate in the path. For example, in domain A, the certificates for TLS server CA_B and TLS client CA_B are signed by the Interconnection CA of domain A when the cross-certification is done.

5.2 Use cases

5.2.1 Operator Registration: Creation of interconnect agreement

SEGs or TLS entities of two different security domains need to establish a secure connection, when the operators make an interconnect agreement. The first technical step in creating the interconnect agreement between domains is the creation of cross-certificates by the Interconnection CAs of the two domains.

Inter-operator cross-certification can be done using different protocols, but the certification authority shall support the PKCS#10 [2] method for certificate requests. The SEG CA, TLS client CA and TLS server CA create a PKCS#10 certificate request, and send it to the other operator's Interconnection CA. The method for transferring the PKCS#10 request is not specified, but the transfer method shall be secure. The PKCS#10 can be transferred e.g. in a floppy disk, or be send in a signed email. The PKCS#10 request contains the public key of the authority and the name of the authority requesting the cross-certificate. When the Interconnection CA accepts the request, a new cross-certificate is

created for the requesting CA. The Interconnection CA shall make the new cross-certificate available to SEGs and TLS entities in its own domain that need to use it. Cross-certificates on the other domain's SEG CA's are stored in a local CR (Certificate Repository) which all SEGs that need to communicate with the other domains shall access using LDAP [5]. Cross-certificates on TLS client CAs and TLS server CAs are made available to TLS entities, e.g. by storing them in a file of trusted CAs on the TLS entity, or by storing them in a local CR (Certificate Repository) which all TLS entities that need to communicate with the other domain shall access e.g. using LDAP [5].

The cross-certification is a manual operation, and thus PKCS#10 is a suitable solution for the interconnect agreement.

Creation of an interconnect agreement only involves use of the private keys of the Interconnection CAs. There is no need for the operators to use the private keys of their respective SEG CAs, TLS client CAs or TLS server CAs in forming an interconnect agreement.

When creating the new cross-certificate, the Interconnection CA should use basic constraint extension (according to section 4.2.1.10 of [3]) and set the path length to zero. This inhibits the new cross-certificate to be used in signing new CA certificates. The validity of the certificate should be set sufficiently long. The cross-certification process needs to be done again when the validity of the cross-certificate is ending.

When the new cross-certificate is available to the SEG, all that needs to be configured in the SEG is the DNS name or IP address of the peering SEG gateway. The authentication can be done based on the created cross-certificates.

When the new cross-certificate is available to a TLS entity, it allows that TLS entity to authenticate TLS entities in the peering network. Authentication is done based on the created cross-certificates.

The certificate hierarchy in the case of two peering operators is illustrated in Figure 3.

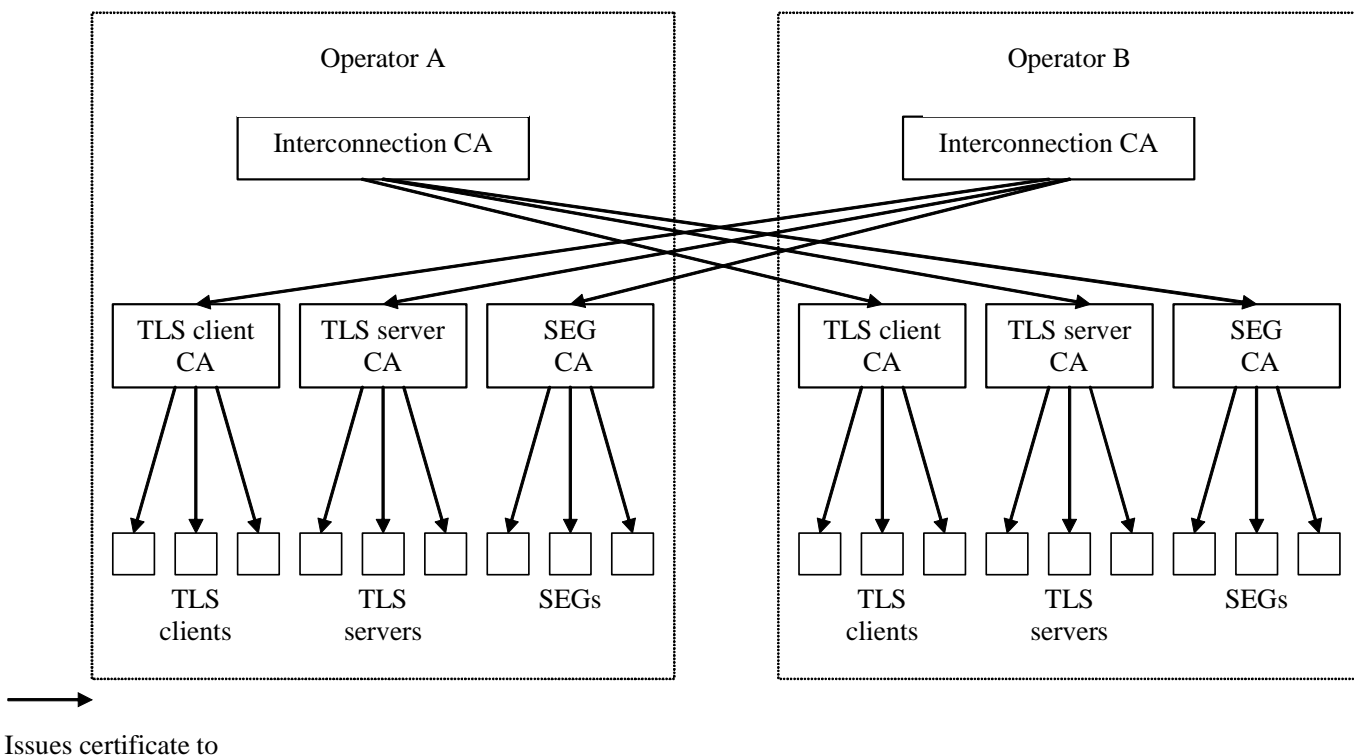

Figure 3: Certificate Hierarchy

5.2.2 Establishment of secure communications

5.2.2.1 NDS/IP case

5.2.2.1.1 NDS/IP case for the Za interface

After establishing an interconnect agreement and finishing the required preliminary certificate management operations as specified in clause 5.2.1, the operators configure their SEGs for SEG-SEG connection, and the SAs are established as specified by NDS/IP [1].

In each connection configuration, the remote SEG DNS name or IP address is specified. Only the local Interconnection CA and SEG CA are configured as trusted CAs. Because of the cross-certification, any operator whose SEG CA has been cross-certified can get access using this VPN connection configuration.

The following is the flow of connection negotiation from the point of view of Operator A's SEG (initiator). Operator B's SEG (responder) shall behave in a similar fashion.

- During connection initiation, the initiating Operator A's SEG A provides its own SEG certificate and the corresponding digital signature in the IKE Main Mode message 3 for IKEv1 and the IKE_AUTH exchange for IKEv2;
- SEG A receives the remote SEG B certificate and signature;
- SEG A verifies the remote SEG B signature;
- SEG A checks the validity of the SEG B certificate by a CRL check to Operator B's CRL databases. If a SEG cannot successfully perform the CRL check, it shall treat this as an error and abort tunnel establishment;
- SEG A verifies the SEG B certificate by executing the following actions:
 - SEG A fetches the cross-certificate for Operator B's SEG CA from Operator A's Certificate Repository or from a local cache.
 - SEG A checks the validity of the cross-certificate for Operator B's SEG CA by a CRL check to Operator A's Interconnection CA CRL database. If a SEG cannot successfully perform the CRL check, it shall treat this as an error and abort tunnel establishment;
 - SEG A verifies the cross-certificate for Operator B's SEG CA using Operator A's Interconnection CA's certificate. Operator A's Interconnection CA's certificate shall be verified if the Interconnection CA is not a top-level CA, otherwise the Interconnection CA's public key is implicitly trusted.

In case IKEv1 has been initiated, then the IKE Phase 1 SA is now established and the Phase-2 SA negotiation proceeds as described in NDS/IP [1] with PSK authentication.

In case IKEv2 has been initiated, then the IKE_AUTH exchange is now completed. Now the IKEv2 CREATE_CHILD_SA exchange can be initiated as described in NDS/IP [1] with PSK authentication.

NOTE: This specification provides authentication of SEGs in an "end-to-end" fashion as regards to interconnect traffic (operator to operator). If NDS/AF (IKE) authentication were to be used for both access to the transport network (e.g. GRX) and for the end-to-end interconnect traffic, IPsec mechanisms and policies such as iterated tunnels or hop-by-hop security would need to be used. However, it is highlighted that the authentication framework specified is independent of the underlying IP transport network.

5.2.2.1.2 NDS/IP case for the Zb-interface

In this case there is no need for cross-certification. Both end entity certificates belong to the same administrative domain and thus authorization check resolves to the same top level CA.

The following is the flow of connection negotiation from the point of view of NE-A (initiator). NE-B (or SEG-B) from the same domain (responder) shall behave in a similar fashion.

- During connection initiation, the initiating Operator A's NE-A provides its own NE certificate and the corresponding digital signature in IKEv1 Main Mode message 3 for IKEv1 and in the IKE_AUTH exchange for IKEv2;
- NE A receives the NE B (or SEG B) certificate and signature;
- NE A verifies the NE B (or SEG B) signature;
- NE A checks the validity of the NE B (or SEG B) certificate by a CRL check to the CRL databases of the same domain. If a NE cannot successfully perform the CRL check, it shall treat this as an error and abort tunnel establishment;

In case IKEv1 has been initiated, then the IKE Phase 1 SA is now established and the Phase-2 SA negotiation proceeds as described in NDS/IP [1] with PSK authentication.

In case IKEv2 has been initiated, then the IKE_AUTH exchange is now completed. Now the IKEv2 CREATE_CHILD_SA exchange can be initiated as described in NDS/IP [1] with PSK authentication.

5.2.2.2 TLS case

After establishing an interconnect agreement and finishing the required preliminary certificate management operations as specified in clause 5.2.1, the operators configure their TLS entities for secure interconnection. The exact process for establishing the TLS connections is dependent on the application protocol and is outside the scope of this specification. However, the general flow is described in the remainder of this clause.

The local Interconnection CA and TLS client/server CAs are configured as trusted CAs in the TLS entity typically by storing them in a file of trusted CAs on the TLS entity. The cross-certificates on the TLS client/server CAs of the remote operator are also made available to the TLS entity, e.g. by storing them in a file of trusted CAs on the TLS entity, or by storing them in a local CR (Certificate Repository) which all TLS entities that need to communicate with the other domain shall access e.g. using LDAP. Because of the cross-certification, any operator whose TLS client CA or TLS server CA has been cross-certified by another operator can establish TLS connections with that other operator.

The following is the connection establishment from the point of view of a TLS client in Operator A (TLSa) and a TLS server in Operator B (TLSb). The case where the TLS client is in Operator B and the TLS server is in Operator A is treated in a similar fashion. The flow is based on the TLS handshake protocol as described in RFC 5246 [16].

The flow is based on the TLS handshake protocol as described in RFC 2246 [11].

- During connection initiation, the TLSa sends a ClientHello message to TLSb. TLSb responds with a ServerHello message followed by a ServerCertificate message, a ServerKeyExchange message, an optional CertificateRequest message and a ServerHelloDone message. The ServerCertificate message will contain TLSb's certificate that was issued by Operator B's TLS server CA. The CertificateRequest message is sent if TLSb wants to authenticate TLSa.
- TLSa receives the messages from TLSb
- TLSa verifies the ServerKeyExchange message using TLSb's public key
- TLSa checks the validity of TLSb's certificate by a CRL check to Operator B's CRL databases. If a TLS peer cannot successfully perform the CRL check, it shall treat this as an error and abort the TLS handshake
- TLSa verifies TLSb's certificate using the cross-certificate for Operator B's TLS server CA by executing the following actions:
 - TLSa fetches the cross-certificate for Operator B's TLS server CA from Operator A's Certificate Repository, from a local cache of the Certificate Repository on TLSa, or from a local certificate store on TLSa if a separate Certificate Repository is not used.
 - TLSa checks the validity of the cross-certificate for Operator B's TLS server CA by a CRL check to Operator A's Interconnection CA CRL database. If a TLS peer cannot successfully perform the CRL check, it shall treat this as an error and abort the TLS handshake;
 - TLSa verifies the cross-certificate for Operator B's TLS server CA using Operator A's Interconnection CA's certificate if the Interconnection CA is not a top-level CA, otherwise the Interconnection CA's public key is implicitly trusted.

- If TLSb requested a certificate using the CertificateRequest message, then TLSa responds with a Certificate message followed by a ClientKeyExchange message, a CertificateVerify message and a Finished message. The Certificate message is only sent if the Server requests a certificate. If present, the Certificate message will contain TLSa's certificate that was issued by Operator A's TLS client CA. The CertificateVerify message is only sent if TLSa's certificate has signing capability. It is used to provide explicit verification of a client certificate.
- TLSb receives the messages from TLSa
- TLSb verifies the ClientKeyExchange and optional CertificateVerify message using TLSa's public key
- TLSb checks the validity of TLSa's certificate by a CRL check to Operator A's CRL databases. If a TLS entity cannot successfully perform both CRL checks, it shall treat this as an error and abort the TLS handshake
- TLSb validates TLSa's certificate using the cross-certificate for Operator A's TLS client CA by executing the following actions:
 - TLSb fetches the cross-certificate for Operator A's TLS client CA from Operator B's Certificate Repository, from a local cache of the Certificate Repository on TLSb, or from a local certificate store on TLSb if a separate Certificate Repository is not used.
 - TLSb checks the validity of the cross-certificate for Operator A's TLS client CA by a CRL check to Operator B's Interconnection CA CRL database. If a TLS entity cannot successfully perform the CRL check, it shall treat this as an error and abort the TLS handshake
 - TLSb verifies the cross-certificate for Operator A's TLS client CA using Operator B's Interconnection CA's certificate if the Interconnection CA is not a top-level CA, otherwise the Interconnection CA's public key is implicitly trusted.
- TLSb sends a Finished message to complete the handshake
- TLSa receives the Finished message to complete the handshake

If the handshake is successfully completed then the secure communications can take place over the TLS connection.

5.2.3 Operator deregistration: Termination of interconnect agreement

When an interconnect agreement is terminated or due to an urgent service termination need, all concerned SEG peers shall remove the IPsec SAs using device-specific management methods, while all concerned TLS entities shall terminate any ongoing TLS sessions with the peer network and not permit those sessions to be resumed (e.g. by prohibiting TLS session resumption).

Each concerned operator shall also list the cross-certificate created for the Interconnection CA, SEG CA, TLS client CA and TLS server CA of the terminated operator in his own local CRL.

5.2.3a Interconnection CA registration

In principle only one Interconnection CA shall be used within the operator's network, but using more than one Interconnection CA is possible (in which case the public keys of all the operator's interconnection CAs should be installed in the operator's SEGs or TLS entities). The involved actions in Interconnection CA registration are those as described in the cross-certification part of clause 5.2.1: 'Operator Registration: creation of interconnect agreement'. Such a situation may exist if the Interconnection CA functions are to be moved from one responsible organisation to another (e.g. outsourcing of CA services).

5.2.3b Interconnection CA deregistration

If an Interconnection CA is removed from the network, it shall be assured that all certificates that have been issued by that CA to SEG or TLS CAs, and have not expired yet, shall be listed in the CRLs.

5.2.3c Interconnection CA certification creation

The Interconnection CA certificate may not be the top-level CA of the operator, which means that the Interconnection CA certificate is not self-signed. If the Interconnection CA certificate is self-signed then it needs to be securely

transferred to each SEG or TLS entity and stored within secure memory otherwise it can be managed in the same way as a SEG or TLS entity certificate.

The Interconnection CA certificate shall have a 'longer' lifetime than SEG CA or TLS CA certificates in order to avoid the cross-certification actions that are needed each time an Interconnection CA certificate has to be renewed.

NOTE: There is no need to involve other operators when creating an Interconnection CA certificate.

5.2.3d Interconnection CA certification revocation

If an Interconnection CA key pair gets compromised then a hacker could use the keys to issue himself SEG CA or TLS CA certificates which in turn could be used to issue SEG or TLS entity certificates. Since however the trusted Interconnection CA certificates are stored locally on the SEG or TLS entity device or in a dedicated repository (i.e. received Interconnection CA certificates within the IKE payload or TLS handshake shall not be accepted), the hacker also needs to compromise the SEG, TLS entity, or the local repository to be able to set up a secure connection.

Existing secure connections need not be torn down. The old cross-certificates - and any other certificates - issued by the Interconnection CA shall be taken out of service by listing them in the Interconnection CA's CRL (provided the operator still has the key available to sign this CRL) and removing them from the dedicated repository. If the Interconnection CA certificate is self-signed then it shall be removed from each of the operator's SEGs and TLS entities. If the Interconnection CA certificate is issued by a higher level CA of the operator, then it shall be revoked by this higher level CA.

The operator has to create a new Interconnection CA key pair, perform the actions as described within clause 5.2.3c for Interconnection CA certification creation, and perform the actions as described within clause 5.2.1 to generate new cross-certificates for all his interconnected networks SEG CAs or TLS CAs.

NOTE: There is no need to involve other operators when revoking an Interconnection CA certificate.

5.2.3e Interconnection CA certification renewal

The Interconnection CA certificate has to be renewed before the old Interconnection CA certificate expires. The renewing of an Interconnection CA certificate involves repeating the actions as described in clause 5.2.3c. This should be done before the old certificate expires.

NOTE: There is no need to involve other operators when renewing an Interconnection CA certificate.

5.2.4 SEG/TLS CA registration

In principle only one SEG CA, one TLS client CA and one TLS server CA shall be used within the operator's network, but using more than one of each of these CAs is possible. The involved actions are those as described in the cross-certification part of clause 5.2.1: 'Operator Registration: creation of interconnect agreement'. Such a situation of having multiple CAs of each type may exist if the CA functions are to be moved from one responsible organisation to another (e.g. outsourcing of CA services).

5.2.5 SEG/TLS CA deregistration

If a SEG CA or TLS CA is removed from the network, it shall be assured that the SEG CA or TLS CA certificates and all certificates that have been issued by the SEG CA or TLS CA to SEGs or TLS entities, and have not expired yet, shall be listed in CRLs. The cross-certificates that are issued to these SEG CAs or TLS CAs, and have not expired yet, should also be listed in CRLs.

5.2.6 SEG/TLS CA certificate creation

The involved actions are those as described in the cross-certification part of clause 5.2.1: 'Operator Registration: creation of interconnect agreement'.

The SEG CA or TLS CA certificate does not have to be the top-level CA of the operator, which means that the SEG CA or TLS CA certificate is not self-signed. One option is to sign the operator's SEG CA and TLS CAs with the operator's own Interconnection CA, as this will already be a trust point established in the operator's own SEGs and TLS entities. If

the SEG CA or TLS CA certificates are self-signed then they should be securely transferred to each of the operator's SEGs and TLS entities and stored within secure memory (see NOTE to clause 7.5).

5.2.7 SEG/TLS CA certificate revocation

This compromise is a serious event as it will require all the cross-certificates issued by other operators' Interconnection CAs to that SEG CA or TLS CA to be revoked.

Existing secure connections need not be torn down, unless they were formed very recently i.e. after the time at which the operator suspects the CA key became compromised, but before the cross-certificate used to establish the tunnel was revoked.

It shall be assured that the SEG CA or TLS CA certificates and all certificates that have been issued by the SEG CA or TLS CA to SEGs or TLS entities, and have not expired yet, shall be listed in CRLs. The cross-certificates that are issued to these SEG CAs or TLS CAs, and have not expired yet, should also be listed in CRLs.

To restore inter-domain interoperability, the operator has to create a new SEG CA or TLS CA key pair and use it to issue certificates to all the SEGs and TLS entities in the operator's own domain. The operator shall then provide a cross-certification request (see clause 5.2.1) for the new SEG CA or TLS CA key pair to the operators with whom it has interconnect agreements.

It is recommended that operators carefully protect their SEG CA and TLS CA keys to limit this knock-on effect across the operator community.

5.2.8 SEG/TLS CA certificate renewal

The SEG CA and TLS CA certificate has to be renewed before the old SEG CA and TLS CA certificate expires. The renewing of a SEG CA or TLS CA certificate involves repeating the actions as described in the cross-certification part of clause 5.2.1: 'Operator Registration: creation of interconnect agreement'. This should be done before the old certificate expires.

5.2.9 End entity registration

5.2.9.1 SEG registration

If not already done, a SEG certificate has to be created (see clause 5.2.11 for a description on certificate creation).

If a SEG is added to the network, the policy database of this SEG has to be configured using device-specific management methods.

Other operators have to be informed of the new SEG: The SEG policy databases of SEGs in other networks may have to be adapted.

5.2.9.2 TLS client registration

If not already done, a TLS client certificate has to be created (see clause 5.2.11 for a description on certificate creation).

If a TLS client is added to the network, then some local configuration may be needed to take the new TLS client into use for secure inter-operator communication. In addition, other operators may need to be informed of the new TLS client.

5.2.9.3 TLS server registration

If not already done, a TLS server certificate has to be created (see clause 5.2.11 for a description on certificate creation).

If a TLS server is added to the network, then some local configuration may be needed to take the new TLS server into use for secure inter-operator communication. In addition, other operators may need to be informed of the new TLS server.

5.2.9.4 NE registration

If not already done, an NE certificate has to be created (see clause 5.2.11 for a description on certificate creation).

If an NE is added to the network, the policy database of this NE has to be configured using device-specific management methods.

5.2.10 End entity deregistration

5.2.10.1 SEG deregistration

If a SEG is removed from the network, the SAs shall be removed using device-specific management methods. The operator of the SEG shall have the certificate of the SEG listed in his CRL. The SPD of the partner network may have to be adapted.

5.2.10.2 TLS client deregistration

If a TLS client is removed from the network, the TLS connections shall be terminated using device-specific management methods. The operator of the TLS client shall have the certificate of the TLS client listed in his CRL.

5.2.10.3 TLS server deregistration

If a TLS server is removed from the network, the TLS connections shall be terminated using device-specific management methods. The operator of the TLS server shall have the certificate of the TLS server listed in his CRL.

5.2.10.4 NE deregistration

If a NE is removed from the network, the SAs shall be removed using device-specific management methods. The operator of the NE shall have the certificate of the NE listed in his CRL.

5.2.11 End entity certificate creation

Using device-specific management methods, the certificate creation shall be initiated. As specified in section 7.2, either the CMPv2 protocol for automatic certificate enrolment or manual certificate installation using PKCS#10 formats can be used. This is an operator decision depending for example on the number of NEs or SEGs and TLS entities.

5.2.12 End entity certificate revocation

If a SEG or TLS entity key pair gets compromised then the existing SAs shall be removed using device-specific management methods. The operator of the SEG or TLS entity shall include the revoked certificate in his CRL.

5.2.13 End entity certificate renewal

A new NE, SEG or TLS entity certificate needs to be in place before the old certificate expires. The procedure is similar to the certificate creation and can be either fully automated by using CMPv2 as specified in section 7.2 or done manually using PKCS#10 formats. This is an operator decision depending for example on the number of NEs, SEGs and TLS entities.

5.2.14 NE CA deregistration

If an NE CA is removed from the network, it shall be assured that the NE CA certificate and all certificates that have been issued by the NE CA to the NEs, and have not expired yet, shall be listed in CRLs.

5.2.15 NE CA certification creation

The NE CA certificate does not have to be the top-level CA of the operator, which means that the NE CA certificate is not self-signed. If the NE CA certificates are self-signed then they should be securely transferred to each of the operator's NEs and stored within secure memory (see NOTE to clause 7.5).

NOTE: There is no need to involve other operators when creating an NE CA certificate.

5.2.16 NE CA certificate revocation

This serious event will require that all NE certificates needs to be revoked.

Existing intra-security domain security connections need not be torn down, unless they were formed very recently i.e. after the time at which the operator suspects the NE CA key became compromised but before the certificate has been listed as revoked.

It shall be assured that the NE CA certificate and all certificates that have been issued by the NE CA to NEs, and have not expired yet, shall be listed in CRLs.

To restore intra-domain security, the operator has to create a new NE CA key pair and use it to issue certificates to all the NEs in the operator's own domain.

NOTE: There is no need to involve other operators when revoking an NE CA certificate.

5.2.17 NE CA certificate renewal

The NE CA certificate has to be renewed before the old NE CA certificate expires.

NOTE: There is no need to involve other operators when renewing an NE CA certificate.

6 Profiling

6.1 Certificate profiles

This clause profiles the certificates to be used for NDS/AF. An NDS/AF component shall not expect any specific behaviour from other entities, based on certificate fields not specified in this section.

Certificate profiling requirements as contained in this specification have to be applied in addition to those contained within RFC5280 [14]. This applies for the SEG, NE, the TLS entity, the SEG CA and the Interconnection CA.

Before fulfilling any certificate signing request, the NE CA, SEG CA and Interconnection CA shall make sure that the request suits the profiles defined in this section. Furthermore, the CAs shall check the Subject's DirectoryString order for consistency, and that the Subject's DirectoryString belongs to its own administrative domain.

NEs, SEGs and TLS entities shall check compliance of certificates with the NDS/AF profiles and shall only accept compliant certificates.

6.1.1 Common rules to all certificates

- Version 3 certificate according to RFC5280 [14].
- Hash algorithm for use before signing certificate: SHA-1 and SHA-256 mandatory to support, MD-5 shall not be used.
- Subject and issuer name format.
 - Note that C is optional element. : (C=<country>), O=<Organization Name>, CN=<Some distinguishing name>. Organization and CN shall be in UTF8 format.
 - or
 - Note that ou is optional element. : cn=<hostname>, (ou=<servers>), dc=<domain>, dc=<domain>.
- CRLv2 support with LDAPv3 [5] retrieval shall be supported as the primary method of certificate revocation verification. HTTP shall also be allowed for checking the revocation status of TLS and NE certificates.

- Certificate extensions which are not mandated by this specification but which are mentioned within RFC5280 [14] are optional for implementation. If present, such optional extensions shall be marked as "non critical".

6.1.2 Interconnection CA Certificate profile

In addition to clause 6.1.1, the following requirements apply:

- The RSA key length shall be at least 2048-bit;
- Extensions:
 - Optionally non critical authority key identifier;
 - Optionally non critical subject key identifier;
 - Mandatory critical key usage: At least keyCertSign and CRL Sign should be asserted;
 - Mandatory critical basic constraints: CA=True, path length unlimited or at least 1.

6.1.3 SEG Certificate profile

SEG certificates shall be directly signed by the SEG CA in the operator domain that the SEG belongs to. Any SEG shall use exactly one certificate to identify itself within the NDS/AF.

In addition to clause 6.1.1 and the provisions of RFC4945 [15], the following requirements apply:

- The RSA key length shall be at least 1024-bit;
- Issuer name is the same as the subject name in the SEG CA certificate.
- Extensions:
 - Optionally non critical authority key identifier;
 - Optionally non critical subject key identifier;
 - Mandatory non-critical subjectAltName;
 - Mandatory critical key usage: At least digitalSignature and keyEncipherment shall be set;
 - Mandatory non-critical Distribution points: CRL distribution point;

NOTE: Depending on the availability of DNS between peer SEGs, the following rule is applied:

- subjectAltName should contain IP address (in case DNS is not available);
- subjectAltName should contain FQDN (in case DNS is available).

6.1.3a TLS entity certificate profile

TLS client certificates shall be directly signed by the TLS client CA in the operator domain that the TLS client belongs to. TLS server certificates shall be directly signed by the TLS server CA in the operator domain that the TLS server belongs to.

In addition to clause 6.1.1, the following requirements apply:

- The RSA key length shall be at least 1024-bit;
- Issuer name is the same as the subject name in the TLS CA certificate.
- Extensions:
 - Optionally non critical authority key identifier;

- Optionally non critical subject key identifier;
- Mandatory critical key usage: At least digitalSignature or keyEncipherment shall be set; According to RFC2246 keyAgreement shall be set on Diffie-Hellman certificates;
- Optional non-critical extended key usage: If present, at least id-kp-serverAuth shall be set for TLS server certificates, and at least id-kp-clientAuth shall be set for TLS client certificates;
- Mandatory non-critical Distribution points: CRL distribution point.

6.1.3b NE Certificate profile

NE certificates shall be directly signed by the NE CA in the operator domain that the NE belongs to. Any NE shall use exactly one certificate to identify itself within the NDS/AF.

The same requirements as listed in section 6.1.3 apply.

6.1.4 SEG CA certificate profile

In addition to clause 6.1.1, the following requirements apply:

- The RSA key length shall be at least 2048-bit;
- Subject name is the same as the issuer name in the SEG certificate;
- Issuer name is the same as the subject name in the Interconnection CA certificate;
- Extensions:
 - Optionally non critical authority key identifier;
 - Optionally non critical subject key identifier;
 - Mandatory critical key usage: At least keyCertSign and CRL Sign, should be asserted;
 - Mandatory critical basic constraints: CA=True, path length 0.

6.1.4a TLS client/server CA certificate profile

In addition to clause 6.1.1, the following requirements apply:

- The RSA key length shall be at least 2048-bit;
- Subject name is the same as the issuer name in the TLS entity certificate;
- Issuer name is the same as the subject name in the Interconnection CA certificate;
- Extensions:
 - Optionally non critical authority key identifier;
 - Optionally non critical subject key identifier;
 - Mandatory critical key usage: At least keyCertSign and CRL Sign, should be asserted;
 - Mandatory critical basic constraints: CA=True, path length 0.

6.1.4b NE CA certificate profile

The same requirements as listed in section 6.1.4 apply except that there is no restriction in the issuer name.

6.2 IKE negotiation and profiling

For certificate based establishment of IPsec SAs between NDS/IP elements, the IKE profile in this clause shall be used. Whether IKEv1 or IKEv2 shall be used for negotiation of IPsec SAs is described in NDS/IP [1].

6.2.1 IKEv1 Phase 1 profile

The following requirements on certificate based IKEv1 authentication in addition to those specified in NDS/IP [1] shall be applied:

For IKE Phase 1 (ISAKMP SA):

- The use of RSA signatures for authentication shall be supported;
- The identity of the CERT payload (including the end entity certificate) shall be used for policy checks;
- Initiating/responding end entities are required to send certificate requests in the IKE messages;

NOTE 1: At least a CERTREQ payload with an empty CA name field should be sent to avoid interoperability problems.

- Cross-certificates shall not be sent by the peer SEG as they are pre-configured in the SEG;
- The end entities shall always send its own certificate in the certificate payload of the last (third) IKE Main Mode message;
- The certificates in the certificate payload shall be encoded as type 4 (X.509 Certificate – Signature);
- The lifetime of the Phase 1 IKE SA (ISAKMP SA) shall be limited to at most the remaining validity time of the peer end entity certificate that would expire first.

NOTE 2: Depending on the availability of DNS between peer end entities, the following rule is applied:

- subjectAltName and ISAKMP policy should both contain IP address (in case DNS is not available);
- subjectAltName and ISAKMP policy should both contain FQDN (in case DNS is available).

6.2.1b IKEv2 profile

The following requirements on certificate based IKEv2 authentication in addition to those specified in NDS/IP [1] shall be applied:

For the IKE_INIT_SA and IKE_AUTH exchanges:

- The use of RSA signatures for authentication shall be supported;
- The identity of the CERT payload (including the end entity certificate) shall be used for policy checks;
- Initiating/responding end entities are required to send certificate requests in the IKE_INIT_SA exchange for the responder and in the IKE_AUTH exchange for the initiator;
- Cross-certificates shall not be sent by the peer end entity as they are pre-configured in the end entity;
- The certificates in the certificate payload shall be encoded as type 4 (X.509 Certificate – Signature);
- An end entity shall rekey the IKE SA when any used end entity certificate expires.

NOTE 2: Depending on the availability of DNS between peer end entities, the following rule is applied:

- subjectAltName and IKEv2 policy should both contain IP address (in case DNS is not available);

- subjectAltName and IKEv2 policy should both contain FQDN (in case DNS is available).

6.2.2 Potential interoperability issues

Some PKI-capable VPN gateways do not support fragmentation of IKE packets, which becomes an issue when more than one certificate is sent in the certificate payloads, forcing IKE packet fragmentation. This means that direct cross-certification or manually importing the peer CA certificate to the local SEG and trusting it is preferable to bridge CA systems. When IKE is run over pure IPv6 the typical MTU sizes do not increase and long packets still have to be fragmented (allowed for end UDP hosts even for IPv6, see Path MTU Discovery for IPv6 – [6]), so this is a potential interoperability issue.

Certificate encoding with PKCS#7 is supported by some PKI-capable VPN gateways, but it shall not be used.

6.2a TLS profiling

For 3GPP uses of TLS for inter-operator security, the TLS profile in this clause shall be used.

6.2a.1 TLS profile

The following requirements are mandatory:

- The TLS server shall always send its own end entity certificate in the ServerCertificate message;
- The TLS client shall send its own end entity certificate in the Certificate message if requested by the TLS server;
- Cross-certificates shall not be sent by the TLS entities in the TLS handshake as they are available locally to the TLS entities.

6.2a.2 Potential interoperability issues

No general interoperability issues are identified.

6.3 Path validation

6.3.1 Path validation profiling

- Validity of certificates received from the peer end entity shall be verified by CRLs retrieved via the mechanisms specified in section 6.1.1, based on the CRL Distribution Point in the certificates.
- Validity of certificates received from the TLS entity shall be verified by CRLs retrieved via the mechanisms specified in section 6.1.1, based on the CRL Distribution Point in the certificates.
- Any NE, SEG or TLS entity shall not validate received certificates from a peer entity whose validity time has expired, but end the path validation with a negative result.
- Any NE, SEG shall not validate received certificates from a peer entity whose CRL distribution point field is empty, but end the path validation with a negative result.
- Certificate validity calculation results shall not be cached in a SEGs or NEs for longer than the resulting IKEv1 Phase 1 lifetime or when IKEv2 is used the lifetime enforced by the end entity.
- Certificate validity calculation results shall not be cached in TLS entities for longer than the TLS connection lifetime.

7 Detailed description of architecture and mechanisms

7.1 Repositories

During secure connection establishment, each NE, SEG or TLS entity has to verify the validity of its peer's certificate according to clause 5.2.2. Any certificate could be invalid because it was revoked (and replaced by a new one) or a NE, SEG, TLS entity or operator has been deregistered.

Consider secure connection establishment between Peer_A in network A and Peer_B in network B.

Peer_B has to verify that:

- a) the cross-certificate of the Peer_A's CA_A is still valid;
- b) the certificate of Peer_A is still valid,

and be able to:

- c) fetch the cross-certificate of Peer_A CA_A (if not found in Peer_A's cache or local store).

Peer_A performs the same checks from its own perspective.

Check a) can be performed by querying the local CRL. For check b), a CRL of the Peer_A's CA shall be queried. At this point of time, the secure connection is not yet available, therefore the public CRL of the Peer_A's CA shall be accessible without relying on a secure connection.

Figure 4 and Figure 4a illustrate the repositories and the above-mentioned steps a) – c). The local Certificate Repository (CR) contains cross-certificates for SEG CAs and possibly cross-certificates for TLS CAs if these are not locally stored in the TLS entities. Local CRLs contains SEG CA and TLS CA cross-certificate revocations, and the public CRL contains revocations of SEG, TLS entity, SEG CA, and TLS CA certificates, and can be accessed by other operators.

An operator's internal repository may contain the revocations of NE and NE CA if not contained in the Public CRL repository.

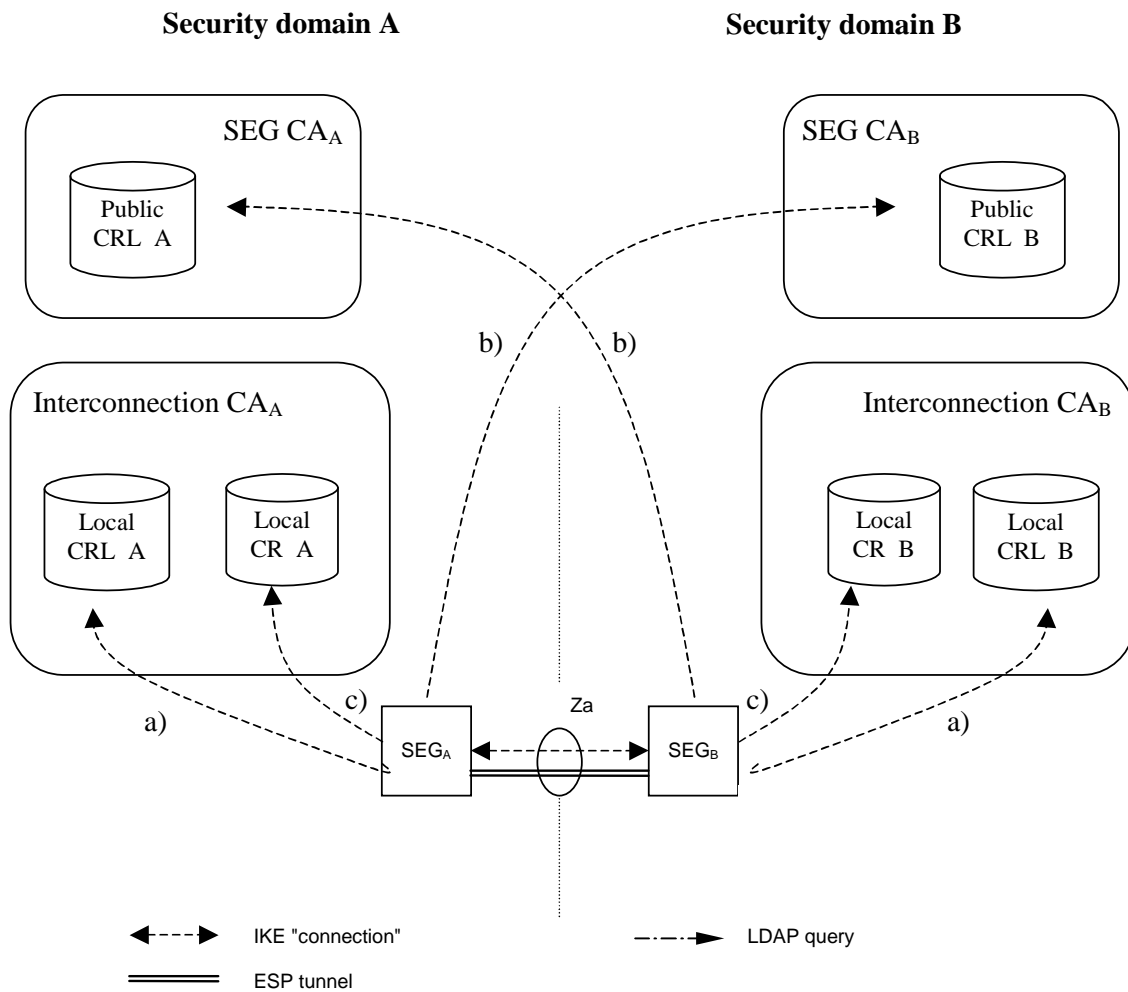

Figure 4: Repositories for NDS/IP to support Za interface

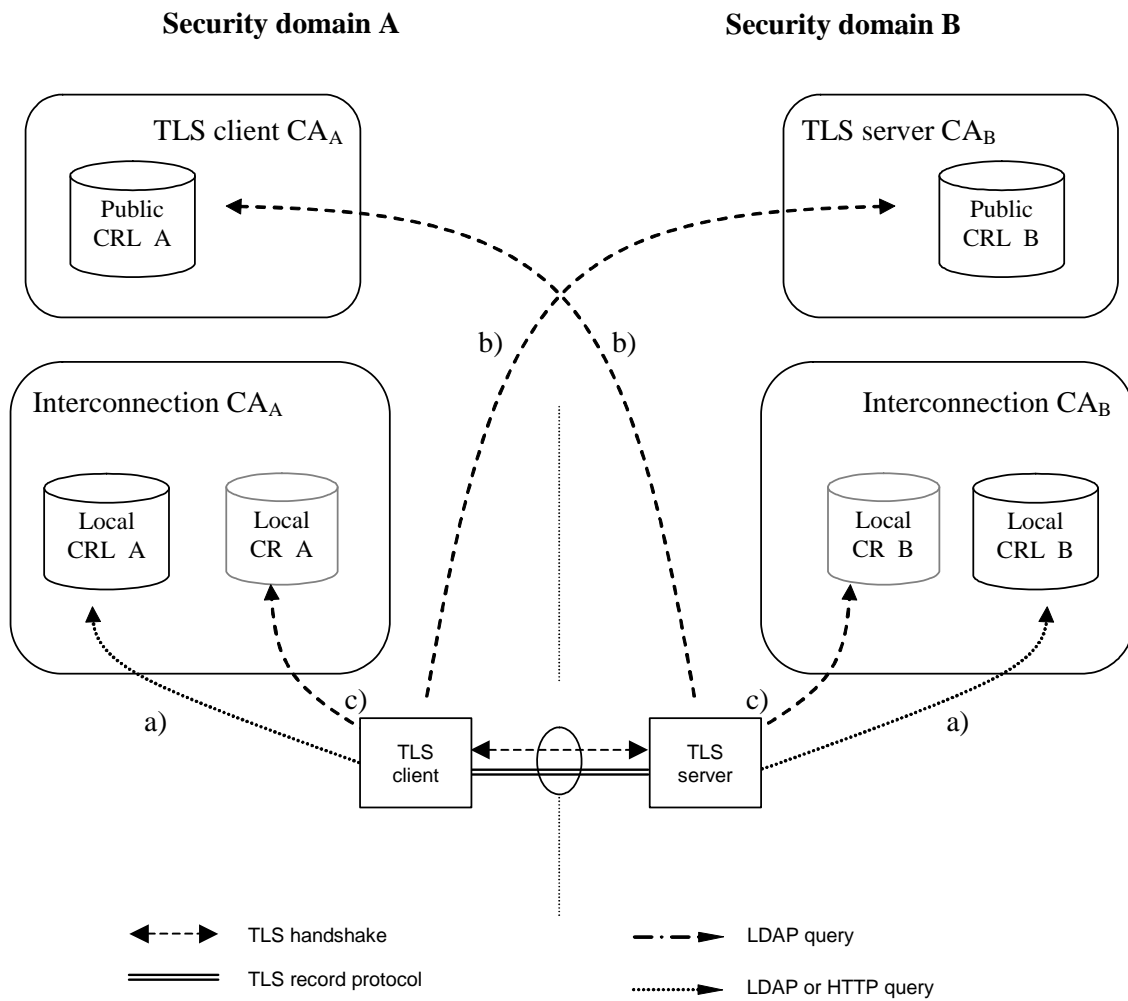

Figure 5: Repositories for TLS case

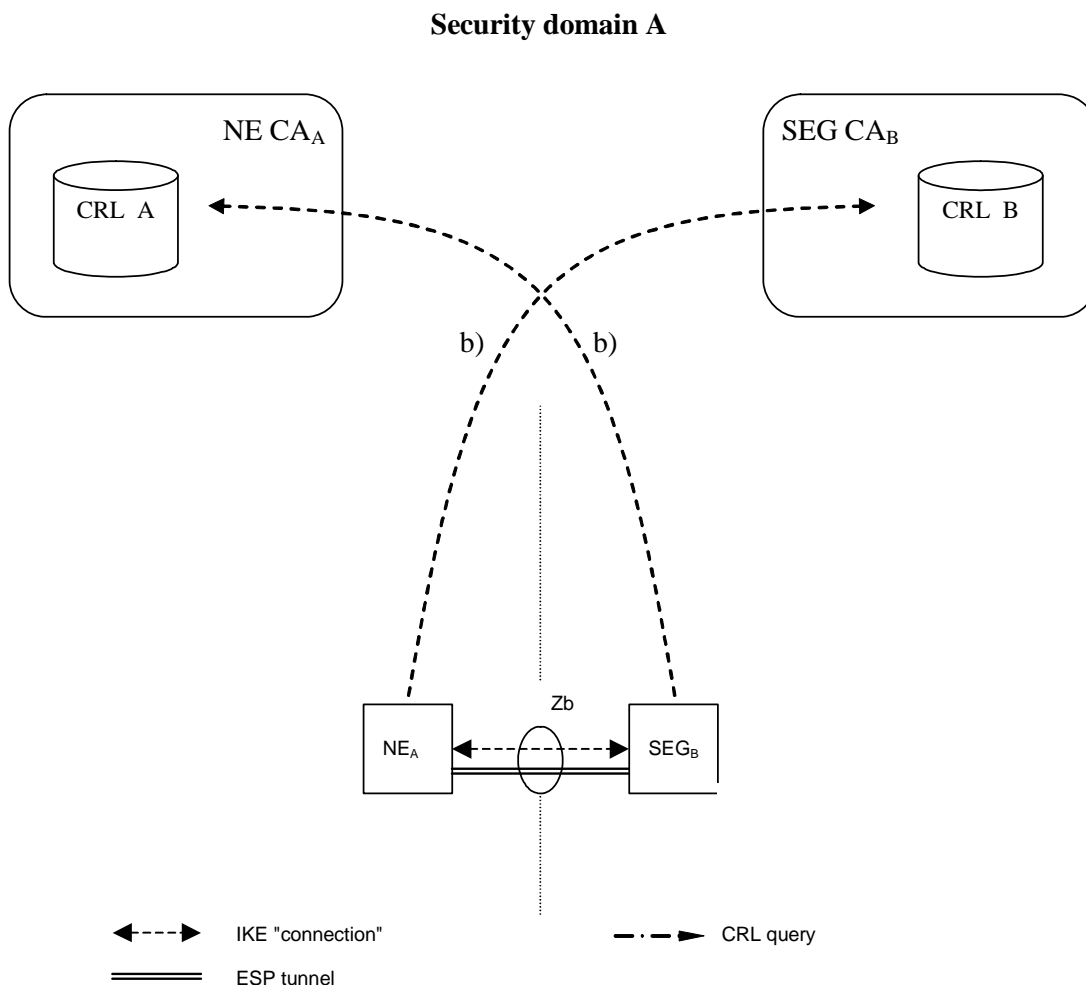

Figure 6: Repositories for NDS/IP to support Zb interface

If the SEG CA, TLS CA or Interconnection CA are combined then the public and local repositories of the CA may be implemented as separate databases or as a single database which is accessible via two different interfaces. Access to the "public" CRL is public with respect to the interconnecting transport network (e.g. GRX). The public CRL should be adequately protected (e.g. by a firewall) and the owner of the public CRL may limit access to it according to his interconnect agreements. Access to a public CRL database does not need to be secured.

NOTE 1: First it is not necessary to secure access to the CRL database as the retrieved CRL is integrity protected and contains no confidential information. Secondly access via an unprotected interface is anyhow necessary in case no currently valid security association is available to access the public CRL database.

SEGs shall use LDAP to access the CRL and cross-certificate repositories. TLS entities shall use LDAP or HTTP to access the CRL repositories. TLS entities may use LDAP to access the cross-certificate repositories, if the cross certificates are not stored locally in the TLS entity. NE's may use LDAP or HTTP to access the CRL repositories.

NOTE 2: Interfaces a) and c) for locating the data used to establish secure communications between operators belong to the scope of NDS/AF (in addition to public b) interface) as the purpose is to guarantee the interoperability between different SEGs, TLS entities and repository implementations. The possible migration to the cross-certification with a Bridge CA would also require these interfaces to be specified.

7.2 Life cycle management

Certificate Management Protocol v2 (CMPv2) [4] shall be the supported protocol to provide certificate lifecycle management capabilities for SEGs. All SEGs and SEG CAs shall support initial enrolment by the SEG to the SEG CA via CMPv2, i.e. receiving a certificate from the SEG CA, and updating the key of the certificate via CMPv2 before the certificate expires.

Certificate Management Protocol v2 (CMPv2) [4] should be the supported protocol to provide certificate lifecycle management capabilities for TLS entities. All TLS entities and TLS CAs should support initial enrolment by the TLS entity to the TLS CA via CMPv2, i.e. receiving a certificate from the TLS CA, and updating the key of the certificate via CMPv2 before the certificate expires.

Certificate Management Protocol v2 (CMPv2) [4] shall be the supported protocol to provide certificate lifecycle management capabilities for NEs. All NEs and NE CAs shall support initial enrolment by the NE to the NE CA via CMPv2, i.e. receiving a certificate from the NE CA, and updating the key of the certificate via CMPv2 before the certificate expires.

Enrolling a certificate to a SEG, NE or TLS entity is an operation that may be done more often than inter-operator cross-certifications, thus more automation could be required by the operator than is possible with a PKCS#10 approach. However, also manual SEG and NE certificate installation using PKCS#10 formats shall be supported. It should be also noted that the lifetime of a SEG CA cross-certificate is considerably longer than the lifetime of a SEG certificate.

NOTE: CMPv2 is preferred to CMPv1 (specified in obsoleted RFC 2510), because of the interoperability issues with CMPv1.

7.3 Cross-certification

Both operators use the following procedure to create a SEG CA or TLS CA cross-certificate:

1. The SEG CA or TLS CA creates a PKCS#10 certificate request, and sends it to the other operator;
2. The Interconnection CA receives a similar request from the other operator;
3. The Interconnection CA accepts the request and creates a new cross-certificate;
4. The SEG CA cross-certificate is stored once into the local CR of the Interconnection CA and LDAP is used to fetch cross-certificates. The TLS CA cross-certificate may be stored once into the local CR of the Interconnection CA and LDAP is used to fetch cross-certificates. Alternatively the TLS CA cross certificate may be locally stored in the TLS entities.

7.4 Revoking a SEG/TLS CA cross-certificate

The following procedure is used to revoke a SEG CA cross-certificate:

1. The cross-certificate is added into the Interconnection CA's CRL;
2. The cross-certificate is removed from the Interconnection CA's CR.

The following procedure is used to revoke a TLS CA cross-certificate:

1. The cross-certificate is added into the Interconnection CA's CRL;
2. If the TLS CA cross certificates are stored in the Interconnection CA's CR, then the cross-certificate is removed.
3. If the TLS CA cross-certificates are stored locally in the TLS entities, then the locally stored cross-certificates are deleted in the TLS entities.

7.5 Establishing secure connections between NDS/IP end entities using IKE on the Za interface

Certificate based authentication during IKEv1 Phase 1 or the IKEv2 IKE_INIT_SA/IKE_AUTH exchanges is shown in figure 4 above. The SEGa uses the following procedure to authenticate SEGb:

1. SEGa requests SEGb's certificate using the CERTREQ payload;
2. SEGa receives SEGb's certificate inside the CERT payload;
3. SEGa authenticates SEGb (verifies signatures);

4. SEGa fetches a CRL from the (public) CRL database of SEG CA_B if the locally cached CRL has expired;
5. SEGa uses this CRL to verify the status of SEGb's certificate;
6. SEGa uses either the locally cached cross-certificate or fetches the cross-certificate from the (local) Interconnection CA_A CR to verify SEGb's certificate;
7. SEGa fetches a CRL from the (local) Interconnection CA_A CRL if the locally cached CRL has expired;
8. SEGa uses this CRL to verify the status of the SEG CA cross-certificate;
9. SEG A verifies the cross-certificate for Operator B's SEG CA using Operator A's Interconnection CA's certificate. SEGa verifies the status of the Interconnection CA_A certificate if the Interconnection CA_A is not a top-level CA, otherwise Interconnection CA_A is implicitly trusted;

NOTE: If the local SEG CA public key is securely installed on every SEG within an operator's domain, then a cross-certificate does not need to be checked when SEGa and SEGb belong to the same operator's domain.

7.5a Establishing secure connections using TLS

The procedure for establishing secure connections using TLS is specified in detail in clause 5.2.2.

7.5b Establishing secure connections between NDS/IP entities on the Zb interface

The procedure for establishing secure connections using NDS/IP on the Zb interface is specified in detail in clause 5.2.2.

7.6 CRL management

NDS/AF compliant SEGs and NEs shall not send an ISAKMP CERTREQ where the Certificate Type is "Certificate Revocation List (CRL)". Receiving NEs and SEGs may ignore this request as section 6.1.3 specifies that CRLs shall be retrieved via a CRL distribution point.

The CRL issuer (which is in most cases the CA) shall only issue full CRLs. The use of delta CRLs is not allowed because of possible interoperability problems and because in the NDS/AF environment the full CRL is not expected to grow too large. The full CRL shall only contain revoked certificates applicable for use within NDS/AF. The CRL issuer shall issue a CRL also in cases that there are no revoked certificates. A SEG, NE or TLS entity is not obliged to query for a CRL via the CRL Distribution Point if a cached one is still available and valid. If no valid cached CRL is available, the NE, SEG or TLS entity shall fetch a new CRL. If no valid CRL can be fetched, the NE, SEG or TLS entity shall treat this as an error and cancel tunnel establishment.

8 Backward compatibility for NDS/IP NE's and SEGs

NDS/IP describes an authentication framework whereby the initial IKEv1/IKEv2 authentication is based on the Pre-shared Secret Key (PSK) authentication method. NDS/AF describes an optional authentication framework which enables NDS/IP end entities (NEs and SEGs) to perform the initial IKEv1/IKEv2 authentication based on the RSA Signatures authentication method. An NDS/AF compliant end entity shall also contain NDS/IP functionality. However, an NDS/IP compliant end entity need not contain NDS/AF functionality unless specifically mandated by TS 33.210[1] or any other 3GPP specification.

Device-specific management has to be used to reconfigure an end entity such that NDS/AF functionality will be used at the IKE initiator side for the initial IKE authentication (i.e. IKE Phase 1 negotiation or IKEv2 IKE_INIT_SA/IKE_AUTH exchange). The transition towards NDS/AF-based authentication may be done on an end entity by end entity basis. Before the first NDS/AF end entity is taken into use it shall be assured that all needed NDS/AF functionality like CRs, CRL databases are available and working. The setting up of a NDS/AF-based IPsec tunnel can be tested in parallel to the protection of existing traffic using the PSK authentication method.

A smooth migration may be done in the following way:

- a NDS/AF end entity shall provide several algorithm proposal's during IKE initial authentication, some based on the RSA signature authentication method, others based on the PSK authentication method;
- the responding IKE peer will select PSK authentication method if it does not support RSA signature authentication method, but it may select RSA signature authentication method if it complies with NDS/AF.
- the IKE responder policy shall be configured such that the RSA signature authentication method shall take precedence over the PSK authentication method to ensure that it is used as soon as the IKE initiator proposes the RSA signature authentication method.

In case of migration on the Za-interface between two operators:

If the SEGs of both operators support NDS/AF-based authentication then both SEG settings may be changed. The pre-shared secrets may then be removed from the SEGs and the IKE initiator shall only use the RSA signature authentication method. However, this removal of PSK is not essential as it may be used as a fallback mechanism. Some care has to be taken that the policy between SEGs of different operators be coordinated otherwise this may result in failed tunnel set up. This would be the case if the initiating IKE peer only uses the RSA signature authentication method and the responding IKE peer only accepts the PSK authentication method. Furthermore, if the PSK is kept as a fallback mechanism after the RSA signature authentication method is introduced, then fallback to PSK should only be allowed if the operator makes a policy change in the SEGs to allow PSK to be used. The operator may temporarily allow fallback to PSK if, for example, the SEGs are unable to verify the necessary certificates because of problems with the PKI. If PSK is kept as a fallback then it may be necessary to renew the PSK periodically for security reasons, or if PSK compromise is suspected.

9 Certificate Enrolment for Base Stations

9.1 General

The chapter specifies certificate enrolment mechanisms for backhaul security. The decision on whether or not to apply the mechanisms is left to other 3GPP specifications.

9.2 Architecture

Figure 7 shows the general deployment architecture for certificate enrolment of a base station at an operator PKI.

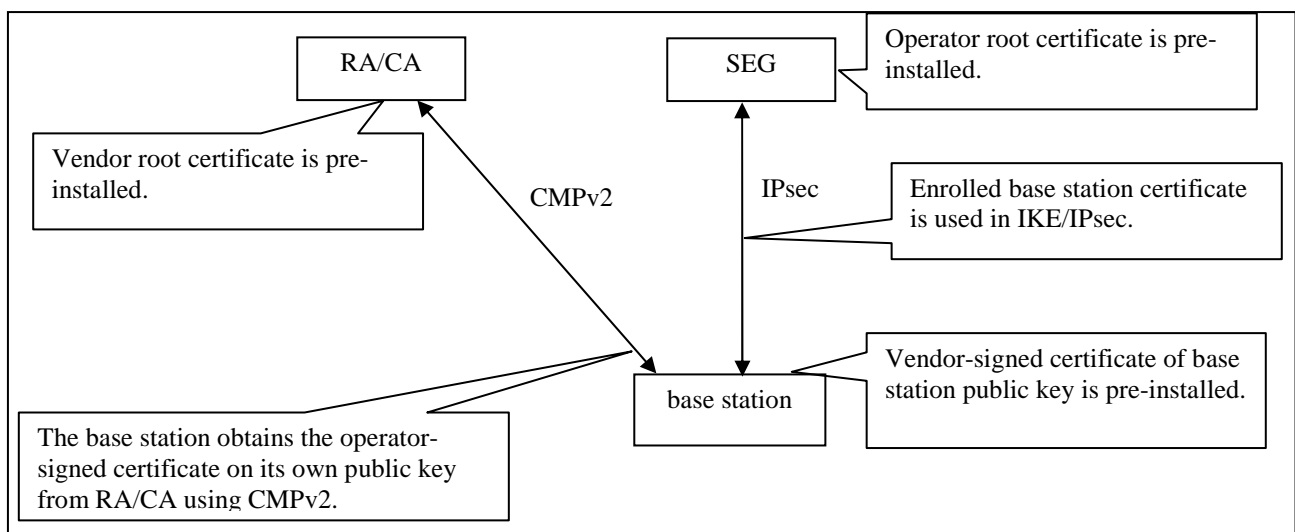

Figure 7: Overview of the security architecture

The base station is pre-provisioned with a public-private key pair by the vendor, and has the vendor-signed certificate of its public key pre-installed.

On initial contact to the operator network the base station establishes a communication channel to the RA/CA of the operator. Using CMPv2 [4] a request for a certificate is sent to the RA/CA. The network authenticates the messages from the base station based on the vendor-signed certificate of the base station and the vendor root certificate pre-installed in the network. The base station shall check the integrity protection on the messages from the RA/CA based on the operator root certificate provisioned in the base station. In a response message the base station receives the operator-signed certificate. During the execution of the CMPv2 protocol the base station has to successfully provide a Proof of Possession of the private key associated to the public key to be certified.

The operator root certificate may be provisioned in the base station prior to or during the CMPv2 protocol run. The protection of the operator root certificate during provisioning may be decided by operator security policy. If an operator root certificate provisioned prior to the CMPv2 protocol run is available the base station shall use it. Otherwise, the base station shall use the operator root certificate provisioned during the CMPv2 run. If no operator root certificate is provisioned at all then the base station shall abort the procedure.

After enrolment has been performed, the base station can use the operator-signed certificate to authenticate itself to the SEG of the operator, which is pre-installed with the operator root certificate. The base station then authenticates the SEG using the operator root certificate.

NOTE: The authentication towards the SEG is part of the normal usage of IPsec-based backhaul security according to TS 33.210 [1].

If at later stage of base station deployment the operator wants to renew the base station certificate, the same procedure will be executed with the old operator-signed certificate of the base station taking the place of the vendor-signed certificate in the initial enrolment.

9.3 Security Mechanisms

The enrolment of base stations shall use the CMPv2 protocol as specified in RFC 4210 [4] and RFC 4211 [19]. The proof-of-possession methods as given by [4] and [19] shall be used.

The profiling of CMPv2 for the purpose of base station enrolment is given in subclause 9.6 of the present document.

9.4 Certificate Profiles

9.4.1 General

All certificates used during the enrolment process of base stations shall follow the requirements given in clause 6 of the present document. Profiling and exceptions are specified in the following subclauses.

9.4.2 Vendor Root CA Certificate

The root certificate of the vendor root CA shall follow the requirements given in subclause 6.1.2 for interconnection CA certificate profiles.

9.4.3 Vendor CA Certificate

If the vendor does not sign the base station certificate by its vendor root CA, the certificate of the CA signing the base station certificates and of any intermediate vendor CA shall follow the requirements given in subclause 6.1.4 for SEG CA certificate profiles, with the following exceptions:

- the issuer name shall be the name of any vendor CA, given that the resulting chain of certificates starting with the base station certificates leads to the vendor root CA;
- the path length shall be greater than 0 for the certificate of an intermediate CA not directly signing the vendor base station certificates.

9.4.4 Vendor Base Station Certificate

The base station certificate signed by a vendor CA shall follow the requirements given in subclause 6.1.3b for NE certificate profiles, with the following exceptions:

- the issuer name is the name of the vendor CA signing the base station certificate;
- the subject name shall be a globally unique fully qualified domain name (FQDN) given by the vendor. The exact definition of this FQDN is left to the vendor, given that the vendor ensures global uniqueness.

9.4.5 Operator Root CA Certificate

The root certificate of the operator root CA shall follow the requirements given in subclause 6.1.2 for interconnection CA certificate profiles.

9.4.6 Operator RA/CA Certificate

The operator may deploy separate private keys for signing certificates and for signing the CMP messages or he may use one single private key for both purposes. In consequence the RA/CA may have two or one certificate(s).

The RA/CA certificate used for signing certificates shall follow the requirements given in subclause 6.1.4 for SEG CA certificate profiles, with the following exception:

- the issuer name shall be the name of any operator CA, given that the resulting chain of certificates starting with the RA/CA certificate leads to the operator root CA.

The RA/CA certificate used for signing CMP messages shall follow the requirements given in subclause 6.1.3 for SEG certificate profiles, with the following exceptions:

- the subject name shall be the same name as used for the RA/CA certificate used for signing certificates;
- the issuer name shall be the name of any operator CA, given that the resulting chain of certificates starting with the RA/CA certificate leads to the operator root CA.

If the operator deploys one single private key for signing of the base station certificates and for signing of the CMP messages, for the single RA/CA certificate the same requirements as above for the RA/CA certificate used for signing certificates apply with the following addition:

- in addition to the key usage extensions specified in subclause 6.1.4, mandatory critical key usage extension bit `digitalSignature` shall be set.

NOTE: According to common security practices, the usage of separate private keys and certificates is recommended.

9.4.7 Intermediate Operator CA Certificate

If the operator does not sign the RA/CA certificate by its operator root CA and if the RA/CA certificate(s) are not directly signed by the operator root CA, the certificate of any intermediate operator CA shall follow the requirements given in subclause 6.1.4 for SEG CA certificate profiles, with the following exceptions:

- the issuer name shall be the name of any operator CA, given that the resulting chain of certificates starting with the RA/CA certificates leads to the operator root CA;
- the path length shall be greater than 0.

9.4.8 Operator Base Station Certificate

The base station certificate signed by the operator RA/CA shall follow the requirements given in subclause 6.1.3b for NE certificate profiles.

Other documents may specify different base station certificate profiles according to their deployment scenario.

NOTE: The intended usage of the base station certificate may have requirements different from the usage of NE certificates as specified in the present document on NDS/AF. Thus the exact profile may depend on other documents specifying the intended deployment scenario.

9.5 CMPv2 Profiling

9.5.1 General Requirements

The following requirements shall apply to CMPv2 usage end-to-end between base station and RA/CA:

- This CMPv2 profile shall only include certificate request and key update functions. Revocation processing, PKCS#10 requests and CRL fetches shall not be part of this CMPv2 profile.
- For PKI Message Protection, this CMP profile shall only use an asymmetric algorithm. `PasswordBasedMac` is not used in the scope of the present document.
- The base station shall be pre-provisioned with a private/public key pair (vendor key pair) and with the related vendor base station certificate signed by a vendor CA.
- If there is a certificate chain from the base station certificate up to the vendor root CA, also the intermediate certificates shall be pre-provisioned to the base station.
- The base station may be pre-provisioned with the operator root CA certificate.
- If the base station is not pre-provisioned with the operator root CA certificate, then the base station shall take the operator root certificate from the certificates received in the initialization response. The selection shall be based on checking which root certificate can be used to validate the received base station certificate.

NOTE 1: Certificate renewal for operator root certificates is not in scope of this clause on base station enrolment. Thus it is assumed that the base station always has a valid operator root certificate available for validation of key update responses.

- The RA/CA shall authenticate initialization requests based on signatures which are validated against the vendor root CA.
- The RA/CA shall authenticate key update requests based on signatures which are validated against the operator root CA.
- The RA/CA shall be configured with the root certificate of the vendor and the operator.
- The RA/CA shall be configured with a RA/CA certificate which is signed either by the operator root CA or by an intermediate CA under the operator root CA.
- If the RA/CA uses different private keys to sign the generated certificates and the CMPv2 messages, the RA/CA shall be configured with the two related certificates, i.e. the RA/CA certificate for signing signatures and the RA/CA certificate for signing CMP messages.
- If the RA/CA certificate or certificates (two in case separate private keys are used for signing of certificates and CMP messages) are not signed directly by the operator root CA, also the certificates of the intermediate CAs shall be configured into the RA/CA.
- The hash algorithms used before generating signatures in the protection field of PKIMessage and for proof-of-possession shall be the same as the hash algorithms specified in subclause 6.1.1 for certificate signatures. The signature algorithms shall be the same as that used in the related certificate profile.

The certificate profiles are specified in subclause 9.4.

NOTE 2: These certificate profiles implicitly specify which algorithms are to be used for the different signatures for proof-of-possession and PKIMessage signing specified in the following subclauses.

NOTE 3: Policies within RA/CA governing the generation and issuing of certificates are not in scope of the present document and left to operator decision.

9.5.2 Profile for the PKIMessage

The following profile shall be applied to the PKIMessage as specified in [4]:

- The support and usage of the optional protection field of type PKIProtection is required by this profile. The message-specific private key to be used in the base station is specified in the subclause 9.5.4 in the profiling of the single PKI message bodies for requests sent by the base station. For the RA/CA the RA/CA private key shall be used, or the separate RA/CA private key for signing CMP messages, if base station certificates and CMPv2 messages are signed by different private keys.
- The support of the optional extraCerts field is required by this profile. The certificates within this field may be ordered in any order. The message-specific content of this field is specified in the subclause 9.5.4 in the profiling of the single PKI message bodies.
- All CMPv2 messages used within this profile shall consist of exactly one PKIMessage, i.e. the size of the sequence for PKIMessages shall be 1 in all cases.

9.5.3 Profile for the PKIHeader Field

The following profile shall be applied to the PKIHeader field as specified in [4]:

- The sender and recipient fields shall contain the identities of the base station and the RA/CA. These identities shall be identical to the subject name present in the certificate for the public key whose related private key is used to sign the PKIMessage. If the recipient identity according to this rule is not known to the sender, any name known to the sender may be used.
- As the field "protection" of PKIMessage is mandatory, also the field "protectionAlg" of PKIHeader is mandatory. The protectionAlg shall be of type MSG_SIG_ALG. The value shall match the signature algorithm in the signer's certificate (belonging to the base station or the RA/CA).

- The usage of the transactionID field is mandatory. The recommended procedures for handling of the transactionID given in [4] shall be followed. The base station shall set this field to a random number that is at least 8 bytes long for the first message in the transaction.
- The usage of the senderNonce and the recipNonce fields is mandatory. The length of the fields as recommended in [4] shall be used. The recipNonce in the very first message in the transaction should be set to 0 by the sender and shall be disregarded by the recipient of the message.

9.5.4 Profile for the PKIBody Field

9.5.4.1 General

The base station certificate enrolment shall support the following CMPv2 PKI message bodies:

- Initialization Request (ir)
- Initialization Response (ip)
- Key Update Request (kur)
- Key Update Response (kup)
- Confirmation (pkiconf)
- Certificate confirm (certconf)

Profiles for the single message bodies above are given in the subclauses below. If no specific profile is given, the provisions of [4] and [19] apply.

9.5.4.2 Initialization Request

The Initialization Request as specified in [4] shall contain exactly one CertReqMessages as specified in [4] and [19], i.e. the size of the sequence for CertReqMessages shall be 1 in all cases.

The following profile shall be applied to the CertReqMessage field and its sub-fields:

- The subject field of the CertTemplate shall contain the suggested name of the base station if the base station has knowledge of it. Otherwise it shall be omitted.
- The publicKey field of the CertTemplate shall contain the public key of the base station to be certified by the RA/CA. The private/public key pair may be pre-provisioned to the base station, or generated inside the base station for the CMPv2 protocol run. The format of this field shall follow RFC 5280 [14].

NOTE: RFC 3280 as referenced by [19] for the format of the publicKey field is obsolete. The present document generally references the follow-up RFC 5280 [14].

- The CertReqMessage shall contain a ProofOfPossession (popo) field, containing a signature field of type POPOSigningKey. The algorithmIdentifier field of the POPOSigningKey field shall contain the signing algorithm which is used by the base station to produce the Proof-of-Possession value, i.e. the signature within POPOSigningKey field.
- If the POPOSigningKeyInput field within POPOSigningKey field is used, the sender field within POPOSigningKeyInput shall contain the identity of the base station as given by the vendor of the base station and contained in the vendor-provided base station certificate.

NOTE: According to [19], the POPOSigningKeyInput field is mandatory if the subject field of the CertTemplate field is omitted.

The PKIMessage sent by the base station shall be signed by the vendor provided private key.

The extraCerts field of the PKIMessage carrying the initialization request shall contain the base station certificate provided by the vendor. If the base station certificate is not signed by the vendor root CA, also the intermediate certificates for the chain up to the vendor root certificate shall be included in the extraCerts field.

9.5.4.3 Initialization Response

The Initialization Response as specified in [4] shall contain exactly one generated base station certificate, i.e. the size of the sequence for CertResponse shall be 1 in all cases.

The following profile shall be applied to the CertRepMessage field and its sub-fields:

- The generated certificate shall be transferred to the base station in the certifiedKeyPair field of the CertResponse field. The transfer shall not be encrypted.

The extraCerts field of the PKIMessage carrying the initialization response shall contain the operator root certificate and the RA/CA certificate (or certificates if separate private keys are used for signing of certificates and CMP messages). If the RA/CA certificate(s) are not signed by the operator root CA, also the intermediate certificates for the chain(s) up to the operator root certificate shall be included in the extraCerts field.

9.5.4.4 Key Update Request and Key Update Response

The structure and content of these messages is identical to initialization requests and responses, thus the profiling given in the previous subclauses for Initialization Request and Initialization Response apply equally, with the following exception:

- The PKIMessage sent by the base station shall be signed with the private key which is related to the last received operator provided base station certificate. The extraCertsField shall contain the base station certificate related to the private key used for signing the PKIMessage. Any intermediate CA certificates shall also be included, if the base station certificate is not signed directly by a root CA.

9.5.4.5 Certificate Confirm Request and Confirmation Response

Initialization responses and key update responses shall always be followed by a Certificate Confirm request and Confirmation response message exchange.

The PKIMessage sent by the base station shall be signed by the same private key which was used in the preceding initialization request or key update request.

The extraCerts field of the PKIMessage carrying the Certificate Confirm request and Confirmation response shall be omitted.

9.6 CMPv2 Transport

Transport of CMPv2 messages between end entities (network elements) and RA/CA shall be done using HTTP-based protocol as specified in draft-ietf-pkix-cmp-transport-protocols [18].

Support is mandatory for communication initiated by the end entities where every CMP request triggers a CMP response message from the CA or RA. Support for RA/CA initiated HTTP requests (i.e. announcements) is not mandatory.

Support for HTTP over TLS (HTTPS) according to [20] is mandatory. Usage of HTTPS is optional.

Annex A (normative): Critical and non critical Certificate Extensions

According to RFC5280 [14], section 4.2 a certificate extension can be designated as either critical or non-critical.

"A certificate using system MUST reject the certificate if it encounters a critical extension it does not recognize; however, a non-critical extension MAY be ignored if it is not recognized."

Optional and mandatory support statements (e.g. section 6 Profiling) are being made with respect to implementation requirements. A receiving SEG or TLS entity shall be able to process an extension marked as critical that is mandatory to support in NDS/AF. When optional to support, a received extension marked as critical shall lead to an error according to RFC 5280.

Annex B (informative): Decision for the simple trust model

B.1 Introduction

In order to document the decision for the "simple trust model", which requires manual cross-certification, this section discusses technical advantages and disadvantages of two basic approaches to providing inter-operator trust for purposes of roaming traffic protection, namely **cross-certification** and a **Bridge CA**. The Bridge CA is an extension of the cross-certification approach, and identified as one of the recommendable solutions for providing inter-operator trust in NDS/AF feasibility study (TR 33.810). Taking into account the current state of PKI software and the general need for simple solutions when there is a choice, the cross-certification without a Bridge CA was chosen for the NDS/AF TS. This Annex discusses the background motivation for such direction.

The direct cross-certification without Bridge CA model is associated strongly with the current practice in the Internet IPsec world, where each IPsec connection is configured with a list of trusted CAs, and anyone with a certificate that has a trust path that can be followed up to such trusted CA (trust anchor) is allowed access. In this model, cross-certification is done at the time the roaming agreement is made. This is called the "**simple trust model**."

The Bridge CA model assumes that all operators wishing to establish a roaming agreement with other operators will first get certified by the Bridge CA for purposes of identification by other operators. This is a necessary preliminary step. Next, when the roaming agreement is done, the operators will configure their IPsec tunnels, with information about which one of the identifiable operators (who have a certificate issued by the Bridge CA) can use that tunnel. This is called the "**extended trust model**", or "separated trust and access control."

This Annex does not discuss the benefits of certificates vs. Pre-Shared Keys. The benefit of cross-certification vs. the explicit listing of roaming peer CAs includes the easier evolution path to a possible eventual Bridge CA model.

B.2 Requirements for trust model in NDS/AF

The following is a list of requirements for the trust model for NDS/AF:

- A. *Simplicity and ease of deployment.* PKI brings many benefits when a large number of operators need to tunnel traffic in a mesh configuration, but its adoption should not be hindered by an unnecessarily complex technical solution. The required technical and legal operations necessary for exchanging traffic with another operator should be as easy and straightforward as possible;
- B. *Compatibility with existing standards.* Unless there are explicit requirements why existing PKI standards should be extended to accommodate 3GPP environment, the 3GPP specifications should be accommodated to the existing standards. This allows best choice of equipment for operators and allows interoperability with non-3GPP environments;
- C. *Usable by both GRX and non-GRX operators.* Both operators making use of GRX providers and those without (using leased lines or even the public Internet), should be able to make use of NDS/AF measures to exchange traffic securely.

B.3 Cross-certification approaches

B.3.1 Manual Cross-certification

The trust model of manual cross-certification is characterized by the clause: "Trust nobody unless explicitly allowed". Issuing a certificate for the authority to be trusted creates the allowances. The manual cross-certification is easy to understand. Also the security of this depends only on the decisions done locally.

B.3.2 Cross-certification with a Bridge CA

The trust model of bridge-CA can be characterized by the clauses:

- "Trust everybody that the Bridge-CA trusts unless explicitly denied". Explicit denials are handled by writing the restrictions (in the form of name constraints) to the certificate issued to the bridge.
- "Trust everybody listed in the certificate which I issued to the bridge". Explicit allowances are listed in the certificate issued to the bridge (in the form of name constraints).

Name constraint is a rarely used extension for X.509 certificates. In essence it is a clause that says who to trust or who not to trust based on names on certificates. The fact that they are relative rarely used and the fact that there is so little official documentation about them is a risk. Name constraints also require that there is some organization doing registration of names in order to avoid name collisions.

B.4 Issues with the Bridge CA approach

B.4.1 Need for nameConstraint support in certificates or strong legal bindings and auditing

If no precautions are taken, it is possible that an operator (M) whose SEG CA has been signed by the Bridge CA (= certified by the Bridge), creates certificates that resemble another operator's (A) certificates, letting M access to operator (B)'s network, even without authorization.

Let's say operator B has the following configuration for access to her subnetwork reserved for handling roaming traffic:

- Local-Subnetwork = some ipv6 subnetwork address;
- TrustedCA's = BridgeCA;
- AllowedCertificateSubject = O=Operator A or O=Operator C or O=Operator D.

NOTE: The IP addresses of the remote SEGs are not limited, as authentication is done based on certificates, and all trusted operators are allowed similar access. If different foreign operators would require to access different subnetworks, there would be several configuration blocks like the above, with the IP addresses appropriately specified.

Such "AllowedCertificateSubject" feature (the term name is imaginary) is widely supported by PKI-capable IPSec devices.

If Operator M used certificates of the following form for her certificates, she would not be allowed in:

- Subject: CN=SEG 1, O=Operator M;
- Signer: CN=SEG CA, O=Operator M.

However, she can fabricate certificates of the following form:

- Subject: CN=SEG 1, O=Operator A;
- Signer: CN=SEG CA, O=Operator M.

Using such certificates would allow full but illegitimate access to Operator B's network revealed for use by Operator A.

Now, there are the following possibilities to circumvent the problem:

1. checking also the Signer name when authenticating foreign operators, either by a) a proprietary "AllowedCertificateSigner" property or b) support for nameConstraints in the Bridge CA certificate issued to operator M;
2. establishing strong legal bindings and auditing that would discourage Operator M from such illegitimate fabrication of Operator A certificates.

The problem with solution 1.a is that such "AllowedCertificateSigner" is not commonly supported by current PKI end-entity products, being in conflict with requirement B.

The problem with solution 1.b is that such "nameConstraints" attribute in certificates is not commonly supported by current PKI CA or end-entity products, being in conflict with requirement B.

The problem with solution 2 is that first of all, an organization willing to run a Bridge CA has to be found before any pair of operators can exchange roaming traffic with NDS/AF mechanisms. Next, there shall be established paperwork and auditing procedures to make sure that the exploit described here can be detected. This is in conflict with requirement A. Also, the illegitimate act described could not be technically prevented beforehand.

If name constraints are used, every time a new roaming agreement is made, each operator shall update the certificate they issue for the Bridge, adding the new roaming partner's name into the certificate. From the point of view of one operator, the number of new certificate signing operations is the same whether a Bridge CA or a direct cross-certification model is in use.

B.4.2 Preventing name collisions

If name constraints are used to prevent the additional "bureaucracy" involved with the Bridge CA, the names written into the certificate need to be registered with a third party to prevent two operators accidentally or on purpose using the same name in their certificates. This is in conflict with requirement B.

B.4.3 Two redundant steps required for establishing trust

As described in the introduction, with the "extended trust model", each operator shall first be certified by the bridge (authentication), and then as the second step, enumerate the trusted operators when configuring the IPSec tunnel (access control).

For the Bridge CA model to work, there is a need for organization that all the other parties involved can trust - and the trust shall be transitive! If you trust the bridge, you shall also trust the other organizations joining to the bridge via the cross-certification. If Operator A and the Bridge CA cross-certify with each other, Operator A will automatically trust every other certified operator to obey the rules. And this trust is not related to the roaming traffic tunnel; the tunnel has to be configured independently of the PKI.

So even if configuring new certificates in the SEGs is avoided when cross-certification is used, the roaming information shall be configured and maintained in the SEG some other way. And the hard part: How the trust provided by the PKI and the roaming agreements is combined, because clearly in this case PKI provided trust is not the same as roaming agreements.

Two steps would be needed:

1. building "trust" through Bridge CA => authenticating the peer SEG;
2. specify in the tunnel configuration which peering SEGs can be trusted.

If the cross-certification is done without a Bridge CA, the steps can be combined into one. What is the additional value of the PKI provided trust (step 1), if the peering SEGs have to be restricted in any case?

B.4.4 Long certificate chains connected with IKE implementation issues

If Bridge CA is used, a SEG CA certificate has to be sent in the certificate payload in addition to the local end entity (SEG) certificate. This leads in Ethernet environments to the fragmentation of the IKE packet, which some current IKE implementations do not support. It is a problem in the implementation, not the protocol. Even in IPv6, the IKE UDP packets need to be fragmented, posing a potential interoperability problem. Clearly it is not a solution to use a different protocol, but instead the current implementations should be fixed. Still, taking into account requirement B, it is safer to avoid the problem altogether by not forcing the fragmentation of IKE packets by not using a Bridge CA.

B.4.5 Lack of existing relevant Bridge CA experiences

The Federal PKI in the USA is an example deployment where a Bridge CA is used to connect together CAs of the various federal agencies. It seems to be however the only documented one of its kind, and is connected with very heavy policy documentation and obviously heavy auditing practices, even within one organization, the federal government. The bridge approach is warranted in the case, because they want to automatically check whether some entity has legal rights to sign some document. The number of entities doing cross-domain PKI validation can be several millions, and it is impossible for one validating entity to keep count of individual signers.

In 3G roaming, the situation is in many ways different. When a new operator is born, the other ones do not automatically want to exchange roaming traffic with the new one, but a legal agreement with that operator and a technical tunnel establishment shall be done. In Federal PKI, the situation is the opposite: nothing should need to be done and still be able to trust the other.

In the Federal PKI, the paperwork and processes make name constraints in certificates unnecessary, and IKE is supposedly not used together with the Bridge CA.

B.5 Feasibility of the direct cross-certification approach

This chapter discusses the direct cross-certification, i.e. manual cross-certification approach, where operators are doing the cross-certification operation only when agreeing to set up a tunnel with another operator. This tunnel setup is a legal and technical operation in any case, so it is feasible to do also the cross-certification at this time, removing the need for the initial step to cross-certify with the Bridge CA.

There is no technical difference regarding the feasibility of direct cross-certification or Bridge CA in the context of GRX or non-GRX environment. GRX might be one possible choice for providing the Bridge CA services.

B.5.1 Benefits of direct cross-certification

The benefits of the direct cross-certification is that as a mechanism it is well known, supported widely by current PKI products and there even exists an evolution path to a Bridge CA solution if the products come to support it adequately, a Bridge CA is established, and the number of operators becomes so large to warrant the use of the Bridge CA technology. Bridge CA uses the cross-certification mechanisms in any case.

The tunnel configuration would look like the following:

- Local-Subnetwork = some ipv6 subnetwork address;
- TrustedCA's = LocalCA.

The information of which operator is allowed access is implicit in the direct cross-certifications that have been done by the LocalCA, thus authentication and access control are tightly connected. If different foreign operators need to access different subnetworks, there would be separate tunnel configurations with SEG IP address for each, including an "AllowedCertificateSubject" limitation. The "AllowedCertificateSigner" limitation is not needed as necessary in this model (compared to the bridge CA model), since the set of operators which can be authenticated are only the ones, that have previously been agreed to trust when doing the direct cross-certification. In the bridge CA case, the set of operators which can be authenticated includes all operators who have joined to the bridge.

B.5.2 Memory and processing power requirements

In case of direct cross-certification, each operator shall store the certificates issued for the other operators locally. They could be stored in the SEG devices, or then in a common repository.

If an operator makes roaming agreements with 500 other operators, this would require roughly 1000 kilobytes of memory, if the operator signs the certificates herself, and one certificate takes 1 kilobyte of memory. This should be quite feasible taken into account the high-end nature of SEG hardware.

Processing power benchmark for validating certificates:

- Hardware: 800 MHz Pentium III, 256 MB of memory.
- 200 x 1024-bit RSA certificates, 1 Root CA (operator's own CA), 200 Sub CAs (other operator CAs) and 200 end entity (SEG) certificates. Also CRLs were verified. Both certificates and CRLs were loaded from disk during the test. The whole test took 3.5 seconds, with probably disk I/O taking most of the time.

In this test 200 certificate chains were validated up to the trusted root.

B.5.3 Shortcomings

As discussed in the previous section, the Bridge CA approach saves memory or storage space in SEGs, because all the other operators SEG CA certificates do not need to be stored with other operators. Just the Bridge CA certificate would be stored, and other certificates retrieved during IKE negotiation.

B.5.4 Possible evolution path to a Bridge CA

If needed, it is possible to take the Bridge CA into use gradually, given that the support by PKI products becomes reality. From one operator's point of view, the bridge CA would be like any other operator so far, and a cross-certification would be made, but additionally the name constraints in the certificate issued for the Bridge CA should be updated every time a new roaming agreement is made.

Annex C (informative): Decision for the CRL repository access protocol for SEGs

In order to document the decision for the protocol for SEGs to access CRL repositories, this section summarises technical advantages and disadvantages of the two candidates.

LDAP

- + implemented by all PKI products (unless purely manual)
- + scalability
- + flexibility (integration possibility to other systems, automatic public key retrieval possibility)
- complexity

HTTP

- + simple
- not supported by all PKI products (although widely supported)

LDAP was chosen as the more future-proof protocol. Although more complex than HTTP, LDAP is well established amongst PKI vendors and operators.

Annex D (informative): Decision for storing the cross-certificates in CR

In order to document the decision for storing the cross-certificates in Certificate Repository, fetching those with LDAP and caching them in SEGs, this section summarises technical advantages and disadvantages of the three alternatives.

The following table summarizes differences between alternatives:

Table D.1

Issue	A) Cross-certificates are stored into SEGs:	B) Cross-certificates are stored into CRs:	C) Cross-certificates are stored into CRs and cached in SEGs upon usage:
1) Initialization issues: storing the cross-certificate during the cross-certification	The cross-certificate is <i>initially</i> stored in several places, that is, into <i>all</i> SEGs (estimated number is between 2 and 10). Pros: - Cons: Certificate must be initially copied in several places. SEGs from different manufacturers may have other O&M interfaces to handle the certificates.	The cross-certificate is <i>initially</i> stored in CR. Pros: The handling is fully standardized. Certificate is initially copied in one place only. The operator should have the repository anyway (due to CRL handling). Cons: -	The cross-certificate is <i>initially</i> stored in CR. Pros and cons as in B).
2) Usage issues: latency during the IKE Phase 1	Pros: No extra latency Cons: -	Pros: - Cons: More latency caused by extra LDAP query (the cross-certificate is queried)	Pros & cons: as in B) at the first time, and as in A) at subsequent times
3) Cleanup issues: removing the cross-certificate	Pros: - Cons: The cross-certificate has to be removed from several places, that is, from <i>all</i> SEGs	Pros: The cross-certificate has to be removed from one single place only Cons: -	Pros: - Cons: The cross-certificate has to be removed from <i>both</i> CR <i>and</i> each SEG.
NOTE:	this functionality is needed only to be able to revoke cross-certificates before the next CRL gets published.		
4) Security issues	Pros: No single point of failure exists. Cons: -	Pros: - Cons: CR represents a single point of failure suitable for an attacker, e.g. to submit a denial of service attack by breaking the communication at the CR.	Pros: Single point of failure partly mitigated Cons: -

Analysis:

- Alternative B) requires one additional LDAP query in every IKE Phase 1 negotiation and will introduce new error cases
- Latency of LDAP: information from LDAP to local disk is cached and populating it takes some time, but in practice this time is not significant.
- The benefit of alternative B) and C) compared to alternative A) is easier management, that is, storing and removing the certificate in/from one single place only.

Conclusion: alternative C) is the most feasible choice, because it combines good points of alternatives A) and B).

Annex E (normative): TLS protocol profile

TLS end points shall support TLS with the following restrictions and extensions, except those TLS endpoints that have been defined for GBA in TS 33.220 [10] and for IMS in TS 33.203 [9]. Both TS 33.203 [9] and TS 33.220 [10] contain their own TLS CipherSuite requirements.

- SSL 3.0 shall not be used as it is outdated.
- At least TLS 1.1 [17] shall be supported. TLS 1.2 [16] should be supported.
- The rules on allowed and mandatory ciphersuites given in TLS 1.2 [16] shall be followed. Ciphersuites with RC4 should not be used.

NOTE: This specification contains TLS profile requirements when both TLS endpoints belong to an NE. However if a new TLS based UE to NE profile needs to be defined, then this can be based on the existence of the above ciphersuites, if this NE needs to implement a TLS profile for NE to NE communication.

Annex F (informative): Manual handling of TLS certificates

The purpose of this Annex is to provide alternative guidelines for TLS certificate handling in case of the absence of the authentication framework for TLS certificates.

Within this Annex following abbreviations are used: CA_A is the certification authority in A's network and CA_B is the certification authority in B's network. $Cert_A$ is the certificate of A and $Cert_B$ is the certificate of B. I_A is the set of identifiers that A may use for identification towards B. T_B is the set of peers trusted by B.

F.1 TLS certificate enrolment

Mutual authentication in TLS is achieved based on public key technology and certificates. Both TLS peers A and B need to contain a certificate store and there shall be at least one certification authority CA that can issue certificates within the security domains in which A and B are part of. $Cert_A$ contains the set I_A of A's identifiers. Each identifier is in the form of fully qualified domain name (FQDN). Similarly, B's certificate is $Cert_B$.

The certificates in the store of B define the group T_B of peers trusted by B. There are several options for creation and enrolment of certificates, three of which are described below.

1. In one option there is a certification authority, CA_B , only in the network of B. CA_B issues a certificate $Cert_B$ to B and a certificate $Cert_A$ to A. The certificates are delivered from CA_B to A and B in a secure way "out of band". Both A and B then add their peer into the group of their trusted peers by inserting that peer's certificate into the certificate store: A inserts $Cert_B$ into A's certificate store and B inserts $Cert_A$ into B's certificate store. This insertion is typically manual and the details depend on the implementation of the management interface to the certificate store.
2. In another option both A's and B's networks contain certification authorities, CA_B and CA_A , respectively. CA_B issues a certificate $Cert_B$ to B and CA_A issues a certificate $Cert_A$ to A. The certificates are delivered from CA_B to A and from CA_A to B in a secure way "out of band". Both A and B then add their peer into the group of their trusted peers by inserting that peer's certificate into the certificate store: A inserts $Cert_B$ into A's certificate store and B inserts $Cert_A$ into B's certificate store.
3. In a third option the CA certificates of both sides are exchanged: the certificate of CA_B is delivered to A and the certificate of CA_A is delivered to B in a secure way "out of band", inserted to the certificate store, and marked trusted. The validation of $Cert_A$ and $Cert_B$, that are exchanged during TLS handshake, is based on the presence of the corresponding CA certificates in the certificate store.

NOTE: In options 1 and 2 the need for certification authority may be avoided if the peers generate self signed certificates and exchange them in a secure way, "out of band". Also, instead of certificates themselves, certificate fingerprints may be exchanged "out of band" in those options.

F.2 TLS Certificate revocation

In the absence of PKI-revocation interfaces, certificate revocation needs to be performed manually. The revocation operation involves the removal of A from the group T_B of peers trusted by B. In the first two enrolment options described above the revocation happens by B removing the certificate of A, $Cert_A$, from its certificate store. This removal can be done manually. In the third option the certificate of A, $Cert_A$, is not in B's certificate store. For that reason B has to have a way to check the validity of $Cert_A$ with the issuer of the certificate (also in the first two enrolment options the amount of manual maintenance operations will decrease if B can check the validity of $Cert_A$ with the issuer of the certificate). This check may be done by using Online Certificate Status Protocol (OCSP) [12] or by using Certificate Revocation Lists (CRLs) [14] published by the issuer of $Cert_A$.

Annex G (informative): Example CMPv2 Message Flow for Initial Enrolment

The purpose of this annex is to provide an overview how the initial enrolment of a base station may be executed.

The message flow for an initial enrolment of a base station to the RA/CA is shown in Figure 8 below. The text below the figure gives a description of this message flow. Precondition for this message flow is that the base station contains the vendor provided private/public key pair and is pre-provisioned with the related base station certificate signed by a vendor CA. If there is a certificate chain up to the vendor root CA, also the intermediate certificates must be pre-provisioned to the base station. The RA/CA is configured with the root certificate of the vendor and its own certificate(s).

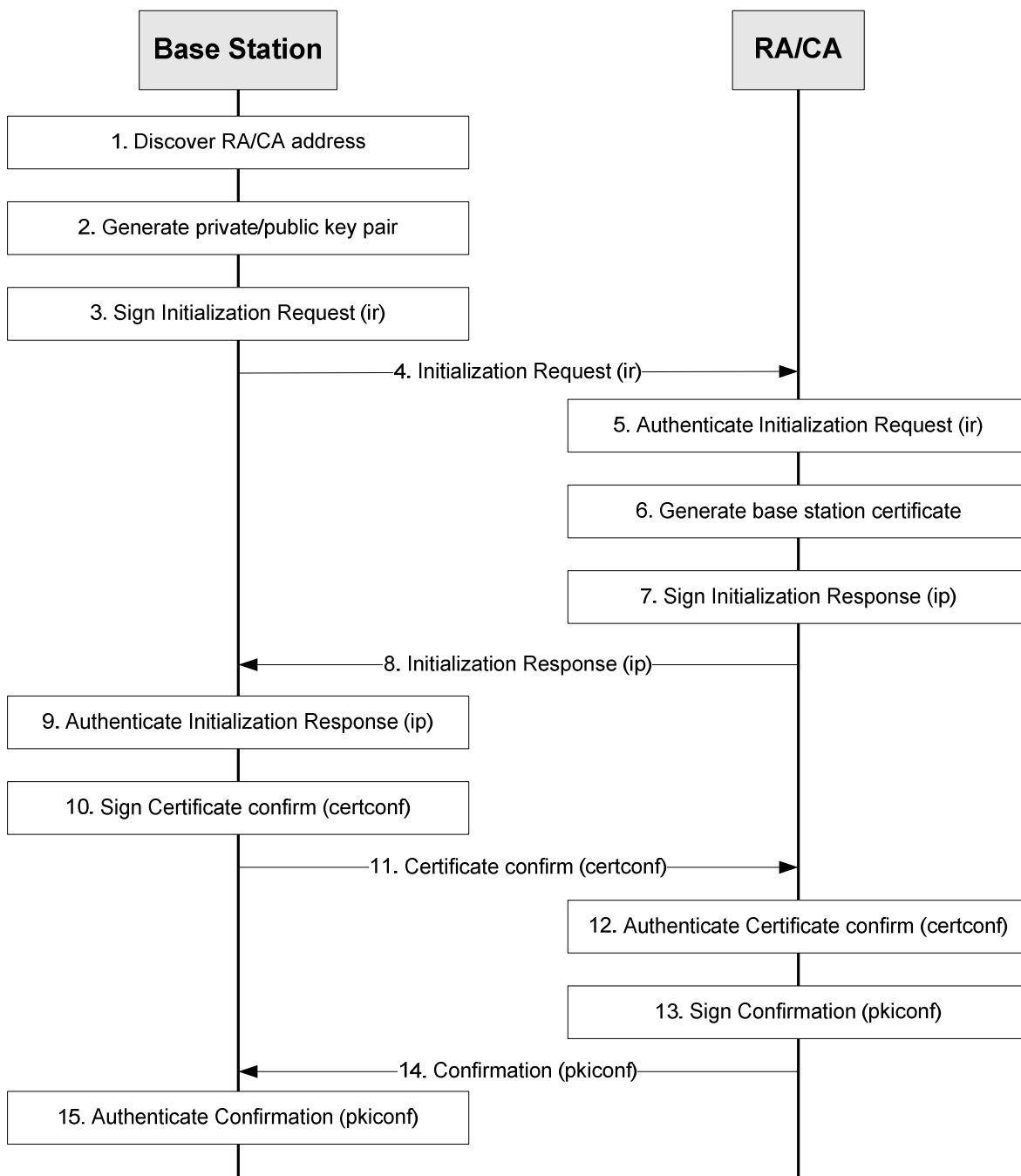

Figure 8: Example message flow for initial base station enrolment

1. The base station discovers the RA/CA address.
2. The base station generates the private/public key pair, if this is not pre-provisioned.
3. The base station generates the Initialization Request (ir). The CertReqMsg inside ir specifies the requested certificate. If the suggested identity is known to the base station, it includes this in the subject field. To provide proof of possession the base station generates the signature for the POPOSigningKey field of the CertReqMsg using the private key related to the public key to be certified by the RA/CA. The base station signs the ir using the vendor provided private key, and includes the digital signature in the PKIMessage. Its own vendor signed certificate and any intermediate certificates are included in the extraCerts field of the PKIMessage carrying the ir.
4. The base station sends the signed ir message to the RA/CA.
5. The RA/CA verifies the digital signature on the ir message against the vendor root certificate using the certificate(s) sent by the base station. The RA/CA also verifies the proof of the possession of the private key for the requested certificate.
6. The RA/CA generates the certificate for base station. If the suggested identity of the base station is not included in the ir message, the RA/CA determines the suggested identity of the base station, e.g. based on the vendor provided identity of the base station contained in the base station certificate.

NOTE: The procedures for determination of the base station identity used by the operator are not in scope of the present document. According to [4], the RA/CA may replace a suggested identity sent by the base station with another identity based on local information.

7. The RA/CA generates an Initialization Response (ip) which includes the issued certificate. The RA/CA signs the ip with the RA/CA private key (or the private key for signing CMP messages, if separate), and includes the signature, the RA/CA certificate(s) and the operator root certificate in the PKIMessage. The appropriate certificate chains for authenticating the RA/CA certificate(s) are included in the PKIMessage.
8. The RA/CA sends the signed ir to the base station.
9. If the operator root certificate is not pre-provisioned to the base station, the base station extracts the operator root certificate from the PKIMessage. The base station authenticates the PKIMessage using the RA/CA certificate and installs the base station certificate on success.
10. The base station creates and signs the CertificateConfirm (certconf) message.
11. The base station sends the PKIMessage that includes the signed CertificateConfirm to the RA/CA.
12. The RA/CA authenticates the PKI Message that includes the CertificateConfirm.
13. The RA/CA creates and signs a Confirmation message (pkiconf).
14. The RA/CA sends the signed PKIMessage including the pkiconf message to the base station.
15. The base station authenticates the pkiconf message.

Annex H (informative): Change history

Change history							
Date	TSG #	TSG Doc.	CR	Rev	Subject/Comment	Old	New
2004-03	SP-23	SP-040168	-	-	Presented for approval at TSG SA #23	1.1.0	2.0.0
2004-03	SP-23	-	-	-	Approved and placed under Change Control (Rel-6)	2.0.0	6.0.0
2004-06	SP-24	SP-040393	001	-	Removal of inconsistencies regarding SEG actions during IKE phase 1	6.0.0	6.1.0
2004-06	SP-24	SP-040394	002	-	Removal of unnecessary restriction on CA path length	6.0.0	6.1.0
2004-06	SP-24	SP-040395	003	-	Correction of 'Extended key usage' extension in SEG Certificate profile	6.0.0	6.1.0
2004-09	SP-25	SP-040623	004	-	Splitting the Roaming CA into a SEG CA and an Interconnection CA	6.1.0	6.2.0
2005-12	SP-30	SP-050654	-	-	Raised to Rel-7 to allow reference by TISPAN	6.2.0	7.0.0
2006-09	SP-33	SP-060507	0005	-	Extending NDS/AF to support TLS	7.0.0	7.1.0
2006-09	SP-33	SP-060504	0006	-	Clarifications and corrections	7.0.0	7.1.0
2006-09	SP-35	SP-070162	0008	-	Specification of TLS protocol profile for future TLS endpoints	7.1.0	8.0.0
2007-06	SP-36	SP-070335	0009	1	Correction of MCC implementation error for CR0008	8.0.0	8.1.0
2008-03	SP-39	SP-080143	0016	-	Introduce Manual TLS certificate handling	8.1.0	8.2.0
2008-03	SP-39	SP-080145	0017	1	Introducing a certificates-based Zb-interface and adding IKEv2	8.1.0	8.2.0
2008-03					Editorial correction ("NOTE" -> "Note")	8.2.0	8.2.1
2009-06	SP-44	SP-090274	0020	--	Corrections for TS 33.310	8.2.1	8.3.0
2009-06	SP-44	SP-090274	0021	--	Correction for TS 33.310: when a SEG may fetch a CRL for peer SEG	8.2.1	8.3.0
2009-06	SP-44	SP-090274	0022	--	Miscellaneous corrections to specification	8.2.1	8.3.0
2009-06	SP-44	SP-090	0019		Update of referenced RFCs and hash algorithm	8.3.0	9.0.0
2009-12	SP-46	SP-090859	0024	1	Some corrections for TS 33.310	9.0.0	9.1.0
2010-03	SP-47	SP-100106	0025	1	NDS enhancement to support backhaul security	9.1.0	9.2.0
2010-03	SP-47	SP-100103	0029	-	Alignment of TLS profile in NDS with TR-069 profile in H(e)NB	9.1.0	9.2.0
2010-04	--	--	--	--	Corrections of clause references in clause 9 and editorial corrections in Annex E.	9.2.0	9.2.1

History

Document history		
V9.1.0	January 2010	Publication
V9.2.1	April 2010	Publication